

PRICE 10 CENTS

IN THIS ISSUE { Hatching Chickens by Electricity  
Radium and Radio-Activity. By Houston

# POPULAR ELECTRICITY

Trade Mark

## IN PLAIN ENGLISH

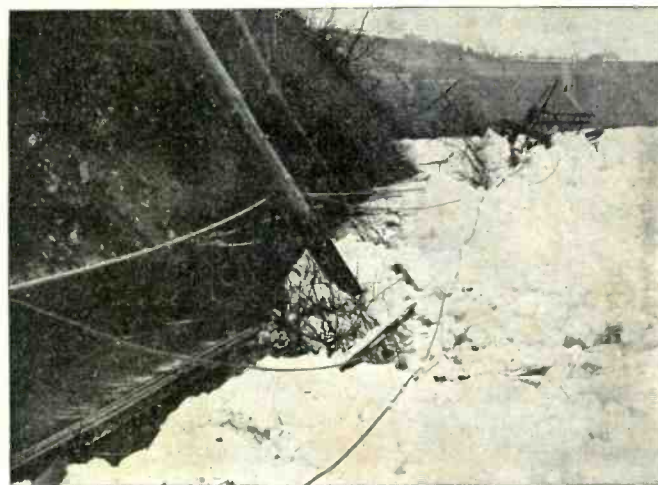

WRECK OF THE NIAGARA  
GORGE RAILWAY

Vol. II.

JUNE 1909

No. 2.



# Will you accept \$5<sup>00</sup> a day for your services?

Whatever your present employment may be—whether you are a man or a woman—this offer is open to you.

You can establish yourself in a **pleasant, profitable and permanent** business that will pay you more than \$5.00 a day at the start—and will pay you as much more as you care to make.

You can learn this business in **less than a week**—and make **good money** while you are learning it. You will have practically no competition.

## You Take no Risk Whatever

You will invest no money in this business until you are **absolutely sure** you can earn the money at it. You therefore **run no risk** of losing money. You are **paid well** for all you do.

You know the principle of the vacuum cleaner. It sucks up dirt and dust from floors, carpets, rugs, furniture, walls, woodwork, etc., and takes all the dirt and dust out of the house—quickly, easily, economically.

It makes housecleaning the work of hours instead of the work of days—and it does the work ten times as thoroughly as any other method.

## How The Business Increases

Every housewife who has a rug, a room or a house cleaned by this process, is so thoroughly satisfied that she tells her friends about it.

You get their orders. They tell their friends—and you get more orders.

You get the work month after month, season after season, year after year. The more customers you get—the more they get for you.

# Duntley Standard Vacuum Cleaners

embody every principle and every improvement known in the vacuum cleaner business—and combine all these advantages in a portable machine, weighing about 50 pounds, that can be easily carried from room to room, or house to house.

You can take one of these machines into a residence and remove every particle of dust and dirt, from every room, without taking up carpets or rugs—without removing furniture—without taking down curtains or portieres—and do it in one-tenth time it could be done otherwise.

### What This Invention Means

Before the invention of the Duntley Portable Standard Vacuum Cleaner, this work could only be done with a big, cumbersome, costly wagon apparatus—yet these wagon outfits earned for their owners immense profits.

The Duntley Portable Standard Vacuum Cleaner does the same work that the big wagon outfits do, and costs only a fraction as much originally and much less to operate. It will therefore, pay you far larger profits.

### My Pay From Profit Plan

I want one good, earnest, honest, active man or woman in every city or town—no matter how small—where residences are lighted by electricity, to engage in the Duntley Vacuum Cleaner business, on the "Pay from Profit Plan."

I will establish you in business—show you how it is done—enable you to make good money while you are learning it—and assure you an income of at least \$5.00 a day.

Or, should you want a Duntley Standard Vacuum Cleaner for use in your own home, I will prove its value, its economy, and its necessity to you—and give you an opportunity to use it, at my expense.

### Let me Prove These Truths

I do not ask you to invest one dollar. All I ask is that you fill out the coupon below, and let me prove to you the truth of every statement here made.

This offer is made to you—now—today—it is your great opportunity to start in a new business—in a coming business—in a profitable business—in a business of your own, that will grow bigger each year. Fill out and mail the coupon right now.

J. W. Duntley, President  
Duntley Mfg. Co., 303 Dearborn St., Chicago

Fill out and mail this coupon today

J. W. Duntley, Pres., 303 Dearborn St., Chicago. P.E.

Dear Sir:—Tell me how I can earn \$5.00 or more a day with a Duntley Standard Vacuum Cleaner, on your "Pay from Profit Plan."

Name .....

Street and No. ....

Town.....State .....

Occupation .....

Will you engage in business yourself?.....

Or, are you interested for use in your home?.....

## LET US FIGURE

on all your Electrical Work. Some of the largest contracts on Electrical work in the country have been performed by us.

### WE INSTALL

Power and Light Plants. Generators and Motors, Electric Light and Power Wiring for Factories, Churches, Schools, Colleges, Theatres, Office, Store and Residence Buildings.

Estimates cheerfully furnished for this class of work in any part of the U. S.

### WE MANUFACTURE

Switchboards, Panelboards, Steel Cutout Cabinets, Junction Boxes, Service Switch Boxes, Theater Stage Plugs, Experimental Switchboards and Appliances for High Schools and Colleges. Newgard receptacles and other electrical specialties.

All Electrical work at the Chicago Electrical Show installed by us.

Manufacturers of the Famous "Newgard" Waterproof Receptacle and Globe.

## HENRY NEWGARD & CO.

30-32 West Monroe St., Chicago, Ill.

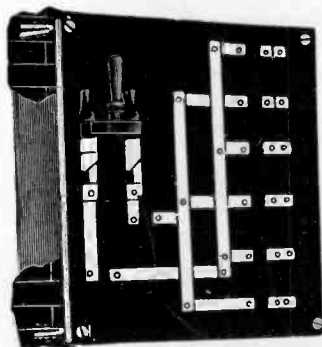

## Secured By Star Screw Anchors

Finish your work up neat, strong, and clean with Star Screw Anchors —or in heavy work with Star Expansion Lag Screws or Star Expansion Bolts.



This is the Star Screw Anchor to use, drill a hole in wall and insert; run screw through fixture and on into the anchor; as the screw tightens the anchor expands and holds as long as the wall stands.

Catalogue and Samples on request.

## STAR EXPANSION BOLT CO.

147 Cedar St. New York, N. Y.

## 25c BOOKS

Our 25c Electrical Books are immensely popular

Here are some of the Titles

- Electricity
- Dry Batteries.
- Electrical Circuits and Diagrams. (Part 1) Direct Current.
- Electrical Circuits and Diagrams. (Part 2) Alternating Current.
- Electric Bells and Alarms.
- Modern Primary Batteries.
- Experimenting with Induction Coils.
- Induction Coils. How to Make and Use Them.
- Simple Experiments in Static Electricity.
- The Wimshurst Machine.
- Alternating Currents, Simply-Explained.
- Small Accumulators.
- Small Electrical Measuring Instruments.

All Fully Illustrated

Mailed postpaid upon receipt of price

Send for full List of over 60 Titles **FREE**

## SPON & CHAMBERLAIN

123 E. Liberty St.

NEW YORK

## Intercontinental University

### BOARD OF DIRECTORS

Includes Justice DAVID J. BREWER, U. S. Supreme Court; Hon. MARTIN A. KNAPP, Chairman Interstate Commerce Commission and Senator CHAUNCEY M. DEPEW, EDWARD EVERETT HALE, Co-founder.



Hon. David J. Brewer



Hon. Martin A. Knapp



Edward Everett Hale  
Ask for Catalog 22  
State course  
wanted

Instruction by mail in practically all lines of business, science and education. Law-Bookkeeping—Accounting—Civil Service—Engineering—Mechanical Drawing—Business Letter Writing. 160 separate courses. To be well educated is to be well paid. We will help you to a better place in life

Intercontinental University  
1444 "L" Street,  
Washington, D. C.

Please send the year book and catalog

I am interested in .....

For our Mutual Advantage mention Popular Electricity when writing to Advertisers.

# ELECTRIC SHOP

Jackson and Michigan Boulevards, Chicago

**P**ROBABLY no show rooms in the world, devoted to the exploitation of a single subject, appeal so broadly and to such diverse interests as do these elegantly appointed Exhibit and Sales Rooms. That the objects and purposes of Electric Shop may be fully appreciated as to their true magnitude and diversity, a partial list is given below of the various electrical utensils, appliances, supplies and equipment there sold.

Art Lamps	Candelabras	Electric Fans	Hand Painted Shades
Silk Shades	Electric Candles	Electric Fountain Lamps	Shaving Mugs
Cigar Lighters	Curling Irons	Heating Pads	Vibrators
Coffee Percolators	Chafing Dishes	Hair Dryer	Tea Kettles
Waffle Irons	Toasters	Milk Warmers	Flat Irons
Cereal Cooker			
Complete Kitchen Outfits	Foot Warmers	Luminous Radiators	Washing Machines
Vacuum Sweepers	Organ Blowers	Ice Making Machines	Coffee Grinders
Electric Dish Washer	Ice Cream Machine	Riveting Machine	Lathes
Mechanic Tools (Electric)	Dough Mixer	Cream Separators	Fans
	Electrician's Supplies		

It is manifestly impossible to here catalogue each and every one of the hundreds of utensils, devices and articles in the Electrical line sold at Electric Shop. Rather have we undertaken to name only a certain few of them—familiarity with which will serve to indicate various and general classification. Our patrons, actual and prospective, are assured that, under such classification, the line so indicated is most complete.

### Central Stations

desirous of increasing the consumption of electric current by supplying their patrons with electric utensils, devices, appliances, lamps, small or large motors, will find in Electric Shop every modern and practical device in the electrical line. Correspondence is invited.

### Contractors and Supply Dealers

Electric Shop is a place to leave or send orders on our great warehouse for electrical supplies, equipment and fixtures of every description. Contractors will find it advantageous to procure all their electrical supplies from this one source, both as regards prices and freight transportation.

#### SEND IN YOUR NAME

for our mailing list. We expect to send out from time to time booklets and printed matter, advertising goods in which you will be vitally interested. Address Dept. A, Electric Shop.

### To the Consumers

Our patrons, whether actual or prospective, may get or arrange at Electric Shop for anything in the Electric line. Whatever electrical device lends to decorativeness, to health, comfort, convenience and economy—whether in the home, office, store or factory—it may be had at Electric Shop.

# Commonwealth Edison Company

# A Hot Point Electric Iron is simple, safe, economical and such a comfort

ANY CHILD can use the **Hot Point Electric Iron**, because it is perfectly safe and simple. One end of the flexible cord attaches to any light fixture in the house. On the other end is a switch plug.

To heat the iron, simply push the switch plug in. And to cool it, take the plug out.

Putting in and taking out the plug controls the amount of electric current carried into the iron, and regulates the temperature.

Shortly after the plug is inserted the iron is hot. From then on you will not need current more than half the time.

The regular household iron weighs 6 lbs., but you never have to **lift** it—no carrying it from stove to board, and when not in use simply tip it up on the broad end. The stand is attached.

The heat all goes into the ironing. Hence, you iron in perfect comfort. You need no holder. Take it to any room, too; or out onto the porch.

**Endorsed by the Electrical Experts  
throughout the Country**

The Hot Point **Automatic** Iron cannot be overheated. Therefore it cannot possibly start a fire. If you forget to pull out the switch plug the automatic device does it for you. It is controlled by the temperature of the iron; is positive and certain. The **Automatic** Iron simply **cannot** get hot enough to do any damage.

The Hot Point **Standard** Iron is exactly the same as the **Automatic** except the automatic control. Someone must think to pull out the switch plug, just as someone must think to turn off your electric lights.

And the same is true of every electric iron in the world, of whatever name, except only the Hot Point **Automatic**. Where the iron will be used intelligently, the **Standard** will answer every purpose, and there is little fire risk.

## PACIFIC ELECTRIC HEATING CO.

Main Office and Factory: Ontario, Cal.  
Eastern Factory: 63-65 W. Washington St.  
Chicago, Ill. Send order to nearest point.

### Central Station Managers and Dealers

This is but one of the many advertisements we are running. We want to turn orders in your town to you. Order samples at wholesale, subject to 30 days approval. State number you will be able to use and we will name special quantity price. Give voltage.



## You Should Have One

Every electric-lighted home in America should have its **Hot Point Electric Iron**.

It will save the housewife hours of time and a world of worry and discomfort. It will keep the servant satisfied and save her time.

Costs only a few cents to do the weekly ironing. Will last for many years. Rarely gives any trouble and that point is covered by

### Our Binding Guarantee

This guarantee is good until July, 1910. It is printed right on the box. If you have any trouble the Lighting Company or Dealer will make your iron as good as new.

### Order a Hot Point Iron

There is no other electric iron so sturdy and strong, so simple and safe, as our **STANDARD** Model.

There is absolutely no other electric iron, except our **AUTOMATIC** Model, which has an automatic safety attachment.

Therefore when you go to your Lighting Company or Dealer ask to see the **HOT POINT** Iron. If they do not have it, order direct.

We ship you one to any part of the United States at the regular retail price of \$5.00 for a 4, 5 or 6-lb. **STANDARD**, or \$6.00 for a 6-lb. **AUTOMATIC**. We prepay the express charges.

Be sure to give voltage. If uncertain, call up your Lighting Company.

PACIFIC ELECTRIC HEATING CO.  
ONTARIO, CAL. CHICAGO, ILL. (Address nearest office.)

Please send me full particulars about Hot Point Electric Irons.  
Send me, charges prepaid, 1 Standard Hot Point Iron, \$5.00  
" " " Automatic Hot Point Iron, \$6.00

(Draw pencil through the one not wanted.)  
Enclosed is check in payment of same.

Name \_\_\_\_\_

Street \_\_\_\_\_ Voltage \_\_\_\_\_

City \_\_\_\_\_ State \_\_\_\_\_

I enquired about it of \_\_\_\_\_

## "The Peacemaker"

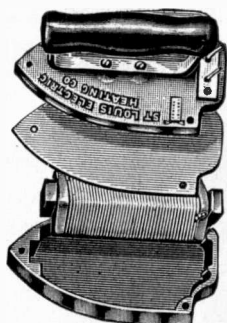

A Pacemaker  
for speed  
in selling  
Electric Irons

For style, finish, balance and workmanship, our 1909 irons are actually far in advance of any others.

Endurance tests—9 hours a day—efficiency and economy trials, heavy work tests—all these the "Peacemaker" has met.

The largest laundries in the Middle West use it and praise it.

The Largest Clothing Factory west of the Mississippi uses it and endorses it heartily. Nothing but sheer merit could accomplish what the "Peacemaker" has done.

If you want to build up a paying flatiron load, here is the iron that will get results—and good will is one of them.

We will ship you any iron under 8-lbs., charges prepaid for \$4.00. Money back and return charges guaranteed, for 30 days' trial.

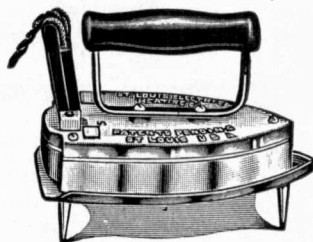

6-lb Ladies' Domestic Iron. Slender Point.

**St. Louis Electric Heating Co.**  
ST. LOUIS.

# POPULAR ELECTRICITY

## BOUND VOLUMES

☞ First twelve issues, complete with index.

☞ Handsomely bound in blue silk cloth, gilt embossed.

☞ We have only a limited supply of bound volumes owing to our inability to secure certain back numbers which had been sold out. Apparently most of our readers value their copies too highly to part with them even at a premium.

☞ We will furnish these bound volumes while they last at **\$2.25, all charges prepaid.**

☞ First come, first served. No more when these are gone. Order quick if you want one.



**POPULAR ELECTRICITY  
PUBLISHING CO.**  
Monadnock Block  
CHICAGO

JUST FROM THE PRESS  
**OPERATORS' WIRELESS TELE-  
 GRAPH AND TELEPHONE  
 HAND-BOOK**

By VICTOR H. LAUGHTER



**U**P-TO-DATE and most complete treatise on the subject yet published. Gives the historical work of early investigators on up to the present day. Describes in detail the construction of an experimental wireless set. How to wind spark coil and dimensions of all size coils.

The tuning of a wireless station is fully explained with points on the construction of the various instruments.

A special chapter on the study of wireless telegraphy is given and the rules of the Naval stations with all codes, abbreviations, etc., and other matter interesting to one who takes up this study.

The most difficult points have been explained in non-technical language and can be understood by the layman. Wireless telephony is given several chapters and all the systems in use are shown with photographs and drawings.

By some practical work and a close study of this treatise one can soon master all the details of wireless telegraphy.

Sold by booksellers generally or sent postpaid to any address upon receipt of price.

12mo., Cloth, 200 Pages, Fully Illustrated, and with Six additional Full-Page Halftone Illustrations Showing the Installation of "Wireless" on the U. S. War Ships and Ocean Liners . . . . . \$1.00

**FREDERICK J. DRAKE & CO.**

PUBLISHERS

P. E. FISHER BLDG. CHICAGO, ILL.

Send for Catalog FREE.

**Own Your Own  
 Private Telephone!  
 A CONVENIENCE ANY TIME**



**Send for one of these  
 32-Page Books To-Day**



Our Booklet No. 80 contains valuable information for every person interested in inter-communicating Telephones and private Branch Exchange Systems for use in—

**HOME—OFFICE—FACTORY  
 BANK—HOSPITAL—HOTEL**

Ask for Booklet No. 80—Second Edition.  
 Sent free upon application to either office

**STROMBERG - CARLSON  
 TELEPHONE MFG. CO.  
 ROCHESTER, N. Y.**

**CHICAGO, ILL. KANSAS CITY, MO.**  
 There are over 1,100,000 "S-C" Telephones in use.



**A HEATING PLANT FOR YOUR HOME**

**SOLE DIRECT TO YOU AT MANUFACTURER'S PRICE**

Don't say you can't afford a heating plant for your home until you GET OUR PRICES. They will surprise you—and we furnish plants in such convenient form that you can INSTALL THEM YOURSELF, if you want to—or have a handy man to do it at day laborer's wages. It costs you nothing to have us make an estimate for you—and we not only save you about 50 per cent in the cost, but we GUARANTEE SATISFACTION. You take no chances. We write it in the contract that our plant will supply the temperature required in each and every room, and hold ourselves in readiness to supply, free of cost, all materials, should it be needed to bring the plant up to our guarantee. Should the plant at any time within one year prove a failure, or unsatisfactory to you, we will refund the entire purchase price upon the return of the plant to us. We will make you (free) complete working drawings, showing the size of pipes to use at every part of the plant and how to place the fittings, so that you can't go wrong. We will cut all large size pipe for the mains and will lend you an entire outfit of tools to do the work. You cannot get a better plant, even if you pay twice as much. It will pay you to write for our Information Blank. Then give us a sketch showing the arrangement of your rooms, or furnish us with the architect's plans, and we will figure out the exact amount of material needed and our price.



**\$195** Is all it costs for a hot water heating plant for this 5-room cottage, 6 radiators. A total of 215 ft. of radiation and a 400 ft. cast iron sectional heater, together with all the necessary pipe and fittings; radiator valves, gold bronze, covering, and, in fact, every bit of material needed.



**\$180** A first class hot water heating plant, for this 8-room house for \$180. 8 radiators, a total of 300 ft. of radiation, a 500 ft., cast iron, sectional heater, gold bronze, all the necessary pipe and pipe fittings, radiator valves, covering & everything needed.



**\$247** This large 11-room house supplied with all the material for a hot water heating plant for \$247. 475 feet of radiation in 11 radiators and a 700 ft. cast iron, sectional heater, gold bronze and all the necessary pipe and pipe fittings, radiator valves, and covering; in fact, every bit of material needed.

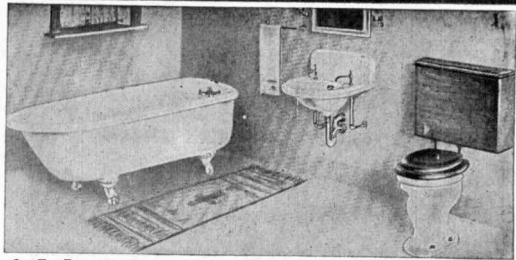
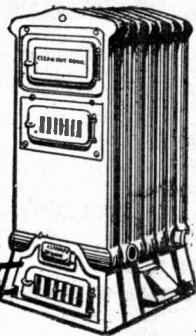

**\$39.00** For this Complete Set of HIGH GRADE BATH ROOM FIXTURES We Sell Direct to the Consumer

This is our No. 5 bathroom combination, regularly listed in our catalog for \$45. We are making a special offer to readers of Popular Electricity on this of \$39. The Bath Tub is 5 ft. long, 30 ins. wide, white porcelain enameled inside and over the rim, and is trimmed with full nickel trimmings. The Lavatory is cast iron, heavy white porcelain enameled and trimmed complete with full nickel trimmings. The Closet is high-grade, sanitary, vitreous syphon wash down bowl with polished oak copper lined tank and seat and cover to match. All parts high-grade. This offer is for a limited time only. Other Bathroom Outfits from \$24.50 to \$125.00

**THE PROBLEM SOLVED**

You can have Modern Sanitary Plumbing installed in your home at very low cost, for our "All Iron Pipe" System enables any handy mechanic, without previous experience, to do the work.

**DON'T BE HELD UP**

for an exorbitant sum in order to possess these conveniences, for we will sell you the material at lowest wholesale prices. There is no mystery about the pipe work for plumbing. It makes no difference—whether in a city, where you have running water and sewerage, or in the country, where you have to provide your own water system and dispose of your own sewerage, you can have these improvements. We will sell you all the material of all kinds needed, make you working drawings, and tell you how to do the work.

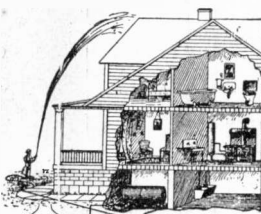

**Pneumatic Water Supply Systems**

We will furnish you with a complete pneumatic or air pressure water supply outfit that will furnish you running water the same as city water works. Prices range from \$40 upward. We will furnish you complete house plumbing outfit like shown in this picture, including the pneumatic water supply system, the bath room outfit, the kitchen sink and range boiler and all the pipe and pipe fittings to install from \$125 upward.

**JUST SEND US A PLAN**

of your house for our free estimate of all the material required to put in these modern conveniences.

**READY ROOFING 95 Cents per Square**

**Galvanized Rubber and Asphalt**

We offer the entire lot of factory mill ends of prepared roofing strictly high grade, brand new, at less than cost of manufacture. There are from two to four pieces of galvanized rubber or asphalt roofing to each roll of 108 sq. ft. This is \$2 and \$3 grades of roofing.

**STEEL ROOFING**

Only \$1.50 per hundred sq. ft. Fifty thousand squares of steel roofing, size 2 ft. 6 in. wide by 5 ft. 6 in. long (30x66 in.) These sheets were used about 30 days in connection with the manufacture of soap. This material was never exposed to the weather and was never nailed. Every sheet is clean and free from nail holes and practically as good as new. EXTRA HEAVY. From 24 to 28 gauge. PRICE FLAT PER 100 SQ. FT. - \$1.50 CORRUGATED PER 100 SQ. FT. - 1.75

**CENTRAL M. & S. CO., CHICAGO.**

The hot water heating plant purchased from you for my 11-room house, which I installed, following your plans, is thoroughly satisfactory. I have no difficulty in heating my house from 75 to 90 degrees in coldest weather. I expect to purchase quite a few plants from you this year to install in other houses. I also bought a pneumatic water supply system and bath room outfit with the necessary piping to connect it all up. I did all the work myself and the entire outfit works perfectly. Five to 10 minutes pumping twice a week supplies all the running water we want. I think almost any man would be able to follow your plans and do the work.

**CENTRAL M. & S. CO., CHICAGO.**

I am much pleased with the hot water heating plant, the pneumatic water supply system, the bath room outfit and kitchen sink that I purchased from you for my home. Every part of this plant is thoroughly satisfactory. We have extremely cold winters here; but the heating plant heats the house perfectly. In purchasing this from you, I saved about \$400.00.

WILLIAM GESSERT, Menominee Falls, Wis.

JOHN GASMAN, Bark River, Mich.

**CATALOG No. 123 BARGAIN BUILDING MATERIAL.** including bath room and plumbing supplies, heating apparatus, pipe and fittings, poultry netting, wire fencing roofing materials, etc. **FREE.**

**Central Machinery & Supply Co.**

2593 Archer Avenue, Chicago

**Guarantee:** The key note of our business is EVERY ARTICLE GUARANTEED AS REPRESENTED AND TO BE SATISFACTORY. Your money will be cheerfully refunded for any article not entirely satisfactory.



# POPULAR ELECTRICITY

IN PLAIN ENGLISH

HENRY WALTER YOUNG, Editor

Vol. 11.

JUNE 1909.

No. 2.

## CONTENTS

	Page		Page
Spectacular Electric Clock.....	Frontispiece	The Amateur and Professional Operator.....	108
ICE DAMAGE TO NIAGARA ELECTRIC PLANTS.....	67	A Forty-Mile Equipment.....	109
Electric Charging Launch.....	69	Wireless Train Signals.....	109
ELEMENTARY ELECTRICITY. CHAPTER 14. By Prof. Edwin J. Houston.....	70	ONE-TO-FIVE-MILE EQUIPMENT. By C. Brandes.....	110
Curious Use of Electric Light.....	73	Marconi and Electrolytic Detectors.....	111
ELECTRICITY AT THE ALASKA-YUKON-PACIFIC EXPOSITION.....	74	Condenser; Coherer.....	111
A Striking Advertisement.....	76	Wireless Operation.....	112
The Oldest Telephone Operator.....	77	Automobile Spark Coil; Liquid Detector.....	112
Electric Plants in the United States.....	77	Tuning Coil; Receiver Resistance.....	112
PRODUCING FRESH AIR BY ELECTRICITY.....	78	ELECTRICAL MEN OF THE TIMES. Lee DeForest.....	113
Submergible Electric Bilge Pump.....	80	ELECTRICITY IN THE HOUSEHOLD.....	114-117
HURRY-UP METHODS OF MILITARY SIGNALING.....	81	READY-TO-RUN ELECTRIC FAN.....	114
MEASURING ELECTRIC CURRENT. PART 1. By Prof. B. A. Perkins.....	82	Economy of Electric Lighting.....	116
Harnessing the Heat of Electricity.....	87	Cost of Electric Heating and Cooking.....	116
SIGHTS OF THE LOUISVILLE ELECTRIC-AL SHOW.....	88	Art Nouveau Electroliner.....	117
An Improved Organ Blower.....	89	Operation of the Electric Vibrator.....	117
Motor Operated Hand Drill.....	89	Instantaneous Water Heater.....	117
HOW TO DO ELECTROPLATING. PART 1. By J. R. Wilson.....	90	JUNIOR SECTION.....	118-121
Explaining the Short Circuit.....	93	SWITCHBOARD STORIES—INSPECTOR No. 17. By C. Tuells.....	118
Telephone in the Silesian Alps.....	93	BATTERY MOTOR CONTROLLER. By F. R. Furnas.....	119
DISTRIBUTION OF ELECTRIC CURRENTS. By Jacob Glogau.....	94	How to Make a Speaking Arc. By B. E. Blanchard.....	121
Novel Bottle Washer.....	95	Battery Plate Holder.....	121
TUNGSTEN LAMPS FOR STREET LIGHTING.....	96	QUESTIONS AND ANSWERS.....	122-127
HANDLING 600 TONS OF ORE IN AN HOUR.....	97	Condenser; Mercury Arc Rectifier; Reactance.....	122
Motor Driven Cash Register.....	98	Choke Coil.....	123
Hill Climbing by Electricity.....	99	Pole Changer; Care of Gravity Cell.....	124
The Romance of Rubber.....	99	Arc Lamp Coil; Wire Rheostat.....	124
Testing Grain.....	100	Solenoid; Induction Coil; Condenser.....	124
Telephone Booth Fan.....	100	Hughes' Microphone.....	125
A Vacuum Cleaner That Disinfects.....	101	Installing Motor.....	125
Largest Electric Water Power Plant.....	101	Winding Relays.....	125
ELECTRIC CARS ON A BANQUET TABLE.....	102	Three-Drop Annunciator and Bell.....	126
Kuch's Quartz Lamp.....	102	Changing Motor Into Generator.....	126
Bell Ringing Transformer.....	103	Dry Batteries; Arc Lamps.....	126
A Glass Switchboard.....	103	Small Dynamo; Resistance and Voltage.....	127
Ultra-violet Rays to Purify Milk.....	103	Mercury Resistance; Lighting Switch; Ruhmkorff Coil.....	127
POPULAR ELECTRICITY WIRELESS CLUB.....	104-112	Dynamo and Motor Assistants and Their Machines (Book Review).....	127
SPARK COIL CONSTRUCTION AND OPERATION. PART 2. By V. H. Laughter.....	104	NEW ELECTRICAL INVENTIONS.....	128-129
BUILDING A "PERICON" DETECTOR. By Alfred P. Morgan.....	107	Electrically Fired Torpedo.....	128
		Measuring the Velocity of Water.....	128
		Traveling Fan.....	129
		Walking on the Ceiling.....	129
		An Electrical Reminder.....	129
		SHORT CIRCUITS.....	130-131
		ELECTRICAL DEFINITIONS.....	132

ISSUED MONTHLY BY POPULAR ELECTRICITY PUBLISHING CO., Monadnock Block, Chicago, Ill.  
YEARLY SUBSCRIPTION, \$1.00 CANADIAN, \$1.35; FOREIGN, \$1.50; SINGLE COPY, 10 CENTS

*No additional copies will be sent after expiration of subscription except upon renewal.*

Entered as Second Class Matter April 14, 1908, at the Post Office at Chicago. Under the Act of March 3, 1879.

Copyright 1909 by Popular Electricity Publishing Co., Chicago, Ill.

## The Del Electric Curling Iron



¶ A new and practical electrically heated device for curling the hair. The only electric curling iron that will produce marcel, pompadour, puff and wave effects. ¶ This iron is self contained—requiring no separate device for heating, thereby insuring absolute cleanliness. ¶ Attaches to any lamp socket by means of cord and plug. ¶ When the iron is sufficiently hot, turn off the current, the cord may be detached and the iron will remain hot for some time. This leaves you free to act without chance of the cord getting in your way. Will be found most convenient when traveling.

Price, \$3.75 complete.

SOLD BY ALL FIRST-CLASS  
DEALERS

Del Sales Company, <sup>98</sup> Jackson Blvd. Chicago

## A GREAT LITTLE BOOK

\$1.00 FOR ONLY ONE DOLLAR \$1.00

STANDARD WIRING

FOR

Electric Light and Power

AS ADOPTED BY

The Fire Underwriters  
of the United States

By H. C. CUSHING, JR.

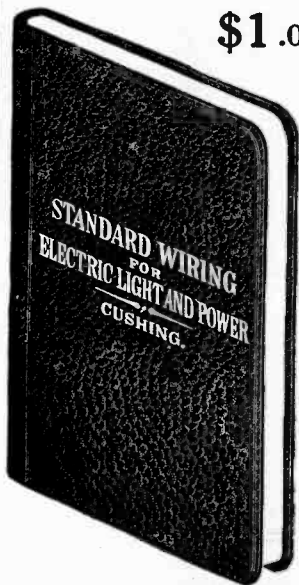

Member American Institute Electrical Engineers, late Electrical Inspector Boston Board of Fire Underwriters and New York Fire Underwriters' Tariff Association.

Containing the National Electric Code, explained with numerous illustrations, together with the necessary tables and formulae for outside and inside wiring and construction for all systems, and a special chapter on alternating current wiring by George T. Hanchet, S. B., Consulting Electrical Engineer, New York. Now in the 15th edition. Handy size for the pocket. Black limp leather binding—gilt embossed. Price \$1.00 prepaid to any address.

POPULAR ELECTRICITY PUB. CO., MONADNOCK BLK., Chicago, Ill.

# Publisher's Page

## What Volume II Means to the Advertiser and Publisher

It is generally conceded among advertisers of national repute that a publication does not carry prestige until after its first year. We have lived with the idea in view that Popular Electricity would become more permanent in its advertising pages after we had passed through this infancy stage.

We offer an advertiser today this so-called, long-looked-for, year-old prestige with a circulation of 75,000 copies and advertising pages numbering 64 net—each and every advertiser in these pages satisfied with the results produced.

Continued patronage by advertisers has been our experience during the last year. From the first one-inch advertisement of \$3.60 that appeared in issue No. 3, there has been nothing but a steady, healthy growth and a constantly increasing enthusiasm among our advertisers.

We expect to do big things in the coming year, and we can do big things for you. You can assist us in accomplishing this end and the way to do it is to advertise.

### MOVING DAY

May 1st is the appointed day for change of domicile among city dwellers, particularly those of us who are addicted to the flat habit—"cave dwellers" as a waggish student of modern Sociology terms us. A considerable number of our subscribers changed their location on May Day. Some of them were thoughtful enough to notify us of the fact. Others contented themselves with notifying their postmaster (or he found it out, he's good at such things) and after this issue is mailed Uncle Sam's notices will come pouring in to change certain addresses for future deliveries. Still others—too many to suit a publisher—failed to notify us or their postmaster and the result will be the return of their magazine with a notation "moved, left no address." Consequently we will have to "kill" such names on our list, until receipt of complaint, or non-delivery of magazine, which is sure to come later. Often the subscriber in such case naively assumes that we should have known of his change of address; takes it for granted, possibly, that we would get it "by induction."

To be sure, we will adjust such complaints and re-mail issues you have missed—if we have them—but we will appreciate it if you will help us to keep your Popular Electricity files complete by notifying us, a month in advance if possible, of any change in your address, giving both old and new location.

### TROUBLE ON THE LINE

Sometimes, of course, mistakes on our part occur. In spite of the greatest vigilance they are to be expected in a large mailing list. Here again our subscribers will confer a real favor if they will advise us promptly. If your magazine fails to arrive within five days of the regular time, let us know, but try to do it good naturedly. We mean well. Here is a complaint that is a classic in its way, the result of an expiration notice sent in error.

"There must have been trouble on the line somewhere, for I certainly fused up my sub. with two subscriptions on Dec. 18th, '08, which should have carried me along without mishap for two years from the date of first wiring, though your letter of the 21st inst., indicates that you will remove my meter in the month of June unless I come forward with another fuse. If you will kindly go back over the line, I think you will locate the trouble about Dec. 31st, '08 for that is the time you forwarded me a card stating that you would extend my current for an extra year. Kindly let me know if you can locate the short, for I am passionately fond of a hot wire, and as every number seems to be getting warmer, I am anxious to know that the trouble has been found. I am more than pleased with your efforts at the central station, for it keeps up the voltage at the farthest point of distribution, giving excellent light in the darkest places."

It is a pleasure to have our attention directed to an un-intentional oversight in such a good natured fashion by one who seems so well versed in the phraseology of the science we are exploiting and who tempers his rebuke with such sincere expressions of hearty approval and appreciation of our efforts to provide a magazine second to none in its field.

### WATCH THIS PAGE

**RENEWALS.** When your subscription expires, you will find a renewal blank enclosed here. You should fill out and return same with remittance at once, to avoid missing a number. Positively no copies will be mailed on any subscription after same expires unless renewed, and we cannot agree to begin subscriptions with back numbers. The date on wrapper of your magazine shows the issue with which your subscription ends.

**CHANGE OF ADDRESS.** Notify us promptly of any change in your address, giving both the old and new location. Since each issue is printed a month before the date it bears, we should be notified at least four weeks in advance, in order to make the necessary change in our records.

ADDRESS ALL COMMUNICATIONS TO

**POPULAR ELECTRICITY PUBLISHING COMPANY, Monadnock Block, CHICAGO, ILL.**



If you want a good piano we save you from \$100 to \$300 by our direct factory-to-purchaser system.

# WING PIANOS

are made by us, in our own factory. They are sold direct from our factory and in no other way. Every unnecessary cost is eliminated. Every dollar spent with us is piano value through and through—the best that 40 years of study and experience can produce. The lowest, factory-price consistent with an artistically and musically perfect instrument

THE WING TONE is so sweet and deep it is in a class of its own. Thousands of customers yearly write and tell us so. "Pure and sweet; every note clear and musical; responsive to the lightest touch, yet possessing great volume and power, without a trace of harshness"—this describes the tone of the WING PIANO.

## THE WING WAY

We will place a WING PIANO in any home in the United States on trial entirely at our expense, without any advance payment or deposit. If, after 20 days' trial in your own home, it is not satisfactory, we take it back. Nothing to be paid by you before it is sent, when it is received, or when it is returned. You are under no more obligation to keep the piano than if you were examining it at our factory. Every expense and all risk is ours, absolutely. Easy installment payments, if you desire them.

When you buy a piano at retail you pay the retail dealer's store rent and other expenses; you pay his profit and you pay the commission or salary of the agents or salesmen he employs. We make the WING PIANO and sell it ourselves. We employ no agents or salesmen. When you buy the WING PIANO you pay the actual cost of construction plus only our small wholesale profit. This profit is small because we sell thousands of pianos yearly. Most retail stores sell no more than 12 to 20 pianos yearly and must charge from \$100 to \$300 profit on each. You can calculate this yourself. These dealers get as much profit on their cheap pianos as on the standard high grade ones. As the cheap pianos cost less than half, they "talk up" and push the cheap pianos—but often call them high grade.

Pioneers of the direct plan of piano selling, our unparalleled success has brought forth many imitators, but no competitors, either as to the excellence of our product or the integrity and economy of our methods. Forty years of daily increasing business and 45,000 satisfied and enthusiastic buyers testify to this.

Ask a Wing customer what he thinks of Wing Pianos and Wing methods. We will send you names in your locality for the asking.

Our commercial standing and references will guarantee you that our word is good and contract gilt-edged. The publishers of any prominent magazine will also tell you this.

The WING PIANO is broadly guaranteed in writing for 12 years.

**FREE EVEN IF YOU ARE NOT READY TO BUY**  
**WRITE OR SEND THE COUPON TO-DAY**

**WING & SON**  
 370-391

W. 13th St.,  
 New York

Send to the name and address written below, your Free Books without any cost or obligation on my part.

"The Book of Complete Information About Pianos."

A copyrighted book of 152 pages with many illustrations. A complete reference book on the piano subject. History of the piano, descriptions of every part, how to judge good and bad materials, workmanship, etc. Teaches you how to buy intelligently. You need this book.

Free for the asking from the old house of

**WING & SON** 370-391 W. 13th St.,  
 New York

### THE MARVELOUS INSTRUMENTAL ATTACHMENT

If you choose, and without extra cost, your piano can have this wonderful addition, imitates perfectly the mandolin, guitar, harp, zither, and banjo. Music written for these instruments, can be played just as perfectly by a single player on the piano as though rendered by an orchestra. It is an integral part of the instrument; does not take in any way from its tone or value as a piano and prolongs the life of the strings and action.

**GOOD FOR \$1.00**

Sign and mail this coupon to Magic Foot Draft Co.  
Dept. 640F, Jackson, Mich.

Name .....

Address .....

By return mail you'll get a \$1.00 pair of Magic Drafts to Try Free, as explained below.

IF YOU HAVE

# RHEUMATISM

write your name and address plainly on the above coupon and mail to us. Return post will bring you, prepaid, a regular \$1 pair of Magic Foot Drafts, the great Michigan External Cure for Rheumatism of every kind—chronic or acute—muscular, sciatic, lumbago or gout. Then after you try them, if you are fully satisfied with the benefit received, send us One Dollar. If not, they cost you nothing. You decide and we take your word.



FREDERICK DYER, Corresponding Sec'y.

Magic Foot Drafts are curing old chronic cases of 30 and 40 years' standing, after everything else had failed, as well as all the milder stages. We have the evidence to prove all our claims. It must be plain that we couldn't send the Drafts out everywhere as we do on approval if they didn't cure. We want every sufferer to try them, so send us your full address on the coupon today. Our valuable illustrated Book on Rheumatism comes free with the trial Drafts. Send no money—only the coupon.



## WANT A BARGAIN? GET THIS!

Electrical Railroading as applied to Steam Railways by Sydney Aylmer Small. 924 pages. Fully illustrated. Handsomely bound in black leather, gilt embossed. A GREAT BOOK. Complete, authentic. Regular price, \$2.50. A few copies only slightly shelf worn (hardly noticeable) for \$1.90 while they last.

Popular Electricity Publishing Company, Book Dept.,  
Monadnock Block, CHICAGO, ILL.



## Vibrate Your Body And Make It Well

You have no right to be sick. No matter what ails you—even if others have told you that your case was incurable—DON'T GIVE UP HOPE. The great natural forces *Vibration and Electricity*, are curing more people today than all the drugs and doctors in the world put together.

### The White Cross Electric Vibrator

gives you your choice of Vibration, Faradic and Galvanic Electricity, either separately or in combination, just as you wish. It Relieves Pain Instantly, and its cures are permanent.

The White Cross Electric Vibrator cures the cause of disease. It sends the rich, red blood leaping and coursing through your veins and arteries straight to where the disease begins. It tones up your nerves, muscles and every vital organ. It makes you fairly tingle with the joy of living.

### FREE Book "Health and Beauty"

Send TODAY for the magnificent free book, "Health and Beauty." This valuable work tells you all about the human body in health and disease. It tells you how you can get well and keep well, no matter what your trouble is. Besides, this book tells you all about the wonderful White Cross Electric Vibrator—it tells you about the very special offers which we are making for just a short time, and how you can get a White Cross Electric Vibrator on a genuine free trial. Your name and address brings this intensely interesting book by return mail. Sign the coupon and mail it to us at once.

Vibration for the Racking Backache of Women.

how you can get well and keep well, no matter what your trouble is. Besides, this book tells you all about the wonderful White Cross Electric Vibrator—it tells you about the very special offers which we are making for just a short time, and how you can get a White Cross Electric Vibrator on a genuine free trial. Your name and address brings this intensely interesting book by return mail. Sign the coupon and mail it to us at once.



## Send coupon today for Free Book

DON'T DELAY A MINUTE. Whether you are sick or well, you should send for this book anyway. Learn how you can save all doctor bills and cure yourself right at home without expense.

Send No Money, just your name and address on the coupon. But write today.

LINDSTROM, SMITH CO.  
253 La Salle St., Dept. 115X  
CHICAGO

Without obligation on me, please send free, prepaid, your book "Health and Beauty" on "Vibration and Electricity" on receipt of this offer.

DESIGN AND MAIL THIS COUPON TODAY

Name .....

Address .....

POPULAR ELECTRICITY

THE  
OK

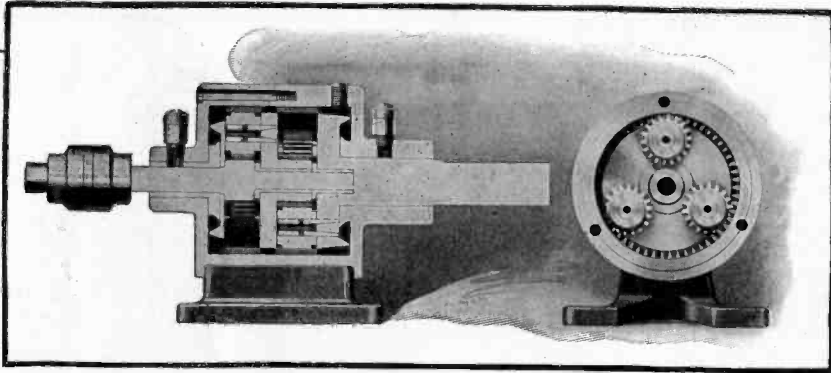

THE  
OK

## Speed Reducing Gear

A COMBINATION COUPLING AND SPEED REDUCER

Efficiency Over 90 Per Cent

1-8 H. P. to 50 H. P.

Write us your wants and let us tell you more about it

# D. O. JAMES & CO.

351 W. Monroe Street, Chicago

## FOLLOW THE POINTERS

If you want the BEST low price dry cell made for

**Electric Bells, Annunciators,  
Gas Lighters, Operating Small  
Motors, etc.**

Price in lots of 12 or more 13½c each

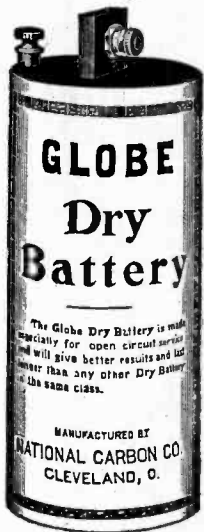

**Fahnestock  
Connections**



**No Extra  
Charge**

*If you are carrying on experiments in which wet or dry cells have to be used, our Battery catalog will prove of interest. Sent Free to all who mention this publication.*

**NATIONAL CARBON CO.  
CLEVELAND, OHIO**

For our Mutual Advantage mention Popular Electricity when writing to Advertisers.



## THE TRAINED MAN GETS THE POSITION

You wish to apply for a position—what qualifications have you to offer?  
 You desire to secure promotion to a better place—are you competent to hold that place?

That which decides your ability to obtain a new position or promotion is your qualification. You must certainly realize this. Incompetency means failure.

To be qualified for a good position in the occupation of your choice you must have the training that enables you to hold your position better than the average man. This requires technical training, as the old methods of practical experience are no longer sufficient. Almost without exception when the places higher up are to be filled it is the trained man who gets the position. Mark and mail the coupon.

For 17 years the I. C. S. has been training men in all circumstances and conditions in life to advance to better positions and earnings. This institution has an equipment consisting of five buildings and 3,000 employees and is backed by an invested capital of six million dollars. Surely such an equipment proves beyond question that the I. C. S. is the most powerful force for promotion in the world. It can be brought to bear upon your advancement in your own home, in your spare time, without obliging you to pay more than you can reasonably afford. You may have a free, full explanation of this plan if you will mark and mail the coupon below.

Have you enough interest in your own future to investigate this offer?

**MAIL THE COUPON NOW**

**International Correspondence Schools**  
 Box 1102, Scranton, Pa.

Please explain, without further obligation on my part, how I can qualify for employment or advancement in the position before which I have marked X.

- |                     |                         |
|---------------------|-------------------------|
| Bookkeeper          | Telephone Eng.          |
| Stenographer        | Elec.-Light. Supt.      |
| Ad. Writer          | Mechanical Eng.         |
| Show-Card Writer    | Plumb. and Steam Fitter |
| Window Trimmer      | Stationary Eng.         |
| Commercial Law      | Civil Engineer          |
| Illustrator         | Building Con.           |
| Civil Service       | Architect's Drafts.     |
| Chemist             | Architect               |
| Textile-Mill Supt.  | Structural Eng.         |
| Electrician         | Banking                 |
| Electrical Engineer | Mining Engineer         |
| Mechanical Drafts.  |                         |

Name \_\_\_\_\_  
 St. and No. \_\_\_\_\_  
 City \_\_\_\_\_ State \_\_\_\_\_

**\$45<sup>00</sup> MONTHLY \$4<sup>50</sup> PAYMENTS**

**LADIES'**

**YOUR CREDIT IS GOOD**

with us. Any honest person can buy a diamond here, or any other article of jewelry from our complete stock, and pay for it on easy payments to suit one's convenience—one fifth down and the balance in eight monthly installments is about as preferable a way as any. No red tape inquisitive systems are used—it is a plain business proposition, based on dealings with honest people.

Our integrity and reliability is unquestioned; we refer you to all commercial agencies and express companies in the United States. Our numerous buying facilities give you the benefit of low prices—one-third is easily saved by dealing with us. Buy a diamond for yourself, your father, mother, sister, brother or sweetheart. It is an ideal gift, remembered by the one so dear to you after all other presents are long forgotten.

The ladies' and gents' elegant rings shown here are extra specials, reduced to \$45.00, so as to give everybody a chance to buy advantageously. The diamond is a beauty—exceptionally white, guaranteed pure, perfect and flawless. Send your name and address, with size of ring desired, and we will send you same by express prepaid. If perfectly satisfied, and we know you will be so, pay the express agent \$9.00; the balance you pay in eight easy monthly installments of \$4.50 each. These rings you see right here are worth, at any retail store, from \$60.00 to \$75.00.

Our line of high grade watches, silver ware, etc. is complete. Our handsome illustrated catalog with many more money saving prices and exquisite descriptions of exquisite jewelry is free for the asking. Write right away.

**WM. E. RENICH CO.**  
Diamonds, Watches, Jewels  
124-130 State St. Chicago, Ill.

**MEN'S**



## Send No Money

JUST YOUR ADDRESS



In order to prove that Rheumatism, Indigestion, Constipation, Neuralgia, Deafness, Nervousness, Paralysis and Insomnia, in fact any ailment or pain due to congestion or poor circulation can be promptly relieved in your own home without drugs or medicines, we want to send you a **Vibro-Life**

### Vibrator Free

Express Prepaid

YOU decide whether to buy it or return it, and it costs you not one cent unless you keep it. Fully guaranteed. Try it ten days, then if you are fully satisfied with the benefit received, buy it; otherwise return it and we will pay the express charge. **Send no money now**—Just fill in and mail the coupon. This offer and special price is for a limited time only, so write at once.



### EUREKA VIBRATOR CO.,

Suite 552 F No. 1269 Broadway, New York City,  
Or Box 652, Brantford, Ontario, Canada.

I am interested in your Free Trial Offer, also free booklet on Health and Beauty.

NAME.....  
ST. AND NO.....  
CITY.....

## Do You Hear Well?

The Stolz Electrophone—A New, Electrical, Scientific and Practical Invention for those who are Deaf or Partially Deaf—

**MAY NOW BE TESTED IN YOUR OWN HOME.** Deaf or partially deaf people may now make a month's trial of the Stolz Electrophone at home. This personal practical test serves to prove that the device satisfies with ease, every requirement of a perfect hearing device. Write for particulars at once, before the offer is withdrawn, for by this personal test plan the final selection of the one completely satisfactory hearing aid is made easy and inexpensive for every one.

This new invention, the Stolz Electrophone (U.S. Patent No 763,575) renders unnecessary such clumsy, unsightly and frequently harmful devices as trumpets, horns, tubes, ear drums, fans, etc. It is a tiny electric telephone that fits on the ear and which, the instant it is applied, magnifies the sound waves in such manner as to cause an astonishing increase in the clearness of all sounds. It overcomes the buzzing and roaring ear noises and, also, so constantly and electrically exercises the vital parts of the ear that, usually, the natural unaided hearing itself is gradually restored.



Mrs. C. Lidecka, 238 12th Ave., Maywood, Ill., wears an Electrophone

Less conspicuous than eyeglasses

**What Three Business Men Say:** The Electrophone is very satisfactory. Being small in size and great in hearing qualities makes it preferable to any I have tried and I believe, I have tried all of them. M. W. HOYT, Wholesale Grocer, Michigan Ave. and River St., Chicago. The Stolz Electrophone Co., Chicago, Ill. Gentlemen—I have used your Electrophone since July 1908. It enables me to hear speakers over 50 feet away. Without it I could not hear their voices. It has improved my natural hearing at least 50%, and has stopped the head noises which were so annoying. Refer to me at any time. Yours truly, E. P. ROGERS, Suite 908-159 LaSalle St., Chicago, Ill.

I have now used your Electrophone over a year, and know that it is a first-class, scientific hearing device. Without it people have to shout directly in my ear to make me hear. With it, I can hear distinctly when spoken to in an ordinary tone. Best of all, it has stopped my head noises, which were a terrible aggravation. LEWIS W. MAY, Cashier, 100 Washington St., Chicago. Write to or call (call if you can) at our Chicago offices for particulars of our personal test offer and list of other prominent endorsees who will answer inquiries. Physicians cordially invited to investigate aurists' opinions. Stolz Electrophone Co., 1854 Stewart Bldg., 7th floor, Chicago. Branch Offices: Philadelphia, Cincinnati, Seattle, Los Angeles, Pittsburg, Louisville, Cleveland, Indianapolis, Des Moines, Toronto. Foreign Office: 82-85 Fleet St., London, Eng.

## A SHINE FOR A CENT

In a Minute



The only practical Electric Automatic C.O.D. Shoe Shiner.

An advertisement for the live merchant that visibly pays its way. An investment opportunity based upon the strongly established "Automatic Vending" idea. Requiring only a moderate investment it presents a good, reasonable, steady means of securing and maintaining a regular growing profit. Ten shins a day will pay 30% on the cost. We are selling Electric Polishers to live merchants and allotting territory to live, responsible agents with some capital. Our proposition is clean, businesslike, profitable. It affords a chance for a man to own, watch and develop a steady, paying business. We solicit correspondence from anyone who desires to extend his income producing power; from any merchant who cares to add one more link to the chain that binds the public to his store.

Price \$1.00

Price \$1.00 to add one more link to the chain that binds the public to his store. ELECTRIC SHOE POLISHER CO., 700 Great Northern Bldg., CHICAGO

## STAMMERERS

GET THIS BOOK FREE



Learn about The Natural Method for the cure of Stammering. This is the Largest School in the World teaching Natural Methods. Write for Book and Special Summer Rates sent free to stammerers on request. The North-Western School for Stammerers, 309 Galena Street, Milwaukee, Wis.



# All FREE

to  
**Popular  
Electricity  
Readers**



**Refinish a Piece of Your Furniture at Our Expense.  
Let Us Send You the Materials FREE.**

**W**E WANT a sample of wood finishing done with our preparations in your home. We will send the materials to do the work. Here they are:  
A bottle of Johnson's Electric Solvo to quickly remove the old finish—  
A bottle of Johnson's Wood Dye (you to choose the color from the 14 different shades) to color the wood—  
A sample of Johnson's Prepared Wax to give that beautiful "hand rubbed" effect.  
And our illustrated guide book for home beautifying which includes complete color card and tells how to finish and refinish wood.

No doubt you have some piece of furniture that you prize highly, yet you do not use on account of the worn condition of its finish, or because it does not harmonize with other furniture or decorations.

Use this outfit, which we want to send you free, for refinishing it, and you will be surprised to learn how easily the work is done and the beauty of the result.

May we send you these three packages, and the valuable six-color book free at once? Learn from the test the beautiful effect obtained from the use of

## Johnson's Wood Dye

It is not a mere stain. It is a deep-seated dye—sinking into the pores of the wood and bringing out the beauty of the grain. When finished with Johnson's Prepared Wax you have a permanent finish of real beauty and most artistic effect. We want to give you these three packages at once. Send ten cents to partially pay cost of packing and postage—using coupon below for your convenience.

Johnson's Wood Dye comes in 14 standard shades:

No. 126 Light Oak  
No. 123 Dark Oak  
No. 125 Mission Oak  
No. 140 Manilla Oak  
No. 110 Bog Oak  
No. 128 Light Mahogany  
No. 129 Dark Mahogany

No. 139 Weathered Oak  
No. 131 Brown Weathered Oak  
No. 132 Green Weathered Oak  
No. 121 Moss Green  
No. 122 Forest Green  
No. 172 Flemish Oak  
No. 178 Brown Flemish Oak

Half-pints, 30c., Pints, 50c. Johnson's Prepared Wax 10c and 25c packages. Also sold in large sizes. For sale by all leading paint dealers.  
Send coupon today to

**S. C. Johnson & Son:**

RACINE,

WISCONSIN

"Wood Finishing Authorities"

**Please Use This Free Coupon**  
I accept your offer and enclose ten cents to partially pay postage and packing on Free Booklet Editor P. E. 6; one sample bottle of Johnson's Wood Dye, shade No. 126; one sample bottle of Electric Solvo, and a sample of Johnson's Prepared Wax

Name \_\_\_\_\_  
Address \_\_\_\_\_  
Name \_\_\_\_\_  
Address \_\_\_\_\_



## A Substitute for Batteries

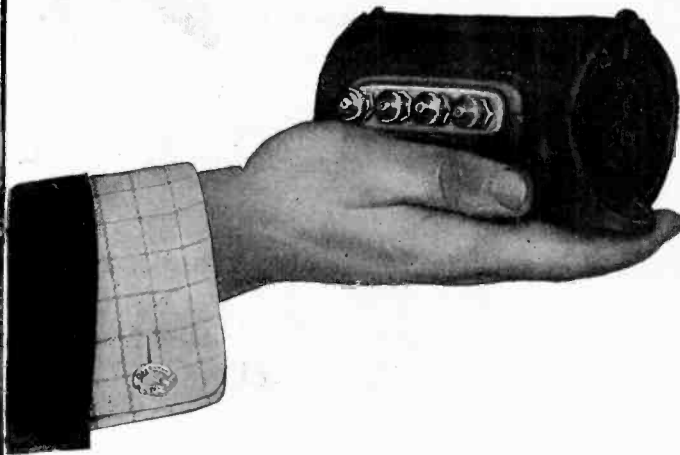

¶ This tiny device, called by electricians a transformer, is arranged to take electricity from the ordinary alternating current lighting circuit, changing the voltage from 110, or more, volts to the proper value for operating bells, buzzers, spark-coils, burglar alarms, miniature lamps, door locks, gas lighting and annunciator systems.

¶ This little transformer will operate on any lighting circuit, requires absolutely no attention, contains no moving or wearing parts and can be installed with an ordinary screw-driver.

¶ It saves the money now being spent for new batteries and eliminates all the work and bother when old batteries refuse to work.

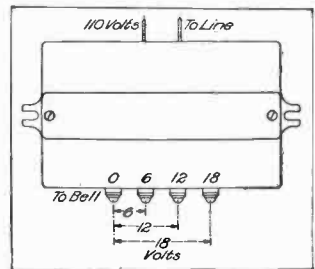

Diagram of Connections

NEW YORK  
OFFICE  
30 Church  
Street

*General Electric Company*

PRINCIPAL OFFICES  
SCHENECTADY, NEW YORK

CHICAGO  
OFFICE  
Monadnock  
Building

Webster's New \$8.50 Encyclopedic Dictionary **FREE** with each of the first 100 orders  
**TREMENDOUS PRICE REDUCTION**—an overwhelming bargain—an extraordinary **HALF-PRICE** offer

**MAGNIFICENT 1909 EDITION FRESH FROM THE PRESS**  
 OF THE

# New Americanized Encyclopedia

FIRST IN WEALTH OF LEARNING, FIRST IN WEIGHT OF AUTHORITY, LATEST IN DATE OF PUBLICATION

Fifteen massive volumes, sumptuous binding. 10,000 double-column pages. 100 superb maps. 37,000 biographical references, hundreds of illustrations, colored plates of the rarest beauty.



**ALWAYS** the GREATEST in the World  
**TODAY** the CHEAPEST in the World

**\$1.00** Secures  
 the Set.

Sent Free for Examination.

A Home University, A College  
 Education, A Huge Library

**The King of all Encyclopedias, at prices never before approached**

You have always meant to get an Encyclopedia—every intelligent man does. NOW IS THE TIME. The possession of this latest and greatest of all ENCYCLOPEDIAS puts you ten years ahead of your less enterprising neighbor. Other books tell you about ONE thing; this tells you EVERYTHING. It covers every phase of human knowledge, discovery, experience and belief. It records every step in the stately march of human progress. It covers all epochs of literature, all forms of government, all systems of religion. All gallant deeds and stirring scenes, all victories of brain or brawn, all marvels of science and invention, all the glorious achievements that have made history luminous and civilization possible are found in the ten thousand teeming pages of these splendid volumes. Can YOU afford to do without it?

**Its Matchless Authority.** The most brilliant thinkers of the century are enrolled as its contributors. Its writers include such men of world-wide fame as Matthew Arnold, James Bryce, John Morley, Andrew Lang, St. George Mivart, Canon Farrar, Edmund Gosse, John Stuart Blackie, Leslie Stephen, Edward Freeman, Lord Kelvin, Robertson Smith, Sir Norman Lockyer, Thorold Rogers, Saintsbury, Swinburne, Simon Newcomb, John Fiske, Cardinal Gibbons, John Bach McMaster, Admiral Melville, Thomas B. Reed, Carroll Wright; and these with hundreds of others equally famous give it an authority so overwhelming so incomparable that it reigns without a rival in the realms of scholarship.

**Incomparably Up To Date.** Our 1909 Edition is fresh from the press and contains events as recent as the election of President Taft, the latest airship flights of the Wright's and Zeppelin, the return of the United States Fleet from its momentous world-voyage and the great Italian Earthquake.

**Special Half Price Offer.** To emphasize the issue of the 1909 edition of this magnificent work we are making for a limited time only a special introductory offer at just ONE-HALF the regular price. The cloth set we price at \$37, the half morocco at \$46. Moreover, with each of the first hundred orders to reach us we will send absolutely FREE Webster's Huge New Encyclopedic Dictionary, retailing regularly at \$8.50. It is bound in Full Sheep, marbled edges, gold stamped and indexed. This combination of the world's most famous Encyclopedia and equally famous Dictionary gives you a magnificent reference library of enormous extent and unmatched value.

**Send No Money Now.** Sign and mail the attached coupon and we will ship you a complete set for five days' FREE examination. You can return them AT OUR EXPENSE if they fail to give you entire satisfaction. We pay all transportation charges. Should you desire to purchase, then send us \$1.00 as first payment and pay the balance at the rate of \$2.00 per month for the cloth and \$2.50 per month for the half morocco.

**Do Not Delay.** At these phenomenal prices the introductory sets will vanish like magic. It is the opportunity of a lifetime. Enrich your mind, adorn your library, delight your family with this stupendous work. Write TO-DAY. Remember, No risk! No obligation! You purchase only if satisfied!

**The Booklovers' Society**

156 FIFTH AVENUE, NEW YORK CITY

P. E.  
 JUNE  
 COUPON

THE  
 BOOKLOVERS'  
 SOCIETY  
 156 Fifth Avenue  
 NEW YORK

Please send me for examination prepaid a complete set of the New Americanized Encyclopedia in half morocco binding at your SPECIAL HALF-PRICE offer of \$46.00. If the set is satisfactory, I agree to pay upon the purchase price the sum of \$1.00 in cash within 5 days after receipt of goods and \$2.50 each month thereafter for eighteen months. Title to remain in The Booklovers' Society until purchase price has been paid. If the books are not satisfactory, I am to notify you promptly and hold them subject to your order. Also send me Webster's New Encyclopedic Dictionary, which I am to receive absolutely FREE should I retain the set.

Name.....  
 Address.....

If you prefer the cloth edition, alter \$46.00 to \$37.00 and \$2.50 each month to \$2.00.

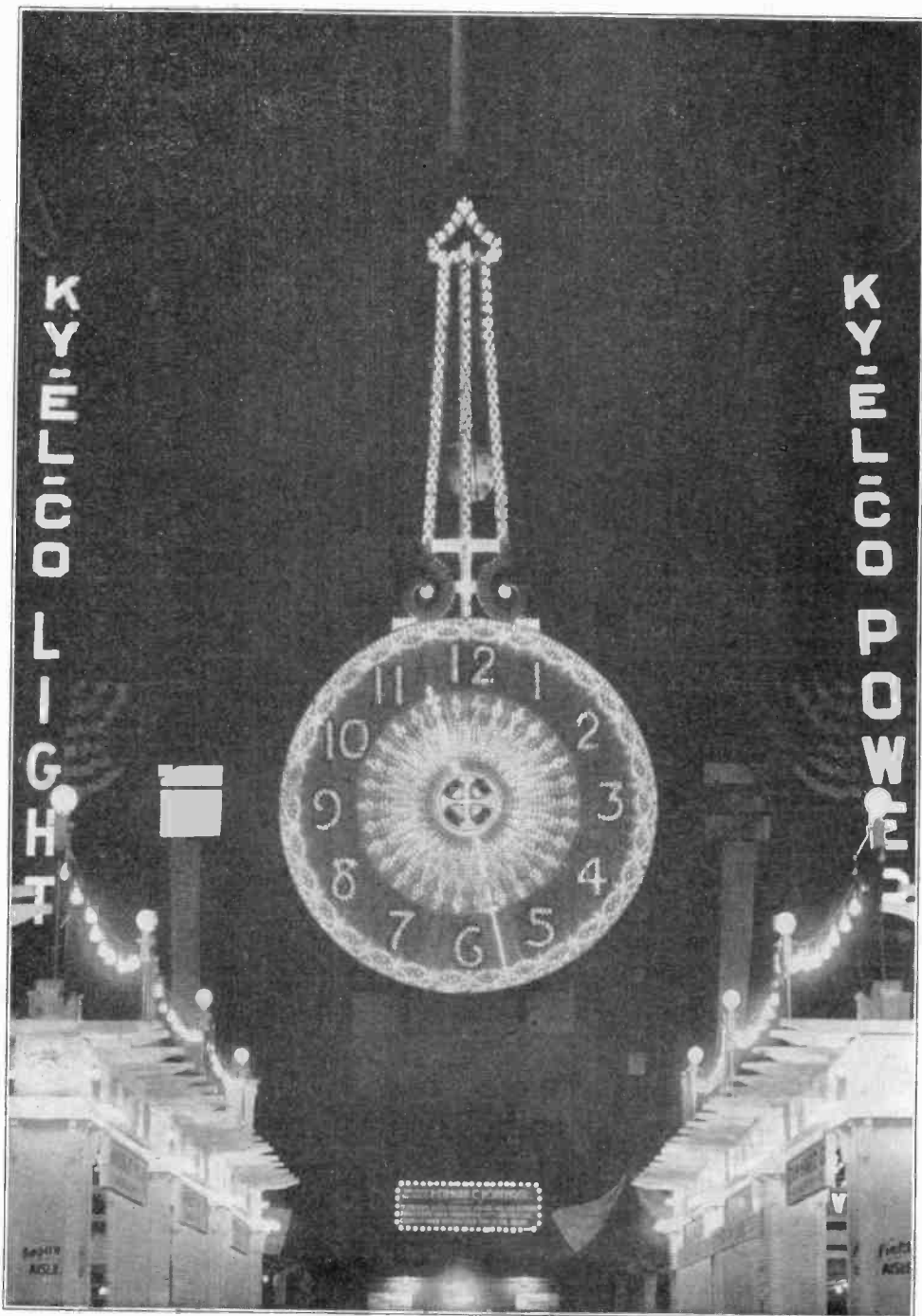

Copyright, 1909, by H. C. Korshage.

SPECTACULAR ELECTRIC CLOCK AT THE SOUTHERN ELECTRICAL AND INDUSTRIAL  
EXPOSITION.

SEE P. 88.



# POPULAR ELECTRICITY

IN PLAIN ENGLISH



VOL. II

JUNE 1909

No. 2

## ICE DAMAGE TO NIAGARA ELECTRIC PLANTS.

Never before in the history of the white man was there such a terrific ice jam at Niagara Falls as occurred during the month of April of this year. The hydro-electric power plant of the Ontario Power Company was shut down by being partly submerged due to the ice, and the other lower Niagara power plants of the Niagara Falls Hydraulic Power and Manufacturing Company were stopped from the same cause and this resulted in shutting down several plants depending on these power stations for electric current.

Peculiar conditions of ice, wind and water at Niagara Falls were such as to produce a jam in the lower river which has never before been equaled. The heavy and continuous winds up the lakes in February resulted in holding back the waters on Lake Erie and causing the phenomenal dry Niagara Falls which produced so much trouble for the hydro-electric power plants above the falls.

The great jam in the Niagara Gorge was caused by the severe winds of the second week in April rushing up the Gorge. The conditions combining to

produce this effect, were the high water in the upper river carrying large quantities of ice over the falls, and the heavy winds which were in a direction to hold the ice back in the lower river.

The wind sweeping up the ravine met the vast quantities of ice passing under the bridges and through the rapids and

whirlpool causing it to become wedged against the banks at Lewiston and Queenstown forming a dam which raised the level of the water 40 to 50 feet above the normal and 20 to 25 feet higher than ever before recorded.

One of the illustrations shows the power plant of the Ontario Power Company and its transformer house on the bank above, on the Canadian side. It may be stated that the water raised so high as to enter the windows

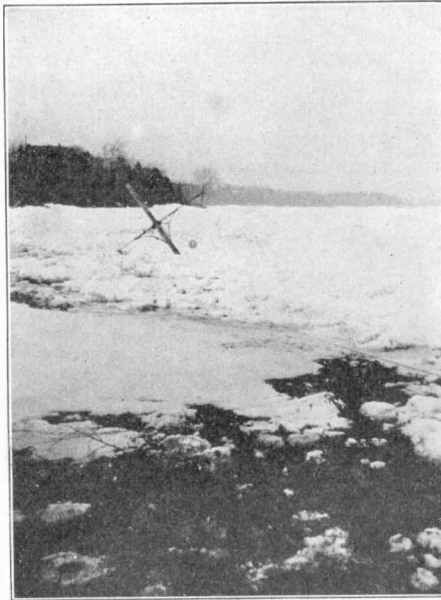

IN THE GRIP OF THE ICE.

and doors of this power plant, completely shutting down the machinery for several days with disastrous results. The high-tension generators were partly submerged, and although the damage to the plant was not permanent the electrical machinery was put out of commission so that the power service on the transmis-

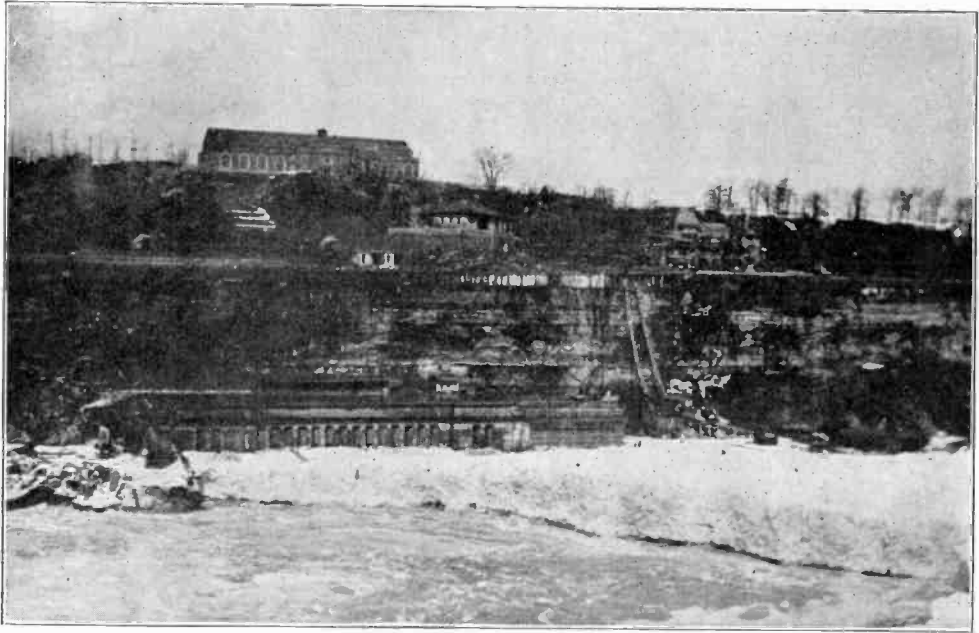

SHOWING THE PARTIALLY SUBMERGED PLANT OF THE ONTARIO POWER COMPANY.

sion lines on the American as well as the Canadian sides was discontinued for a time.

As soon as possible, arrangements were made for a high tension current supply from the other Canadian Power

plants above the Falls temporarily for supplying the Canadian power users, while on the American side the 10,000 horse power gas engine power plant of the Lackawana Steel Company was utilized for operating the Buffalo and Ham-



ICE PILED FIFTY FEET HIGH BELOW THE CANADIAN FALLS.

burg Electric Railway as well as for supplying the power users of the Ontario Power Company between Niagara Falls and Rochester.

The ice jam at the falls and the river filled with thousands of tons of ice which was piled 50 feet high on the Canadian side below the falls, wrecking the electric incline railway. The Maid-of-the-Mist was carried high and dry and its dock completely wrecked. The Great Gorge Electric railway on the American side was completely buried in some places 20 feet under the ice, its pole line and trolley wires wrecked and the tracks badly damaged, as shown in the picture on the front cover of this issue.

#### ELECTRIC CHARGING LAUNCH.

Electric power for launches and yachts has great advantages such as freedom from danger of fire or explosion, absence of heat, odor, vibration, noise, etc. But it also has the limitation that long distance cruising is impossible unless there are intermediate points where the storage batteries may be recharged.

With a view to overcoming the above objection, and to enable him to make long trips independently of charging stations on shore, Mr. Benjamin Douglass, Jr., of New York, has had built for him a unique floating charging plant to be used as an auxiliary to his handsome electric yacht *Cascapedia*. It is the first craft of its kind and the builders believe

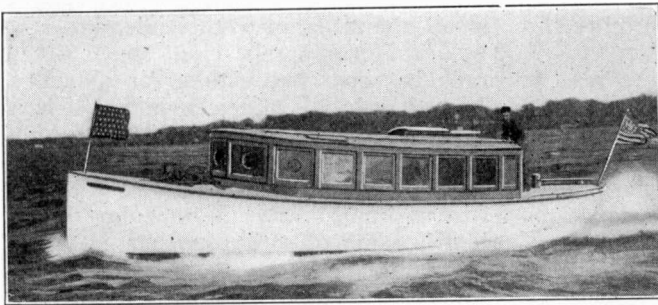

By Courtesy of the Electrical World.  
ELECTRIC-GASOLINE CHARGING LAUNCH.

that it solves the question of the use of electricity in large yachts, since it can be operated at full power for 100 hours on one filling of the fuel tank, thus enabling the yacht to make a trip of 2,000 miles

before either craft would have to enter port.

The name of this unique little boat is the *Kilowatt*; and following completion, she was shipped to Palm Beach, Fla., where her owner used her during the winter. With the recharging launch as an auxiliary, the yacht *Cascapedia* is not dependent upon electricity ashore for charging her batteries.

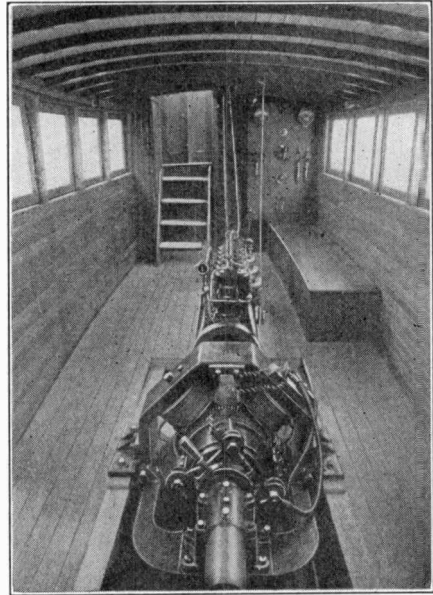

By Courtesy of the Electrical World.  
CHARGING OUTFIT OF THE "KILOWATT."

The *Kilowatt* is 35 feet long, nine feet beam and two feet draft. Her power equipment consists of a 40-horsepower six-cylinder gasoline engine, connected to the propeller shaft. It also drives a charging dynamo. The dynamo is so arranged that current can be generated while the boat is lying at anchor or when under way. The plant has sufficient capacity for recharging the yacht's batteries in three or four hours. The charging launch has a speed under her gasoline power of nine miles an hour and carries 400 gallons of fuel, on which she can be operated for 100 hours.

# ELEMENTARY ELECTRICITY.

BY PROF. EDWIN J. HOUSTON, PH. D. (PRINCETON.)

## CHAPTER XIV.—RADIO-ACTIVITY.

As yet we are far from having discussed all phenomena similar to those produced by X-rays. There are still more curious effects to be recorded. Bearing in mind the fact that the X-rays were emitted from those portions of the walls of the Crookes tube that were rendered phosphorescent by the bombardment of the cathode rays, it occurred to Henri Becquerel of France that possibly other phosphorescent substances might emit X-rays. In order to test this he placed a crystal of a uranium salt, i. e., uranyl-potassium sulphate, illumined by sunlight, on a sensitive photographic plate that was protected from the direct action of the light by being covered with several thicknesses of black paper. When placed in sunlight Becquerel found that the uranium salt emitted a radiation capable of passing through the opaque paper, and affecting the photographic plate.

To his great surprise, Becquerel afterwards discovered that the uranium compound did not require to be exposed to sunlight in order to produce this radiation; it also gave it out in the dark.

Becquerel afterwards found that this curious power of emitting rays in the dark was possessed by nearly all chemical compounds containing uranium, a chemical element that possessed a larger atomic weight than any of the other elements, i. e., 238.5.

Briefly, Becquerel's discovery was as follows: Various substances, all of which in his early experiments contained the element uranium, emitted in the dark, without any prior exposure to light, peculiar radiations or emanations that resembled the X-rays in their power of rendering non-conducting gases through which they passed sufficiently conducting to permit them to gradually discharge insulated charged bodies; of readily passing through substances opaque to ordinary light; of exciting fluorescence or phosphorescence in bodies on which they fell, and of affecting photographic plates.

The peculiar rays thus discovered by

Becquerel in the uranium minerals are generally known as the uranium rays. They are, however, sometimes named after their discoverer, the Becquerel rays. The ability of these substances to thus throw off or emit these rays is known as radio-activity, and the substances are known as radio-active substances.

A careful study of the uranium salts by Becquerel and others, as well as of a mineral known as uranite, or pitchblende, from which metallic uranium is obtained, soon led to the discovery of certain elements whose radio-activity is far greater than that of uranium or any of its salts. The cause of this greater activity was apparently to be attributed to the presence of some especially active material. Investigations soon led to the discovery of new chemical elements known as thorium, polonium, actinium and radium. The rays emitted by all these substances possess properties similar to those of the uranium rays. In order to distinguish them from one another, they are known as the thorium rays, the polonium rays, the actinium rays and the radium rays.

Of all the above substances, radium possesses the power of emitting this radiation to an extent far in excess of any other substance. Radium exists in very small quantities in pitchblende, and other uranium minerals, from which it can only be separated with great difficulty. It so closely resembles barium that it is very difficult to separate the two substances. That radium is a chemical element, however, is shown by the fact that it imparts a crimson color to the bluish flame of a Bunsen burner, while barium imparts to it a green color. Moreover, radium possesses marked radio-activity, while barium does not.

Some idea of the small quantity of radium present in ordinary pitchblende may be formed from the fact that Professor and Madame Curie, who first obtained this element from the mineral refuse from which uranium had been extracted, have estimated that it would re-



quire no less than 5,000 tons of this refuse to produce a kilogramme (2.2 pounds) or 1,000 grammes of radium.

But radium possesses another property far more remarkable than its peculiar radiation. Like the uranium salt, it is able continually to throw off the energy existing in its peculiar way independently of any source of energy from without. The amount of this radiation has been carefully measured. A single gramme of radium is capable of continually throwing off an amount of energy sufficient to melt its own weight of ice per hour.

Or, putting it in another way, a radium salt is continually emitting an amount of energy which is capable of vertically lifting a piece of matter of a weight equal to its own, continuously against the force of gravity, at the level of the sea, at a rate of ten meters (39.3 feet) per second.

When first observed, this apparent disobedience of radium to the law of the conservation of energy referred to in a preceding chapter naturally occasioned no little surprise, but as soon as it was discovered that the liberation of energy was accompanied by the breaking up of the atoms of the radio-active substance into particles called electrons or corpuscles, particles far smaller than ordinary atoms, it was understood that the disobedience to the law of the conservation of energy was only apparent. In other words, a greater amount of energy is evidently charged on the so-called atoms of matter than had before been supposed.

In order to understand this, let us again refer to the heat emitted continuously by a mass of radium. Before the discovery of radio-active elements, the heat produced by the combustion of a sufficient weight of hydrogen and oxygen to form one gramme of water had been carefully measured and was found to be greater than that given out by equal weights of any other known chemical elements. The total heat energy, however, emitted by the complete disintegration of a single gramme of radium is one million times greater than that involved in the combination of hydrogen and oxygen sufficient to form one gramme of water. In other words,

there exists an enormous store of energy in a latent condition in the so-called chemical atoms of radio-active materials, that would never have been recognized had not the chemical elements been undergoing gradual chemical disintegration.

Radium rays are moreover capable of effecting a sensitized photographic plate in a manner similar to X-rays. The process is ordinarily quite slow unless

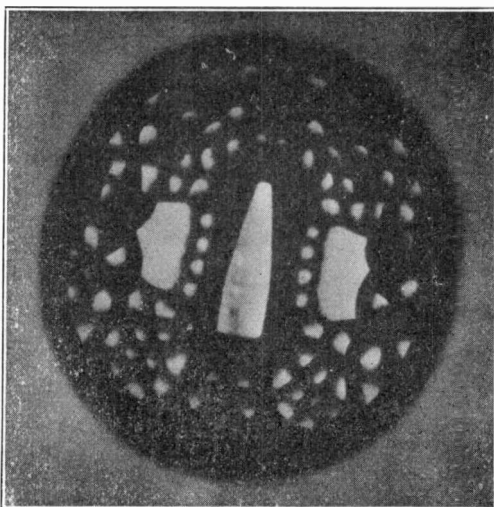

FIG. 91. FROM A PHOTOGRAPH TAKEN BY RADIUM RAYS.

the radium salt is very concentrated, producing powerful rays. Fig. 91 is reproduced from a radium photograph or radiograph, as it is called. In this case the article photographed was a metallic disk with a perforated design which shows in the white portions of the picture. The dark portions are metal. The disk was laid upon a photograph plate in a perfectly dark room and the radium salt, which consisted of pure radium bromide and very powerful, was held about six inches above the disk, the exposure being but a few minutes. The picture is not as clear as the ordinary photograph owing to the fact that there was no focusing arrangement, as is the case when a camera is used.

Let us now inquire how it is that a radio-active element such as radium is able continuously to emit its peculiar radiation. As a result of careful investigations made by many physicists, it is

now generally believed that, like all other radio-active elements, such as uranium, thorium, polonium, actinium, etc., radium is constantly undergoing atomic explosions whereby fragments of different sizes are thrown off; that these substances pass in all directions from the material in straight lines, carrying with them small electric charges; that their power of penetrating ordinary matter is due to their small size, the particles passing not through the molecules or atoms of gross masses, but through the spaces between them.

It might be objected to this explanation, that if a radio-active material is constantly throwing off its particles, it should soon undergo an appreciable decrease in weight. But the particles it throws off are so exceedingly small and the atomic explosions or disintegrations go on at so slow a rate, that it would require hundreds if not thousands of years for the loss to be sufficiently great to be recognized by an ordinary chemical balance.

It has been estimated that in the case of uranium and thorium, the change in weight goes on so slowly that it would require at least one million years to permit the difference in weight to be detected by a delicate chemical balance. Even in the case of radium, in which the change is far more rapid, it has been estimated by Rutherford and others that at least 1,500 years would be required to reduce a given mass of radium to half its original mass, and even at the end of 30,000 years, at least one one-millionth part of the mass would still remain. Nevertheless, since even this slow change is short when compared with the life of the earth, it is evident that radium must be continually produced, since, otherwise, all the radium would long ago have disappeared.

It is believed that an atomic disintegration of matter is constantly going on; that at certain stages in this disintegration the more markedly radio-active elements are produced, such as uranium and radium. Taking, however, the case of radium, the most active of the radio-active elements, it is evident that by its breaking up there are produced a variety of other chemical elements. One of these has actually been detected; that is,

the element helium, which had been proved to exist in the atmosphere of the sun before the discovery of radio-activity.

The radio-active elements like radium are not believed to break up instantly into the element helium. On the contrary, in the case of radium, its atomic explosions must produce new elements not only in the particles thrown off from the atoms, but in the remnants of the atoms. Neither of these substances can continue to be radium, since they do not contain sufficient matter to form radium atoms. Nor is it believed that, as in the case of radium, helium is produced by the first set of atomic particles that are thrown off by the exploding atoms, but by what are known as radium-emanations.

The first explosive disruption of the radium atom produces a radium emanation in the shape of a gas. There are, however, other emanations known as radium emanations, A, B, C, D, and E, all of which are solids. The time required for one of these emanations to pass into

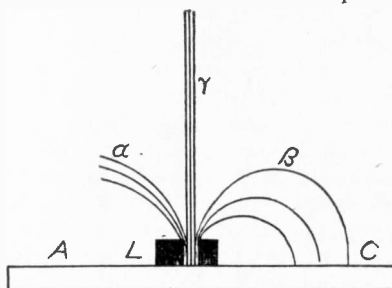

FIG. 92. METHOD OF DEMONSTRATING THE THREE KINDS OF RADIUM RAYS.

another varies from a few minutes to several years.

It will be seen that the theory of radio-activity as above given is contrary to the old belief that the atoms of matter are the ultimate or smallest particle in which matter can exist. This theory would rather regard all matter as consisting of a single kind of material, the difference in the so-called chemical elements being due to the differences in the number and groupings of this elemental matter.

The most important discovery that has been made concerning the rays thrown off from all radio-active elements is that they are all capable of producing three

different types of radiation. If a small quantity of radium salt is placed at the bottom of an open narrow cylindrical lead vessel (L), Fig. 92, the radium rays can pass freely out from the opening at the top. Now these rays, like the rays emitted by all radio-active substances, consist of the  $\alpha$  rays, the  $\beta$  rays, and the  $\gamma$  rays. Ordinarily these rays will pass out commingled or associated with one another. If, however, a strong magnetic field is applied at right angles to the plane of the sheet of paper, and directed towards the sheet, the three kinds of rays are separated from one another as shown. The  $\gamma$  rays continue in a straight line as shown without any deviation; the  $\beta$  rays are deflected to the right, moving through the circular path as shown, so that if (A C) represent a portion of a photographic plate placed under the vessel the  $\beta$  rays will produce an impression on it; the  $\alpha$  rays are bent in the opposite direction and also describe a part of the arc of a circle, but are rapidly absorbed after passing a short distance from the lead tube.

These three classes of rays possess the following properties; i. e.:

(1) The  $\alpha$  rays consist of positively charged bodies that are thrown out with a velocity of about one-tenth that of light. They are readily absorbed, and are deflected by a powerful magnetic or electric field. The amount of this deviation, however, is smaller than that of the cathode rays produced in an ordinary vacuum tube under the same strength of field.

(2) The  $\beta$  rays are less rapidly absorbed and are far more penetrating in their character. They consist of negatively charged bodies that are thrown off with the velocity about the same as that of ordinary light. They are far more readily deflected than are the other rays, and appear to be identical with the cathode rays produced in a vacuum tube. These rays negatively electrify all objects on which they strike.

(3) The  $\gamma$  rays are extremely penetrating, and are not deflected by a magnetic field. They are capable of readily passing through most substances opaque to ordinary light, and appear to possess properties identical with very penetrating X-rays.

Zinc sulphide phosphoresces brightly under the influence of the rays from radium. If a screen covered with zinc sulphide is exposed to a radium salt, it will glow or phosphoresce brightly, and if the surface of this screen is examined by means of a magnifying glass, it will be seen that the light is not uniformly distributed, but comes from a number of scintillating points.

In order to demonstrate this property, Crookes constructed a piece of apparatus known as the spintharoscope, consisting of a small piece of metal dipped in a solution of a radium salt and fixed at a distance of several millimeters from a zinc sulphide screen placed at one end of a short brass tube and examined through a lens placed at the other end of the tube. When observed in this manner the zinc screen appears as a dark background dotted with brilliant points that appear and disappear with great rapidity. The appearance of the points corresponds to the successive explosions of the radium salt.

(To be continued.)

#### CURIOUS USE OF ELECTRIC LIGHT.

A curious use to which the electric light has been put was recently recorded in Pearson's Weekly. There has just been completed inside the Small Bird House at the London "Zoo," an arrangement of incandescent lamps, the object of the installation being to induce the tiny feathered inmates to take breakfast a couple of hours earlier than they otherwise would do. It is controlled by a switch outside the building, and each morning at six a keeper turns on the lights. This, of course, arouses the birds, who commence feeding forthwith, under the impression that day has dawned. The same dodge has been used from time immemorial for fattening quails for the London market. These birds feed only in the early morning, so, after being caught, they are kept in underground cellars, fitted with electric lights, which are periodically switched on and off. Every time the lights are raised, the quails start eating, going contentedly to roost when they are lowered. In this way a bird can be induced to eat as many as twenty-four breakfasts in one day.

## ELECTRICITY AT THE ALASKA-YUKON-PACIFIC EXPOSITION.

Exploitation of Alaskan and Yukon territories and the fostering of trade on the Pacific Coast is the object of the Seattle exposition to be held this year. The University of Washington owns the Alaska-Yukon-Pacific exhibition grounds, which will be utilized by that institution after the exposition is over. One million dollars has been appropriated by the State of Washington for University and State buildings, the grounds

central court with cascades, fountains and a geyser station.

In all modern expositions the feature which has attracted most attention and comment has been the electrical illuminations. Electricity made the Pan-American. It was the most-talked-of feature of the St. Louis exposition and in this respect Seattle is not going to be outdone, for although it may not be as great in size as other expositions it will

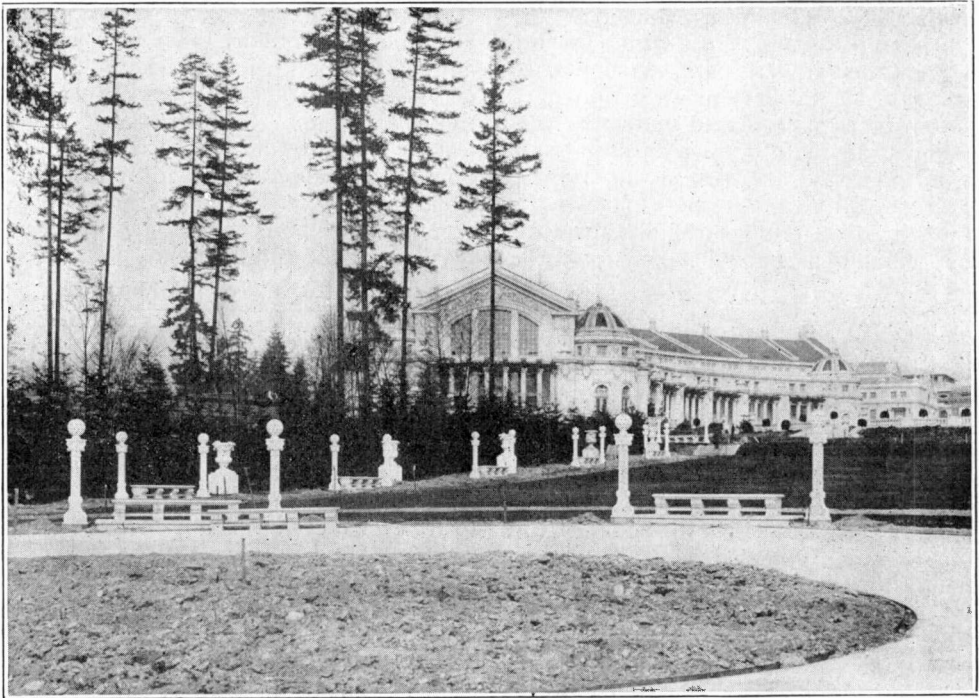

PORTION OF THE ELECTRICALLY LIGHTED GROUNDS OF THE SEATTLE EXPOSITION—MANUFACTURERS' BUILDING.

of which include 250 acres. The United States Government has also appropriated nearly three-quarters of a million dollars.

The site of the exposition is located in the suburbs of Seattle between Lake Washington and Lake Union, about five miles from the central district of the city. There will be 45 exposition buildings, including mines, manufacturers', engineering and machinery, as well as government, state and foreign pavilions and exhibit buildings, arranged about a

make up in quality and artistic effects what it may lack in quantity, and this in spite of the fact that current must be brought from Snoqualmie Falls, 50 miles away.

The buildings will all be outlined with incandescent lamps of the frosted type, of eight candle-power, a total of about a quarter of a million being utilized. The State and Government Building will have about one hundred thousand lamps in service while the street and park lighting will employ an equal number.

About fifty thousand lamps will also be used at the cascade court and geyser basin and on the buildings surrounding them. It was considered advisable to utilize electroliers about the grounds, as shown in one of the pictures, consisting of large balls on ornamental staff columns, with about 40 electric lamps of 20 candle-power each on the surface of each ball. In the park and on the shore of Lake Washington festoons will be provided along the paths and through the trees.

Alternating electric current at a very

lamps and motors used on the grounds. One of these motor-generators is shown in the second illustration.

A new steam operated electric plant is also being built for the university buildings and the current developed by it will be used as an auxiliary to the "imported" electricity, in case of emergency.

During the entire exposition season a wireless telephone and telegraph station will be in operation, receiving messages from steamers entering and leaving Seattle. A pavilion with tower 100 feet

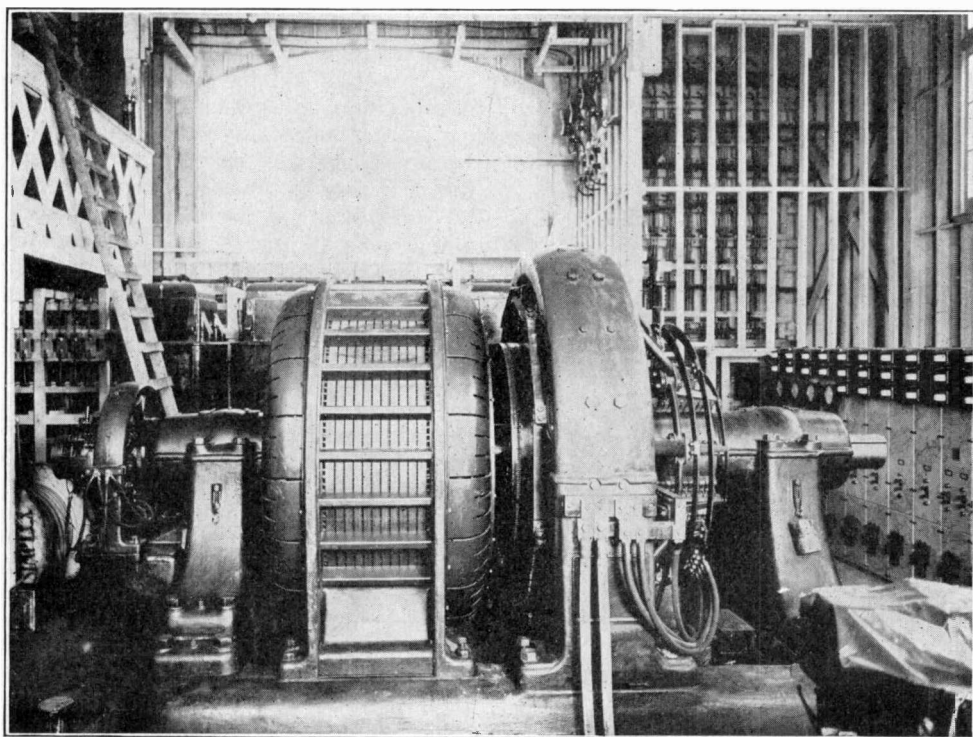

ONE OF THE MOTOR GENERATORS WHICH SUPPLIES CURRENT FOR THE EXPOSITION.

high voltage will be brought from the power station already at the Falls to a substation located on the grounds. Here it will be passed through transformers which will reduce the voltage somewhat and then into motor-generators. These machines consist of a motor and a dynamo, or generator, on the same shaft. The motor is revolved by the incoming current and turns the dynamo armature, which in turn generates direct current of a voltage suitable for operating the

in height of rustic design has been constructed near the main entrance. The antenna or aerial is supported from the top of a pole 50 feet high mounted on the top of this tower, giving a total height of 150 feet above the base.

A daily newspaper published in this wireless telephone and telegraph pavilion will contain news received by the wireless instruments and messages from the steamers arriving from and leaving for Alaska and the Yukon district.

### A STRIKING ADVERTISEMENT.

The accompanying diagram is a reproduction of an advertisement recently placed in a number of periodicals by a large storage battery manufacturing company and it illustrates in a striking manner one of the great problems in electric central station operation; namely, how to straighten out or equalize the daily load "curve."

The irregular black line which looks like a jagged mountain range represents in a general way the load on an electric plant between the hours of 12 o'clock

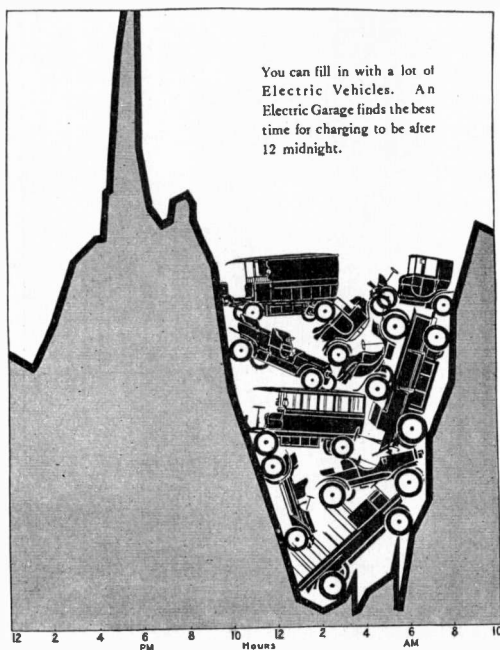

A STRIKING ADVERTISEMENT.

noon and 10 a. m. the following day. Each point on the curve represents the load on the station at the particular hour designated on the base line immediately below that point. From 12 o'clock to 4 p. m. we see that there is a fairly heavy load due to motors and a few lights that are in operation during that portion of the day. Then, a little after 4 o'clock, if it be during the short days of late fall, winter and early spring, the people all over the city begin to turn on their lights and the curve rises sharply and runs up to a great height, but only stays there for a short time, when it begins to fall off as the consumers begin to turn off their

lights and the motor service drops off. This high point is known as the "peak load" and is one of the worries of the central station manager, for, although money is received for the current sold during the peak, extra generating machinery must be installed to take care of it even though this machinery be idle the rest of the 24 hours.

From 8 p. m. the load falls off rapidly until a minimum is reached about 2 to 6 a. m. Then it begins to rise rapidly at 6 a. m., when the people are burning early morning lights, the factories are starting up, etc.

Only a glance at the diagram is necessary to show even the casual observer that there is a long period during the night when an immense investment in generating machinery is earning nothing for the company. Some electric companies get around this to a certain extent by installing great storage batteries which are charged by the dynamos during the slack periods of the day and which pour their current into the system during the peak load. In this way fewer dynamos may be used, and be made to work during the entire 24 hours. But the storage batteries are very costly, so the attendant saving in dynamo investment is counteracted to a considerable extent.

A more ideal condition would be to obtain commercial load which will come on during the hours of the night, and to forcibly remind central station managers of one kind of night load is the object of the advertisement. Electric automobiles and trucks of all kinds must have their batteries charged, which operation takes a number of hours. Therefore, the "ad" says, in language plainer than words, "Central stations, encourage the use of electric vehicles in your city, which will be charged at a time when your machinery is idle and which will help to straighten out your load curve."

The largest storage battery in the world has been installed at the Sixteenth Street Station of the New York Edison Company. The 150 cells have a capacity of 22,000 amperes for one hour at 120 volts. It will be used only in emergencies.

### THE OLDEST TELEPHONE OPERATOR.

Much has been said by various owners of telephone systems relative to the precociousness of their offspring in connection with the operation of telephone switchboards, and numberless items on this subject have appeared from time to time in the various telephone publications. To date, however, so far as the writer is personally aware, says Mr. L. E. Knapp in a letter from Dallas, Texas, no claim has been made as to the age limit for employes for the operating department.

In this connection I think it likely that Mrs. Bynum is the oldest operator in the United States and possibly in the world. Mrs. Bynum, the mother of J. Fowler Bynum, owner of the Eagon Branch Telephone Company of Kaufman, Texas, every day operates a system having very nearly one hundred telephones. Mrs. Bynum is seventy-two years of age, notwithstanding which, she has a very good "telephone voice" and her hearing is most excellent. She recalls without reference to any bulletin the combination of rings for any subscriber who may be desired upon the system. She states that she enjoys the task of operating the switchboard and telephone system very much and that, in fact, without it she would find it rather hard to pass the time.—*Telephony*.

Nearly 300 miles of line for power transmission purposes is to be put up by the Ontario Hydro-Electric Power Commission in order to supply various towns and cities in Ontario with electricity generated at Niagara Falls. About a million pounds of aluminum wire will be used. The line will consist of three cables supported on towers spaced 550 feet apart.

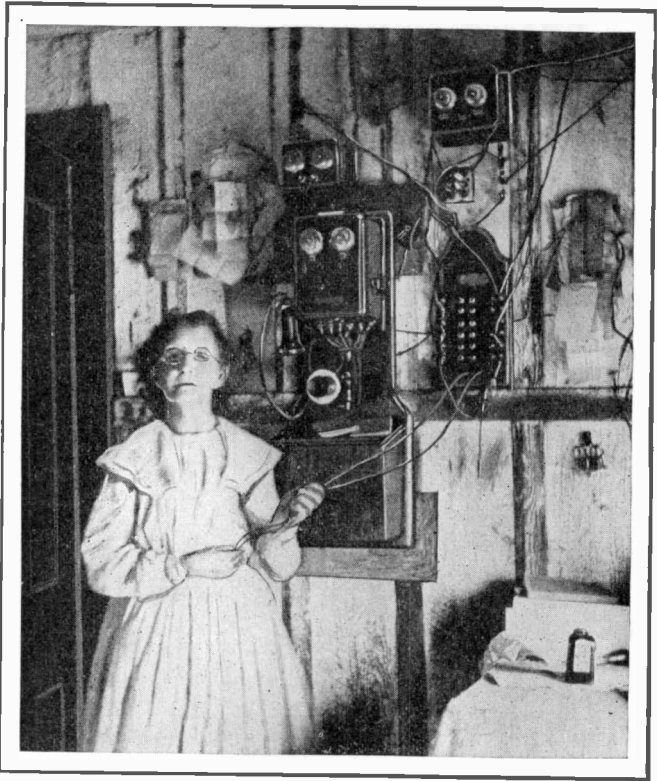

THE SWITCHBOARD AND OPERATOR AT KAUFMAN, TEXAS.

### ELECTRIC PLANTS IN THE UNITED STATES.

The census director has issued a preliminary report on the electric light and power stations of the United States. The statistics relate to the year ended December 31, 1907. The totals do not include isolated plants or plants that are idle or in course of construction.

The total number of establishments in 1907 was 4,714, an increase of 30.2 per cent over 1902. These plants gave employment to 34,642 wage earners and developed 5,858,121,680 kilowatt hours. These central stations supply current for 555,921 arc lamps and 41,807,944 incandescent lamps. The total horsepower capacity of the stationary motors served was 1,649,026. The increase in lighting during the five years was considerable but the greatest increase was in the numbers of motors supplied with current, a total increase of 276.5 per cent.

# PRODUCING FRESH AIR BY ELECTRICITY.

BY M. M. HUNTING.

The city of Berlin is well known as a Mecca for scientists, and within the walls of its numerous laboratories many a problem of enormous scientific value has been solved. Not the least among these is the problem of producing fresh air by electricity. Much of the advancement in this line has been through the untiring efforts of a German, Dr. Fischer. He simply feeds a current of air into one of his electrical machines and in a twinkling out comes the germless air for us to breathe. His apparatus is called the "Ozone Fan," and is capable of concentrating the ozone in the atmosphere, and

is a deadly enemy of these pests. This same ozone is found in small quantities in the sunlight, and we all know that the ordinary sunshine is more or less of a disinfectant, and for this reason health authorities urge upon us the habit of getting as much of it as we possibly can.

Dr. Fischer's ventilator produces this germ-slaughtering gas by taking advantage of an exceedingly high temperature, something like 2,000° C., and for this purpose the well known Nernst glower, applied so successfully to the Nernst

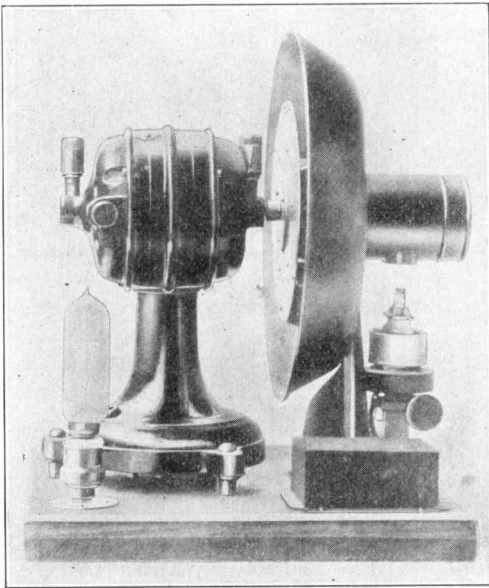

DR. FISCHER'S OZONE FAN.

by means of a very high temperature this ozone is liberated and is re-distributed, with the proper amount of oxygen, and is made ready for us to breathe.

The distinction that is so noticeable between the air we are forced to breathe in the average city and the sweet and pure air of the country, is due to the fact that this very same colorless gas, ozone, is present in larger quantities in the air of the country. We might say it is almost conspicuous by its absence in most cities, and for this reason also, germs rather prefer the city air, for ozone

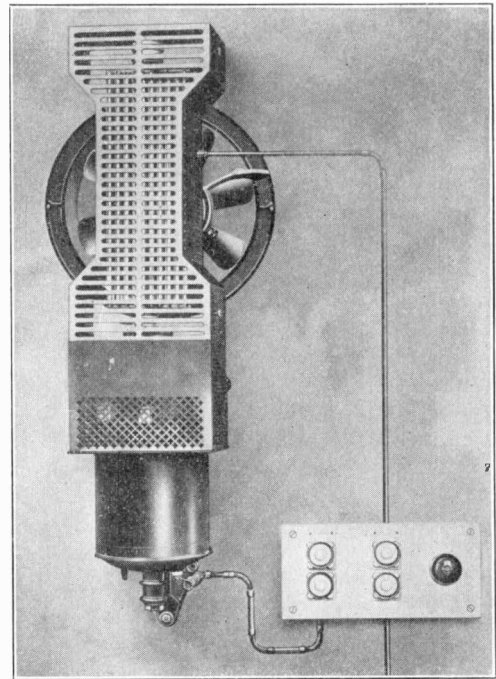

OZONE WALL FAN.

lamp, adapts itself admirably. The fan draws the air current as it is needed, over the heated glower and it is thereby heated to the desired temperature. Now, it is immediately mixed with cold air and this sudden change causes the free gas to be liberated and made ready for further use.

Briefly, the apparatus consists of a small ventilator working upon the suction principle. The fan is placed inside



a funnel containing the Nernst glower, which is readily adjustable. This glower will not conduct current until it is raised to a certain degree of temperature, which temperature is obtained by using a heating coil. When the ventilator starts to operate, the first current is received by

000 cubic feet, and the machine takes one hour to do this amount of work.

There is still another design of ozone fan, manufactured by a German firm. This fan depends upon electric discharges, or flashes, to produce the necessary ozone. It resembles the electric ozonizer for the purification of water, from which Dr. Fisher conceived his idea, and which he has embodied in his ozone fan, described above.

The second ozone fan described is intended for air shaft installation, and on account of the nature of its makeup it is highly insulated. The fan drawing the air into the ventilator is fitted with iron rods and plates, alternating. Each pair of rods and plates being electrodes of a high tension circuit of an alternate current transformer, and for the

sake of safety one terminal is grounded. The only noticeable evidence of what is taking place is a slight bluish streak produced between the plates and the rods.

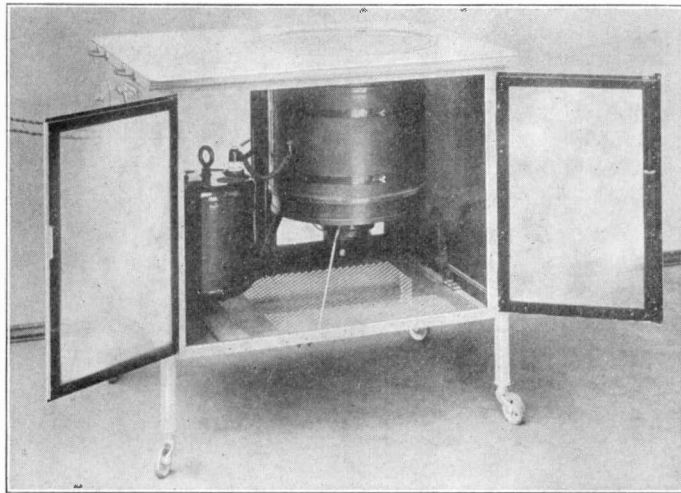

PORTABLE OZONE FAN.

the heating coil. This continues until the glower is heated up to a point where it will carry current itself, when an electromagnet starts the fan-motor and at the same time the heating coil becomes disconnected.

Now for a person to breathe undiluted ozone would be very detrimental to the body, for the pure gas acts in a highly damaging manner upon the mucous membrane. To overcome this disadvantage, the inventor has perfected his apparatus so that it is able to furnish this gas in the proper amount for breathing purposes, i. e., one-tenth of one per cent.

The fan overcomes the obstacle of furnishing a damaging amount of the gas by destroying a certain proportion and keeping a constant average strength of the mixture of common air and ozone.

The operating expense of this artificial fresh-air plant is very low when one considers the benefit derived by humanity from breathing such an atmosphere. It requires from 30 to 150 watts (one twenty-fifth to one-fifth horsepower) of current to convert from 35,000 to 175,-

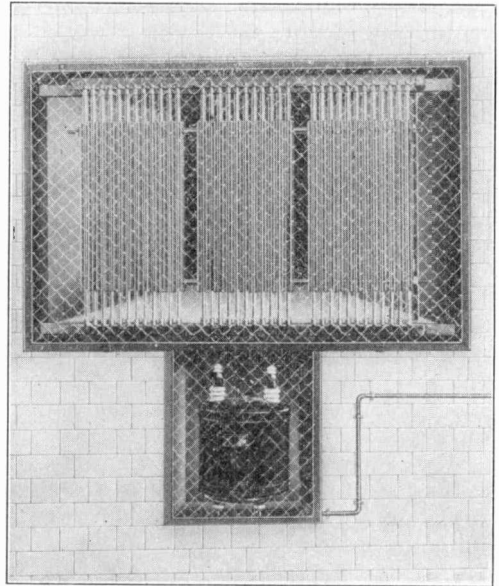

OZONIZER FOR AIR SHAFT.

Aside from this difference the fan acts in a manner similar to the former one.

When very large areas, as an entire building, are to be ventilated the ozone is manufactured outside the building and after being thoroughly mixed with the proper amount of air, is then forced by means of a compressor, first into air pits and then by means of conduits, throughout the entire building.

This electrical form of aeration will prove a blessing in numerous places where the question of ventilation has long been a serious one, i. e., in subways, churches, theaters, and on board ships, where strictly fresh air is always at a premium.

#### SUBMERGIBLE ELECTRIC BILGE PUMP.

The construction and method of operation of a unique submergible bilge pump operated electrically, are shown in the accompanying pictures. The pump is used for pumping waste water out of basements where the floor level is below the sewerage system. Ordinarily the vertical motor on top of the centrifugal pump shaft is above the floor line, but in case the basement should become flooded the motor would not be injured and would work as low as 17 feet below the surface of the water.

The pump motor and automatic parts are placed under a "protecting hood" which allows ventilation under ordinary conditions, and in case of a flooded basement the hood prevents the motor from being injured.

The protecting hood is built to utilize the principle of the compression of gases. It is hollow cylinder with the bottom end open and is set on top of the motor. The sides and top are air-tight. For water to rise inside the hood, there must be a pressure put on the

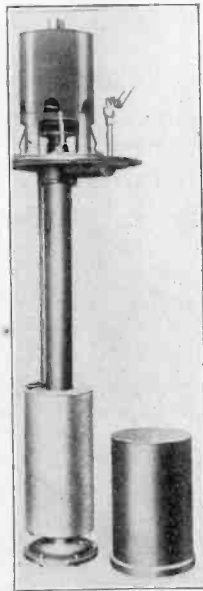

ELECTRIC BILGE PUMP.

water to overcome the pressure of air in the hood.

It requires one atmosphere, or a pressure equal to about 15 pounds to the square inch to compress the air in the hood sufficiently to allow the water to rise in the hood half way. This is ap-

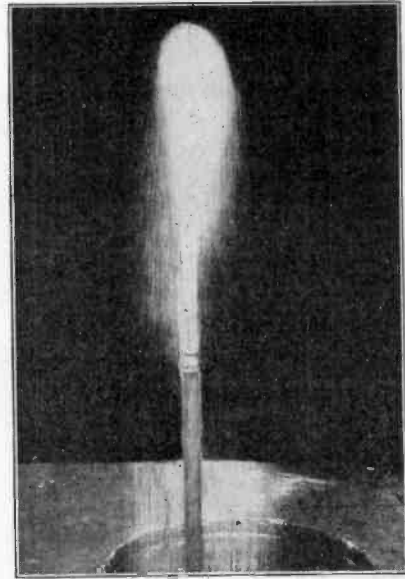

PUMP AND MOTOR OPERATING UNDER WATER.

proximately the pressure that would be encountered 34½ feet below the surface of a body of water. The motor windings being one-third of the way up in the protecting hood, for the water to rise inside even one-fourth of the way in the hood, the latter would need to be under 17 feet of water.

The principle may be demonstrated by taking an ordinary drinking glass and a pail full of water and turning the glass up-side-down so that the opening of the glass is toward the water, and pushing the glass straight down into the water until the bottom of the pail is reached. The water has not risen to any appreciable extent in the glass, and you could burn a match or piece of paper inside of the glass until the oxygen became exhausted.

Electric sirens are in use on the railways of Germany. The sound is produced by the vibrations of a metallic diaphragm under the influence of an electromagnet.

**HURRY - UP METHODS OF MILITARY SIGNALING.**

In recent years the coast defenses have been materially improved and strengthened. In no particular has more progress been made than in the electrical devices by which the fire from the heavy guns is directed by the artillery officers. The days are gone by when the gunner "sighted" his gun, as a marksman aims his rifle. Now the great size and range of the guns make

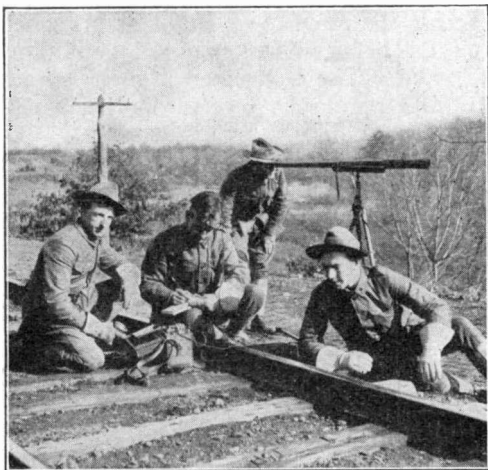

USING THE FIELD BUZZER ON A RAILROAD TRACK.

it necessary that the method of sighting be scientific.

The Signal Corps, whose duty it is to furnish and maintain the electrical signaling apparatus, is now using a new portable wireless telegraph set, which makes it possible for a scouting party to keep in communication with the main body at a distance of 15 to 25 miles. The wireless set, as useful as it is, does not, as yet, displace the other methods of signaling.

The field buzzer used by the Signal Corps is a practical and efficient instrument. The apparatus is used for transmitting telegraph messages. The buzzer consists of a small vibrating armature, which operates from the power of five tiny dry batteries, making a buzzing noise of high pitch. The high frequency current developed from its induction coil to the line will find its way across "breaks" and over ground "leaks" that would put the ordinary telephone and

telegraph circuits out of business. The practical use of the apparatus can be readily seen. A scout wishes to go ahead and send back his information immediately. He gets on a horse, and as fast as his horse can gallop the fine wire is laid out on the ground, and if it falls into water, or should a team pass over the wire and break the circuit, it makes little difference. When he finds out what he wishes to know, he signals his message through the wire without dismounting, as the circuit is completed through the horse's body to the ground.

It is also possible to signal with this buzzer by using a railroad track or barbed-wire fence for a conductor, as any small breaks in the circuit will be bridged across as explained above.

Captain E. H. Hotchkiss, First Company Signal Corps, C. N. G., has invent-

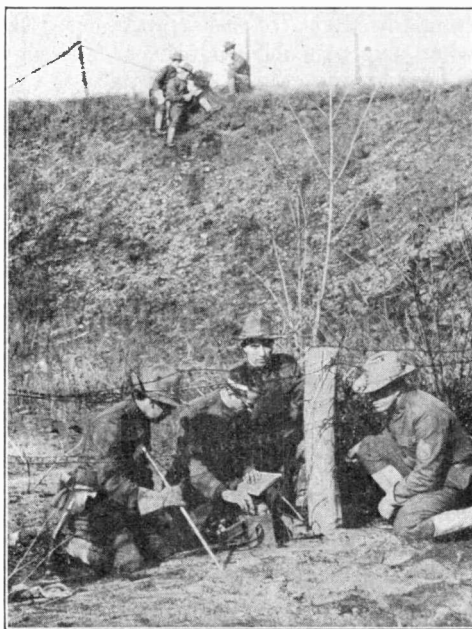

SIGNALING OVER A BARBED-WIRE FENCE.

ed a ground device that fastens to the heel of the shoe, thereby completing the buzzer circuit, making it possible for two men to start off in either direction and keep in touch with each other. The device was given a thorough test at Fort Wright, N. Y., last summer, and while the men climbed trees and walked on stones that were dry and well insulated, communication was maintained.

# MEASURING ELECTRIC CURRENT.

BY PROF. B. A. PERKINS, A. B. (STANFORD).

CONSUMERS' METERS.

Power companies which sell electric current have adopted several methods for charging consumers for the electric energy they use. In the flat rate or contract system of charging for electric lighting, each customer pays a certain amount per month per lamp. The expense of putting in a meter and the additional expense and trouble of looking after it are thereby avoided, but as power is usually wasted when sold under this system, the power companies must charge enough to cover the *waste* as well as the *use* of the power.

The meter method of charging has proved more satisfactory, both to the company and to the consumer. But when a measurable quantity of anything is bought and sold it is but natural that the buyer as well as the seller should want to know how it is measured.

The meter for measuring currents in ampere units is called an ammeter. These ammeters (ampere meters) generally have a movable coil of insulated wire pivoted on jewel bearings and held in position between the two poles of a permanent magnet by an elastic spiral spring. When a current is sent through the coil, it becomes magnetic and reacts with the permanent magnet so as to cause it to rotate. The rotation is indicated by a pointer and is proportional to the current flowing through the coil.

From the equation,  $\text{Volts} = \text{Amperes} \times \text{Ohms}$ , we see that with constant resistance, the current will vary directly as the voltage that causes it. Meters for measuring volts (voltmeters) are, consequently, constructed on the same principle as ammeters. They differ from ammeters only in having the movable coil made of fine wire having great resistance. The coil rotates in proportion to the current flowing through it, which in turn is in proportion to the electromotive force or voltage that causes it.

We notice a difference, however, in the way in which the ammeter and voltmeter are connected in the circuit. The ammeter being used to measure the vol-

ume or quantity of current passing through a circuit is so connected that the whole current passes through it. The voltmeter being used to measure the amount of electromotive force used in driving the current between two given points is connected to these two points across the circuit. A shunt or branched circuit between the two points is thus formed. The voltmeter branch having a high resistance receives only a small portion of the total current.

When we cause the ordinary direct current used in lighting circuits to flow through an ordinary 16 candle-power lamp we find the current measures  $\frac{1}{2}$  ampere. If we connect a voltmeter across the circuit between the point where the current enters the lamp and the point where the current emerges from the lamp, we find that an electromotive force of 110 volts has been used in driving the current through the lamp. The power, or watts, consumed by the lamp is  $110 \times \frac{1}{2} = 55$  watts, from the established formula,  $\text{Watts} = \text{Current} \times \text{Electromotive force}$ . When the lamp is used one hour it consumes 55 watt-hours or .055 kilowatt-hours of energy, a kilowatt being equal to 1,000 watts.

The meters that are used for measuring in terms of watt-hours or kilowatt-hours the supply of electric energy to the houses of consumers are called watt-hour meters (sometimes called recording or integrating wattmeters). It is in this type of meter, which combines the principles of both ammeter and voltmeter, that the consumer is interested.

There are several types of watt-hour meters. Most of them are small direct-connected motor-generators. Those used on direct current circuits are of the commutator type, while those on alternating currents are usually of the induction type. All of these combine three essential elements; (1) the motor element which develops driving torque or rotative effect, (2) the generator element, which develops retarding torque, and (3) the counting or recording element.

All motors and generators consist mechanically of two parts—a stationary part and a rotating part. When either machine is in operation, each of its two parts is an electromagnet. The stationary part is generally called the “field,” the rotating part the “armature.” In the case of motors, each wire in the armature experiences a sidewise thrust tending to move it across the magnetic lines of the field in a direction at right angles to the direction of the wire’s length and also at right angles to the field’s magnetic lines of force. That this thrust or force is not along the line connecting the field and the armature, but at right angles to this line, marks a striking difference between the electromagnetic force and the forces elsewhere encountered. This thrust at the surface of the armature, or “drag,” as it is often called, is found to be proportional to the current in the armature and to the strength of the field. If the field has no iron in it, its strength is proportional to the current in it. The total drag on the armature multiplied by the radius of the armature gives its turning force or torque. The power of the motor is proportional to the torque and the angular speed of the armature.

The motor element of watt-hour meters used on direct-current circuits consists of a fixed magnetizing coil or field which is connected with the mains in the same manner in which an ammeter is connected and hence is often called the current coil; and a rotating coil or armature which, being connected across the mains like a voltmeter, is often called the pressure coil.

The drag on the armature is dependent on the reaction between the armature and the field and is equal to the product of the magnetic strength of each. There is no iron in the field coils of the motors used in meters so the strength of the field (magnetic flux) is directly proportional to the current. The strength of the armature’s field is also proportional to the current in it, but as the armature is connected across the mains like a voltmeter, the current in it is proportional to the amount of electromotive force that has been used. We see, then, that the reaction or drag between these two coils will be proportional to the

power or watts consumed. And, since with any given motor, the radius of the armature remains constant, its torque is also proportional to the power consumed.

By measuring this driving torque of the motor element of our meter, we could measure the power consumption. But it is not easy to measure the torque directly, though fortunately there is a way to get around this difficulty. The armature’s angular velocity is proportional to the driving torque and inversely proportional to its retarding torque. If these two torques increase in the same ratio, then the armature’s angular velocity will be proportional to the power consumed. Since it is much easier to measure and record the armature’s angular velocity than it would be to measure and record the driving torque, we avail ourselves of that method.

But how can we secure a retarding torque that will always increase as the driving torque increases? That is what the generator element of our meter is for. The generator element consists of an aluminum disk carried on the same shaft with the motor armature and rotated in a field of constant value produced by permanent magnets. This disk on being rotated in the constant magnetic field has generated in it a current proportional to the speed of rotation. The current thus generated reacts with the field of the permanent magnets producing a retarding torque proportional to the velocity. With this ingenious retarding arrangement added to the motor element of our meter, we can measure the armature’s angular velocity rather than its torque, since both are now proportional to the power consumed.

All that is now necessary to add to the measuring device in order that it may measure the energy supplied to our circuit is a mechanism to record the total number of the armature’s rotations since each rotation represents a certain amount of energy. This mechanism consists of a train of gear wheels connected to the armature’s shaft. The wheels operate pointers on the dials. Thus with the motor element, the generator element and the recording element, the watt-hour meter is complete.

In Fig. 1 is shown the armature (spherical portion) of the motor ele-

ment, the armature shaft, and on the lower end of the latter the generator disk. Fig. 2 shows the gear wheel mechanism driven by the rotating elements of the meter and which move the little pointers around on the dials to indicate the number of watt-hours. Fig. 3 shows the watt-hour meter complete with front cover removed. At the bottom is seen the generator disk revolving in the field of the permanent magnet. In the cen-

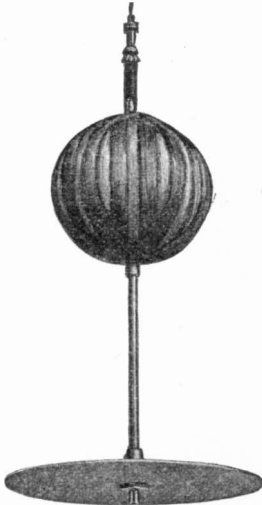

FIG. 1. ARMATURE AND GENERATOR DISK OF A WATTMETER.

ter, partly concealed, is the revolving armature, the shaft of which drives the gears for the little pointers of the dials at the top.

The induction type of watt-hour meter which is generally used on alternating current circuits consists, like the commu-

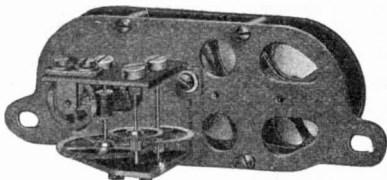

FIG. 2. GEAR WHEEL MECHANISM.

tator type just described, of three elements—a motor element, a generator element and a recording element. The only point of difference between the two meters is in regard to the motor element. In the induction type the field is made up of two coils; one connected in series

with the circuit, the other as a shunt or branch between the point where the current begins its work for us and the point where it has finished its work for us. The combined field strength is consequently equal to the current times volts, or the watts that are consumed on our load.

The armature consists of an aluminum disk similar to the generator armature and rotated on the same shaft. As in the commutator meter, the driving force on the motor's armature and the retarding torque in the generator's armature increase in the same ratio, both being proportional to the amount of power consumed on the load. It remains, then, as in the first case, merely to record the armature's rotations by means of a train of gear wheels operating pointers on a dial.

Watt-hour meters of modern make are very accurate instruments. To secure

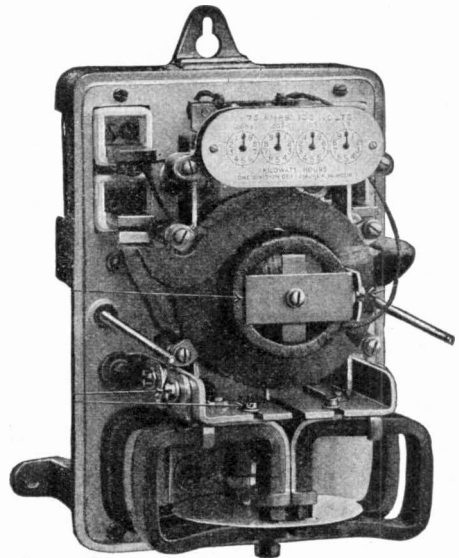

FIG. 3. WATTMETER ASSEMBLED.

greater accuracy the revolving shaft is mounted on jewel bearings. The Westinghouse service meters bear this statement of their accuracy: "This meter registers directly in kilowatt-hours. It has been compared with a standard meter in the factory of this company and registers within two per cent plus or minus from two per cent of full load to 50 per cent overload, which overload it will carry continuously."

All meters, however, should be tested once or twice a year. The best way to test meters on the premises is to connect an accurately calibrated watt-hour meter in series with the house meter and thus compare the readings of the two. A rough method of testing which may be employed by the customer is to use a given number of incandescent lamps for a given time and compare the calculated energy required with that registered by the meter. Since each 16 candle-power lamp consumes about 55 watts, the calculated energy consumption would be:

Number of lamps  $\times$  55  $\times$  hours burned = watt-hours.

We must now learn to read the number of watt-hours registered on the meter dials. This is very much like learning to read time on a watch. The watch has but one dial though it has two pointers, one of them being geared to rotate  $1/12$  as fast as the other. Since meters deal with larger numbers than a watch, they need more pointers. To place four or five pointers on a single dial would make the reading needlessly confusing, hence a separate dial is provided for each pointer. The pointers are geared to rotate in a ratio of tenths—that is, each successive pointer (going from right to left) rotates  $1/10$  as fast as the preceding one.

In the upper row of dials in Fig. 4 the pointer on the first dial at the right has made half a rotation and moved through five spaces, each dial being divided into 10 spaces.

The pointer on the second dial moving  $1/10$  as fast, has moved through  $1/2$  space; the third pointer has moved  $1/10$  of  $1/2 = 1/20$  space; while the fourth pointer has moved  $1/10$  of  $1/20 = 1/200$  of a space.

When the first pointer has moved through 10 spaces (indicating the consumption of 10 watt-hours) it is again at 0, so that one could not see that it had moved at all, but the pointer on the second or ten's dial is now pointing to 1. So also when the pointer on the first dial has made 10 complete rotations (passed over 100 spaces) the pointer on the second dial has made one complete rotation and both are at zero, but the pointer on the third or hundred's dial

is pointing at 1, thus indicating the consumption of 100 watt-hours of electric current.

Generally the pointers will not be pointing directly at a figure, but somewhere between two. It is always the figure which the pointer has left and not the figure which it is approaching that is to be taken.

The second row of dials in Fig. 4 gives a reading of 0726, thus indicating

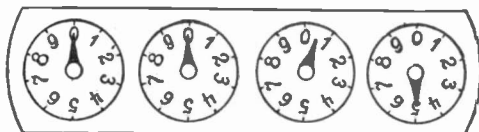

Reading 5.

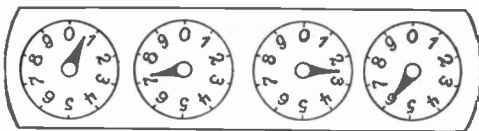

Reading 726.

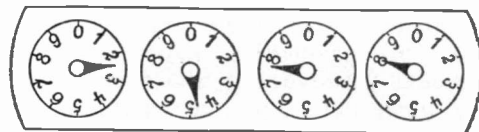

Reading 2,478.

FIG. 4. HOW TO READ THE METER.

the consumption of 726 watt-hours, while the third row gives a reading of 2478, indicating a consumption of 2,478 watt-hours or 2.478 kilowatt-hours. Some meters have the dials calibrated to read directly in kilowatt-hours. In some ways this is more convenient because most of the bills are made out in kilowatt-hours.

As a rule the bills are rendered monthly, but the meters are not turned back to zero at the beginning of each month. The amount consumed in one month is obtained by subtracting the previous month's reading from the present month's reading.

When you receive your next bill for electric power you may have at least the satisfaction of checking it with your meter's reading before paying out your money for it.

## HATCHING CHICKENS BY ELECTRICITY.

Nature has a way of doing things in such an apparently simple manner that men are inclined to think they can easily accomplish the same results by artificial means and encounter no great difficulty. It appeared to be so easy for the old hen to sit three weeks on a dozen eggs and hatch a brood of chickens that some

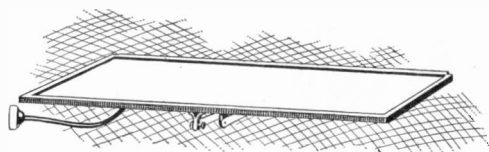

FIG. 1. THE "ELECTROPLANE."

one evolved the idea of making an incubator which would do the work of a dozen hens. It was then found that the main object in the life of a hen was not such a simple matter after all. Among other things, there could be very little variation from "hen temperature" or there would be trouble. This temperature of 103 degrees, Fahrenheit, must be maintained during the whole period of incubation, with the exception that for short periods, corresponding to the time that a hen is off the nest, it may drop a few degrees. So, after all, it was no simple matter to devise a satisfactory incubator.

To keep the temperature constant with the old-style incubator is a problem, and added to that there is the odor from the oil lamps, the frequent attention, refilling of lamps, etc. Naturally, therefore, the question arose, How can we make an electric incubator which will keep an even temperature and require no attention? After much experimental work the problem was solved, and a complete electrical equipment designed, not only for hatching the chickens, but for brooding them until they are old and strong enough to care for themselves.

First in this unique chickens hatching system comes the "Electroplane," which is the trade name for an asbestos, metal-bound electrically heated and regulated diaphragm, designed for use in the upper part of the egg chamber. A sketch of this electroplane is shown in Fig. 1.

Underneath the asbestos plane is a heating coil, through which current from the ordinary lighting circuit is passed. The resistance of this coil of German silver wire to the passage of the current causes heat to be generated, which is transmitted to the asbestos plane, giving a uniform distribution of heat at all points above the eggs.

To keep the temperature constant a "thermostat" is included in the circuit. This thermostat is made of two metals of different expansive properties when under the influence of heat. These metals are fastened rigidly together, so that when they are heated one expands more than the other, and the solid strip begins to curve into a bow shape. When the temperature reaches a certain point the metal strip bends sufficiently to separate two contacts in the circuit and shut off the current. Then, the current

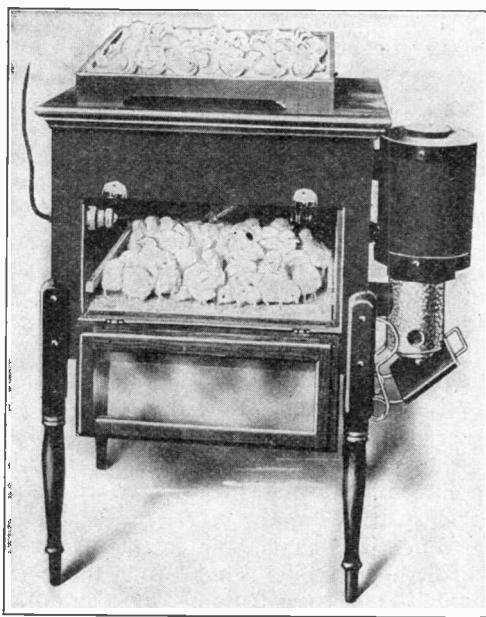

FIG. 2. THE "ELECTROBATOR."

being shut off, the temperature gradually falls and the strip of metal straightens out till the contacts touch again and current once more flows. This process goes on constantly, but so delicate is the apparatus that the temperature varies but a part of a degree.



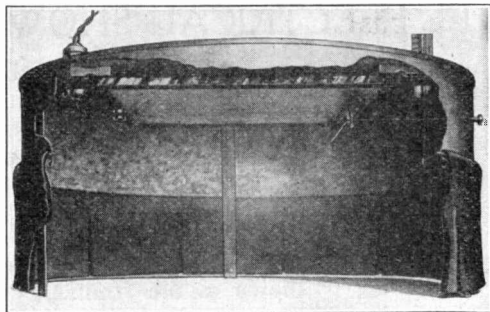

FIG. 3. ADAPTABLE ELECTRIC HOVER.

The Electroplane is so constructed that it can be placed in an ordinary lamp-heated incubator and electrical operation secured with very little trouble. Or it may be used in a special incubator known as the "Electrobator," shown in Fig. 2. Almost no attention is required, and the temperature remains practically constant day and night.

After the chickens are hatched it is

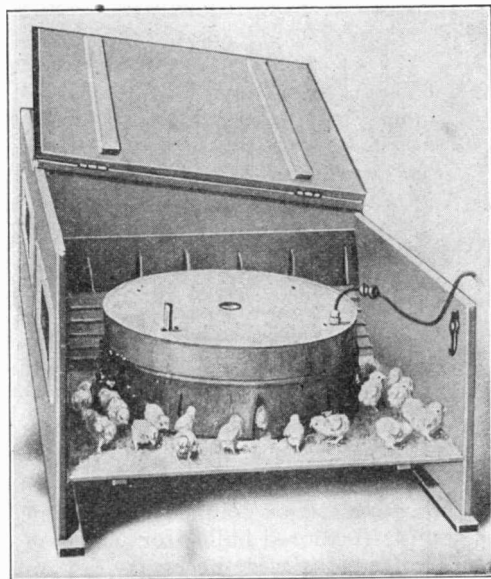

FIG. 4. ELECTRIC HOVER AND ENCLOSURE.

necessary to use an artificially heated brooder or hover. This is provided for by the adaptable electric hover shown in Fig. 3. In the illustration one side is cut away to show the interior. It consists of a circular, asbestos-lined casing, which stands on four legs, the open

part at the bottom being covered with a curtain, so that the chicks may run out and in. In the upper part is hung one of the Electroplanes, as described above, with temperature regulating thermostat. Another view of the hover is shown in Fig. 4, where it stands in an enclosure in which the chicks may exercise.

#### HARNESSING THE HEAT OF ELECTRICITY

It is an impatient, speed-mad age, and electricity, quicker even than light, is the one agent to faithfully keep the pace a hustling people has set. This insatiable demand for speed has done more to further the wonderful development of electricity in the past few years than any one thing. In this "press-the-button" age both necessities and luxuries are demanded at the touch of a finger.

The mails are too slow, and electricity must carry the messages through the air over the seven seas!

Steam power is too cumbersome, and electricity must bear the burdens!

Oil and gas are too inconvenient, and electricity must give light!

Last of all, coal has been pronounced archaic and electricity must give heat!

There is no time to waste over slow fires. The demand is for instantaneous heat and plenty of it. Electricity, which has answered all the problems of speed, has been called upon and the result is a long list of electric radiators and electric heating and cooking devices.

No more mysterious source of heat can be imagined than that afforded by electricity. Without flame, smoke or gases it is ready in an instant and can be regulated at will from a slight warmth to the carbon-melting temperatures of the electric arc furnace.

Evidence that electricity as a source of heat is taking a very important place in this impatient world is that the Eagle Hotel, in Grand Rapids, Mich., has been equipped with luminous electric radiators.

A St. Louis druggist prevents selfish customers from monopolizing the free telephone by installing a switch in the telephone wire, and placed behind the prescription counter. This can be opened so as to prevent the use of the telephone by the "long-winded" offender.

## SIGHTS OF THE LOUISVILLE ELECTRICAL SHOW.

The city of Louisville and her business institutions have made a remarkable demonstration of the advancement which has been made in the application of electricity. The Southern Electrical and Industrial Exposition which was held April 12th to 24th was the first big electrical show to be held in a southern city, and it is expected that the results of the demonstration will be far-reaching in their effect upon the electrical development of the South. To enter the great armory, canopied with color and shim-

electrical clock one hundred feet high. On the north wall of the building was probably the largest oil painting ever hung, being a panoramic view of New Albany and Jeffersonville, Louisville's two largest suburbs.

The spectacular feature of the show was the electric clock above mentioned and which is shown in the frontispiece of this issue. It is the invention of H. C. Korfhage, a jeweler of Louisville. The proportions of the clock were truly amazing to the spectator. It was 48 feet

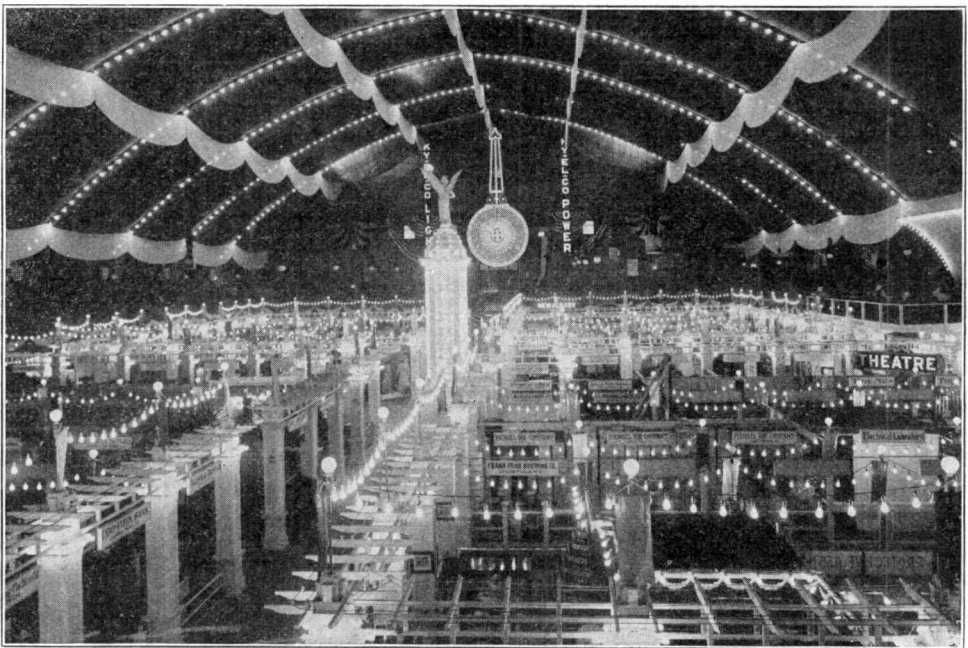

THE SOUTHERN ELECTRICAL AND INDUSTRIAL EXPOSITION AT LOUISVILLE.

mering with the gleams of thousands of electric lights was to see what a modern city may be made at night.

Numerous exhibitors, representing various kinds of electrical devices, occupied the gaily decorated booths. A center tower, forty feet high, symbolized the Goddess Electra, and she held aloft an electric lamp, which gleamed into the lofty ceiling of the great building, entirely roofed over with tightly drawn green cloth, out of which sparkled hundreds of lights in well ordered rows. On the south wall of the armory was an

in length,  $23\frac{1}{4}$  feet in width and weighed over 3,000 pounds. It contained 5,500 multi-colored bulbs, for which 11,000 connections were necessary.

The number of lights used on this single clock, when analyzed, brings forth more startling comparisons. They number more than the entire amount of incandescent globes used to illuminate the cars of the whole street car system of the city of Louisville and would light brilliantly 275 residences or stores, allowing 20 lights to each.

The dial of the clock is 20 feet in di-

ameter and differs widely from the ordinary clock dial, in that although it indicates hours, minutes and seconds, it has no hands. The time by minutes is indicated by 60 series of lights, each containing 32 electric globes and radiating from an ornamental centerpiece to the outer edge of the dial. One series remains lighted for one minute and shows the position of the minute hand as indicated in the picture. Shorter rows of different colored lights indicate the hour hand, and these light up at five different points during the hour. The seconds are shown by 60 lights placed at equal distance around the extreme outer edge of the face. The hour figures are about three feet high and are outlined in colored globes. Each second the illumination in the outer circle of lights moves forward one, and when the entire clock has been encircled the lights indicating the minutes also advance; and the hour hand makes its slow journey at twelve-minute intervals.

Despite the huge proportions of the clock it will keep absolutely correct time even to the second, and this is the first time that such minute accuracy has been attempted in so large a clock. The motive power for the pendulum movement is supplied by a small magnet at the side and near the top of the pendulum, but this is not visible from the floor, and the impression produced is that the pendulum is operated by its own momentum.

#### AN IMPROVED ORGAN BLOWER.

One of the interesting applications of electric motors is the use of this power for church, concert and house organ blowing. It has long been recognized by organists and builders that for organ blowing a centrifugal fan is far superior to feeders operated by any other method, because of the absolutely steady pressure developed, which greatly enhances the quality and purity of tone of old and modern organs.

Until recent years this type of machine could not be used because of the excessive noise of the ordinary trade fan blower, which formerly was the only machine of this character on the market.

The Kinetic blower has been designed

expressly for organ blowing, and has effectually overcome this difficulty. The machine consists of several fans mounted on one shaft, by the rotation of which the required air pressure is generated, each fan adding the pressure developed by itself to that of the preceding fan.

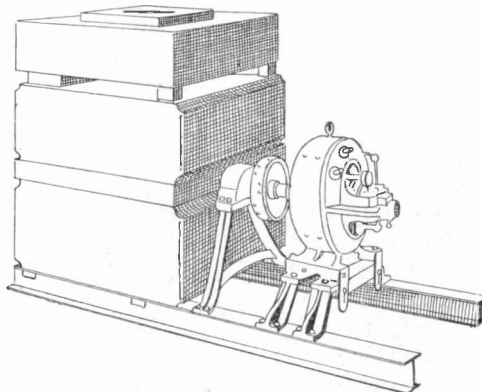

AN IMPROVED ORGAN BLOWER.

These fans are enclosed in a case and the whole mounted on an I-beam base and direct connected or belted to an electric motor; motors in all cases being unenclosed. It can be run equally well by either direct or alternating current motors. No care is required by either blower or motor other than filling the oil cups every few weeks.

#### MOTOR OPERATED HAND DRILL.

Many a laborious drilling operation may be performed with comparative ease by the motor operated hand drill which can moreover be used in more inaccessible places than the ordinary

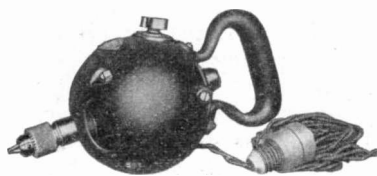

MOTOR HAND DRILL.

breast drill. The motor is inclosed in a spherical casing provided with a handle. The drill holder is mounted on the end of the motor shaft and a flexible cord and plug for attachment to a lamp socket completes the apparatus.

# HOW TO DO ELECTROPLATING.

BY J. R. WILSON.

## PART I.

Electroplating is the process by which a metal or alloy (mixture of two or more metals) held in solution by a liquid is deposited electrically on a prepared surface. From the solution the metal is thrown on to the object receiving the deposit and at the same time an equal quantity is dissolved from metal plates (called anodes) suspended in the solution. Hence, although the solution is constantly robbed of metal, it is fed by the anodes, which must always be of similar metal to that held in solution, so that the strength of the solution is maintained.

The first consideration in installing an electroplating outfit is the selection of a light and well ventilated room and if possible the separation of the room into two sections—one for the polishing work and one for the plating work. This should be done because the dust and lint from the polishing operation is liable to ruin the plating solutions which must be kept clean. If it is not practical to separate the rooms a little care in keeping the solutions well covered when not in use will be satisfactory.

### PREPARATION OF THE "WORK."

Before an article can be plated it must be perfectly clean and smooth. This means that the surface as well as being free from scratches must be free from grease or grime, otherwise the plate will not adhere. This is an essential point to bear in mind. Do not become too enthusiastic to see the work finished, for here is where the plater will fail more often than at any other stage of the work.

Assume, now, that the object to be plated, which is termed "work," is a rough iron or steel casting. Its surface is full of sand and scale which can be removed only by immersing in an acid solution. This is called "pickling," and to do it, secure an earthenware jar (it will be necessary to have several of these for different solutions) large enough to hold the largest piece of work that will require plating. Label this

jar "acid dip" and make up the following solution:

Sulphuric acid (oil of vitriol) . . . 1 part  
Water . . . . . 4 parts

In all the operations it is necessary to use good, clean, soft water (rain water is the best); hard water makes all the solutions difficult to handle. To mix the above, place the water in the jar and pour the acid in gently, stirring the mixture constantly. Remember never to pour water into the acid as violent heating takes place and possible spattering of the acid.

Immerse the work in the acid solution, suspending it by wire from the edge of the jar. This may require 30 to 90 minutes. Remove from time to time and if the scale and sand loosens readily when brushed with a stiff wire brush and wet pumice it has been pickled sufficiently. If it does not come off readily reimmerse. This must not be overdone, however, as the casting itself will be attacked by the acid and a porous surface result which it is useless to attempt to plate and might as well be thrown away.

Having removed the crust and sand as directed above, the work is ready to be polished.

All castings of whatever metal require pickling before polishing. If the work is a machined piece of course this is neglected. If the casting is copper, brass or bronze, then it is best to pickle the casting in dilute muriatic acid (muriatic acid, 1 part; water, 15 parts), next remove the scale and then clean and brighten it by dipping in the following solution:

Sulphuric acid . . . . . 50 parts  
Nitric acid . . . . . 100 parts  
Common salt . . . . . 1 part  
Lampblack . . . . . 1 part

Mixed in the order named.

Rinse well in hot water and it is ready for the polishing wheel.

A polishing outfit consists of a lathe, which should revolve at a speed of 2,500 to 2,800 revolutions per minute, polishing wheels of various sizes and materials, emery, glue and a water jacketed glue pot.

The most preferable lathe is that operated by power by means of belting from countershafting or by direct connected electric motor. If neither electric or steam power is available, a good foot-power lathe of the latest type gives very satisfactory results. Having secured a lathe, fasten it firmly to the floor or bench, as very much vibration retards good work.

Polishing wheels are made up of numerous layers of canvas glued or ce-

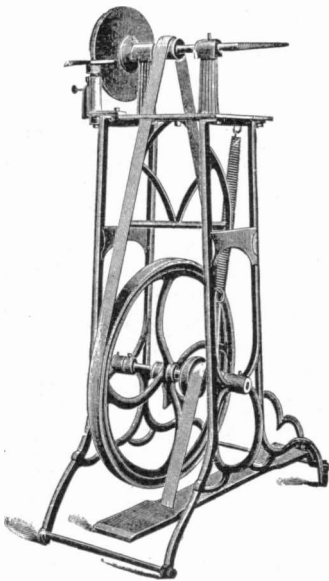

FOOT POWER POLISHING LATHE.

mented together; or may be of felt or of wood, the latter being faced with leather. The selection is a matter of preference. If the work is a flat piece with edges that must be sharp and square the last named is preferable.

The wheels before they can be used must be faced with emery. As each work must be gone over on three or four different grades of emery, it will be necessary to have the following grades, each kept in its own long shallow box and labeled: No. 60, 80, 100, 120, 140, 180.

Prepare a good running glue—the best glue must be procured as ordinary glue will not hold the emery—and apply it to the face of the wheel with a brush. To do this conveniently, place a snug fitting mandrel (a rod or stick) through the center hole of the wheel and rest

the projecting ends on two parallel supports so that the wheel will be free to turn. Roll the wheel in No. 60 emery until it presents a well covered surface and set aside to dry. Repeat the operation with each wheel using a different grade of emery for each. Do not allow the different grades of powdered emery to become mixed. Label each box plainly.

The first step in the polishing process is called "roughing out." If the work is iron or steel use a No. 60 emery; if brass or any other soft metal use No. 80 or No. 100. Place the wheel on the spindle of the lathe and start up the power, always having the wheel turn towards the operator. If the wheel is not properly balanced it will wobble or pound. In this case shut off the power, remove the wheel and using a mandrel as directed for gluing, rest the wheel on two parallel and horizontal knife edges. The wheel will turn until the heaviest side is downward. Tack or screw a small piece of lead on the wheel directly opposite the part that points downward. Continue this till the wheel is balanced.

Hold the work at about the middle of the lower front quarter of the wheel. It should be held firmly in the hands, using a gentle and uniform pressure, and when applying or removing the work do so abruptly and firmly; otherwise the work may be thrown from the hands. The work must be kept "alive" on the wheel; that is, not allowed to stop at one place or excessive grinding will result. This must be remembered especially when buffing after plating.

Taking, for example, No. 60 wheel for the roughing out, when the surface has been gone all over and nothing but No. 60 marks show, use the next finer wheel (in this case No. 80) and repeat the process until only No. 80 marks show. Then use the next finer wheel and before applying the work apply a little tallow or oil to the revolving wheel with a cloth swab. This is called the grease wheel. Before this wheel can be used again on other work the grease must be removed by applying a piece of lump pumice to the revolving wheel. It is best to use a wheel for this step that has been worn smooth.

For softer metals than iron or steel it is best to use the finer grades of emery. Remember that no scratches must show. The surface must be perfectly smooth as plating covers up nothing in the way of defects; in fact it makes them more prominent.

To get the brightest polish or surface on metal some prefer to further polish the work on a felt or cotton flannel wheel (the latter is made of several sections of cloth each section containing several layers sewed together) using a polishing composition such as tripoli or rouge. This is not essential, however. For the amateur it is best to buy the cloth wheels outright than to try to make them.

For those who cannot afford to provide a polishing lathe the work can be done by hand just as well as it was in the days before power was used. For the removal of scratches, etc., provide lumps of pumice and face them up by rubbing on a flat stone. With these lumps dipped in water go all over the scratched surfaces thoroughly until all scratches are obliterated. Then go over all the work until the surface is uniform. Rinse and dry the work. Then go over it again using emery cloth; this rubs out scratches made by the pumice. Scour off all traces of emery with a soft hair brush and water, rinse well and go over the surface again using rotten stone to rub out the emery marks. The stone must be dipped frequently in water. When the surface appears quite smooth, finish with a piece of buff leather smeared with fine cut crocus, tripoli, or rotten stone and oil.

Polishing wheels six to eight inches in diameter and one to  $2\frac{1}{2}$  inches thick are best to use instead of the larger wheels, especially with a foot power lathe or a very small bench lathe.

The work now presents a magnificent surface but it would be a grave mistake to attempt to plate it yet. The surface during the above operations has become smeared with grease and oil that is almost imperceptible. Even the slight amount of oil coming from the hands will cause the plating to peel off.

To make the surface chemically as well as mechanically clean is the next essential step. To do this provide an old

iron kettle or water jacket of a glue pot and a gas stove or plate. Make up a hot caustic potash solution by dissolving one-half to one pound of potash (lye) to each gallon of water used. Maintain this at boiling temperature and having fastened a sling wire to the work (this is done by twisting a piece of wire to the work and bending into shape of a hook) suspend the work in the solution from the edge of the tank. This will effectually remove the grease or oil. When the work has been in this solution 10 to 15 minutes remove, rinse in clean water and then scour it with pumice

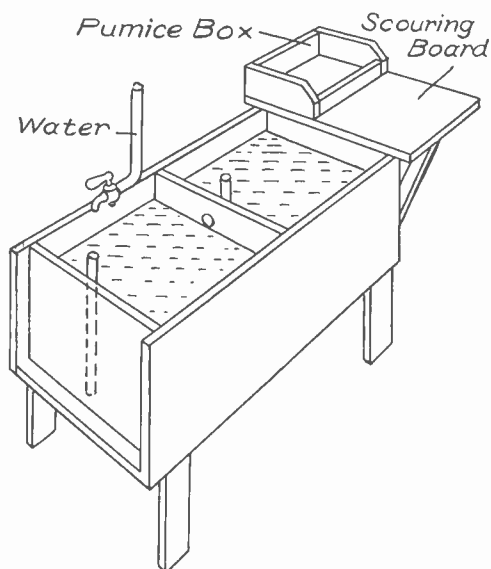

SCRUBBING AND RINSING TANK.

stone using a stiff bristle brush. If the metal is brass or any other soft metal, Vienna lime or whiting is sometimes preferred to pumice, as it is not so liable to scratch. Rinse well in water and if the latter runs evenly over the surface (that is, does not separate) the surface is clean. Be sure this is the case.

Now dip the work, if it is iron or steel, for a moment in an acid solution composed of one part muriatic acid to eight parts of water, rinse again in clear water to remove all traces of acid and transfer the work without delay to the plating vat. If the work is any other metal than iron or steel then in place of the acid dip a cyanide dip is used. This is pre-

pared by dissolving one-half pound of chemically pure cyanide of potash to a gallon of water, and used cold. Keep this in a glazed earthenware jar (the same as those for the various acids) and label it "cyanide dip." Keep all dips and pickles covered when not in use.

For the scrubbing and various rinsing operations it is essential to have plenty of good, clean, running water. Some convenient arrangement must be devised. As a suggestion, provide a wooden vat and separate it in two divisions as shown in the cut by placing a partition across the center. Have a faucet over one division and water running into it constantly. Near the top of the partition a hole should be bored and the water from the above division will flow into the second division. The waste pipe in the latter must have a standing overflow extending not quite to the level of the hole in the partition. Nail a board across the end of the tank farthest from the first division. This will serve for the scouring board and also on which to keep a box of pumice or whiting. After scrubbing the work on the board it is then dipped in the overflow water (second division) and then rerinsed in the other division, in clean water. This clean water will also answer for the various other rinsings mentioned.

(To be concluded.)

#### EXPLAINING THE "SHORT CIRCUIT."

In this electrical day one hears and reads a great deal about "short circuits" without having the slightest idea of what the expression means.

The "short circuit" means simply that wires have become crossed or connected so as to form a by-path or shunt of comparatively low resistance through which so much of the electrical current passes as practically to cut out that part of the circuit through which the current originally flowed. In other words a "short circuit" has replaced the normal circuit which may be considered as a "long circuit." The cutting out of the resistance of the long line permits the power to rush over this path of low resistance and if the apparatus was not protected by the circuit-breaker, the electrical machinery would do itself serious harm.

To prevent serious effects from accidental short-circuits of electric lighting wires in buildings a "fuse" is inserted in the circuit just inside the building. In case a nail or some other falling object short-circuits the electric wires in the house this "fuse" blows out; i. e., melts out, and throws the circuit open so no electricity can flow through the wires in the house until the "short" is found and corrected.

#### TELEPHONY IN THE SILESIAN ALPS.

The mountains of Silesia are noted for their heavy frosts and sleet storms. Trees, rocks, telephone and telegraph poles, and even houses, are enveloped in a thick coat of ice and snow, so distorted and grotesque as to leave their true form scarcely recognizable. The illustration presented here gives a good idea of the

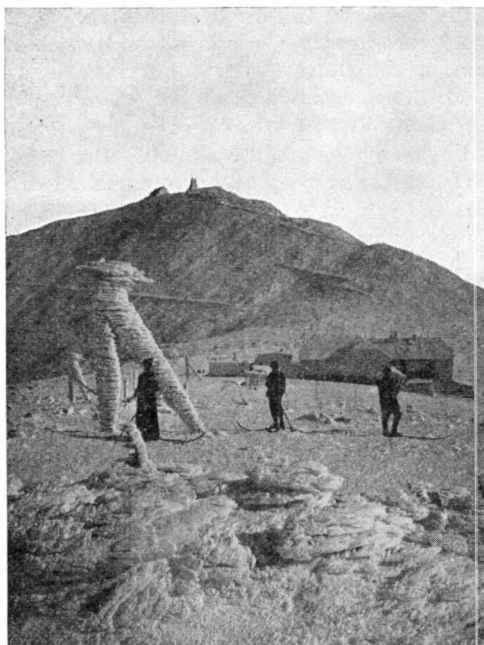

ICE FORMATION IN THE SILESIAN ALPS.

appearance of the telephone poles at such a time. The telephone lines and systems in Silesia are owned by the government, which removes the wires from their overburdened poles during the winter and stores them out of harm's way until spring.—Telephone Engineer.

# DISTRIBUTION OF ELECTRIC CURRENTS.

BY JACOB GLOGAU.

The two common systems of electric distribution are known as (1) the constant current and (2) constant potential. In the constant current system, as the name implies, the current is constant and as the resistance is variable the voltage rises and falls. In a constant potential system the voltage remains constant and as the resistance varies the current rises and falls.

**The Constant Potential System.**—This system is used for interior work because there is not much danger on account of the low voltage used for this system. The voltage generally used is 110, 220, and no higher than 550 volts, and in the regular work 110 volts is the standard.

The size of the conductor used is determined by the amount of current it can carry without over-heating, and secondly the drop in potential allowable for economic lighting. The second condition is the most important as the first condition is reached after the second one has been determined.

Following is a table showing the safe carrying capacity of interior wires:

Size of wire. No.	Circular Mils.	Current in amperes. Rubber Ins.
14	4.107	12
12	6.530	17
10	10.380	24
8	16.510	33
6	26.250	46
5	33.100	54
4	41.740	65
3	52.630	76
2	66.370	90
1	83.690	107
0	105.500	127
00	133.100	150
000	167.800	177

When laying out the design for the distributing system care should be taken to obtain a symmetrical system. If this is not followed out some illumination will be lost, the lamps will not receive the right amount of power and will burn dim.

One of the most used systems is that known as the three-wire system. There are a great many advantages in this system, among them the saving of copper wire, which forms the greatest item in all kinds of electrical work. The higher

the voltage transmitted the less copper is used to transmit it, thus a 110-volt lamp requires one-half of an ampere, but if we were to use a 220-volt lamp then the lamp would only consume one-fourth of an ampere, thus reducing the size of the wire to one-half the size, thus it follows that there is a great saving of copper.

In the three-wire system the lamps are arranged so that two 110 volt lamps, requiring twice the voltage but equal the current of one lamp, are practically con-

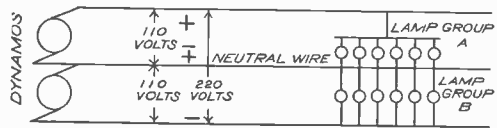

FIG. 1. THE ORDINARY THREE-WIRE SYSTEM.

nected in series across the two outside wires. Fig. 1 shows an ordinary three-wire system.

The middle wire is called the neutral wire, the outer wires being generally made about one-half the size that would be required for the same number of lamps burning on a two-wire system. Theoretically the neutral wire may be one-half the size of the outside wires, but in practice the three wires are generally of the same size, so as to permit one-half of the lights on if the other half is not burning. Looking at the diagram, suppose all of the lamps to be turned on. Current will flow from the positive side of the circuit through the two groups of 110-volt lamps in series to the negative side of the circuit. None will therefore flow back through the neutral wire to the dynamo, and the circuit is said to be balanced. Suppose, however, one of the lamps, as in group (B), is turned out. There is then more current flowing through the lamps of group (A) than can pass through the lamps (B) to the negative side, so the surplus current (equal to the current of one lamp) flows back to the dynamo through the neutral wire. Turning out more lights in group (B) correspondingly increases the current on the neutral. In this manner we are able to burn the ordinary 110-volt



lamps on what virtually amounts to a 220-volt circuit with a consequent saving of copper as explained above.

The foregoing is the principle upon which the three-wire system operates, although there may be used what is known as a "compensated" generator; one machine, to take the place of the two dynamos.

The Constant Current System. This system is used for outside work only owing to the high voltage used, the voltage being from 550 to perhaps 3,000 for arc lighting. The lamps used in this system of lighting are connected in series. Fig. 2 shows a series circuit (con-



FIG. 2. A SERIES CIRCUIT.

stant current) for 550 volts with five 110-volt lamps in series.

In this system the capacity of the wires in the circuit is equal to the current necessary to feed one lamp as all the lamps in the series circuit require the same amount of current, thus in a 550-volt circuit there are five 110-volt lamps, the combined amperage being one-half ampere.

The system is very simple, but there are a great many objections which have to be overcome, first, as each lamp takes the same current, as the number of lamps increases the voltage also must be increased and then if one lamp is extinguished the whole circuit becomes dead and all the lights go out. In the arc lighting system there may be 50 lamps on the circuit, the current used being about ten amperes and the voltage about 2,500.

When series lamps are used they must be equipped with an automatic cut-out so that if for some reason one lamp breaks the circuit will not be disturbed. The circuit of the lamp is therefore divided into two parts, one path going through the filament of the lamp and the other path going to the two terminals; between these terminals there is a piece of paper. If the lamp breaks the voltage due to the electromotive force of the system will pierce the paper and the two terminals will make contact, thereby re-establishing

the circuit. In trolley cars the voltage used is 550 volts, thus requiring the connecting of five lamps in series, the only objection being as stated before that if one lamp goes out the other four will also go out.

#### NOVEL BOTTLE WASHER.

Small dairies, carbonating and bottling establishments usually have a considerable number of bottles to clean, although probably not enough to warrant the installation of an expensive automatic bottle washer. To meet this need a small motor driven bottle washer has been developed. It consists of a 1/5 horsepower motor with cast iron bracket for attaching to a tub or sink. A specially designed shaft receives the brush spindle, the end of the motor toward the brush being provided with a special housing to protect it from moisture.

In operation the tub or sink is partially filled with water and the bottles to be

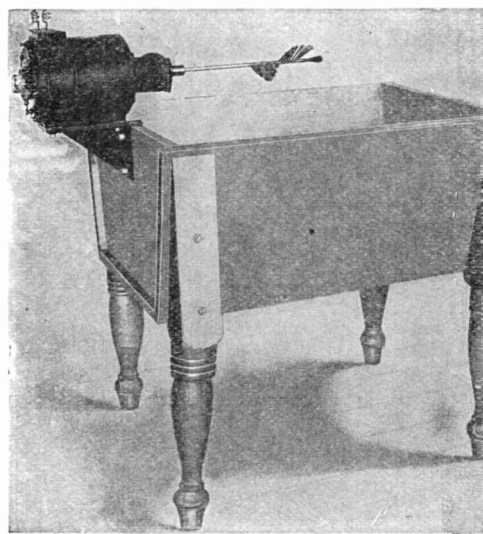

ELECTRIC BOTTLE WASHER.

cleaned are immersed within convenient reach of the operator. The rapidly revolving brush is inserted in the mouth of each bottle in turn, leaving the bottle partially or entirely filled with water during the process. If the bottle is held firmly and a slight pressure exerted to

force the bottom against the brush, entirely satisfactory results may be obtained.

Inner globes of enclosed arc lamps may be easily and thoroughly cleaned by this device and central stations operating 50 or more lamps will find that the resultant saving of time and labor will in a short period repay the small amount invested in one of these outfits.

### TUNGSTEN LAMPS FOR STREET LIGHTING

High efficiency of the new tungsten lamp has made the incandescent lamp a serious competitor in the field of street lighting. Of late years we have seen the incandescent lamp used for this purpose



STREET LIGHTING WITH TUNGSTENS.

only in very small towns, and even there the indifferent results secured with the old style carbon filament lamp were rapidly leading to its disuse in favor of arcs. With the tungsten, however, about three times the light can be obtained

from the same amount of current, so an old field of usefulness is being revived for the incandescent lamp.

The tungsten lamp for street lighting is burned on what is known as the series system, which requires only one wire. A special apparatus has also been devised to keep the current constant so as not to burn out the delicate filaments. Sometimes the lamps are burned in clusters, sometimes singly. This enables the lighting to be adjusted to the requirements of different localities. The system has even been so far developed

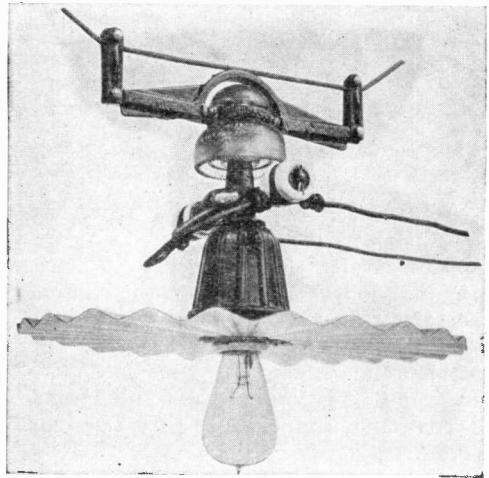

TUNGSTEN STREET LAMP AND REFLECTOR.

as to enable the tungstens to be burned in conjunction with series arc lamps, using one circuit for the two, so an arc lamp may be burned in one spot, where a very strong light is desired, and farther on in the same circuit, a tungsten may be connected, where less brilliancy is needed.

One of the pictures shows a street in an outlying and rather select district, which is lighted with a line of tungstens. With neat poles and ornamental brackets they do not detract from the beauty of the surroundings. The second illustration is a near view of one of the lamps, provided with radial wave reflector and also with means for raising and lowering the lamp where center span suspension is used, as in the case of the ordinary arc lamp.

**HANDLING 600 TONS OF ORE IN AN HOUR.**

Six hundred tons of iron ore handled in an hour, and by one man. It is almost unbelievable. Yet it is accomplished daily at the great sheet and tube plant in Youngstown, Ohio, and is but another example of the part electricity plays in industrial works.

A steel bridge hundreds of feet long spans the ore yard and serves six blast furnaces. Adjacent to the furnaces are storage bins under which the larry cars operate to conduct the ore from the bins to the furnace skips. One supporting leg of the bridge rests on this bin structure, and the other is carried by a concrete wall 26 feet high.

The bridge with its cantilever exten-

sions travels back and forth from one end of the bridge to the other; also operated by a motor. The grab bucket is raised and lowered by motors, and with its mouthful of ore weighs 50,000 pounds. All these operations are controlled to a nicety by the man in the traveling cage.

**PRODUCTION OF NITROGEN FERTILIZER.**

It has been calculated that the amount of fertilizer in the form of natural nitrates still available is less than that required for the world's supply for the next 20 years—that is, assuming that no new sources shall be discovered. It is this fact which has brought into such prominence the necessity of



MOTOR OPERATED TRAVELING BRIDGE FOR HANDLING ORE.

sions is approximately 460 feet long. The iron ore is brought within reach of the bridge by transfer cars, which operate between the car dumper a thousand feet or more from the ore yard and run on tracks carried by the bin structure. These transfer cars discharge their load through an open track onto baffle plates, which form a temporary pile along the bin side of the storage yard. By means of the grab bucket the bridge gathers up the ore and places it in storage or removes it from the storage pile and delivers to transfer cars for distribution into various compartments of the bins, from which the supply for the blast furnaces is drawn as needed.

The bridge travels along the tracks propelled by two 52-horsepower motors.

obtaining a fresh supply of nitrogen compounds, and has consequently led to the erection of large plants for fixing the nitrogen of the air.

In spite of the many attempts which have been made to fix atmospheric nitrogen, little pioneer work in the way of research has been done to assist the inventor to obtain the best yield from any form of apparatus.

As pointed out in a paper read before the Institution of Electrical Engineers in London, by Cramp and Hoyle, most inventors have attempted to fix the nitrogen of the air by the use of very high temperatures—that is, by really attempting to burn the nitrogen in the presence of oxygen to  $\text{NO}$  and  $\text{NO}_2$ , usually by means of the electric arc. In

some cases, instead of burning the gases direct, union has been obtained by means of a third substance, such as calcium carbide.

Each succeeding designer has decided upon some point in the form of the discharge to be used, which he believed to be the most important factor in determining the production of the gas. Thus one believes that it is most essential to get the current of air into very intimate relationship with the flame (Neville and Guye). Another considers that the essential condition is to have no continuous flame, but a very large number of arcs (Kowalski and Moscicki). A third thinks that not only is a large number of arcs necessary, but that these should be also very long and very thin (Bradley and Lovejoy). Others attempt to combine these results with effects of very high temperature of the gas followed by very sudden cooling; and, again, some believe in the effectiveness of temperature gradient alone, whether the arc be large or small.

The Frank and Caro process consists in the forming first, in an electrical furnace, of calcium carbide, and then passing nitrogen over this material when at a red heat, the result being that the nitrogen combines with the calcium carbide forming cyanamide. It is essential for this process that the nitrogen should be free from oxygen, and this is obtained by fractional distillation of the air (Linde) in the manner now used for producing oxygen. It will be seen from this that oxygen is given off as a valuable by-product.

In all the processes except that of Frank and Caro, the object is to produce  $\text{NO}_2 + \text{NO}$ , which, when combined with water, gives a mixture of nitric and nitrous acids. From these is then usually produced nitrate of calcium, which is the fertilizer sold. In the last process the cyanamide is sold direct, and decomposes slowly in the presence of water, giving off ammonia, which is absorbed by the soil or taken up by the plants. It is worthy of remark that this substance assists the production of nitrifying micro-organisms, which themselves are germinated in large quantities and sold for use as active fertilizers.

#### MOTOR DRIVEN CASH REGISTER.

Utilization of an electric motor to drive a cash register is one of the latest departures. The cash register is only used for about one-half second at each operation and the number of operations made in a day is high at one thousand, so that the time the mechanism is actually in service is relatively short. It was, therefore, considered impractical to use a motor which would run continuously, it being desirable to have an efficient machine which would be able to start, do its work and stop in about one second. On

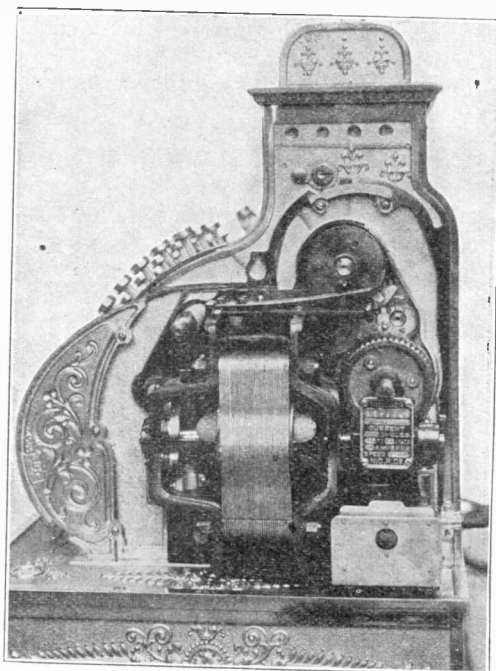

MOTOR DRIVEN CASH REGISTER.

direct current this would be a comparatively easy matter. It was thought best to utilize a motor which would be universal for all currents so far as the mechanism was concerned.

A motor was therefore designed with the idea of using the same armature for all currents involved and of making the magnetic field of such a nature that different voltages and frequencies could be compensated for in the field turns of the motor. This resulted in the design of a motor able to operate on any commercial circuit that will light an incandescent lamp. The registers are con-

structed to operate on anything from 40 to 500 volts direct current and on alternating current circuits ranging from 100 to 250 volts and frequencies from 10 cycles to 140 cycles per second, the actual power required of the motor being about  $\frac{1}{8}$  horsepower.

The object of utilizing electric motors on cash registers is to eliminate the turning of the handle of the register. Certain keys are depressed on the register representing the amount of the sale and then the key representing the clerk or person making the sale is pressed. This automatically turns on the current, operates the register, and then the motor stops; all this being done in about  $\frac{2}{3}$  of a second.

#### HILL CLIMBING BY ELECTRICITY.

School buildings always look very well, situated on the top of a hill, but untold toil is expended by the generations of students in reaching them. One enterprising institution has overcome this



HILL CLIMBING BY ELECTRICITY.

objection by building an incline railway with double track, cable hoist and cars capable of carrying 20 passengers up the steep grade.

One car goes up as the other comes down, one balancing the other. The drum which carries the cable operating the cars is driven by a 20-horsepower electric motor.

#### THE ROMANCE OF RUBBER.

Next to copper and iron, rubber is the most important material in the electrical industry. It is used extensively as an insulating material, being one of the best insulators of electricity in the world. Nearly all the wires that carry electrical current are protected with rubber insulation. Rubber prevents the electricity escaping through contact of the wire with other conductors; it prevents accidents, fires, and keeps the electrical apparatus from burning out and destroying itself.

Many primitive uses were found for this wonderful gum, but owing to its susceptibility to changes of temperature, which rendered it sticky and more or less fluid, rubber did not come into its own until early in the last century. At that time it was discovered, after a great deal of experiment, that by mixing sulphur with crude rubber and subjecting it to a high degree of heat, these former deficiencies were eliminated and a material was produced which was both tough and elastic, and would retain those properties under varying temperatures. This process of curing was called vulcanization and is the basis of rubber making today.

So great has been the development of rubber manufacture since that time that its products now exceed a value of five hundred million dollars annually.

Contrary to the popular impression, rubber gum is not derived from the sap. It is secured from a milky juice or latex which is found only in the bark. This latex contains a substance known as caoutchouc (the active principle of rubber), together with certain albuminoids, resins, etc., which upon the evaporation of moisture coagulate, forming a thick, spongy substance. The percentage of caoutchouc, in proportion to other ingredients contained in the latex, determines the quality of the rubber.

The regions from which rubber gum is secured form an irregular belt in the tropics and sub-tropics extending around the earth, the quality procured varying greatly according to the species of plant, the soil and the climate.

Rubber gathering in the Amazon River district is a hazardous and difficult

undertaking. The supply comes from wild trees scattered throughout dense forests, to which paths must be cut through the tangled and luxuriant undergrowth. Even then, the trees can only be reached during three to five months of the year, as throughout the wet season the forests are completely inundated. The climate is so unhealthy that white men cannot do this work and it is necessary to rely upon the native blacks, who at best are undependable and lazy. Their reluctance to join rubber gathering expeditions can readily be understood when it is remembered that out of a season's expedition perhaps only half will return alive.

When a rubber tree is found the native gatherer cuts a series of gashes into the bark with his machete, encircling the tree from the ground up, as high as he can reach. Cups are fastened to catch the latex as it oozes out. When a sufficient quantity is collected it is removed to the temporary hut where a dense smoke-producing fire is made of certain nuts and palm leaves. Then taking his wooden paddle the native dips it into the latex and holds it over the fire, turning it round and round until the latex coagulates. As soon as it is hard a new layer of latex is added and coagulated as before. This process is continued until the mass has grown too large for handling, when the paddle is taken out and the rubber set aside for export. The process of coagulation and fumigation with these specially selected nuts and leaves prevents decay and adds to the life and wear resistance of the manufactured product.

#### TESTING GRAIN.

Mr. Lyman J. Briggs of the Bureau of Plant Industry has invented a method of testing the moisture content of grain by its electrical resistance. The importance of the invention depends upon the desirability of knowing accurately the condition of grain in storage or in transit. An electric current is passed through the grain from one metallic electrode to another, and a form of the apparatus has been devised suitable for employment in cars and elevators. Thus far the experiments have been confined to wheat. Heat

plays an important part, since the resistance rapidly decreases as the temperature increases, and so the temperature has to be taken into account. The moisture content can be determined by this method with a probable error not exceeding three per cent. The electrical resistance of wheat containing 13 per cent of moisture is 50 times that of wheat containing 15 per cent of moisture.

#### TELEPHONE BOOTH FAN.

Everyone is familiar with electric fans and knows what a relief they are in the summer time for offices and for houses, but their use is being extended to another field where they are as much appreciated. To anyone who has occasion to use long distance telephone booths at all it will be a source of pleasure to know that an eight-inch fan is now on the market which can be used to keep the air in circulation in the booth.

These fans look like toys and some people have facetiously said they would

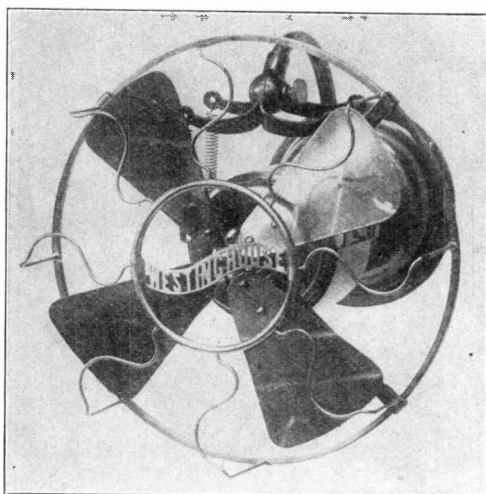

TELEPHONE BOOTH FAN.

do for a watch charm, but they are far from being mere toys. The blades spread but eight inches while the motor is not half that size. The motor is supported by springs from an arm screwed to the side of the booth, and may be tilted or turned through a wide range of directions. The springs pre-

vent any transmission of vibration from the motor to the telephone, and as the fan is noiseless the effect is to blow the impure air out of the booth and bring in fresh without in any way affecting the use of the telephone. As booths are usually provided with several small holes the air is circulated even with the door closed, but of course the best ventilation comes when the door is opened.

The fan is kept running all the time and consumes about one quarter of the current required by an ordinary 16-

candlepower carbon lamp. A regulating switch is provided in the base of the bracket from which the motor is suspended, by which the speed may be adjusted to three values, any one of which may be used for running indefinitely. The movement of the air is dependent upon the speed of the fan, as is the amount of power required. In some booths the lowest speed of the fan is sufficient. At the usual rates for power, 10 cents a kilowatt-hour, it would cost a cent and a half to run it all day long.

#### A VACUUM CLEANER THAT DISINFECTS.

Here is a vacuum cleaning machine which not only removes dust and dirt, but disinfects the room as well. It is of the electric portable type, run by a little motor deriving current through a flexible cord from the ordinary lamp socket.

The operating parts are all contained in a neat wood cabinet. In this cabinet



A VACUUM CLEANER THAT DISINFECTS.

is the motor which drives an exhaust fan, which sucks air through the long flexible tube. Inside the box, the dust is separated from the incoming air and then this same air is passed through a disinfectant, which has previously been saturated with a one per cent solution of hydroformaline or a five per cent solution of carbolic acid. It is possible in this way to thoroughly disinfect the air in an office or an entire house

#### LARGEST ELECTRIC WATER POWER PLANT.

The largest electric power station in the world will shortly be erected within fourteen miles of Johannesburg, S. A., under the terms of a contract officially announced, by which the Victoria Falls Power Company will supply electric power to practically all the mines in that great group.

**ELECTRIC CARS ON A BANQUET TABLE.**

Recently in San Francisco there was a convention of central station men and distributors of electric automobiles and their equipment. They met to discuss ways and means of furthering the use of electric vehicles, for the charging of automobile batteries is becoming an important line of central station business. During the convention a banquet was given to the delegates by one of the large

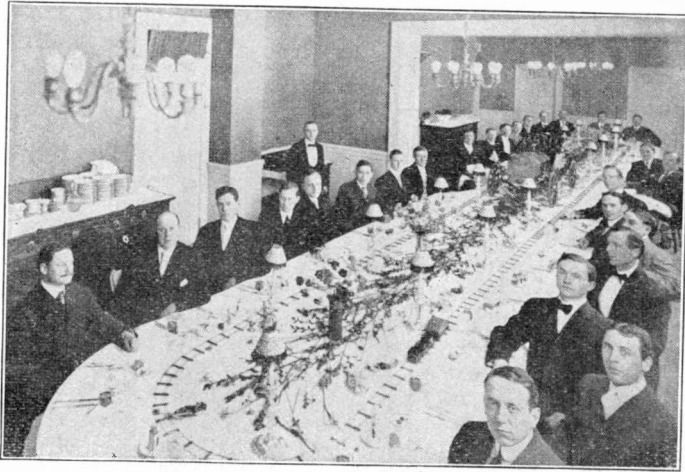

ELECTRIC CARS ON A BANQUET TABLE.

storage battery manufacturers, and a unique feature of the banquet was the installation of a miniature electric car running on a track extending entirely around the table. This car was operated by a storage battery and carried messages and cigars to the guests.

**KUCH'S QUARTZ LAMP.**

The mercury lamp, invented by Arons and greatly improved by Cooper Hewitt, is well known. Its distinguishing characteristic is its unpleasant blue-green light, and the peculiar shape of the lamp itself, which, for 110 volts, is over a yard long. The mercury vapor therein is in a very ethereal condition. Such a lamp will burn about 1,000 hours and take about 0.6 watt per Hefner candle-power. Dr. Küch has shown that with increased current this lamp shows at first decreased efficiency, but with still further increase of current there is a second increase in efficiency, so that it is possible, by taking advantage of this fact, to pro-

duce a more economical lamp. But here comes in the difficulty that at a temperature of 60° C. or 127° F. the glass tube of the ordinary mercury lamp commences to soften. To get around this difficulty Küch made a lamp out of melted quartz and increased the current still further. Naturally the temperature of the mercury rose proportionately, and the lamp, instead of working under vacuum had an internal pressure of one atmosphere.

Considerable economy was effected, as the current necessary was reduced from 0.6 watt per Hefner candle-power to only 0.3; further, the lamp was in more convenient shape. A lamp for 220 volts is, for instance, only about six inches long. The color of the light could not be called beautiful; being much like that of the old mercury lamp, but not so unpleasant as that, as the new one emits considerable red light also. This is very plainly seen when one places a lamp of each kind behind a red transparent disk. The quartz lamp shines brightly, while the other is almost invisible. The quartz lamp is made for 2.5 to four amperes and 110 to 220 volts. The watt consumption per candle-power when the lamp is provided with reflector, etc., is for the lower hemisphere, about 0.3 watt. The lamps can be set in almost any ordinary factory and are readily interchangeable. They may be used for photographing, copying, for drying patent leather, for sterilizing liquids (by reason of the germicidal effect of the ultra violet rays); under water, by reason of the lack of sensibility of the quartz to change in temperature; and for medicinal purposes. The life of such a lamp is given as about 1,000 hours, continuous operation.

A wireless telephone is to be used along the coast as a fog signal. It has been tried out and found to work well under heavy weather conditions.



**BELL RINGING TRANSFORMER.**

This little piece of apparatus which can be held in the palm of the hand is a bell ringing transformer which is arranged to take power from the ordinary 110 volt, alternating lighting circuit and change it to the proper value for operating electric bells, buzzers, etc. It is made with several taps in the secondary winding so that six, 12 or 18 volts may be obtained at will. It requires no attention, thereby placing it in direct contrast to the ordinary battery, which is frequently out of order at the times when it is needed most. The core and coils are placed in a small metal box with lugs attached for convenience in fastening to the wall or ceiling.

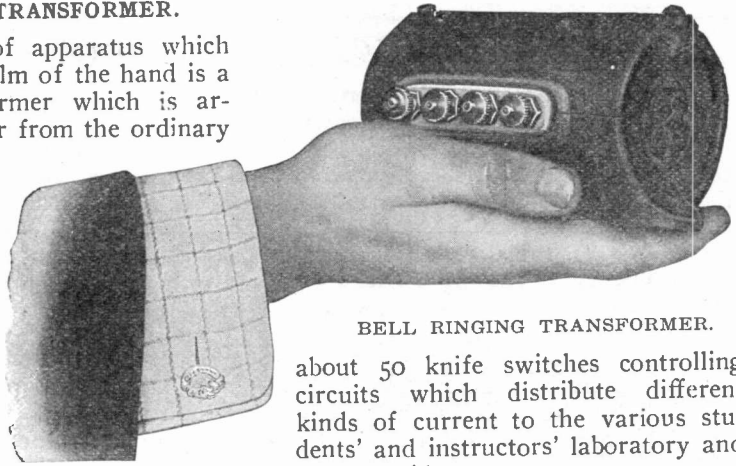
**BELL RINGING TRANSFORMER.**

about 50 knife switches controlling circuits which distribute different kinds of current to the various students' and instructors' laboratory and lecture tables.

These currents, direct and alternating, are of various strengths. One circuit may ring an ordinary electric bell, another of great capacity furnishes a heavy current flow for making experiments requiring many amperes, at low voltage. High tension direct current may be had, also alternating current for the transformers, some of which step the voltage up as high as 100,000 volts.

The glass board is one inch thick. It is five feet high and six feet long, all in one piece, and is placed inside of a fine cabinet with plate glass doors. All bus bars, as the rear conducting bars are called, are of copper, highly polished and lacquered. The whole equipment, though somewhat expensive, presents a very handsome appearance.

**A GLASS SWITCHBOARD.**

Plate glass is an unusual material for the construction of a switchboard, slate or marble being ordinarily used. A unique board of this kind has, however, been constructed for the private laboratory of the San Jose High School, in San Jose, Calif. On this board are

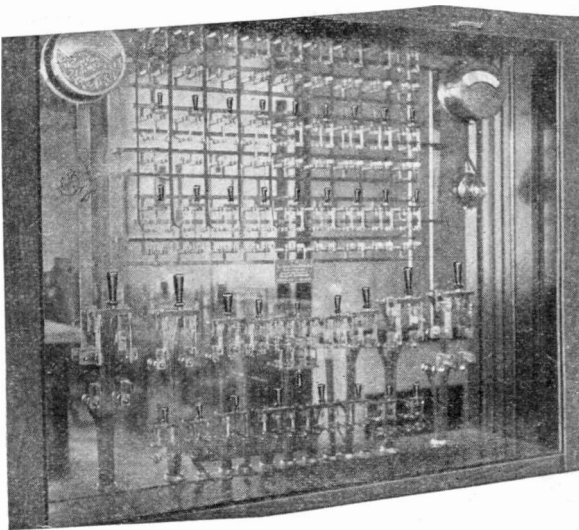
**A GLASS SWITCHBOARD.****ULTRA VIOLET RAYS TO PURIFY MILK.**

Two scientists in Lyons, France, are said to have made the discovery that milk subjected to the ultra-violet rays emitted by Krohmayer's mercury vapor lamp will be completely sterilized. The milk is run through a glass pipe and exposed but a moment to the effect of the rays. These ultra-violet rays, by their chemical effect, kill any germs which are present in the milk.

## POPULAR ELECTRICITY WIRELESS CLUB.

Membership in Popular Electricity Wireless Club is made up of readers of this magazine who have constructed or are operating wireless apparatus or systems. Membership blanks will be sent upon request. This department of the magazine is devoted to the interests of the Club and members are invited to assist in making it as valuable and interesting as possible, by sending in descriptions and photographs of their equipments.

# SPARK COIL CONSTRUCTION AND OPERATION.

BY V. H. LAUGHTER.

PART II.

Before going into the actual construction of the secondary it will be advisable to explain some of the features and technical terms. In the previous chapter we learned that the secondary of a spark coil is a large amount of small wire wound on over the primary, which is composed of a few layers of heavy wire. The two windings are insulated from one another by an insulating tube. The operation of the vibrator in the primary circuit sets up a current of several thousand volts in the secondary. Great care should therefore be used in the insulation of the secondary, as otherwise the results will be poor, due in the usual cases to a "breakdown" or short circuit across the windings.

In coils of the  $\frac{1}{2}$ -inch size and over, it is necessary to divide the secondary up into sections. That is, the total amount of wire to be used in the secondary is wound in several spools or sections and the sections assembled with an insulating substance placed between them and the exposed terminals connected so that one continuous winding is formed.

In a coil of the  $\frac{1}{2}$ -inch size only two sections would be necessary, while in a 2-inch size six would be needed. The number of sections increases with the size of the coil. If the secondary is not properly insulated the previously mentioned breakdown is liable to occur, which ruins the efficiency of the coil, and makes it necessary to rewind the whole to find the faulty portion. The best method is properly to insulate the secondary at the beginning. If the coil were wound without sections, it would be an easy matter for the "breakdown" to occur, as the adjacent turns of the different layers would carry widely different voltages, and the insulation would

very probably be punctured and a short circuit result.

By dividing the secondary up in sections and insulating the sections from one another, the danger of a "breakdown" is reduced to a minimum as the turns in each individual section carry voltages which do not differ widely from each other, and there is no danger of puncture. As a further precaution the secondary terminals of a coil should never be held so far apart that the spark breaks across at irregular intervals for this places the secondary of the coil under a great strain and is liable to cause the breakdown.

### SECONDARY WINDING.

To construct a secondary for the four inch coil under consideration, the following apparatus and materials are necessary: Winding machine, section former, five pounds number 34 single silk covered magnet wire, about five pounds of insulating material, and 40 or 50 sheets of ordinary size filter paper.

The secondary in this instance will be divided up into 16 sections, although in the table of dimensions to appear in a later chapter a greater number of sections is recommended, but considering the special method of winding used in this case, the 16 sections will answer. The size of wire to be used will largely determine the number of sections. For instance, if No. 36 wire were used in place of No. 34 the number of sections should be increased to at least 24. The silk covered wire is used in preference to the cotton covered, as it offers more perfect insulation, and the thin covering allows a greater number of turns to be wound in a certain space than the cotton covered, although the cotton covered can be used.

A view of the secondary sections is shown in Fig. 6. The length from end to end is eight inches and the diameter  $3\frac{3}{4}$  inches. As the secondary is to be wound in 16 sections this will give a width of  $\frac{1}{2}$  inch to each section and a diameter of  $3\frac{3}{4}$  inches, therefore the

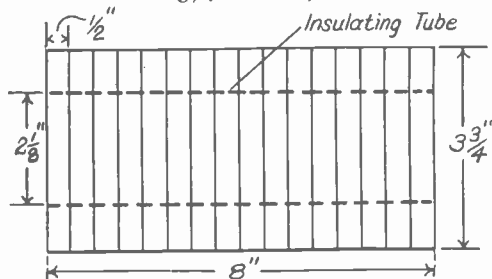

FIG. 6. CONSTRUCTION OF SECONDARY SECTIONS.

section former will have to be made to conform to these dimensions.

#### WINDING MACHINE.

The winding of a secondary for even the smallest size coils is a tedious job if attempted by hand, and can be best accomplished by some type of winding machine. The turning lathe makes an excellent winding machine, although it is not usually found in the amateur's shop, so usually he is thrown on his own resources to supply some type of machine that will answer.

In connection with the winding device is a bucket which holds the insulating substance, the substance being kept in a boiling state and the magnet wire drawn through, so that a certain amount of the wax will adhere to the covering over the wire. This serves to hold the wire in place on the section former, and provides insulation.

Several kinds of insulating substances can be used, but a mixture of paraffine and beeswax in equal proportions will prove ideal. The beeswax gives a higher melting point to the mixture, and should by all means be added if the coil is to be used in warm climates.

The general constructional plan to be followed out in the winding machine is shown in Fig. 7. (A) represents the original spool of magnet wire, (B) the small guiding spool, (E) a large drive wheel belted to a smaller pulley on the section former, (G) the paraffine receptacle consisting of the tin bucket

(F) placed inside of a larger one (G). Between the two, water is poured which prevents the paraffine from becoming overheated and catching fire. The alcohol lamp (H) keeps the paraffine in a boiling state.

The exact method to be used in constructing the machine can of course be changed to suit the ideas of the builder, but the same general plan should be followed out, for it is very essential that the paraffine be applied to the wire as the winding operation proceeds.

For the supports and the base it is best to use heavy two-inch wood so that no vibration will occur when the crank handle is turned.

The drive wheel at (E) in a type of this machine that the writer used was the lower drive wheel of a sewing machine, and the upper wheel (C) was the upper pulley. The two were mounted on the support, being held in place by bolts. The lower wheel was provided with a handle for turning as shown. It is evident that a dismantled sewing machine would make an excellent winding device, as foot power could be used

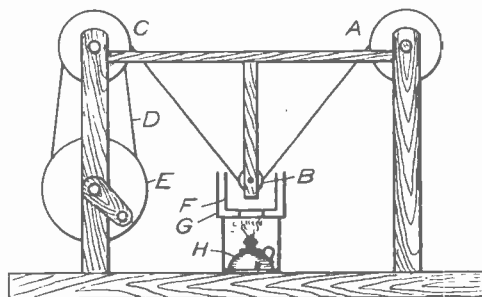

FIG. 7. WINDING MACHINE.

for driving, allowing both hands free to guide the wire.

#### SECTION FORMER.

Considering that the winding machine has been constructed the section former will be next taken up.

The method of winding in this case will be known as the double-section plan which is far more convenient and easier to connect with other sections than with the single-wound section plan.

The sections will measure from  $3\frac{3}{4}$  to four inches in diameter, and as the insulating tube over which the sections are to be placed measures  $2\frac{1}{8}$  inches in diameter, the sections must necessarily be

wound on a mandrel of this size. The view of a section former is shown in Fig. 8. It consists of brass plates (A A A), 1/16 inch thick and four

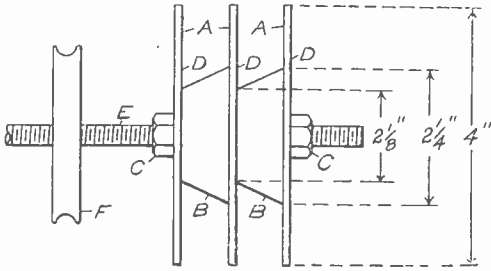

FIG. 8. SECTION FORMER.

inches in diameter, mounted on the bolt (E) with wood cones (B B) placed between, and held in position by screwing up the nuts (C C). The supports which hold the section former in the winding machine should be slotted in order that the section former can be easily removed when the winding of a section is completed. The ends of the bolt rest in these slots and the pulley (F), Fig. 8, then becomes the upper pulley shown in Fig. 7.

The wood cones (B B) measure  $2\frac{1}{8}$  inches in diameter at the smaller end and  $2\frac{1}{4}$  inches at the larger end. This will allow the cone to be pushed from the center of a wound section without disarranging the winding. Small holes (D D) are drilled in the plates through which the end of the magnet wire is led.

Before beginning the winding cut 80 or 90 sheets of common filter paper to the exact diameter of the disks (A) and with central diameters to make a neat fit over the wood cones, the holes in half of them being  $2\frac{3}{8}$  inches in diameter and in the other half  $2\frac{1}{4}$  inches.

Considering that the section on the right hand side of the former is to be wound first, place two sheets of the filter paper against the inner sides of the brass plates. Lead the end of the magnet wire from the spool (A), Fig 6, around the guiding spool (B) on up to the section former and to the left through the small hole (D), of the middle plate, taking several turns around the left hand cone to hold it in place.

Begin turning the handle of the drive

wheel and guide the magnet wire over the space between the plates, as evenly and smoothly as possible. The winding should not be carried on too fast, but the speed should be such that the magnet wire will reach the coil being formed before the wax had time to set. A number of authorities recommend that the winding be carried on with the former immersed in the boiling paraffine solution; this plan is of course the best where the coils are manufactured for commercial use, but the amateur would find this a difficult method, and the plan as given above will be followed out.

The first section should be wound with exactly three ounces of wire, and for the rest of the sections an estimate can be made of the wire required, as each section will hold approximately the same amount of wire in the space as determined for the first. The most reliable method is to weigh the original spool of magnet wire before the winding is begun, and after the estimated amount has been wound on, the difference between the two weights will be the amount on the section.

Considering that the first section is wound on the former on the right hand side, the section former is now taken from the bolt and turned around so that the wound section is on the left hand side. The middle face plate is removed and the cone and the other face plate screwed up against the wound section. This will leave the inside terminal of the wound section exposed. The end of the magnet wire from the spool is brought to the section former as before, but instead of being led through the hole in the face plate, it is connected to the exposed end of the wound section.

The connection is made with a drop of solder and a small amount of tape wrapped over the exposed portion. This section when wound will fit up closely against the first section with only the filter paper between. The necessity for turning the former around is apparent for this will make the two winding, or commonly called double section, continuous. Seven other double sections are wound in this manner.

The next operation is the boiling-out process. Place the sections one by one in boiling paraffine and continue to boil

until all bubbles have ceased to appear at the surface. The sections are next placed in cool linseed oil and allowed to soak well for an hour or so. The sec-

tions are now completed and will be laid aside for the final assembling which will be taken up at a later point.

(To be continued.)

## BUILDING A "PERICON" DETECTOR.

BY ALFRED P. MORGAN.

Certain metallic oxides and sulphides possess the remarkable property of rectifying electrical oscillations. These crystals conduct current better in one direction than in the other; that is, their conductivity is unidirectional. Prof. G. W. Pierce has shown that in the case of carborundum the current at a pressure of 10 volts may be one hundred times greater in one direction than in the other. As the voltage is raised this ratio decreases.

The crystals also exhibit a remarkable regenerative power or are able when inserted in the antenna circuit to rectify electrical oscillations into a pulsating direct current which produces sounds in the telephone receivers without the aid of a local battery.

The following is a partial list of the minerals and crystals possessing these properties and which may be employed as "thermo-regenerative" detectors in radio-telegraphy or telephony.

Material and Chem. Name.	Formula.
Carborundum—Silicon Carbide.....	SiC
Fused Silicon—Silicon .....	Si
Iron Pyrites—Iron Sulphide.....	Fe S <sub>2</sub>
Copper Pyrites—Copper Sulphide..	Fe Cu S <sub>2</sub>
Chalcopyrites—Copper-Iron Sulphide	
.....	Cu <sub>2</sub> SFe <sub>2</sub> S <sub>3</sub>
Hessite—Telluride of Silver or Gold.....	
Zincite—Zinc Oxide.....	ZnO
Octahedrite, or Anastase—Oxide of	
Titanium .....	Ti O <sub>2</sub>
Stibnite—Antimony Sulphide. ....	Sb <sub>2</sub> S <sub>3</sub>
Molybdenite—Molybdenum Sulphide....	MoS

The "pericon" detector is one of the most important of the many crystal detectors. It offers many advantages over the electrolytic. When once carefully adjusted it will remain so for a long period unless it is roughly handled or burned out by placing near a strong transmitter and not properly shunted.

For some reason or other mystery has more or less surrounded the construction of a "pericon" detector. In reality it is very simple and consists of two min-

eral pellets properly mounted and placed in contact with one another.

It is well to buy from a reliable dealer in wireless telegraph supplies a pound of each of the two minerals, chalcopyrites Cu<sub>2</sub> S Fe<sub>2</sub> S<sub>3</sub> and zincite ZnO. The large lumps are broken up into small bits and tested by placing a fragment of each in contact with one another in a crystal detector.

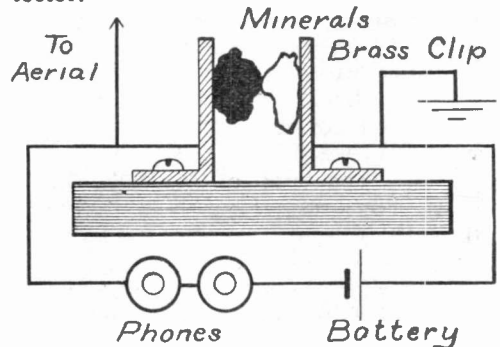

FIG. 1. SIMPLE FORM OF CRYSTAL DETECTOR.

A simple form of crystal detector is shown in Fig. 1. Two spring clips are fastened to a block of wood. This is connected up as a usual detector and the test made by placing different fragments of the minerals between the springs and listening to the signals in the telephones. In this manner the relative merits of the different specimens may be found and the best specimens selected to be set permanently in the cups.

The most sensitive pair is selected and each is mounted in a brass cup, similar to the ordinary silicon detector, as shown in Fig. 2. The minerals are mounted so as to project about 1/16 of an inch above the edges of the cups. The zincite ought to present a flat surface and the chalcopyrites a rather blunt point. The latter mineral is set to one side of the centre of the containing cup so that by revolving, the blunt point may be brought

into contact with any part of the zincite.

Since heating the chalcopyrites is liable to reduce its sensitiveness somewhat, the metals are mounted in a composition known as Wood's metal. Wood's metal is an alloy consisting of four parts of bismuth, two parts lead, one part of tin and one part of cadmium. This alloy melts at 137.8° F. The cups are thoroughly cleaned and brightened inside and then poured nearly full of melted Wood's metal. The minerals are pressed in the molten metal and held there until it cools and hardens, as shown in Fig. 2.

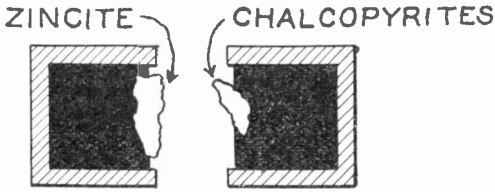

FIG. 2. METHOD OF MOUNTING THE CRYSTALS.

Fig. 3 shows the scheme of a "pericon" detector. The base measures 5½ by 3 by ¾ inches and is preferably of hard rubber. The posts (A) and (B) are mounted 2½ inches apart and are 1½ inches long and ½ inch in diameter. They carry threaded rods (P) and (P¹) which are made of brass ⅛ of an inch in diameter and two inches long. Two hard rubber disks (CC) 1½ inches in diameter and ½ inch thick are bored and threaded to fit the rods. They serve as

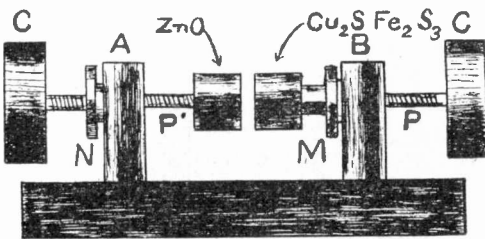

FIG. 3. PERICON DETECTOR.

insulating handles to adjust the detector. The rods are threaded the entire length so as to screw into the standards (A) and (B). Lock nuts (M) and (N) are provided to fasten the plugs in position when adjusted. A spiral spring is placed between the lock nut (M) and the chalcopyrites cup. The tension of the spring should be just strong enough to bring

the minerals into light contact. The tension is adjustable by the nut (M).

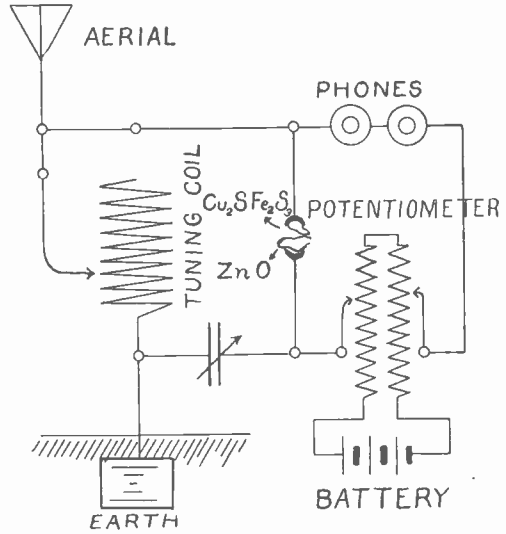

FIG. 4. THE PERICON DETECTOR IN CIRCUIT.

Connections are shown in Fig. 4. The battery is so connected that the current flows from the copper to the zinc. When connected up such a detector if nicely adjusted will prove very satisfactory even for amateur work.

#### THE AMATEUR AND PROFESSIONAL OPERATOR.

The right of amateur operators to cast messages to the "winds" promiscuously, thereby interfering with the work of commercial and government operators, has been questioned, and there has been considerable newspaper discussion on the matter of legislation to prevent this. While it is not probable that such legislation will be passed, still it is for the amateur to remember that although the all-penetrating and imponderable ether is free as the air, still there are certain ethical rules which should be followed in wireless telegraphy as in any other line of work.

Wireless telegraphy is one of the most interesting forms of experiment in all the electrical field for the amateur. It is a good thing, but, to use a very slangy expression, which seems to fit the case, don't let us "kill it." It is not always policy to try and get in touch with every government and commercial station. Every fleeting message which the operators

of these stations may receive does not give them the same joyous thrill which is experienced by the enthusiastic amateur who has just got his apparatus to working after, perhaps, many trials and failures. You wouldn't think of connecting a telegraph instrument somewhere out on a commercial line and then calling all the operators along the line for a morning salutation.

The situation is quite aptly set forth by Mr. O. S. Van Olinda, one of the readers of Popular Electricity who takes this subject seriously. In a recent letter for the benefit of the Wireless Club, he writes:

"Amateurs and experimenters in wireless would do well to remember that the operator at a naval or commercial station is placed there for the sole purpose

#### A FORTY MILE EQUIPMENT.

Harold S. Pratt of Elgin, Ill., has accomplished very good results with apparatus which is largely of home construction. The views show the operator with his portable sending and receiving set also the mast on the rear of his residence which supports a 60-foot antenna. His portable set which is of the Marconi type, includes a three-inch coil, call relay, bell, sounder and tapper, condensers, choke coil, etc.

In his laboratory the youthful experimenter also has a complete equipment for long-distance work, and with it he has been able to communicate with Chicago, which is 40 miles distant. This equipment contains, among other things, a two kilowatt transformer.

The mast and antenna support are of

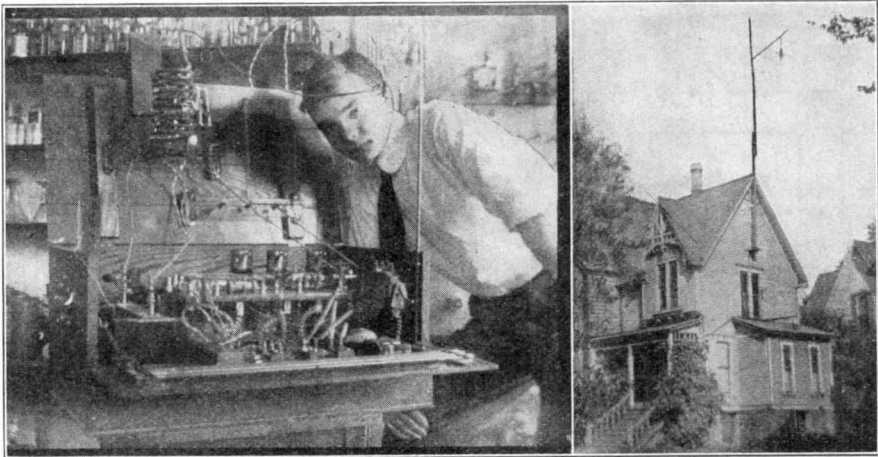

A FORTY-MILE EQUIPMENT AND ITS OPERATOR.

of doing business and those higher up expect him to do the best he can to get his 'stuff' through. It has been my experience that wireless operators, as a class, are a very broad-minded and accommodating set of men and the amateur owes it to himself to be as considerate as possible and do all he can to avoid the necessity of restrictive or prohibitive legislation. The writer does not believe that laws regulating wireless would be held constitutional, but we may be able to save a lot of expense and trouble if we can get along without laws, and every electrical journal, amateur and experimenter should assist in a campaign of education along that line."

the jointed kind and are fastened to the side of the house, leading up over the roof where the second joint is spliced on. This is a very simple and efficient method for erecting masts for experimental purposes.

#### WIRELESS TRAIN SIGNALING.

Wireless communications have been successfully carried on from a special train on the Lake Shore Railroad to Cleveland and Chicago, while running at full speed. From the results of experiments so far it is anticipated that with perfected apparatus the system will be practical.

# ONE TO FIVE-MILE EQUIPMENT.

BY C. BRANDES.

Most amateurs find it advisable to begin their experimental work with the construction of a small equipment capable of transmitting four or five miles. The following description and diagram will, therefore, be likely to fulfil the requirements of many who are just taking up the work. Under favorable conditions the apparatus will transmit from one to five miles.

The sending set consists of a one-inch

apart than diameter of tube, so that when it is inserted it will press against the tinfoil inside the tube.

The writer has transmitted with a set of this kind from his laboratory in the tower of the Trinity Building, New York, to Manhattan Beach, a distance of about 12 miles. This may sound like exaggeration, but it is nevertheless a fact. The height of this tower from the street is about 375 to 400 ft. The aerial was

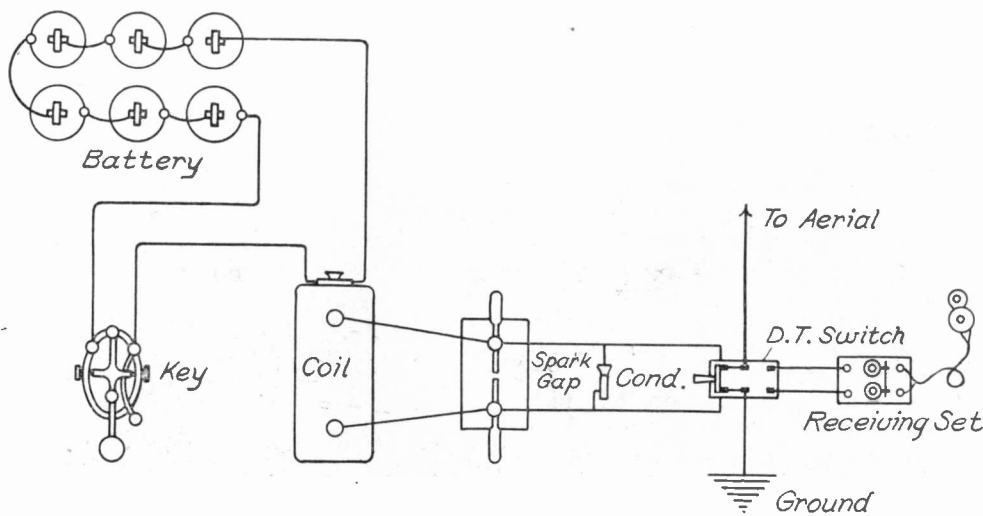

ONE TO FIVE-MILE EQUIPMENT.

A B C spark coil, which is specially built for wireless purposes, giving a fat, hot spark which cannot be obtained from X-ray coils and the like. Six dry batteries should be used to obtain good results. A zinc spark gap, a small condenser, and a key are also required.

The condenser is shunted across the spark gap, and a simple type which was found to work admirably may be made up by taking a glass test tube about six inches long, and covering it with tinfoil both inside and outside, within about two inches from opening. Contacts may be made on the outside by winding a piece of wire around outside of tube over the tinfoil, and on the inside by making a small V-shaped spring. The V-shaped spring should be spread a little wider

suspended from the tower to a flag-pole on the other end of the building, a distance of 250 feet. The aerial was made of two strands of No. 12 galvanized wire, 250 feet long, looped. The conditions, therefore, were particularly favorable.

The aerial required for transmission of one to five miles should be from 20 to 60 feet high. This is all according to nature of surrounding country. Where there is woodland or other obstacles, a higher aerial is required than if you are located on an elevation or near water.

The receiving end may consist of the complete receiving set as described in February issue, or other types of construction previously described in this magazine.



### A SIMPLE ZINC SPARK GAP.

Perhaps some of our wireless experimenters using spark coils, have never thought how easy an efficient zinc spark gap can be made at a slight cost. Zinc has been found to be the best material for a spark gap owing to its peculiar qualities. The writer has made one which has proven very satisfactory and is as good as those for which you pay as high as \$1 and upwards.

Secure a piece of well-seasoned wood and cut four by seven inches, having a thickness of about one inch. Bevel the corners and plane the surfaces smooth, after which apply a coat of shellac. When this is dry, a coat of wood stain of any desired color can be applied which will make a better appearance. Next secure two common battery zincs, such as those used in sal-ammoniac batteries, having screw terminals at the ends where connections are made. These zincs when purchased are usually square half of the length and round the other half. If a lathe is at hand, these can be turned down to a round surface, or can be filed down, as zinc is almost as soft as lead. Secure two porcelain cleats of the two-wire kind, with wood screws, and fasten them on the finished board about two inches from each end. Before tightening down, the zincs can be inserted between each of the cleats and the spark gap adjusted and screwed down tight. The gap can be adjusted by loosening up the screws in the cleats.

## WIRELESS QUERIES.

ANSWERED BY V. H. LAUGHTER.

### Marconi and Electrolytic Detectors.

*Questions.*—(A) Please tell me if I can make and use a Marconi magnetic detector, and is it more sensitive than the electrolytic

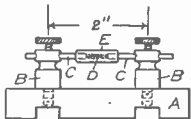

FIG. 1. SIMPLE COHERER.

detector? (B) What is the most sensitive coherer that can be used in connection with the relay and how is it made? H. H. L., Tacoma, Wash.

*Answers.*—(A) The Marconi magnetic detector is not nearly as sensitive as the liquid, silicon and numerous other types on the market at the present day. We would recommend that you construct the electrolytic kind, which is wonderfully sensitive and simple. A detector of this type is shown in answers to H. L., this issue.

(B) One of the most simple coherers is the ordinary metal filings kind. First, get a suitable wood base (A), Fig. 1, seven inches long, three inches wide,

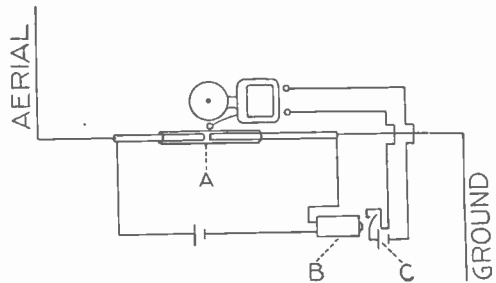

FIG. 2. COHERER CONNECTED FOR RECEIVING.

and one-half inch thick. Two large binding posts are now mounted on the base as shown at (B B). The binding posts should have a side hole of sufficient size to allow the insertion of a 1/16 inch brass rod. Next get two brass rods, two inches in length, and amalgamate the ends by dipping first in acid and then in mercury. The brass rods are now mounted as shown in the sketch with the two inside ends separated about 1/16 inch, and a glass tube that will make a neat fit is slipped over the ends. Between the two ends of the rods as indicated by (D) are placed the metal filings. The filings can be made of nickel with a trace of silver added, using a very coarse file in the preparation. Sift in a thin cheesecloth to allow all the fine dust to escape. The decoherer, which can be a common electric bell, is mounted on the base so that the hammer will hit the glass tube when in operation. The exact adjustment can best be found by actual experiment. The manner of connecting the coherer for receiving is shown in Fig. 2. The coherer is shown at (A) in circuit with the battery which operates the relay (B). The battery (C) operates the decoherer.

**Wireless Operation.**

**Questions.**—(A) Can a relay be made to operate in conjunction with a carborundum detector for calling? I have a one-inch spark coil connected to an aerial 65 feet high and want to operate about one mile. (B) Which is better for the above use, the carborundum or microphonic detector? About how far would I be able to receive with this set, employing a detector of the above named type. (C) Which is the stronger, a magnet wound with one hundred feet of number 20, or one hundred feet of number 36, and how much? (D) Does it work just as well with either pole of the spark coil connected to the aerial? —E. L., Peoria, Ill.

**Answers.**—(A) The carborundum detector cannot be used in connection with the relay or bell signaling device. The construction of a coherer receiving set is described in the answer to H. H. L. this issue.

(B) If adjustment is perfect the carborundum detector is the more sensitive. You should be able to receive from commercial stations from 50 to 100 miles away.

(C) The magnet wound with 100 feet of No. 20 wire would be the stronger, as it will allow more current to flow through the turns. It would be impossible to give the exact difference in strength between the two without knowing the size of the magnets, the number of turns and the current flowing through each.

(D) In practical use no difference will be noticed.

**Automobile Spark Coil; Liquid Detector.**

**Questions.**—(A) Will an automobile spark coil do for wireless? (B) How is a liquid detector made? H. L., Hutchinson, Kan

**Answers.**—(A) Yes.

(B) A liquid detector can be made according to the accompanying plan.

(A) represents a wood base 5 by 3 inches

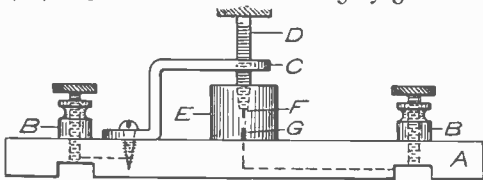

FIG. 1. LIQUID DETECTOR.

and  $\frac{1}{2}$  inch thick. Binding posts (B B) are mounted near the ends of the base. (C) is a metal standard  $\frac{1}{2}$  inch wide,  $\frac{1}{8}$  inch thick and  $1\frac{1}{2}$  inches in height when bent to the shape shown. A thumb

screw (D) is mounted on the standard with the .0004 Wollaston wire clamped in a slit at the end as shown at (F). (E) represents a glass cup with the platinum wire (C) soldered in the bottom. Leads are carried from the platinum wire in the cup and from the metal standard to the respective binding posts.

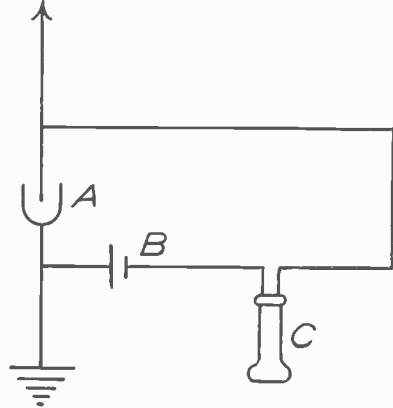

FIG. 2. PLAN FOR CONNECTING LIQUID DETECTOR.

The cup should measure approximately  $\frac{1}{2}$  inch in diameter and  $\frac{3}{4}$  inch deep. The cup is filled to about three-fourths of its height with a 20 per cent solution of sulphuric acid. The plan for connecting is shown in Fig. 2. (A) represents the detector, (B) the battery and (C) the telephone receiver.

**Tuning Coil; Detector; Receiver Resistance**

**Questions.**—(A) In making a tuning coil could I use a smaller wire than that used to make the tuning coil described in the July issue? (B) In making the liquid detector like described in the July issue what size cup should be used to hold the acid? (C) How can I determine the resistance of a telephone receiver? L. F., South Whately, Ind.

**Answers.**—(A) A smaller size could be used but is not recommended.

(B) About  $\frac{1}{2}$  inch in diameter and  $\frac{3}{4}$  inch high.

(C) A simple method would be by use of a volt meter, battery, and several known resistance spools. Connect the volt meter, battery, and receiver in series, and note the point at which the indicating needle of the volt meter rests. Next connect the known resistance spools in the circuit in place of the telephone receiver and continue to change the resistance until indicating needle rests at the same point.

# ELECTRICAL MEN OF THE TIMES.

LEE DE FOREST.

Experience has taught us that the dreams of to-day are likely to be the realities of to-morrow. Two years ago speech could only be projected through space as far as human lungs would permit. To-day we have the wireless telephone, so far developed that conversations have been carried on over a distance of several hundred miles.

Among the half-dozen inventors who have done most to develop wireless telegraphy and telephony is Dr. Lee De Forest. He is a young man, only 36 years of age, but, the cares which have been his, in developing his various inventions and securing the recognition which was justly his, have accentuated in his face the lines of grim determination of his Huguenot ancestry.

Dr. De Forest was born in Council Bluffs, Ia., in 1873, although his early boyhood was spent in Alabama. He prepared well for his work, being graduated by Sheffield Scientific School of Yale (electrical and mechanical engineering) in 1896, and after three years of post graduate work receiving the degree of Ph. D. from the same institution.

It was about this time that the Hertzian wave theory had astounded the scientific world, and it interested him deeply, so much so that he wrote his doctor's thesis on the subject and made the wireless transmission of intelligence his life work.

The first year out of college was spent in the telephone experimental laboratory of the Western Electric Co., with the short-lived American Wireless Tele-

graph Company of Milwaukee and as assistant editor of the Western Electrician of Chicago. Determined, however, to continue his wireless experiments he resigned from the last position and attended Armour Institute for one year, where he could have laboratory facilities. Here he developed the electrolytic receiver to a commercial stage, testing it later at the international yacht races in 1901, when the Shamrock II was defeated.

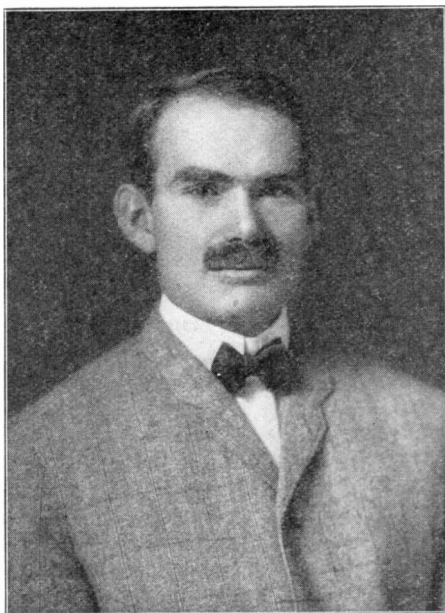

Soon after, the De Forest Wireless Telegraph Co. was formed, called afterwards the American De Forest and finally the United Wireless Telegraph Co. During this interval he developed his general system of wireless telegraphy, including transmitter, tuning devices and sending transformer. All did not go smoothly with the company, however, and it was reorganized. De Forest thereupon severed his connection entirely, assigning all patents to the reorganized

company, but retaining the right to use them himself as sole licensee.

In the fall of 1906 he began his experiments on the wireless telephone, following out previous ideas, and in the spring of 1907, after several successful demonstrations of the apparatus, the Radio Telephone Company was formed. In February, 1908, he went to Paris, France, and demonstrated his apparatus on the Eiffel tower. During this test the long-distance record was made, gramophone music being heard at a naval station near Marseilles, over 550 miles away. His system was also used successfully on the ships of the famous Pacific Squadron.



# ELECTRICITY IN THE HOUSEHOLD

## THE "READY-TO-RUN" ELECTRIC FAN.

The uses of electric current have now become so numerous that we need not be surprised to see almost any machine operated by electricity. Among other applications the electric motor has been applied to various ventilating devices which have been in the nature of fans, both of the propeller type and of the cased type.

Of the propeller types of fan, the desk is most common, while we generally think of a cased-in fan as one large

dences, large offices, such as banks, accounting rooms, and private offices, by desk fans. This method has not proven altogether satisfactory, due to the fact that the desk fan merely stirs up air but does not produce real ventilation. Some people have fancied that cool air is necessarily pure, while others imagine that they are being made comfortable simply because the air in a room has been set in motion. Just here lies the difference between real ventilation and apparent ventilation.

To produce real ventilation, the overheated air must be removed to allow fresh air to take its place. With a desk fan real ventilation is practically impossible, while with a small cased fan it is not only possible but is actually being accomplished in many places.

To meet these conditions, a cased fan has been designed which has the good features of the desk type, in that it is of moderate cost, requires but a small amount of electric current, and is so light that it is easily carried from room to room. The disadvantage of the desk fan, that of merely stirring up the air, has been entirely eliminated, for, the fan being of the cased type, it positively and noiselessly removes the overheated air. With the fan is furnished a flexible canvas hose about 20 feet in length, so that the fan may be placed anywhere in a room within 20 feet of the window and the overheated air discharged to the outer atmosphere.

The set is made in three sizes, the smallest of which weighs but 25 pounds, while the largest weighs only 50 pounds. They are equipped with either a direct-

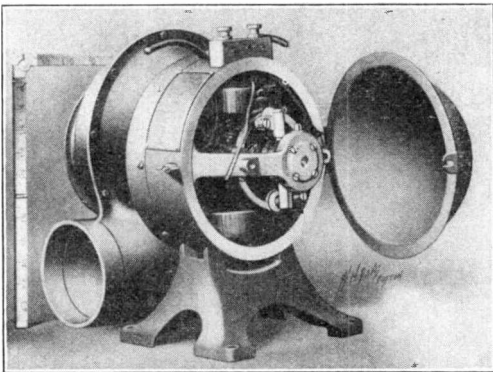

THE READY-TO-RUN ELECTRIC FAN.

enough to supply ventilation for a public building, factory, hospital, or school-house. It is true that comparatively few attempts have been made to produce a fan of the cased type in small sizes; the matter of expense being the principal obstacle. However, the cased fan has certain advantages over the propeller type; in fact, it is infinitely superior for certain conditions.

Due to the slight expense, it has been customary to ventilate rooms in resi-

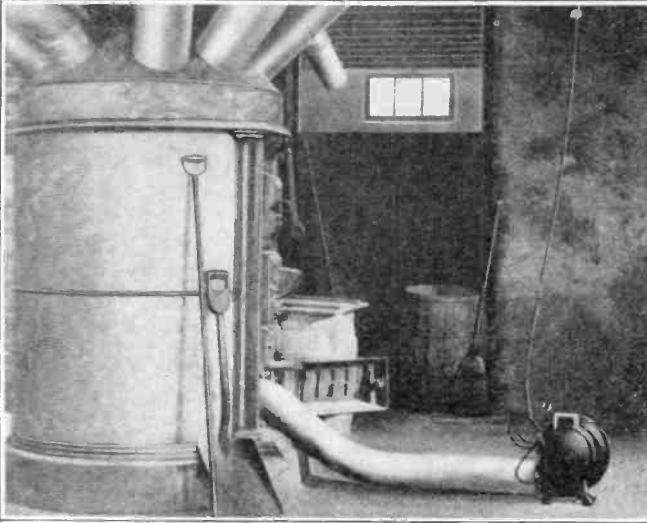
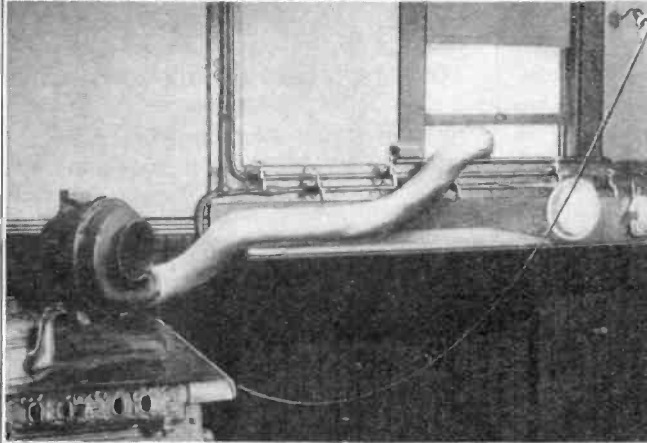
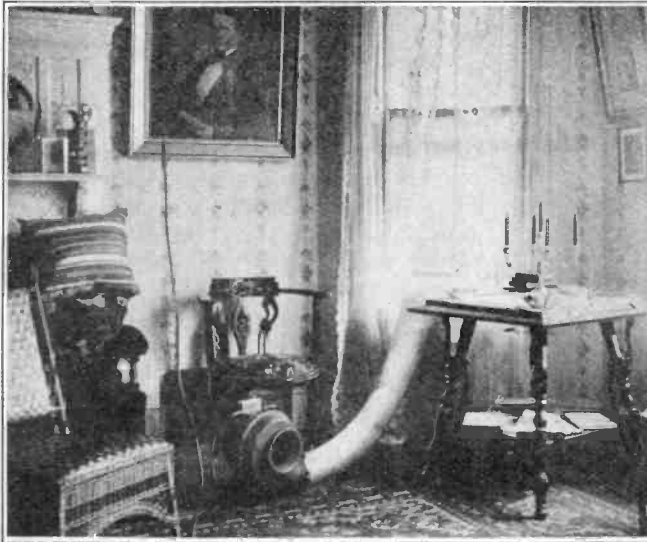

VARIOUS APPLICATIONS OF THE READY-TO-RUN ELECTRIC FAN.

current motor or an alternating-current motor, the armature of which is mounted upon the same shaft as the fan wheel. The set requires so little power that it can be run by the lighting circuit. It is an exceedingly convenient little set and has been given the name of "Ready-to-Run," for no installation is necessary. It can be set in operation by simply putting the plug, which is at the extremity of the cord furnished for the purpose, into the electric light socket and turning the switch.

In the residence, club-house, or hospital, the fan is used for clearing the atmosphere of tobacco smoke, cooking odors, etc., in a manner shown in the illustration, and it is also used for blowing the furnace when the natural draft is insufficient. Among other uses may be mentioned the ventilation of small rooms such as sick rooms, telephone booths, motor-boat cabins, etc., and in factories and power houses, it is also efficient for local ventilation and for blowing dust from machines.

The automatic electric egg-boilers, like those on the *Lusitania* and *Mauretania*, are able to cook 200 eggs at once, a clock arrangement causing the basket containing the eggs to hop out of the water at any half minute up to six minutes. Another novelty is a self-dumping oyster-cooker for stews. At the expiration of a given time the cooker pours its contents into a soup plate and automatically shuts off the electricity.

**ECONOMY OF ELECTRIC LIGHTING.**

The economy of electric lighting is very near to the hearts and pocketbooks of all users of electricity for lighting purposes. It is a broad statement, and one that will surely cause some surprise, when the electrician tells us that electricity is the most economical light for the home, if used right. "If used right," that is the secret and yet how few of us understand enough about the mysterious current to use it at its best advantage.

It is not vaulting over the borders of truth to say that in nearly every home now using electric light the regular monthly bills could be cut down fully twenty per cent with a little care and attention and a little more knowledge about electricity and electric lights.

If the householder who complains about the electric light bills from month to month will observe the following rules he will find that the cost for lighting his home is nothing unreasonable. And it is the desire of any progressive lighting company that these rules be followed, for a satisfied customer is a constant advertiser of the benefits to be derived from central station current.

Don't waste light.

Use the smallest candle-power lamps which will do the work required.

Use reflectors for close work.

Keep a few of the new metal filament lamps on hand for use where a large amount of light is required for any length of time. They will pay for themselves many times over.

A blackened lamp means a dimmed light. Throw it away. Paying for current to operate a dim light is the height of extravagance. One new lamp will often give as much light as two old ones.

Don't spoil a good lamp by surrounding it with a light-killing shade. Many of the ornamental shades are nothing more or less than fancy glass light-sponges which absorb most of the light rays.

Rooms finished in dark colors require more light than rooms finished in light colors.

Don't expect to light your house in winter as cheaply as you do in summer.

It is impossible, for there are several hours more of daylight in summer than in winter.

The daylight brightness of an ordinary room, into which the sun is not directly shining, was found by an illuminating engineer to be commonly not more than 1/10 candle-power and sometimes as low as 1/100 candle-power per square inch. Most artificial lights have a much greater intrinsic brightness, and this accounts for their injurious effects when the eyes are not shielded from their full glare. He concludes that a diffused light of 1/5 to 1/10 candle-power per square inch is best. Strain and injury to the eye have been attributed to ultra-violet light, but such light is less in various incandescent illuminants than in direct or even reflected sunlight.

**COST OF ELECTRIC HEATING AND COOKING.**

Electricity is beginning to take the place of the coal-stove in the home and it is promised by men who look wisely into the future that within a few short years a large portion of the cooking and heating will be from electric power. Already a great many homes contain an electric kitchen wherein all the cooking and baking is done in electric ovens and electric heated utensils. A capable engineer recently tested the heating devices used in his own home and prepared the following table to show their economy:

**COST OF ELECTRIC HEATING AND COOKING DEVICES—10-CENT PER KILOWATT**

	HOUR RATE.
Electric Flatiron, 3 lbs. 2½c.	per hour
" " 6 lbs. 6c.	" "
Pint Water Heaters... 3c.	" "
Quart Water Heaters.. 3c.	" "
Two-qt. Water Heaters 10c.	" "
Six-qt. Water Heaters. 13c.	" "
Combination 4-quart	
Cooker .....	10c. " "
Tea Kettle 4-quart....	3c. " "
Coffee Percolators ...	3c. and 5c. per hour
Chafing Dish .....	3c. per hour
10-inch Stove .....	12c. per hour
Frying Pans .....	5c to 13c. hour
Broiler .....	9c per hour
Oven .....	10c. " "
Corn Popper .....	3c. " "
Cooking and Baking	
Outfit Complete ....	\$10 per month, average
Cigar Lighter .....	1c. per hour
Shaving Mug .....	1½c. " "
Heating Pad .....	½c. " "
Luminous Radiator ...	7½c. to 15c. per hour.

**ART NOUVEAU ELECTROLIER.**

One of the most pleasing of the new styles of electroliers recently produced is shown in the picture and is designed to carry Nernst lamps. It is designed

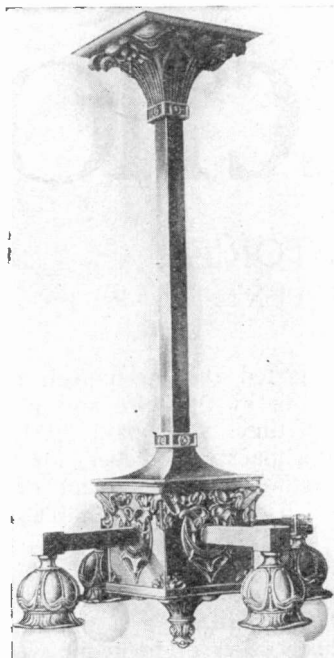

ART NOUVEAU ELECTROLIER.

with either two or four arms, the ornamental treatment being pronounced without detracting from the fundamental simplicity of the design.

**OPERATION OF THE ELECTRIC VIBRATOR.**

H. B. P.—The reason your electric vibrator does not operate properly and gives only a faint and almost imperceptible "buzz" is undoubtedly because you are trying to use on an alternating current circuit a vibrator that is designed for direct current. The current supplied to most homes for lighting purposes is alternating in character; that is, it flows in first one direction and then in the opposite direction many times in a second. Such current will not operate a direct current vibrator of the plunger type. There are vibrators of the motor type on the market, however, which operate on either direct or alternating current.

**INSTANTANEOUS WATER HEATER.**

To provide hot water quickly for washing and cooking purposes the instantaneous electric water heater is a very convenient device. It is simple in construction, consisting of insulated carbon electrodes placed inside of an iron pipe. The current passes through the water from one electrode to the other. The sketch shows the heater as it would be attached to a wash basin, being placed directly in the cold water inlet pipe. When cold water is wanted no current passes through the heater. When it is desired to heat the water, the wall switch

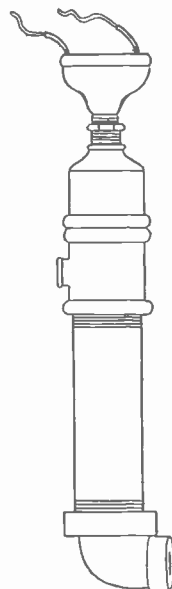

INSTANTANEOUS WATER HEATER.

is turned so that current flows through the heater. A special advantage of the device is that should the current accidentally be left turned on, no damage would result to the heater as would be the case were coils used to heat the liquid.

Chief Health Officer Levy, of Richmond, Va., recently stated through the columns of the Richmond newspapers that portable gas and oil stoves were a menace to health when allowed in living or sleeping rooms. The result has been a large demand in that city for the new electric luminous radiators which emit no noxious or deadly gases and do not destroy the oxygen in the air.

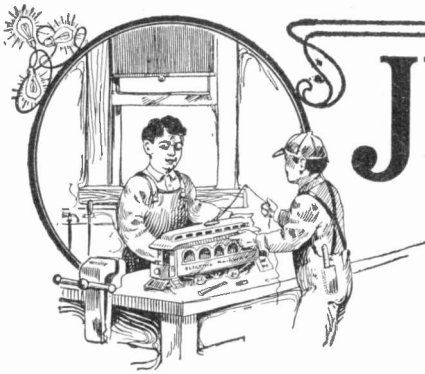

# JUNIOR SECTION

## SWITCHBOARD STORIES.

INSPECTOR NUMBER SEVENTEEN.

BY C. TUELLS.

It wasn't long after Marshall Wilder had been assigned to a bench in the meter repair department of the electric light company that the superintendent called him up to the office and, after telling him how satisfactory his work had been, presented him with a nickel-plated meter sealing tool that imprinted the company name and "Inspector No. 17" upon the lead meter seals, and told him that he was going to promote him to the inspecting department. He gave him the customary lecture that usually goes with a promotion, and concluded by telling him to report to the head inspector the next morning.

Marshall assumed his new duties with a cheerfulness that wasn't wholly actuated by the substantial increase in wages that accompanied his new job, for he found it a pleasant change from rewinding coils and soldering shunts. The outdoor life was also an agreeable feature, for fresh air is far ahead of soldering acid fumes and lacquer.

He ran across some peculiar cases during his inspecting experience. In one house he went into on his rounds he found the meter at a standstill. It was a prepayment or coin-in-the-slot meter, and on removing the cover he found stuck in the slot a quarter with a hole in it and a short copper wire attached. Upon questioning the lady of the house, she reluctantly confessed that for a long time that same quarter had kept the meter in operation. When the light ran low she would drop the quarter in un-

til it started the mechanism and then pull it out by the wire and save it for the next time. She paid dearly for her petty dishonesty, however, for the company estimated the amount of current she had used (and they didn't get it too low), and she had to settle or go to court.

Then there was the case of Jacob Steinberg. He ran a clothing store and kept open every night in the week. His bills, however, had dropped off to only a dollar and a half or two dollars a month, so Inspector No. 17 was sent down to investigate. He went down into the cellar and read the meter and then turned on two lights upstairs in the store. The meter didn't even start. He turned on two more, and still it showed no change. Finally, with eight lamps going it barely began to register. When he took the casing from the meter he did not wonder at its tardiness, for every part of the mechanism was thick with a fine white dust. The wily Hebrew had heard that meters were not always dust-proof, and had purposely sifted all the ashes from his store right under and within two feet of the electric meter. Of course, he protested his ignorance, and Marshall could prove nothing, but the ash barrel was moved, just the same.

But for out and out rascality, one customer got ahead of them all. He complained to the electric company that his light was bad; didn't seem to light up his house properly—poor current, he



insisted. The head inspector turned the matter over to Marshall and he went down to locate the trouble, for trouble hunting was his business. Everything at the house looked all right, and if quantity of lamps was any advantage, it should have been well lighted, for there was a cluster or a chandelier in every room. His meter showed that



HE HAD HEARD THAT ALL METERS WERE NOT DUST PROOF.

very little "juice" was going through it—far below the amount necessary to light the house.

After looking around for awhile Marshall started to look for trouble along the line, commencing at the point where the wires entered the house. He didn't need to go far. Running his hand along the wires, he felt a pair of unexpected branch wires, leading upward in between the inner and outer walls of the house, and going upstairs he found that two-thirds of the lights were tapped from this circuit, which left the feed wires before they entered the meter. A closer

investigation showed that a few of the lights were fed from the line after it went through the meter, which current, of course, had to be paid for, but on the whole the electricity used hadn't been costing much until Marshall arrived. That individual promptly reported the case to headquarters and the police were called in, with the result that the dishonest customer spent two years canseating chairs—all because of the efficiency of Inspector No. 17.

### BATTERY MOTOR CONTROLLER

BY F. R. FURNAS.

In using batteries for experimental work it is desirable to obtain different voltages and different current strengths for the operation of various pieces of apparatus, such as small motors, etc. This may be done by using resistance in series with the batteries, but the resistance wires of the ordinary rheostat absorb the energy of the battery and convert it into heat, which is a waste. A better way is to use a device which will enable one to readily make different groupings and arrangements of cells to accomplish the same result. Such a device is shown in Figs. 1 and 2, but before taking up the description it is well to understand how the different arrangements of cells will affect current and voltage.

One cell of dry or wet battery will give from one to two volts, according to its kind or condition. If we connect two cells in series, that is, the positive of one to the negative of the next and the two outside terminals free for connection to the motor, the voltage across the outside terminals will be twice as great as that of one cell. With three cells in series the voltage will be three times as great, and so on.

If, on the contrary, we connect cells in parallel, that is, all the positive to one terminal and all the negatives to the other terminal, the voltage across these two terminals will be equal to the voltage of one cell, but, of course, the greater the number of cells connected in this way, the greater will be the available power which can be obtained from the battery as a whole before it will run down.

Going one step further, the cells may be connected in what is known as series-parallel relation. For example, we may take three cells and connect them in series, giving three times the voltage of one cell and having an outside pair of positive and negative terminals. Then we may take three other cells and connect them in the same way. Then connect the positive terminals of the two groups of cells to one terminal of the motor and the negative terminals of the two groups to the other terminal of the motor. The voltage impressed upon the motor will in this case be the total voltage of one group of cells, or the voltage of three cells in series, but the current capacity will be twice that of one group.

To make these various combinations the apparatus above referred to will be found very handy, as it saves the trouble of changing battery wires every time a new voltage is desired. It works on the same principle as the street car controller and can be constructed at very small cost.

This particular controller is designed for eight cells of battery, and there are four "steps" or combinations available.

Make a wooden drum, as shown in

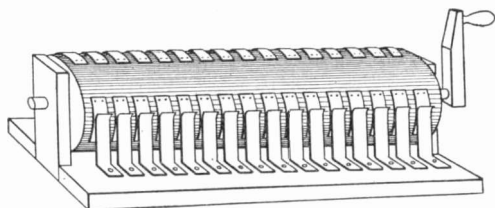

FIG. 1. BATTERY MOTOR CONTROLLER.

Fig. 1, and mount it on a board base, so that it may be easily turned by the handle. Take 16 strips of brass, zinc or other metal and bend them at right angles. Then mount them on the base, as shown, so that their upper ends will touch the circumference of the drum. To these we will connect our power plant of batteries permanently, as shown in Fig. 2. On the drum tack four rows of metal strips so that they will rub under the angle pieces as the drum is turned. Two of these rows are shown in Fig. 1.

Next connect these various strips of metal together by wires, as shown in Fig. 2, which is a diagram drawn as if the surface of the drum were spread out flat, showing all four rows at once.

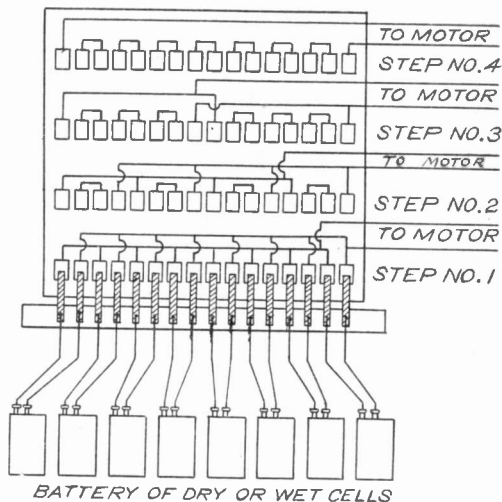

FIG. 2. CONNECTIONS OF BATTERY MOTOR CONTROLLER.

By carefully tracing the connections in each of the four steps it will be readily seen that in step No. 1 all the eight cells are in parallel, giving the voltage of our cell. When the drum is revolved so that step No. 2 comes into position, the cells will be connected in series-parallel arrangement, consisting of four groups of two cells each, giving twice the voltage of one cell. Step No. 3 is a series-parallel arrangement of two groups of four cells each, giving four times the voltage of one cell. In step No. 4 all the cells are in series, giving eight times the voltage of one cell.

Various mechanical means of connecting the different steps of the controller with the wires leading to the motor, so as not to conflict with the turning of the drum, will suggest themselves to any ingenious experimenter.

The first practical demonstration in this country of the new process of telegraphing photographs was made March 4th, when pictures of Taft and Roosevelt were flashed over the wires between Washington and New York.

## HOW TO MAKE A SPEAKING ARC.

BY B. E. BLANCHARD.

A speaking or singing arc, as it is called, is by many considered a difficult device to arrange and secure good results. The writer has within the last month demonstrated this pleasing experiment several times, connections for the same being made as shown in the diagram.

A hand-feed arc lamp similar to the one shown should be used. The base (D) is of wood. (E) slides up and down the shaft or rod, regulating the distance between the carbon tips. Insulation between carbons is provided by the fibre or mica plate, (F), the bolts passing through fibre cylinders. (C) represents asbestos board, slitted to allow the arm (E) to move up and down, and is quite necessary in keeping the rear part of the lamp and the hand feed mechanism cool. (A) consists of a hexagonal frame of iron, each rod having a layer of one-eighth inch asbestos between it and the wire wound upon it. The wire used is No. 14 Krupp resistance wire, 81 turns or 95 feet being wound on each coil,

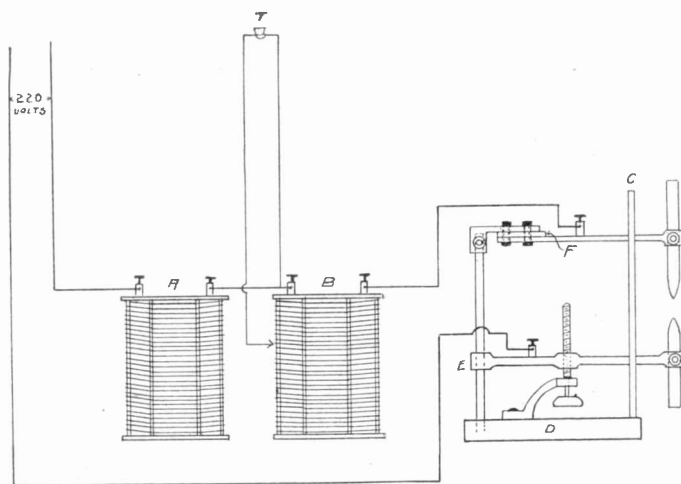

METHOD OF CONSTRUCTING SPEAKING ARC.

(A) and (B). Connect the coils as shown, taking off a tap at the binding post of (B) for one side of the telephone transmitter circuit. Then while someone sings or whistles steadily into the telephone transmitter, (T), move the other lead represented by the arrow, up and

down the coil (B) until the arc while burning gives out the singing distinctly. A transmitter taking 2.5 amperes without heating gives good satisfaction, the lower its resistance the better. The writer used an International and also a Corwin.

The arc should be made as long as possible and one-half inch cored carbons provided. A third piece of carbon for starting the arc should be at hand.

Besides the human voice, the phonograph may be utilized, in which case the best results were obtained by removing the megaphone portion, and holding the transmitter close to the needle diaphragm. Results may be obtained on a 110-volt circuit, but the most satisfactory operation is from 220 volts.

## BATTERY PLATE HOLDER.

Sheet zinc, on account of its brittleness when amalgamated, is not suitable for battery plates, but may be used for this purpose by fixing the plates between pieces of glass, which may be done as follows:

Cut the plate of the size required from a sheet of zinc; old zinc will answer the purpose. Cut two glass pieces the size of the plate. Solder a piece of copper wire to one end of the zinc to serve as an electrode, or else cut a narrow strip nearly off on the vertical edge of the zinc, and bend it upward to serve as the electrode. Then amalgamate the zinc, and fix it between the glass plates. This may be done by tying strings around the three plates at each end, by holding them together with strong rubber bands, or,

more neatly, by means of sealing wax. The plate is then ready for use in the battery cell.

This easy, quick and cheap method of making zinc plates will prove very convenient for amateurs. The plates render good service, and last a long time.

## QUESTIONS AND ANSWERS.

Readers of Popular Electricity are invited to make free use of this department. Knowledge on any subject is gained by asking questions, and nearly every one has some question he would like to ask concerning electricity. These questions and answers will be of interest and benefit to many besides the one directly concerned. No consideration will be given to communications that do not contain the full name and address of the writer.

### Condenser; Mercury Arc Rectifier; Reactance.

*Questions.*—(A) Explain how a condenser in battery circuit is charged and discharged. (B) How does a condenser act on an alternating current? (C) Explain the operation of the mercury arc rectifier. (D) What is meant by reactance?—S. N., Milwaukee, Wis.

*Answers.*—(A) When one terminal of a battery is connected to the wire of a submarine cable, and the other terminal to ground, placing a galvanometer in the circuit, the galvanometer will show current flowing into the wire for quite a time before the galvanometer needle will

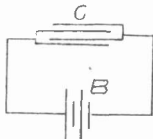

FIG. 1.

cease to be deflected. The energy represented by the charge pouring into the cable seems to be stored up in the form of stress. Similarly if a battery and condenser are connected as shown in Fig. 1, current will flow into the condenser and the plates will become charged. The most current will flow the moment the connections are made, and in the fraction of a second will cease to flow. The current will now act as if

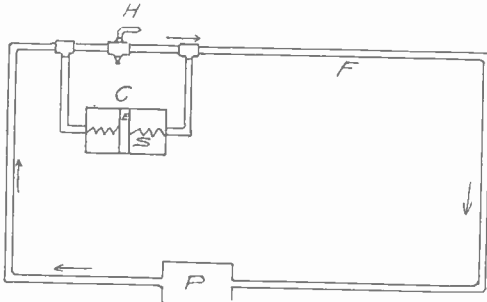

FIG. 2.

the circuit were broken. The condenser acts as if it had acquired a counter electromotive force equal and opposite to

that of the battery. Now remove the battery, connect the terminals of the condenser together and for an instant current will flow and then drop to zero.

(B) With alternating current this charge and discharge takes place with the alternations. Fig. 2 may assist in understanding this further. (P) is a pump, (C) a cylinder and piston, the water being the carrier of energy. Allow (H) to be opened and let the pump set water to flowing through pipe (F) in the direction of the arrows. Now shut the valve. The water will continue in

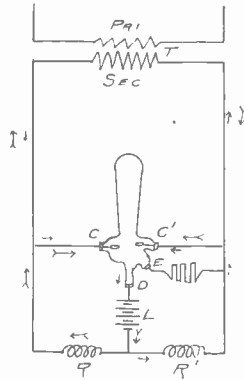

FIG. 3.

the direction of motion set up. On the left of the piston an excess of pressure will push piston (E) to the right and compress the spring (S). As soon as the flow ceases the stress in the spring (S) will give back the energy just given to it. The water in the pipe will follow, or a reverse current is set up until equilibrium is restored. If the valve (H) is opened too soon this reverse current must be overcome.

(C) The principle of the mercury arc rectifier is this: If current is made to flow in one direction between two points through mercury in a glass tube exhausted of air, and the direction of flow be suddenly changed, making what

was the negative electrode, positive, the current will cease to flow, because mercury displays the characteristic of opposing the change in direction and the formation of a new negative electrode.

Referring to Fig. 3 (C C') are positive electrodes, (D) is the negative mercury cathode, (T) is a transformer, (L) batteries to be charged, (R R') reactances, and (E) a starting electrode.

By tilting the tube to the right on starting the rectifier, a mercury path is made between (E) and (D), which starts the arc when the tube is restored to the vertical. Assume the direction of current to be as indicated by plain arrows. Current passes from (C) to (D) and through the load and reactance (R'). On the next alternation the tail arrows show the current from the other side of the transformer (T), passing from electrode (C') to (D), through (L) and (R) to the other side of the transformer (T). Thus at all times through the load (L) current is flowing in one direction. The reactances (R) and (R') at each reversal discharge, holding the arc until the voltage reaches the strength necessary to act against the counter electromotive force of the load. These reactances also smooth out the fluctuations in the direct current.

(D) If two wires are placed parallel to each other, and an alternating current passed through one of them, an electromotive force will be generated in the other wire at all times in the opposite direction to that in the first; that is, current would flow in the opposite direction if the two ends were brought together. This is due to the phenomenon known as induction. Now, if we take one conductor of any alternating current and place in it a coil of wire you will see that the current flowing in each turn of the coil will induce in each neighboring parallel turn an electromotive force in the opposite direction tending to oppose the electromotive force or voltage initially impressed upon the coil. Thus there is set up in the coil a counter electromotive force which opposes the voltage of the main circuit and holds down the current flow. This phenomenon is known as reactance. Direct current finds no resistance to its flow through such a coil, other than the ohmic resist-

ance of the wire, because there is no rise and fall in the current and consequently no inductive effect of one coil upon the others. For full mathematical demonstration see any textbook upon alternating currents.

#### Choke Coil.

*Questions.*—(A) Please explain the action of a choke coil. (B) How may a choking coil be made? (C) Does a choking coil and a kicking coil perform the same service?—R. S., Chicago, Ill.

*Answers.*—(A) The passage of an alternating current through a coil of wire is opposed by an influence that chokes or impedes the current. This is due to the building up of a magnetic field in the coil. This choking effect increases with the frequency of the current and the number of turns of wire. If a mass of

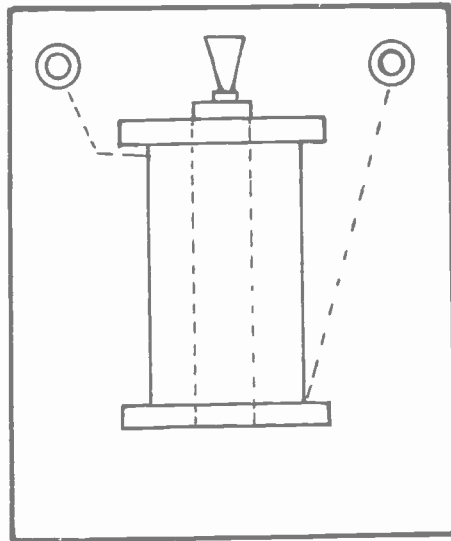

CHOKE COIL WITH REMOVABLE CORE.

iron be placed inside the coil the magnetic flux will be increased because iron is a better conductor of such lines than air, and the choking effect of the coil will be still greater than without the core. This advantage of being able to choke the current without much loss is confined to alternating current. If as in a direct current a resistance is introduced, useless heat is set free, whereas by using a reactance coil as in a lamp circuit, current is choked with very little loss of energy.

(B) The diagram shows the arrangement of a coil in which the iron core may be moved. See answer to J. B., February issue, 1909.

(C) Yes.

#### Pole Changer; Care of Gravity Cell.

*Questions.*—(A) Will you please explain the operation of a pole changer and give diagram? (B) How long should a blue stone battery be worked? M. L. B., Princeton Jct., N. J.

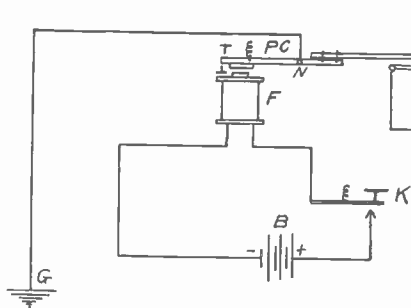

POLE CHANGER.

*Answers.*—(A) A pole changer is used in what is called the polar duplex telegraph system. The pole changer serves to reverse the polarity of the battery to the line. The diagram shows a pole changer at station (K) and a polarized relay at receiving station (R). When key (K) is closed, relay (F) attracts armature (P C), which, resting on bearing (N) lifts contact at (D), closing contact at (D') and opening contact at (E) thus reversing the direction of current to line and around coil (P R) to ground. Armature of (P R) thus opens and closes circuit through sounder (S).

(B) This depends on the work the battery has to do. A pale or dirty brown colored solution indicates a bad condition of the cell. By the time a cell consumes three pounds of copper sulphate it should be cleaned.

#### Arc Lamp Coil; Wire Rheostat.

*Questions.*—(A) What kind of a device can I use in series with my hand adjusted arc lamp? (B) How can I make a simple rheostat of wire for use on a 110-volt circuit?—J. F. W., Seneca, N. Y.

*Answers.*—(A) See answers to T. W. P., May issue, and R. S. in this issue.

See also answer to J. B., February issue, 1909.

(B) See "General Plan for a Home Made Rheostat," in the April issue.

#### Solenoid; Induction Coil; Condenser.

*Questions.*—(A) Will any current be generated in a solenoid moved around a closed magnetized iron ring, the ring being inside the solenoid? (B) Suppose there were an air gap in the ring; would this affect the moving

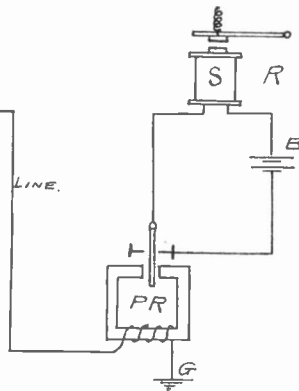

solenoid? (C) How does the metal sheath outside the metal core inside some induction coils increase the secondary current when it is slid out of the coil? (D) How may one find the capacity of a condenser required to offer little impedance to an alternating current of given frequency and voltage as in the common battery telephone system? (E) If one terminal of an insulated primary battery be grounded would any current flow?—E. E. G., Madison, Ind.

*Answers.*—(A) and (B) A current will flow in a closed circuit coil whenever there is a change in the number of lines of force within the coil. A bar magnet moved into and out of such a coil will cause a current in the coil. If the coil is wound about a ring magnet we should say that no current would be produced in the coil because of the uniformity of the lines of force in the iron. If an air gap were made in the ring and the solenoid moved about the ring, current would be induced in the solenoid coils moving over the air gap, as at that point the lines would change in density.

(C) The copper tube that slides over the iron core shields the iron core from the primary because the primary induces large currents in the copper tube itself on account of its low resist-

tance. The induced currents oppose the primary currents so that the resulting effect on the iron core is reduced. Withdrawing the copper tube allows the primary current to act directly upon the core.

(D) This is a problem where rigid rules cannot be laid down. Condensers for telephone purposes are of a high capacity built of alternate layers of paraffine paper and tinfoil.

(E) Not unless the other terminal be grounded, thus closing the circuit.

**Hughes' Microphone.**

*Question.*—I would like to construct a simple microphone. Will you explain how Hughes' microphone is made? J. J., Junction City, Ore.

*Answer.*—Fig. 1 shows the original microphone consisting of three nails. By

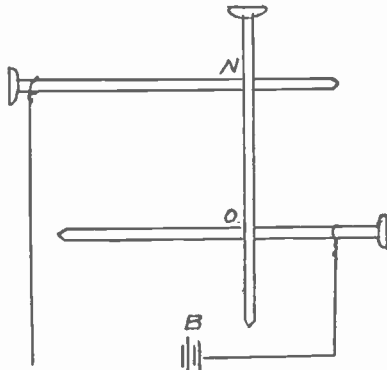

FIG. 1. HUGHES' NAIL MICROPHONE.

these, Hughes demonstrated the principle of variation of resistance of contacts (N, O) by vibration. Fig. 2 con-

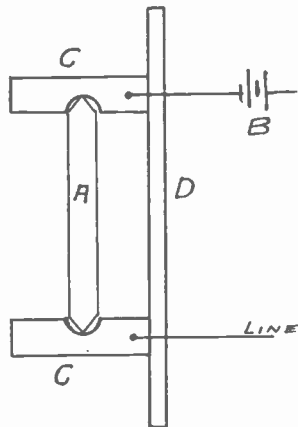
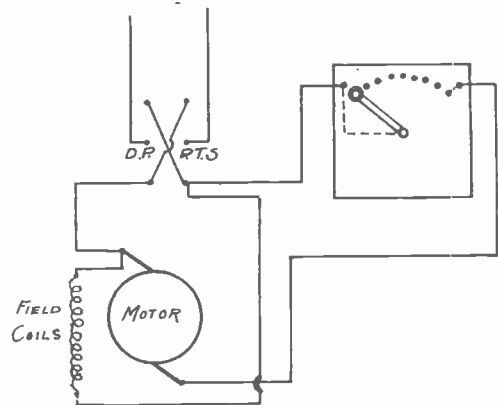

FIG. 2. HUGHES' CARBON MICROPHONE.

sists of a gas carbon pencil (A), pointed at each end and carbon blocks (C, C) fastened to a sounding board (D). The blocks (C, C) are hollowed out to loosely hold the carbon pencil (A) and are the points to which terminals of circuit are connected. The least noise near this instrument produces a very strong, loud vibration in a receiver in the circuit. The pencil (A) vibrates, varying the resistance of the circuit. The Blake transmitter described in the March, 1909, issue operates on the same plan. See also "Construction of a Simple Microphone," January, 1909, issue.

**Installing Motor.**

*Question.*—Please let me know how to connect up an eight horse-power motor, rheostat and pole changer. J. H. G., New York City.



SHUNT MOTOR CONNECTIONS.

*Answer.*—See diagram, showing connections for a shunt motor with rheostat in series with the armature winding.

**Winding Relays.**

*Questions.*—(A) Can a 75-ohm telephone receiver be wound for 1,000 ohms? How much and what size wire may be used? (B) How much and what size wire should I use to change a four-ohm relay to 20 ohms? H. G., Mountain View, Okla.

*Answers.*—(A) It is not practical to use a wire smaller than No. 40, B. and S. gauge. The resistance of 1,000 feet of No. 40 wire is 1,047 ohms; of the same length of No. 38 is 658 ohms.

(B) Use 600 feet of No. 25 wire. The standard 20-ohm relay is wound with 14 layers of 67 turns each of No. 25 wire.

**Three Drop Annunciator and Bell.**

*Question.*—Kindly advise how I can make an annunciator for a house call bell with three drops.—R. B., Scranton, Pa.

*Answer.*—In Fig. 1 you will find the

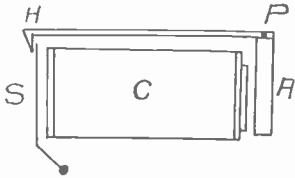

FIG. 1. PRINCIPLE OF THE ANNUNCIATOR.

principle underlying the construction of nearly all annunciators. When current flows through the coil (C) the armature (A) is attracted, and being pivoted at

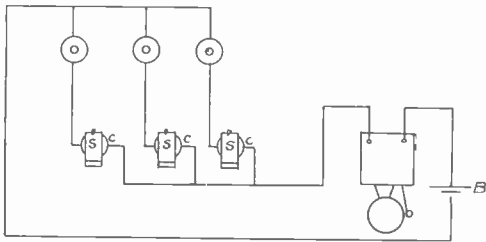

FIG. 2. METHOD OF CONNECTING THE THREE DROPS AND ONE BELL.

(P), the lever hook (H) rises and allows the shutter (S) to fall and display a number painted on its inside face. Fig. 2 shows method of connecting circuit for three drops and one bell.

**Changing Motors Into Generators.**

*Questions.*—(A) I have a motor that requires 110 volts to run it. I wish to change it into a generator. How may I do so? (B) How many volts would I get? (C) I have a motor which I tried to run as a generator, and I was told to magnetize the fields, which I did. I wish now to run it again as a motor, but on attaching batteries it will not run. The wiring or connections have not been changed.—R. G. W., Pittsburg, Pa.

*Answers.*—(A) Connect the positive lead as a generator to the positive side of supply circuit and the negative lead to the negative side. Assuming a shunt-wound motor, it will run in the same direction as that in which it ran as a generator.

(B) You should be able to get 110 volts, varying the speed until the required point is reached.

(C) This is a difficult question to answer and the causes are numerous.

Among them may be open field coil; broken wire in starting box; wrong connection of the shunt field; dirty brushes, etc.

**Dry Batteries; Arc Lamps.**

*Questions.*—(A) Will you explain how to make a small electric dry battery? (B) Why is a rheostat used with a stereopticon arc lamp? (C) Could an arc lamp be run by wires from a lamp socket with no rheostat in circuit? (D) Could an arc be used on a 220-volt circuit alternating or would it work best on a 110-volt direct current? F. C. S., McKees Rocks, Pa.

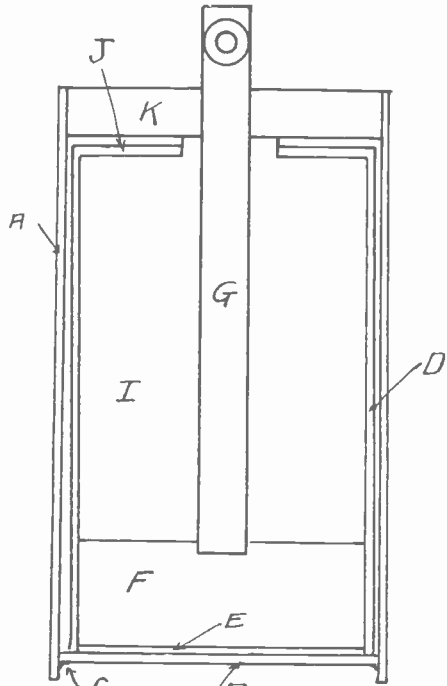

- A - Zinc Shell
- B - Bottom  $\frac{3}{4}$ " Up
- C - Solder
- D - Blotting Paper
- E - Pasteboard
- F - White or Red Sand
- G - Carbon Stick
- H - Brass Terminal
- I - Carbon and Manganese Powder
- J - Blotting Paper Turned In
- K - Sealing Compound

SIMPLE DRY CELL.

*Answers.*—(A) Place in a jar one pound of chloride of zinc crystals. Pour over them a quart of distilled water. Let stand for half an hour. Then pour the water off into a clean jar. If the crystals are not all dissolved, add a pint of water, let stand as before and pour into the first portion of the solution. When all crystals are dissolved, dilute the zinc



chloride solution thus obtained by putting in an equal amount of distilled water. Put sal ammoniac into this solution in the proportion of one pound of sal ammoniac to every two quarts of water. Set this aside, labeling it "Battery Solution."

To make the cell, take an already lined zinc can, blotting paper as shown in the sketch being the lining, and fill with battery solution. After the paper has absorbed some of the solution, pour it out and invert the can to dry out a little. Now mix finely powdered carbon and manganese wet with the battery solution until a stiff paste results. Put into the can the carbon center post with two tablespoonfuls of sand at the bottom. Now fill in with the paste, ramming down carefully. The sketch of the cell will make the rest clear. The top may be sealed over with paraffine wax.

(B) The ordinary arc lamp takes but 45 to 50 volts. When used on constant potential circuits of more than 50 volts, it is necessary to introduce a certain resistance in series, in order to take up part of the voltage, and also to act in a steadying capacity to the arc; until this dead resistance was used in series with arc lamps on constant voltage circuits, such lamps were not successful.

(C) A lamp socket is designed to supply only about one and one-half amperes to any device plugged in. See (B).

(D) A small transformer should be used in the first case, and a rheostat in the second.

#### Small Dynamo; Resistance and Voltage.

*Questions.*—(A) I have a ring armature six inches in diameter and three inches in length. If properly wound and revolved at 1,500 to 2,000 times a minute what voltage and current should I get? (B) Would it make any difference in the output if the field poles were  $\frac{1}{2}$  inch instead of one inch thick? (C) Would it make any difference if the armature was made of laminated iron disks instead of a solid iron ring? (D) Does a resistance in an electric circuit make any change in the voltage?—L. C. E., Wampa, Idaho.

*Answers.*—(A) Using  $1\frac{1}{4}$  pounds of No. 24 wire on the armature, and 7 pounds of No. 24 wire on the field magnets you should get approximately 100 volts and  $1\frac{1}{2}$  amperes at the speed you designate.

(B) To push lines of force through a long magnet circuit requires more energy than to crowd them through a short one.

(C) By providing a laminated core for the armature, eddy current losses are eliminated.

(D) The fall or drop in voltage over any electric circuit is proportional to the resistance.

#### Mercury Resistance; Light Switch; Ruhmkorff Coil.

*Questions.*—(A) Can mercury be used as a rheostat? (B) Is it possible to arrange three switches so that lights may be turned on or off at three different points? (C) what would a Ruhmkorff coil giving a 2-inch spark cost?—E. L. A., Tacoma, Wash.

*Answers.*—(A) Mercury stands next

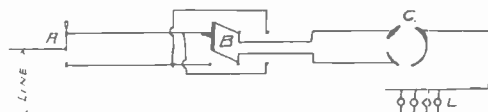

SWITCHING LIGHTS FROM THREE POINTS.

to silver and copper in conductivity and is hardly feasible to use as resistance.

(B) Diagram shows how connections may be made to control lights from any one of three points. (A) is a single pole, double throw switch. (B) is a double pole, double throw switch. (C) is a snap switch.

(C) List prices of two to  $2\frac{1}{2}$ -inch Ruhmkorff coils range from \$35 to \$50, according to finish and enclosing cabinet. You might be able to get a discount from this cost.

## BOOK REVIEW.

DYNAMO AND MOTOR ATTENDANTS AND THEIR MACHINES. (Fifth edition.) By Frank Broadbent. London: S. Rentell & Co., Ltd. 133 pages, with 66 illustrations.

This is a practical book for practical men, taking up such subjects as how to choose the right dynamo or motor for particular purposes, erecting machines, methods of driving, how to start, stop and parallel dynamos, speed control, faults and how to find them, etc. Some of the later types of apparatus are illustrated and there are also numerous diagrams helpful to the operator in running his machines.

## NEW ELECTRICAL INVENTIONS.

### ELECTRICALLY FIRED TORPEDO.

The torpedo shown in the cut is designed to be fired by electricity when it strikes the target, and the firing mechanism is all contained within the torpedo itself. A standard torpedo shell is represented, consisting of an outer shell with-

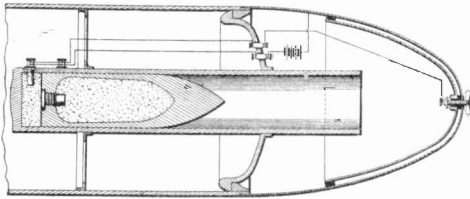

ELECTRICALLY FIRED TORPEDO.

in which is mounted the torpedo proper containing the explosive. The torpedo is ejected under the water from the usual firing tube.

The nose of the torpedo is provided with an inner metallic casing which extends only a short distance back and is insulated from the outer casing. As the torpedo proceeds through the water, the little screw propeller seen at the forward end turns, and the threads on its shaft draw an electrical contact up until it touches the inner casing of the torpedo nose or war head as it is called. An electrical circuit is now complete through a battery and sparking arrangement with the exception that there is a break between the outer and inner casing of the warhead. When the torpedo strikes the target the metal casings of the warhead are jammed together, completing the circuit and firing the charge.

A point of advantage in the scheme is that there is no danger of premature discharge. The only way the circuit can be closed is by jamming the two casings together and at the same time having the screw contact, which is operated by the propeller, brought up against the inner casing. The latter is the case only after the torpedo is under way in the water and the propeller has performed its function.

The system is the invention of Lieutenant Commander Cleland Davis, United States Navy, Washington, D. C.

### MEASURING THE VELOCITY OF WATER.

A simple electrical device for measuring the velocity of water current consists of a sort of revolving propeller blade held against the current by a rearwardly projecting vane. On the shaft is a make-and-break device which opens and closes a battery circuit a given number of times for each revolution. A telephone ear-piece with head-band for

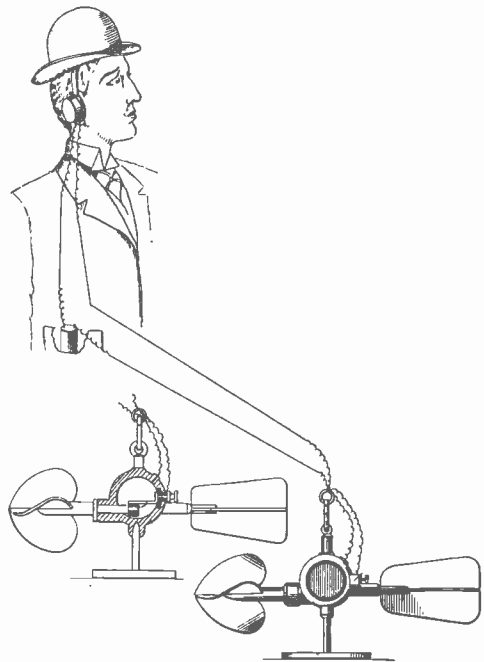

APPARATUS FOR MEASURING VELOCITY OF WATER.

the operator is also included in the circuit, so that with every closing of the circuit the operator hears a click in the receiver. He is thus enabled readily to count the number of revolutions of the shaft in a given length of time. The instrument has been previously calibrated so that it is known how many revolutions it will make in a minute when submerged in water flowing at various known velocities, so by a little calculation the operator can ascertain the velocity of the stream he is measuring. The inventor is J. S. J. Lallie of Denver, Colo.

**TRAVELING FAN.**

An inventor, Frank B. Thilow, of Philadelphia, has hit upon the idea that an electric fan may be made which will travel about a room expelling the impure air from every corner. The illustration shows his invention. A double fan with a motor between is suspended from wheels which run upon a little iron track. The rails of this track form the two main

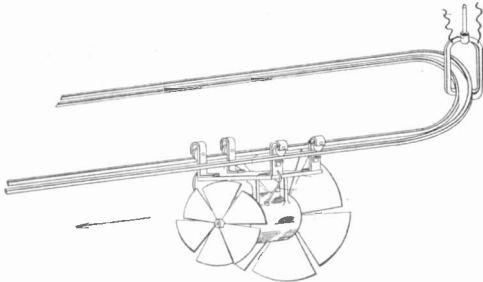

TRAVELING FAN.

conductors of the electric circuit from which the current is collected by a simple device and carried to the motor. When set in motion the larger fan presses against the air with sufficient force to send the whole device along the track, which is continuous.

**WALKING ON THE CEILING.**

The accompanying diagram shows in a general way an arrangement to enable a person to walk, slide or skate in an

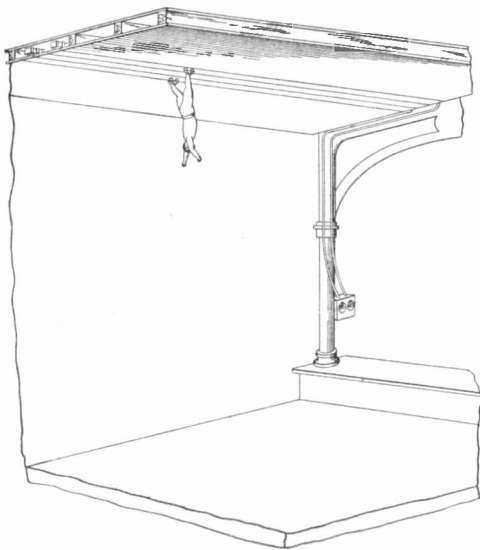

WALKING ON THE CEILING.

inverted position on the under side of a ceiling. Its inventor, Ernest F. George of Manlius, N. Y., calls it an "electric aerial ambulating system." The scheme is to place a number of electromagnets in the ceiling, concealed from view, of course. They are arranged in parallel rows. These magnets are energized by wires carrying electric current. On the feet of the actor are skate-like appliances made of iron, which are attracted by the magnets.

**AN ELECTRIC REMINDER.**

Most of us have had recourse at some time or other to the time-honored practice of tying a string around the finger to enable us to remember to do a certain thing at a certain time.

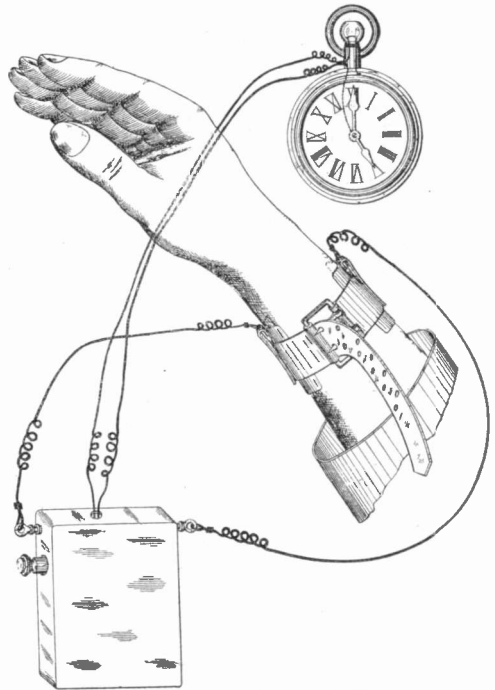

AN ELECTRICAL REMINDER.

A more elaborate device is shown in the illustration which is the invention of two citizens of Austria-Hungary. It consists of a battery and induction coil and a specially made watch. Wires from the secondary of the coil lead to electrodes strapped on each side of the wrist. The watch closes the circuit to the battery at any predetermined time, which starts the induction coil and gives the sleeper a "rousing" shock.

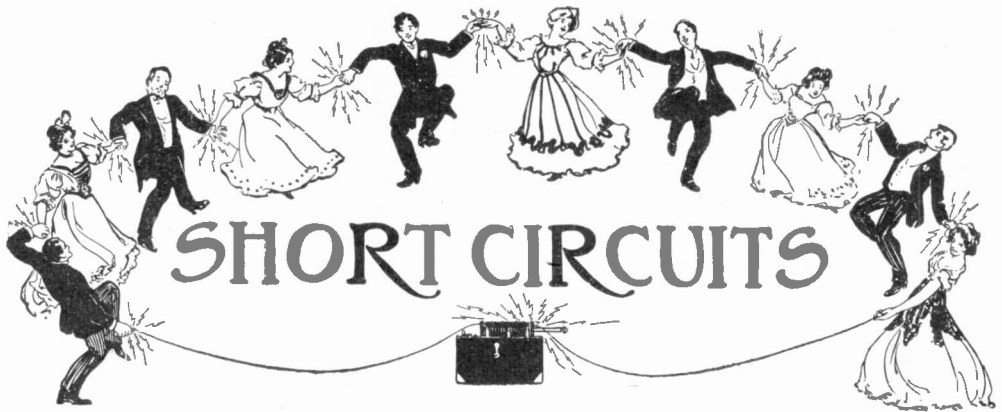

They were playing 500, when a very pompous lady bid eight on diamonds. "Have you any diamonds?" she said to her partner. "No," said her partner, a very little mild-tempered man, but added hastily, "I've got what you dig 'em with."

\* \* \*

A gentleman and his wife, both of whom were greatly respected by their neighbors for their Christian charity, entertained a visiting clergyman from a distant city. Among the guests were members of their own church. A bright little daughter of the host was greatly interested in the good doctor, and very curious to know why people should say grace before eating. The doctor was pleased at the question, and hastened to inform her that all good people endeavored to return thanks in that manner for the good things which were given.

"Yes," exclaimed the little inquisitive, "but you don't say grace just like my papa said last night."

"How was that?"

"My God, what a supper!"

\* \* \*

The teacher was giving a geography lesson, and the class, having traveled from London to Labrador, and from Thessaly to Timbuctoo, was thoroughly worn out.

"And now," said the teacher, "we come to Germany, that important country governed by the Kaiser. Tommy Jones, what is a Kaiser?"

"Please 'em," yawned Tommy Jones, "a stream of hot water springin' up an' disturbin' the earth!"

\* \* \*

Once upon a time there were two prisoners in jail. One was in for stealing a cow; the other for stealing a watch. Exercising in the courtyard one morning, the first prisoner said, tauntingly, to the other: "What time is it?" "Milk-ing time," was the retort.

\* \* \*

Every family should have a curfew, says an exchange, which should "ring tonight" and all other nights if needed. These curfews are inexpensive and can be made at home. Take a piece of siding two feet long and whittle one end to a handle. Take the child that needs the curfew and bend it over a barrel. Now take the siding and use it as a clapper. Put it on hot, dividing the strokes evenly, and see that none misses. Good for a boy or girl up to 18, and three applications are warranted to cure the most pronounced case of street loafing that exists. The resulting music is said to be more effective than singing "Where Is My Wandering Boy Tonight?"

Englishman (in British Museum):—"This book was once owned by Cicero."

American Tourist:—"Pshaw! That's nothing. Why, in one of our American museums we have a lead pencil which Noah used to check off the animals as they came out of the Ark."

\* \* \*

A ruralist in Missouri posted his lands—the notices reading as follows:

"Notis—Trespaser will be persecuted to the full exten of 2 mean mungrel dogs wich ain't never ben overly soshibil with strangers an' I dubbelp barl shot gun wich ain't loaded with no sofy pillers dam if I ain't tire of this hel-raisin' on my property."

\* \* \*

Professor (to his aged cook)—"You have now been twenty-five years in my service, Regina. As a reward for your faithfulness I have decided to name the bug I recently discovered after you."—Meggendorf Blaeter.

\* \* \*

"What became of Pat?"

"He was drowned."

"And couldn't he swim?"

"He did for eight hours, but he was a union man."

\* \* \*

Matrimonial Catechism.—What is marriage? Marriage is an institution for the blind.

Should a man marry a girl for money? No. But he should not let her be an old maid just because she's rich.

When a girl refers to a "sad courtship," what does she mean? She means that the man got away.

Is an engagement as good as a marriage? It's better.

When asking papa, how should a young man act? He should face papa manfully, and never give him a chance at his back.

When the minister says, "Do you take this woman for better or for worse?" what does he mean? The bridegroom's people construe it one way, and the bride's family interpret it another. It is very sad.

When a man says he can manage his wife, what does he mean? He means he can make her do anything she wants to.

When a child is smart and good, to whose family is it due? To its mother's.—Chicago Medical Recorder.

\* \* \*

"You are charged with stealing nine of Colonel Henry's hens last night. Have you any witnesses?" asked the justice sternly.

"Nussah!" said Brother Jones humbly. "I specks I's sawtuh peculiar dat-uh-way, but it ain't never been mah custom to take witnesses along when I goes out chicken-stealin', suh."



HAD THE ANCIENT EGYPTIANS UNDERSTOOD ELECTRICITY?

## ELECTRICAL DEFINITIONS.

**Accumulator.**—Storage battery.

**Alternating Current.**—That form of electric current the direction of flow of which reverses a given number of times per second.

**Ammeter.**—An instrument for measuring electric current.

**Ampere.**—Unit of current. It is the quantity of electricity which will flow through a resistance of one ohm under a potential of one volt.

**Ampere Hour.**—Quantity of electricity passed by a current of one ampere flowing for one hour.

**Anode.**—The positive terminal in a broken metallic circuit; the terminal connected to the carbon plate of a battery.

**Armature.**—That part of a dynamo or motor which carries the wires that are rotated in the magnetic field.

**Branch Conductor.**—A parallel or shunt conductor.

**Brush.**—The collector on a dynamo or motor which slides over the commutator or collector rings.

**Bus Bars.**—The heavy copper bars to which dynamo leads are connected and to which the out-going lines, measuring instruments, etc., are connected.

**Buzzer.**—An electric alarm similar to an electric bell, except that the vibrating member makes a buzzing sound instead of ringing a bell.

**Candle Power.**—Amount of light given off by a standard candle. The legal English and standard American candle is a sperm candle burning two grains a minute.

**Capacity, Electric.**—Relative ability of a conductor or system to retain an electric charge.

**Charge.**—The quantity of electricity present on the surface of a body or conductor.

**Choking Coil.**—Coil of high self-inductance.

**Circuit.**—Conducting path for electric current.

**Circuit-breaker.**—Apparatus for automatically opening a circuit.

**Collector Rings.**—The copper rings on an alternating current dynamo or motor which are connected to the armature wires and over which the brushes slide.

**Commutator.**—A device for changing the direction of electric currents.

**Condenser.**—Apparatus for storing up electrostatic charges.

**Cut-out.**—Appliance for removing any apparatus from a circuit.

**Cycle.**—Full period of alternation of an alternating current circuit.

**Diamagnetic.**—Having a magnetic permeability inferior to that of air.

**Dielectric.**—A non-conductor.

**Dimmer.**—Resistance device for regulating the intensity of illumination of electric incandescent lamps. Used largely in theaters.

**Direct Current.**—Current flowing continuously in one direction.

**Dry Battery.**—A form of open circuit battery in which the solutions are made practically solid by addition of glue jelly, gelatinous silica, etc.

**Electrode.**—Terminal of an open electric circuit.

**Electromotive Force.**—Potential difference causing current to flow.

**Electrolysis.**—Separation of a chemical compound into its elements by the action of the electric current.

**Electromagnet.**—A mass of iron which is magnetized by passage of current through a coil of wire wound around the mass but insulated therefrom.

**Electroscope.**—Instrument for detecting the presence of an electric charge.

**Farad.**—Unit of electric capacity.

**Feeder.**—A copper lead from a central station to some center of distribution.

**Field of Force.**—The space in the neighborhood of an attracting or repelling mass or system.

**Fuse.**—A short piece of conducting material of low melting point which is inserted in a circuit and which will melt and open the circuit when the current reaches a certain value.

**Galvanometer.**—Instrument for measuring current strength.

**Generator.**—A dynamo.

**Inductance.**—The property of an electric circuit by virtue of which lines of force are developed around it.

**Insulator.**—Any substance impervious to the passage of electricity.

**Kilowatt.**—1,000 watts. (See watt.)

**Kilowatt-hour.**—One thousand watt hours.

**Leyden Jar.**—Form of static condenser which will store up static electricity.

**Lightning Arrester.**—Device which will permit the high-voltage lightning current to pass to earth, but will not allow the low voltage current of the line to escape.

**Motor-dynamo.**—Motor and dynamo on the same shaft, for changing alternating current to direct and vice versa or changing current of high voltage and low current strength to current of low voltage and high current strength and vice versa.

**Multiple.**—Term expressing the connection of several pieces of electric apparatus in parallel with each other.

**Multiple Circuits.**—See parallel circuits.

**Neutral Wire.**—Central wire in a three-wire distribution system.

**Ohm.**—The unit of resistance. It is arbitrarily taken as the resistance of a column of mercury one square millimeter in cross sectional area and 106 centimeters in height.

**Parallel Circuits.**—Two or more conductors starting at a common point and ending at another common point.

**Polarization.**—The depriving of a voltaic cell of its proper electromotive force.

**Potential.**—Voltage.

**Resistance.**—The quality of an electrical conductor by virtue of which it opposes the passage of an electric current. The unit of resistance is the ohm.

**Rheostat.**—Resistance device for regulating the strength of current.

**Rotary Converter.**—Machine for changing high-potential current to low potential or vice versa.

**Secondary Battery.**—A battery whose positive and negative electrodes are deposited by current from a separate source of electricity.

**Self-inductance.**—Tendency of current flowing in a single wire wound in the form of a spiral to react upon itself and produce a retarding effect similar to inertia in matter.

**Series.**—Arranged in succession, as opposed to parallel or multiple arrangement.

**Series Motor.**—Motor whose field windings are in series with the armature.

**Shunt.**—A by-path in a circuit which is in parallel with the main circuit.

**Shunt Motor.**—Motor whose field windings are in parallel or shunt with the armature.

**Solenoid.**—An electric conductor wound in a spiral and forming a tube.

**Spark-gap.**—Space between the two electrodes of an electric resonator.

**Storage Battery.**—See secondary battery.

**Thermostat.**—Instrument which, when heated, closes an electric circuit.

**Transformer.**—A device for stepping-up or stepping-down alternating current from low to high or high to low voltage, respectively.

**Volt.**—Unit of electromotive force or potential. It is the electromotive force which, if steadily applied to a conductor whose resistance is one ohm, will produce a current of one ampere.

**Voltage.**—Potential difference or electromotive force.

**Volt Meter.**—Instrument for measuring voltage.

**Watt.**—Unit representing the rate of work of electrical energy. It is the rate of work of one ampere flowing under a potential of one volt. Seven hundred and forty-six watts represent one electrical horse power.

**Watt-hour.**—Electrical unit of work. Represents work done by one watt expended for one hour.

## POPULAR ELECTRICITY

# HOW THE PRESIDENT SAVES AN HOUR EVERY DAY

A NEW SYSTEM WHICH ECONOMIZES THE TIME OF THE OFFICERS OF THE COMPANY  
AS WELL AS THE MANAGERS AND CLERKS.

**L**IKE most other men with Hurry as their gad-fly, I sometimes hear of astonishing things that I mean to look into, but which "business" drives out of my mind before I have the opportunity to investigate. But when I was told at luncheon the other day that the active President of a great corporation had installed a system whereby he could instantly and directly issue a general order to all the heads of departments throughout the building, at one time without leaving his room, I remembered to have heard about that wizard-like performance before, and determined to follow the lead at once, before I could lose it again. Fortunately I was acquainted with the President, and I found him not only willing but rather pleased to show me the operation of the wonderful saver of time and annoyance.

Just under the pigeon-holes of his desk, out of the way of everything and almost out of sight, was set an innocent looking box not more than 11 inches long and 6 inches high; a row of small levers ran along the lower part of it, above which were two orifices that might remind one of a pair of exaggerated eyes.

"Demonstration number one," said the President, and reaching over he pulled down several levers; "Buzz," went the instrument and several "buzzes" answered. "Now I know," said he, "that my heads of departments are at their end of the wire and I'm going to issue a general order about deliveries," which he did in a low tone of voice at a distance of at least 6 feet from the box, and rather away from it than toward it. "Is that understood, Mr. Evans, Mr. White, etc.?" and he went down the line of names. Imagine my astonishment when "Yes, sir, O. K.," came from the box.

as each name was called in tones clearly audible in every part of the private office (about 15 feet square). It was almost uncanny.

"You see," he said, "instead of sending a boy and bringing them to my office from distances of 100 to 700 feet and on different floors, I can issue a general order and have it acknowledged in 10 seconds.

"Demonstration number two will show you how the private office can be secluded even from my stenographer who used to be its most consistent invader," continued the President, as he pressed another lever; instantly the box said, "Yes, sir, ready"—walking to the extreme end of the office he dictated a letter in a tone of voice scarcely above a whisper and, mind you, without connection with or apparent regard for the location of the box—talking into the air. "Read that back, please," and out of the instrument came the text of the letter word for word clearly understandable and distinct to both of us.

"This feature is particularly desirable," he said, "when I have a number of gentlemen in the office and want to dictate an agreement or a letter. It saves the time for them and for me which would be required for her to come to the office and depart; I get her instantly and when through dictating I shut off and we are immediately ready to resume our conference."

"The third demonstration will show you how secret communication is assured. We will assume that you are a salesman and have quoted me a price on a large quantity of oil. I press my bookkeeper's lever," suiting the action to the word, "and ask 'What did we pay for that last supply of oil?' Now I take this receiver off the hook; that automatically causes the instrument to act like an ordinary telephone—I get the information and you have heard nothing. Further

and entire secrecy is assured by the fact that no matter how many lines are opened on the other end (or substation), nothing can be heard unless I switch them on here (at the master-station). No central is necessary—the inter-communicating and cutting out system is evidently perfect in its arrangement and is entirely governed by my pressing the lever.”

“Here is also an interesting test that I have tried. We will suppose that clerk No. 1 has laid the blame for an error on clerk No. 2, I connect up both clerks without either knowing that the other is on the wire; then I say to clerk No. 2, ‘Clerk No. 1 says that you are at fault in this case,’ and state the reason. Clerk No. 2 gives his side and if it is not correct Clerk No. 1 breaks in and tells him so. They then argue it and I hear both sides without taking them away from their desks or having them invade my office for the discussion.

“It is quite a detective in its way and beside giving me much inside information I figure that it saves me perhaps as much as one to two hours a day, which is obviously a great consideration.

“Our Secretary, Treasurer, General Manager and Superintendent, all have Master Stations and we can communicate with each other constantly without leaving our desks and without the bother of either talking into a mouthpiece or holding a receiver to the ear.”

“Does it ever get out of order?” I asked.

“Ours has not as yet and it has been installed six months,” was the reply. “It is put in on a rental basis and The National Dictograph Company guarantees all maintenance and perfect working order.”

By the way, the name of this little Wizard of modern business is the Dictograph, but that name hardly expresses its capabilities as demonstrated to me, and in fact it would be hard to find a name that would.

I have just learned of another very interesting and practical service which the Dictograph rendered. A certain financial institution of large interests, through being checkmated in several important moves, was convinced that some of its employes were not only “leaking” but playing with the other side.

Suspicious actions led the officers of the Institution to believe that one room was consistently used for conferences by the employes in question—in this room they proceeded to install a Dictograph, setting it in the wall and covering it with wall paper so as to make it entirely invisible.

The conspirators (so to speak) met, their discussion, word for word, was heard by the Company officials some distance away, and the graft of the traitors as well as the embarrassment (financial and otherwise) of the Institution, came to an immediate ending.

Further investigation gives me the information that while the National Dictograph Company is a young concern, its instruments are now installed in some of the largest and most conservative Banks, Trust and Life Insurance Companies Industrial Corporations in New York and Chicago.

The purpose of the Company, now that the practicability and usefulness of the Dictograph has been proved by actual rentals to great Corporations, is to take immediate steps toward making it universally known and used.

It would seem that every business man would conserve his best interests by writing to the Sterling Debenture Corporation, 225 Fifth Ave., New York, for Booklet No. “N 381,” which gives full information about the Dictograph, its purposes, its rentals, installations and plans for the future.

By W. W. GRIFFITH.

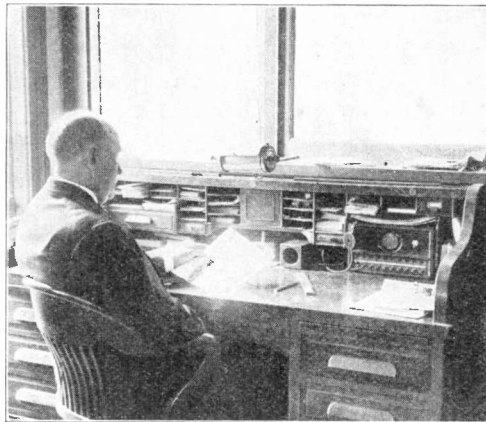

President of large corporation dictating to his stenographer through the Dictograph.



# CLASSIFIED ADVERTISING

Rates, 40 cents per agate line, cash with order, nothing less than 3 lines.  
Advertisements should be in our office on or before the 2d preceding date of issue.

## Help Wanted.

WE EXPECT to have positions for a number of men as automobile car drivers, and interurban railways; only sober and reliable men need apply; experience unnecessary; send four-cent stamp for applications. The Western Transportation Company, American Nat. Bank Bldg., St. Paul, Minn.

WANTED—Railway mail clerks, city carriers, postoffice clerks. Many examinations coming. Yearly salary \$600 to \$1,600. Short hours. Annual vacation. No layoffs. Salary paid twice monthly. Over 8,000 appointments to be made during 1909. Country residents eligible. Political influence not necessary. Common education sufficient. Candidates prepared free. Write immediately for schedule of coming examinations. Franklin Institute, Dept. F 62, Rochester, N. Y.

THE UNITED TRADE SCHOOL CONTRACTING CO., conducts a trade school and wants men to learn plumbing, bricklaying or electrical trade. No expense and hundreds have learned in a few months. Steady work guaranteed. Address 120 E. 9, Los Angeles.

## Patents.

PATENTS—H. W. T. Jenner, patent attorney and mechanical expert, 608 F Street, Washington, D. C. Established 1883. I make an investigation and report if patent can be had, and the exact cost. Send for full information. Trade-marks registered.

PATENTS—Advice and books free. Highest references. Best results. I procure patents that protect. Watson E. Coleman, Patent Lawyer, 612 F St., N. W., Washington, D. C.

PATENTS SECURED — Inventor's Pocket Companion free. Send description for free opinion as to patentability. W. N. Roach, Jr., Metzgerott Bldg., Washington, D. C.

## Agents Wanted.

THE LIGHTNING MULTIPLIER POST CARD will solve problems in multiplication quick as a flash, with absolute accuracy. Indispensable to every person who uses figures. Cannot get out of order. Send for one, and you will wonder how you ever got along without it. Agents wanted. Sample, 10 cents in stamps. The Simplicity Co., Chicago.

DON'T ACCEPT an agency until you get my samples and particulars. Chance of a life time to get into a money-making business. T. M. Sayman, 2390 Franklin Ave., St. Louis, Mo.

## Agents Wanted.

AGENTS—Our \$2 adding machine is making a tremendous hit, good territory unoccupied. Smith Supply Co., B.-6, Los Angeles, Cal.

BIG MONEY FOR AGENTS. A few more "live ones" wanted in every locality. The most liberal proposition ever offered. Write for particulars. State line of business or where employed. Positively no postals will be given attention. Popular Electricity Pub. Co., Book Dept., Monadnock Block, Chicago, Ill.

AGENTS—Handle a staple article, men's and women's handkerchiefs. Factory to consumer through you. Established line. Continuous orders. Rare opportunity. Write to Republic Mfg. Co., 2071 Greene St., New York.

YOUR NAME ON RUBBER STAMP. 10c; with address, 15c; pad, 12c; dater, 15c. Stamps, 10c per line, postpaid. National Stamp Works, 110 Fifth Ave., Chicago. Agents wanted.

EARN MORE MONEY! "The Booster Magazine" puts you "next" to a 600 per cent profit mail order business and an automatic press proposition actually paying workers \$65 weekly. Other big features galore. In a class by itself. Get out into the sunshine. Quit "grinding"! "Booster" starts you. Two months' trial, 10 cents. P. M. Burdick, 351 Dearborn St., Chicago.

STOP, women and men; hurry; seven new, useful fast sellers; 30 others to select from; big profits; write for \$2 free offer and particulars. Fair Mfg. Co., Box 208, Racine, Wis.

## Inventions.

EXPERT AND SUCCESSFUL inventor will develop ideas and inventions, build models, make drawings and give general advice in perfecting and marketing inventions. Long experience. Circular free. L. Casper, 633 No. Park Ave., Chicago, Ill.

## Schools.

\$200 TO \$600 MONTHLY EASILY MADE fitting eye glasses. Short, easy mail course. Reduced tuition. Big demand for opticians. Write to-day for free "Booklet O." National Optical College, St. Louis.

TELEGRAPHY taught quickly. R. R. wire in school. Living expenses earned. Graduates assisted. Correspondence course if desired. Catalog free. Dodge's Institute of Telegraphy, 49th St., Valparaiso, Ind. Established 1874.

AUTOMOBILE SCHOOL—Learn the automobile business, repairing and driving, in which you can earn good wages and have healthful and pleasant work. We give a thorough and practical course in road work and repairing. For full particulars address Academy of Automobile Engineering, 1420 Michigan Ave., Dept. "C," Chicago, Ill.

## POPULAR ELECTRICITY

### CLASSIFIED ADVERTISING.

(CONTINUED.)

#### For Sale.

FOR SALE—Complete set of castings, with blue prints of  $\frac{3}{4}$  h. p. gasoline stationary engine; includes governor and timer, screws, etc. \$10. Comet Motor Works, 17 W. Madison St., Chicago, Ill.

FOR SALE—Complete 3-rail electric railway. Cost \$20.00. Will sell for \$9.00. Further particulars for red stamp. E. A. Gordner, Box 547, Rochester, N. Y.

FOR SALE—Amateurs, make your coils with a slide wire bridge. Drawings and instructions, 50 cents. No toy. Cost, \$3.00. Advance Bridge Co., 125 E. Jefferson St., So. Bend, Ind.

FOR SALE—A large quantity of No. 34 single silk magnet wire at \$1.50 per pound; any address prepaid; nothing less than one-half pound. Geo. E. Glasser, Charlotte, N. Y.

EXCHANGE OR SELL your motors, generators, steam and gasoline engines, cameras, magic lanterns, phonographs, printing press, musical instruments, real estate or anything of value, new or second-hand. Send 4c stamp for best trading plan known. National Exchange Co., 929 Olive, St. Louis, Mo.

THREE THOUSAND FORMULAS—My 368-page volume of recipes and trade secrets, cloth bound, only 40c prepaid. Worth dollars. Satisfaction guaranteed. Wiley Sanderson, Dept. E, Ypsilanti, Mich.

SNOW SCENES—Views from one of Maine's most picturesque places. 5 ft. snow, 6 actual photo-cards, highly polished, 50c. Suitable for framing. C. Stanley, L. B. No. 5, Dixfield, Me.

LUBRICANTS, asbestos, graphite and mica candles for loose pulleys and shaftings; no drip; no dirt; economical. Swain Lubricator Co., 252 E. Lake St., Chicago.

#### Business Opportunities.

CONCRETE—Learn how to handle this material, by reading "Concrete," a monthly magazine devoted to the uses of Portland cement. Practical, instructive articles, written in plain English. Sample copy, 10c. Yearly subscription, one dollar. Concrete Pub. Co., 299 Owen Bldg., Detroit, Mich.

500% PROFIT seems incredible, don't it? Send us 10c silver for copy of our folder, "How to Make Money Making Mirrors." Money returned if not satisfied. Economy Chemical Co., Box P-805, Ludington, Mich.

MAIL ORDER BUSINESS FOR SALE—Has been operated for several years with excellent results as a "spare time" proposition, clearing a neat sum each week. Could be easily developed into a larger business if desired. For further information and reasons for selling out address Mrs. G. L. Patterson, Brooksville, Ky.

I HAVE listed with me to sell all subjects, I. C. S. and A. S. C. bound volumes. Do not buy until you get my prices. M. C. Suttle, McLeansboro, Ill.

#### Wireless.

WIRELESS SUPPLIES—Norway iron core wire, No. 22, straightened and cut to length. 20c per lb.; No. 27 German silver, 400 ohms. 45c; No. 26 enameled wire, 300 ft. 35c; platinum wire for detectors, 5c per inch; No. 34 S. C. C. magnet wire, \$1.23 per lb. All sizes and insulations at proportionate prices. Tinfoil 35c per lb.; Leyden jars, condensers, spark gaps, interrupters, etc. Complete price list on request. O. S. Dawson, 156 Wabash Ave., Chicago, Ill.

WIRELESS EXPERIMENTERS, 1200 OHM receivers, each \$3.00. Wound with copper wire and very sensitive. First 25 sold will be fitted with nickel plated headband. W. C. Getz, 345 N. Charles St., Baltimore, Md.

CARBON WIRELESS DETECTOR sent prepaid upon receipt of 50c. Simple, sensitive and strong. Dept. Q, 357 E. 46th St., Chicago.

WIRELESS TELEGRAPHY—Send twenty-five cents, coin, to-day and receive by return mail complete instructions, with diagrams, for making a complete sending and receiving station. Among instruments described are 1-inch coil and two different types of receivers. Box 519, Lima, Ohio.

THE NEW SILICON DETECTOR will increase your receiving radius 500%. Only type sold to experimenters authorized by owners of Silicon patents. Infringers prosecuted! Send for special price list. W. C. Getz, 345 N. Charles St., Baltimore, Md.

WIRELESS. One-inch spark coils, specially made for wireless. Fat hot spark. Regular \$6.00. Special this month \$4.50. Also larger coils. A B C Wireless Specialty Co., 111 Broadway, New York.

WIRELESS EXPERIMENTERS—The Wireless Equipment Co. has taken over the business of W. C. Getz and will continue the same high efficient apparatus. Address all communications to Wireless Equipment Co., West Arlington, Md.

PRICE \$1.25 Induction Coil Experimental Apparatus. 25 articles, something new. Send stamp for catalogue. Hertzian Elec. Co., 1009 E. 42d St., Brooklyn, N. Y.

WIRELESS TELEGRAPHY. Complete instructions, with diagrams, for making 1 inch coil, two types of receiver, and all other instruments necessary for a complete wireless sending and receiving station. Price, \$.25 (coin). Box 519, Lima, Ohio.

1,000 OHM Wireless Receivers \$1.75. Very sensitive and absolutely reliable. New Wireless Detector. You want to know about both. Send stamp for descriptive circulars. Alden Wireless Co., Campello, Mass.

LEARN WIRELESS TELEGRAPHY. Operators make big salaries. Why? Because they are scarce. Big field; easy to learn; cost small. Instructions free. H. R. Steele, 229 Greene Ave., Brooklyn, N. Y.

# POPULAR ELECTRICITY

## CLASSIFIED ADVERTISING.

(CONTINUED.)

### Miscellaneous.

ALL SAFETY RAZOR BLADES 2½c each. Double edged blades a specialty. We sterilize, resharpen and return your own blades better than new. Send address for convenient mailing package. Keenedge Co., 87 Keenedge Bldg., Chicago.

YOU WANT THIS: "Conversations on Electricity," by Prof. Joseph G. Branch, the well-known electrical engineer and author. An elementary work expressly for students and engineers, written in dialogue form, giving a vivid idea of the subject and making a strong impression on the mind of the reader. Easy to understand. Elucidates the alternating current—its nature and applications—in an unusually clear manner. 282 pages, handsomely bound, profusely illustrated with cuts and diagrams. Price \$2.00 postpaid. Special price for thirty days only, \$1.75. Add this to your electrical library before this offer expires. Popular Electricity Pub. Co., Book Dept., Monadnock Block, Chicago, Ill.

AMATEURS READ THIS—200 WATT DY-NAMO—Rough castings, \$4; blue prints, 50 cents. If castings are ordered within thirty days after prints, price of prints refunded. Lee, Harris & Co., Box 41, Jamestown, N. Y. Photo for 2-cent stamp.

FREE TO ALL—Our illustrated catalogue of tricks and novelties, etc. National Trick & Novelty Co., Dept. B, 2806 State St., Chicago, Ill.

POCKET COMPEND. OF ELECTRICITY—272 pages, cloth bound, indexed, only 40c prepaid. Satisfaction guaranteed. Wiley Sanderson, Dept. E, Ypsilanti, Mich.

BLAKE'S ELECTRICAL CONNECTING CORDS meet want of ready means of connecting complicated apparatus using moderate currents. Indispensable to electrical workers. Soft, flexible, different colors for easy tracing, spring-clip attachments. In 20, 30, 40-inch lengths. Prices 10, 15, 20c each. W. Blake, 253 Blake St., New Haven, Conn.

BOYS—BOYS—This is for you, and those who like boys. "The Boy Electrician," by Prof. Erwin James Houston. A book every boy will enjoy and learn something from. 326 pages—10 full page illustrations. Price \$1.50—or free for only three paid yearly subscribers to Popular Electricity. Popular Electricity Pub. Co., Book Dept., Monadnock Block, Chicago, Ill.

SAFETY RAZOR BLADES sterilized and sharpened better than new; 2 cts. each. 5 years' success. Send for blade box and circular. Electro Stropping Co., 122 Sheby St., Detroit, Mich.

NEW MAGNET WIRE, sizes from 24 to 39, at amazing low prices. Write for prices. New storage batteries, 6-60, \$7.50. Walter W. Hartman, Clay Center, Kansas.

EVERYONE USING DRY BATTERIES send 25c for scientific instructions. Renew exhausted batteries cheaply; last long as new. Fairmount Telephone Co., Leightons Corners, N. H.

### Miscellaneous.

MAKE MIRRORS AT HOME. Big profits with little outlay. One 18x36-in. mirror costs \$2.00 to \$5.00. You can silver a glass this size for 20c. Send 50c in stamps or money order and we will send you EXPLICIT DIRECTIONS how to do it; also how to emboss, grind, foil, gold leaf, frost chip and make imitation stained glass. How to transfer photos on glass, bore holes in glass and cut skylights. George L. Patterson & Co., 2214 Monticello Ave., Morgan Park, Ill.

THREE THOUSAND FORMULAS. My 368-page volume of recipes and trade secrets, cloth bound, only 40 cents, prepaid. Worth dollars. Satisfaction guaranteed. Wiley Sanderson, Dept. E, Ypsilanti, Mich.

SNOW scenes. Views from one of Maine's most picturesque places. 5 ft. snow. 6 actual photo-cards, highly polished, 50c. Suitable for framing. C. Stanley, L. B. No. 5, Dixfield, Me.

MEDICAL AND SPARK COILS repaired. Send stamp for full detail drawings on a medical or spark coil. Price 50c. Address J. Lockie, R. 1718, Marquette Bldg., Chicago.

MAGIC POCKET TRICK FREE. Catalogue included, send 4c in stamps. Magic, Dept. 17, 270 W. 39th St., New York.

FREE—Our latest illustrated catalogue of tricks, novelties, puzzles, books, etc. Peerless Trick & Novelty Co., 3146-3148 State St., Chicago, Ill., Dept. O.

SELL your surplus couplings and fittings. We buy. Write us. A. & J. Mfg. Co., 24 W. Randolph St., Chicago, Ill.

THREE THOUSAND FORMULAS—My 368-page volume of recipes and trade secrets, cloth bound, only 40 cents, prepaid. Worth dollars. Satisfaction guaranteed. Wiley Sanderson, Dept. E, Ypsilanti, Mich.

THREE BIG LISTS, description and synopses of plays, monologues, farces, vaudeville sketches, parlor comedies, French plays, mock trials, drills, marches, imitations, popular entertainments and handbooks. How to write plays, minstrel joke books, make-up material and books, pantomimes, tableaux, parlor magic, etc., etc. Three big lists mailed to any address for 10 cents. Charles MacDonald & Co., 53 Washington St., Chicago, Ill.

VOLTMETERS, AMMETERS, \$1.50 EACH. We offer at the above price an instrument superior in action to any selling at four times this sum. Unlike the common gravity meter the needle comes to rest quickly. Send for descriptive circular. For those desiring to construct their own meter we will furnish complete drawings and instructions for building the above instruments at 25 cents each or both 40c (postpaid). Paradox Supply Co., Box 551, Reading, Pa.

WONDERFUL INVENTION—Canchester Incandescent Kerosene Lamp; burns with or without mantle; 10 times brighter than electricity, gas, or acetylene, at 1/10 cost. Burner fits all standard lamps; saves 75% oil. No trimming wicks. \$10 daily. Beware of imitations. Outfit FREE. Canchester Light Co., 26 State, Dept. P. E., Chicago.



# Principal and 10% Dividends Guaranteed

10,000 shares of the 10% participating preferred stock of the Balch Publishing Company, guaranteed as to principal and dividends, are herewith offered for subscription at \$10 per share, par value, subject to following:

## TERMS

- Plan A—Cash in full payment when subscribing.
- Plan B—25% with subscription, balance in 3 equal monthly payments.
- Plan C—10% with subscription, balance in 6 equal monthly payments.

No subscription for less than 5 shares will be accepted. Make checks and Money Orders payable to Balch Publishing Company.

## DIVIDENDS

Commence from the date on which stock is paid in full, and will be paid by check semi-annually on March 1 and September 1 of each year.

## GUARANTEE.

The Preferred annual dividend of 10 per cent is guaranteed for 3 years, and the repayment of the principal with a premium of 5 per cent is guaranteed on demand at the end of 3 years. In the event of Mr. Balch's death prior to the expiration of the 3 years, the full amount due under the guarantee becomes payable in cash, a special fund having been provided for that purpose by insurance on Mr. Balch's life. The Guarantee appears on every stock certificate.

## Profits in Magazine Publishing.

Frank A. Munsey started in the magazine business with a capital of \$40; his business now pays a profit of \$1,000,000 a year. The stock of the S. S. McClure Company is

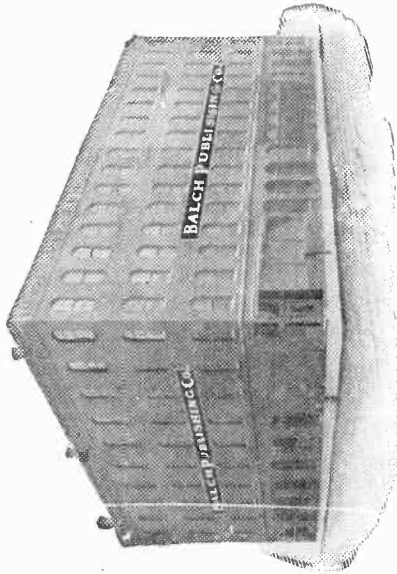

Building at Kinzie Street and Dearborn Avenue, occupied by Balch Publishing Company.

## REFERENCES.

Numerous references of the most substantial character will be furnished on request.

## GENERAL INFORMATION.

The Balch Publishing Company is an Illinois Corporation, doing business in Chicago and highly regarded locally. The entire capital is \$150,000, of which \$50,000 is common stock owned by Mr. Frank O. Balch. There are no bonds, mortgages or prior liens of any kind. The Company owns and publishes "Home Life," a mail-order monthly magazine with a circulation of 900,000 copies per issue and an advertising patronage approximating \$25,000 per month. The magazine is known to every advertising agency in the United States and is

# Right at Home

A few names of associates and business friends in Chicago who have subscribed for the "Home Life" shares:

- T. C. Frederick, Treasurer Bedford Quarries Co.
- Geo. Gillette, Attorney.
- D. W. Gaylord, Adv. Manager Balch Publishing Co.
- H. A. Bingham, Sales Manager Pilscher-Hamilton Paper Co.
- H. A. Bowman, President Bowman Auto. Adding Co.
- John Arthur Dixon, Asso. Editor Chicago Record-Herald.
- Wm. E. Duff, Circul. Mgr. Balch Publishing Co.
- Alfred Bersbach, Treasurer Manz Engraving Co.
- John Hindman, President Colonial Mercantile Co.
- Right Rev. Samuel Fallows,

worth \$1,000 a share. The income of the Curtis Company from the Ladies' Home Journal and the Saturday Evening Post is nearly \$6,000,000 a year. The annual income from the Cosmopolitan Magazine is about \$1,500,000. The property is now owned by William Randolph Hearst, who bought it from John B. White and Walker, who made several fortunes from the magazine. The profits of everybody's magazines are estimated as being as high as \$800,000 a year. Other American magazines are all large profit earners. A well known English author about ten years ago accepted \$2,000 worth of McClure's stock for a story. Recently he sold this stock for \$20,000. During the time when he held the stock it paid him dividends of \$14,000, making a total of \$34,000 cash for the \$2,000 worth of fiction manuscript. If you had been able to secure an investment of only \$100 in Munsey's magazine, that investment would now be paying an income of \$1,000 every year, and would be worth at least \$10,000 in cash. Those who had the opportunity to be come interested with magazines when they first offered their stock to the public have become wealthy.

**It is decidedly worth your while to look into this without delay. There are only 10,000 shares at \$10 each. They are offered for sale in the columns of our own monthly magazine, "Home Life," having a circulation of 900,000 copies per issue, and through the columns of several other standard publications with a combined circulation of over a million; it is therefore expected that the entire issue will be promptly subscribed.**

Fill out and mail either the attached coupon or application.

# Balch Publishing Company

## 51 Dearborn Avenue, Chicago, Ill.

### APPLICATION

BALCH PUBLISHING COMPANY,  
51 Dearborn Avenue, Chicago, Ill.

Subject to your guarantee I herewith subscribe for ..... shares of your 10% Guaranteed Preferred Stock at \$10 per share on plan, ..... and enclose herewith \$..... as required under the said plan, agreeing to pay the balance if any, according to your terms. Certificate is to be issued meas soon as full payment is made.  
Please acknowledge receipt.

Date..... Name..... Address.....  
Please write plainly.

- M. E. Bishop Chicago Director.
- W. J. Thompson, Manager Eills Co.
- Arthur E. Swett, Swett Advertising Agency.
- E. C. Bode, Adv. Mgr. Chicago Examiner.
- J. E. Dunning, Supt. Printing Dept. Balch Pub. Co.
- Leon F. Titus, Banker.
- H. E. Groth, Treasurer Maxim Advertising Co.
- S. F. Marchant, Treasurer Plicher - Hamilton Paper Co.
- J. B. Ott, President Ott Printing Co.
- Robert C. Harell, President Steamfitters' Supply Co.
- W. A. C. Smith, Manager The Ohio Quarries Co.
- M. Rothschild, Manager Chicago House Wrecking Co. And others as prominent.

### COUPON

BALCH PUB. CO.,  
51 Dearborn Ave., Chicago, Ill.  
Please mail me a free copy of "Home Life" and your booklet containing references and complete information about the 10% shares.

Name.....  
Address.....



## Be a Salesman

Earn a good salary, \$1,000 to \$10,000 a year and expenses. Enter the most pleasant, and best paid profession in the world, where you are paid all you earn, where there is no limit to your earning power. Be a producer, the one man the firm must have. We will teach you to be a salesman by mail in eight weeks and assist you to secure a position with a reliable firm, through our Free Employment Bureau. Hundreds of our Graduates placed in good positions. We always have plenty of good openings with leading firms all over the country. Over 500,000 Traveling Salesmen employed in the United States and Canada. If you are ambitious and want to earn from two to ten times what you now do, our Free Book "A Knight of the Grip" will show you how to do it. Write for it today. Address nearest office.

Dept. 158 National Salesman's Training Association, New York, Chicago, San Francisco, Kansas City, Minneapolis.

**When in Need of Tools DECIDE ON "Klein Tools"**

They have been the standard for years, they are the standard today, and you get the best there is. Send 3c in stamps for 65 page 71) Catalog, and Discount Sheet, full of interesting tools for Electricians and Linemen.

**MATHIAS KLEIN & SONS,**  
Station U, 3,  
CHICAGO, ILL.

### THE AMERICAN SOCIETY OF ELECTRICAL STUDENTS.

All Students of Electrical Engineering, Physics, and the Mechanic Arts, are invited to become Charter members of the above Society.

The Society will hold Annual Conventions, own its own Information Bureau, and will publish and issue to its members a Monthly Bulletin of the latest Achievements in the Arts and Sciences, and topics of interest to Students. Charter Membership fee, \$2.00 and Annual dues, \$2.00.

For further particulars, and address all applications for membership to

**Louis E. Walkins, M. & E. Engr. Brockton, Mass.**  
P. O. Box 204, or No. 140 Belmont Street, Brockton, Mass.

### Small Motors

You are looking for a small motor of 1-32, 1-16 or 1-8 horsepower to do real work, then get a **Birtman Motor**. It is no toy but can be applied to hundreds of useful purposes. Operates on either alternating or direct current.

For full particulars address

**C. F. Birtman Co.** 152-158 Lake St. Chicago, Ill.

### HOW TO TEST

With a Voltmeter

resistances, batteries, coils, etc. and to locate trouble on telephone and other circuits, described in our catalog No. 14. Send for it. It's free and describes also our accurate, compact and inexpensive portable and switchboard voltmeters, ammeters and volt-ammeters.

**L. M. PIGNOLET, 78 Cortlandt Street, NEW YORK**

**\$2.00 VALUE FOR \$1.00.**

New Standard Pocket Flashlight Outfit, including 2 extra New Refillable or day batteries, electric lamp and attachable Electric Search Pipe. All guaranteed. To introduce it, complete for \$1. By mail, postage extra, 15c. New Tubular Pocket Flashlight with Tungsten lamp ready for use 75c., or with 2 extra Refillable batteries \$1., postpaid. Headquarters for latest Electrical Novelties at lowest prices. Big Net catalog for stamp. Discounts to dealers. **ELECTRIC NOVELTY COMPANY**, M'rs. and Imps., Washington Nat. Bank Bldg., Pittsburg, Pa.

## Here, Cigaret-Smokers

### Roll A Cigaret In 5 Seconds

The "Kwick-Roller" is a marvel. Rolls a perfectly-formed cigarette that never unravels, quicker than by hand, and **Makes Better Cigarets Than You Can Buy**

Gives better "draw," a sweeter smoke and more compact "roll." Carry it in your vest-pocket; no tobacco waste; used for any tobacco, with any paper. It's a luxury. Tell your friends about it. Send us the name of your dealer and 25c in stamps or coin and we'll send you one quick. To Dealers—You can make more money selling a "Kwick-Roller" and one sack of tobacco than selling several boxes of ready-made cigarettes. Write for our liberal offer.

**SIGARET ROLLER WORKS, 39 W. Quincy Street, Chicago, Ill.**

### WATKINS SPECIAL 3 HORSEPOWER MOTOR

Two Cycle Type. Weighs but 30 lbs. Especially adapted for CANOE or LIGHT BOAT. Has aluminum base. Copper water jacket. Steel crank shaft. Bearings bronze bushed. Special carburetor. Crank shaft bearing 1x2 1/2 in. Wrist 1/2 x 1 1/2 in. thus insuring a long-lived motor.

**THE WATKINS MOTOR CO.**  
528-538 Baymiller Street,  
CINCINNATI - OHIO, U. S. A.

# “TELEPHONY”

¶ Is a handsomely illustrated, ably edited, weekly exponent of one of the most marvelous of modern American industries. ¶ Twenty years ago the Telephone was a curiosity. Today it is a Business Necessity. Practically indispensable, even in the Social and Domestic affairs of the Nation. ¶ The Independent Telephone Field alone represents an investment of over \$500,000,000, while more than \$25,000,000 is expended by it annually for supplies. ¶ Here is a field affording young men of ability and ambition greater opportunities than almost any other vocation which they can possibly adopt. ¶ Engineering, Contracting, Inventing, Manufacturing, Construction, Maintenance, Management and other departments of Telephone work reach out with open arms inviting the talented youth of today to become the prosperous leader of tomorrow.

## Easy to Learn at Home

¶ All of the fundamentals of Telephone work can be readily learned at home by any bright young man through the reading of good books and the careful perusal of the one great medium of the Telephone industry, “Telephony.” ¶ “Telephony” is a weekly publication which covers every phase of the Telephone business. ¶ In the course of a year “Telephony” presents over 4000 printed pages or the equivalent of more than 40 of the ordinary sized \$1.50 books. ¶ The subscription price of “Telephony” is \$3.00 a year, but readers of Popular Electricity can secure it at a special rate of \$2.00 temporarily by employing coupon blank herewith. ¶ We also present below a list of some of the leading Telephone books all of which “Telephony” is prepared to furnish, postage prepaid, for prices indicated after each. ¶ Insert above your name, when ordering, either the word “Telephony” or the title of the book you want.

### BOOK LIST

A. B. C. of the Telephone, J. E. Homans.....	\$1.00
American Telephone Practice, K. B. Miller.....	\$4.00
Electrical Instruments and Testing, N. H. Schneider.....	\$1.00
Handy Electrical Dictionary.....	\$0.25
Modern Electrical Construction, Horstmann & Tousley.....	\$1.50
Modern Wiring Diagrams, Horstmann & Tousley.....	\$1.50
Telephone Principles and Practice, G. W. Wilder.....	\$2.00
Telephone Construction, Installation, Wiring, Operation and Maintenance, W. H. Ratcliffe and H. C. Cushing, Jr.....	\$1.00
Telephone Construction, Methods and Costs, C. Mayer.....	\$3.00
Telephony, A. V. Abbott (6 Vol.).....	\$6.00
Telephony, W. C. Boyrer.....	\$3.00
And Paul Latzke's Great Telephone Story, "A Fight with an Octopus".....	\$0.25

**TELEPHONY  
PUB. CO.**  
Monadnock Block  
CHICAGO, ILL.

Gentlemen: I enclose herewith \$..... for which please send me.....

**COUPON—Cut out and mail today**

**Write for Our Telephone Book  
Catalogue, Free**

Name.....  
St.....  
City.....  
State.....  
(Popular Electricity)

# YOUR CHANCE

To Get These Standard Books  
At 1-3 Off. For one month only

NOT MORE THAN ONE COPY OF EACH TO A PURCHASER

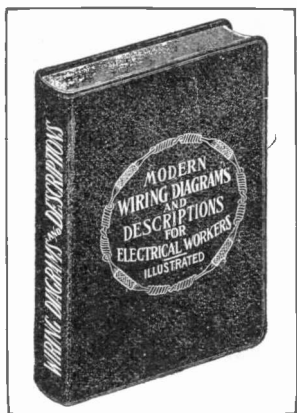

\$

\$

## Modern Wiring Diagrams and Descriptions

A Handbook of Practical Diagrams and information for working electricians and students of practical electrical matters, showing at a glance just such information as will assist them to take up any line of electrical construction.

By Henry C. Horstman and Victor H. Tousley.

2nd Edition Revised and Enlarged. 241 pages—fully illustrated, with working drawings and circuits.

Limp leather binding—Gilt Embossed. Regular Price, \$1.50. Sale Price, \$1.00.

POPULAR ELECTRICITY PUBLISHING CO.,  
Monadnock Block, Chicago, Ill.

Gentlemen—Enclosed find \$1.00, for which send me Modern Wiring Diagrams and Descriptions as per your special sale offer.

Name .....

Address.....

Town.....State.....

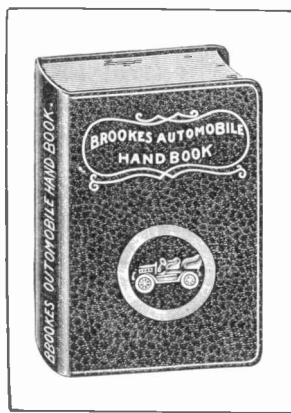

\$

\$

## The Automobile Hand Book

Giving full and concise information on all questions relating to the **construction, care and operation** of gasoline and electric automobiles, including road troubles, motor troubles, carbureter troubles, ignition troubles, etc. With numerous tables, useful rules and formulas.

By L. Elliott Brookes.

Revised and Enlarged Edition—479 pages, with over 100 illustrations.

Bound in limp leather—Gilt Embossed. Regular Price, \$1.50. Sale Price, \$1.00.

POPULAR ELECTRICITY PUBLISHING CO.,  
Monadnock Block, Chicago, Ill.

Gentlemen—Enclosed find \$1.00 for which send me Brookes' Automobile Hand Book as per your special sale offer.

Name .....

Address.....

Town.....State.....



**We  
Protect  
The  
TRADE**



Dealers—Send us your name at once,  
we want to send you FREE  
our Catalog 15.

*Write at once.*

**R. Williamson & Co.**

Manufacturers of  
Electric and Combination  
Fixtures and House  
Lighting Supplies.

Washington & Jefferson Sts., Chicago

**Will You Accept This  
Business Book if We  
Send it Free?**

Sign and mail the coupon below. Send no money!  
Take no risk!

One hundred and twelve of the world's master business men have written ten books—2,079 pages—1,497 vital business secrets, ideas, methods. In them is the best of all that they know about

- Purchasing
- Credits
- Collections
- Accounting
- Cost-keeping
- Organization
- Retailing
- Wholesaling
- Manufacturing
- Salesmanship
- Advertising
- Correspondence
- Selling Plans
- Handling Customers
- Office Systems
- Short-cuts and Methods for every line and department
- Position-Getting
- Position-Holding
- Man-Handling
- Man-Training
- Business Generalship
- Competition Fighting

A 9,059-word booklet has been published describing, explaining, picturing the work. Pages 2 and 3 tell about managing businesses great and small; pages 4 and 5 deal with credits, collections and with rock-bottom purchasing; pages 6 and 7 with handling and training men; pages 7 & 12 with salesmanship, with advertising, with the marketing of goods through salesmen, dealers and by mail; pages 12 to 15 with the great problem of securing the highest market price for your services—no matter what your line; and the last page tells how you may get a complete set—bound in handsome half morocco, contents in colors—for less than your daily smoke or shave, almost as little as your daily newspaper.

*Will you read the book if we send it free?  
Send no money. Simply sign the coupon.*

**The System Co., 151-153 Wabash Ave., Chicago**

If there are, in your books, any new ways to increase my business or my salary, I should like to know them. So send on your 16-page free descriptive booklet. I'll read it. 178-6

Name \_\_\_\_\_  
Address \_\_\_\_\_  
Business \_\_\_\_\_  
Position \_\_\_\_\_

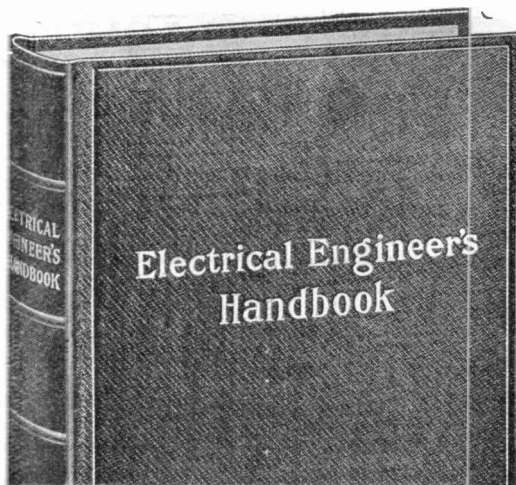

**Special Offer**

The I. C. S. Electrical Engineers' Handbook contains more practical information about the electrical engineering profession and allied trades than any other book of its size in existence. It is a Little Giant Encyclopedia of information compiled from the courses of the International Correspondence Schools which were written by the best experts in the country.

This book is not only of value to men in higher positions but can be successfully used by workers in subordinate positions in these trades on account of the fact that it is readily understood without a knowledge of higher mathematics. It contains rules, formulae, tables and diagrams of connections that are most generally used by wiremen, dynamo attendants, foremen of construction, managers, engineers, and superintendents of power stations, and superintendents of electric-lighting and electric-railway systems, and manufacturers and dealers in electric apparatus and supplies.

**OUR SPECIAL OFFER:** To better introduce the value of I. C. S. Instructions to members of these trades we will send this book containing 420 pages, 262 illustrations, bound in cloth with gilt top and title, and regularly sold at \$1.25 to anyone sending us the coupon below and

**50c**

**Act NOW!**

**INTERNATIONAL TEXTBOOK COMPANY,  
Box 1102-P, Scranton, Pa.**

I enclose 50 cents for which please send me one copy of your "Electrical Engineers' Handbook."

NAME \_\_\_\_\_  
STREET AND NO. \_\_\_\_\_  
CITY \_\_\_\_\_ STATE \_\_\_\_\_

**Good for 75 cents.**

# LOFTIS SYSTEM DIAMONDS WATCHES ON CREDIT

YOU CAN EASILY OWN A DIAMOND OR WATCH, or present one as a gift to some loved one. Send for our beautiful descriptive catalog. Whatever you select therefrom we send on approval. If you like it, pay one-fifth on delivery, balance in 8 equal monthly payments. Your credit is good. Our prices the lowest. As a good investment nothing is safer than a DIAMOND. THE OLD RELIABLE ORIGINAL DIAMOND. It increases in value 10 to 20% annually. Write today for our descriptive catalogue, containing 1,500 illustrations, it is free. AND WATCH CREDIT HOUSE, **LOFTIS BROS. & CO.** Dept. F685, 92 to 98 State St., Chicago, Ill.—Branch Stores: Pittsburg, Pa., and St. Louis, Mo. | Do it now.



## ILLUSTRATING

—Law—Pharmacy—Cartooning—Shorthand—Bookkeeping—Nursing—Journalism—Telegraphy—Penmanship  
Taught by mail and in our resident schools. Founded 1850. Income increased while learning. Graduates everywhere. Write for our free booklet—tells all. State course desired.

**NATIONAL CORRESPONDENCE SCHOOLS 42 N. Penn'a St., Indianapolis, U. S. A.**

### TEN THOUSAND TELEGRAPHERS WANTED

by railroads, commercial companies and Wireless Companies. Only schools in America teaching

### WIRELESS TELEGRAPHY

We operate fifteen Wireless Stations. Main Line R. R. Wires in each one of our Institutes. Supervised by R. R. Officials. Write for prospectus.

### NATIONAL TELEGRAPH INSTITUTE

Cincinnati, Ohio Philadelphia, Pa. Memphis, Tenn. Davenport, Iowa Columbia, S. C. San Francisco, Cal.

## LEARN TO DRAW

Artists and draftsmen make \$20 to \$100 a week. Pleasant, refined, fascinating work for men, women boys and girls. We guarantee proficiency or will refund tuition.

Quality As Home in Spare Time

Illustrating, Cartooning, Commercial Designing taught by artists trained in American and European Schools. Instruction adapted to each student's needs. Advisory Board of world's best artists approves lessons. Test Work Sent FREE to ascertain individual talents and needs. State course wanted. You assume no obligation. Mechanical, Architectural and Sheet Metal Pattern Drafting also taught successfully. ACME School of Drawing, 237 South St., Kalamazoo, Mich. If interested, ask about the **ACME RESIDENCE SCHOOL IN KALAMAZOO**

### YOURS FOR \$75.00 CASH

\$10 to \$15 daily profit printing Business Cards, Calling Cards, Form Cards, Post Cards, Programs, Tickets, Etc.



And \$25 a month for 8 months. Complete outfit ready to start a card printing business.

### The Original Automatic Card Printing Press, Size 12x12x24.

Self-inking and self-feeding. Prints 120 cards a minute. The greatest modern money maker. Complete outfit includes press, 14 fonts of type, ten drawer type cabinet, 10,000 blank cards, full assortment of tools, etc.

FREE. Our Catalog tells what others have done.

### Automatic Printing Press Co. Original and sole manuf'rs. 183 Dearborn St., CHICAGO

Reference: Hamilton National Bank. Capital \$500,000.00

## Fractional Adding and Subtracting Rule

**Price \$1.00**

A practical, useful and time-saving device for students in engineering schools, machine designers, mechanical and civil engineers, etc. Adds and subtracts fractions for you, eliminating tiresome figuring and insuring absolute accuracy. You can't make a mistake.

Full directions for using. Your money back if not in every way satisfactory. Endorsed by leading instructors in mechanical schools, and by practical mechanical men in all fields. Send today. Price \$1.00. Address **BURGESS & SAUERBERG 801 Kortlander Building GRAND RAPIDS, MICH.**

## ELECTRICITY

### Practically and Individually TAUGHT

Our pupils actually handle the tools and machinery.—Instructors stand beside them, directing, criticising and showing the how to work.—Day and Evening sessions.—Call and inspect our school and equipment or write for prospectus.

**New York Electrical School**  
36 West 17th Street, New York

For our Mutual Advantage mention Popular Electricity when writing to Advertisers.

**THE WIZARD  
MESSAGE VIBRATOR**

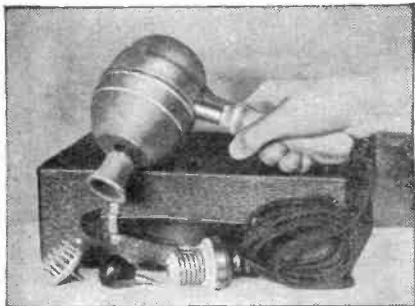

Better than most Vibrators selling at three times its price.

Investigate the "Wizard" before purchasing other makes Operates on both Alternating and Direct Current 110 Voltage. Has the switch in the handle.

Aluminum Case, Maple Handle. Green Silk Conductor Cord. Scalp, Face, and Body Applicators.

Small and neat leatherette covered case.  
WE ALLOW EVERY DEALER A GOOD PROFIT.

Price, \$7.50.

**The Wizard Co., Chicago.**

**MURDOCK  
STYLE A M RECEIVING SET**

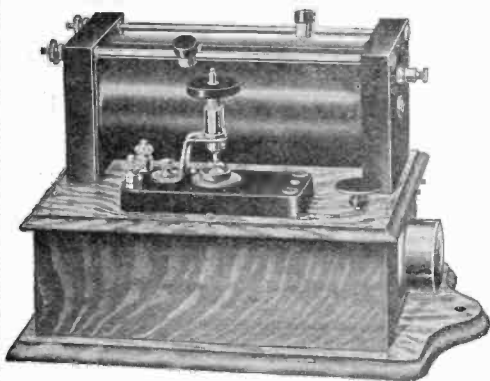

**\$10.00**

**Without Head Receivers or Batteries**

Straight Double Slide Tuning Coil, Style AM Detector. Condenser Test Key and Buzzer. Mounted on Solid Quartered Oak Box.

Instruments all connected ready to attach to antenna.

Weight packed for shipment 8 lbs.

Send for Latest Bulletin.

**WM. J. MURDOCK & CO.,**  
50 Charters Street Chelsea, Mass.



**YOUR START IN LIFE**

Do you realize the vast importance of this — "*Your Start in Life?*" To be successful you must make a *good* start, in the *right* way.

The field of drawing offers an unusual opportunity. Many of the world's greatest engineers began their successful careers as draftsmen.

*You* have the same chance to-day. *You* can become a skilled draftsman—hold a good, clean, congenial position at good pay. *How* Good will do it, with the aid of the new enlarged *Four Volume Edition*

**CYCLOPEDIA of DRAWING**

A complete, comprehensive treatise embodying 1680 pages of practical instructions on Machine Design, Lettering, Blue Printing, The Orders of Architecture, and Sheet Metal Pattern Drafting.

The books also contain 1200 illustrations, plates, tables, diagrams, etc., supplemented with a series of practical test questions. The pages are 7x10 inches in size, printed in large clear type on special paper; beautifully bound in half morocco.

These books are compiled from the instruction papers of the American School and to acquaint the public with the superiority of the School's instruction methods. We will place these books in your home absolutely free of charge for five days.

**FREE EXAMINATION:**

Fill in and mail the coupon. The books will be sent you at once. Carefully examine the books. Compare them with other similar works. If you do not find them superior to all others, if you are not satisfied, notify us to send for them at our expense. If you keep the books send \$2.00 within five days and \$2.00 a month until you have paid the special introductory price \$9.80. The regular list price of this set is \$20.00. Order now—this offer expires in thirty days.

**IMPORTANT SUBJECTS COVERED:**

Sheet Metal Pattern Drafting; Tinsmithing; Architectural Sheet Metal Work; Skylights; Cornices; Roofing, etc.; Practical Problems; Tables; Mechanical, Architectural, Perspective, Isometric and Freehand Drawing; Blue Printing; Mechanical and Architectural Lettering; Rendering in Pen and Ink and Water Colors; Water Color Hints for Draftsmen; Shades and Shadows; The Tuscan, Doric, Ionic, Corinthian and Composite Styles of Roman Architecture; Shop Drawings; Machine Drawing; Machine Design, etc.

**FREE OFFER COUPON**

American School of Correspondence,  
Chicago, U. S. A.

Please send set Cyclopedic of Drawing for five days' free examination. I will send \$2 within 5 days and \$2 a month until I have paid \$9.80; otherwise I will notify you and hold the books subject to your order. Title not to pass until fully paid.

NAME .....

ADDRESS .....

OCCUPATION .....

EMPLOYER .....

Pop. Elect. 609.

POPULAR ELECTRICITY

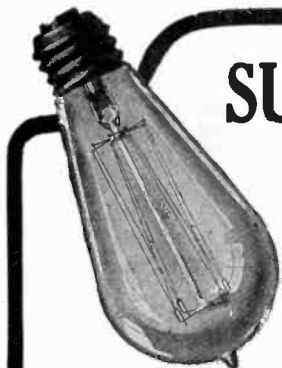

# SUNBEAM Tungsten LAMPS

(ELECTRIC DAY-LIGHT)

## SAVE 25%

☐ Does this mean anything to you? By substituting Sunbeam Tungsten Lamps for your *coal eating* carbon filament lamps, you can obtain  $2\frac{1}{2}$  times as much light or you can, by using fewer lamps, obtain the *same illumination but a much superior quality of light* and reduce your current bills 250%. ☐ Equal satisfaction on alternating or direct current. Can be burned in any position. ☐ Made in 25, 40, 60, 100 and 250 watts. For the office, factory, trains, steamboats, automobiles, etc. ☐ Write us *and write today* for our bulletin No. 66 telling all about them.

SUNBEAM INCANDESCENT LAMP CO., Manufacturers

ESTABLISHED IN 1889

CHICAGO

TORONTO

NEW YORK

WESTERN ELECTRIC CO., Distributors

Stocks in 20 Large Cities

## ANOTHER SPECIAL

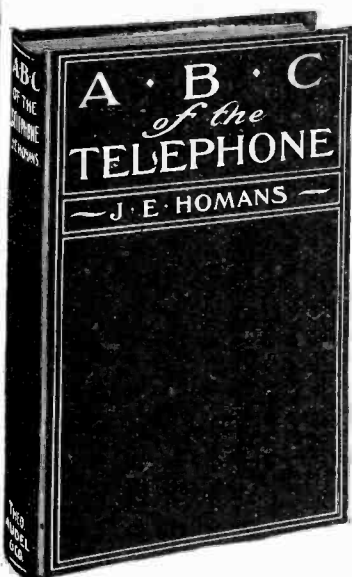

### FOR TELEPHONE MEN AND EVERY ONE

who wants to know more about this interesting branch of electrical science.

The A B C of the Telephone—2d and revised edition—a practical and useful treatise for students and workers in telephony. Contains a Review of the Development of the Industry, with full description of numerous valuable inventions and appliances, together with very many illustrations, diagrams and tables.

Price \$1.00. For one month only, 80 cents, postpaid. If you haven't this book, better get it now.

**POPULAR ELECTRICITY PUBLISHING CO.**

Book Dept.

MONADNOCK BLOCK - - CHICAGO, ILL.

For our Mutual Advantage mention Popular Electricity when writing to Advertisers.

# Be the Master



Only the man who is "The Master"—master of himself—master of his trade or profession wins great success.

It's Knowledge, not strength that gives this mastery to man. The educated trained, thinking workman is in demand.

If mechanically inclined you can educate yourself—you can prepare for advancement by using this portion of our Great Specialized Engineering Library:

## CYCLOPEDIA OF ENGINEERING

### Important Subjects Covered

Calorimeters—Pumps—Elevators—Indicators—Valve Gears—Turbines—Compression and Absorption—Refrigeration—Gaseous and Liquid Fuel—Condensers—Navigation—Air Brakes—Machine Shop Work—Ventilation—Heating—Air Compressors—Principles and Management of Direct Current Dynamos and Motors—Storage Batteries—Automobiles, Lathes, Planes, Milling Machines, etc.

A practical, general reference work on steam boilers, steam, gas and oil engines, marine and locomotive work, mechanical drawing, management of dynamos and motors, electric lighting, wiring, etc.

These six volumes contain 3,200 pages, size 7x10 inches, and over 2000 full-page plates, drawings, diagrams, formulas, tables, etc. Also contains a series of practical test questions, with solutions, and is carefully indexed for ready reference.

### It Costs Nothing to Look and Little to Buy.

Upon receipt of coupon we will send you a set of this great Cyclopedia, by pre-paid express, without deposit or guarantee of any kind. Keep the books five days, examine them carefully, give them every possible test. We want you to be the judge—you are under no obligation. If you decide the books are not what you want, advise us and we will have them returned at our expense. If you keep the books send us \$2.00 within five days and \$2.00 a month until you have paid the special price of \$18.60. Regular price is \$36.00.

**This Offer is Good Until March 1st.**

**FREE!** Order promptly and we will include, as a monthly supplement, one year's subscription to the

**TECHNICAL WORLD MAGAZINE** A regular \$1.50 monthly, presenting twentieth century scientific facts in plain English. Latest discussion on timely topics in science, invention, discovery, industry, etc. The strongest serial of the season, "WHO OWNS THE EARTH," appears in the February issue. **Just Mail The Coupon:**

**AMERICAN SCHOOL OF CORRESPONDENCE**  
CHICAGO, U. S. A.

**FREE OFFER COUPON**

Pop Elect 6-09  
A. S. of C.  
Please send set of Cyclopedia of Engineering for 5 days' FREE examination, also T. W. for one year. I will send \$2 within 5 days and \$2 a month until I have paid \$18.60, otherwise I will notify you and hold the books subject to your order. Title not to pass until fully paid.

Name .....

Address .....

Employer .....

Occupation .....

**Something Electrical for Everybody**



Catalogue 24M, 184 pages, 1,000 illustrations, with net prices on application

- Anti Doc Medical Battery - \$2.00
- Hi Up Dry Battery {"A" 2 1/2 x 6 1/2} .25
- Guaranteed for {"B" 3 x 7 1/2} .50
- Ignition Work {"C" 3 1/2 x 8 1/2} .60
- D. P. Pony Telephone Receiver for Wireless, 1,000 ohms - 2.50
- No. 1465 Headband and one Receiver, 1,000 ohms 3.50
- No. 1465 Headband and two Receivers, 1,000 ohms - 6.00
- Leglers Key - - - - - 1.05
- Grant Sounder, 5 ohms - - - - - 1.40
- Eureka Telegraph Instrument - - - - - 1.15
- Magneto Telephone, No. 1514 for long lines each 5.50
- Battery Call Telephones, No. 1561 for short lines " " 2.50
- Mesco Electric Engines, three sizes, \$0.75; \$1.00; 1.25
- Trouble Lamps for Autos, Motor Boats, etc. - 1.25
- Elite Battery Ammeter - - - - - 2.00
- Call Bell Outfits - - - - - .60
- Floor Tread for Servant's Call - - - - - .72
- Battery Rheostat, 20 ohms - - - - - .65
- Electric Vibrators (3 styles), \$5.00; \$10.00 and - 15.00

**Manhattan Electrical Supply Co.**  
 NEW YORK CHICAGO  
 17 Park Place 188 Fifth Ave.

**ROBERT P. MURPHY, Prop.**

**HOTEL ALBANY**

41st Street and Broadway, New York

Remodeled, Handsomely Furnished New Throughout



Absolutely Fireproof. In the heart of the City.  
 500 Rooms. 300 Bath Rooms. European Plan.  
 Cuisine Unexcelled. Gentlemen's Cafe, Ladies'  
 Restaurant and Moorish Rooms. Popular Prices.  
 Plenty of life—but Homelike.

**\$1.00 PER DAY AND UP**  
 SEND FOR BOOKLET.

Meet me at the College Inn, under the Albany,  
 New York's Leading Rathskeller, a place to eat,  
 drink and be merry. Music.

**ONLY 50c.**

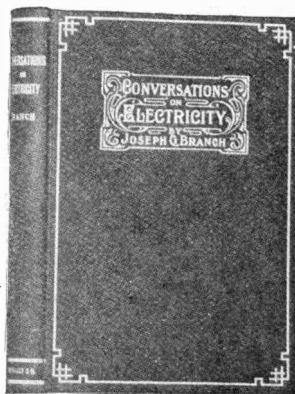

Down and 50c a Month for Three Months Gets You

**CONVERSATIONS IN ELECTRICITY**

By Joseph G. Branch, B. S., M. E.

**The Book You Ought to Have.**

Written in dialogue form, giving a vivid idea of the subject and leaving a strong impression on the mind of the reader.

The author, who is well known as an authority on electricity, deals with the subject in a clear and elementary way in order to familiarize the student with the principles of the science.

Special attention is paid to the alternating current, owing to its daily increasing use.

282 pages—105 illustrations—Strongly and handsomely bound in green cloth, gilt embossed.

A valuable addition to any library. Your list of electrical books not complete without this volume which has never before been offered on such liberal terms.

POPULAR ELECTRICITY PUBLISHING CO.  
 Monadnock Block, Chicago.

Gentlemen—Enclosed find 50c for which send me Conversations in Electricity, by Joseph G. Branch. I promise to pay the balance, \$1.50, within three months, at 50c a month. Title not to pass until book is paid for in full.

Name.....  
 Address.....  
 Town..... State.....

# Yours 2 Years for \$1.50

You will like **PRACTICAL ENGINEER**. From cover to cover it is packed with good, live, steam and electrical engineering information, interesting illustrated articles, helpful editorials, experiences of active engineers and the latest and most useful facts about power plant operation and machinery.



**PRACTICAL ENGINEER** collects from all over the world and publishes sound, definite, reliable data on subjects in which you are interested and it presents these things in terms that you'll easily understand. You need **PRACTICAL ENGINEER**—every man associated with electrical machinery needs it. It will make your work easier and help you to do it better—in fact you'll get from each issue more good suggestions for improving your work, lessening labor and cutting costs than from any other source. For every word is adapted strictly to the needs of the man-on-the-job. Send in your subscription to-day and you'll get the June number for a starter. It's a complete book on the Isolated Electric Lighting Plant. It tells how best to place lights, the amount of light needed for certain work—the efficiency of different styles of Lamps, how to install conduit wiring, neat wiring, and concealed work. How to figure the size of wiring needed in electric circuits. How to arrange switchboards. How to connect up generators. Hints on Storage batteries, and hints on the care and operation of complete electric plants. You ought to have this big fine electrical number. To you it is worth many times the price of subscription. So send for it to-day. \$1.50 is all it costs you for 2 whole years—24 big issues and you get the valuable tool free.

Simply send your personal check, money order, or \$1.50 cash, and the electrical number and square will be sent to you promptly. If, after looking them over you do not think you have your money's worth, return the square and your money will be refunded at once—Send in your subscription to-day.

**PRACTICAL ENGINEER, 395 Dearborn St., CHICAGO, ILL.**

Canadian subscribers please add \$1 extra for postage.

You Can Get This Valuable Tool FREE



This Six Inch Combination Square is made of Polished Steel with deeply engraved figures and dimensions and takes the place of a whole set of common try squares. You can adjust it to any point within its length and it combines in one compact tool; a square, a miter, depth gauge, level, and a handy little scratch awl on the bottom. It is just the thing for an engineer or mechanic and you'll find use for it constantly. And, remember, it's yours free with two years subscription to **PRACTICAL ENGINEER**.

**THIS STEEL COMBINATION SQUARE SENT FREE**

## A Live Wire To Central Stations

¶ Don't you sometimes wish your advertising could be made to present your proposition from a different view point? Let some one who knows take up the subject in a different way—appeal on new lines to a new lot of people, as well as the old crowd. We want to convince you that you need this kind of advertising service—what it would mean to you—what it has meant to the largest Central Stations in the country. Then we want to convince you that we can give you this service and do for you what we have done for others. Our proposition will be interesting—your inquiry for it will entail no obligation.

**Wm. D. McJunkin**  
**Advertising Agency**

167 Dearborn St., Chicago.

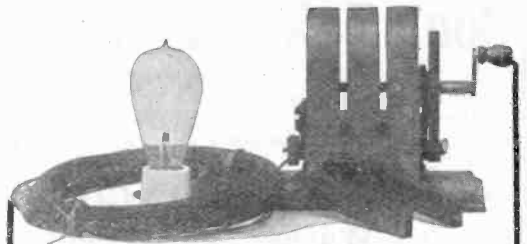

We Bought the \$10,000 Stock of the  
Geen Electric Novelty Co., Chicago,

**AT AUCTION**

Will Split the Profits With You.  
This GENERATOR (weighs 6½ lbs)

Will light a 16 C. P. lamp, excite coils, test through 10,000 ohms, fine for test and experimental bench.

ALSO

- 2 pair electric magnets wound with silk wire.
- 1 large permanent magnet.
- 1 test electric lamp.
- 1 socket.
- 1 switch.
- 1 coil wire.
- and 6 nickel binding posts, sent on receipt of \$5.

**Western Electric Salvage Co.**  
(NOT INC.)

597 S. Washtenaw Avenue, Chicago, Ill.

**IF YOU DON'T USE ELECTRICITY**

STEAM OR GAS

**Use Just Water Power**

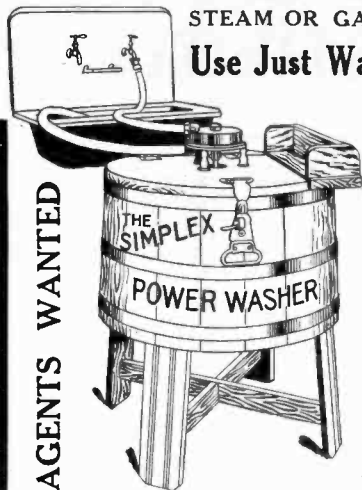

AGENTS WANTED

Found in every modern home. Runs the "Simplex" Washing Machine at a penny an hour—and runs it in such a manner that it washes clothes satisfactorily.

The Women throughout the country are interested in this labor-saving device. It is medium priced and stands the racket better than any. Motors made wholly of brass, needs no repairs, no money lost in broken

parts. Is compact, with no working parts exposed. Hundreds are in use and every one is selling more.

The "Simplex" motor works on 20 lbs. of pressure and can be attached on hand power machines. Sold with tub or motor only. **Stands up in competition.** Can be demonstrated by blowing into inlet hose!!! Users recommend it because it cuts washday in half. Must be seen working to be appreciated. Send for particulars. **Live Agents Wanted**—men who know a good money maker when they see it! Address

**THE SIMPLEX WASHER CO., 288 Lake Street, Milwaukee, Wis.**

**THE "National"**

A **PORTABLE VACUUM CLEANING MACHINE**

combining efficiency, practicability and economy. Can be attached to any electric light socket.

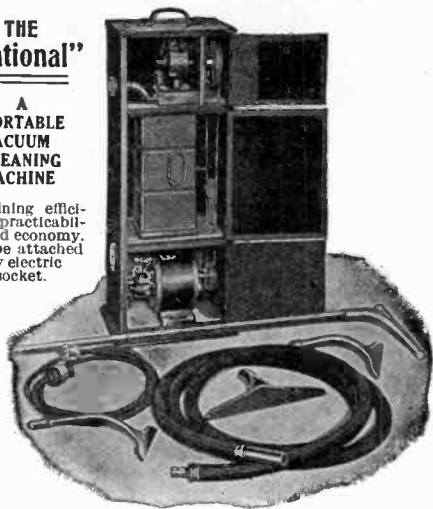

**EFFICIENT** Because it thoroughly accomplishes its purpose.  
**PRACTICAL** Because of its simplicity and compactness.  
**ECONOMICAL** Because of its minimum cost of maintenance and operation.

Growing concerns and responsible parties wanted for agents. (Exclusive territory given. Price Complete \$100.00. Send for Catalogue and Particulars

**NATIONAL VACUUM COMPANY**

**20 Broad Street. NEW YORK**

**Don't Take Chances**

with so-called electric washing machines still in the experimental stage.

We have been making an excellent line of Cylinder Washing Machines ever since 1903. If you buy the

**SANITARY PARAGON Electric Washer and Wringer**  
(Made of Metal Throughout)

you are certain of a *reliable* machine which embodies all the essential features of *durability, efficiency and service*. The **Paragon** is conceded by laundry experts and leading engineers to be the Acme of Perfection and mechanical ingenuity.

Before buying any washer do not fail to send for our illustrated Catalog A14.

**PARAGON MFG. CO.**

**3619-23 Ashland Ave. CHICAGO**

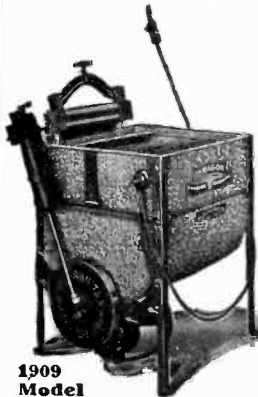

1909 Model

**Hotel Cumberland**

**NEW YORK**

S. W. Corner Broadway at 54th Street

Near 50th St. Subway, 53rd St. Elevated and all Surface Lines.

Ideal Location near Theatres, Shops and Central Park.



**NEW and FIREPROOF**

Strictly First-Class Rates Reasonable.

**\$2.50 with Bath**

AND UP

**Restaurant Unexcelled**

Prices Moderate

Send for Booklet

**10 Minutes Walk to 20 Theatres**

**HARRY P. STIMSON, R. J. BINGHAM,**  
Formerly with Hotel Imperial. Formerly with Hotel Woodward



## The Plunket Jr.

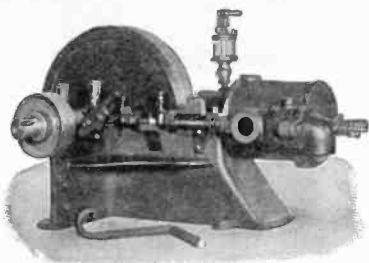

### A HIGH-GRADE, HALF HORSE POWER GAS AND GASOLINE ENGINE.

Weight 68 lbs.      Water Jacketed      Four Cycle

For Laboratory, Shop or Home, efficient, simple,  
durable

(Equal to two extra men about the place)

Perfectly governed so a wide range of speeds is always at  
operator's command.

Use City Gas or Gasoline.

Send for catalogue and prices

### J. E. PLUNKET

47-49 So. Jefferson St.

CHICAGO

## ADJUSTABLE PIPE STOCK

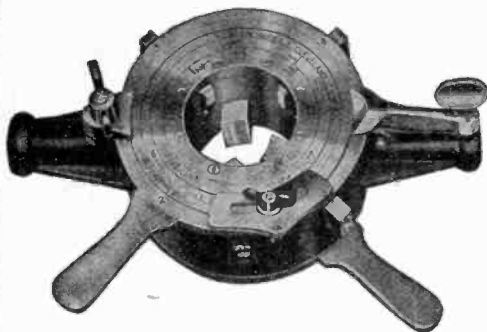

Dies open—You don't have to back off.

Adjustable Guides center pipe perfectly.

Improved Gauge for duplicate threads.

Dies thread two sizes without change.

SEND FOR CATALOG

### THE OSTER MFG. CO.

2180 East 61st Street,

CLEVELAND, OHIO

## Craftsman Lantern

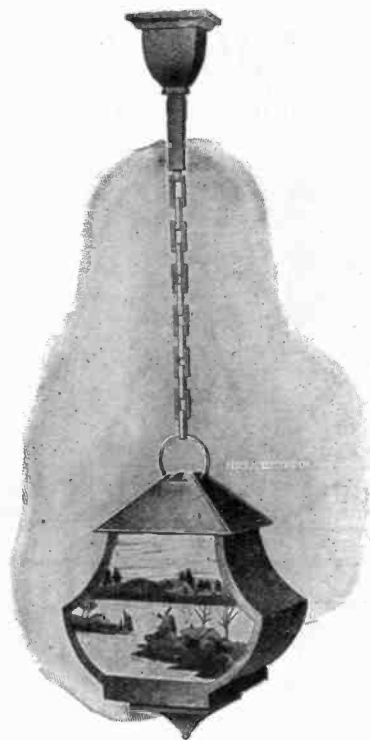

No. 802

An unusual lamp, hand-made throughout. Very attractive for hall, den or porch. Art glass panels in carefully selected colors, over which pleasing land and water scenes are reproduced in carefully selected colors in metal outline work with a very unique shadow effect. Entire lamp finished in verde antique.

Price \$31.50 F. O. B. Chicago.

Manufactured Exclusively By

### Federal Electric Company,

Lake and Desplaines Sts., Chicago.

# 2c a Week Pays Wash Bill!

Write for  
FREE Book

Electricity or Water-Power Does the Work

## Just a "Twist of the Wrist" Starts or Stops the Machine!

The 1900 Motor Washers are now at work in thousands of homes. They are doing the work formerly done by women, at a cost of 2 cents a week for power! Saving thousands upon thousands of dollars in wash bills. Saving worlds of wash-day troubles. Leaving the women free to do other work while the machines are doing the washing.

## The 1900 Motor Washer Washes a Tubful in Six Minutes!

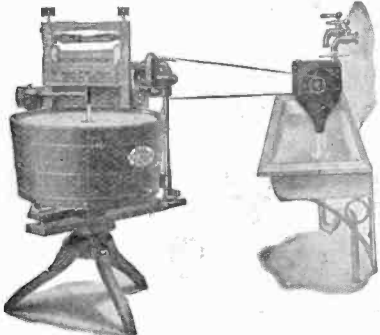

**1900 Water Motor Washer**  
Can be connected with any water tap instantly

### Handles heavy blankets or dainty laces.

The outfit consists of the famous 1900 Washer with either Electric Motor or Water Motor. You turn on the power as easily as you turn on the light, and back and forth goes the tub, washing the clothes for dear life. And it's all so simple and easy that overseeing its work is mere child's play.

### A Self-Working Wringer Free With Every Washer

The motor runs Washer and Wringer. We guarantee the perfect working of both. No extra charge for Wringer, which is one of the finest made.

### Write for FREE BOOK and 30 Days' FREE TRIAL OFFER!

Don't doubt! Don't say it can't be done! The free book proves that it can. But we do not ask you to take our word for it. We offer to send a 1900 Motor Washer on absolute Free Trial for an entire month to any responsible person. Not a cent of security—nor a promise to buy. Just your word that you will give it a test. We even agree to pay the freight, and will take it back if it fails to do all we claim for it. A postal card with your name and address sent to us today will bring you the book free by return mail. Address, The 1900 Washer Co., 3339 Henry St., Binghamton, N. Y. Or, if you live in Canada, write to the Canadian 1900 Washer Co., 355 Yonge St., Toronto, Canada.

**1900 Electric Motor Washer**  
Can be connected with any ordinary  
Electric Light Fixture



## Everybody Works But Mother \$1.04 a Year for your Washing

¶ Ever stop to figure the great saving in money, health and energy by using an Automatic Electric Washer. ¶ It saves the woman's hands, stops the lame back, does away with the disagreeable features in the home that constantly arise on wash-days—just turn on the current for a few minutes and your washing is done. ¶ The simplest Electric Washer on the market and the most reliable—guaranteed to do cleaner work in less time and at less expense than any other Electric Washer on the market. Don't hesitate to ask us about it. There is a lot to be told that will interest you and save you money.

**Automatic Electric Washer Co., Newton, Iowa**

Let Us Tell You  
**WHY**

The Electric Fire Place is



Convenient,  
Safe, Clean  
and Eco-  
nomical.

Install it  
anywhere

No chim-  
ney needed.

Write now  
for catalog.

**RATHBONE & PANIGOT COMPANY**

Patentees and Sole Makers

Grand Rapids - - Michigan

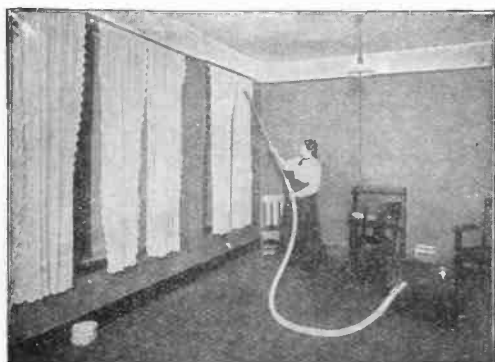

The "LITTLE GIANT"  
ELECTRIC  
PORTABLE  
SUCTION **CLEANER**

For Cleaning Carpets, Rugs,  
Mattresses, and Curtains.

Removes every particle of dust from Books, Pictures,  
Shelves, Draperies, Portieres, etc.

Costs less than one cent per hour to operate.

Price, complete, \$85.00

SEND FOR LITERATURE

**PACIFIC SUCTION CLEANER CO.**

322 POST ST., SAN FRANCISCO, CAL.

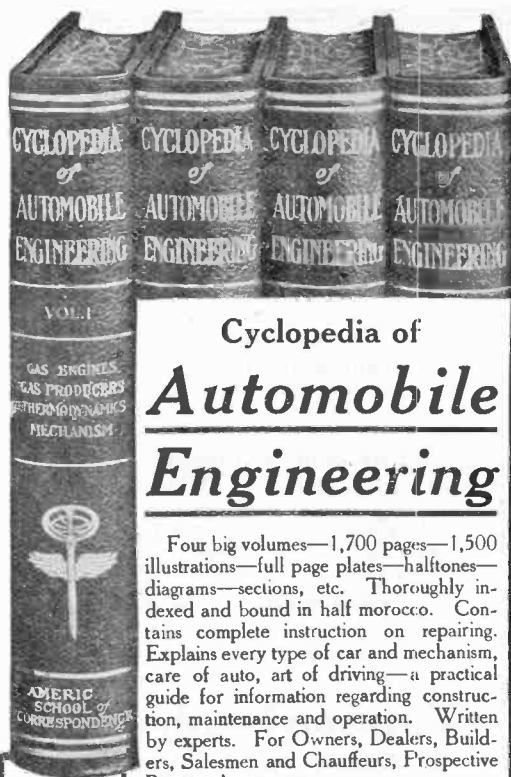

Cyclopedia of  
**Automobile  
Engineering**

Four big volumes—1,700 pages—1,500 illustrations—full page plates—halftones—diagrams—sections, etc. Thoroughly indexed and bound in half morocco. Contains complete instruction on repairing. Explains every type of car and mechanism, care of auto, art of driving—a practical guide for information regarding construction, maintenance and operation. Written by experts. For Owners, Dealers, Builders, Salesmen and Chauffeurs, Prospective Buyers, Agents, etc.

**Free Introductory Offer:**

EXAMINE THESE BOOKS AT OUR EXPENSE. We will send you a complete set by prepaid express. Keep them five days—give them a thorough and careful examination. If you do not wish to keep books advise us and we will have them returned at our expense. If you keep the books send us \$2.00 in five days and \$2.00 a month until special introductory price of \$12.60 has been paid. Regular list price \$24.00.

**PARTIAL LIST OF CONTENTS:**

Automobile Operation—Care—Trouble—Breakdown—Repairs—Automobile Power Plants—Cooling and Oiling Systems—Ignition Systems—Spark Coils—Buying a Motor Car—Gasoline, Electric and Steam Cars—Tires—Puncture—Accessories—Driving—Motorcycles—Gas and Oil Engines—Fuels—Care of Gas Engines—Electricity—Storage Batteries—Direct Current Motors—Mercury Vapor Converter—Primary Batteries—Steam Engines and Boilers—Valve Gears—Indicators, etc.

Order promptly and we will include FREE for one year, as a monthly supplement, the TECHNICAL WORLD MAGAZINE, a regular \$1.50 monthly, full of interesting scientific topics written in popular form.

**FREE OFFER COUPON**

American School of Correspondence, Chicago, U. S. A.

Please send set Cyclopedia of Automobile Engineering for 5 days' free examination; also Technical World for 1 year. I will send \$2.00 within 5 days and \$2.00 a month until I have paid \$12.60; otherwise I will notify you and hold the books subject to your order. Title not to pass until fully paid.

NAME .....

ADDRESS .....

OCCUPATION .....

EMPLOYER .....

Pop. Elect. 6-09.

## ELECTRICIAN & MECHANIC

is a magazine which will help you. It is a practical monthly for every one who wants to learn about electricity, or who uses tools. Its articles tell you how to make dynamos, engines, wireless telegraph apparatus, furniture, models, etc. It is the only magazine of its kind in the world.

### EDITORS

FRANK ROY FRAPRIE, M.Sc.Chem. Prof. A. E. WATSON, E.E., Ph.D.  
M. O. SAMPSON

### REGULAR FEATURES

**Electricity.** Practical and simple articles on electrical science, new applications and history, all illustrated. How to make dynamos, motors, batteries, all kinds of electrical apparatus. How to wire for bells and electric lights, install telephones, etc.

**Mechanical Articles.** How to use lathes and machine tools. How to use tools of all kinds. Forging, metal working, soldering, brazing, plating, etc. How to build gas engines, steam engines and other machines. All about gas engines and flying machines. Illustrated articles on everything new in mechanical progress.

**Woodworking and Manual Training.** How to build mission furniture. Wood finishing, staining, polishing, etc. Woodwork joints and cabinet making. How to make useful and handy articles of wood. Mechanical drawing, etc.

**Wireless Telegraphy and Telephony.** Full information of all that is new in wireless. Any one can build a wireless station from our descriptions. Our Wireless Club has nearly a thousand members in America and even beyond the seas.

All articles written in simple language for everybody to read. \$1.00 a year. Three months' trial, 20c.

### SPECIAL THIRTY DAY OFFER

For Thirty Days Only, or until our stock of back numbers is exhausted, we offer twelve back numbers and a full year's subscription for \$1.35. Money orders only; no stamps accepted.

**Sampson Publishing Company,** 1140 Beacon Building  
BOSTON, MASS.

## NOTICE

*To the Electrical Trade Throughout  
the Country*

### MR. CHAS. E. GREGORY

Is pleased to notify his many friends in the Electrical Trades that  
he has the management of the great

### COEY AUTOMOBILE LIVERY COMPANY

Where 90 Beautiful De Luxe and Thomas Cars are awaiting your call

Country Tours

Park Rides

Opera Service

Taxicab Service

And General Commercial Passenger Transfers

LOCATION, 1710 INDIANA AVENUE      PHONE 1042 CALUMET  
CHICAGO, ILL.

# The WORLD Is YOURS For \$3.00

**TECHNICAL WORLD MAGAZINE** } BOTH FOR  
 and the } **\$3.00**  
**NEW PEERLESS 12-INCH GLOBE**

The regular price of THE TECHNICAL WORLD MAGAZINE is \$1.50 a year, but it's worth far more. You could not duplicate the Peerless Globe for \$6.00. We have, however, purchased many thousands in order to bring this great bargain opportunity within the reach of our patrons and friends.

## New Peerless 12-inch Globe



Height 20  
Inches.

—the latest globe on the market, lithographed in ten permanent oil colors. The stand which is made of oak, weathered finish, is more up-to-date and far superior to the old-style iron base. The ball, or globe proper, is finished with high-grade varnish and is, therefore, impervious to water. It can be kept bright by an occasional wiping with a damp cloth.

**TIME DISC**—By means of a time disc at the north pole, time at any point in the world may be instantly approximated by noting the time at the point where observation is made.

**ISOTHERMAL LINES**—The isothermal lines are represented by red and blue lines for January and July and at various intervals the mean temperature for three months is noted.

The **ANALEMMA**—Just west of Mexico is the Analemma representing a figure eight. This is divided into months and the months, in turn, into days, and shows just where the direct rays of the sun strike the earth for every day in the year.

**NOTE.** The globe weighs eight pounds when packed ready for shipment. The subscriber must pay the freight or express charges when delivery is made.

**Technical World Magazine**  
**Chicago, U. S. A.**

Pop.  
Elect.  
6-09  
ORDER  
BLANK

Technical  
 World Magazine  
 Chicago, U. S. A.  
 For the \$3.00 enclosed please send me The  
**Technical World Magazine**  
 for one year, and the 12-inch  
**Peerless Globe**, as advertised.

Name.....  
 St. Address.....  
 City.....State.....

POPULAR ELECTRICITY

# BRYAN-MARSH TUNGSTEN LAMPS

For All Classes of Electric  
Lighting Service

---

## General Lighting—

100-125 Volts.

25-40 watts—Small Bulbs—Edison Base

40-60-100-250 watts—Regular Skirted Base

## Series Street Lighting—

1.75-3.5-4.0-5.5-6.6-7.5 amperes.

25-80 candle-power sizes.

## Sign and Decorative Lighting—

New Tungsten Sign Lamp—5 watts—4 c. p.

## Automobile and Battery Lighting—

All sizes and candle-powers for low-voltage  
service.

**Best Lamps for Best Service**

---

# BRYAN-MARSH COMPANY

CHICAGO, ILL.

CENTRAL FALLS, R. I.

Branch Offices: New York, Minneapolis, Cincinnati, Denver, Oakland

For our Mutual Advantage mention Popular Electricity when writing to Advertisers.

# Got a Quarter?

INVEST IT IN ONE OF THESE  
HANDY LITTLE VOLUMES and Get

**\$5.00 Worth**

OF PRACTICAL KNOWLEDGE.  
BETTER VALUES Never OFFERED

## THE WIMSHURST STATIC MACHINE.

How to Make and Use It.

A Practical Handbook on the Construction and Working of the Wimshurst Machine, including Radiography and Wireless Telegraphy, etc., and other Statical Electrical Apparatus.

By Alfred W. Marshall, A.M.I.E.E. Second Edition, revised and enlarged—112 pages. Fully illustrated. Price, paper covers, 25cts.

## INDUCTION COILS.

How to Make and Use Them.

Containing full particulars on the construction and use of medical and sparking coils for wireless telegraphy, gas engines, automobiles, gas lighting, X-rays and all other purposes. With complete tables of windings for coils, giving  $\frac{1}{4}$  inch up to 12 inch sparks, and full description for the construction of mercury interrupters.

By Percival Marshall, A.I.M.E. New Edition, revised and enlarged by Kurt Stoye, Instructor, Baron de Hirsch Trade School. 76 pages, 35 illustrations. Price, paper covers, 25cts.

## MAKING WIRELESS OUTFITS.

By Newton Harrison, E. E.

A concise and simple explanation on the construction and operation of simple and inexpensive wireless equipments for sending and receiving up to 100 miles. Gives full details and drawings of apparatus, diagrams of circuits and tables, and including the Morse and Continental Codes.

The Latest on Wireless Telegraphy.

61 pages, 27 illustrations. Price, paper covers, 25cts. Bound in cloth, 50cts.

Better get all these while you think of it.  
Stamps Accepted.

**Popular Electricity Pub. Co.**

BOOK DEPT.  
MONADNOCK BLOCK  
CHICAGO - ILLINOIS

# INTENSE LIGHT

F  
L  
A  
M  
I  
N  
G

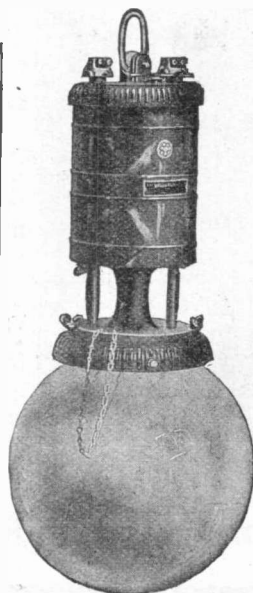

A  
R  
C  
L  
A  
M  
P

The sun alone can rival  
the intensity of the

## Warner Flaming Arc

One or two of these lamps in front of, or in, your place of business, by their wonderfully mellow and intense light, attract and hold attention as no other illuminant can.

Carbons of the Warner lamp are vertical as in the ordinary arc, allowing of a compact and neat design.

Lamps are fire proof and practically indestructible, and are made to operate on alternating or direct current.

No high-priced foreign carbons; only one carbon  $5\frac{1}{2} \times 12$  needed to retrim; practically no expense for repairs.

Be a Leader in your locality  
by using the Flaming arc. Its  
light is an advertising magnet  
for you to use in your business.

**WARNER ARC LAMP CO.**  
MUNCIE, IND.

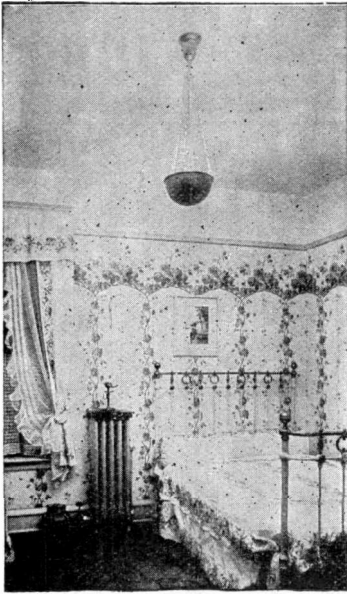

# 24 HOURS OF DAYLIGHT

The "I" Comfort System of Indirect Illumination is the most practical and efficient method for **Lighting Halls, Offices, Assembly Rooms, Residences, Etc.**

This system affords a nearer approach to daylight than any other method of artificial illumination, yet it involves no greater current consumption than for the direct lighting systems in general use. One 100-Watt Tungsten lamp is ample for a room like the above—15 feet square, with light ceiling and dark walls. 1200 installations giving perfect satisfaction. Write for our testimonials. Our new catalog contains information of direct value to you. A line to us will put you in touch with greatest idea of up-to-date illumination.

**C  
O  
M  
F  
O  
R  
T  
S  
Y  
S  
T  
E  
M**

**National X-Ray Reflector Co. 247 E. Jackson Boulevard, Chicago.**

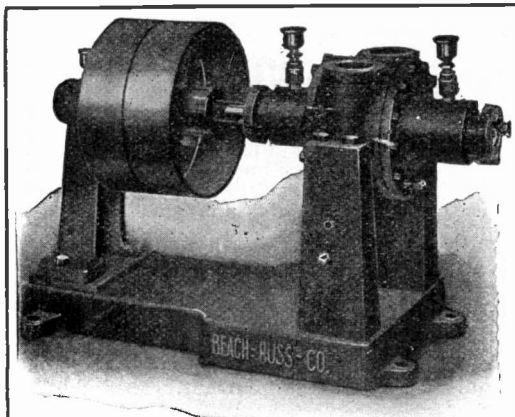

## DIRECT-CONNECTED SLOW-SPEED ROTARY ELECTRIC PUMP

Automatic, silent, primes itself, has positive action on the water. Will pump any liquid that is free from grit. Arranged with tank switch to control operation, starting when tank is two-thirds empty and stopping when water is at proper level. A most durable pump, all wear being easily taken up. For use in Tanneries, Laundries, Dyers, Hotels, Institutions and Private Houses.

Let us quote you on Rotary Pumps for all purposes, Vacuum Pumps, Pressure Blowers, Blower Burners, Flat Irons.

**BEACH-RUSS CO.. 214 Fifth Ave., Chicago.**

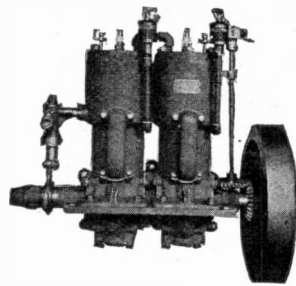

## Marine Gasoline Engines

From 1½ to 15 H. P.

3 H. P. Engines, complete with Boat Fittings, (no tank or pipes), \$59.00.



**Sterling Engine Company**

29 South Clinton Street  
CHICAGO, ILL.



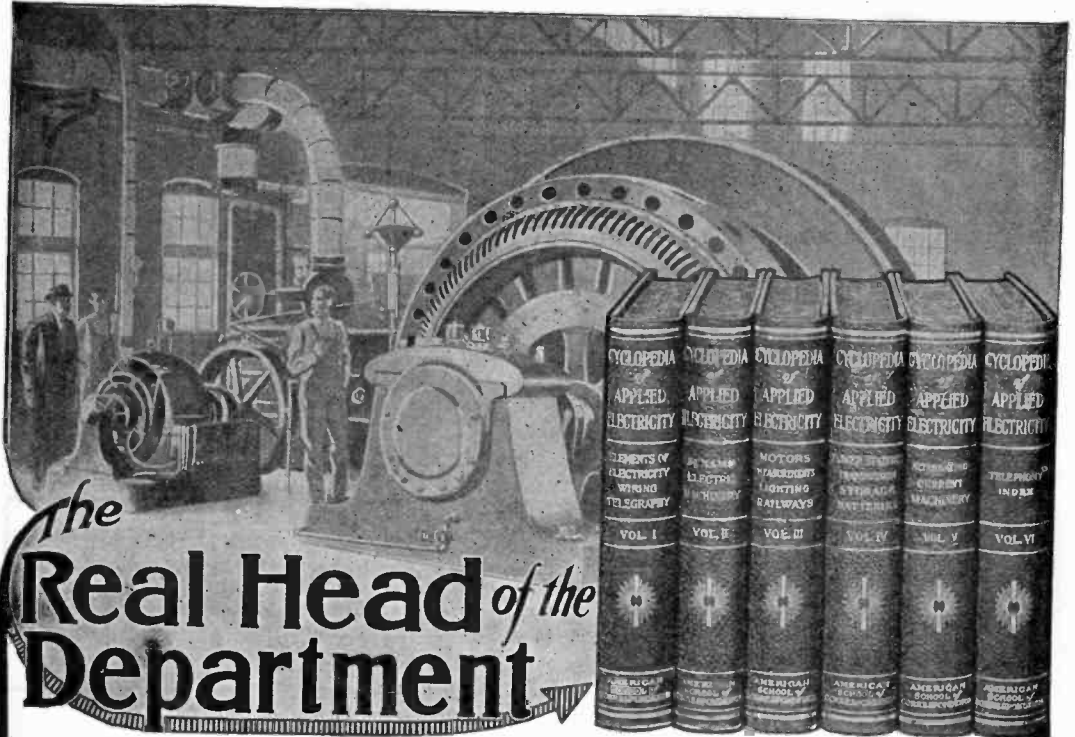

*The*  
**Real Head of the Department**

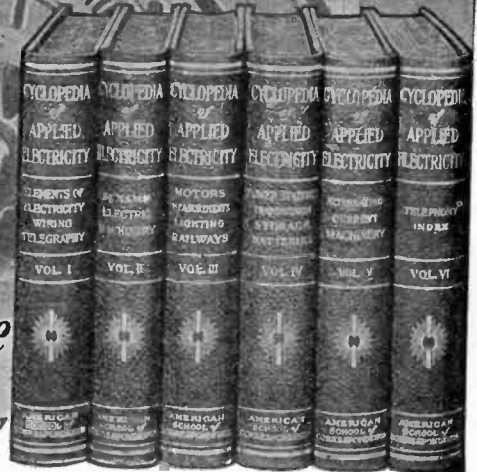

**The Cyclopedia of Applied Electricity**

is a storage battery of electrical knowledge. It is charged right up to the minute with reliable information—it is the *real head of the department* because it contains the work and knowledge of over thirty practical electrical engineers, experts and teachers. This work contains a complete record of their experiments, discoveries and observations. Just the information that the head of any electrical department should have at his finger tips for ready reference.

**YOU CAN ADD THIS KNOWLEDGE TO YOURS AT HALF PRICE IF YOU ORDER PROMPTLY**

To introduce this great work, we will fill orders for the next thirty days at \$18.60 per set, payable \$2.00 after examination and \$2.00 per month. The regular price is \$36.00. Order promptly. The half price edition is limited.

**EXAMINATION FREE!** It won't cost you a dollar to examine the books. Just fill in the coupon. The books will be sent to you absolutely FREE of charge. You can return them at our expense if not satisfactory.

These six big volumes contain 2,896 pages, covering 4,000 different topics. Hundreds of special photographs, diagrams sections, condensed tables and formulas. Page size 7 x 10 inches. Printed in large, clear type on special paper, substantially bound in half red morocco.

**PARTIAL SYNOPSIS OF CONTENTS:**

- Electric Wiring—Electric Telegraph—Wireless Telegraphy—Telautograph—Theory, Calculation, Design and Construction of Generators and Motors—Types of Dynamos and Motors—Elevators—Direct Current Motors—Direct-Driven Machine Shop Tools—Electric Lighting
- Electric Railways—Alternating Current Motors, etc.—Single Phase Electric Railway—Management of Dynamos and Motors—Power Stations—Central Station Engineering
- Storage Batteries—Power Transmission—Alternating Current Machinery—Telephony—Automatic Telephone—Wireless Telephony—Telegraphone, etc.

With this special offer we will also include as a monthly supplement a year's subscription to the

**TECHNICAL WORLD MAGAZINE**

This is a regular \$1.50 monthly covering present day scientific facts and inventions. An ideal magazine for the home because it is just enough different from the others to make it interesting. Fill in the coupon to-day—don't wait for to-morrow.

**AMERICAN SCHOOL OF CORRESPONDENCE**  
CHICAGO, U. S. A.

P. E.  
6-09  
A. S. of C.

Please send me Cyclopedia of Applied Electricity for five days' free examination. Also T.W. for one year. I will send \$2 within five days and \$2 a month until I have paid \$18.60; otherwise I will notify you and hold the books subject to your order. Title not to pass until fully paid.

**FREE OFFER COUPON**

NAME.....

ADDRESS.....

OCCUPATION.....

EMPLOYER.....



# 10 DAYS FREE TRIAL "RANGER" BICYCLE

on approval, freight prepaid in any place in the United States without a cent deposit in advance, and allow ten days free trial from the day you receive it. If it does not suit you in every way and is not all or more than we claim for it and a better bicycle than you can get anywhere else regardless of price, or if for any reason whatever you do not wish to keep it, ship it back to us at our expense for freight and you will not be out one cent.

**LOW FACTORY PRICES** We sell the highest grade bicycles direct from factory to rider at lower prices than any other house. We save you \$10 to \$25 middlemen's profit on every bicycle—highest grade models with Puncture-Proof tires, Imported Roller chains, pedals, etc., at prices no higher than cheap mail order bicycles; also reliable medium grade models at unheard of low prices.

**RIDER AGENTS WANTED** in each town and district to ride and exhibit a sample 1909 Ranger Bicycle furnished by us. You will be astonished at the wonderfully low prices and the liberal propositions and special offers we will give on the first 1000 sample going to your town. Write at once for our special offer.

**DO NOT BUY** a bicycle or a pair of tires from anyone at any price until you receive our catalogue and learn our low prices and liberal terms. **BICYCLE DEALERS:** you can sell our bicycles under your own name plate at double our prices. Orders filled the day received.

**SECOND HAND BICYCLES**—a limited number taken in trade by our Chicago retail stores will be closed out at once, at \$3 to \$8 each. Descriptive bargain list mailed free.

**TIRES, COASTER BRAKES,** single wheels, inner tubes, lamps, cyclometers, parts, repairs and everything in the bicycle line at half the usual prices. **DO NOT WAIT** but write today for our Large Catalog beautifully illustrated and containing a great fund of interesting matter and useful information. It only costs a postal to get everything. Write it now.

**MEAD CYCLE COMPANY, Dept. P251, CHICAGO, ILL.**

GET WISE

## SAVE MONEY! Here's Your Chance!

**MODERN ELECTRICAL CONSTRUCTION**, by Horstman & Tousley. A reliable, practical guide for the beginner in electrical construction, showing the latest approved methods of installing work of all kinds according to safety rules of National Board of Underwriters. Fully Illustrated. Black leather binding. Price \$1.50. A few slightly soiled copies (don't hurt book a bit) for \$1.00. First come, first served.

Popular Electricity Publishing Co., Book Dept., Monadnock Bldg., Chicago, Ill.

# Don't Be a Wage Slave

**Make \$3,000.00 to \$5,000.00 a Year**  
**Be a Doctor of Mechano-Therapy**

Are you tired of working for wages which barely keep body and soul together? Have you the ambition to enjoy the profits of your own labor? To gain social prominence and financial independence? To go forth among your fellow men with your head up—an honored and respected citizen of your locality? Have you thought of going into business for yourself?

## THEN SEND FOR OUR FREE BOOK

Entitled "How to Become a Mechano-Therapist." It tells how every man and woman, with an ordinary, common school education, can acquire a profession within a few months which will insure financial independence for life. **GET OUR BOOK**—it costs you nothing.

### WHAT IS MECANO-THERAPY?

Mechano-Therapy is the art, or science, of treating disease without drugs. It is similar to Osteopathy, but far superior, being the latest, up-to-date method of treating disease by the Natural Method. It heals as Nature heals—in accordance with Nature's laws. The Mechano-Therapist is a drugless physician. His medicines are not drugs, but scientific combinations of food, circumstance, idea, water and motion. He is skilled in compelling the body to DO ITS OWN HEALING with its own force, rather than with poisonous drugs of the old school practitioner.

### CAN I LEARN IT?

Have you asked yourself this question? We answer unhesitatingly, YES.

If you have so much as an ordinary, common school education you can learn.

You learn if you have the ambition to better your condition.

We can teach you in a very short time, so you may enter this profession—when you do, you begin to make money. We supply all lessons and necessary text books free of cost to you. No apparatus is used. You do not even need a place to work. All you require is your two hands. Certainly you can learn. The free book tells all.

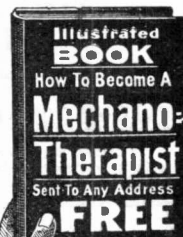
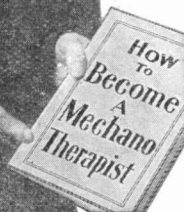
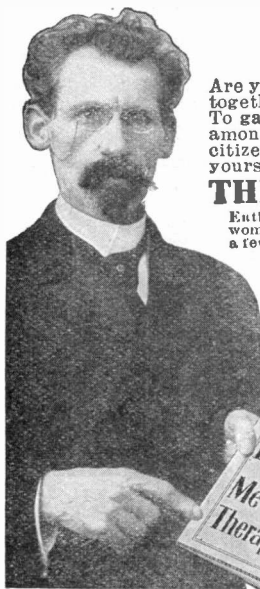

SEND FOR THIS BOOK TODAY, IT IS FREE

## We Teach You in Your Own Home

We can teach you an honorable and profitable profession in a few months, which will insure your financial independence for life, making it possible to have an income of \$3,000 to \$5,000 a year. We teach you by mail, in your own home, without interfering with your present duties. No matter how old you are. Any person—man or woman—with just an ordinary school education, can learn Mechano-Therapy. It is easy to learn and results certain. We have taken hundreds of men and women who were formerly clerks—farmers—stenographers—telegraph operators—insurance agents—railway employes—in fact, of nearly every known occupation—old men of 70 years who felt hopeless—young men of 20 years, without a day's business experience—salaried men, who could see nothing in the future but to become Oilerized, and laboring men, who never realized that they had within themselves the ability to better their conditions. Write for our FREE book, which explains all—today.

**AMERICAN COLLEGE OF MECANO-THERAPY, Dept. 761, 120-122 Randolph Street, Chicago, Ill.**

For our Mutual Advantage mention Popular Electricity when writing to Advertisers.

# Be Your Own Doctor



If you have the **ELECTRO-ROL** in the house and use it at the first indication of pain, no matter if it is **RHEUMATISM NEURALGIA LUMBAGO**

or from a cold or over exertion you will save many dollars and hours of suffering. ¶ Every pain caused by a functional disorder or congestive condition will yield almost instantly to Electro-Rol treatment. ¶ Let us send you our new catalog. The price is within the reach of every one.

**ACTIVE AGENTS SHOULD WRITE US**  
**OLIVER ELECTRIC MFG. CO.**  
 1031 Walnut St., PHILADELPHIA, PA.

# "CURE YOURSELF BY ELECTRICITY"

**New Book—Illustrated from Life— Sent FREE to all who write.**

Write to-day for our new Free Book—"Cure Yourself by Electricity"—Illustrated with photos from life. Shows how the New Home Batteries cure Rheumatism, Neuralgia, Lumbago, Headache, Insomnia, Constipation and all nerve-affections and diseases arising from sluggish circulation; also how they afford electric baths and beauty massage without cost at home.

**THIS BATTERY**

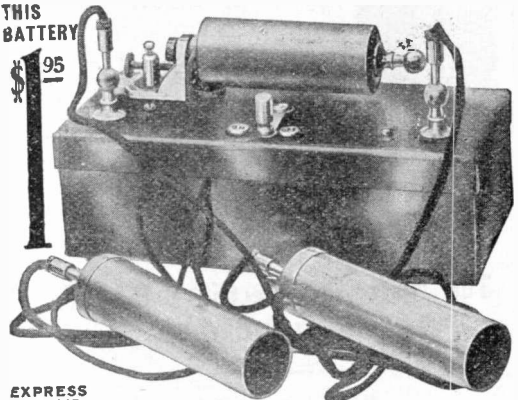

**EXPRESS PREPAID**

Every Home Should Have a Home Battery.

We send our batteries Prepaid without a cent in advance (prices \$1.95 and up) and allow **10 DAYS' FREE TRIAL**. Write for our Book.

**DETROIT MEDICAL BATTERY CO.,**  
 695 Majestic Bldg., Detroit, Mich.

# WRITE TODAY

For my latest Catalogue and Special offer on

## SELF-EDUCATIONAL BOOKS

Sent Absolutely Free to any Address

- Operator's Wireless Telegraph and Telephone Hand Book... \$1.00
- Elementary Electricity Up-To-Date..... 1.00
- Practical Armature and Magnet Winding..... 1.50

FOR SALE ONLY BY

**George C. Harris,**  
 44 N. CURTIS ST., CHICAGO

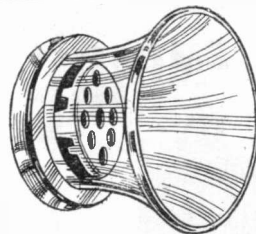

# The "Germless"

## Glass Telephone Mouthpiece Universal Attachment Fits Any Phone

Is a sanitary device made of clear crystal glass and is rapidly replacing the rubber mouthpiece, which is an ideal breeding place for all sorts of germs. Endorsed by prominent bacteriologists, health departments and telephone companies throughout the country.

The glass part can be instantly removed for cleaning and as quickly readjusted.

It is less liable to breakage than the rubber mouthpiece, and positively gives better telephone transmission.

For office, store, and the home. Equip your phone now and take no more chances of contracting disease.

Sent prepaid to any address in the United States for 25c each in stamps or coin.

Light is the greatest destroyer of germ life.

**AGENTS WANTED—Write For Special Terms.**

**THE COMMERCIAL APPLIANCE CO.**  
 Suite 819, 135 Adams St. CHICAGO, ILL.

# "1900" Dry Cells

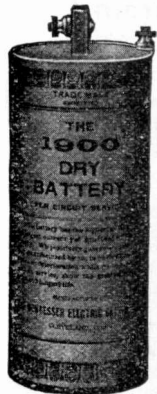

ARE the Batteries of Merit. Eighteen years of successful operation make them of

## Known Quality

Manufactured by

The Nungesser Electric Battery Co.  
CLEVELAND, OHIO

General Sales Office:  
128 West Jackson Boulevard  
CHICAGO

## For Indoors Or Outdoors

Here is the only practical pipe for smoking in a breeze, while motoring, boating, or outdoors anywhere. It is wind-proof, because the air-draft is from below, as it should be (see draft-holes in bottom of bowl).

It is the only practical pipe for office or house use, because the ashes or fire cannot spill, and in case of callers or interruptions, you can put it in your pocket—lighted—without danger of fire, and resume your smoke when they leave.

## IRVING'S WIZARD PIPE

The B. P. O. E. Best Pipe on Earth

For the B. P. O. E. Best People on Earth



Two Grades, Straight or Curved Stems  
Genuine French briar bowls, best rubber stems.

### A REVELATION TO SMOKERS

Tobacco above, kept dry and sweet by the rising heat. Perfect combustion, uninterrupted by saliva, consumes nicotine tar. Antiseptic Wick in cartridge shell absorbs all saliva. Smoke clean and sweet enough to inhale. Cigarette smokers quickly converted to this pipe's use. Style X, \$1.00. Style XX, Sterling silver mounted, in leather-covered case, \$2.00. Mailed post-paid with 1 doz. antiseptic cartridges on receipt of price.

Wizard Patent Developing Co., Inc.  
Dept. 7, 128 West 31st St., New York  
*Liberal Terms to Dealers*

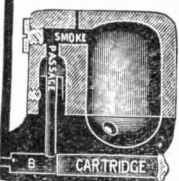

# HOTEL EMPIRE



WE OFFER YOU THE MOST DELIGHTFUL

HOTEL ACCOMMODATION AT MODERATE COST

BROADWAY, (LINCOLN SQUARE) AND 63D ST. NEW YORK CITY

All surface cars pass or transfer to door Subway and "L" stations, one minute

### ALL MODERN IMPROVEMENTS

Rooms, with detached bath, . . . \$1.50 per day up  
Rooms, with private bath, . . . 2.00 " "  
Suites, with private bath, . . . 3.50 " "

W. JOHNSON QUINN, Proprietor,

## Steel Pulley for Power Houses

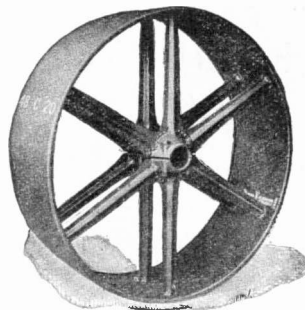

### The Only Steel Pulley Made

that has sufficient structural strength to be made in large sizes and all sizes; have metal bushings so that they never slip on the shaft—all are split and are very easy to erect—being all metal, dampness does not effect them—*—are always in running balance.*

*We want to tell you more about this.*

ONEIDA STEEL PULLEY CO.  
105 S. Clinton Street, CHICAGO, ILL.

**RING WITHOUT BATTERIES**



**The Rollinson Bell Ringer**

will operate buzzers, door bells, hotel calls, elevator calls, automatic gas lighters, etc., from an ordinary 110-volt lighting circuit, without the use of batteries.

The bell ringer is made in three sizes, all three taking 100 to 130 volts from the line and changing it to 6-13-19 and 8-16-24 volts respectively for supplying the bell circuit. Using alternating current, the device may be said to operate without cost for current.

**MOHAWK ELECTRIC CO., Albany, N. Y.**

**WE WILL MAKE YOU HEAR!**



**At last the PERFECT treatment for deafness.** The genuine Pneumo-Oscillating method—the same method used by all the most successful ear specialists—now ready for your use, right in your own home. Send today for our **GREAT FREE EAR BOOK**—“**PERFECT HEARING.**”

This free book tells you how you can treat your own ears, just as well, yes, even better than the highest priced specialist. And your improvement will be even more rapid than if you were receiving the same treatment from a specialist, because you can treat your ears as often as they need it, and without a cent to pay.

Remember, this is the genuine **Pneumo-Oscillating treatment**—the same treatment that has cured thousands of cases of deafness. For the first time the treatment is offered you right at home, and if your case is curable **this great machine will restore your hearing.** Eighty-five per cent of all people who are deaf may be cured. You may be one of those. The Pneumo-Oscillating treatment will tell you. So write today. **GET OUR GREAT FREE BOOK**

**The White Cross Ear Oscillator**

The wonderful machine which gives our famous Pneumo-Oscillating treatments—is a boon to all who are deaf. You should read about this marvelous instrument anyway. Don't fail to send the coupon for this Free Book. If you are wholly deaf, deaf in one ear or merely getting deaf, you should have this book. So send today. The road to perfect hearing is before you. Complete communication with the outside world.

**THE COUPON BRINGS THE FREE BOOK—**

“**PERFECT HEARING**” sent free for just your name and address on the coupon. If your hearing is in any way affected, you should send for this valuable free book today. No matter how severe or how long standing your case may be. No matter even if you have been told that your case is incurable send for this free book anyway. Post yourself on this wonderful treatment. Get details of our Special Introductory Offer which lasts for a short time only. No obligations. Just your name and address is all we ask. But send for the free book today. free and without any obligations, your free book, “**Perfect Hearing,**” and full particulars of your Special Introductory Offer on the White Cross Ear Oscillator.

**LINDSTROM, SMITH CO.,** Dept. 1157, 253 La Salle St., CHICAGO, ILL.—Please send me  
**LINDSTROM, SMITH CO.,** Dept 1157, 253 La Salle St., CHICAGO, ILL. Name..... Address.....



**Something for Everybody**  
 An Invention for the People  
 To See it is to Want it

**Tungsten Adapter**

For Burning Tungsten Lamps on Any Fixture

Only one difficulty has stood in the way of the universal adoption of the Tungsten lamp—it must be burned in a vertical position—and many fixtures and sockets are not installed with this in mind.

The Benjamin Tungsten Adapter disposes of this “vertical difficulty” in less than a minute’s time. It is as inexpensive as it is simple.

While the necessity for buying fixtures is thus obviated, old ones are not infrequently improved in appearance by the changed position of the lamps.

Let us tell you more about it.

**BENJAMIN ELECTRIC MFG. CO.**

42 W. Jackson Blvd.

CHICAGO

# QUALITY INSURANCE

Means the elimination of faults in your Product by RIGID TESTS.

Shrewd manufacturers do not jeopardize their trade by shipping half-developed goods. Careful purchasers buy subject to specifications and tests.

We are the medium for satisfactory dealings. We make all manner of electrical and photometrical tests and furnish you with exact and dependable data.

## Electrical Testing Laboratories

80th St. and East End Ave.,

NEW YORK, N. Y.

# The Latest Auto Signal

## NO MORE BROKEN BULBS.

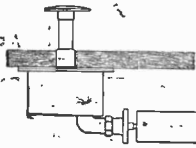

- ☐ Operates with the foot independent of the motor.
- ☐ An air dashpot, all brass, with a capacity of 27 cubic inches.
- ☐ Costs no more than the ordinary horn.

## INCREASES YOUR HONK 300%

- ☐ Dust, water and air proof, and guaranteed to last a lifetime.
- ☐ Attached underneath footboard, and requires but five square inches.

**W. G. WORDINGHAM, 211 Grand Ave., MILWAUKEE, WIS.**

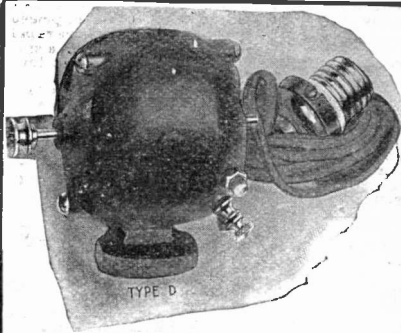

TYPE D, \$5 00 Express prepaid.

## WIZARD TOY MOTORS

For alternating and direct current 110 volts—Just use your electric light socket—The most substantial and powerful toy motor on the market.

Wizard Motors operate on Any Light Circuit; simply hook into the light socket; plug and cord with every order. We make all kinds of Toy Motors. Write for Circular 27.

## THE WIZARD COMPANY,

Cor. Dearborn and Randolph Sts. CHICAGO, ILL.

BUSINESS PROMINENCE SOCIAL SUCCESS WEALTH

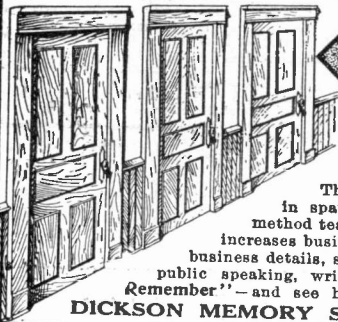

## The Master Key

# Stop Forgetting MEMORY



*My book: HOW TO REMEMBER, sent free to readers. It opens the doors of wealth and achievement with the master key that fits all locks.*

**"You are no greater intellectually than your memory"**

There is nothing difficult about my method. You can study anywhere, at any time, in spare moments. I have taught more than 40,000 people how to remember. My method teaches you how to remember things you have seen, read and been told about, increases business capacity, income, social standing—also how to remember faces, names, business details, studies—develops will, concentration, personality, self-confidence, conversation, public speaking, writing, etc. Write today for free copy of my interesting book—"How To Remember"—and see how simple my memory training really is. Address

DICKSON MEMORY SCHOOL,

929 Auditorium Building, Chicago

For our Mutual Advantage mention Popular Electricity when writing to Advertisers.

## DIAMONDS ON CREDIT

**20% DOWN—10% PER MONTH**



Why wait for your Diamond until you have saved the price? Pay for it by the Lyon Method. Lyon's prices are fully 20% lower than any others. Lyon's Diamonds are guaranteed perfect blue-white, imported in the rough, cut and polished here to save import duties and middlemen's profits. A written guarantee accompanies each Diamond. You have the option for exchange at any time at full purchase price. All goods sent prepaid for inspection. **10% discount for cash.** Send now—today—for our catalogue No. 2, splendidly illustrated. *Established 1843.*

**J. M. LYON & CO. 71 Nassau St., New York**

2317 \$25, 2132 \$60, 2315 \$35, 2189 \$50, 2113 \$50, 2162 \$50, 2158 \$30, 2110 \$35, 2306 \$60, 2198 \$25, 2160 \$40, 2380 \$25.

## What's the Use of Working for \$15 per week when you can be your own boss and earn \$200.00 PER MONTH?

This is the average earnings of more than 500 of our customers who are operating and demonstrating our

**"WONDER" CANNON** Automatic Photo Button Machine

No experience necessary. No dark room required. Our "Wonder" Cannon takes, develops and finishes photo button in 30 seconds ready to wear. Can be set up in 20 seconds ready to operate. A big money maker at fairs, carnivals, picnics and all out-door celebrations. **COMPLETE OUTFIT \$25.00**, including the necessary supplies for making 300 finished photo buttons. *Send for free circular.*

**CHICAGO FERROTYPE CO., Room 103 Ferrotpe Bldg., Congress and Laflin Sts., CHICAGO**

### ELECTRICAL HANDBOOKS 10 CENTS EACH

- 1 How to Make a Dynamo.
- 2 How to Make a Telephone.
- 3 How to Make an Electric Motor.
- 4 How to Make a Storage Battery.
- 5 How to Make a Wimshurst Electric Machine.
- 6 How to Make a Magneto Machine.
- 7 How to Make a Medical Induction Coil.
- 8 How to Make a Pocket Accumulator.
- 9 How to Make a Plunge Battery.
- 10 How to Make a Voltmeter.
- 11 How to make a Galvanometer.
- 12 How to Make a Hand Dynamo.
- 13 How to Make a Talking Machine.
- 14 How to Make a 1-8 H. P. Dynamo or Motor.
- 15 How to Make a Toy Motor.
- 16 How to Make an Electric Bell.
- 17 How to Make a Telegraph Instrument.
- 18 How to Wind Armatures.
- 19 How to Wind Field-Magnets.
- 20 How to Make an Ammeter.
- 21 How to Make a Thermocouple.
- 22 Motor Rotation.
- 23 How to Make an Electric Soldering Iron.
- 24 How to Make a small Electric Heater.
- 25 How to Make an Electric Furnace.
- 26 How to Make Hand Feed Arc Lamp.
- 27 How to Make a Jump Spark Coil.
- 28 How to Make a Rheostat.

*All Books ILLUSTRATED with Working Drawings.*

**E. BUBIER PUBLISHING CO., LYNN, MASS**



Made As Well As a Watch

## SAPPHIRE BEARINGS

Our "Advance" Volt Ammeter

Accuracy beyond question. Made right and **STAYS RIGHT.** Indicates in EITHER direction. Placed in fine morocco case, with snap fastening.

**ELDREDGE ELECTRIC MFG. CO.**  
17 Post Office Square, Springfield, Mass.

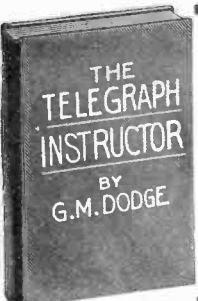

## 75c TO KNOW HOW TO BE A COMPETENT TELEGRAPH OPERATOR

Best "Plain English" treatise on the art of Telegraphy. The Demand Exceeds the Supply for good Operators, so be fit.

Regular price of Telegraph Instructor is \$1.00; for thirty days only we will send it to any address prepaid for only 75c.

**POPULAR ELECTRICITY PUBLISHING CO., Monadnock Bldg., Chicago**

For our Mutual Advantage mention Popular Electricity when writing to Advertisers.

POPULAR ELECTRICITY

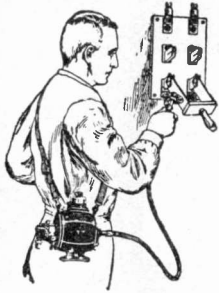

**ELECTRIC PORTABLE POLISHING MACHINE**

Consists of small motor with straps for swinging over operators shoulder and on the armature shaft of the motor a flx shaft is provided, at the end of which is a holder for rotary polishing discs, buffs, etc. Useful for polishing signs, railings and other brass work. Also in the garage central station, etc.

**ELECTRICALLY OPERATED AIR COMPRESSORS**

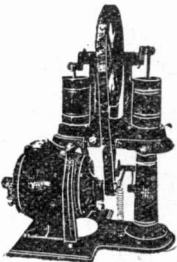

For Garages, Saloons, Central Stations, Air Brush work, etc. etc. Single and double cylinder types. Automatic pressure regulators.

We make a line of small electric lathes and a variety of other electric specialties. Write for circulars and price.

**VICTOR ELECTRIC CO.**

55-61 Market St.

CHICAGO, ILL.

**Electrical Testing So You Can Understand It.**

Are you limited in the knowledge of Electrical Testing?

Are you spending lots of time and money looking for troubles that you could locate and clear with the apparatus you now have at hand, or could make, if you only knew how.

It is wonderfully simple when you understand the principle.

We tell it to you so you can make even difficult tests the first time.

Our language and drawings simply make you see the theory and then you cannot make a mistake.

For 25 cents we can furnish you information on Electrical Testing subjects, written in a non-technical manner so that you can advance in this line of work to the rank of an expert. The information is worth many times the price and you cannot afford to be without the newest practical schemes. Money refunded if not satisfied.

Enclosed find 25 cents for which send me the following instructions.

- |   |                          |
|---|--------------------------|
| 1. How to locate telephone cable trouble with a voltmeter.                            | 25c for each intruction. |
| 2. How to test telephone lines by ear.  |                          |
| 3. How to wire your voltmeter to make all manner of tests and locations. New methods. | 1.....                   |
| 4. How to make loop tests with a Wheatstone bridge.                                   | 2.....                   |
|   | 3.....                   |
|   | 4.....                   |

Name.....  
Address.....  
City.....

**Middleton Bros.** 1361 Monadnock Block. CHICAGO, ILL.



**\$1.00 Down—and \$1.00 a month for 2 mos.**

will secure you this set of Electrical Books worth over **FOUR DOLLARS**—or secure 6 paid subscribers to **Popular Electricity** and we will send them to you **FREE OF CHARGE.**

**First Steps in Electricity or Electricity for Beginners**

For the beginner in the Electrical Trade this book is what you want.

**Electricity Made Simple**

Just the book for beginners and electrical workers whose opportunities for gaining information on the branches of electricity have been limited

**The Electrical Handy Directory**

This little Directory gives you the definition of all electrical words and terms.

**Easy Experiments in Electricity and How to Make Them**

The very latest and most valuable work on Electricity for the amateur or Practical Electrician published

P. E. June '09

Gentlemen:  
Enclosed find \$1.00 for which send me your group No. 1 of books. I promise to pay the balance—\$2.00—within 2 months, at \$1.00 per month. Title not to pass until books are paid for in full.

NAME.....  
STREET & NO.....  
TOWN..... STATE.....

For our Mutual Advantage mention Popular Electricity when writing to Advertisers.





# PROMOTED!

☐ Don't worry about the boss not having his eye on you and noticing the improvement in your work. Remember he is human—he is on the look-out for good men. His success, and the firm's, depends on his ability to select the right man.

☐ If you are a little better than the other man—if you know more about your work than he does, do you suppose the boss will pass you by and boost the other fellow?

☐ You wish you had a better job. You wish you knew more, then you could do more and earn more. Fill in the blank form below and let us tell you how these wishes can be realized.

☐ Our advice, based upon the experiences of our successful students and graduates will cost you nothing. It may start you right and change your whole future.

☐ The American School of Correspondence is an educational institution. We employ no agents or collectors. The merits of our work make this unnecessary.

☐ Advice regarding the work you wish to take up and our complete Bulletin will be sent for the coupon. There's no obligation attached to this—mail it to-day.

**WE HELP MEN HELP THEMSELVES**

**AMERICAN SCHOOL of CORRESPONDENCE**  
CHICAGO, U. S. A.

## FREE INFORMATION COUPON

**American School of Correspondence:**

☐ Please send me free your Bulletin of engineering information and advise me how I can qualify for position marked "X."

- |                           |                                       |
|---------------------------|---------------------------------------|
| .... Electrical Engineer  | .... Telephone Engineer               |
| .... Draftsman            | .... Heating and Ventilating Engineer |
| .... Civil Engineer       | .... Plumber                          |
| .... Mechanical Engineer  | .... Architect                        |
| .... Stationary Engineer  | .... Hydraulic Engineer               |
| .... Structural Engineer  | .... Textile Boss                     |
| .... Municipal Engineer   | .... Sheet Metal Pattern Draftsman    |
| .... Railroad Engineer    | .... College Preparatory Course       |
| .... Structural Draftsman | .... Sanitary Engineer                |

NAME .....

ADDRESS .....

OCCUPATION .....

Pop. Ele. t. 6-09.

# 150,000 People— Attended the ELECTRICAL SHOW at Chicago Last Year

---

**T**HIS throng was made up of people interested in the development of electricity; particularly from the consumer's standpoint.

The development of this marvelous force together with the great strides made in the manufacture of electrical accessories used in the home, in the office, in the factory and on the farm, has made it vitally important that the manufacturer of electrical accessories, the jobber and the supply house should be interested and support the Electrical Show which takes place in Chicago next year.

It is the general opinion that all who have exhibited at this show have received benefits which they could never have secured in any other way. The public has become interested in the exploitation of their products to the extent that the demand made upon the manufacturer to supply the consumer of electric current has been greater than ever before.

The location for exhibitors in the Coliseum is a vital point in the success of their exhibit. By reserving space considerably ahead of time you will be able to secure your desired position in the hall.

---

**Electrical Trades Exposition Company**  
**Monadnock Block    ::    CHICAGO, ILLINOIS**

Made in Larger Sizes. Write Us.

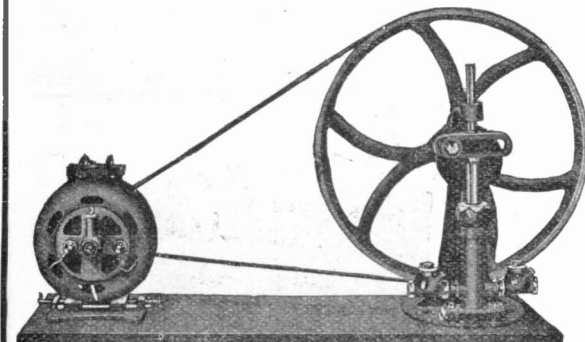

## “JARVIS” ELECTRIC DRIVEN HOUSE PUMPS

70 Gal's. per hour, 1-8 h.p.

For A. C. Current - - \$40.00

For Direct Current - - 30.00

Fully Guaranteed. Your money back if you wish.

Jarvis Engine and Machine Works  
LANSING, MICH.

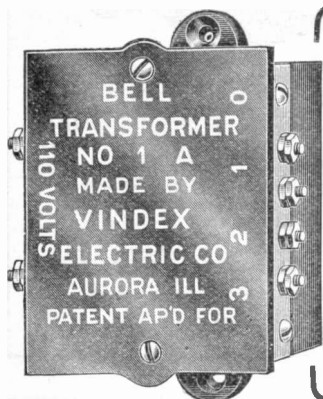

## Ring Bells Form Light Circuit

☑ No more battery troubles if you use the **Vindex Transformer**.

☑ This small device is so constructed that it can be connected to any electric light circuit of 110 volts and reduces the current to the proper voltage for operating door bells, burglar alarms, miniature lamps, small battery motors, gasoline engine ignition and all low voltage domestic electrical apparatus.

☑ Absolutely safe, and can be installed by anyone; never gets out of order, always ready for use, and consumes so little current that a meter will not record it.

☑ Write us today for prices and full particulars regarding this most economical and wonderful device.

VINDEK ELECTRIC CO., AURORA, ILL.

## Instructions in Wireless Telegraphy

**For 25 Cents** we will send you a book telling how to construct your own wireless outfits. Spark Coils, Relays, Coherers, Tapping Keys, etc. Written in plain English. Facts only—no red tape and non-technical.

**ELECTRICAL EXPERIMENTERS SUPPLY HOUSE**  
Dept. E, 622 Wells Street, CHICAGO, ILL.

Dealers and Manufacturers of Wireless Apparatus and Electrical Toys at low prices.

Send 5 cents postage for Illustrated Catalog—Credit Slip.

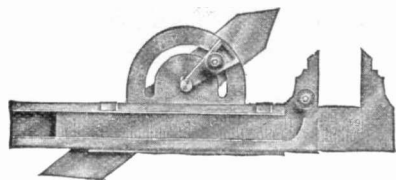

16 to 1.

FOR SALE AT ALL LEADING HARDWARE STORES, OR SENT DIRECT, POSTAGE PREPAID,

\$1.15.

## Wiet-Goethe Combination Gauge and Caliper Rule

You can carry more than sixteen ACCURATE TOOLS in your vest pocket.

Every High grade mechanic should have one of these tools.

Chicago Steel and Brass Works

1700 Fisher Building

Chicago, Illinois

# KEEP COOL Enpeesee --- --- **Fans** --- ---

**Vogel's Cooling Cabinet  
and Air Purifier**

**Vogel's Ventilator and  
Air Filter**

We are ready to sub-license manufacturers and dealers in Electrical apparatus to assemble and install our apparatuses.

Write for particulars to the

## Natural Power Company

1512-14 Clark Avenue,  
ST. LOUIS, MO.

---

---

LICENSED MANUFACTURERS  
Haynes-Langenberg Mfg. Company,  
St. Louis, Mo.

Vogel's System Co., Limited,  
Unity Bldg., Chicago, Ill.

Southern Illinois Electric Co.,  
East St. Louis, Ill.

Woodward Harold Co.,  
Traction Bldg., Indianapolis, Ind.  
Brockdorff Witzemann Works,  
Berlin, Germany.

## THORDARSON'S Wireless Transformers

CASH PRICE \$22.00

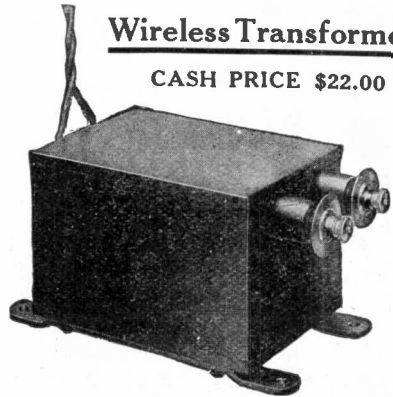

**High Potential or step-up transformers**, as powerful as a 10-inch induction coil, for wireless telegraphy, charging condensers, ozone generators and other experimental purposes. 250 watt capacity. Can be run from any alternating current lamp socket.

We are equipped to furnish transformers up to 100 K. W. capacity. Any secondary voltage desired. Quotation on request.

**Thordarson Electric Mfg. Co.**  
151-157 South Jefferson Street  
CHICAGO

## NEW AND SECOND-HAND ELECTRIC MOTORS — IN ALL SIZES —

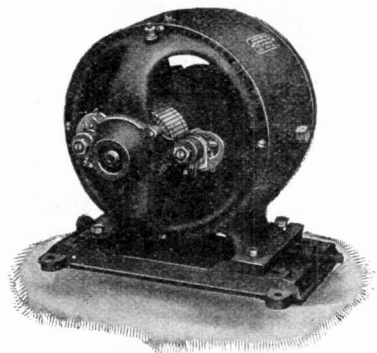

Let us quote you on  
your requirements

**Olson-Boettger Electric  
Mfg. Co.**

St. Paul, Minnesota.

POPULAR ELECTRICITY

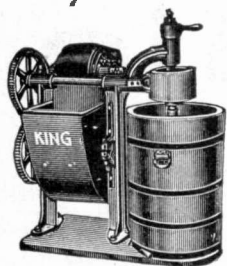

The New  
20th Century  
Ice Cream  
Freezer and  
Crusher

A complete ice cream plant in one machine—electrically driven. No belts or pulleys. Requires small space. Why not make your own ice cream and save money? The ideal freezer for confectioners and druggists. Made in 2 sizes—20 and 40 quart. Write for catalogue and prices.

R. A. Dewsberry, Chicago, Ill.  
46 N. Morgan Street

• We  
Cure

Eye  
Troubles



SEND FOR **Free Eye-Book** THEN TREAT YOUR OWN EYES

It doesn't matter what your eye trouble is, or how serious or chronic it may be, this great Eye-Book will show you how to treat your own eyes at home. No Knife. No pain. No trouble. Not necessary to see a doctor.

Our book about eyes sent free, tells all about it; things you ought to know, but which your doctor has never told you, and contains letters from many who have been cured.

A postal card will get the book and we will give you our free advice if you will write us a short description of your case. Write now while you think about it. Address

North American Eye Specialists

2477 North American Building

CHICAGO, ILL.

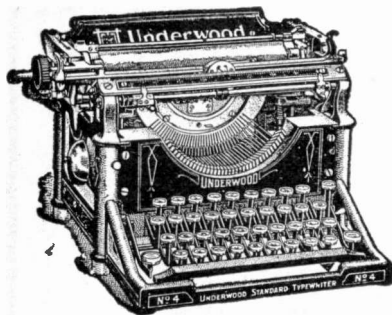

The  
Printing  
Point

Badly typewritten letters convey an impression of careless business methods, but the machine is often more to blame than the operator.

The UNDERWOOD

types always reach the proper printing point. The type-bar operates through—or with—a guide—a feature peculiar to the Underwood—and patented. The type *must* go right. There's no other way. It cannot wobble up or down, or sideways. Good looking work is easy and the visible writing prevents operator's blunders.

The simple mechanism which secures perfect work in the Underwood is a mighty interesting exhibit of ingenuity and skill. Why not come look at it? Knowledge of the Underwood will help you to secure greater efficiency. It will be a pleasure to help you to just as much knowledge of the Underwood Standard Typewriter as you choose to acquire.

**UNDERWOOD TYPewriter COMPANY, Inc.**  
ANYWHERE

For our Mutual Advantage mention Popular Electricity when writing to Advertisers.

# The Radio

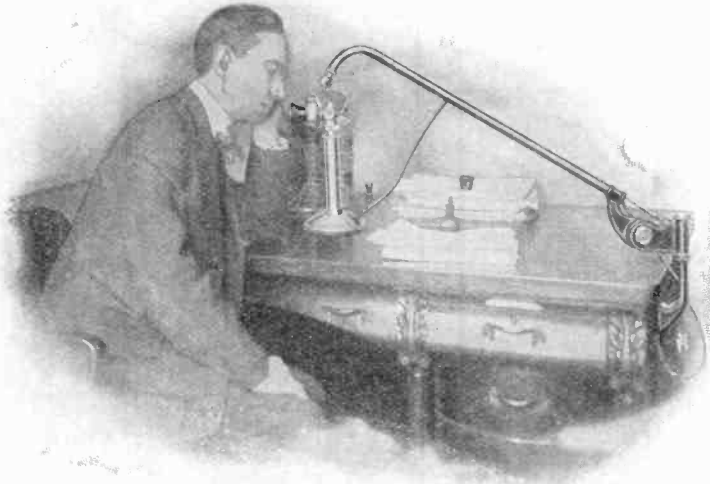

Radio Telephone Holder in Use.

**A**DJUSTABLE, Flexible Telephone Holder meets ALL requirements and suggests many NEW ones, which are impossible with any other TYPE.

The RADIO is adaptable to any make of desk telephone and can be mounted on ANY style of desk or table, or on the wall or floor.

The RADIO permits one telephone to serve four people without getting up from their desks.

The RADIO is up and off of the desk, out of the way, when not in use.

The RADIO normally holds the telephone proper in a vertical position, yet by an ingenious device the user can tilt it so that the position suits his convenience while using; when released, it automatically resumes its normal or vertical position, the arm remaining at angle desired.

The RADIO makes a wall telephone and a desk telephone one.

If some one wants to use your telephone you do not have to arise from your desk, as would be the case with some other makes that hold the telephone so that it can ONLY be used while sitting.

The RADIO can be used while standing as well as sitting.

The RADIO, while holding the telephone perfectly secure, does not hold it rigidly, but flexibly and always vertically unless user desires it otherwise while using.

The RADIO is never in the way, but always ready for instant service.

The RADIO will remain at any angle, but can be moved up or down, or in any direction desired with the slightest touch, so perfectly is every part balanced.

The RADIO in simplicity and perfection, has fewer parts than any other telephone holder, is better made and finished, better designed and is of a better appearance; it is a marvel of ingenious invention and meets the instant approval of all who see it.

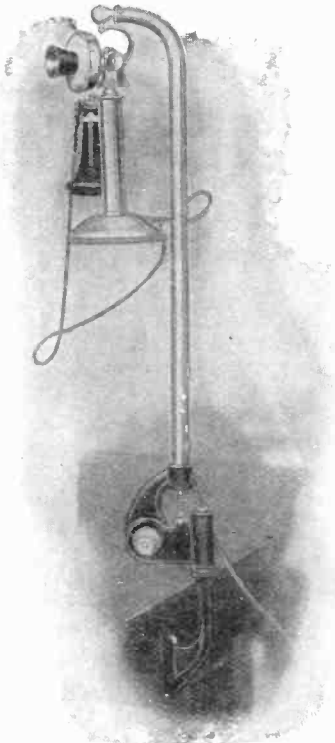

Radio Adjustable Telephone Holder.

**Price \$3.50 Each, Ready to Attach.**

*Write for Illustrated Literature.*

**Swedish-American  
Telephone Company  
CHICAGO, ILLINOIS**

# The Practical House Cleaner



We want to send this machine to every housekeeper in America who uses electricity, that she may prove for herself that it will thoroughly clean any room in a few minutes. All we ask is that you send your name and address.

## The Hoover Electric Suction Sweeper

does more than any vacuum cleaning system. Unlike all other systems, it is not necessary with the Electric Suction Sweeper to first sweep the floor with a broom to remove pins, match sticks, etc., that lodge in the pipes and stop them up. Nine-tenths of the work required from a cleaning machine is on the floor. There is little need for dusting when you use the Electric Suction Sweeper—it takes up and holds the dust without scattering it about the room. Yet we furnish attachments, at small extra cost, that do clean portieres, curtains, furniture and bed clothes. The work of spring house-cleaning becomes a pleasure with the Electric Suction Sweeper.

The Electric Suction Sweeper sells for considerable less than any good vacuum system, and costs but a little more than a good range, sewing machine or other household convenience that would not give as much satisfaction.

If you would like to try this machine at our expense—we pay express charges and make delivery to your home.

Send name and address today to

**Electric Suction Sweeper Co., Dept. 19, New Berlin, Ohio**

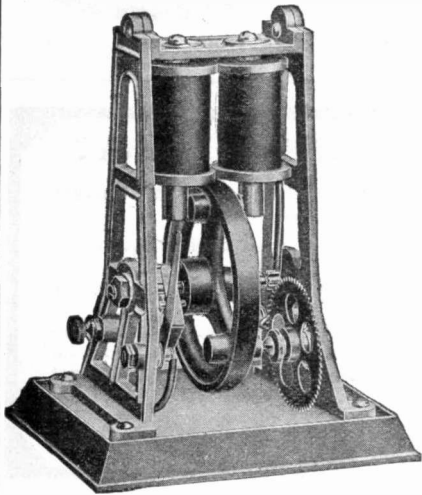

SEND FOR CATALOG

## This is one of the H-K Electric Engines

Style F

¶ We make seven styles of Engines, also Aerial Swings, Merry-Go-Rounds, Ferris Wheels, etc. : : :

**The H. K. Electric Toy Company**  
INDIANAPOLIS, INDIANA

## POPULAR ELECTRICITY

### U. S. or CANADIAN PATENTS

**\$25.00**

We pay all expenses and  
disbursements except  
Government fees

**A**SSOCIATES throughout Continental Europe, Great Britain, the Colonies, South America and Canada enable us to investigate and prosecute foreign interests with dispatch.

Our Pamphlet No. B for the asking.

**THE INDUSTRIAL LAW LEAGUE, Inc.**

170 Broadway, NEW YORK CITY, N. Y.



## Make More Money

Increase your personal earnings or those of your business by learning the modern method of business promotion. If you are handicapped by the small salary of a narrow, crowded line of work, prepare for one of the varied well-paid positions in the great profession of advertising. If you are a business man and want to increase the volume and profits of your business

### Learn Advertising

We provide expert, practical instruction in writing, planning and managing retail, mail-order, trade-paper or ask-the-dealer advertising, agency work and soliciting. To prove the superiority of our instruction we offer the mail course on

**30 DAYS FREE TRIAL**

or an evening FREE in New York. Write for particulars. National advertisers should ask for Business Analysts Blank for planning campaigns.

**GEORGE FRANK LORD, INC., 333B 4TH AVE., NEW YORK**

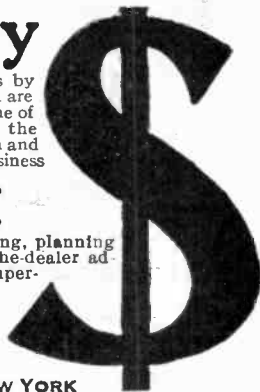

## Are You Using Central Station Power?

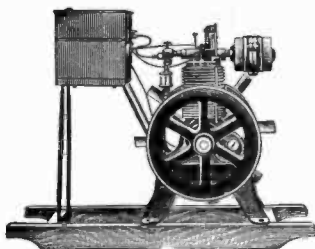

**IF NOT—A WHITE LILY GAS ENGINE** should be your first thought when you **BUILD YOUR OWN POWER PLANT.**

Stands up under the severest tests. Guaranteed free from imperfections in workmanship and material.

Let us give you the benefit of our Knowledge on Gas Engines when applied to Electric Power Plants.

Our 30 days' free trial, which is the only way our Gas Engines are sold—ought to convince you that the White Lily Gas Engine is the only Engine for your needs. We have data on Installing Power Plants which will interest you greatly.

**White Lily Mfg. Co., 1549 Rockingham Road, Davenport, Iowa.**

## A Practical Book—for Practical Men

Electrical Wiring and Construction Tables, by Henry C. Horstman and Victor H. Tousley. Saves tedious calculations. Every wireman, foreman, engineer, contractor, architect should have a copy. Bound in full Persian morocco. Handy size for coat pocket. Price \$1.50. A few handled copies, good as new, for \$1.00 each. Get yours while you can. Won't last long.

**POPULAR ELECTRICITY PUBLISHING COMPANY, Book Department  
Monadnock Block, Chicago, Ill.**

For our Mutual Advantage mention Popular Electricity when writing to Advertisers.



# PATENTS = PATENT ATTORNEYS

**PATENTS** Secured Promptly and with special regard to the legal protection of the invention  
 HAND BOOK FOR INVENTORS AND MANUFACTURERS SENT FREE UPON REQUEST

**C. L. PARKER, Patent Lawyer**

Patents, Caveats, Trade Marks, Copyrights, Reports as to Patentability, Validity and Infringement. Patent Suits Conducted in all States.

**REFERENCES:** American Tire Co., Automatic Vending Machine Co., Lippincott Pencil Co., International Ore Treating Machinery Co., Globe Machine and Stamping Co., Metal Manufacturing Co., Builders Iron Foundry, Morgan Machine and Engineering Co., Berkshire Specialty Co., Stewart Window Shade Co., Macon Shear Co., Acme Canopy Co., Oaks Manufacturing Co., Cox Implement Co., Columbus Buggy Co., National Index Co., Handy Box Co., Iron-Ola Co., By-Products Chemical Co., Alabama Brewing Co., National Offset Co., Antiseptic Supply Co., Floor Clean Co., Fat Products Refining Co., Richmond Electric Co., Railway Surface Contact Supplies Co., National Electric Works, Modern Electric Co.

Mr. Parker on November 1, 1903, after having been a member of the Examining Corps of the U. S. Patent Office for over five years resigned his position to take up the practice of patent law.

Address 12 MCGILL BUILDING - - - WASHINGTON, D. C.

Samuel G. McMeen                      Kempster B. Miller  
**McMeen & Miller**  
 Patent Solicitors and Patent Experts

In connection with our telephone engineering practice we make a specialty of securing electrical patents for inventors, and of giving expert advice in patent matters. We also have facilities for marketing meritorious electrical inventions.

1456 Monadnock Block,                      787 Market Street,  
 CHICAGO    SAN FRANCISCO

**PATENT SENSE** and PATENTS THAT PROTECT  
 yield our clients enormous profits. Write us for PROOF. Inventors lose millions through worthless patents. R. S. & A. B. LACEY,  
 Dept. 52, Washington, D. C. Estab. 1869.

**THE INVENTOR'S UNIVERSAL EDUCATOR**  
 TELLS ALL ABOUT PATENTS,  
 HOW TO SECURE THEM, HAS  
**600 MECHANICAL MOVEMENTS**  
 also 50 PERPETUAL MOTIONS  
 Every inventor should have a copy. Price \$1.00 by mail.  
 —Address—  
**F. G. DIETERICH, Uray Bldg., Washington, D. C.**

**PATENTS SECURED.** Inventor's Pocket Companion free. Send description for free opinion as to patentability. W. N. Roach, Jr., Metzerott Building, Washington, D. C.

**PATENTS**  
 are the greatest source of profit; patent your idea before someone else does; a valid patent, granting as it does, a monopoly is an excellent business foundation; it is also a salable piece of property. I have constant demand for good patents; inventors with good practical ideas write. I will patent and market your inventions. BOOK FREE.  
**SANDERS, 115 Dearborn St., Chicago Ill.**

**PATENTS**  
 TRADE MARKS AND COPYRIGHTS  
**SECURED OR FEE RETURNED**

Send model or sketch and description of your invention for free search of the U. S. Patent Office Records. Our Four Books mailed Free to any address. Send for these books; the finest publications ever issued for free distribution.

**HOW TO OBTAIN A PATENT**  
 Our Illustrated 80 page Guide Book is an invaluable book of reference for inventors and contains 100 mechanical movements illustrated and described.

**FORTUNES IN PATENTS**  
 Tells how to invent for profit and gives history of successful inventions.

**WHAT TO INVENT**  
 Contains a valuable list of inventions wanted and suggestions concerning profitable fields of invention. Also information regarding prizes offered for inventions, among which is a

**PRIZE OF ONE MILLION DOLLARS**  
 offered for one invention and \$10,000 for others

**PATENTS THAT PAY**  
 Contains fac-similes of unsolicited letters from our clients who have built up profitable enterprises founded upon patents procured by us. Also endorsements from prominent inventors, manufacturers, Senators, Congressmen, Governors, etc.

**WE ADVERTISE OUR CLIENTS' INVENTIONS FREE**  
 in a list of Sunday Newspapers with two million circulation and in the *World's Progress*. Sample Copy Free.

**VICTOR J. EVANS & CO.**  
 (Formerly Evans, Wilkens & Co.)  
 Main Offices, 615 "F" Street, N. W., Washington, D. C.

**PATENTS THAT PROTECT AND PAY**  
 Advice and Books Free. Rates Reasonable. Highest References. Best Services.  
**WATSON E. COLEMAN, Patent Lawyer**  
 612 F St. N. W., WASHINGTON, D. C.

For our Mutual Advantage mention Popular Electricity when writing to Advertisers.

Let Us Send YOU A **Monarch Vibrator** ON APPROVAL

**Guaranteed to be the most powerful, durable and practical vibrator of its size made.**

These vibrators contain complete, perfect Electric Motors, and are made to run on their own dry cells or to attach to electric light socket like a lamp. Fully adapted to professional requirements, yet the **most economical and satisfactory for home use.** Light, compact, noiseless; motionless handle. To prove our strong claims for the **Monarch**, we send it prepaid **TO TRY FREE**



Don't buy a vibrator without careful consideration of every one of the above points, including scope of guaranty.

**For Beauty**

Helps to restore to nature's

intended perfections. Removes wrinkles and facial blemishes. If too thin, it brings the blood and develops fullness of the neck, arms or deficient parts, by building new flesh. If too stout, it brings the blood to wash

away adipose tissues. Splendid for the scalp, for the complexion and after shaving. Prevents dandruff, irritation, falling hair, baldness.



**For Health**

Furnishes passive exercise to parts which suffer from congestion, the cause of all disease, bringing the rich, purifying blood in quick response to its swift pulsations, and restoring normal functions. Soothes excited nerves and brings sweet, refreshing sleep.

Let us send you a vibrator, prepaid, without a cent in advance, so that you may know for yourself the wonderful benefits of vibration when given by a high grade machine. Liberal allowance for old machines in exchange. Our new Book, "Health and Beauty Without Medicine," with illustrations from life, FREE. Write to-day. Address

**MONARCH VIBRATOR CO., 544 Security Building CHICAGO, ILLINOIS**

**WIRELESS COMMUNICATION**

Now is the time to engage in the study of the new art of wireless. The demand for trained wireless operators is growing constantly. The recent government action has increased the demand 100 per cent. Salaries of trained operators range from \$15.00 to \$40.00 per week.

**THE AMERICAN WIRELESS INSTITUTE**

is the only universally recognized school in the world for the teaching of this art.

**APPLICATIONS NOW ON FILE FOR 100 EXPERT OPERATORS**

Come in and be one of the first to take a position in this new field that offers promotion, good salaries and boundless opportunities.

Descriptive matter free on request. Address nearest office.

27 WILLIAM STREET  
NEW YORK N. Y.

UNIVERSITY BUILDING  
DETROIT, MICH.



**Factory Price \$49.00**  
Pipes and Registers Extra  
We will pay freight  
Anywhere east of  
Omaha and north  
Of Ohio River

# On Trial

Until Jan. 1st  
At Our Expense  
You to be the Judge and Jury



We will send you, direct from our factory, a complete Hess furnace heating outfit of best quality, all made to your measurements, for \$25 to \$100 less than you can buy from dealers. We will supply special plans and full directions for installing, and will loan you all necessary tools so you, or any man handy with tools, can put up the equipment easily.

## Our Unusual Free-Trial Offer

You may place the purchase price in the hands of your local banker, who will hold it until Jan. 1st, while you test the heater. If the test is not satisfactory, ship the goods back to us. We will pay the return freight charges, and the banker will refund your money.

### Special Heating Plans

You send us a rough sketch of any building you wish to heat and we will have our experts prepare a simple, clear plan showing the best possible arrangement of furnace, pipes and registers, for your building, together with the exact cost to you of the complete outfit. The plan, and our advice are absolutely free. No obligation on your part to buy of us or to pay us one cent.

### Important Booklets Free

At great expense we have compiled and published two very important booklets which are sent free to those who write. Our booklet, "Modern Furnace Heating" contains numerous illustrations and clearly explains every principle involved in furnace heating for any class of building. "These Bear Witness" gives the names of thousands of users of Hess Furnace Outfits, to whom we refer.

The Hess Steel Furnace Burns Any Fuel. Besides any kind of coal, gas or wood, any other fuel, such as chips, twisted straw, corn cobs, etc., may be utilized and money saved.

Write Now - Today For Booklets **Hess Warming & Ventilating Co.** 912 Tacoma Bldg. OHIOGAGO

## The Baby Torch



Lights with a match.

**BURNS** without air-pressure: gives intense blue flame. The smallest, most compact and efficient torch made.

For Electricians, Wiremen and Automobile Users.

WRITE FOR PRICES  
**H. W. HARROLD**  
Valparaiso, Ind.

Size of Tank, 3 x 2 inches

# FAITHORN CO.

PRINTERS  
AND  
ENGRAVERS  
FOR  
PUBLICATIONS



---

FAITHORN CO.  
66-74 Sherman Street

**AGENTS** PORTRAITS 35c, FRAMES 15c, sheet pictures 1c, stereoscopes 25c, views 1c. 10 days credit. Samples and Catalog Free. Consolidated Portrait Co., 290, 110 W. Adams St., Chicago.

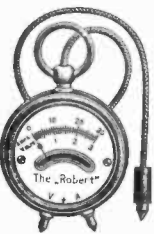

### Robert Pocket Meters

For general battery testing  
Dead-Beat Accurate, Durable, Guaranteed  
Send for Catalogue  
Volt-Ammeters

0-3 Volts, 0-30 amperes,	\$6,	incl. 1'th'r case	
0-6 Volts, 0-30 amperes,	\$6,	" " "	
0-12 Volts, 0-30 amperes,	\$6,	" " "	
<b>Ammeters</b>			
0-30 amperes,	\$4,	incl. 1'th'r case	
<b>Volt-Meters</b>			
0-3 Volts,	\$4,	incl. 1'th'r case	
0-6 Volts,	\$4,	" " "	
0-12 Volts,	\$4,	" " "	

ROBERT INSTRUMENT CO.  
68 Shelby St., Detroit, Mich.

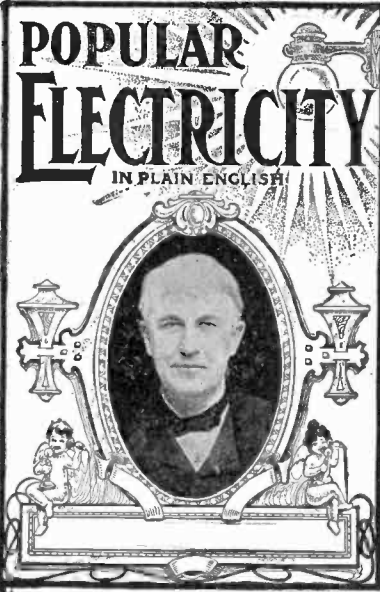

# KNOW ELECTRICITY

You are interested in electricity  
—everyone is.

You are familiar with hundreds  
of its applications but there are  
thousands that you have never  
dreamed of, and new ones are  
coming up every day.

Electricity is fast becoming the ruling power in  
industrial and home life, and you owe it to yourself to  
become familiar with its principles and its possibilities.  
The best way to do this is to read

## POPULAR ELECTRICITY

the new magazine that tells you all about this marvelous  
force in language you can understand.

There are no technical discussions, everything is  
presented in a simple, entertaining style.

Only \$1 a year (\$1.50 Canadian and foreign). Simply  
fill in the coupon and send to us with a dollar bill. Also  
enquire into our subscription proposition. You can  
make easy money and a lot of it.

---

Enclosed find \$1.00 (\$1.50 if Canadian or foreign) for which send  
POPULAR ELECTRICITY for one year to

Name .....

City .....

Street No. .... State .....

THE "POSITIVE"  
ELECTRIC  
VACUUM  
CLEANER

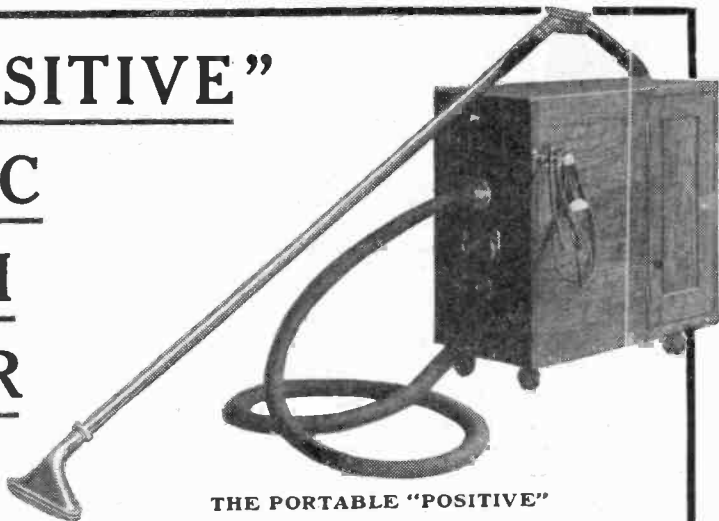

THE PORTABLE "POSITIVE"

IT HAS NO VALVES

**Portable, Light and Efficient for  
Private Homes, Hotels, Hospitals, etc.**

The "Positive" is an efficient vacuum cleaner and will do more than pick up surface dirt. **It will renovate.**

It is substantially constructed along the right mechanical principles. Easy to operate and will last a life-time. Will maintain a vacuum of 9 inches at the nozzle.

The "Positive" is handsome in appearance, the entire machinery being enclosed in a highly polished oak cabinet. Operates from any ordinary incandescent light circuit.

THERE ARE NO BAGS TO CLEAN

*Manufactured only by*

*Write for Catalogue*

**ELECTRIC CLEANER CO.**

General Sales Offices  
1654-5-6-7-8-9 Monadnock Block

**CHICAGO, U. S. A.**

**THE "BEST" LIGHT**

A portable, pure white, steady, safe light. Brighter than electricity or acetylene. 100 candle power. No grease, dirt nor odor. Lighted instantly. Costs 2 cts. per week. Over 200 styles. Every lamp warranted. Agents wanted. Write for catalog. Do not delay.

**THE BEST LIGHT CO.**  
380 E. 5th St., Canton, Ohio

**MAKES AND BURNS ITS OWN GAS**



**TELEGRAPHY**

The Omnigraph Automatic Transmitter combined with standard key and sounder. Sends you telegraph messages at any speed. 5 styles, \$2 up. Circular free.

**OMNIGRAPH MFG. CO.**  
39 N. Cortlandt St., New York



**WIRELESS TELEGRAPHY**

THE FIVE MILE OUTFIT, the most efficient complete sending and receiving station for distances of 5 miles. The range of the receiving station is limited only by the power of the transmitter. Price, complete, \$9.15. Same outfit, with 2-inch coil, for 10-15 miles, \$12.90. 2-inch coil, \$7.75. 1 1/2-inch coil, \$5.00. All our coils are wound to produce a heavy, hot spark and are absolutely guaranteed. Our new Corborundum Detector is guaranteed superior to the electrolytic. Each, \$1.00. Send stamp for large illustrated circulars of all kinds of wireless goods.

**INTERNATIONAL WIRELESS CO., Dept. E., Lima, Ohio**

**W. H. CRUMB & COMPANY**

Engineers :: :: Contractors

Telephone Engineering and Construction  
Plans, Specifications and Estimates  
Promptly Furnished.

**835 Monadnock Bldg., Chicago, Ill.**

**DO YOU LIKE TO DRAW?**

**THAT'S ALL WE WANT TO KNOW**

Now, we will not give you any grand prize—or a lot of free stuff if you answer this ad. Nor do we claim to make you rich in a week. But if you are anxious to develop your talent with a successful cartoonist, so you can make money, send a copy of this picture, with 6c in stamps for portfolio of cartoons and sample lesson plate, and let us explain.

**The W. I. EVANS SCHOOL OF CARTOONING**  
325 Kingmoore Bldg., Cleveland, Ohio.



**WIRELESS EXPERIMENTERS, ATTENTION!**

We keep the highest grade wireless and electrical supplies in stock. **SPECIAL THIS MONTH ONLY.** Imported graphite cups for your electrolytic detector \$.15. Wollaston wire .0005 per inch \$.10 and .0001 per inch \$.25 **SPECIAL 1 1/2 IN. SPARK COIL.**

For \$6.25 we sell Detectors, Coherers, Condensers, Tuning Coils, Te Receivers, Spark Gaps and COILS. Send 2c. Stamp for large catalogue. **SPECIAL PRICES GIVEN TO OUR NEW CUSTOMERS.** Write now. Don't delay.

**THE I. W. T. WIRELESS, 728p Broadway, Brooklyn, N. Y.**

**Electric Motor Watch Charm**

A genuine Electric Motor, inclosed multipolar type. Runs 2000 revolutions per minute. Highly polished and plated. A powerful "Pocket Battery" with every outfit. Postpaid, \$1.00.

**DESPATCH MFG. CO.**  
112 N. First St., Minneapolis, Minn.



**Manz Engraving Co.**

Holister Press

**75 E. Monroe Street, Chicago**

Desirable Quality, Reliable Service  
Staple Prices. Send us your wants.

**FOOT AND ELECTRICAL DRIVEN**

Power and Turret Lathes, Planers, Sharpers, and Drill Presses.

Write today for our Complete Catalog.

**Shepard Lathe Co.**  
B. 131 W. 2nd St., Cincinnati, Ohio



**DYNAMO - MOTOR \$3.85**

(A Dynamo and Motor in One)

As a dynamo it will light 40 candle power; operate induction coils; charge storage batteries; decompose water; electroplate, etc. As a motor, will operate sewing machine, jeweler's lathe, emery wheel, circular saw, advertising devices, and other useful appliances. Send stamp for catalog. Nos. 11 and 12 of new things electrical.

**ARROW ELECTRIC CO.**  
103 South Canal Street, Chicago, Ill.

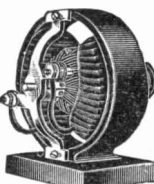

**MAGIC TRICKS** Our latest illustrated book tells you how to do all kinds of tricks. GET ONE and shine as a star entertainer among your friends. Price only 25c. Send for catalog.

**PEERLESS TRICK AND NOVELTY CO.**  
Dept D, 3146 & 3148 State St., Chicago, Ill.



**DIE MODELS SPECIAL WORK TOOLS MACHINERY**

**NATIONAL STAMPING AND ELECTRIC WORKS**  
153-159 S. JEFFERSON STREET. CHICAGO, ILL.

This most remarkable 2-8 inch plate absolutely generates in wet weather, the only one in the world guaranteed to do so. Gives a 3 inch spark, 100% greater output for its size than any such machine ever made. Send stamp for catalogue.

**Statid Machine**

**THE HERTZIAN ELEC. CO.**  
1009 E. 42d Street Brooklyn, N. Y.



**ANYTHING ELECTRICAL**

A 3c Stamp will secure our New Big Catalog. Positively the most comprehensive of its kind published. 25 pages of Experimental and Higher Grade Wireless Outfits alone.

**J. J. DUOK**  
428 St. Clair St. TOLEDO, O.

For our Mutual Advantage mention Popular Electricity when writing to Advertisers.

# EXCELSIOR AUTO-CYCLE

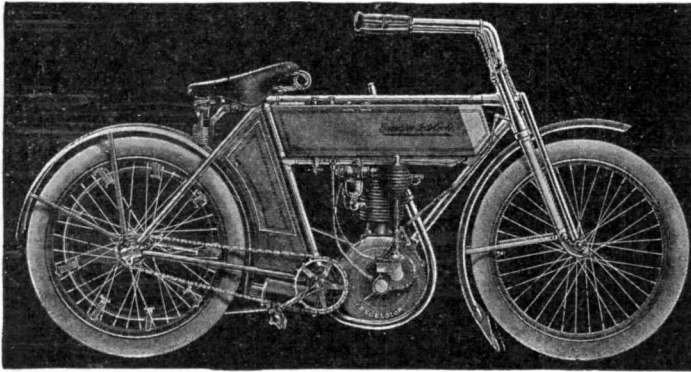

Wins again, defeating all other motor-cycles and automobiles in two great Hill Climbs.

At Atlanta, Ga., two Excelsiors First and Second, winning by a wide margin over stripped racers.

At Redlands, Cal., four Excelsiors finished 1, 2, 3 and 4 on a hill 15 miles

long and one mile high in 18 min. 5 sec.

The winning automobile, a 60 H. P. stripped racer, required 24 min. 12 sec.

These were all strictly stock Excelsiors and their accomplishment tells the story of Excelsior quality.

## EXCELSIOR SUPPLY COMPANY

Established 1876

233-237 Randolph Street, Chicago, Illinois.

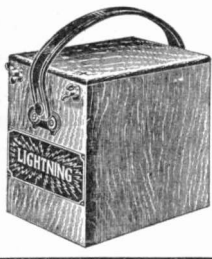

### Save Money!

The  
**Lightning  
Storage  
Battery**

Guaranteed for one year.

**6 Volts, 60 Amperes - - \$12.50**

**6 Volts, 80 Amperes - \$16.50**

Used for automobiles, marine ignition, vibratory outfits, fans, etc. This battery is cheaper by far than dry cells—it can be recharged any number of times at the small cost of 15 to 25 cents.

Write for FREE catalog, also special price on nine inch fan and battery complete.

### LIGHTNING ELECTRIC & ACCESSORIES CO.

172 Michigan Ave., Chicago, Ill.

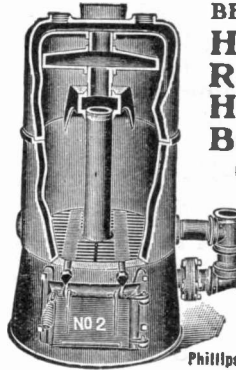

**BEST  
HOT WATER  
RESIDENCE  
HEATING  
BOILER MADE**

Guaranteed and Sold Direct  
Where We Have no Agent

Capacity of Heater nearly doubled without additional fuel by use of Center Pipe carrying water up through the center of deep fire pot. Heats from all sides. We want to sell you a heater. Write us today.

Phillips Heating Co., Dept. B Aurora, Ill.



### Electric Power Motor

Sample prepaid for **35c**  
Agents wanted

Empire Elec. Works, 1174 Bridgeport, Conn.

### LEARN TELEGRAPHY

Start right. Get **The Telegraph Instructor** by C. M. Hodge. Best "Plain English" treatise on the art ever published. For beginners or practical men. 260 pages. Fully Illustrated.

Regular price \$1.00. Special **75c prepaid.**  
**POPULAR ELECTRICITY PUBLISHING CO.**  
Book Department Monadnock Block, Chicago, Ill.

POPULAR ELECTRICITY



Wm. H. Crane



Mable Hite



David Warfield



E. S. Willard

# THESE 22 STARS

And many more use and endorse the Swedish Electric Vibrator.

Copy of letters from them stating what it has done for them mailed FREE to any address.



Cecil Lean



Florence Holbrook



W. W. Hinshaw

This Vibrator is a **Gymnasium, a Physician, a Beauty and Health builder and Youth Restorer, all in one.** It gets right down to the centers of **Natural Stimulation and Revitalizes you Permanently.** No bad after effects as with drugs. It **Reaches the Nerve Basis,** increasing the flow of **Nervo Fluids.** It **Exercises, Strengthens, Revitalizes, gives New Energy, Soothes and Rests** you, all at the same time, by reason of its wonderful **50,000 Penetrating Vibrations** per minute and its **Perfect Rhythm.**

**"HEALTH, STRENGTH, ENERGY ARE CONDITIONS OF HARMONIOUS VIBRATION."** "Disease is interrupted or discordant vibration."

The Swedish Electric Vibrator will give you the **Perfect Rhythm** of health. It will **Unclog** the bowels in **Two Minutes.**

It will **Recharge, Revitalize and Re-energize** a fagged man or woman. A few touches with the Vibrator will **Cure Any** headache.

It will touch the morphic nerve and soothe the most restless to sleep.

It will **Bring** the bloom of youth to faded cheeks—**The Kind That Won't Come Off.**

It will loosen the scuff and dandruff, cause the hair cells to resume healthy action; **Brings** the life-giving blood to the scalp and apparently **Resurrects** the dead hair cells and follicules as **Plenty of New and Glossy Hair** is the result.

It will cure any case of Rheumatism.

It will do and cure a thousand and one things that we would like to tell you **How** it does and **Why.** Don't be skeptical. Write us about **Any** ailment or condition and we will give you free advice **JUST HOW** to effect a cure or **Correct** a condition.

We have a **Book** of many pages, **Illustrations, Charts, Diagrams** and Instructions in **Plain English** which we will mail **Free** to any address.

**OUR DIAMOND MEDAL** Vibrators are operated by batteries or electric light current. The most **Efficient** and **Powerful** Vibrator of **Any** size or price. The **Only** Vibrator with a **Perfect Rhythm.** A Vibrator without a Rhythm is like a ship without a rudder.

**GUARANTEED FOR FIVE YEARS. PRICES Within the Reach of All.**

## SWEDISH ELECTRIC VIBRATOR COMPANY

602-640 Farragut Avenue, CHICAGO, ILL.



Trixie Friganza



Joseph Sheehan



Frank Gotch



John Kling

For our Mutual Advantage mention Popular Electricity when writing to Advertisers.



POPULAR ELECTRICITY



Elsie Janis



Kyrle Bellew



Mabel Taliaferro



Joe Weber



Battery Current Operated Vibrator for use where electric light current is not available. Batteries and all come in this portable case.



Showing Battery Vibrator and fine point Applicator.



Julia Sanderson

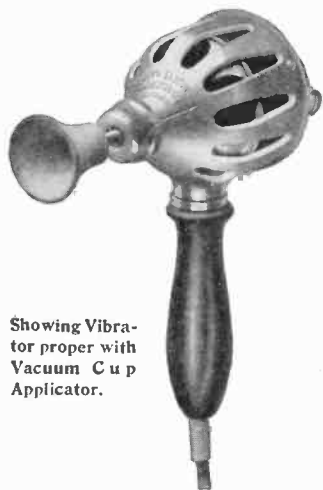

Showing Vibrator proper with Vacuum Cup Applicator.



Electric Light Current Operated Vibrator Outfit. This Vibrator operates on either 110-120 volts, direct or alternating current; 60 cycles also wound special for 133 cycles and 220 volt D. C.



Harry Bulger



Camille D'Arville



O. Overall



Mordecai Brown



Frank Chance



Michael Donlin

For our Mutual Advantage mention Popular Electricity when writing to Advertisers.

## The Third Annual New York Electrical Show

will be held in the  
MADISON SQUARE GARDEN, NEW YORK  
October 11th to 21st inclusive

**T**HIS year's show will have a large number of industrial exhibits, which will be of great interest to New Yorkers and also the many visitors that will be in town for the Hudson-Fulton Celebration.

The price of space will include all decorations, which will be a great convenience and saving to exhibitors.

For space write to

THE THIRD ANNUAL  
NEW YORK ELECTRICAL SHOW, INC

124 West 42d Street, New York

**\$ 50.<sup>00</sup>**  
**FOR THIS**  
**COMPLETE**  
**BATH**  
**ROOM**  
**OUTFIT**

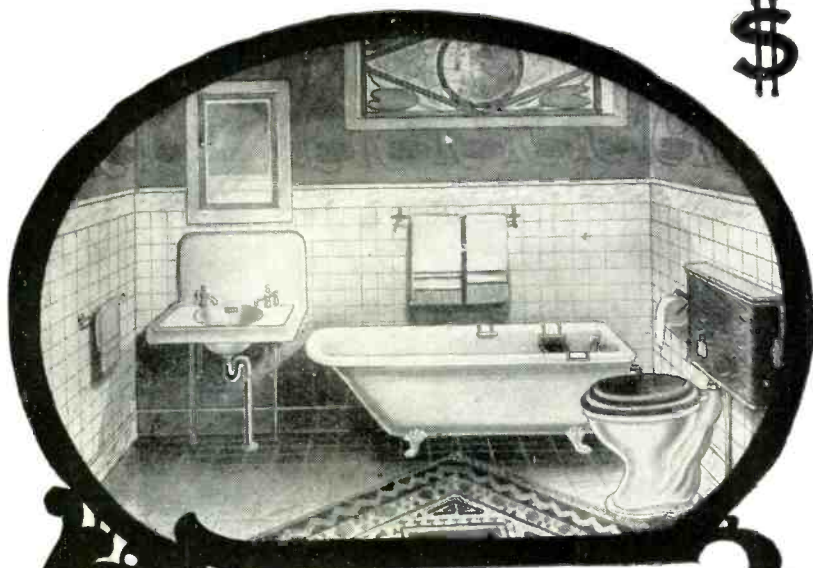

**Clean—Sanitary—Odorless—Newest Designs**  
**Best Appliances—Finest Nickel Trimmings**

Here is an example of our ability to save you 40 to 60 per cent in the purchase of high-grade plumbing fixtures. We guarantee that every article used in this outfit is absolutely brand new and first-class in every particular.

**THE BATH TUB** is spotless white porcelain enameled, with heavy roll rim and of very graceful shape.  
**THE LAVATORY** is beautiful, spotless white porcelain enameled, with full set of nickel-plated trimmings.

**THE CLOSET** is the latest and most sanitary, vitrious syphon jet; polished solid oak seat and tank.  
**THE ACCESSORIES** include bath seat, nickel-plated soap cup, two towel bars and toilet paper holder.  
**NO JOINTS TO WIPE**, all threaded pipe connections.

This is our No. 3½ Outfit, and our price of \$50.00 absolutely includes all of the plumbing fixtures shown in the illustration, properly crated and packed for shipment.

This is but a sample of the many different styles that we offer for sale. Fifteen different combinations ranging in price from \$25.00 to \$200.00. Our prices will save you one-half what your plumber would ordinarily charge you.

We furnish a written binding guarantee with every outfit that we sell. If any material is not fully up to our representations or your expectations, we will exchange at our freight expense or refund your money.

**Our Book on Plumbing Material** contains charts, drawings and diagrams; shows how any ordinary mechanic can install plumbing fixtures without wiping joint; also tells how to secure perfect sanitation. We send it free if you mention where you have seen this advertisement.

**Heating Plants from \$100 Up**

We save you from 30 to 50 per cent.

Send us a sketch or diagram of your house for our estimate.

Steam and hot water heating plants of modern construction furnished you complete, ready to install. Our efficient Engineering Department furnishes you correct heating ideas. Any handy man can install our plants, either in new or old buildings. Our complete, yet simple, instructions sent with each plan.

**Write for Our Book, "COLD WEATHER COMFORT"**

A useful heating guide. Gives full and necessary information on the care of your plant. Contains one thousand heating hints. Mailed free to any one mentioning this publication.

Our 500-page catalogue, No. 891 on merchandise for the Home, the Field and the Work Shop is mailed free

We buy our goods at Sheriffs' and Receivers' sales.

**CHICAGO HOUSE WRECKING COMPANY**

35th and Iron Streets, Chicago

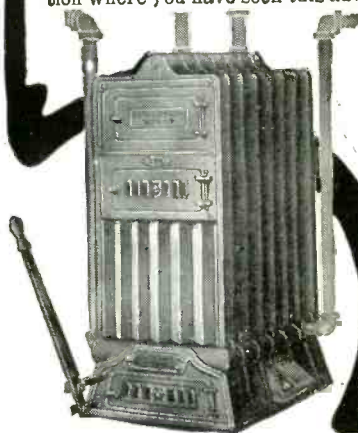

# Thor - Electric

WASHWOMAN  
HOUSEMAID  
MAN-OF-ALL-WORK



ALL  
IN  
ONE

Washes and wrings by electricity without packing the clothes in a wad, as many other washers do—keeps the water hot during the wash—and, with its **UNIVERSAL ROD**, operates the ironing machine, the ice cream freezer, the grindstone, and performs countless other household tasks.

## READ WHAT

*Pomeroy, Wash.,  
Jan. 29, 1909.*

*We enclose herewith draft in payment of your invoice of Jan. 9th. The two "Thor Electrics" arrived on the 27th inst., and were sold immediately. Please enter our order for six more.*

**TUCANNON  
POWER CO.**



## OTHERS SAY

*Chico, California,  
Dec. 26, 1907.*

*I have been trying for the last ten years to get a cylinder washer in which the cylinder would revolve in both directions but could not find one until I heard of yours.*

**A. H. LOCEY.**

THE THOR MAKES WASH DAY REST DAY

## Sent on 30 Days' Free Trial

*Write Us for Free Illustrated Book, "Easy Way Wash Day," Showing All Styles, Sizes and Capacities.*

## HURLEY MACHINE COMPANY.

1204-159 S. Jefferson St.,  
CHICAGO.

74 First St.,  
SAN FRANCISCO, CAL.

2504 Flatiron Building,  
NEW YORK.