

# Popular Electricity

*In Plain English*

VOL. III

JUNE 1910

No. 2

## The Tomorrows of Electricity and Invention

By

Thomas A Edison

I understand that the readers of Popular Electricity are numbered among those who are interested rather in the future of electricity than in its past. I shall be glad to be counted as belonging to this class, for while no longer young in the sense of mere years, it is with what electricity can yet do that I am concerned in these days. If I thought that the possibilities of electrical development were exhausted I should not give it a moment's consideration. Sometimes fathers come to me, or write to me, about their sons, and want to know if in view of the fact that so much of the field of work is already occupied by electricity, I would recommend it as a career. It is assumed by them that all the great electrical inventions have been made, and that nine or ten billions of dollars is about all that electricity will stand, in the way of investment. Well, if

I were beginning my own career again, I should ask no better field in which to work. The chances for big, new electrical inventions are much greater than before the telegraph, the telephone, the electric light and the electric motor were invented; while each of these things is far from perfect. We shall have easily \$50,000,000,000 of money in electrical service in 1925, and five times as many persons will then be employed in electricity as now, most of them in branches for which we have not yet got even a name. I often pick up my laboratory note books, of which I have hundreds, full of hints and suggestions and peeps into Nature, and realize how little we have actually done to set electricity at work, let alone determine its secret. Why, barely thirty years ago, there was no dynamo in the world capable of supplying current cheaply and efficiently

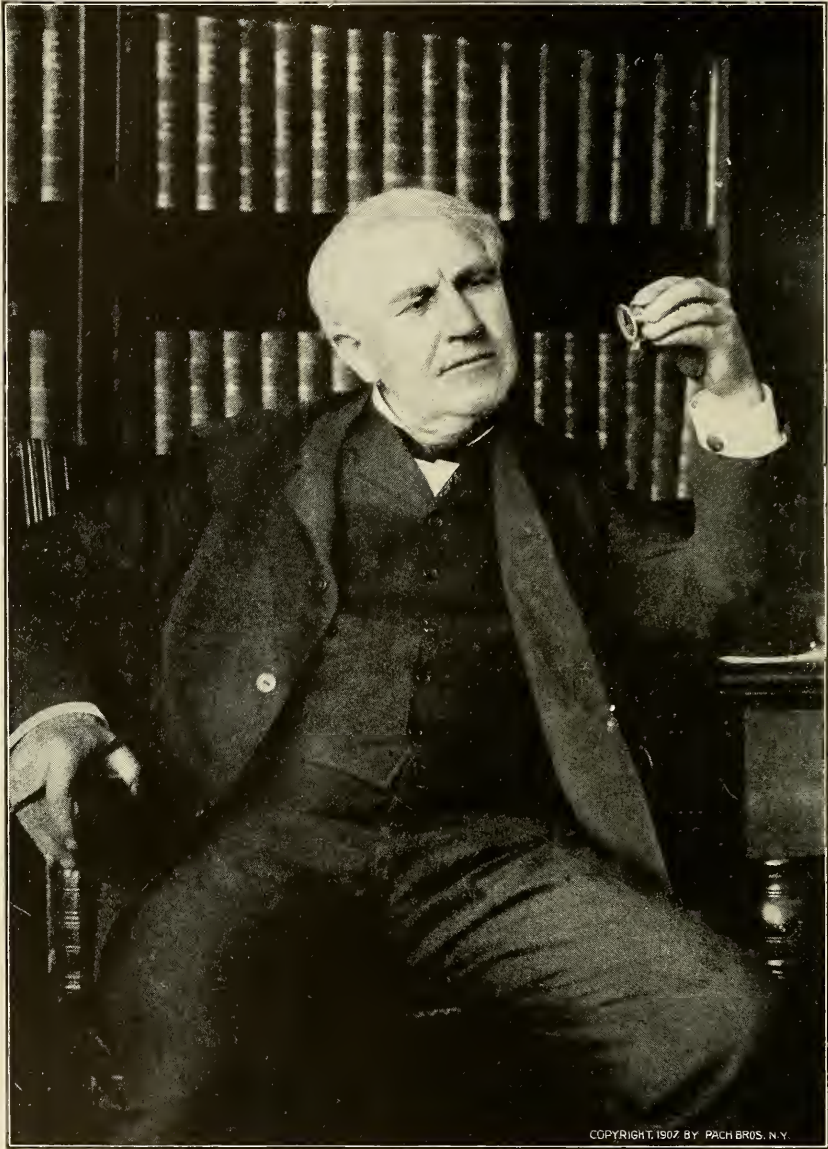

COPYRIGHT, 1907 BY PACB BROS. N.Y.

*Thomas A Edison*



# POPULAR ELECTRICITY

## IN PLAIN ENGLISH

HENRY WALTER YOUNG, Editor



Vol. III

June, 1910

No. 2

### CONTENTS

	Page		Page
THE TOMORROWS OF ELECTRICITY AND INVENTION. By Thomas A. Edison.....	79	All in Thirty Years .....	128
ELEMENTARY ELECTRICITY, CHAPTER XXVI. By Prof. Edwin J. Houston.....	84	Telling Temperature in Bins of Grain.....	129
New Type of Transmission Tower.....	86	Demagnetizing Watches .....	129
THE LIGHT AND POWER OF BROOKLYN. By W. W. Freeman.....	89	Sharpening Files .....	129
The Meditations of a Science Man.....	91	Submarine Telegraph Cable .....	130
CURRENT FROM WHERE? CHAPTER III. By Edgar Franklin.....	92	Heating Pad as an Incubator .....	130
THE NEW EDISON STORAGE BATTERY.....	99	Electric Steels as Money Savers .....	130
Magnetic Pull and Temperature .....	101	The Telephone's Alertness .....	130
German Wireless Vs. British Cable.....	101	Cutting Metals by Electric Arc.....	131
To Test Current Polarity .....	101	Electric Crane to Carry Locomotives .....	132
THE GHOST ELECTRICIANS. By Fred R. Furnas.....	102	Portable Power Elevator .....	133
Three Illustrious Wrights .....	103	The Storing of Electric Heat .....	133
THE FIRST CARBONLESS ARC LAMP. By Warren H. Miller.....	104	Electricity Produces Mountain Air .....	134
TALKS WITH THE JUDGE .....	106	A Ton at a Time or One .....	135
WHERE ELECTRICITY STANDS IN THE PRACTICE OF MEDICINE. CHAPTER VI. By Noble M. Eberhart.....	107	Simplicity the Key Note .....	136
Drawn Tungsten Filaments .....	111	An Electric Pyrometer's Record .....	137
GETTING OUT AN "EXTRA" .....	115	Electric Anesthesia .....	138
Arc Light Bath .....	116	Electric Welding Saves Heat .....	138
How to Calculate Illumination .....	116	Electric Gate Opener .....	139
Protecting Signal Batteries .....	117	Railroad Crossing Signals .....	139
Magnet Coils as Heaters .....	117	Paper Making with Electric Power .....	140
Ice Handling by Electricity .....	118	Electric Driving Increases Output .....	140
Holding Court by Telephone .....	118	The Latest Taxicab .....	141
Plant Growth and Electricity .....	118	Getting the Time in Races .....	141
Electric Diving Sign .....	119	Stone and Marble Cutter .....	142
Automobile Battery Exchange .....	119	Candelabra Switch .....	142
Collapsible Signs .....	119	ELECTRICAL MEN OF THE TIMES. H. M. Bylesby.....	143
Bare Wires of an Unseen Metal .....	119	SPEAKING OF WASH DAY .....	144
Resistance .....	119	Electric Travelers' Iron .....	145
Some Odd Electric Lamps .....	120	AT THE CHAFING DISH LUNCHEON. By Florence Latimer.....	146
The Newspaper Cause .....	121	Connecting Cooking Devices .....	147
Telephone in the School Room .....	121	Fans and Home Comfort .....	148
Para Rubber .....	121	AN ELECTRICAL LABORATORY FOR \$25. PART VI. By David P. Morrison.....	149
Lightning and the Ancients .....	122	Trapping a Telephone "Josher" .....	154
Exhibit Hall for Accident Prevention .....	122	A HIGH POWER WIRELESS EQUIPMENT. PART II. By Alfred P. Morgan.....	155
The Eskimo and the Telephone .....	123	THE COLLINS WIRELESS TELEPHONE. Protective Device for Wireless Apparatus.....	158
Cutting Lamp Filaments on a Planer.....	123	Eiffel Tower Wireless Station .....	160
Lamp Flasher .....	124	That Night at Chester .....	161
Using Saw Dust Electrically .....	124	The "Pyron" Detector .....	162
What Weight Can a Dry Battery Lift.....	125	Spark Coil Dimensions .....	163
Displaying Lamp Shades .....	125	Wireless Queries .....	164
Telephone Coil Carrier .....	125	QUESTIONS AND ANSWERS .....	165-167
Lifting Magnet Recovers Cargoes.....	126	NOTES ON THE LAW OF PATENT TITLES.....	168
Across the Atlantic with a Thimble Battery.....	127	Training Base-Ball Pitchers .....	169
Curing the Sleeping Sickness .....	127	Electro-Magnetic Ironing Board .....	169
Electrocuted Eggs .....	127	Tuning Fork for Ear Treatment .....	170
In-Door Lighting from Out-Door Lamps.....	128	Aging and Curing Tobacco .....	170
Navigating in Lake Ice .....	128	Book Review .....	170
Making Battery Porous Cups .....	128	ON POLYPHASE SUBJECTS .....	171
		SHORT CIRCUITS .....	172
		COMMON ELECTRICAL TERMS DEFINED.....	174

**RENEWALS** When your subscription expires, you will find a renewal blank enclosed here. You should fill out and return same with remittance at once, to avoid missing a number. Positively no copies will be mailed on any subscription after same expires unless renewed, and we cannot agree to begin subscriptions with back numbers. The date on wrapper of your magazine shows the issue with which your subscription ends.

**CHANGE OF ADDRESS** Notify us promptly of any change in your address, giving both the old and new location. Since each issue is printed a month before the date it bears, we should be notified at least four weeks in advance, in order to make the necessary change in our records.

ISSUED MONTHLY BY POPULAR ELECTRICITY PUBLISHING GO., Monadnock Block, Chicago, Ill.  
 YEARLY SUBSCRIPTION, \$1.00; CANADIAN, \$1.35; FOREIGN, \$1.50; SINGLE COPY, 10 CENTS

No additional copies will be sent after expiration of subscription except upon renewal  
 Entered as Second Class Matter April 14, 1908, at the Post Office at Chicago. Under Act of March 3, 1879.  
 Copyright 1910 by Popular Electricity Publishing Co.

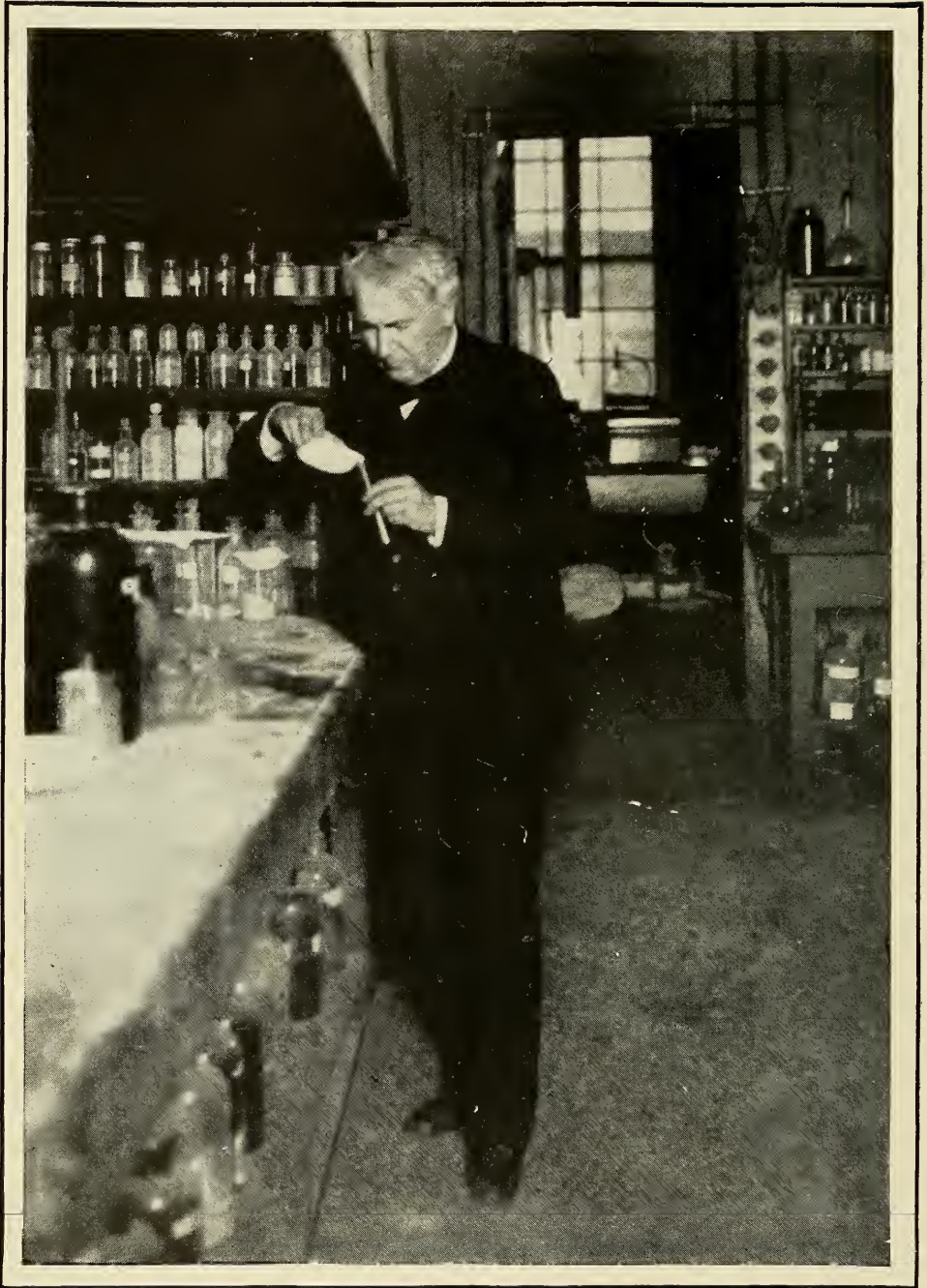

to the little incandescent lamp, and some of the keenest thinkers of the time doubted if the subdivision of the electric light was possible. Tyndall remarked in a public lecture, with a dubious shake of his head,

that he would rather Mr. Edison should have the job than himself. It is those that will work at the art in the next fifty years that are to be envied. We poor gropers of the last fifty are like the struggling farmers

among the bare New England rocks before the wide grain fields of the West were reached. The crops have been thin, without reapers or threshers to harvest them. We haven't gone very far, yet, beyond Franklin or Faraday.

Look at the simple chances of improvement in what devices are known today. They are endless. About one hundred million carbon filament lamps are made here every year, much the same in all essentials as a quarter of a century ago. We must break new ground. Lately the art has gone back to metallic filaments bringing down to one-third the amount of current needed for the same quantity of light. That is only a step. The next stage should be to one-sixth, and, as Steinmetz says, carbon is still in the game, for many of its qualities render it superior to metal. It is the same way with electric heating and cooking appliances, very ingenious even now, and better than any other means; but ten years hence they will be superseded and in the museums with bows and arrows and the muzzle-loaders. As for the electric motor, it will not be perfectly utilized until everything we now make with our hands, and every mechanical motion, can be effected by throwing a switch. I am ashamed at the number of things around my house and shops that are done by animals—human beings, I mean—and ought to be done by a motor without any sense of fatigue or pain. Hereafter a motor must do all the chores.

Just the same remarks apply outdoors. For years past I have been trying to perfect a storage battery and have now rendered it entirely suitable to automobile and other work. There is absolutely no reason why horses should be allowed within city limits, for between the gasoline and the electric car, no room is left for them. They are not needed. The cow and the pig have gone, and the horse is still more undesirable. A higher public ideal of health and cleanliness is working toward such banishment very swiftly; and then we shall have decent streets instead of stables made out of strips of cobblestones bordered by sidewalks. The worst use of money is to make a fine thoroughfare and then turn it over to horses. Besides that, the change will

put the humane societies out of business. Many people now charge their own batteries, because of lack of facilities; but I believe central stations will find in this work very soon the largest part of their load. The New York Edison Company or the Chicago Edison should have as much current going out for storage batteries in automobiles and trucks as for power motors; and it will be so some near day. A central station plant ought to be busy twenty-four hours. It doesn't have to sleep. So far, we electrical engineers have given our attention to two-thirds of the clock; and between 10 p. m. and 6 a. m. have practically put up our shutters, like a retail store. I am proposing to fill up that idle part of the clock.

Electricity is the only thing I know that has become any cheaper the last ten years, and such work as I have indicated, tending to its universal use from one common source, is all aimed consciously or insensibly, in this direction. I have been deeply impressed with the agitation and talk about the higher cost of living, and find my thoughts incessantly turning in that direction. Prices are staggering! Before I became a newsboy on the Grand Trunk Railroad, I raised and distributed market garden "sass" grown at the old home at Port Huron, Michigan, and made many a dollar for my crude little experiments that my mother with great doubt and trepidation let me carry on. Thus with early experience as a grower and distributor, reinforced by fifty years of inventing and manufacturing, I am convinced pretty firmly that a large part of our heightened expense of living comes from the cost of delivering small quantities to the "ultimate consumer."

My poor neighbors in Orange pay four or five times what I do for a ton of coal because they buy in such small quantities; and thus the burden falls on the wrong shoulders. This appeals to my selfishness as well as to my philanthropy, for the workingman hasn't much left to buy my phonograph or to see my moving pictures with, if all he makes is swallowed up in rent, clothing and food. I'll speak about rent a little later. In clothing we have got onto the universal "ready-made" basis which has vastly cheapened dress while ensuring



COPYRIGHTED 1904, BY BYRON, N.Y.

a fastidious fit. When we come to food, let us note how far we have already gone in centralized production of the "package." I believe a family could live the year around

without using anything but good "package" food. What is needed is to carry that a step further and devise automatic stores where the distributing cost is brought down

to a minimum on every article handled. A few electro-magnets controlling chutes and hoppers, and the thing is done. I wonder the big five- and ten-cent stores don't try the thing out, so that even a small package of coal or potatoes would cost the poor man relatively no more than if he took a carload. If I get the time I hope to produce a vending machine and store that will deliver specific quantities of supplies as paid for, on the spot.

Butchers' meat is one of the elements in high cost of living that this plan may not apply to readily; but it is amazing how far, even now, automatic machinery goes in carving up a carcass. We shall simply have to push those processes a little further. Thousands of motors are now in use running sausage machines, for example. Besides I am not particularly anxious to help people eat more meat. I would rather help them eat less. Meat eating like sleeping is a bad habit to indulge. The death rate and sickness of the population of the country could be reduced several per cent, in the ratio of abstinence from animal food.

One most important item in the modern high cost of living is rent. The electric railway has been an enormous factor for good in distributing people so as to lessen congestion and lower rents. But homes and rents are still much too high in price because of the cost of construction. I saw it coming long ago and hence went into the making of cement, the cheapest and most durable building material man has ever had. Wood will rot and burn, but a cement and iron structure seems to last forever. Look at the old Roman baths. Their walls are as solid today as when built two thousand years ago. When I came to the close of some experiments on magnetic ore milling, on account of the opening up of the Mesaba Range—which will not last forever—the insurance companies cancelled their policies because of the "moral hazard" on my idle buildings. I said to myself that I would construct buildings that did not have moral risk, and thus went into the Portland cement industry. I have already put up a great many large buildings of my own all of steel and concrete, avoiding this moral risk, and now I am rapidly developing the

idea, in building with large iron molds, houses for poor plain folk, in which there is no moral risk at all, nothing whatever to burn, not even by lightning. When I get through, the fire insurance companies can follow the humane societies, for the lack of material to work on.

My plans are very simple. Nothing that is fundamental and successful in dealing with the wants of humanity in the mass, must ever be complicated. I just mold a house instead of a brick. A complete set of my iron molds will cost about \$25,000, and the working plant \$15,000 more. As a unit plant, I will start six sets of molds, to keep the men busy and the machinery going. Not less than 144 houses can be built in a year with this equipment. A single house can be cast in six hours. With interest and depreciation of 10 per cent on a sum of say \$175,000, the plant charge against each house is less than \$125. I believe that the houses can be erected complete with plumbing and heating apparatus for \$1200 each when erected on land underlaid with sand and gravel. Each house may be different in combination of design, color, and other features; and endless variation of style is possible. The house I would give the workingman has a floor plan 25 by 30 feet, three stories high, with cellar, on a lot 40 by 60 feet, with six large living and sleeping rooms, airy halls, bath and every comfort. In cut stone such a house would cost \$30,000. These houses can be built in batches of hundreds and then the plant can be moved elsewhere. When built these communities of poured houses can become flowered towns with wide lawns and blooming beds, along the roadways. Rats and mice and Croton bugs will have as much show in them as in the steel safe of a bank. Cement neither breeds vermin nor harbors it. There is nothing in all this that is not common sense and easy of practice. With a fair profit these houses should rent at ten to twelve dollars per month. Who would not forsake the crowded apartment or tenement on such terms for roomy, substantial houses, fitted with modern conveniences, beautified with artistic decorations, with no outlay for insurance or repairs and with no dread of fire or fire bugs?

# Elementary Electricity

By PROF. EDWIN J. HOUSTON, PH. D. (Princeton)

## CHAPTER XXVI.—THE INCANDESCENT ELECTRIC LAMP

The incandescent electric lamp depends for its operation on the fact that any part of a circuit the resistance of which is comparatively high, will be heated to incandescence by the passage of the proper current.

The possibility of producing artificial light by electricity flowing through a high resistance conductor has been known for a long time. At a very early date a man named Children made an investigation on the effects produced by the passage of electricity through conductors consisting of different metals. The current employed for this purpose had sufficient strength to raise the wires to bright incandescence.

Besides the above, a number of early experiments were made by De La Rue, Grove and others. De la Rue produced a device not unlike the electric lamp of later days. It consisted of a spiral wire placed inside a glass cylinder in order to protect the glowing conductors from the action of the air. This early form of lamp is represented in Fig. 166.

But since the amount of light produced by most of these early devices was so small and their life or ability to continue supplying this light so short, none of these devices can properly be considered as operative lamps.

One of the most important properties that a substance suitable for use as the incandescing or light-emitting part of an incandescent electric lamp is a high refractory power; that is, it must be capable of being raised to a high temperature without fusing, such, for example, as a wire of platinum or a cylinder or rod of carbon. Without going into their description, it may be said that many early forms of incandescent electric lamps employed these substances for their light-emitting material.

As we have seen, the heat produced in any

conductor by the passage of an electric current may be either entirely non-luminous or unaccompanied by light, or partly luminous or accompanied by light. Unfortunately, the radiation produced by the passage of an electric current through wires of platinum or rods of carbon contains a greater proportion by far of non-luminous than of luminous heat.

Even in the case of the best form of fairly modern incandescent electric lamps the heat emitted by the glowing filament is greatly in excess of the light. Sixteen candle-power incandescent lamps, or those that produce a light equal to that produced by sixteen standard candles, require, for their proper operation, an expenditure of electric energy equal to about 50 watts. Now, it can be shown that of this activity about 48 watts are employed in producing non-luminous radiation, and but two watts, or four per cent, in producing luminous radiation. Although in later types of incandescent electric lamps somewhat better results have been obtained, the fact exists that even in its best form the incandescent electric lamp is far better as a source of heat than of light. Indeed, electric lamps have been successfully employed for electric heaters.

Nor is this disproportion between the percentage of the non-luminous and luminous heat limited to incandescent electric lamps. Nearly all other sources of artificial illumination are equally deficient in this respect. Indeed, most luminous sources show even a greater disproportion as can be seen from the following figures. The Welsbach incandescent-mantle gas-lamp, a lamp that is far more economical than the light of the ordinary gas burner so far as the amount of light it produces, but which possesses the disadvantage of producing ghastly effects in interior illumination from the absence of the red rays and the presence of a large percentage of green rays, produces  $2\frac{1}{2}$  per cent of light and  $97\frac{1}{2}$  per cent of heat, while a common candle flame yields but  $1\frac{1}{2}$  per cent of light and  $98\frac{1}{2}$  per cent of heat. The light of the magnesium lamp produced by burning a ribbon of metallic

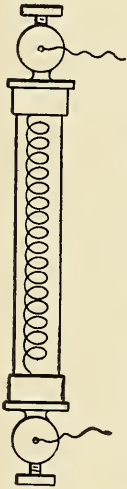

FIG. 166  
DE LA RUE'S  
LAMP



magnesium, produces 12 per cent of luminous rays and 88 per cent of heat rays. The ordinary carbon arc lamp possesses a somewhat greater economy, but even it yields only 13 per cent of light rays to 87 per cent of heat rays.

In strong contrast with the above is the light emitted by the glow-worm or the fire-fly. This is essentially a cold light as distinguished from the above sources which produce what might be called a hot light, since the light emitted by these animals consists of probably 98 per cent or 99 per cent of light and two per cent or one per cent of heat rays.

In order to increase the percentage of the luminous rays emitted by any heated conductor, it is only necessary to raise the conductor to a higher temperature. Generally speaking, there is no difficulty in raising the temperature of an incandescent carbon thread or filament and thus increasing the percentage of its useful light-producing energy. To do this it is only necessary to increase the electromotive force or electric pressure applied to the lamp terminals. But when this is done the life of the filament is thereby greatly shortened. Indeed, it is possible to pass a sufficiently powerful current through the filament instantly to destroy it by the resulting high temperature. There is then a practical limit beyond which the light-emitting power of a carbon filament cannot be carried.

A comparatively small increase in the temperature of an incandescent filament is attended by a marked increase in the amount of light it gives off. The temperature at which the ordinary incandescent filament is employed is about  $1345^{\circ}$  C. ( $2453^{\circ}$  F.). If this temperature is increased a few degrees only, the candle-power, or the quantity of light the filament emits, will be materially increased. But even this slight increase results in the gradual disintegration of the carbon in the filament, and, consequently, in a decrease in its light. It has been shown that an increase of but  $2^{\circ}$  C. is accompanied by an increase of 3 per cent of light emitted.

Were it possible safely to double the temperature of an incandescent filament, the amount of light it would be capable of giving off would probably be something in the neighborhood of 64 times what it originally emitted. It will be understood, therefore, how valuable the discovery would be of some substance that could safely be employed

as an incandescent filament at a higher temperature than that at which the carbon filament is ordinarily employed. As will be shown in the next two chapters this has been done in the case of the tantalum, tungsten, and osmium lamps as well as with the Nernst and the Cooper-Hewitt lamps, with the most satisfactory results.

The substance almost universally employed for the filament or light-emitting part of the incandescent electric lamp up to within the past few years was carbon. Carbon possesses a number of properties that eminently fit it for this character of work. It can readily be obtained in a nearly pure condition; can be prepared in threads or strips of uniform diameter; can be readily rendered electrically homogeneous throughout all parts of its length; can be given a surface eminently qualified to emit or throw out light; and, most important of all, is exceedingly refractory, since it can be heated to a very high temperature without disintegrating or breaking up. Generally speaking, however, this lamp can be made to possess an efficiency of from 3.1 to 3.5 watts per candle with a life of about 800 hours.

The general principles of operation of the incandescent electric lamp having now been described, it remains to show how lamps are actually constructed in practice. Since, when exposed to the air, incandescent carbon rapidly unites with the oxygen, it is evident that it would be impracticable to attempt to use incandescent carbon filaments when exposed to the air, as such filaments would rapidly be destroyed by combustion. It is necessary, therefore, to place them inside a transparent globe or chamber.

It was at one time believed that it was not necessary to exclude all gases or air from the lamp chamber or globe; that if the oxygen only were removed, the presence of nitrogen or carbonic acid gas would be harmless. Indeed, at one time incandescent lamps were constructed in which the globes were purposely filled with nitrogen gas. Such lamps, however, were soon found to possess smaller efficiency than the lamps provided with vacuum globes since the convection currents set up in the lamp chamber lowered the temperature of the glowing filament by the rapid extraction of heat.

But a more serious objection soon manifested itself in the employment of an atmosphere of inert gas within the lamp chamber. A rapid disintegration or breaking down of

the filament resulted from the dashing of the gaseous molecules against the glowing carbon. This process, known as air-washing, resulted in the mechanical disintegration of the filament and consequently a decrease in the length of its life.

It was not long before it was found that a lamp chamber filled with carbonic acid gas was also impractical. While carbonic acid gas is incapable of combining directly with any more carbon and would not therefore be injured, yet it was able to give up some of its oxygen to the glowing carbon, thus being converted into carbon monoxide and liberating oxygen. It is, therefore, the universal practice of the present day to place the incandescent carbon filament inside a lamp globe or chamber in which a vacuum is maintained as nearly perfect as practicable.

The early forms of incandescent electric lamps employed rods of carbon, cut or fashioned from the hard carbon deposited inside the retorts in which illuminating gas is produced by the destructive distillation of coal. The impracticability of obtaining such rods in sufficient length and thinness led to the employment of other kinds of carbon.

In Edison's early form of incandescent electric lamp, the carbon filaments, were formed by cutting a horseshoe-shaped piece from a sheet of cardboard or other stiff paper and then subjecting it to a carbonizing process by prolonged heating while out of contact with air. By means of carbon filaments so prepared he produced the incandescent lamps that when first exhibited created such excitement all over the world, and resulted in the unwarranted and therefore but temporary depreciation of the selling price of gas stocks.

Another thing necessary in the construction of an incandescent lamp is to provide a suitable support inside the lamp chamber for the incandescing filament, as well as means for passing the current into and out of the chamber. These supports must be of such a character as will make it possible to maintain a high vacuum in the chamber. The leading-in wires, i. e., the wires by which the current enters and leaves the lamp chamber must not, by expansion, crack or break the portions of the glass chamber through which they pass.

It is evident that the dimensions of the leading-in wires must be such that they will

not be sensibly increased in temperature by the current. Moreover, they must consist of some fairly good conducting material whose rate of expansion, under an increase of temperature, does not differ greatly from that of the walls of the glass chamber through which they pass.

Of all the materials that have been employed for leading-in wires, platinum has been found the best, since the rate at which it expands by increase of temperature is practically the same as that of glass.

Various forms of glass supports are employed for the carbon filaments. In the form shown in Fig. 167, the leading-in wires are fused to the glass support shown

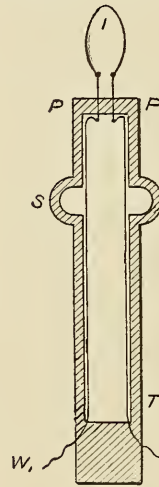

FIG. 167  
GLASS SUP-  
PORT FOR  
FILAMENTS

by melting the glass around them. As will be seen, this support consists of a small piece of glass tubing (T) with a shoulder blown on it at (S). The two platinum wires (PP) are placed inside the tube, which is then fused around it by the flame of a blowpipe. In order to decrease the expense of manufacture, platinum wire is only employed at the places where it is sealed into the glass of the support, the remainder of the wire for by far the greater part of its length consists of pieces of copper wire ( $W_1$   $W_2$ ).

It is especially necessary to provide good electrical joints, where the incandescent filament joins the leading-in wires. Various plans have been employed to provide such a joint. Probably the simplest and best consists in joints formed by a paste of a carbonaceous material that is afterwards hardened by baking.

The filament so mounted is then placed inside a suitable glass chamber or lamp globe, such as shown in Fig. 168. This globe is first provided with a glass tube (A T), as shown in Fig. 169, and a suitably shaped shoulder formed on it. The opening at the neck thus formed is of such a size that when a mounted filament is introduced as shown in Fig. 170, the shoulder comes so nearly in contact with the

narrow part of the neck at (G) that an airtight joint can be formed by fusing the glass of the support and that of the lamp chamber together.

Matters being thus arranged it is now necessary thoroughly to exhaust the lamp chamber. The pumps employed for this purpose are capable of producing a nearly



FIG. 168



FIG. 169



FIG. 170

#### STEPS IN THE PROCESS OF LAMP MAKING

complete vacuum. In most cases the greater portion of the air is first removed by the action of a mechanical pump with automatically operated valves, and the rest of the exhaustion obtained by any good form of mercury pump. When the required vacuum is reached the lamp is removed from the pump by a blowpipe flame applied at the constriction (A) in the tube (T), so as to separate it by fusion.

No little trouble was experienced in the early days of manufacture of the incandescent electric lamp from the difficulty of maintaining the necessary vacuum. No matter how carefully the lamp chamber had been sealed, air would somehow or other leak into the chamber so that the length of life of the lamp was too small to permit it to be used in practice. This leakage was at first attributed to air entering at the points of the lamp chamber through which the leading-in wires passed; for, it would seem that this was the only place where air could possibly get into the chamber. When it was found that the difficulty was not situated at these places, it was suggested that the leakage was probably due to the platinum wire, taking in or occluding gas which passed through the spaces between the molecules and so found entrance into the chamber. Happily, however, the problem was soon solved, so that the vacuum of an incandes-

cent lamp bulb can now be made so high that lamps are now made that may have a life in excess of 800 hours.

If, as was done in the early history of the manufacture, the lamp bulb with its mounted filaments was removed from the pump by fusion of the glass at (A) while the lamp filament and chamber were cold, the vacuum would necessarily be rapidly destroyed by the air that had been occluded or shut up between the pores of the carbon filament, or had adhered in the shape of a thin film of liquefied gas to the walls of the lamp globe or chamber. The force with which the occluded air clings to the solid surfaces would be so great that it would not pass out of the lamp chamber, during the operation of pumping, along with the free air, and would, therefore, remain in the bulb and filament

after the lamp was sealed off and removed from the pump. Under these circumstances, as soon as the current was sent through the filament, thereby heating both the filament and the lamp chamber, the gas was driven off, greatly vitiating the vacuum, and soon resulting in the destruction of the filament.

The cause of the difficulty having been discovered, its remedy was evident. As soon as the lamp globe has all the air it originally contained drawn out by the pump except that occluded by the filament or adhering to the walls of the chamber, an electric current is passed through the filament the strength of which is somewhat in excess of that required to maintain the lamp in constant operation. If, while this is being done, the pumps are kept in constant operation, the air thus liberated is carried out of the chamber, so that when the lamp chamber is sealed, a permanently high vacuum is assured.

There is a requirement of the carbon filament of the incandescent electric lamp that has not yet been alluded to. The filament must not only have a much higher resistance than other portions of the lamp circuit, but it must also possess a comparatively small mass together with a fairly extended surface; for, it is from the surface of the glowing filament that the light is emitted. The

double requirement of a fairly extended length of glowing conductor, and a small mass, can only be met by making the glowing conductor of comparatively small diameter; that is, of giving it the form of a thread or filament.

But the requirements of the carbon filament do not stop here. Not only must it possess a fairly high resistance but this resistance must be the same for any small portion throughout its entire length. If the resistivity of the carbon, that is, its electric resistance per unit of mass, varies in different parts, or if the carbon filament is thicker in some places than others, its electric resistance at different portions of its length will vary. Consequently, when the electric current passes through it, only those parts of the filament that possess the relatively highest resistance will begin to glow or emit light, so that the filament will possess a disagreeable spotted appearance.

If, in order to avoid unequal brightness of the glowing filament, the strength of the current be increased, the portions of next highest resistance will begin to glow until finally, when a sufficiently strong current strength has been reached, the filament will glow uniformly throughout its entire length. But such a filament must necessarily be short lived. If the current strength is such as to produce good luminous effects in the parts of lowest resistance, it will be too great for those of high resistance. The life of the filament would therefore be necessarily short.

By the use of an ingenious process known as the flashing process, spotted filaments can be readily rendered electrically homogeneous throughout. Before mounted in the lamp globe, each filament is placed in a carbonaceous liquid or vapor and an electric current, the strength of which is gradually increasing, sent through it. By this means the points of highest resistance of the filament are first raised to incandescence. These points receive a coating of electrically deposited carbon due to the decomposition of the carbonaceous liquid or vapor and thereby have their electric resistance lowered. The current is then increased, so that the next highest resistance portions of the filament begin to glow, and these in turn have carbon deposited on them. The consequence is that if the current is properly increased in strength, in a very short time all parts of the filament are thus automatically brought

to the same resistance per unit of length and the filament glows uniformly.

Improvements in the manufacture of a variety of carbon filaments known as squirted filaments have rendered it possible to make them of a small diameter and of fairly considerable length so electrically uniform throughout that the flashing process can be dispensed with.

(To be Continued.)

## New Type of Transmission Tower

An entirely new idea in the support of high voltage line wires, is shown in the cut, the idea being not to bring the tension of the line on any one of the supports but rather to support the weight of the conductors on each one of the steel transmission towers. It will be noticed that this type of transmission tower differs widely from any of

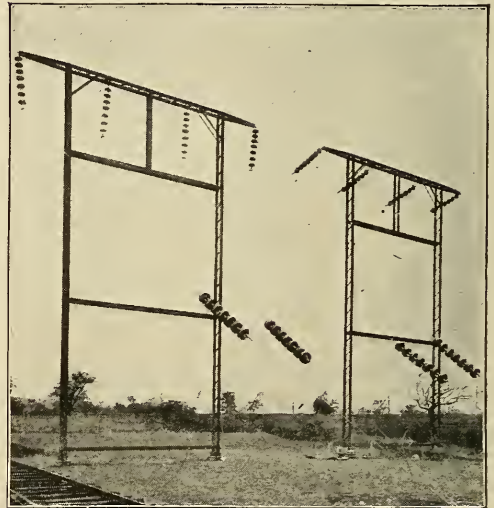

TRANSMISSION TOWER

the steel towers used at the present time, in that the supporting insulator chains allow a considerable amount of freedom to the swinging of the wires and at the same time act as a very reliable support. No transmission towers of this type have been put in actual use as yet and the photographs shown were taken of the experimental line which was erected by the General Electric Company on their farm at Schenectady for experimental purposes. The insulators are novel, being composed of alternate concave disks of porcelain and galvanized links.

# The Light and Power of Brooklyn

By W. W. FREEMAN, Vice-President and General Manager of the Edison Electric Illuminating Company of Brooklyn

Less than a quarter of a century ago ground was broken in Pearl Street for the first electric light plant in Brooklyn. This was in 1889. Imagine a little plant consisting of two, 250 horse-power engines belted to two of the old Edison dynamos each with its pair of grotesquely tall fields—this was the start. As "charter" consumers there were a theatre, a barber shop and an ice cream parlor.

Coming forward to the present we find

Four months after the original station commenced operation the company had connected to its system the equivalent of 6600 16-candle power lamps, and there was great enthusiasm at the progress made. But measured by the standards of the present this was insignificant. Only a short time ago the Sales Department called my attention to the fact that the new business signed during a recent month exceeded the aggregate business connected to the system of

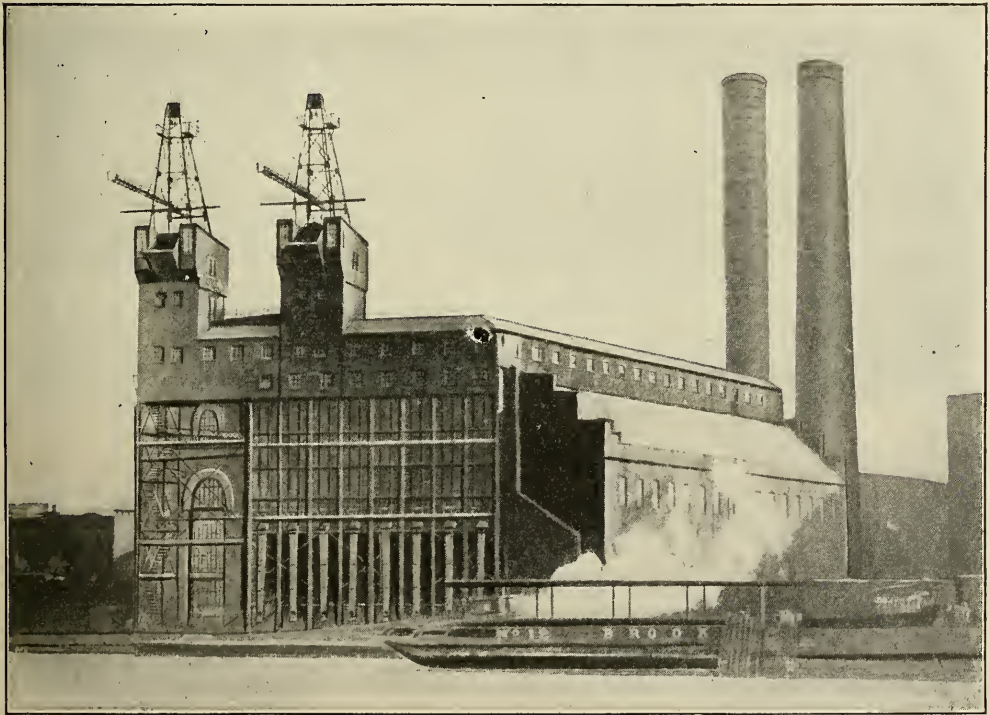

GOLD STREET POWER HOUSE OF THE EDISON ILLUMINATING COMPANY OF BROOKLYN

that the largest power house of the company is equipped with the latest type of steam-turbine driven dynamos, turbo-generators as they are called, each one of which has a capacity of fifty times that of the original engines.

In the beginning the capital invested was \$500,000. Today it is \$25,000,000.

the company at the close of its first four years of operation.

These comparisons may serve to illustrate to some extent the rapid development of the business, and it is my opinion that this development, notwithstanding its rapidity, is but prophetic of an even more rapid and successful development to come.

The Borough of Brooklyn has an area of 77 square miles with a present population of 1,500,000 and room for several millions more. The Borough is certain to become the controlling Borough of the Greater New York through its voting power.

The electric franchises of the company are

The property of all of the above companies, excepting the Kings County Electric Light & Power Company, is owned by the Edison Company, the capital stock of which is in turn owned by the Kings County Company, and, through lease agreement, the net profits from the operation of the combined systems

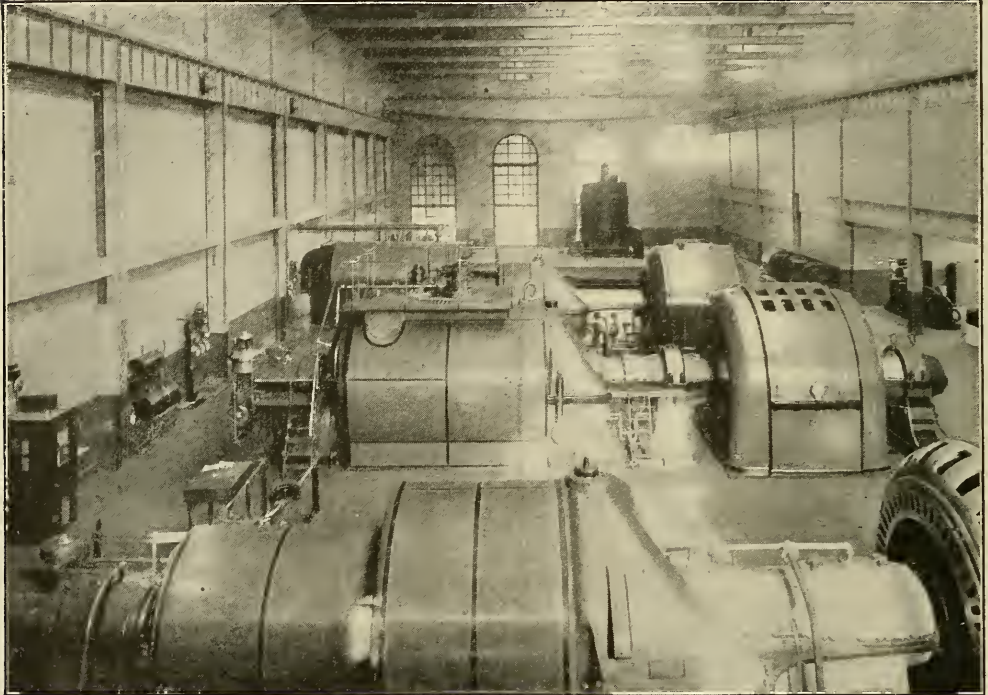

STEAM TURBO-GENERATORS IN THE GOLD STREET POWER HOUSE

all perpetual and cover the entire Borough. There are no other electric franchises in existence, except one that is confined to a single ward, namely, Flatbush, and which is owned by the Brooklyn Union Gas Company. Under the present charter of New York future franchises must be limited to twenty-five-year terms.

To those who care to understand the financial phases of the subject the following will be of interest. The system now operated by the Edison Electric Illuminating Company of Brooklyn is a combination of systems of the Citizens' Electric Illuminating Company of Brooklyn, Municipal Electric Light Company of Brooklyn, Amsterdam Electric Light, Heat & Power Company, the Bergen Beach Light & Power Company and the Kings County Electric Light & Power Company.

are paid to the Kings County Company, which is the financing company, whose securities are held by the public.

The outstanding securities are as follows:

\$10,000,000	Kings County Capital stock.
2,500,000	Kings County first mortgage 5 per cent Gold bonds, due 1937
5,176,000	Kings County 6 per cent gold bonds due 1997, additionally secured by purchase money mortgage on Edison stock, and interest payments secured by \$1,000,000, guarantee fund deposited with trustee.
2,500,000	Kings County 6 per cent convertible debenture bonds, due 1922, and convertible into stock at par after 1913
4,275,000	Edison first mortgage 4 per cent bonds due 1939; issue limited to \$10,000,000.

---

\$24,451,000

The merit of these securities is evident to any one who will examine the company's record.

The Edison 4 per cent bonds are secured by first mortgage on the plant and property costing and worth four times the bond issue, and the earnings for 1909 applicable to the bonds were more than eleven times the interest.

The Kings County 5 per cent bonds are secured by first mortgage on the plant and property costing and worth several times the bond issue, and the earnings for 1909 were more than thirteen times the interest.

The Kings County 6 per cent bonds are also more than adequately secured, and the earnings for 1909, after payment of prior bond interest, were more than five times the interest.

The convertible debenture bonds paying 6 per cent interest and the capital stock, paying 8 per cent dividends, represent real money put into plant and property, without capitalization of franchises or earning power.

The present organization of the company has been built up with extreme care, and is composed of men who have grown up in the business, or have been selected because of special qualifications for specific work. The officers and the departmental heads are organized into a staff council, which meets at luncheon one day of each week, at which meeting matters of general interest are discussed and inter-departmental affairs determined. There are sixteen members of the staff council.

The Sales Department of the company is thoroughly organized and aggressively conducted. At the present time 68 men are employed in getting business.

Perhaps nothing shows more plainly the rapid advance in the use of electricity than a record, year by year, of the connected load of the light and power company in almost any city where aggressive methods have been pursued. The following table is the record of the Brooklyn Edison company from 1890 to 1910, everything, power and light, being reduced to the equivalent of 50 watt units, or in other words to a unit represented by the ordinary 16 candle-power, carbon-filament lamp.

*Connected to System in Equivalent to 50  
Watt Units*

January 1st 1890	6,060
" " 1891	25,170
" " 1892	41,379
" " 1893	75,450
" " 1894	100,533
" " 1895	128,189
" " 1896	154,523
" " 1897	199,052
" " 1898	227,095
" " 1899	267,193
" " 1900	310,943
" " 1901	376,243
" " 1902	465,041
" " 1903	537,352
" " 1904	637,083
" " 1905	808,189
" " 1906	932,715
" " 1907	1,167,595
" " 1908	1,345,233
" " 1909	1,546,498
" " 1910	1,772,357

Glancing down this row of figures you will see a constantly and rapidly rising trend. Where will it end? I venture to say that in Brooklyn—in any large city—the end will not come until electricity produced at large central power plants will meet every requirement for light and power and heat of that city.

## The Meditations of a Science Man

How doth the busy little volt  
Improve each shining hour?  
He travels on the D. C. line  
And gives the people power.

And when he meets the little ohm,  
It standing in his way,  
He sends an ampere in his place  
And stays and wins the day.

And when he's done his daily task  
And made the motor go,  
Like chickens home to roost he hikes,  
Back to the dynamo.

Or perhaps he takes the A. C. line,  
Because he thinks it pays,  
And takes his family along  
And then we have a phase.

And if they meet along the line  
A henry or a farad,  
They'll treat him as they did the ohm,  
For which we should be glad.

For if the busy little volt  
Did not work both day and night  
Where would we get our kilowatts  
And our electric light?

# Current From—Where?

BY EDGAR FRANKLIN

## CHAPTER III

### ACCIDENTS

The entire platform of the Bronton railway station was a decidedly lengthy affair.

Wholly level with the road-bed at the station end, matters were radically different down by the distant freight shed. Here, with the track side at loading height above the rails, the off side of the platform presented a good ten-foot drop to jagged rocks.

Half way down the platform, Race waited in the sunshine as Dunbar hurried toward him from the station.

"It's our stuff all right," announced the latter, as Race fell into quick step beside him. "The actual generators are here anyway."

"All that pile?" Race squinted at the heavy crates and cases at the far end.

Two big generators there, son, when they're assembled," Dunbar chuckled excitedly, as he trotted forward.

Race followed more slowly. The things *were* there—that was the main consideration. One item at least was off his mind; now he could concentrate on the coal question and start a new bombardment of the railroad, as concerned their wandering engines.

Yes, their luck had turned. Race felt it, as his optimism began to surge back. This was the first really encouraging event since the arrival of their boilers—it was an omen of better things to come. The outrageous coal letter of a week ago remained unanswered; maybe the Stelton people were repenting now. And as for the engines—why, they might turn up at any minute and—

"Bob!"

Race, startled out of his pleasant reverie, all but jumped to his partner's side.

"Wnat in thunder's this?" that gentleman demanded forcefully. "One whole armature's missing here!"

"Missing?" queried Race.

"Yes! Core—shaft—commutator—everything! They—"

He stopped short. Race was at the rear end of the platform and just now, staring downward with open mouth, he was not

listening. Hastily, Dunbar followed his gaze.

And with a wild little cry he ran to the end of the platform, jumped to the ground and went clambering down the shallow gully behind. Race, following, was at his side a moment later, swearing fervidly.

Here, there and everywhere, torn, splintered and broken, were bits of thick board. In the center, tilting on the edge of a rock, rested a big, wheel-like, oily complication of windings and loose wire ends, of steel and copper—wrecked!

"Is that—*it!*?" Race choked at last.

"Yes! Look!" Dunbar squatted beside it and almost wept. "Look at that shaft! It's bent at both ends and all strained out of shape in the middle and—look at that commutator! It's smashed to bits! And see this winding—it's bruised in a full inch! The wire's cut in a dozen places!"

"It hit that rock—right there—and smashed it!" Race snarled. "And—psst!"

Together, they looked up. Overhead, at the edge of the platform, stood Baker, freight agent, stupid of countenance and sluggish of movement.

"Say! Ain't that a darned shame!" he demanded.

For the moment, Race's vocabulary failed him.

"I left her jest as she was, fer you to see—so's you couldn't blame it on me," pursued Mr. Baker. "They come in late last night and I had ter git 'em unloaded—had t' send the car back on the early freight. Some o' the boys must 'a' left her too near the edge—an' she jest toppled over sometime during the night."

"Which one of the boys, and how the devil could she topple over?" the president demanded in a roar, as he gripped the trestle under the platform and climbed straight up, eyes blazing.

Baker backed away.

"It—it must 'a' been some o' the train crew," he protested. "They slept in the station last night—I couldn't stay there all



night—they got the stuff off early this morning, before I came.”

“That’s all a string of lies!” thundered Race, as his partner, less excited, sadder of expression, reached his side.

“That ain’t no lie,” said the freight man, as he continued a highly judicious backward course toward shelter. “I tell ye——”

“And I tell you that the responsibility is right on *you!* I know you’re an ass, Baker, but there’s more in this than plain imbecility. Who knocked that thing over the edge?”

“Now, lookahere! I—tell yer I found it like that,” sputtered the agent. “Maybe you kin claim damages, but you gotter claim ’em from the railroad. I gotter put in my report, that’s all. I ain’t got no responsibility. I ain’t got no re——”

“You haven’t, eh?” shouted Race. “Well, by the time I’ve kicked the truth out of you, you’ll find how much——”

He darted toward Baker—and Dunbar caught him as Mr. Baker’s steps pattered down the platform at something like twenty patters per second.

“It’s done now, Bob. If killing that little cur would do any good, I’d advocate it, but it won’t. The thing’s hopeless——”

Mr. Race pulled himself together. For a moment his teeth gritted; then he said:

“No way of fixing it up here?”

“We have no facilities in town yet. We——”

“All right!” Race interrupted again. “You go over to our hoodoo powerhouse, nestling there in the pretty pines. Tell ’em to get that mess together and ship it straight back to the builders. You can walk back to the office,” he added, as he stepped into the dusty machine. “I’m in a hurry.”

“What are you going to do?”

“Write to the manufacturers, order a new armature and stick a special delivery stamp on the letter,” responded the president, as the little car departed with its customary suddenness.

It was at no particularly brisk rate that he returned to the “Bronton Electric Light & Power Company” sign, however; and his low speed was just as well, for Race happened to be staring at the vibrating bonnet and not at the landscape ahead; dogs, humans and other movable things had time to dodge as he pondered.

This last calamity dispelled whatever lingering notion he might have of blaming their series of misfortunes upon mere coin-

cidence. The wanderings of the engines might be well enough laid to error; it was possible, at least, for an isolated building to catch fire three successive times without crime having been committed: but the price of coal looked daily more and more like a hold-up with a definite purpose behind, and this thing of having an entire armature inadvertently step backward of its own accord and commit suicide on the rocks was too great a strain on credulity.

Mr. Race decided as he stopped before the office that he would write one letter instead of two, and if the second didn’t result in damages and the removal of Mr. Baker’s official scalp, it would be because the gentle art of flavoring his ink with sulphuric acid had suddenly left Race.

Carey was at his desk when the president entered; and, curiously, Mr. Bowers stood there, too, apparently on the verge of leaving. He saluted Race with a nod and a grin that, to the latter’s irritated nerves, held a queer quality of tolerant pity.

“Just been chatting with the treasurer of the company,” he observed, indicating Mr. Carey with his thumb.

“I didn’t suppose you were boxing with him,” said Mr. Race, briefly, as he took his seat.

Bowers stared for a second and chuckled.

“Sore over your busted machinery, hey?” he asked.

“What the dickens do *you* know about that?” came from Race as he faced about.

“Why—I heard about it. That’s all.”

“How? You haven’t been near the station, because it’s early morning still and you’ve got a spotless new shine and there’s no dust around your legs—and the dirt down there’s a foot deep,” Mr. Race fired at him, surprisingly.

Mr. Bowers went into a series of guffaws. At the end, he laid an unwelcome hand on Race’s shoulder and puffed:

“It’s wonderful the way you reason out them things, Sherlock. The fact is, I sent a man down to cart up a keg o’ bolts to my place, and he said somebody’s electric motor or something was all smashed to smithereens.”

“Well, it’s not yours and you won’t worry about it, will you, Bowers?” snapped Race.

The brilliantly-clad man chuckled again; he dragged a chair beside the desk and, seating himself heavily, he faced Race with a look of hearty, honest pity in his eyes

"Don't get mad, boy," he said, quietly. "Them things'll happen t' beat the devil, sometimes. This is one o' the cases—that's all. You got to give up now, hey?"

"You stay up late on the last night in June and watch us giving up," replied the president, viciously.

Bowers' smile was very tolerant.

"That's all right, boy, but you know, down in your heart, that your whole blamed plant's down and out now. That's what brought me over when I heard the bad news."

"What?"

"Yes!" Bowers leaned forward earnestly. "I've watched you two young fellers. I know you've sunk your last cent in this; I know what you're up against and I know the way you feel about it—sorer'n blazes." He took the cigar from his mouth. "Now, I'm darned sorry for both o' you. I went up against it twenty years ago, and there was nobody to be sorry for me. Therefore, while I ain't no multimillionaire, *I'm ready to buy out this whole joint* cheap—and you'll save something instead o' nothing."

"Buy us?" came from between Race's teeth, when breath returned.

"For cash, to hold on to against the day when conditions are fitter."

"How much cash?"

"I should say, about fifteen thousand dollars," said Bowers calmly.

"Including the charter?" said Race, out of the fog of emotions that seemed to have enveloped his brain.

"I wouldn't give three cents for your charter. You can have it."

"But you *would* be willing to pay fifteen thousand for everything we have and expect—boilers, engines, generators, transformers, exciters, switchboard, lines, poles, lamps—everything else?"

"That's the idea."

Race drew a long, quivering breath.

"Bowers," he said, with a mighty effort at self-control, "I will assume that you don't know what you're talking about—because if I assumed anything else I'd pitch you out that window if I broke my neck doing it!" He swallowed hard.

"I'll say right here that the best piece of advice this firm can give you, is to get an estimate on what it costs to trim up a town of over five thousand people with electricity even on the small scale we're using for a starter. If it's ignorance, it's putting you in

line for a coroner's verdict of deliberate suicide."

"It's 'way below cost—but it's more'n you'll get in July. My idea's to call that investment dead money till the time comes to start up and make real money. *You* can't swing it."

"Pardon me, Mr. Bowers, but you're not quite certain of that!" Carey broke in abruptly.

Bowers eyed him with an insolent smile.

"You're Bronton's rich man, but you're no wizard. You couldn't have no plant running on time now—you wouldn't start her on a sure dead loss, anyway. If you were that kind o' guy, you wouldn't be rich now." He turned to Race. "Well, does it go?"

"Get out of here," snarled the president.

Mr. Bowers laughed shortly as he strolled to the door and opened it.

"Race, I'd hate to call you a——" he began.

"You'd hate it a lot worse after you'd done it!" yelled the president as he gripped the arms of his chair and glared wildly at the caller.

The door closed. Race, with a jerk, brought up the typewriter and hammered hard for some minutes. With a swish, two sheets were signed and folded and addressed. And with hard-set jaws, the president arose quickly and snatched his hat.

"I'm going to mail these and telephone to Wilkes, the freight agent at Kane Junction, and see if those engines are in sight," he said abruptly.

"Why not telephone now?"

"Because I'm going over to use the 'phone in Carroll's drug-store," said Race, excitedly. "I'm getting superstitious about this whole business. I don't want the call to come from here. It's beginning to seem as if everyone in town knew more about our affairs than we do—I don't know why."

"Robert, do you know, I'm beginning to have that same sensation," exclaimed Carey, with some amazement in his eyes.

He stared after the younger man, as the latter hurried out and turned toward the post-office.

A minute or two later, Mr. Race brushed by a heavily-built man in the doorway of Carroll's store; and in the mood of the moment, he was tempted to deliver a brief talk on the comparative space occupied by door and by fat people, when:

"Don't get hot, boy. You think it over," said Mr. Bowers, as he stepped to the street, and strolled away, puffing calmly.

Race's teeth bared as he looked after him, and his fists clenched. And then, with commendable self-control, he relaxed and stepped into the telephone booth and called for Kane Junction and the freight office. That call usually meant a long wait, and, receiver still at his ear, the president of the electric company was about to make a final request for speed, when faintly over the line came:

"Yes. This is Kane Junction. What'd you cut me off for?" And then, loudly: "Hello, Bowers!"

Race's breath fairly exploded into the transmitter. Then:

"What'n blazes you doin'?" reached him "Is that you, Bowers?"

"Yes." Race contrived, with admirable gruffness.

"What? This is Wilkes."

For the second time, Race all but tottered from his little stool.

"They cut me off," pursued the slightly familiar voice of the freight agent. "Say! What I wanted t' ask you, Bowers. Did they put them electric motor things on the blink?"

"Knocked 'em to smithereens," Race risked, in a gruff imitation of Bowers that was heightened by the sudden dryness in his own throat.

"All t' the good," responded the freight agent, happily. "Well—don't you worry none. Them engines don't stand no more chance o' getting there alive than——"

The circuit was broken again, and the wire merely buzzed.

But it was all, all sufficient. Race rose like a man in a trance and walked straight across to the office.

Certainly, if luck had deserted him in every other direction, Fate this time had handed him the very quintessence of explanation, in a very neat, compact and unexpected package.

He looked up and down the street for Bowers. That gentleman was laughing heartily as he chatted with the cigar man a block below—and for the moment the president was tempted to rush at him and denounce him publicly.

And sense returning in a second or two he laid his hand on the knob and entered his own domain.

## CHAPTER IV

### AN EVENING CALL

Dunbar, rather dusty, had just arrived. "She's shipped," he said, tersely.

"What?"

"To be more exact, I set three of our men to crating her. She'll be ready to pull out of the gully and put on the eleven o'clock train. Then I left money to prepay the thing by express. It cost like fury, but it was worth it—getting Merrivale's straight express receipt."

"Hum!"

Mr. Race settled down in his chair.

"It may have been worth it. I don't know."

"Why?"

"Because I have had positive assurance from the railroad company that when our engines do get here, they'll be smashed."

"*What?*"

Briefly, Race related his telephone experience. Alike agape, Carey and Dunbar stared at him; and at the end they looked at one another for a moment and then back at Race.

"Are you sure the man said *Bowers?*"

"Bill, have you ever seen me answering advertisements for patent eardrums?" the president demanded.

"But it seems——" Mr. Carey hazarded.

"It isn't what it seems—it's what it *is*," said Race. "That was Wilkes' voice and Bowers must just have left the telephone. Bowers is at the bottom of all our troubles!"

There followed a silent minute or two.

"Bowers has always seemed really friendly," Dunbar murmured.

"Bowers is a good actor."

"And frankly, I should say, too, that Bowers, despite his roughness, has always appeared honest and pleasant enough, until this morning," contributed Carey. "There was too much assurance in him when he made that offer."

Race scowled at them.

"Gentlemen," he said, "I'll admit that, up to this morning, I, too, took Bowers at his face value—kind of a bore, but a reasonably decent citizen with some money, starting in business in a growing town that's going to be a big city some day. Now I know otherwise. Now I know that he's back of the coal proposition—back of smashing our dynamo—back of the delay in our engines——"

Carey shook his head.

"Admitting that he has a motive," he interrupted, "assuming that he has managed to convince the Stelton people that, for some reason we don't know, they will profit by the hold-up; assuming, too, that he paid Baker or someone about the depot to smash the generator, Bowers is certainly not controlling the freight manipulation of a trans-continental railroad."

Mr. Race's eyes opened wide suddenly.

"No! He's not!" he shouted. "And he doesn't have to! D'ye remember that letter six or seven weeks ago—the one from the railroad that said they'd traced the car half way from Chicago to the Junction, and that it was headed straight for the Junction and had never arrived there?"

"Yes."

"Well, Bowers slid down and corrupted Wilkes. And Wilkes sent that car kiting for the Coast—and he may have opened it before it went, and God only knows what shape our engines are in at this minute!"

"That—that might account for it," Carey muttered, as he regarded Race with narrowed eyes.

"That does account for it, and now——"

"Now, what are we going to do about it?" Dunbar asked blankly.

"Do?" yelled Mr. Race. "Arrest the whole blooming bunch. Get warrants for them all and——"

"Perhaps Keller, our lawyer——" said Carey.

"I'll go and see him." Race was on his feet in an instant. "I'll—there he goes now!" He hurried to the door and jerked it open and called.

Mr. Keller pulled up his buggy and stared.

"Come in! Come right in! It's important!"

The lawyer obeyed. And Race, hands in his pockets, eyes blazing, hurled at him without preliminary:

"See here, Mr. Keller——"

"Mr. Race, I'm in a great hurry just at the moment. Mr.——"

"He can wait. Listen. Suppose we'd discovered unexpectedly that someone in this town had managed to cut off our coal supply altogether, had bribed people right and left to smash our machinery and burn our power-house, and generally do everything to put us out of business and make us lose our charter, what's the quickest way of getting a warrant or warrants?"

"Yes. Quite so," said Keller, with his unruffled smile. "When did you make this remarkable discovery?"

"This morning?"

"How?"

"I overheard a telephone conversation that wasn't meant for me."

"Did anyone else overhear it with you?"

"Certainly not."

"Then I take it that this —er—telephone conversation merely confirms matters of which you already have proof positive?"

"We haven't proofs of any sort, but this——"

"Then if you are depending on something that you, personally and alone, heard over a wire, I should hesitate at swearing to a complaint," smiled Mr. Keller, as he stepped to the door. "Courts have a way of demanding evidence, and people one arrests have a way of getting back at the fellow who arrests them without making a case."

He stepped calmly into his buggy and gathered up the reins, while Race stood on the top step and glowered at him.

"We'll talk this over later, Mr. Race," he called. "Don't do anything hasty, for it's dangerous. Giddap, Sam!"

Whereat the buggy rattled swiftly away and Mr. Race slouched back indoors.

"I——think that was the shortest, sweetest consultation with a lawyer I ever knew," he said dazedly.

"Keller can put a good deal into a few words. He's right," sighed Carey.

"Keller could copy the Bible on a postage stamp," muttered the president.

"And the safest thing for the moment, is to sit back and smile mysteriously," added Dunbar, in bewilderment.

For a full quarter hour, Race sat staring at the ceiling. Then:

"It's Bowers, and—he's got his own motive. Eh?"

"Everything points that way."

"Then we'll find out the motive and act accordingly."

"How?"

Mr. Race grinned.

"Bill," he said, "I love to make money and fight the other fellow for it in the open and I hate this meet-me-by-the-old-mill-at-midnight business, *but——*"

"Well?"

"I have one fixed idea in mind. Why the dickens it hasn't occurred before I don't know. Probably because Bowers never

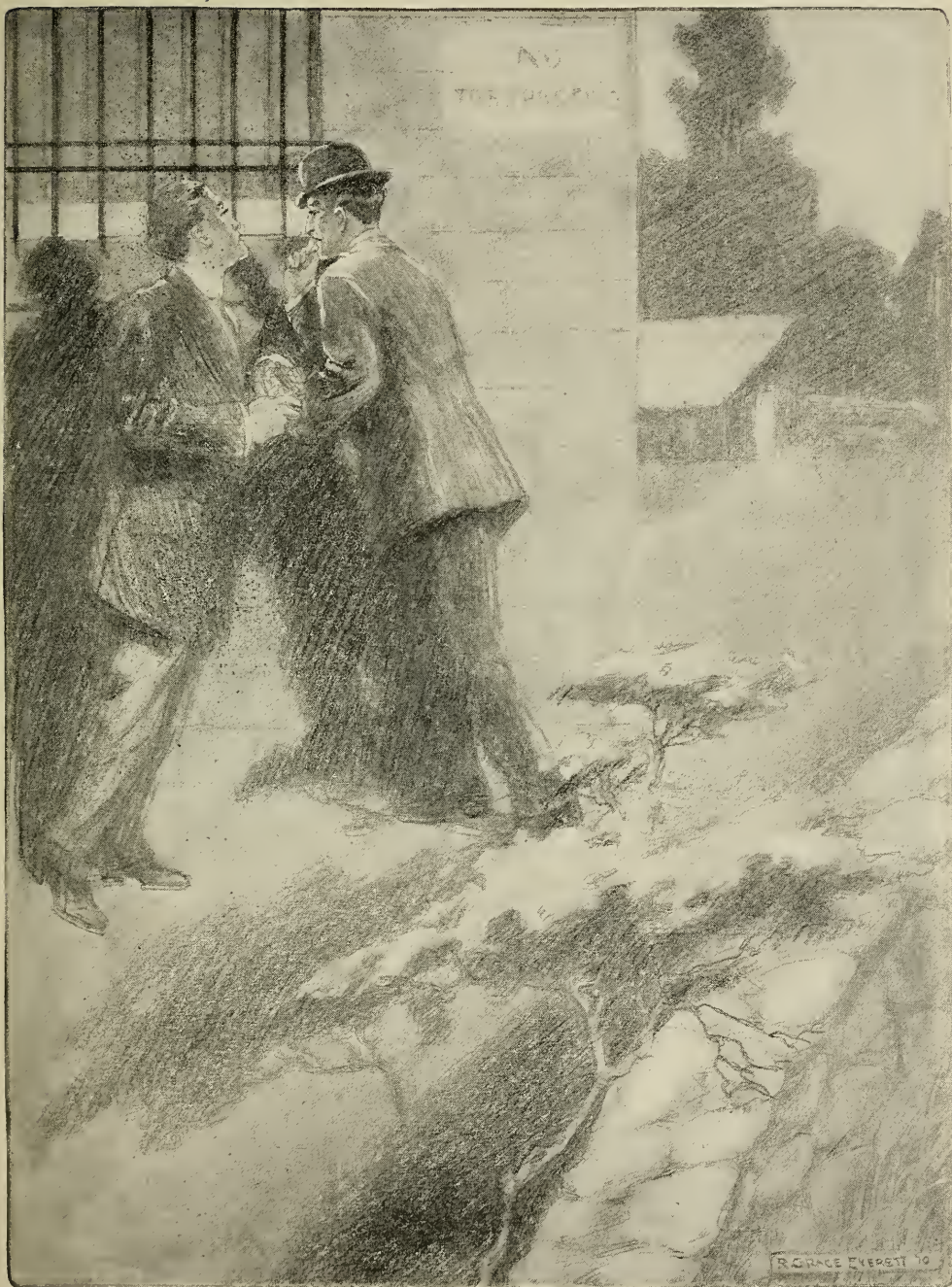

THEIR EYES FITTED TO THE CRACK THEY STARED, RIGID

laid himself open to suspicion before today." He leaned forward. "Tonight, William," he said with a faint grin, "you will eschew your early-to-bed, early-to-rise nonsense and be ready for a long walk, about half past twelve. . . . Meanwhile," he ended, "I'm going down to the depot and watch that armature go aboard, for I told 'em to fix that one if they could and send us a new one of they couldn't, inside of six minutes after it reached them. As for you," he grinned, "you get the wagon and two or three men and begin putting arc-lamps where they'll attract attention. Get up three or four and make a fuss about it. Go over to Berg's first and stick 'em in the show windows. There is nothing," concluded Mr. Race, "nothing on earth like keeping up the bluff."

It was nearing one o'clock when they started from the comforts of Carey's home and headed for the new section of Bronton.

The two pairs of long legs swung steadily. The more thickly populated part of Bronton passed to the rear. The newer, bigger suburban places, still as death itself, pitch-black save for a lone light in an upper window here and there, followed. Then even they emerged into small places, far apart—and at last the pair were hurrying along in the new section of Bronton, where "For Sale" signs were the sole tenants of newly graded lots.

Ahead, red lanterns marked the little dip in the road, through the new railway cut. They passed through swiftly, under the unfinished steel work which would be the carriage road a little later; and very cautiously indeed they struck off on a rough wagon track, hedged with thick bushes on either side.

It was an ideal night for inconspicuous traveling—clouded heavily with no moon behind the clouds, hazed with a light, murky spring mist.

Slowly now and carefully, picking their footsteps very daintily, lest a stumble should bring a cry from one of them, Race and Dunbar avoided even brushing the bushes. They struck a heavy, barbed wire gate and a silent gasp escaped them.

"We can vault it. Go easy!" Mr. Race commanded.

The wire was behind and now, rather suddenly, a big brick building was looming blackly just ahead—and Race stopped.

"Someone else walking around," he commented.

They listened long. The noise was not repeated, but Dunbar was making queer little noises of his own.

"Bob!" he breathed. "Hear that—that little, tiny humming?"

"I hear it. Come on. Crouch low, Bill."

Stealthily, they crept on and on. And Race's hand met the cold brick wall and he breathed:

"He's got all his iron shutters closed, eh? Bowers must be particular about draughts. Come around here—away from the door."

A dozen soundless paces and both men straightened up as if jerked to their feet by a single wire. They had passed half a dozen shutters, to be sure—shutters which revealed tiny lines of light around the edge; but here was a shutter open a full inch and sending forth a stream of yellow radiance. And quite as mechanically as they had risen, their eyes fitted to the crack—and they stared, rigid.

And they found good cause for rigidity in that brief inspection of Mr. Bowers' new "factory."

Their eyes fell first upon the gentleman himself, sitting in a far corner and talking to a man in overalls. Another person, similarly clad, was shuffling calmly around the big machine near the center of the room—an electric generating unit, engine, and generator directly connected, so large, so beautiful in its newness, emanating the word "P-O-W-E-R" so clearly from every line, that even Race guessed correctly at its ability to supply every fixture that stood ready for the Bronton Electric Light and Power Company.

Mr. Bowers was going to manufacture electricity. Indeed, so fond did he seem of electricity that he must use it even now—for the little gas-engine generator beside him was whizzing merrily for the sole purpose of lighting his plant.

An involuntary croak escaped Dunbar. It found almost instant echo a dozen yards away, in:

"Who's there?"

"Duck!" breathed the president.

"Answer, or I'll shoot!" the voice said very distinctly, as bushes began to crunch.

"Sneak! Bill!" hissed Race. "Wake up!"

And as they took the first step into further blackness, there came a red flash and a report—and a bullet flattened on the brick wall above them!

(To be continued).

# The New Edison Storage Battery

Years ago Thomas A. Edison set out to build a storage battery which would eliminate the serious faults of the lead type, chief of which is the great weight in proportion to the power obtainable. After making *nine thousand* experiments he thought he had it, and the original Edison battery was launched six years ago. It was a radical departure from the working principles of all former batteries. He had started fresh, forgetting everything that had been done before.

As the ordinary man would look at it the original battery was a success. It proved lighter, cheaper and cleaner. It gave more output for equal weight than any other battery. Its greater initial cost was offset by lower cost of upkeep and operation. It

did not deteriorate when left uncharged and was not injured by over charging.

They equipped 250 automobiles with this first battery, known as the E type. These batteries, some of them in operation from two to five years, proved superior to lead batteries and more economical than horses.

But Edison had other ideas. He had not reached the results he had anticipated; so he did a characteristic Edison thing. He closed the factory, scrapped the machinery, withdrew the Type E battery from the market and started out afresh after the perfect storage battery. What cared he that the Type E battery was a commercial success? It wasn't the battery to go down in history bearing his name. So after six years more of persistent toil he brought out the new Edison battery which is said to be as much better than the original as the original was

better than the lead plate type. The new battery is called the Type A. It is made in two sizes, the Type A-4 containing four plates and the Type A-6 six plates.

The active materials are oxides of nickel and of iron, respectively, in the positive and negative electrodes, the electrolyte being a solution of caustic potash in water.

The retaining cans are made of sheet steel, welded at the seams by the autogenous

method, making leakage or breakage from severe vibration impossible. The walls of the can are corrugated so as to give the greatest amount of strength with a minimum weight. The can is electroplated with nickel, and a close union of the steel and nickel is obtained by fusing



GARAGE OF THOMAS A. EDISON AT LLEWELLYN PARK, N. J.

ing them together so that they are practically one metal. This coating of nickel protects the steel from rust, and also gives to each cell an attractive and highly finished appearance.

Each cell of the A-4 type contains four positive and five negative plates.

Each positive plate consists of a grid of nickel-plated steel, holding 30 tubes filled with the active material, in two rows of fifteen each.

The tubes are made of very thin sheet steel, perforated and nickel-plated. Each tube is reinforced and protected by small ferrules, eight in number. These prevent expansion, thereby retaining perfect internal contact at all times.

The active material in the tubes is interspersed with thin layers of pure metallic nickel in the form of leaves or flakes. The

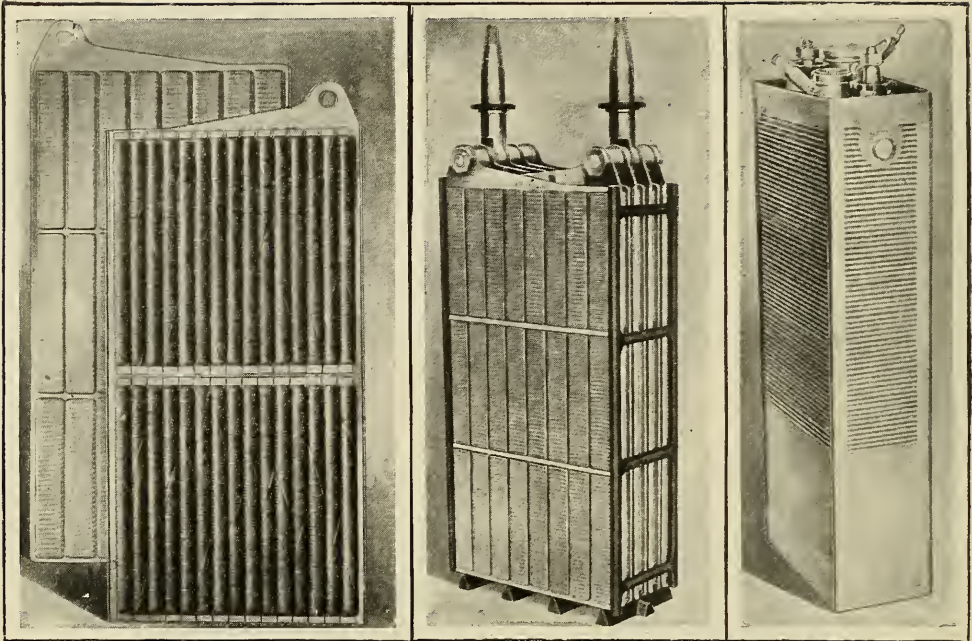

PLATES OF THE EDISON BATTERY

PLATES ASSEMBLED

CELL COMPLETE

pure nickel flake is manufactured by an electrochemical process.

Each negative plate comprises 24 flat rectangular pockets supported in three horizontal rows in a nickel-plated steel grid.

The pockets are made of thin nickel-plated steel, perforated with fine holes, each pocket being filled with an oxide of iron very similar to what is commonly called iron rust. In the negative plate each pocket is subjected to very heavy pressure, so that it becomes practically integral with the supporting grid.

In a cell the positive and negative plates are assembled alternately, the positive plates connecting with the positive pole, and the negative plates with the negative pole. They are correctly distanced on this rod by nickel-plated steel spacing-washers, and held firmly in contact by nuts screwed on both ends.

If this description has been followed closely it will be seen that in an assembled cell nickel plates are alternated with iron plates, and that the two outside plates are both iron or negative plates. The outer surfaces of the outside plates are insulated from the retaining can by hard rubber sheets. Specially designed hard rubber pieces are fixed between the can and the side and bottom edges of the plates; and these, together with hard

rubber rods inserted between the plates, maintain correct spacing of the plates at all points and insure permanent insulation.

Each cell has a cover which is welded in place by the same autogenous process used for the side and bottom seams.

On the cover are four mountings. Two of these are the stuffing boxes through which the positive and the negative poles extend.

One of the other two is the "separator," so called because it separates spray from the escaping gas while the battery is charging. This prevents loss of electrolyte and renders the gases inodorous.

The fourth mounting is an opening for filling the cell with electrolyte and for the adding of distilled water to take the place of that which evaporates. This opening has a water-tight cap which is held in place by a strong catch. Fastened to this cap is a small spring, so arranged that the cap will fly open unless properly fastened. This reduces the possibility of leaving the cap open accidentally, thereby causing the electrolyte to spill out should the cells be violently agitated by vibration of the automobile.

The electrolyte consists of a twenty-one per cent solution of caustic potash in distilled water.



In order to fill the cells and to add water conveniently a special filling apparatus was devised. It consists of a nickel-plated copper tank, rubber tube, filling nozzle and electric bell and batteries to indicate when the can has been filled to the proper level, as it is impossible to see into it. To fill a cell the nozzle is placed in the filling aperture and the valve released—the proper

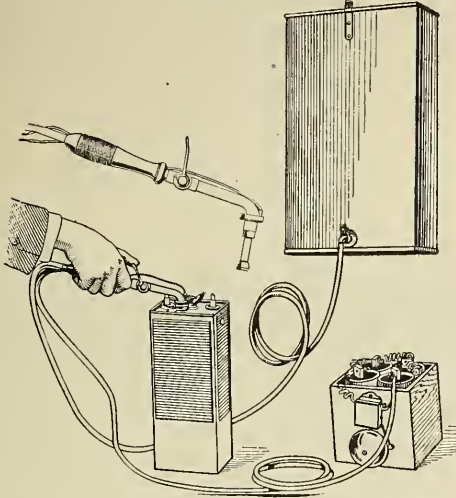

ELECTRIC FILLING APPARATUS FOR THE EDISON STORAGE BATTERY

height of solution being indicated by the ringing of the bell.

The Edison Storage Battery Company of Orange, N. J., manufacturer of the battery, has this to say concerning its advantages:

"An Edison battery weighs about half as much as a lead battery for the same output; but in addition to this it saves about fifty percent of its weight in the construction of the truck itself. That is, a truck built to carry an Edison sixty-cell battery would save not only 500 pounds in battery weight, but about 250 pounds in the weight of the truck built to carry lead cells."

### Magnetic Pull and Temperature

Experiments have been made to show that the temperature of a magnet has something to do with its power to attract and hold. By placing a magnet in alcohol Mr. Pictet found that if the unit 57 measured the pull at  $+30^{\circ}\text{C}$ , the attraction when the temperature was at  $-103^{\circ}\text{C}$  was 76, thus showing a decided increase in power at a low temperature.

### German Wireless vs. British Cable

The Germans have long been nettled at the British monopoly of ocean telegraph cables which, more than any other single factor, is held responsible for the present supremacy of Great Britain over Germany in foreign markets. With most of the cables under its control, England can obtain news of foreign market changes or of any events likely to influence the same much more quickly than Germany, and its representatives can color the cabled news in harmony with the plans of the British. This was clearly demonstrated by the effect that the opening of a direct cable between America and Germany had on the German bond markets which formerly had only received the belated information long after the English traders had been able to protect their interests.

Owing to the tremendous investment required and the poor prospects of adequate returns for lines competing with the present British cables, the laying of new cables under German control to other parts of the globe has been out of the question and Britannia has continued to rule both the seas and the world markets. Now the wireless telegraph promises a competing means of communication and Germany has already begun to erect wireless signal stations for this special purpose.

Recent tests have shown that the vessels regularly plying between Germany and its African colonies, if properly equipped, repeat messages between the two, and the various colonies are therefore to have wireless stations.

Then the financiers of Berlin hope to see the circuit extended to Japan, to offset what they consider a pernicious activity of the British in coloring the news cabled from the island of Nippon.

### To Test Current Polarity

A testing paper for finding the polarity of weak currents may be made by saturating a piece of blotting paper with potassium iodide and a little starch paste. With the paper slightly damp, place the terminals of the battery so that they are separated by the testing paper. A blue stain will appear at the anode or wire connected to the positive pole.

# The Ghost Electricians

By FRED R. FURNAS

The spirits of Watt, Coulomb, Ampere, Dr. G. S. Ohm and Alexander Volta, respectively, were strolling around Chicago, taking in the sights. At the corner of Van Buren and Dearborn streets they came suddenly upon the wraith of Ben Franklin.

Ben was gazing in hypnotic fascination at the trolley of a North State Street car. The conductor of the car was endeavoring to get the trolley wheel back on the wire and being too lazy to get off the car, was leaning from the rear vestibule and sawing the cord up and down in his efforts to replace the wheel on the wire. Naturally, he created a minia-

pectedness, caused him to start violently. In fact, in his agitation, he stepped right through a steel "elevated" post.

"Fellow," he exclaimed, "know you not even the rudiments of gentlemanly conduct? But, hold! whom have we here? Watt! Ohm! Volta! Coulomb! Verily, birds of a feather—and did I not meet you, too, at the last convention of the Scientific Souls?"

"That you did," replied Ampere, "and my jocular greeting was based on the strength of our brief acquaintance. We, too, took advantage of the centurial solar storm, enabling us to come from Mars back to Earth.

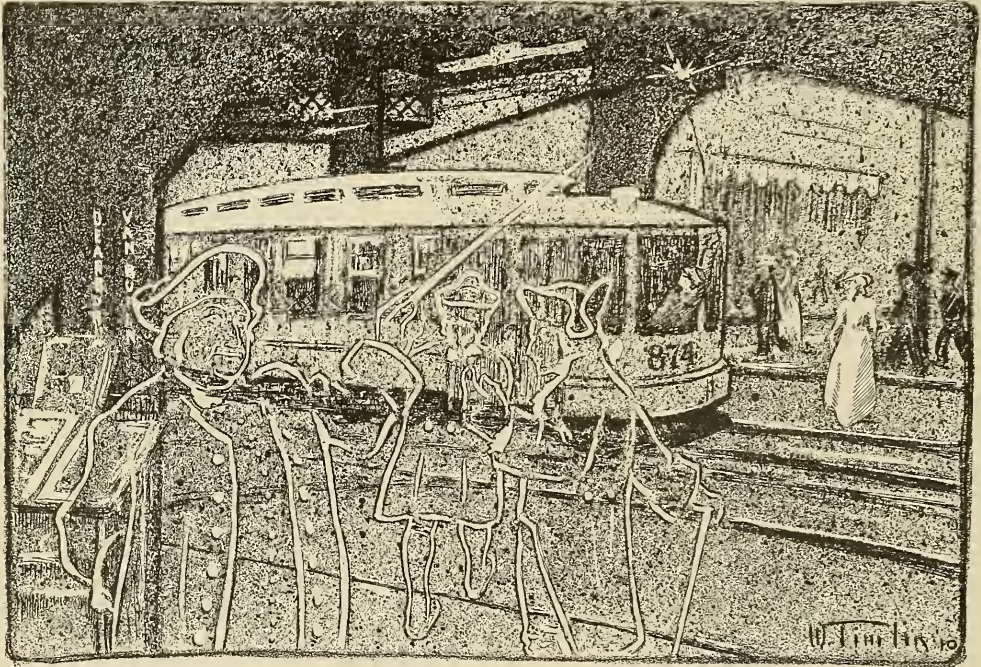

STEPPED RIGHT THROUGH A STEEL "ELEVATED" POST

ture fireworks display, as the motorman, being engaged in a discussion of city hall graft when the trolley had "jumped," had left his controller one or two points "on."

"Hello, Ben," called out Ampere, "come out of the trance!" Now Franklin's sense of dignity had in no wise been abated by his transition from the mundane to the spiritual world, consequently the familiarity of Ampere's address, together with its unex-

We had best be quick to see what changes we can, that have taken place on our old home, the Earth, ere the etheric disturbance subsides, blocking our return to Mars.

"But these strange conveyances!" exclaimed Franklin; "I can in no wise account for the propulsive power in them. I have deduced, from the sparks given out by my metallic cord, that it is undoubtedly electrical, but further than this I am lost.

"Evidently, my electrophorus and pith ball experiments are no clue to this mysterious force. Even should the coach be pushed forward by the repulsion of static or frictional electricity, one can easily comprehend that the compressional strain on the little iron rod would be sufficient to bend it. Verily, it savours strongly of the infernal."

"Away with conjecture!" cried Volta, "let us all ride upon it, the better to study its mechanism. Mayhap its mystery will be self-explained." Ignoring the "pay-as-you-enter" sign, the six spirits walked bodily through the side of the car and looked around for seats. Each of the party, with the exception of Dr. Ohm, found one, and after some hesitation, the Doctor sat boldly down *in* an old lady, causing her no inconvenience whatever by so doing.

Nothing could be ascertained by the defunct scientists, however, in regard to the car's power, although they enjoyed the ride immensely. For several hours they rode around the city, boarding this car and that. Watt and Volta were considerably diverted by the corset, pickle and bean advertisements in the car; Coulomb and Ampere found the view from the car windows very interesting; while Franklin, always of an investigating turn of mind, had soon studied out the system by which fares were collected and sometimes registered. Presently he nudged Ohm, surreptitiously.

"Note the proclamation at the forward end of the vehicle, Doc.," he remarked.

"THE CITY GETS 55 PER CENT," read Ohm. "Well, what of it?"

"That means that the coach line gets 25 per cent," said Franklin.

"Odds Zounds, Ben," exclaimed Ohm, "thou wert a better kite flyer than a mathematician. Who gets the other 20 per cent?"

Franklin grinned slyly and jerked a ghostly thumb in the direction of the rear platform. "Foorsooth, the coachman," he replied.

Two electricians had entered the car and taken a seat near the ghostly passengers. Something in their conversation caused the spooky sextet suddenly to sit up and listen.

"Yes," one of the men said, "the fuses were blown out. That was all, for a wonder. You see, they've got a kid down there that's always experimentin' with this wireless dope; got a wagon load of apparatus laying around, such as tuning coils, transformers, detectors, etc., and he's got the roof of the

house lookin' like the back yard of a woman who takes in washing. Wires strung all over. Y'see, the kid claps a transformer, takin' about 10 amperes at 104 volts on the primary, across mains that was only plugged with six ampere fuses.

"Naturally, them fuses goes, the minute he connects up. So, bein' a foxy kid, he takes and wires his fuse plugs with No. 16 copper wire, so's he won't be bothered by fuses blowing all the time.

"Of course, since the kid's been monkeyin' at this, the meter hasn't done no loafing, either, and the way the old lady kicks on the bills for juice is something awful, I guess.

"You see, she don't know that a watt is a current of one ampere at a pressure of one volt, flowing through one ohm's resist—" But Messrs. Watt, Coulomb, Volta, Ampere, Ohm and Franklin, deceased and in the spirit, waited to hear no more, but drifted collectively through the roof of the car and back to the planet Mars, mystified by the complexity of the wheels of an industry which their historical experiments had set in motion.

### Three Illustrious Wrights

In our admiration for the great advances in aviation due to the ability, daring and persistence of Orville and Wilbur Wright, we should not forget that there is at least one other of the same name whose pioneer work has gone down in history. It was John Wright, the English physician and surgeon, whose finding of a suitable working solution made electroplating practical.

Back in 1840, while his fellow countryman Elkington was working hard to develop a successful method of plating baser metals with gold or silver, John Wright of Birmingham hit upon the use of a cyanide solution of the metal that is to be deposited upon the other. So wise was this choice of a plating solution by Wright that today after just seventy years it still remains the accepted standard. Fortunately for him, the credit for it was not delayed till after his death, but as in the case of our winged countrymen came to him in his prime. Elkington, who proceeded to exploit the sale and use of apparatus for electroplating objects hung in a cyanide solution, paid a royalty to Wright and after Wright's death to his widow.

# The First Carbonless Arc Lamp

By WARREN H. MILLER

An arc lamp without carbons! Incredible! Ever since Sir Humphrey Davy first exhibited the beauties of the carbon arc the idea of an electric arc has been always associated with carbons—an intensely luminous vapor of carbon, under terrific temperatures, due to the electric current and the resistance of the vapor. To get the vapor, you volatilize the carbon into infinitesimal particles, and, to get a continued supply of particles, you must have a convenient stick of carbon and means to feed it properly into the crater of the arc. That's all there is to the arc lamp. Even the flaming arc is simply the same old carbon supply, with the addition of coloring mineral salts.

But, hold! Suppose we enclose this arc in a tube, and let the vapor be some sort of a condensible material, and at the same time a conductor of electricity, of high resistance. Then we get the arc as before, but the vapor, after passing along the tube, can be condensed in a suitable chamber at the ends, and is then ready for another trip. It is a curious thing, but the particles of carbon in the arc lamp are not necessarily burnt—for the most part they merely are heated to incandescence and fly off into the atmosphere.

In the same way, a metal may be found, that will not burn or oxidize, and yet be heated to incandescence by the current, and give out light but not burn. If such a metal can be found, that will not condense later into solid and unmanageable form, we have an arc without carbons, non-renewable, continuous.

The regenerative flame arc is one answer to this idea, using the vapor over again before it gets a chance to solidify. It is used somewhat in Europe and is now exploited by one company at home, on European patent licenses. But, among the very few metals that will condense into liquid form and thus answer our proposition of a carbonless arc, mercury is the only one in common use, and easily obtainable. And it gives the other answer for a continuous arc, for it will vaporize under the heat of an electric current, and will readily condense back into a liquid, once out of the region of the arc. The familiar green

Cooper-Hewitt mercury lamp is an example of this metal, used to make light.

Now, as glass is the material for the tube, and as it melts at the comparatively low temperature of about 1500°F. you cannot get the mercury arc very hot, and so there are two unfortunate results from this limitation—the tube must be long and unwieldy to get enough resistance at that temperature, and the color will be a pale nauseating green, turning everybody's complexion to a sea-sick, lemon-rind appearance, falsifying all color values and robbing the lamp of many fields of usefulness.

But, if the temperature be carried on up, say, a thousand degrees higher, not only may the tube be shortened to a few inches, making it compact and in manageable form, but also the luminous intensity will increase enormously, and the green be almost entirely replaced by white and yellow rays—the nearest light to daylight yet produced. This new material for the tube must be transparent, and capable of being manipulated into suitable shape, and must also be able to stand about 2500° of heat, which no glass possibly can.

To find and apply this material to practical use, took years of the best labors of the scientists of Germany and France. It meant years of discouragement against the well-nigh impossible problems of fusing and working the mineral *quartz*, of getting a flux that would weld it to glass without melting the latter; but it was finally accomplished, and our illustration shows the first of fifty of the Silica-Westinghouse lamps, often called quartz lamps, installed here and there, about the city of Paris, France. Only the tube which holds the arc is quartz, the condenser bulb and trunnions are of blown glass, welded to the quartz tube, for the latter will not blow and shape, even at high temperatures, as will glass.

The mechanical construction is the same as the ordinary mercury vapor lamp. The current passes first through a central selenoid which it energizes, tipping up the bulb so that the mercury flows across the bottom of the tube, thus establishing a path for the main current. This at once boils the mercury and the current flows both through

the boiling mercury in the bottom of the tube and the vapor above it.

In a few seconds the whole tube is one arc of vapor, and the resistance has risen to such a point that it cuts out the solenoid by the little tripphammer magnet shown on the right of the opened lamp in the illustration. The bulb at once drops, so no more mercury can get across, but the vapor arc is now established, and feeds along the tube with the current, continually condensing in the bulb at the negative end, while more from the puddle of mercury just over the cathode, is continually being vaporized. In this way the arc keeps up indefinitely, condensing and vaporizing over and over again.

The light is a beautiful whitish yellow, faintly tinged with green, very brilliant and powerful, giving about the same illumination as a flaming arc, but a splendid soft color with no sharp inky shadows. Its economy is  $\frac{1}{4}$  watt per candle; voltages 110 and 220; amperage, three amperes for both sizes; rated candle powers, 1000 and 2000. The lamp is mounted in multiple, that is to say, direct across any 110 volt or 220 volt line, without any resistance, or having to put two or more of them in series, so it can be installed anywhere without working up any special lighting scheme. They cost in Paris, about \$40 for the 1000 c. p. and \$47 for the 2000, with a charge of \$6 for replacing any burner that gives out after 1000 hours service. Before that time they are replaced free of charge, but the usual life has been found to be about 2000 hours.

With such a lamp, having no renewals of carbons and no cleaning of globes to look after, the ideal arc seems at hand. One curious fact about the lamp nearly upset the whole thing, after all the years of labor of the scientists and engineers who developed it. They found after at last getting the quartz and glass blown together so as to get an arc out of it, that the ultra-violet rays

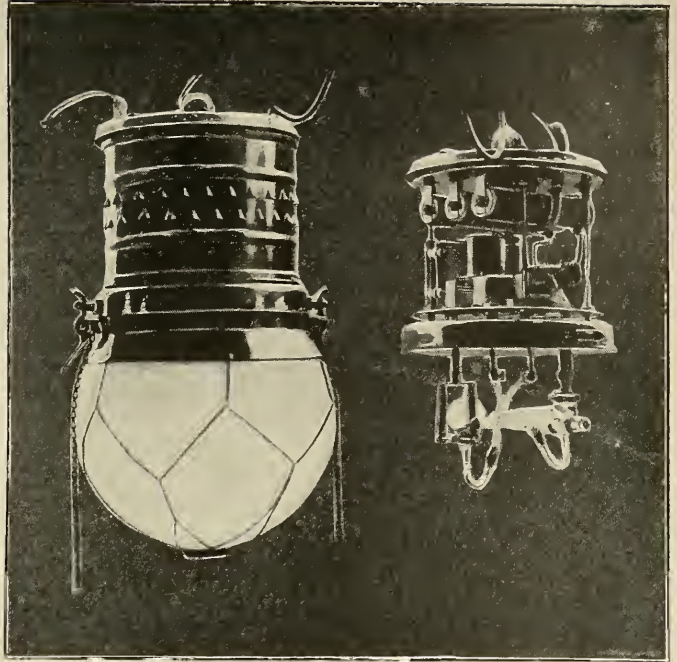

THE QUARTZ LAMP

of the spectrum went right through quartz, while they are arrested by ordinary lead glass. This sounds only scientific and of no great practical importance, but when you reflect that these rays are dangerous to eyesight, it must have caused considerable consternation to make the discovery. But in actual practice, these rays are not harmful beyond nine feet from the lamp, and the outer lead glass globe protects one absolutely, no matter how close he gets. In case of breakage of the outer globe, the lamp would be of no practical danger to the public, being hung anywhere from fifteen to twenty-five feet above the ground to get good distribution. But when working on it to make adjustments or the like, one would have to wear glass goggles. The matter will make no difference whatever in the practical use of the lamp. All electrical apparatus is "dangerous" if you neglect simple precautions, and the only man whom it affects is the expert who may have to adjust a broken resistance or some such accident. He will put on glasses, just as an electrician working around a switchboard puts on rubber gloves.

At present there is but one of these lamps in America.

# Talks With the Judge

## He Wonders About the Storage Battery

"What is the principle of the storage battery?" asked the Judge one day as we were strolling down Michigan Avenue. His inquiring mind had been turned in that direction by an easy running, quiet electric brougham which sped down the smooth asphalt with a lady at the steering bar.

"You have told me that electricity cannot be seen or tasted or smelled," he continued, "Yet you say it can be *stored up* in a battery. I'd like to know how you can make that statement?"

"I don't believe I ever did make it in those words," I replied. "If I did I was in a great hurry. As a matter of fact, the storage battery does not *store* electricity, or bottle it up in other words. It simply brings about chemical changes in the battery plates which puts them in a state so that they can produce electric current by themselves, as in the case of the ordinary primary battery as it is called which rings your door bell.

"The common storage battery consists of two lead plates or two sets of plates, corrugated or in the form of perforated grids. The plates of each set are connected together and when placed in the cell the plates of each set alternate with each other but do not touch. The cell is then filled up with a dilute solution of sulphuric acid and water, called the electrolyte. In this state, however, the cell will not generate an electric current. It must be *charged*.

"To charge the cell the two sets of plates are connected to the two terminals of a direct-current circuit and current sent through it. The set of plates through which the current enters the cell is called the anode. The other set is called the cathode. When the current starts to flow through the cell a very lively chemical action takes place. The anode at once begins to receive a coating of lead peroxide (red lead) while the

cathode turns gray and spongy although it still remains metallic lead. As soon as the anode becomes completely covered with the peroxide of lead, which takes quite a long time, the cell is *charged* and must be taken out of the circuit.

"Now we have an altogether different cell from the one with which we started out. Before the cell was charged we did not have a battery in any sense of the word because we did not have two different metals for the plates, which is necessary for a battery. After the charging, however, we have one plate of metallic lead and one of peroxide of lead, and the charged cell is capable of delivering current in a manner similar to any primary battery. Connect its terminals to a circuit and you can run motors or burn lamps the same as if you had a dynamo connected.

From the moment the cell begins to furnish current, or *discharge*, it begins to run down. Current begins to flow from the gray plates through the electrolyte to the red plates; that is, in a direction opposite to that during charging, and the chemical action is also opposite, undoing the work of the charging process. The oxide of lead changes to sulphate of lead, and the spongy lead on the other plates also to sulphate of lead. The current continues to flow until both sets of plates are changed to sulphate of lead and then it ceases, because the plates are then *alike*, and as I have said, no battery will operate unless the plates are of *different* metals or compounds.

"The discharge being complete the cell must be charged over again before it will give current. You will now understand, however, that the electricity is not stored. The nature of the plates is simply changed by the charging current, then they are ready, with their electrolyte to act as a common battery."



# Where Electricity Stands in the Practice of Medicine

By NOBLE M. EBERHART, A. M., M. S., M. D.

## CHAPTER VI.—THE APPLICATION OF HIGH FREQUENCY CURRENTS BY MEANS OF VACUUM TUBES

We have considered the application of high frequency currents by means of auto-condensation and their use in the generation of ozone, and it seems fitting at this time, to devote a chapter to the numerous uses to which high frequency currents may be put by means of the glass vacuum tubes so commonly in use. This is especially important at this time because the manufacture of portable and low-priced instruments for generating high frequency currents makes them as accessible as a faradic battery and



FIG. 1. BODY TUBE

I venture to assert that within a few years, they will be as generally in use.

The principal value of the high frequency currents as applied with the vacuum tubes is in skin diseases, chronic ulcers, headaches,

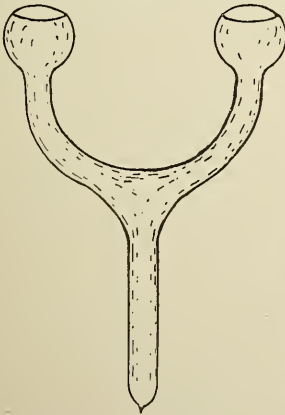

FIG. 2. EYE TUBE

neuralgias, and other painful conditions and for the relief of all diseases of a catarrhal nature, no matter what organ or part of the body may be affected, if accessible.

The glass vacuum tubes employed are of a number of different shapes suited

to their special use. For instance, as shown in Fig. 1, we have one with a large bulb on the end which is suitable for applying these currents to the body or to the face; any place

where the flat surface of the tube may simultaneously give the current to a considerable area at one time. In Fig. 2 we have a form used in treating the eyes. The tube branches



FIG. 3. EAR TUBE

so there is a bulb to come in contact with each eye; another form, Fig. 3, shows a small tube which may be used in the ear; another, Fig. 4, in the throat, etc.

All these tubes are made to fit into the socket of a common handle. For body work

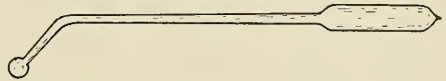

FIG. 4. THROAT TUBE

I prefer a handle with a fixed socket, Fig. 5, but for other purposes I employ one where the socket holding the tube may be placed at any angle, Fig. 6.

When the high frequency current passes



FIG. 5. HANDLE WITH FIXED SOCKET

through the vacuum tube the latter lights up usually with a blue or blue-violet color; sometimes with a white light, according to the vacuum of the tube.



FIG. 6. HANDLE WITH MOVABLE SOCKET

On account of the violet color this form of electricity sometimes, though incorrectly, has been called the "violet ray."

When the hand is in contact with the excited tube there is no sensation from the current, but when the hand is withdrawn a little way from the electrode, fine sparks

jump across in accordance with the strength of the current. I have said that no sensation is noticed when the hand is in contact with the tube; this applies to the higher frequencies and in some forms where the frequency of the current is comparatively low there will be communicated the sensation that is felt when holding the electrode of a faradic battery.

At this point it might be well to define what we mean by a high frequency current. The term frequency has the same application that it has with the commercial alternating current. Here we understand the current to be constantly changing its polarity, with a complete reversal of the current constituting an alternation. Two alternations make a cycle and the number of complete cycles occurring in one second of time constitutes the frequency of the current. Thus, with the ordinary current, we find that the average number of cycles per second is 60, varying from this up to 133, all of which represent low frequency currents.

As we increase the frequency the rapidity becomes such that the cycles really are oscillations, but the analogy is preserved, and so in genuine high frequency currents the number of cycles or oscillations may be from 100,000 to several millions per second. The dividing line between medium and high frequency is placed at various points by different authorities. Many call all currents with a frequency of 10,000 or more, high frequency currents, while I personally prefer to place the dividing line at 100,000 as seeming to be more nearly in proportion. Therefore, a high frequency current means one in which the number of cycles has been increased to an extraordinary degree. Now, a current of 10,000 cycles would probably yield some faradic sensation through the glass vacuum tube, but one with a million cycles per second would give absolutely no sensation whatever when there is perfect electrical contact. With this word of explanation let us again take up the matter of applying the vacuum tubes. How shall we know what amount of current to use in exciting the vacuum tubes? How may it be measured?

As the hand is brought near the excited tube it will be found that there is a definite point where a spark is capable of jumping across the intervening distance between the hand and the tube; this distance will remain the same while the same amount of

current is passing through the tube. Decreasing the amount of current shortens the spark and increasing the current lengthens it. The spark or fine spray that comes from the tube is spoken of as the effluve.

I have employed the length of spark that may be drawn from the vacuum tube as a rough method of standardizing its dosage.

This method is crude and open to some serious objections, but it is the only method that I have been able to devise which will apply to all forms of apparatus. If I say that I employ a tube capable of emitting a one-half inch spark, it gives to the physician some definite idea of the amount of current employed. It does not take into consideration the sharpness of the spark which must be regulated according to individual sensibility.

In treating skin diseases, such as pimples, eczema, psoriasis, etc., I use the tube shown in Fig. 1, and pass enough current through the tube to enable me to draw from it a spark of from one-half to three-quarters of an inch. In applying the tube, however, I do not hold it away from the skin, so that the full-strength spark has a chance to pass, but keep it in light contact with the skin so that there is only a slight stinging sensation.

The reason why I wish to have a current sufficiently strong to give the specified length of spark is that this insures a certain intensity of current. Occasionally as patients become accustomed to the use of the high frequency I raise the tube from the surface slightly, thus giving a spark as sharp as they will tolerate. This, however, is only done where we wish to produce a quick reaction, as the application of the spark is followed by an increased amount of blood and a consequent reddening of the surface treated.

In treating pimples tending to form small pustules, I find that a few seconds' application of as sharp a spark as the patient will permit is often capable of preventing their further development.

Generally, however, the application is made by a to-and-fro motion of the tube, so that it does not remain steadily in contact with any one spot, but by reason of passing back and forth over the skin avoids too intense an irritation in any one portion. The length of time for making the application averages from three or four up to ten minutes. In many of these cases the high frequency is employed in connection with the X-ray, in which case the high frequency is given



for from three to five minutes only, but where it is the sole treatment employed, twice that time will be satisfactory. In this connection it is worth while to mention that I believe the use of the high frequency current in connection with the X-ray enables us to give more X-ray with less danger of a "burn" than is the case when the X-ray is employed without the high frequency current.

My theory in accounting for this is that the X-ray has the effect of gradually decreasing the amount of blood supplied to a given part by reason of increasing the layer of cells lining the small arteries, which finally become smaller and smaller in size until with a serious X-ray burn we have death of tissue, necrosis or gangrene produced by starvation from insufficient blood supply. On this account the tendency of the high frequency current to increase the determination of blood to a particular area, and its generally stimulating effect upon the circulation, tends to offset this particular action of the X-ray and thus enables us to give safely a somewhat longer or more frequent X-ray exposure.

In treating pimples and other skin diseases daily applications of the high frequency currents are advised. In Fig. 7 the application of the current to the face is illustrated. In this instance the tube is inserted in the handle with the fixed socket.

In treating eczema, psoriasis and other conditions where itching is a prominent symptom, it frequently will be found desirable to raise the tube slightly from the surface so that the patient receives a spark. I would use a tube of about the same strength used in acne, but the spark gives great relief in itching and the patients appreciate the treatment where they get more of the spark than occurs with the tube in actual contact with the skin. In both eczema and psoriasis, however, the reaction from the treatment occurs quickly and therefore the

application should not, as a rule, last more than from four to seven or eight minutes; occasionally two or three minutes will be ample.

In treating skin cancer, lupus and also in chronic ulcers or old sores I use a spark as sharp as the patient will allow, which is usually one of about one-fourth to one-half inch, and keep the tube raised about that distance above the surface treated, so that the full effect of the spark is obtained. This gives a very strong, stimulating and at the same time germicidal effect from the spark.

When headaches, neuralgias, and other painful conditions are being treated, a spark of one-half to one inch is the guide for the



FIG. 7. APPLYING HIGH FREQUENCY DISCHARGES TO THE FOREHEAD

amount of current to be passed through the tube. In most of these cases the tube must be kept pretty close to the surface treated and the application must continue until the pain is relieved which will be all the way from five to ten minutes, occasionally longer. Where congestion is responsible the drawing of a considerable amount of blood to the surface gives relief of pain in much the same way that counter-irritation from a mustard plaster would act.

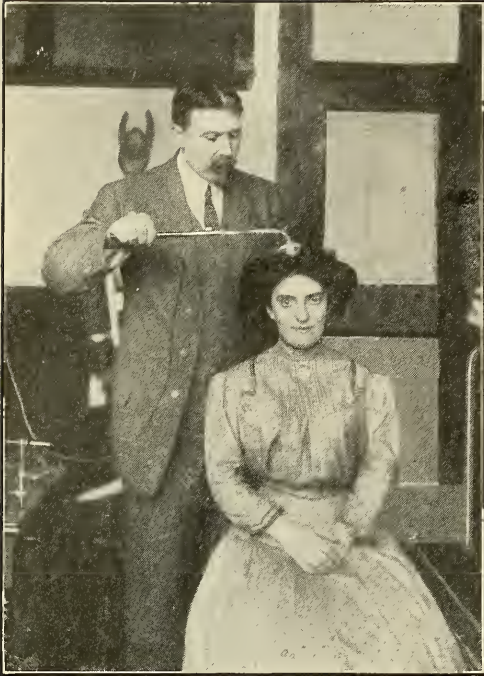

FIG. 8. SCALP TREATMENT

In lumbago and other forms of muscular rheumatism this same method should be used.

I accidentally discovered a few years ago that the high frequency current was not only useful in stimulating the nutrition of the hair roots and thereby increasing the growth of hair and preventing it from falling out; but also that applying it for a sufficient period of time will restore the color to the hair in premature grayness, and in one case a result was obtained where the grayness was not premature. The length of time required to produce this result is so long that few

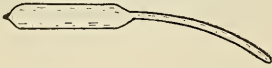

FIG. 9. NASAL TUBE

people have the patience and perseverance to carry out the treatment; many, however, will employ the current for the purpose of preventing falling of the hair. In these cases I recommend the combination of vibration with high frequency. The application of the current to the scalp is illustrated in Fig. 8. I use a spark of one-fourth to one inch. Too sharp a spark will not only be painful, but will produce tiny sores from the caustic effect of the current.

In catarrhal conditions the treatment consists in applying a suitable tube to the surface from which the catarrhal secretion is coming, or as near thereto as possible. For instance, in nasal catarrh a small vacuum tube (Fig. 9) is slipped into the nostril. Another form of tube is suitable to pass back into the throat. In Fig. 10 is shown a small vacuum tube passing into the ear, as used in the treatment of catarrhal deafness. Here the advantage of the handle with the movable socket is apparent, as it enables the patient to hold the tube in place comfortably and easily and also keeps the wire connecting the tube to the apparatus away from contact with the hand.

Catarrhal conditions in any of the orifices of the body are similarly treated and physicians will understand the scope of this treatment.



FIG. 10. APPLYING THE EAR TUBE

In all applications of this nature where the tube comes in contact with a mucous membrane the tube is adjusted before the current is turned on and in this way, since there is perfect contact between the tube and the body, there is no painfulness whatever in the treatment.

The current is allowed to pass for an average of seven minutes, when it is turned off before the tube is removed.

High frequency currents are capable of producing annoying, though superficial burns if left too long in contact with a mucous

membrane, such as the red skin lining the mouth, nose, etc. On this account I make it a rule never to leave a vacuum tube in contact with a mucous membrane for more than seven minutes at any one treatment.

Another way in which high frequency currents have a burning or cauterizing effect upon the skin is where a sharp spark is allowed to play steadily on one point. This has been taken advantage of in the destruction of warts, callouses, corns, etc., by using as sharp a spark as possible and keeping it

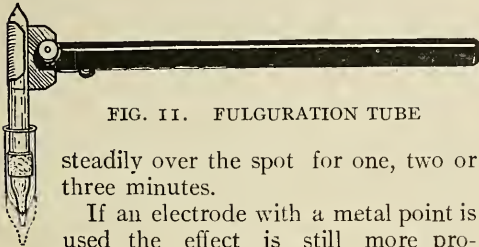

FIG. 11. FULGURATION TUBE

steadily over the spot for one, two or three minutes.

If an electrode with a metal point is used the effect is still more pronounced.

This method as applied with a tube, such as the one illustrated in Fig. 11, is known as fulguration, and is a method much in vogue at the present time, especially in Europe, for the destruction of malignant growths.

In this tube the spark is emitted from a



FIG. 12. TREATING THE EYES

platinum point and the outer tube or jacket around it enables it to be kept from surrounding tissues, as the spark can only pass

out through the tiny opening in the end of the jacket. This can be pushed up or down, thus accommodating the distance to the length of spark desired.

Whether this treatment will prove of lasting value, remains to be seen.

In treating the eyes the tube is used most conveniently with the handle with the movable socket as illustrated in Fig. 12. The eye electrode may be held lightly but firmly against the closed lids; the patient holding the handle easily and comfortably.

Although the spark from the tube has been proved to be germicidal, it seems scarcely necessary to suggest to the physician the necessity and importance of carefully cleansing and sterilizing the vacuum tubes in order that no disease may be carried from one patient to another.

This is easily accomplished by either of two methods. The first is to keep the tubes immersed in jars of antiseptic solutions when not in use; and the other is to sterilize them in such solutions both before and after using.

(To be continued.)

### Drawn Tungsten Filaments

Simultaneous announcement of great inventions and discoveries of the same nature from widely different places has been common in the history of the world. An example of this is the case of Hittorf and Crookes who, working independently, found that when air in a tube (Crookes) was gradually reduced to one one-millionth of its original volume, the red rays give way to blue as the vacuum is increased.

Up to the present time tungsten lamp filaments have been made by mixing powdered tungsten and a binding paste, and then squirting this under pressure through a small die. Drying, cutting and finally purifying by an electric current completes the process of making the filament.

England and America are said to have just found another way of producing tungsten filaments. Dr. Whitney of the General Electric Company by means of an especially designed furnace produces pure metallic tungsten of such ductility that it can be drawn into fine wire of great strength. At the same time Siemens Bros. Dynamo Works of England announce the production of a tungsten drawn filament lamp under the name of "one-watt," indicating a high efficiency.

# Electrical Securities

By "CONTANGO"

THE LARGE PLANT—THE GRADUAL LINKING UP OF PLANTS IN SYSTEMS—THEIR INCREASED FINANCIAL STRENGTH—THE ECONOMIC REASONS FOR SUCH ABSORPTIONS

In the last issue the general financial arrangements of the small plant were considered and the general outline of procedure in such cases outlined. Now as to the financing of large plants:

There is first to be taken up the formation of the large central station company, then its relation to the individual concerns which it, in so many cases, gradually absorbs, and then the means by which these consolidations admit of the parent plant strengthening and protecting the securities of the smaller plants. Thus, for example, we have a company with bonds and stock amounting to a certain amount and it is found that back of this there is the greater security of a parent company. A small plant in a small town has been brought into existence by the issuing of bonds to the extent of, say, \$50,000, and there is in the hands of the owners, common shares to the amount of \$25,000—this, we will say, has all been paid for by the capital subscribed by local men and all of it is absolutely paid up. The bonds are issued to the public, and very naturally the question is asked—What security is there behind the investment other than a project? This question may be followed up to the ultimate absorption in the big central station system.

In such case these bonds, that is the money derived from their sale, is generally apportioned to the equipment, building up and developing of the plant. In some cases such bonds are issued under the special designation of equipment bonds. It is not necessary here to complicate matters by the consideration of this form of security. The point is: What are the tangible assets of an enterprise of which bonds to the extent of \$50,000 are offered to the public? One hears a good deal of companies with patents, patent rights and problematical good-will all set out as representing assets, sometimes for almost the whole amount of the capital stock outstanding, but it may be at once stated that as far as electrical securities are concerned this peculiar feature will scarcely

ever be found. And this fact in itself marks their difference from, and advantage over many other forms of quasi-industrial securities. In electrical securities at all worthy of consideration in any way, the visible assets are speedily recognized. The goodwill which is so often spoken of in other lines of business is in this case fortified by the public need, and this should never be lost sight of. Assuming then that bonds issued to the public are general bonds, a part and parcel of the enterprise, they form an absolute guaranteed mortgage on the property and title of the shareholders.

The shareholders have secured the original rights to the property with franchises, and the actual property on which such a plant is to be built and in the developing and organizing of which they have used their initiative and enterprise. The public has all this, and, as well, an absolute security in the plant which their money builds. The profits of the business over and above the fixed interest on the bonds belong to the owners of the shares of common stock—to the men, indeed, who started the enterprise, and the greater the amount they can earn on that common stock the greater the security of the bondholders.

But, on the other hand, the amount earned on the common stock or shares of the company is no concern of the outside public, any more than it is if Tom, Dick or Harry should build up a private business and make therefrom a large fortune, except in this one particular, that being what is termed a public service or utility corporation and thereby serving the public, the shareholders or owners of the stock are bound more or less by law and courtesy to give the public a good service at lowest possible rates commensurate with a fair return on the money invested in the enterprise after allowing for proper expenditures. This is practically the crux of the situation in so far as it may relate to the regulation of a public service corporation or the establishment of any lighting plant or trolley line.

Now as to the enterprise necessary to control, in the sense of ownership, and start the big concerns in the large cities where all manner of watchdogs, in behalf of divers interests are ever on the lookout to herald or note a false step.

It is clear that the financing of a large plant must be hedged around with many perplexities and complexities altogether foreign to the establishment of a small plant in the average small town.

To start with there are the franchise to be obtained, the different political factions to be considered, and to put it bluntly, the omni-present publicity organs to be more or less humored. Not necessarily as regards the latter because of any special temper, just the reverse, but because of political leanings or affiliations which to a degree affect the public service corporation at its start. The satisfaction of all these divers critics only makes the position of the securities of a great central station plant, once established, doubly secure. For then the co-operation of the average banker or broker is certain. Thus one gets down to the meat of the financing of a big public utility corporation, or big plant in a big city, to put it in plain English. And on the successful establishment of such a central station plant always depends the future and welfare of the many small plants that will sooner or later be controlled by or linked up to it. That means of course plants in the same city or vicinity.

One will suppose that it is a large town and that many people have to be served, involving an outlay of much capital to equip the central station and obtain entrance overhead and underneath to the principal streets of the city. It is possibly easy to imagine what it means, for it is and has been one of the liveliest issues of the day.

Thus, once the work arranged for and the cost apportioned, it may readily be seen that in such an enterprise, after the initial difficulties of starting, the later difficulties of effecting co-operation with the public and the physical difficulties of actual completion have been figured out and overcome, there has been created a most solid and concrete tangible asset.

The satisfactory position of the central station plant in a large center when properly managed and financed is thus attained largely through the certainty of the integrity of the work to be done and being done and

the permanent character of the investment.

This of itself is making the electrical security of today the best and safest known, for the very simple reason that it is created out of the necessities of the public, by the good-will of the public and has the backing and countenance of the public, as forming an integral part of their daily well-being and one which is acknowledged to be permanent—in the vernacular, to stay.

Having thus established these fundamental conditions of tangible assets, real property and stability, the value of the securities created out of such an undertaking may be considered more in detail together with their relation to the securities of the small plants. Suppose a large company with outstanding capital stock amounting to \$25,000,000 has been formed, this capital belonging to private owners and such part of the public as has been brought into the undertaking by public subscription to the capital stock—the chances are that an immediate bond issue will be made to pay for the large central station plants and the transmission system necessary to serve and cover the wide territory in which the company operates. These bonds will be the first issue, then unquestionably they will be made a first lien on the whole property and title of the undertaking. Five per cent is probably the fixed rate of interest payable on them and they are offered for sale to the public at that figure. This interest is absolute and final. It must be paid out of earnings after current expenses have been met and before anything else.

Then follows the further developing of this central station plant or system whereby other and smaller plants are acquired. Possibly these already have a bonded indebtedness, the bonds of the parent plant are therefore further enlarged to acquire these smaller properties or for the purpose of retiring the outstanding bonds of the concerns taken over. In this way it is really a case of going on from strength to strength if conservative and judicious financial methods are observed. But the mere fact of a big company guaranteeing the securities of a smaller concern, unless they are taken in as a direct part of the new securities created must not in any way interfere with investors looking closely into the value of the issues of the original plants. The actual assets of the smaller concerns must be ascertained at all times.

The new bonds of the big company pay for the whole property of the little ones as far as fixed and outstanding indebtedness is concerned—a general issue of the stock or shares in the parent company takes care of the ownership in the same way, usually by exchange of existing stock certificates for certificates of shares of stock in the new company. The new general bonds of the big company are not only a charge on the small plants even where there are outstanding bonds on the small plants, but they act as a direct lien on the whole property. Thus the interest on them must be paid before anything else except the interest on the original bonds of the small companies left outstanding. These have the right of prior mortgages as to the property out of which they have been created, and they also have the further guarantee of the securities of the parent or holding company.

The large company usually makes arrangement to take up the bonds of the smaller plants and substitute therefor from time to time, issues on the property as a whole. Thus holders of securities based on concerns which have been absorbed are protected at every stage of the development. And this concentration of small plants in a large central station system is now recognized as an economic necessity.

There is the old axiom that the greater the demand the greater the production, and the greater the production the lower the cost; for where things are produced in great quantity they are able to be made and sold at much smaller cost. In no product is this more true than with electricity. The very essence of its cheap production lies in its production in quantity on a large scale, in a large central station plant. And in the case of the production of electricity, this is carried to a still further and still more logical conclusion by the selling and

distributing of the current in bulk, that is wholesale and at a wholesale price to the very large manufacturing concerns and street railway and other such companies, which in the ordinary course might otherwise have their own big stations and supply their own power.

It is the absolute necessity for ultimate consolidation, a condition well recognized by the general public, that brings about the great financial transactions and absorptions to which allusion has been made. When a great central station system with a capital, say, of \$30,000,000 and bonded indebtedness of perhaps \$25,000,000 decides on a further increase of its capital stock, it is quite safe to assume that it is filling its destiny in the community which it serves and is making great and profitable strides in the way of development and growth. It secures more cash to provide for the needs of the very near future and therefore those who have the good judgment and sense to invest in the securities of such a concern are certain, ultimately, of larger dividends on their shares of stock, not to mention ownership in a property always enhancing in value year by year. And should a bond issue for equipment and further additions be decided on in the case of a company not overburdened with such fixed charges, then, too, the buyer of these bonds is getting an ever increasing security for his five per cent income and one that may be described as gilt edged. There is nothing like the securities of a company whose business consists in supplying something needed and used by the public in daily life, and that is why the issues of well managed and carefully financed public service corporations are always eagerly taken up by the well posted and are prime favorites with successful bond houses.

(To be continued.)



### Getting Out an "Extra"

Getting out an "Extra" in any big newspaper plant depends a great deal upon electricity. It is electricity that makes it possible for you to read all about the baseball game in the base-ball extras right after the game ends. If it were not for electricity shortening every step in modern news-

through the telegraph instrument near him, typewriting it as it is clicked off by the instrument. A copy reader sits at the table with him and corrects the "copy" as it comes from the typewriter and he in turn passes the "copy" along to the linotype operator seated at the linotype machine which runs by electricity. The linotype operator casts the story into metal, line by

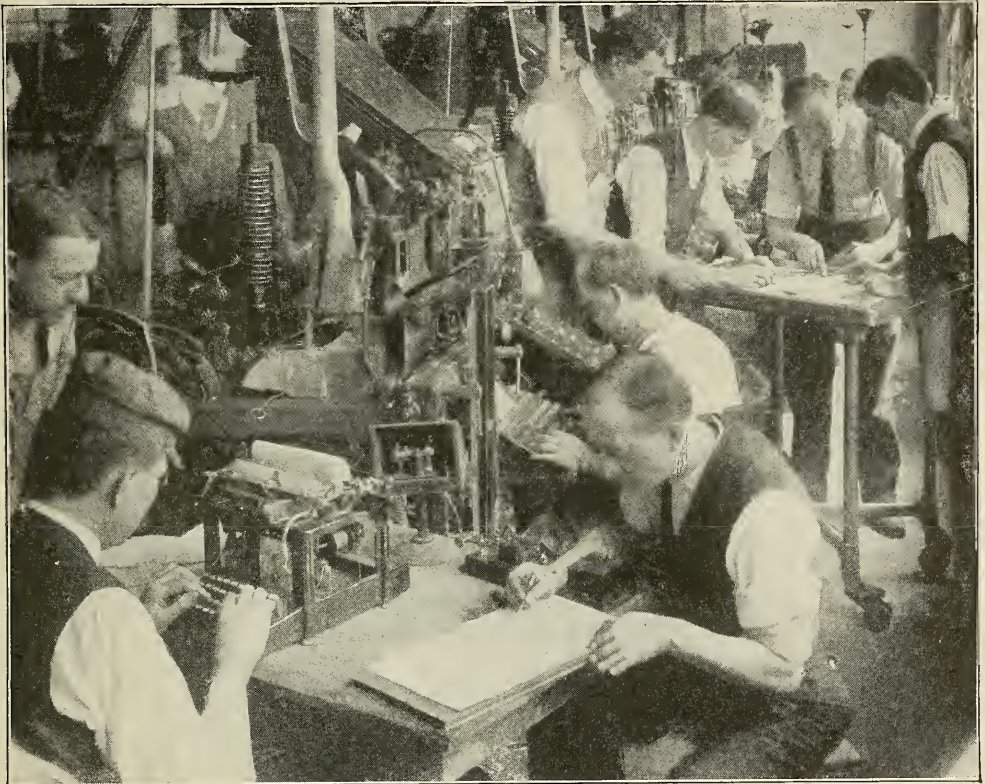

THE "EMERGENCY CORNER" IN A NEWSPAPER COMPOSING ROOM

paper publication, the quick extras telling you all about the accident almost as soon as it happens would not be on the streets until many, many minutes after. All modern newspapers are depending upon electricity for their power. The big triple-deck presses are run by electric current, and clear through the plant to the telegraph department electricity controls the situation.

Here is a scene in the "composing room" of a big afternoon newspaper when the forces are concentrated into the "emergency corner" getting out a "hot" news story for an extra. The telegraph operator seated at the table in the left hand corner depends upon electricity to carry the news to him

line, which is assembled in the "form" by the four men who are at work just beyond the linotype operator. These men are the "composers" and make up the page in metal in duplicate of the printed page.

As soon as the story is "all in," the metal form is locked and sent hurrying to the stereotypers who, with their electrically controlled and heated machines are able to reduce their time to seconds instead of minutes.

In less than two minutes the big plates are cast and are being locked into the presses and in another minute the current of electricity is turned on and the presses are stacking up the extras faster than anyone has ever been able to count them.

### Arc Light Bath

It is a well known fact among physicians that the blue, violet and ultra violet rays of light have decided curative properties when applied to the surface of the body. The illustration shows a bath cabinet built with the idea of providing a means of giving such treatments. At the left is an arc lamp so enclosed and situated as to throw its rays through the glass front of the cabinet and upon the body of the patient within. The color of the rays are controlled by a glass slide holder on the front of the lamp in which glasses of different colors may be placed in changing the treatment to meet the requirements of individual patients.

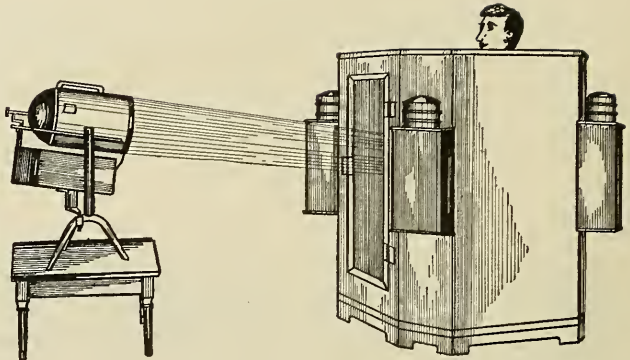

ARC LIGHT BATH

The interior of the cabinet is white and at each corner, as shown, is placed an arc lamp and reflector. Rows of incandescent lamps are also arranged in the interior of the cabinet.

### How to Calculate Illumination

How to go about locating and finding how many and what candle-power lamps to provide to light any given room is a problem usually given over to the illuminating engineer.

A booklet "How to Figure Illumination," to be had for the asking by any one interested, has just been published by the Sunbeam Incandescent Lamp Company, Chicago and New York. The Western Electric Company of Chicago also sends out copies.

The table opposite is based on data obtained from experience. In order to use this table intelligently we should know the meaning of two or three terms. In England and America the sperm candle is the standard for measuring candle-power, and the light which this will give at any point one foot away is called a foot candle. If a standard sixteen candle-power incandescent lamp be suspended vertically, the light which it will give at a point one foot away from the lamp and in a horizontal plane passing through the filament will be sixteen foot candles. Since the intensity of light varies inversely as the square of the distance, at a point two feet away four foot candles will be given, and at a distance of four feet from the lamp one foot candle of light would be the intensity, thus the unit "foot candle" is derived.

	Foot Candles Required	Constant Dark Light
Bookkeeping .....	3 to 5	4 5
Corridor, Halls.....	.5 to 7	4 5
Depots, Assembly Halls and Churches.....	.75 to 1.5	4 5
Drafting Rooms.....	5 to 10	4 5
Desk Lighting.....	2 to 5	4 5
Factory, [general, where individual drops are used .....	2 to 3	4 5
Factory .....	4 to 5	4 5
Hotel Halls .....	1 to 1.5	4 5
Hotel Rooms .....	2 to 3	4 5
Offices (waiting rooms).....	1.25 to 2.5	4 5
Offices (private) .....	2 to 3	4 5
Offices (general) .....	3 to 4	4 5
Offices (where desk lights are used).....	1.5 to 2.5	4 5
Reading .....	1 to 3	4 5
Residence .....	1 to 3	4 5
Stores (light goods)....	2 to 3.5	4 5
Stores (dry goods) ....	4 to 6	4 5
Stores (clothing) .....	4 to 7	4 5
Store Windows.....	5 to 20	4 5
School Rooms.....	2 to 3	4 5

Rooms to be lighted are classified as dark or light according to walls and furnishings, and in each case the table provides a constant to use in figuring, this constant representing the average foot candle intensity produced by one watt per square foot, using the tungsten filament lamp.

The formula below used with the table is based on the light given by the tungsten filament Mazda lamp, which is rated at 1½ watts per candle-power.



$\frac{\text{No. of sq. ft. in room} \times \text{foot candles required}}{\text{Constant}} = \text{Wattage required}$

Assuming a dark school room 40 by 50 feet to be lighted, substitution from the table gives:

$2000 \times 3$   
 $\frac{\quad}{4} = 1500$  watts required at  $1\frac{1}{4}$  watts

per candle power, or a total of 1200 candle power. The type and number of lamps may now be easily found, remembering that a large number of small lights give better distribution than a few large ones.

### Protecting Signaling Batteries

How batteries may be protected on railroad, fire and other alarm systems is shown in the accompanying illustration of the

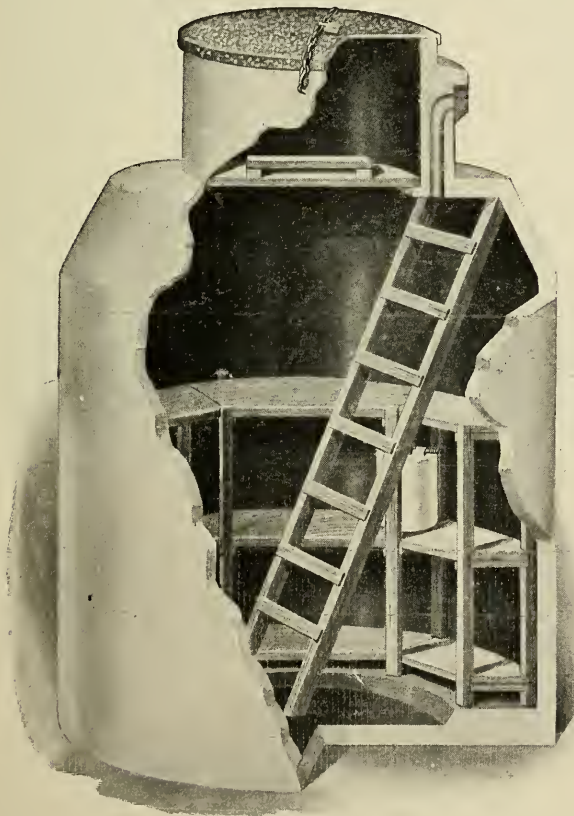

SIGNAL BATTERY VAULT OF CONCRETE

Potter-Winslow concrete battery vault. The battery man enters the vault by first lifting a heavy cast iron cover which has below it an air chamber. After lifting a second

wooden cover resting on felt he enters by the ladder. All around him the walls are coated with asphaltum which keeps out dampness, but in addition to this, just back of the asphaltum are air channels in a bituminous fibre structure, these dead air chambers affording an insulation against heat and cold.

### Magnet Coils as Heaters

The so-called "Lifting Magnets" as now used in large steel plants and foundries for loading and unloading pig iron or scrap, usually have the magnet coils surrounded by a massive steel casing which protects the coils from injury. On some makes the coils are impregnated with a high insulation compound before they are slipped into the casing. In others, the core and windings are first inserted into the case and this is then filled with the insulating compound which is forced in while hot and which cools into a solid mass that both increases the insulation and keeps out all moisture.

The one great drawback to such a solid filling lies in its binding the magnet tightly in the casing so that it cannot be withdrawn for repairs. If the device never needed overhauling, that would not matter, but an apparatus that is used around railway cars where it can accidentally be jammed between two cars, may in time need attention. When this happens, the repair man does not try to pry the magnet out, for he might damage the insulation on some of the coil windings in doing so. He simply connects the terminals of the magnet coils to a convenient circuit and turns on enough current to overheat the windings. Thus the magnet coils become heaters, melting the insulating wax or compound so that it can be poured off. Incidentally, this method shows how well such lifting magnets are able to stand excessive heat, for no manufacturer would deliberately instruct his repair crew to overload any device unless he knew that the insulation was perfect.

### Ice Handling by Electricity

In an artificial ice-making plant, large heavy blocks of ice have to be lifted from the freezing tanks or cans and removed to other parts of the plant. The accompanying illustration shows an electrically driven crane carrying a cake of ice 20 feet wide and 12 feet high. The supporting rods,

### Plant Growth and Electricity

The farmer must depend for his crops upon the warm weather, right amount of moisture, and good soil. By throwing a switch it is possible that in the future electricity may be a means of growing plants in a shorter time even, than under normal conditions.

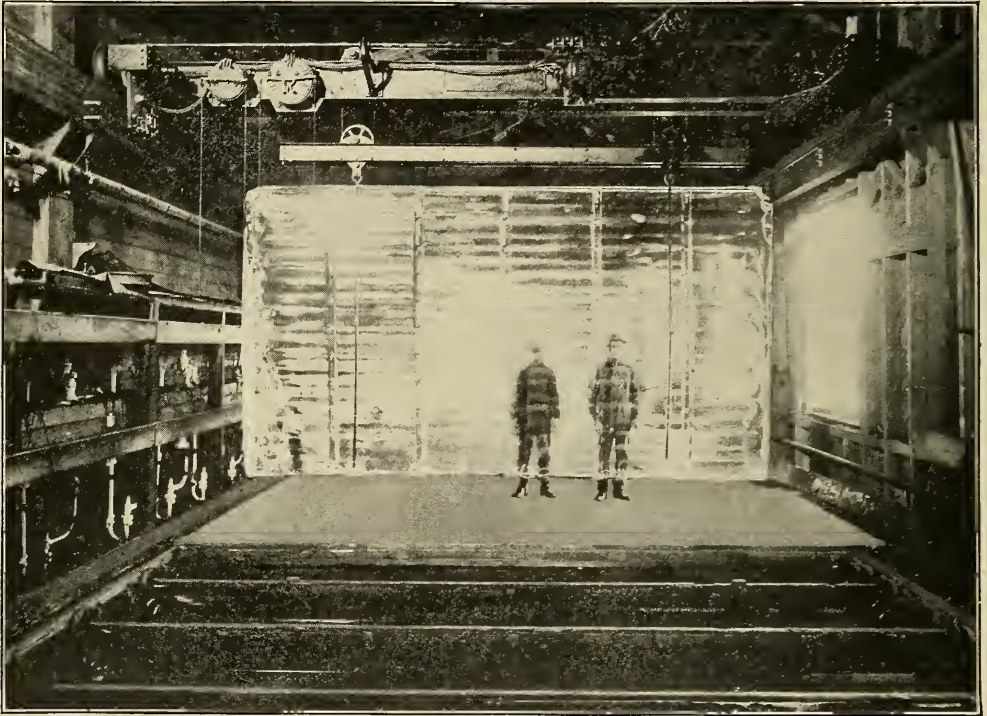

ELECTRIC CRANE CARRYING ICE SHEET

which can be seen, are frozen into the ice while in the cans, the latter being just visible at the openings in the floor. The transportation of such a weight of ice to cutting tables or to shipping platforms by hand labor would increase considerably the cost of production.

### Holding Court by Telephone

The fact that contagious diseases cannot be transmitted over the telephone wires enabled Judge F. E. Bowser of Warsaw, Indiana, to try a case at home while quarantined because his children had scarlet fever. The Judge heard the evidence by telephone and imposed a fine and a 60-day sentence upon a young man for stealing.

Metal plates have been placed in the soil and charged with current by connecting to wires. Beets with which the ground was planted yielded two and one-half times as much sugar from one acre as where electricity was not used.

A galvanized iron wire network charged with from 70,000 to 100,000 volts from an induction coil and dynamo has been experimented with. This network, supported on posts, about eighteen feet above the ground, is said to increase the yield per acre by one-third, through the effect of the static discharges from the wires to the plants. This effect may be easily felt when walking under the wires as a prickling sensation similar to that felt when walking under a rapidly moving belt charged with "static".

## Electric Diving Sign

Following the popularity of the moving-picture show, electric sign men are using the idea of motion to attract attention.

The illustration shows a sign erected at Euclid Beach, a lakeside resort of Cleveland. The "act" is as follows: The girl first appears on the platform, poised for a dive. She then disappears for a few seconds, and is next seen just as she enters the water,

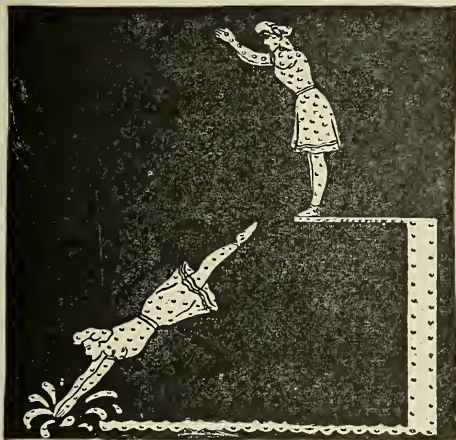

ELECTRIC DIVING SIGN

which splashes and ripples as she disappears. The following legend then appears in letters of light: "Come in, the water's fine."

A motor driven sign flasher throws rapidly on and off the lights of one position after another and then the invitation which without doubt attracts many a bather.

## Automobile Battery Exchange

The best way to light an automobile is a question which according to *Motor Age* requires some thought at the present time.

The generator built either on the plan of a dynamo or a magneto adds a good deal to the mechanism of the car besides making it cost more. One novel solution offered is that of using small storage batteries based on some sort of an exchange system similar to that employed by lighting companies in providing new lamps to their customers, the old ones being received in part or full payment for the new. If such a plan could be arranged the annoyance and trouble of waiting for a battery to charge would be done away with.

## Collapsible Signs

Those who enjoy an occasional bit of word play—and who among us does not?—will appreciate the wording on the two views of a "knock-down" electric sign. It consists of a triangular base to which both the lamp and the flasher are fastened, a front with the removable glass sign, a pair of folding metal sides and a triangular top. The parts hook into each other so that they can be assembled without the use

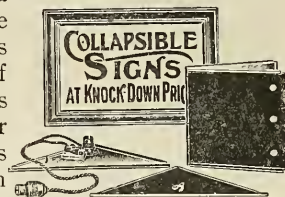

COLLAPSIBLE SIGN

of tools. When separated, they are easily transported as a whole dozen of them would hardly take up more room than a single pair of similar but non-collapsible signs.

## Bare Wires of Unseen Metal

It is possible to have exposed wires without an insulating covering and yet not have the metal itself visible. That may sound like a paradox, yet it is practically true in the case of aluminum wires of which over half a million dollars worth were recently ordered by a single company for its transmission lines. For while aluminum does not seem to be tarnishable, it really becomes coated with a thin film of an oxide of aluminum on continued exposure to the air. This coating closely resembles the metal itself in color, so that what we commonly see is a coat of oxide of aluminum and not the metal itself. It is probably this oxide which makes it so difficult to solder aluminum, so that wires of this material have to be actually fused to the contact terminals.

## Resistance

For a given length and weight aluminum has the least electrical resistance and mercury has the greatest. For a given length and cross-section annealed silver has the least resistance and bismuth the greatest.

## Some Odd Electric Lamps

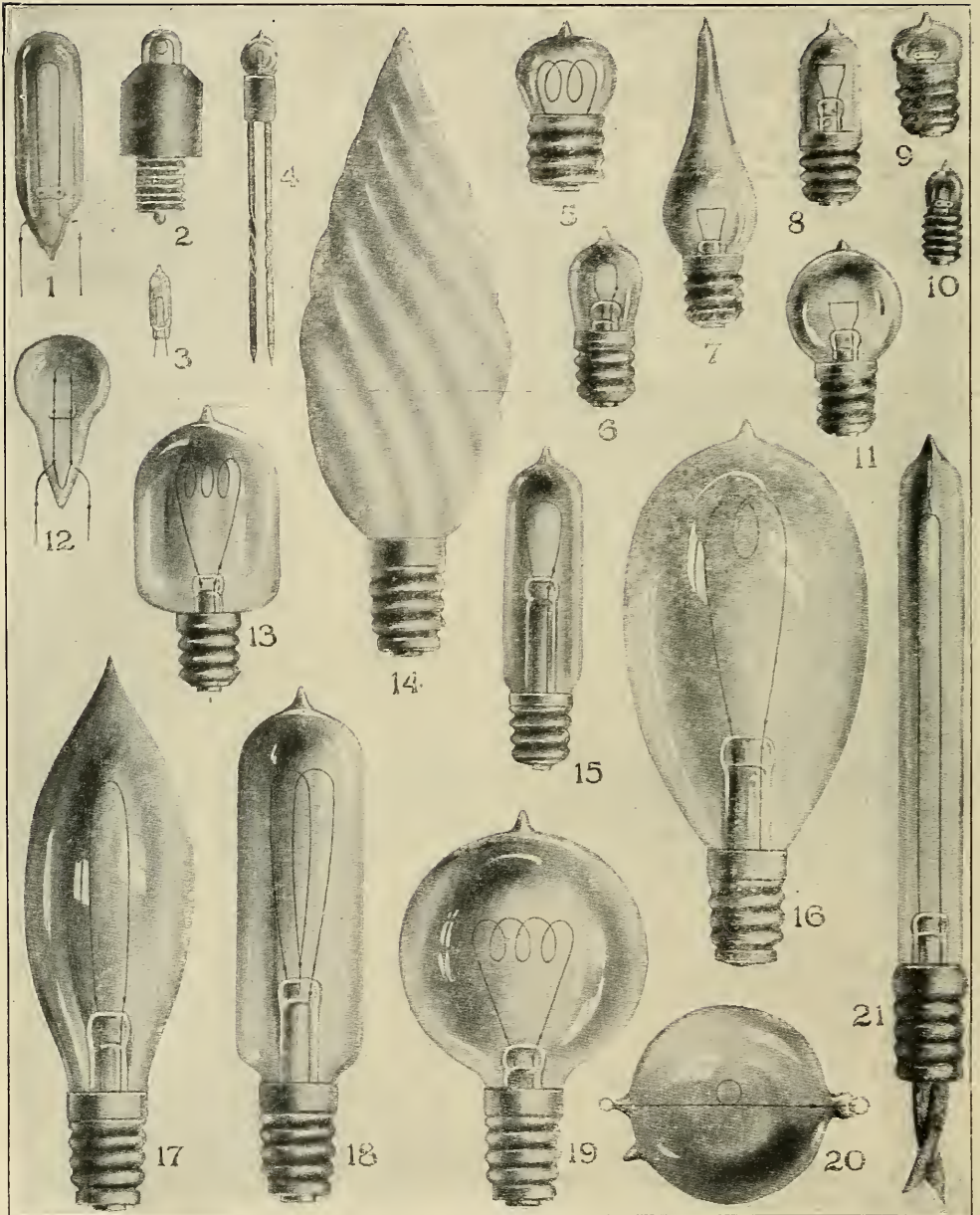

Above are some of the many shapes in which miniature incandescent lamps are made for battery, surgical, dental and decorative purposes: (1) Large dental, (2) gun night sight, (3) grain of wheat, (4) scarf pin, (5) range finder, (6) round, (7) candle, (8) tubular, (9) Flat end round, (10) round 1 c. p., (11) round, (12) surgical, (13) Fisk instrument, (14) candelabra, (15) series and multiple candelabra, (16) series candelabra, (17), (18), (19) candelabra, series and multiple, (20) festoon. (21) torpedo.

## The Newspaper Cause

The current that leaves the motor of the street car and seeks to make its way back to the powerhouse along the track, often comes to a place in the rails where it is much easier traveling to jump off the rail to adjoining moist soil and then to a nearby water or gas pipe. All is well until this current leaves the pipe for some better path, when it takes with it bits of the pipe, finally producing a leak. This destruction of the pipe is called electrolysis.

As is too often the case a newspaper reporter not versed in things electrical having to tell the readers of his paper why a certain telephone line was to be changed from an overhead to an underground line did the best he could by asking the lineman about it, and was jokingly told that there was trouble on the overhead wires caused by the "electric currents known as electrolis." The next morning the newspaper account read:

"The electric currents, known as electrolis, in the air have become so strong that it is impossible to run a wire more than fifty miles without grounding, even at ten miles the currents gathered from the air will almost tear their arms from the sockets and they have frequently been against it where at ten miles the current was strong enough to burn off a wire or furnish power for a low resistance electric bulb."

This is somewhat in line with a recent newspaper report of the cause of a fire, reading:

"As no other cause could be found, it is probable that the fire was started by crossed electric wires."

## Telephone in the School Room

The telephone is still further extending its already wide use as a convenience and time saver by being of service in the schools. Any one associated with central or even ward schools will know of the numerous things that require the attention of an associate teacher or the principal.

What are called "interphone systems" are now made, consisting of a wall transmitter and receiver in each room, and a main station small enough to be placed on one side of the principal's desk with a few batteries on the floor. Labeled push buttons designate the circuits to the rooms. When one of these is pushed the bell rings

in the room called, and talking may begin by merely taking the receiver off the hook. At the main station any room may also be connected to any other.

## Para Rubber

This picture shows half a "biscuit" of pure Para rubber, just as it was received from South America. There are many different kinds and grades of rubber, but the best rubber comes from the country around the upper part of the Amazon River and is generally referred to as Up-River Para.

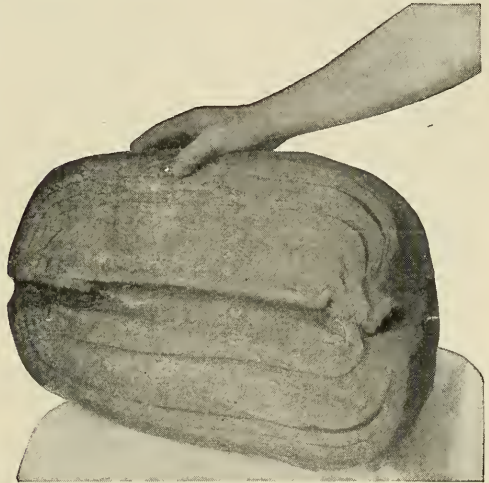

A "BISCUIT" OF PARA RUBBER

For use in compounds for insulated wires and cables, as described by the Hazard Manufacturing Company of Wilkes-Barre, Pa., the biscuit is ground between rollers covered with small teeth while a stream of water is played on it. This breaks up the rubber and takes out the dirt which has accumulated during the process of curing.

The ground rubber is then thoroughly dried and put through a further curing process when it is ready to be mixed with other ingredients. This mixing is done by taking the various ingredients and the rubber and rolling them between two smooth rollers. This compound is folded on itself and run through the rollers many times until it is thoroughly mixed.

The compound is now in a plastic state and ready to be put on the wire. Next comes the vulcanizing or hardening which is the finishing process. The compound is then ready for covering the wires.

## Lightning and the Ancients

The study of atmospheric electricity, as noted by Killingworth Hedges in his book "Modern Lightning Conductors," dates from very early times. It is doubtful whether the supposition that the art of pro-

Museum where the bronze is now placed.

The picture herewith, selected from Philbert de l'Orme's work dated 1560, entitled *L'Instruction*, shows that architects at that period had to contend with thunderstorms. De l'Orme was the architect of the Tuileries and died in 1570.

It is generally supposed that Divisch, a learned priest, erected the first lightning conductor in Europe at Prendiz, Bohemia, in 1754; the rod was said to have been 130 feet high, and although he was patronized by the Emperor and Empress Stephen and Maria Theresa, it had to be taken down a year later, as it was said to have occasioned a terrible drought. It is not likely that Franklin had heard of Divisch.

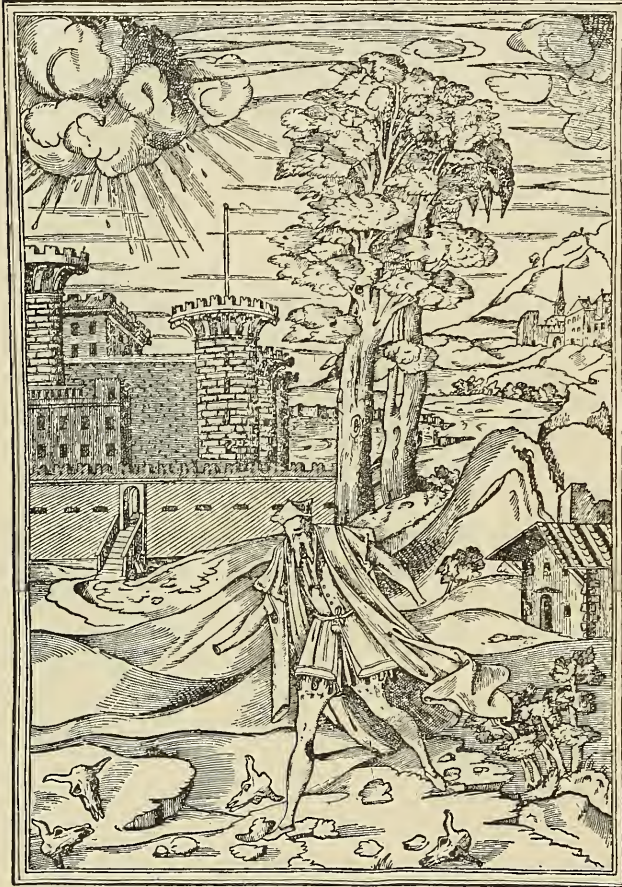

THE BAD ARCHITECT

tection from lightning was known to the Egyptians but the Greeks and Romans are reported to have drawn fire from the sky. And Tullus Hostilius is said to have perished in a sacred experiment of this kind. Cicero, in his ode against Catiline, drew attention to the bad omen to Rome that was caused by the gilded figure of Romulus being destroyed by lightning. The same stroke mentioned by Virgil, *Æneid VIII*, burnt the hind legs of the well-known bronze Capitoline Wolf, probably by a side flash. The damage can still be seen by the tourist who visits the Capitoline

## Exhibit Hall for Accident Prevention

An exhibit hall for devices to prevent accidents has just been engaged in the Engineering Societies' Building, by the American Museum of Safety. This will constitute a permanent exhibition, free to the public, of safeguarded machines in operation, models, charts and photographs.

No exhibit will be displayed that has not been approved by the Board of Approval of Exhibits. There will be no charge for space, but a plan of each installation must be submitted in advance to the Director of the Museum. Each exhibit will be accepted as a loan for one year, then to be replaced by others if substantial improvements have been made. The Museum assumes no responsibility for any damage by fire, or loss by theft, and exhibitors showing non-patented devices or processes, do so at their own risk.

The Board of Approval consists of Professor F. R. Hutton, Philip T. Dodge, Charles Kirchoff, T. C. Martin, and W. H. Tolman.

All makers and inventors of safety devices, in the threefold aspect of safety for the worker, the public and the machine,

are invited to exhibit. All applications for space should be sent to the Director, at the Museum, 29 West 39th street, New York City.

### The Eskimo and the Telephone

Prof. D. B. McMillan, of the Peary North Pole expedition, relates an amusing story regarding the efforts of an Eskimo to construct a telephone line.

The Eskimo came into possession of a piece of wire of considerable length and never having seen wire before he asked Professor McMillan what it was and what it was for. He was told that the white man strung it on poles stuck in the ground and by talking



to an instrument at one end the voice could be heard at the other end. After some search the next morning, the Eskimo was found to be engaged in telephone construction work of his own. He stuck some sticks in the ground and hung his wire on them. He held one end of the wire to his mouth and talked to it at the top of his voice. Then he ran as fast as he could to the other end and held the wire to his ear with the expectation of hearing his own words repeated.

When he failed to hear any sounds the expression on his face revealed his opinion of his white friend.

### Cutting Lamp Filaments on a Planer

Before baking or "carbonizing" the almost threadlike part which forms the filament in the ordinary incandescent lamp, this has to be cut or otherwise trimmed to the required slender shape. Can this be done by cutting the material on an ordinary machine shop planer? Our machinist readers will probably smile at the seemingly rash suggestion, yet this is neither a wild speculation nor a mere laboratory possibility, for it has been a commercial success. Indeed there was one season within the memory of most of our readers when all the filaments used by two of the smaller lamp factories in this country were made by this process in a little shop hardly a block away from the recently outgrown headquarters of Popular Electricity. And thereby hangs this bit of history:

When the Thomson-Houston Electric Co., which is one of the constituents of the General Electric Co., first introduced its dynamos on the Continent, its European representative was instructed to study the incandescent lamp situation there so as to see what European make of lamp could wisely be offered in connection with their apparatus. That was over twenty years ago, long before the methods of making the present high efficiency filaments had been evolved, and yet there were already a variety of lamps on the European market for which the filaments were roughed out in different ways. Some makers started with threads or fibres of bamboo, wool or cotton; others stamped the shape out of a thin cardboard or celluloid sheet. But the man whose filaments at that time were reported as showing the best test records did none of these in the lamp factory which he, though himself a Russian, was operating at Rotterdam in Holland. Being an able chemist, he had worked out a mixture which could easily be carbonized into a hard, fairly tough and uniform product. Carefully mixing the ingredients in the right proportions into a solution, he poured a thin layer of the liquid mixture into a shallow pan with a heavy bottom which had been planed perfectly level. Then he let it stand until the more volatile parts of the mixture evaporated, leaving in the pan a thin coat of jelly which gradually hardened to the consistency of a stiff glue. Then before it reached the brittle stage, he would clamp the pan on an ordinary metal working

planer and with a fine tool would cut the thin mass into narrow strips about as wide as they were thick. The stroke of the planer was adjusted so that the cutting tool would not quite reach either end of the pan, but would leave a connecting strip across the end of all the strips, which was cut off after the strips were tied on the carbonizing block.

By this seemingly crude method he secured filament strips or threads that were unusually uniform and homogeneous throughout their length, having no hard spots or knotty places such as were frequently found in filament threads or fibres prepared by other methods. Moreover he avoided the patents covering these other processes of filament making.

Of course his filament threads shrank considerably in size while being carbonized in this manner, so that the actual cutting was to a much larger section than that of the finished filament. Many years later, the same uniformity of structure in filaments, together with still higher efficiency, was obtained by other methods. But that is another story.

### Lamp Flasher

Here is a simple scheme for making a lamp flasher or "winker" for advertising purposes, etc. The lamp can be made to burn for about five to 10 seconds and remain dark the same length of time.

Take a small glass tube four inches long and  $\frac{1}{4}$  inch in diameter open at both ends and place a plug of sealing wax in the lower end through which is passed the end of a piece of No. 40 S. C. C. copper magnet wire. The remainder of the wire, about 20 feet in all, is wound in a single layer on the tube and finally carried down to binding post (A).

The tube is nearly filled with mercury, carrying on its surface a float of sealing wax. Through the float is passed a small piece of an old lamp filament, the hooked portion at the top being the platinum leading-in wire. A twisted strip of metal is fastened to the upright support so that the hook just touches its outer end. You can make a little adjusting screw to regulate the position if you desire. This metal strip is attached to binding post B. From one side of the source of current a wire connects to the lamp and post (A). From the other wire

of the source connection is made to the post (B).

In operation, current flows through the lamp, around the coil of wire on the tube, up through the mercury and hook to the spring and then back to binding post (B) and out.

In passing around the fine wire coil the current heats the latter and causes the mercury to expand, raise the float and break the circuit at the contact of the wire hook and

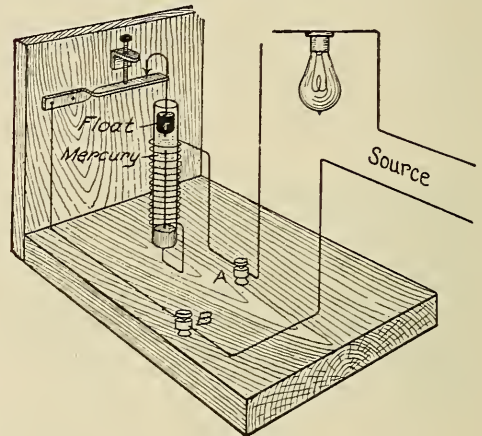

SIMPLE LAMP FLASHER

metal strip. The tube then cools down, the float falls with the mercury and the circuit is closed again. This keeps up indefinitely and causes the lamp to wink with pleasing regularity.

### Using Sawdust Electrically

Every now and then the daily papers bring in an item about some one who is trying to utilize the sawdust which accumulates all too rapidly at some sawmills and woodworking establishments. Meanwhile some of our electric furnace pioneers have quietly gone ahead and have already been using sawdust for years as one of the ingredients for making that exceedingly hard grinding material, carborundum. To produce this, a heavy current is passed through a core of coke surrounded by a mixture of carbon, sand, salt and sawdust. Which again goes to show what marvelous results can be obtained from the most commonplace ingredients when the magic of the electric current is available.



## What Weight Can a Dry Battery Lift?

Storage batteries have many uses where the relation of their weight to their normal output in electrical energy is quite important. For instance, any vehicles propelled by storage batteries must carry the dead weight of these batteries, and the less this weight is in proportion to their output, the less energy will be spent in moving the batteries them-

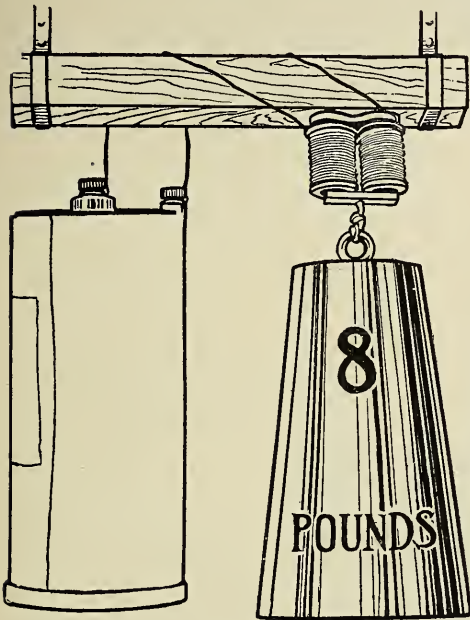

EXPERIMENT WITH A DRY BATTERY

selves. The last two decades have shown decided decreases in the weights of such batteries, but how about the so-called dry batteries? What improvement has there been in the dry cells most of which have carbon and zinc elements with a pasty sal-ammoniac solution?

Some years ago one experimenter found that with a carefully proportioned electromagnet he could get a single dry cell to lift almost its own volume of iron. Has this record been surpassed, so that we can now get a dry battery with a lifting power fully equal to its bulk in iron? It is so easy to modify the contents of so-called dry cells by pouring in different solutions, that many of our readers have undoubtedly tried it. Now who can show the best record with such a battery for holding up its own volume of iron, and for how long a time?

## Displaying Lamp Shades

The customer who is buying globes or shades always likes to see the effect on the shade with the light inside.

The accompanying illustration shows how one fixture house does this. A table is

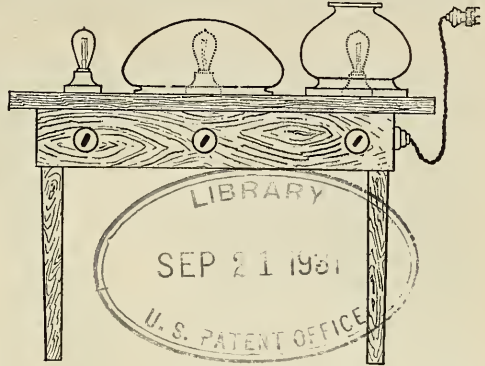

LAMP DISPLAY TABLE

fitted with three lamp sockets already wired. Into these sockets may be screwed any size or type of lamp the customer contemplates using. Then the shade is set over the lamp and the switch snapped on. In this way several shades may be tried out at once and the effects compared.

## Telephone Coil Carrier

A writer in *Telephony* describes a contrivance for carrying induction and ringer coils so as not to have them injured by tools in the bag. Take a piece of 2 x 4 inch pine

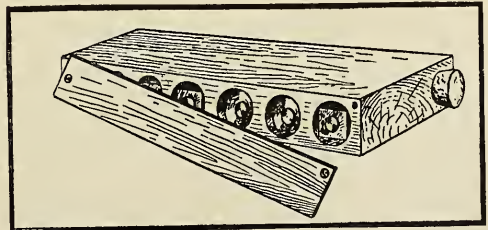

TELEPHONE COIL CARRIER

of any desired length and, by using an expansion bit, drill holes just the size of each coil, so as to prevent rattling around. An additional coil may be carried by drilling a hole in the end of the block and plugging with a cork. A strip secured by two screws serves as a cover.

### Lifting Magnet Recovers Cargoes

Giant lifting magnets made by the Cutler-Hammer Clutch Company of Milwaukee are being employed to recover steel cargoes from barges that have sunk in the Mississippi River. The first experiment was made recently near New Orleans, where a barge load of kegged nails was raised successfully.

The magnet was brought from Milwaukee by express and the Carnegie Steel Company promptly dispatched C. S. Proudfoot, an expert electrician, from their Homestead Steel Works to install the magnet and oversee its workings.

The work of recovering the cargo was then taken over by the American Steel and Wire Company, another subsidiary of the



RECOVERING A CARGO OF NAIL KEGS WITH A LIFTING MAGNET

The barge, which sank on Feb. 9 had been towed from Pittsburg to New Orleans laden with 1500 tons of wire nails in kegs, steel barrel hoops, staples and barbed wire. It broke loose from the tug when landing, struck the wharf and sank within thirty feet of the docks at Lafayette Street in fifty-five feet of water. Almost instantly, however, as was developed by divers, the barge began slipping into deeper water.

Even the manufacturers of magnets were sceptical as to their efficiency for this purpose, as a magnet had never been used for such purposes under water. But this New Orleans loss was a good chance to make a trial.

Steel Corporation, which owned the larger portion of the sunken material. It, through L. H. Korndorff, division freight agent, concluded a contract with C. W. Wood of New Orleans, who with an associated firm of divers, has recovered the steel and thoroughly demonstrated the success of the magnet.

The largest haul made with this magnet, consisted of five kegs of nails weighing 100 pounds each; one bundle of hoops weighing seventy-nine pounds; one bundle of fence wire weighing 155 pounds; thus aggregating somewhat over 700 pounds. When the magnet was working in a well-supplied part of the barge an average haul was about four kegs of nails. A particularly attractive

feature of the work was the appearance of a bunch of nails in the exact shape of the keg stuck to the magnet. In being pulled up the keg had been broken off, and sticking to the magnet these nails held in the shape of the keg.

In order to drop the load immediately when desired, because the effect of the magnetism on the nails had a tendency to make them stick even after the current was turned off, the current in the magnet was reversed.

---

### Across the Atlantic with a Thimble Battery

---

In no other respect is the contrast between wireless and submarine telegraphy more striking than in the amount of electrical energy required for transmitting messages over the same distance. Being so constructed as to send out the waves in almost all directions besides the particular one for which the message is intended, an ordinary wireless outfit must imply a tremendous waste of energy as compared with the ocean cable in which the current is all concentrated in one delicate receiving mechanism. So delicate is the latter that messages have been sent not only across the Atlantic but for double the length of the oldest Atlantic cable with the current from a silver thimble battery.

This is what the famous electrical engineer of the Atlantic Telegraph Company, the late Latimer Clark, described briefly in a letter dated at Valentia in September, 1866: "With a single galvanic cell composed of a few drops of acid in a silver thimble and a fragment of zinc weighing a grain or two, conversation may easily, though slowly, be carried on through one of the cables or through the two joined together at Newfoundland to form a loop. And, although in the latter case the spark, twice traversing the breadth of the Atlantic, had to pass through 3700 miles of cable, its effects at the receiving end are visible in the galvanometer in a little more than a second after contact is made with the battery. The deflections are not of a dubious character, but full and long, the spot of light freely traversing a space of 12 to 18 inches on the scale; and it is manifest that a battery many times smaller would suffice to produce similar effects."

Of course every forward step towards concentrating or directioning the wireless waves will reduce the energy required for transmitting messages by the same, but we evidently have a long way to advance before our wireless methods can be at all compared in efficiency with the submarine telegraph of even 45 years ago.

---

### Curing the Sleeping Sickness

---

Not being satisfied with the slow rate at which drugs act upon the so-called "sleeping sickness" so common in Africa, a young mine owner who contracted the disease in Rhodesia is also being treated by a refrigeration method in the tropical hospital at Liverpool. The method used requires him to spend a number of hours daily in a room kept at a uniform temperature somewhat below the freezing point. How was this to be obtained independent of the weather?

The answer was soon found: simply by installing a small refrigerating plant run by the ever convenient electric motor.

At last reports the patient had increased the time during which he could stay awake in the cooled room from two to about six hours and was suffering much less from the usual pains in the joints. Thus another method seems to be added to the many ways in which electricity is vanquishing ailments that have long baffled the medical profession.

---

### Electrocuted Eggs

---

The peculiar taste of a cold storage egg is something not easy to mistake. It is possible that this taste may be removed if the experiments now being made by the Rochester Railway and Light Company are successful. It is claimed that when fresh eggs are placed in cold storage the eggs are alive, and that they are slowly frozen to death and in spite of the preservative qualities of the ice the eggs do not taste good when cooked.

It is now believed that by "electrocuting" the eggs the natural fresh taste may be retained and not removed when the eggs are placed in cold storage. The eggs are "killed" by placing a metal cap on each end of the egg and then throwing on a pressure of 500 volts.

## Indoor Lighting from Outdoor Lamps

Is it practical to do indoor lighting with outdoor lamps? The suggestion sounds almost like a paradox and yet is not that what we universally do in the daytime when we get our indoor illumination from the outdoor sun? Were we not spoiled by the advances made in artificial lighting by means of lamps placed in all sorts of indoor locations, the idea of leaving the lamps out of doors might not seem so preposterous.

It is unusual, to be sure, and yet there are occasions where this is not only practical but advisable. One of these was found some years ago in connection with a powder magazine located on the outskirts of an Iowa town, where the only available current was that of a direct current arc circuit.

An incandescent circuit might safely have been carried right into the structure, and an alternating current might have been transformed to a suitably low voltage for this purpose, but to bring the high voltage arc circuit into the powder magazine seemed risky. So the lamps were hung out of doors close to thick glass windows, but instead of the usual glass globe each was fitted with a reflector which threw the light inside.

## Navigating in Lake Ice

The high power electric search lights with which vessels on the Great Lakes are now equipped prove most useful in the early spring nights when the water is covered with a partially broken ice field. By means of the light, openings are located, thus often saving many hours of delay.

## Making Battery Porous Cups

The porous cup of a battery is a familiar object to electricians but only now and then will you find any one able to tell you how it is made. The first porous cups to hold the carbon of a battery were used by Leclanche in France. The materials, which must be pulverized and mixed to make the cup, are feldspar, eight parts; ball clay, six parts; kaolin, nine parts; quartz, two parts. The last gives the mixture strength. Kaolin is a china clay imported from England, and feldspar is a mineral common in Vermont. The whole mass in pulverized form is mixed while water is poured upon it until thin, about like common paint. In this shape it is run through a fine screen into a tank having a floor of tiling through which heat from a coal fire at one end passes, boiling the liquid for about 25 or 30 hours. By this time the water is about all evaporated. Pieces of the cooled mixture are placed in cups or moulds of plaster Paris. A disk is then forced down into the cup pressing the clay into shape along the sides. After the clay in the plaster Paris cups is partially dry, the formed cups are taken out and placed in clay boxes which hold several, and moved in this way into a drying kiln, where after twenty hours of burning at a temperature of about 1800°F. the cups are taken out, cooled and packed for shipment.

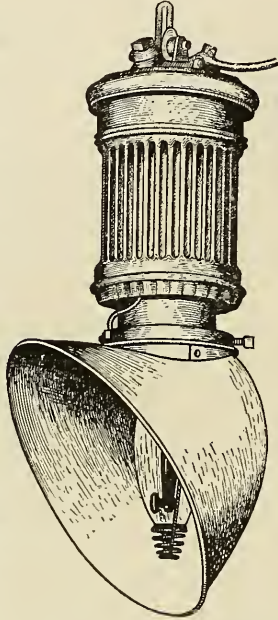

CONSTRUCTED TO THROW  
LIGHT THROUGH A  
WINDOW

## All in Thirty Years

Mr. Samuel Insull, president of the Commonwealth Edison Company of Chicago, in a recent address before the Electrical Trades Association gave some interesting statistics concerning electrical development in this country. There are in the United States, he says, 5,500,000 telephones in use, representing \$550,000,000 capital, or about \$100 for every telephone. There are in this country 40,247 miles of electric railways using 89,216 cars and capitalized at \$4,557,000,000. There are 6,000 central stations, costing \$1,250,000,000, earning \$250,000,000 a year and developing 2,500,000 horsepower. In all about \$6,000,000,000, Insull says, is invested in the electrical business in the United States. This is equal to about \$75 for every man, woman and child in the country—and all in 30 years.

## Telling Temperature in Bins of Grain

Grain stored in one large bin will often heat. A good many dollars would be saved if the temperature down in the grain could be known at any time. This has been made possible by the Zeleny thermometer. About ninety years ago it was found that two metals, such as bismuth and antimony, if heated while in contact would generate an

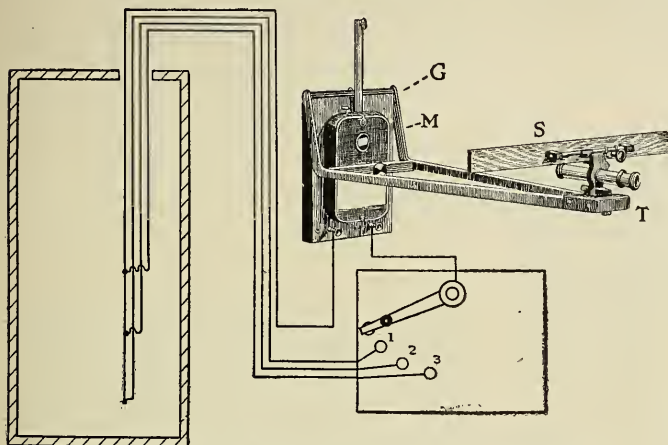

APPARATUS FOR TESTING GRAIN TEMPERATURE

electromotive force and this principle, that of the thermo-electric pile, is used in this device.

In the illustration one wire of nickel-copper is run in a conduit for protection down into a bin represented at the left. At various points taps are taken off with copper wire. An ordinary galvanometer and scale is placed on the wall near a contact board on which the wires terminate. When the lever is in the position shown, all the circuits are open and the scale (S) is moved so that on looking through the telescope the scale is shown, by reflection from the little mirror in the galvanometer. Then the lever is moved over to point (1), for instance, this places the galvanometer in circuit with one of the thermo-electric junctions down in the bin. A slight current will then flow through the galvanometer due to the heating of the junction and will deflect the galvanometer mirror so that the scale as you look through the telescope will appear to move over. The distance which it moves indicates the temperature of the junction, as the scale is calibrated to read in temperatures.

## Demagnetizing Watches

Very often an electrician or an engineer or even a visitor to an electric light plant discovers after a few days that his watch is losing a half hour a day, or more, from becoming magnetized by the dynamos. In the newer stations where the most modern machines are used there is not so much danger from these "stray" magnetic fields as there is around older types of machines.

The apparatus used by jewelers for correcting this trouble consists of an elliptical piece of soft iron with a hole in the center large enough to permit the watch to be inserted. Over the iron are wound a number of layers of fine insulated wire. Alternating current is sent through the wire and if there is none handy an additional device known as a polarity changer must be used with direct current.

With very little trouble and no expense anyone may demagnetize his own watch by a simpler method. Take a heavy thread or a light string about two feet long and tie the ring of the watch to it. Hold the string by one end and turn the watch around until the string is twisted about fifty turns. Allow the string to unwind and as the watch revolves pass it slowly back and forth about two inches above the fields of a motor or dynamo, not smaller than a quarter horse power, while the machine is running. Great care must be taken to keep the watch revolving constantly while it is over the motor.

## Sharpening Files

One of the tools often of service to the worker in the electrical line is a file. A very satisfactory though odd way to sharpen these tools is to clean them of all grease and suspend them from a metal plate in a bath of three parts of sulphuric acid, six parts of nitric acid and 100 parts of water. In the bath are also immersed several carbons connected to the metal plate. The file cavities only are eaten deeper so that the edges are made as sharp as if worked by a file cutter.

## Submarine Telegraph Cable

This sketch of a telegraph cable, which is one-half the actual size, gives some idea of the care taken in the building of such cables. Jute, which forms some part of the insulation, is made from the fibre of an East Indian plant. The twenty-three No. 4 wires serve for mechanical protection and strength. When we consider that this

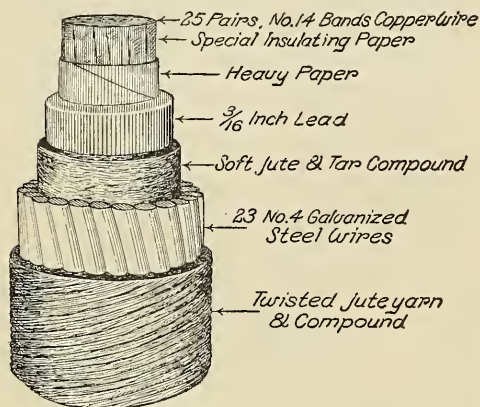

SUBMARINE TELEGRAPH CABLE

cable is made in mile lengths weighing twenty-six tons, it is surprising to know that the soft jute, the No. 4 wires and the twisted jute yarn are all put on at the same time. One test given this cable was that of applying 2000 volts electrical pressure between each current carrying copper wire of the core and all the others, and between all the conductors and the ground.

## Heating Pad as an Incubator

An interesting experiment in the use of electricity to hatch eggs was recently made by the Cleveland Electric Illuminating Company, Cleveland, Ohio, the apparatus being placed in its display window.

The "incubator" was very simple, consisting of an ordinary electric heating pad upon which were placed one dozen eggs, a small dish of water and a thermometer. A large glass dome was used to cover the "nest." In twenty-one days and a few hours eight little chicks were running around in a pen previously provided, and hundreds of people stopped at the window long enough to look and exclaim, "What do you think of that!"

## Electric Steels as Money Savers

As at present planned and conducted, electric smelting furnaces do not promise to reduce the general cost of steel. What they are doing, and will continue to do at an increasing rate, is this: they will produce a uniform product of much higher grades of steel at only slight advances in cost over the ordinary grades. Such high strength steels can be made and indeed have already been made by non-electric processes, but the electric furnace simplifies their manufacture and makes it much easier to obtain a uniform product. Then while the result may seem considerably higher in price per pound than ordinary grades of steel, it will prove cheaper for the same service wherever both strength and the cost of transportation are important items.

Thus, suppose you needed some steel wire strand to stand a steady pull of a thousand pounds. For quantity orders, you would find on the Chicago market four grades of galvanized steel strand on which the breaking strains and the costs per 100 feet (at this writing) are as follows:

Common Steel.....	1-2 inch	8500 lb.	\$1.35
Siemens-Martin.....	7-16 inch	9000 lb.	1.77
High Strength.....	5-16 inch	8100 lb.	1.62
Extra High Strength..	9-32 inch	10900 lb.	1.62

The last of these would weigh only a third as much as the first, hence for distant points the saving in freight would more than offset the difference in cost. Besides, the fittings used with it can all be smaller and the labor of installing it would undoubtedly be less. Wherever transportation is an important factor, the higher grade steels can easily mean a saving and the electric furnace will speed their economical production.

## The Telephone's Alertness

With the great strides in things scientific and their application to every day life, we become blind to some of the really marvelous properties of devices with which we are apparently familiar. Consider the small bar magnet, the little coil of wire, and the disk iron in the telephone. The delicacy of this little instrument is well shown by Preece who calculates that an audible sound is produced in the receiver by a current of .000,000,000,000,6 ampere, while Pellet finds that a sound is produced by a difference of potential between the terminals of the receiver of 1-2000 of a volt.

# ELECTRIC CURRENT AT WORK

*NEW DEVICES FOR APPLYING ELECTRICITY*

## Cutting Metals by Electric Arc

The use of the storage battery to run motors and supply current for lights is common, but to apply its energy, as was recently done with success, to cutting up sheets of metal where great heat is needed is quite unusual.

On the fourteenth floor of the Auditorium Building, Chicago, were some large wrought iron tanks 24 feet in circumference and 12 feet high. These tanks were a part of the

them. To dissemble them by removing rivets, would have caused too much noise, and also would have left the sections in too large pieces to go through the door of the passenger elevator.

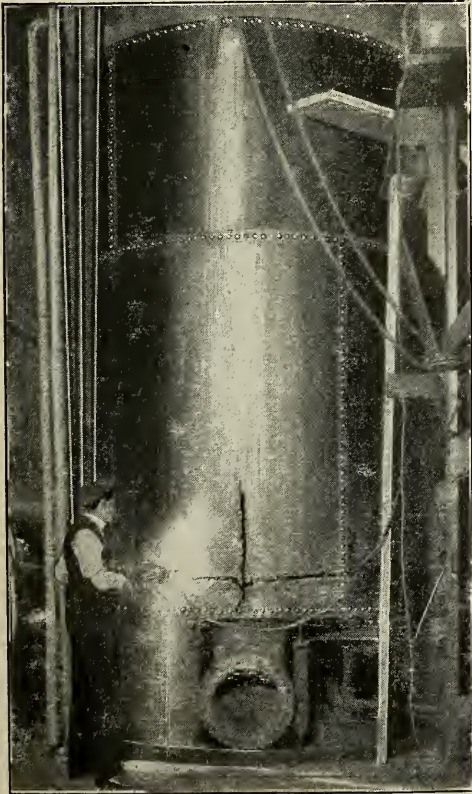

MAKING THE FIRST CUT ON THE TANK

hydraulic elevator system for which steam was substituted. The tanks occupied so much space that it was decided to remove

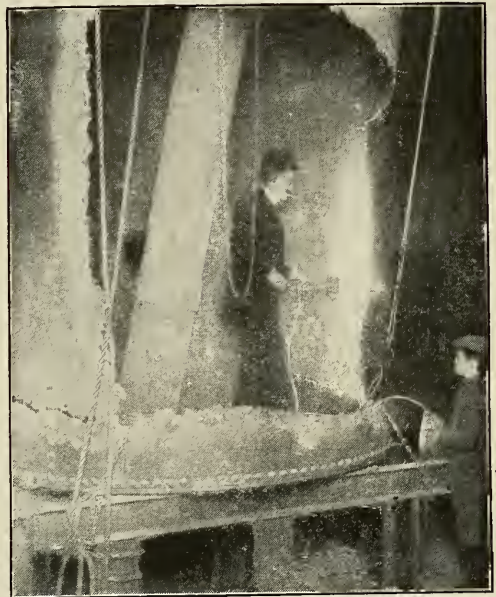

FINISHING THE CUT FROM THE INSIDE

It was finally decided to cut each tank into ten sections by using a carbon point electrode. This point was connected by a heavy copper cable to one terminal of a 40-cell, 150 ampere-hour, Jewell storage battery, of the Haschke type, so named after the inventor; the other terminal of the battery, which was temporarily removed from an automobile for the purpose, was connected to the tank itself. Then, when the carbon point was held to the iron of the tank, a fierce arc was formed which cut through the metal like a hot knife through wax.

The resistance of the circuit being very low the battery discharged at an enormous rate, 500 to 700 amperes, almost, in fact as if there had been a dead short circuit.

The arc was so extremely bright that it was necessary for the operator to wear colored glasses to keep from being blinded. One of the illustrations shows the first cut being made from the outside. A hole was bored straight through the  $\frac{3}{8}$ -inch wrought iron shell in four and one-half seconds. The second illustration shows the work being continued from the inside. Altogether, 465 running feet of cut was made in this way.

This method has also been used to cut I-beams in buildings where alterations were to be made and to open safes where the only one knowing the combination had died suddenly.

### Electric Crane to Carry Locomotives

One of the most thrilling sights to the visitor in a locomotive works is to see the electric crane come spinning down the ways, pause for a moment over a giant locomotive weighing perhaps a hundred tons, lower away the grappling hooks and chains, lay hold of the monster and raise it as if it were a billet of wood, and hurry off with it to some other part of the shop.

The illustration is a view in the shops of the Southern Pacific Railway in Bakers-



SAFE DOOR PUNCTURED BY ELECTRIC ARC

field, Cal. The crane is of the Whiting type, with a capacity of 120 tons. In this case it is working in the boiler shop, but it would be capable of lifting the completed locomotive just as easily as it does the boilers.

The span of the crane is 57 feet  $4\frac{1}{2}$  inches, with a lift of 23 feet 7 inches. It is driven by two 60 horse power motors.

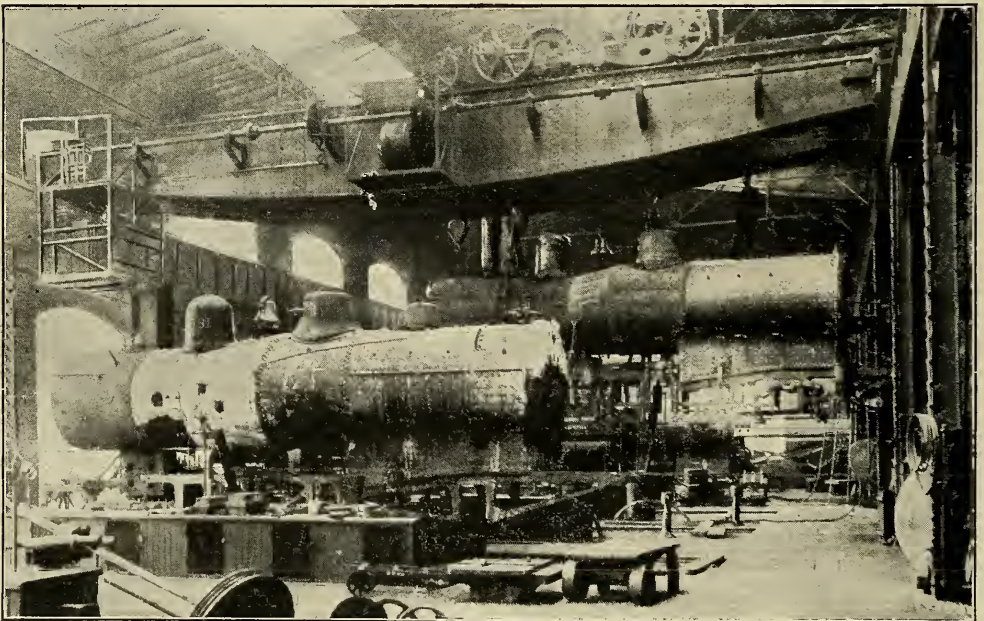

ELECTRIC CRANE CARRYING LOCOMOTIVE BOILER



### Portable Power Elevator

Piling heavy bales and boxes in warehouses requires hard manual labor, especially where the ceilings are high, and it is not an unusual thing to find stock roughly handled or poorly piled. The Economy electric tiering machine consists of a platform raised and lowered along metal posts

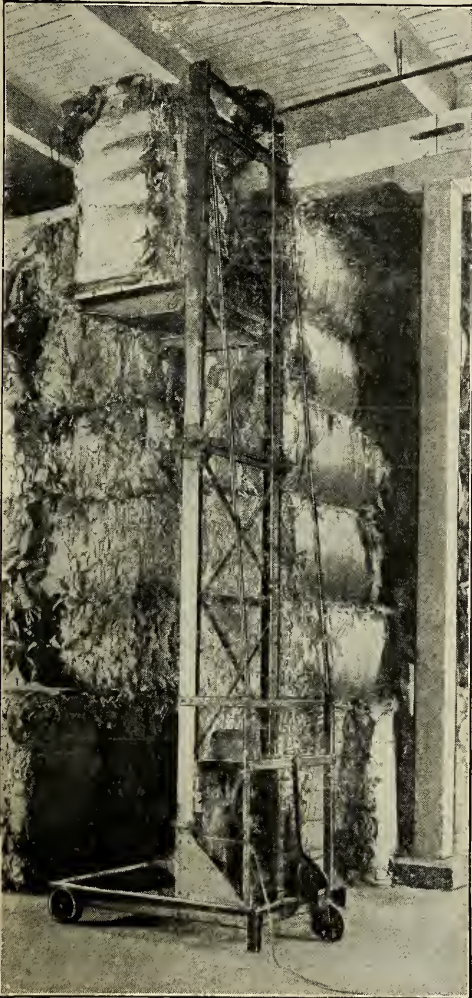

PORTABLE POWER ELEVATOR

by a motor. The machine on wheels is pulled along to the place needed and stock is placed on the table and lifted to the top of the pile, 2000 pounds being a load. A heavy cable and plug connect the motor to the power circuit. The machine in the picture is being used to pile large bales of waste paper.

### The Storing of Electric Heat

In the April, 1910, issue of POPULAR ELECTRICITY brief mention was made of the device of G. G. Bell, a London engineer, to store up the energy of electric current so that it might be available for use at any time. By its use it would be possible for the electric power companies to furnish

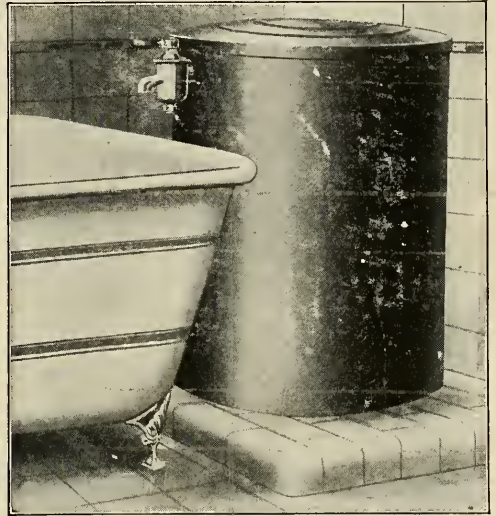

FIG. 1. BELL'S HEAT STORING DEVICE

current to residence consumers on a more economical basis, owing to the fact that the current could be supplied at a constant rate during the 24 hours or else, if desired, at low load periods of the day. As it is now, the householder is likely to demand current at the very busiest part of the day and aggravate that troublesome factor known as the "peak load." Thus the central station must charge the consumer a little more for current to make up for this "readiness to serve" feature of its service. You say you do not exactly understand why this is. Well suppose you and one thousand other householders begin using your electric cooking apparatus at six o'clock on a winter's day. This is the time when lights are going full blast all over the city, the central station machinery is taxed to its utmost at that time. In order to get you and your neighbors for customers the company had to install more machinery in order to be ready to serve you when everyone else was being served. It could have taken care of you nicely without additional expense if it could

have known that you would not take any current during the peak load.

It is just here that the advantage of a heat storing device would lie and Mr. Bell's invention, of which we are now able to show some illustrations, contemplates such a system, Fig. 1 being an external view.

It will be noted by the drawing, Fig. 2, that the apparatus consists of a central

nary manner, and, by means of a simple arrangement, a proportionate amount of electric current would be automatically cut out of the electric heater retaining the total load at 200 watts, say, if adjusted for that amount. Thus the consumer may use 200 watts continuously throughout the day instead of, say, nothing for several hours in the day and then five or six hundred watts for short periods at other times in the day, in the latter case very probably, when every one else on the system is using a large amount also.

### Electricity Produces Mountain Air

Nature constantly vitalizes out-door air by sunshine, winds, rain, snow and electrical discharges. The peculiarly fresh, invigorating, pure, sweet and wholesome air after a thunderstorm is due to the ozone produced by the electrical discharges.

Ozone, from the scientific standpoint, is considered as an allotropic form of oxygen, "condensed oxygen" if you please. The ordinary form of oxygen contains two atoms

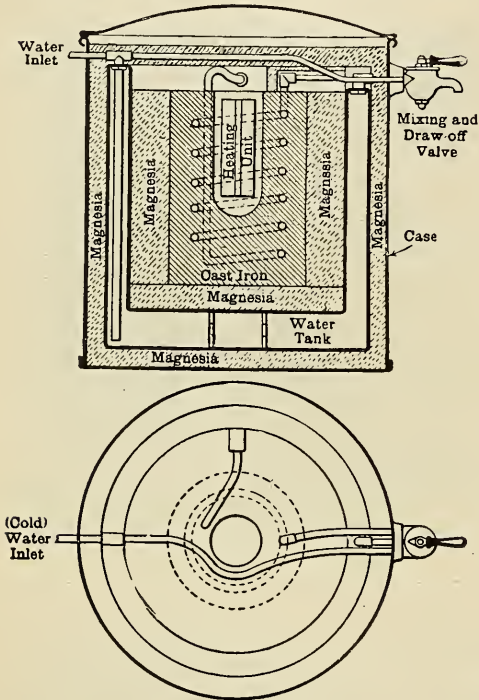
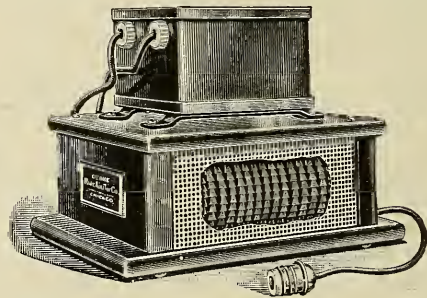

FIG. 2. SECTIONAL VIEW OF HEAT STORING DEVICE

block of iron with a coil of pipe cast within and an electric heating unit located in an opening in the center. The cast iron block is embedded in a covering of magnesia two inches in thickness, a water reservoir being located between the latter insulating covering and the outside shell or casing of the device. The water is passed through the coil of pipe in the cast iron block absorbing the heat from the latter when hot water is desired for domestic uses. The block of iron absorbs the heat from the electric current which is flowing continuously in the heater elements.

If a consumer desires to use the electric current for other purposes than producing hot water for cooking, etc., he can switch on his electric light or a motor in the ordi-



OZONE GENERATOR

to the molecule. The chemist represents it by the symbol  $O_2$ . Ozone, on the other hand, which is made out of oxygen by electrical processes, contains three atoms to the molecule,  $O_3$ . Ozone molecules, however, are very unstable. They want to get back to the oxygen form as soon as possible, and that third atom of oxygen in the ozone molecule, which feels it doesn't belong there, is on the lookout to combine with something else. Sometimes it combines with another restless atom in another ozone molecule, or else it seizes upon and oxidizes (burns) the carbon of which bacteria are known to be largely composed.

Knowing these things the scientist said: "Ozone must be a powerful germicide."

And sure enough experiment proved that it was. Then inventors set about devising ways to produce ozone for this specific purpose and one of the results is an electrical machine known as the Ozone Pure Airifier which is made by the Ozone Pure Airifier Company, 307 Rand-McNally Building, Chicago.

The small generator here illustrated, which is only 11 by 8 by 8 inches, when attached to an electric light socket, furnishes a sufficient supply of ozone properly to ozonize a bedroom or sick room, practi-

cally insuring the occupants of the room a refreshing night's sleep; in fact, no better condition of ozonized air can be procured at the seashore, pine woods, in Colorado or at the Adirondack mountains.

It practically imitates the action of a thunderstorm on the outside, right in the bedroom, home, office, store or factory, at an expense of only a fraction of a cent per hour. The revitalizing principle of the ozone makes it a preventative as well as a corrective of such conditions as hay-fever, asthma, catarrh, insomnia, nervousness, tuberculosis, fevers, etc.

While the small size or bedroom machine, only, is illustrated, the generator is made in various capacities up to that required for the very largest buildings.

### A Ton at a Time or One

Nothing could show much more forcibly than this illustration the difference between

old methods and new. Pig iron is pretty heavy stuff and it takes a lot of tedious, back-aching labor to unload a car of it in the old way, by hand. The modern method is by the use of the electro-magnet attached to a crane, which will pick up a ton of the heavy pieces as easily as a man could one.

It is said that the ordinary cost of handling a ton of pig iron by hand labor is from five to eight cents, depending upon the "carry." The lifting magnet will do the work for half a cent per ton and isn't half as apt to go on a strike.

When current is turned on the magnet literally grabs a mouthful of the iron chunks. The instant the current is switched off the magnetism departs and the magnet drops its load.

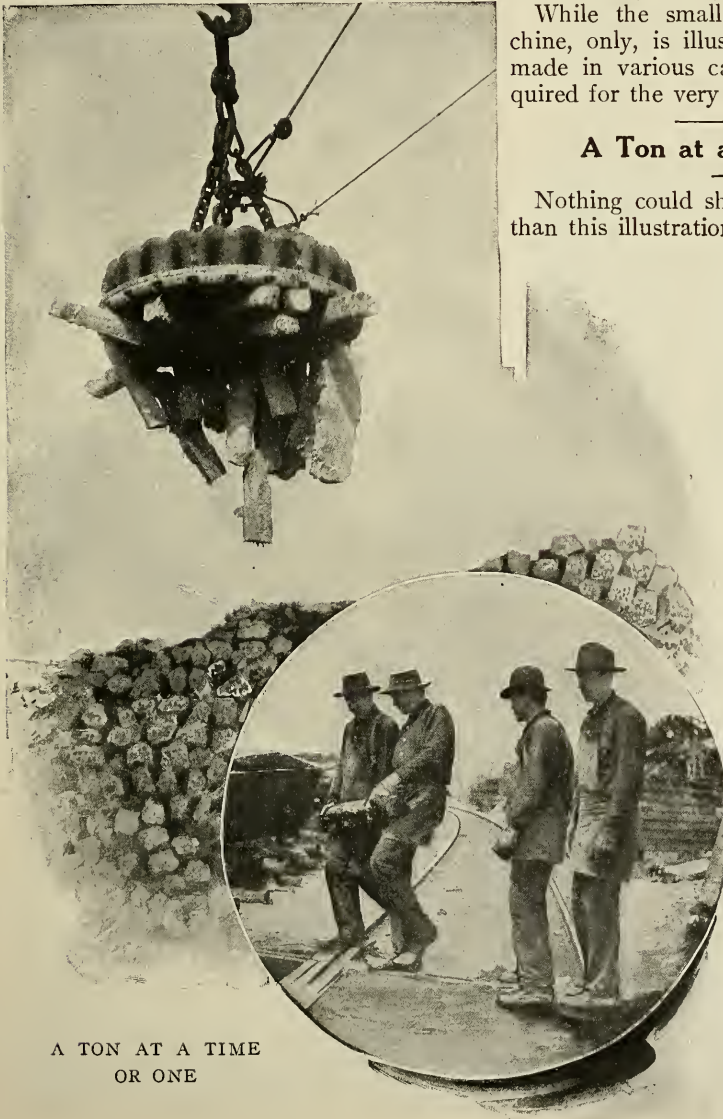

A TON AT A TIME  
OR ONE

### Simplicity the Keynote

One hears on all sides these days of the wonderful strides that have been taken in the application of electricity as a means of power distribution and of the immense business the large electrical factories have developed in supplying the demand for motors. One glance at the two accompanying cuts will show a potent reason for this development more vividly than reams of written matter.

The views are in the "picker" room of a modern cotton mill. The upper view shows the old method, transmitting the power by many belts and shafts; while the lower one shows the new way with a five-horsepower motor on each machine. Is it any wonder

the mills and factories are discarding the old for the new?

### Testing a Cable

The man with the fishpole in the picture opposite is locating trouble in a lead-covered telephone cable. It may be a ground or a short circuit, but just where the fault is the telephone receiver which the trouble man is holding to his ear, will tell by its behavior.

The outfit consists of a high frequency vibrator and battery located at the office or at some point on the line where the wires in trouble can be reached. The terminals of this vibrator are connected to the wires to be tested, which must have no current on them at the time except that supplied by the vibrator and dry cells. On the upper end of the fish pole carried by the man who goes out along the line is a coil of wire called a detector which is connected to the telephone receiver which he holds at his ear by a pair of wires down the pole, this part of the outfit working on the principle of the secondary of a transformer. As the trouble man follows the cable along closely with the coil carried by the pole the receiver con-

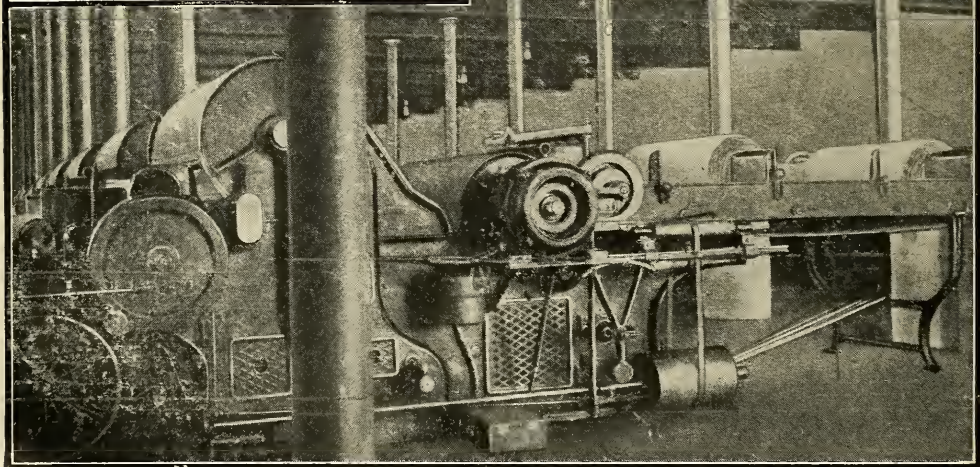
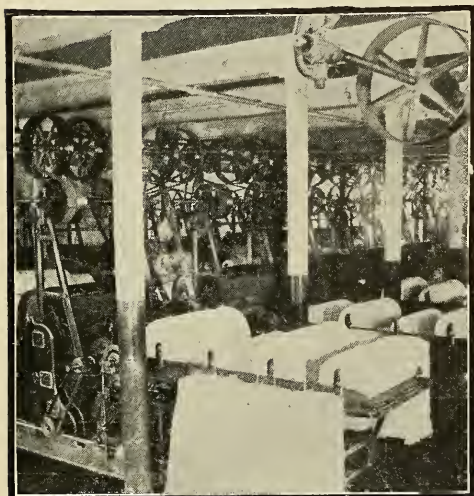

"PICKER" ROOM IN A COTTON MILL BEFORE AND AFTER MOTOR DRIVE

tinues to "howl" like the electric auto-horn, from the effect of the current, which flows from the vibrator along one wire in the cable, across the short circuit and back to the vibrator.

When the coil carried by the pole passes the short circuit it, of course, then leaves behind the two wires in which the vibrator



CABLE TESTER AND METHOD OF OPERATION

current is flowing, and consequently the receiver becomes quiet. The tester is thus able to tell within a few inches where the trouble in the cable lies.

In testing for grounds in conduits or cables one side of the vibrator is connected directly to the conduit or to the cable sheath in which the trouble exists and the other side to the

faulty wire. By placing the detector coil close to the conduit or sheath and parallel to it the tone can be heard, but not loud, except at the outlets, where it is very distinct.

### An Electric Pyrometer's Record

Here is a piece of the "tell-tale" marking which is continuously done by an electric recording pyrometer. In this case the recording instrument was in the superinten-

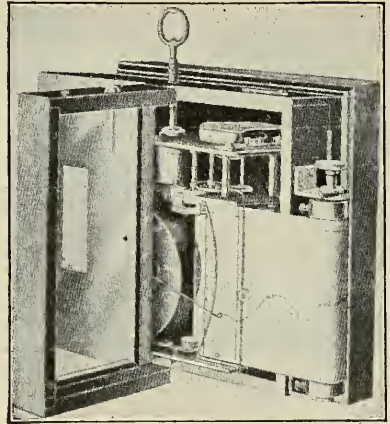

ELECTRIC PYROMETER

dent's office, quite a distance from the furnace to which it was electrically connected. This furnace was intended to be kept at an even temperature of 1440°F. and the attendant

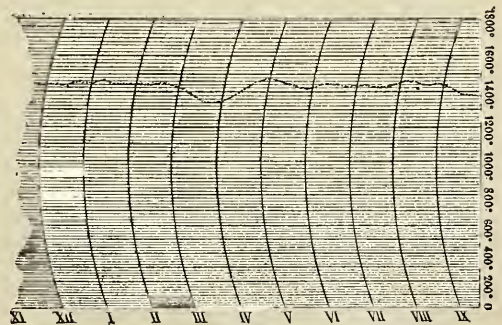

PYROMETER RECORD

did well from midnight until nearly three o'clock. Then he seems to have dozed off, for the chart shows a decided drop in the temperature, followed by some excess over the normal. It is such variations that often spoil the whole charge and a visual record

of this kind not only forms a check on a negligent attendant but also gives due credit to the watchful one.

### Electrical Anesthesia

For minor operations, the nerves may be made insensible to pain by subjecting them to a mild but intermittent, direct current—not an alternating current which con-

### Electric Welding Saves Heat

Compared with the various non-electric methods of welding or brazing metals, the electric welding process shows a wonderful saving in the amount of heat needed, since it concentrates the heat right on the spot where it is required. All blowpipe or torch methods scatter a large share of the available heat while incidentally applying some at the

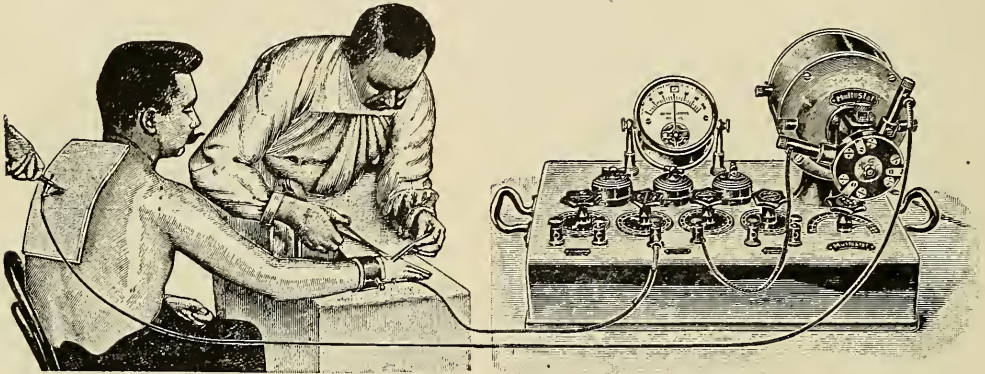

PERFORMING AN OPERATION UNDER ELECTRICAL ANESTHESIA

tinually reverses its direction, but a current flowing steadily in the same direction and interrupted at regular intervals. The action is claimed to be strongest with about a hundred interruptions of the current per second and with the current left on for about a tenth of each period, that is for one thousandth of a second after each interruption.

In the apparatus as illustrated, the current interrupter consists of a small motor driving a split ring on which the contacts are adjustable as to their distance and therefore as to the length of each current pulsation. Adjustable resistances allow the current to be varied, its strength being indicated by the milliammeter shown just to the left of the current interrupter. The strength of current needed varies both with the individual and with the extent of the nerve exposure that is to be deadened. Generally two milliamperes (.002 amperes) are sufficient for producing a concentrated local anesthesia. The terminals are applied to the nerve which is to be rendered numb, the positive electrode being usually applied to the corresponding spinal nerve center.

right point, but not so with the electric welding process. In many kinds of work the man operating the welder can even hold the metal pieces right in his hands while

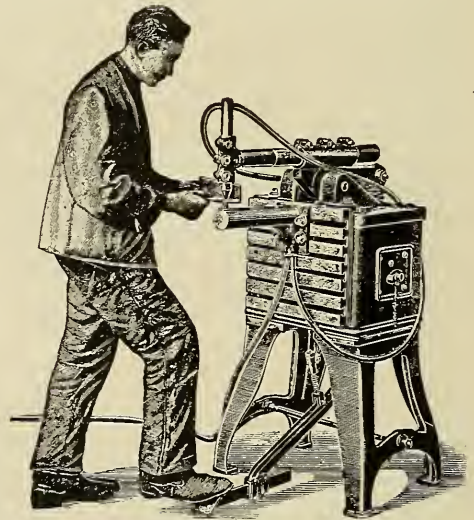

OPERATING AN ELECTRIC WELDER

he uses a foot lever to turn the current on and off. Of course the metal parts will

conduct the heat to his hands if he holds them long enough, but before this happens he is through with the weld and has passed it to a cooling rack.

Incidentally the greater coolness makes a big difference in the rate at which the operator can work as compared with the chemical or flame methods which waste so much of their heat on the adjacent metal parts and on the air of the room. This is particularly true in summer when the man who welds by electricity can profit by the zephyrs from an electric fan which would be barred in the other cases as the draft might interfere with the directing of the flame.

### Electric Gate Opener

Besides using electric door openers, much as we do in our modern apartment houses or even in ordinary flat buildings, our British cousins have adapted the same to the unlatching of garden gates. These gates are often at quite a distance from the house, so that it would take too much current to have the battery itself operate the

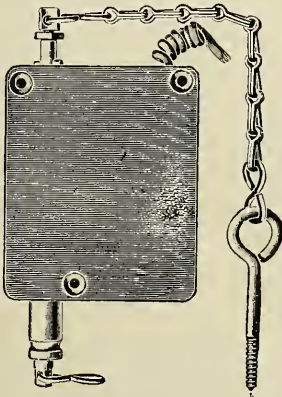

ELECTRIC GATE OPENER

latch. To save the battery power, the locks are arranged so that the magnet merely moves a pawl or catch, whereupon a strong spring moves the latch itself. The screw eye shown in the cut is screwed into the jamb of the gate so that closing the gate pulls the chain taut and rewinds the spring. Of course the lock itself is weatherproof and the wire is either carried under the walk or run inconspicuously along the garden wall to the house.

### Before Porcelain Insulation

While porcelain was used in the shape of knobs for supporting wires even on the earliest electric light installations, the art of making porcelain in difficult shapes with any uniformity in size had not yet been learned by the porcelain makers. The one material that at that time could be easily worked into any desired shape and that gave some insulation, was wood and this was promptly utilized on the pioneer work

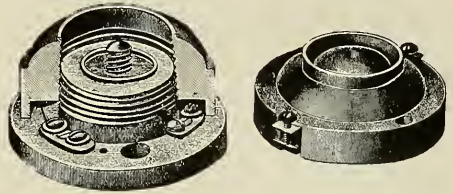

EARLY WOOD FIXTURES

throughout the country. Indeed, instead of being confined to crude and homemade products for which its use was quite excusable, it formed the insulating parts of devices made by the tens of thousands in nicely finished forms. Thus Keyless Wall Sockets (corresponding to what we now call receptacles) were made with a short wooden shell which was screwed on the base part and covered the binding screws to which the wires were attached. Ceiling rosettes were also made of wood, sometimes with metal clips for the wire terminals right on them so that the wires could be connected to the lamp cord at the rosette.

The sight of these wooden devices with the bare wires right on the inflammable wood may make the modern inspector shudder, for it meant a steady risk of fire and indeed was responsible for many of the fires that were actually traceable to electric wiring. By the time this serious objection to the use of wood as an insulation was clearly proven, the porcelain makers had begun to duplicate one after another of the wooden shapes in a safer material, so that wood played the part of both a makeshift and an educator. Today wooden sockets or rosettes such as we are picturing would be hard to find even in towns that have gone backward, but the cuts will interest those who like to trace the influences that helped in the early stages of electric lighting

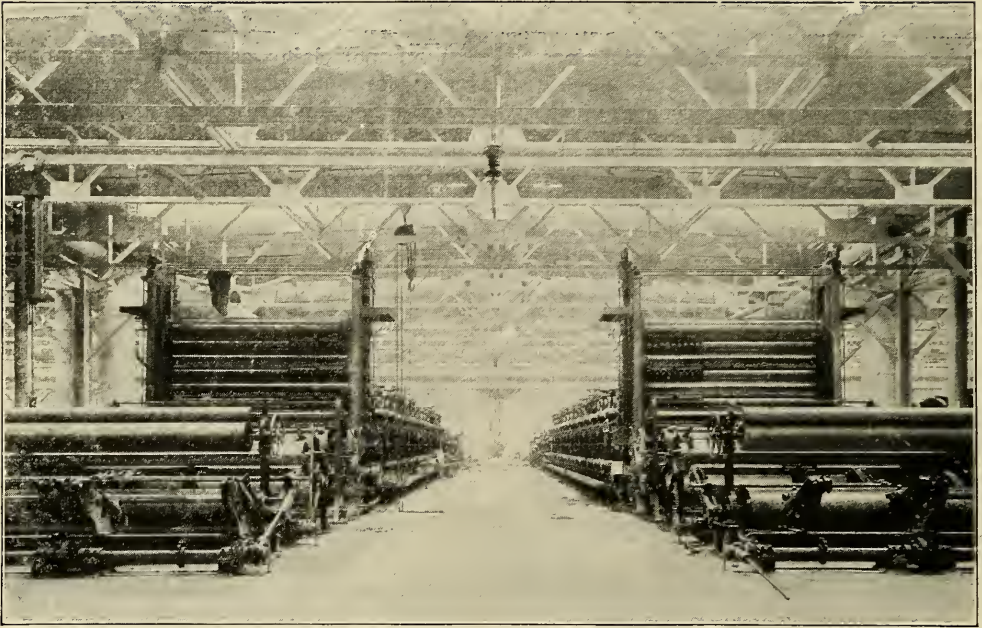

A LONG ROW OF METAL CYLINDERS, DRIVEN BY MOTORS, FINISH THE PAPER

### Paper Making with Electric Power

Many changes in the making of paper have taken place since the ancient Moors over in Spain first manufactured it from cotton. The people across the Mediterranean changed the method a little by using rags because cotton could not be easily obtained, and today although we use rags, too, we also grind up wood and run the machines by electricity.

White pine or poplar wood is cut into slabs and ground on heavy millstones, then conveyed to tanks where acid and live steam reduce it to pulp. Next it is washed, screened, worked on by the "beaters," mixed with resin, clay and the required coloring matter to make the paper desired, after which it goes to the wet end of the paper machine to be now transferred to the drying rolls shown in the illustration. These rolls and in fact all of the machines of the United Box and Paper Company near Lockport, N. Y., are operated by electric motors. The long row of metal cylinders are heated by steam and gradually dry out the paper as it passes from one set to the next until finally it emerges finished and is wound into rolls for facility of shipment.

### Electric Driving Increases Output

Actual tests recently made in a cotton mill in which electric motors at each loom had been substituted for the old rope drive showed these results: In all thirty of the looms the speed had been increased a little over nine per cent, but owing to the freedom from the jerking which comes occasionally with all belt or rope drives (as when the joint passes the pulley of the machine) the increased speed did not add to the breakage of threads. This higher speed in itself would increase the output a little over 9 per cent and the ability to start and stop each loom more quickly than before without snapping the threads showed a still greater increase in the working capacity per day. With the 30 looms tested it was found that with the old method of driving them the unproductive time (that is, the time during which the looms were standing still) plus the time consumed in starting and stopping them was 40 per cent of the total working hours. The adoption of electric motors as individual drivers for each loom reduced this to 26.4 per cent. The power consumed by the same looms was  $4\frac{1}{2}$  per cent less than before and the output was increased by 15 to 20 per cent for different classes of work.



### The Latest Taxicab

The type of automobile shown in the photograph is an electric taxicab which has been undergoing exhaustive tests in the taxi service of Boston. So far the experiment has proved a marked success and it is more than probable that Boston will be one of the first cities in the United States to have electric cab service.

The taxicab company of Boston after considerable investigation picked out a type as shown in the picture to suit their specifications and decided to test it. This was done by giving it the same service as the ordinary taxicabs were and comparing the results. So far the test has been an entire success. The cars are charged at night, and while good for 75 to 100 miles on a single charge, they are rarely run over 50 miles a day, so that charging once a day is ample. They have required less repairs than the gasoline cars and the "mechanical

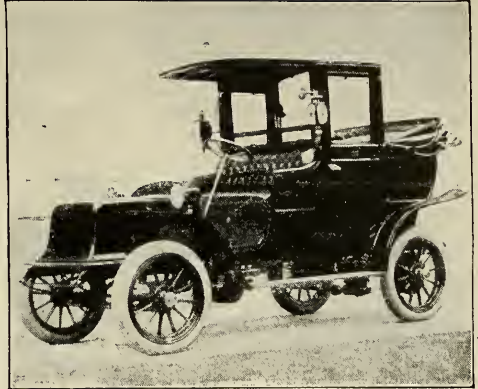

ELECTRIC TAXICAB

care necessary for keeping them in running order is greatly reduced," to quote the words of the man in charge of the tests.

Altogether it is probable that the Boston company will gradually replace their machines with electric taxicabs.

### Getting the Time in Races

If five or six men with stop watches try to get the exact time of a horse race or automobile race, it has been found that they will vary as to the time taken, an average being the only way to decide the matter.

After the automobile races at Indianapolis last August, where various methods were tried out, Mr. C. H. Warner, Beloit, Wis., set to work to devise some better way to

record time, the results being shown in the picture. This instrument is called a horo-

graph. It consists of a small enclosed motor at the left, on the shaft of which are four wheels containing type which at the proper time print upon the strip of paper just above, and over which runs a type-writer ribbon. The first wheel indicates hours, the next minutes, the third seconds and the fourth hun-

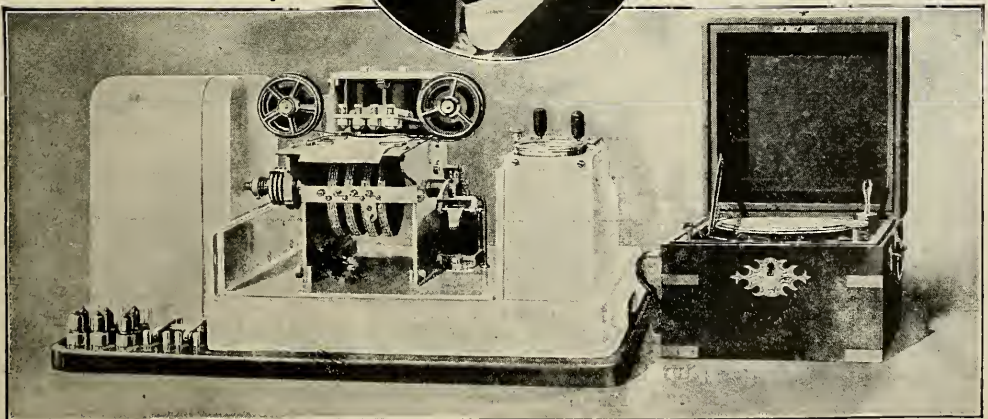

THE WARNER TIME RECORDER AND ITS INVENTOR

dredths of a second. Between the ribbon wheels are shown a pair of magnets which operate the four little hammers that crowd the strip of paper against the type wheels. When in use the motor is started, while the electrically connected clock on the right by proper clutches keeps the wheels under the paper in position to record the hour, minute and second. A wire across the track is connected to a trap which is operated by the shock of the automobile hitting the wire (not by the strain on the wire) so as to close the contact in the magnet circuit. This causes the magnets to throw down the four little hammers, thus printing the time, opposite which is written the name of the car. A similar operation records the finish.

### Candelabra Switch

The accompanying "phantom" view shows the arrangement of the Cutler-Hammer

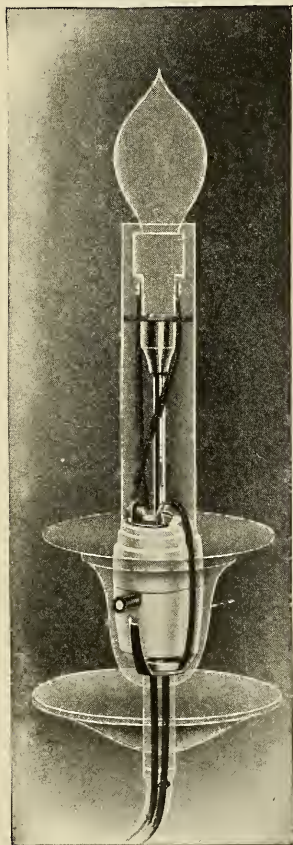

"PHANTOM" VIEW OF A  
CANDELABRA SWITCH

candelabra switch designed for controlling electric candelabra lamps. At the bottom is seen a porcelain body, held in the candelabra base by prongs, which contains the switching mechanism. Pressure on the little push bar shown at the side of this porcelain element turns the lamp on. Pressure on the other end of the bar, which projects on the other side of the porcelain, turns the lamp off. The lamp itself is carried on a socket stem which projects up through the candle-shaped body, the wires being connected

as shown. The principle is applied with equal advantage to various forms of canopies, bracket lights, etc.

### Stone and Marble Cutter

Drilling, cutting and carving of marble and stone has heretofore been done by

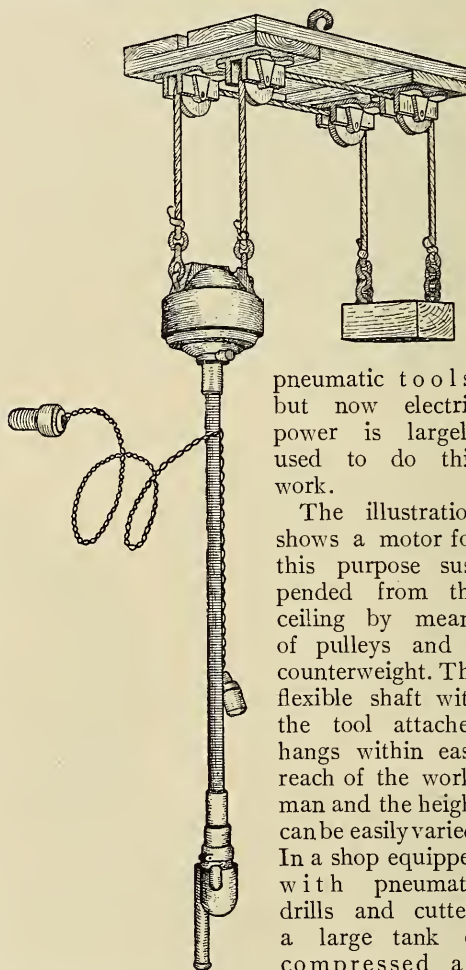

STONE AND MARBLE  
CUTTER

pneumatic tools, but now electric power is largely used to do this work.

The illustration shows a motor for this purpose suspended from the ceiling by means of pulleys and a counterweight. The flexible shaft with the tool attached hangs within easy reach of the workman and the height can be easily varied. In a shop equipped with pneumatic drills and cutters a large tank of compressed air must be kept supplied from a compressor even when only one or a few tools are being used, while with an electric tool the pendant switch hanging alongside the shaft allows the motor to be stopped when the tool is not in use. Foster & Hosler, Chicago, who make this device, state that 5400 blows a minute may be struck and that the vibration so common in pneumatic tools is greatly reduced.

# Electrical Men of the Times

H. M. BYLLESBY

Many men find their hands full in directing one public-service utility, but Henry Marison Byllesby, whose portrait appears on this page, is connected in various responsible capacities with no less than thirty-one public-utility corporations widely scattered throughout the United States. Nearly all of these enterprises are large and important, and of course Mr. Byllesby does not immediately supervise the many details involved in the operation of these properties. He does the work through an engineering organization in Chicago which he has built up, and which, in the character of men engaged in it, in high-class, clear-headed work, in esprit de corps and effectiveness per human unit, and in size, is quite an unusual aggregation of men working toward a common end.

Mr. Byllesby is a clergyman's son and was born in Pittsburg 51 years ago. He was educated at the Western University of Pennsylvania and at Lehigh University, being in the class of 1878 at the latter institution and taking the course in mechanical engineering. From 1881 until 1885 he was on the engineering staff of the old Edison Electric Light Company of New York. He is one of the group of early associates of Mr. Edison who are now directing large affairs. He made the drawings for the historic Pearl Street electric light station in New York city and installed plants and electrical works in Canada. During this period also he had charge of the notable electric-lighting displays at the Louisville, St. Louis and New Orleans expositions. These were perhaps

the largest intallations made up to that time.

From 1885 until 1890 Mr. Byllesby was first vice-president and general manager of the Westinghouse Electric Company and managing director of the Westinghouse Electric Company, Ltd., of London, England. When he went with these companies the alternating-current electric system was little more than a laboratory experiment. Within ten months he had equipped the shops

in Pittsburg and was turning out a full line of alternating-current apparatus. Next Mr. Byllesby turned his attention to the operating field, and early in 1891 he became president of the Northwest General Electric Company of St. Paul—a central station organization. He established the present business of H. H. Byllesby & Company in Chicago in 1902.

The career of Mr. Byllesby has been an exceptional one; he is an all-around electrical man. Not only is he an engineer,

central station operator, a business administrator and a financier, but he is an inventor as well. Thirty-six patents relating to electrical apparatus have been issued to him.

In 1882 Mr. Byllesby was married to Margaret Stearns Baldwin, daughter of H. B. Baldwin of the New Jersey Central Railroad. His residence is in Chicago, with a summer home, "Arrowglade," at Lake Geneva, one of the most beautiful lake resorts in Wisconsin. He is a member of many technical societies and also president of the Chicago Civic Federation.



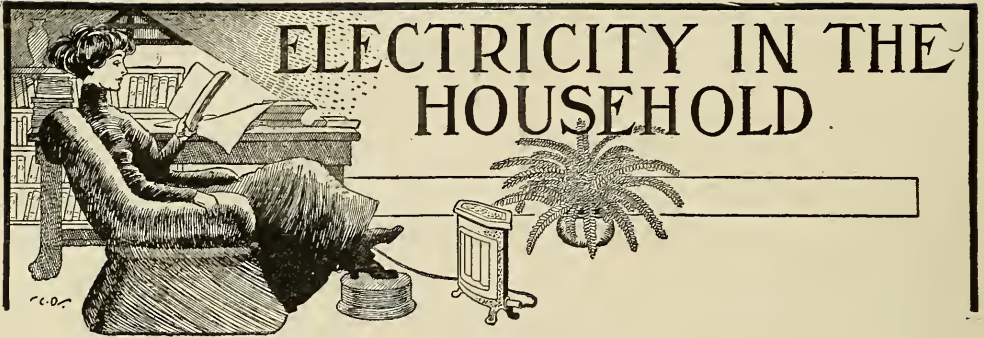

## Speaking of Wash Day

Perhaps you may think you cannot afford to buy an electric washing outfit. If you are good at figures, however, you may easily prove to yourself that the seemingly rather

large first cost is really an investment which pays good dividends. Take a pencil and paper and calculate how much the weekly wash costs you in a year, figuring in the



THE ELECTRIC LAUNDRY COMPLETE

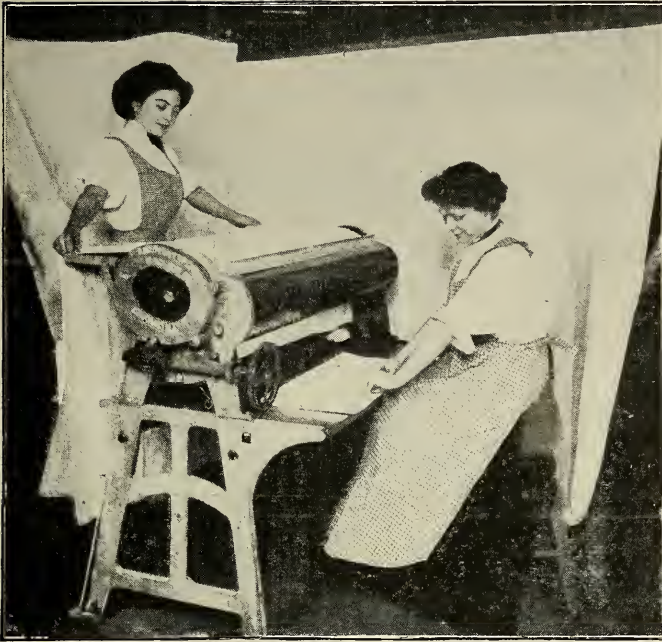

WORKING THE MANGLE

wages of the woman who comes in on Monday and Tuesday to do the washing and ironing, or add up the laundry bills for a year, if you have all the work done in that way. Take into consideration also the annoyance of having the help fail you at the critical time, the natural depression of "Blue Monday," and all the other things which have come to make "washday" the bugbear of the housewife for so many generations.

Now balance up against these things the cost of an electric household laundry outfit and the cost of the current needed, which is but a few cents an hour while the machines are actually working. The Monday work, which with the aid of the electrical apparatus becomes insignificant, you are now able to perform yourself, thereby saving the wages of a laundress. The result of your figuring will be all in favor of the electrical method and the machines, which will last for years, will be found to pay for themselves many times over.

Taking as an example the outfit of the American Ironing Machine Company. It embodies a motor driven washing machine and wringer and an electrically operated and electrically heated mangle. One of the pictures shows the whole equipment

fitted with overhead drive although the machines are also made with individual motors, which latter are perhaps a little more neat in appearance.

Have you ever stopped to think what a few cents' worth of electric current turned into an outfit of this kind will do for you? The washing means only the work of putting the clothes into the machine, and then, when they are done, of steering them through the wringer. The ironing consists only of handling and folding the clothes after they have passed through the rolls. Washday then becomes "wash hour" and arrangements for the operation need not be made for any set day in the week but for such time as may best suit your convenience.

### Electric Traveler's Iron

Of course, when you have been traveling you have at some time been confronted with the problem of getting certain articles of apparel pressed out into shape to wear right away. In a hotel if you send these things out, even if accompanied by tips and many admonitions to hurry them through, you are likely to sit and do a lot of fidgeting before you see them again. An electric flatiron among the things in your luggage would then be a welcome friend. But perhaps you have neglected to put it in because it is a troublesome thing to pack and you're afraid it might get to sliding around in your trunk and tear things up like the old time cannons in a man-o'-war when they broke away from their moorings and went careening about the decks.

The American Electric Heater Company suggests the idea of furnishing an electric iron in a neat velvet lined leatherette case. It is easily packed and at the same time the iron is kept away from dirt and moisture when not in use. Many women prefer to have their regular household irons put up in this way.

# At the Chafing Dish Luncheon

By FLORENCE LATIMER

Having recently attended a unique little luncheon, I am going to tell you about it while it is fresh in my mind and because I know that for the readers of this department the "magic button" has as much charm as for me.

The hostess had been worrying herself almost sick trying to devise some inexpen-

about the dining room helping to prepare their own lunch.

Another thought that beat the other "all hollow" was this:—If things aren't good I'll never know it, for after preparing them they'll declare that they never tasted better, and what's better still, they'll really think so. Just like a friend of mine who, when she

was a little girl ate a mud pie, just because she made it and the children dared her to. She crossed her heart and "hoped to die" if it wasn't good, and do you know, to this very day she almost believes it was good.

So this woman felt intuitively that an electric chafing dish would be her salvation. Her invitations were written under her name on her regular calling cards something like this—"Luncheon, One o'clock April 7, 1910—Reply." These were fitted to tiny envelopes, ad-



We Were Eager to Begin

sive way to entertain a few ladies to whom she felt under obligation. I know that sounds terrible, for, of course, our friends wouldn't want us to feel that way about it, but all the same we do have a queer sort of feeling about always accepting and never entertaining, and that was just the way she felt. She was greatly handicapped in the beginning by having no maid. But suddenly it dawned upon her that she possessed what was infinitely better than any servant "an electric chafing dish, percolator and toaster." Simultaneously came the thought "a chafing dish party." Not the ordinary one where spilled alcohol prevails, but an electric party. Why not? And then came visions of ladies in dainty aprons flitting

dressed and posted.

Seven ladies, myself included, accepted and were there promptly at one o'clock to be welcomed by a smiling hostess, who invited us into her dainty bedroom and contrary to the prevailing style asked us to remove our hats. My but I was glad, for I had a splitting headache and, of course, forgot and said so.

"My dear girl," she said, "how does it happen that you have a headache?" You must know that electricity is a panacea for all pain."

In a moment she brought forth an electric vibrator which she quickly adjusted to a lamp socket, applied it to my temples and then at the back of my head and (whether

you believe me or not) my head was well in five minutes. Think of it. I certainly mean to have a vibrator.

Each of us was provided with the dearest little chafing dish apron, made of two Japanese napkins—of daff-o-dil design (that being the flower she used for decorations, etc.). Then we were ushered into the dining room.

The table was a round one, and dainty doylies took the place of a table cloth, a tall vase of daff-o-dils adorned the center and two highly polished electric chafing dishes (one of them borrowed, of course,) a percolator and a toaster were arranged around the table about equal distances apart.

There was a dish of iced olives and one of pickles, besides some dainty peanut-butter sandwiches, salt and pepper shakers, forks and spoons and all the ingredients with which to prepare the following menu: Oysters fried, creamed asparagus on toast and delicious coffee.

We laughed and all declared we felt as eager to begin as when little girls we were allowed to cook "taters" on a brick stove in the back yard.

We chatted as we made good things to eat—two ladies to each device—and in a few moments everything was ready. Good? Well I should say so. No make believe about an electric chafing dish.

We had vanilla ice cream served in tiny, new flower pots. On top was a liberal sprinkling of grated chocolate to resemble earth, and stuck up in the middle of each flower pot was a single daff-o-dil. We certainly enjoyed every moment of the time and almost before we knew it the afternoon was gone.

We were much interested in all electrical things, and I have often wondered why so few of us, comparatively speaking, take advantage of electric current—a power that creates neither heat, odor nor dirt. I am happy to know, though, that some women are making use of its wonderful advantage in making housework, if not a real pleasure, at least less like the drudgery of the past.

Before the party broke up we all agreed to pay a visit in a body to the Electric Shop as soon as moving season was over, and make a study of all the new types of electrical cooking utensils that have been developed so wonderfully and put upon the market of late.

## Connecting Cooking Devices

There are many women who are very cautious about using electric household devices, and still others who delay buying such convenient kitchen appliances as coffee percolators, chafing dishes, bread toasters and the like because they have an inexplicable feeling that electricity is something to be feared. With the present methods of putting electric wires, fixtures and sockets in buildings and the care used in constructing house-



QUICKLY AND SAFELY CONNECTED

hold devices it is entirely unnecessary to get into this state of mind. Even if one were to touch the inside of a socket nothing more than a sharp tingling sensation would be felt and no bodily harm would result. So let us get away from the fear of a danger, which, after all, is only apparent. Electric cooking utensils are provided with means, such as the Hubbell attachment plug, for instance, of connecting them quickly and safely to the lamp socket.

## Women Vote for Electricity

At a recent election in Owosso, Mich., where about half the votes were cast by women, the proposition to grant a new electric light franchise was carried by a large majority. Women may not generally view the business aspects of franchise grants in the same way that men would do, but when it comes to any move that will promise them more electrical conveniences, you can count on them every time.

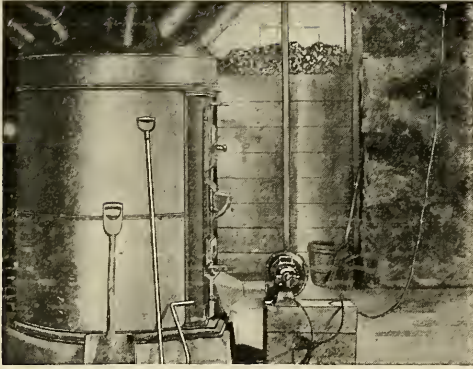

### Fans and Home Comfort

What a time you had on cold windy days last winter keeping the furnace going so that the house would be comfortable. One of the Sturtevant ready-to-run ventilating fan sets such as is shown at the furnace in the illustrations would no doubt have remedied the whole trouble. Placing the fan in front of the damper and blowing air into the furnace would have roused it up. The fan may also be placed in the fresh air duct as illustrated in the second picture, thus forcing the furnace a little and also fanning in some fresh air besides.

That room which was so hard to keep warm when the wind was in a certain direction might have been made comfortable by placing the ventilating fan over the register so as to draw the warm air out into the room; then again let the fan blow air from the warm room into the chilly one.

The housewife who is shown at work in the kitchen is not worrying how she can keep the odor of the cooking cabbage and other vegetables from the other rooms in the house, for the fan is gathering up the air and passing it out of the window. On Monday she uses the fan in the laundry to dry the clothes and to remove the excessively moist air while washing.

In the sick room the ready-to-run fan is almost a necessity, giving the needed ventilation at slow speed without draft.

And, don't forget the boys who drop in for a friendly game on a hot summer evening. With one of these fans in the window you would never know the next morning that there had been smoking in the room the night before. It all went out of the window instead of settling in the curtains and rugs.

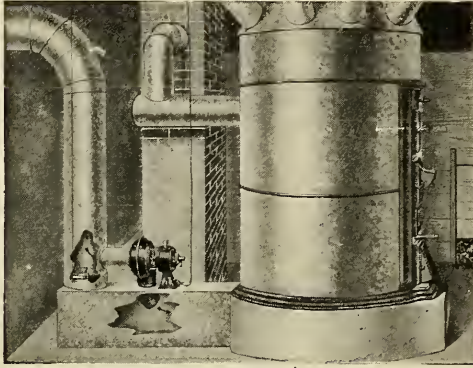



# JUNIOR SECTION



## An Electrical Laboratory for Twenty-Five Dollars

By DAVID P. MORRISON

PART VI.

CONSTRUCTION OF A STORAGE BATTERY

After you have completed the equipment for your laboratory described in the previous numbers you will still find yourself badly in need of some form of battery that is capable of delivering a strong current for a considerable time. Such is the secondary or storage battery.

The storage cell, however, must be charged from some other source of electrical energy by passing a current through the cell for several hours in the opposite direction to that it would flow in if the cell were supplying current or discharging. Oftentimes storage cells are charged from gravity batteries by allowing a very small current to flow through them for quite a number of hours, and the storage cell can then be discharged at a much greater rate than it would be possible to obtain from the gravity battery alone. With your transformer and electrolytic rectifier you can charge a storage battery direct from an alternating current circuit.

All storage cells might be thought of as consisting of three parts, usually, a number of lead plates, a solution of sulphuric acid into which the plates are placed and a containing vessel for holding the solution. There are three different storage cells described in the following paragraphs, they differing more in mechanical construction than in any other way, the chemical action being practically the same in all of them.

It might be well at this point to describe in a very elementary way just what takes

place in a storage cell when it is charging and discharging. If an electric current is passed through a conducting liquid, such as sulphuric acid, the liquid will be decomposed. This chemical decomposition is called electrolysis, and the liquid in which electrolysis takes place is called an electrolyte. The current is usually carried into and out of the solution by means of large plates as the electrolyte has a high resistance. These plates are called the electrodes, and the one at which the current enters the electrolyte is called the anode and the electrode at which the current leaves the electrolyte is called the cathode. The plates in the case of a storage cell are usually spoken of as grids and the cathode of the cell on discharge is called the positive grid and the anode is called the negative grid.

The commercial storage cell has a cathode of lead peroxide ( $\text{PbO}_2$ ), an anode of spongy metallic lead, and an electrolyte of dilute sulphuric acid. When this cell is discharged both the lead peroxide and spongy lead are changed into insoluble lead sulphate ( $\text{PbSO}_4$ ) and when it is again charged by forcing a reversed current through the cell the lead sulphate is converted back into spongy lead and lead peroxide respectively. The lead peroxide and spongy lead are called the active materials of the cell. These active materials are mechanically weak, porous, and poor electrical conductors, and they are usually supported in openings made in large plates of metallic

lead. These metallic grids not only serve as mechanical supports, but also to conduct the current to and from the active material which constitutes the real electrode.

A very simple storage cell may be made in the following way: Procure from a plumber two pieces of lead pipe. One of these pieces should have an internal diameter of approximately two inches and be six inches long, and the other one should have an outside diameter of about one inch and be seven inches long. Square off both ends of the larger pipe and solder a circular piece of lead just inside of one end with a very poor quality of solder so as to form a lead cup. If you use ordinary solder which contains a large percentage of tin the cup is likely to leak after a short time as the sulphuric acid attacks the tin and will eat it away. This cup is to form the negative plate of the cell. A terminal should be provided for making your electrical connection. Cut from some sheet lead a piece  $\frac{5}{8}$  inch in width and about three inches long. Solder one end of this piece to the upper end of the cup, and a binding post can be attached to the other end which will be explained later.

Drill the second piece of lead pipe as full of 3-32 inch holes as is possible, except for a distance of about  $\frac{3}{4}$  inch from each end. Saw six or eight notches in one end to a depth of about  $\frac{1}{2}$  inch, and bend the projecting teeth thus formed inward so as to close up the end of the pipe. This pipe need not be water tight at this point, but sufficiently tight to hold a paste that will be explained later. This second tube is to form the positive terminal of the cell and must be supported inside the larger tube in such a way that it will not come in contact with it.

Cut from some  $\frac{7}{8}$  inch pine a square piece whose edge is equal to the outside diameter of the larger pipe. Drill in the center of this piece a hole of such a size that the smaller lead pipe will fit snugly into it. Saw quite a number of slots in the upper end of the smaller tube to a depth of  $\frac{3}{8}$  inch. Now bend the projecting pieces outward and down until they are at right angles to the side of the tube. A terminal strip should be soldered to the upper end of the smaller tube as in the case of the larger tube. You should immerse the wooden block in smoking hot paraffine wax and allow it to remain until thoroughly saturated with the wax.

This will protect the wood from the action of the acid. Make sure that you do not get any paraffine on the lead tube as it will prevent the acid coming in contact with it.

You should now make a box to place your cell in to prevent its being overturned. Make the inside dimensions of this box as follows: Each side should be equal to the outside diameter of the larger pipe, or a little greater, and it should have a depth  $\frac{7}{8}$  inch greater than the length of the larger pipe. Cut a groove in one of the sides so that the piece that was soldered to the outside of the pipe for a terminal will slip into it and prevent the pipe from turning around inside the box. The base of the box can be made considerably larger than the outside dimension of the box and this will add greatly to the stability of the cell.

The two terminals of the cell can be attached to the outside of the containing box by means of two screws and back connected binding posts fastened to their ends which will give an easy means of making connections to the cell. The containing box should be boiled in hot paraffine wax until it is thoroughly saturated. The space surrounding the tube when it is placed in the containing box may be filled with sawdust which will aid in holding the tube in place.

Your cell is now complete except the paste in the inner tube. To make this paste proceed as follows: Make a weak solution of sulphuric acid in an old dish, by pouring the acid into the water very slowly. Never pour the water into the acid but always pour the acid into the water slowly and be very careful in handling the acid as it destroys everything it may happen to touch. This solution should consist of one part acid and 12 parts water. Procure from a paint shop about 1  $\frac{1}{4}$  pounds of red lead and mix with the sulphuric acid a sufficient amount to fill the inner tube. Stir this mixture with a stick and make it very stiff. Now ram the tube full of this paste to within 1  $\frac{1}{2}$  inches of the top. Remove all the paste that may have oozed through the holes and put the tube aside to dry.

When the paste is dry place the inner tube in place in the wooden block and this block should fit into the upper end of the containing box and rest upon the upper end of the larger tube. Fill the larger tube with a solution of sulphuric acid to within  $\frac{1}{2}$  inch of the top. This solution should contain

about 30 parts of acid by weight in 100 parts, the acid having a specific gravity of 1.84, or it should contain about 33 percent of acid. The specific gravity of the resultant solution should be about 1.25 which can be determined by means of a hydrometer.

The solution can be poured into the cell through the upper end of the inner tube after the cell is all assembled.

This cell can be easily charged with three gravity batteries. Connect the three cells in series, and the positive terminal of this battery must be connected to the inside tube and the negative terminal to the outside tube of the storage cell. The first time the battery is charged it should be allowed to stand connected to the gravity battery for five or six days. Fig. 51 shows a cross section through the cell just described. The connections of the gravity battery and cell for charging are shown in Fig. 52.

The above cell will give very satisfactory results but the capacity no doubt will not be

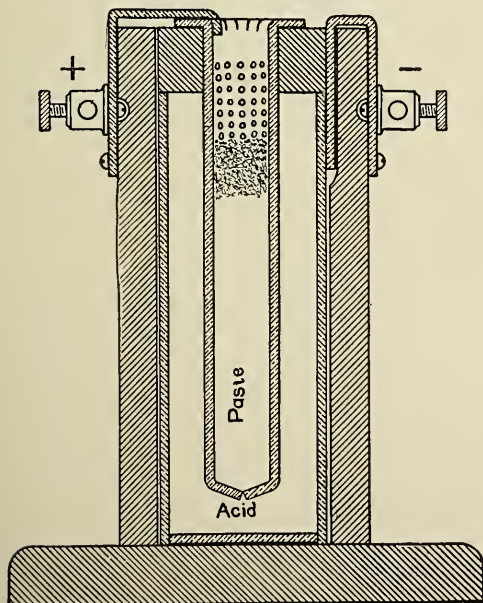

FIG. 51. CROSS SECTION OF THE STORAGE BATTERY

sufficient to meet the general requirements. It is customary to allow about five amperes per square foot of positive plate on charge.

The above rate is based on an eight hour discharge, meaning that your cell should supply about five amperes per square foot of positive plate for a period of eight hours. If this discharge rate is increased the time will necessarily be decreased and if the rate is decreased the time will be increased. The product of the current times the time a cell will supply that current is its ampere-hour capacity. This ampere-hour capacity is usually given for the eight hour rate. It is impossible to get as many ampere hours out of a storage cell at a high rate of discharge as you can at a lower rate of dis-

#### SIZE OF PLATES 6x6 INCHES

Number of Plates	Discharge in Amps. for 8 hrs	Discharge in Amps. for 5 hrs	Discharge in Amps. for 3 hrs	Normal Charge Rate
3	2.5	3.5	5	2.5
5	5	7	10	5
7	7.5	10.5	15	7.5
9	10	14	20	10
11	12.5	17.5	25	12.5
13	15	21	30	15

charge. You can never get as many ampere hours out of your battery as you put into it, no matter what the rate may be, as its efficiency is not 100 per cent. The above table gives the data on the type D battery made by the Electric Storage Battery Company.

A much larger capacity cell can be made

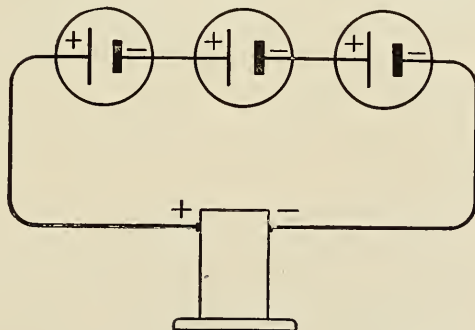
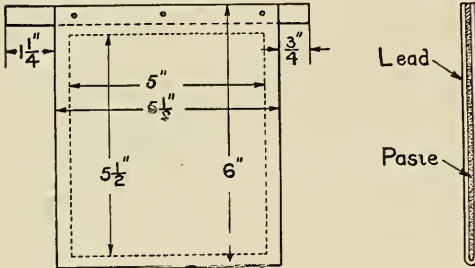

FIG. 52. CONNECTIONS FOR CHARGING

as follows, and its capacity can be increased indefinitely by increasing the area of the plates and the number of plates in each cell. Fig. 53 gives the general dimensions of the plates which can be made as follows: For each plate you must procure a piece of thin lead  $13\frac{1}{4}$  inches by  $5\frac{1}{2}$  inches. In each cell you will need one more negative grid than positive, which prevents their being bent out of shape due to unequal chemical action. Suppose you select seven grids, four negative and three positive. Remember that

this can be any number as well as seven although it is customary to increase the size of the plates as you increase the number, rather than increasing the number indefinitely as the capacity of the cell increases.



FIGS. 53 AND 54. CONSTRUCTION OF BATTERY PLATE

Lay all of the plates in a pile and clamp them together. Then bore them full of 3-32 inch holes inside the squares marked on them as shown by the dotted line in Fig. 53. These pieces should then be bent over the rounded edge of a  $\frac{1}{8}$  inch board, forming plates  $5\frac{1}{2}$  by  $6\frac{1}{2}$  inches. Place an oak board  $\frac{1}{8}$  inch thick and  $5\frac{1}{4}$  inches wide between the two sides of the plate and hammer the edges together. Cut from some  $\frac{1}{8}$  inch lead seven pieces  $7\frac{1}{2}$  inches long and  $\frac{1}{2}$  inch wide. These pieces are to be soldered between the upper edges of the plate after the active material has been put into place. It might be well to use several rivets in holding the plates and pieces together.

Allow the pieces to project  $\frac{3}{4}$  inch beyond the plates at one end and  $1\frac{1}{4}$  inches at the other. A cross section through one of the plates is shown in Fig. 54.

Mix in an old dish a thick paste of dilute sulphuric acid and red lead. Make the dilute sulphuric acid by adding about one part acid to twelve parts of water. Now fill three of the plates with this mixture forcing it in place with a stick, but be careful not to bend the sides of the plates. Fill the remaining four plates with a paste of litharge or yellow lead and sulphuric acid made in a similar manner to that just described. All of the paste that may be forced out through the holes in the plates should be removed and the plates all set aside and allowed to dry.

While your plates are drying you can construct the containing vessel for your cell. If it is possible for you to obtain a rectangular glass jar approximately six inches broad,

six inches wide and seven inches deep, inside dimensions, it will serve admirably as a containing vessel. You can, however, change the dimensions of the plates given in Fig. 53 so that they will correspond perhaps to the dimensions of your jars if you happen to have any.

In the event you have no glass jars and are unable to procure any, a simple containing vessel may be made in the following manner: Make a wooden box, whose inside dimensions correspond to those given above for the glass jar, from some  $\frac{3}{4}$  inch material. This box should be well constructed and it would be advisable to put it together with screws and glue. When the box is complete it should be immersed in hot paraffine and allowed to remain for several hours until it is thoroughly saturated with the wax. If you can procure some pitch or asphaltum and line your box with it the life of the box will no doubt be greatly increased. The best lining of course would be one made of sheet lead, but you will have to use additional care to prevent your cell being short circuited by the projecting lugs on the various positive and negative plates coming in contact with the lining where it bends over the edge of the containing vessel. The likelihood of such a short circuit occurring can be reduced to a minimum by placing strips of glass on the upper edge of the vessel upon which the lugs, on the sides of the plates, may rest.

Cut twelve wooden strips 3-16 inch square and six inches long that are to be used in separating the plates in the cell. These pieces should be thoroughly boiled in paraffin wax. When the plates are dry you will be ready to assemble your cell which may be done as follows: Take one of the negative plates and lay it on a smooth board, then place two of the small strips across it about one inch from the edge and running parallel to its longer dimension, which will make the separators stand on end when the elements are placed in the containing vessel. Now lay on top of these two pieces one of the positive plates with its edges parallel to the edges of the first plate, and the longer lug projecting in the opposite direction to that of the negative or first plate. Place the remaining five plates in the pile with the separators between them and the long lugs of all the negative plates projecting in one direction and the long lugs of the positive plates projecting in the oppo-

site direction. Fasten all of the plates together with several very strong rubber bands placed around them. Cut from some  $\frac{1}{8}$  inch sheet lead two pieces about one inch wide and 12 inches long, solder these pieces to the ends of the long lugs on the positive and negative plates. Allow all the surplus length of the above pieces to project at one end which will form the terminals of the cell.

Place the elements in the containing vessel, making sure they do not come in contact with the walls of the vessel if it is lead lined. Fill the vessel with dilute sulphuric acid to within about one inch of the top. This acid should be mixed as previously described.

With the above arrangement of plates there will be a considerable portion of them that will not be immersed in the acid. This can be prevented by bending the lead strip fastened between the upper edges of the plates into the form shown in Fig. 55. You will of course need a deeper containing vessel

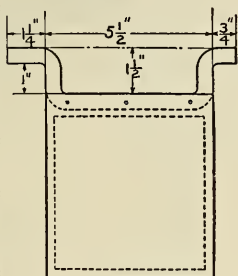

FIG. 55. METHOD OF BENDING THE LUGS

you expect to build the plates of the same size as in the previous case. Cut from a piece of one inch oak a block 5 by  $5\frac{1}{2}$  inches and fasten it to a larger board. Now cut from the  $\frac{1}{4}$  inch lead seven strips 5-16 inch wide and about 26 inches long. Bend these strips around the block forming seven frames as shown in Fig. 56 and solder the ends together.

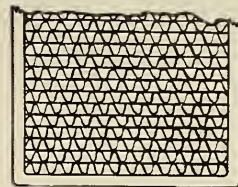

FIG. 57. CORRUGATED AND PLAIN STRIPS ASSEMBLED

Now cut from the 1-16 inch lead strips 5-16 inch wide and run part of them through the gears of a lathe or crimping iron. Place one of your frames on top of a smooth surface and fill it full of corrugated and plain strips, alternately, until it is like Fig. 57. Then take your soldering iron and solder the ends of these pieces to the frame.

Four of these plates should now be filled with the litharge paste and the other three with the red lead paste. After they are dry they can be placed in a pile separated by small strips of wood and fastened with

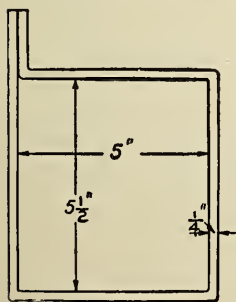

FIG. 56. ANOTHER TYPE OF BATTERY GRID

when this change is made, and the lead strips will have to be longer than in the previous case.

It might be well for you to cut some pieces of wood of such a size that they will just slip down between the elements and the containing vessel and prevent any movement of the elements. These pieces must be thoroughly saturated in paraffine wax.

A second method that has been employed by the writer in making the grids is as follows: Procure from the plumber a quantity of 1-16 inch sheet lead and also a small quantity of  $\frac{1}{4}$  inch sheet lead. The size and number of plates you expect to build will determine the quantity of lead and the dimensions of the sheets you must procure. Let us assume

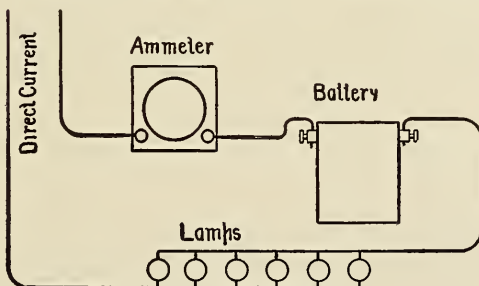

FIG. 58. CONNECTIONS FOR CHARGING

rubber bands. Solder a strip of lead to the projecting lugs, all of those on the positive plates being on one side and those on the negative plates being on the other side. Two pieces of glass tube may be placed in the containing vessel to rest the elements upon and prevent them coming in contact with the walls. When the elements are in place the vessel may be filled with acid as in the previous case until it covers the plates.

These cells can be charged from a gravity battery just as the first cell, but the time required will be considerably longer on account of the greater capacity. If you are fortunate enough to have a direct current source of

power at hand such as a 110 volt lighting circuit you can charge your battery from it. The proper connections for charging the battery in this way are shown in Fig. 58. You should allow, as previously stated, about five amperes per square foot of positive plate which can be regulated by changing the number of incandescent lamps connected in parallel.

All of the lead should be as pure as it is possible to obtain, a kind known as chemical or desilverized lead is the best. You should be careful in handling your paste and acid not to get any foreign substances in them.

If you have a blow pipe and can use it burn or fuse all connections. When solder is used make it of four parts lead and one part tin and use resin as a flux.

A storage cell should give about 2.2 volts when fully charged and should never be discharged below 1.7 volts. It should never be allowed to stand in a discharged condition and should be given a small charge every few weeks even though it is not used. If it is desired to put the cell out of service discharge it to about 1.5 volts, pour off the acid, fill the jar with water and completely discharge it. The water can then be removed and the plates thoroughly washed. They will then keep almost indefinitely. Always use rain water in mixing acid.

(To be Continued)

### Trapping a Telephone "Josher"

"We sent for you," began the telephone manager as the middle aged man in the grey suit was ushered into his office, "to see if you could suggest any way for us to stop the annoying of our operators by some one using your phone. You know our employees have strict instructions to talk only business, else they would keep other subscribers waiting, and when we find one of the girls holding a long conversation before making the connection, she is promptly reprimanded. Then if she insists that the party on the line would not tell her the number wanted, but kept on "jollyng" her—what are we to do?"

"Don't ask me," snapped the man in the grey suit indignantly. "That is your lookout as to how you handle your help. But if they report that any smart young men have been entertaining them on the wire, they must have told you the wrong

phone number. It is very rarely that any young fellow gets at my phone and my stenographer happens to be a woman of very few words. You ought to have found out the right number instead of getting me to come clear over here right in the midst of a busy week. Here you are taking up



my time when I never even heard of such a thing as 'jollyng' an operator and I"—

"Oh, if that is the case," interrupted the telephone man who had remained calm while his visitor's temper was visibly rising, "it is only fair that we at least show you what we mean. You know we use the phonograph a good deal in training new operators to speak the set phrases in a low and resonant voice. Now here is a record that may give you the idea." With that he slipped a cylinder on the phonograph beside his desk. "Number, please," began a gentle voice, followed by a man's voice that started: "Good morning, Maud, how are you feeling today?" "Number, please." "Say, isn't your name Maud? Didn't I see you at the show last night?" Good, was it not?" "What number do you want?" (This time more emphatically.) "Oh come, don't be in such a hurry. You know —"

The manager looked up, then reached over and shut off the phonograph, for the man in the grey suit had risen, highly flushed. "I think, I— I—," he stammered. "Yes," said the telephone man, I know you need to get back to your office. Thank you very much for coming in." The middle aged man in grey slipped out of the room rather sheepishly, for the voice that the phonograph had repeated, was unmistakably his own!

# POPULAR ELECTRICITY WIRELESS CLUB

Membership in Popular Electricity Wireless Club is made up of readers of this magazine who have constructed or are operating wireless apparatus or systems. Membership blanks will be sent upon request. This department of the magazine will be devoted to the interests of the Club, and members are invited to assist in making it as valuable and interesting as possible, by sending in descriptions and photographs of their equipments.

## A High Power Wireless Equipment

By ALFRED P. MORGAN

### PART II.—AERIAL SWITCH AND INDUCTION COIL

The high-tension cable leads from the insulating bushing in the window pane to

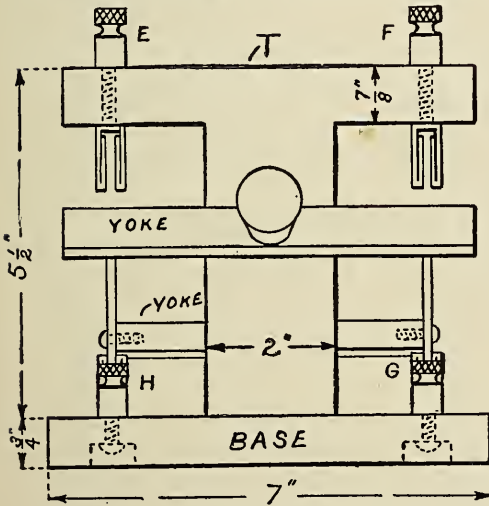

FIG. 14. END VIEW OF SWITCH

the aerial switch. The aerial switch is used for quickly changing the aerial and the ground from the receptor to the transmitter or vice versa.

An ordinary power switch may often be adapted for this purpose but the best plan is to construct one according to the design indicated in Figs. 14 and 15.

The base is a sheet of hard rubber 7 by 11 by  $\frac{3}{8}$  inches. The two large knife blades are made of hard brass and measure 8 by  $\frac{5}{8}$  by  $3-32$  inches. A small blade measuring 3 by  $\frac{5}{8}$  by  $3-32$  inches serves to break the primary transmitting current when the switch is up, so that in case of an accidental touch of the key while receiving, the detector will not be injured. In a looped aerial system the precaution is absolutely necessary, for the high voltage currents necessary, for the high voltage currents necessary, would pass across the anchor gap and into the receiving instruments. With an open aerial the third knife blade is often used to short circuit the detector during each period of sending so that it is not made inoperative by the heavy discharge of the transmitter.

Two methods of fastening the knives to the yokes are illustrated in Fig. 16. In the first method the end of the knife blade is bent at right angles and fastened to the yoke by means of a short 10-24 brass machine screw and nut. The second method is not

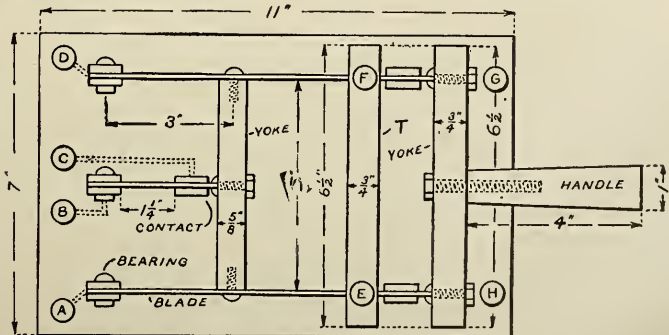

FIG. 15. PLAN OF SWITCH

quite so simple but offers a better appearance and is somewhat stronger. The end of the blade is cut out in the shape shown. A slot  $\frac{3}{32}$  inch wide and  $\frac{1}{4}$  inch deep is cut in the yoke at the point where it is desired to fasten the blade. A hole is bored in the center of the yoke and in the same

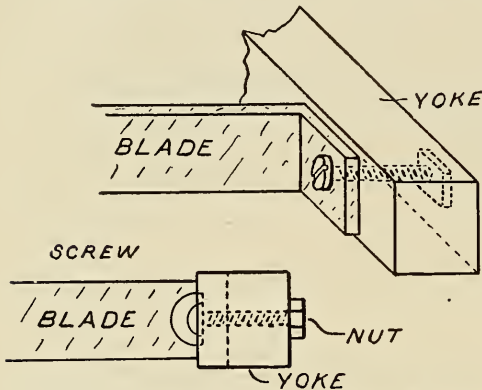

FIG. 16. METHODS OF FASTENING KNIVES TO YOKE

plane as the slot. A 10-24 machine screw passes through the hole and the end of the blade is placed under the head of the screw so that when a nut is screwed against the other side of the yoke the two blades will be held firmly in the slot. The "T" which serves as a support for the upper contacts is made of  $\frac{3}{4}$  inch hard rubber. Two pieces of rubber may be used in its construction instead of one and in that manner some material economized.

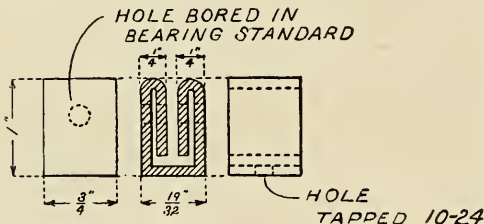

FIG. 17. CONSTRUCTION OF CONTACTS

The yokes are also of hard rubber. The smaller one is fastened to the large blades so that it moves up and down with them.

The construction of the contacts and bearing standards is shown in Fig. 17. The only difference between them is that the bearing standards have a hole bored through them as indicated by the dotted lines in the illustration. They are both formed out of a strip of brass.

Eight binding posts are mounted on the base and on the "T". They make connection to the bearing or contact to which they are nearest as indicated by the dotted lines. (A) and (D), Fig. 15, connect respectively to the aerial and the ground; (B) and (C) are included in the primary circuit of the induction coil or transformer or are placed directly across the detector terminals; (E) and (F) lead to the receiving apparatus, while (G) and (H) are connected with the transmitting instruments. A wiring diagram of the complete transmitter showing the position of the aerial switch will be given later.

A hard rubber handle four inches long is fitted to the switch yoke so that it may be thrown up or down. The contacts should press against the blades firmly but not so hard that they stick.

A great deal of hard rubber is used in the construction of the switch just described and since it is rather expensive some may be tempted to use fibre. Fibre is all well and good for small induction coils and transformers but when used on a switch in connection with the powerful coil and transformer to be described later, is worthless.

The author in his experiments first used fibre, and one rainy day when things were damp, the fibre yoke became slightly conductive and a brush discharge between the blades of the switch commenced. The transmitting was continued but in a short time the fibre became so carbonized that almost all of the energy passed across. A hard rubber yoke was substituted with the result that the base began to leak and soon burned out and so was discarded in favor of the rubber. The conducting layer, spoken of in connection with aerial insulators is due to smoke and the action of the atmosphere and does not form on the rubber when it is used for instrument insulation about the operating room.

#### INDUCTION COIL

Reference has been made previously to the charging of the aerial but without explaining definitely how it is accomplished. In small "untuned" outfits, the secondary terminals of an induction coil are connected one to the antenna and the other to the earth. The spark gap is also bridged across the secondary terminals. This arrangement is the one presumed in the explanation of the generation of electrical waves, but is worthless for long distance work. The usual



method is to employ the induction coil to charge a condenser. The condenser in discharging produces an oscillatory discharge which passes through a large coil of heavy wire called a transmitting helix and acting at once as a transformer to impress the oscillations on the aerial and also as a variable inductance to "tune" the circuits with.

Choice lies between the induction coil and two types of transformer known respectively as the "open" and "close" core depending on whether or not the magnetic circuit is metallically complete. Since the induction coil may be operated on batteries it is more commonly used and will be the most suitable in the average station.

An induction coil in its simplest form consists of two or three layers of insulated wire wound around an iron core and surrounded by a winding composed of many thousand turns of very carefully insulated fine wire. The two windings are known respectively as the primary and secondary. When an interrupted direct current is sent through the primary, a magnetic field is established in the neighborhood of the coil. The lines of force in this magnetic field cut the secondary coil, and, being of a constantly changing value because of the fluctuations of the primary current, they induce a current in the secondary. Since the same number of lines of force are generated and destroyed with every "make" and "break" of the primary current, the electromotive impulses in the secondary are equal. But by means of a "condenser" shunted across the interrupter the current at "make" requires more time to grow than to die away at "break," which latter, in fact, is practically instantaneous. The induced electromotive force at "break" while not lasting so long as that at "make" is much greater in intensity and is sufficient to pass through the air as a spark.

#### CORE

The first consideration in building a coil is the selection and preparation of the iron wire which is to form the core. In order to promote rapid changes in the magnetic field it is never solid but is built up of a large number of soft iron wires. Since a high degree of magnetization is to be produced, the iron must possess a great degree of permeability and Norwegian iron will be found to be very suitable in this respect. It is considerable of a task to cut the wires for the core of a large induction coil and so

if the wires are purchased already cut, much labor may be saved.

The wire is annealed by placing it in an iron pipe and plugging the ends with clay. The pipe and its contents are then laid in a coal fire where the whole mass will come to an even red heat slowly. The fire is then permitted gradually to die out and the pipe and wires left in the ashes until cool.

When cold the wires are removed from the pipe and each one separately rubbed with emery paper until bright. After brightening they are dipped in hot water, wiped dry, and dipped in a thin solution of shellac and allowed to dry.

The wires are brightened in order to remove the rust and scale which adheres to them and lowers the proportionate amount of iron it is possible to place in a given core.

The wires may be straightened by rolling them one at a time between two boards.

The core of the coil in question should be 25 inches long and three inches in diameter. The wires are No. 8 B. and S. gauge.

After forming into a perfect cylinder in which all the wires are parallel, the core is wrapped with two or three layers of well varnished linen.

The primary is wound over the linen and is composed of three layers of No. 10 B. & S. gauge, double cotton covered magnet wire as indicated in Fig. 18. There is no advantage in carrying the primary the full length of the core and so it begins and ends about  $1\frac{1}{2}$  inches from the ends.



FIG. 18. COMPLETED CORE AND PRIMARY

An insulating tube is placed over the primary to separate it from the secondary. It is formed of four layers of hard sheet rubber 1-16 of an inch thick and 23 inches long. The rubber may be softened by steaming and then wrapped directly around the primary or around a form of the same diameter and slipped over the primary afterwards. The overlapping edges, that is the beginning and finishing edges should be beveled with a file and cemented.

(To be continued.)

# The Collins Wireless Telephone

The following description of the Collins wireless telephone system is fairly complete with regard to the sending apparatus. The receptor comprises a thermo-electric

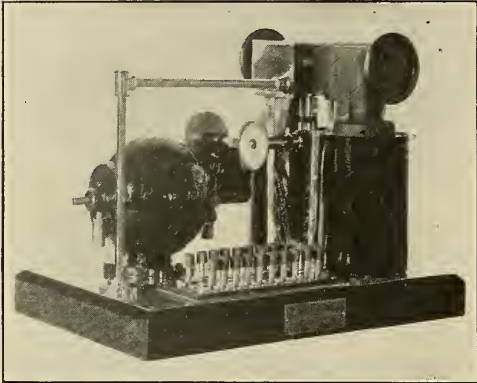

FIG. 1. COLLINS' REVOLVING OSCILLATION ARC LAMP

detector the full details of which cannot be given out at the present time.

The transmitting apparatus in its entirety includes a Collins revolving oscillation arc lamp, Fig. 1; a high frequency and high potential variable tuning inductance transformer, Fig. 2; an adjustable tuning auto-transformer, and the usual revolving variable

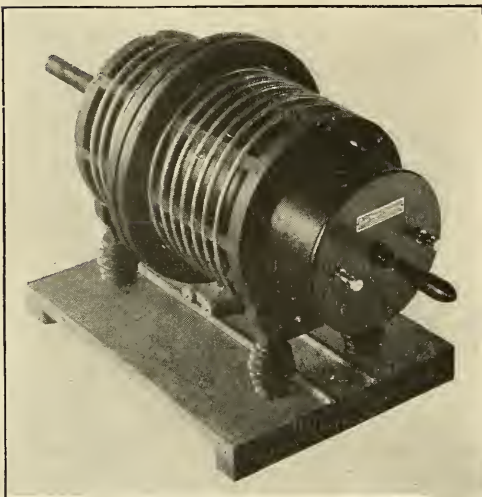

FIG. 2. TUNING INDUCTANCE TRANSFORMER

condenser. These separate devices are designed to withstand potentials of 5,000 volts or more. Fig. 3 shows the scheme of connections, and Fig. 4 is a general view of the apparatus in use.

The initial current is at a pressure of 500 volts direct. This was raised to 5,000 volts in the case of transmission between Newark and Philadelphia, though a pressure of 2,500 volts is generally used, produced by a motor-generator set. The latter high-voltage current is used to operate the revolving oscillation arc lamp, which is an improvement on those previously employed.

The lamp proper consists of a pair of hard carbon disk electrodes, and these are mounted on parallel spindles so that they are in the same plane, and are connected by means of bevel gears secured to an insulated shaft. The disks are insulated from each

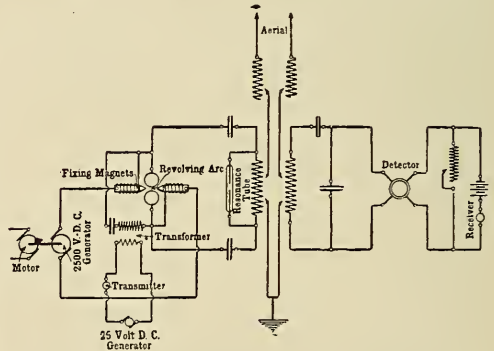

FIG. 3. SCHEME OF CONNECTIONS

other by mica bushings fitted in the gearing, the casing forming one of the connections, while the insulated bearing in the bottom of the casing forms the other.

The gearing is so arranged that the disk electrodes are rotated in opposite directions, the power being furnished by a small motor. One of the bearings of the shaft is mounted in a keyed sleeve, which permits the spindle carrying one of the carbon disks to be moved toward or away from the opposite disk, so that the length of the arc may be varied while the lamp is in operation. The carbon electrodes are placed in a metal casing, while the rotating mechanism is attached to the bottom of the casing. In the long-distance test between Newark and Philadelphia hy-

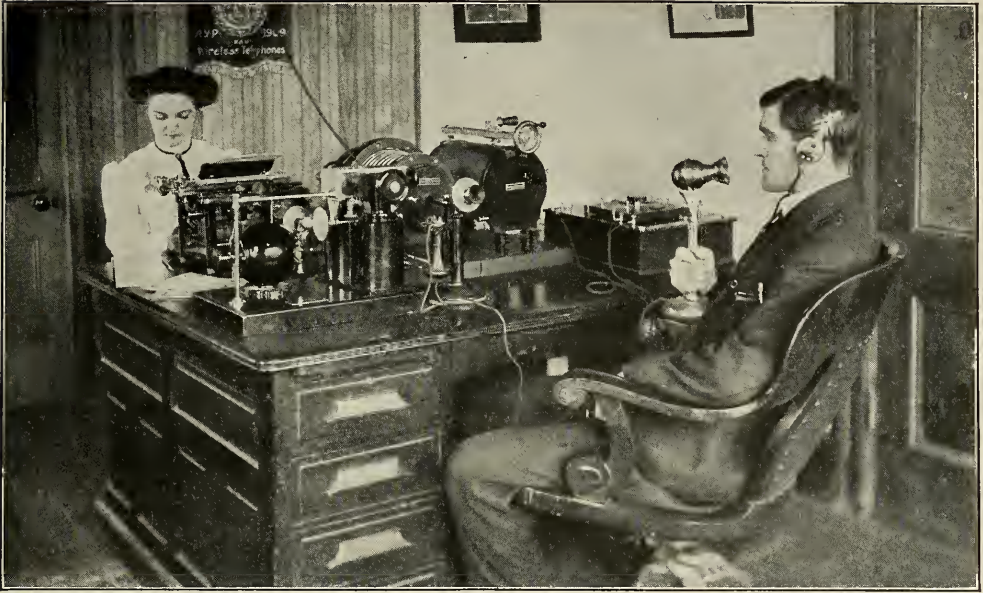

FIG. 4. MR. COLLINS AND HIS WIRELESS TELEPHONE

drogen was used, but for short distances the arc burns in an air blast.

The rotating oscillation arc obviates the disadvantages of the stationary arc, in that a constantly fresh, cool surface is presented to the arc, preventing uneven burning away of the electrodes which gives rise to disturbances in the oscillations.

As in all arc type telephones the principle embodies the burning of a direct current arc. There is in addition a secondary circuit, including the telephone transmitter, by means of which another current, fluctuating with the voice waves, is also impressed upon the arc, in this case through a transformer. These fluctuations imposed upon the arc circuit affect the arc and likewise the oscillating circuit which is connected across it to send out the oscillatory waves from the aerial.

The chief improvement in the combination tuning inductance transformer used by Collins is that a new and novel means of contact is introduced, whereby any variation of the inductance can be had, and in tuning a wireless telephone transmitter this is vitally necessary. The contact is made by a ring provided with three small grooved pulleys, which press against the turns of the tubing forming the primary. Having a spiral form, this coil causes the ring,

when it is rotated, to travel back and forth.

The secondary is arranged to slide in or out of the primary, making a loose coupling, which is another essential in the production of high-frequency undamped oscillations.

The transmitter is of the carbon granule type, but of special design. It is formed of two oppositely disposed diaphragms with the granules between them, so that the voice impulses cause them to vibrate against each other, thus increasing the amplitude as compared with a single diaphragm transmitter.

The longest distance covered by the system was 81 miles, between Mr. Collins' laboratory in Newark, N. J., and the Land Title Building in Philadelphia.

### Protective Device for Wireless Apparatus

In the winter the experimenter need have little fear of lightning or "static," but as summer approaches he begins to think of thunderstorms and their effect on his apparatus. This is especially true of the beginner in the art, who is often led to abandon his hopes of setting up his own station, on account of supposed danger from lightning. No particular danger should arise, however, if the apparatus is suitably protected.

Lightning in general may be considered to be composed of many small charges of atmospheric electricity which have been united into one large charge. These small charges are not in themselves dangerous to wireless instruments. Their elimination by discharges to trees, clouds, and other objects, is never noticed, except by wireless operators, for the amount of energy in each is small and the discharges are not perceptible either to the eye or the ear. The wireless operator, however, can hear these discharges in the summer, and sometimes in the winter, as clicks in his telephone receivers, and he calls them "static."

Just before a thunderstorm the air is filled with these small charges. They gradually unite, forming one large charge. When the large charge approaches sufficiently near to any object, such as a cloud having an opposite charge, or a pole or a tree on the earth, the energy stored in the charge appears as lightning, and if this energy should use an aerial system as a means of escaping to the earth, it would melt the wire and cause considerable damage, since a large quantity of heat would be developed.

A good solution of the problem is a means of eliminating all the small charges near the aerial as soon as they are formed, and thus to prevent the formation of a large and dangerous charge. The device used is a single pole double throw porcelain base switch, connected as shown in the drawing. The switch is preferably mounted outside the house on a window sill, or in some convenient dry place. A wire connected to one of the spring clips of the switch leads to the instruments in the house. The other is connected to an outside ground. The use of a gas or water pipe is not recommended for this purpose, for the idea is to keep the high tension charges wholly outside the building. An iron or brass pipe driven six or eight feet into the ground will do very well. The wire leading from the switch to the ground should not be smaller than No. 8. The switch blade is connected to the aerial.

When the apparatus is in use, the aerial is connected to the instruments. At all other times the aerial should be connected to the ground by throwing the blade of the switch to the other position.

As the small charges form, they are conducted by the aerial to the ground. The

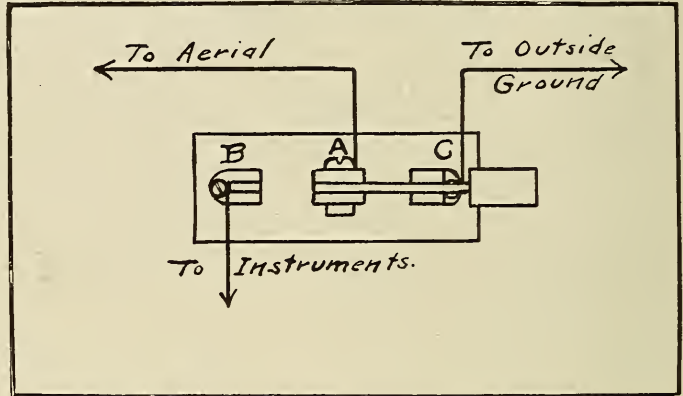

SWITCH TO GROUND AERIAL DURING STORMS

aerial is then acting as a lightning rod. The wireless experimenter should be careful to always ground the aerial when it is not in use, and he will not be troubled by lightning. The writer has used this device for nearly four years, and lightning has never caused him annoyance during this time.

### Eiffel Tower Wireless Station

Everybody knows of the Eiffel tower, the ornament of Paris and the pride of the Parisian. This tower, 1000 feet high, is being used for the purpose of supporting the largest wireless antennae ever set up, the wires being about 1500 feet in length. Six aerial wires spread harp-like toward the park below. Each antenna is calculated to stand a pull of nearly 15,000 pounds at the same time being insulated well enough to stand a tension of over a million volts. To insulate perfectly each aerial wire under this enormous mechanical stress and swayed by strong winds is a great problem in itself. The ground wires are buried under the foundations which again are lower than the level of the Seine river. These grounds cover nearly 2000 square feet.

All the instruments are underground. There is enough space to accommodate all the instruments sending and receiving sepa-

rately. There are also rooms for the officers and about 20 soldiers as well.

The capacity of this station is about 75 kilowatts. Storage batteries of sufficient capacity are always kept charged for times of emergency. Transformers are ordinarily used, however, capable of stepping up the voltage to as high as 110,000 volts.

There are Leyden jars in the condenser equipment, and they constitute the most



EIFFEL TOWER AND WIRELESS ANTENNAE

powerful condenser battery ever set up. A direct voltage of 110,000 volts maximum is introduced.

The loss of energy in the whole system is almost eliminated owing to the perfect insulation from all ground. The arrangement of the anchors of each aerial wire is remarkable in this respect. In some places the antennae would have needed to be anchored right in the streets of traffic. This difficulty was overcome by erecting pillars of concrete into which the wire ends were fastened in such a way as not to form any angle, insuring against breakage. Where the wire finds its end in the midst of the park it is fastened to a concrete foundation.

Unfortunately the late flood which caused millions of dollars of damages in Paris also entered into the new underground compartments, submerging the machinery, and the sulphuric acid of the storage battery by no means improved the insulation of the machines and transformers. But in a few months the station will be in complete working condition.

The engineers take it for granted that they will be able to control all the French colonies in Africa as well as communicate with America. At the same time it has been asserted that with the Eiffel tower station all the steamers will remain in touch with Europe until they arrive in the States, and those traveling east to China and Japan, the Indies, etc., will remain in communication until they get the signals from the Californian coast stations.

EMILE RUEGG.

### That Night at Chester

*Editor, Popular Electricity:*

Referring to article, "Suggestions for Aerials," by Mr. E. H. Waits, in edition April, 1910, I would like to inform him that the station he heard at Chester, Pa., one night last November was in a sense hardly an "amateur" station, as most stations operated by other than government or commercial operators are generally called. It was the U. S. Scout Cruiser, "Chester," sending, and at the time which the conversation quoted was sent was working with the Navy Station at Fire Island, N. Y.

I remember the night distinctly as I had just made some changes in my receiving set here and was listening for some of the battleships which were to assemble in Hampton Roads in a few days. The reason I am so positive that it was the "Chester" we both heard is that I heard her call-letter (at that time "C-V") when she signed off, very plainly, as well as the sign of the operator whom I knew. The "Chester" was invited to Chester, Pa., for some celebration of some kind, I do not know exactly what, but the crew of the "Chester" were all "shown a good time" to quote from the wireless.

The "Patuxent" is a large sea-going navy tug with a small wireless equipment and only one operator, who incidentally looks out for all the electrical equipment of

the ship. On this particular night we were at Norfolk, Va., and all the stations, ship and shore, heard the "Chester." There was no static and it was a good night for wireless.

The "Chester's" transmitter is a five kilowatt, Shoemaker set, and they have done good work with it.

I did not see the February number of POPULAR ELECTRICITY, but would be glad to correspond with Mr. Waits if he will drop a card to J. L. Allen, Elec. 1st class U. S. S. "Patuxent" care of Postmaster, New York.

JEROME ALLEN.

U. S. S. Patuxent, April 9, 1910.

### The "Pyron" Detector

The "pyron" detector is one of the latest of the mineral or crystal type of detector. The active material used in this detector is iron pyrites, or "fool's gold," as it is sometimes called. This is a sulphide of iron, chemically designated as  $FeS_2$ , which is a natural compound occurring in nature in

(M) may be made from copper or brass, about 1-32 inch thick. A slot  $\frac{1}{8}$  inch wide and  $\frac{3}{4}$  inch long is cut or punched in (M), or a hole  $\frac{1}{4}$  inch in diameter will serve the purpose if the slot cannot be made by the builder. (M) passes under a binding post formed from battery binding posts as shown. This arrangement allows the cup to be moved readily, so that different portions of the surface of (F) may be brought under the point of screw (G).

The standards (A) and (C) are made from square brass rod,  $\frac{1}{2}$  inch wide. Both these standards are drilled and tapped at each end for an 8-32 thread, and a hole  $\frac{1}{8}$  inch in diameter is also drilled through (C) at (X). A hole is drilled and tapped for the 8-32 thread of a thumb-screw (T).

The strip (D) may have a thickness of 1-16 inch, and may be made of phosphor bronze, brass or copper. Of these three materials phosphor bronze is the best for this purpose. The screw (G) has an 8-32 thread, and a lock nut as shown. The vertical movement of (D) is regulated by means of the hard rubber disk (S), which moves up or down the threaded brass rod (J) as

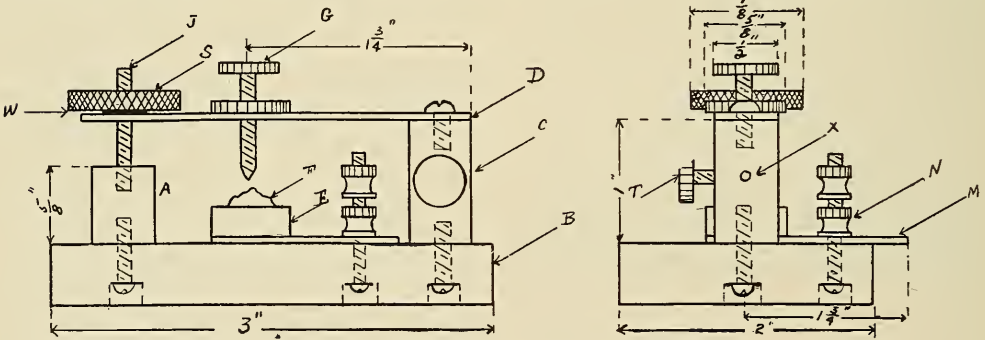

CONSTRUCTION OF THE "PYRON" DETECTOR

large quantities, both in the massive condition, and in bright cubical crystals. Either a fragment or a crystal will serve our purpose. The size of the piece is not important, but may conveniently be about  $\frac{1}{4}$  inch square.

In the drawings (F) represents the piece of iron pyrites, which should be so selected and placed in the brass cup (E) that the exposed surface is clean and bright. (F) is held in (E) by means of solder or some alloy of low melting point. Cup (E) is fastened to a metal strip (M) by means of a flat headed machine screw or by solder. Strip

it is revolved. (W) is a metal washer. (J) should be soldered into the standard (A).

It will be found that the iron pyrites has a few very sensitive points, and when the point of (G) rests on one of these points the detector gives very good results in long distance work. A certain pressure of (G) on (F) gives best results, and this pressure is varied by revolving disk (S). Mr. Pickard, who developed the Pyron detector, states that when the detector is properly adjusted, it is the most efficient of the rectifying type known to him, for comparatively short distance work. It is

practically unaffected by "static" or atmospheric discharges, and by the transmitting apparatus, and therefore it need not

be short circuited while the operator is sending.

A. B. COLE

## Spark Coil Dimensions

A large part of the questions asked by amateurs relate to the dimensions and windings of spark coils. Below is printed a table giving exact information on all the essential parts of the coil. It was compiled by an expert in coil construction and represents the best practice at present in the construction of coils for wireless work. Those who are building coils should study this table carefully. Also those who have built coils which do not give the results expected had better see that the dimensions and windings in general correspond to those here given.

Size of Coil	$\frac{1}{4}$ -inch	$\frac{1}{2}$ -inch	1-inch	2-inch	3-inch	4-inch	5-inch	6-inch	8-inch	10-inch
A	5 $\frac{1}{2}$ -in.	5 $\frac{1}{2}$ -in.	5 $\frac{3}{4}$ -in.	7-in.	8-in.	8 $\frac{1}{4}$ -in.	9 $\frac{1}{2}$ -in.	10-in.	14-in.	24-in.
B	$\frac{1}{2}$ -in.	$\frac{1}{2}$ -in.	$\frac{3}{8}$ -in.	$\frac{3}{8}$ -in.	$\frac{3}{8}$ -in.	1-in.	1-in.	1 $\frac{1}{4}$ -in.	1 $\frac{3}{8}$ -in.	3-in.
C	Cardboard Tube		Cardboard Tube and Empire Cloth		Empire Cloth					
D	1-16 in.		Tube 1-16 in. 2 layers cloth		2 layers	3 layers				4 layers
E	No. 20	No. 20	No. 18	No. 16	No. 16	No. 16	No. 16	No. 14	No. 14	No. 12
F	225	225	170	184	208	232	256	214	320	400
G	Empire Cloth							Micanite		
H	4 layers		6 layers		8 layers			$\frac{1}{8}$ -in.	$\frac{1}{8}$ -in.	$\frac{1}{8}$ -in.
L	No. 38			No. 36 Enamelled						No. 28 Enamel
J	3 oz.	4 oz.	$\frac{3}{4}$ lb.	1 lb.	1 $\frac{1}{2}$ lbs	2 lbs.	3 lbs.	5 lbs.	8 lbs.	12 lbs.
K	1	1	2	2	2	3	3	4	8	16
L	1 $\frac{3}{8}$ in.	1 $\frac{3}{8}$ in.	1 $\frac{3}{4}$ in.	2 $\frac{1}{4}$ in.	3 in.	4 in.	4 $\frac{1}{2}$ in.	5 in.	8 in.	11 in.
M	4 $\frac{1}{2}$ in.	4 $\frac{1}{2}$ in.	4 $\frac{1}{2}$ in.	5 $\frac{3}{4}$ in.	6 in.	6 in.	6 in.	6 $\frac{1}{2}$ in.	7 in.	12 in.
N	250	300	800	1400	2000	2500	3800	6000	8500	10,500

A—Length of Core.  
 B—Diameter of Core.  
 C—Kind of Insulation on Core.  
 D—Thickness of Insulation on Core.  
 E—Size (B. & S.) Primary Wire. (D. C. C.)  
 F—Number Turns Primary Wire.  
 G—Kind of Insulating Tube.

H—Thickness Insulating Tube.  
 I—Size (B. & S.) Secondary Wire.  
 J—No. Pounds Secondary Wire.  
 K—No. Sections in Secondary.  
 L—Approximate Diameter, Secondary.  
 M—Distance between Coil Heads.  
 N—Total Number sq. in. of Foil in Condenser.

Note: These coils use a medium speed vibrator.

## WIRELESS QUERIES

Answered by A. B. Cole

*Questions sent in to this department must comply with the same requirements that are specified in the case of the questions and answers on general electrical subjects. See "Questions and Answers" department.*

### Potentiometer and Tuning Coil

*Questions.*—(A) Is a core of wood suitable for a potentiometer? (B) How much German silver wire and what size would I need for a potentiometer having a core three inches in diameter and seven inches long? (C) Would a pasteboard roll do for the core? (D) How much No. 28 D. C. C. wire would I need for a tuning coil  $3 \times 12$  inches?—T. R. S., Cohasset, Mass.

*Answers.*—(A) Yes.

(B) About four ounces of No. 24 single silk covered 18 percent German Silver will give you 100 ohms on such a core.

(C) Yes.

(D) About 600 feet or six ounces.

### Receiving Radius; Wave Length; Tuning Coil

*Questions.*—(A) Over what distance can a 10 K. W. commercial station be heard by a station having an aerial 40 feet long and 50 feet high, a single slide tuner, fixed and variable condensers, silicon detector and one 1000-ohm receiver? (B) What is the wave length of a tuner six inches in diameter, 12 inches long wound with No. 24 enameled wire? (C) Give dimensions of a tuner to catch a message of 1800 meters wave length, same to have a core six inches in diameter and using No. 24 enameled wire?—A. H., Lexington, Ky.

*Answers.*—(A) About 800 miles under ordinary conditions, over water.

(B) About 8000 meters.

(C) Length about four inches, other dimensions as you give them.

### Aerial Wires for Two Inch Coil; Relay with Precision Coherers

*Questions.*—(A) Which is the better for all-around work, a two or four wire aerial? (B) What length will work best with a two inch coil? (C) Should one use a high or low resistance relay with precision coherers? (D) Are relays used on telegraph lines simply for resistance or to enable one to use fewer batteries?—J. M. S., Rudolph, Ohio.

*Answers.*—(A) A four wire aerial.

(B) Four parallel wires, each 50 feet long, all connected together at each end, give very good results.

(C) A relay of from 150 to 300 ohms works well.

(D) A relay of high resistance has a winding of fine wire on the magnets. By

using wire of small diameter, and consequently high resistance, many turns are obtained on a magnet of given size. For this reason a current of less intensity is required to operate the relay. Therefore the use of a high resistance relay on a telegraph line requires less battery than a low resistance relay of similar construction.

### Wireless Telephone

*Questions.*—(A) In the wireless telephone described in the April issue are the ends of the core wires in the impedance coil pushed up to meet each other or is a space left, and how much space, if any? (B) Could the core be made of one continuous wire? (C) How long should the fiber be upon which the wire for the choke coil is wound? (D) Will cardboard or rolled asbestos do for a substitute for the fiber tube? (E) What kind of a condenser is used and please give data for its construction?—P. E., Minneapolis, Minn.

*Answers.*—(A) The ends of the core wires of the impedance coil should meet.

(B) Yes.

(C) About four inches.

(D) Either will do, but asbestos is better.

(E) The condenser should be of the adjustable type, and may consist of 25 glass plates, each 5 by 7 inches, coated with tin foil sheets  $3\frac{1}{2}$  by  $5\frac{1}{2}$  inches. The exact capacity used will depend largely on the aerial, but the above condenser will have a sufficient maximum capacity for most amateur aerials.

### Wireless Telephone

*Questions.*—(A) Give diagram and dimensions of choke coil and impedance coil for wireless telephone. (B) Also specify condenser for above. (C) If a key is inserted in the wireless telephone circuit will the equipment work as a wireless telegraph for a distance of two miles? (D) Could a chemical converter for changing 110 volts A. C. to D. C. be used for the arc of the above apparatus.—L. F. M., Germantown, Philadelphia, Pa.

*Answers.*—(A) and (B) See answer to P. E. in this issue, also article on "A Simple Wireless Telephone Set" in the April, 1910, issue.

(C) Yes.

(D) The rectified current as supplied by a chemical converter cannot be used, since the action of the arc in producing high frequency oscillations requires a direct current of constant intensity. The chemical converter produces a direct current which is pulsating, that is, varies in intensity many times per second.



# QUESTIONS AND ANSWERS

Use of this department is free to readers of Popular Electricity, but attention will not be given to questions which do not comply with the following rules: All questions must be written in the form of a letter addressed to the Questions and Answers Department and containing nothing for the other departments of the magazine; two-cent stamp must be enclosed for answer by mail, for space will not permit of printing all answers; the full name and address of the writer must be given.

## Elevator Signaling System

*Question.*—Will you please explain the operation of the ordinary elevator signal system using red and white lights at the various floors.—A. H., Chicago.

*Answer.*—The diagram in general of such a system is here given. Current is supplied at 110 or 220 volts to a 1-4 H. P. motor-generator (26) on the high voltage side (20) of the machine, the mains being

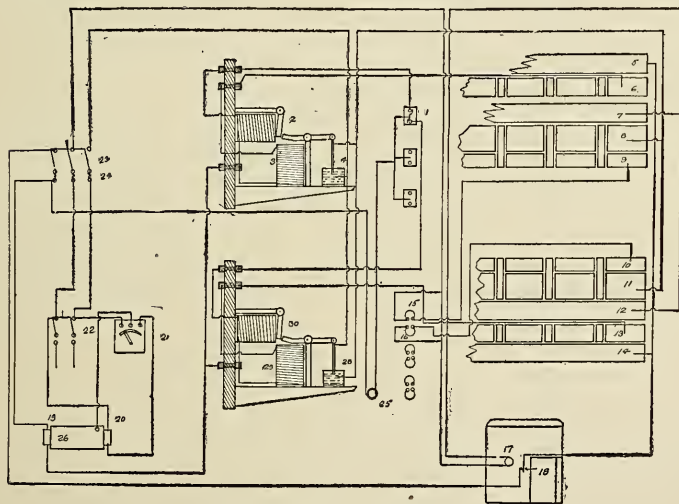

ELEVATOR SIGNAL SYSTEM

connected to the switch (22). Current at 10 volts from the low voltage side (19), is used to operate the push buttons and magnets through one blade of switch (23). By closing switch (22), starting the motor generator and closing switch (23), the high voltage is thrown on to light the "up" and "down" lamps on the floors. The wiring for one car is shown. The upper magnets and mercury cup (4) control the "up" light when the "up" button (1) is pushed on any floor. The lower set of magnets

control the "down" light when the down button is pushed. At the right of the diagram are brass studs (5) to (14) mounted on slate and connected to the light and magnet circuits. This panel and those for the other elevators is situated at the top of the shaft in some convenient place. To each car mechanism in this system is connected a chain gear which through a worm gear causes a contractor to slide over studs (5)

to (14) opening and closing circuits at the proper time as the car goes up or down the shaft. Something of the operation may be understood by tracing out a signal.

If a person on the third floor wishes to go up he pushes the "up" side of button (1). The current then finds a path from (19) through snap switch (25), to (1), thence to magnet (2), pulling its armature and allowing the armature on (3) to drop, plunging the needle at its end into the mercury cup (4) which closes the 110-volt circuit up to (8); then, as the traveling contractor

attached to the driving mechanism of the car bridges across (8) and (9) the circuit is completed, for the floor signal light (15) and the car operator's light (17), the contactor being adjusted to throw on the lights two or three floors from the floor at which the car should stop. When the car passes the third floor the contactor opens the floor light and signal circuit which establishes a circuit from (26) to magnet (3) up to studs (6) (5), through (18) back to (23), thus energizing magnet (3) and raising

the needle out of the mercury and resetting the magnets (2) (3) in their normal position. In case a car is loaded, the operator may transfer his signal to the next car by pressing push button (18) on his car, which opens the circuit and allows the magnet controlling the needle to be de-energized, thus holding the signal for the following car.

#### The Automatic Telephone; Resistance Coil for Arc Light

*Questions.*—(A) Explain the operation of the automatic telephone. (B) How many feet and what size B. & S. gauge iron wire should be used as a resistance coil for a 35-40 amp., 110-v., hand feed arc lamp?—J. P. D., Newark, O.

*Answers.*—(A) Consider a 100 line exchange. Each telephone is connected through the line wires with a machine having a vertical shaft, which can be raised, lowered and rotated. This shaft carries a set of contact springs or wipers. Connection is made through the wipers with contact lugs connected to each of the other telephones or machines. These lugs are arranged in ten banks of ten each; each bank is semi-circular, and one bank is above another. Each telephone has a separate machine and each of the hundred telephones is "multiplied" in each machine in these contact lugs. In calling a telephone, say number 75, a subscriber moves a disk on his telephone to number seven and lets go. This sends seven impulses over one side of his line and ground to the machine. These impulses operate an electro-magnet which raises the vertical shaft and contact wipers to the seventh bank of lugs. The subscriber then moves the disk to number five and lets go. This sends five impulses over the other side of the line, which operates another magnet which rotates the wipers to the fifth lug in the seventh bank. This makes contact with lugs 75 which are multiplied through to telephone 75. The subscriber then rings by pressing a button on his telephone. When through talking each subscriber hangs up and this automatically restores the machine wipers, etc., to zero position. Provision is made for busy signals and central energy. Exchanges of over 100 subscribers are arranged in groups of 100 machines each and provision is made for automatic trunkings between the groups.

(B) You will need about 176 feet of No. 12 iron wire, or you can use 95 feet of No. 14 iron wire.

#### Receiver in Series With Buzzer

*Questions.*—(A) Can a telephone receiver work in series with a buzzer so that the receiver will buzz when a wireless signal is coming in? (B) Will the winding need to be taken from the receiver so that it will not have more than 4 ohms resistance, or that of the buzzer, or will it work with 75 ohms resistance by increasing the resistance of the buzzer?—H. M. K.

*Answers.*—(A) We know of no way to do this.

(B) Either way will do if you wish to operate the receiver and the buzzer in series, but you will get a sound in the receiver several hundred times as strong as that produced by a distant wireless station.

#### Charging Leyden Jars; Telephone Magnetos; Wet Batteries vs. Dry Batteries

*Questions.*—(A) Name some of the simplest ways to charge a Leyden jar. Can it be charged by means of an electrified comb or glass rod? (B) Would a telephone magneto run as a synchronous motor with the current from another magneto? (C) With what size wire should I rewind my four bar telephone magnetos to get twelve volts? (D) Is it better to use a sal ammoniac battery for experimental purposes than to use a dry battery when sal ammoniac sells for 13 cents per pound?—O. M., Moline, Mich.

*Answers.*—(A) The simplest and best way to charge a jar is by means of a glass plate static machine. It can be charged by means of an electrophorus or electrified rods as you suggest, but the results will be disappointing. A jar can often be heavily charged by holding the knob near a moving belt.

(B) No. The magnetizing current produced by the generator would not be sufficient to affect the motor.

(C) The voltage depends on the number of turns, not in the size of the wire. Take off the wire now on the armature, counting the number of turns as you do so, and rewind with about one-sixth the number of turns, using as large a wire as possible so as to obtain the greatest current capacity; or divide the wire now on the armature into six equal lengths, lay the six wires together and twist the ends together, making electrically one wire of six times the cross section, and rewind the armature as though the six wires were one. Magnetos vary so much as to voltage and capacity, it is impossible to give better directions from your description.

(D) Dry batteries are never better than wet batteries except as a convenience. You

can always renew the parts of a wet battery, hence, irrespective of price, you will find the wet battery better for experimental purposes. You will find other batteries, such as the bichromate, still better than the sal ammoniac for experiments.

### Quadruplex Telegraphy

*Question.*—Please show diagram and explain the principle of quadruplex telegraphy.

*Answer.*—The principle may be understood from the diagram, in which (PC) is a pole-changer, (K) a key, (R) a Morse relay and (PR) a polarized relay. With the key (K) in its present position only a part of the battery is available. This current is sufficient to operate (PR) when the

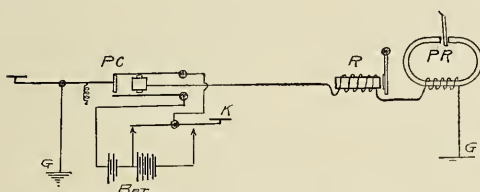

QUADRUPLEX TELEGRAPH

pole-changer key is worked, but is not strong enough to cause the armature of (R) to respond. When both (R) and (PR) are to receive at the same time, key (K) as well as key (PC) is used. Key (K) sending full battery current through (R) makes the armature of (R) a receiver of the message sent by (K).

### Commutating Pole Motor

*Question.*—What is a commutating pole motor?—M. R. H., Austin, Texas.

*Answer.*—A commutating pole motor is one in which commutating poles are placed between the main field poles and are wound with insulated copper wire or strip connected in series with the armature circuit so that the proper proportion of the main current flows through the auxiliary field coils around the commutating poles. The main field is usually wound with a shunt winding, but it may have also a compound or series winding when service conditions require.

The function of the commutating poles is to produce a magnetic field of such an intensity as properly to reverse the current in the armature coils short circuited during commutation, the brushes remaining in a

fixed position. The detrimental effect of the armature reaction which ordinarily produces sparking at the commutator is thereby avoided and sparkless commutation is insured at all loads within the speed ranges specified, as the strength of the auxiliary field is always proportional to the load and independent of the main field. Further, these poles are reversible in action, enabling motors to be run equally well in either direction. By the addition of commutating poles, therefore, motors can be operated at a higher output and a greater speed range, thereby reducing the size of machines for the same horse-power, and at the same time enabling larger overloads to be carried for short periods.

### Direction of Current in a Cell; Polarization

*Questions.*—(A) In the different kinds of cells does the current flow from the positive to the negative element, or does it flow from the negative to the positive? (B) What is the meaning of polarization?—B. S. P., Jasper, Ala.

*Answers.*—(A) In a simple cell the plates, the liquid and the connecting wires from one plate to the other form the electric circuit. Much confusion results from not clearly understanding what is meant by the terms here explained. Assuming a cell with a zinc and a copper plate immersed in dilute sulphuric acid. The wire connected to the copper plate is called the positive electrode, and the other the negative. The copper plate itself is called the negative plate, and the zinc the positive plate. When the ends of the wires connected to the plates are joined the electric circuit is completed and current flows from the zinc plate through the electrolyte to the copper plate and from the copper plate through the wire to the zinc. For further information see page 275 of the September, 1909 issue.

(B) In the cell just mentioned the condition may be represented in chemical terms before the circuit is closed by the following:

Zn	H <sub>2</sub> SO <sub>4</sub>	H <sub>2</sub> SO <sub>4</sub>	Cu
Zinc	Sulphuric Acid	Sulphuric Acid	Copper

After the circuit has been closed for a time the following represents the condition:

ZnSO <sub>4</sub>	H <sub>2</sub> SO <sub>4</sub>	H <sub>2</sub>	Cu
Zinc Sulphate	Sulphuric Acid	Hydrogen	Copper

The hydrogen collects on the copper plate forming a resistance, and the bubbles allow little of the surface of the copper to come in contact with the electrolyte. The current falls off and polarization has taken place.

# Notes on the Law of Patent Titles

By OBED C. BILLMAN, LL. B., M. P. L.

**Patent-Right Notes.**—A valid patent, without regard to its pecuniary value, is a sufficient consideration for a promissory note. But a note given for a patent which proves to be void is without consideration, and cannot be enforced. So also such note may be avoided for breach of warranty or upon proof of false and fraudulent representations by the assignor, as where the assignor falsely represents that he is the owner of the right sold, or that a patent had been obtained. In a suit on a note for a patent the questions whether there was fraud or warranty in the sale, and, if either, what was the value of the right sold, are for the jury.

**Statutory Regulation of Patent-Right Notes.**—In several states it is provided by statute that notes given for patent rights shall contain the words "given for a patent right."

5. The right to an invention not yet patented, or the inchoate right to obtain a patent or an extension or renewal, may be assigned so as to pass an equitable title to the assignee. The statute provided that patents may be granted and issued or re-issued to the assignee of the inventor or discoverer, the assignment being first entered of record in the patent office.

**Co-tenancy Created by Assignment.**—The assignment of an undivided interest in a patent right constitutes the assignee a joint owner or tenant in common with the assignor.

6. **Agreement to Assign.**—An agreement, either before or after the issuance of a patent, to assign the patent, or an interest therein, is valid, and will be specially enforced in equity in a proper case. A contract by an inventor, to assign to an assignee of his invention all future improvements which he may make thereon, is valid and not contrary to public policy. It seems, however, that an agreement to assign in gross the product of all one's future labors as an inventor is void. It is immaterial whether the agreement is in writing or not. Such agreements are not within the statute of frauds, nor within the provision of the statute that patents shall be assignable by an instrument in writing, and need not be recorded.

7. **Cancellation and Rescission of Assignments.**—An assignment or contract for the sale of a patent or interest therein may be rescinded or cancelled for fraud. So, also, an assignment may be cancelled by mutual agreement, and the cancellation and destruction of an unrecorded assignment by agreement of the parties reinvests the title in the assignor, without a formal reassignment to him. A contract of assignment will not be rescinded at the suit of the assignor without an allegation of fraud or offer to return the consideration, or other ground justifying equitable interposition.

**What Passes by Assignment. In General.**—In general, an assignment of an invention or patent, or interest therein, will pass only the specific right, title, or interest described in the conveyance.

**Extensions and Renewals.**—An assignment of a patent carries the right for the original term only, unless the instrument of assignment contains words indicating an intention to convey the right to an extension or renewal also, in which case such right will pass. Such conveyance becomes operative upon the grant of the extension.

**Improvements.**—The same rule applies to improvements as to extensions. An assignment of the patent does not of itself pass the right to future improvements, but may be made to do so by the use of apt words. But in order to have this effect it must plainly appear from the language used that such was the intention of both parties. An assignment of future improvements on a particular machine will not convey any interest in a future patent for a machine radically different though having the same object.

**An Assignment of an Improvement conveys no right to the original patent.**

**Right to Sue for Past Infringement.**—A mere assignment of a patent does not carry the right to sue for past infringements. But such right is assignable and will pass when expressly included in the conveyance. A claim for profits and damages for past infringement cannot be assigned separately from the patent, since this would give a right of action for such claim in disregard of the statute.

*Record Unnecessary.*—An assignment of the right to sue for past infringements need not be recorded.

*Assignment Conveying only Assignor's Interest.*—An assignment not purporting to convey all the right, title and interest granted by the letters patent, but only the right, title, and interest of the assignor, passes only such right, title, and interest, as he has at the time, and if he has previously parted with some interest, such interest will not be affected by the assignment although the first transfer may not have been recorded. The form of the assignment in such case is sufficient to charge the second assignee with notice of the prior unrecorded assignment. Such an assignment is not a mere release or quitclaim of the assignor's interest, and implies that a patent has been issued in due form. But it does not import a warranty by the assignor that he conveys all the rights under the letters patent.

*Warranty of Validity of Patent.*—It has been held that on an assignment of a patent there is no implied warranty of its validity nor utility. On the other hand it is well settled that the invalidity of the patent is a good defense to an action for the purchase price or on a note given therefor.

### Electro-magnetic Ironing Board

Using magnetic attraction to produce and vary the pressure of the iron upon cloth or other material being pressed is the subject of a patent issued to E. St. Clair Clayton, Baltimore, Md. The ironing board consists of a magnet wound with a coil of wire

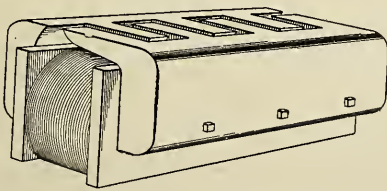

Perspective view of a magnet

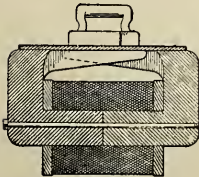

Cross sectional view of the magnet

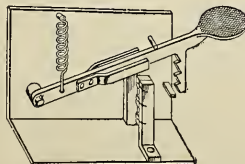

Foot control switch

ELECTRO-MAGNETIC IRONING BOARD

with the pole ends dovetailed into each other but having air spaces between. A thin board of wood or non-magnetic material is laid on the magnet surface and upon this the usual cloth. By connecting the magnet coil to the circuit through a foot switch and resistance the current around the magnet may be varied at will, thus increasing or decreasing the downward pressure of the iron on the goods, making a light iron do the work of a heavy one and relieving the operator from lifting a heavy iron.

### Tuning Fork for Ear Treatment

Isidor Müller of Vienna, Austria-Hungary, is the inventor of an electrical device for vibrating the auditory nerve. It consists of an electrical tuning fork which is made to vibrate by a small electro-magnet.

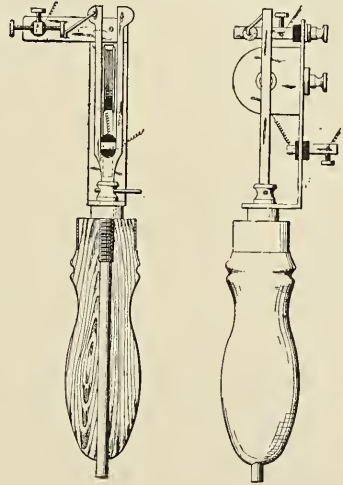

TUNING FORK FOR EAR TREATMENT

It has a projection which is pushed tightly into the ear passage and when the current is turned on, the air in the ear passage, the tympanum and the skull itself is set into vibration which vibrations are communicated to the auditory nerves and brain center. It is used for the purpose of clinical examination and for treatment of diseases of the ear.

### Training Baseball Pitchers

The illustration shows a patented device of Harry E. Hire, Mark Center, Ohio, which is to be used as a training equipment

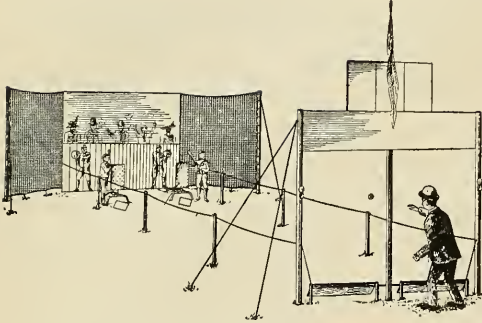

TRAINING BASE-BALL PITCHERS

for pitchers in the outdoor game of baseball. The screen at the back represents the grandstand and catcher. At the proper distance in front of it is placed a figure representing the player at bat. The home-plate is provided and just behind it a padded frame which is called the "umpire." Balls thrown by the pitcher if passing over the home-plate as they should will ring a bell, the circuit of which is closed when the ball strikes the umpire.

### Aging and Curing Tobacco

Green tobacco must be subjected to a treatment of dry, warm air before it is ready for consumers. The cut shows leaves of green tobacco hung in an enclosure on racks

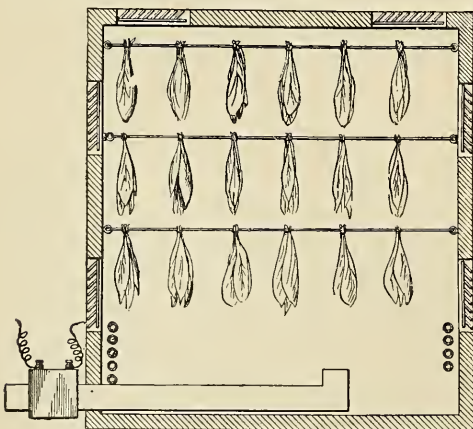

AGING AND CURING TOBACCO

ready for curing by a patented process. At the corners near the bottom are electric heating coils for keeping the temperature at

approximately 100°F. Ventilation is provided at the sides and top. "Modified" air used in the process is made by passing air through a flaming arc and into the enclosure. The air so treated contains nitrogen peroxide. From 24 to 96 hours completes the treatment. S. G. Martin, W. O. Bartholomew, and E. Schaaf of Chicago, St. Louis, and St. Marys, Mo., respectively, are the patentees.



THE MOTION PICTURE. ITS MAKING AND ITS THEATRE. By David S. Hulfish, Chicago: Electricity Magazine Corporation. 1909. 144 pages with 23 illustrations. Price, paper, 50 cents; cloth, \$1.00.

The desire of the public to know something about the production of the moving picture and the chance by theatre owners to profit from the experience of others is accorded in this volume. The book consists of two parts, the first being devoted to describing how moving pictures are made, and written in a way to be interesting to the average reader. The second part gives to the theatre owner and operator information on an infinite number of problems that are sure to arise. Although the book is largely a compilation of the author's answers to questions by machine operators, by theatre managers, and by the public, yet much additional matter has been put into this form to make the treatise complete.

PRACTICAL HANDBOOK OF MEDICAL ELECTRICITY. By Herbert McIntosh, A. M., M. D. Boston: Therapeutic Publishing Company. 1909. 498 pages with 200 illustrations.

Electricity is becoming more and more recognized as having a definite and established place in the practice of medicine. When rightly used by an ethical member of the profession it is a great aid not only in diagnosis but as a valuable assistant to established methods of treatment, and in some cases as a specific treatment. This work is calculated to give the physician as much as he will be required to know about the theories and laws of electricity and how to apply it in his practice.

# ON POLYPHASE SUBJECTS

## Why Don't You Use Electricity

Millions of people in this country today make use of electric current in one form or another; from the householder with a single porch light to the largest railroad systems, the greatest factories, the deepest mines. In between these extremes there are also other millions whose homes, stores, factories and shops have never been equipped with the wires which bring about better and more economical conditions. This, for various reasons, which in the general run turn out to be not reasons at all but simply lack of understanding of the real benefits and economies to be derived by the use of electricity. Of course electricity as an applied force is still comparatively young, and it takes time for anything to grow. If all were to suddenly wake up to its advantages at once and demand current the central stations and the manufacturers would be tied up in a terrible tangle trying to fill the demand. Still, without bringing about such a chaotic state of affairs, the consumption of current would be tremendously increased if only those who are just wavering on the dividing line were to make up their minds in favor of the modern way of doing things.

It would be interesting to know just why those who do not use current in their homes and places of business have not taken the step which tends toward their own betterment in every way; what answer they would give to the question: Why don't you use electricity? If sufficient answers to this question could be obtained from people in all walks of life and in all localities some very interesting data would be available and possibly some valuable conclusions might be drawn.

It is presumed that all who are readers of POPULAR ELECTRICITY are users of electricity in one way or another. But you know people who are not, and we would like to have you put that question to some of them and give us their answers. Some may think it too expensive, others may be afraid of it, others again may not have cen-

tral station service available and do not know how to obtain current in any other way. But no matter what the answers may be they will have a value in the data we wish to collect, and we will appreciate your services in helping to obtain it. Simply ask a non-user why he doesn't use electricity and give us his answer together with the nature of his business (whether he is a householder, storekeeper, dentist, manufacturer or what not). Also any other information which might have a bearing, such as the price of electricity and of gas in that locality, whether fuel is plentiful or scarce.

The more of these answers we can get the better, and we feel that we can depend on our readers to help obtain them.

---

One is reminded of the old quotation: "Water, water everywhere, but not a drop drink," when contemplating

## Still Trim Lamps

the curious state of affairs in Palermo, Cal. This town, which has two railroads passing through it and is not out of the world by any means, is decades behind in electrical development, and although thousands and thousands of horsepower of electrical energy pass through it, the inhabitants cannot use the current and are worrying along with the old fashioned kerosene lamp. The housewife, looking through her window, can see the tower of the Great Western Power Company's plant where 150,000 horsepower of electrical energy is developed. In other directions can be seen the plants of the Pacific Gas and Electric Company and the Oro Water, Light and Power Company with thousands of horsepower more. Some of the transmission lines from these plants pass through the town, yet the women must trim the primitive lamps in the morning for approaching darkness.

However, the townspeople look for better things, and in the near future their homes will in all probability be lighted by electricity from a substation.

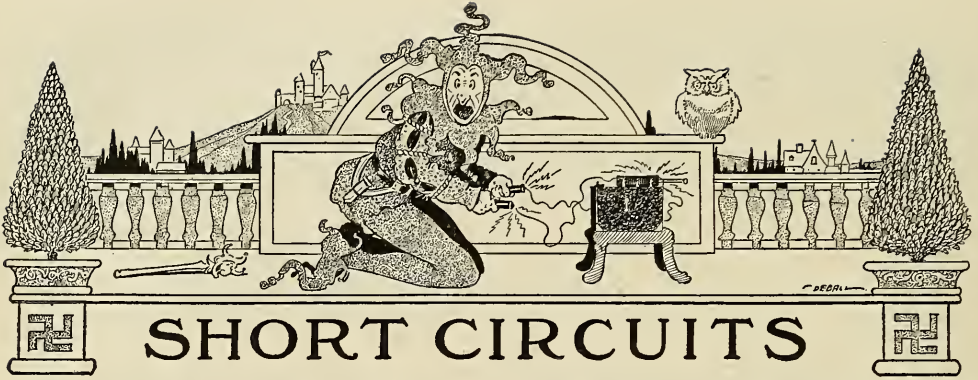

## SHORT CIRCUITS

One of the officials of the Midland railway, coming from Glenwood Springs recently, was telling a young woman on the train how wonderfully productive Colorado's irrigated ground is.

"Really," he explained, "it's so rich that girls who walk on it have big feet. It just simply makes their feet grow."

"Huh," was the young woman's rejoinder, "some of the Colorado men must have been going around walking on their heads."

\* \* \*

"Yis, Mrs. Muggins, Pat and Oi part to mate no more. Oi want to the hospital to ax aftter him. 'Oi want to see me husband,' sez Oi; 'the man that got blowed up,' 'Yez can't,' sez the dochter, 'he's unther the infloenyeec of Ann Esthetics.' 'Oi don't know the lady,' sez Oi, mighty dignified loike, 'but if me lawful wedded husband can act loike that whin he's at death's door, Oi'll have a divorce from him!'"

\* \* \*

Customer: I look upon you, Sir, as a robber.  
 Courteous Solicitor: You are privileged to look upon me in any character you choose to assume.

\* \* \*

"What did you do, James, when Edward called you a liar?" asked the teacher.

"I remembered what you said, that 'A soft answer turneth away wrath,'" replied James.

"Good boy. What soft answer did you make?" queried the interested teacher.

"Why, I hit him with a rotten tomato," said James.

\* \* \*

"Is that you, dear?" said a young husband over the telephone. "I just called up to say that I'm afraid I won't be able to get home to dinner tonight, as I am detained at the office."

"You poor dear," answered the wife sympathetically. "I don't wonder. I don't see how you manage to get anything done at all with that orchestra playing in your office. Good-by."

\* \* \*

A Washington woman has in her employ as butler a ducky of a pompous and satisfied mien who not long ago permitted a chocolate-colored damsel, long his ardent admirer, to become his spouse.

On one occasion when the mistress of the house had occasion temporarily to avail herself of the services of the butler's wife, it was observed that whenever the duties of the two brought them in conjunction the bride's eyes would shine with extraordinary devotion.

"Your wife seems wonderfully attached to you, George," casually observed the mistress of the house. "Yes, ma'am," answered George complacently. "Ain't it jest sickenin'?"

\* \* \*

One winter's evening, in "The City of Churches" (Brooklyn), when a water inspector was going his

rounds, he stopped at one of the mains in a busy street to turn off the water, owing to some repairs. He had just put the handle on the tap and begun turning, when a hand was placed on his shoulder. Looking around, he was confronted by a tipsy gentleman, who exclaimed solemnly:

'So I have found you at last, have I? It's you that's turning the street around, is it?'"

\* \* \*

A few days after a farmer had sold a pig to a neighbor he chanced to pass the neighbor's place, where he saw their little boy sitting on the edge of the pig-pen watching its new occupant.

"How'd d'ye do, Johnny," said he; "how's your pig today?"

"Oh, pretty well, thank you," replied the boy. "How's all your folks?"

\* \* \*

A rather seedy looking man hurried excitedly from the rear coach into the one ahead. "Has anyone got any whisky?" he shrilly inquired. "A lady back there has fainted."

Half a dozen flasks were offered instantly. Seizing one, he looked at it critically, uncorked it, put it to his lips, and took a long, lingering pull.

"Ah!" he exclaimed, with gusto, "I feel better now. Seeing a woman faint always did upset me."

\* \* \*

The teacher had been telling the class about the rhinoceros family. "Now, name some things," said she, "that are very dangerous to get near to, and that have horns."

"Automobiles!" replied little Jennie Jones, promptly.

\* \* \*

"Fountain pens," snapped the wife, "remind me, Horace, of some husbands."

"Why?" responded the meek little man.

"Expensive, can't be depended on, won't work, and half the time they're broken!" she snorted.

"That's pretty rough, Maria!" bleated Horace. "I call it most unkind, in fact. Really! But you couldn't compare a fountain pen with some women."

"Of course not!"

"No, Maria. You see, a fountain pen will dry up, and some wives won't."

\* \* \*

Mrs. X (away from home)—John, did you leave out anything for the cat before you started?

Mr. X (who dislikes the beast)—Yes; I left a can of condensed milk on the table, with the can opener beside it.

\* \* \*

A little girl fell out of bed during the night. After her mother had picked her up and pacified her, she asked her how she happened to fall out. The child replied: "I went to sleep too near the place where I went in."



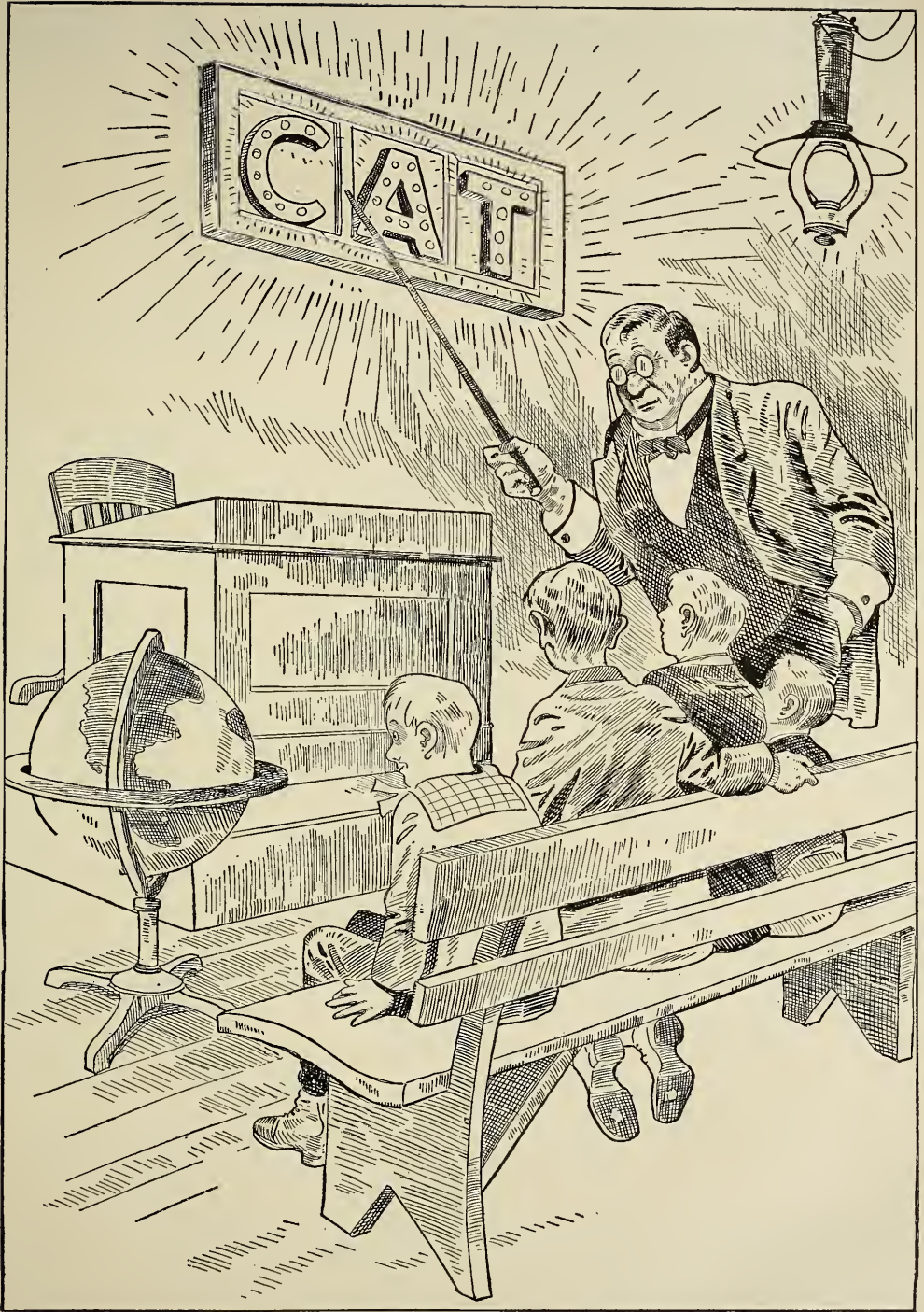

The Night School of the Future

# COMMON ELECTRICAL TERMS DEFINED

In this age of electricity everyone should be versed in its phraseology. By studying this page from month to month a working knowledge of the most commonly employed electrical terms may be obtained.

**ANNEALING.**—Heating iron used for electromagnets and allowing it to cool gradually increases the magnetic conductivity. This process when done by passing an electric current through the material is termed electric annealing.

**ANNUNCIATOR.**—A magnet and drop arranged to indicate, by the latter, when the circuit, normally open, is closed. Used on passenger elevators to give notice to operator of passenger waiting; in hotel offices; on automatic alarms; telephone switchboards, etc.

**ANODE.**—Applied to the plate in an electroplating bath from which particles of metal are carried for deposition upon the article to be electroplated. Also the positive plate in an ordinary battery, the positive plate being the one to which the negative terminal of the outside circuit is attached. Also the positive terminal in an X-ray tube.

**ANION.**—The electronegative element or radical of a molecule, such as oxygen. It is the portion which goes to the anode in electrolytic decomposition.

**ANSWERING JACK.**—The termination of a subscribers' line in a telephone switchboard panel into which the operator plugs when answering the call. The subscriber's line terminates in only one answering jack located in one of the switchboard panels.

**ARC.**—An electric arc is produced by placing the ends of two electrodes near enough to each other to allow the voltage to force current across the resistance of the air gap, these electrodes forming the terminals of an electric circuit. This arc produces the most intense heat known.

**ARC LAMP.**—An electric lamp producing light by means of the arc formed between its electrodes. These electrodes are ordinarily of carbon, sometimes one is of metal, however, as in the magnetite arc lamp, sometimes also the carbons have special cores as in the flaming arc. Arc lamps are also of the open and enclosed types, in the latter the arc burning in a globe from which the air is nearly all excluded. Generally represented in a circuit drawing thus:

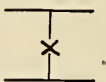

**AREOMETER.**—A glass tube enlarged and weighted at the bottom and having a scale marked on the upper portion for measuring the specific gravity of a fluid. In a light liquid this tube will float deeper than in a heavy one, the specific gravity being read directly from the scale. Used in caring for battery solutions.

**ARMATURE.**—The part of a dynamo or motor which revolves between the pole pieces. It consists of an iron core (usually laminated) on which are wound a large number of turns of insulated wire. These coils of wire cut the lines of force between the magnet poles and, in a dynamo, generate electric current. In a motor the lines of force react upon the wires of the armature and give the latter a rotating movement thus converting electric energy into mechanical motion. In some few machines the armature is stationary and the fields

revolve. The term is also applied to the bar or mass of iron or steel designed to be acted upon by a permanent magnet, as a nail placed across the poles of a horseshoe magnet when laid away.

**ARMATURE, DISK.**—An armature in which the coils are wound so as to be flat and carried on the face of a disk forming the core.

**ARMATURE, DRUM.**—An armature which takes the form of a drum or cylinder, the armature wires being wound on its surface or in slots below the surface.

**ARMATURE, RING.**—Armature whose core is in the shape of a ring.

**ARMATURE COIL.**—One of the coils wound on the armature core in a dynamo or motor.

**ARMATURE CORE.**—The mass of iron upon which the armature coils are wound.

**ARMATURE REACTIONS.**—When a dynamo is doing work the current in the armature coils sets up a magnetic field in addition to that produced by the field poles. The effect of these two fields upon each other together with the rotation of the armature results in armature reaction which may show itself in several forms, such as: eddy currents and heating, cross magnetization of the armature, sparking at the brushes, tendency of the armature current to demagnetize on account of the lead of the brushes (see Angle of Lead), changing of the place (see Neutral Point) where the brushes best take current from the commutator.

**ARMATURE SLOTS.**—Slots in the surface of an armature core in which the windings are placed.

**ARMATURE STAMPINGS.**—Thin pieces of soft sheet iron stamped out to the form of the cross-section of the armature core. They are then piled one above the other to build up the core, forming what are called the laminations. They are pressed together under hydraulic pressure and mounted on the armature shaft.

**ARMATURE WINDINGS.**—The coils of wire wound on the surface or in the slots of an armature. In the larger machines these sometimes take the form of copper bars.

**ASTATIC GALVANOMETER.**—A galvanometer equipped with an astatic needle. (See Astatic Needle.)

**ASTATIC NEEDLE.**—Two magnetic needles suspended parallel and near each other with opposite poles adjacent and in the same plane. So arranged, they are practically unaffected by the earth's magnetism and will remain pointed in any direction. This fact is made use of by surrounding one needle by a coil of wire leaving the other outside. A very feeble current passed through this coil will produce a strong deflection of the needles, the principle being made use of in the astatic galvanometer.

**A. W. G.**—An abbreviation for "American Wire Gauge."

**B. S. G.**—An abbreviation for "British Standard Gauge."

**B. and S. W. G.**—An abbreviation for "Brown and Sharp's Wire Gauge."