

POPULAR ELECTRICITY

Trade Mark
IN PLAIN ENGLISH



ALICE DOVEY, WITH LEW FIELDS

Vol. II

APRIL 1910

No. 12

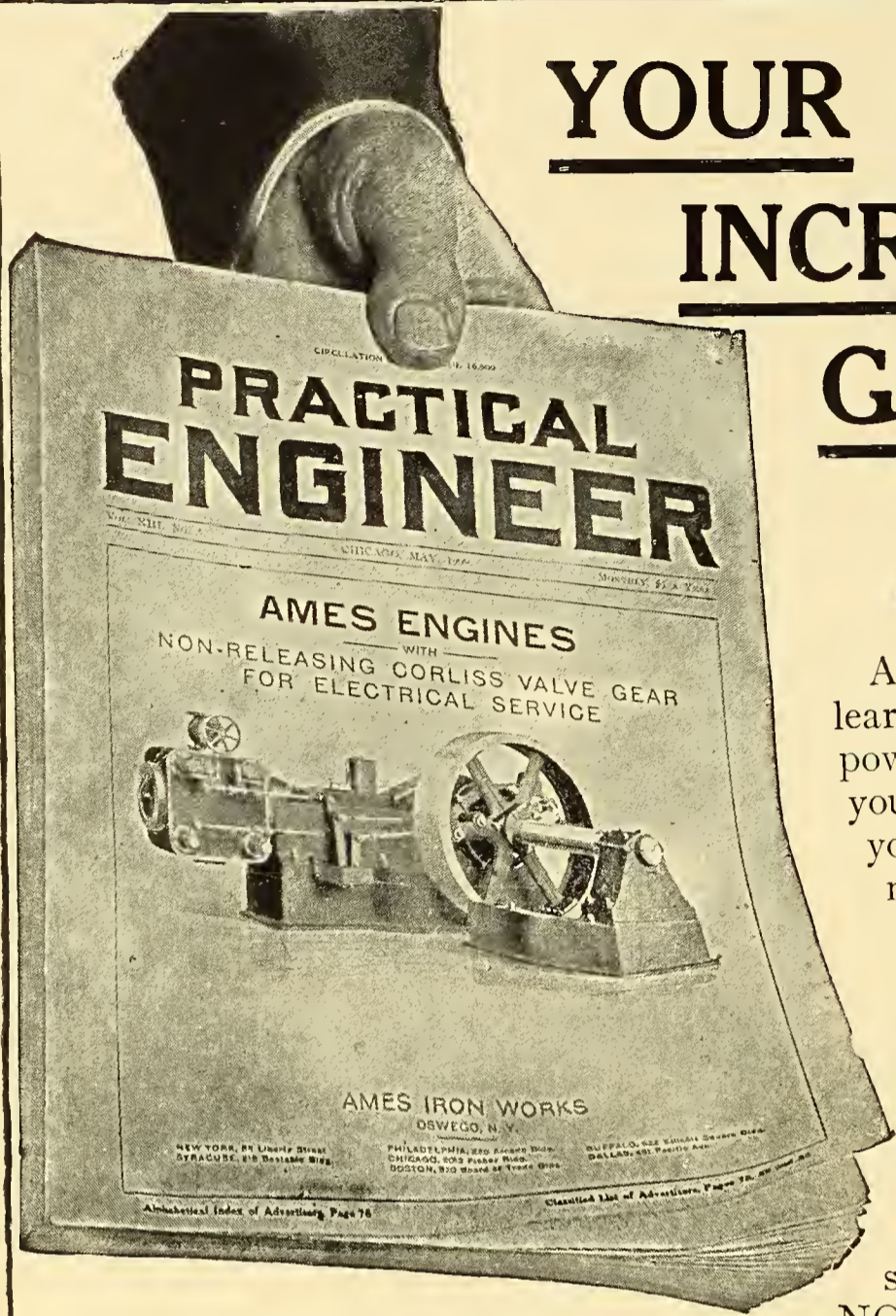

YOUR SALARY WILL INCREASE IF YOU GRASP THIS OPPORTUNITY

At a cost of but a few cents per issue you can learn how to save hundreds of dollars in your power plant. Practical Engineer will inform you, simply and plainly, the way to reduce your fuel expense, stop your steam losses and many other ways in which you can decrease your operating expenses. It is brimful of up-to-date, straight-to-the-point editorials, written by men who dig right into the heart of power plant problems.

The January Fuel and Furnace number is the most complete and practical treatise on Combustion, Fuels and Furnaces ever printed. This issue alone sells for 50 cents, but if you accept this offer NOW we will also send you twenty-three regular issues, each one the equivalent of a book of two hundred pages. But that is not all; if you mail us the coupon below, before our supply is exhausted, we will send you Practical Lessons in Electricity, which alone sells for \$1.50.

regular issues, each one the equivalent of a book of two hundred pages. But that is not all; if you mail us the coupon below, before our supply is exhausted, we will send you Practical Lessons in Electricity, which alone sells for \$1.50.

25 BOOKS FOR \$1.75

Practical Lessons in Electricity is just the book you have been looking for. It puts the prime facts of electrical knowledge so clearly and simply that any beginner can learn from it easily and rapidly. It is also a complete manual of conveniently arranged information of great practical value to the experienced electrical man. The book measures $6\frac{1}{2} \times 10\frac{3}{4}$ inches, contains 240 pages printed with good type on heavy paper, strong cloth binding and so attractive in appearance that you will be proud to have it in your library.

Now is the time to fill out and mail the coupon with money order or cash for \$1.75.

You will receive by return mail the big Fuel and Furnace number and Practical Lessons in Electricity and your name will be entered to receive Practical Engineer all of 1910 and 1911. If after reading three numbers you are not satisfied, ask us for your money—we will gladly send it back on return of the book.

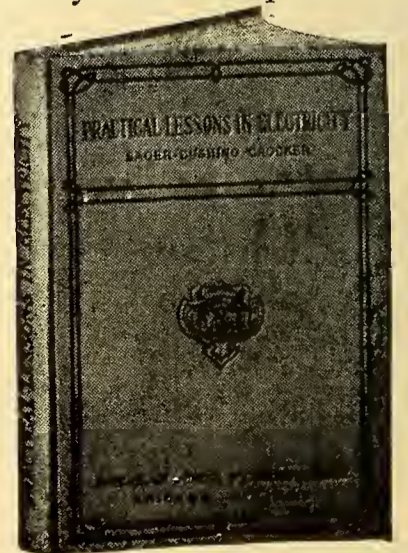

April

Practical Engineer
359 Dearborn St.
CHICAGO, ILL.

For the enclosed \$1.75, send me Practical Engineer for two years and include without cost, the big 230 page "Fuel and Furnace" number and Practical Lessons in Electricity, which I understand will be sent by return mail. I understand that my money will be cheerfully refunded on return of book, if I'm not thoroughly satisfied with my bargain.

Name.....
Address.....
City..... State.....
Occupation.....

CUT OUT ALONG THIS DOTTED LINE AND MAIL TODAY

\$20.00 to \$50.00 A Day Easily Made



Go in Business for Yourself
Let Us Send You a
Little Giant Cleaner
On 30 Days Trial

A Little Giant Cleaner should pay for itself in less than two months, out of the profits of the business after paying help and all expenses.

It is capable of earning \$250.00 to \$300.00 clear profit a month and we cannot see where there is a possible chance for anyone that buys a machine to fail to make big money, but every reason why they should make thousands of dollars.

Give Us a Chance to Help You

You can make \$2500 to \$3000 a year on each machine. It advertises itself and orders for work come pouring in so you should be busy all the time.

The Little Giant House Cleaner is proving one of the greatest money-makers ever put on the market. If you are willing to hustle you can easily make \$2,500 to \$3,000 a year on each machine you own. Make a start to-day and you will never regret it. As soon as you earn money enough and have one machine paid for, buy another, hire other men and let them make \$10 or \$15 a day for you. Getting one of these machines and hiring a man to run it, beats working for a living to a standstill. Be "Johnny on the Spot" with a machine and get the cream of the business. If you can get a number of these machines working, they should make you rich. We believe there never has been a machine placed on the market that has so pleased everybody, met with such immediate success, and made so much money as the house cleaning machine.

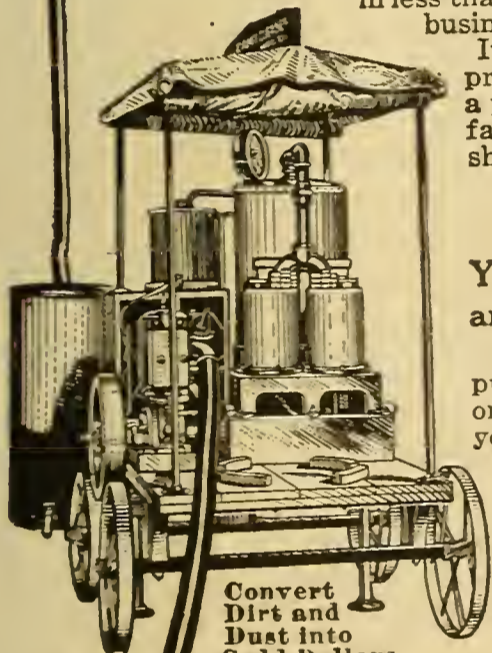

Convert
Dirt and
Dust into
Gold Dollars

Send for the Free Book, it Tells All

The Little Giant reaches every crack, corner and crevice of the floor; the cracks in the wall, the ceiling and mouldings. It cleans and renovates bedding, comforts, blankets, mattresses and pillows; the cracks or crevices in wooden and iron beds; even the dust, fuzz and other accumulation in tightly coiled woven-wire springs.

It consists of a powerful gasoline engine, a double acting suction air pump, a vacuum condenser, cold water tank, electric spark battery, vacuum gauge, high-pressure suction hose, observation glass and cleaning tools—all properly connected so as to work in unison and give the desired results. The whole is erected on a substantial four-wheel wagon, to be drawn by hand, so that it can be moved from place to place.

A Perfect Wonder

Nothing to Compare With It.

There are several small machines on the market for home use to be worked either by hand or a small water or electric motor, but they have never been a success because they do not have power enough to clean with, although they will draw the top dust from the room. The Little Giant Cleaner does the same work in the same way as the large machines costing from \$2,000 to \$7,000 each. It has the same size hose.

We have seen it pull out pail after pail of dirt from houses—dirt that was impossible to remove completely by the ordinary means of beating, etc. When it is working on the streets, the dirt and filth pouring through the observation glass attracts a crowd of people that look with wonder. They would not believe it possible.

Our Liberal Offer — Pay for it Out of Your Profits

We want you to investigate this exceptional opportunity. We do not believe there is any business where so small an investment will bring such wonderful returns, because right here in Toledo we have proved this by our own actual experience.

We have such implicit confidence in the wonderful money-making powers of the Little Giant House Cleaner—that we will ship one to any live man, who is honest and willing to work, on 30 Day's Trial—upon such liberal terms that it is next to impossible to lose. We will even go further and allow you to pay for it in installments, and in such a way that your profit should easily take care of your payments.

In our illustrated book we give full particulars as to how to organize your business solicit orders, what to charge for the work and how to turn every minute of your time into money. We will send it to you free. Every ambitious man who has any "get-up" in him should write at once for this book. A postage stamp will bring it to you and it will show you how you can become independent and one of the prosperous men in your community.

Send the Coupon for Free Book, full information and our Easy Terms.

McCreery Manufacturing Co.
118 McCreery Building
Toledo, Ohio

cut off here — write to
McCreery Mfg Co., 118 McCreery Bldg., Toledo, Ohio
Please send me your free book and full information about The Little Giant House Cleaner.
Name.....
Address.....

GOOD PUBLIC SERVICE COMPANY BONDS

BEARING 5% INTEREST

can be selected from our new circular of Bond Investments. The companies whose bonds we handle can show physical property more than sufficient as security and excellent earnings to prove that the companies operate under successful managements and in favorable communities.

We quote below attractive prices on two corporation bonds of merit.

ECONOMY LIGHT & POWER COMPANY

FIRST 5's. Due December 1, 1956

Price 98 and Interest

This company owns both a hydro-electric and steam plant in Joliet, Ill., which city and surrounding territory it supplies with electricity for light and power. The net earnings at the present time are over $2\frac{3}{4}$ times the interest charges.

CALIFORNIA GAS & ELECTRIC CORPORATION

UNIFYING AND REFUNDING 5's. Due November 1, 1937

Price 95 and Interest

The purely physical property of this company is estimated to be worth \$65,000,000 or nearly double the total outstanding bonded debt. The company serves 60% of California's population. Its properties comprise 130,000 developed electrical horse power, 14 gas plants and the street railways of Sacramento, Cal. The net earnings are more than twice the interest charges.

Full information regarding bonds on request.

N. W. HALSEY & CO.

BANKERS

152 Monroe St., CHICAGO

NEW YORK

PHILADELPHIA

SAN FRANCISCO

Electrical Securities

The stocks and bonds of first class ELECTRIC LIGHT, POWER and TELEPHONE companies offer to investors generous interest returns, combined with a high degree of safety and promise of future enhancement in value.

We have made a particular study of this class of securities, and we invite the correspondence and inquiries of those who are seeking desirable investments

RUSSELL, BREWSTER & CO.

Members of New York and Chicago Stock Exchanges

111 Broadway, New York

137 Adams St., Chicago

POPULAR ELECTRICITY

IN PLAIN ENGLISH

HENRY WALTER YOUNG, Editor

Vol. II

APRIL, 1910

No. 12

CONTENTS

	Page		Page
TELEGRAPH CABLE-REPAIRING ON A CHRISTMAS DAY. By Dr. A. E. Kennelly	779	ELECTRIC CURRENT AT WORK.....	818-825
Hazardous Line Construction	782	MOTORS IN WOOD WORKING PLANTS	818
TWO MONTHS ON THE SUMMIT OF MOUNT ROSA. By Dr. Alfred Gradenwitz....	783	Ice Cream Making on a Large Scale	820
Storing Electrical Heat	785	Electrically Made Whetstone	821
ELECTRICAL SECURITIES. By "Contango".	786	A Safe Lamp Socket	821
ELECTRIC LIGHT AND POWER FOR COUNTRY HOMES. Part 3. By Louis A. Pratt	789	The Pay-as-You-Go Meter	822
ELEMENTARY ELECTRICITY. CHAPTER 24. By Prof. Edwin J. Houston.....	794	Physicians' Vibrator	822
Dr. Acheson Receives Perkin Medal.....	798	Hot Air Treatment for Rheumatism....	822
X-Rays as Dental Detectives	798	Giant Hammer-Head Crane	823
WHERE ELECTRICITY STANDS IN THE PRACTICE OF MEDICINE. CHAPTER 4. By Noble M. Eberhart	799	An Electric Man-of-All-Work.....	824
TALKS WITH THE JUDGE	802	Where One Circuit Controls Another....	824
Electrically Made, Electrically Used.....	803	Three Electric Smelting Furnaces.....	825
Generating Electricity by the Sun's Rays. By Victor H. Laughter	804	ELECTRICAL MEN OF THE TIMES. Dr. A. E. Kennelly	826
MOST WONDERFUL CLOCK SYSTEM EVER BUILT. By Joseph B. Baker.....	805	ELECTRICITY IN THE HOUSEHOLD...827-831	
Down at the Power House. By Fred R. Furnas	808	AGAIN A WOMAN HAD HER WAY. By Florence Latimer	827
Living Candelabra	810	Sewing Without Effort	829
Northern Lights May be Electrified Neon.....	810	Electric Irons as Little Stoves	830
Railway Car Like Halley's Comet	810	Greater Than the Wash Tub.....	830
Cleptograph Camera	811	ELECTRICITY A SERVANT OF STAGE PEOPLE. By Alice Dovey	831
Rotasphere for Organ Blowing.....	811	JUNIOR SECTION	832-838
Simplest Alarm of Them All	811	AN ELECTRICAL LABORATORY FOR TWENTY-FIVE DOLLARS. Part 4. By David P. Morrison	832
Quicksilver not Quick Electrically.....	812	Fire and Burglar Alarm	836
Conduit for Electric Cables	812	Model Electric Locomotive	837
Signalling to Mars	812	Hand Power for Small Dynamos	838
Carbon Disk Arc Lamp	813	POPULAR ELECTRICITY WIRELESS CLUB	839-845
Snow on African Wires	813	A SIMPLE WIRELESS TELEPHONE SET—ARC SYSTEM. By A. B. Cole.	839
Charging Foundry Ovens with an Electric Crane..	813	Suggestions on Aerials	841
Novel Church Attraction	814	A Leading-In Insulator	842
Did Edison Make Good?	814	Marconi Receives Noble Prize	842
Anaesthesia by Electricity	814	WIRELESS QUERIES.....	842
Radium to be Made More Quickly.....	814	QUESTIONS AND ANSWERS	846-849
Does Dust Hamper Reflectors?.....	815	NEW ELECTRICAL INVENTIONS	850
Energy a Product of Mass and Velocity.....	815	Electric Hair Drier	850
Rejuvenated Sons of Jove	815	Theatre Without Ushers	850
Electric Tape Mends Water Pipes	816	Novel Light Diffuser	850
Electrical Easter Rabbit	816	NOTES ON PATENT INFRINGEMENT. By Obed C. Billman	851
Signal Cables for Australian Mines	816	Maver's Wireless Telegraphy and Telephony. (Book Review)	852
Electricity Makes Dead Dog Bark.....	816	Dykes' Troubles, Remedies and Repairs of the Automobile and Gas Engine (Book Review).....	852
Handy Electrician's Screw Driver.....	817	ON POLYPHASE SUBJECTS	853
Pump that Needs no Watching	817	SHORT CIRCUITS	854
Motor Electric Bell	817	ELECTRICAL DEFINITIONS	856
Faking High Voltage Sparks	817		

RENEWALS When your subscription expires you will find a renewal blank enclosed here. You should fill out and return same with remittance at once, to avoid missing a number. Positively no copies will be mailed on any subscription after same expires unless renewed, and we cannot agree to begin subscriptions with back numbers. The date on wrapper of your magazine shows the issue with which your subscription ends.

CHANGE OF ADDRESS Notify us promptly of any change in your address, giving both the old and new location. Since each issue is printed a month before the date it bears, we should be notified at least four weeks in advance, in order to make the necessary change in our records.

Issued Monthly by POPULAR ELECTRICITY PUBLISHING CO., Monadnock Block, Chicago, Ill.

Yearly Subscription, \$1.00; Canadian, \$1.35; Foreign, \$1.50; Single Copy, 10 Cents

No additional copies will be sent after expiration of subscription except upon renewal

Entered as Second Class Matter April 14, 1908, at the Post Office at Chicago. Under Act of March 3, 1879.

Copyright 1910 by Popular Electricity Publishing Co.



Will You Give a Home Test to Johnson's Under-Lac at our Expense?

WE WANT you to know Johnson's Under-Lac by actual proof and real test. *One* trial will convince you how far superior it is to shellac or varnish.

How much simpler, more economical, easier and more satisfactory to apply.

Let us send you a bottle, free and prepaid, and our illustrated booklet "The Proper Treatment of Floors, Woodwork and Furniture," which answers every question on the care, preservation and beautifying of every wood surface—is full of valuable hints and helps on home decoration.

Johnson's Under-Lac

Imparts a beautiful, brilliant and lasting finish to floors, woodwork and furniture—over surfaces being dressed for the first time, over dye stains, filler or the bare wood; over an old finish of any kind.

You know the fault of varnish. It is thick, sticky—dries slowly in a mottled way.

Under-Lac dries evenly and quickly—but not too quickly, like shellac which laps and crawls and dries before it is well on. Under-Lac is thin, elastic—dries hard in half an hour. Use it for *any* purpose for which you would use shellac or varnish.

Johnson's Under-Lac produces a splendid *permanent* finish.

For Linoleum and Oil Cloth

It brings out the pattern to best advantage, giving a finish as glossy as new; protects from wear and makes cleaning easy.

The most economical because it goes farthest and lasts longest. Gallon cans, \$2.50. Smaller cans down to half pints. Write today for the samples and our book of Home-Beautifying Suggestions, Edition P. E. 4. Clip coupon or take down address now.

**S. C. Johnson & Son
Racine, Wis.**

I accept your offer of a sample of Johnson's Under-Lac, better than varnish or shellac; also Booklet, Edition P. E. 4, I agree to test the sample and report results to my paint dealer.

Name.....

Address.....

Please use Coupon—Cut on dotted Line

**S. C. Johnson & Son
Racine, Wis.**

"The Wood Finishing Authorities"



For our Mutual Advantage mention Popular Electricity when writing to Advertisers.



Come! Quick! Danger!

Are you prepared for this call—no matter from which department it comes? Just think what it would mean to have constantly at your elbow for consultation, an expert on the very problems that puzzle you. That's just what you would have in the

Cyclopedia of Applied Electricity

Six Big Volumes—Bound in Half Morocco—2,896 Pages 7x10 inches—Printed on special paper in large, clear type—2,000 full page plates, diagrams, formulas, etc.

Written by thirty expert Electrical Engineers, the biggest men in the profession! It is a working guide for the student or practical electrician, and a ready reference for the expert.

Examine These Books at Our Expense

So confident are we that the books are just what you want, that we will send them to you by prepaid express—you keep the books 5 days—examine them carefully, test them, apply them to your every-day work. If satisfied that the books are the most complete and comprehensive work ever published on electricity, keep them, send \$2.00 within five days and \$2.00 a month until you have paid \$18.80, the special introductory price—the regular list price is \$36.00. If not suited to your needs, notify us. We will send for them at our expense. Fill in and mail the coupon today—the books will be sent you at once.

IMPORTANT SUBJECTS TREATED IN DETAIL

Electric Wiring—Electric Telegraph—Wireless Telegraphy—Telautograph—Theory, Calculation, Design and Construction of Generators and Motors—Types of Dynamos and Motors—Elevators—Direct Current Motors—Direct-Driven Machine Shop Tools—Electric Lighting—Electric Railways—Alternating Current Motors—Single Phase Electric Railway—Management of Dynamos and Motors—Power Stations—Central Station Engineering—Storage Batteries—Power Transmission—Alternating Current Machinery—Telephony—Automatic Telephone—Wireless Telephony—Telegraphone, etc.

Special Offer If You Mark and Mail Coupon Promptly

For a short time we will include, as a monthly supplement, for one year, the **TECHNICAL WORLD MAGAZINE**. This is a regular \$1.50 monthly, full of Twentieth Century Scientific facts, written in popular form. Also contains the latest discussions on timely topics of invention, discovery, industry, etc.

American School of Correspondence
CHICAGO, U. S. A.

FREE OFFER COUPON

Name.....
Address.....
Occupation.....
Employer.....

P. E.
4-10
A. S. of C.
Please send me Cyclopedia of Applied Electricity for five days' free examination. Also T. W. for one year. I will send \$2.00 within five days and \$2.00 a month until I have paid \$18.80, or notify you and hold the books subject to your order. Title not to pass until fully paid.

TEN THOUSAND TELEGRAPHERS WANTED

by railroads, commercial companies and Wireless Companies. Only schools in America teaching

WIRELESS TELEGRAPHY

We operate fifteen Wireless Stations. Main Line R. R. Wires in each of our Institutes. Supervised by R. R. Officials. Write for prospectus.

NATIONAL TELEGRAPH INSTITUTE

CINCINNATI, OHIO

PHILADELPHIA, PA.

MEMPHIS, TENN.

DAVENPORT, IOWA

PORTLAND, ORE.

COLUMBIA, S. C.



If YOU Would Be Successful Stop Forgetting

THE KEY TO SUCCESS

MEMORY the BASIS of All KNOWLEDGE

You are no greater intellectually than your memory. Send today for my free book: "How to Remember"—Faces, Names, Studies—Develops Will, Concentration, Self-Confidence, Conversation, Public Speaking. Increases income. Sent absolutely free—Address **DICKSON MEMORY SCHOOL, 929 AUDITORIUM BLDG., CHICAGO**



Learn Telegraphy

MORSE and WIRELESS

At My Practical School. Demand for operators from Railroads and Wireless Co's greater than supply. Graduates assisted. We occupy our own large modern building. R. R. train wire and complete wireless station. **Endorsed by Railroad and Western Union Officials.** Teachers are practical experts. Living expenses earned. Easy payments. Correspondence courses if desired. Catalogs Free. **GEORGE M. DODGE, Pres., Dodge's Institute, 21st Street, Valparaiso, Indiana. Established 1874.**



LEARN CHIROPRACTIC

The new method of drugless healing **EARN \$50 TO \$100 PER WEEK**

Our free book tells how you can learn to detect disease and remove the cause by Howard's method of Spinal Adjustment. Positively the most simple, direct, advanced and scientific method of drugless healing. Based on unerring natural laws. Anyone can understand it; learned in spare time. Improve your social prominence and financial standing. Start now on the road to honor and success. Write for free book and special scholarship offer **NATIONAL SCHOOL OF CHIROPRACTIC 1702 W. Congress St., Dept. 8 Chicago, Ill.**



IF YOU STAMMER

Attend no other school until you hear from me. Largest stammering school in the world curing by the improved natural method. No sing-songing or time-beating methods. Beautiful 88 page book and special rates sent free. **Lee Wells Millard, President, NORTH-WESTERN SCHOOL FOR STAMMERERS, Inc., 919 First St., Milwaukee, Wis.**



LEARN WATCHMAKING

By our profit sharing plan. We teach the most modern methods of **Watchmaking, Engraving, and Jewelry Repairing.** Individual instructions. Positions for graduates. Endorsed by leading jewelers. Write for our free catalogue. **Chicago School of Watchmaking Dept. 30, Bush Temple, CHICAGO**

AT THE QUALITY SCHOOL

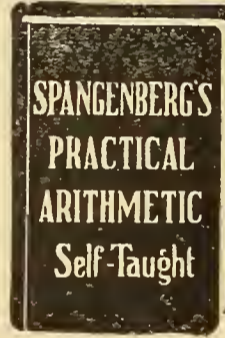

ARITHMETIC SELF-TAUGHT

A plain, easily-understood volume for ALL who have not had the opportunity of learning this subject thoroughly, or who have forgotten what they once learned. 257 pages. **REQUIRES NO TEACHER.** This great **60 Cents,** little book sent postpaid for (stamps accepted) leather binding, \$1. **GEO. A. ZELLER BOOK CO., Est. 1870. 4464 W. Belle Place, St. Louis, MO.**

100 Men Wanted to Learn WIRELESS—Big Demand

for Wireless Operators on land and sea. Earning big salaries. Expert Technical Instructions in all branches. Continental and Morse codes taught. Spring session now commencing. Special Rates. Also; correspondence course. Write, **INTERNATIONAL WIRELESS SCHOOLS Suite 620 171 Washington St. Chicago, Ill.**

Earn \$60 to \$140 Month



Hundreds of positions open for steam railway **Firemen and Brakemen,** and electric railway **Motormen and Conductors.** Experience unnecessary. Write immediately for full particulars stating position desired. **RAILWAY ASSOCIATION, 319 Dwight Bldg., Kansas City, Mo.**

YOUNG MEN WANTED

Honest Guarantee of Position

Learn Telegraphy and other branches. Few months practice, day or evening, leads to steady, good paying position. If you knew the urgent demand on us from railroads and telegraph companies for graduates you would come at once. We invite investigation. Established 1897. Terms reasonable. Write for full particulars. **Milwaukee Ry. and Com. Institute, 44-58 Hathaway Bldg. Milwaukee, Wis.**

DEAF OR HARD OF HEARING

LEARN TO READ THE LIPS

and comprehend every word spoken without hearing a sound. Discard ear trumpets and mechanical devices of every description. Write for **Free Treatise on Lip Reading** **The Lip Reading Institute Box No. 191 CLEVELAND, O.**

AUTOMOBILE ENGINEERING and DESIGNING

A great, new and uncrowded profession for men has been created by the wide use and manufacture of the Automobile, and its accessories. Our school is the only institution devoted exclusively to the instruction of Chauffeurs, Owners and Designers in all that pertains to the manufacture, operation and maintenance of every well known car. We teach you by mail. **New York School of Auto Engineering, New York City**

By affiliation with the New York School of Auto Engineering, and under our Co-operative Educational Plan, we offer you this complete course in Automobile Engineering *without a cent of cost*—only a slight service is required. Why not send a postal today and receive full information?

THE PEOPLES UNIVERSITY
P. O. Box 824, University City, St. Louis, Missouri

ELECTRICITY PRACTICALLY AND INDIVIDUALLY TAUGHT

Through the medium of tools and machinery. You are qualified in a few months under the guidance of skilled instructors in the largest and best equipped electrical school in the U. S. to occupy a responsible position in the electrical field or to enter into an electrical contracting business of your own. Write or call for Prospectus.

NEW YORK ELECTRICAL SCHOOL
40 West 17th Street New York City

Free, Send Today

For Our New

Illustrated Catalog of Electrical Books

Containing descriptions and illustrations of up-to-date books you need to increase your knowledge of Electricity. Also full particulars regarding our

Special Offer
An Electrical Library Free

Popular Electricity Book Dept.

1252 Monadnock Block

CHICAGO, ILL.



OUR HOME

The
Quickest
Way
to
Learn
a
Prof-
itable
TRADE

is by practical working ideas instead of books—as taught by the Coyne National Trade Schools. Takes but a short time to learn, saves three or four years that would otherwise have to be spent as an apprentice—and makes you independent for life—no woman or machine can take away your position.

**The Most Profitable Trades are Those of
Plumber, Electrician and Bricklayer**

Skilled workmen are in great demand everywhere and hundreds of our graduates

Earn \$5.00 to \$8.00 per Day

We give each student practical, individual instruction under actual working conditions. Equipment and methods far ahead of other institutions. Enter at any time—at any age. Drawing and estimating are included with each trade, enabling you to take the best positions or start in business for yourself. We assist graduates to profitable positions. Start today. We have a course in Mechanical Drafting that you can take at the school or at home. Sent FREE—Our large Illustrated Catalog giving full particulars of our entire instruction. Write for it today and start on the road to independence and a large income. Address me personally.

L. L. COOKE, Director in Chief

Coyne National Trade Schools

1736 N. Ashland Ave., Cor. Wabansia Ave.

CHICAGO, ILL.

LEARN TO RUN AND REPAIR AUTOMOBILES

Demand for Trained Men far exceeds the supply. Work pleasant. You can learn all in six weeks. Every man wanting to own an Automobile, become a chauffeur, expert repairer, agent or desiring to learn any branch of the MONEY Automobile business should take our practical course. Fine opportunities for young men. Send for our catalog.

EARN BIG MONEY

KANSAS CITY AUTOMOBILE SCHOOL,
(Largest, Best Equipped Automobile School in America)
2157 E. 15th Street, Kansas City, Mo.

LEARN THE AUTOMOBILE BUSINESS

EARN \$100 to \$175 MONTHLY

The Chauffeur travels just as far as the owner, sees all the scenes and is paid well for it. Demonstrators, Inspectors, Testers, Repairmen and Assemblers have present employment at good salaries. All are in great demand because of the rapid growth of the automobile business and lack of skilled men. Our correspondence course covers mechanism, operation and repairing and equips you to fill any of these positions. You study in your spare time. Rates reasonable. Write today for particulars.

CLEVELAND AUTOMOBILE SCHOOL
2161 East 9th Street

BE A TRAVELING SALESMAN

Traveling Salesmen Earn the Biggest Salaries of any class of men in the world. Over 600,000 employed in the United States and Canada. The demand for good Salesmen exceeds the supply. We will teach you to be one by mail and assist you to secure a good position through our FREE EMPLOYMENT BUREAU. We receive calls for thousands of Salesmen and have assisted thousands of men to secure good positions or better salaries. A great many of our graduates who formerly earned \$25 to \$75 a month, have since earned from \$100 to as high as \$500 a month and expenses. Hundreds of good positions now open. If you want to secure one of them or increase your earnings, our Free Book, "A Knight of The Grip" will show you how. Write or call for it today. Address nearest office.

DEPT. 423 NATIONAL SALESMEN'S TRAINING ASSOCIATION
Chicago, New York, Kansas City, Minneapolis
San Francisco, Atlanta, U. S. A.

CIVIL SERVICE

Government positions pay well. Our course of mail instruction will quickly fit you to take and pass the competitive examinations. Study in your spare time and in your own home.

The Home Correspondence School, Springfield, Mass.

By affiliation with The Home Correspondence School, and under our Co-operative Educational plan, we offer you this complete course in Civil Service Training without a cent of cost—only a slight service is required. Why not send a postal today and receive full information?

THE PEOPLES UNIVERSITY

P. O. Box 823 University City, St. Louis, Missouri

For our Mutual Advantage mention Popular Electricity when writing to Advertisers.

Learn Wireless

DON'T BE BEHIND THE TIMES

Get in touch with things of To-Day. It will help To-Morrow.

The Demand for Trained Men is greater than the Supply.

Be Prepared: Don't Delay.

We are the Leading and Pioneer School in the World in the Instruction of

WIRELESS ENGINEERING

Practical and Individual Instruction in
**WIRELESS TELEGRAPHY
AND TELEPHONY**

Graduates fully qualified to accept positions as Wireless Operators,

**ENGINEERS, DRAFTSMEN,
INSPECTORS**

**EXPERT INSTRUCTORS,
DAY AND EVENING
CLASSES**

A cordial invitation extended to all to visit our Institute.

Catalogue and schedule of rates mailed upon application to

**The American
Wireless Institute**

114 Fifth Ave., New York, N. Y

The Biggest Help

To any business is a good Advertising Agency. Yet its service costs the client nothing---if the agency is efficient. Otherwise it may cost a good deal.

We don't attempt to run your business. We don't know how. What we profess to know is advertising, and how that motive power may be applied to your business---with results.

Is your advertising successful? Does it reach the class you seek to interest? Is it *convincing*? If it lacks one or more of these essentials, let us confer with you, by mail or in person.

**Wm. D. McJunkin
Advertising Agency**

167 Dearborn St., Chicago

Are You Acquainted with *Modern Machinery*

a monthly journal devoted to the manufacture of machinery?

Modern Machinery

contains articles on pattern-making, foundry-practice and machine shop work in every issue. These articles are written by men of wide experience in their respective industries. They tell about the latest methods of machinery manufacture, in a way which is both interesting and instructive.

Modern Machinery

is the only journal in the country which publishes articles covering all of the industries connected with the manufacture of machinery in every issue. The subscription price is only \$1.00 per year. You cannot afford to do without it.

Write today for a list of valuable premiums which we give free with one years subscription. We pay a very liberal commission to solicitors.

Modern Machinery

961 Monadnock Block, CHICAGO

The More You Know The More You're Worth

to yourself and others, and the more fun and profit you get out of your daily work and amusements.

Here's a list of books that will give you a practical working knowledge of electricity in its various applications.

They'll help you in your studies, enable you to conduct new and more interesting experiments, enhance your value to your employer and increase your earning power.

Each book covers its particular subject thoroughly and concisely, is written in "plain English," fully illustrated, and offered at a price within the reach of all. We prepay shipping charges.

Liberal Special Offer

Furthermore, in order to acquaint every reader of **Popular Electricity** with our Book Department, for the next thirty days we will give you free with each purchase of these books amounting to \$2.00 or over, your choice of a Handy Electrical Dictionary or Practical Compend of Electricity.

The Dictionary is considered the best work of its kind. Has 224 pages, margin indexed, containing over 4,800 definitions with 7 pages of diagrams. The Compend is a wonderful little hand book of 272 pages, 116 illustrations, covering the ordinary applications and appliances of electricity, with wiring diagrams, condensed glossary of terms, telegraphic code, useful tables, etc. Both books are vest pocket size, enabling you to have them "on the job" when wanted, with strong cloth binding.

On a purchase of \$3.00 or over you can get 10% discount and choice of these books. On \$4.00 or over 10% discount and both books.

Of course, we won't make much on this offer, but we'll have a chance to demonstrate the value of our Book Department to you. It's your future business we're after.

Remember, the time of this special offer is limited, so make your selections early and send in your order. You really can't afford to overlook this opportunity.

POPULAR ELECTRICITY BOOK DEPARTMENT

Monadnock Block, CHICAGO, ILL.

Ask for our illustrated Book Catalog—it's free

BEST and simplest treatise for amateurs or experienced operators. Complete, thorough, up-to-date. Contains all necessary information for successful experiments or practical "wireless" work. 180 pages, 87 illustrations. Handsome stamped cloth covers. **\$1.00.**

A NEW book of unusual value. Is a complete, practical guide for the beginner, imparting a thorough, comprehensive knowledge of electricity and showing how to apply such knowledge in a practical way. 443 pages, fully illustrated. Handsome cloth. **\$1.25.**

SPLENDID for beginners. 3 volumes in one; Electricity, Magnetism, Voltaic Electricity. Explains its subjects simply and clearly, illustrating the principles presented with entertaining experiments easily performed at home. 283 pages, profusely illustrated. Cloth. **\$1.00.**

A RELIABLE, practical guide for beginners or electrical workers, showing the latest and most approved methods of installing work of all kinds to comply with the safety rules of the National Board of Underwriters, including valuable hints for electrical inspectors. 250 pages, over 100 illustrations. Gold stamped limp leather. **\$1.50.**

A COMPLETE, up-to-date, thoroughly reliable manual of useful information for all desiring a practical, non-technical work on electroplating and electrotyping. Includes all necessary tables, electrical rules, formulae, etc. 178 pages, 50 illustrations. Gold stamped limp leather. **\$1.50.**

A COMPREHENSIVE, concise treatise for study or reference, explaining fully all practical armature windings in detail, illustrating both theoretical principles and shop practice, with everything necessary to an intelligent understanding of the subject. 230 pages, fully illustrated. Full Persian Morocco. **\$1.50.**

A CLEAR, terse, comprehensive work on the construction, care and management of telephone systems, including testing and clearing of "trouble," with special data on Farm telephones of great value to builders and promoters of rural lines. 170 pages, illustrated. Strong cloth. **\$1.00.**

ONE of the most valuable works for the amateur or practical electrician. Presents a wonderfully interesting series of experiments, explaining just how to conduct them and also how to construct the apparatus required with inexpensive materials and tools easily obtained. Simply written, fully illustrated. 204 pages. Stamped cloth. **\$1.00.**

A THOROUGH, practical instruction book containing everything necessary to the study of telegraphy, arranged in easy lessons, including experiments in electricity and magnetism with which operators should be familiar. 170 pages, fully illustrated. Cloth. **\$1.00.**

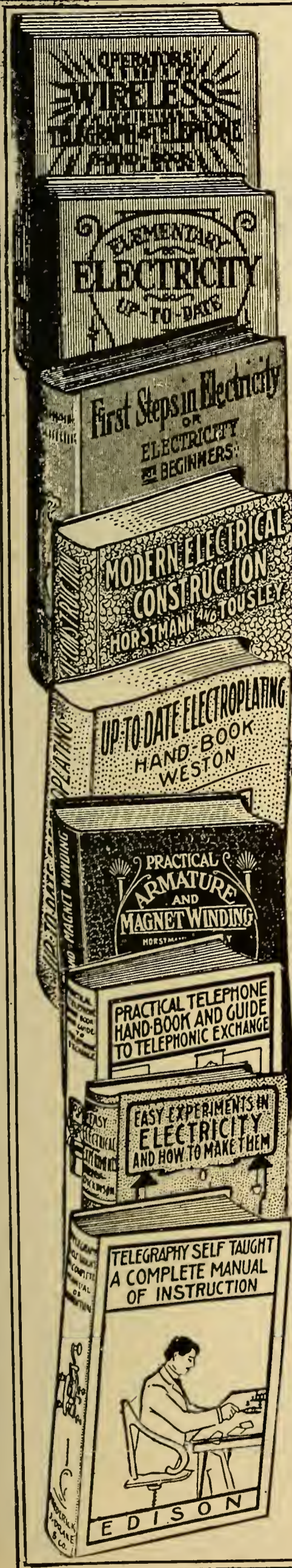

For our Mutual Advantage mention Popular Electricity when writing to Advertisers.



The Man Wanted

There is a place *any* time for the man who is master of business—for the man who *knows* not only the task under his hand but the things that depend upon it. Your value to your employer or your business—the number of places ready for you, is in exact proportion to the *definite*, practical knowledge you can bring with you.

What You Can Grasp

- VOLUME I—Business Organization, Advertising, Sales, Collections, Credits, Shipping, Export Shipments, Business Statistics, etc.
- VOLUME II—Purchasing and Stores, Catalogues, Time Keeping, Cost Analysis, Shop Management, Practical Manufacturing Methods, etc.
- VOLUME III—Commercial Law, Banking, Clearing House Methods, Partnerships, Corporations, Securities, Contracts, Leases, etc.
- VOLUME IV—Methods of Bookkeeping, Principles of Accounting, Trial Balance, Corporation Methods, Voucher Systems, etc.
- VOLUME V—Special Accounting, Systems, Inventories, Stock Brokerage, Recording and Billing, Handling Bankruptcy Proceedings, etc.
- VOLUME VI—Auditing, C. P. A. Requirements, Corporation Accounting, Corporate Business, Specialized Forms for Corporation Auditing, etc.
- VOLUME VII—Banking, Savings and Safety Deposit Accounting, Publishers' Accounting, Installment Sales and Collections, Advertising and Subscriptions, Practical Accounting Problems, Magazine Records, etc.
- VOLUME VIII—Brewers' Accounts, Retail Store Accounting, Mail Order Business, Follow-up Systems, Stock-Keeping, Classifying Costs, etc.
- VOLUME IX—Insurance, Real Estate, Loans, Abstracts, Contractors' and Insurance Accounts, Cost Keeping, Agency Organization, etc.
- VOLUME X—Department Store Accounts, Store Management, Hotel and Club Accounting, Commission and Brokerage, Trade Discounts, etc.

INTRODUCTORY OFFER COUPON

American School of Correspondence: P. E. 4-'10
 Please send set Cyclopedia of Commerce, Accountancy and Business Administration for 5 days' free examination. Also Technical World for 1 year. I will send \$2 within 5 days and \$2 a month until I have paid \$24.00, or notify you and hold the books subject to your order. Title not to pass until fully paid.

NAME

ADDRESS

OCCUPATION

EMPLOYER

No Matter What Branch of Business YOU Are in

the American School's new Cyclopedia of Commerce—a complete reference library of practical Business Knowledge in ten big volumes—will put within your reach at any moment all the facts connected with your work. It will perfect you in the closer knowledge of *your* department, will familiarize you with the work of other departments—will give you a broad survey of general business procedure. For the man who is ambitious to be a *big* business man—for the executive who desires to more intelligently check and guide the work of those below him, this great

Cyclopedia of Commerce Accountancy and Business Administration

consisting of ten handsome volumes,
 over 3,500 pages, 1900 illustrations, page plates, etc.,

is an ever-reliable, always dependable help in every problem. No such complete and yet instantly accessible digest of Business Knowledge was ever compiled before. The question that puzzles you, the emergency that confronts you, can be quickly solved with the help of these books.

Free Examination.

Test the value of these books, in *your* work—take no risk, but simply send the coupon. Examine the 10 big volumes thoroughly for 5 days—measure for yourself the benefits *you* can derive from them—the new avenues to power and position they open up for you. If you are not convinced, you need not spend a single penny on them. If you do need them, the payment is made easy and convenient for you—and in addition you will receive, as a monthly supplement, the Technical World Magazine for one year. Read the coupon, then sign and mail it today.

AMERICAN SCHOOL OF CORRESPONDENCE
 CHICAGO, U. S. A.

Do You Love the Old Songs?

Do you want "Heart Songs" on your piano the year round—elegant, refined in appearance, inviting you in spare moments to play or sing the piece most suitable to your mood, whether a rollicking sea-song or the tenderest lullaby? Do you want these famous old songs that have come down through the ages, gathered in a handy volume that may be referred to at any time, bound in a handsome and serviceable manner, opening flat like a hymn book? Do you want a music book of the kind and quality that will be treasured in the home and handed down as a family heirloom? Do you want to know just what 25,000 music-

loving people, like yourself, have selected as the best four hundred songs? Do you want your boys or girls to make their "progress" in music lessons an unending pleasure to yourself as well as affording them a most valuable education? **Such a book**

is "Heart Songs" acknowledged by highest musical authorities as the most comprehensive and correct volume of old songs ever issued. No music library is complete without it.

ANSWERED

The Prize Awards made in the compiling of this book were conferred by the well-known and popular composer, Victor Herbert, and Director Chadwick, of the New England Conservatory of Music

Over 512 Large Pages

Over 400 complete Songs with Words and Music



YES!

HERE IS OUR OFFER

HEART SONGS must be seen to be appreciated. If your book store does not have it, fill in the coupon, giving name of your dealer, and we will send a book to you through him for your inspection. It costs us money to do this, but we have so much faith in the book itself that we know if this advertisement has interested you to the extent of asking us to let you see a copy, it will practically sell itself, and a lot more to your friends.

Handsomely bound in Gold and Garnet with illuminated cover. Price \$2.50 net

CHAPPLE PUBLISHING CO., Ltd., Boston, Mass.

Kindly send me through.....
(dealer's name)

.....
(address)

a copy of "Heart Songs" for inspection. If it fulfills the promise of your advertisement I want it.

Name

Address.....

If you prefer you can omit the dealer's name and enclose \$2.50 direct to us. We will return your money if the book is unsatisfactory.

An Interesting Proposition

You Can Have Your Choice

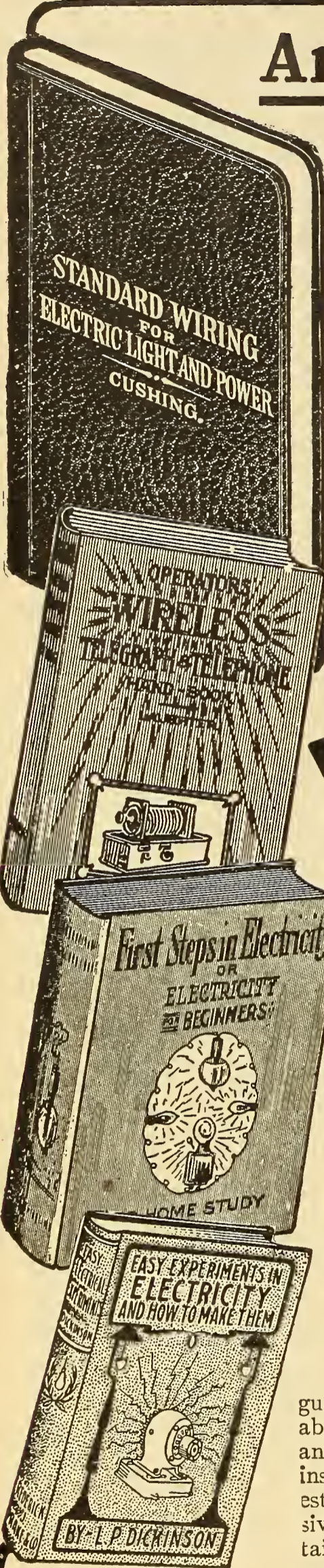

As adopted by the fire underwriters of the United States. Contains the National Electric Code explained with numerous illustrations, with the necessary tables and formulæ for outside and inside wiring and construction for all systems. Over 150,000 Copies Sold.

Up-to-date and most complete book on "Wireless" yet published. Full directions for constructing experimental sets, and various apparatus winding spark coils of all sizes and dimensions, tuning of wireless stations, etc. Includes Naval Station rules, with codes, etc. and several chapters on wireless telephony. All in simple language. 200 pages, fully illustrated, with 6 additional half-

full page tones showing installation of "Wireless" in the U. S. War Ships and Ocean liners.

Three volumes in one. Containing Electricity, Voltaic and Magnetism. Everything simply explained. For the beginner in the Electrical Trade this book is what you want. Over 280 pages fully illustrated.

One of the latest and most valuable works on electricity for the amateur or practical electrician published. Tells you in easily understood language everything you should know about various electrical instruments and apparatus of all kinds, with instructions for conducting interesting experiments with inexpensive materials and tools easily obtained. 206 pages, fully illustrated.

Remember—we cannot give you these books with your own Subscription

of these Practical Books on Electricity—the best of their kind—with a Handy Electrical Dictionary (see small cut) containing over 4800 electrical terms and phrases with 7 pages of diagrams—if you will send us

One Paid Yearly SUBSCRIPTION To Popular Electricity



AT ONE DOLLAR (Canada \$1.35, Foreign \$1.50)

And 25c additional to cover packing and shipping charges on the books.

The subscription must be for some one not already a subscriber to POPULAR ELECTRICITY and your own subscription will not do. We give you the books for getting us a new subscriber—not for subscribing yourself.

POPULAR ELECTRICITY appeals to all classes of readers—has something of interest for everybody. Your friend—neighbor—business associate—fellow employe—any one of the people with whom you come in contact—only needs to have you call attention to our magazine to become interested and give you a subscription.

A few minutes work will win you the books. Many of our readers have already taken advantage of this offer. Why not you?

Don't let this chance slip. Select the book you want, send in the subscription with remittance (including the 25c for charges) and we will forward book and dictionary at once.

POPULAR ELECTRICITY PUB. CO.

Monadnock Block, Chicago, Ill.

Gentlemen: Enclosed find \$.....for which send POPULAR ELECTRICITY to (subscriber's name and address here Not your own.)

Name..... Town.....

St. & No..... State.....

Send me **HANDY ELECTRICAL DICTIONARY** and (name of book wanted) as per your special offer.

Write your name and address plainly on space below.

Name..... Town.....

St. & No..... State.....

SAVES MONEY

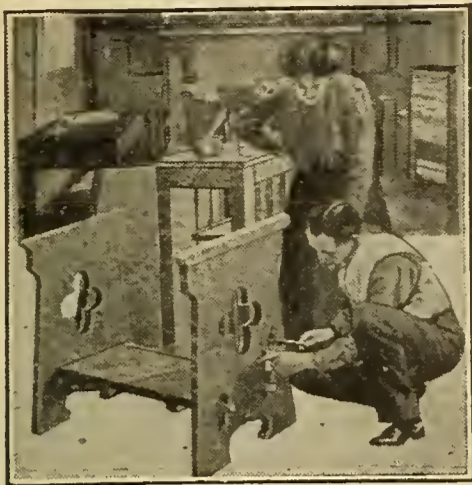

MAKE IT YOURSELF
WITH THE SIMPLEST TOOLS

“HOME-CRAFT” Furniture

We send you the pieces of selected quarter-sawed oak, smoothly dressed, accurately cut ready to fit, together with all of the materials for finishing. It is a very fascinating, pleasant occupation and quite the proper thing to make your own furniture. Write today for new, beautifully illustrated book, enclosing four cents in stamps for postage. It will explain everything. (Incorporated 1906). Address

Home-Craft Company

226 Caswell Blk., Milwaukee, Wis.

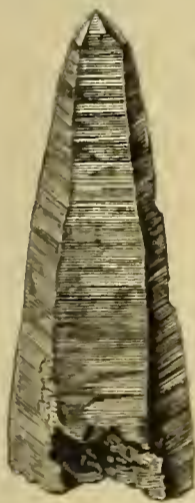

New “Crystal” Detectors for “Wireless”

Valuable information not in the latest books, is just published and will be mailed free on request. Buy your minerals direct from specialists in mineralogy. Selected “points” $\frac{1}{2}$ inch to $\frac{3}{4}$ inch long of **Bornite**, **Chalcopyrite**, **Domeykite**, **Galena**, **Molybdenite**, **Niccolite**, **Pyrite**, etc., at $2\frac{1}{2}$ to $3\frac{1}{2}$ cents each, postpaid. **Zincite**, $12\frac{1}{2}$ cents. Money refunded if unsatisfactory. Free price list describing many other less known minerals useful in wireless work.

FOOTE MINERAL CO., (Crystal Dept.)

107 N. 19th St., PHILADELPHIA, PA.

We Refer to any Teacher of Mineralogy.

STUDY MUSIC

We teach Piano, Organ, Singing, Harmony, Counterpoint, etc. by mail. We teach beginners as well as advanced pupils. We can teach you more in three months with an hour's study each day, than you can learn in a year under the ordinary method. Our courses are particularly valuable to music teachers.

Quinn-Campbell Conservatory of Music, Chicago

By affiliation with the Quinn-Campbell Conservatory, and under our Co-operative Educational Plan, we offer you this complete course in Music *without a cent of cost*—only a slight service is required. Why not send a postal today and receive full information.

THE PEOPLES UNIVERSITY

P. O. Box 825, University City, St. Louis, Missouri

Have You Seen a Recent
Sample of

Telephony.

THE AMERICAN TELEPHONE JOURNAL

We will be glad to send one

FREE!

Manufacturers, Dealers or Readers interested in the Telephone Field need this Progressive Publication.

Telephony

covers a field of over 20,000 Telephone Exchanges, employing more than 200,000 well-paid men who expend annually over \$150,000,000!

Telephony

is the recognized authority of one of the greatest industries in the world. It covers its particular field just a bit more thoroughly than any other industry is covered by one given medium.

Telephony

is issued every Saturday. It also provides its advertisers with a Telephone Bulletin Service, and a “**Directory of the Telephone Industry**,” in which are listed over 18,000 operating Telephone Companies, Manufacturers, Dealers, Contractors and Engineers.

Telephony

is one of the Best Investments that any Advertiser can make for a very modest sum. Try it!

Telephony Publishing Co.

MONADNOCK BLOCK

Chicago

LEARN THE **AUTOMOBILE** TRADE

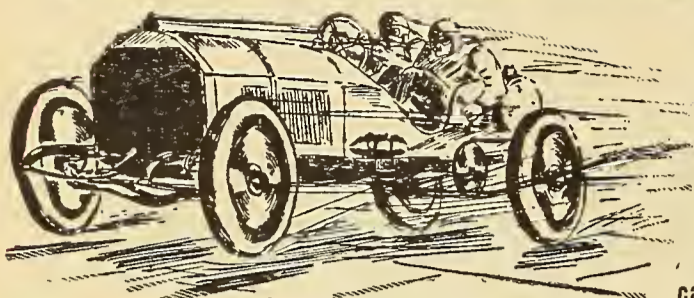

Pick up any Automobile Paper and see how the Factories are working day and night and note their advertisements calling for help

There is Life, Pleasure and Future in this Business

AUG. FALKENHEIMER of Oshkosh, Wis., ordered our Course in September, he writes us January 15th and says: "I now have a good paying position with one of the largest Auto Concerns in the country—I owe it all to your Course and to the Diploma, the Course gave me the knowledge and the Diploma helped me to get an audience with the Superintendent—it's great, refer any one you want to me." The above is part of an unsolicited testimonial, written by a young man who has been benefitted and whose long wished for dream has come true—we have hundreds of letters on the same order which are reproduced in our free catalogue.

It is easy to get into any branch of the auto business because the demand is so great—

It is the coming trade and now is the time to start and your start is with

DYKE'S AUTO & GASOLINE ENGINE INSTRUCTION

Even though you are employed—now is the time to learn the trade and then watch your opportunity—

One of our students opened a repair shop, others are driving cars, some are working in factories, as assemblers and testers—

One student took the agency for a gasoline engine, and is now selling and repairing gasoline engines for stationary and farm and boat use and is doing well—

It is not only for those who wish to learn the trade, the expert repairman, the auto and boat owner—it is for everybody.



C. L. Leeper, of Ash Grove, Mo., (Jan. 24 10) says "I have had four years experience in auto and engine work, but have found many kinks solved I have never heard of—Your models and course is perfect."

Otto Osborne, Zanesville, Ohio, says "It is just like working on a real car. I find it more than meets my fullest expectations." IT IS EASY TO LEARN.

Dyke's Course is the only one which can be taught by mail and a moment's thought will convince you—

See these working models, they afford the actual practice and enable you to understand the meaning of all the terms and phrases used in the 24 lessons—there are also 34 charts—DYKE'S COURSE is the cleverest proposition in the world today—It is interesting, you will enjoy studying it—It will be a pleasant and profitable time spent.

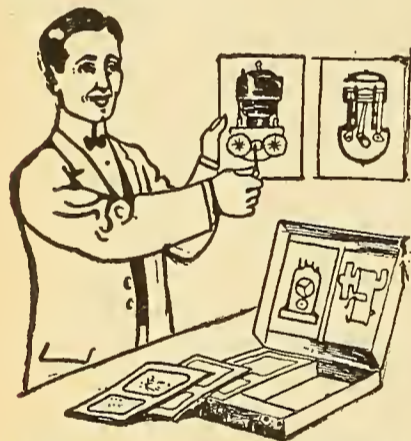

See These Models—They Work—There are two sides to each Model and all moving parts of metal.

Mr. DYKE was the first Auto Supply man in America and built the fifth successful Automobile in this country. His experience is embodied in this course. Mr. Dyke made a special trip to Europe to secure additional matter for this great Course. The working models were designed and are made in Europe by a leading mechanical artist.

We Teach You everything there is to learn about the Automobile and Gasoline Engine, first the principle, then the rest comes as if by magic. You will then understand subjects such as valve setting, timing ignition, how the cylinders fire, construction of all forms of Magnets and how to set them, storage batteries and all systems of wiring, and many other important subjects.

SPECIAL TRIAL OFFER. YOU CAN'T LOSE A CENT. Send us \$5 Cash and your promise to pay the other \$5 in 30 days. We will then send you the Course and will give you two days' time for inspection and if you don't like it return.

FREE Catalog—Send for it today, Auto Button with Course and Diploma when you Finish.

Fill in this blank and send it to me today.

Date _____ 1910

Dyke's Cors'p School Motoring,
1300 New Bank Commerce Bldg., St. Louis, Mo.

Dear Sir: Enclosed find \$5. Send me your full course. I agree to send you the other \$5 within 30 days or return the course within 2 days if not satisfactory.

Name _____

Address _____

A COMPLETE **Electrical Workers' Library**

By **HENRY C. HORSTMANN** and **VICTOR H. TOUSLEY**

Positively up-to-date and written for the men who do the work

We defy any publisher in the world to produce a more practical collection of books for the electrical worker than this series. The immense sale of these popular books since date of publication has been greater than any electrical books ever sold to working electricians.

The Reason?

They are practical and do not confuse the worker. They also have the highest endorsement of the International Brotherhood of Electrical Workers.

To substantiate this claim we offer the sum of One Hundred Dollars to any publisher who will produce a sworn statement showing a greater sale of any similar book or books treating on the subject matter that these do, for the length of time they have been on the market.

As to our reputation for keeping business promises, we will refer you to any bank or business house in Chicago.

For the next ninety days we are making a special introductory offer of the complete set of four volumes, neatly cased (regular price \$6.00).

Our special introductory price to electrical workers \$5.00, prepaid to any address upon receipt of price. To all persons ordering this set by return mail, we will present, free of charge, our Handy Electrical Dictionary for the Vest Pocket, bound in red Russia Leather, gold edges, indexed, 224 pages, illustrated. If the books ordered are not found entirely satisfactory in every way, they may be returned and your money will be cheerfully refunded. To electrical workers already having any of the below enumerated volumes, we will supply single copies of any one or more books at \$1.50 each, postpaid to any address in the world.



Send for descriptive booklet which gives a partial list of contents

- Electrical Wiring and Construction Tables** 120 pages 70 diagrams
- Modern Electrical Construction** 340 pages 173 diagrams
- Modern Wiring Diagrams and Descriptions** 250 pages 200 diagrams
- Practical Armature and Magnet Winding** 232 pages 128 diagrams

Each volume is substantially bound in full Persian Seal Grain Morocco Leather, stamped on the outside covers in genuine gold leaf, round corners, red edges, pocket size, printed on super-calendered book paper.

Address all orders to the Publishers

Frederick J. Drake & Company
222 Fisher Bldg., CHICAGO, U. S. A.

**Electricians,
Wireless Operators,
Linemen, Students**

\$1.00

On Account will give you the opportunity of becoming an Expert in the Electrical Field.

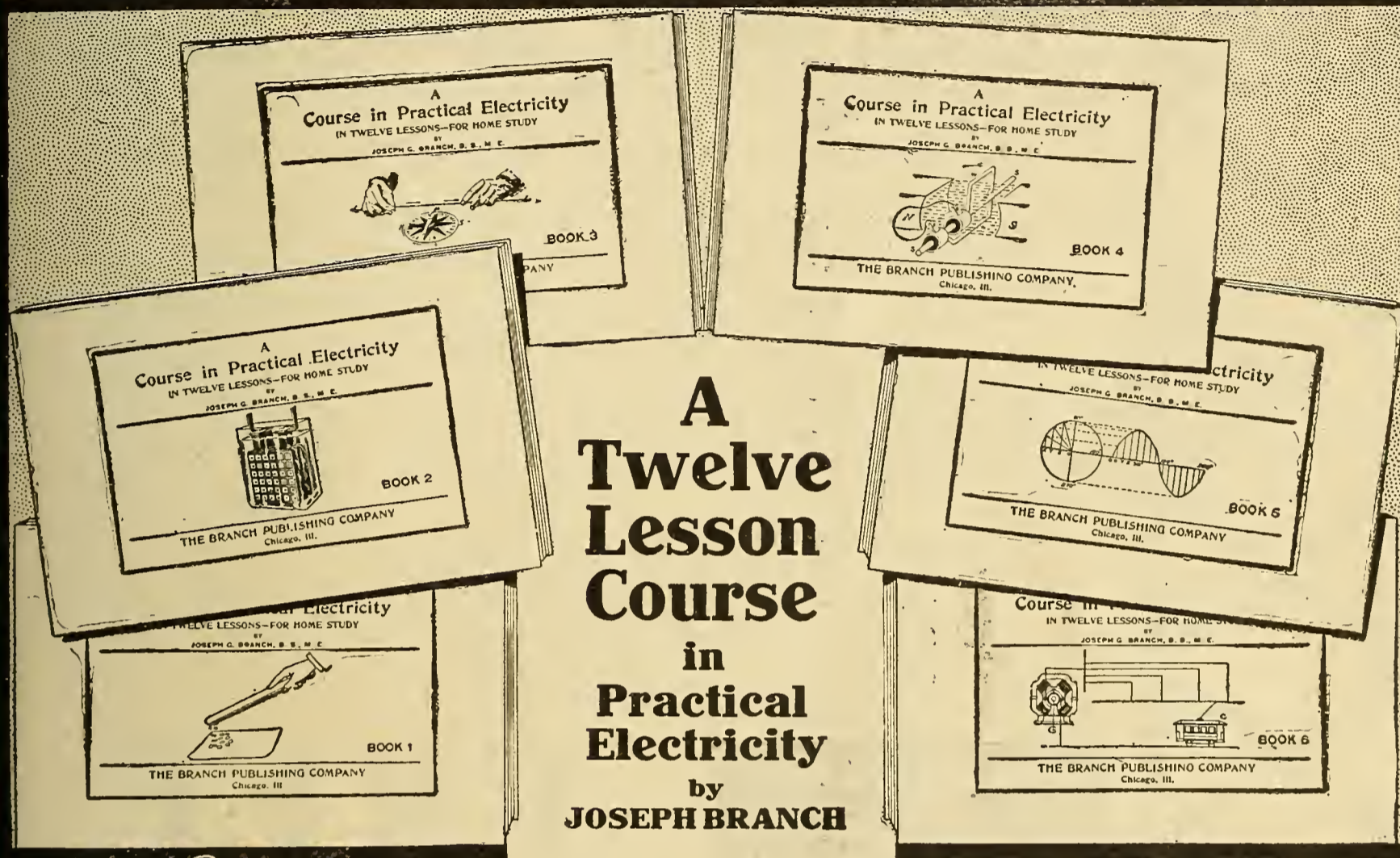

**A
Twelve
Lesson
Course
in
Practical
Electricity
by
JOSEPH BRANCH**

Practical Electricity in Twelve Lessons, by Joseph G. Branch, B. S., M. E. Six volumes, profusely illustrated, with diagrams, circuits and working drawings. Used by the leading schools and operators and **universally endorsed**. Following are only two out of our many testimonial letters:—

Mohawk, Keweenaw Co., Michigan, Jan. 31, 1910.
The Branch Publishing Co., Chicago, Ill.

Dear Sirs:—
Enclosed please find Post Office Order for the sum of \$1.50 (One Dollar and Fifty Cents) One Dollar in payment for Course in PRACTICAL ELECTRICITY; and 50 cents for which please send me one of your Charts showing the Development of the Steam Engine.
I think your Course in PRACTICAL ELECTRICITY is great, and I would advise every student in Electrical Engineering to take up your Course in 12 Lessons.
It is SIMPLE to learn, and when once learned, it is not easy to forget. Respectfully yours,
H. H. CARTER, M. E.

Elizabethport, N. J., Station A, Jan. 25, 1910.
The Branch Publishing Co., Chicago.

Dear Sirs:—
Enclosed find \$1.00 for Book 2 (Lessons 3 and 4) of PRACTICAL ELECTRICITY.
I tackled the study of Electricity before, but used to get tired and quit. I find your system much more lucid and interesting than the style of the textbooks, and it has a tendency to encourage the student who hasn't much ambition or desire left for study after a hard day's work.
For such, and for the busy man in general, your Course in PRACTICAL ELECTRICITY fills a long felt want.
Yours sincerely,
JOHN COLBERT.

A complete course of **Home Study** on electricity in all its branches, simple, practical and comprehensive. The only strictly **up-to-date** course in electricity published. On receipt of \$1.00 cash we will send you the first two lessons (Book 1) and include with same a **Consultation Certificate**, entitling you to the advice and assistance of electrical experts on all questions arising in this Course of Study. The balance payable at the rate of \$1.50 per month for six months, making the entire cost of the Course of Study \$10.00, if ordered AT ONCE. Send for our *New Electrical Catalog at once—Free.*

The Branch Publishing Co.
46 Van Buren Street, Chicago, Ill.

THE BRANCH PUBLISHING COMPANY
46 Van Buren Street, CHICAGO

Enclosed find \$1.00. Please send me Practical Electricity in Twelve Lessons, Branch Method. Six Volumes, with **consultation certificate**. I promise to pay balance of \$9.00 in monthly payments of \$1.50 each. Title not to pass until paid in full.

Name.....
Town.....
City..... State.....
Employer..... (P.E-4)



CHIEF DRAFTSMAN

Will INSTRUCT PERSONALLY a limited number selected, ambitious men in

Practical Drafting, Detailing, Designing

Draftsmen Drawing \$125-\$150 Monthly

Are NOT MADE in Schoolrooms,
Are NOT MADE by Reading Books,
Are NOT MADE by making Copies,
Are NOT MADE at home drawing pictures
from printed book lesson.

LET ME TELL YOU:

It requires actual, practical, up-to-date
DRAFTING-ROOM WORK to train YOU to
gain the PRACTICAL EXPERIENCE that your
employer will demand of you.



FREE

This \$13.85
DRAWING OUTFIT
and Free Position

As Chief Draftsman of Engineering firm I know exactly the Quality and Quantity of PRACTICAL training, knowledge and actual up-to-date experience (not school knowledge) you must have, in order to obtain a good position and advance to highest salary.

I give INSTRUCTIONS UNTIL COMPETENT and
PLACED in POSITION at above Salary

DON't waste TIME and MONEY trying to learn from books or printed "STUFF" you can only learn on PRACTICAL WORK which I furnish you.

Address **CHIEF DRAFTSMAN**

Div. 10, Eng's Equip't Co. (Inc.), Chicago

To Our Loyal Supporters

¶ With this issue Popular Electricity is two years old. We have felt with each succeeding month during this period that we have gained a stronger position in the estimation of our readers and our advertisers.

¶ In any race, the higher the aspirations of the contestant and the swifter his companions in the race, the more strenuous must be the effort put forth.

¶ When entering the contest we chose the Marathon event rather than the short and more spectacular dash.

¶ We rely on the rich, young blood of a growing industry, with the enthusiastic support of a deeply interested public, to give us the stamina to strengthen with each succeeding lap of the race.

¶ In the meantime you, our supporters, have had the pleasure of seeing us draw up on the leaders and "running stronger."

¶ You may pass the word along that Popular Electricity is going to lengthen its stride in these next laps and make the race in a manner which will merit your continued loyalty.

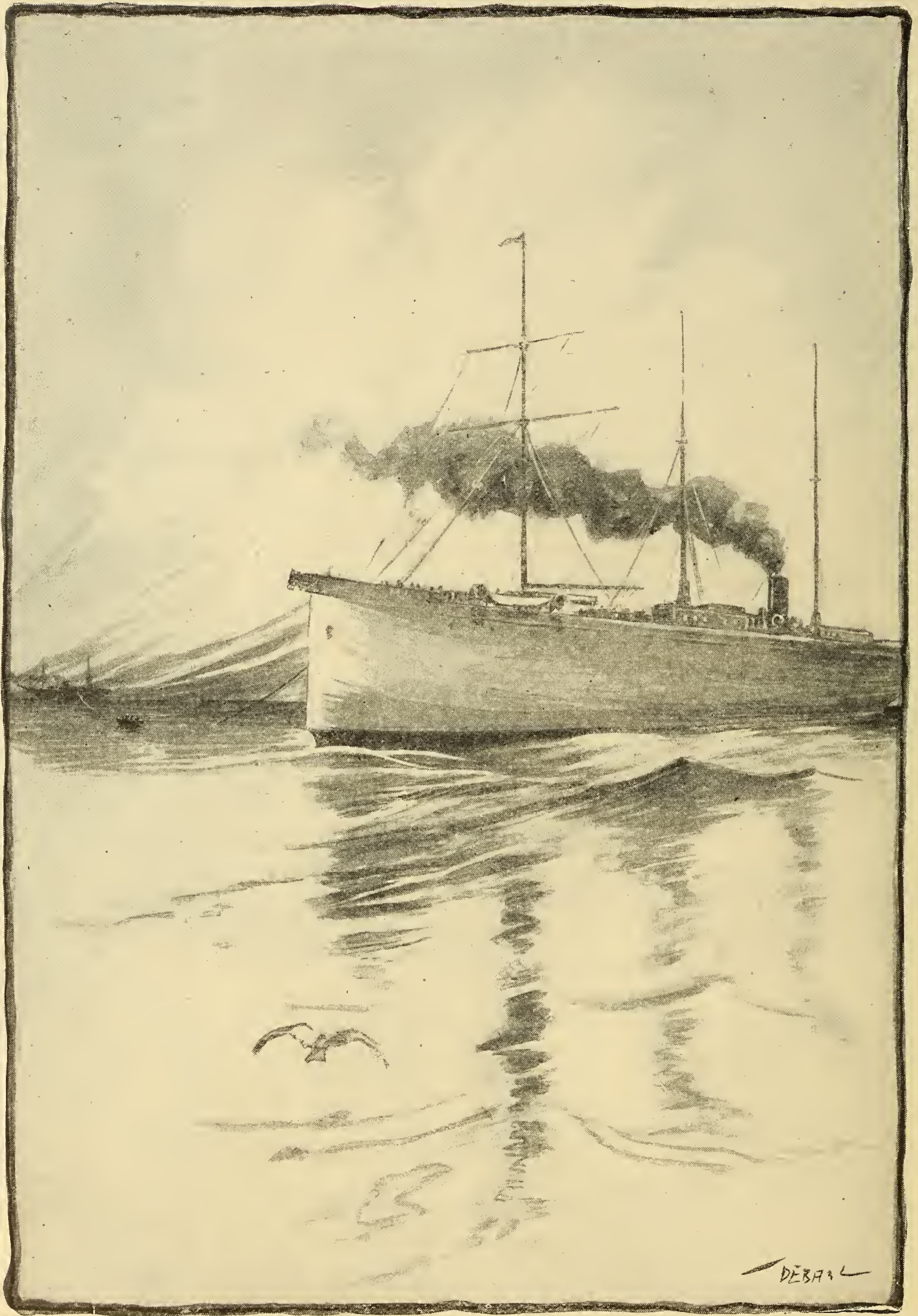

DEBAR

THE CABLE WAS HAULED FROM OUR FRIEND'S TANK INTO OUR OWN

LIBRARY
SEP 21 1931
U. S. PATENT OFFICE

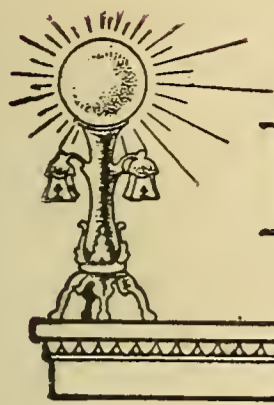

POPULAR ELECTRICITY

IN PLAIN ENGLISH

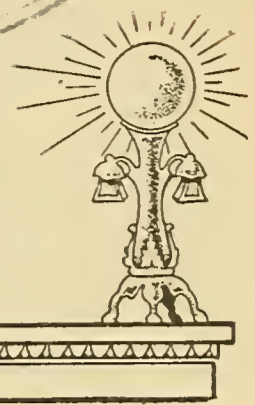

VOL. II

APRIL 1910

No. 12

Telegraph-Cable Repairing on a Christmas Day

By DR. A. E. KENNELLY, Professor of Electrical Engineering, Harvard University

On board a submarine-cable repairing steamer there are no holidays while the work lasts, nor is Sunday a day of rest. From the necessity of the case work goes on without interruption, watch and watch, until the cable operated upon is completed, and the final splice is slipped from the bows.

Some five and twenty years ago, a cable ship, on which I served as electrical engineer, was engaged on the Indian Ocean, in repairing a cable between Aden and Bombay. The cable had suddenly broken, interrupting a message in the middle of a word. By electrical measurements, continued with very little rest during several days at Aden, I had arrived at a satisfactory estimate of the position and distance of the fracture. The captain and I had marked off the assigned point on the chart, and the vessel, after steaming to the appointed spot far out of sight of land, lowered a "mark buoy" to keep the position. The cable had broken in fairly deep water. Soundings indicated over a mile of depth. Cables are repaired occasionally in three miles of water; so this depth gave us no alarm.

After some days of fishing with the grapnel, steaming slowly to and fro across the line of cable, with about a mile and a half of grapnel rope, we succeeded in lifting the cable on the Aden side of the break. We found the Aden end in good electrical and mechanical condition, and we buoyed it; that is, we lowered it back to the bottom, fastened to the moorings of a large cable buoy that floated on the surface of the sea

with more than a mile of rope hanging below it. We then spent more than a week fishing eastward of this buoy for the Bombay end, with very ill luck. The bottom was very rocky and we hooked rocks repeatedly, but no cable. On one occasion, when evidently dragging the grapnel up the face of a deep-sea precipice, we found more than half a mile of difference in depth between soundings taken at the bow and stern of the ship. That is, the lead reached bottom from the ship's stern, on the top of the cliff; but another lead lowered from the bows at the same time reached bottom half a mile deeper, over the sunken cliff. It was easy to understand how the cable had broken in this vicinity.

After losing time, rope and grapnels on this forbidding but deeply submerged rocky region, we decided to shift our fishing ground gradually further to the east, or Bombaywards. We finally hooked the cable on Christmas eve, about thirty miles east of the Aden-end buoy. The bottom here, although somewhat deeper, we found to be soft and smooth, a great comfort to drag the grapnel over after our harsh experiences on the rocks during the previous week. It so happened, however, that we were short of spare cable on board.

A cable-repairing vessel commonly carries a few hundred miles of new spare cable in her tanks. This stock is available for replacing old and defective cable in repairs. But we had been long in commission, and our stock had run low. We had only some

thirty miles in the ship. We had been driven by rocky bottom further and further from the Aden end, in this repair, until it was becoming doubtful whether, when we picked up the Bombay end, we should have enough on board to reach back to the Aden-end buoy and complete the repair. However, in cable work, one has to take good weather while it lasts, and to do one's best, trusting to effort and good fortune.

All through the watches of the night before Christmas we steadily lifted the cable with the big winch. As the grapnel-rope came up, fathom by fathom, we knew from its tension that the cable was coming up with it. At last, when Christmas day dawned, the grapnel was at the bows, with the bight of cable hanging from it. Soon two chains were fastened to the cable, one on each side of the grapnel, the tension of the bight taken on these chains, the grapnel slackened down and lifted in, the cable sawn through by the boatswain, between the chains, the short western end slacked away, and the eastern, or Bombay end taken to the winch. A few turns of the drum, and this end was on the deck. Active hands soon opened up the end, to get at the electric core of guttapercha-covered copper strand. A wire from the testing room was quickly twisted on. In a few moments we had called and received answering signals from Bombay. A few minutes more, and tests showed that the cable between ship and Bombay was in excellent electrical condition.

Clearly the next thing to do was to splice the Bombay end on to the ship's cable in the tank, and to pay out all there was on board towards the buoy on the Aden end, thirty odd miles away. There was not enough to reach that buoy even on a bee line, to say nothing of the inevitable slack, or excess, that is sure to be laid down in such depths. Besides, we did not dare to follow a bee line, because that would inevitably lay the new cable over the old hilly and rocky bottom, where it would probably soon break again. It was imperative to follow a detour, over a smooth bottom that our previous soundings had located. We could, at best, only expect to buoy the end of the ship's cable a few miles away from the Aden-end buoy. The Bombay- and Aden-end buoys might then be floating in sight of each other, but how should we fill in the gap? We had hopes

of using the short western end now hanging from the bows, if we could pick it up safely, and if it were long enough; but we felt very doubtful about it. So the sun rose over the eastern horizon, and found us splicing the Bombay end to our tank cable with anxious forebodings, and no very Christmas spirit.

A joint and splice is a tedious affair of two or three hours, especially in the tropics, where the new and soft guttapercha cover has to be hardened by immersion in an artificially cooling mixture, before the harsh steel wires are laid over it. While the splice was being made, we hanging motionless over the Bombay end, a steamer came into sight on the southwestern horizon. She advanced in such a manner as gradually to indicate that she would pass us about a mile to the south. Imagine our surprise when, long before we could flag-signal her, it became apparent, from her big wheels at bow and stern, that she was a cable steamer like ours. Very soon we remembered that the repairing vessel of another cable company was shortly expected to arrive at Bombay from Zanzibar. She probably had plenty of new cable in her tanks. The management of the cable company to which she belonged was closely connected with that to which our ship belonged, so that if we could only secure authority for a transfer of a few miles of cable from her tanks to ours, our distress would vanish. The question was how to secure the needed authority?

The managing director of our company, in London, was ordinarily always accessible to important messages from the cable-ships, at any hour of the day or night; but we knew that he would probably spend Christmas at a remote little town in Scotland. Could we reach him by wire in time? The approaching cable-ship might sympathize with us in our predicament, and might be willing to stay by us for a few hours, at most; but she could not be expected to give any cable to us without explicit orders to that effect from her owners in London.

Without delay we prepared as brief a message as possible, addressed from our ship to the managing director, pointing out the urgency of our need, the unlooked for presence of the other vessel, the favorable opportunity of fine weather, and begging for orders, on both ships, to effect a transfer of the necessary cable. At the end of the

despatch, a brief but urgent request was appended to all cable stations en route to London, for the prompt handling of the message and of the expected reply. In a few minutes we had signalled the message to Bombay, through the cable at our bows, and Bombay sent it westwards to Aden, over a duplicate intact Bombay-Aden cable. The message was soon spelling its way to Great Britain by successive stages at Suez, Alexandria, Malta, Marseilles and London. At each of these stations the message would be regularly transcribed afresh. We had sunrise about four hours before London, so that the day was still young in Scotland. We believed the message would reach London in less than half an hour, and would then be sent on by the postal telegraph system to Scotland. What would then happen? Would it be promptly delivered, and an answer awaited? Or would it hang fire for hours, owing to some misconnection? The issue was vital to us. If we received a few miles of cable, we might hope, with good luck, to complete our repair of the Aden-Bombay cable that day. If not, it would be hard to say when we might finish it.

Meanwhile, our hopes lay in coaxing our passing cable ship to bide with us until such time as orders might come. She was probably as much astonished to see us as we had been to see her, for we were out of the track of regular steamer traffic. After a time, we saw her course slightly alter, so as to approach us more closely. As soon as she came within flag-signalling range, for this was long before the days of wireless telegraphy, we sent up column after column of bunting to the masthead, telling of our predicament and of what we had asked for, by wire to London. She slowed down, as she neared us, and we finished the message with Morse code from the steam whistle. She stopped about a quarter of a mile off, lazily lifting on the smooth ocean swell. Would that reply come from Scotland while she was in the mood to stay?

Neither captain desired to leave his own ship, so it was arranged that I should go over, in a small boat, to the other ship and tell, in person, the story we had already signalled. If I could think of any good stories, long ones, with plenty of collateral detail, I was incidentally to tell them, so far as they would go. Any proceeding short of piracy on the high seas, that would keep that ship from running away before

she gave us cable, would be heartily endorsed.

I was soon on the gangway of the other ship, and received a cordial welcome. They saw the cable hanging from the bows of our ship, and could observe that we were "flying light," our Plimsoll-mark being far above the water. They sympathized with us in our straits, and were quite willing to stop and "communicate" with us for a reasonable time, in the hope of receiving orders to help us.

At last, after an interval that seemed a small era, but was actually only about two hours, the welcome reply came to us from the managing director in Scotland, over the cable from Bombay. Yes, certainly, take the needed cable, with an accompanying order to the other ship to give what reasonable assistance in the way of cable that safety would permit.

According to the story we heard in England some months afterwards, the telegraph operator in the little Scotch town was much surprised to receive our urgent despatch on Christmas morning, and made every effort to deliver it speedily to the managing director. That gentleman was not at his usual residence, but the messenger located him in church, and surprised the congregation by charging up the aisle. The managing director is said to have kept to his pew, but to have sent back the reply by the messenger, written in pencil on the fly-leaf of a hymn-book. This reply came back, retranscribed at Carlisle, London, Marseilles, Malta, Alexandria, Aden, Bombay, and our ship's testing room.

The managing director's orders, clear and laconic, were the best Christmas greeting from him we could have wished. At once, the scene changed with us. The other ship went to quarters with alacrity. A long coil of stout heaving line was placed in our small boat, and the latter returned to our ship, paying out the heaving line as it came.

On reaching our vessel, the heaving line was taken to the winch, and the end of the cable from our friend's tank was thus hauled into one of our tanks. She helped the cable out over her bows with her winch, and we hauled it in over our stern-sheave; so that there was a slack loop of nearly half a mile of cable between the two ships. We were then able to telegraph messages to Bombay by the cable over our bows, and messages

to our friendly visitor by the incoming cable over our stern. In a few hours we had taken cable enough to be safe for all reasonable contingencies. Our friend then cut the cable on her forecastle, and let the end go with a farewell message through the core. We picked it all up and spliced it on to the cable in the other tank. Away went our friend on her course for Bombay, with our blessing to her speed. We let go the short western cable, now no longer worth delaying over, and steamed westwards for the Aden-end buoy, paying out cable as we went.

All went well with our fortunes that day. We reached the Aden-end buoy late that afternoon, and picked up the end attached to its moorings late that evening. Before midnight the Bombay and Aden ends, in

good electrical condition, were married in a final splice, that was let go from our bows with a sigh of relief from all hands. The repair was finished, and we had a mile or two of cable left in the tank.

When I think over the inherent improbability of our repair taking place at the point on the line of cable where the course from Zanzibar to Bombay intersects, of the other vessel's happening to be ordered on that course quite independently of our work, of her happening to pass just in the nick of time, during fine weather and broad daylight, all on Christmas day, it is hard for me to shake off the early belief of childhood that Santa Claus really exists, or to escape the hazy idea that he can occasionally make his appearance under two masts and a smokestack.

Hazardous Line Construction

The line of the Colorado Telephone Company extending to Canon City goes through some rather ticklish places in the Royal Gorge as shown in the pictures. This line is eight miles long and for three miles of this distance it follows along the precipitous sides of towering mountain walls. In some cases the line

work had to be done by men in chairs lowered by ropes from some accessible crag. The cross arms in such cases were fastened horizontally by drilling holes in the rock in which to stick the ends of the arms. The men hung in the chairs required from an hour to a whole day to drill one of the holes.

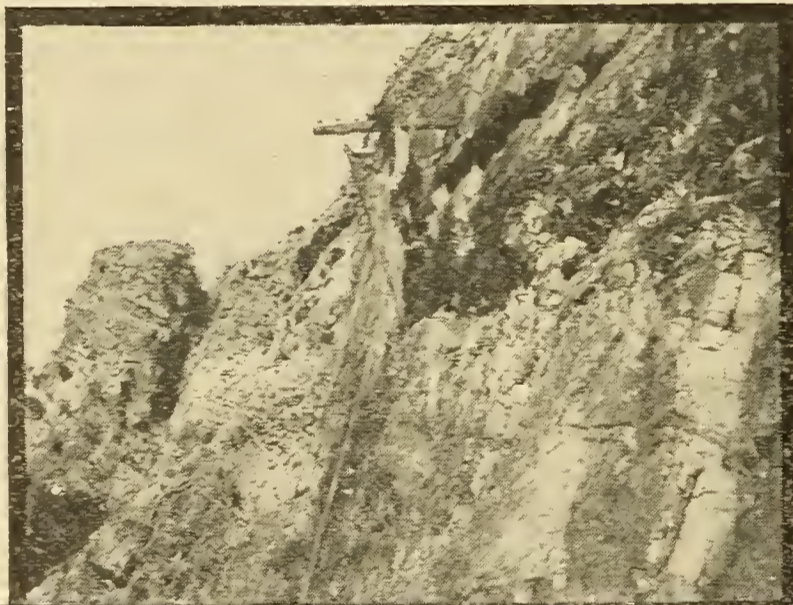

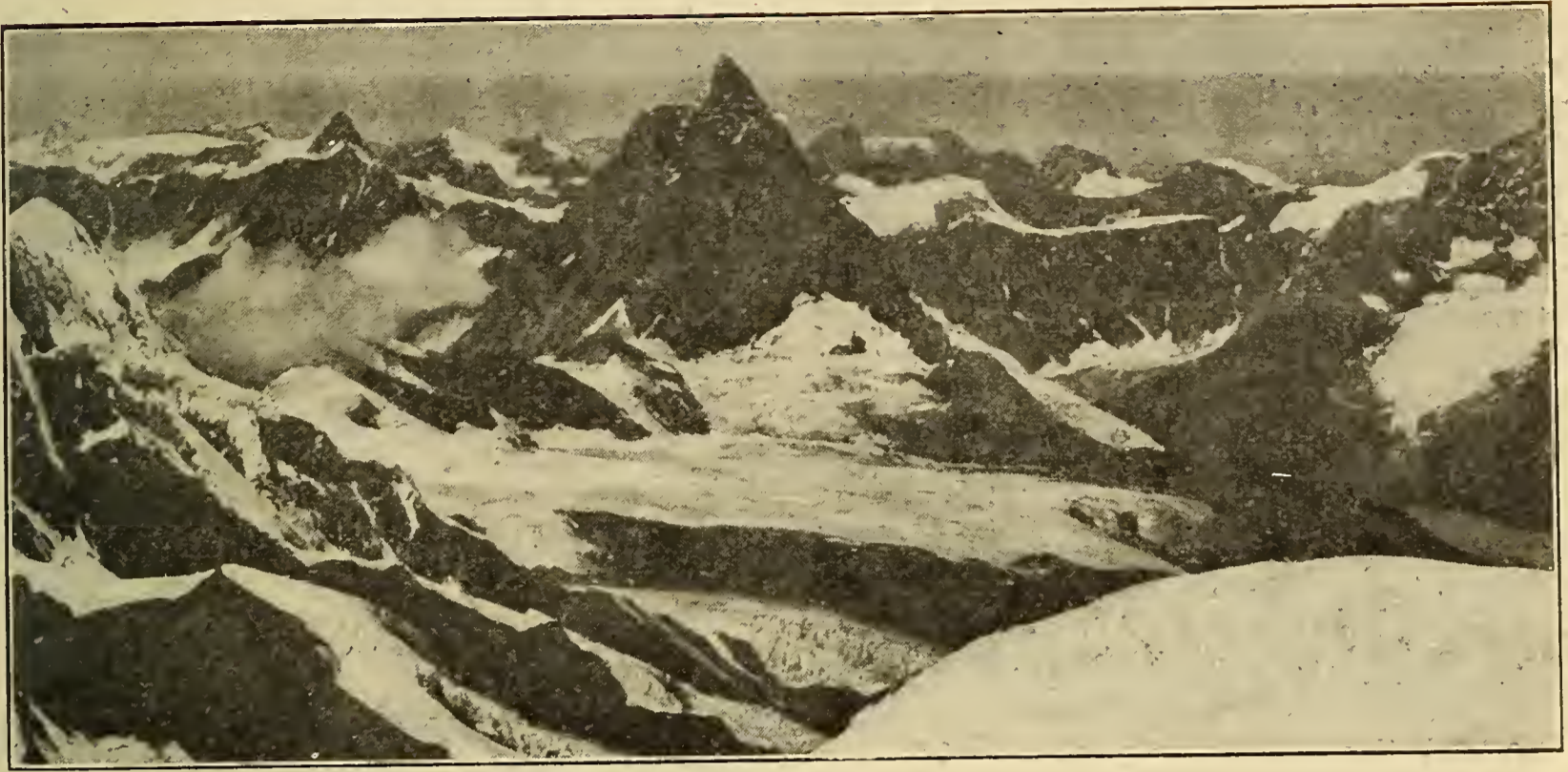

Two Months on the Summit of Mount Rosa

By DR. ALFRED GRADENWITZ

Those acquainted not only with the incomparable beauties of the Alps but also with the inclemency and terrors of their highest peaks will have some difficulty in realizing how human beings may spend two months' time every year among these lofty heights under hardships similar to those of arctic travelers, and even utilize every moment of their voluntary seclusion for meteorological researches of a highly scientific character.

Still less will they conceive of the possibility of constructing on a point towering far above all human abodes, an institute fully equipped with all the requirements of modern observatories.

Yet, this has been achieved by the valorous scholars of Mount Rosa Observatory.

Few branches of science have, during recent years, made such powerful strides as that commonly known as cosmical physics; being an application of pure physics and chemistry to the very wants of the universe and especially our globe.

Now, it is impossible to get any notice of the phenomena taking place in those far-distant worlds which fill up the firmament, other than through the intermediary of the light rays given out by them, and as, on passing through the lower strata of atmosphere, these rays undergo a number of changes and deformations, only observa-

tories placed on high mountain summits are likely to yield any useful data as to the constitution of the universe. As regards meteorology proper, which on account of its immediate practical bearing is of special interest to man, a number of local factors, such as the configuration of the ground, presence of water sheets, vicinity of mountain chains, forests, deserts, steppes, etc., profoundly influence the temperature, pressure, moisture and electrical condition of the air as well as the direction and speed of winds. On these very factors is based our knowledge of the changing condition of atmosphere and accordingly the giving of weather forecasts which is the practical aim of applied meteorology.

Only those who have at some time of their life been dazzled by snow storms on those giddy heights, stung by the fierce prickling due to atmospheric electricity, carried along by violent gales, deafened by the tumult of near-by lightning and witnessed a hurricane raging on Alpine summits, will be able to conceive of the terrific intensity of meteorological phenomena. In fact, the phenomena going on underneath are merely the countershocks of those occurring above the denser part of the atmospheric envelope.

The Queen Margherita Observatory is built on the highest point but one of all Europe, viz., on the summit of Mount

Rosa, at 13,680 feet above sea-level. It is so absolutely isolated from all sides that observations carried out up there are, unlike those made on the foot or the slope of mountains, quite unaffected by the influence of the ground. From great height, the eye looks down vertically to the bottom of an abyss more than 6,000 feet in depth, while bridging the immeasurable distance of an unbounded series of chains and mountains,

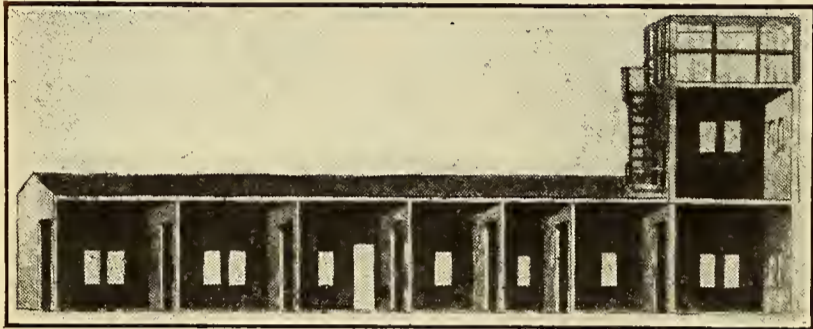

ARRANGEMENT OF THE EIGHT-ROOM OBSERVATORY

that subside by degrees towards the Lombardic plain, or dominate the central Alpine circle whose range is marked by no apparent limit. In fact, the horizon embraced from the observatory is about 125 miles in radius, comprising unknown wonders of dusky rocks, unexplored precipices, delicate cirri of forms endlessly renewed, and wide stretches of clouds that frequently reach

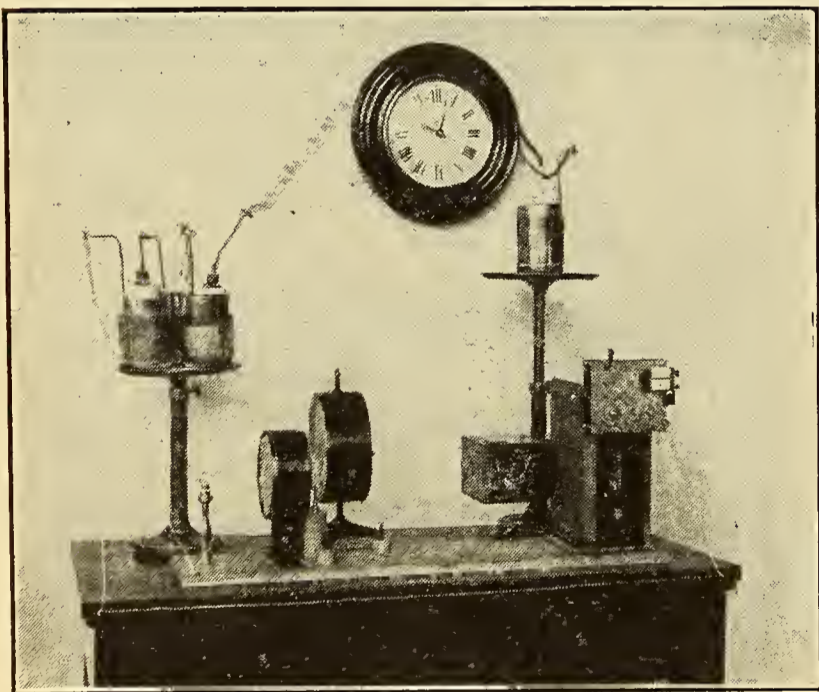

PHOTOGRAPHIC SELF-RECORDING ELECTRO-METER

up to the observer's feet, and of rounded cumuli, shaped by the sun into masses of incandescent balls which the moon converts into a region of silver mountains and valleys.

In fact, a spot better adapted for investigations of the sun's activity, of the

electricity of air, of winds, storms, and the whole multitude of heavenly phenomena, as well as those partaking of terrestrial life, could hardly be imagined.

This observatory, which belongs to a system of four meteorological stations situated at 3,600, 7,644, 9,000 and 13,680 feet respectively, is constructed of wood, with double walls separated by an interval of 30 inches, preventing too rapid a dispersion of the inside warmth, while offering a better resistance to the extraordinary violence of winds.

In order to be protected against lightning, the observatory has been coated entirely with copper-sheet from the ground to the roof, exclusive of the doors and the inside of



FOURTEEN DEGREES CENTIGRADE BELOW ZERO IN THE OBSERVATORY

the floor. It thus forms a cage entirely enclosed, and from the electrical point of view presents an absolute safety. The metal envelope is provided with a number of sharp points serving as additional lightning arresters and is connected to the ground as well as possible by means of braided copper strands carried along the mountain slope.

As seen from one of the cuts the observatory comprises eight rooms—the dormitory of the Alpine Club, kitchen of the Alpine Club, observatory kitchen, observatory dormitory, director's room, physiological laboratory, physical laboratory and meteorological observatory proper.

In order to form a permanent connection with the outside world, Dr. C. Alessandri, director of the observatory, conceived the idea of installing a telephone plant that connects the station with the remaining

meteorological stations of Mount Rosa as well as with the plain, thus making the observatory the highest telephone station in the world.

The laying out of the telephone wires obviously was a task extremely difficult and dangerous, the more so as the weather was uniformly bad. At the upper end of the line no telephone poles are used, the insulation of the dry snow being considered sufficient to protect the wires.

The scientists working at the observatory have to provide themselves with sufficient food to last during the time (sometimes several weeks) when, in consequence of bad



CARRYING BOXES OF INSTRUMENTS UP
MOUNT ROSA

weather, no communication can be had with the outside world.

As the temperature on those heights is even lower than in polar regions—being practically always below zero, while even in the summer months the thermometer falls to temperatures below 20° C. very efficient stoves had to be provided to maintain a tolerable temperature in the interior of the observatory. After denaturated alcohol heating had given rather poor results, a premanent-fire anthracite stove was installed.

One of the most serious troubles the inhabitants of the observatory are exposed to is mountain sickness, from which only a few on those heights are exempt.

Storing Electrical Heat

So far the storage battery has been the only device for storing up electrical energy (in the form of chemical energy) so that it could be used as required, and the storage battery has not been developed to a stage to make it practicable for the household. As a result the electric light plant must be built with a capacity sufficient to meet the demands of the moment of all the patrons of the company, which demands result in high "peak loads" at certain periods of the day.

Realizing the difficulty of perfecting an apparatus for storing electricity, G. G. Bell, a London engineer, and member of the British Institution of Electrical Engineers, conceived the novel idea of storing heat energy instead of electrical or chemical energy as in the case of the storage battery.

Briefly, Mr. Bell proposes to supply a house with a device which will consume an equal amount of current during the whole 24 hours, thus more than quadrupling the efficiency of the machinery in the power house by making it produce useful current all the time instead of having a large amount of equipment idle save during an hour or two a day.

The apparatus consists of an iron block some 18 inches high and a foot in diameter. This block is encased in magnesia, so that no heat escapes. In the center of the block is placed a removable electric heating unit in several sections. When the heating unit is raised to a very high temperature it heats the block which will remain heated indefinitely except for what heat is taken from it for cooking, etc.

When the householder turns on his lights the current is automatically cut off from the heater in sufficient quantity to supply the lights. When the lights are turned off the current begins to work on the block once more. When ironing day comes, the electric iron is turned on, and the amount of current necessary to heat the iron is withdrawn from the supply to the heater.

The heater itself serves for a variety of purposes. In its original form it was designed for hot water alone. Its present development not only does away with tanks and kettles, but provides hot air, steam or hot water for heating, with a great saving of space, and provides unlimited heat for cooking.

Electrical Securities

By "CONTANGO"

THE GENERAL SITUATION—SMALL AND LARGE PLANTS

"Electrical securities," to quote so eminent authority as Frank A. Vanderlip, president of the National City Bank of New York, "particularly electric light securities, are among the most recent types of investment upon which the public is now asked to pass judgment almost every day of the week. Electrical undertakings of all kinds have grown more rapidly than any other form of industrial activity. The electric lighting business has more than doubled in the past five years, and that means it has in it a future and vitality, that are bound, of course, to carry it to enormous proportions."

Mr. Vanderlip refers to the extraordinary popular interest now manifested in all things electrical, and to the favor with which the banks generally regard electrical securities, and indeed, recommend investment in them to their patrons. As a matter of fact, those who have been active in the field of electrical endeavor have for years foreseen the splendid future now in part being realized, and for many years past those who may be termed as being on the "inside" have eagerly sought investments in electrical enterprises.

It is indeed the electrical age, and it is the wide-spread electrical expansion now going on that the president of the National City Bank doubtless has in mind.

It is not only the day of the electric lighting plant, but also that of the trolley, and east, west, north, and south the lines projected, to be built, and being built, come whirling forward thicker than autumn leaves in Vallambrosa.

The great development in the use of electric power also seems to offer a continued growth that is quite likely to be as rapid as has been the case in the lighting field. Moreover, it is the telephone age, and every farm house in the country is fast being put in touch with its neighbor and the world at large by means of this method of communication, and as yet not all the telephone lines are joined in one big system. For better or worse there are still many private lines

and independent companies, many of which grow and thrive apace without outside assistance. The point of it all is that this tremendous expansion in electrical enterprise means a constant call for an enormous amount of money, which sooner or later must come out of the pockets of the general public.

It is then the purpose of this series of articles to take up carefully each phase of the present-day very important question of electrical securities, and show the remarkable opportunity now presented to prospective investors by examining into present conditions and indicating the probable future growth.

The total investment in electric light plants alone has now passed beyond the billion dollar mark. Five years ago there were some four thousand companies with a total investment of, say, \$700,000,000. And yet with all this extraordinary increase in the past five years, already noticed, there is in reality comparative darkness on the part of the investing public as to the real character and quality of the enterprises into which all this money has gone and is going.

As to the electric railways there is, too, practically little more knowledge of a general or popular nature concerning the worth and possibilities of their securities.

Let there be light. For the opportunity of the century is before us if it is only properly brought to light.

Of the trolley lines, it may be said briefly at this time that, of those actually built and brought to the state of working, the majority are susceptible of remunerative development if adequately connected up as part of comprehensive systems, and therein will be found their best future.

With the electric light and power undertakings it is a different story. The business has been almost uniformly profitable in the past, the market for the product developed with extraordinary rapidity, and, in point of fact, the business has been one of the few

to pass through the various panics without serious results to income.

In the years gone by, investors at large have perhaps been slow to put their money into such companies. But it has really been through lack of thorough knowledge of conditions. Therefore the attitude of the mind of the average investor is at this time the most important point in the development of the electric lighting field.

While it is true that the tendency is towards combination and the creation of large corporate securities, creating really great enterprises whose securities are readily absorbed by the big banks and bond houses, yet it is very possible and very profitable for small electric light plants to be built and operated successfully, extending their scope from time to time as demands are made upon them. It is in such enterprises that the present active interest in electrical securities of all kinds will find its best outlet and greatest opportunity. The small plant established on a cash basis in a town of even so small a population as 6,000 offers one of the most satisfactory chances at the present time.

As to the hesitancy of the general investor to take up electrical securities in the past, aside from the lack of intimate knowledge, "investors," to quote Mr. Vanderlip again, "have hesitated a good deal in giving full confidence to such securities because of conditions inherent in the nature of the business.

"Up to a few years ago, the electrical development was so rapid that the method and cost of production did not settle down to anything like a standard rate. No one knew at what moment some genius might come along with a new invention in dynamos or lamps that would make scrap of the best plant so far erected; a matter of great discouragement to the bondholder, and partly explaining why comparatively so few electrical light securities were found on the bond lists of any of the great security exchanges in the years gone by."

"Then there has been the question of overhead wires and franchises of little security against competition."

"These difficulties are now in a rapidly increasing measure being removed. There is standardization of methods and cost of production. Wires are run in conduits, the acquisition and control of which render illegitimate and irresponsible competition more difficult.

"We are, therefore, I believe, entering upon an era in which investors will look with increasing favor upon electrical securities, and in which the funds available for electric development will be obtainable with much greater ease and at much lower rates than before."

Mr. Vanderlip has also expressed himself of the opinion that the public is fast recognizing that its rights are best safeguarded by granting monopoly privileges to these public service companies and then subjecting the monopoly to reasonable regulations. An attitude at once recognized and appreciated by the investor.

Another reason why electrical securities have not been so popular with investors has been the lack of the "general marketability" of such securities, i. e., the seeming lack of ability to transfer or dispose of them in case of need. But it is far different today. It is indeed the day of electric bonds, and there is now a wide market for securities of this nature. In fact, when conditions of permanency, fair size and economical operation have been established a security has been created that will make more than favorable comparison with any security returning a similar rate of interest.

The careful investor will of course closely look into, and analyze the concern, the securities of which he contemplates buying, in this connection it is the intention to and make this series of articles of direct help by discussing frankly and simply the whole matter of such stocks and bonds. It will be explained exactly what they are. The usual manner of financing, lighting plants and trolley lines will also be brought out with the best way to bring about splendid results. All this in direct easy terms so that any one may understand the kind of securities offered, the interest that should be paid, and also enterprises that might be considered doubtful and therefore to be avoided, by reason, say, of excessive rates of interest offered or other like points, will be touched on.

For example, it is the opinion of the authorities that the earnings of a given company must reach twice its interest charges, and that even that figure of net earnings must only be reached after a fair charge has been made for maintenance, and after an adequate reserve has been set aside for renewals and a depreciation fund. Expenditures for renewals must not be placed under operating

expenses. In other words a proper and normal, steady growth must be indicated.

The large number of lighting plants has perhaps somewhat held back the tide of general investment in electrical enterprise. The \$1,200,000,000 or so, according to the Government report, invested in them, has been divided among some 8,000 or 10,000 plants. To understand securities of such a nature and number has been beyond the comprehension of the average investor, without definite information and special knowledge. Now, however, for the reasons already alluded to, there is a decided change, and the average investor is much more readily interested, with corresponding opportunity for the wide awake bond house.

Though this is not an age of diversion of interest and isolation, but one of concentration and consolidation, particularly in the case of electrical undertakings, yet there is splendid opportunity for small plants in comparatively small places provided they are in control over a fair area, well populated. Competitive isolated plants in the large centers of population are doomed to go, for under such conditions it is only from a large business able to produce economically and charging low rates that there is any ultimate hope of salvation. These indeed are the two main phases of the electric light situation—the big central station in the large centers and the small plants in small towns. In a future article special attention will be given to them; and in addition there have to be considered:

Electric light and power concerns.

Trolley lines and systems.

Hydro-electric power supply undertakings.

But it must be reiterated that the whole fundamental principle of the electric lighting and power business rests in the fact that it is naturally a one company business—be it in small or large centers—and the harm of unwarranted or needless competition must

be clearly shown up and the economic advantages of combined management over large areas demonstrated. Individual companies and their securities may also be discussed as illustrative of the points mentioned.

As to hydro-electric power supply undertakings they are producing new conditions. To quote Mr. Vanderlip once more—:

“The utilization of great waterpowers, which are now being so rapidly developed, will tend toward a combined management covering a large area. The progress that is being made in long distance transmission is of the greatest importance in this direction. Indeed, in my opinion, the next era of distinct development in the electric lighting field will come as a result of the progress made by technical experts in economical long distance transmission. With great power stations located in the heart of the coal districts on the one hand, or drawing their energy from the great water power plants on the other, the problem of the cheap production of current would seem to be pretty well solved. If current thus produced can be economically distributed over a very large area, as indeed it is now being in many sections, the way will be open to securing the economies of a concentrated management and the added advantage of large corporate issues, and that combination should result in large profit to the business venture, and in a high degree of satisfaction to security holders. For the tendency of the times is, it seems to me, distinctly in the direction of recognizing the naturally monopolistic character of the electric lighting business.”

There are in truth many very attractive and desirable investment opportunities in electrical securities these days, and an effort will be made in these articles to bring them to the attention of the public, popularize them and show investors how to discriminate.



Electric Light and Power for Country Homes

By LOUIS A. PRATT

PART III.

In the preceding chapter wiring methods were described and it will now be possible to determine the material necessary to order for this part of the work and have it ready when the rest of the equipment arrives. We will next proceed to the determination of the actual plant, taking up methods of charging batteries which has a relation to the voltage of the system used.

METHODS OF CHARGING BATTERIES

There are three methods of charging batteries, namely: direct from generator, through resistance, or with use of a booster.

For domestic service, where the plants are small in capacity, the booster system may be eliminated. Three standard equipments for strictly lighting and for lighting and power service, are here described:

1. A low voltage system, which may be known as a strictly storage battery lighting system, for use with low voltage tungsten lamps, of $27\frac{1}{2}$ or 30 volts. The battery will consist of 15 to 18 cells, depending upon the distance of the storage battery from the center of distribution of the lighting system, and the size of the wire. If the engine and the battery are to be installed in the house, 15 or 16 cells will be ample. For this system the special low voltage generators, 30 to 50 volts, should be obtained. When charging the battery in this case there will be no loss through resistance, since the required voltage may be obtained direct from the generator.

2. This system consists of engine, 110-volt generator and storage battery for 30-volt lighting system, the battery to be charged from the 110-volt circuit through resistance. This combination system is intended for use where the current is to be distributed about the place for power purposes, the higher voltage being required for the power distribution, while the house lighting will be done from the 30-volt battery and not direct from the generator. The switchboard for use with this system will provide for two circuits, properly protected with fuses, one for 110-volt power circuit and the other for battery and 30-volt lighting circuit.

3. This system consists of engine, 110-volt generator and battery for 110 volts, and it can be used for both lighting and power. The battery being for 110 volts (56 cells), and there being no voltage booster employed, it will need to be divided into two sets of 28 cells each and these sets charged in parallel through resistances, as previously explained.

This will make a very flexible system, it being possible to furnish current to lamps of the lighting system, at the same time current is furnished for power distribution, direct from the generator, the battery being either on charge or cut out of the circuit; or, if necessary, it is possible to discharge the battery in parallel with the generator, the generator voltage to be adjusted (by means of a field rheostat) to correspond with voltage of the battery. This method, of course, would require closer attention on the part of the operator, but in this way it will be possible to care for an increased lighting load, in case general illumination is required for some special function, which illumination would require more current than either the generator or battery alone would be able to furnish.

HOW TO DETERMINE SIZE OF PLANT

In selecting an electric lighting plant, including storage battery, considerable variation may be made in the size of the engine, generator and storage battery necessary for supplying a certain amount of electric light or power.

The capacity of the plant should in any case be somewhat in excess of the total amount of work to be done, but the size selected should depend to some extent on whether it is considered expedient to do the entire lighting, or work, from the storage battery during the hours when the engine is not running, or whether the heaviest load is to be taken from the engine direct and the battery only used as a reserve for lights, or a small amount of power, during hours when the engine is shut down; or, again, whether it is expedient to run the engine and battery in parallel, that is, taking the current from both the generator and battery during the time of the heaviest load.

As conditions vary with every installation, there is no simple rule by which the size of engine, generator and storage battery may be determined. To give an idea of what may be expected or depended upon for different styles of installation, we here describe three typical plants:

First: We will consider a small domestic lighting plant where there is little or no power used except for lighting. This plant may consist of a three horse-power vertical engine with $1\frac{3}{4}$ kilowatt 30 to 50 volt generator and a 16-cell storage battery with a capacity of 15 amperes for eight hours or twenty-two 16 candle-power 30-volt tungsten lamps for eight hours. Fifty of these lamps may be installed for lighting house, barn and premises.

This plant will be practically ideal in its operation for this amount of lighting, and a small amount of power may be taken from the engine direct, or small motors, such as sewing machine motors, fan motors, etc., may be run from the storage battery. It is hardly probable that all 50 lamps would ever be burned at the same time during an entire evening. However, if they should all be used at the same time the battery would have a capacity sufficient to supply current for nearly three hours. If, however, it is desired to burn the full number of lamps for a longer period, the engine can be run in parallel with the battery. In this case, even though a hit-and-miss engine is used, perfectly steady light is secured. Where a larger number of lamps than 50 is desired for special occasions, 75 or 100 lamps can be burned by operating the battery and engine in parallel. Switchboards are provided with switches for such operation. It is probable that for an ordinary evening not over 10 lights will be burned on an average of $3\frac{1}{2}$ hours each. This would make a total of about 35 lamp-hours, and as the total capacity of the battery is 175 lamp-hours, it would only be necessary to charge the battery twice a week under these conditions. The charging may be done at regular intervals, or it may be found later that there is other work which can be profitably done from the engine and the battery charged at the same time. In any event, only a very small amount of attendance is necessary to keep the battery fully charged and the electric current ready for instant use.

Second: We will consider the installation of a larger plant, where the engine is

to be used for power during the day, and a storage battery installed for lighting during the evening and during hours when the engine is not running. For this plant a 15 horse-power engine may be selected with the same $1\frac{3}{4}$ kilowatt generator and a 16-cell storage battery, as in the first plant. If during the day, the engine has a regular load of less than 15 horse-power, the surplus power can be utilized to run the generator and charge the storage battery. Either a throttling or hit-and-miss governor engine may be used, as the lighting will be taken only from the storage battery, and therefore the close regulation given by the throttling governor engine is not essential. The results which may be expected from the storage battery will be the same as with the smaller plant, except that it may be charged while the engine is doing other work amounting to perhaps 12 horse-power, with practically no extra amount of attendance, and a small, but efficient, lighting capacity can thus be obtained at practically no additional expense whatever.

Third: We will consider the installation of a plant on a large farm or estate, where there is the heaviest class of farm machinery to run at various times, and, also, a considerable amount of lighting is required. For this plant a 20 horse-power Alamo standard throttling governor engine, a $12\frac{1}{2}$ kilowatt Westinghouse Type "S" generator, and a 56-cell storage battery for 110-volt lighting and power circuit, having a capacity of 20 amperes for eight hours may be selected. Current is to be supplied for one 25 horse-power motor, one five horse-power motor and one two horse-power motor required for operating machinery on the premises. There may be a large number of lamps installed at various points, so that the 110-volt circuit is more desirable than the 30-volt circuit, on account of the distance the current has to be transmitted. Tungsten lamps should generally be installed, but some carbon filament lamps of small candle power may be more desirable in some out of the way places where they are only occasionally turned on.

The capacity of the storage battery would be sufficient to operate forty 16 candle-power carbon filament lamps for eight hours, or about fifty 32 candle-power tungsten lamps for eight hours. This capacity is somewhat in excess of the requirements for lighting, but this is desirable if power is also to be taken from the battery from time

to time when it is not expedient to run the engine.

You will note that one motor is of larger capacity than the capacity of the engine. This motor is provided for extra heavy work. Motors have a larger over-load capacity for a short time than gasoline engines, and if the heaviest work to be done is between 20 and 30 horse-power, with 30 horse-power as the maximum load, the necessary current may be obtained by running the engine and battery in parallel. If the battery is fully charged on the start it may be called upon for 10 horse-power in addition to the capacity of the engine, so that for a short time with the use of the 20 horse-power engine and storage battery, 30 horse-power may be taken from the largest motor.

If a considerable amount of ordinary work is done with the five horse-power motor, under the average conditions, power for this motor will be taken from the engine and the storage battery can be charged at the same time. However, if it is not convenient to run the engine, this motor may be operated from the storage battery for several hours without discharging the battery sufficiently to interfere with an average evening's lighting being done without re-charging the battery.

The current for the two horse-power motor will ordinarily be taken from the battery and it may be run at any time without serious consideration of the current which it consumes.

The descriptions of the above plants are merely intended as suggestions as to the style of installation best suited for varying conditions.

USES OF ELECTRICITY FOR COUNTRY HOME AND FARM

It is hardly necessary to point out the many and varied uses of electricity on modern farms or in country homes, but it may prove of interest to describe briefly some of the various devices which have been perfected since the electric current has been brought to serve man's every day needs, in the shape of convenient power as well as for illumination. The large illustration shows the devices described in the following paragraphs and many others.

In manufacturing plants the use of individual electric motors for operating machinery has for some time been recognized, both from the standpoint of economy in the use of current, and in doing away with unsightly, complicated and power-consuming

shafts and other transmission equipment, so in the use of the electric current for operating farm machinery, the individual motor makes the use of this power practical at any point where needed, at the lowest possible expense. Portable motors can be moved from point to point and attached to different machinery when the service of that particular machine is required. To anyone familiar with farm requirements, the advantage of this is at once apparent.

In the line of household utilities, the percentage of work which can be done by electricity is being rapidly increased, and a few of the most important and serviceable devices of this character are here described.

For the laundry, the electric iron is not only a perfect laundry iron, but also a lady's iron, for ironing fine linens and delicate laces. It can be used in the boudoir, or in any comfortable room in the house where there is a lighting socket. It is convenient to carry when traveling, for pressing mussed garments. When sewing, it can be used as a pressing iron right in the sewing room, thus saving time and steps to and from the kitchen or laundry. The iron heats perfectly by electricity, and remains always at the right temperature. It heats itself only and not the room, as does a stove. It is made in five, seven and nine pound sizes.

The most modern and satisfactory types of washing machines are now sold with electric motors as a part of the equipment. The motor-driven machine is almost as great an improvement over the hand-driven as is the latter over the open tub and washing board. A modern motor-driven machine will wash a tubful of clothes in from 10 to 15 minutes, and when they are washed the same power wrings them dry.

The electric sewing machine motor, which gets its current from the lighting socket, does away entirely with the pedaling of the sewing machine. Without it, easy running is the best that can be said of any machine; with it, any machine becomes self-running. It converts the treadle, which has been accountable for so much fatigue and backache, into a foot rest.

The motor fits any machine and can be operated by any woman. All that is required is to turn the switch to start and stop it. The speed of the machine is regulated by a slight pressure of the foot. The motor consumes no more current than a 16 candle-power carbon filament lamp.

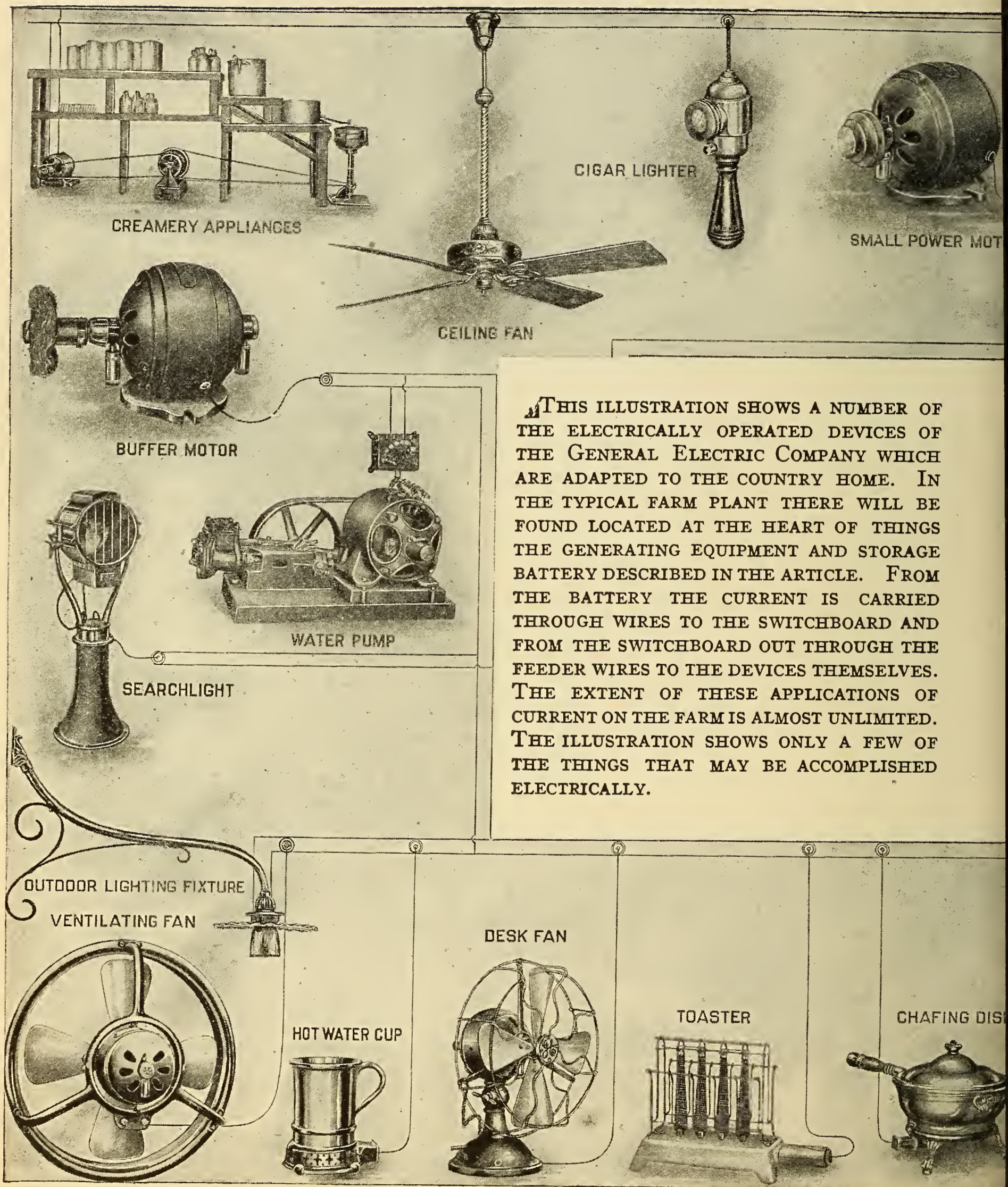

The electric radiator furnishes heat in its simplest and most convenient form. There being no combustion, it is absolutely cleanly and sanitary. It is an ideal heater for cool spring and fall days when the regular heating system furnishes too much heat for comfort.

During the winter its glow serves admirably to add cheer to the steam heated room.

The electric house fan is noiseless and for this reason is a desirable fan to use in the sick chamber. It can be used in one

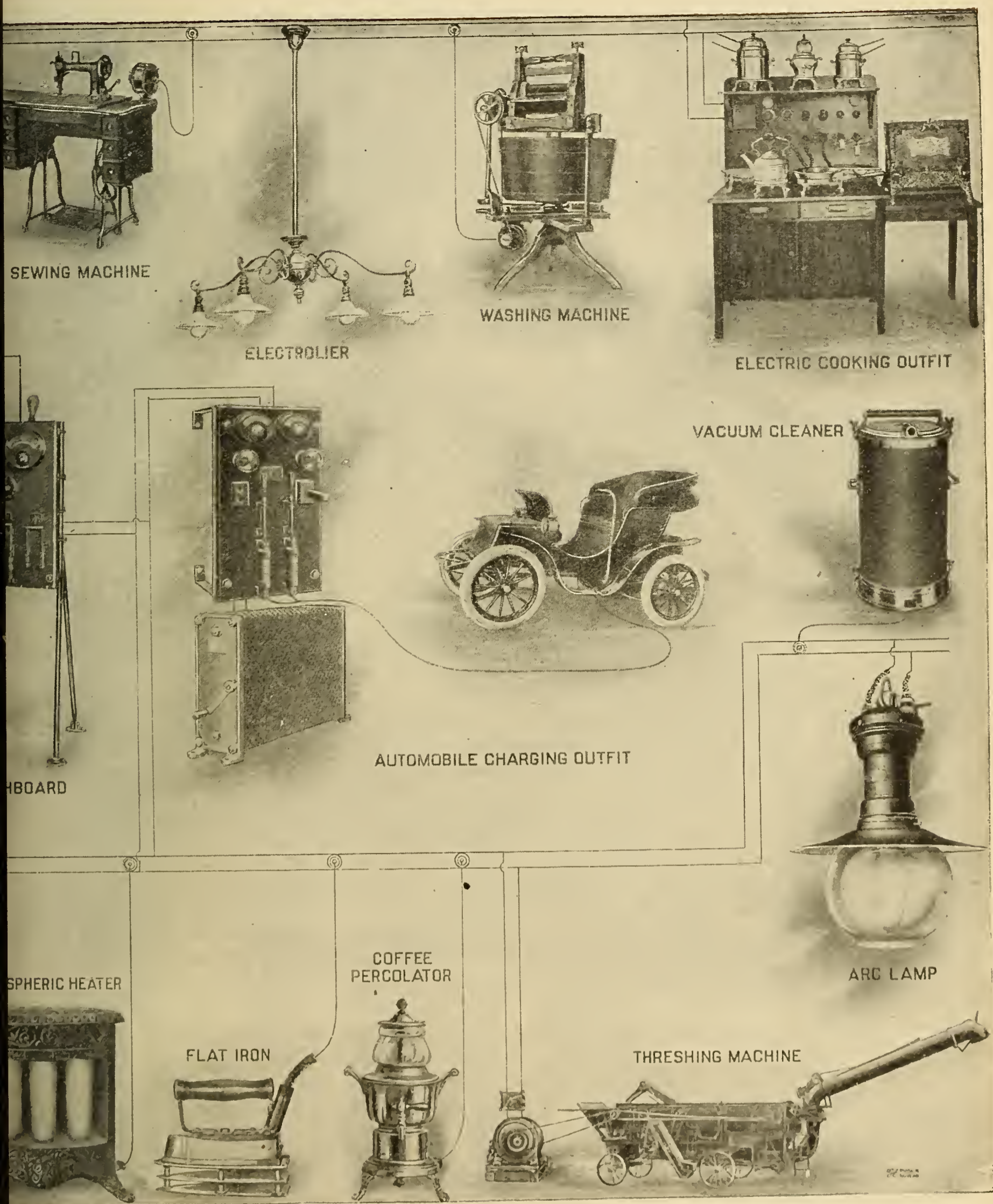

SEWING MACHINE

ELECTROLIER

WASHING MACHINE

ELECTRIC COOKING OUTFIT

VACUUM CLEANER

AUTOMOBILE CHARGING OUTFIT

BOARD

ARC LAMP

SPHERIC HEATER

COFFEE PERCOLATOR

FLAT IRON

THRESHING MACHINE

room on the table and in another as a wall fan.

A single demonstration of vacuum cleaning generally leads to the adoption of this method. Sweep a nine-by-twelve rug as clean as you possibly can with broom and carpet

sweeper; then apply a good vacuum cleaner. The quart or more of dirt that it will suck up and convey into its receptacle is a convincing argument.

No method of making toast is so satisfactory as the electric. The electric toaster



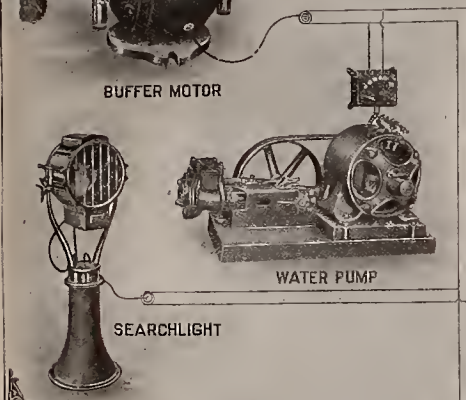
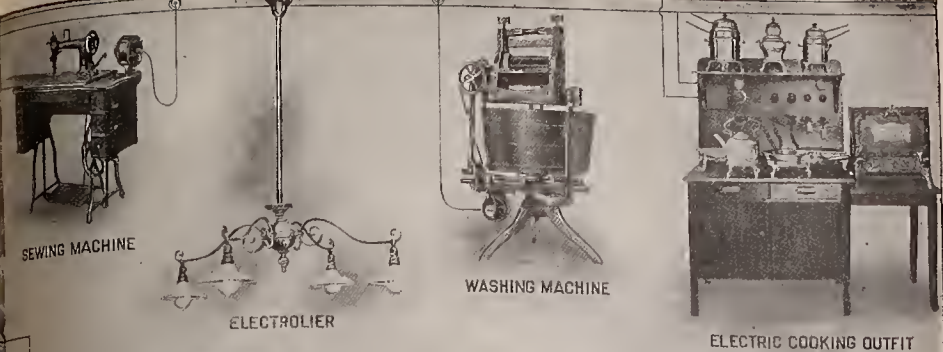
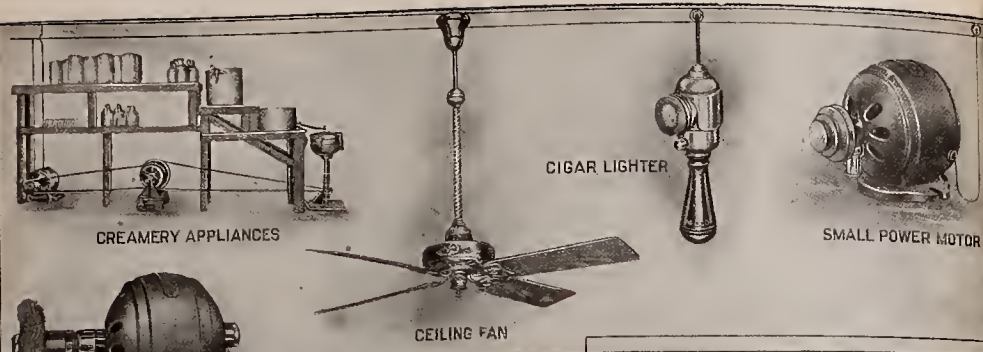

THIS ILLUSTRATION SHOWS A NUMBER OF THE ELECTRICALLY OPERATED DEVICES OF THE GENERAL ELECTRIC COMPANY WHICH ARE ADAPTED TO THE COUNTRY HOME. IN THE TYPICAL FARM PLANT THERE WILL BE FOUND LOCATED AT THE HEART OF THINGS THE GENERATING EQUIPMENT AND STORAGE BATTERY DESCRIBED IN THE ARTICLE. FROM THE BATTERY THE CURRENT IS CARRIED THROUGH WIRES TO THE SWITCHBOARD AND FROM THE SWITCHBOARD OUT THROUGH THE FEEDER WIRES TO THE DEVICES THEMSELVES. THE EXTENT OF THESE APPLICATIONS OF CURRENT ON THE FARM IS ALMOST UNLIMITED. THE ILLUSTRATION SHOWS ONLY A FEW OF THE THINGS THAT MAY BE ACCOMPLISHED ELECTRICALLY.

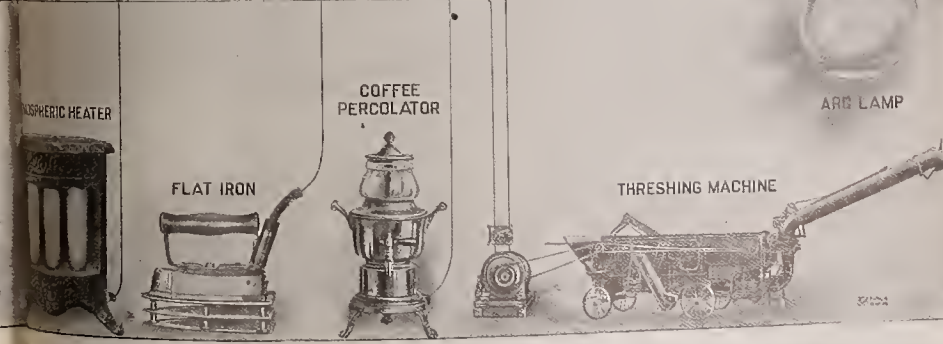
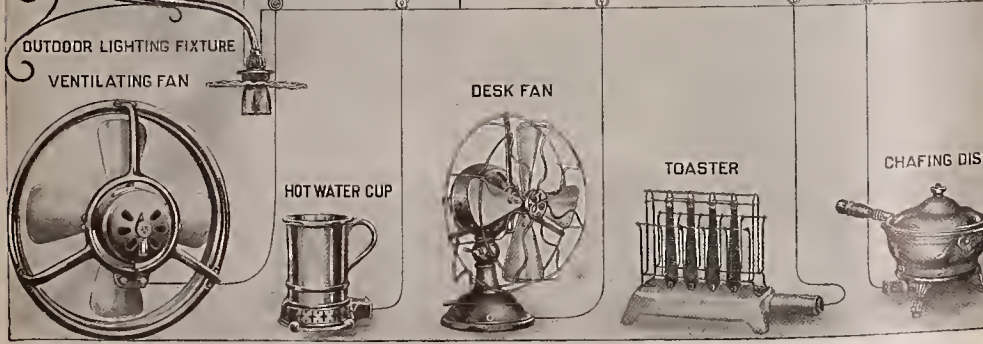
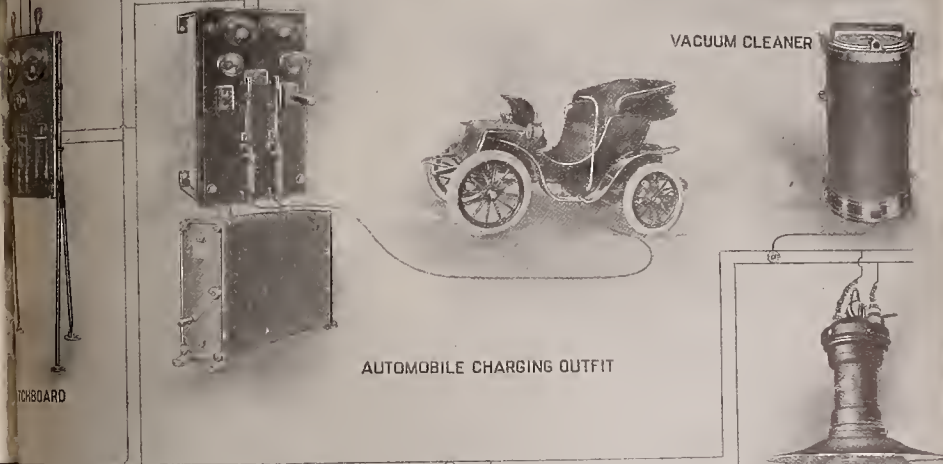

The electric radiator furnishes heat in its simplest and most convenient form. There being no combustion, it is absolutely cleanly and sanitary. It is an ideal heater for cool spring and fall days when the regular heating system furnishes too much heat for comfort.

During the winter its glow serves admirably to add cheer to the steam heated room. The electric house fan is noiseless and for this reason is a desirable fan to use in the sick chamber. It can be used in one

room on the table and in another as a wall fan. A single demonstration of vacuum cleaning generally leads to the adoption of this method. Sweep a nine-by-twelve rug as clean as you possibly can with broom and carpet

sweeper; then apply a good vacuum cleaner. The quart or more of dirt that it will suck up and convey into its receptacle is a convincing argument. No method of making toast is so satisfactory as the electric. The electric toaster

stove makes delicious golden brown toast right on the dining table. In addition to a wire grid for making toast, some forms are provided with a steel plate for making grid-dle cakes and for cooking small portions of almost anything.

Where electric current is available on large dairy farms, it can be used to operate any

of the present styles of milking machines. With the milking machine one man can milk from two to six times the number of cows in the same length of time that it is possible for him to milk by hand. The different styles of machines now on the market take from a one-half to three horse-power motor for their operation.

Elementary Electricity

By PROF. EDWIN J. HOUSTON, PH. D. (Princeton)

CHAPTER XXIV.—ELECTRIC HEATERS

As we have already seen, the passage of an electric current through a conductor is invariably attended by an increase in its temperature. The heat so produced may be either non-luminous or unaccompanied by light, or luminous or accompanied by both heat and light.

The quantity of heat produced by the passage of an electric current depends on the amount of electric energy that produces it. The rise of temperature depends both on the rapidity with which the heat is produced and the rapidity with which it is dissipated or lost. The increase of temperature is most rapid when the electric current begins to pass through the conductor. The increase of temperature, however, does not continue, the loss of heat becoming more nearly equal to the increase until finally, when these two quantities equal each other, the temperature remains constant.

An electrically heated body can part with or lose its heat in three ways; i. e.:

(1) Its heat is carried off by any body that comes in contact with its surfaces. This manner of losing heat is known as conduction. An electric conductor that has been insulated by covering it with cotton, silk, rubber or caoutchouc, loses its heat mainly in this way. So, too, a conductor of the above character, provided with an outer covering or sheathing of lead, loses its heat mainly by conduction.

(2) When the heated body is surrounded by a gas or liquid, as when a bare wire or conductor is placed in the air or in water, it gives up its heat to the molecules of liquid or gas that come in contact with its surface. This causes an expansion of the liquid or gas that sets up currents called convection

currents, the heated liquid or gas moving from the conductor towards the colder portions of the mass. This process is called convection.

(3) No matter whether the heated body be bare or covered it will lose a certain proportion of its heat by what is known as radiation. In this case it sends off waves that radiate or move in all directions from the heated body and so carry away the heat to cooler parts of the surrounding medium.

The quantity of heat required to raise the temperature of a given amount of different substances varies, but is constant for the same substance. In order to raise the temperature of one pound of water one degree Fahrenheit, an amount of energy, 778 foot-pounds or 1055 joules, must be expended. And this is true whatever may be the source of the energy that is so expended. It may have been produced by mechanical, by chemical, by electrical, or by magnetic means. But in every case the expenditure of 778 foot-pounds or 1055 joules will be required to raise the temperature of one pound of water one degree Fahrenheit.

In order to determine the amount of heat produced by the passage of a given quantity of electricity through a circuit in a given time, a device known as the electric calorimeter is employed. The simple form of this instrument, represented in Fig. 153, consists of a thin wire (MN), placed in a glass vessel nearly filled with water. A thermometer (T) is passed through a cork in the top of the vessel so as to bring its bulb near the center of the liquid. In this manner, the amount of the increase in the temperature of the water that has

been produced by the passage of a given current in a given time, can be measured.

The quantity of heat is measured in heat units called calories, a calorie being the amount of heat required to raise the temperature of one gramme of water, one degree Centigrade. Consequently, if the weight of water in the glass vessel of the calorimeter is known in grammes, and the quantity of electricity passing is known in amperes, from the increase in temperature as indi-

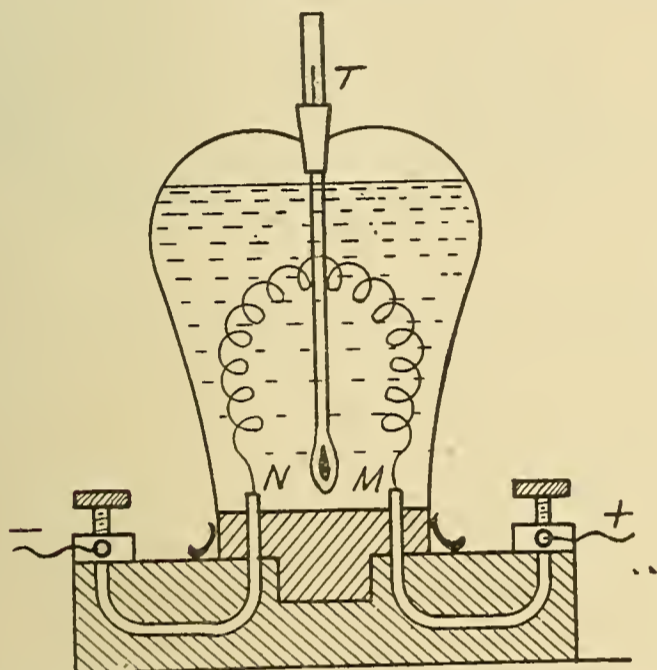

FIG. 153. SIMPLE ELECTROMETER

cated by the thermometer, the quantity of heat produced in calories can be obtained.

The amount of heat liberated by the passage of an electric current is proportional to the square of the current strength in amperes multiplied by the resistance of the circuit in ohms. If a current of ten amperes passes through a circuit whose resistance is four ohms, the amount of energy expended will be ten multiplied by four, or four hundred watts. Or, since one watt equals .24 calories per second, the total quantity of heat generated is equal to $400 \times .24$, equals 96 calories per second.

The actual increase, or rise in temperature produced in any conductor by the passage of an electric current, depends on the following circumstances, i. e.:

(1) On the amount of heat liberated in the conductor.

(2) On the nature of the medium surrounding the conductor.

(3) On the character and temperature of bodies in the neighborhood of the conductor.

The amount of heat liberated in a given length of conductor depends:

(1) On the electric resistance of that length of conductor.

(2) On the current strength passing through that length.

(3) On the extent of surface of that portion of the conductor, or, in other words, on both its length and diameter.

(4) On the nature and condition of the surface of the conductor.

The heating effects produced by an electric current are employed in practice for a variety of purposes, such as electric heaters, electric furnaces, electric radiators, electric stoves, electric soldering irons, fuse wires, etc.

So far as its actual efficiency is concerned, an electric heater is unable to compete with a coal fire or gas stove. If the electricity employed in the heater coils be obtained by steam power, as is generally the case, it would of course be more economical to burn the coal directly to produce the heat than to burn it under a boiler, use the steam generated to drive an engine, the engine to drive a dynamo, and the current produced by the dynamo to heat an electric heater.

But there are cases in which the use of an electric heater is more economical than the use of a coal or gas stove. An electric heater can be placed in operation by the mere closing of a switch, and the highest temperature it is capable of producing obtained in a few minutes. Then, when the heat is no longer required, it can be turned off almost instantly by the opening of the switch.

The above is not the case with the coal or gas stove. A stove requires a long time before it can be brought to the required temperature, and when the heat is no longer required, it takes a long time to extinguish the fire economically. For this reason, therefore, there are a number of electric heaters suitable mainly for cooking purposes that can compete economically with coal and gas stoves. The actual amount of heat required to prepare a cup of coffee or tea, or to broil a steak, is comparatively small, and this amount can be readily obtained and the current turned off when the cooking is done. But in the case of coal or gas cooking stoves or ranges an amount of heat far in excess of what is necessary for either of the above mentioned services is produced. Nor indeed is this limited to cooking devices, since an electric air heater, turned on for a quarter of an hour or so, will comfortably heat the air of a small room, and when the heating is no longer

required the heat can be turned off, while in the case of the hot air heater the fire in the furnace must be kindled many hours before its use is actually required.

Another advantage possessed by electric heaters is to be found in the fact that they do not vitiate the air. There are no noxious gases or products of combustion given off by the electric heater as in the case of the gas stove or coal furnace.

The actual temperature to which a given current of electricity can raise a conductor depends on the value of its resistivity or electric resistance per unit of length. A certain current strength passing through a given resistance produces a definite quantity of electricity. Since a short thin piece of wire of a certain kind of material may possess the same electric resistance, as a long stout wire of another material, it is evident that the liberation of the same quantity of heat in these two different conductors will produce very different temperatures. The shorter the wire, the higher the temperature to which the conductor will be raised, and the longer and stouter the wire, the lower the temperature.

The construction of the electric heater is exceedingly simple. It consists practically of a coil or coils of wire of some material that is not readily fused by heat. The heating coil is arranged so as to be able readily to give its heat either to the air that comes in contact with it when the coil is intended to act as an air heater, or to a mass of metal or iron with which it almost comes in contact, only being separated from it by a thin layer of some non-conducting material such as porcelain.

When properly constructed an electric heater is an exceedingly efficient device. Indeed, its efficiency is far greater than that of any other electric device. Practically all the energy of the electric current is converted into heat energy.

Various shapes are given to the coils of electric heaters. Sometimes they are in the form of flat spirals applied to the surface of a metallic plate by the use of fused glass or porcelain, which, when cooled, hardens and holds the coils to the plate at the same time insulates contiguous turns from one another, so necessitating the current to pass through the entire coil from one end to the other.

Heating coils of the above description are efficient in action, since all parts of the surface of the coil come almost in contact with

the metallic plate to be heated. They possess the disadvantage, however, that when fused or burnt out it is difficult to replace them. A modification, therefore, has been adopted whereby the heating coils consist of an edgewise-wound spiral of special resistance ribbon, suitably insulated between the separate turns, and enclosed in a mica-lined copper cylinder. When a heating coil burns out it can instantly be replaced by a fresh coil.

In order to obtain a large heating surface the heating coil is generally made fairly long. The material of which it is constructed consists of some material that possesses a high electric resistivity. Galvanized iron wire is commonly employed for large car heaters and German silver wire or other suitable alloy for most other heater coils. For the heating of street cars, the cabins of ships, and the small rooms of houses, the electric heater possesses marked advantages over coal gas stoves, since, as already stated, it can be turned on only when heat is needed and turned off when the heat is no longer needed.

The electric heater is employed in the kitchen, for culinary purposes, in the form of stoves, broilers, toasters, coffee and tea kettles, waffle-irons, etc., etc.

In all of these devices the heater consists of various heating coils placed inside a short cylinder that is provided with a flat upper surface on which the vessel in which the cooking is to be done is placed. In order to obtain the greatest efficiency from a heater of this character, it is necessary that the pan, pot, kettle, or other device in which the cooking is to be done, shall be provided with a perfectly flat base so that it can come at all points of its surface in contact with the heating surface of the electric stove.

In most cases electric heating devices are provided with a number of separate heating coils. When so arranged it is possible rapidly to vary the quantity of electricity passing by the use of what is known as a temperature-regulating switch. This is a switch by means of which the resistance of the heating coils can be varied by coupling the separate coils in series, multiple, etc. In this way a marked saving is possible in the amount of current employed since by arranging the regulating switch when the current is first turned so that a powerful current passes, the heater is brought to its highest temperature in a few minutes, when

a smaller current will suffice to keep the heat fairly constant.

Fig. 154 represents a form of electric heater known as the portable stove or disk heater. Here the heating coil is placed inside a short metallic cylinder provided with a flat base, and is connected with an electric

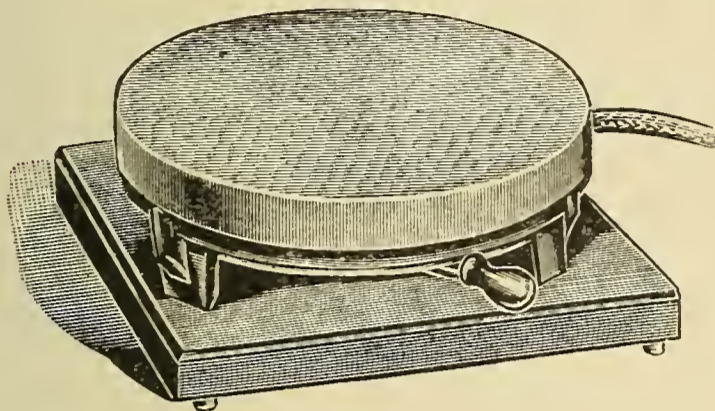

FIG. 154. ELECTRIC DISK STOVE

source by means of conducting wires represented at the right-hand side of the figure. The temperature-regulating switch is represented in front of the figure. Such a stove reaches its full temperature two minutes after the strongest current is turned on.

There is also what is known as an electric griddle cake cooker and toaster, which in construction does not differ from that of the portable stove save in dimensions and shape. An electrically heated cooker and toaster is especially suited for the cooking of griddle cakes. The electric resistance of the heating coils is proportioned so that a temperature of about 700° F. is obtained. Cooking by such a device is attended by the most satisfactory results by reason of the uniformly high temperature ensured.



FIG. 155. DISK STOVE AND TEA KETTLE

In the electrically heated tea-kettle, Fig. 155, an electric stove is provided with a tea-kettle furnished with a flat bottom so as to ensure good contact with the upper surface of the stove. This device is provided with a three-point temperature regulating switch.

In the electric chafing dish, a construction similar to that of the electric stove or disk heater is employed. Here a chafing dish with a perfectly flat bottom rests on the upper part of the stove. This pan can

also be employed for frying, for the heating of soups, or for the boiling of water.

The electric device known as the farina boiler, Fig. 156, is of efficient service in the kitchen. It consists of an outer vessel of heavy nickel-plated copper. The inner vessel is made entirely of porcelain. A heating coil consisting of nickel-plated copper, is placed directly in a water bath surrounding the porcelain pot in which the cooking is done. A three-point temperature-regulating switch is employed.

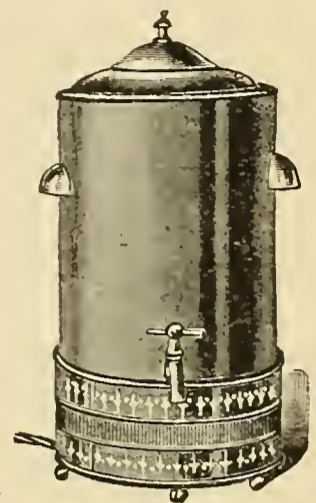

FIG. 158. HOT WATER URN

It will be observed that the above form of heating device differs from the others in that the heating is effected by means of

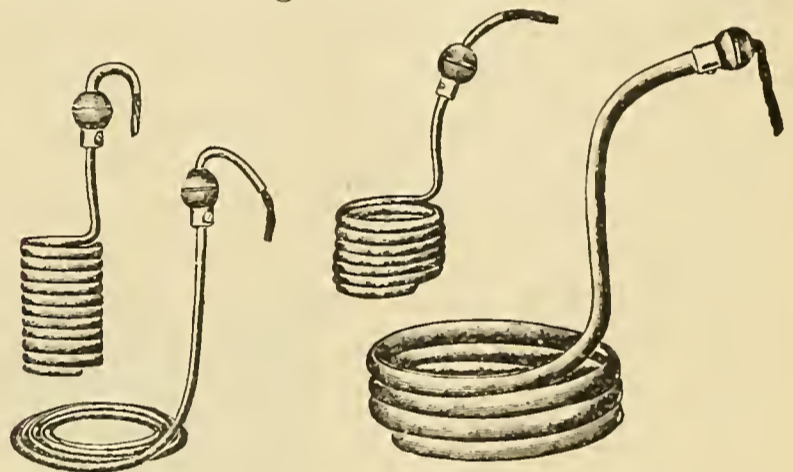

FIG. 157. IMMERSION COILS

what is known as immersion coil heaters. These are devices whereby the current is sent through coils of wire that are placed directly in the liquid to be heated. Four coils of this type are represented in Fig. 157.

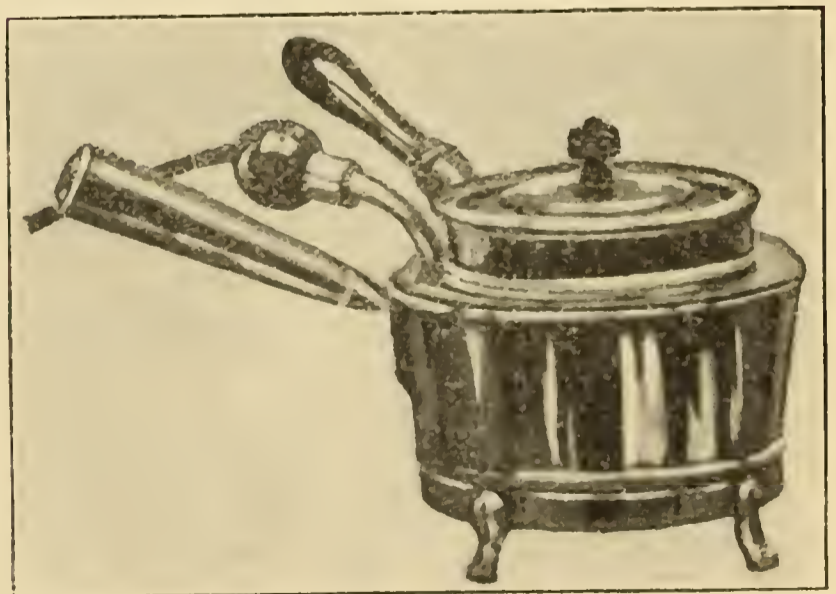

FIG. 156. FARINA BOILER

They are made either in the cylindrical or flat form, for use with both alternating and

direct currents as may be necessary by the character of the current employed in the house.

In the device known as the electric hot-water urn, a nickel-plated copper vessel is provided, as shown in Fig. 158, with immersion-coil heaters for rapidly raising the temperature of the water, so as to bring it to the boiling point.

In the electrically heated oven a hot-air space is employed for baking, and other processes generally carried on in the ordinary oven. The electrically heated oven possesses marked advantages over ovens in which the heat is obtained by the burning of coal, gas or oil; for, the electrical oven is devoid of noxious gases, and, moreover, it is possible readily to obtain in them varying temperatures and to maintain them constant for any length of time.

The electric oven is provided with a heat regulating switch. Generally, too, a device known as a pyrometer is employed in which a needle is moved over a graduated arc by the expansion of a rod of metal exposed to the heat, indicating the temperature by its position on the scale. Such an electric oven is represented in Fig. 159. As is generally the case, this oven is provided with a number of separate heating coils, so connected with a temperature-regulating switch as to enable one or more of the coils to be cut out, or all the coils arranged in series or in parallel. Since, under such circumstances, the temperature produced will depend on the position of the temperature regulating switch, it is possible to use this switch in place of the pyrometer to indicate the temperature.

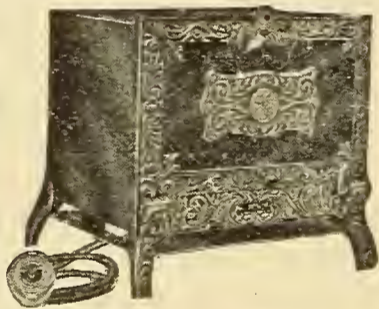

FIG. 159. ELECTRIC OVEN

(To be Continued.)

Dr. Acheson Receives Perkin Medal

Dr. Edward Goodrich Acheson of Niagara Falls was presented with the Perkin medal at the meeting of the New York Section of the Society of Chemical Industry. Dr. Acheson is one of the foremost men in the development of electro-chemical processes and he is the inventor of the process of making carborundum and artificial graphite by electric heat.

X-Ray as Dental Detective

Some years ago one of the most prominent oculists of Cleveland had a patient whose right eye was unaccountably inflamed. Persistent local treatment did not seem to help the trouble, which was evidently due to causes not seated in the eye itself, yet the lady seemed otherwise in perfectly normal health. Finally, almost in despair, the oculist sent her to a dentist whom he knew to be exceedingly painstaking in his examinations. The dentist's inspection showed the teeth to be in almost ideal condition, with no ready indications of trouble, but a more searching scrutiny disclosed a slight and almost wholly concealed abscess at the root of her left eye tooth. While he was treating this in the usual manner, the eye gradually improved so that both dentist and oculist discharged their fair patient at about the same time.

A year later the lady's other eye began to show a similar trouble. Remembering her previous experience, she did not bother the oculist at all but went direct to the same dentist who had handled her case so well before. He carefully scrutinized the corresponding tooth on the opposite side of her mouth, but search as he would, not a sign of even the slightest abscess or other trouble was to be seen. However, the logic of the previous experience had strongly impressed both him and his patient, so with the lady's consent he drilled right down into the root of the healthy tooth; and sure enough, there was an abscess too faint to show at the gums or even to make the tooth ache, yet influential enough by pressing on a certain nerve to affect the opposite eye. By curing this tooth ailment he promptly cured the eye also, thus again showing not only that there was a connection between the two, but also that serious difficulties might be caused elsewhere in the body by tooth troubles which could not possibly be discerned in the ordinary manner.

Such cases might arise over and over again and how was he to locate the seat of the trouble without boring into sound teeth? Would the X-rays locate them? A few trials soon showed that they would and this dentist gradually became one of the best patrons of an X-ray operator who now is specializing on radiographs of the teeth. The method is simple enough, but the results are often surprising.

Where Electricity Stands in the Practice of Medicine

By NOBLE M. EBERHART, A. M., M. S., M. D.

CHAPTER IV.—RHEUMATISM, GOUT AND ARTHRITIS DEFORMANS

There is no disease in which a greater variety of remedies has been employed than in rheumatism. For this reason it is not strange that electro-therapeutic measures have come in for their share of use.

In acute rheumatism of the joints they are of comparatively little value, except in connection with the usual methods of treatment, but in muscular and chronic rheumatism they have proved of exceptional value. It is to be borne in mind that our definition of electro-therapy embraced the application of all electrically operated devices used in the treatment of disease, thus including electric light baths, vibration, etc.

If I did not believe conscientiously in the real value of electricity in rheumatism I should not include it in this series, but on the other hand to assert that electricity is in any sense an unfailing cure for rheumatism is quackery.

Acute articular rheumatism, also known as inflammatory rheumatism or rheumatic fever is a very common disease. It is probably the most painful disease flesh is heir to.

It is characterized by swelling of the joints, which is non-suppurative, that is, there is no primary tendency to form pus. It is a constitutional disease, and involves the whole system, and is not limited to a local condition merely. The fever is irregular, and profuse and very acid sweats are present.

It is especially prone to shift from joint to joint and to involve other organs. In more than half of the cases the heart becomes affected. This is usually in the form of endocarditis, which means an inflammation of the lining of the heart. As a matter of fact, the inflammation is almost always limited to the valves.

Rheumatism is usually preceded by a sore throat, such as an attack of tonsillitis. This is one reason for our present theory that rheumatism is an infectious disease, with the infectious agent unknown, although some success has attended efforts to identify it.

The older theory that lactic acid was the cause has been given little credence of late. Like the question of the hen and the egg, it is impossible to say which came first; whether an excess of lactic acid causes rheumatism or rheumatism causes an excess of lactic acid.

Rheumatism is confounded frequently with rheumatic gout, (called arthritis deformans or rheumatoid arthritis) and there is a strong belief among the laity that it is caused by an excess of uric acid in the system, which is a condition present in gout.

Rheumatism affects especially fibrous and serous tissues. Of itself it is rarely fatal, although a fatal termination through some of its complications, such as disease of the heart or pneumonia, occurs sometimes. The mortality rate is less than three per cent.

Rheumatism is most common in the early months of the year.

In a series of 514 cases reported by Barstow, 337 were in males and 177 in females. Of these cases the knee-joint was affected in 351; the ankle in 256; the wrist in 125; the shoulder in 116; foot, 109; hand, 97; elbow, 78; hip, 44. Frequently the disease is symmetrical, that is, both knees or both wrists or both ankles will be involved.

Impoverishment of the blood (anemia) is quickly produced by rheumatism.

The cause of rheumatism as stated above is not definitely known, but the frequency with which tonsillitis ushers in the attack renders the theory of infection probable, and the tonsil is looked upon by many physicians as the gateway through which the disease secures a foot-hold. One of the principal reasons for believing this to be an infectious disease is the similarity between its symptoms and those where a known infection exists.

In acute articular rheumatism, which, by the way, means rheumatism of the joints or articulations, the electrical treatment is of value principally in the relief of pain,

through the application of high candle-power electric lights, either incandescent or arc, which also possess some germicidal properties.

In acute muscular rheumatism, of which the most common examples are lumbago and stiff neck, vibration and the spark from the high frequency vacuum tube have cured many cases, and we are justified by clinical experience in warmly advocating their use.

I have made more than one skeptical doctor a convert to the value of these methods by applying them in his own case.

Incandescent or arc light baths, through the radiant heat evolved, are equally useful, and static sparks are similar in their effect to high frequency sparks.

Muscular rheumatism affects the voluntary muscles, which are those muscles whose action is directly under the control of the will. It also involves their point of attachment to the bones and those sheets or bands of connecting or investing tissue called fasciæ. It bears various names according to the part affected. Thus a "stitch in the back" which is located in the lower part of the back, in the region of the lumbar joints of the spine is called lumbago. If it involves the muscles of the side and back of the neck it is called by physicians tortycollis; by the laity, "stiff neck."

Differing from articular rheumatism, this is entirely a local disease, and is brought on by a sudden chilling after violent exertion, or by sitting in a draught, and is more common in individuals who are of gouty or rheumatic tendencies.

Prolonged vibration over the seat of the pain will always afford relief. The high frequency spark is particularly useful and all electrical devices which generate intense, but dry, heat. Galvanism is advised by many authorities, also the sinusoidal current.

In chronic articular rheumatism we have stiff and painful joints to contend with. The swelling is usually slight if it exists at all, and fever ordinarily is absent.

Weather changes affect the pain, which also is increased by movement and generally worse at night. There is a strong tendency to deformity about the joints. In these cases vibration has given the best results, and high frequency sparks, auto-condensation, faradism and electric light baths are indicated and may be employed to great advantage, according to the individual case.

Gout is a disease caused by faulty or disordered nutrition, and it is accompanied by acute and painful inflammation of joints.

There is an excess of uric acid and the normal ratio between uric acid and urea is greatly decreased. There is also a deposit of a sodium salt about the joints. One theory of the cause of gout is imperfect oxidation of food-material and deficient elimination of waste products.

There is no question but the use of fermented liquors and the abuse of one's system through over-eating, and insufficient exercise are the most common exciting causes. The disease is more frequent in men than in women, and there seems to exist in certain families, a predisposition to gout. We call this a gouty habit.

The big toe joint is commonly the seat of acute attacks of gout and the right side is more often involved than the left.

In chronic gout the deposit of chalky material in and about the joints is marked and these "chalk-stones" may be found in various parts of the body. They are common about the knuckles and in the ears. Dyspepsia is an almost constant symptom and acute attacks of gout become more and more frequent.

Since faulty elimination and disturbed nutrition are so evidently concerned in the production of gout, it naturally suggests to us that those electro-therapeutic measures which increase nutrition and elimination would be directly indicated.

Of these there is none better than the high frequency current of D'Arsonval given by auto-condensation. (See illustration in February number of Popular Electricity.) And as auto-condensation is the treatment for arterio-sclerosis (hardening of the arteries) which is so commonly a symptom of gout, this treatment is still more positively indicated. It must not be given during the acute attack as it will only aggravate the pain, but should be given ten or fifteen minutes daily between attacks.

The disturbed proportion between uric acid and urea is altered still more during a period of two or three weeks, when it rapidly returns to normal.

High frequency sparks; static electricity in form of wave or of brush or spark discharge, and the sinusoidal current are all useful, on account of their beneficial effect on metabolism and disturbed nutrition.

During the acute attack the high candle power lamps are the only electro-therapeutic measure I would advise.

The value of various salts of lithia in this disease has caused them to be administered electrically as well as by mouth.

One method is to immerse the affected part in a two-percent solution of lithium chloride attached to the positive pole of the galvanic current, the circuit being completed by large pads on the patient's back connected to the negative pole. The lithium is thus carried in by cataphoresis, as it is strongly attracted toward the negative pole.

Arthritis deformans, commonly called rheumatoid arthritis, because of its supposed relationship to rheumatism, is a chronic disease involving the joints. Frequently those peculiar bony joints known as Heberden's nodes are present.

Heberden's nodes, named after the physician who first described them, are small bony growths or "knobs" occurring on the fingers. The word arthritis signifies inflammation of a joint.

The disease has been considered an incurable one and the deformity resulting from it has been beyond the reach of medical skill. Benefit has been obtained from vibratory massage, hot air treatments, and recently the successful use of the X-ray has been reported by several conservative men.

(To be Continued.)

Phonographs in Reporting Debates

One of the most ingenious uses to which the electrically-operated phonograph has been put in the business and professional world is found in the employment of the talking machine as the aid of the official congressional reporter. Indeed, without the assistance rendered by these machines the present system of reporting the debates of our national legislature would be almost an impossibility.

The United States Senate and United States House of Representatives are notoriously the most difficult bodies in the world to report verbatim. The stenographic record of every word spoken on the floor of the chamber of each body is made by a corps of a dozen expert shorthand writers—six in the Senate and six in the House—who by reason of their exceptional proficiency receive salaries of \$6,000 per annum for an average of six months' work a year. These

official reporters work in "shifts" in taking down debate—that is, they relieve one another at frequent intervals.

It is in the translation and transcribing of the shorthand notes made during the heat of debate that the business phonograph renders such assistance, in behalf of economy of time and labor. Upon retiring from the legislative chamber after an interval of reporting the official reporter immediately reads his notes, or rather the translation of them into a phonograph. This done, he is enabled with scant loss of time to return

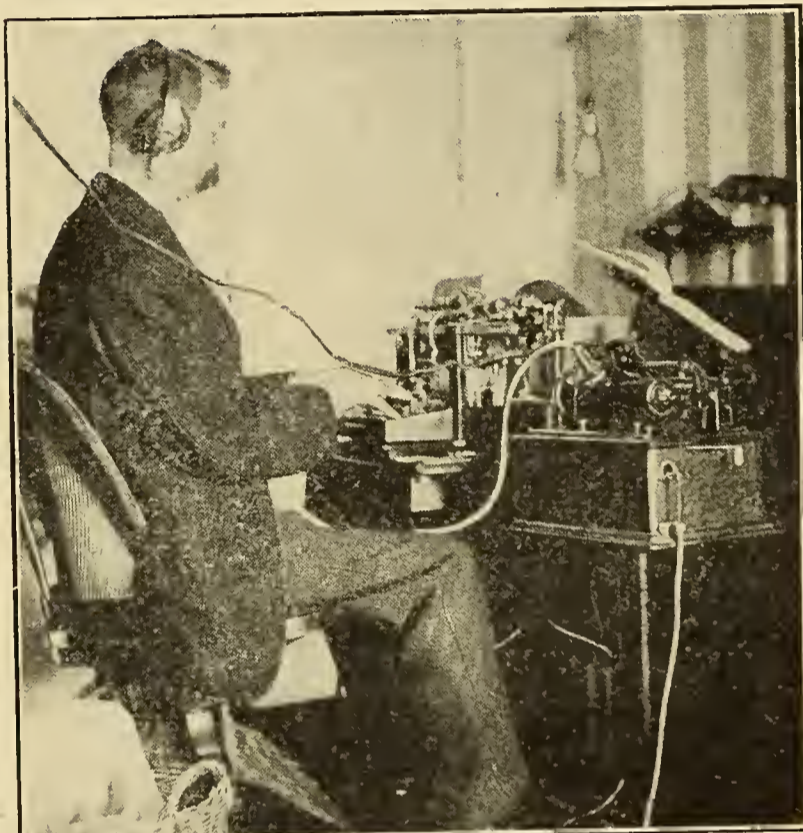

Copyright by Nathan Hawcutt

TRANSCRIBING FROM AN ELECTRICALLY OPERATED PHONOGRAPH.

to the scene of debate and relieve the reporter on duty there who forthwith goes through the same procedure.

With this plan in operation the detailed report can be prepared at leisure from phonographic dictation by the typewriters to whom this portion of the work is assigned, and in an emergency requiring the quick preparation of a typed report for transmission to a senator or representative for correction, it is possible to distribute the phonograph cylinders among several typists and thus secure simultaneous work on a lengthy speech or discussion. At the headquarters, respectively of the Senate and House reporters, are "shaving machines" for resurfacing the obsolete phonograph records in order to fit them to be again used for dictation. The shaving machines, like the phonographs themselves, are operated from the electric light circuit.

Talks with the Judge

HE IS MYSTIFIED BY CIRCUIT-BREAKERS AND AIR PUMPS

As I rounded the corner one evening on the last lap of my homeward journey I caught up with the Judge who had just left an Evanston car. I could see by the way he walked, with head bent down and a puzzled look upon his face, that he was confronted with another electrical problem.

Sure enough, with hardly a "How do you do," he sang out: "There are two things that are always happening on that car that I'm blamed if I can understand. I want to know how that pump, or whatever it is, under the car, can start up and chug away

do with the air brakes. But what the other thing is for I haven't the least idea. Maybe it was put up there by the motorman to show how little we common passengers know about electricity, and to give us the impression he is saving our lives at the risk of his own as he reaches up and yanks it back into place as nonchalantly as if he were scratching his ear."

"One thing at a time, please," I said as I fell into "synchronism" with his step and his conversation. "We'll settle the pump first, for it is a pump, as you surmised, and

it pumps air under pressure into a long cylindrical tank under the car, from which it is used as required to operate the air brakes. It won't be necessary to explain the operation of the latter for you are probably already familiar with this wonderful system devised by Mr. Westinghouse.

"But every time air is taken from the tank to operate the brakes—the motorman does this with the little handle at his right hand which he nurses so carefully while he is stopping the car—the pressure in the air tank goes down, and soon would be so low that the brakes could not be operated. This air must then be replenished every little while by the air pump, which in turn is driven by an electric motor—not the motor that runs the car.

"Of course it would be foolish in these days of automatic machinery to set a man to watch the pressure gauge and start up the

motor when more air was needed. The motorman, too, has his hands too full to take care of the controller, the air brake valve and the track sander. Give him another lever to take care of and he would be "bushed" on a hard run, to borrow a rural expression.



All the Women Say, "Oh, Mercy!"

while the car is standing still and nobody moves a lever of any kind. And I also want to know what that thing is up over the motorman's head that every once in awhile goes off with a flash and a bang and makes all the women say, 'Oh mercy.' I do know this much—the pump has got something to

"So the starting and stopping of the pump motor is made automatic. The motor is operated by current from the trolley, and normally its switch is open and is held open by the air pressure conducted through a pipe from the tank and acting on the under side of a little piston working in a cylinder. When the pressure falls below the given value the piston falls, under the action of a spring, until a contact attached to it closes the motor circuit. Then the motor starts up and the pump works away until the pressure in the tank is raised to normal again and the piston forced up, opening the contact and shutting off the current to the motor.

"That's all there is to it. The reason the pump runs so much during the time when the car is at rest is because the motorman has a moment before used air out of the tank to stop the car.

"Now as to the little affair that causes the flash over the motorman's head, followed by subdued shrieks within the car. It is not a source of danger at all but is in reality a sort of electrical safety valve, called a circuit-breaker. You will notice that it opens most frequently when the car is starting up or is climbing a grade at too fast a clip.

"At such times the motors take a great deal of current—much more than during ordinary running. A railway motor, being what is known as a series motor, is a fiend for eating up current when it has a big job on hand like starting a car full of people too suddenly. And it will literally work itself to death trying to make good. The motor has no way of complaining to the motorman when it has more than enough to do and the latter keeps turning on the "juice." This is when the circuit-breaker takes a hand.

"The circuit-breaker is an automatic switch. The handle which you see the motorman throw over after the circuit-breaker has 'blown' carries, inside the little asbestos lined box, a pair of very springy copper brushes which bear against two copper blocks, closing the circuit so that current can get to the motors when the controller handle is moved. It takes quite a push to bring the handle over, but it is finally held by a little catch.

"Next you will ask, 'What releases the circuit-breaker?'

"This is done by what is called a solenoid, also located inside the little box. It is

simply a coil of very heavy wire through which the current must pass in order to get to the motor. Working inside this coil is an iron plunger which is connected to the catch which releases the circuit-breaker.

"Following a well-known principle of electricity, when current flows through such a coil a plunger of iron in the coil will be drawn still farther in, the strength of the pull varying directly with the amount of current flowing in the coil.

"What happens, then, when the motor takes too much current for its own good? The current through the coil gets so strong that the iron bar is drawn up sufficiently to trip the catch and the circuit-breaker flies open with a noise like a pistol shot. The flash comes from the arc which is drawn between the opening contacts.

"Who'd ever thought they would go to that much trouble to take care of a motor," said the Judge as we parted.

Electrically Made, Electrically Used

Is there not a peculiar fitness in the growing use of aluminum wire for electric circuits, as instanced by its adoption for long distance transmission lines at Guelph, Nelson, Toronto, Winnipeg and other Canadian points? If any metal deserves to be called electrical, it is aluminum, since its very existence as a metal depends on electrical processes. Small batches of it were made by other methods over eighty years ago, but it took electrolytic processes to make even the first commercial quantities on a small scale.

That was 55 years ago when the current had to come from primary batteries, so it is no wonder that the metal as then made in France brought ninety dollars a pound, almost a third the price of gold.

American progress during the last fifteen years has perfected electrical methods for producing aluminum of about 99 per cent purity, and while this is comparatively weak in large shapes, it becomes much stronger when drawn into wires. Then its lightness much more than makes up for its lower conductivity (as compared with copper) so that it is growing to be a commercial article for transmitting the very currents that are needed to free it from the oxides and fluorides with which it is found to be chemically combined when mined.

Generating Electricity by the Sun's Rays

By VICTOR H. LAUGHTER

About a year ago there was considerable comment about Mr. George S. Cove's device for generating electricity from the radiant energy of the sun. The only device described at the time was in a sense rudimentary when compared with the improved solar electric generator which Mr. Cove has recently put in operation on the roof of his new laboratory in the historic Maiden Lane, New York.

It is not claimed that the new apparatus is perfect or even that it uses a very large

circuit and heated will cause a current to flow through the circuit.

The first practical apparatus which Mr. Cove constructed at Somerville, Massachusetts, consisted of 976 thermo-actinic units connected with storage batteries in which it stored, in the light of subsequent developments, a comparatively feeble current, which was sufficient, however, to operate several tungsten lamps of low voltage.

Many improvements in the shape, ar-

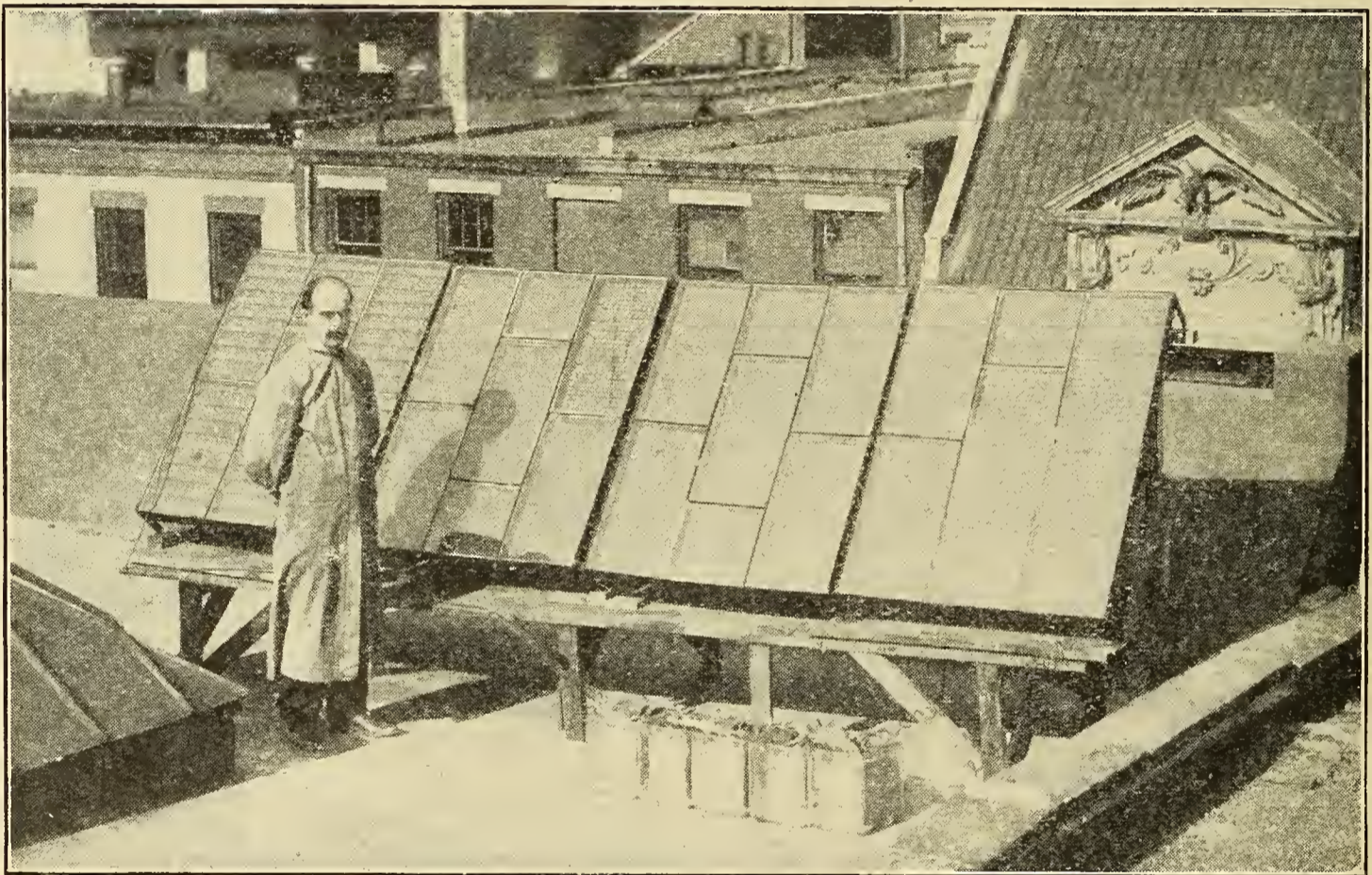

MR. COVE AND HIS SUN ELECTRIC GENERATOR

proportion of the energy contained in the rays which strike upon its surface, but Mr. Cove has satisfactorily demonstrated to many engineers and electrical experts that the so-called thermo-couples constructed from the peculiar alloys which he uses make possible a machine very much more effective in every respect than the antimony-bismuth thermopile or any other known caloric device, as it goes further than the mere transmutation of heat rays into an electrical manifestation. For clearness it may be stated that a thermopile or thermo-couple consists of a junction of two dissimilar metals, which when placed in an electric

rangement and composition of "plugs," meaning the thermo-couples, in the insulating material and in the method of connection have greatly increased the efficiency of the machine.

Recently the inventor set up an improved generator in New York which consisted of a frame of 16 square feet, containing 1804 plugs, each having about one square inch exposed to the rays of the sun under strips of violet glass, while the other end was sheltered beneath the apparatus.

Very careful tests of this type showed that the device was capable of generating one horse-power to 272 square feet of sur-

face in contact with the direct rays of the sun, equivalent to 2.75 watts to each square foot.

This machine was improved by a system of convolutions which increased the metallic surface under the glass about three times in the same horizontal area, so that a surface of 96 square feet develops over eight watts to the square foot, which makes the apparatus practical in a small way for small

lighting plants even in its present stage of development.

These results, of course, are unthinkable in connection with the ordinary thermopile, as resistance in the external circuit causes rapid diminution of the amperage. With Mr. Cove's device resistance seems to cause no more decline in the flow of current than might be expected in the use of electricity from any other source.

Most Wonderful Clock System Ever Built

By JOSEPH B. BAKER

Gleaming in lines of burnished gold against the evening sky, the tower clock of the Metropolitan Building, facing on Madison Square, New York City, is one of the horological marvels of the present day. New Yorkers take pride in showing out-of-town visitors the tall white tower and its clock—especially at nightfall, when to the music of the chimes sounding the quarters is added the flashing of the time from the lantern at the topmost point, seven hundred feet above the street. By day and night, from as far as they can be seen at all, the four giant dials can be read, and far above the city's din every fifteen minutes the bells announce the flight of time to all within earshot. And the red and white flashing beacon sends the same message far afield, readable on a clear night by all within a radius of fifteen miles. The

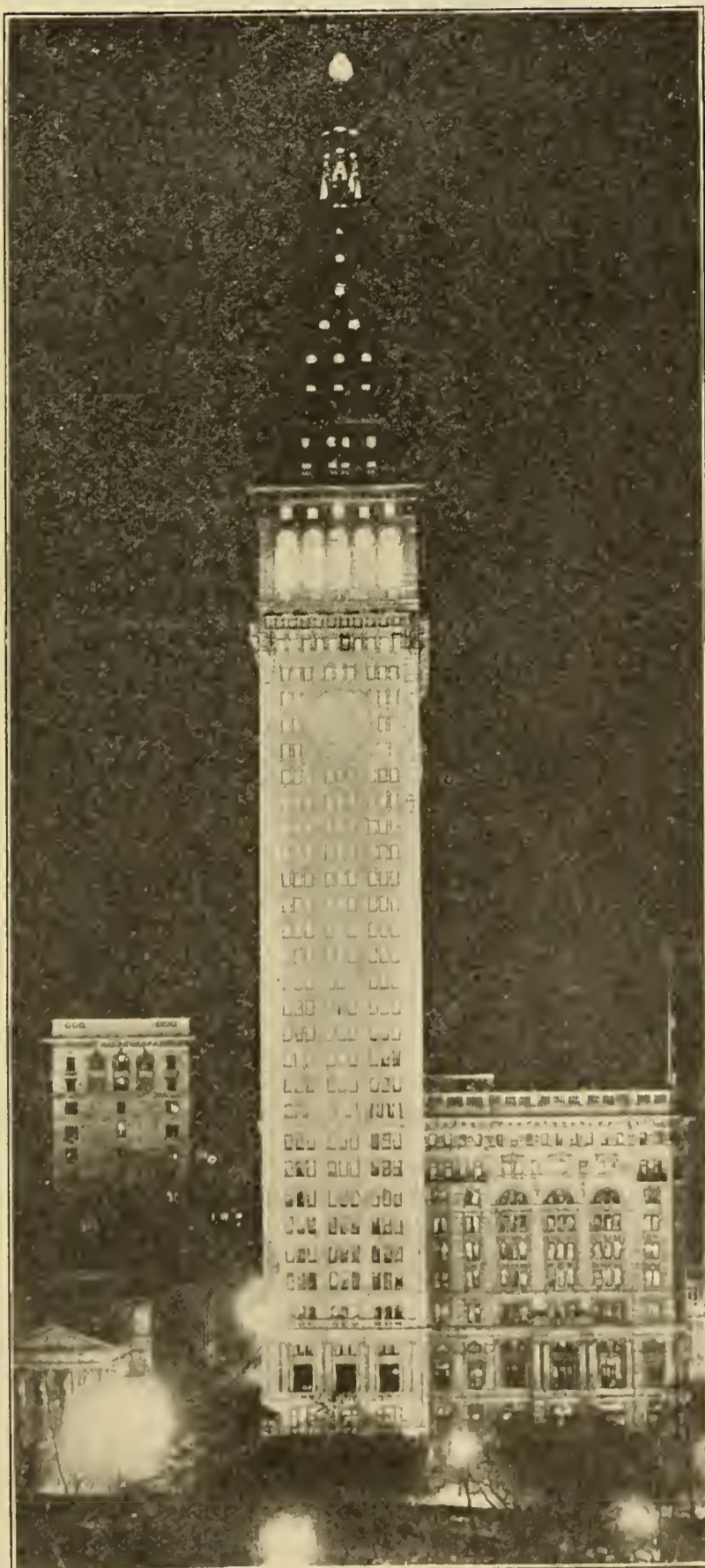

THE METROPOLITAN TOWER AT NIGHT

whole constitutes quite the most remarkable clock system that has ever been built.

The tower clock dials, illuminated at night by many incandescent lamps, are 26 feet six inches in diameter, with numerals four feet high and minute marks $10\frac{1}{2}$ inches in diameter. The hands, driven by an electric motor, are 17 feet and thirteen feet three inches long, respectively, and weigh, together, 1700 pounds. The four bronze bells constituting the hour-strike and the chimes have an aggregate weight of 13,500 pounds, and the flashing lantern is equipped with red and white incandescent lamps mounted in an octagonal lantern of an aggregate candle-power of over 22,000. The clock system includes, beside the four tower dials, hundreds of other secondary clocks distributed throughout

the offices and other rooms of the building. All of this mighty horological equipment is electrically actuated and controlled from a single "master clock," which is itself electrically self-winding, requiring no touch of human hands from one year's end to the other.

This master clock is situated in the magnificent Directors' Room of the Metropolitan Life Insurance Company, on the second floor of the building. It is contained in a beautifully carved mahogany case, 12 feet high, matching and harmonizing with the costly furnishings of the room. This clock movement, which is the soul and center of the entire system, is a mercury pendulum movement of the very highest grade, with a non-tarnishing silvered dial and gold-plated ornamentation. Behind a large plate-glass door in the case are transmitters, mechanically controlled from the master clock, for operating the distant tower movements, the other secondary clocks, the chimes and hour-strike, and the flashing equipment. Every secondary clock circuit is brought out through an adjustable resistance and a pilot-clock movement, so that any desired set of clocks may be cut into service from the master clock and without going to the secondary clocks themselves, by manipulating press-buttons in the case.

Leaving the master clock ticking solemnly away in its splendid surroundings, let us take the express elevator to the twenty-sixth floor of the tower and enter the clock-room behind the west dial. Here are the panels on which are mounted the delicate relays, operated from the master clock and themselves actuating heavy magnetic switches mounted on another set of panels near by. The front of the room opens out into a ferro-

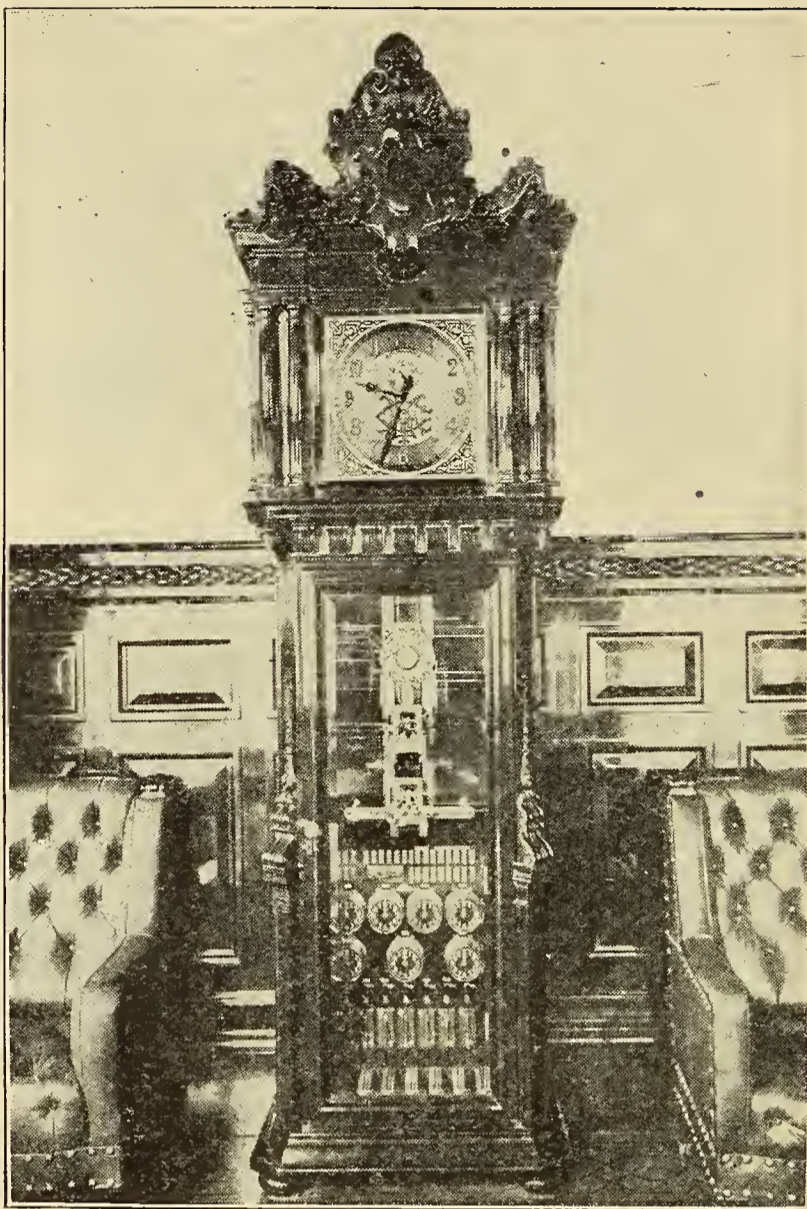

SELF-WINDING MASTER CLOCK

a slide in each hand near the point of attachment to its arbor the lamps which light the hands up at night may be reached. The hands are faced with polished wire-glass, and each is fitted with a pair of ingenious rolling carriages on which are mounted "linolite" lamps, giving the effect of a nearly continuous double line of light. The lamp carriages run on rails on a track in the structure of the hands, and are hinged together in sections, so that they may be withdrawn through the slide for the purpose of renewing the lamps. At the center of the minute-hand is a glass-faced boss containing a center cluster of ordinary bulb lamps.

The illumination of the dial itself is by an indirect method designed to give the most brilliant and at the same time the most distinct tower clock lighting in the world. The entire interior of the dial casing is painted a permanent dead-white having high reflecting power for diffused light. Two concentric circular rows of 20-candle-power tungsten lamps, two hundred in all, are mounted in front of curved reflectors of corrugated, silvered glass, which throw all

concrete casing, some 30 feet square and projecting out about 30 inches from the wall of the tower. This is the tower dial, with its numerals and minute-marks cut through the front wall and glazed with heavy plate wire-glass through which a birdseye view may be obtained of the city and Hudson River and the distant Jersey hills. The landscape looks far enough below, though here we are only half-way up the tower! Sliding shutters at the dial center give access to the backs of the monster hands—of steel-frame construction with copper casings—and through

of the direct rays against the rear wall of the casing. By this means the glass fronts of all of the numerals and minute-marks are strongly and evenly lit up, yet without any glare or blurring of the dial as seen from the outside of the tower at night. By day also, when the space back of the dial is unlighted, the numerals cut through the dial contrast well with its white surface.

The massive hands of each tower dial are carried on a set of "dial works" consisting of a steel shaft and sleeve running on ball bearings and driven by an electric motor. The "dial movement" containing the motor and its gearing is also equipped with an automatic cut-out device which turns the illumination off at 20 minutes before sunrise and on at 20 minutes after sunset, with the progressive advance of the season. There are no cumbrous weights and pulleys to operate the hands of the clock—the little electric motor, obedient to the control of the master clock and its relays and switches, starts up once every minute and runs for fifty seconds, driving the minute hand through one minute-space on the big dial during each run. Two motors are employed in each tower movement, either one alone being well able to drive the hands, and a centrifugal tell-tale device, mounted on the shaft, being used to signal to the Chief Electrician's office in case of "trouble" on either motor.

The electric "torch" on the tip-top of the tower is also turned on and off by the same automatic device that controls the dial illumination. From the magnetic switches in the clock-room, which are operated by the tiny contacts at the master clock, heavy feeder cables carry the current which flashes the time all through the night—one, two, three and four red flashes for the four quarters and one white flash for each stroke of the hour. The white light, given by 88 large incandescent lamps with uncolored bulbs, burns continuously except just before the time to announce each quarter-hour, at which time it is extinguished preparatory to the flashing.

When one has gone all over the building and seen the various parts of the clock system in operation, one is better prepared to examine the master clock, with its faithful pendulum the prime mover of all these wonderful horological details. In charge of so many functions as the master clock is, there is "something doing" all the time in the

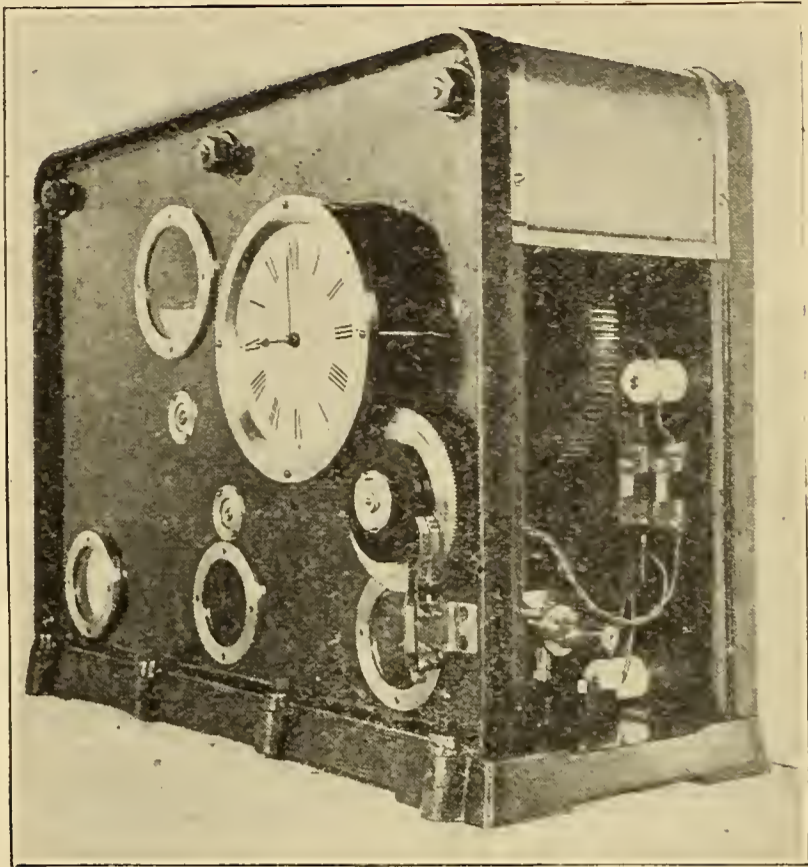

ELECTRICALLY DRIVEN TOWER MOVEMENT

array of beautifully finished gleaming mechanism. Let us watch the chimes transmitter, which consists of a little brass cylinder with four pairs of accurately adjusted platinum contacts bearing upon it and arranged to be closed in a certain order by the rotation of the cylinder. Once every 15 minutes, and a sufficient time before the even quarter-hour, a rod moved by the main transmitter releases the cylinder, allowing it to rotate and close the contacts for the proper quarter-hour chimes. The timing of these contacts is such as to cause the first stroke of the hour bell to occur accurately on the hour, allowing plenty of time beforehand for the chimes to strike their four "measures" and get through. The hour-strike transmitter is mechanically operated from the chimes transmitter.

Suppose the time is a little before two. As we watch, the drum of the chimes transmitter begins to turn, and one after another all of the four contact fingers are kicked up into the air. The sound of the answering tower bells comes down to us, but tardily, on account of the great distance; but it is a kind of music simply to watch the changing measures marked by the dancing bits of metal. Before we realize it, the motion ceases, and we turn our glance to the hour-strike mechanism. Its contact fingers close and open twice, in leisurely succession, followed by the booming notes from the 7000-pound B-flat "announcing bell" from its place on the forty-fifth story.

Down at the Power House

By FRED R. FURNAS

The old electrician was preparing to start up for the night run. The telephone had been interrupting our conversation for some twenty minutes, with frequent demands from various parts of the little city to "please turn on the juice."

Not deeming it advisable to ignore these requests any further, the old man stepped to the door of the boiler room and "looked at the steam." Finding this at the correct pressure, he casually remarked to his fireman that he would have to "hump himself" up to about eleven o'clock, on account of the

gloves and clapped in the main switch. As the big dynamo caught its load, the shrill howl changed to a deep groan, for it was the habit of the natives of the little city to throw in or snap on, according to the kind, their switches, connecting the lights at the first hint of darkness. Consequently, a heavy load was thrown on the power house from the start.

The system in use was 2200 volts, single phase alternating current generated at the power house, and distributed over the city at that pressure. At residences and stores

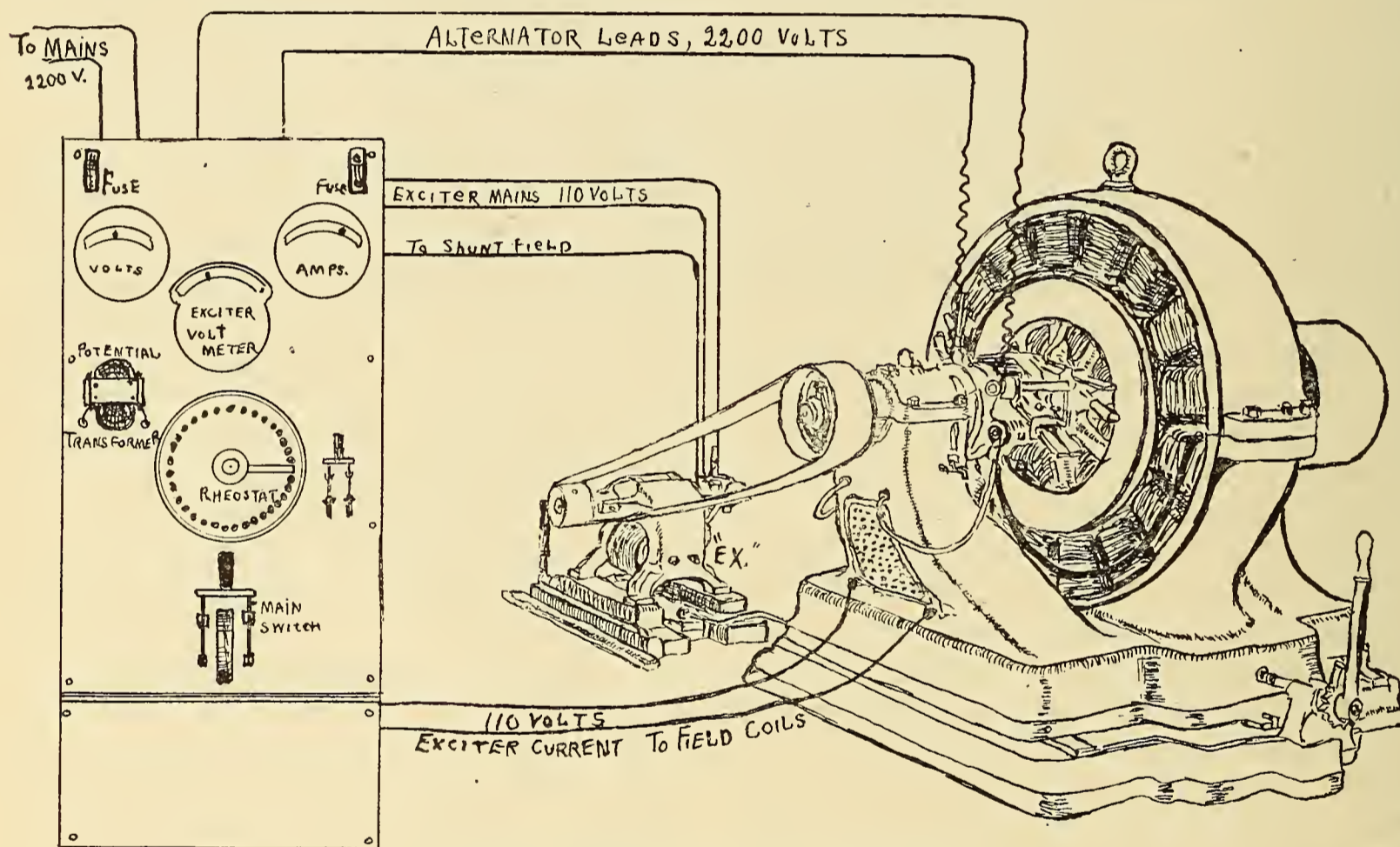

THE POWER HOUSE EQUIPMENT

extra load that would be thrown on that night by the street carnival lighting display.

Turning to the big Corliss engine, he admitted steam to her cylinder slowly and gradually. Her 16-foot flywheel began to revolve faster and faster and one of the alternators, belted to high speed from the counter-shaft, began to hum in shrill crescendo, louder and louder. One of the two dynamos was used only in heavy emergencies, being thrown in or out with a large friction clutch.

When the speed had risen to the right proportions, as indicated by the exciter voltage, the old man donned a pair of rubber

it was stepped down by transformers to 104 volts for the lamps.

In the downtown district, where the heavy localized consumption of current permitted, larger transformers, with correspondingly higher efficiencies, were used; each one feeding current to several stores and offices.

The electrician now proceeded to raise the pressure in the mains to 2200 volts. It may interest the reader to know how the voltage of a high pressure alternator dynamo is controlled and regulated. For this purpose the drawing is referred to. By means of the rheostat on the switchboard,

the old man cut out resistance in the field circuit of the little direct current exciter (EX), thereby increasing the voltage of this little dynamo. This increased voltage or pressure forces a larger current from the small machine through the field magnet coils of the big alternator, which increases the magnetic flux, or amount of magnetism in its iron cores. The windings on the revolving armature of the alternator, sweeping through this magnetic field, generate a current, the voltage of which depends upon the strength of this magnetic flux. Thus by varying the voltage of the little "exciter," the pressure of the alternator may be varied at will.

The electrician now proceeded to oil up first the alternator and then the exciter, adjusting the brushes on the latter and, with some caution, applying commutator compound to the rectifier and collector rings of the former.

Twenty-two hundred volts is not considered a high pressure in these days when we have transmission lines carrying 120,000 volts, but it is sufficient to kill almost as quickly as the latter named pressure and the old electrician was accordingly careful to stand on the raised wooden platform and keep one hand behind his back. Going over to the switchboard, he noted that the ammeter registered 30 amperes in the main circuit, and by a little mental calculation he knew that the alternator was delivering around 80 horsepower.

His engine was rated at 200 horse-power, and he expected to crowd her to full capacity when the carnival lights were thrown on. The peak or maximum load under ordinary conditions was about 100 horse-power, and one dynamo could usually carry the entire load without undue overheating, as this peak load seldom lasted more than one and a half hours: between 8:30 and 10:00 o'clock.

On this particular night, however, machine No. 2 had to be thrown in and this the old man proceeded to do, so as to get her ready for business. Being alternating current generators, they must be "synchronized" or placed in step with one another. This means that when the current of the machine in operation is flowing in one direction (and it reverses 120 times per

second at a frequency of 60 cycles) the switch connecting the two machines in parallel must be closed at the instant that the incoming machine's current coincides in direction of flow, with that of the first machine.

The electrician watches the synchronizing lamps glow and darken, as the alternators, unharnessed, as yet, assist and oppose each other in turn. When the fluctuations have slowed down to about one beat in every three seconds, he throws in the switch in the middle of one of the dark intervals of the lamps, and thenceforth the machines keep step and work together in perfect harmony. But he must watch the voltage of each machine occasionally and keep each at the same value, otherwise heavy cross currents will flow between the alternators. This would be a waste, as the engine would be developing power that never left the power house.

The ammeter suddenly jumped from 53 to 72 amperes, the lamps dimming; and the electrician was here, there and everywhere, adjusting the voltage, watching the engine, steam and instruments. Evidently, in the matter of stringing festoons of lamps over the streets at intervals, the capacity of the power plant had not been closely inquired into, for the current climbed steadily up to 75 amperes, and the engine was already overloaded. The old electrician, however, had another card up his sleeve, in the shape of a motor generator set of 30 kilowatts connected to the 500-volt direct current trolley feeders of the city railway.

This machine converted the 500 volts direct current such as is used by street cars into 104 volt alternating current. In less than half an hour the old man had "banked" three 10-kilowatt transformers to "step up" this 104-volt pressure to 2200 volts, connected them to his motor-generator set, cut off his New York street mains from the alternators and thrown his "imported juice" on that line.

The two alternators, which had heated up to an uncomfortable degree, were now able to "get away with it," and having everything running smoothly, even the fireman, the old man sat down by the switchboard again and lit his pipe.

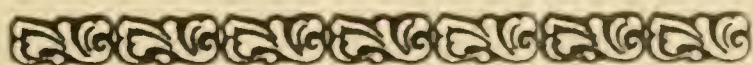

Living Candelabra

Remarkable electrical effects are produced in some of the scenes of "The Three Rivals," a pantomime presented in the Circus Schumann in Berlin, Germany. In the castle of the hero, the "Knight of Champagne," red flames, made by projecting electric light



LIVING CANDELABRA

through fluted ribbons burn on the candlesticks. Under the columns of the palace, standing on pedestals, are gold bespangled maidens and pages carrying candlesticks and giving the appearance of living candelabra as shown in the picture, which is reproduced from Mitteilungen der Berliner Elektrizitäts-werke.

Northern Lights May Be Electrified Neon

Professor Elihu Thomson points out that there is ample evidence that the illumination of an aurora occurs at a great elevation in the atmosphere. One of the latest revelations regarding it is that one of the newly discovered gases, neon, is concerned in the display. Every element, when rendered luminous, exhibits a certain line in a spectroscope different from those shown by other substances. The spectroscope is useful in

telling the composition of things. It has recently been noticed that the lines observed during an auroral display correspond with those obtained when neon is tested in a laboratory. Neon is one of the constituents of the atmosphere, but it exists in very small quantities, and, owing to its extreme lightness, rises to a high level. It is very sensitive to an electrical discharge, as has been proved by repeated experiments. Whether the electric disturbance comes directly from the sun or is produced indirectly by a derangement of the earth's magnetism, it is hard to say, but in either case, the neon shows that some electric force is at work.

Railway Car Like Halley's Comet

One of the unique advertising features connected with Chicago's recent Electrical Show was an electrically illuminated street car, the first Chicago has ever had for exploitation purposes. It was put together in the shops of the Chicago City Railway and was operated over the South Side lines and the "through routes," covering the North and West sides, from 4:30 to 10 o'clock p. m. It attracted much attention as a brilliant advertising "stunt." During the rush hours several nights the car stood on



ELECTRICALLY ILLUMINATED CAR

the Madison Street "spur" track, just off State street, where it was seen by thousands of workers on their way home. The car was put together in twenty-four hours' time, otherwise more elaborate effects would have been employed. As it was this electric car looked like Halley's comet coming down the street.

Cleptograph Camera

The tangle of electrical instruments and wires shown in the picture appears to be rather "messy," but it is said to be a real electrical and mechanical detective when it comes to photographing thieves and recording the time of their operations. It was designed by Signor G. B. Epifanio Camusso of the Cassa di Risparmio de Pinerolo in Italy.

It consists of a photographic camera and a system of wires and contacts properly distributed over the windows, doors and curtains of the room to be protected. As soon as the thief enters the house or office or touches any article of value a contact is unconsciously made by the stranger and the camera does the rest.

The Cleptograph automatically directs itself towards the burglar who has involuntarily made the contact and after having opened the objective shutter, it ignites the magnesium powder arranged to supply the flashlight, and then closes the objective after the exposure has been made. The film is automatically exchanged and a new charge of powder made ready, at the same time registering the exact hour and minute of the theft.

All of these divers operations are completed in far less time than is required to describe them, and the apparatus is almost instantly ready for taking another view, as soon as the intruder touches some other contact.

As an invisible detective the cleptograph thus follows any and all motions of the thief in order to prepare a set of authentic and irrefutable documents to assist the police in their search for the criminal. The camera and working parts may be boxed in and concealed from the burglar, all except a small opening to allow the scene to be photographed through the lens.

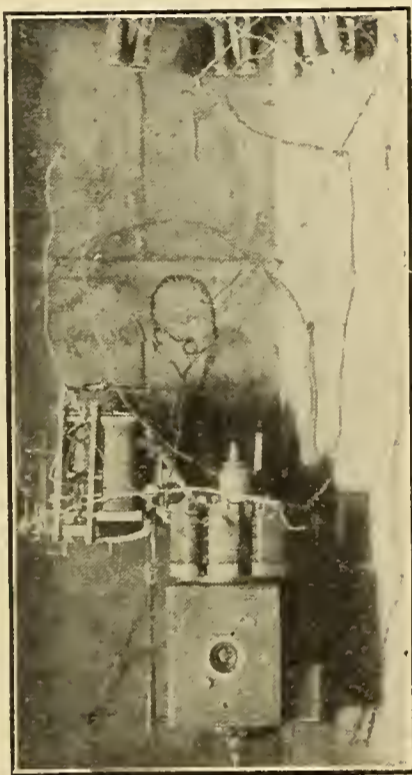

CLEPTOGRAPH

Simplest Alarm of Them All

The ordinary alarm clock will vibrate and move around over a smooth surface when the alarm is going off. You can make use of this fact in making a very simple electric alarm.

Through the top of a box put two screws the distance apart of the feet of the clock. The screws should be counter sunk slightly. Connect the points of the screws to a battery and bell so that the circuit will be closed when the two feet settle on the two screw heads.

Now wind and set the alarm, place one clock foot on one screw and the opposite foot very near to the other screw. When the alarm goes off the foot will move over and drop on the screw, closing the circuit and the electric bell will ring till disconnected. One trial will show which way the clock moves with the vibrations.

Rotasphere for Organ Blowing

The rotasphere is a novel English device for the application of electric power to organ blowing. This apparatus utilizes the old-fashioned bellows movement for "raising the wind" as required by a full sized organ instead of using rotary fan blowers as usually employed when electric motors are installed for this purpose. The ordinary reciprocal bellows movement is obtained and worked as indicated by a sprocket reducing gear and chain, driven by a small electric motor. An aluminum hemisphere is employed on the end of the motor armature shaft, driving the apparatus through a pneumatic tired wheel.

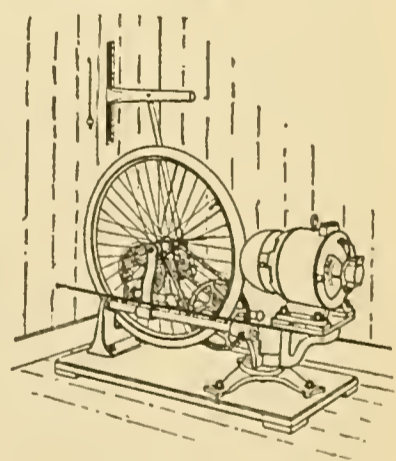

ROTASPHERE

It will be seen that automatic regulation of the wind supply to the requirement of the organ is obtained by varying the point of frictional contact between the hemisphere of the motor shaft and the tire. This is accomplished by swiveling the motor and attached hemisphere through an angle of 90 degrees by means of a chain and reacting spring which are under the direct control of the bellows movement.

Quicksilver Not Quick Electrically

Anyone who has handled that unusual metal, mercury, which is a silvery liquid at our ordinary temperature and which speedily splits up into countless globules when spilled on a floor or table, will understand why it is also called "quicksilver." But quick as it is in subdividing itself into globules, it is not so speedy in electrical ways where it is surpassed for certain classes of work even by that sturdy metal, platinum.

Having so long been used in thermometers for indicating temperature within range of the eye, and being itself a good conductor it was natural that mercury should be tried and used also in "long distance thermometers." Thus in large theatres where every effort is made for the comfort of the audience, it is important that the engineer in charge of the heating and ventilating should note the temperature in various parts of the theatre without leaving his post. This has been accomplished by placing regular mercury thermometers at various points in the building, each with wires inserted at the upper and lower end of the glass tube. The upper wire is of such length as to be just out of reach of the mercury at a temperature of, say, 68 degrees, and both wires connect with a battery and an annunciator in the engineer's room. Then when the mercury rises beyond the desired normal, it closes the circuit and signals to the engineer who can reduce the supply of heat for that part of the house.

While this method is perfectly practical it has had the objection of being slow in giving the desired indication. It might be five or ten minutes after an abnormal change in temperature before the engineer was informed of it, and meanwhile the improper heating would continue. To improve on this, something more rapid in action than mercury was needed and this has been found in platinum wire when used in a somewhat different manner. Instead of connecting a thermometer to the wires at each "station," a simple platinum wire is used as a resistance through which a current flows from the regular electric light circuit to a sensitive ammeter in the engine room. This platinum wire being exposed to the air, changes rapidly in resistance with every variation in temperature, either up or down, and each change in resistance makes a corresponding difference in the

reading of the ammeter. Recent tests in a modern theatre showed that the same temperature variation which took five minutes to actuate a mercurial device, showed itself by the platinum resistance method in three seconds. In other words, platinum proved a hundred times as speedy for this purpose as the sprightly metal which we popularly call the quicksilver.

Conduit for Electric Cables

The drawing herewith shows an immense conduit tube being put in by the Ontario Power Company of Niagara Falls, N. Y. The conducting cables for carrying the elec-

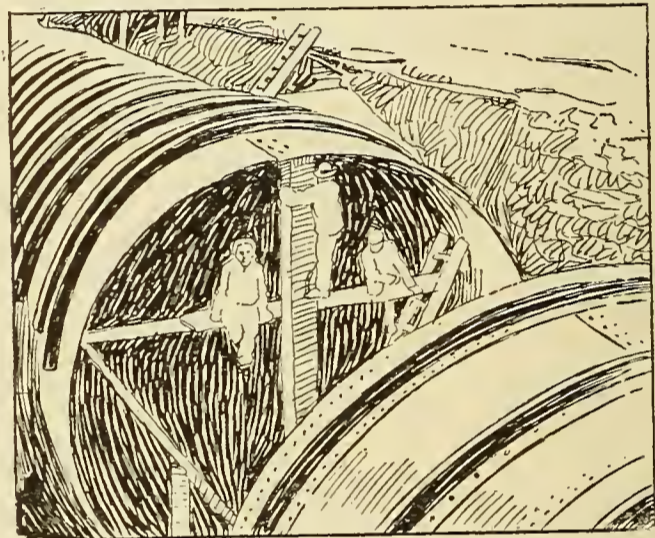

EIGHTEEN FOOT CABLE CONDUIT

trical energy generated at the plant of the Ontario Power Company will be carried in this underground conduit to the plant of the Hydroelectric Power Commission of Ontario where it will be delivered, on contract, at 12,000 volts' pressure. The tube is of steel 18 feet in diameter.

Signaling to Mars

An electric light of 4,000,000,000,000 candle power would be necessary to signal to Mars, according to Prof. Mietke, a German scientist. To produce such a light would require an electrical plant hundreds of thousands of times larger than any ever built; and we are not anxious enough yet for conversation with our neighbors to undertake it. On the other hand, if the inhabitants of Mars possessed a telescope which would magnify 10,000 diameters he estimates that they could see the signals as light points if we only had a "little" lamp of say 360,000,000 candle power. This might be operated for a few thousands of dollars an hour -and still we are not very anxious.

A Carbon Disc Arc Lamp

One of the great problems of the early arc lamp manufacturers was that of making their lamps burn all night. Even a twelve-inch upper carbon was entirely consumed in about eight hours, so that the lamp could not be burned from dusk till dawn unless it was retrimmed at about midnight.

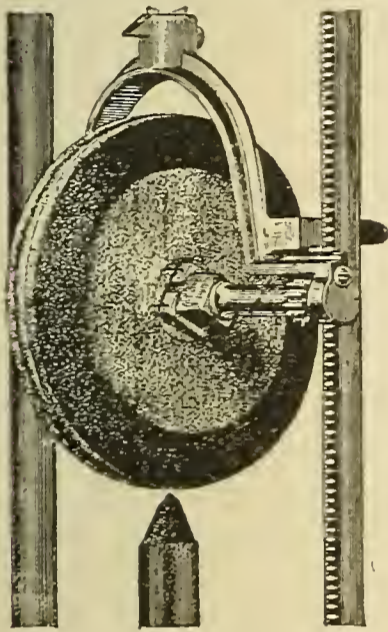

CARBON DISK ARC
LAMP

Brush, who invented the arc lamp, solved the problem by making a twin lamp in which one pair of carbons was automatically switched into action when the other pair had burned low. Then when his patents barred others from doing the same, one of the New England Yankees who did so much for arc light development designed a lamp with the upper (or more rapidly consumed) carbon in the shape of a carbon disk which would easily burn for a full twenty-four hours. A rack on one side of the supporting frame rotated the wheel slowly as the carbons were consumed, so that it made one revolution every hundred minutes, and the whole lamp was considerably shorter than the twin carbon types. Later on, the use of an enclosing globe to maintain a partial vacuum in the globe was made practical by Louis Marks, enabling the old shape of carbons to be burned ten times as long as before. The carbon disk type of lamp thereby became merely a historical curiosity, but it is interesting even today as showing how cleverly an inventor managed to evade a patent when the same threatened to monopolize the making of lamps for all-night arc lighting.

Snow on African Wires

That the unusually heavy fall of snow and sleet during January should have broken some electric light wires in various parts of the United States and of Canada is not surprising, but our part of the globe has not been the only one to suffer. The southern hemisphere was some five months ahead

of us in that respect, for on August 17th snow fell at Johannesburg in South Africa to a depth of over a foot, breaking down trees as well as many electric light wires. In this country line wires are commonly made strong enough to stand a considerable added weight of snow or sleet, but this had not been thought necessary in the diamond mining section, so the unusual occurrence of a heavy snowfall preceded by sleet was too much for them and that evening even the theatres in Johannesburg had to close for lack of light.

Charging Foundry Ovens with An Electric Crane

In modern foundry practice, large ovens are commonly used for two purposes. One is for annealing hard iron castings which are to be made "malleable." The other is for drying or even baking the moulds themselves when they are to be used for certain

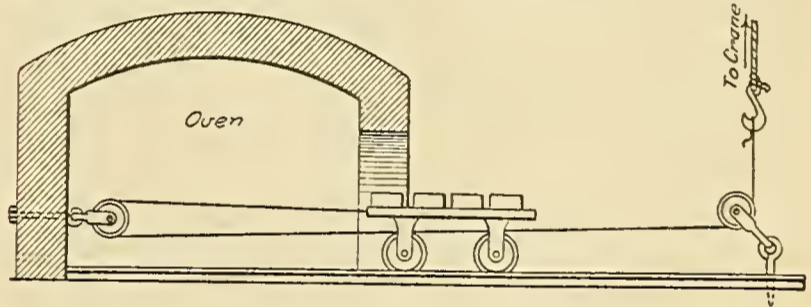

CHARGING FOUNDRY OVEN

classes of castings. In either case the materials are commonly loaded on four-wheeled trucks which can be run right into the oven.

Instead of moving these heavily loaded trucks in and out of the ovens by hand, some foundries are now utilizing the electric traveling cranes with which they have to be equipped if they are to handle large castings economically. To do this, a rope fastened to one end of the truck is passed over a pulley hooked to the rear wall of the oven. The rope is then run back under the truck to another pulley placed in the path of the traveling crane and up to the crane hook. Then when the hook is raised, it pulls the truck into the oven as you can see from the cut.

To pull the car out, the rope is attached directly to the other end of the truck. In either case no more elaborate equipment is needed than merely the two tackleblocks, two hooks suitably located in relation to each oven door and an ample length of rope.

Novel Church Attraction

Now that the electric sign has become so prominent among business people as a means of attracting trade, a pastor of a certain church thought out an advantageous scheme of using an electric sign.



ELECTRIC CHURCH
SIGN

The picture shows the "Welcome" sign over the door. The idea has been much admired by the congregation and the public, and other churches may follow in the adoption of the electric sign as more attractive than the ordinary painted sign.

Did Edison Make Good?

Every now and then we see items making the rounds of our newspapers in which the writers question the ability of our modern inventors to keep their promises. Of course there is a large class of theorists, wild predictors and unscientific experimenters whose promises must be discounted heavily. But when it comes to men of established reputation and men who are cautious in their predictions, it may be well to remind them of similar doubting articles that circulated through our press some thirty years ago. Here is a typical one which appeared in the Philadelphia Bulletin:

"If Mr. Edison wishes public faith in that electric light of his to remain steadfast, he will have to give an early demonstration of the truth of his claim that it is a practical success. When he first announced that he had solved the problem of dividing the light and of adapting it to domestic uses, there was a general inclination to accept the story with absolute confidence, because Mr. Edison had proved by his previous inventions that he could achieve some things which had been regarded by other men as impossible. But, after all, the proof of the pudding

is in the eating. So the world, after waiting patiently for the public display of an invention which sent gas stocks down as soon as it was heralded, will be disposed, unless Mr. Edison shows his hand, to suspect that the Edison Electric Light and the Keeley Motor will have to be ranked together as enterprises which contain much more of promise than of performance!"

Just what the Philadelphia papers wrote when Edison did make good, history sayeth not.

Anesthesia by Electricity

Doctor Louise Robinovitch, the Russian physician, who has become prominent in this country through her demonstrations of electrical anaesthesia, recently managed the electrical part of an operation on a human subject in St. Francis Hospital, Hartford, Conn. Heretofore her experiments have been upon animals, but in this instance a man had four frost-bitten toes amputated while his leg was made numb below the knee by the electrical process.

Doctor Robinovitch's plan consists of sending an interrupted current of electricity through the affected part of the human body to be operated upon. No other part is affected. A current at fifty-four volts was used in this instance, reduced to one-tenth of that amount. The interruptions of the current were estimated at 20,000 a minute.

The secret of the use of the device is in correctly applying the electrode to the nerve that controls the affected part. Doctor Marcus M. Johnson, the surgeon who performed the operation, said there were no bad after-effects, and the patient suffered no pain. He declared that the feat marked an epoch in anaesthetic surgery and that other forms of anaesthesia were likely to be entirely supplanted by Doctor Robinovitch's process.

Radium to Be Made More Quickly

Sir William Ramsay is said to have discovered a process whereby radium can be made from pitchblende in six or seven weeks instead of in as many months. The total quantity of radium which has thus far been recovered for scientific use throughout the world is estimated not to exceed one-fourth pound. The total stock in the London Hospital is only about 16½ milligrams.

Does Dust Hamper Reflectors?

If housekeepers and storekeepers realized the effect which a regular weekly or fortnightly cleaning of reflectors and shades has on the amount of light made available by them, they would insist on this cleaning, just as they insist on a regular scrubbing of their floors. How dust cuts down the amount of light distributed from a lamp (for which light you have to pay whether

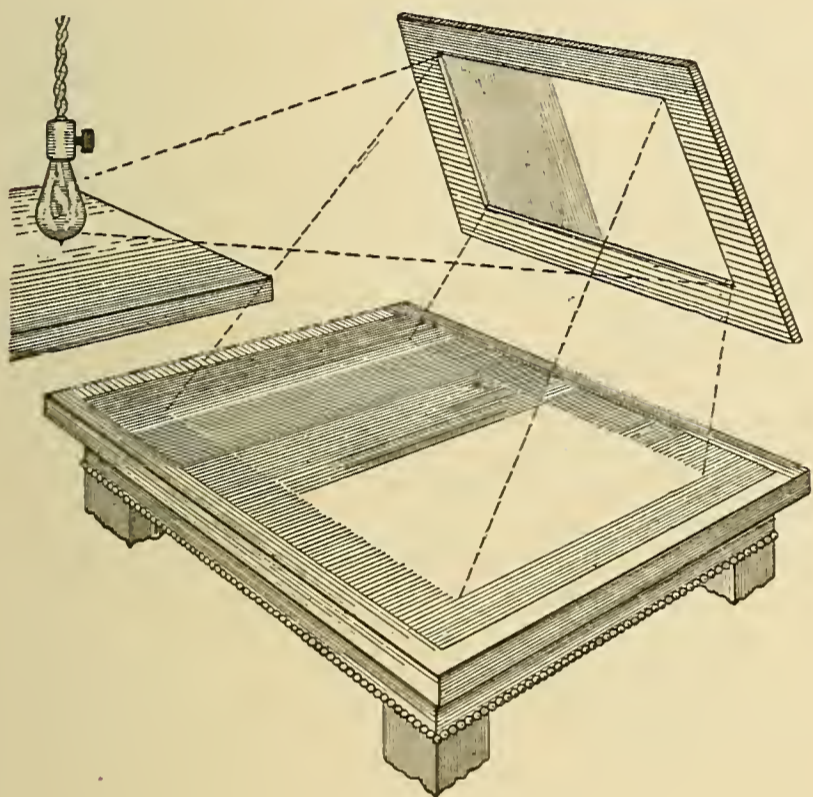

A SIMPLE TEST OF REFLECTING SURFACES

it is well utilized or not) is easily shown by the simple experiment pictured herewith:

Take a mirror which has been allowed to gather dust either by neglect or by being laid on the floor when a room is being swept, wipe half of it carefully but leave the other half covered with dust. Lay a sheet of white or light colored paper on a table near a lamp, but screened from the direct light of the lamp by a board or book. Then place the mirror so that it reflects the light of the lamp to the paper, when the difference in reflective power between the cleaned and the dust-laden halves of the mirror will show clearly on the paper.

For best results, the lamp should be screened either by an opaque shade or by heavy wrapping paper, so that its light will be shed only on the mirror, and there should be no other lights in the room. Otherwise some of the light diffused from the walls and ceilings will also reach the sheet of paper and spoil the contrast which this experiment may show to the surprise of many an otherwise neat housekeeper.

Energy, A Product of Mass and Velocity

The energy or power of a moving object is proportional not only to its weight or mass but to its velocity as well. Microscopic particles projected at high velocities have an energy equal to that of a much heavier body traveling at a slow gait. This is the reason that radium possesses such enormous energy. The particles shot out from it, although they are microscopically small, travel with the velocity of light. Rankin said that a spider web running over pulleys with the velocity of light would be capable of running all the machinery in England. We also know that a small stream of water at enormous velocities will tear down mountain sides as in the hydraulic system of mining. Remembering these things it is then not so hard to conceive how electric current, which has a velocity equal to that of light, is capable of transmitting thousands of horsepower over an insignificant wire.

Rejuvenated Sons of Jove

You will often run across a jolly looking individual who wears a button on which is a figure which looks like a little red devil. He belongs to the Order of the Rejuvenated Sons of Jove, and must necessarily be an



electrical man. The order is national in its scope and includes electrical salesmen, engineers, inventors, manufacturers and others engaged in electrical callings. Every once in awhile the order holds a "rejuvenation"—they had one at the last electrical Show in Chicago. It is told about that they had a pair of "electrical shoes" there, through which the luckless initiate, before his rejuvenation was esteemed complete, received most startling shocks.

Electric Tape Mends Water Pipes

One of our regular contributors reports that he has found ordinary "friction tape," as used for wrapping wire joints, to make an effective temporary bandage for leaky water pipes. Being unable to reach his favorite plumber at a time when a leaky pipe threatened to ruin the ceiling below it, he gave the leaky spot a heavy wrapping of tape and was surprised to find that even on a hot water pipe this makeshift did good service for a week or ten days at a time; which shows another advantage in having an electrical experimenter right in your own house in times of emergency.

Electrical Easter Rabbit

Electrically lighted scarf pins have been made for years in America as well as in Europe, and some of these pins have been in the shape of owls or other animals with

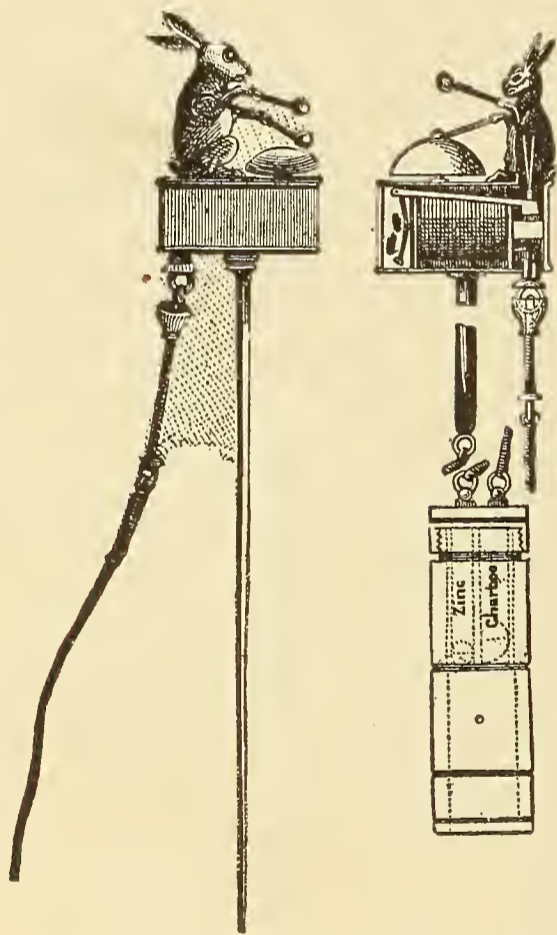

ELECTRICAL EASTER RABBIT

eyes that would light up when the wearer pressed a pocket switch.

But some of the French jewelry workers have gone further by devising scarf pins and brooches with parts moved by tiny electromagnets. For instance, one firm put out some Easter rabbit pins, scarcely larger than the cut, with the rabbit apparently seated on a little box with a small gong before it. This box contained a pair of elec-

tromagnets connected by fine wires to a switch and a pocket battery, the latter being somewhat larger in proportion than here pictured. On pressing the switch, the rabbit hammered a tinkling tune with both paws. Owing to the large amount of hand work on it, this must have been a costly article, and fortunately for our pocket books, it did not appear right in the midst of the "chestnut bell" craze which some of our readers will remember. The cut is from an old and now rare volume of "La Nature."

Signal Cables for Australian Mine

Where electric signals are used in mines, they protect not only vast property interests but also the lives of scores and sometimes hundreds of workmen. It is therefore

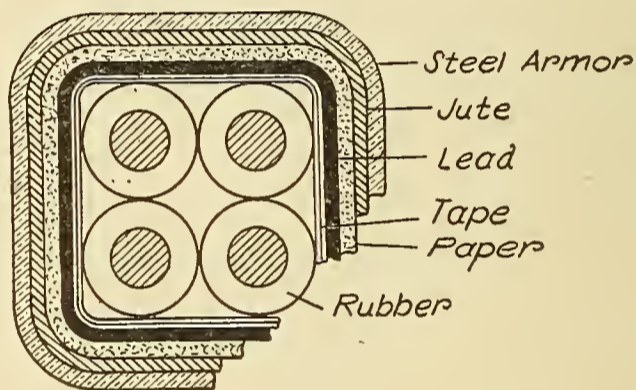

SECTION OF SIGNAL CABLE

doubly important that the signal wires should be guarded against injuries of any kind, such as may come to them either by abrasion or by the action of moisture and of the various chemicals encountered underground.

The wires used for this purpose in certain Australian mines are protected either in pairs, or sometimes in fours, by six successive wrappings. First come rubber and tape to give good insulation, then a sheathing of lead to keep the moisture out. Next a further insulating wrapping of a specially prepared paper, then a layer of jute as a mechanical protection and an outer steel armor.

Electricity Makes Dead Dog Bark

Dr. Marage of Paris, by means of slight currents of electricity has caused the larynx of a dog after it was dead to bark exactly as if the animal were alive. The effect was simply a physiological one due to the contraction of the muscles of the vocal organ under the electrical influence.

Handy Electrician's Screw Driver

For starting screws in places that are hard to reach with both hands the little device shown in the cut will be found useful. Any kind of a wood handle will do. A piece of 1-8 or 3-16 iron rod is set firmly in the

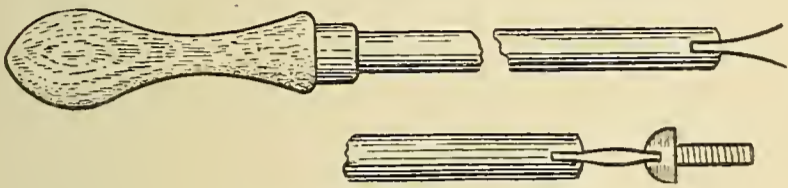

HANDY SCREW DRIVER

handle and a deep saw slot made in the end. Then take two pieces of clock spring and set them in the slot with a little solder, so that their ends spring away from each other. The springs when bent together will catch and hold the screw and, if properly made, will drive the ordinary machine screw or small wood screw clear to the head. For larger screws it may be used for starting only, heavier material being used for the springs for doing heavier work.

Pump That Needs No Watching

One of the most valuable applications of electric motors is to the performance of operations which are of so rare occurrence as to make the presence of an attendant an expensive luxury. For such service electricity is an ideal source of power, as it admits of automatic control, is always ready for instant use, and costs nothing except when it is being used. There is no delay waiting to get up steam and its use is not attended with odor, noise, or steam. The motor and controlling apparatus occupy very little space and may be installed on the wall or ceiling where it will be out of the way. Such a device becomes a servant that needs no watching and never forgets.

An excellent example of the utility of the electric motor equipped with automatic control is its application to the operation of pumps required to maintain a certain water level in a tank. If the water level falls below a certain predetermined value the controlling device, worked by a float, automatically closes the motor circuit and the pump continues to operate until the water level is raised to a predetermined value, when current is cut off and the motor stops.

Motor Electric Bell

This strikingly original form of electric bell is designed more especially for fire-alarm service. D. Foster Hall of Springfield, Mass., is the inventor. The device consists of a small self-starting motor, with an arm connected to the armature shaft. This arm carries two sliding weights on each end which act as strikers and are held in place by spiral springs on the arm piece. These springs are sufficiently strong to overcome

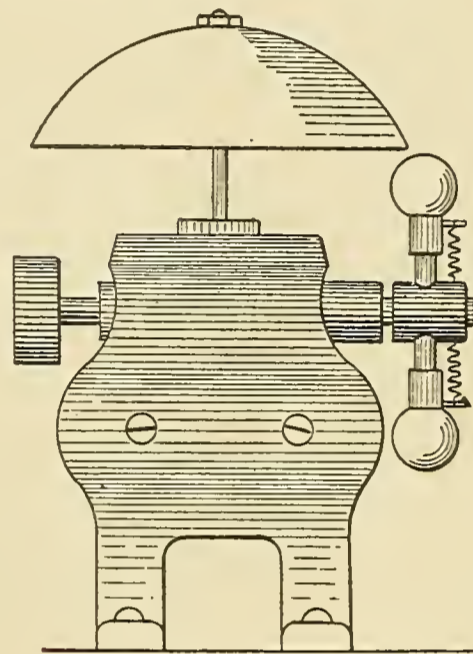

MOTOR ELECTRIC BELL

the centrifugal force of the motor when at full speed. These strikers should just strike the edge of the gong when running. This bell can be used in any place or position where the old style bell is used. Three dry cells are sufficient power.

Faking High Voltage Sparks

"All is not gold that glitters"—nor is all high voltage that gives a fierce and crackling spark. Last fall a London music-hall performer who claimed to give the marvelous exhibition of coolly taking a shock of 30,000 volts, astonished large audiences night after night. One man who thought that this self-styled "medical electrician" had discovered wonderful secrets paid a fancy price to become his pupil, only to learn that the pretended expert was a faker. The suit through which the deceiver was ordered to return the tuition money showed that in his public performance he used a type of high frequency apparatus built for college and hospital work, which gave a harmless spark. Then to get his impressive effects, he cleverly used fireworks paper which crackled and flared in addition to this spark.

ELECTRIC CURRENT AT WORK

NEW DEVICES FOR APPLYING ELECTRICITY

Motors in Wood-Working Plants

By S. ADAMS

No one familiar with electricity doubts that it is the ultimate solution of the power problem of the future. The advantages of the electric motors which utilize the power are many, but frequently the most important advantage is found after the application has been made. The usual advantage is that the motor, because it can be started and

Use of motors in woodworking plants is particularly interesting in that it illustrates how deceiving casual inquiry may be. At first thought it would appear that the cost of steam power would be low because all the refuse produced in the shape of kindling wood, shavings and saw dust would be burned with some coal under the boilers

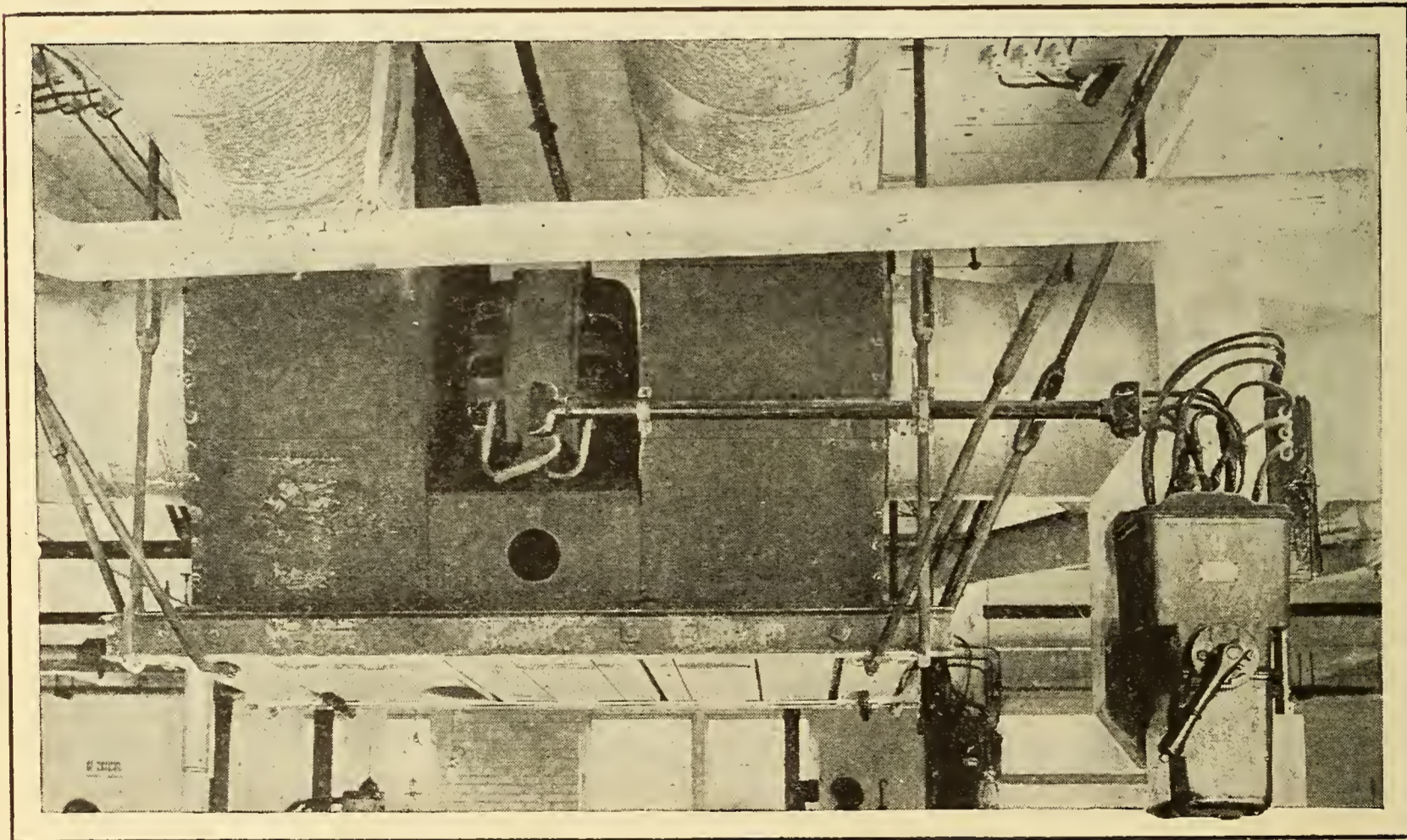

MOTOR DRIVEN EXHAUST FAN FOR COLLECTING SHAVINGS

stopped so readily, saves much power, in a manner similar to electric light which may be turned on and off so easily. But in many cases the convenience of the power is of far more importance than the saving in the cost, and again the motors may be found to make the machines produce more than when driven by any other form of energy and hence effect a material economy of much greater importance than the cost of power.

and reduce the fuel bill to a low point, while electric power would be costly as it would need to be purchased from a company some distance away burning only coal.

But that such is far from the case may be seen from the installation illustrated. Formerly the fuel bills amounted to over \$60 per month without consideration of any other items for power, while at present the electric power bills amount to about \$120 per month.

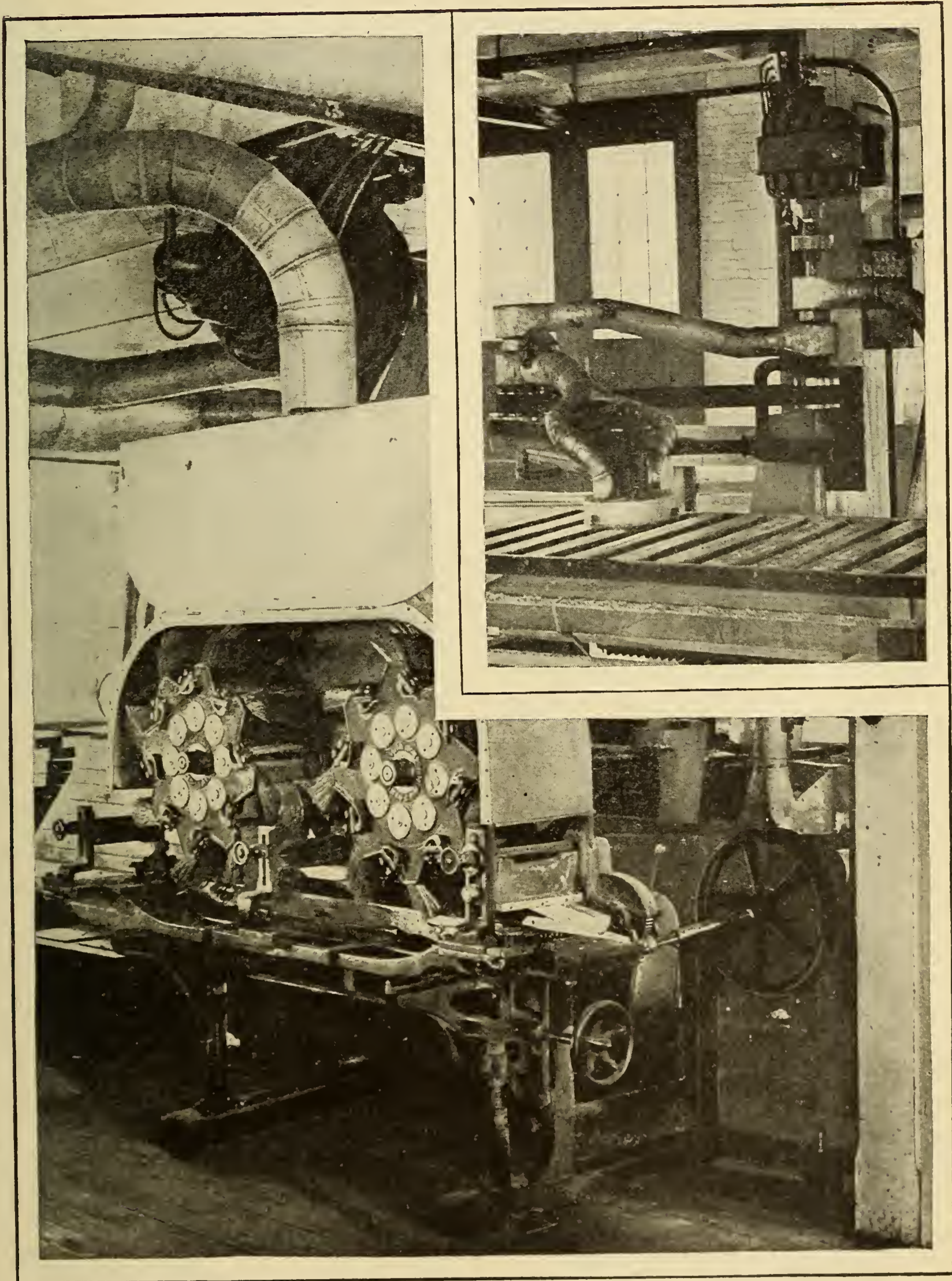

SURFACE SANDER AND MOULDING SANDER AT WORK

If this were all to the question, steam power would still be driving those machines, but not only is more work being done by the mill and a shaving collector system used, but all the shavings, refuse, wood, etc., above

those required for the heating system, are sold to local stables, ice houses, etc., or baled in a baling press and shipped out in car load lots. The sale of this refuse amounts to \$90 per month, which makes the total monthly

cost of power but \$30, which, for an installation with a total installed horse-power of 231, is absurdly low.

There are numerous other items, some of which may be mentioned showing the advantage of electric motor drive. The workmen before were constantly troubled by slipping belts because of the difficulty in tightening belts from a line shafting, and consequently the machines did less work than now when the motors provide a positive drive. The greatest convenience for starting and stopping each machine is provided by a starting switch for the motor located close to the machine itself, so that there is no excuse for running a machine when not actually in use. The elimination of much overhead belting clears the room of obstructions and provides better light and ventilation and permits more ready handling of the material to be worked. The power is more reliable, the fire insurance rate has been reduced, the surroundings for the men have been made more agreeable so that they work more easily and hence better, and the quality of work turned out is improved by the steadier speed of the machines.

The adaptability of individual electric motors for different requirements is well shown in the illustrations of machinery used in this planing mill formerly driven by a steam engine with many belts and considerable shafting. The amount of work necessitated an increase in the size of the factory, and the old power plant was dismantled and the power purchased from a central lighting and power station. They left only the boilers which are used for low pressure steam to supply heat in winter and as required for the dry kilns. Thus all danger from boiler explosion is eliminated and the fire risk very materially reduced.

In one instance a jig saw was used, with a motor mounted on the lower side of the table top and belted to the crank shaft which drives the saw. The starting switch is also located on the under side of the saw table, so that the motor may be started and stopped with the greatest convenience. The usual method consists in belting from the line shaft.

The special machine for sandpapering moulding embodies two wheels on which are mounted eight broom-like affairs faced with a sheet of sand paper cut into narrow widths. These brooms revolve and brush the sandpaper over the moulding as it is pushed through. The motor is mounted on the

ceiling and belted to a counter shaft below the machine, the belt being protected by a wooden guard. The sander is shown with the side open to allow inspection of the interior.

A different type of sanding machine is used for flat work. It consists of a flat disk of sand paper mounted on the flat side of the wheel, which may be rotated at a high speed. The wheel is supported by an elbow arrangement so that it may be moved over a wide area. The motor as may be seen in the illustration is mounted on a post used for supportning the roof and is of the vertical type. Air from a distant suction fan is exhausted through the galvanized sheet iron pipes and draws every particle of dust up and away from the work on the principle of the vacuum cleaner, with which we are more or less familiar.

This blower system is a very interesting part of the plant and is shown in one of the pictures. There is a double fan driven by one motor. This sucks in air through one system of pipes which go to the machines, and blows it out through another system, and delivers the shavings and saw dust to the room where they are baled up for shipment.

Electrically Made Whetstone

One of the great advances due to the electric furnace has been the saving in the cost of grinding metals by abandoning emery wheels for carborundum and its



SILICON CARBON
WHETSTONE

allies. It took the extremely high heat of the electric furnace to produce these modern abrasives, which are now commonly sold in the shape of wheels or disks. They cut even steel so much faster than the older materials used for either grinding or sharpening, so it is logical that they would also do for hand use if made in suitable shapes.

This is being done with another product of the electric furnace, silicon carbide, which is now offered either in the plain slip forms or mounted in wood, as substitutes for the familiar whetstones.

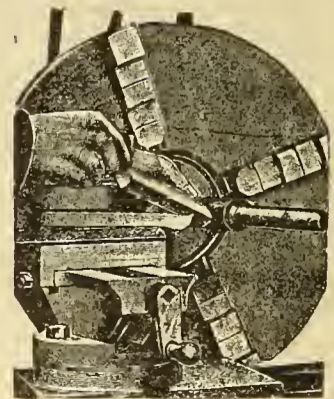

SILICON CARBIDE
FILE

as substitutes for the familiar whetstones.

Lathe tools can also be sharpened by what the German makers call a "silicon carbide file" without being removed from the holder and therefore without changing the set of the tool. This ability to sharpen tools right in place must mean a considerable saving of time and adds still another to the long list of ways in which electrical progress is helping to reduce manufacturing costs.

Ice Cream Making On a Large Scale

Ice cream is no longer looked upon as a mere frozen dainty for summer consumption. It may now be classed as an important food stuff.

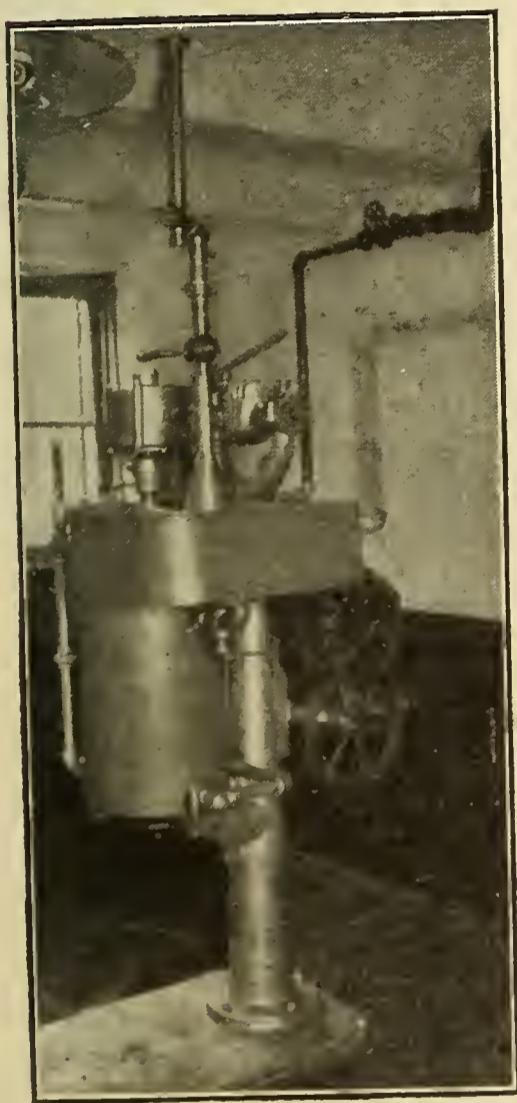

UPRIGHT ICE CREAM
FREEZER

In large cities well-equipped factories have been built to supply the demand. There is such a plant in Altoona, Pa., having a capacity for making and storing 3000 gallons of ice cream daily.

Electric current is used in all the important processes. There must be artificially cooled rooms for keeping the cream and hardening the finished product. The big compressor for furnishing this refrigeration requires a 50

horsepower motor. In the ice-cream making department there are two Duplex ice-cream mixers having a capacity of 150 gallons each. These mix the ingredients ready for the freezers. Directly underneath the mixing room is the freezing room containing two upright cream freezers like the one shown in the cut, having a capacity of 60 gallons each, driven by Westinghouse motors. After being partially frozen in these machines the cream is run into delivery cans of various sizes.

A Safe Lamp Socket

It is absolutely impossible to get a shock in turning on and off this new type of electric light socket and in many cities its use is permitted over radiators, pipes, bathtubs, etc., where the rules are very stringent regarding such installations. Examination of the diagram will show wherein the safety of the P. & S. socket lies and how it would be impossible, even if you were standing on a perfect "ground," to get a current through your body in handling the switch.

In the center you will see a little oval cam. This is of porcelain, an almost perfect insulator, and turns when you turn the switch button. When it is turned over to the horizontal position the two springs are pressed over and make contact with the little vertical metal strips on the inner side of the porcelain shell.

In any incandescent lamp one terminal of the filament is connected with the threaded brass shell at the base and the other to the metal button or knob at the end of the lamp. When you screw the lamp into this socket the button is forced against the brass strip which extends obliquely out into the middle of the socket. The screw threads of the socket and lamp also make electrical contact.

To the two screws in the lower end of the porcelain base are connected the two wires of the electrical circuit.

Suppose now that the lamp is screwed in place. No current will flow through it with the porcelain cam in the vertical position. When the cam is turned over by the switch button, however, the two vertical metal springs are forced over and make contact with the metal strips in the sides of the shell. Now let us follow the current: It enters, say, from the left hand wire, goes through the screw and vertical spring to the left hand vertical strip and from there runs over along the oblique, projecting member to the button on the end of the lamp. From there it passes up through the lamp filament, heating it to incandescence, and then passes

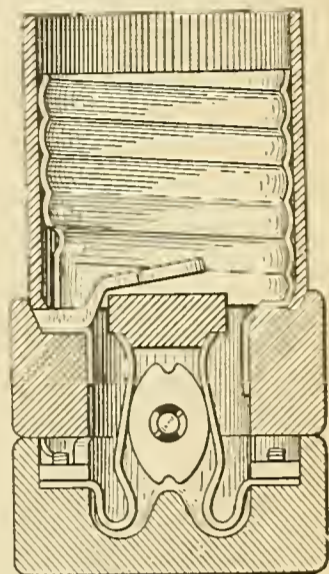

SAFE LAMP
SOCKET

out through the screw threads of the lamp to the threaded portion of the socket, down the right hand vertical strip to the right hand spring and out over the other wire.

The lower part of the socket is all porcelain. The threaded part is protected by insulating material, and the switch button is protected from the current-carrying parts by the fact that the cam is of porcelain. Therefore you couldn't get a shock if you were to try.

The Pay-As-You-Go Meter

Perhaps some of you have never known that there is such a thing as a prepayment meter which enables you to pay for your electric current as you go along, but there is, and it operates upon the coin-in-the-slot principle.

The prepayment device made by the General Electric Company is supplied either in combination with or separate from the regular meter. The attachment which goes with an ordinary meter is shown in the diagram. It consists of four principal parts—the escapement train, coin device, switch and rate device, and may be installed in any part of the house most convenient to the user.

When it is desired to make an advance payment the winding knob is turned so that the arrow points upward. A quarter dollar is then inserted in the slot and the knob turned to the right, the coin serving as a key which operates the mechanism within the device, turning the registering wheel and placing the coin to the credit of the consumer. If the circuit is open when the coin is deposited, the same motion of the knob which moves the registering mechanism closes the circuit switch contained within the case of the attachment.

The dial of the combined prepayment meter is enlarged and contains in addition to the standard marking, a scale marked in plain figures over which a pointer passes, indicating the number of coins remaining to the credit of the depositor. When the meter has a separate prepayment attachment, the dial showing the number of coins standing to the customer's credit, is placed on the attachment.

When the first coin is deposited and the knob is turned, closing the main switch, the pointer rests opposite the first division on the scale. If a second coin is deposited before the current purchased with the first coin has been consumed, a second motion of the knob will bring the pointer opposite the second division on the scale. Twelve coins can thus be deposited consecutively, after which the slot is automatically closed, and further prepayment cannot be made until the value of one or more coins has been consumed.

Whenever energy to the value of one coin has been delivered through the meter, the escapement is released (mechanically in the combined device, and electrically in the separate device) turning the pointer back

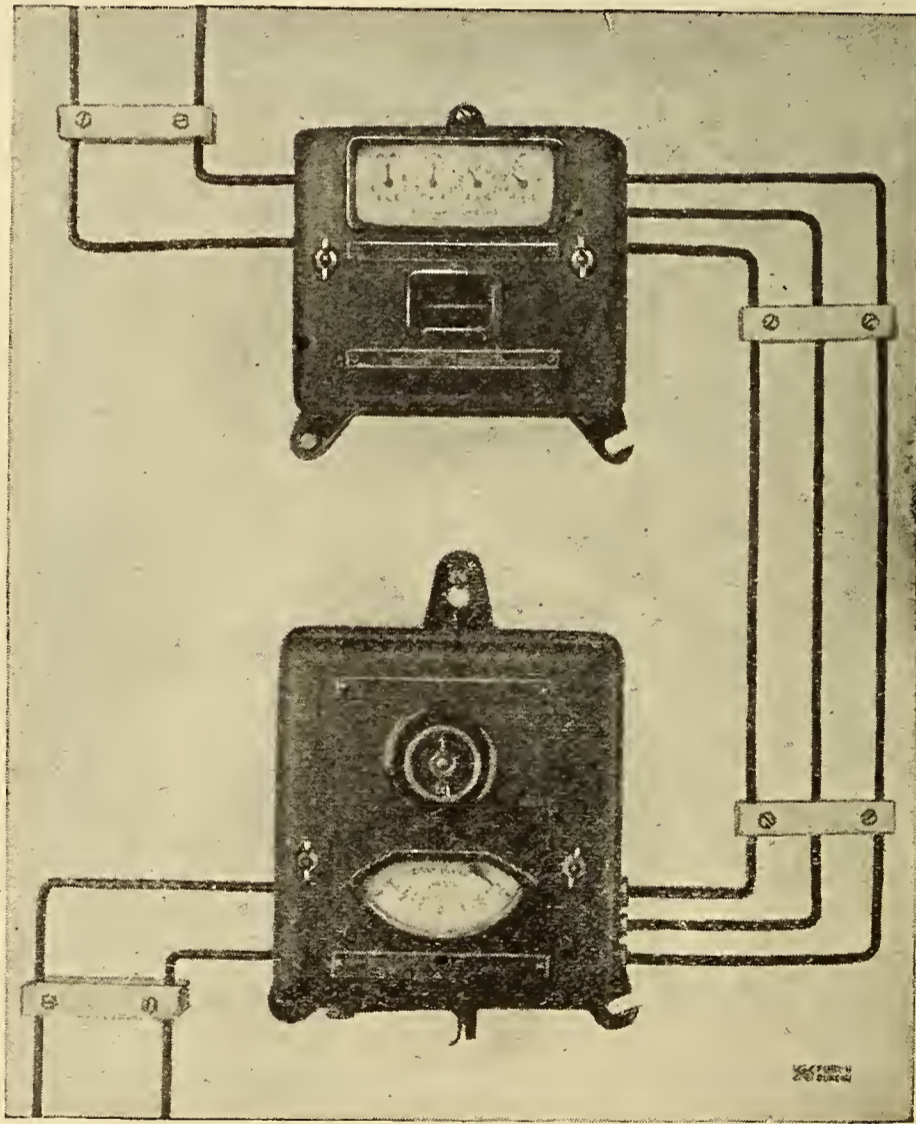

PAY-AS-YOU-GO METER

one division. This process continues until all the energy for which prepayment has been made has been delivered. Thus the depositor can ascertain at any time how much energy can be obtained without further prepayment.

When all the energy has been delivered, the circuit switch is opened and no more current can be obtained until further prepayment has been made.

Physicians' Vibrator

All of us are more or less familiar with the ordinary electric vibrator, a small self-contained instrument held in the hand of the operator. A somewhat different type is shown in the picture and which is used in physicians' offices. It is very powerful in its effects and is sure to get down to the seat of the trouble, no matter how deep it may lay in the bones and tissues of the body.

It operates on alternating current, the motor being carried on a portable stand. The long flexible shaft attached to the revolving motor shaft drives the vibrating instrument in the operator's hand.

In speaking of the uses of an electric vibrator from the medical standpoint it may be of interest to state that the best medical authorities maintain that when a function or an organ is diseased the nerve center controlling the same usually shows undue sensitiveness to deep pressure or vibration.



HIGH POWER VIBRATOR

It therefore follows that a good vibrator becomes a most important aid to diagnosis by locating the sensitive spots along the spinal processes and at other important nerve centers.

Hot-Air Treatment for Rheumatism

Hot air is known to be helpful in relieving rheumatism and the Germans have further discovered that it may be successfully applied for this purpose by the use of an electric blower ordinarily used as a hair drier. Such blowers now on the market are made to deliver heated air as well as cold air when desired.



TREATING DOG FOR RHEUMATISM

A writer in *Mitteilungen der Berliner Elektrizitäts-Werke* describes how this has been done to bring health and relief to dogs that are suffering with rheumatism. The beautiful collie lying in the chair seems to be enjoying his electrical hot air treatment and finds relief from pain.

Other domestic animals suffering in the animal hospitals were also subjected to the treatment; for example, horses with lame shoulders, and they also seemed to obtain considerable relief.

Giant Hammer-Head Crane

An immense electric crane has been installed at Akunoura, Nagasaki, in Japan, for the Mitsu Bishi Dockyard and Ship Works. This is the largest crane in the Orient. It is 177 feet high and has a lifting capacity of 150 tons. Five 50-horsepower motors are required to operate it. One man can work the crane from a cabin beneath the girders.

An Electrical Man-of-All-Work

A unique electric storage battery locomotive is in service at Constable Hook, N. J., handling ingots and copper ore at the works of the Orford Copper Company. The motors are of the enclosed type and the storage batteries require no attention during working hours. It is maintained that the cost of operation for haulage is far less than with animal power.

The narrow gauge locomotive weighs four tons and is designed for a track having a gauge of $21\frac{1}{2}$ inches. It measures 70 inches high and 56 inches wide over all, the total length being 12 feet, and it travels at a speed of from one to four miles an hour.

It is surprising, however, the amount of work this little locomotive will do. It will haul 50 tons on the level, 25 tons on a one per cent grade and 15 tons on a two per cent grade.

Where One Circuit Controls Another

Most of the electric signs, which have proven such effective business bringers to live stores in large as well as small cities, are supplied with current by the local

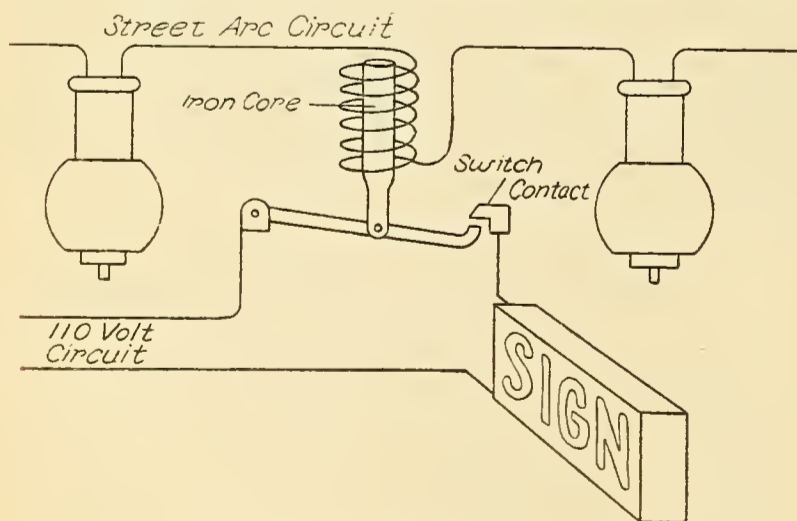

CIRCUIT CONTROLLER FOR SIGNS

electric light companies at a fixed price per month, based on their being lit from dusk up to a certain hour. This involves the problem of lighting and extinguishing

them all simultaneously, which is commonly done by means of time switches, or clocks which actuate a switch whenever a certain hour is reached.

Now there are some cities where the street

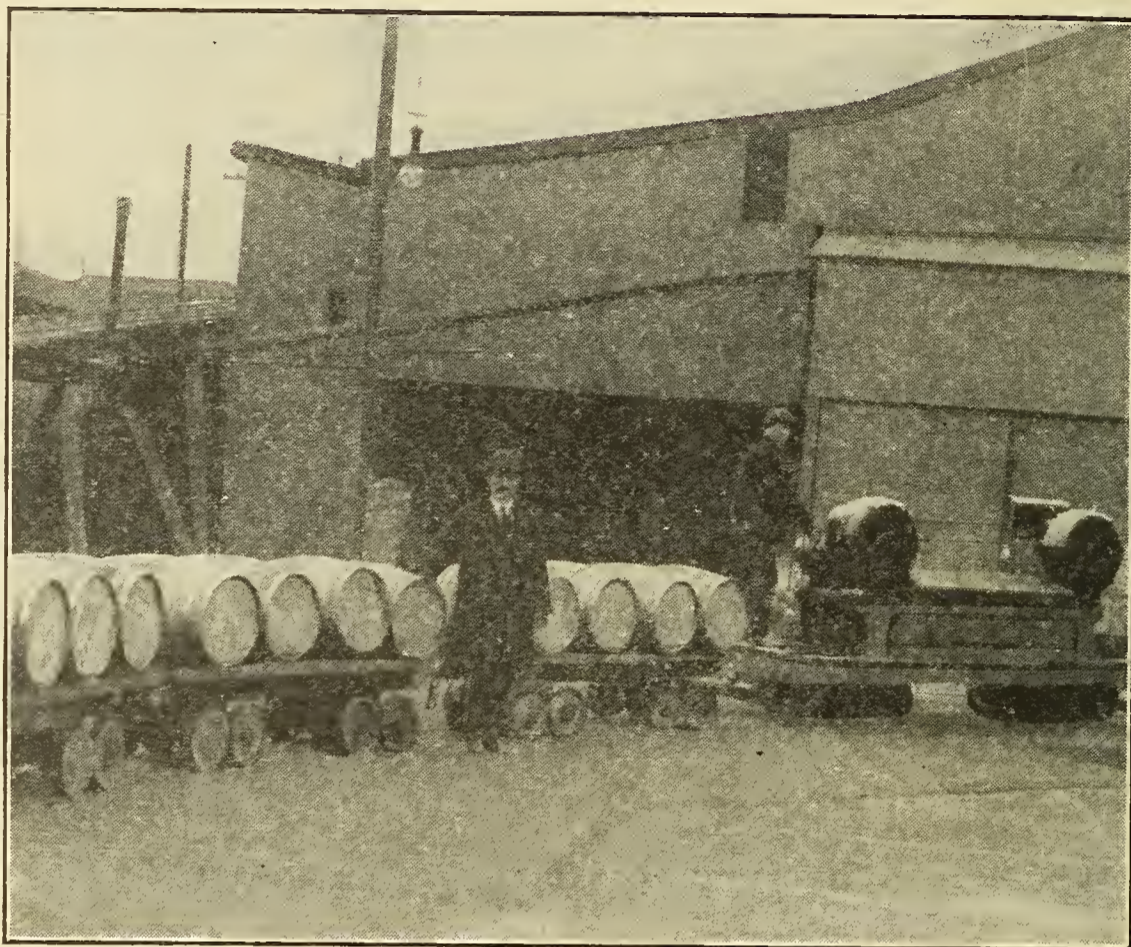

FOUR TON NARROW GAUGE LOCOMOTIVE

lights are turned off at midnight and when such a city has a number of signs that also are to run only till midnight, it would seem logical that both should be run from the same circuit. But safety will not permit this, as the close spacing given to the wires inside the signs will not allow of insulations that would be ample for the high voltages generally used for the street lighting, so the current for the signs must come from low voltage circuits.

However, a shrewd electric light manager in the west has done the next best thing, by letting his street lighting circuit switch the current on and off the signs, so that these signs burn only during the regular street lighting hours. To do this he simply connects his street lighting circuit (which is a series arc light circuit) with a solenoid at each sign, the core of each solenoid being attached to a switch. When the lighting circuit is started up, the solenoid raises the core, the principle of the solenoid coil being that an iron core placed partly in the coil will be drawn in still farther when current flows around the coil. The drawing up of the core closes the switch so

that current will flow from an ordinary 110-volt circuit to the sign lamps. Then when the street lights are shut off, the solenoid ceases its pull and a spring (or gravity) opens the switch. This plan, which is shown in principle in the cut, saves the expense of having a man wind the time switches, as the solenoid switches need no attention. Of course the method is applicable only where the city is willing to waive the crime-preventing power which good street lamps exert even more after midnight than during the evening hours.

Three Electric Smelting Furnaces

The temperature of the electric arc as formed between the carbon tips in arc lamps is somewhat above the melting point of iron. Therefore if iron ore, pig iron or

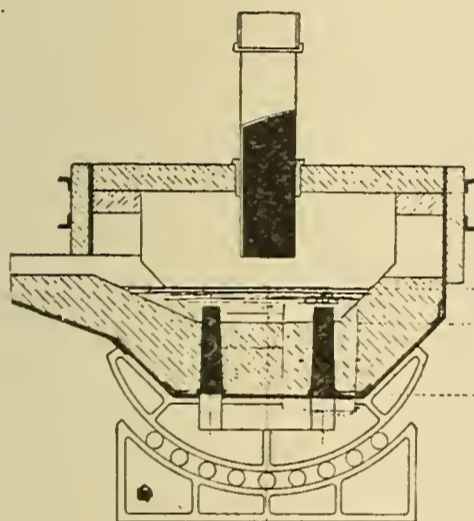

GIROD FURNACE

scrap iron are placed in a receptacle which contains an electric arc and which is closed so that the heat cannot escape, the heat of the arc will melt the iron. There are many localities where iron ore

abounds but where the cost of coal for heating the ordinary cupolas is out of reach. Whenever such a locality has ample waterpower available, the electric furnace can be used for the smelting.

In this field, as in most of the chemical and allied lines where progress depends more on slow plodding than on sudden spurts of ingenuity, continental Europe has been in the lead. Over thirty years ago one of the Siemens brothers patented the first smelting furnace in which metal was melted by being placed in the path of an electric arc. Since then a large number of other types have been brought out both experimentally and commercially, and of these we are picturing three typical forms.

In the Stassano type the arc plays between the tips of two carbons projecting through the walls of the furnace above the level of the ore or metal. The whole furnace is rotated by the vertical pinion shown in the cut, connection being made to the terminals

by brushes and rings. On alternating circuits three carbons are used, the voltage in either case being between 100 and 110. The carbons enter through packing boxes cooled by water and are adjusted by hand.

Instead of having the arc directly between

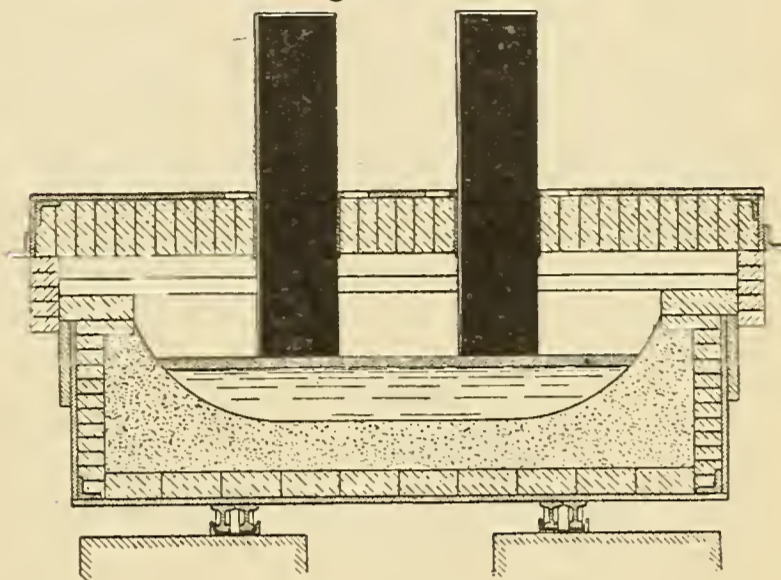

HEROULT FURNACE

the carbons, the Heroult furnace has it between each of the carbons and the molten metal. Both carbons enter through the removable dome or cover of the furnace which operates at 100 to 110 volts.

The third type, that of Girod, goes still further in placing a pair of iron terminals under the molten ore or metal, so that the arc must pass from the upper carbon through the metal to reach the submerged terminals. This furnace is designed for use on alternating currents at 60 to 75 volts, and is set on rollers so that it can easily be tilted to pour out the liquefied contents. It has the great advantage over both of the other types that it practically does away with the

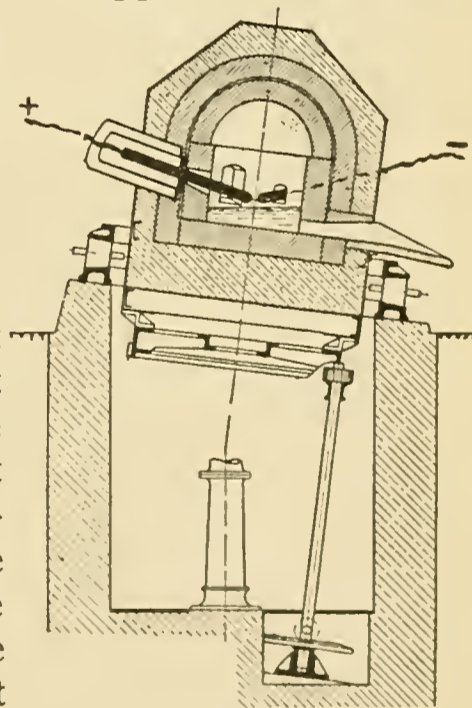

STASSANO FURNACE

leaking of current through the walls of the furnace. These walls have to be of materials that will withstand high degrees of heat and such materials usually become poorer in insulating qualities as the temperature rises. Then if both terminals are in adjacent parts of the furnace wall, as in the Stassano and Heroult types, it is difficult to prevent considerable current from leaking through.

Electrical Men of the Times

DR. A. E. KENNELLY

Among the leaders in the study and application of electricity in the United States a high place must be accorded Dr. A. E. Kennelly, professor of electrical engineering in Harvard University. Dr. Kennelly is a man of scientific attainments, and he has an international reputation. Among the men who investigate electrical phenomena and on whose work the determination of electrical units of measurement is based this resident of Cambridge, Mass., is known and honored.

Dr. Kennelly was born in Colabah, Bombay, India, December 17, 1861. He was educated in University College School, London. The bent of his mind was early exhibited, for we find him in 1875 and 1876, while still a mere boy, assistant secretary of the Institution of Electrical Engineers in London. In the latter year he entered the service of the Eastern Telegraph Company as operator, and two years later was made assistant electrician.

By 1880 he was chief electrician on board a cable-laying ship, and for the next seven years he was engaged in the work of laying submarine cables in various parts of the world. During this time he received a gold watch for participation in the swift repair of a cable in 2300 fathoms of water and was also awarded a decoration by the Khedive of Egypt for his services in laying a cable into the port of Suakim on the Red Sea.

In 1887, at the age of twenty-five, the young Englishman passed to another stage of his career by coming to this country and entering the laboratory of Thomas A.

Edison at Orange, N. J., as Mr. Edison's principal electrical assistant. For several years Dr. Kennelly was associated with the great inventor, and in 1892 he was consulting electrician for the Edison General Electric Company. From 1893 to 1900 the subject of this sketch was in partnership with Prof. E. J. Houston, in Philadelphia, the firm being Houston & Kennelly, consulting electrical engineers. In

the year last named Dr. Kennelly was electrical expert to the Signal Corps of the United States Army, and in 1902 he was the engineer in charge, for the Mexican government, in laying the Vera Cruz-Frontera and Frontera-Campeche cables. Since 1902 he has been professor of electrical engineering at Harvard.

Dr. Kennelly has served two terms as president of the American Institute of Electrical Engineers (1898-1900), and is a member of a number of other learned and technical societies. He was a United States

representative and vice-president at the International Electrical Congress of 1900 in Paris and a United States delegate and general secretary at the International Electrical Congress of 1904 in St. Louis. He has honorary degrees from the University of Pittsburg and Harvard University and has taken out about ten patents for electrical inventions. He has contributed largely and valuably to technical literature, and in his own name, or jointly with others, has written about twenty books on varied applications of electricity. Few engineers have done more useful work.

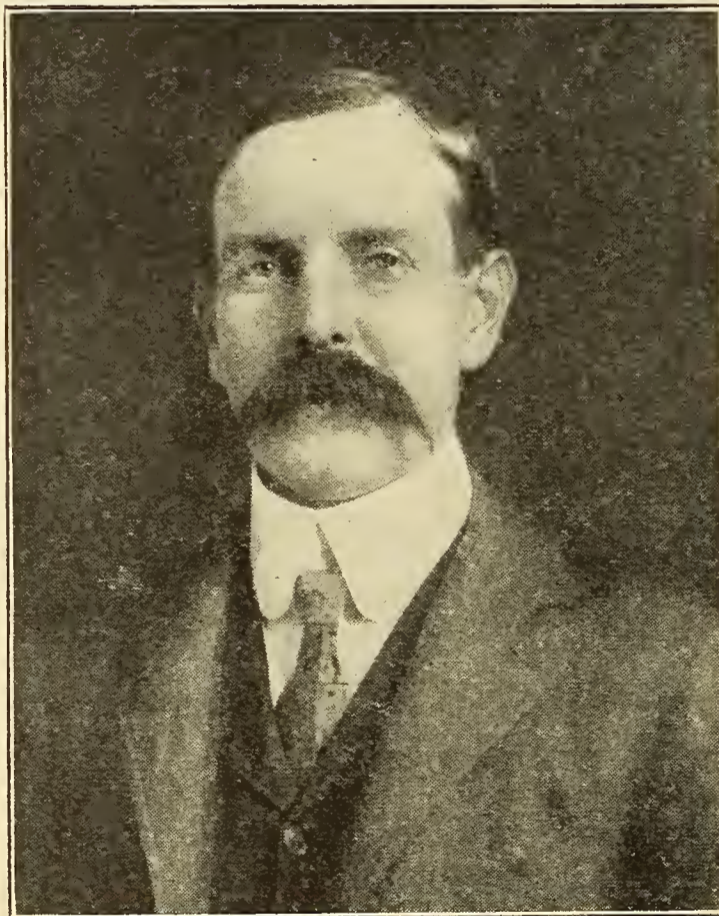

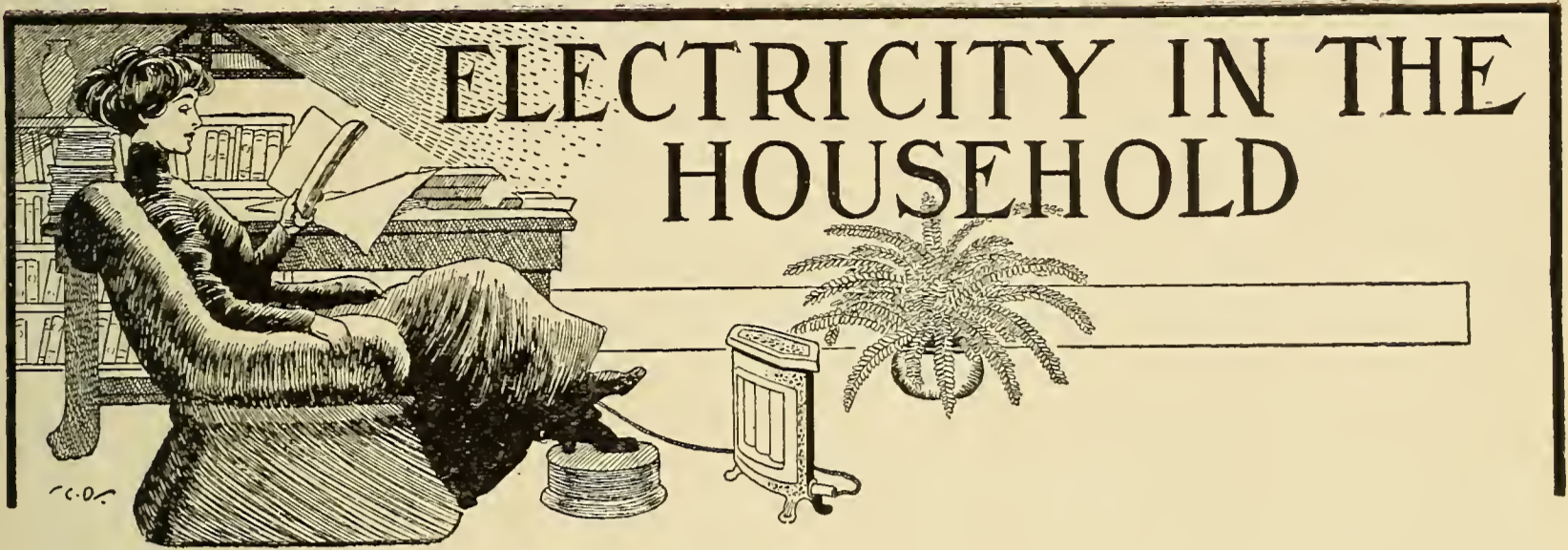

Again a Woman Had Her Way

By FLORENCE LATIMER

Hello! Ah, hello, Edith! How are you this morning? How am I? Oh, honey—I'm miserably happy.

Tell you about it? Yes, I suppose I could, only I'm always afraid somebody's on the line besides ourselves. Anyway I'll risk it.

Hugh and I had a regular "argument" this morning, and he said some mean things about "driving us all to the poor-house."

"What was it all about?" Simply because I insisted on having that electric range—you know the one I've been so crazy about—and *he* calls that an "extravagant whim." Now that just shows how farsighted a man is.

Happy? Oh, yes, hilariously happy because it's here, just the same. And mind you, my dear, it's here to stay!

No, he doesn't know it yet, but I have a scheme—you know he's been crazy to have some of his friends out to a real, old-fashioned southern dinner, and you know how I've always discouraged the idea because I could never rely on a maid to cook it.

"Cook it myself?" Not on a *gas* range! No, thank you!

But now, things are different, my plan is to telephone these friends of his, your "worsen" half included, ask them out to dinner to-night, and if you will come over and help me, we will prepare a dinner on this range that will smoothe his ruffled spirits and at the same time convince him that my new electric range is a real "joy forever"—and then "we shall see, what we shall see."

You'll hurry, won't you, dearie? You know it's late now, and I'm so anxious that this dinner be absolutely perfect. But how could it be anything else with this range to cook it on? Now while you are getting ready I shall telephone to the gentlemen all. Isn't the telephone the greatest invention ever? I wonder how we lived before we had them, don't you? All right, dear. Good-bye.

Now let me think—What shall I have? Tomato soup, barbecued lamb, stuffed potatoes, corn pone, banana salad, coffee, and an old-fashioned sweet potato pie.

Oh, there's Edith now. Come up.

"Did I telephone them?" Well, I should say I did, and they all seemed eager to accept, and are coming, every mother's son of them, all "delighted, I'm sure," etc.

Oh, won't Hugh be surprised?

But, my dear, I've got to put him in the best possible humor before I tell him what I've done, and you know the most direct way to a man's heart! So listen, I'm going by the way of an electric range.

Come out and look at it. Isn't it a beauty? And look, Edith, all these cooking utensils to go with it. Look at this broiler and that waffle iron. Oh, I know I shall enjoy cooking *now*.

"Expensive?" Not very. I know it looks like quite a sum to put in a cooking stove, but, my dear girl, stop and think a moment. In three months I can save it in a maid's salary, and aside from that I can cut down my grocery bill one-third.

You agree with me, don't you? Yes, I knew you'd see it. That's because you're a woman.

The cost of electric current is a question that always comes up. But if you use common sense along with your electric range there are a great many ways by which you can economize on "watts." For instance, with the oven heat alone, an ordinary dinner may be cooked. While the meat is being roasted, the potatoes baking, the tomatoes may be slowly simmering (in the oven) for the soup, also the peas which have been seasoned and put into a covered pan. Of course the corn bread and the pie are



"I want to put him in the best possible humor"

cooked in the oven also. So you see by using judgment you can generally get up a good meal without having all the stew pans, water heaters, frying pans, etc., going at once. A wasteful woman might do this and run up large current bills. But she would do just the same if she were using a gas range and there would be the same "kick" about gas bills.

Now you want to know how to concoct these southern dishes that you've heard so much about. Well, we will begin with the tomato soup.

We'll take the tops of two bunches of celery (I mean the leaves). Boil in about one quart of water until it is reduced to one pint. Strain through a colander, and add one quart of tomatoes, into which throw a liberal pinch of soda (to keep the milk from curdling), and a small onion cut fine.

Simmer slowly (in the oven, of course) until about ten minutes before the meal is served, then strain the whole through the colander into one quart of sweet milk; season with salt, pepper and about one large tablespoonful of butter, allow to come to a boil and thicken with one tablespoonful of flour stirred into a cup of sweet milk. I'm going to let you take care of that part. But you must listen while I tell you about the other things so that you can qualify when it comes to southern cooking.

To barbecue the lamb, rub well with salt, pepper and a tablespoonful of flour. Place it in a roasting pan, and over it pour one quart of warm water, one-fourth cup of vinegar, one-fourth cup of butter and a liberal dash of cayenne pepper. Roast slowly until well done. Serve with mint sauce.

Wash thoroughly six or eight rather large potatoes. Place them in the oven to bake and when done cut through lengthwise, nearer one side, scrape the skins free of potato without breaking them. To the potatoes add a piece of butter, the size of an egg, salt, two tablespoonfuls of cream or rich milk, beat white and light, and put back into the skins. Now print them with a fork and brown in the oven. They must be

served hot.

"Mammy's corn pones" come next. To three cups of white corn meal add one teaspoonful of salt, one-half teaspoonful soda and one tablespoonful of lard. Mix with the meal thoroughly, then wet with buttermilk to the consistency of soft bread dough. Form into small pones, place in a row on a hot greased griddle and print with two fingers. Bake a nice brown and serve while hot.

Always remember that in the South we use the pure white corn meal. Never the yellow kind.

For the banana salad, place on each small plate a crisp lettuce leaf. Slice a banana through lengthwise and sprinkle with fresh roasted peanuts chopped fine and over all a mayonnaise dressing made from the following recipe:

To the yolk of each well-beaten egg (use as many as you desire) add one tablespoonful of vinegar, dash of salt, mustard, and paprika or cayenne pepper. Stir well together and cook in a double boiler, stirring all the while. When thick add a piece of butter and beat until almost cold. This will keep for a week and may be thinned with cream as needed.

Now for the sweet potato pie. Take three medium sized sweet potatoes boiled done. While hot peel and press through the colander, add a piece of butter the size of an egg, one small cup of sugar, one-half cup of rich milk, the yolks of four eggs, well beaten, one teaspoonful of vanilla, and a pinch of cinnamon. Beat until light and smooth. We'll bake them in open crusts and when done cover them with a meringue made of the whites of four eggs beaten to a stiff froth, adding four tablespoonfuls of sugar and a few drops of lemon juice or extract. These go in the oven again for a few moments to brown lightly.

Now, you see, Edith, our dinner is nearly ready. While we've been putting things together time has been flying. You remember, don't you, that it was exactly five o'clock when we began? Now it is almost 6:30. They will be here directly. I asked them for 6:45.

Doesn't everything look good?

Oh! look, Edith! They are coming now, and he's with them. But I'm not afraid. Just wait till he tastes our deliciously cooked dinner and knows how very little "fuel" it took to prepare it, he will be urging all his acquaintances and friends to "invest in an electric range and save money," and you know "Money well spent brings sweet content."

* * *

Ting-a-ling—Ting-a-ling. Hello! This you, Edith? Yes, this is Florence.

"Is he going to let me keep the range?" I should say he is—after the way things went off last evening. He said he guessed we might as well, seeing that this is the Electrical Age, anyhow.

And do you know—I had to laugh—he's bound he's going to have one of those new electric shaving mugs and one of the electric shaving mirrors. He started to work bright and early this morning so he could stop in at the electric light company's display room and pick them out.

Sewing Without Effort

Our mothers were delighted with the advent of lighter running machines driven by foot power and thought them a great improvement over the old hand operated kind of the early days. Even so, however, the work meant and still means bent backs and weary muscles and the strain has only

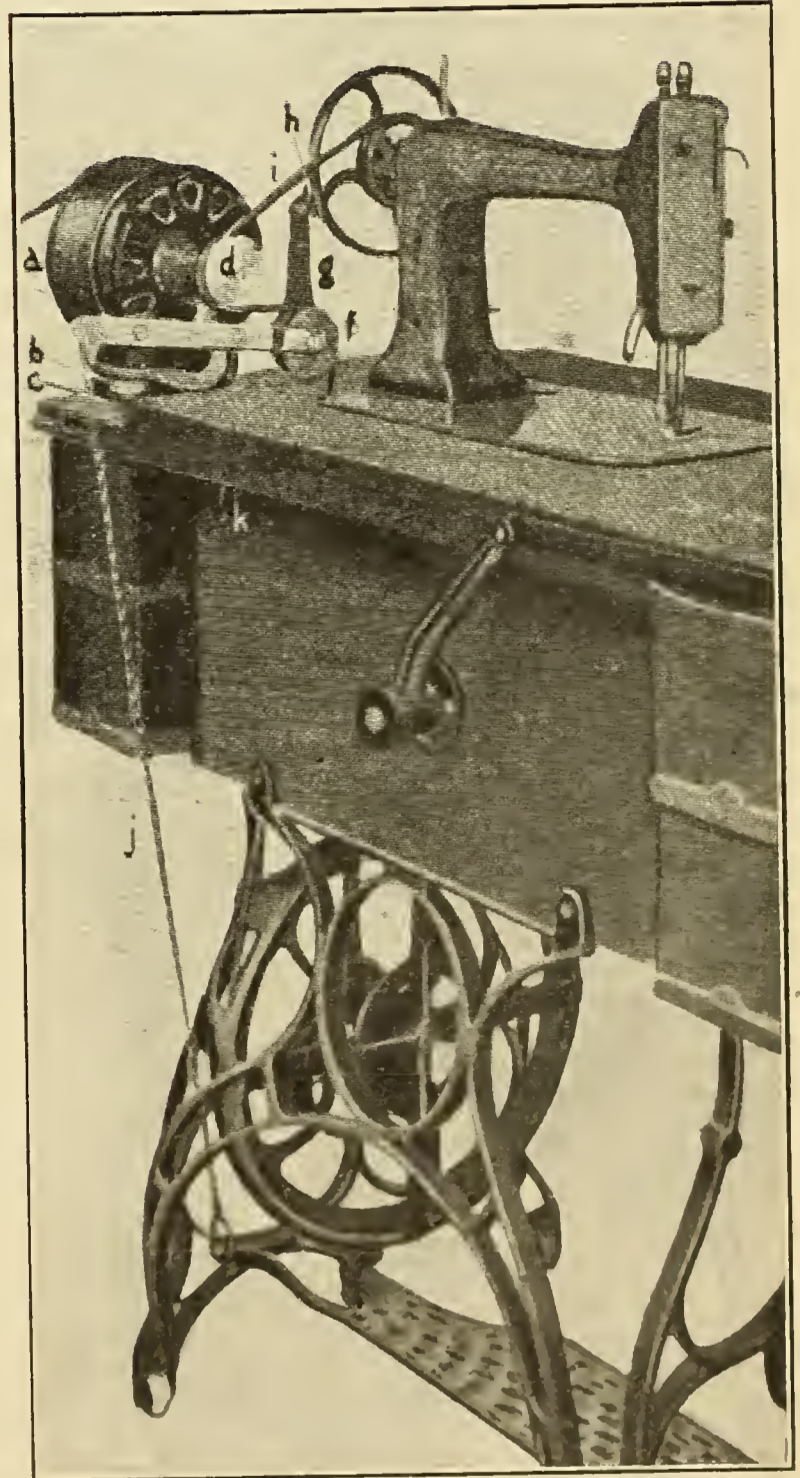

MACHINE RUN BY A LITTLE MOTOR

too often proven too much for mothers with an already over-crowded day. But dressmakers are expensive and usually the work was done in spite of pains and aches.

All this can be done away with now if only one has electricity in the house, and the cost of the equipment is little more than is paid to a seamstress for a single visitation. Little motors have been devised that will run the machine, leaving you only the re-

sponsibility of properly guiding the cloth under the needle.

Certain makers have designed the frames of their machines so as to accommodate motors made especially for their make. These are neat and effective and in great demand. Another motor has been made to go on over the hand wheel of certain machines and it, too, is very successful. Still a third is made to fit all machines, old and new, and the Westinghouse Company which is making it has found it difficult to supply the demand.

One of these motors is shown mounted on an ordinary household sewing machine. We have lettered the parts for easier reference. The motor itself is labelled (a) and is mounted on a slotted base (b) with a felt pad (c) to prevent its scratching the table. If desired the motor can be taken from the base by pulling out a little spring. Usually, however, it is left in place ready for instant use. A very ingenious scheme has been devised to drive the hand wheel, the belt, (i), running over a little grooved pulley (d) on the motor and being given the proper tension by another small pulley (f) which can be moved up and down by means of a chain (j) attached to the treadle. The rod which usually runs from the treadle to the fly wheel is disconnected and removed. A spring keeps the arm (e) raised and this keeps the belt loose by lowering the idler pulley (f). If the motor is started its pulley simply turns in the loose belt and the machine does not move, for in addition to the belt being loose a little brake is also pressed against the hand wheel at (h), the arm (g) being attached to the arm (e) and operated by the same spring. If, now, the treadle be slightly depressed the idler pulley is raised and the belt tightened and at the same time the brake is lifted from the hand wheel. The motor is running at full speed but the tension on the belt is slight and its grip on the motor pulley accordingly not very great. The result is the machine runs very slowly. If more pressure is applied at the treadle greater tension is put on the belt and the machine goes faster. Finally the tension is sufficient to eliminate the slip and the machine runs faster than it is possible to make it go by the old foot-power system. Any speed can thus be maintained from a single stitch to this highest speed and the machine can be stopped instantly by releasing the slight pressure on the treadle.

Electric Irons as Little Stoves

In a certain boarding house full of girls in the city of Boston there was great elation when one of them discovered a new use for the electric flatiron. With most of these girls strict economy had to be practised and



when they found out that they could get a small electric iron to press out their laces and even shirt waists they were quick to invest their savings in one of the little economizers. But one of these same girls, with a bit of inventive genius, quickly discovered that the iron could be turned upside down and converted into a small stove. On its flat surface she easily boiled water, made fudge and even fried eggs and did other cooking.

Greater Than the Wash Tub

Five pretty girls devoted to the study of domestic science went into a laundering competition for an hour with five colored washerwomen, at the recent Electrical Show in Chicago. The latter used the old-fashioned washboards, tubs and wringers while the girls operated the new style electric washing machines and wringers. The girls took their time—the colored women worked like Trojans. If they washed half as many clothes in that hour as the five girls did with the electric machines they were to get \$100. The suds flew fast and furiously with the colored women, but they lost the \$100, although they were well compensated for the hour's work.

Electricity a Servant of Stage People

By ALICE DOVEY—WITH LEW FIELDS IN "OLD DUTCH"

I am no electrician. I don't even know what a watt is, much less a kilowatt hour. But I do know that electricity does a great many things for we stage people, and we find it a convenience and an amusement in more ways than one.

Perhaps you may think that the women you see on the stage don't have a longing occasionally for the little things of domestic life which mean so much to a woman—are not half frantic sometimes to get on an apron and mix up something to do a little cooking. I suppose the desire is inborn, for women have cooked ever since Noah's little house-boat party.

Anyhow I know I have my complete electric outfit and you should see what I can "manufacture" with even a toast-stove,

a coffee percolator and a chafing dish.

It's easy, of course, to order a breakfast brought up to one's room in the morning.

But there are a whole lot of times that I find I would rather get up and fix up a little breakfast for myself. All the utensils are convenient as can be and it only takes the turn of a switch to set them going full blast.

Then, too, after the show in the evening, it gets monotonous always going out to a cafe for the dinner we all feel we must have after a hard evening's work. I enjoy a little chafing dish party in my room as well as the girls blessed with their own homes—and my friends do too.

Another time at which I find my electrical utensils very convenient is after matinee performances. I have them in my stage dressing-room on those days and frequently do not go to the trouble of putting on street

clothes and going out between the afternoon and evening performances, but prepare a little lunch right there.



A CHAFING DISH PARTY FOR TWO

clothes and going out between the afternoon and evening performances, but prepare a little lunch right there.

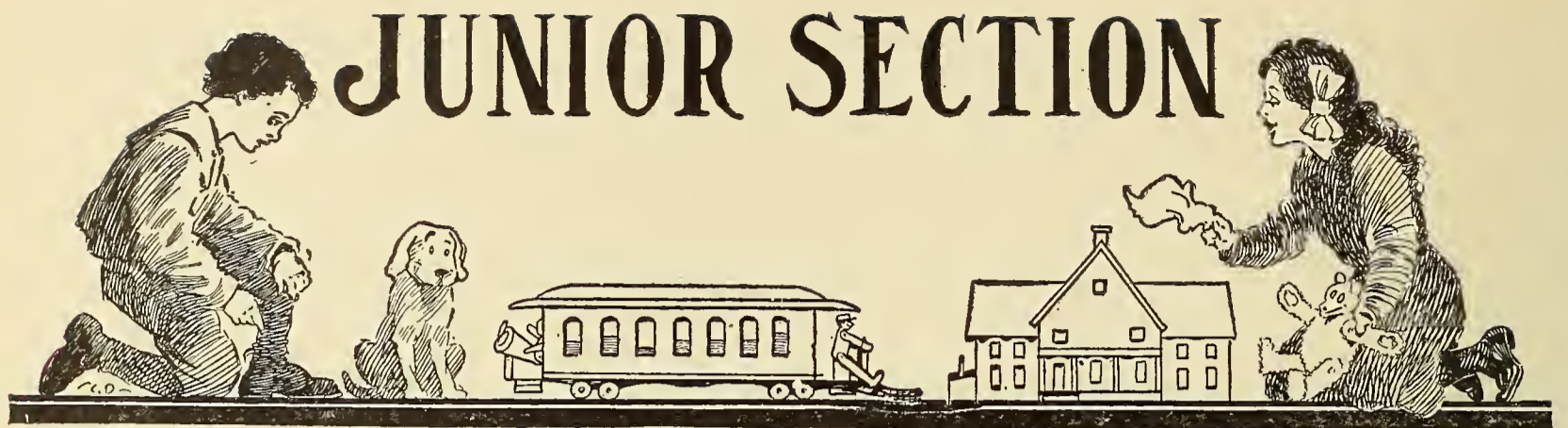

JUNIOR SECTION

An Electrical Laboratory for Twenty-Five Dollars

By DAVID P. MORRISON

PART IV.

After completing your electrolytic rectifier and transformer you will find yourself badly in need of some form of ammeter and voltmeter for making current and voltage measurements. There are numerous forms of instruments, differing in construction, principle of operation, range of indication, etc., that may be constructed and used to indicate the electrical pressure between two points, or the current flowing in a circuit.

All of the instruments that are suitable for direct current measurements cannot be used for alternating current work, while all alternating current instruments, ammeter and voltmeters, can be used on a direct current circuit, but their indication is not as a rule as accurate as on an alternating current, due to the disturbing effects of stray magnetic fields, etc. The instruments should be constructed so that they can be moved about without changing the accuracy of their indication. They are often called "portable ammeters" or "portable voltmeters." The instruments described in this article are of the "portable" type and will be much more satisfactory than those whose position must be accurately adjusted before they will give a correct reading.

The following description applies to an instrument that can be used on direct current but not on alternating current. It may be used as an ammeter or a voltmeter, depending upon the connection of the moving system. It will be found here that considerable mechanical skill will be required as quite accurate machine work must be

done on the various parts. Almost every boy, however, has a friend in some machinist or else has a school shop equipment at his disposal where he will be allowed to do this part of the work.

Secure a piece of steel $1\frac{1}{4}$ inches wide and about 5-16 inch thick and 13 inches long. Now bend this piece into a horse-shoe form shown in Fig. 29. (Part of the curve is not shown in the drawing.) Have a blacksmith do this for you.

File out the opening between the two ends perfectly smooth and make it of a uniform diameter at all points. File the ends off so that they are parallel, which can be determined by placing a straight edge against both of them at the same time. Drill two holes in each end as indicated at the right in Fig. 29, which is looking at the ends of the magnet. These should be 1-16 or 3-32 inch in diameter and tapped to take a small machine screw. Also drill four other holes one in each edge and near the ends. These should be of approximately the same size as those drilled in the end, and tapped to take small machine screws as in the previous case. You are now ready to harden your magnet.

Secure a piece of round iron that will fit snugly in the opening between the ends of the bar. Then get from the blacksmith a pair of large tongs with flat jaws that will grip the ends of the bar and hold them firmly against the round iron core. Place the magnet in a good hot fire, with iron core between poles, and heat it uniformly to a cherry red;

then grip it with the tongs very tight and plunge into a bucket of water, holding the ends against the iron core with the tongs until thoroughly cooled. In this way your magnet will not be bent out of shape while tempering. It will be almost impossible

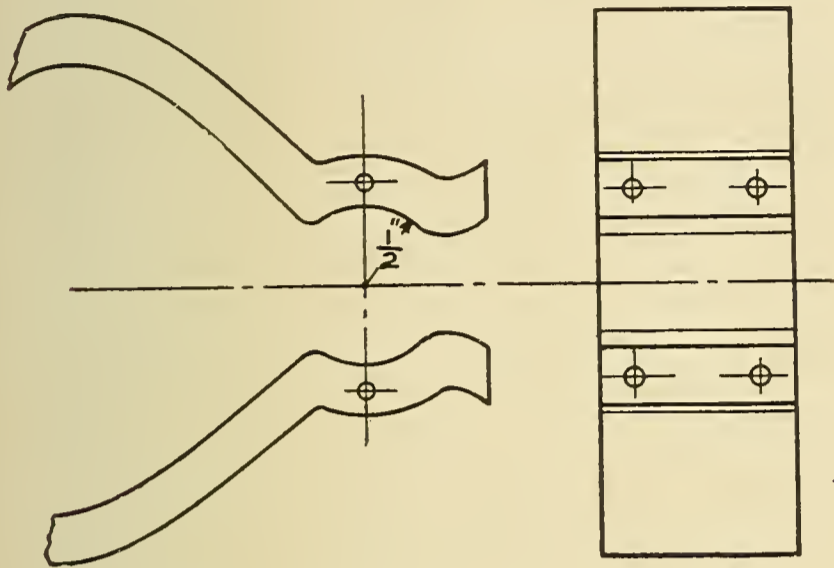

FIG. 29. THE PERMANENT MAGNET

for you to make any changes in the magnet after it is hardened.

Your magnet may now be magnetized. This can be done by placing its ends in contact with the poles of a powerful electromagnet, or by winding quite a number of turns of rather large wire around it and passing a strong direct current through this winding. The strength of the magnet may be increased when it is being magnetized by tapping it gently.

Now cut from some soft iron a cylindrical piece $1\frac{1}{4}$ inch long and $\frac{3}{4}$ inch in diameter. Round off its edges and drill two small holes in one side and tap them to take small machine screws. This piece is to serve as a core for the moving system to rotate about, and will be mounted rigidly in the center of the opening between the poles of the magnet. The number of magnetic lines passing from one pole to the other through the circular opening is greatly increased by the use of this iron core, as it is a much better conductor of magnetic lines than air.

Mount the iron cylinder as follows: Cut from some $\frac{1}{8}$ inch sheet brass a piece $1\frac{1}{4}$ inches wide and two inches long. Drill four holes in this piece to match those in the ends of the magnet and mount it in place with the four machine screws. This piece must always be made of brass or some other non-magnetic material. Solder on the inside of this piece another piece of brass of the form shown in Fig. 30. The

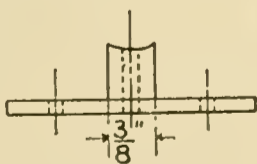

FIG. 30

side of this piece of brass next to the opening between the poles should be filed out so that it will fit the curvature of the iron core and it should be of such a thickness that the core will be exactly in the center of the opening between the ends of the magnet, when it is fastened to the brass support. Drill two holes in this brass support to match those in the iron core and fasten the core with the two machine screws. It would be best not to drill the core until after the brass has been drilled as the holes can then be easily matched.

To construct the moving system you should proceed as follows: Secure some thin aluminum and roll it out until it is only a few thousandths of an inch in thickness. Then cut from it a piece 5-16 inch wide and $4\frac{3}{8}$ inches long. Bend this piece around a wooden core of the dimensions shown in Fig. 31, making a lap seam at the joint.

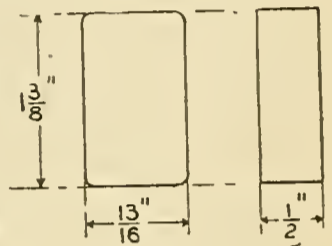

FIG. 31

Now cut from some 3-64 or 1-16 inch steel rod two pieces $\frac{1}{2}$ inch in length and file one end of each to a point. After these pieces

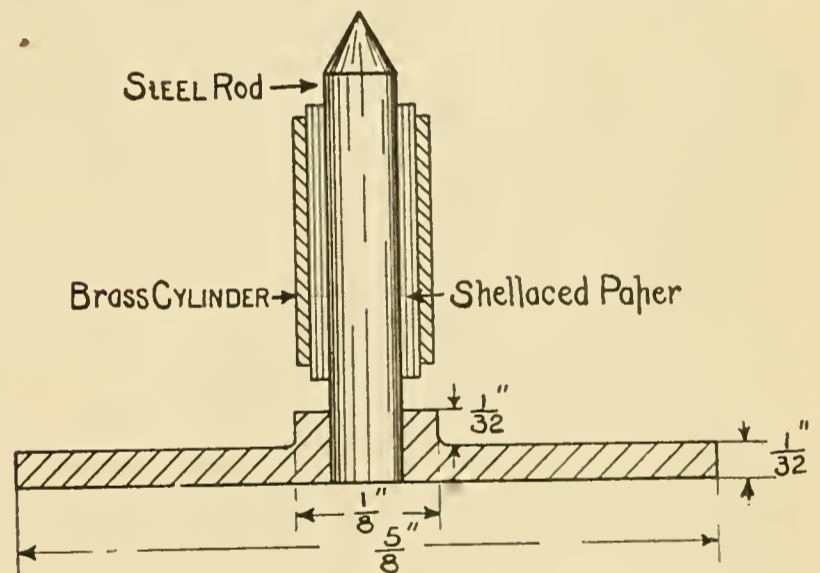

FIG. 32. PIVOT FOR THE MOVING SYSTEM

have been pointed they should be well tempered. Next cut two pieces from aluminum or brass whose dimensions correspond to those of the lower cross section portion in Fig. 32. Drill a hole in the center of each of these pieces of such a size that the unpointed end of the steel rod will have to be forced into them. After the rods are put in place wind around them three or four turns of good quality paper, shellacing each layer. Two thin brass cylinders about $\frac{1}{4}$ inch in length that will fit tight on the outside of the paper you just wound on the steel rods are now made.

Cut from some very thin spring brass a pointer and solder it to the end of one of the brass cylinders as shown in Fig. 33. The needle should be balanced by placing a small quantity of solder on the short end.

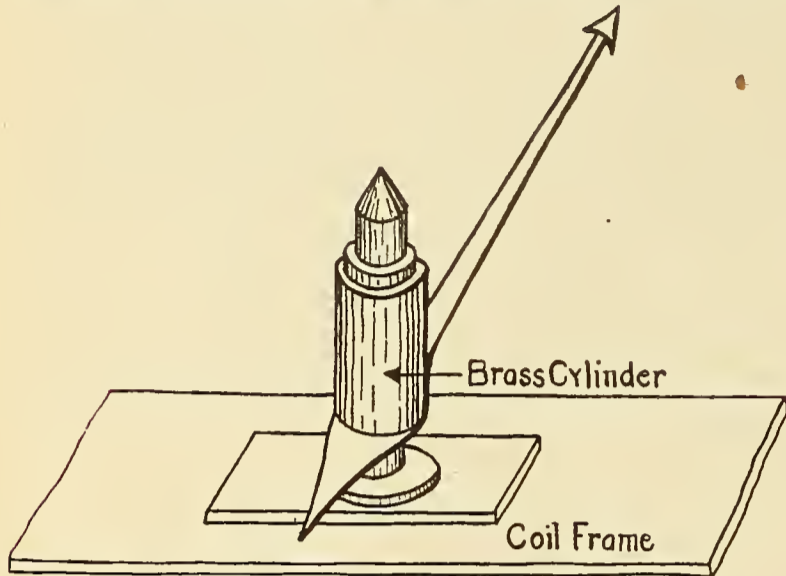

FIG. 33. HOW THE NEEDLE IS MOUNTED

Put these cylinders in place first shellacing the paper, and allow them to remain undisturbed until thoroughly dry. Now fasten these pieces carrying the points to the ends of the aluminum frame with some jewelers

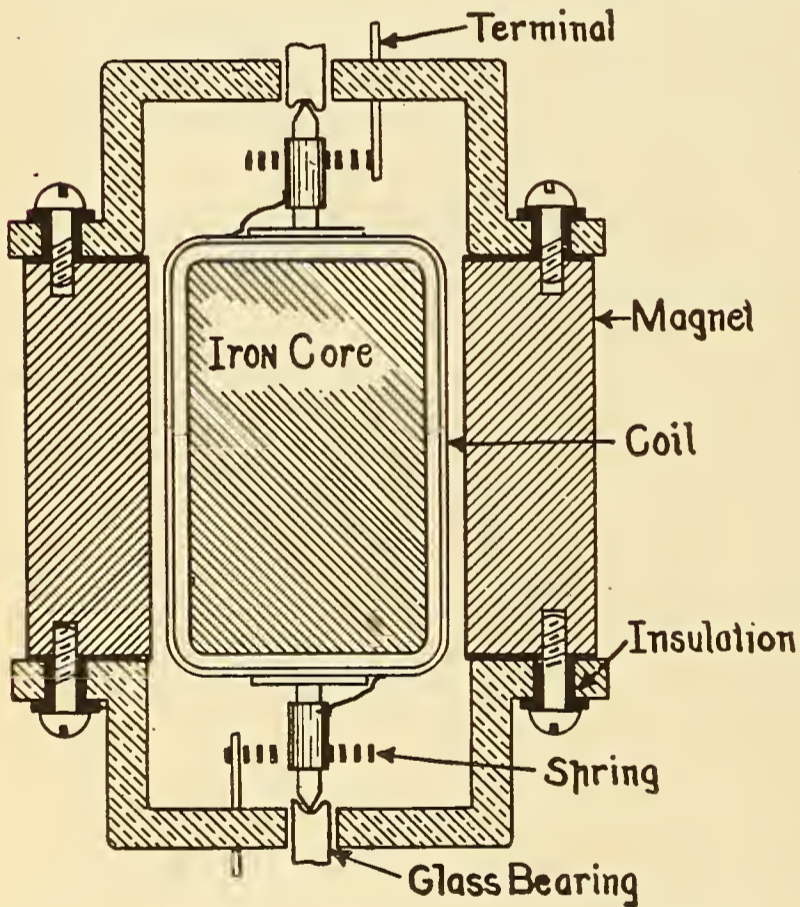

FIG. 34. MOVING SYSTEM MOUNTED IN THE BEARINGS

wax or shellac, placing the needle perpendicular to the plane of the coil. Fig. 34 shows how they are mounted. You must use great care in seeing that the pivots are exactly in the center of the frame. Otherwise the coil will rub on one side when mounted in its bearings.

Place two or three layers of tissue paper on the outside of the frame shellacing it in

place and then wind on about thirty turns of No. 36, or smaller, B & S gauge single cotton covered wire. The ends of this winding should be soldered to the two brass cylinders on the steel rods as shown in Fig. 34.

Secure from a jeweler two fine spiral springs and solder the inside ends to the brass cylinders near their outer ends. They will lie horizontally as shown in Fig. 34. These springs should be so arranged that one tends to wind up and the other to unwind when the coil is rotated, and their outer ends are fastened. Be careful in doing this soldering not to heat the tube too much as you are likely to loosen it from the frame. Before winding on the wire it might be well for you to take the frame off of the wooden core and see if you have the pivots in the center of the ends. They can be easily changed now but it would be almost impossible to do so after the winding is in place.

After the winding and springs have all been put in place you must balance the moving system by supporting the coil in a horizontal position on the two pivots. Add ballast to the lighter side until the coil is practically balanced. You can use beeswax for this



FIG. 35

purpose. The moving system is now complete and ready to be mounted in its bearings which can be made as follows:

Secure two pieces of brass $\frac{1}{8}$ inch thick, $\frac{3}{8}$ inch wide and three inches long and bend them into the form shown in Fig. 35. Drill a hole in each end of these pieces to match those drilled in the edges of the magnet. These pieces must not make electrical contact with the magnet, hence insulating bushing and washers should be used around the screws holding them in place.

Cut two circular disks of cardboard that will fit in the opening between the magnets and place these pieces in the opening between the poles of the magnet one near each edge. Now pass a needle through the center of these disks and mark the point where it comes in contact with the brass supports just made. All the various parts should be marked so that they can be put back together always in the same way. Drill in these supports a $\frac{3}{16}$ inch hole with the points you located in the above manner as centers. These openings are for the bearings in which the steel points are to operate.

The bearings can be made from glass tubing as follows: Place the end of a piece of tubing whose outside diameter is about $\frac{1}{8}$ inch, in a gas flame and heat it until the end softens and runs together. Hold the tube in a vertical position with the heated end up and allow it to cool, and there will be a tapered opening like the bottom of a wine bottle formed in the center of the end of the tube. After experimenting a little while you will be able to produce very good bearings. These ends should be cut off about $\frac{3}{8}$ inch in length and they can be mounted in the openings in the brass strips as shown in Fig. 34 by means of some jeweler's wax or common sealing wax. You must be patient in adjusting the bearings as the operation of your instrument depends a great deal upon them. The ease with which the adjustment of these bearings can be made may be increased by mounting them in a hollow screw that is threaded to fit the openings, in

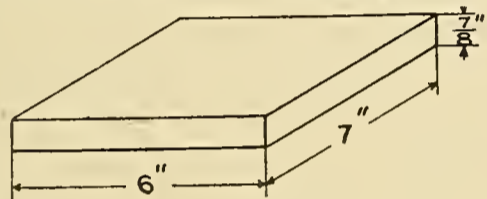

FIG. 36.

the brass supports, which must also be threaded. A lock nut placed on these screws will serve to hold them in place after the adjustment is made.

Cut from some well seasoned cherry or other close grained wood a piece whose dimensions correspond to those given in Fig. 36. This piece is to serve as a base for the instrument. The magnet and moving system can be attached to this base by means of several pieces of brass bent over the magnet and fastened to the base with screws. There should be several blocks of wood mounted on the base for the magnet to rest upon so that the lower support for the moving system will not touch the base. It might be well to cut grooves in these blocks for the magnet to fit in as that will also reduce the likelihood of its moving out of position.

A heavy piece of cardboard should now be mounted under the needle that is to serve as the scale. The needle as it is mounted will point out into the curved portion of the magnet. This cardboard should be of such a size that the needle will move through about sixty degrees from its zero position to the extreme position. Draw two arcs on this cardboard with the pivot of the moving system as a center. The

radius of the outer circle should be a little more than the length of the needle and the radius of the inner circle should be about $\frac{1}{4}$ inch less than that of the outer one. The length of these arcs depends upon the movement of the needle or pointer.

The outer ends of the two springs should now be soldered to two pieces of brass that are fastened to the supports for the bearings. These pieces of brass form the terminals of the instrument. These springs should be soldered when the needle is in the zero position which results in there being practically no tension in either of them.

In using this moving system as a voltmeter it will be necessary to connect some resistance in series with it, the value of this resistance being determined of course when the instrument is calibrated. A small wooden spool can be mounted underneath the scale and inside of the magnet upon which this resistance can be wound. It, no doubt, would be best to use German silver wire for this resistance as the volume of wire required for a given resistance is considerably less than when copper is used. A number of different coils can be placed in series with the moving system, this changing the value of the deflection produced by a given voltage.

The construction of the case will be left entirely with the boy building the instrument.

Binding posts should be provided for making connections to the instrument and should be mounted outside the covering for the moving system.

To calibrate your instrument, to be used as a voltmeter, you will need a voltmeter whose indication is known and has its scale marked. You no doubt can borrow an instrument from some one to be used for this purpose, and it will be called a "standard." Connect your instrument in parallel with the standard, making sure you have sufficient resistance in series with the moving system to prevent its being injured by an excessive current flowing through it when the two instruments are connected to the source of electromotive force. You had best start with very small values of electromotive force which will reduce the likelihood of the instrument being injured. Then adjust the voltage impressed upon the two instruments in parallel until the standard reads three volts; this can be done by means of a resistance connected in series

with the instruments. Now change the resistance in series with the moving system of your instrument until the indication corresponds to a full scale deflection making sure the standard still reads three volts. When this adjustment is secured, make a fine mark on the scale directly beneath the needle. Then reduce the voltage impressed, noting the readings of the standard and at the same time marking the position of the needle corresponding to each value of voltage read on the standard. Thus your instrument is capable of measuring up to three volts.

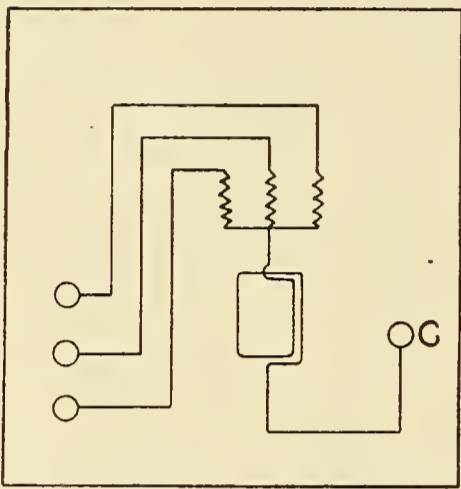

FIG. 37. CONNECTIONS

The instrument can be made to indicate higher voltages by placing additional resistance in series with the moving system. Fig. 37 shows the connections of a moving system so that a full scale deflection corresponds to three different voltages. The terminal marked (C) is common to the three circuits, and each of the circuits has a separate coil that is used in making the adjustments.

This same moving system may be used as an ammeter to indicate the current in a circuit by connecting it in parallel with a resistance called a shunt.

The current divides in the two circuits inversely as their resistances, hence the current flowing through the moving system can be adjusted by varying the resistance of the shunt. The instrument can be made to indicate any value of current by varying the resistance with which the moving system is connected in parallel. To calibrate the instrument you must connect a standard ammeter in series with it and adjust the parallel resistance until the full scale deflection is produced by the desired current. The other points on the scale can be marked by changing the current in the circuit and marking the position of the needle for each indication of the standard. This parallel resistance can be placed inside of the instrument just the same as the series resistance was in the case of the voltmeter. The parallel resistance must be of a much greater current carrying capacity.

[The next article will take up the construction of an ammeter and voltmeter which can be used on either alternating or direct current; also the construction of a simple switchboard.]

(To be Continued.)

Fire and Burglar Alarm

Any one who can work with carpenters' tools and who has an elementary knowledge of electricity can install a fire and burglar alarm in a residence. It will be necessary to fit to each window and door an alarm spring, and these springs may be purchased of any dealer in electrical supplies. The two wires from each spring may be dropped to the basement and there connected so that the springs will be in series. The springs may be so placed that the windows may be left open a few inches for ventilation and the occupants of the house may feel sure that no one can enter the window unknown to them.

If a window is raised above the spring it releases the spring and opens a gravity battery circuit. When this circuit is opened the armature of a relay is released, this armature having hitherto been held up against the relay magnet because of the current which flowed through the magnet coil from the gravity battery. This in turn closes the gong circuit which is operated by dry batteries. For the relay a "pony" telegraph relay may be used. The contact points must be in the reverse position from that in which they are used for telegraphic work in order that the gong circuit may be closed when the gravity battery circuit is broken.

For the fire alarm a strip of tin foil about an inch wide should be clamped with porcelain cleats between two strips of copper. This tin foil is connected in the gravity battery circuit by means of the copper strips and placed over the furnace or wherever a fire is most likely to break out. If the furnace becomes overheated the tin foil will be quickly burned out, the gravity battery circuit opened, and the alarm sounded.

This alarm is a perfect protection against the common sneak thief though it might not protect against the skilled burglar who has more or less of a technical education. The average home, however, has more to fear from the sneak thief than from the skilled burglar, for the latter confines his

attention to buildings in which considerable wealth is known to exist.

There is another form of burglar alarm in which, when a window is opened, the window spring closes a circuit. In this

Model Electric Locomotive

The accompanying cut shows the model electric locomotive made by Nathan Lord of Boston, Mass., which won the first prize for

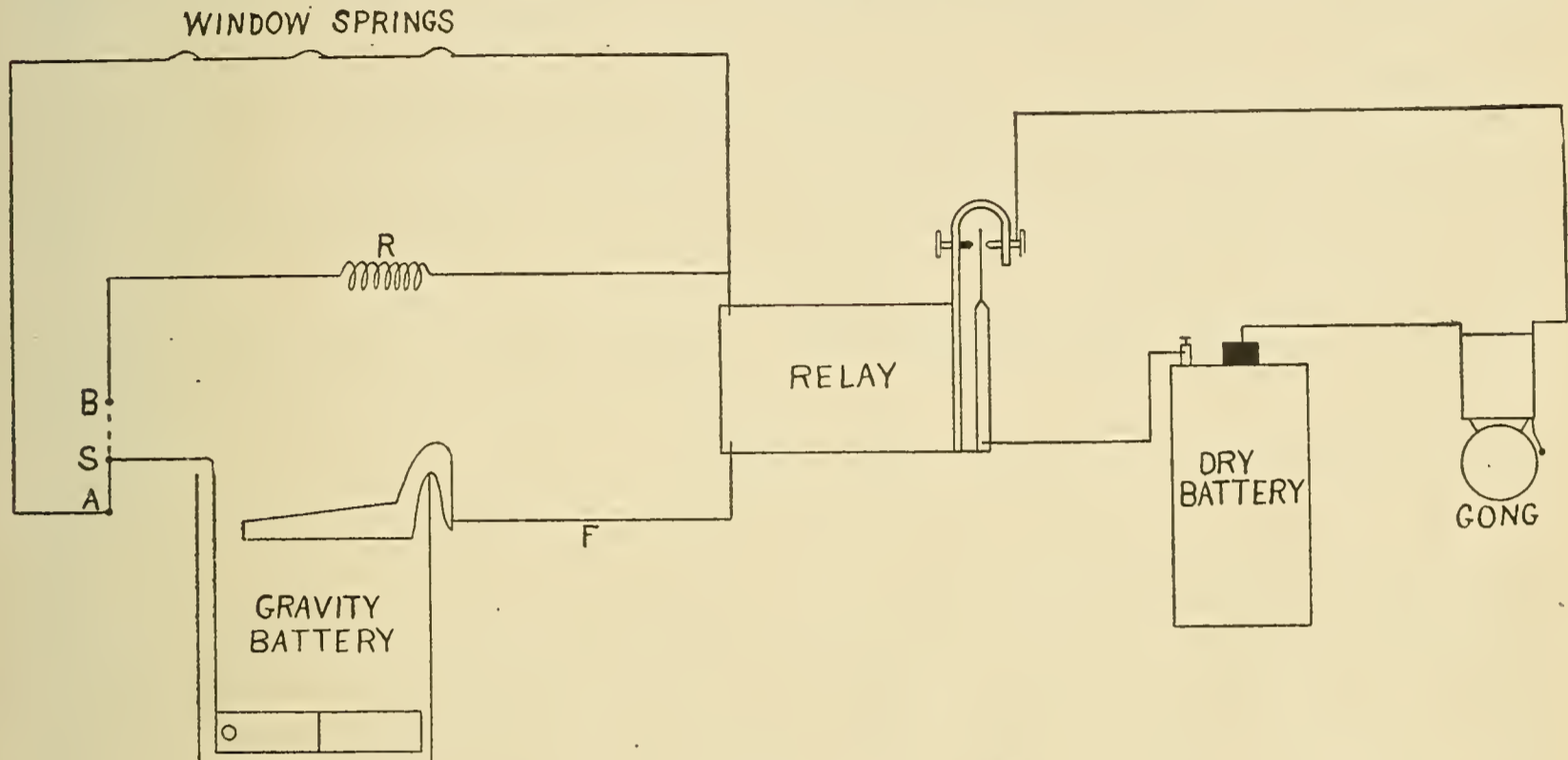

FIRE AND BURGLAR ALARM

alarm only a dry battery circuit is used. Now it is easily seen that a burglar who might discover that a house was wired for an alarm and could not discover which form of alarm was used would be perplexed, for the very thing which would prevent one kind of alarm from ringing (opening the circuit by cutting the wires) would cause the other to ring.

A single pole double throw switch is placed at (S) in the diagram. When the switch is thrown to (A) the window springs are in circuit. In the daytime the switch can be thrown to (B). The current will then flow through the resistance coil at (R) and the windows can be opened without ringing the gong. This is a convenient arrangement for keeping the gravity battery busy when it is desired to open the windows, for, as you may not know, a gravity battery must be kept working on a light load.

Of course a single pole switch can be placed anywhere in the gong circuit. If the tin foil is connected at F, the fire alarm will be in circuit day and night.

amateur electric construction at the Boston Electric Show. The locomotive is a fac-simile of a New York Central locomotive and was built by the constructor with nothing more encouraging to help him than a picture cut out of a technical periodical.

Mr. Lord is a high school student and has never seen an actual electric locomotive or studied electricity. He had the idea to build an electric locomotive some two years ago and with the clipping, which gave him an idea of the exterior appearance of the real thing he set to work and devoted the whole of his spare time for the following



MODEL ELECTRIC LOCOMOTIVE

two years in its construction and completed it in time for the electric show.

One of the remarkable things about the model is that it is made of such materials as are at hand in the average household. The body of the locomotive is composed of wood of egg crates, the doors were made of tin from old tomato cans, even the bars and under pinning were made of cigar boxes and thicker material. The locomotive is equipped with journal boxes, hinged doors, glass windows, controller, two motors, third rail contact, headlights, and swivel trucks. The model is two feet long and travels on a four-inch track.

Hand Power for Small Dynamos

If the amateur experimenter has an old discarded lawn mower he can make an excellent hand power device to drive small dynamos. The mower is first taken apart and the roller and connecting pieces, between the two end castings which contain the bearings, thrown away. These two end castings (bb) Fig. 1, are then bolted securely to the wooden uprights (aa) by the lugs or projections which originally supported the roller of the mower.

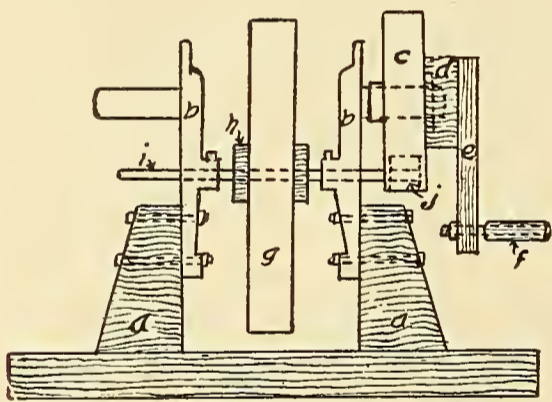

Fig. I

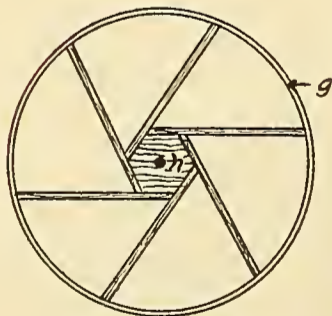

Fig. II



Fig. III

HAND POWER MACHINE

Care must be taken to get the two bearings which support (i) exactly in line so that it will turn freely without binding.

The cutting knife is driven from its shaft and replaced by the large pulley wheel (g) shown in Figs. 1 and 2. The center piece or hub is a block about four inches long, whose ends are six-sided figures. Bore a hole in the center just large enough to drive tightly on the shaft. The spokes are nailed to this hub. The rim (g) may be made of a strip of sheet iron bent in circular form, but a piece of an old cheese box, about two inches wide, makes an excellent wooden pulley face for a wheel about sixteen inches in diameter.

A ratchet or some other device is used, generally on the small gear wheel (j) to prevent the knife from turning when the mower is pulled backward. This had better be discarded and the gear fastened permanently to the shaft, by filing a notch on the inside of this gear and a corresponding one on the shaft and driving in a nail, as at (x), Fig. 3.

To one of the mower traction wheels (c) is bolted the wooden block (d) and the crank arm (e). The handle (f) may be part of a broom handle, and it turns easily on the bolt which is fastened at right angles to the end of the crank arm.

A flat endless belt made out of about four thicknesses of good canvas sewed together connects the large pulley (g) to the small pulley on the dynamo.

The speed of the dynamo is of course regulated by the speed at which the crank is turned. For example if (c) and (j) are geared one to six, and the large pulley (g) is sixteen inches in diameter and the small pulley on the dynamo, say two inches in diameter, and it is desired to run the dynamo at 1800 revolutions a minute; then the right speed to turn the crank would be

$$1800 \times 2 \times 1$$

or about 38 times a minute.

$$16 \times 6$$

The type of lawn mower used has gear teeth on the inside of the traction wheel. If the mower at hand differs in construction the reader can make any slight alterations needed for his particular mower. But I think in every case the general plan of mounting can be followed. It will be noticed that only one set of gears or those on one side of the mower is needed, the casting (b) on the left serving merely as a bearing for (i).

JAMES P. LEWIS.

POPULAR ELECTRICITY WIRELESS CLUB

Membership in Popular Electricity Wireless Club is made up of readers of this magazine who have constructed or are operating wireless apparatus or systems. Membership blanks will be sent upon request. This department of the magazine is devoted to the interests of the Club, and members are invited to assist in making it as valuable and interesting as possible, by sending in descriptions and photographs of their equipments.

A Simple Wireless Telephone Set—Arc System

By A. B. COLE

The construction of a small wireless telephone outfit of the speaking arc type is quite a simple matter if a proper design is followed. The set described in this article is adapted to operate on 100- to 120-volt direct current circuits, but will also run satisfactorily on circuits whose voltages are as low as fifty. The set can not be operated on alternating current circuits.

It has been found that when a telephone transmitter is connected across a choke coil, which is in series with an arc light burning on a direct current circuit, words spoken into the transmitter will be reproduced by the arc. If an impedance coil is placed in the direct current circuit, and the arc is properly connected to an aerial system, as used for wireless telegraphy, the arc will set up oscillations in this system. These oscillations in turn set up electric waves which are radiated in all directions by the aerial, and these waves will affect wireless telegraph receiving instruments at a distance.

In order to make an efficient outfit for this purpose it will be necessary for the builder to follow quite closely the principal dimensions given below, for satisfactory results cannot be obtained nearly so easily in wireless telephony as in wireless telegraphy.

Fig. 1 shows the method of constructing the arc proper. The lower or negative electrode is of carbon, held in a brass tube as shown in the detailed drawing in Fig. 2. This carbon is the same as that used for street arc lights. The upper or positive electrode is made from brass or copper tubing, and has an inlet (I) and an outlet (O) for water circulation within it. Considerable heat is generated at the electrodes of the arc, and greater efficiency is obtained by cooling the positive electrode. The inlet and outlet tubes should be about 1½ inches long.

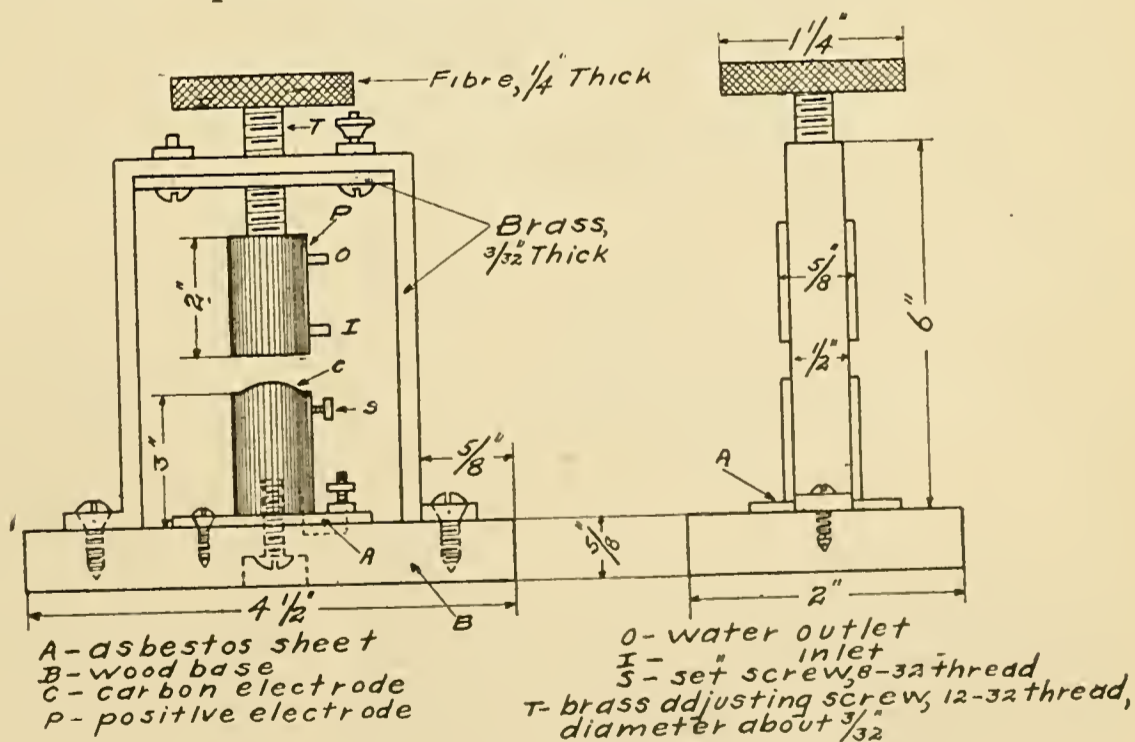

FIG. 1. CONSTRUCTION OF THE ARC

When the set is in operation the inlet tube is connected by rubber tubing to a water faucet. A good way to do this is to provide a rubber stopper large enough to fit inside the faucet. A glass tube about

5-32 inch outside diameter may be inserted in the hole in the stopper, and the rubber tube may be slipped on the glass tube. If the stopper has two or more holes those not needed may be closed by inserting glass rods. The outlet tube is connected by means

way, of ten coils of No. 14 German silver wire, each coil containing 95 turns, and each turn having a diameter of $\frac{3}{4}$ inch. It should be so arranged that any number of coils from zero to ten may be connected in circuit when desired. Any rheostat having a maximum resistance of at least 50 ohms, and a carrying capacity of at least six amperes will do for this purpose.

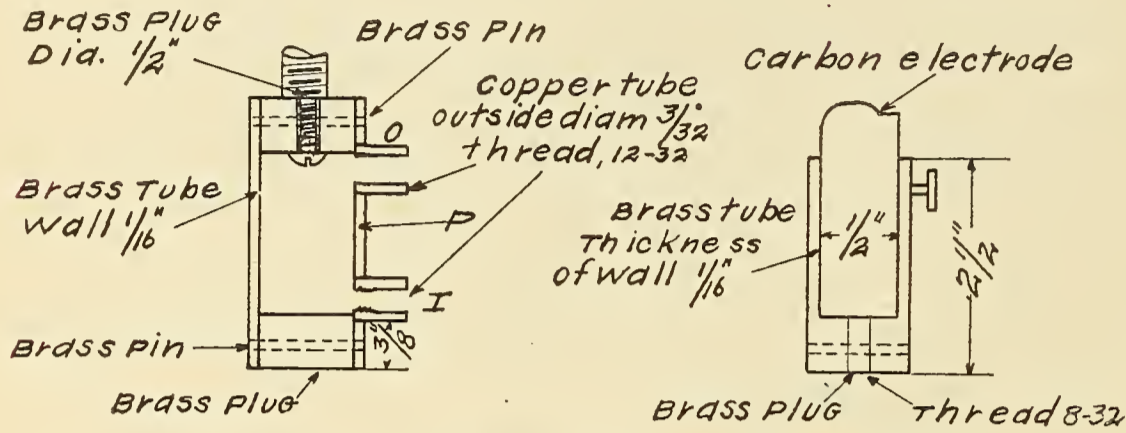

FIG. 2. DETAILS OF CARBON HOLDER

of a rubber tube to a sink or drain pipe, so as to dispose of the water after it has passed through the positive electrode.

The negative electrode is stationary, and the carbon should always project at least one-half inch beyond its brass holder, so that the arc will be formed on it, not on the brass. The carbon may be moved up from time to time by loosening the set screw (S). The positive electrode (P) may be moved

the standard type known as a "long distance transmitter." The impedance coil should have an outside diameter of eight inches and a cross section of $1\frac{3}{4}$ square inches. The core is built up of No. 18 soft iron wire. If the wire is rusty, so much the better. It should be procured as rusty as possible. The core is built up of a large number of separate wires, each of sufficient length to give the core the above diameter. The ends

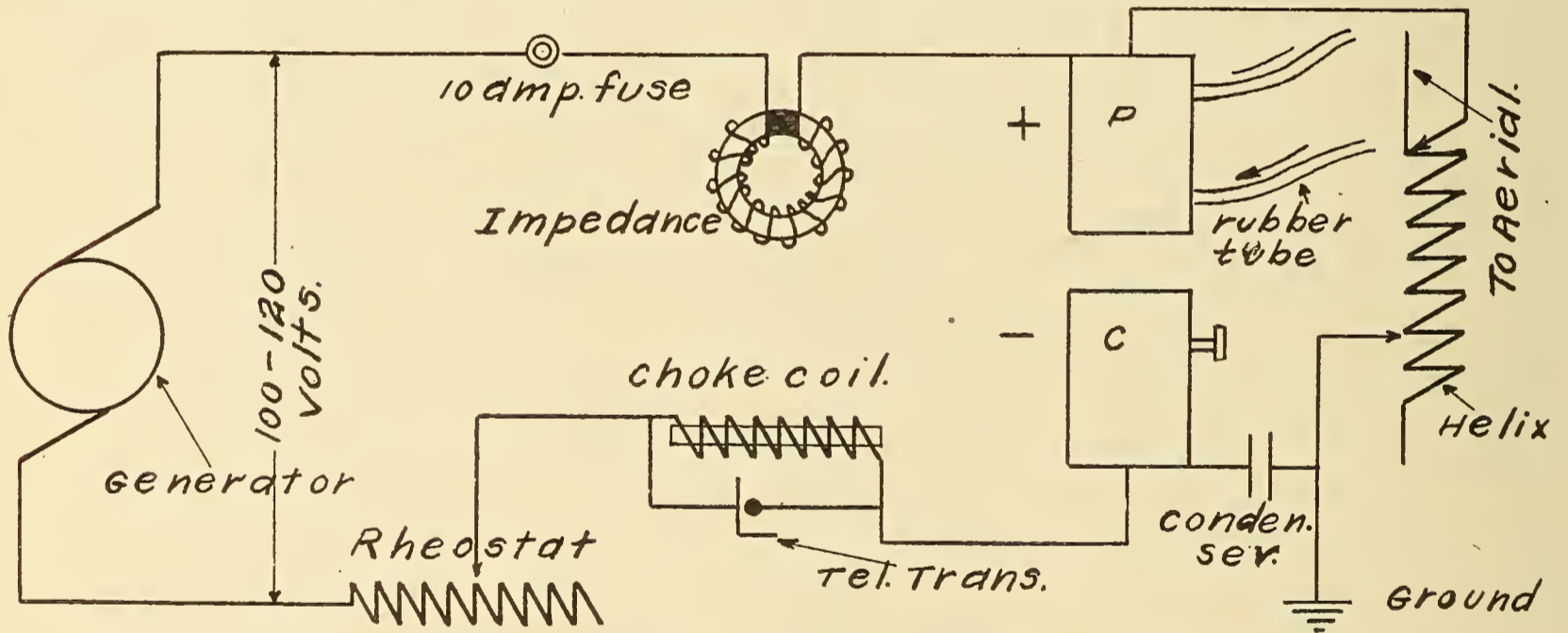

FIG. 3. CONNECTIONS OF WIRELESS TELEPHONE

up or down by means of the large fibre headed thumbscrew (T). This screw should be so fastened to the upper plug of (P) that the screw may be revolved without revolving (P). This may be accomplished as shown in the detailed drawing, or in any way the builder desires, so that the cooling water cannot leak out at the point where the thumbscrew enters the plug.

The rheostat shown in the diagram of connections, Fig. 3, is made in the ordinary

of the wires are butted up against each other and are held by a fibre tube about two inches long and $1\frac{1}{2}$ inches in diameter.

An easy way to form the core is to wind a number of wires around a drum to give them the proper shape and length, and then to cut them off and insert them in the fibre tube. After the core has the proper diameter the wires may be held in place by wrapping ordinary insulating tape around them. When this has been done three layers of

No. 12 D. C. C. magnet wire should be wound on in the same way that any electromagnet is wound.

The ten ampere fuse shown in Fig. 3 should not be omitted. When using the set be sure that water is flowing at a sufficient rate through the positive electrode to keep it comparatively cool.

The general theory of the operation of this set is as follows: When any sound strikes the transmitter diaphragm it vibrates in accordance with the intensity and frequency of the sound wave. This vibration is transmitted to the carbon granules, thereby increasing and decreasing the resistance of the transmitter as a whole. The variation in resistance causes a variation in the current flowing through the choke coil and the arc. Of course the variations are very small compared to the current flowing in this circuit, but nevertheless are sufficient to cause the original sound to be reproduced by the arc.

Variation in the arc current causes electrical oscillations to be set up in the circuit including the arc, the condenser, and the helix. When this circuit is properly related to the aerial-ground circuit a maximum quantity of electrical energy is radiated by the aerial. The relation of the above circuits is varied as in wireless telegraphy by moving the variable contacts of the helix from one turn of wire to another. A Geissler tube may be inserted in the aerial circuit to show when a maximum quantity of energy is being radiated, or a hot wire ammeter may be used for the same purpose if available. The purpose of the impedance coil is to prevent the oscillations generated at the arc from flowing through the circuit including this coil, the generator, the rheostat and the choke coil.

This set may be used for purposes other than that of wireless telephony. One inventor has used several arcs in series, placed in parks and amusement places. The telephone transmitter was placed before a phonograph, and the music was reproduced by each arc. The set worked very well and attracted considerable attention. In this case the arcs were self regulating.

The builder of this set will find it very instructive, and will, no doubt, be able to devise many experiments, which may lead to important discoveries. The arc system of wireless telephony is practically the only one used at the present time.

If the above set is well constructed, and with a good aerial, the owner should have no difficulty in working over distances of four or five miles.

Suggestions for Aerials

In the February issue of Popular Electricity was printed a letter from Mr. E. F. Waits describing a very complete amateur station which he had built. In a subsequent letter he informs us that as a result

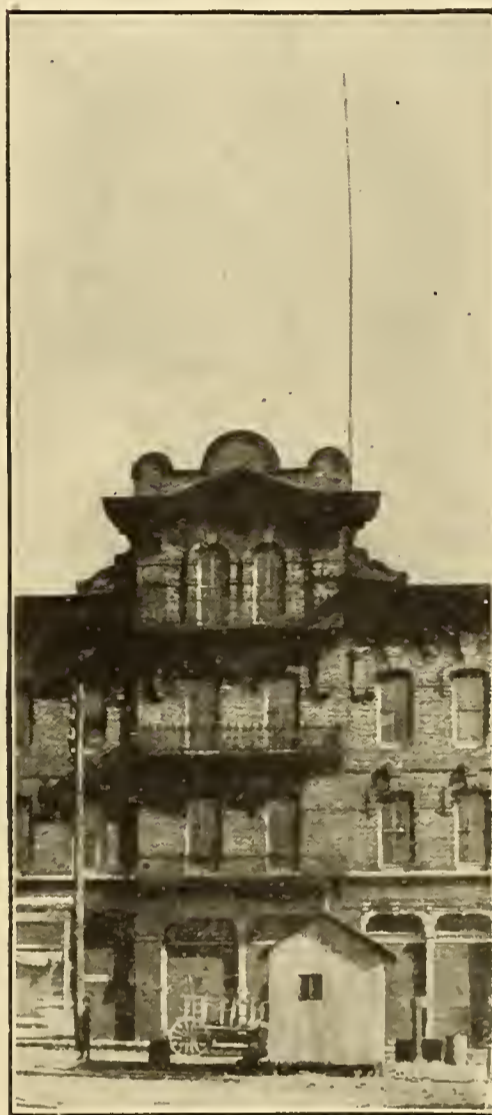

he has received dozens of letters from those interested in wireless and has made many new friends. He makes some further interesting comments in his second communication which we are glad to quote, as follows:

"I enclose a photograph of the main support of the aerial. This may also be of interest to some one who has trouble in that

line. This pole is a common gas pipe, in three sections, each one being about 18 feet long. It simply sets on a board which is made to fit the roof and is held in place by three guy wires at each joint. The bottom pipe is $2\frac{1}{2}$, the center two, and the top $1\frac{1}{2}$ inches, inside diameter. On top is a "T" to which is fastened the two top guy wires and the pulley. Through the pulley runs a 7-strand steel cable for raising and lowering the aerial. From the ground to the top of the pole is just 125 feet. The guy wires make this pole so rigid that it could be climbed if it should ever be necessary.

"In using a silicon detector, did you ever drill a small hole in the end of the brass contact screw and insert a piece of gold? A piece of old spectacle temple is just the right size and quality. Try it.

"If the two boys, who were in Chester, Pennsylvania, will write to me, I would like to know the size and kind of apparatus they were using one night last November. 'We are at the dock in Chester, Pa. We are having a big time in Chester, Pa. How is things with you?'"

"You were evidently talking to someone in Philadelphia, a distance of only 10 or 12 miles, and it seems to me that you were wasting a lot of energy, as I am over 900 miles away and heard you very plainly."

A Leading-In Insulator

It is an absolute necessity that all wireless stations no matter how large or small should have a leading-in insulator that will "hold" the discharge without leakage. The insulator described below will take the discharge from transformers up to three kilowatts and induction coils up to 25 inches. It will cost about 50 to 75 cents.

The materials needed in its construction can be purchased in any electrical supply

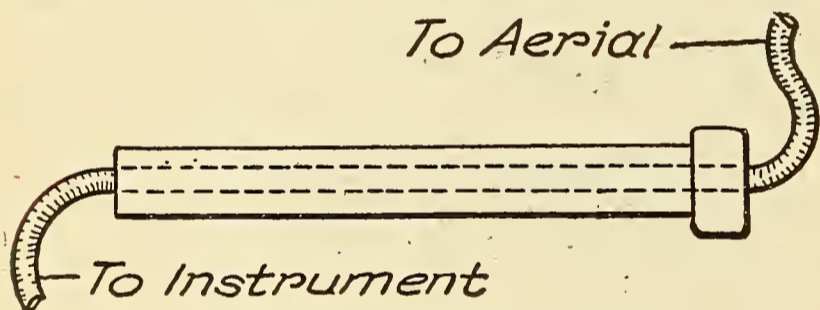

LEADING-IN INSULATOR

house. They will consist of one unglazed porcelain tube 14 by two inches, knobbed at one end and with walls three-eighths of an inch thick; one pound of red sealing wax.

The tube should be boiled fifteen minutes in paraffine to remove dampness, then cleaned of superfluous paraffine. When cold shellac the outer wall and as much of the inner wall as can be conveniently reached with a small brush. It should then be allowed to dry and harden. The leading-in wire (high tension cable preferably) should be put through the hole; allowing about two feet to protrude from the knobbed end of the tube for aerial connections, and from the other end to attach to the lead to the instruments.

Next, pour the sealing wax around the wire till the tube is filled up flush with the ends. After this has cooled shellac the tube and a foot or so of the projecting wires.

GEORGE F. WORTS.

Marconi Receives Nobel Prize

The Nobel prize for physics was this year awarded jointly to Guglielmo Marconi of London, and F. K. Braun of Strasburg University, Germany. The prize, which amounted to \$40,000, was divided equally. The privilege of awarding it is maintained by the Swedish Academy of Science. Mr. Marconi received the recognition for his research and development work in the field of wireless telegraphy.

WIRELESS QUERIES

Answered by A. B. Cole

Questions sent in to this department must comply with the same requirements that are specified in the case of the questions and answers on general electrical subjects. See "Questions and Answers" department.

Simultaneous Use of One Antenna for Two Wave Lengths

Question.—Is it possible to use one antenna for two sets of different wave length working at the same time?—J. G. H., Omaha, Neb.

Answer.—Yes, in fact every untuned set sends out many different wave lengths whenever the key is depressed. Probably the best arrangement for your purpose would be a double transmitting set consisting of two coils or transformers, two keys, two spark gaps, etc., using two transmitting transformer tuners, the secondary of each tuner being connected to the aerial.

Condenser Calculations; Re-Winding Receiver

Questions.—(A) What would be the capacity of a condenser having 45 sheets of tinfoil (35 square inches of active surface per sheet) with paraffined paper as dielectric? (B) How is the capacity of a condenser determined? (C) How could I make a variable condenser for a receiving set? (D) Is an aerial consisting of four strands 50 ft. long the same in efficiency as one with two strands and 100 ft. long? If not which is best? (E) Could I rewind an ordinary pony receiver to get a high ohmage (1000 or more) and get good results? If so what kind and size of wire should be used?—E. B. E., Elizabeth, N. J.

Answers.—(A) The capacity of such a condenser depends on several factors and the only satisfactory way to determine it is to measure it.

(B) By somewhat complicated laboratory methods involving comparison with a condenser of known capacity. We expect

to publish an article on this subject in the near future, as the method is too long to be described here.

(C) Two metal tubes, one about three inches in diameter, and the other a little smaller, should be arranged so that the smaller may slide into the larger. Each should be eight inches long, and they should be separated by paraffined paper. Solder a binding post to each, and use these for the condenser terminals.

(D) If the height of both the above aerials is the same, the former will be better for transmitting, and the latter better for receiving.

(E) This depends on the construction of the receiver, and as you do not advise the make, we cannot say, since in some cases you would obtain no better results.

Construction and Operation of a Morse Register

Question.—Please show how to connect a Morse register with a silicon detector, double slide tuner, and fixed condenser, also how to make a Morse register.—W. B., Brooklyn, N. Y.

Answer.—Connect the register in place of the telephone receivers in the diagram in answer to J. S. C. in the January issue. A battery of two or three dry cells should be included in series with the register. See answer to R. T. in these columns. A Morse register consists of a pair of electromagnets with an armature which carries a pen, which touches and makes a mark on a strip of paper when the armature is drawn down by the magnets. The paper is moved steadily past the pen point by clock work.

Detectors and How to Connect Receiving Apparatus

Questions.—(A) How shall I connect the following receiving set: 140 foot aerial 40 ft. high; one single slide tuning coil, one double slide tuning coil, two large fixed condensers, two variable condensers, one small induction coil, silicon detector; one pair 750 ohm receivers? (B) What would be the receiving radius of such a set? (C) Would a silicon work better and be more sensitive with a potentiometer and battery? (D) Which is the most sensitive an electrolytic, silicon or carborundum detector?—F. S., Benton Harbor, Mich.

Answers.—(A) See diagram in article in Jan., 1910, issue on "Condensers in the Receiving Circuit."

(B) About 400 miles.

(C) Yes, carborundum and perikon being the types of thermo-electric detectors which are improved by the use of a battery.

(D) The electrolytic is considered the most sensitive of the three.

Wireless Aerials

Questions.—(A) Does it take more power to operate a wireless with a 6-strand antenna 100 feet long than a four-strand antenna 40 feet long? (B) Which is the best for sending and receiving an aerial 60 feet high at one end and 20 feet at the other end and 100 feet long or an aerial 60 feet high at both ends and 40 feet long? (C) What is the best location for a wireless on a hill or on the level?—N. W. P., San Francisco, Cal.

Answers.—(A) Not necessarily more power required, but will radiate more energy, and therefore will be suitable for a more powerful set.

(B) The former aerial will be better.

(C) The better location is on a hill.

Detector Switch

Question.—Please give diagram showing how to connect two detectors to a switch, so that each may be used at will.—A. S. H., New York, N. Y.

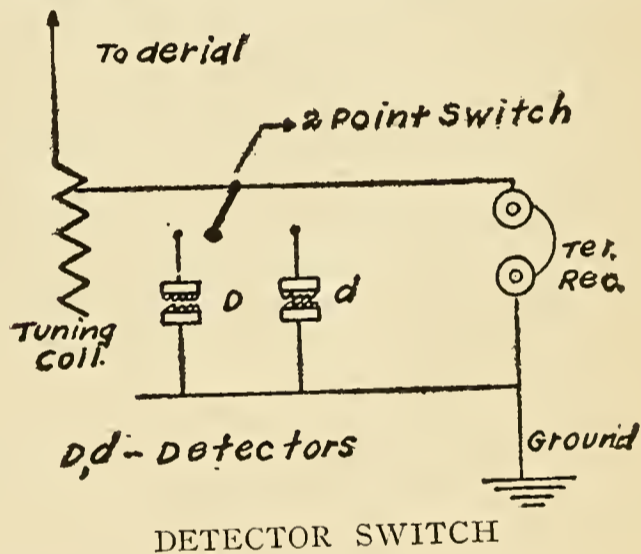

Answer.—See diagram.

Use of a 150-Ohm Relay

Question.—Can you give me an idea of how I may use my 150-ohm relay to receive up to 12 miles without making a polarized relay.—R. T., Germantown, Pa.

Answer.—We do not recommend the use of an ordinary 150-ohm relay for this purpose. Most relays are not sufficiently sensitive to very weak currents. We often receive inquiries as to how a silicon or other mineral detector may be caused to operate a recording device, and you may be thinking of doing this, but even if you intend to use a coherer as the sensitive instrument we do not believe you will have satisfactory results, for the coherer cannot be depended upon for working over such long distances, while mineral or electrolytic detectors in connection with sensitive telephone receivers will operate over several hundred

miles. Recording devices, such as the Morse register, cannot be operated by the above mentioned detectors. Any progressive experimenter who invents a device to record distant wireless messages will find a large field for the invention, since the practice at the present time is to have operators on duty continually.

Short Distance Buzzer Equipment

Questions.—(A) Will you describe the aerial to be used with the short distance buzzer equipment described in the January issue in answer to H. B. H.? (B) Would you advise the use of a battery in the receiving circuit of buzzer set? (C) What style and what resistance in ohms should I use?—M. L. S., Northampton, Mass.

Answers.—(A) The aerial should consist of at least four parallel wires. No. 14 aluminum wire will do very well. Connect all wires together at each end. The wires may be separated by a wooden rod, commonly known as a "spreader." Place the aerial as high as possible, 60 feet from the ground will do. Make the wires as long as possible. Forty feet is an average length. Insulate the aerial well from all conducting objects by means of glass or porcelain insulators. At the lower end of the aerial connect a No. 12 copper wire to all wires, and lead this wire into the house through an insulated tube.

(B) No.

(C) Any ordinary door bell or buzzer will do; they generally have a resistance of one ohm.

Wireless Telephone

Questions.—(A) Should electricity be able to run through a transmitter all the time or only when talking into it, especially in a wireless telephone. (B) I have an aerial made from No. 14 aluminum wire, four strands 50 feet long, 65 feet at one end, 40 feet at the other. Will this aerial do for a wireless telephone?—B. R., Jr., Tropico, Cal.

Answers.—(A) No, since the grains of the transmitter tend to fuse together under this condition.

(B) Yes, very well, for short distance work.

Unusual Wireless Phenomena

Questions.—I have been receiving from a commercial station and when it stopped I opened my battery switch, cutting off the current. In another minute I heard another station faintly. (A) Why was that? (B) Does the message jump the switch? (C) When I closed the switch again I could hear nothing. Was it because I had no potentiometer? (I used only a carborundum detector.) (D) When I open my battery switch and then

take a connection off the pole of the battery and tap it lightly on again it clicks in the receiver (with the switch off). Why is that? (E) The other night I heard two women talking (very faintly) in my receiver which was puzzling to me. I looked at my aerial and saw a telephone wire running about 15 feet away. Can you give an explanation of this?—G. L., Chicago, Ill.

Answers.—(A) Because carborundum may be used without a battery, and your telephone receivers were probably connected in some way across the detector.

(B) The signals may possibly leak across the material of the switch base, especially if this base is of slate.

(C) When you closed the switch again you probably jarred the detector, throwing it out of adjustment.

(D) When you make and break the battery circuit the tendency in most detectors is to make them more sensitive.

(E) Simple induction between the telephone wire and your aerial. This is explained fully in the February number of this magazine under a "Simple Wireless Telephone Set."

Quarter-Inch Spark Coil

Question.—Please give dimensions for a quarter-inch spark coil.—C. K., Chicago.

Answer.—Length of core, $3\frac{3}{4}$ inches; diameter of core, $\frac{3}{8}$ inch; primary wire, No. 23 B and S gauge; number of layers of primary coil, 2; secondary wire, No. 36 B and S gauge; number pounds secondary wire, $\frac{1}{4}$. Condenser: number of sheets, 40 (2 in. by $1\frac{1}{2}$ in.); battery voltage needed, 2.

How a Spark Coil Should Be Operated

Questions.—I am experimenting with wireless apparatus and have a zinc spark gap, no ground connection. (A) Should the zinc pieces be pointed? (B) Should a condenser be used on the receiving end, if so where should it be placed? (C) When I connect my condenser across the spark gap my coil gives a massive white spark, but will not work my receiving apparatus. When I disconnect the condenser it gives a small blue spark and works the receiver. Can you account for this?—E. P. B., Pataskala, Ohio.

Answers.—(A) If you use pointed terminals the spark will be longer than if round or flat pieces are used. A heavy, fat spark is best for wireless.

(B) See article "Condensers in the Receiving Circuit" in the Jan., 1910, issue.

(C) The condenser seems to be too large for the coil and is absorbing too much of the energy.

Tuning Coil

Questions.—(A) How much, what kind and what size of wire gives best results for a tuning coil? (B) How thick would the core be and how many turns should I make?—G. H. C., Washington, D. C.

Answers.—(A and B) About one-half pound wound on a wooden core two inches in diameter, and ten inches long, gives excellent results. Single or double cotton covered wire may be used, but we recommend enameled wire since it is easier to make the sliding contacts touch the wire at all positions, because of the ease with which the enamel insulation is removed. No. 20 wire is a good size, and will give you about 250 turns on the above coil.

Sending Helix with Double Winding

Question.—Is it possible to make a sending helix embodying a primary and secondary winding? If so, please give general directions for making same, also what are its advantages.—S. W., Indianapolis, Ind.

Answer.—Sending helices embodying a primary and a secondary winding are used to a small extent, and they have the same advantages as the variable coupling tuning coil or transformer. See article "A Variable Coupling Tuning Coil," January issue.

The primary may be wound on a fibre or glass tube four inches in diameter and ten inches long. The primary is of No. 10 hard drawn copper or brass wire, wound in a spiral, with consecutive turns one inch apart. The secondary winding, or No. 12 wire of the same material as the primary winding, is wound on a fibre or glass tube of an outside diameter of three inches and a length of twelve inches. Consecutive turns of this winding should be $\frac{3}{4}$ inch apart. Any kind of contacts the builder wishes may be used for both windings. Two contacts should be made for each winding.

Aerial Insulation

Question.—When I bring my aerial wire near the binding post of the spark coil I get about a half-inch spark. Is this caused by poor insulation on the aerial wire?—D. C., Henderson, Ky.

Answer.—This sparking between the aerial wire and the binding post of the coil is due to the fact that ordinary insulation is not sufficient for the high tension currents used in wireless work, and it shows the necessity of insulating the aerial and its leading-in wires very well. These wires should be supported by glass, porcelain, or other good insulating material at all points

where they might touch any conducting object.

Receiving Radius

Questions.—150 miles away is a commercial station, power .35 kilowatts, 1250 meter wave length. About 100 miles of this distance is over water. (A) Can I hear this station with the following outfit: electrolytic detector, tuning coil, fixed condenser, potentiometer, two 75-ohm receivers, a two-wire aerial 50 feet high and 75 feet apart? (B) What change in the above would be necessary, if any?—D. B., Ft. Myers, Fla.

Answers.—(A) You should have no difficulty in hearing the above station with your outfit.

(B) The use of a higher aerial or one consisting of three or four parallel wires will increase the receiving radius of the set.

Receiving Transformer

Question.—In a receiving transformer have the number of turns of wire on primary and secondary any relation to each other and is there a rule for the different gauges of wire on each?—T. S. R., Brooklyn, N. Y.

Answer.—The number of primary and secondary turns of a receiving transformer is generally about 2 to 3. There is no fixed rule for the different gauges on each, but the secondary generally is wound with wire from two to eight sizes smaller than the primary. Both these windings should be of fairly large wire, so as to decrease heat losses, which, although small, lower the efficiency of the instrument.

Operation of Spark Coil on 110 Volts

Questions.—(A) What apparatus would be necessary to enable me to use 110-volt alternating current on a one-inch spark coil? (B) What instruments would increase the receiving power of a silicon detector and a pair of 75 ohm receivers? (C) Does zinc make a better spark gap than brass?—E. S. G., St. Joseph, Mo.

Answers.—(A) Most one-inch coils can be run on 110-volt A. C. circuits without the use of any intermediate device, and in this case they are nothing more nor less than open core transformers. If you operate the coil in this way, you should screw down the interrupter tight, as otherwise you will burn up the contact points.

(B) The use of a good pair of 500-ohm telephone receivers in place of those you are now using will give you better results.

(C) Zinc is nearly always used for spark gaps by operating wireless companies, but personally we have found little difference between the efficiency of zinc and brass for this purpose.

QUESTIONS AND ANSWERS

Use of this department is free to readers of Popular Electricity, but attention will not be given to questions which do not comply with the following rules: All questions must be written in the form of a letter addressed to the Questions and Answers Department and containing nothing for the other departments of the magazine; two-cent stamp must be enclosed for answer by mail, for space will not permit of printing all answers; the full name and address of the writer must be given.

Twin Conductors; 500-Volt Wiring; Elevator Annunciator Diagram; Controlling Lights from Three Points; Measuring Wire

Questions.—(A) Under what conditions may twin conductors be used? (B) If called upon to increase the pressure on an old wiring system from 220 to 500 volts, what would be necessary in the way of changes on the old wiring? (C) Please make a sketch showing how to wire up an elevator annunciator for six floors. (D) Give diagram explaining how to control three hall lights from any one of three points. (E) A copper wire 1.25 inches in diameter. What is its circumference in inches? Its cross-sectional area in square inches? Its cross-sectional area in circular mils.—F. E. K., Asbury Park, N. J.

Answers.—(A) Quoting the National Electrical Code, Rule 24-d, "Twin wires

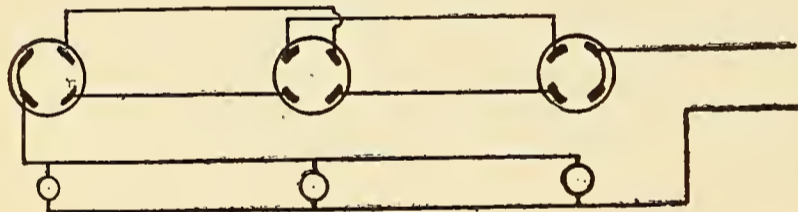

CONTROLLING LIGHTS FROM THREE POINTS

must never be used, except in conduits, or where flexible conductors are necessary."

(B) If you will refer to the Code, a copy of which may be obtained on request by writing to the Board of Underwriters in any large city, you will find that the general rules for wiring apply to low-potential systems and are the same for all voltages of over ten volts and less than 550 volts. We are assuming that this is not trolley current. Motors operating at 550 volts must be thoroughly insulated by wooden base frames, or have the motor casing permanently grounded. Switches and fuses would have to have spacing in accordance with the higher pressure. Switches are usually built for 126 to 250 volts, and for 251 to 600 volts, the spacings varying with reference to current carried also, Code Rule 52-1. Code Rule 53 covers this same point as to fuses.

(C) The diagram shows battery (B A T), common wire (C), and a return wire (R). From the middle point of the shaft the wires are run into a seven-wire cable which goes to the bottom of the car and up the side into the annunciator.

The return wire (R) is connected to one side of each drop magnet, and the other side of the coil is connected to the wire in the cable that corresponds to the number of the floor as noted on the face of the annunciator.

(D) See diagram. The outside switches are three-point, and the center switch a four-point.

(E) The circumference of any circle equals the diameter times 3.1416. 3.1416×1.25 inches = 3.927 inches, circumference. The area of any circle is one-fourth of the diameter squared multiplied by 3.1416. $\frac{1}{4} \times (1.25)^2 \times 3.1416 = 1.225$ square inches. The diameter of any wire expressed in thousandths inches if squared gives the cross-sectional area in circular mils. Hence, $(1250)^2 = 1,562,500$ circular mils area.

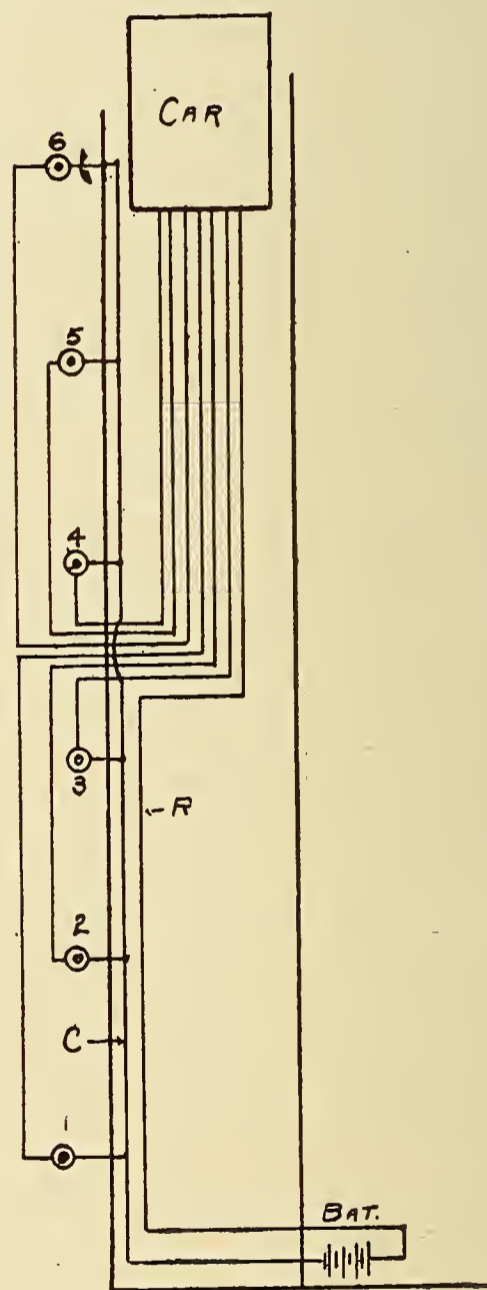

ELEVATOR ANNUNCIATOR DIAGRAM

Electric Apparatus for Removing Hair

Question.—Kindly describe how to make an electrical apparatus for removing hair from the face. I have a medical coil. Will it be of any assistance?—A. H. S., Brooklyn, N. Y.

Answer.—Your medical coil will be of no use in the construction of this apparatus, as the faradic current has no electrolytic effect. The current strength required to remove hair is that furnished by three or four dry cell batteries, which should be so adjusted by means of a rheostat that they can be thrown into the circuit one at a time. The best apparatus for this purpose is the galvanic wall-plate, or the portable dry cell galvanic battery, with a milliammeter to measure the exact amount of current, the required amount varying from ten to 30 milliamperes.

The method of application is to introduce a steel needle attached invariably to the negative pole of a galvanic battery, and pass this needle alongside of the hair down into its root, an average distance of perhaps 1-32 to 1-16 of an inch. The current is then turned on gradually in accordance with the amount of pain produced, up to not more than four dry cells, nor more than 30 milliamperes, if a meter is used. In a few seconds little bubbles will appear at the side of the needle, and after an application of from 20 to 30 seconds the current is turned off and the needle removed, when by taking hold of the hair with a pair of tweezers it should pull out easily from the skin. If it sticks and does not come out readily the needle should be introduced again and the process repeated. Its principle depends upon the production of an alkaline caustic by the negative pole which destroys the hair follicle, and when this has been successfully accomplished the hair comes out without requiring any force, and the end of the root will be found blackened by the action of the current. Too many hairs should not be removed at one time close together on account of making the spot too sore. The after-dressing should be some simple antiseptic such as peroxide of hydrogen. No scar will follow the use of the negative pole, but if the positive pole should inadvertently be used a firm scar will result and also the needle will stick in the skin and be difficult of removal. Owing to the fact that the hair often curves abruptly just below the surface of the skin, there will be some instances where the hair will be burned through, but the root not destroyed; these hairs will grow again.

Ampere-Hour Capacity of a Dry Cell

Question.—How long will a 2½ by 6 inches dry cell last on a 2½-volt miniature lamp if the lamp is burned only 10 or 15 minutes at a time?—A. D. C., Maysville, Ky.

Answer.—Dry cells vary somewhat as to voltage and current supplied depending on the make. The voltage of one cell is about 1.5. The new Excelsior dry cell, 2½ inches by 6 inches, is rated to give 6 to 8 ampere-hours; the extra quality cell to give 10 to 12 ampere-hours. Not knowing the make of your cell we cannot answer your question more definitely. It might be said further, however, that dry cells of the ordinary size should not be used where a current greater than .15 ampere is required. A 2½-volt lamp requires about 0.2 ampere, so that using the first cell above mentioned the lamp will be supplied with sufficient current at the proper voltage for 40 hours.

The capacity of a storage cell of battery is rated in ampere-hours. The normal rating for cells of battery accepted by all battery manufacturers is the number of amperes a cell is able to supply on discharge for eight hours. When we speak of a twenty-ampere cell we mean a cell that will deliver 20 amperes for eight hours, and the cell has a capacity of 160 ampere-hours.

Double-Pole, Double-Throw Switch

Question.—What is a double-pole, double-throw switch.—H. D., Mishawaka, Ind.

Answer.—A double-pole, double-throw switch is a two-blade knife switch usually installed so as to be operated in a horizontal position. Contact jaws at the left and another pair at the right are provided. This switch may be used when two sources of current enter a building, the blade studs being connected to the motor or light mains. Throwing the switch to the left uses current from one source, and to the right connects to the second source.

Making a Small Storage Battery

Question.—Please give information regarding the construction of a small storage battery.—E. E. H., Minneapolis, Minn.

Answer.—To make a storage battery after the type of the Plante cell, get two plates of thin sheet lead about 1-16 inch thick, 36 inches long and six inches wide. At the end of each plate fuse a lug. The plates should be roughened on both sides by pounding with a coarse file. Next get some rubber at least ¼ inch thick or more, and cut into

$\frac{1}{2}$ inch strips. Lay three of these strips on one plate and upon these strips place the other plate. On top of this plate place three more rubber strips. Next make a cylinder of wood one or two inches in diameter and a little longer than the plates are wide, and soak with paraffine. On this cylinder roll the lead plates and hang in a glass or porcelain jar. In the jar place ten parts of water and one part sulphuric acid. Next the forming process must be applied. This consists in charging the battery in one direction up to about 1.9 volts, then reversing the current and charging in the other direction. After this has been done several times the plates become spongy and their surface is increased. Now mark one terminal positive (+) and always charge thereafter in but one direction. Ordinarily the discharge rate of a storage cell is .04 ampere per square inch of surface of positive plate, considering both sides of the plate, and the discharge may be figured about four ampere-hours per pound using the total weight of both plates as a basis.

Electric Current for Destruction of Moles and Warts

Question.—How is electric current applied to destroy moles and warts?—C. C. D., Georgetown, Ohio.

Answer.—In the removal of moles, warts and other small growths by the galvanic current the negative pole is always employed. A steel needle is used in a handle supplied by the manufacturers for purpose of electrolysis, and the wart or mole is transfixed by the needle, at its base, on a level with the surface of the surrounding skin. The current is then turned on gradually to the extent of possibly 30 or 40 milliamperes of current, if a milliammeter is employed, which is preferable. The current is allowed to pass for a minute or a minute and a half, depending on the size of the growth, and the quantity of bubbles that appear alongside of the needle, showing its activity. The needle then should be withdrawn partially from the growth and thrust in at a somewhat different angle, until the whole base of the growth has been subjected to the electrolytic effect of the alkaline caustic, which the negative pole liberates.

Sometimes it is found convenient to turn off the current, withdraw the needle and then introduce it again at right angles, and allow the current to pass as before. The object

of this process is to destroy the blood vessels supplying nourishment to the growth, when it will shrivel and fall off in a few days. If the growth has a small stem it is much more easily destroyed than when it is flat with a broad base. The growth whitens out as the current passes through it, but afterwards becomes black and shrivels up. No treatment is necessary after the needle is removed other than the simple application of peroxide of hydrogen. If the first treatment has not been sufficient, a second treatment may be applied at the end of five or six days.

Transformer Questions; Two-Phase Operation; Low-Voltage Lamps

Questions.—(A) In a toy transformer from which a number of voltages can be obtained, is the wattage consumed always the same regardless of the voltage used? (B) In a large transformer does the amperes consumed on the secondary change the amperes flowing in the primary? (C) Can an ammeter be placed on the primary circuit to show the amperes consumed in the secondary? If so, how is it possible, for as I understand, there is no connection between the primary and secondary coils? (D) Would either pair of a two-phase circuit be considered single phase? (E) If a motor operates on two-phase, must the current be brought from two transformers? (F) If the current from each transformer were 110 volts, would the above motor be called a 110-volt, two-phase, or a 220-volt, two-phase, motor? (G) What voltage is best for isolated plants where storage batteries are used? (H) Are low voltage lamps as economical as high voltage lamps?—P. J. F., Sigourney, Iowa.

Answers.—(A) Large transformers have a higher efficiency than small ones. On full load a one kilowatt transformer has an efficiency of about 95 per cent, while a 15 kilowatt transformer has a tested efficiency of 97 per cent. The efficiency of any transformer is very low when the energy delivered is small; this efficiency increases as the output increases and reaches a certain maximum. Beyond this point the efficiency decreases because of the increase in the copper losses. The wattage taken by any device depends upon its resistance, and the voltage improved upon its resistance, the current being thus determined.

(B) Any change of current taken from the secondary of a transformer produces a proportional change of current flow in the primary.

(C) Yes. The readings will however have to be corrected or rather reduced for the efficiency of the transformer; that is, for the core losses, in order to show the second-

ary current. In other words it would be necessary, if accuracy is desired, to know the efficiency of the transformer for the loads on which readings are desired.

(D) Two-phase alternators have two similar and independent single-phase windings on the same armature, so placed that when the electromotive force in one winding is at its highest, the electromotive force in the other winding is zero. Two-phase machines are usually provided with two sets of collector rings, one set for each phase.

(E) By one arrangement a transformer is connected to each phase and secondaries are run to each phase of the motor. Both phases are independent throughout. This plan is used on a two-phase four-wire system.

(F) The motor would be rated according to the voltage between the two wires of one phase.

(G) The answer to this question will depend upon the amount of money to be invested in a storage battery equipment. Cells should not be discharged below 1.75

volts. For a 110-volt system $\frac{110}{1.75} = 63$ cells

would be required. Batteries are most used in connection with two-wire and three-wire, 110-volt or 220-volt direct current systems.

(H) Yes, practically so, if operated at their rated voltage. Any given type of lamp made in various sizes for varied candle-powers is rated in watts per candle-power.

Phase; Lamps in Series; Spark Gap

Questions.—(A) What does the word "phase" mean in electricity? (B) What number of lamps in series are needed to reduce 110 volts to 50 volts? (C) How can the voltage of a dynamo be increased? (D) What voltage does it take to make electricity jump across an air gap?—C. H., Pheonixville, Pa.

Answers.—(A) The word "phase" is used to denote relation. To illustrate, suppose two channels connecting with the sea, one channel narrow and rugged, the other smooth and deep. As the tide ebbs and flows in these two channels, the difference between the high and low tide in the first channel will be greater than in the second. We may speak of this as lag in phase of the tide in the first behind the tide in the second channel. Alternating currents, as they flow, build up and tear down magnetic fields. This is called self-induction. Because of it,

the alternating current in any wire lags behind the electromotive force. This again is a lagging in phase of the current behind the E. M. F. If two separate coils be wound on an armature and their ends be connected to four slip rings, two single phase circuits are formed differing in phase according to their relative position on the armature.

(B) It will depend upon the voltage of the lamps. Two 30-volt lamps will do the work. Why not use one 52 volt lamp. This will allow 62 volts at the terminal of the circuit, and this lamp is more common than lamps of smaller voltages.

(C) By increasing the number of turns in each coil on the armature, and by decreasing the resistance of the field coils by using larger wire, thus increasing the flux.

(D) See answer to A. R. H. in the September, 1909, issue.

Changing a Magneto Generator to a Motor

Question.—I have an A. C. dynamo and wish to make it an A. C. motor (110 v.). It is very much like a magneto. An armature wound with No. 36 silk covered wire revolves between two permanent magnets. Please give size of wire, etc.—H. L. S., Lewiston, Idaho.

Answer.—You do not give sufficient data for an intelligent answer. We doubt if your machine will operate as a motor at all. If the armature has a single pair slot as in a telephone magneto you cannot make a motor of it. Before wasting time on it, connect it in series with an eight or sixteen candle-power lamp with your available source of A. C. current. If it won't run you cannot make a motor of it. If it does run, disconnect it and then find out what voltage it gives as a generator. Then count the number of turns of wire on the armature and take off or add to the turns proportionally to give 110 volts.

Rewinding a 52-Volt Induction Motor for 110 Volts

Question.—I have a 52-volt 60-cycle induction motor, $\frac{1}{8}$ h. p. The stator has 36 slots and is wound with $1\frac{1}{4}$ pounds of No. 21 D. C. C. wire, 900 turns in all. Please give me the data for re-winding the same for 110 volts 60 cycles.—A. Z., Detroit, Mich.

Answer.—Rewind with 1904 turns of No. 24 D. C. C. wire.

Note that 900 is not an even multiple of 36.

NEW ELECTRICAL INVENTIONS

Electric Hair Dryer

This hair-drying device, which is the invention of W. A. Soles of New York City, is designed for use in hair-dressing establish-

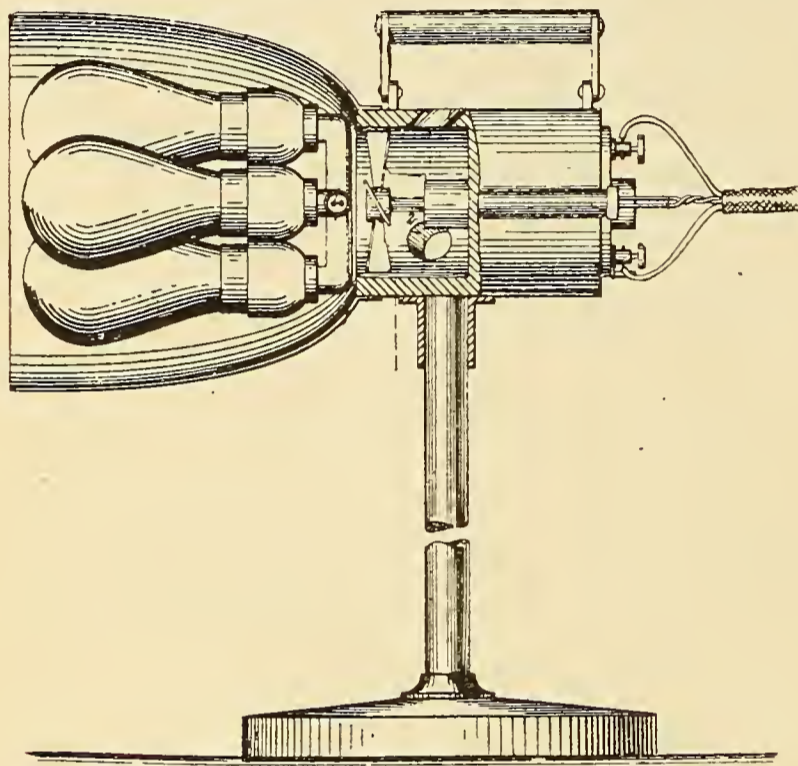

ELECTRIC HAIR DRIER

ments, barber shops, etc. It is arranged to insure drying of the hair by heated air and under the invigorating influence of artificial light. As seen by the cut there is a sort of bell-shaped reflector containing three incandescent electric lamps, immediately behind which is mounted a small electric motor driven fan. The air is thus projected outwardly over the lamps and heated in the passage to a considerable degree.

Theater Without Usher

To facilitate seating of the audiences of moving-pictures theaters and other amusement halls where there are no reserved seats Paul T. Kenny of New York City has patented a system of electric lamp signals to designate unoccupied seats. The house is so arranged that the visitor must travel certain aisles to get to certain rows of seats. Each seat is provided with a lamp which remains lighted as long as the seat remains unoccupied. As fast as the seats

are occupied the lamps go out. The lamps being adjacent to each row of seats in a section the unoccupied seats are determined at a glance. When each section is full a turnstile in the aisle leading to that particular section is automatically locked. When one or more seats are vacated and persons wish to leave, the turnstile is unlocked. All the seats are connected by circuits with a signal board in the ticket seller's booth and as soon as all the seats are occupied



THEATRE WITHOUT USHERS

the ticket seller sees it at a glance and the "All Seats Occupied" sign is displayed.

Novel Light Diffuser

The latest type of light diffuser for in-

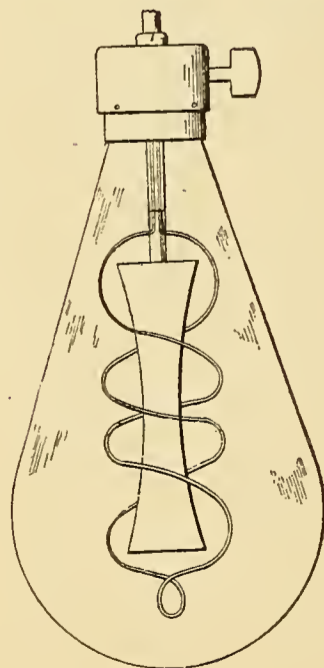

NOVEL LIGHT DIFFUSER

candescent lamps is contained within the bulb. As shown in the diagram the filament is mounted spirally around a hollow glass body having a concave surface. The faces are covered on the inside with a reflecting substance. The bottom of the reflector is also concave and reflects a certain percentage of the light downward. Charles H. Crutchfield of New Boston, Tex., is the patentee.

Notes on Patent Infringement

By OBED C. BILLMAN, LL. B., M. P. L.

Of Patents for Designs; Of Patents for Machines; Of Patents for Manufactures;
Of Patents for Processes

Of Patents for Designs.—*In General.*

—A design patent is infringed by a subsequent design which presents substantially the same appearance or produces the same effect upon the eye. The method by which the similarity of appearance is produced is immaterial. Where substantial identity of appearance exists, it is of no consequence that the figures in the infringing design are smaller than in the patented design.

Use of Part.—The taking of a part of a patented design may be an infringement, provided the part taken is covered by the patent. But where the patent is for a combination of old parts with new, it is not infringed by the taking of the old parts only, and the substitution for the new parts of others which are not equivalent thereto.

Test of Identity.—The test to be applied is not the eye of an expert, but that of an ordinary observer giving such attention as is ordinarily given by purchasers of the article which embodies or contains the designs. Hence, if such a person would be deceived into buying one article, supposing it to be the other, the design first patented it infringed by the latter, notwithstanding differences in detail between the two. But if such a person would not be so deceived, there is no infringement, despite the fact that the differences are slight. This rule has been construed to mean that the purchaser must be one giving special attention to the design and not to the article simply.

Use of Different Name or Trade Mark.—The use of a different name or trade mark in connection with an infringing design does not render it any the less an invasion of the patentee's exclusive right.

Of Patents for Machines.—*In General.*

—A patent for a machine is infringed by a subsequent machine which is substantially identical therewith, notwithstanding colorable, evasive, or formal differences between the two machines, that is, by an arrangement of mechanism which performs the same services and produces the same result by substantially the same means, operating in the same or substantially the same manner.

No Matter How Closely Infringement May be Approached, it is avoided if the substance of the patented machine is not taken. Thus, a machine is not an infringement when it performs substantially different functions, or performs the same functions in a substantially different way, or produces a substantially different result.

Identity of Principle.—Substantial identity exists when the alleged infringing machine embodies the principle of the patented machine. Where there is diversity of principle there is no infringement. When used in this sense "principle" means "mode of operation," or, in other words, the operative cause by which a certain effect is produced.

In Applying this Test of Infringement, inquiry should be directed to those parts of the machine which really do the work, so as not to attach undue importance to other parts which are only used as a convenient mode of constructing the entire machine.

Identity of Effect or Result.—Identity of effect or result does not constitute infringement unless it is produced by the same or substantially similar means. But where there is identity of means it is sufficient if the result is the same in kind though not in degree.

Substitution of Equivalents.—The substitution of a known mechanical equivalent for one or more of the devices or parts of the patented machine is an evasive difference, insufficient to avoid infringement.

Of Patents for Manufactures.—*In General.*

—A patent for a manufacture is infringed by a subsequent manufacture which is substantially identical therewith, that is, which serves the same purpose and accomplishes the same thing by the use of substantially the same means operating in substantially the same manner—notwithstanding formal or colorable differences, such as the substitution of equivalents.—But there is no infringement when there is a substantial difference in purpose, means, mode of operation, or result.

Use of Different Materials.—When a patent is limited to an article made of a speci-

fied material, it is not infringed by any similar article made of a different material.

Identity of Process.—A patent for a product produced by a particular process is not infringed by a similar product produced by a substantially different process.—But if the patent covers the product only, and not the process, it is infringed by a substantially similar product produced by an entirely different process.

Of Patents for Processes.—In General.—A patent for a process is infringed by a subsequent process which invokes the same principle, and accomplishes the same result by the use of the same or substantially the same means. Where the substance or essence is taken, infringement is not escaped by colorable or evasive changes.

Identity of Means.—A patent for a process is not infringed by a subsequent process which accomplishes the same or a similar result by the use of substantially different means. Hence the identity of two processes is not established by the similarity of their products, although such similarity may tend to prove identity. But if the patented invention is substantially taken, infringement is not avoided by a mere variance from the best manner of practising it.

Use of Part and Substitution of Equivalents.—A process which omits one or more characteristic features or essential steps of the patented invention without substituting equivalents therefor does not infringe. But it does infringe if a step is only colorably omitted, or if a known equivalent is substituted for an omitted step. A process which produces the result contemplated by the patentee of a prior patented process, by the use of only such of the described means as are essential to that end, is an infringement.

Transposition of Steps.—A mere transposition in the order of the successive steps of a patented process is sufficient to avoid infringement.

Addition of Steps.—The use of a patented process is none the less an infringement because of the employment of something else in addition thereto.

Use of Different Apparatus.—Where a patented process is neither dependent upon, nor limited to any specific apparatus or machinery for carrying it into effect, it is infringed by the use of different apparatus for practising the same process even though such different apparatus is patentable as an improvement.



MAVERS' WIRELESS TELEGRAPHY AND TELEPHONY. By William Maver, Jr. New York: Maver Publishing Company, 1910. 366 pages with 258 illustrations. Price \$3.00.

This is the fourth edition of Mavericks' valuable book and it is thoroughly abreast of the times. While the theory of wireless communication is by no means slighted the author has paid particular attention to the practical side of the subject and has made a work which is excellent alike for the practical worker and the student. There are practical descriptions of the latest improvements in wireless telephony and telegraphy with excellent diagrams to enable the reader to follow out and make and connect up apparatus. An Amateur Department has also been added in this last edition, which will be found of great assistance by the young experimenter who wishes to build his own equipment.

Each subject has been treated both from a theoretical and a practical standpoint in simple language and without mathematics. The result is a comprehensive account of the history, theory, apparatus, practical operation, practical applications and prospects of wireless telegraphy, which it is thought cannot fail to be instructive and profitable to the technical student, the general reader and the investor.

DYKE'S TROUBLES, REMEDIES AND REPAIRS OF THE AUTOMOBILE AND GAS ENGINE. By A. L. Dyke. St. Louis: A. L. Dyke, 1909. 308 pages with 320 illustrations.

This covers the automobile question from leather top to tire and everything in between—engines, engine troubles, ignition systems, lighting systems, accessories, etc. It tells how to choose cars for different requirements, how to discriminate among second-hand cars, how to prepare your car for the road, how to drive it, how to "baby" it, how to use stern measures, when to coax it, when to command it. Then there's a very useful feature embodied entitled the "Workshop and Motor House." Almost every man that really enjoys a car also likes to tinker around in a shop of his own. This chapter has some very good hints on simple shop practice.

ON POLYPHASE SUBJECTS

AFTER TWO YEARS

This issue completes the first two volumes of Popular Electricity. Thousands of our readers have been with us practically from the first and we are sure that they will agree that there has been a steady improvement in the magazine. To them and to later subscribers we hold forth the promise that greater improvements are forthcoming.

In the first place the volume of reading pages will be increased, indeed ten additional pages have already been added in this issue, and in the March issue, while plans are in progress which will make necessary further enlargement before the third volume is completed.

Although in a magazine of the character of Popular Electricity the things of scientific and practical interest relating to the production and use of electric current must be given the place of primary importance, still, we believe, there is also a place for a limited amount of material of a fictional nature—a good serial story and some short stories now and then. As a consequence, the May issue, beginning a new volume, will contain the first installment of an electrical story by Edgar Franklin, who needs no introduction to the general magazine reader. This story will tell of the thrilling experiences of two young Americans in a little Wisconsin town, who start out to build and operate an electric light plant as a business venture and for the general betterment of conditions in the community. Of course, they run into unforeseen difficulties and are all but down and out when a startling discovery is made which brings them out triumphant. This story, as well as others which are to follow, is necessarily based upon an electrical subject.

“Electrical Securities” is a subject upon which most people are not as yet fully informed. Over a billion dollars is invested in the electric lighting industry in this country. The number of plants is steadily increasing, and of the immense capital required a good portion must come from the small investor. It is well, therefore, to make a study of electrical securities and find out just what they represent and how they stand in the financial world. In this issue begins a series of articles under the above title which will tell in “Plain English” the facts concerning this form of investment.

Readers of the Wireless Department will be pleased to know that a serial article is in hand by Alfred P. Morgan which will tell how to build a complete high power sending and receiving equipment; one which will compare favorably with commercial apparatus. This will begin in the May issue.

In response to a query printed in this department in the February issue many requests have been received to publish the electrical definitions in a serial form; that is, print different ones each month, with more elaborate explanations, until finally, by saving the copies, a fairly complete electrical dictionary may be obtained. This will be done and the most frequently employed electrical terms fully defined.

Biographical sketches of “Electrical Men of the Times” will be continued from month to month, lending inspiration to the younger element to emulate those who have been conspicuously successful in the electrical field.

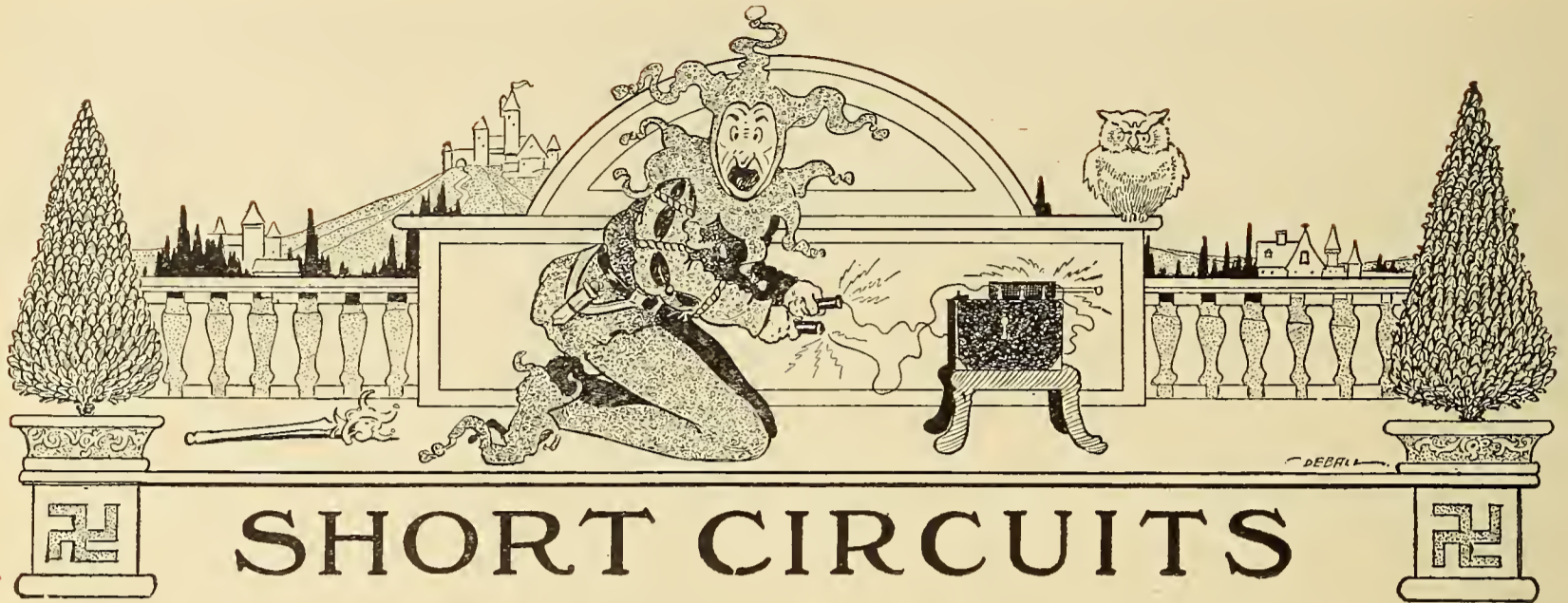

SHORT CIRCUITS

A man who had been sojourning in an insane asylum had just been pronounced cured and told he could start for home in a day or two. He sat down immediately and wrote a letter telling the joyful tidings. Moistening a stamp to place on the envelope he dropped it accidentally, only to see it shoot across the floor, up the wall and across the ceiling. With an air of great dejection he sat down, pulled out the letter and added a postscript: "Oh hang it! I can't come home. I'm crazier'n ever."

The stamp had fallen on the back of a roach.

* * *

A young woman from the city had been staying on a ranch up in the cattle country for a few weeks. Seeing some calves running across a pasture, she exclaimed, "Oh! what pretty cowlets."

"Yes, miss," drawled the ranchman, pulling his mustache to conceal a smile, "they are pretty, but them's bullets."

* * *

Miss Up-to-date—I want to see some of the latest costumes.

Floor Walker—Have a seat, Madame, and wait a few moments—The style is just changing.

* * *

Teacher: Johnny, can you tell me how iron was first discovered?

Johnny: Yes sir.

"Well! Just tell the class what your information is on that point."

"I heard father say yesterday that they smelt it."

* * *

"Come indoors immediately!" called the nurse to a small boy whose father was going out. "You won't go to heaven if you're so naughty."

"I don't want to go to heaven," was the aggrieved reply; "I want to go with father!"

* * *

"Why don't you go on the picnic?"

"Ah, I'm too tired. Let's soak a few sandwiches in emonade and eat 'em on the kitchen floor."

* * *

Three Irishmen were stopping at a second-rate hotel and one of them imbibed so freely at the bar that he had to be carried to his room, in which also slept a negro in a separate bed. His comrades, as a practical joke on him, proceeded to paint the Irishman's face black. In the morning when awakened by the proprietor, he got up and happened to catch sight of himself in the mirror. "Oh, bejabers," he exclaimed, "if the blamed idiots haven't gone and woke the darky by mistake!"

And he crawled back into bed.

* * *

Elsie—Why is Clara always so short of money—didn't her father leave her a lot?

Madge—Yes; but, you see, she's not to get it till she's thirty, and she'll never own up to that.

* * *

Most southerners are gallant. An exception is the Georgian, who gave his son this advice:

"My boy, never run after a woman or a street car—there will be another one along in a minute or two."—Everybody's.

The venerable farmer with the tobacco-stained whiskers and furrowed brow climbed aboard the limited and shambled into the smoker.

"Mister," he drawled, when the conductor halted before him, "is that thar two-cents-a-mile rate good on this train?"

"It is," replied the conductor brusquely. "Where is your ticket?"

The old man fumbled in the depths of an ancient shot-bag.

"Ain't got no ticket, mister," he said slowly, "but here is two cents. I never rode on one of these pesky fliers, and I just want to feel the sensation. Put me off after I've rode one mile."

* * *

Milton—Gibson doesn't seem to be getting rich at poultry raising.

Bilton—No; but he says his hens have taken to eating their own eggs, and he has hopes that they'll become self-supporting.

* * *

It was on a Superior street car, and the handsome young man had arisen from his seat as the pretty girl entered.

"Oh, please!" she twittered, "don't get up. Keep your seat, pray do!"

The young man looked at her admiringly.

"Well, that's mighty sweet of you, little girl," he said, "and I hate to turn down a bid like that. But, honest, we've got an important date, and here's where I get off. Call me up by 'phone some day, won't you?"

When we left the car she was still blushing.

* * *

Examination papers always provide a fund of amusing reading. Following are some of the slips of school boys:

"George Eliot left a wife and children to mourn his genii."

"The capital of Russia is St. Petersburg on the Duma."

"Henry I died of eating palfreys."

"Louis XVI was gelatined during the French revolution."

"If the air contains more than 100 per cent of carbolic acid it is very injurious to health."

"The earth is an obsolete spheroid."

"A deacon is the lowest kind of a Christian."

"Horse power is the distance one horse can carry a pound of water in an hour."

* * *

Judge—You are a taxpayer.

Talesman—Yes, sir; I am.

Married or single?

Married three years last June.

Have you formed or expressed any opinion?

Not for three years, your honor.

* * *

Mr. Jones had recently become the father of twins. The minister stopped him on the street to congratulate him.

"Well, Jones," he said, "I hear that the Lord has smiled on you."

"Smiled on me," repeated Jones. "He laughed out loud at me."

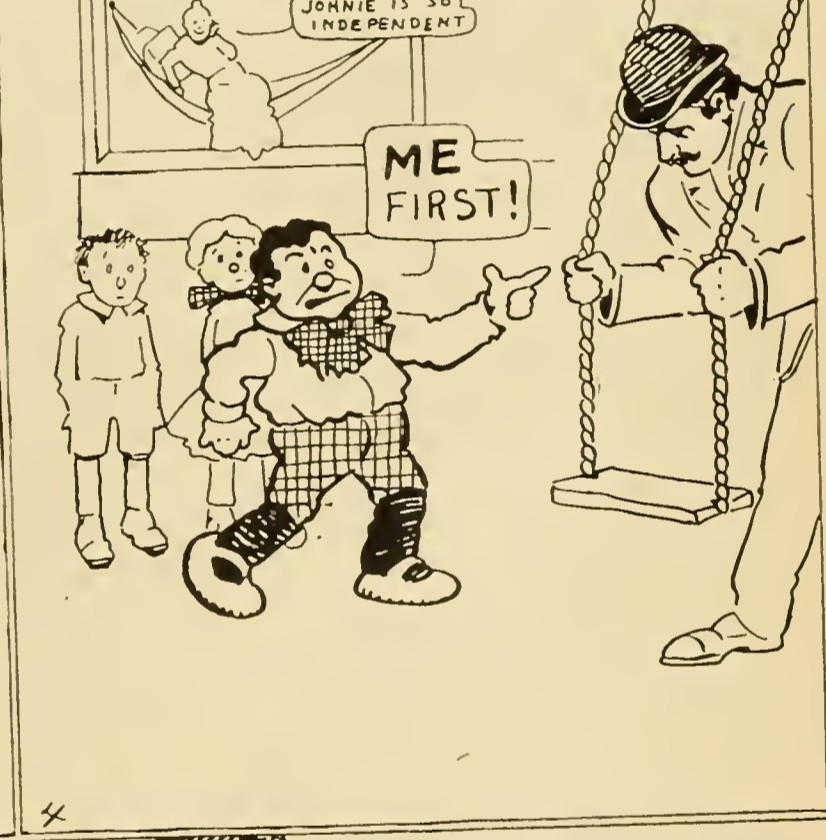

ELECTRICAL DEFINITIONS

Below are defined a few of the most common electrical terms. They are reprinted from month to month and will be of assistance in understanding the magazine text

- Accumulator.**—See secondary battery.
- Alternating Current.**—That form of electric current the direction of flow of which reverses a given number of times per second.
- Ammeter.**—An instrument for measuring electric current.
- Ampere.**—Unit of current. It is the quantity of electricity which will flow through a resistance of one ohm under a potential of one volt. The international ampere is the current which, under specified conditions, will deposit .001118 gram of silver per second when passed through a solution of nitrate of silver in water.
- Ampere Hour.**—Quantity of electricity passed by a current of one ampere flowing for one hour.
- Anode.**—The positive terminal in a broken metallic circuit; the terminal connected to the carbon plate of a battery.
- Armature.**—That part of a dynamo or motor which carries the wires that are rotated in the magnetic field.
- Brush.**—The collector on a dynamo or motor which slides over the commutator or collector rings.
- Bus Bars.**—The heavy copper bars to which dynamo leads are connected and to which the outgoing lines, measuring instruments, etc., are connected.
- Buzzer.**—An electric alarm similar to an electric bell, except that the vibrating member makes a buzzing sound instead of ringing a bell.
- Candle Power.**—Amount of light given off by a standard candle. The legal English and standard American candle is a sperm candle burning two grains a minute.
- Capacity, Electric.**—Relative ability of a conductor or system to retain an electric charge.
- Charge.**—The quantity of electricity present on the surface of a body or conductor.
- Choking Coil.**—Coil of high self-inductance which retards the flow of alternating current. See self-inductance.
- Circuit.**—Conducting path for electric current.
- Circuit-breaker.**—Apparatus for automatically opening a circuit.
- Collector Rings.**—The copper rings on an alternating current dynamo or motor which are connected to the armature wires and over which the brushes slide.
- Commutator.**—A device on a dynamo shaft for gathering the circuit from the various coils of the armature and sending it out over the line as direct current. On a motor it takes current from the line and passes it on to the armature coils.
- Condenser.**—Apparatus for storing up electrostatic charges.
- Cut-out.**—Appliance for removing any apparatus from a circuit.
- Cycle.**—Full period of alternation of an alternating current circuit.
- Dielectric.**—A non-conductor.
- Dimmer.**—Resistance device for regulating the intensity of illumination of electric incandescent lamps. Used largely in theaters.
- Direct Current.**—Current flowing continuously in one direction.
- Dry Battery.**—A form of open circuit battery in which the solutions are made practically solid by addition of glue jelly, gelatinous silica, etc.
- Electrode.**—Terminal of an open electric circuit.
- Electromotive Force.**—Potential difference causing current to flow.
- Electrolysis.**—Separation of a chemical compound into its elements by the action of the electric current.
- Electromagnet.**—A mass of iron which is magnetized by passage of current through a coil of wire wound around the mass but insulated therefrom.
- Farad.**—Unit of electric capacity.
- Feeder.**—A copper lead from a central station to some center of distribution.
- Field of Force.**—The space in the neighborhood of an attracting or repelling mass such as a magnet or a wire carrying current.
- Fuse.**—A short piece of conducting material of low melting point which is inserted in a circuit and which will melt and open the circuit when the current reaches a certain value.
- Generator.**—A dynamo.
- Inductance.**—The property of an electric circuit by virtue of which lines of force are developed around it.
- Insulator.**—Any substance impervious to the passage of electricity.
- Kilowatt.**—1,000 watts. (See watt.)
- Kilowatt-hour.**—One thousand watt hours.
- Leyden Jar.**—Form of static condenser which will store up static electricity.
- Lightning Arrester.**—Device which will permit the high-voltage lightning current to pass to earth, but will not allow the low voltage current of the line to escape.
- Motor-dynamo.**—Motor and dynamo on the same shaft for changing alternating current to direct and vice versa, or changing current of high voltage and low current strength to current of low voltage and high current strength and vice versa.
- Multiple.**—Term expressing the connection of several pieces of electric apparatus in parallel with each other.
- Neutral Wire.**—Central wire in a three-wire distribution system.
- Ohm.**—The unit of resistance. It is arbitrarily taken as the resistance of a column of mercury one square millimeter in cross sectional area and 106 centimeters in height.
- Parallel Circuits.**—Two or more conductors starting at a common point and ending at another common point.
- Polarization.**—The depriving of a voltaic cell of its proper electromotive force.
- Potential.**—Voltage.
- Resistance.**—The quality of an electrical conductor by virtue of which it opposes the passage of an electric current. The unit of resistance is the ohm.
- Rheostat.**—Resistance device for regulating the strength of current.
- Rotary Converter.**—Machine for changing high-potential current to low potential or vice versa.
- Secondary Battery.**—A battery whose positive and negative electrodes are deposited by current from a separate source of electricity.
- Self-inductance.**—Tendency of current flowing in a single wire wound in the form of a spiral to react upon itself and produce a retarding effect similar to inertia in matter.
- Series.**—Arranged in succession, as opposed to parallel or multiple arrangement.
- Series Motor.**—Motor whose field windings are in series with the armature.
- Shunt.**—A by-path in a circuit which is in parallel with the main circuit.
- Shunt Motor.**—Motor whose field windings are in parallel or shunt with the armature.
- Solenoid.**—An electrical conductor wound in a spiral and forming a tube.
- Spark-gap.**—Open space between the two electrodes of a spark coil or resonator.
- Storage Battery.**—See secondary battery.
- Thermostat.**—Instrument which when heated, closes an electric circuit.
- Transformer.**—A device for stepping-up or stepping-down alternating current from low to high or high to low voltage, respectively.
- Volt.**—Unit of electromotive force or potential. It is the electromotive force which, if steadily applied to a conductor whose resistance is one ohm, will produce a current of one ampere.
- Volt Meter.**—Instrument for measuring voltage.
- Watt.**—Unit representing the rate of work of electrical energy. It is the rate of work of one ampere flowing under a potential of one volt. Seven hundred and forty-six watts represent one electrical horse power.
- Watt-hour.**—Electrical unit of work. Represents work done by one watt expended for one hour.

\$1000 Invested in Western Union Yielded \$150,000.00

An investment of \$100 in Bell Telephone when the company was first organized has paid \$201,000 in cash dividends.

Edison Electric jumped from \$100 to \$4,000 a share in twelve months.

No other class of investment has paid early investors such huge dividends as telegraph and cable stocks. And without exception, everyone who bought these stocks on a ground floor basis and held on, reaped large fortunes.

You have the opportunity *now* of securing an investment that will earn for you even greater dividends than the foregoing companies paid early investors.

This opportunity is open to you in THE TELEPOST—the wonderful system of automatic telegraphy that is rapidly superseding all other methods.

Every year over 100,000,000 messages are handled by the telegraph companies. The combined profits of these companies approximate \$9,000,000 to \$12,000,000 annually.

Yet The Telepost sends *more words per minute over one wire* than all the other companies can send

over 65 wires. The Telepost rates are the cheapest in the world. The maximum being but *one cent a word*.

Just as with postage, distance is not considered in the Telepost charges. A twenty five-cent message nets the Telepost Company fourteen cents profit. Other companies make but three and one-half cents a message. The Western Union's latest report shows five and one-sixth cents a message. This is a liberal estimate.

On this basis the Telepost Company will earn enormous profits, exclusive of the overwhelming amount of new business which, by reason of its superior service and greatest economy, the Telepost must command.

No other enterprise ever showed an investor such enormous and certain future profits. For never before has the public been offered such liberal inducements to become interested in a public service enterprise on a basis that will entitle investors to a share in the immense dividends that the Telepost Company will soon be earning.

Telegraph companies as a rule have been owned by a few people who receive all the enormous income.

THE TELEPOST

(The Independent Telegraph Company)

The Telepost is not a project. Nor is it a possibility. Today it represents an income-producing property. It is *actually* in public service operation in different parts of the country, East and West.

The Telepost sends as many as 1,000 to 1,800 words a minute. Under the old system 15 words a minute is a generous average.

Mechanism has finally succeeded human effort in the dispatching of telegrams. And the change means *profit* to you whether or not you seize this once-in-a-lifetime opportunity to get your share in Telepost earnings.

100 Words for 25 Cents

The Telepost will soon have entirely superseded the telegraph. Telegraphic communication will be as ordinary as communication by mail. For as many as 100 words may be sent by Telepost *to any part of the United States for 25 cents*.

Not only will personal communication anywhere be made a matter of minutes, but the world will be better informed. No longer need news matter be a matter of scant information, elaborated upon. But complete and accurate information will be possible with the economy of time and expense the Telepost affords.

So extensive is the field of the Telepost that space forbids further explanations of it wonders. It is enough to say that it stands today as a *revolution of vital conditions*. And you will profit by the change if you'll investigate it further.

It Will Pay You to Learn More

Upon request you will be sent complete details. Also absolute proof of the Telepost's splendid success wherever it is in use today. A postal will bring you full information on this subject.

This is your time to turn impulse into action—to secure a comfortable income—to become independent. But you must not delay. To neglect further investigation may mean to you the loss of a life-long opportunity.

And you'll realize this when the use of the Telepost becomes *universal*—at no far distant date. Do not think that we are urging you to a quick decision. It simply means that you must hurry your inquiry, because early investors have a considerable advantage.

Write today for Telepost Booklet, No. 381, which is fully explanatory.

STERLING DEBENTURE CORPORATION

Brunswick Bldg., Madison Sq., New York



Mere Wishing Won't

Envy the boss or the men who are in touch with him *will not bring you promotion.* You must have ambition backed by the *training* that brings you under the chief's notice—that makes you a *factor* in the business rather than a mere worker.

You can easily acquire such a training. Other poorly-paid but ambitious men have overcome greater obstacles than those which beset you, and have reached well-paid positions through the help of the International Correspondence Schools of Scranton. The attached coupon will bring you a complete solution to the problem. Mark it. Doing so places you under no obligation to go to any expense.

Think of the greatest *practical* training institution in the world *going to you,* no matter where you live, and training you in *your spare time,* without requiring

How The I. C. S.

I enrolled for my I. C. S. Course when employed as a telegrapher. I am still holding a position at the same occupation, but my salary has been increased \$25.00 per month since I started my Course.

LOUIS A. WOOD,
441 Brook St., Galesburg, Ill.

While employed as a machinist I enrolled for my Course in the I. C. S. After devoting some time to study under your direction I secured a position as Detail Designer. I am now a Mechanical Draftsman and have tripled my salary since enrolling.

CHAS. H. ROCHEFORT,
1135 E. Dunning Street,
Jackson, Mich.

When I enrolled in your Schools I was employed as a shop hand for the Pennsylvania Railroad Company. I am at present employed as a Draftsman for the master carpenter. My earnings have been increased \$20 per month. I think very highly of your Institution.

HERBERT A. LANDIS,
P. O. Box 25, Altoona, Pa.

To a very large extent my I. C. S. Course is responsible for my advancement from a position as lineman to Chief Inspector of the Tri-State Telegraph and Telephone Company. I am now earning \$25 a month more than I did when I enrolled.

CLIFTON O. BONHAM,
663 Hague Ave., St. Paul, Minn.

I was a laborer when I enrolled for my I. C. S. Course. I then secured a position as helper for the engineer at Butler Bros., and secured an increase in salary of over 100 per cent. The knowledge gained from my Course is responsible for my advancement and I would recommend the I. C. S to any ambitious man.

ARTHUR PETERSON,
770 Case St., St. Paul, Minn.

When working as a loom fixer at Racine, Wis., I enrolled for an I. C. S. Course. My previous education was quite limited. I am now Boss Weaver at the La Porte Woolen Mills and have materially increased my earnings.

WILLIAM TROUSDALE,
216 Second St., La Porte, Ind.

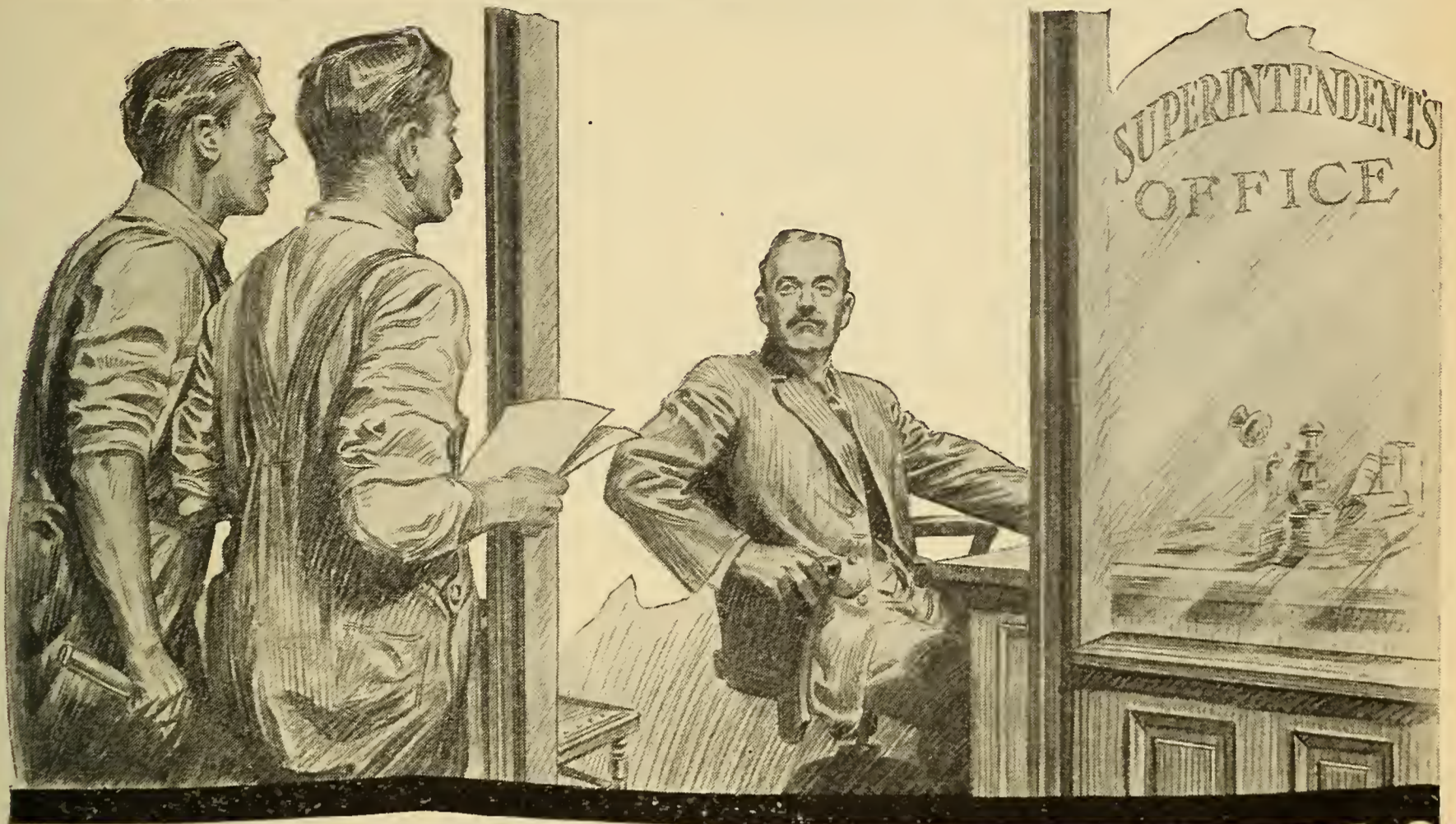

Bring You Success

you to leave home, stop work, or to buy so much as a single book. *Yet that is exactly what the I. C. S. will do.* There is no hurry, no keeping step with other students, no loss of time. I. C. S. instruction is *individual* as well as practical. It gets right at your weak points and quickly puts you in a position to command a good salary *at the occupation of your own choice.*

Mark the coupon. Remember that on an average 300 men every month **VOLUNTARILY** report success as the *direct result* of I. C. S. help. During November the number was 302

Mere wishing won't bring you success. Training will. The I. C. S. will bring you the training. The coupon will bring the I. C. S. **MARK IT N-O-W.**

Brings Success

The instruction afforded by the I. C. S. is a great blessing to those who are denied the privileges of a college education. I enrolled for a Course when I was employed as a wire chief. I am now Manager employed by the Atchison, Topeka and Santa Fe Railroad Co. at Albuquerque, and have increased my earnings \$25 per month.

A. E. DOUGLAS,
701 S. Walter St., Albuquerque, N. M.

My Course in the International Correspondence Schools of Scranton, Pa., is very largely responsible for my advancement from a position as wiper to that of Train Rule Instructor and in increasing my salary \$75 per month more than it was when I enrolled.

J. R. TREPANIER,
136 Queen Street, Quebec

I was working as an overseer of weaving when I enrolled for my I. C. S. Course. I am now Superintendent and Designer and my salary has been very materially increased. Much valuable information can be gathered from your Course and I consider the teaching staff competent and very obliging.

CHAS. T. WILKINS,
Stratford, Ont.

SALARY-RAISING COUPON

INTERNATIONAL CORRESPONDENCE SCHOOLS

Box 1102, Scranton, Pa.

Please explain, without further obligation on my part, how I can qualify for employment or advancement in the position before which I have marked X

Bookkeeper
Stenographer
Advertisement Writer
Show Card Writer
Window Trimmer
Commercial Law
Illustrator
Civil Service
Chemist
Textile Mill Supt.
Electrician
Elec. Engineer

Mechan. Draughtsman
Telephone Engineer
Elec. Lighting Supt.
Mech. Engineer
Plumber & Steam Fitter
Stationary Engineer
Civil Engineer
Building Contractor
Architect
Structural Engineer
Banking
Mining Engineer

Name _____

Street and _____

City _____ State _____

FOSTORIA MAZDA!

MAZDA!

Sounds all right doesn't it?

Listen!

Centuries ago Mazda was the Sun God of the Persians—His influence there has waned, so Mazda has come to America to lend his name to the newest, the most desirable, the best type of incandescent lamp the world has ever seen. His influence here is on the ascent. High efficiency—better illumination—longer life—the answer:

FOSTORIA MAZDA

The improved tungsten lamp at a reduced price.

Fostoria Tungsten was remarkable—it was the acme of metal filament incandescent lamps.

But the FOSTORIA COMPANY never stand still—a new method, a better lamp and a lower price now characterize their offering.

FOSTORIA MAZDA is absolutely up to the minute—the latest discoveries—the most recent methods and the most accurate manufacturing care sum up to produce the Fostoria Mazda—the lamp worth while!

AND PRICES ARE REDUCED!

Quality is boosted—average life take a jump and the price goes down! But not only Mazda—Fostoria means best in every line—Carbon, Gem, Tantalum and Miniature.

WRITE THE NEAREST OFFICE

Fostoria Incandescent Lamp Company

Main Office and Factory—Fostoria, Ohio

Norfolk—Atlanta—St. Louis—Oakland, Cal.—Oklahoma City—Chicago—St. Paul
AGENCIES EVERYWHERE

Instantaneous Electric Water Heater

With the simple turn of a
switch, water is heated to
boiling in 45 seconds

In the Home

This is an ideal utensil for use in the modern home electrical. On the Buffet, it provides, instantaneously, hot water for brewing tea, for making or weakening coffee, for use in the chafing dish and for various other table and culinary purposes.

In the Sick-room

In case of sickness in the home, where pure, hot water is needed frequently and often quickly in emergencies, for aseptic and dietetic use, its convenience is unequalled.

For Miscellaneous Uses

The whole year round, for providing hot shaving water, when the furnace fires are low, and for similar conveniences, the instantaneous water heater fills a large field of usefulness. For Bar, Hospital and other purposes it is already in quite extended use.



For Convenience, Beauty, Efficiency and Durability

As well as simplicity of operation, this water heater has no rival. It has stood the test of time—3 years on the market. And from an economical standpoint it offers the greatest electrical efficiency on the smallest current consumption of any. All parts with which water comes into contact are of brass. The receptacles which contain the water are genuine cut glass. All other parts are heavily plated with nickel.

Made in Two Styles and Sizes

The style shown at the top of the page is No. 804, and contains one gallon of water. The style shown below is No. 703, containing three quarts. This is not so elaborate in size and finish as No. 804, but both have the star pattern of cut glass ball globe, and either one makes a very ornamental object on buffet, bar or elsewhere.



Prices: No. 804 \$27.00
No. 703 22.00

Shipped carefully packed, and express charges prepaid

Electric Shop Michigan and Jackson **Chicago**
Boulevards

MAZDA

B
U
C

TANTALUM

BUCKEYE

GEM

E
Y
E

CARBON

“The Best Lamps Made”

“AND a LAMP for EVERY REQUIREMENT”

If in Need of Lamps—and Want the Best

WRITE WIRE CALL

THE BUCKEYE ELECTRIC COMPANY

Main Sales Office and Works

CLEVELAND, OHIO

CHICAGO, 23 East Lake St.

PITTSBURG, 112 Fulton Bldg.

DALLAS, 220 Linz Bldg

FEDERAL ELECTRIC COMPANY

You know the advantages of vacuum cleaning. Have you selected the machine to do the work in your home? If you were buying an automobile you wouldn't take the first one offered you. So with vacuum cleaners, construction and mechanical excellence as well as appearance and finish must be considered.

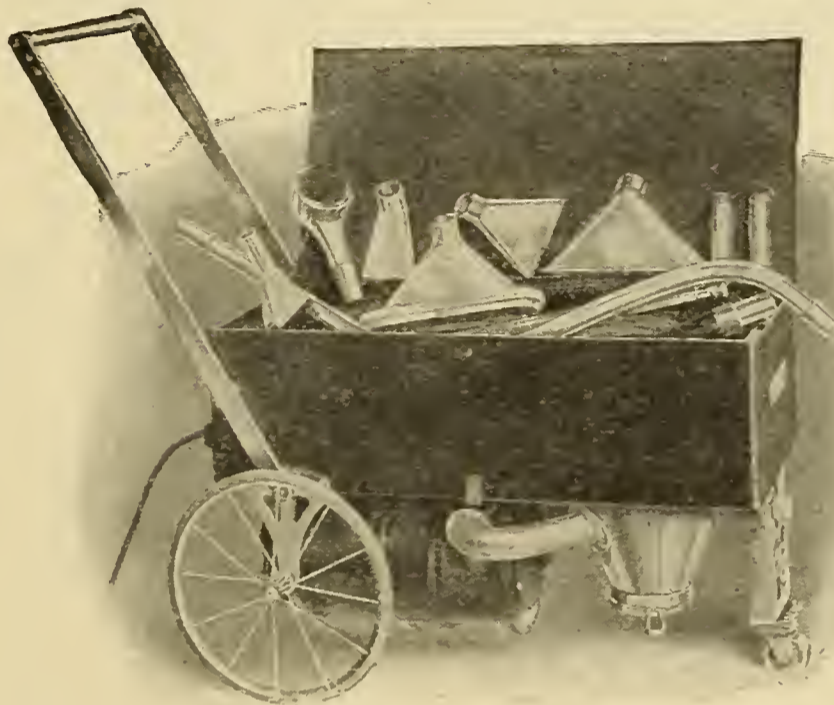

From the polished aluminum tools and mahogany finished Cabinet to the direct connected rotary pump—the Federal Electric Vacuum Cleaner combines good material with experienced construction and skilled designing.

The choice of a machine as a permanent household investment is worthy your careful consideration. An efficient cleaner with reliable mechanism, easily moved about the house, with nothing to wear out or get out of order—such is the

Federal Electric Vacuum Cleaner

All tools in compact cabinet convenient and always there when wanted. Easily operated and moved about the house. Ask for our handsomely illustrated catalogue. A post card will bring it to anyone contemplating the purchase of a high class vacuum cleaner.

Federal Electric Company

Lake and Desplains Sts., Chicago

His Only Rival

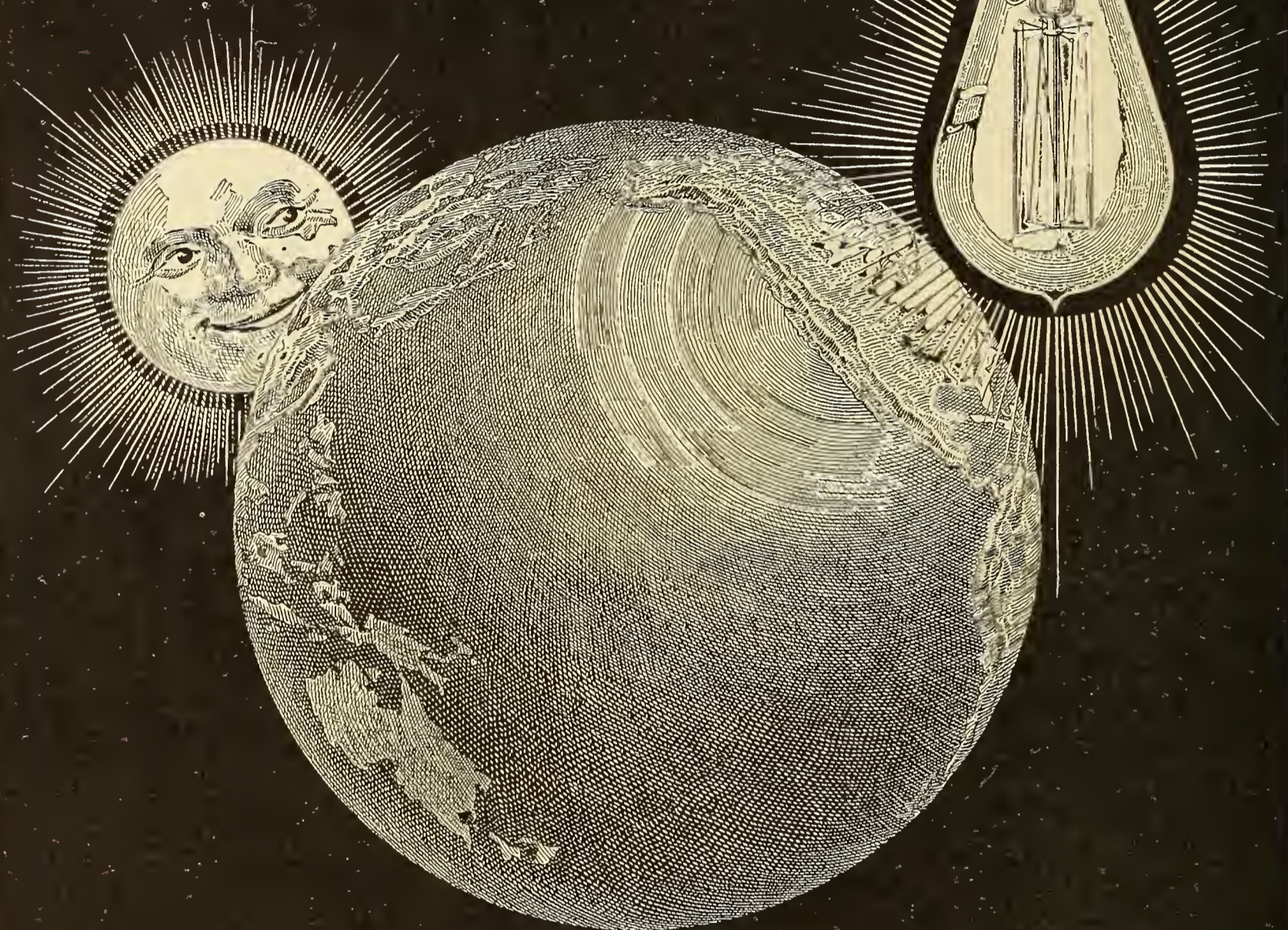

General  Electric
MAZDA LAMP

CLASSIFIED ADVERTISING

Advertisements in the section of Popular Electricity, will cost 40 cents a line, cash with order, and in order to secure proper classification must be in this office the first of the month preceding date of issue

AEROPLANE

AEROPLANE:—COMPLETE DESCRIPTION with working drawings, how to make either Monoplane or Biplane of most successful type, 15 cents. Edward Hibline, 708 Lafayette Ave., Baltimore, Md.

AGENTS

ELECTRIC LIGHT COMPANIES EVERY-where want men to sell electric current and appliances. Learn the How and Why by reading **SELLING ELECTRICITY**, published monthly at 74 Cortlandt St., New York—\$1.00 per year.

AGENTS MAKE BIG MONEY SELLING OUR new gold letters for office windows, store fronts and glass signs. Any one can put them on. Write today for a free sample and full particulars. Metallic Sign Letter Co., 400 N. Clark St., Chicago, Ill.

WONDERFUL INVENTION—CANCHESTER Kerosene Incandescent Lamp burns with or without mantle; 6 times brighter than electricity, gas, acetylene or gasoline at 1-10 cost. Burner fits any lamp; saves 75 per cent oil. No trimming wicks. \$10 daily. Beware of imitations. Handsome outfit furnished. Canchester Light Co., 26 State, Dept. P. E., Chicago.

YOU CAN MAKE FROM \$200.00 TO \$2500.00 in addition to your regular salary under our new salary plan. Special opportunities for employees of electrical concerns, telephone, telegraph, light and power companies, etc. Particulars free on request. Circulation Department, Popular Electricity, Chicago, Ill.

BOOKS

BOOKS FOR THE MERRY AND WISE—Catalogue for stamp. Paul Duff, 373 Dearborn St., Chicago.

ELECTRICAL BOOKS. ALL SUBJECTS. Write for our new illustrated book catalog. Free. Popular Electricity Book Dept., Monadnock Block, Chicago, Ill.

HYDE'S TELEPHONE TROUBLES AND HOW to find them, and manual of cost units, new edition. Price, 25c. Hyde Pubs. Co., 183 5th St., Milwaukee, Wis.

BUSINESS OPPORTUNITIES

"MAKE RICE CRISP"—NEW CONFECTION; sells like wildfire; enormous profit; machines \$10.00 to \$20.00; big sample box "Rice Crisp" and literature 10c. Shaw Manufacturing Co., 908 Laguna St., San Francisco, Cal.

MAKE MIRRORS AT HOME—SCIENTIFIC method. Nearly all profit. Complete instructions 40 cents. P. J. Harkness, Dept. A., East Lynn, Ill.

BUSINESS OPPORTUNITIES

VALUABLE MONEY MAKING BOOKS. Write for free descriptive circulars. A. R. Weissgerber, 3457 N. Hamilton, Chicago.

RAPID CALCULATION BY "PRODUCTS OR DIVIDENDS" beats any machine. Get free particulars and learn the system. G. A. Christensen, Civil Engineer, Box 22-E, San Francisco, Cal.

ATTENTION—OUR PROPOSITION OFFERS you best chance you ever had for making easy money and lots of it. Write for our salary plan. Most generous ever presented. Popular Electricity Publishing Co., Monadnock Block, Chicago.

BE YOUR OWN BOSS—LEARN MIRROR-making and resilvering. You can easily make from \$4 to \$7 daily. Anyone can do the work at home in spare time. Write for free booklet and sample. G. F. Redmond, Dept. H., Boston, Mass.

EASY MONEY—LOTS OF IT, FOR OUR REP-resentatives. Special opportunities for superintendents, timekeeper and all employees of electrical concerns, Salary and commission. Write for particulars. Popular Electricity Circulation Dept., Monadnock Block, Chicago.

START LEGITIMATE MAIL-ORDER MER-cantile business of your own; possibilities unlimited; cash orders, good profits; conducted by anyone. We print your catalogs, supply everything; sell you merchandise at wholesale, show you how, on small investment. Write for free booklet and sample catalog. Central Supply Co., Kansas City, Mo.

START A PERMANENT BUSINESS OF YOUR own. We, as manufacturers, start you and furnish everything. No canvassing. Three simple, successful Mail Order Plans to keep our factories busy. We coach you and show you how to get business. You pay us in three months and make big profits. Spare time to start. Write today for positive proof. Pease Mfg. Co., 1185 Pease Bldg., Buffalo, N. Y.

IF YOU WORK WHERE THERE ARE 100 OR more employes, buy one of our \$15.00 nut vending machines and put it up in the most convenient place. During the noon hour it will be liberally patronized. The outside of public school buildings also a splendid field. Our machine is different from all others. It is made of aluminum, is rust, dirt and water proof, and operates perfectly. It is a beauty. We will supply you with nuts at regular wholesale prices. The Ernst Co., 45 La Salle St., Chicago, Ill.

MAKE MIRRORS AT HOME. BIG PROFITS with little outlay. One 18x36 in. mirror, costs \$2.00 to \$5.00. You can silver a glass this size for 20c. Send \$1.00 in stamps or money order and we will send you **EXPLICIT DIRECTIONS** how to do it; also how to emboss, grind, foil, gold leaf, frost chip and make imitation stained glass. How to transfer photos on glass, bore holes in glass and cut skylights. George L. Patterson & Co., Dept. 4, Brooksville, Ky.

COINS AND STAMPS

FOREIGN STAMPS—9 DIF. JAPAN, 5c; 10 Australia 5c., 7 Africa 5c., 250 mixed Foreign China, Chili, etc., 10c. 75 dif. Old U. S., worth \$1.50, only 10c. Stamps bought. H. J. Kleinman, 3643 N. Marshall St., Philadelphia, Pa.

\$7.75 PAID FOR RARE DATE 1853 QUARTERS. \$20.00 for a Half-Dollar. We pay a cash premium on hundreds of coins. Keep all money coined before 1880, and send 10 cents at once for our New Illustrated Coin Value Book; size 4x7. It may mean your fortune. C. F. Clarke Co., Coin Dealers, L. B. 12, Le Roy, N. Y.

ELECTRIC MATERIAL

RENEW OLD DRY BATTERIES—COMPLETE guaranteed instructions only 25c. Northern Supply Co., 3451 N. Hamilton, Chicago.

DRY BATTERIES RENEWED BY ANYONE for 10 to 25c. per doz. Good as new. Formula \$1. Will send this month for 35c. FAIRMOUNT TELEPHONE CO., Leighton's Corners, N. H.

STORAGE BATTERIES, 6 VOLTS, 60 AMPERES, \$7.50. Electrolytic rectifiers, charging batteries from alternating current, \$5.00. Electro Novelty Co., York, Pa.

FOR SALE

FOR SALE CHEAP, BELT DRIVEN AIR COMPRESSOR, slide valve engine and two boilers. National Can Co., Detroit, Mich.

LUBRICANTS, ASBESTOS, GRAPHITE AND mica candles for loose pulleys and shaftings; no drip; no dirt; economical. Swain Lubricator Co., 250 E. Lake St., Chicago.

FOR SALE—COMPLETE SET OF CASTINGS, with blue prints of 3-4 h. p. gasoline stationary engine; includes governor and timer, screws, etc. \$10. Comet Motor Works, 17 W. Madison St., Chicago, Ill.

BEST VALUE EVER OFFERED FOR 25c—Wireless Telegraphy Made Simple, by Victor H. Laughter. Including also "Wireless Telephone Receivers," "Construction of a Wireless Telephone Transformer," and "How to Make a Polarized Relay." In plain English—fully illustrated and with codes and diagrams. Edition limited—better order at once. Popular Electricity Book Department, Monadnock Block, Chicago, Ill.

HELP WANTED

NO NEED TO BE WITHOUT MONEY. OUR new plan gives you a chance to earn lots of money, whether you have only a little spare time or wish to devote all of your attention to our interest. Don't wait, but write at once for our salary proposition. Popular Electricity Publishing Co., Monadnock Block, Chicago.

BIG PROFITS SELLING VULCAN FOUNTAIN and Stylo Pens; well advertised; easy to sell; write for catalogue showing liberal discounts. Ulrich & Co., 27 Thames Street, New York.

HELP WANTED

CIVIL SERVICE EMPLOYEES ARE PAID well for easy work; examinations of all kinds soon; booklet 50, describing positions and telling easiest and quickest way to secure them, is free. Write for it now. Washington Civil Service School, Washington, D. C.

WANTED—1000 CHAUFFEURS AND REPAIR Men. Our demand for automobile engineers exceeds the supply; calls for men of intelligence and mechanical bent, capable of commanding \$100 to \$150 monthly upon graduation. Resident courses \$15-\$50. Home correspondence courses completed by practical road and shop work at any of our branches or affiliated schools, highly successful. Look This Up. Auto Schools of America, 1680 Michigan Ave., Chicago.

MEN WANTED—TO PREPARE FOR RAILWAY Mail, Internal Revenue, Customs and Post Office Examinations. \$50.00 to \$125.00 monthly. Annual vacations. Short hours. Steady work. Common education sufficient. Country and city residents equally eligible. Political influence unnecessary. Over 15,000 appointments this year. Write immediately for schedule showing places and dates of Spring Examinations. Preparation free. Franklin Institute, Dept. R., 57, Rochester, N. Y.

INSTRUCTIONS

MECHANICAL DRAWING—TEN LESSONS One Dollar. Additional lessons ten cents. Lucien Jones, 115 South 54th Street, Philadelphia.

SUCCESS SHORTHAND TAUGHT BY COURT reporters to beginners and stenographers. The system used by experts. Instruction by mail. WRITE FOR CATALOGUE. Sent Free. If a stenographer, state system. SUCCESS SHORTHAND SCHOOL, Suite 14, 79 Clark St., Chicago, Ill.

MISCELLANEOUS

FIFTY PHOTOS OF HUNTSVILLE AND money making lot proposition, for four cents. A. W. Newson, Huntsville, Ala.

ENGRAVING—POSTAL BRINGS DESCRIPTIVE card, any time; J. Kiola, Engraver, 620 Omaha Bldg., Chicago, Ill.

BROTHER—ACCIDENTALLY DISCOVERED root will cure both tobacco habit and indigestion. Gladly send particulars. F. F. STOKES, Mohawk, Fla.

"AVIATION PHOTOGRAPHS"—Showing the wonderful world record breakers at FIRST INTERNATIONAL AVIATION MEET ever held in America at Los Angeles. Set of ten postpaid, 75 cents. Homer Howry Co., Broadway Central Bldg., Los Angeles, Cal.

"ABILITY," THE MONTHLY MAGAZINE of Business Education, and general good reading, for the progressive workers of all trades and professions. Especially instructive and entertaining to all people. 10 cents a month, 50 cents a year. Same price to foreign countries. Stamps accepted. The "Ability" Company, 210 Caswell Building, Milwaukee, Wis.

ARE YOU INTERESTED IN THE TELEPHONE BUSINESS? Write for our premium offer. Western Telephone Journal, Vinton, Iowa.

POPULAR ELECTRICITY

MISCELLANEOUS

FLAMELESS POCKET LAMPS ARE EXTREMELY interesting! Make them yourself at trifling cost. Simple and reliable instructions for 25 cents. Shelby Company, West Park Station, Philadelphia.

YOU OUGHT TO KNOW THE ORES OF gold, silver, copper, iron, lead, zinc, tin, nickel, graphite, sulphur. These 10 specimens also interesting booklet, on minerals, 25c (coin). G. MacLaughlin, C. E., Sharpsville, Pa.

ANYBODY CAN MAKE GOOD CUTS WITH my simple zinc etching process; price, \$1; specimens and particulars for stamp. T. M. Day, Box E., Windfall, Ind.

RUBBER STAMPS AND SPECIALTIES—BEST prices—prompt delivery—Most complete line. Don't buy till you see my big catalog. Free. Theo. Helbling, 708 Marquette Bldg., Chicago.

BLOODHOUNDS, FOXHOUNDS, NORWEGIAN BEARHOUNDS, Irish Wolfhounds, Deerhounds. Illustrated Catalog 4 cent stamps. Rockwood Kennels, Lexington, Ky.

"23 For Dirt." CLEANS EVERYTHING. Everybody needs it. Ask your dealer, or send 10c. for can. Agents wanted everywhere. C. C. C., 403 S. 12th St., St. Louis, Mo.

EITHER SEX EARN \$10.00 WEEKLY, SPARE time, decorating post-cards, new process; package beautiful samples with complete instructions, 10c. J. F. Pollard & Son., Box 231, Joplin, Mo.

A NEW BUSINESS—CLEAN TYPEWRITERS, re-ink typewriter ribbons, etc. I made \$30 per week. Plenty of work in every locality. Valuable booklet for stamp. Desk 6, A. Neubauer, Erie, Pa.

METALIZE FLOWERS AND INSECTS FOR jewelry. Make hatpins, brooches, etc., of them. Big demand. Immense profits. Send 50c. for 5 complete formulas and full instructions. A. Page Benson, Stewartville, Minn.

GUMMED LABELS—3000 FOR \$1.00 POST-paid. Any size up to 1x2. Two colors. All work satisfactory or money back. Trial order convinces. Send for FREE samples. E. Terrace Mfg. Co., Belmar, Pittsburg, Pa.

DANDY HOME BUSINESS, SELLING NAMES, formulas and other valuable information by mail. Some make \$100 to \$1000 monthly. Instructive booklet for stamp. INFORMATION SYSTEM, Box E3, Marietta, Ohio.

YOU SHOULD HAVE ONE OF OUR SELF-Winding Clocks. They are simple, accurate. See the movement on page No. 671, February issue. Your Jeweler or us. Imperial Electric Clock Company, Granite City, Illinois.

OUR ATTRACTIVE PENNY PEANUT AND candy machines work long hours all kinds of weather and get the money. A few dollars will put you on Easy Street. New England Vending Machine Co., New Haven, Conn.

MISCELLANEOUS

MOTION PICTURE MACHINES, FILM VIEWS, Magic Lanterns, Slides and similar Wonders For Sale. Catalogue Free. We also Buy Magic Machines, Films, Slides, etc. Harbach & Co., 509 Filbert St., Philadelphia, Pa.

NO NEED TO BE WITHOUT MONEY. OUR new plan gives you a chance to earn lots of money, whether you have only a little spare time or wish to devote all of your attention to our interest. Don't wait, but write at once for our salary proposition. Popular Electricity Publishing Co., Monadnock Block, Chicago.

WE MANUFACTURE GLASS PAPER. PLAIN glass windows made to look like real stained glass. Easily applied and beautifies the home. Something new for agents. Two sheets of this glass paper sent as a sample with catalogue in colors and complete instructions on receipt of 10 cents. S. H. Parrish & Co., 216 Clark St., Chicago.

MOTORS

BUILD YOUR OWN MOTOR. COMPLETE machined parts, including all material and instructions necessary to build 1-6 h. p. d. c. dynamo or motor—\$8.00. Horn Electric Company, 36 S. Canal St., Chicago.

BARGAINS—ALTERNATING AND DIRECT current motors, dynamos, also plating dynamos, all makes, sizes, sold, bought and repaired. Eugene L. Richter Electric Co., N. E. Cor. Ubiar & Columbia Ave., Philadelphia, Pa.

MUSICAL

THE GREAT SONORA MUSIC BOXES NOW may be purchased on time, realistic production of the greatest songsters of the day, hitherto impossible and right in your own home. Knight's, 247 12th, St. Louis, Mo.

PATENTS AND INVENTIONS

MODELS MADE FOR INVENTORS. LOW prices. S. H. Merryman, Towson, Md.

PATENTS SOLD FOR 5 PER CENT. WE force sales by constant advertising. Send for plan. Patent Sales Co., Merchantville, N. J.

TWO BOOKS FREE—ALL ABOUT PATENTS and their cost. Shepherd & Campbell, Patent Attorneys, 2196 McGill Bldg., Washington, D. C.

PATENTS PROCURED FOR TEN DOLLARS Attorney's fees. Twenty years' experience. M. Pierce, Downing Building, New York.

BOOK FREE: "PATENT SENSE AND PATENT Non-Sense," or "Why so Many Patents Are Worthless as a Protection." Written so you can understand it. Obed Billman, Cleveland, Ohio.

PATENT—ADVICE AND BOOKS FREE. Highest references. Best results. I procure patents that protect. Watson E. Coleman, Patent Lawyer, 612 F. St., N. W., Washington, D. C.

PATENTS AND INVENTIONS

PATENTS SECURED—INVENTOR'S POCKET Companion free. Send description for free opinion as to patentability. W. N. Roach, Jr., Metzert Bldg., Washington, D. C.

PATENTS OBTAINED OR NO CHARGE made. Easy payments. 15 years official examiner U. S. Patent Office. Patents advertised for sale free. Send sketch or description of invention for free search and report on patentability, also guide book. E. P. Bunyea Co., Washington, D. C.

INVENTORS, ATTENTION! HELP US build an inventors' Trust. A sure fortune if you have a valuable idea. Write for particulars of plan. We will protect your ideas, and sell your patents for you. Address, International Patent, Investment & Mfg. Co., Livingston, Montana.

HAVE YOU AN IDEA? WRITE FOR OUR books, "Why Patents Pay," "100 Mechanical Movements," Perpetual Motions—50 illustrations. Mailed free. F. P. Dietrich & Co., Patent Lawyers, Washington, D. C.

PROTECT YOUR IDEAS—WE SHARE THE risk of the patent application. Advice and booklet free. Milo B. Stevens & Co., Attorneys, 800 14th St., Washington, D. C.; 351 Monadnock Block, Chicago. Established 1864.

WANTED—PARTY TO UNDERTAKE THE selling of my patent for an Automatic Railway Switch, a firm holder, especially for street and industry. Address G. Lange, 904 Garden St., Hoboken, N. J.

PATENTS—H. W. T. JENNER, PATENT AT- torney, and mechanical expert. 608 F. Street, Washington, D. C. Established 1883. I make an investigation, and report if patent can be had, and the exact cost. Send for full information. Trade-marks registered.

POST CARDS AND PICTURES

MEN—DON'T MISS THIS OPPORTUNITY— a set of 6 postal cards, real photos of beautiful girls, 35c. per set. J. Sargant, Upland, Indiana.

12 BEAUTIFUL POST CARDS, CANADIAN Views for 25c., of Important Buildings, 1000 Islands, Cobalt Silver Mines, etc. J. R. Spearman, Forest, Ont., Can.

"CCC MEMBERS" EVERYWHERE WANT to send you Post Cards. Join today, 12c. Curtis Correspondence Club, 3935 Tracy Ave., Kansas City, Mo.

REAL ESTATE

PUBLIC LAND IN OREGON. WRITE FOR free booklet "Millions of Acres Public Land Given Away in Oregon, When, How, Where." Douglas County Abstract Co., Roseburg, Ore.

SCHOOLS

\$200 TO \$600 MONTHLY EASILY MADE FIT- ting eye glasses. Short, easy mail course. Reduced tuition. Big demand for opticians. Write today for free "Booklet O," National Optical College, St. Louis.

SCHOOLS

"ACTUAL DRAFTING ROOM PRACTICE"— Mechanical Tracing taught in 6 weeks. Trial lesson \$1 (cost). **ORNAMENTAL IRON** Drafting—detailing stairs—Elevator Enclosures, etc., in 3 months. Dept. E., Art Metal Eng. Co., Chicago, Ill.

AUTOMOBILE SCHOOL—LEARN THE AU- tomobile business, repairing and driving, in which you can earn good wages and have healthful and pleasant work. We give a thorough and practical course in road work and repairing. For full particulars address Academy of Automobile Engineering, 1420 Michigan Ave., Dept. "C," Chicago, Ill.

HAVE A TRADE OF YOUR OWN. SHOW card writing and sign painting pay big money. Instruction by practical men who had charge of these departments in big Chicago concerns. No talent required. Howard System makes you proficient. Book and material free. Howard School, 314, 716 W. Madison St.

TYPEWRITERS

A RARE CHANCE IS NOW AFFORDED OF getting a good \$100.00 typewriter at only \$10.00, others \$20.00—\$30.00. Rebuilt like new. Rented and rent applies on price, or sold on easy payments. Knight's, 243 12th., St. Louis, Mo.

TYPEWRITE IT—THE PEN IS OUT OF fashion. Splendid Oliver Visible, or Remington, \$2 cash, \$2 a month for 11 months. Fully guaranteed. Supply limited. A. E. Atchison, 2110 West 21st St., Chicago.

TYPEWRITERS: CALIGRAPH, \$6.00; HAM- mond, Yost, Densmore, Williams, \$10.00; Remington, \$12.00; Smith Premier, \$15.00; Oliver, \$24.00; Underwood, \$30.00; all makes on hand; fifteen days' trial allowed, and a year's guarantee. Send for catalogue. Harlem Typewriter Exchange, Dept. 89, 217 West 125th St., New York City.

WIRELESS

WIRELESS, ELECTRICAL AND HIGH FRE- QUENCY APPARATUS, 1910 catalog for stamp. Walter W. Hartman, Clay Center, Kan.

WIRELESS INSTRUMENTS AND PARTS— Double pole receiver with head band \$1.75. Send for catalogue. Poche Wireless Co., 256 Purchase St., Boston, Mass.

1000-OHM GUARANTEED WIRELESS BI- POLAR RECEIVERS \$1.75. Positively the best. 002 Microfarad fixed receiving condensers, \$0.30; complete receiving sets, \$8.25 up. Send stamp for circular T. T. Alden Wireless Co., Campello, Mass.

WIRELESS BARGAINS. WE HAVE ON HAND a number of good 2 to 12 inch spark coils with Electrolytic Interrupter, suitable for wireless telegraphy and experimental work. Will sell at great bargain to dispose of this line. Scheidel Western X-Ray Coil Co., 547 W. Jackson Blvd., Cor. of Clinton St., Chicago, Illinois.

AGENTS PORTRAITS 35c. FRAMES 15c. SHEET PICTURES 1c. STEREOSCOPES 25c. VIEWS 1c. 30 Days' Credit. Samples and Catalogue Free. CONSOLIDATED PORTRAIT, Dept. 1404, 1027 W. Adams St., Chicago

VIBRATION IS LIFE!

Read What Others Say

Here are a few of the hundreds of unsolicited testimonials from people who have used the White Cross Electric Vibrator and know what it has done. It will do the same for you.

PARALYSIS TREATED BY VIBRATION

Upon the request of my sister, who urged me to use her great Electric Vibrator on my son when I was thoroughly hopeless of his cure from physicians' treatment, I write you this recommendation. My son is 16 years old, and eight months ago became paralyzed from the after-effects of diphtheria. He was so badly afflicted that his arms and limbs were twisted out of shape and was confined, all doubled up, in his bed. Medicine and attention did no good, and I had become discouraged in all ways. After treating first his spine at the base and then his limbs with your vibrator he felt such relief that I kept up the treatment regularly, with the result that we soon had him around in a wheel chair. Next he was going around on crutches, and now, after three months' treatment, he is going around with a cane and will soon be entirely cured.

3122 Indiana Ave., Chicago. MRS. C. KNIGHT.

WHAT A DOCTOR SAYS

I have received your Vibrator, and to say that I am well pleased with it is not enough. I wish I could tell every physician just how bad he needs one in his office. I am sure he would not hesitate to place his order for one at once.

Longmont, Colo. DR. W. H. EASTER.

VIBRATOR BEST FOR RHEUMATISM

My husband uses your vibrator for rheumatism and says he never had anything so good in all his experience. I would not be without it myself, as I find it is good to relieve stomach pains, back ache, and besides I continually use it for face massage. I used to go down town for that, while now I save the money and the time, besides being comfortable in my own home.

2935 Vernon Ave., Chicago, Ill. MRS. S. H. BROWN.

Here is a Picture of the wonderful WHITE CROSS ELECTRIC VIBRATOR, the only vibrator in the world which combines the three great forces of Vibration, Galvanic and Faradic Electricity. This is the very same machine which has cured thousands of cases which had been given up by the best physicians as incurable. Read the letters above, then send the free coupon at once.

The secret of the ages has been discovered in **Vibration.**

Great scientists tell us that we owe not only our health but even our very life to this wonderful force.

Vibration gives life and vigor, strength and joy to everyone.

Vibration is the most marvelous curative agent known. It is the remedy provided by Nature for all illness and disease. It cures like magic. Simple, sure and inexpensive—it banishes drugs and doctors forever.

The White Cross Electric Vibrator On Free Trial!



This wonderful instrument gives you the three greatest natural curative forces in the world—Vibration, Faradic and Galvanic electricity.

We want to prove to you at our expense what the great White Cross Electric Vibrator will do for you. We want you to actually feel its invigorating, health-giving thrill coursing through your own body. We want you to see for yourself how quickly it removes pains and aches—how marvelously it cures. We take all the risk.

Cures These Diseases

Rheumatism, Headache, Backache, Constipation, Kidney Disease, Lumbago, Catarrh, Scalp Diseases, Skin Diseases, Deafness, Weak Eyes, General Debility, Nervousness.

A Vibrating Chair Free

With the White Cross Vibrator you can make a perfect vibrating chair out of any chair. A chair which will give you the same results as the kind used in the biggest hospitals and sanitariums. You cannot do this with any other vibrator in the world. **Swedish Movement** right in your own home. You can give yourself the very same treatments for which specialists and sanitariums charge from \$2.00 to \$3.00 each. The nervous, irritable, worn-out man or woman will obtain quicker and more permanent benefit from a few minutes each day in the vibrating chair than from hundreds of dollars worth of medicines.

This Valuable Book, "Health and Beauty," NOW SENT FREE

This wonderful book describes the human body in health and disease so plainly and clearly that anyone can understand. It tells how to get healthy and beautiful and how to keep so. This book tells you what vibration will do for you and how you can get the **White Cross Electric Vibrator** sent right to your home for an actual free trial.



SIGN this COUPON

Get this valuable free book at once. No matter how healthy you may be now, the time will come when you will need this book **badly.** It may save your life or the life of some of your loved ones. Learn all about our offer—the most astounding and generous offer ever made. Don't wait. Don't delay. Sign the coupon **NOW!**

LINDSTROM SMITH CO.,
253 LaSalle Street,
Dept. 1404
CHICAGO,
ILL.

LINDSTROM SMITH CO.,
253 La Salle St.,
Dept. 1404
CHICAGO, ILL.

Without obligations on me please send me free your special reduced price offer, free Book on Health and Beauty, treatment of disease by vibration and electricity, and complete catalog.

Name.....

Address.....

SIGN THIS COUPON AND MAIL TODAY

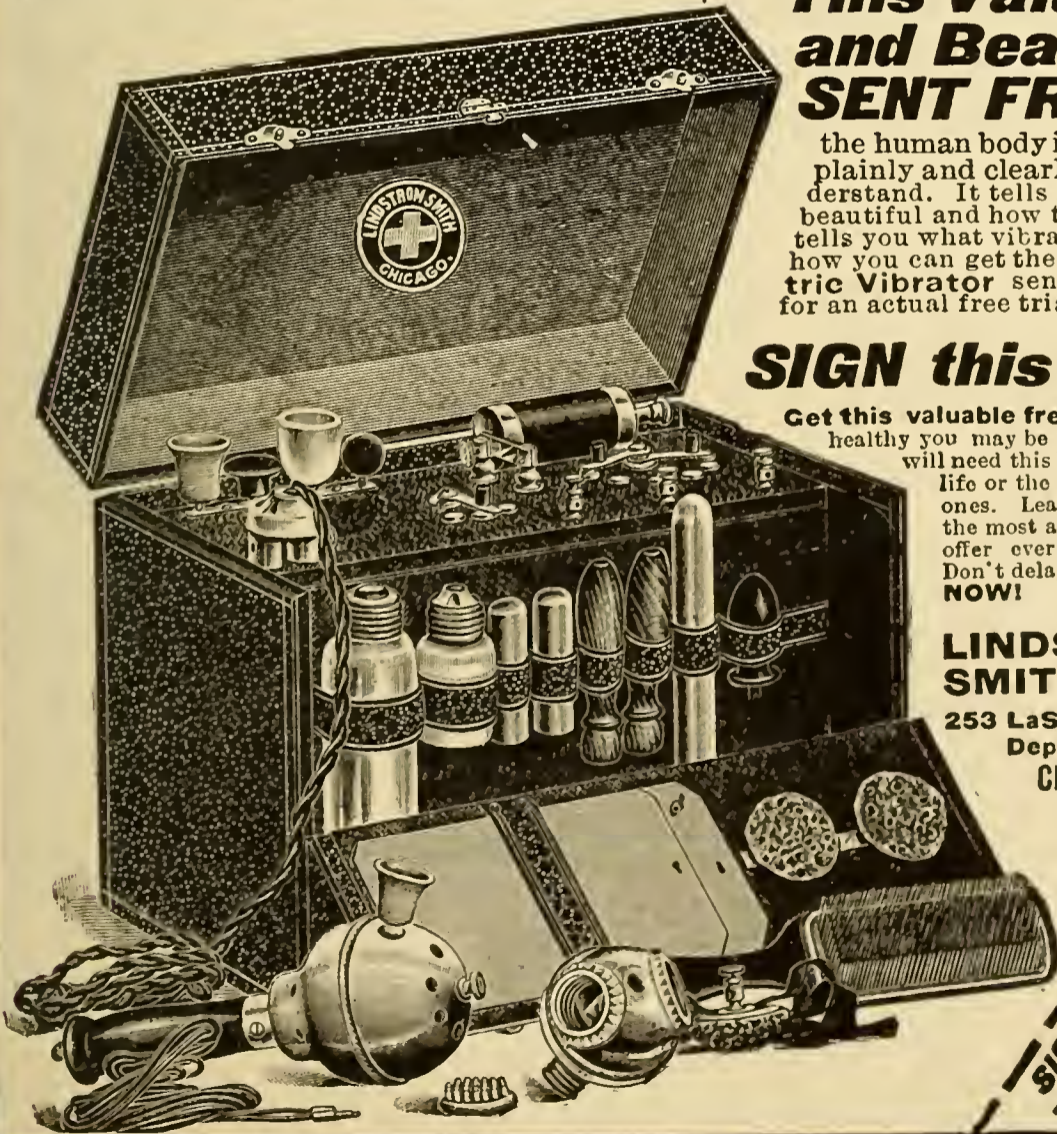

A Message of Thanks

We desire to express to the exhibitors and all who were in any way interested in the Fifth Annual Electrical Show which has just closed in Chicago, our thanks for their co-operation in making it the finest and most successful electrical show in the history of the industry.

The Electrical Trades Exposition Company, will in the future, continue to exploit electrical exhibitions with the idea in view of furthering to the Electrical Trade and the general public the wonders and scientific advancement that the electrical industry is constantly achieving.

The Sixth Annual Show, which will be held the last two weeks of January, 1911, will be greater than ever before, and already exhibitors have made reservations of space.

Have you reserved yours?

ELECTRICAL TRADES EXPOSITION CO.

115 Dearborn Street

CHICAGO, ILLINOIS

WHO ELSE WANTS THIS DOLLAR BOOK FREE?

Our 1910 Book—Newer Styles—Lower Prices



SEND NO MONEY—NO STAMPS

Simply mail us the coupon printed below. Or write us a postal, if you prefer. We will then mail you this great book, now fresh from the presses, picturing more than 3,000 new-style things for the home. A part of the pictures are in actual colors. This book shows a greater variety of Furniture, Carpets and House-furnishings than is shown in any retail store in Chicago. On each article it quotes a price lower than you ever saw. It shows the newest creations in furniture, draperies, etc. And it offers you credit on everything. Have whatever you want, at our lowest cash prices, and pay us a little each month.

WE TRUST YOU FOR

Furniture
Carpets—Rugs
Silverware
Chinaware
Lamps—Clocks
Refrigerators

Sewing Machines
Washing Machines
Pianos—Stoves
Talking Machines
Baby Carriages
Draperies, Etc., Etc.

We sell goods on credit at lower prices than ever were quoted for cash. You can have these home comforts now and begin at once to enjoy them. No need to wait for the money. Simply pay as you can. We charge no interest and ask no security. Our dealings are all confidential. Any person who wants to make home more attractive is the right sort of person, and his credit is good with us.

OVER A YEAR TO PAY

Pay a few cents down on each dollar. Then take the goods, use and enjoy them, and pay us a little each month. On the average we allow a year to pay. On pianos, two years. If misfortune comes, or loss of work, we do what we can to help out. Our whole effort, from the time you first deal with us, is to make you a permanent customer. And you will be. You will never buy housefurnishings elsewhere, and pay others' prices, after you once deal with us.

30 DAYS' FREE TRIAL

Whatever you select can be used for one month before you decide to buy it. Every article is sent on approval. You not only see it, but use it. You compare it with other similar articles, and compare our prices with others. If the article, for any reason, is unsatisfactory, simply send it back. You are under no obligation. The month's use will not cost you one penny.

FACTORY CASH PRICES

Cash mail order houses will try to convince you that credit costs more than cash. See for yourself if it does. Get our catalog and compare the prices. See who sells the lowest. The fact is, we sell on credit exactly as low as for cash. Our cash customers get not a penny of discount. To all we sell at factory prices, plus our one small profit. No middlemen of any kind get profit on our goods. We defy any other mail order house to show one price as low as we offer on a similar piece.

CUT OUT THIS COUPON and mark which catalog you want. Please do it now—before you forget it. Let us prove at once that credit costs you less than cash.

SPIEGEL, MAY, STERN CO., 198 Fisk St., Chicago

Please mail me the catalogs marked.

—General Catalog. —Piano Catalog,
—Stove Catalog. —Graphophone Book.

Name _____

Postoffice _____

State _____ R.F.D. _____

SPIEGEL, MAY, STERN CO., 3198 Fisk St., Chicago

SAVING OF 15 TO 50 PER CENT

We guarantee on every article a saving of 15 to 50%. We don't refer to your local store prices, for they are enormously high. We refer to catalog houses, selling for cash, and claiming to undersell us. Get our goods on trial. If you don't find that we undersell everyone else, simply send our goods back. Ask others to send goods on approval, as we do, and keep those which cost the least.

CAPITAL \$7,000,000

This is the largest concern of its kind in existence. Our combined capital is \$7,000,000. We have 500,000 customers. Our mail order buildings cover six acres of ground. In addition, we own 25 mammoth retail stores, in the heart of the largest cities, where we meet the fiercest competition in America. The only way in which we have grown to this size is by underselling all competition. Now we dominate the field. We control the output of scores of factories, and our enormous buying power enables us to practically fix our own costs. It would bankrupt any lesser concern to attempt to meet our prices.

You may pay cash if you want to, but we have no discount for cash. You may as well buy on credit, as half of the world is doing. You gain nothing by paying cash.

FOUR FREE CATALOGS

Our General Catalog gives pictures, prices and descriptions of everything for the home—of 3,000 things like these: Furniture, Chinaware, Sewing Machines, Carpets, Rugs, Silverware, Washing Machines, Draperies, Lamps, Clocks, Baby Cabs, etc.

Our Stove Catalog shows 70 styles of Empire stoves and ranges, costing from 89c up. Any one of these stoves will pay for itself in fuel saving before you finish paying us.

Our Piano Catalog shows the very finest grades of pianos, as low as \$175.00. We accept no money down, but simply send the piano and let it sell itself. This book will save you at least \$100 on any piano you want.

Columbia Graphophones are shown in a separate catalog—all styles and all records. We will send you a machine with 12 records on 30 days' free trial.

(45)

For our Mutual Advantage mention Popular Electricity when writing to Advertisers.

Can your printer equal these prices?

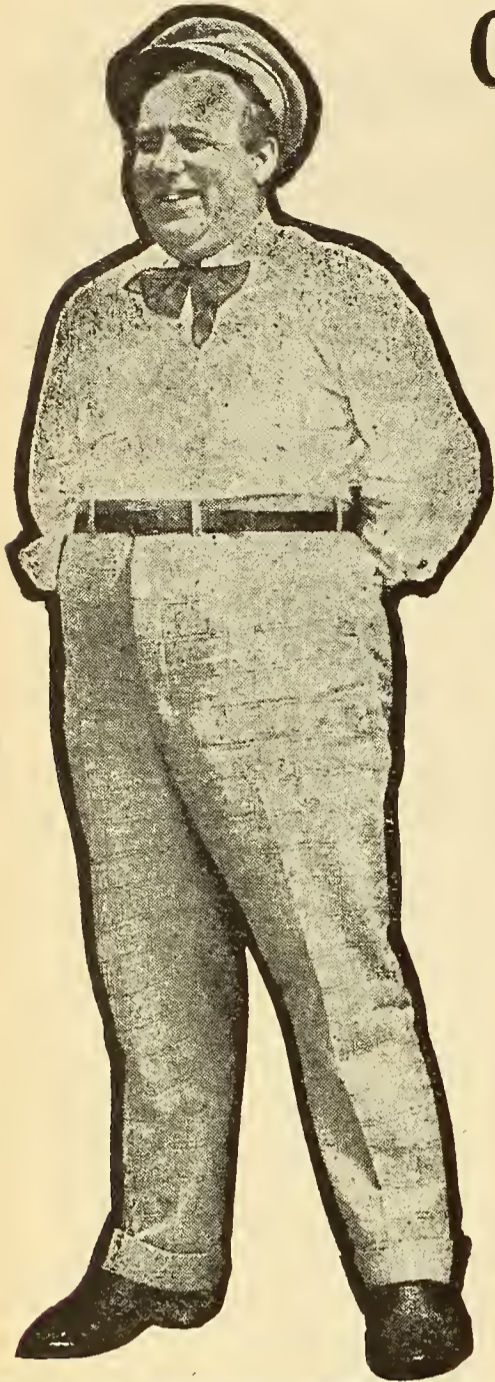

500 8½x11 Letterheads or 4-page Note
Heads, on a good grade of 16-lb. Bond Paper } \$5⁰⁰
500 No. 6½ Envelopes to Match }
500 Cards, 2¼x4 inches on good 4-ply }
cardboard—all for

I will furnish 1000 of each as above for **\$7.75**

CASH WITH ORDER

Ask your local printer to quote prices on the same sort of work I give prices on below. They include every item—include my personal supervision—no extras unless you order them, and if you do, I'll tell you in advance exactly what they will cost you.

8-Page Booklet

Size of page 6 x 9, one color ink, fine grade paper:

5M	"	"	"	\$ 31.50
10M	"	"	"	49.25
25M	"	"	"	108.50
50M	"	"	"	164.50

Additional thousands, each \$2.75

Don't think that because my prices are so much lower than his that I have cheapened the quality of my work. Just a penny postal will bring you samples—proof to the contrary.

C. E. KIMBALL, Vice-President and General Manager

THE CLINIC PUBLISHING COMPANY

4741 E. Ravenswood Park, Chicago

Every Up-to-Date Concern Uses More or Less Loose-Leaf Stuff

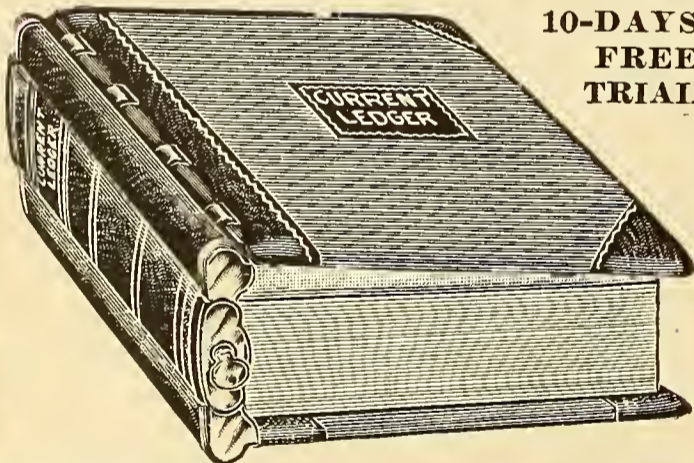

10-DAYS
FREE
TRIAL

They use it because it pays them to do so, and the nearer right it is the better it pays.

That's our business—nothing else—and we know the game. We make sheets for all binders and binders for all sheets and we do it right—right goods at right prices, quality and service. You want to be shown. Give us a chance and we'll show you.

The Greatest Scoop Ever Made in Aluminum Round Back Ledger Binders was when Tengwall Invented the Automatic Lock

We want to send you the latest-thing-in-ledgers outfit on 10-days' free trial, charges paid.

Among the Forms and Systems Which Are Our Specialties, We Mention the Following Binders to Fit:

- | | | |
|-----------------------------|-------------------------------|----------------------------------|
| 1. Ledger Leaves | 6. Monthly Statement Systems | 11. Requisition Systems |
| 2. Uniform Bills of Lading | 7. Record of Invoices Payable | 12. Bank Statement |
| 3. Billing & Charge Systems | 8. Record of Checks Drawn | 13. Duplicate Check Voucher |
| 4. Purchase Systems | 9. Record of Cash Received | 14. Warehouse Receipt System |
| 5. Order Systems | 10. Record of Bills Payable | 15. Duplicate Remittance Letters |

These are not cut and dried outfits, but ideas which we are prepared to adapt to your business. Write, say what you want (we've got it or can make it for you) and full details will be given.

Buy direct from our factories, get "good stuff," and save your money. Illustrated Catalog on request. Write, using your business letter-head and saying where you saw this adv., for our booklet—"How to Save Money in Your Bookkeeping Department."

THE TENGWALL COMPANY

Originators, Devisers and Manufacturers of Loose Leaf Systems

4742 E. Ravenswood Park, CHICAGO, U. S. A.

27 Thames Street, NEW YORK, U. S. A.

For our Mutual Advantage mention Popular Electricity when writing to Advertisers.

ECONOMIC GAS PRODUCERS

FOR POWER OR FUEL

Principal Features—

- Simplicity—No valves to adjust.
- Automatic air and water vapor control for different loads.
- Rich gas immediately upon the start of the engine.
- Radiation losses reduced to a minimum.
- Large overload capacity.
- Superheated air and water vapor supplied to the fuel.
- Easy to clean and examine—CLEAN GAS.

COMPLETE POWER PLANTS—Catalog Free

DORNFELD-KUNERT CO., Inc.
Watertown, Wisconsin

HERE'S THE ANSWER

To your "Wireless" Questions
and by the best authorities
on the subject.

Includes, in addition to "Wireless Telegraphy Made Simple," in five parts, by Victor H. Laughter, "Wireless Telephone Receivers" and "Construction of a Wireless Transformer," by Alfred P. Morgan, and "How to Make a Polarized Relay."

ALL FOR 25 CENTS

This entire series of articles appeared in issues of **Popular Electricity** now out of print. They contain just the information necessary for the construction and operation of simple wireless equipments, in plain, simple language within the comprehension of any amateur.

We have revised and printed them in book form, fully illustrated, with wiring diagrams and wireless codes, which will be immensely helpful to you in your work.

PRICE, ONLY 25c. PREPAID

The edition is limited, so send in your order at once.

POPULAR ELECTRICITY BOOK DEPT.,
MONADNOCK BLOCK, CHICAGO, ILL.

Pay as You are Able

Get Our
Big . .
Book



Send us a postal now, for a free copy of Woolf's Inc. magnificent new Encyclopoedia of Fashions, which fully illustrates and describes hundreds of the very latest styles for men's and women's wear. Shows exactly what the very swellest city people are wearing. Helps you

**Dress Like the
Best**

Tells you how to get beautiful, stylish clothes on credit; gives full particulars of our easy pay-as-you-are-able plan.

Illustration shows just one of the "classy" styles we offer—all magnificently tailored and priced at the most amazing saving in cost. Write for a copy today. Select whatever you want from the many magnificent bargains you need

Send No Money

**\$12 50
and up**

with your order. Remember, satisfaction is guaranteed. We give you six months to pay for whatever you purchase. You don't have to give any security, and we charge you no interest. Nobody will know you are buying on credit. Every transaction is strictly confidential, between you and us. Think of the great convenience of having

One-Half Year to Pay

for your purchases and getting the finest, most splendidly tailored garments, at prices so exceedingly low.

Send to this free book immediately and don't buy anything else till it comes. Lest you forget it, **WRITE NOW.**

Woolf's Incorporated

Dept. 245, Douglas Park Station, CHICAGO, U. S. A.
The World's Largest Mail-Order Credit Establishment
Caution:—We have no agents or local representatives



\$50 WEEKLY PROFIT \$50

This is what hundreds of our operators are earning. There is no reason why you cannot do the same. Become an operator of the

WONDER CANNON CAMERA

There are unlimited moneymaking opportunities in this business which the ambitious man will not overlook.

The Cannon Camera makes eight finished photo buttons in one minute, ready to wear.

Positively no Experience Necessary

Detailed instructions accompany each outfit, which will enable you to learn the business in about 30 minutes. **ONLY \$25** needed to start this big moneymaking business. This pays for complete outfit consisting of **Wonder Cannon**

Camera, tripod and supplies for making 400 finished photo buttons that readily sell for 10 cents and 15 cents each.

The **Wonder Cannon** always gets the big money at fairs, picnics, carnivals, on street corners, and in fact everywhere people gather. Write today for our **Free Catalogue.**

CHICAGO FERROTYPE CO., Dept. 103, CHICAGO, ILL.

Preserve your last twelve issues with a new **PATENT BINDER** which you can obtain by sending us 75 cents.
Popular Electricity Pub., Co. Chicago

Deaf People Now Hear Whispers

WIRELESS TELEPHONES FOR THE EARS

They make the Deaf hear distinctly. They are out of sight when worn. Wilson's Ear Drums are to weak hearing what spectacles are to weak sight. They are sound-magnifiers, just as glasses are sight-magnifiers.

They rest the Ear Nerves by taking off the strain—the strain of trying to hear dim sounds.

And they can be worn for weeks at a time, because they are ventilated, and so soft in the ear holes they are not felt, even when the head rests on the pillow.

These little telephones make it easy for a Deaf person to hear weak sounds, just as spectacles make it easy to read fine print. And the longer one wears them the better the hearing grows. Because they rest up, and strengthen the ear nerves.

By making the sounds louder, it is easy to understand without trying and straining. They make Deaf people cheerful and comfortable.

Wilson's Ear Drums make sounds strike hard on the center of the human ear drum, instead of spreading out weakly all over the surface.

Deafness from any cause, earache, buzzing noises in the head, raw and running ears, broken ear drums, and other ear troubles, are relieved and cured by these little wonder-workers.

A sensible book, about Deafness, tells how they are made, and has printed in it letters from hundreds of people who were deaf but who now hear.

Clergymen, Lawyers, Physicians, Telegraph Operators, Trainmen, Workers in Boiler Shops and Foundries—tell how their hearing was brought back to them, almost instantly, by the proper use of Wilson's Ear Drums.

This book has been the means of making 326,000 Deaf people hear again. It will be mailed free to you if you merely write a post card for it today. Get the free book for proof. You owe it to yourself and to your friends to learn how to be well.

Write for it today to the Wilson Ear Drum Co., 902 Todd Building, Louisville, Ky.

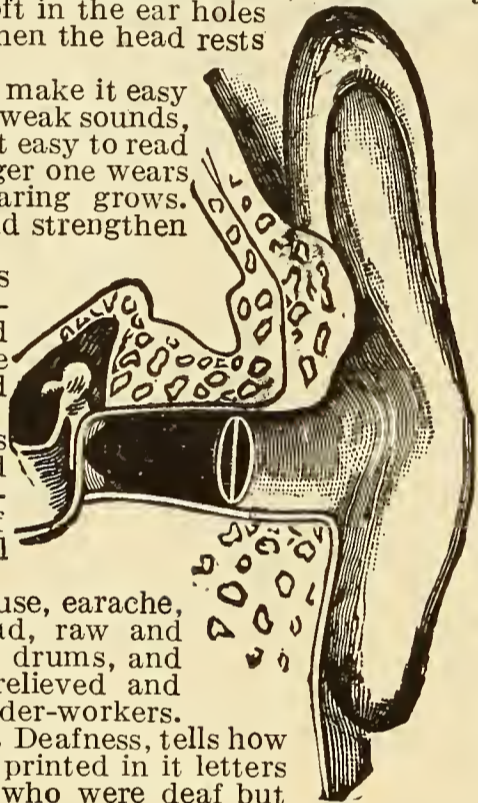

RHEUMATISM

Let me send you a Dollar's Worth of the Great Michigan External Remedy Which is Curing Thousands to Try Free

JUST SIGN AND MAIL MY COUPON



FREDERICK DYER, Corresponding Sec'y

Let us cure your Rheumatism (no matter where located, how severe, or whether it is chronic, acute, muscular, sciatic, lumbago or gout) with our powerful, yet harmless, Magic Foot Drafts. They have even cured cases of 30 and 40 years' standing where baths and doctors and medicine failed.

Just sign and mail the coupon below. Return mail will bring you prepaid a regular \$1 pair of Magic Foot Drafts, the great Michigan cure for every kind of Rheumatism—chronic or acute—muscular, sciatic, lumbago or gout—To Try Free. Then if you are fully satisfied with the benefit received send us One Dollar. If not, keep your money. You are the judge, and we take your word. We know what Magic Foot Drafts are doing, for we send them everywhere, and wait for our pay until the work is done. Let us send you a pair. Valuable illustrated booklet free with the Trial Drafts. Send no money—just the coupon. Do it today—now.



This \$1.00 Coupon Free

Good for a regular \$1.00 pair of Magic Foot Drafts to be sent Free to Try (as explained above) to

Name.....

Address.....

Mail this coupon to Magic Foot Draft Company, 440F Oliver Bldg., Jackson, Mich.

Eyeglasses Not Necessary

That the eyes can be strengthened so that eye glasses can be dispensed with in many cases has been proven beyond a doubt by the testimony of hundreds of people who publicly claim that their eyesight has been restored by that wonderful little instrument called "Actina."

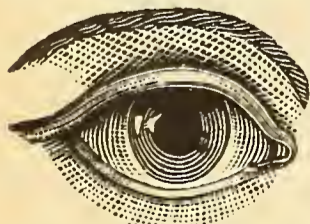

"Actina" is a reliable remedy for sore and granulated lids, iritis, cataracts, etc., without cutting or drugging. Over 85,000 "Actinas" have been sold, therefore "Actina" is not an experiment.

"Actina" is absolutely safe to use. Every member of the family can use the one instrument for any form of disease of the Eye, Ear, Throat or Head. One will last for years, and is always ready for use. It will be sent on trial, postpaid.

Send your name and address to the Actina Appliance Co., Dept. 315 N, 811 Walnut St., Kansas City, Mo., and you will receive, absolutely FREE, a valuable book—Prof. Wilson's Treatise on Disease.

"THE TELEGRAPH INSTRUCTOR"

by C. M. Dodge. One of the best "plain English" treatises on the art ever published. For beginners or practical men. 260 pages. Full illustrated. Cloth covers. Price, postpaid, \$1.00. FREE for two paid yearly subscriptions to POPULAR ELECTRICITY.

POPULAR ELECTRICITY, Book Dept. Monadnock Block, Chicago, Ill.

For our Mutual Advantage mention Popular Electricity when writing to Advertisers.

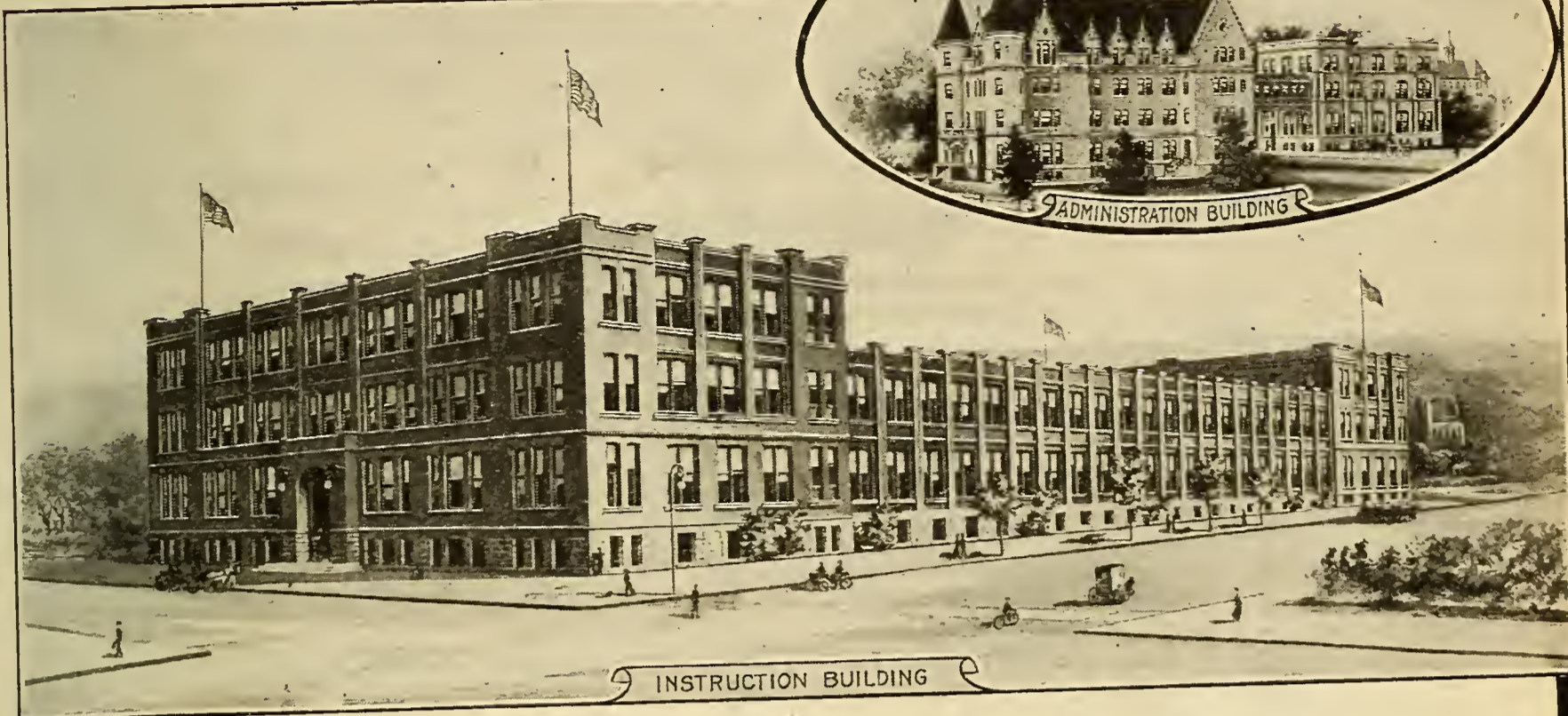

The Best Training School for Electricians

For more than 18 years the International Correspondence Schools, of Scranton, Pa., have been teaching to electricians the best theory and practice of their trades. The I. C. S. are the best training schools in the world for electricians because: (1) I. C. S. Courses are first prepared by practical men—men that have met and solved the problems common to every-day work—and then rewritten by I. C. S. experts to suit the particular needs of the man having to get his technical training in odds and ends of time. (2) Each I. C. S. Course is prepared to qualify students for a particular branch of work; students study only what is necessary to equip them for the work they want to follow. (3) I. C. S. Courses are easy to learn, easy to remember, and easy to apply; they are written in a clear, concise, direct way that drives home facts and makes them stick.

Not a month goes by in which the I. C. S. do not receive upward of 300 voluntary letters telling of positions bettered and earnings increased through study of I. C. S. Courses. During December the number was 409. In a single year the increases in salary reported by students of the Schools have amounted to more than Two Million Two Hundred Thirty Thousand Dollars.

The I. C. S. can better your position, increase your pay, brighten your future. No matter where you live, what you work at, how little spare time you have, nor how limited your means—there is an I. C. S. way for you. To find out all about it will cost you nothing and place you under absolutely no obligation whatever. Just mark and mail the attached coupon. Don't put it off until "after a while." Mail the coupon NOW.

International Correspondence Schools
Box 1102, Scranton, Pa.

Please explain, without further obligation on my part, how I can qualify for a larger salary and advancement to the position before which I have marked X.

Electrical Engineering Electric-Lighting Supt. Electric-Railway Supt. Electrician Electric Car Running Electric Mach. Designer Dynamo Foreman Dynamo Tender Wireman Telegraph Engineer Telephone Engineer Civil Engineer	Mechanical Engineer Mechanical Draftsman R. R. Construc. Eng. Mining Engineer Architect Contractor and Builder Plumbing & Heat'g Con. Architectural Draftsman Chemist Bookkeeper Ad Writer Civil Service Exams.
---	--

Name _____
 Street and No. _____
 City _____ State _____



10 DAYS FREE TRIAL

We will ship you a "RANGER" BICYCLE

on approval, freight prepaid, to any place in the United States *without a cent deposit in advance*, and allow ten days free trial from the day you receive it. If it does not suit you in every way and is not all or more than we claim for it and a better bicycle than you can get anywhere else regardless of price, or if for any reason whatever you do not wish to keep it, ship it back to us at our expense for freight and you will not be out one cent.

LOW FACTORY PRICES We sell the highest grade bicycles direct from factory to rider at lower prices than any other house. We save you \$10 to \$25 middlemen's profit on every bicycle. Highest grade models with Puncture-Proof tires, Imported Roller chains, pedals, etc., at prices no higher than cheap mail order bicycles; also reliable medium grade models at unheard of low prices.

RIDER AGENTS WANTED in each town and district to ride and exhibit a sample 1910 "Ranger" Bicycle furnished by us. You will be astonished at the *wonderfully low Prices* and the liberal propositions and special offer we will give on the first 1910 sample going to your town. Write at once for our *special offer*. **DO NOT BUY** a bicycle or a pair of tires from *anyone at any price* until you receive our catalogue and learn our low prices and liberal terms. **BICYCLE DEALERS**, you can sell our bicycles under your own name plate at double our prices. Orders filled the day received. **SECOND HAND BICYCLES**—a limited number taken in trade by our Chicago retail stores will be closed out at once, at \$3 to \$8 each. Descriptive bargain list mailed free.

TIRES, COASTER BRAKE rear wheels, inner tubes, lamps, cyclometers, parts, repairs and everything in the bicycle line at half usual prices. **DO NOT WAIT**, but write today for our *Large Catalogue* beautifully illustrated and containing a great fund of interesting matter and useful information. It only costs a postal to get everything. Write it Now.

MEAD CYCLE CO. Dept. G234 CHICAGO, ILL.

Goehst Insulation Cutter

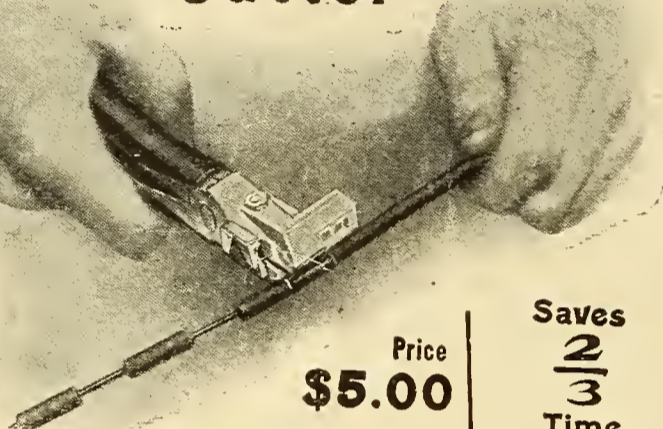

Price \$5.00

Saves $\frac{2}{3}$ Time

Send for Pamphlet

Mathias Klein & Sons, Station U. 3 Chicago, Ill.

HESS FURNACE



We will deliver a complete heating equipment at your station at factory prices and wait for our pay while you test it during 60 days of winter weather.

The entire outfit **must satisfy you** or you pay nothing. Isn't this worth looking into? Could we offer such liberal terms if we didn't know that the **Hess Furnace** excels in service, simplicity, efficiency, economy?

We are makers—not dealers—and will save you all middlemen's profits. No room for more details here. Write today for free 48-page booklet which tells all about it.

Your name and address on a post card is sufficient.

HESS, 912 Tacoma Bldg., Chicago

No. 45 "Leader" Hess Steel Furnace Price \$49 Delivered East of Omaha and North of Ohio River Pipes and Registers Extra

Broken Articles Made New

If you have any broken articles which are made of "cast iron" and have given you good service, why throw them away when you can repair them in a few minutes time, and you have your article as good as new by the use of

C R U Brazing Salt

The operating is so simple anyone can do it. First you clean the article thoroughly, then fasten together at the break by binding wire, then place it in the fire until it becomes a cherry red heat, throw on some brass filings on the break together with some **C R U BRAZING SALT** and your article will be brazed or mended, which makes it as strong as it was when you first purchased it.

1 lb. . . . \$1.00 or 12 lbs. . . . \$10.00

Write today for full particulars and Jobbers' Proposition.

CHAS. R. UEBELMESSER CO.
BAYSIDE, N. Y., L. I.

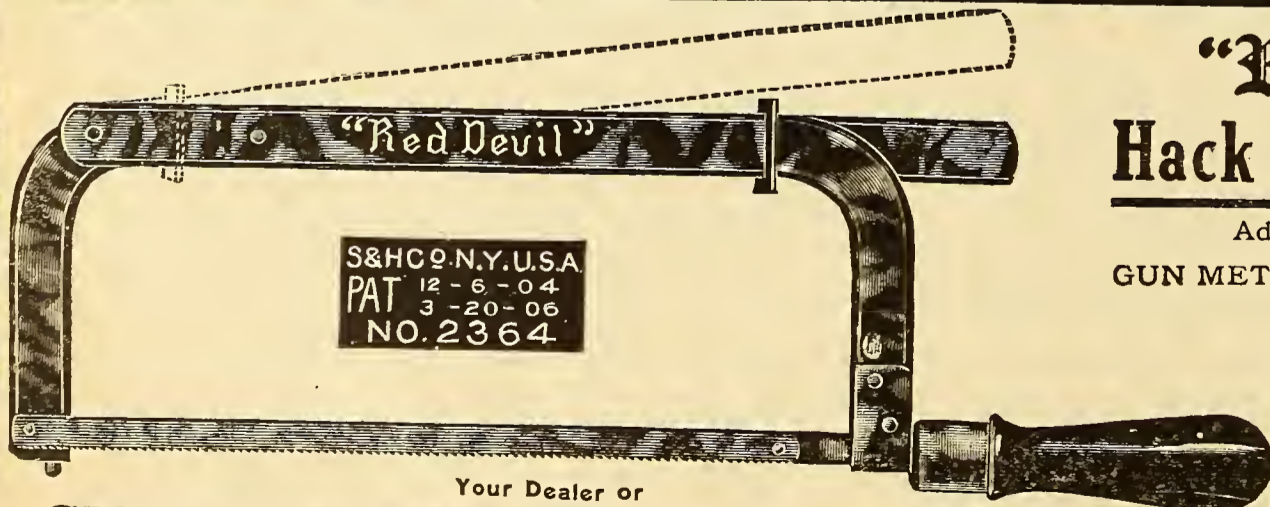

"Red Devil" Hack Saw Frames

Adjustable 8 to 12 inches

GUN METAL FINISH \$1.00 EACH

SPECIAL OFFER

Return this advertisement with your order and we will include with same one dozen *genuine* "Red Devil" Hack Saw Blades gratis—this offer limited to 30 days from issue of this magazine.

Your Dealer or **SMITH & HEMENWAY CO., 110 Duane St., New York City**

P. E. 4-10

For our Mutual Advantage mention Popular Electricity when writing to Advertisers.

Fairbanks-Morse Motor Drive

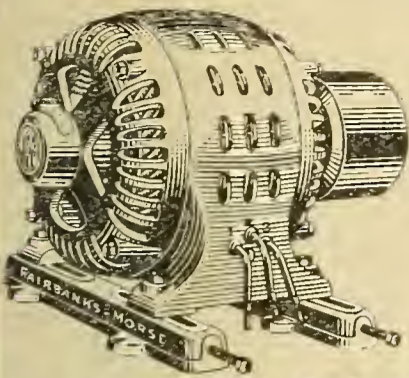

will reduce your power bills and give you ideal service. No dirt, grease or idle pulleys or shafting. FAIRBANKS-MORSE Induction Motors have shown the highest efficiency in many competitive tests.

Built in sizes from $\frac{1}{2}$ to 200 H. P.

Mention this publication and write at once for Catalog No. 1163 A M.

FAIRBANKS, MORSE & CO., 481 WABASH AVENUE CHICAGO, ILL.

THE BARNES VARIABLE SPEED Alternating and Direct Current Motor

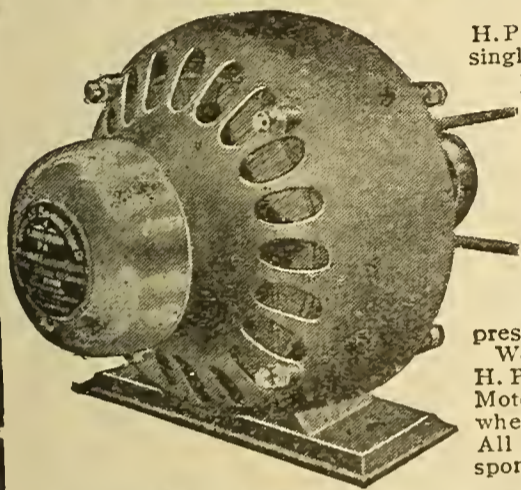

1-12 and 1-8 H.P. The only high speed, single phase, alternating motor that absolutely will not heat. Armature and field pieces are laminated. Brushes are self-adjusting. The 1-12 H. P. size for all family washing machines. The 1-8 H. P. size for coffee mills, printing presses, etc. We also manufacture a 1-12 H. P. A. C. or D. C. Dental Motor with chucks for emery wheels and buffing purposes. All motors guaranteed. Responsible agents wanted.

BARNES MFG. CO., Susquehanna, Pa.

Bargain Prices On New and Used Electrical Machinery



We Buy, Sell, Rent, Trade and Repair Electrical Machinery. Our Stocks are Large, Prices

Low and our Used Machinery is as Good as New. Write for Bargain Booklet Number Thirty.

Tell us what you have and what you need. We can interest you.

The F. BISSELL COMPANY
226-230 Huron St., TOLEDO, O.



Do You Want Electric Light or Power for Your Country Home or Farm?

If you are out of reach of central station current and wish to install a gas engine electric outfit, either with or without storage battery, write for our Handbook, here illustrated. Alamo Electric outfits are standard. Our prices are as low as consistent with high-grade machines suitable for permanent installations. Investigate our proposition, it places you under no obligation.

The Alamo Manufacturing Co., 73 South St., Hillsdale, Mich.



Alamo-Westinghouse Low Voltage Storage Battery Outfit

"THE STRELINGER"

For more than 12 years "THE STRELINGER," the old reliable 4-Cycle Marine Motor, has stood for the best in Marine Gasoline Engines.

A distinct success. First Quality in material and workmanship from fly wheel to propeller. The MOST RELIABLE, DURABLE and ECONOMIC Marine Motor made. The engine that ALWAYS MAKES GOOD, because it is built right. Famous for endurance. Customers who bought the first engines write: "It is as good today as the day it was purchased, always goes, and never gives any trouble; have not spent a dollar for repairs." That is the engine you want.

January, 1910, we purchased the United Manufacturing Company's Plant and will continue the manufacture of the "LITTLE GIANT" 2-Cycle Marine Motors. We can furnish you engines from 1 1/2 to 60 H.P. Agents wanted. Send for Free Catalog today. Send 10c for a nickel plated pocket marine compass.

THE STRELINGER MARINE ENGINE CO.

No. 64 Congress Street, East, Detroit, Michigan, U.S.A.

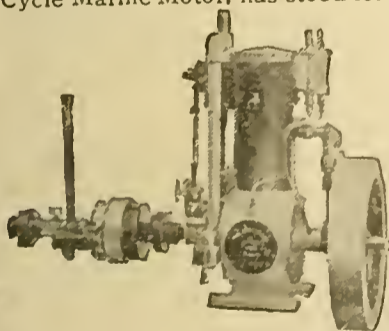

"PERFECTION" ENGINES

Perfection Marine Engines are sold under a guarantee to give complete satisfaction or free replacement.

2 H.P. \$48 Complete-Ready to install.

You can't equal them for power, speed, efficiency, simplicity of construction, ease of operation and quality of finish. Low prices possible because of large output. All sizes 2 to 25 H.P. Hand-some Catalog giving full details, free. Send for it.

THE CAILLE PERFECTION MOTOR CO.
119 Amsterdam Ave. Detroit, Mich.

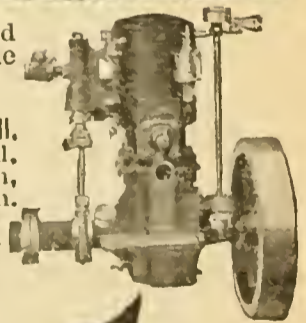

Send for our Handsome Boat and Engine Book, Mailed FREE

Just like a 30-Footer only smaller.



Do not think of Buying a Launch or Engine until you see our Handsome Book WHICH EXPLAINS FOUR WONDERFUL LAUNCH BARGAINS

Only \$121 for this complete 16-ft. Launch -3 H. P., guaranteed self-starting Engine, weedless and Wheel Rudder. Result of 30 years' experience. Money back if not as represented. Write for free catalog today.

Special Bargains in WECO reversible, self-starting engines to those building or buying their own Hulls. Engine controlled by one lever



Special proposition to agents for a limited time only.
C. T. Wright Engine Co., 3301 Canal Street, Greenville, Mich.

For our Mutual Advantage mention Popular Electricity when writing to Advertisers.

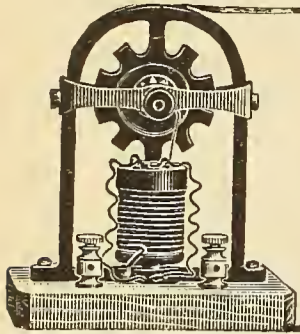

This is the

ARISTO MOTOR
For only \$1.00

It is yours

This electric motor is the most beautiful and powerful for its size there is on the market. It is cast solid, no cheap material used on it. The metal parts are highly ornamented and makes a very beautiful looking machine. The motor runs on one dry battery, two or more cells of battery will give wonderful power and speed. This is just the motor you want, will drive any kind of toy machinery. You will like it, as hundreds of others do. Complete Directions with every motor. Money refunded if not satisfactory. Send 20 cents for Postage. **ARISTO COMPANY, 2514 N. Halsted St., Chicago, Ill.**

A School Within Itself

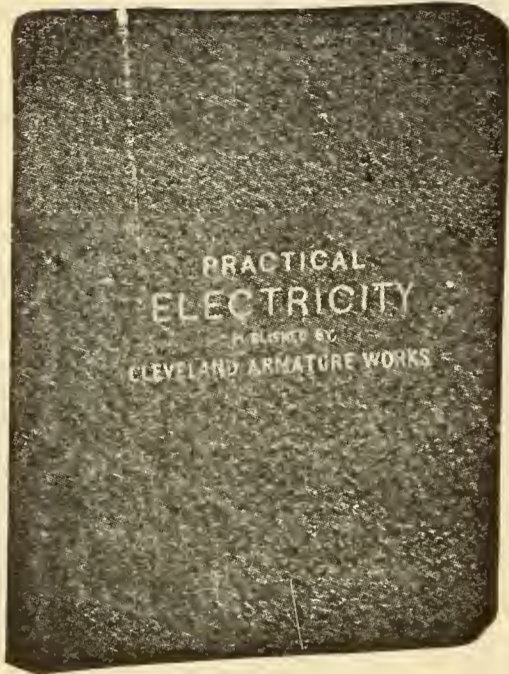

There are XX chapters in all, XIX carrying you from the fundamental principles of electricity on through the various branches to a point where the careful student comprehends the complete designing, care and operation of a dynamo or motor, and I chapter on electric automobiles, outlining their construction, care and operation, and all about storage batteries and how to handle them. Each subject is carefully written and to the point. After a student studies a subject, he is questioned on that subject in such a manner as to bring clearly to his mind the points he needs to know regarding same. A DICTIONARY in back of book will enable him to learn the meaning of any electrical word, term or phrase used in this book, as well as hundreds of others in common use. All required tables necessary in the study are in it.

TABLE OF SUBJECTS:

- | | |
|--|--|
| <p>Chapter
I—Wiring.
II—Electric Batteries, Electro Plating.
III—Magnetism.
IV—The Magnetic Circuit.
V—Magnetic Traction.
VI—Magnetic Leakage.
VII—Energy in Electric Circuit.
VIII—Calculation of Size of Wire for Magnetizing Coils.
IX—Calculation of EMF's in Electric Machines.
X—Counter EMF.
XI—Hysteresis and Eddy Currents.</p> | <p>Chapter
XII—Armature Reaction.
XIII—Sparking.
XIV—Winding of Dynamos and Motors.
XV—Proper Method of Connecting Dynamos and Motors—Self Excitation.
XVI—Diseases of Dynamos and Motors, their symptoms and how to Cure Them.
XVII—Arc and Incandescent Lamps.
XVIII—Measuring Instruments.
XIX—Alternating Current.
XX—Automobiles.</p> |
|--|--|

A Dictionary of over 1500 Electrical Words, Terms and Phrases, giving a brief meaning of all which are in common use.

\$2.00 PER COPY—FIFTH EDITION—24,000 COPIES SOLD

The offer we make of refunding money if book is not satisfactory upon examination is AN UNUSUAL ONE in connection with the sale of a book. But we have no fear of its return. Your decision will be what thousands of others have been. Money would not buy it if it could not be duplicated. We could print testimonials by the hundreds. It is best to order and be your own judge of its merits. **CLEVELAND ARMATURE WORKS, 4730 St. Clair Ave., Cleveland, Ohio.**

Armatures and Fields Wound, Commutators Filled
AMERICA'S GREATEST REPAIR WORKS

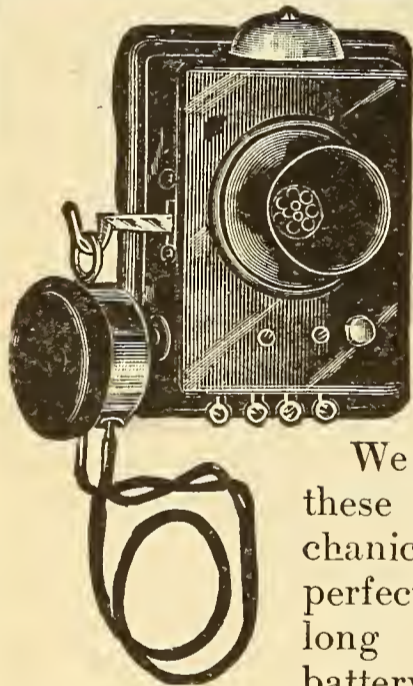

\$2.00 EACH
or
\$3.75 per pair

**The Lowest Priced
High Grade Phone
Made.**

We absolutely guarantee these 'phones to be mechanically and electrically perfect, and to work as long a distance as any battery 'phone made.

Instruments are equipped with push button and bell for signaling.

Distance Phones work depends upon size of wire and number of batteries used. Good for 500 feet on two dry cells per instrument.

C. O. D. orders accepted if one-half of amount accompanies order.

Shipping weight per pair is 5 lbs.

If more than two phones are required on a system advise us of your requirements.

EMPIRE ELECTRIC WORKS
1174, Bridgeport, Ct.

The Guaranteed Cell



The list of satisfied "Red Seal" customers is growing larger each day. A trial is assuring; a comparative test with other makes it convincing that our "satisfaction guaranteed" cells will do all we claim for them. Catalog 24 E for the asking.

Manhattan Electrical Supply Co.
New York, 17 Park Place
Chicago, 188 Fifth Avenue

ELECTRICAL TOYS FOR BOYS

Scientific **ELECTRICAL** Novelties
Practical, Complete, Durable, Harmless

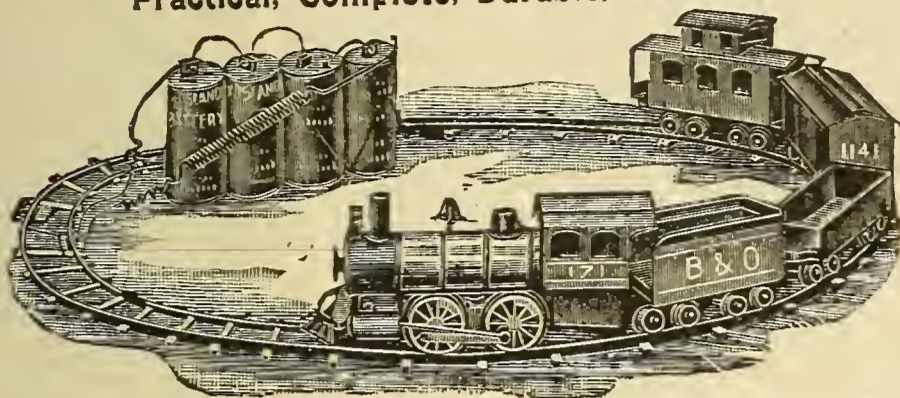

EVERY boy in the country can easily own a railroad. Costs little and pays big dividends in fun. Our Models of Locomotives, Trains, Trolley Cars, Dynamos, Lamps, etc., are practical and durable inventions. Equipped with dry batteries, no acids or liquids used, perfectly safe and harmless. Electrical toys instruct as well as amuse.

Catalog B, fully illustrated, quoting low prices—SENT FREE.

THE CARLISLE & FINCH CO.

264 E. Clifton Ave., Cincinnati, Ohio

Largest Manufacturers Electrical Novelties in the World.

MEN-TEL

Wireless Dry Battery



SPECIALLY designed and constructed to meet all battery requirements of Wireless Telegraph and WIRELESS Telephony apparatus. Worth their weight in specie to all students of this marvelous science.

SENT TO YOU DIRECT

The MEN-TEL Wireless is **different** from any other Dry Cell. Forwarded direct to you.

Price 35 cents or SIX for \$2.00.

Write today for Circular 11

The Men-Tel Wireless Battery Co.
CINCINNATI, OHIO

The 1900 Dry Battery



for **Wireless Telephone and Telegraph**, experimental and research work, has proven itself to be the best dry battery you can possibly purchase because of its high electro-motive force as

well as its great efficiency—both of these features being necessary when battery current is required to produce satisfactory results.

The Known Quality

of the 1900 dry cells also recommends its use for automobiles, motor boats and all applications of gas engine ignition. Write today for our catalog and circular which gives full information and particulars.

The Nungesser Electric Battery Co.
CLEVELAND, OHIO

General Sales Office:—128 West Jackson Blvd., CHICAGO



DO YOU WANT TO MAKE A TOY TRANSFORMER?
Primary 110 Volts Secondary 10 Volts
400 Watt Capacity

I will send you everything to make this transformer for \$3.00

- | | |
|---------------------------|-------------------------------------|
| 1 Mahogany finished board | 1 Attachment plug and 5 ft. cord |
| 1 lb. primary wire | 1 bottle Shellac |
| 1 lb. secondary wire | 1 sheet Insulating cloth |
| 2 pieces red fibre | 5 yards Insulating sleeving |
| 4 Binding posts | 1 set Blue Prints with Instructions |
| 2 lbs. Iron (Norway) wire | |

EDGAR P. HAZAZER

(Instructor of Electricity, Coyne Trade School)

12th and Washtenaw Ave., Chicago, Ill.

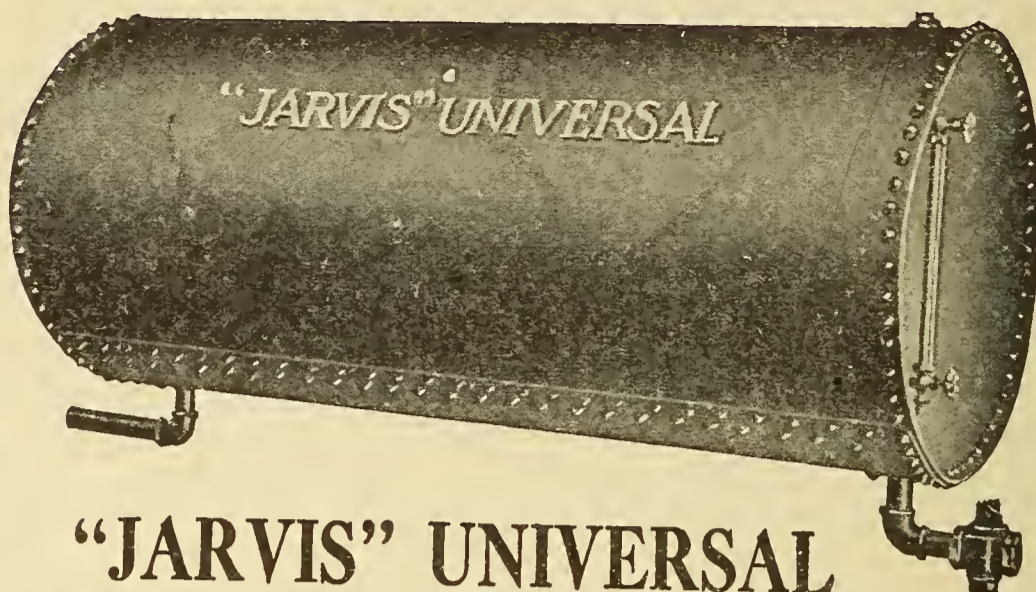
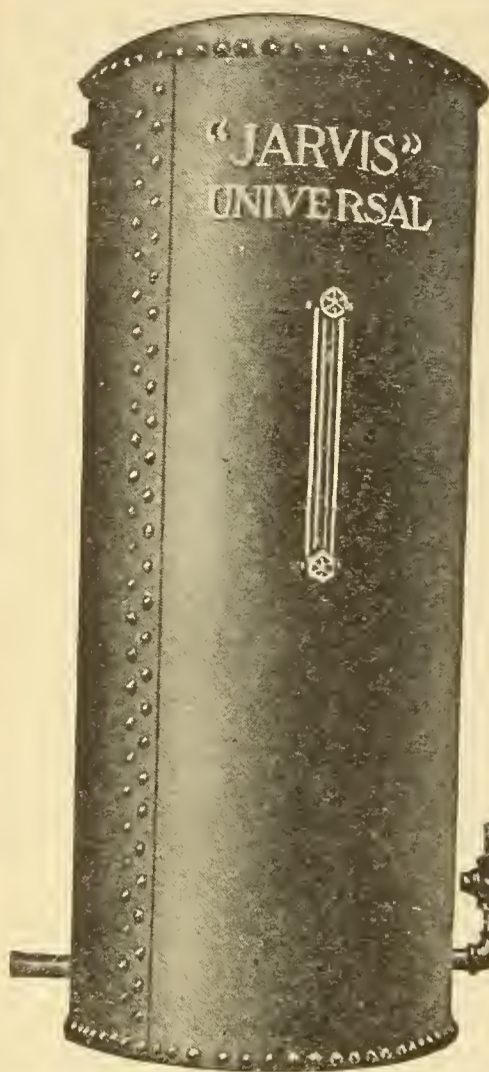

"JARVIS" UNIVERSAL STORAGE TANKS

Are Made in All Sizes for Any Purpose

We also make complete pumping outfits for home, stable, hotel or garage

Ask for Bulletin No. 107

JARVIS ENGINE & MACHINE WORKS, Lansing, Mich.

Do You Ever Have Trouble with Your Dry Batteries?

This little transformer will operate your door bells, buzzers, burglar alarm systems, etc., so that you can ALWAYS RELY on them.

It can be installed in places where the size and appearance of batteries would not permit of their being used.

Can be connected to any ordinary house circuit and 4, 8 or 12 volts obtained.

If you cannot secure one from your dealer we can supply you direct. Anyway it will pay you to send for our free illustrated leaflet, N4511.

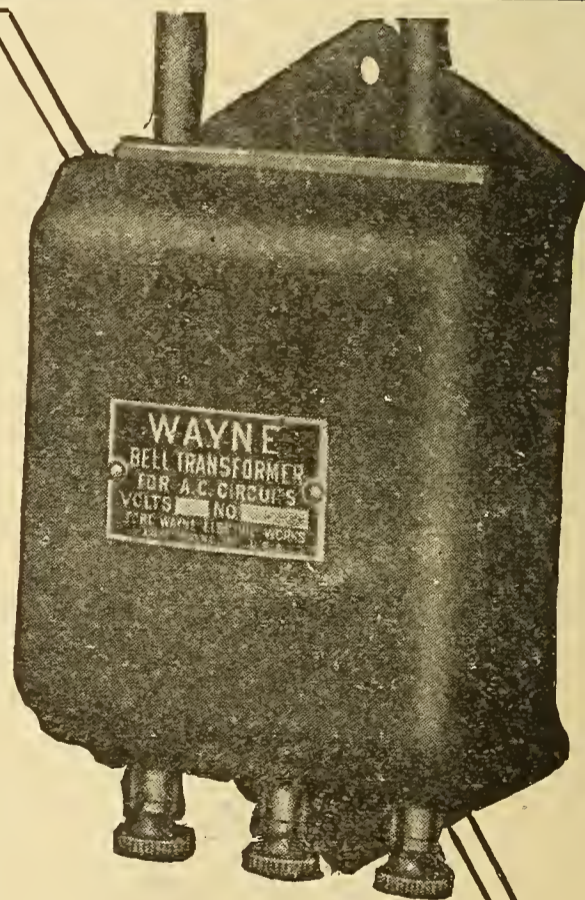

Fort Wayne Electric Works

FORT WAYNE, INDIANA

Address

Name

N4511

Please send me your little illustrated leaflet

Low Cost Electric Lighting Plants for Factories, Homes and Suburban Residences

Small electric plants are no longer an expensive proposition. The Tungsten lamp, of low voltage and small current consumption, has entirely revolutionized electric lighting.

A small gas engine, generator, switchboard and a storage battery of a few "Chloride Accumulator" cells comprise a simple and reliable outfit which will furnish current day or night. The engine need only be operated occasionally. The outfit occupies but small space and requires no special skill for operation. The "Chloride Accumulator" is the storage battery used by the largest and smallest central stations, railways and telephone companies.

The numerous advantages of electricity are now open to everyone.

Ask any of these sales offices for "The Tungsten Publication L.V."

THE ELECTRIC STORAGE BATTERY CO.

1888

PHILADELPHIA, PA.

1910

New York Boston Chicago St. Louis Cleveland Atlanta San Francisco Toronto

The "Exide" Sparking Battery is the highest grade Automobile Battery. Ample power, big spark, old troubles all eliminated.

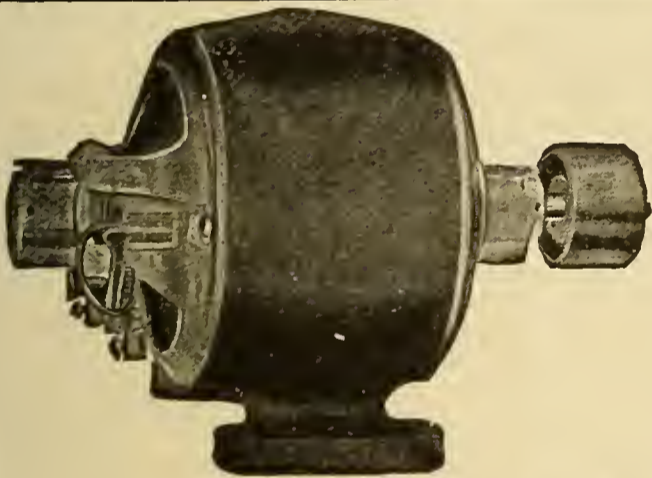

Electric Lighting Outfits

for Motor Boats, Country Homes, Stores, Small Factories and Laboratories.

We have the best and most complete Lighting System for such purposes ever made.

We furnish a High Grade Dynamo, Switchboard and Storage Battery.

It will pay you to write to us at once. Our Lighting System has some very interesting features about it, some of which are: first low selling cost, simplicity, durability and economy. Our new Electric Light outfit catalogue is just off the press. Send 4 cents in stamps.

Schug Electric Manufacturing Co.

Electric Lighting Department

DETROIT, MICH., U. S. A.

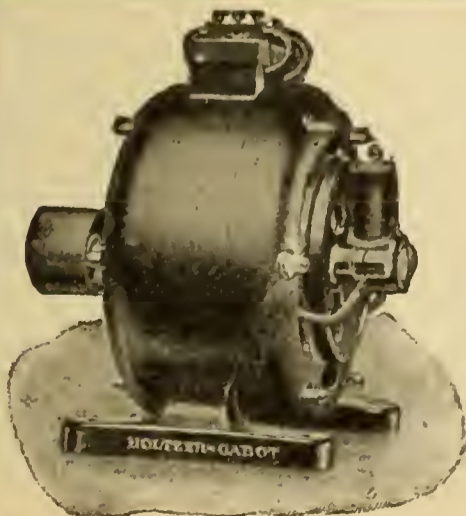

ALTERNATING CURRENT MOTORS

$\frac{1}{8}$ to 2 H. P. Single Phase, Induction Type, Self Starting.

Send us your plans at once and let us figure your "Motor" wants.

Our Engineering department is especially equipped for this purpose, and therefore guarantee you satisfaction.

Write for special bulletin 30E4.

The Holtzer Cabot Electric Co.
Brookline, Mass. 397 Dearborn St., Chicago, Ill.

A Flood of Tungsten Light

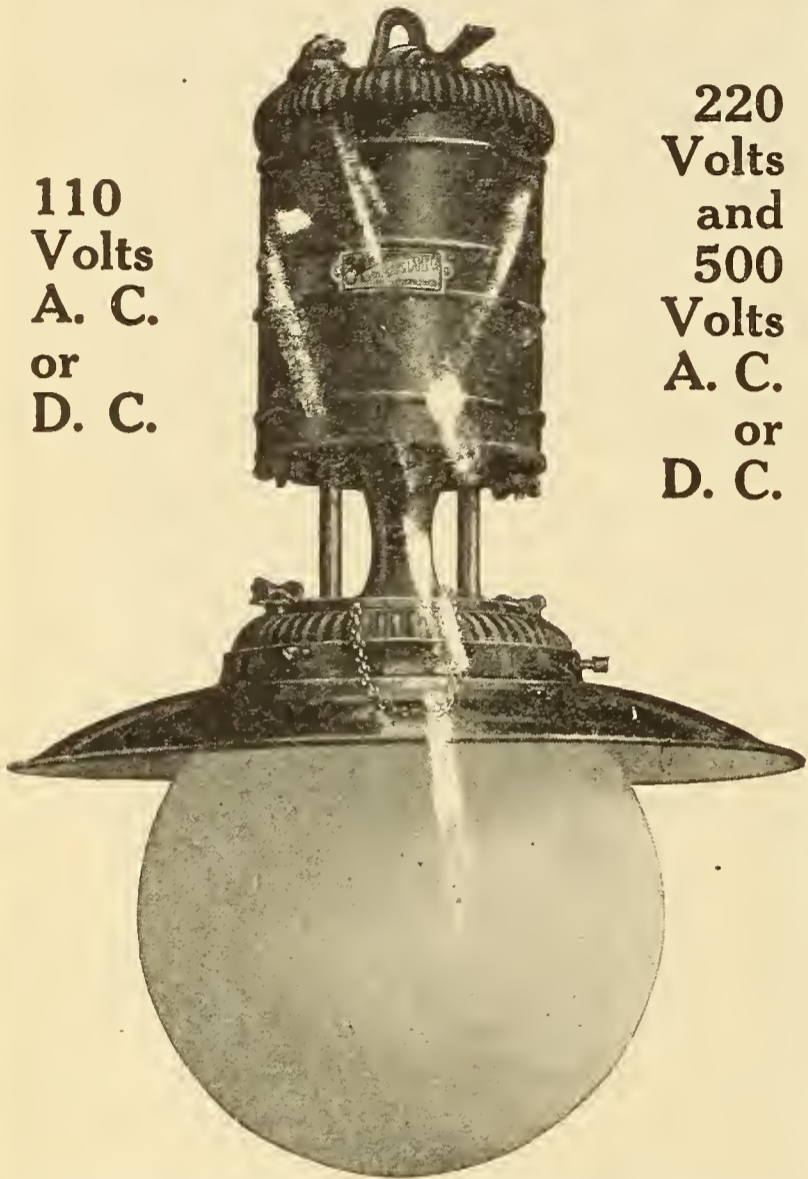

110
Volts
A. C.
or
D. C.

220
Volts
and
500
Volts
A. C.
or
D. C.

**300% More Light and
No Additional Cost**

The "Warner Tungsten Arc Lamp" offers you the best there is in Electrical Illumination—solves the problem of expensive lighting of the store, factory and office.

You know what the Tungsten lamp has done for you in reducing your lighting bills and at the same time increasing the efficiency of light and giving you stronger, better and purer light.

The Warner Tungsten Arc Lamp does the same thing for you, only in a greater capacity. We know how to remove your lighting difficulties.

Our new product is the result of 15 years' experience in the manufacture of electric lighting.

We offer you our knowledge. We offer you the latest invention in Arc Lighting. Do you accept it—it's free. If so, sign the coupon and send it to us.

The fact that Electric Lighting from the consumers' stand-point is so entirely new, and the many angles of saving, in the purchase and distribution of Lighting effect, makes us want to be of assistance. Answer today.

WARNER ARC LAMP CO.

Wilton Junction, IOWA

Warner Arc Lamp Co., Wilton Junction, Ia.

Gentlemen:

Please send me, without cost, circulars regarding your new Arc Lamp.

Name.....

Address.....

State.....

P.E.4

GUDEMAN & COMPANY

Manufacturers and Importers of

Electrical Decorations and Novelties

24 West 33rd St.

NEW YORK, N. Y.



Electrically Lighted Rosebush

**Effective
Electrical
Decorations
such as**

Fruit Trees
Flower Baskets
Center Pieces
Floral
Garlands
and many other
novel and
pretty
designs

Table Decorations Our Specialty

Miniature and Decorative Lamps of all
Descriptions

Write for Catalogues and Discount

The New Electric Lamp Flasher

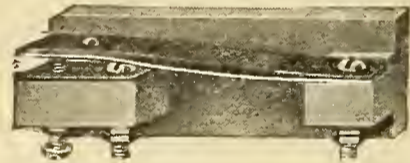

can be used in connection with any 16 c. p. electric lamp, a. c. or d. c. and flashes the lamp as well as a motor driven flasher will.

Innumerable Electrical Effects may be produced by its use.

Most fascinating novelty ever invented. Size 1 x 3 x 1 inches, weighs 2 1-2 oz. Price by mail 80 cts.

Write today.

PHELPS MFG. CO.

266 Jefferson Avenue

DETROIT, MICH.

VULCAN ELECTRIC SOLDERING TOOLS

Make your work **easiest,
quickest, cleanest.** Con-
tinuous Self-heat.



All Users of Soldering Coppers! Write for full particulars; state exact voltage and describe your work.

Vulcan Electric Heating Co., 549 W. Jackson Bd., Chicago

Wireless Special for this month. Fixed condenser for receiving, 60c post paid. **Fiends** 1 1-4 inch coil \$5.00. Enameled wire No. 24 for tuning coil 90c per lb. Send stamp for circular or call.

KENWOOD SUPPLY CO.

812 E. 46th St.

Chicago, Ill.

H. M. Byllesby & Company ENGINEERS

Examinations and Reports

218 La Salle Street
Chicago

**The NEW 1910 MODEL
"IDEAL"
Lawn-Mower
Grinder**

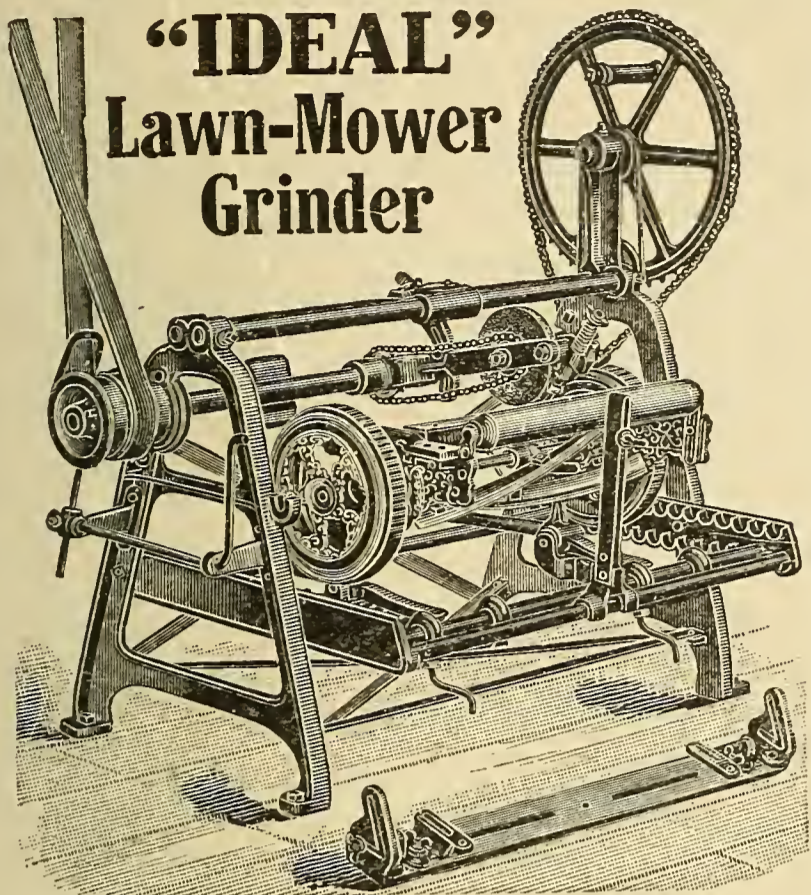

Grinds the reel knife to fit either a crooked or straight lower blade — something never done before. Nothing like it on the market. Sharpens a mower perfectly in 15 minutes. The biggest money-maker you can have in your shop. Write for circular and price TODAY.

The HEATH FOUNDRY & MFG. CO.
(Successors to the Root Bros. Co.) PLYMOUTH, OHIO

**This is Why You Should
Use Star Screw Anchors**

Because they'll hold anything you have to fasten to brick, stone, tiling, granite, marble, etc.; neatly, securely and at a great saving in cost.

Throw away the plugs and soldering iron and write for a few samples of the STAR. "Leading in" makes a botchy, unsightly looking job and wood plugs split and in the end decay and tumble out.



A wood screw and a scientifically constructed lead composition Anchor

Star Screw Anchors

Hold just where these other means of fastening prove so unsatisfactory. Use them for fastening towel racks, tooth brush and glass holders, cabinets, etc., to wall of tile, slate and light timber. Large sizes can be used to attach motors, push buttons, switches, electric lights, etc., to walls of heavier material, such as brick, stone, etc. Will not deface finest marble. Write for catalogue 10 and free samples.



STAR EXPANSION BOLT CO.
Catalogue Department 10
147-149 Cedar Street, New York City

HESS MEDICINE SANITARY LOCKER
CABINET

THE only modern Sanitary Steel Medicine Cabinet or Locker. Handsome beveled mirror door. Snow white, everlasting enamel, inside and out.



FOR YOUR BATHROOM

Costs less than wood and is better. Should be in every bathroom. Is dust, germ and vermin proof and easily cleaned with warm water.

Made in four styles and three sizes. Price \$7.00 and up.

Send for illustrated circular.

HESS, 912 L Tacoma Bld., Chicago

Makers of the Hess Steel Furnace.
Sold on Approval. Free Booklet.

ELECTRIC BENCH FILER

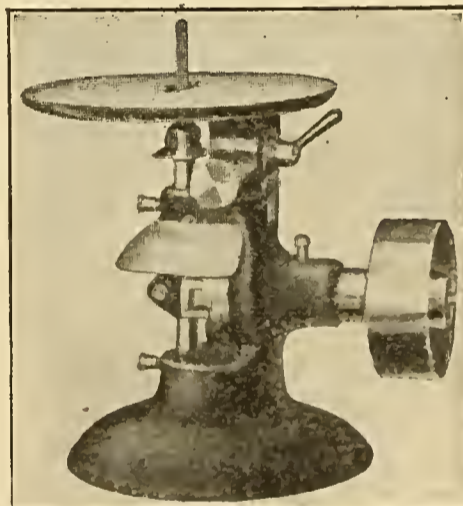

The Brull Bench Filer solves the problem of die making. Made in two styles—belt or direct connected motor driven. Can use current from any electric lamp socket of 110 volts, direct current or alternating current.

Send for our Catalog "C" at once.

R. C. KENDALL & CO.
749 1st Nat'l Bank Bldg.
CHICAGO

BUY YOUR PLUMBING AT WHOLESALE PRICES



DOING BUSINESS FOR 25 YEARS AT SAME ADDRESS.

\$24.95 for complete bath room outfit. Five foot roll rim porcelain enameled bath, porcelain enameled lavatory, low pattern syphonic closet, \$39.00. Hardin's warranty beats any other guarantee.

Save 35 to 70%

Complete Heating Plants and Water Systems for Country Homes. Get our 150-page Money Saving Catalog No. 9, Free. Write today.

JOHN HARDIN CO., 4553 Cottage Grove Avenue
CHICAGO, ILL.

For our Mutual Advantage mention Popular Electricity when writing to Advertisers.

HOMES FURNISHED ON CREDIT

Just a little payment now and then—whatever you can conveniently spare—and the furnishings you select are soon paid for. We give you a year's time on every purchase and you enjoy the full use of the goods while paying for them. We charge absolutely nothing for this credit accommodation—no interest—no extras of any kind. It's by far the most liberal plan of credit that is serving the American people today. Everything held strictly confidential.

Catalog No. 19 FREE

Our big new Catalog tells all about our most generous credit plan. Write for it at once. It's an immense volume, handsomely illustrated in colors, quoting factory prices on furniture, rugs, carpets, curtains, pianos, crockery, sewing machines, clocks, silverware, stoves, ranges, pianos, go-carts, refrigerators, etc. Write for it today.



No. 55 Extension Table, massive pedestal design
6 ft. length, 42 in. round top.
10.95
75c per mo.
Made of solid oak, carved claw feet.
Terms \$1.50 cash, 75c per month.

Hartman Furniture & Carpet Co.

Dept. A 6 223-229 Wabash Ave., Chicago, U.S.A.
Largest, oldest and best known home refurnishing institution in the country—established 1855—55 years of success—22 big stores—over 700,000 customers—capital and resources larger than any similar concern in the United States.

The New Automatic Electric Washer

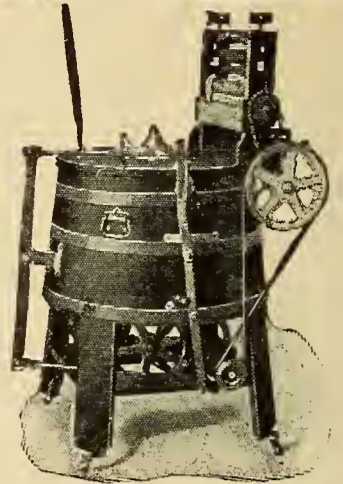

is driven by a rawhide gear; an exclusive feature of this machine.

☐ The reversible wringer enables the operator to release clothing caught in the rolls. No other machine on the market offers these advantages with so little gearing and levers to confuse. Built for women to operate.

☐ Write for terms and prices.

Automatic Electric Washer Co.
NEWTON, IOWA

NEW INVENTION A DUSTLESS HOME AIR DOES THE WORK

New Home Vacuum Cleaner New Principal. Double action. Constant suction. Cleans carpets, rugs, matting on floor. Takes place of brooms, brushes, dust cloths. Cleans without sweeping. Raises no dust. Constant, powerful suction draws dust, dirt, grit and germs through body and fibre of carpet into cleaner. No electricity, motor, power or operating expense. Child or delicate woman operates easily. Mrs. M. V. Buckingham, Nebr. "Home Cleaner certainly takes fine dirt out of carpets." Prof. Geo. S. McDowell, Pa.: "Took 8 1-2 ounces fine dirt from carpet 10x13 ft. So they go. Hundreds of letters of praise and satisfaction.



Lady had matting too old to take up.

Cleaner saved it; cleaned on floor. So handy, so easy. Weighs 8 lbs. Think of it! A dustless home-cleaner than ever before—without sweeping, dusting, house-cleaning. **New Home Vacuum Cleaner, Price \$8.50.** Does same work as high priced machines. This great blessing heretofore possible only for the rich, now within reach of all—rich or poor—village, city or country. Sent anywhere. Order now—you won't regret it. Not sold in stores.

Free Sample to Agents.

\$36 to \$180 per week.
W. H. Morgan, Pa., "Send 60 Cleaners at once. Sold 32 so far this week, making 75 in 9 days."
C. F. Goff, Mo.: "Sold 5 Vacuum Cleaners last Saturday—my first attempt."

\$8.50

Not an old, worn out proposition. Entirely new. Field untouched—unlimited. Experience unnecessary. Takes every family by storm. Sells itself. Make money easy. Men or women. All or part time. Show 10 families, sell 9. **Enormous demand.** Think of millions of homes wanting—needing Vacuum Cleaner. Start now in a profitable, easy, important business. Money comes easy. Don't delay. Don't let someone else beat you to it. Write today for Agents Big Profit Plan. Risk a penny to bring tidal wave of success.
R. ARMSTRONG MFG. CO.
500 Alms Building Cincinnati, Ohio.

The "IMPERIAL" A Portable Vacuum Cleaning Machine

Combining Efficiency, practicability and economy. Can be attached to any electric light socket.

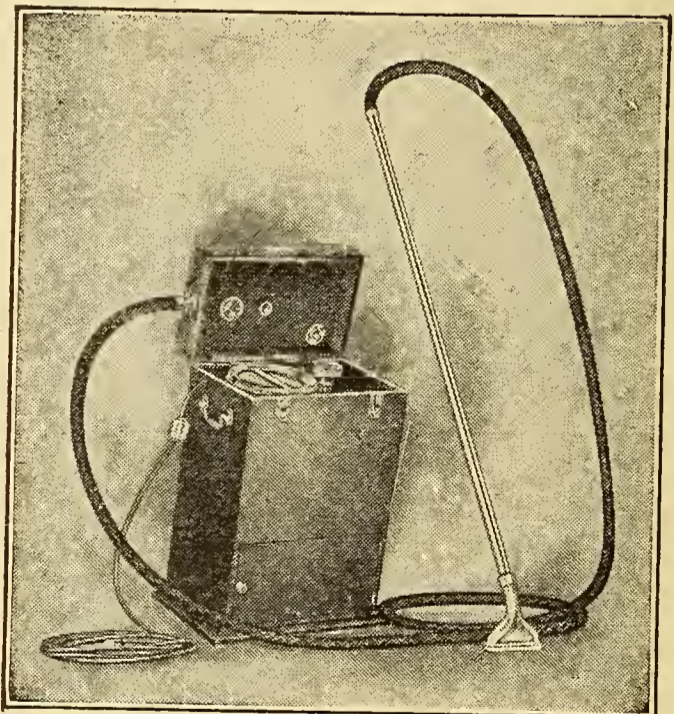

"The Only High-Grade, Efficient Machine on the Market." Guaranteed.

A Dividend Payer for Central Stations
Growing Concerns and responsible parties wanted as agents. Exclusive territory given. Send for catalogue and particulars.
Price \$100 Complete

EMPIRE VACUUM COMPANY

702 Postal Telegraph Building, Chicago, Illinois
112 West Thirtieth Street, New York, N. Y.

**A PENNY PAYS FOR
The Washing
When You Have An
ELMO**

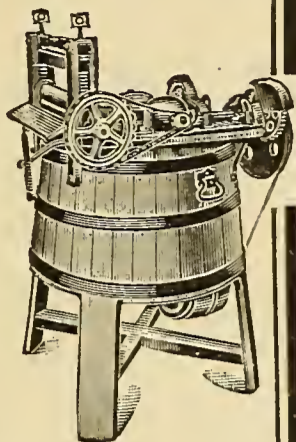

which is operated from the electric light circuit used in your home every day, and is so arranged that connection can be made to any electric lamp fixture, and by turning the button the balance of the wash day trials can be forgotten at the small cost of only ONE ONE-HUNDREDTH OF A DOLLAR.

The Elmo power washer has a great many features which are decided improvements over other types, one of these advantages is the improved lid which permits machines to be opened without turning off the power, as the gears become disconnected automatically. Another good feature is that all the gears and working parts are shielded so that there is no such things as torn clothes or crushed fingers.

The reversible wringer is the greatest labor and time-saving feature of the Elmo Power Machine, as it can be run either forward or back by the simple shifting of a lever on the side of the machine, therefore the trouble of napkins, handkerchiefs and other small pieces of clothing never become tangled and torn in the rollers.

The entire secret of this washing machine is the "Back-gear" which is used by no other washing machine on the market. A postal card will bring to you our circular "A Penny Pays for the Washing" which you should have before purchasing. Write today for full particulars.

GRINNELL WASHING MACHINE CO.

Successors to Thompson Bros. Co.

Dept. 25

GRINNELL, IOWA

Summer Comforts of the Ocean
In the Smallest Home

COLONIAL

8 IN. UNIVERSAL D. C. DESK FAN

Can be used on Desk, Table or for Side
Wall Suspension

Consumes little more than half the current taken by an
incandescent Lamp

Large Wind Out-Put

**HAND-
SOMELY
FINISHED**



**SOLID
BRASS
GUARDS
AND
BLADES**

**Do not buy until you have seen
This Perfection of Fan Making**

If your dealer does not have one
Write us direct

**THE COLONIAL FAN & MOTOR CO.
WARREN, O.**

\$1⁰⁰ a Week

For the Splendid

**MEISTER
PIANO**

Price \$175
Guaranteed for 10 Years



30 Days Free Trial
in Your Own Home

**No Cash Payments Down.
No Interest. No Extras.**

We Pay the Freight

¶ This Parlor Grand Meister is remarkable for its full rich tone and the beautiful style of its case, which is of genuine mahogany, double veneered throughout. Modern improved construction and finest of materials used. Try it a month without a penny of cost and get your own ideas of its mellow tone and artistic appearance.

¶ If it isn't the best piano you ever saw or heard at the price, we will send for it and pay the return freight.

¶ Send for the Meister Piano Catalog which contains colored illustrations and details of construction. Send today.

Rothschild & Company
2366 State Street, Chicago, Ill.

Easy Picking For You, If You "Know How"

You can build up a profitable business by relegating to the junk-pile some of the thousands of lighting installations that are now "Back Numbers,"—antiquated through the wonderful improvements which have been made in lamps and lighting appliances.

You can actually **create work** by applying the common-sense principles of illuminating engineering to every-day practice—a field that offers the best opportunities for the man who can "produce the goods."

Clear and convincing information on this subject can be secured from the pages of

THE ILLUMINATING ENGINEER

36 West 39th Street ∴ ∴ New York

YOU WILL SEE FOR YOURSELF, IF YOU SEND FOR A SAMPLE COPY—FREE TO ANY "GO-AHEAD" ELECTRICAL WORKER. ∴ ∴

Just off the Press—1910 Edition
Standard Wiring
for Electric Light and
Power as Adopted by the

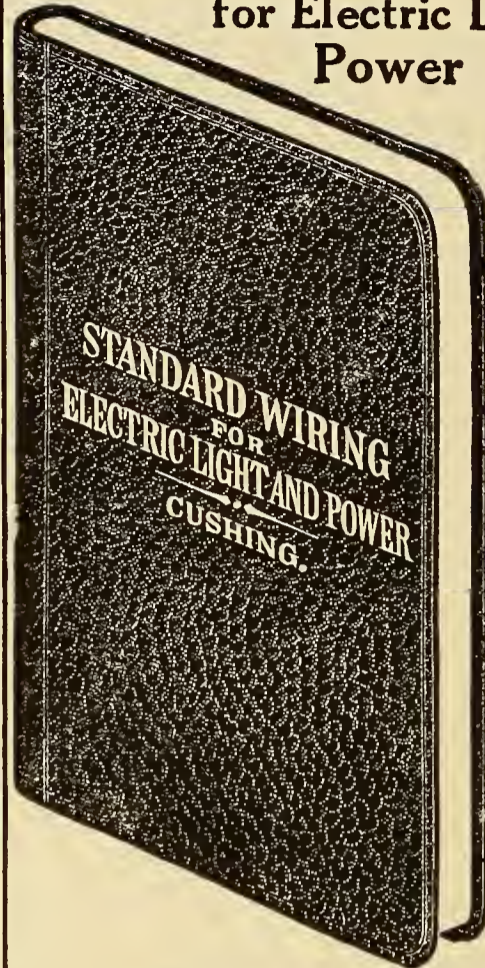

Fire
Underwriters
of the
United States

Containing the National Electric Code, explained with numerous illustrations, together with the necessary tables and formulae for outside and inside wiring and construction for all systems. Everything revised right up-to-date. Handy size for the pocket. Black limp leather binding—gilt embossed.

Price prepaid

\$1.00

Free for 2 paid yearly
Subscriptions
to
**Popular
Electricity**

POPULAR ELECTRICITY BOOK DEPT.
Monadnock Block, CHICAGO, ILL.

Send for our illustrated Catalog—FREE

ATTENTION!!

Mr. Inventor and Experimenter:

Are you completing a new device which you intend to market? Are you experimenting with a device which is about completed? And have you something Electrical or Mechanical which you would like to submit in an intelligent and interesting manner?

BRING IT TO US and let us make your cuts for illustration, which will bring out the merits of your goods. There is no better way to demonstrate or interest anybody than with good photos or a well illustrated catalogue.

We show you the way to accomplish these results.

If you have not had any experience in the art of Photography, Half Tone work and all kinds of Engravings—Write us and we will instruct you without cost.



ENGRAVING
COMPANY

141-149 OHIO STREET—Cor. La Salle Ave.
CHICAGO

Electrician and Mechanic

is a practical magazine for everyone who wants to learn about electricity, or who uses tools. Its articles tell you how to make dynamos, engines, wireless telegraph apparatus, furniture, models, etc. The only magazine in the world of its kind.

Features for 1910

WE have in preparation or now running articles on a practical wireless set working up to 1000 miles, an induction motor, a wireless telephone that will work, an aeroplane, how to run automobiles, forging and tool-making, and others too numerous to mention.

Special Offer: We have 300 sets of the last 6 numbers of **ELECTRICIAN AND MECHANIC**. Send us \$1.00 for a year's subscription (within 30 days) and we will send the 6 back numbers FREE.

SAMPSON PUBLISHING CO.
1140 Beacon Building : BOSTON, MASS.

AT 1/25 THE COST OF GENUINE DIAMONDS



you can enjoy all the delight and all the satisfaction which costly gems can bring. RHODESIAN DIAMONDS are just as magnificent, just as sparkling, just as brilliant as genuine diamonds and they will last indefinitely. They look like, wear like, are mined, cut and polished like the very finest diamonds. And they only cost 1-25th as much. Sold on approval subject to examination and under strongest guarantee. WRITE for CATALOG of the famous RHODESIAN GEMS. Sent FREE on request anywhere. Write this very day.

RHODESIAN DIAMOND CO. (Todd & Tracy, Owners,) 1421 Unity Bldg., Chicago

LETTERS

by the Kier New Process. Letters that pull more replies because they most closely resemble actual type-written copies. Send a small order for trial. If we please you—pay us,—if we do not please you,—no charge. We leave it with you.

KIER LETTER COMPANY

Phone Harrison 4018

358 Dearborn St., Chicago

VACUUM WASHER 30 DAY TRIAL

To prove to every reader of this magazine that she can wash clothes with least work and wear with

Syracuse "EASY" Washer

we will ship one on 30 days' trial and pay freight both ways if you do not find it far better than any you ever tried. Easy pumping motion. Water heated in rust-proof tub. Cleanses laces, clothes, carpets. Write for free booklet, valuable recipes and trial offer.

DODGE & ZUILL
539C Dillaye Bldg., Syracuse, N. Y.



VENTRILOQUISM

Learned by any Man or Boy at Home. Small cost. Send today 2-cent stamp for particulars and proof.

D. A. SMITH, ROOM 1336—2040 KNOXVILLE AVENUE, PEORIA, ILL.

For our Mutual Advantage mention Popular Electricity when writing to Advertisers.



For Owners, Dealers, Builders

Salesmen and Chauffeurs

Cyclopedia of Automobile Engineering

Four big volumes—1,700 pages—1,500 illustrations—full page plates—halftones—diagrams, sections, etc. Thoroughly indexed and bound in half morocco. Presents the most complete information on the automobile industry—its history and development from the time of its invention up to its present state. Describes all makes of machines—mechanisms, care of auto, art of driving—a practical guide for information regarding construction, maintenance and operation. Contains complete instruction on repairing. Written by experts.

Examine the Books at Our Expense

We will send you a complete set by prepaid express upon receipt of coupon. Keep them five days—give them a thorough and careful examination. If you do not wish to keep books advise us and we will have them returned at our expense. If you keep the books send us \$2.00 in five days and \$2.00 a month until special introductory price of \$12.80 has been paid. Regular list price \$24.00.

PARTIAL LIST OF CONTENTS

Automobile Operation—Care—Trouble—Breakdown—Repairs—Automobile Power Plants—Cooling and Oiling Systems—Ignition Systems—Spark Coils—Buying a Motor Car—Gasoline, Electric and Steam Cars—Tires—Puncture—Accessories—Driving—Motorcycles—Gas and Oil Engines—Fuels—Care of Gas Engines—Electricity—Storage Batteries—Direct Current Motors—Mercury Vapor Converter—Primary Batteries—Steam Engines and Boilers—Valve Gears—Indicators, etc.

Order promptly and we will include FREE for one year, as a monthly supplement, the **TECHNICAL WORLD MAGAZINE**, a regular \$1.50 monthly, full of interesting scientific topics written in popular form.

FREE OFFER COUPON

American School of Correspondence,
Chicago, U. S. A.

Please send set Cyclopedia of Automobile Engineering for 5 days' free examination; also Technical World for 1 year. I will send \$2.00 within 5 days and \$2.00 per month until I have paid \$12.80; otherwise I will notify you and hold the books subject to your order. Title not to pass until fully paid.

Name.....
Address.....
Occupation.....
Employer.....

Pop. Electricity 4-'10

WIRELESS EQUIPMENT FOR COMMERCIAL USE

We display a cut of our \$40.00 Receiving Set mounted in a mahogany cabinet. It consists of the celebrated Ferron detector, receiving transformer (wound in bare copper wire, and by a special method, protected by patent), tubular condenser and special 2,000 ohm head set. The same instruments unmounted, cost but \$29.00. This set has a proven range of 800 to 1200 miles. The worth and efficiency of these instruments is now well known to practically every live wireless operator. We have yet to record the first complaint concerning our high claims for the Ferron detector. See testimonial in this month's issue of Popular Mechanics on great range of Ferron. This letter is only one of hundreds.

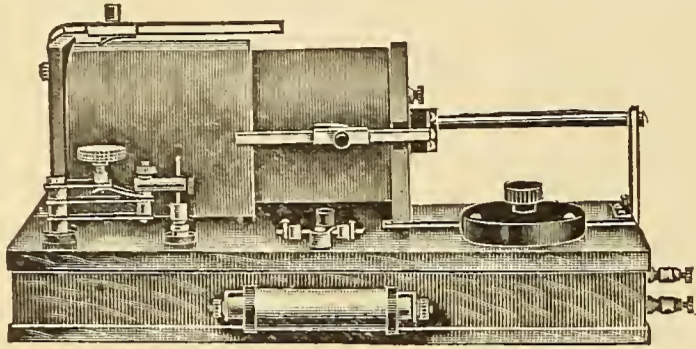

Mounted in Mahogany Cabinet, \$40.00
Entire Set Unmounted, only - 29.00

Send 3c stamp for our Big Catalog of 120 pages of anything Electrical or Wireless. Over 40 pages of wireless instruments for the experimenter and for private installation and commercial use.

J. J. DUCK, 428 St. Clair St., Toledo, Ohio

Elyria Wireless Supply Company

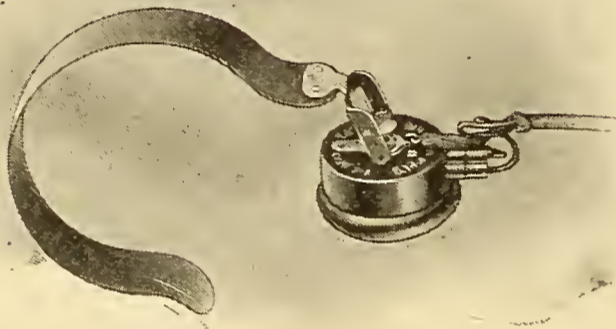

Manufacturers and Dealers in

**Wireless Telegraph and Telephone
Supplies, Storage Batteries, Battery
Lamps, Automobile Specialties**

..... SPECIAL

In order to introduce our goods we will send you a pocket Learner's Wireless Telegraph Instrument with catalog and instructions for 25c. postpaid. This amount will be credited to you on first order of one dollar or more.

ELYRIA, OHIO, U. S. A.

Murdock Wireless Apparatus

Our New List Shows:

Loose Coupled Tuners.....	\$15.00
Variable Condensers.....	8.00
2 K. W. Keys.....	8.00
Antenna Switch.....	15.00
1-4 1-2 K. W. Spark gaps.....	5.00
Silicon Detectors.....	15.00
Head Receivers.....	\$2.70 to 15.00
Receiving Sets..	\$8.00, \$15.00, \$26.50, 49.00

Get this list before ordering.

**If you want "Quality" get
"Murdock's"**

Wm. J. Murdock Co.

50 Carter St., Chelsea, Mass.

324 Dearborn St., Chicago. 162 Minna St., San Francisco

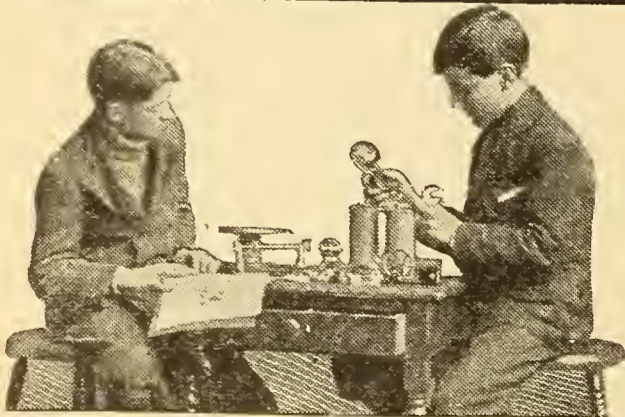

Boys, Study Electricity

at small cost right in your own room. Experiment with and make batteries, door bells, etc., with one of our complete laboratory outfits. You can learn all about the principles of electricity with all the hard college words left out. Makes a successful experimenter out of the bungler.

An Electrical Laboratory Set

consisting of battery motor, electric engine, wire, bell, push button, dry battery, horse shoe magnet, electro magnet, filings, flashlight, 1 point switch, 3 point witch, miniature lamp and socket, and a very valuable book describing over 150 experiments in electricity to be done with this apparatus, which is a complete course in elementary

\$5.00

FREE—Mention this magazine when you order and we will include free a year's subscription to it.

electricity. The book alone is well worth the price of the whole set. The value of the set if each article was purchased separately would be over \$8.00. We will send the outfit complete to any address, only . . .

Send Stamp for Complete Description

THE TREMBLY ELECTRIC COMPANY, Main Street, Centerville, Ia.

For our Mutual Advantage mention Popular Electricity when writing to Advertisers.

Manual of Wireless Telegraphy

By Lieut. Com. S. S. Robison, U. S. Navy

Complete; Thorough; Up-to-date

The only book on wireless telegraphy which covers the subject properly in clear and simple English, from the elements of electricity to complete description and diagrams of the various receiving and sending circuits.

Sent postpaid on 5 days approval on receipt of \$1.50. Money refunded if not satisfactory. We will be pleased to include with every order our illustrated catalogue of Wireless Telegraph Apparatus.

O. T. LOUIS COMPANY

Specialists in Scientific Apparatus
59 Fifth Avenue, NEW YORK

FREE

A Pocket Cigar Self Lighter (retails 50c) with every purchase of \$1.00 and over. Our No. 9, 35 page catalog, containing valuable information and Real Bargains



in our New Novelties, Toys, Wireless, Electric and Auto Supplies, is just out, and we make the above offer for this month only, in order to induce everybody to get a copy. New \$1.25 Flashlight with 4 C. P. Tungsten Lamp, 1500 flashes, now postpaid, 75c; with extra Battery, \$1.00. Send red stamp today for large Catalog with complete list of

- | | |
|---|--------------------------------|
| Electric Flashlights...33c up | Electric Scarf Pins.....35c up |
| Electric Engines.....40c up | Miniature Lamps.....9c up |
| Miniature Tungsten Lamps.....25c up | |
| Electrifier for Auto Oil or Gas Lamps.....35c | |
| Rechargeable Batteries, 3 volts.....15c | |
| Storage Batteries, 20 Ampere hours.....\$1.60 | |
| Tungsten Lamps with Brass Sockets, 6 volt.....30c | |
| Receptacles and Silverplated Reflectors, each.....04c | |
| All Metal Box Telephones, one station.....\$1.65 | |

Dealers and Agents:—Send letter head for favorable terms and discounts for quantities.

STANDARD ELECTRIC NOVELTY CO., Dept. C
Manufacturers and Importers

246 Third Ave., PITTSBURG, PA. 49-53 River St., CHICAGO, ILL.

DETECTOR CRYSTALS FREE

For 30 days we will send one crystal for wireless use together with our new catalogue E of 1910 Wireless Apparatus to any Wireless Operator sending a two cent stamp. This mineral, if used properly, is undoubtedly THE MOST SENSITIVE KNOWN. Address nearest office.

INTERNATIONAL WIRELESS CO.

Lima, Ohio

Los Angeles, Calif.

Wireless Supplies

Complete sending and receiving sets, \$1.60 up. Electrolytic Detector 1.50, Detector Stand, \$1.25. Potentiometer, \$1.65, Tuning Coils, \$2.25 to \$4.50. Also a full line of small Motors, Dynamos, Bells, Telephones, Flashlights, etc. Send 2c. stamp for large illustrated catalogue. Franklin Elec. Novelty & Mfg. Co., 846 9th Avenue, New York, N. Y.

Wireless Apparatus

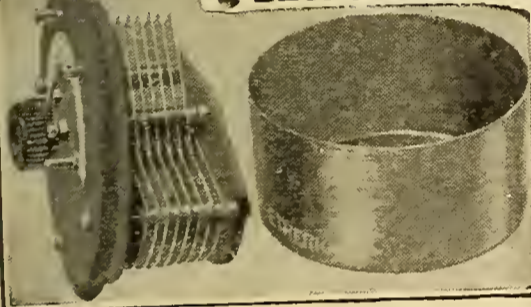

Our improved type variable condensers will increase the range of your receiving station 50 per cent. Price, \$5.00.

Send 2 cent stamp for catalog.

Etheric Electric Co.

71 Barclay Street
NEW YORK

WIRELESS APPARATUS

Amateur Professional

We wish to announce that our large 1910 catalog, devoted exclusively to wireless telegraph apparatus of recognized merit and reliability, is now ready for circulation. In it we list complete lines of both amateur and professional apparatus. Enclose 2 cent stamp for mailing.

NORTHWESTERN WIRELESS CO.

507 Sellwood Bldg.

Duluth, Minn.

BIG OFFER FOR 60 DAYS ONLY

THIS COMPLETE EXPERIMENTAL OUTFIT FOR \$5.00

LAST CALL — ACT NOW



- 1—Magneto Generator 6½ pounds in perfect condition, bronze bearings, brass gear drive, armature silk wound.
- 2—Miniature Lamps.
- 2—Miniature Lamp Sockets.
- 1—Electric Bell.
- 1—Switch.
- 1—Electrical Dictionary.
- 4—Pair silk wound Electro-Magnets.
- 1—Box Swedish Iron Filings.
- 1—Push Button.
- 1—Permanent Magnet.

All good in coupon providing same is sent with your order

FREE COUPON:—Send in your order and we will send you free in addition to the above goods, 1000 miscellaneous Machine and Wood Screws, one fine Induction Coil, 2 extra Incandescent Lamps, one Solenoid Magnet and one Telephone Drop.

Name

Address.....

WESTERN ELECTRIC SALVAGE CO., Not Inc.

(P. E.) 1224 S. Washtenaw Ave., CHICAGO, Ill.

XXTH CENTURY ICE CREAM FREEZER AND ICE CRUSHER

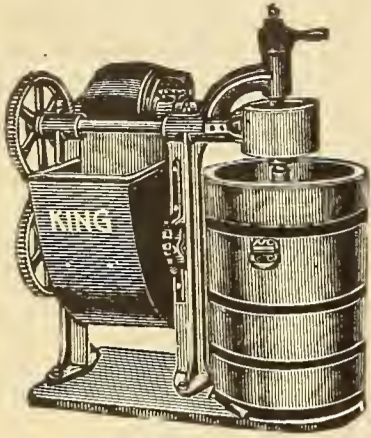

All in one machine and operated directly by an electric motor. The Freezer or Crusher can be run independent of each other or both can be in operation at the same time.

This complete plant occupies but about 8 or 9 square feet of floor space, and is a convenient height of 36 inches. Made in two capacities, 20 quarts and 40 quarts. Especially designed for Hotels, Restaurants, Cafes, Confectioners, Caterers, etc.

We also have a special Central Station and Electrical Dealers proposition, which is not only interesting but profitable. Write today for our Terms.

R. A. DEWSBERRY

216 N. MORGAN ST.

CHICAGO, ILL.

Reversible Electric Motor

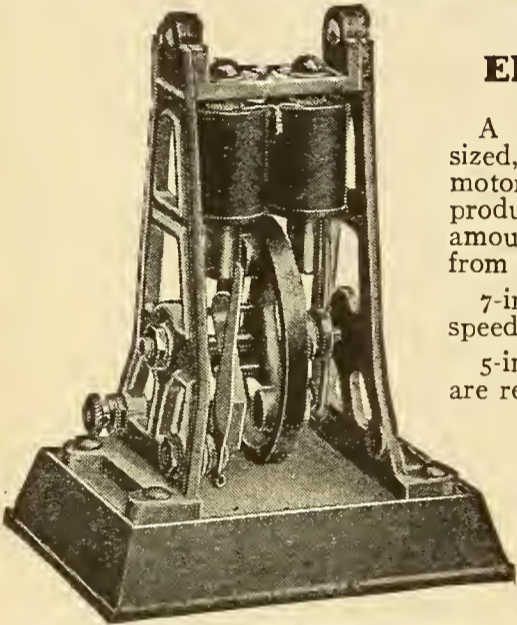

A perfect model of full sized, vertical type, electric motor, mechanical perfect, producing the greatest amount of power possible from the ordinary battery.

7-inch motor, with two speed gearing. Price, \$2.00

5-inch motor, (both sizes are reversible). Price, \$1.00

Send your dealer's name, for complete list of electrical toys.

THE H.-K. ELECTRIC
TOY CO.

Indianapolis, Ind.

Preserve your Copies of POPULAR ELECTRICITY

WITH OUR PATENT BINDER

Stout board covers, in beautiful black Levant grain cloth finish, with extra heavy black duck back, making it practically indestructible. *Popular Electricity* stamped in genuine gold leaf on front cover. Holds one complete volume (12 issues). Will last for years. :: :: :: ::

Price, only 75 cents, Postpaid

Popular Electricity Book Dept.

Monadnock Block, CHICAGO, ILL.

HOW YOU CAN EARN \$300 OR MORE A MONTH

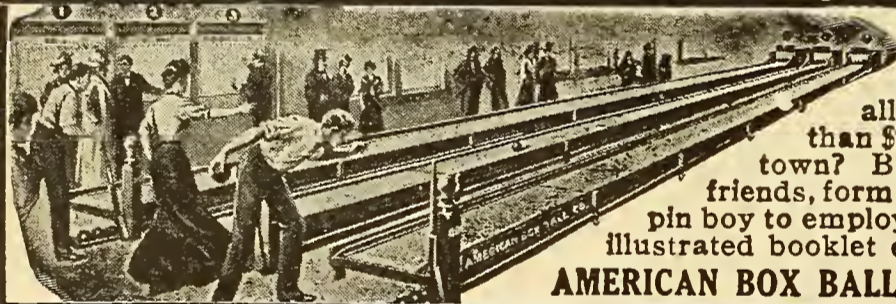

One box ball alley costing \$150, took in \$513 the first fifty-one days at Sullivan, Indiana. Two other alleys costing \$365, took in \$1,372.95 in five months. Four large alleys costing \$840, took in \$1,845.20 in fifty-nine days, more than \$900 a month. Why not start in this business in your own town? Both men and women go wild with enthusiasm; bring their friends, form clubs and play for hours. Players set pins with lever—no pin boy to employ. Alleys can be set up or taken down quickly. Write for illustrated booklet explaining EASY PAYMENT PLAN. Send for it today.

AMERICAN BOX BALL CO.,

1905 Van Buren Street, Indianapolis, Indiana

DIAMONDS ON CREDIT WATCHES LOFTIS SYSTEM

GIVE YOUR SWEETHEART A DIAMOND RING

Write for Our New Catalog containing over 1500 beautiful photographic illustrations of Diamonds, Watches and Artistic Jewelry. Select any article you would like to own or present as a gift to a loved one; it will be sent on approval to your home, place of business, or express office, without any obligation whatever on your part. If it is satisfactory in every way, pay one-fifth down and keep it, balance in eight equal monthly amounts. If not entirely satisfactory, return it. We pay all charges and take all risks. We have absolute faith in our goods because we know they are the very best quality and highest grade of workmanship. **An Account With Us** is a confidential matter. Our customers use their charge accounts with us year after year, finding them a great convenience at such times as birthdays, anniversaries, engagements, weddings, graduation, etc.

LOFTIS
BROS. & CO.

Diamonds as an Investment are better than a savings bank because they pay four times the rate of interest. They increase in value from 15% to 20% each year. Our prices are lowest; our terms are easiest. We allow 8% discount on all cash orders. Send today for a free sample copy of the Loftis Magazine, devoted to "Styles and Stories of Diamonds, Precious Stones, Fine Watches and Artistic Jewelry."

THE OLD RELIABLE ORIGINAL DIAMOND
AND WATCH CREDIT HOUSE
Dept. D685, 92 to 98 State St., Chicago, Ill.—Branches: Pittsburg, Pa., & St. Louis, Mo.



DIAMOND SPECIAL
Ladies' and Gentlemen's
Diamond Rings. \$11.00
down; \$5.50 per month

For our Mutual Advantage mention Popular Electricity when writing to Advertisers.

Don't Be a Wage Slave

Make \$3,000.00 to \$5,000.00 a Year

Be a Doctor of Mechano-Therapy
We Teach You By Mail or In Class

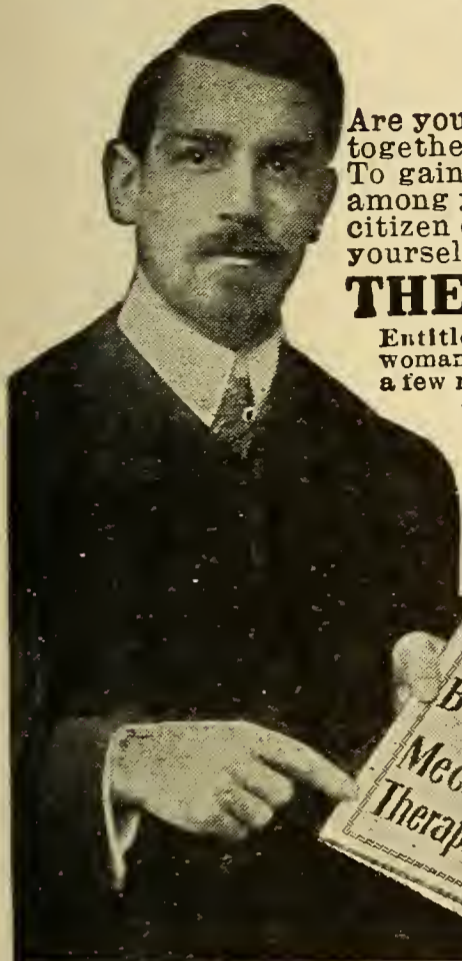

Are you tired of working for wages which barely keep body and soul together? Have you the ambition to enjoy the profits of your own labor? To gain social prominence and financial independence? To go forth among your fellow men with your head up—an honored and respected citizen of your locality? Have you thought of going into business for yourself?

THEN SEND FOR OUR FREE BOOK

Entitled "How to Become a Mechano-Therapist." It tells how every man and woman, with an ordinary, common school education, can acquire a profession within a few months which will insure financial independence for life. **GET OUR BOOK**—it costs you nothing.

WHAT IS MECHANO-THERAPY?

Mechano-Therapy is the art, or science, of treating disease without drugs. It is similar to Osteopathy, but far superior, being the latest, up-to-date method of treating disease by the Natural Method. It heals as Nature heals—in accordance with Nature's laws. The Mechano-Therapist is a drugless physician. His medicines are not drugs, but scientific combinations of food, circumstance, idea, water and motion. He is skilled in compelling the body **TO DO ITS OWN HEALING** with its own force, rather than with poisonous drugs of the old school practitioner.

CAN I LEARN IT?

Have you asked yourself this question? We answer unhesitatingly, **YES**.

If you have so much as an ordinary, common school education you can learn.

You learn if you have the ambition to better your condition.

We can teach you in a very short time, so you may enter this profession—when you do, you begin to make money. We

supply all lessons and necessary text books free of cost to you. No apparatus is used. You do not even need a place to work. All you require is your two hands. Certainly you can learn. The free book tells all.

We Teach You in Your Own Home

We can teach you an honorable and profitable profession in a few months, which will insure your financial independence for life, making it possible to have an income of \$3,000 to \$5,000 a year. We teach you by mail, in your own home, without interfering with your present duties. No matter how old you are. Any

person—man or woman—with just an ordinary school education, can learn Mechano-Therapy. It is easy to learn and results certain. We have taken hundreds of men and women who were formerly clerks—farmers—stenographers—telegraph operators—insurance agents—railway employes—in fact, of nearly every known occupation—old men of 70 years who felt hopeless—young men of 20 years, without a day's business experience—salaried men, who could see nothing in the future but to become Oslerized, and laboring men, who never realized that they had within themselves the ability to better their conditions. Write for our **FREE** book, which explains all—today.

AMERICAN COLLEGE OF MECHANO-THERAPY, Dept. 984, 120-122 Randolph Street, Chicago, Ill.

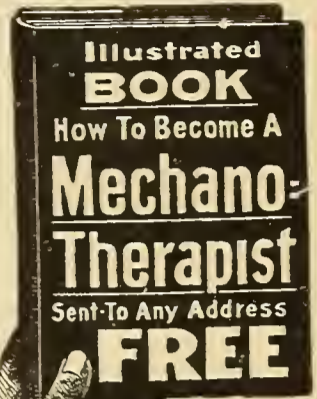

SEND FOR THIS BOOK TODAY, IT IS FREE

Electricity as a Remedy

The curative value of electricity when properly applied is only just beginning to be recognized.

Many people who could derive benefit from this great natural healing agent are repelled by the thought of the electric current and the plugs, wires, coils, etc., connected with the ordinary battery. All these objections are overcome in the

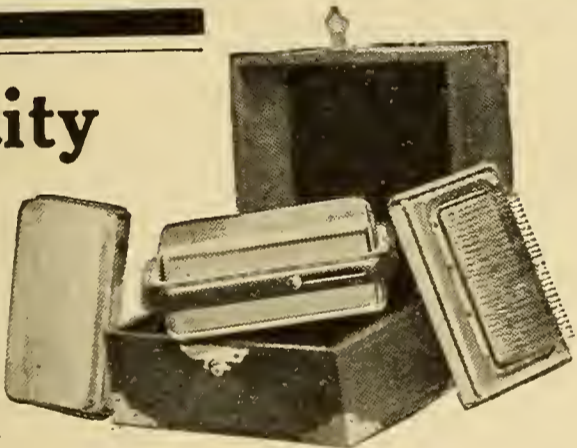

Wizard Wireless

which not only has no wires, plugs liquids, but is so compact, simple and convenient that it fits the hand.

The current is mild pleasant and bracing and may be regulated as desired. For rheumatism or nervous troubles, under development, nervous debility and circulatory disorder, it is endorsed by physicians and used in their practice. Hundreds of sufferers who have been helped and cured after drugs failed, have written enthusiastic letters regarding benefits derived from a few minutes daily use.

Write for profusely illustrated book "Electricity as a Remedy." We send it Free

It tells just what the Wizard Wireless is, how it works, what it cures and why it should be in every home. Every one interested in electricity should know about the Wizard Wireless.

GENESEE SALES CO.
Suite 384, 211 Lake St.,
CHICAGO

CANADA OFFICE: CENTRAL ELECTRIC CO., 36 Adelaide St., W. Toronto

ELECTRICITY BOOK FREE

Profusely Illustrated with Photos from Life.
Write for it today.

This splendid book is compiled from the best authorities in the world. Explains how electricity as supplied by inexpensive batteries cures Rheumatism, Dyspepsia, Insomnia, Liver and Kidney Trouble and all nerve affections and diseases due to poor circulation. Explains how to enjoy the famous electric baths and beauty and health massage at home at little cost.

THIS BATTERY

\$1.95

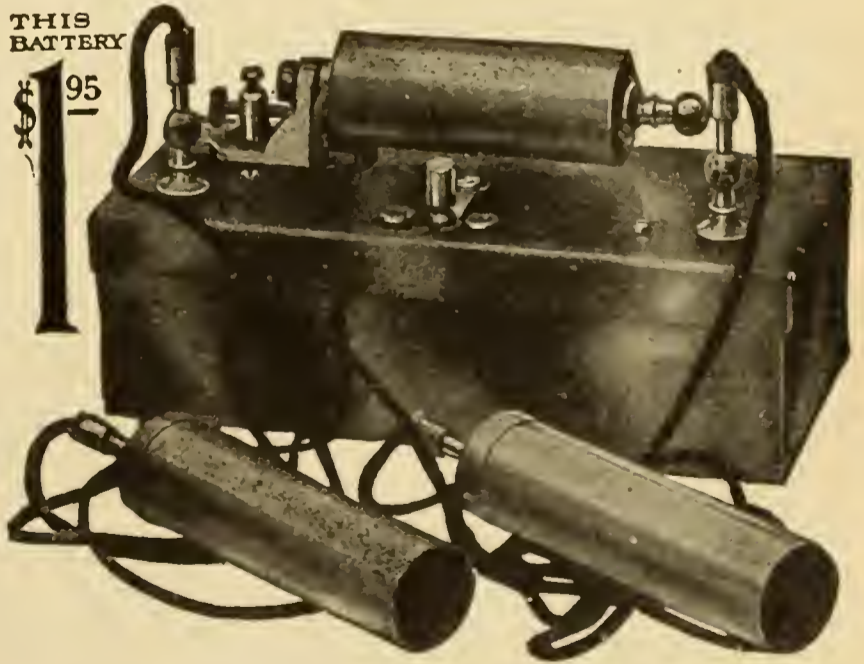

This book also lists the latest improved Batteries (Prices \$1.95 to \$24.00), which we send on 10 days' free trial.

DETROIT MEDICAL BATTERY CO
499 Majestic Bldg., Detroit, Mich.

Write today for our free book.

For our Mutual Advantage mention Popular Electricity when writing to Advertisers,

PATENTS

THAT PROTECT and PAY
Send for FREE 85-page book.
Advice free. Terms reason-

able. Highest references. Best results.

Recommended Patent Lawyer in the Bankers' Register and special list of selected lawyers.
Also in Martindale's Law Directory, Sharp & Alleman's Directory of Lawyers, The
Gast-Paul Directory of Lawyers, and Kime's International Law Directory.

ALL BUSINESS GIVEN PROMPT AND PROPER ATTENTION

Member of the Bar of the United States Supreme Court and all of the other Courts in the District of Columbia

A large list of strong recommendations furnished free.

WATSON E. COLEMAN, Patent Lawyer, 612 F St., N. W., Washington, D. C.

TESTED APPARATUS Means the Elimination of Faults in Your Product.

Electrical and photometrical tests of every description.
Checking electrical instruments of all kinds and classes.
Inspecting and testing new electrical machinery, apparatus and material at factories and after installation.
Tests on any electrical machinery and apparatus made anywhere.
Arc and incandescent lamp tests, either electric, gas, acetylene or oil.
Illumination tests made anywhere.
Secondary standards of candle-power furnished.
Facilities furnished to experimenters and investigators.

We have recently added to the above, coal testing, and are now prepared to make proximate analyses and calorific determinations on samples of coal, promptly and accurately.

ELECTRICAL TESTING LABORATORIES

80th Street and East End Avenue

NEW YORK, N. Y.

VITAL POWER 100% Added to your Men- tal and Physical Capacity

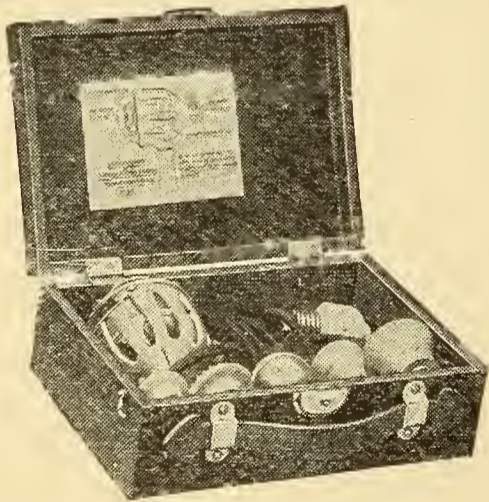

The Swedish Electric Vibrator

will cultivate your system up to the top notch standard; it will CURE nearly every ailment; it will give you VITAL POWER; it will throb and thrill you into a tireless human engine with POWER to think TWICE AS CLEARLY and DO twice as MUCH. When you come in from a hard day's work, it will SOOTHE, REST and REVITALIZE you from head to foot; it will cause your blood to go LEAPING and BOUNDING through your veins and arteries; cause the flow of nerve fluids to saturate the innermost nerve. You

Operates on either Alternating or Direct
Electric Light Current or its own
Powerful Batteries.

Prices, \$12.50 to \$30.00

can actually feel disease and weakness being driven from you and NEW LIFE and power being generated.

IT SETS LOOSE in the blood and lymphatic vessels all stray and impure matter that CLOG UP the capillaries. These impuri-

ties are poisoning and weakening your system and need only to be RATTLED LOOSE, combined with blood so that it can and will be TAKEN OUT OF THE BODY through the excretory organs

It takes a big, illustrated book, with charts and diagrams and instructions in PLAIN ENGLISH to SHOW and TELL HOW OUR VIBRATOR will cure any ailment, correct any physical condition. We will send it to you FREE.

Write us today—and let us PROVE to YOU what we say—at our cost.

SWEDISH ELECTRIC VIBRATOR CO., 1740-1750 FARRAGUT AVENUE CHICAGO, ILL.



PATENTS PATENT ATTORNEYS



PATENTS Secured Promptly and with special regard to the legal protection of the invention.

HAND BOOK FOR INVENTORS AND MANUFACTURERS SENT FREE UPON REQUEST

C. L. PARKER, Patent Lawyer

Patents, Caveats, Trade Marks, Copyrights, Reports as to Patentability, Validity and Infringement.
Patent Suits Conducted in all States.

REFERENCES: American Tire Co., Automatic Vending Machine Co., Lippincott Pencil Co., International Ore Treating Machinery Co., Globe Machine and Stamping Co., Metal Manufacturing Co., Builders Iron Foundry, Morgan Machine and Engineering Co., Berkshire Specialty Co., Stewart Window Shade Co., Macon Shear Co., Acme Canopy Co., Oaks Manufacturing Co., Cox Implement Co., Columbus Buggy Co., National Index Co., Handy Box Co., Iron-Ola Co., By-Products Chemical Co., Alabama Brewing Co., National Offset Co., Antiseptic Supply Co., Floor Clean Co., Fat Products Refining Co., Richmond Electric Co., Railway Surface Contact Supplies Co., National Electric Works, Modern Electric Co.

Mr. Parker on November 1, 1903, after having been a member of the Examining Corps of the U. S. Patent Office for over five years resigned his position to take up the practice of patent law.

Address 12 MCGILL BUILDING

WASHINGTON, D. C.

PATENTS that PROTECT

Our 3 books for inventors mailed on receipt of 6 cts. stamps.
R. S. & A. B. LACEY, Washington, D. C., Dept. 52 Est. 1869

SAMUEL G. McMEEN

KEMPSTER B. MILLER

McMEEN AND MILLER ELECTRICAL ENGINEERS

Patent Solicitors and Patent Experts

In connection with our engineering practice we make a specialty of securing patents for inventors, and of giving expert advice in patent matters.

1454 MONADNOCK BLOCK
CHICAGO

333 GRANT AVE.
SAN FRANCISCO

WHEN desirous of information inquire at the information dept. of Popular Electricity Pub. Co.

BOOK FREE

HOW TO JUDGE A PATENT

"WRITTEN SO YOU CAN UNDERSTAND IT"

OBED C. BILLMAN CLEVELAND, OHIO.
WASHINGTON, D. C.

SATISFIED CLIENTS IN EVERY STATE

Dieterich's
**50 Perpetual
Motions**
With 100 Mechanical Movements
Books tell all about Perpetual
Motion and how to obtain Patents
BY MAIL 25 CENTS STAMPS & SILVER
F. DIETERICH 61...OURAY WASH D.C.

PATENTS

TRADE MARKS AND COPYRIGHTS

SECURED OR FEE RETURNED

Send model or sketch and description of your invention for free search of the U. S. Patent Office Records.

Our **Four Books** mailed free to any address. Send for these books; the finest publications ever issued for free distribution.

HOW TO OBTAIN A PATENT

Our Illustrated 80 page Guide Book is an invaluable book of reference for inventors and contains 100 mechanical movements illustrated and described.

FORTUNES IN PATENTS

Tells how to invent for profit and gives history of successful inventions.

WHAT TO INVENT

Contains a valuable list of inventions wanted and suggestions concerning profitable fields of invention. Also information regarding prizes offered for inventions, among which is a

PRIZE OF ONE MILLION DOLLARS

offered for one invention and \$10,000 for others.

PATENTS THAT PAY

Contains fac-similes of unsolicited letters from our clients who have built up profitable enterprises founded upon patents procured by us. Also endorsements from prominent inventors, manufacturers, Senators, Congressmen, Governors, etc.

WE ADVERTISE OUR CLIENTS' INVENTIONS FREE

in a list of Sunday newspapers with two million circulation and in the *World's Progress*. Sample copy free.

ELECTRICAL CASES A SPECIALTY

We have secured many important Electrical patents.

VICTOR J. EVANS & CO.

(Formerly Evans, Wilkins & Co)

Main Offices, 615 "F" Street, N. W., Washington, D. C.

ELECTRICAL ENGINEER

Eugene C. Brown
Suite 4, Victor B. dg.
Washington, D. C.

Mr. Brown is a graduate Electrical Engineer and was for seven years an Examiner in Electrical Division U. S. Patent Office, and is prepared to render expert services in preparation and prosecution of Electrical cases. Send Sketch for Advice

**PATENT
LAWYER**

4-in-1 Volt-Ammeter

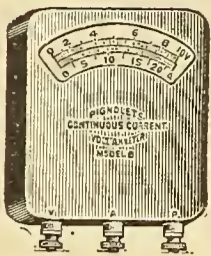

Measures high and low volts, amperes and resistances. It's accurate, compact, inexpensive.

Send for complete catalog No. 15 of portable and switchboard voltmeters and ammeters.

L. M. PIGNOLET

78 Cortlandt Street

NEW YORK

WIRELESS COILS



These high grade Wireless Coils, like the illustration, are perfectly balanced, wound with the highest quality of enameled wire, and are capable of producing good hot spark from 1-2 inch to 2 1-2 inches in length. Prices extremely low.

Storage Batteries of the very highest type and quality, capable of delivering 6 volts for 60 ampere hours and guaranteed for 1 year for \$12.00. Large discount to dealers.

Particulars sent for 4-cent Stamp—Dealers free,
LEMKE ELECTRIC CO. (Dept. P. E.) Milwaukee, Wis.

EVERY BOY HIS OWN TOYMAKER



Greatest boys' book ever written. Tells how to make a Steam Engine, Camera, Windmill, Microscope, Electric Telegraph, Telephone, Magic Lantern. Boats of every kind, kites, balloons, toys, wagons, bows and arrows, stilts, animal traps, etc. Over 200 pictures. This book and catalogue only 10c. postpaid.

Commercial Electric Co

Dept. D, Kewanee, Ill.

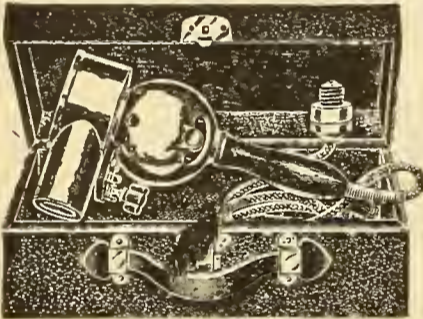

HORN VIBRATORS HAIR DRYERS SMALL MOTORS

Run on both 110 volts direct current and 60 cycle alternating current. Best machines on the market for a moderate price. Live agents wanted.

Send for a catalogue

Horn Electric Co.

36 S. Canal St. Chicago



\$54.00 Per Day Camera-Scope

The record of the

And we can prove it. Anyone can operate it. Makes 6 finished button photographs a minute. Price of Camera-Scope, with supplies for making 300 pictures (enough to pay for the complete outfit) \$25.00. Extra buttons \$1 per hundred; extra frames, \$1.50 per gross. Be independent and make money for yourself. Write today.

The Mountford Mfg. Works 96 Maiden Lane
New York, N. Y.

FOOT AND ELECTRICAL DRIVEN

Power and Turret Lathes, Planers, Sharpeners, and Drill Presses.

Write today for our Complete Catalog.

Shepard Lathe Co.

B. 131 W. 2nd St., Cincinnati, Ohio

ELECTRICITY

VOLTAMP

The most wonderful and fascinating scientific study of the age. Every Boy, Girl and Grown-up should know about it. The new "VOLTAMP ELECTRICAL PRODUCTS"—

our 112 Page Catalog now ready, the most complete and interesting book ever issued—is full of illustrations and descriptions of the latest VOLTAMP Electrical Novelties—Motors, Dynamos, Toys, Machine Models, Telegraph and "Wireless" Instruments, Ruhmkorff Coils, Spark Coils, Geissler Tubes, Switches, Meters, Lamps, Flashlights, Transformers, Tools, etc. The greatest line of Miniature Electric Railways ever shown. Anything Electrical for Anybody. Prices consistently low.

Send for this Catalog—6 cents in stamps or coin, which will be refunded on first order of 50 cents or over. No postals answered.



VOLTAMP ELECTRIC MFG. CO., Park Bldg., Baltimore, Md.

GASOLINE SOLDERING IRON BLOW TORCH



Here's the greatest time and fuel saver on earth, puts the heat right to the spot. Our booklet mailed to any address.

EMMELMAN BROS. MFG. CO.

Dept. A

Indianapolis, Ind.

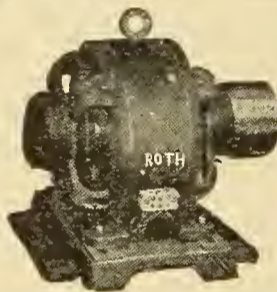

ROTH

ELECTRIC MOTORS
POLISHING LATHES
FORGE BLOWERS
SPECIAL MACHINERY

ROTH BROS. & CO.

1358 W. Adams St.
Chicago, Ill.

136 Liberty St.
New York City



JUNIOR BELL RINGER

Will operate all bells or buzzers in your home when connected to alternating current circuit

Price \$3.00 Any inexperienced person can install it. Consumes no current. Will last a life time. Weight 3 lbs., dimensions 6 in. x 3 in. x 2 in. When ordering state the voltage in your home.

Thordarson Electric Mfg. Co.

217 South Jefferson Street, CHICAGO, ILL.

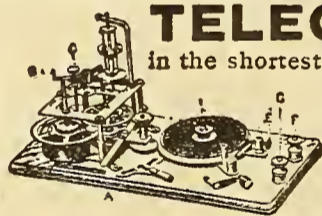

TELEGRAPHY TAUGHT

in the shortest possible time. The Omnigraph Automatic Transmitter combined with standard key and sounder. Sends you telegraph messages at any speed just as an expert operator would. Five styles, \$2 up; circular free.

OMNIGRAPH MFG. CO.

H Cortlandt Street

New York

ELECTRIC

GOODS FOR EVERYBODY. World's headquarters for Dynamos, Motors, Fans, Toys, Railways, Batteries, Belts, Bells, Pocket Lamps, Telephones, House Lighting Plants, Books. If it's electric we have it. *Undersell All.* Fortune for agents. Catalog 4c.

OHIO ELECTRIC WORKS, Cleveland, Ohio

"How to Construct a Practical Wireless Telegraph"

With illustrations, diagrams, and fine copy of the Codes, 25c. A 2c stamp brings our bulletin of wireless supplies.

CHICAGO WIRELESS SUPPLY CO.

Room 520, Auditorium Office Bldg.

Chicago, Ill.

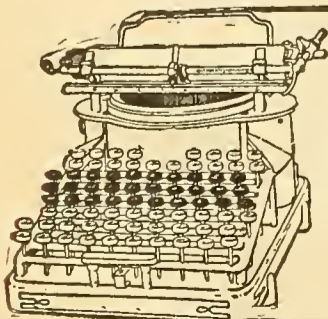

The Best of \$100.00

PALS

In telegraphy, the typewriter and Meco-graph are becoming inseparable—equally popular, equally indispensable.

Over 60 Per Cent

More movements required to send on a Morse key than on a MECOGRAPH. Good senders get best salaries. Best senders use the MECOGRAPH. Write for new circular.

MECOGRAPH COMPANY

321 Frankfort Ave.,

Cleveland, Ohio

\$7.50

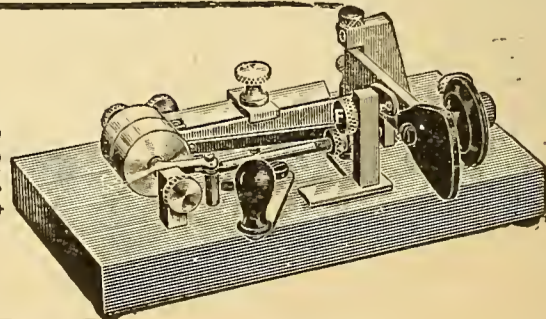

Sound Focusing Receiver

If you don't
hear well
over
the telephone
use this.



Adapted to any Make or System of Telephones

Anyone can attach it easily

This Receiver is designed and made expressly for hard-hearing and partially deaf people. It **concentrates** and **amplifies** the sound, excludes all outside noise. It is **extremely sensitive**, reproduces the sound **loud** and **distinct**. (We also make this in the shape of head band or watch case receivers for Wireless Telegraph use, wound to especially high resistance.)

SENT PREPAID TO ANY ADDRESS IN UNITED STATES

Price for Telephone use, as per cut, including cord \$2.00 each
Price for Wireless Telegraph, Watch Case type, including cord 3.00 each

SWEDISH-AMERICAN TELEPHONE COMPANY

1741-1751 Berwin Avenue

CHICAGO, ILL.

Excelsior Auto-Cycle

VISIBLE

SUPERIORITY

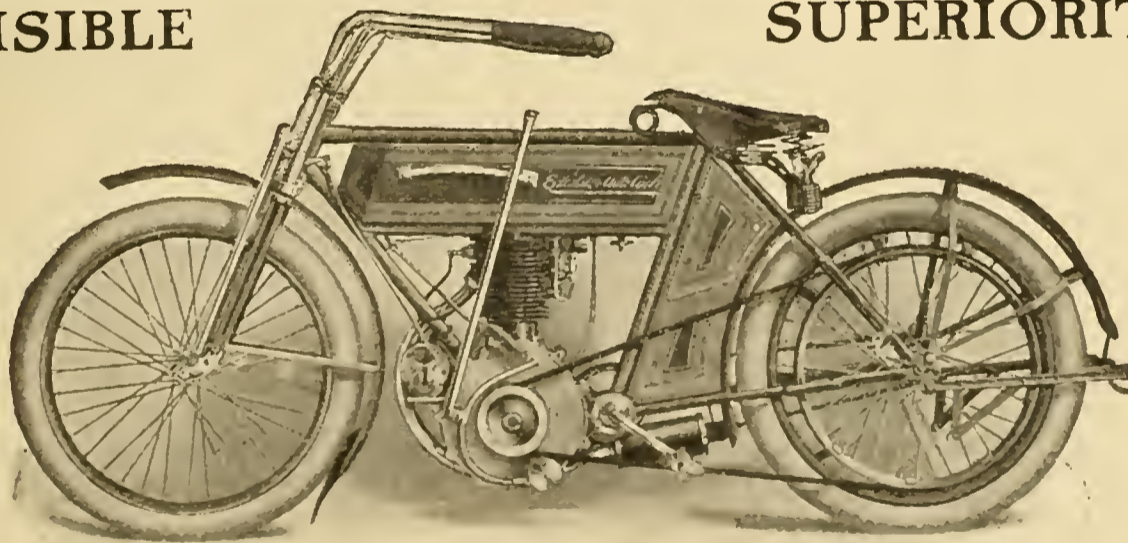

It is easy to claim high qualities hidden somewhere on the inside, but the discerning buyer wants to be "shown." The qualities of the

Excelsior Auto-Cycle

are not hidden or elusive. They show all over.

Here are a few of them: Straight line frame, powerful, rational speed motor, low saddle position, mechanical sight feed oiler, positively internally lubricated hub brake, real shock absorbing spring fork and simple, positive grip control. These are some of the points that have established the **EXCELSIOR REPUTATION, THE ONE THAT ALWAYS MAKES GOOD.**

Established 1876. Catalog H10 gives full details. Why not send for it? Members M. M. A.

Excelsior Supply Company, 233-237 Randolph St., Chicago

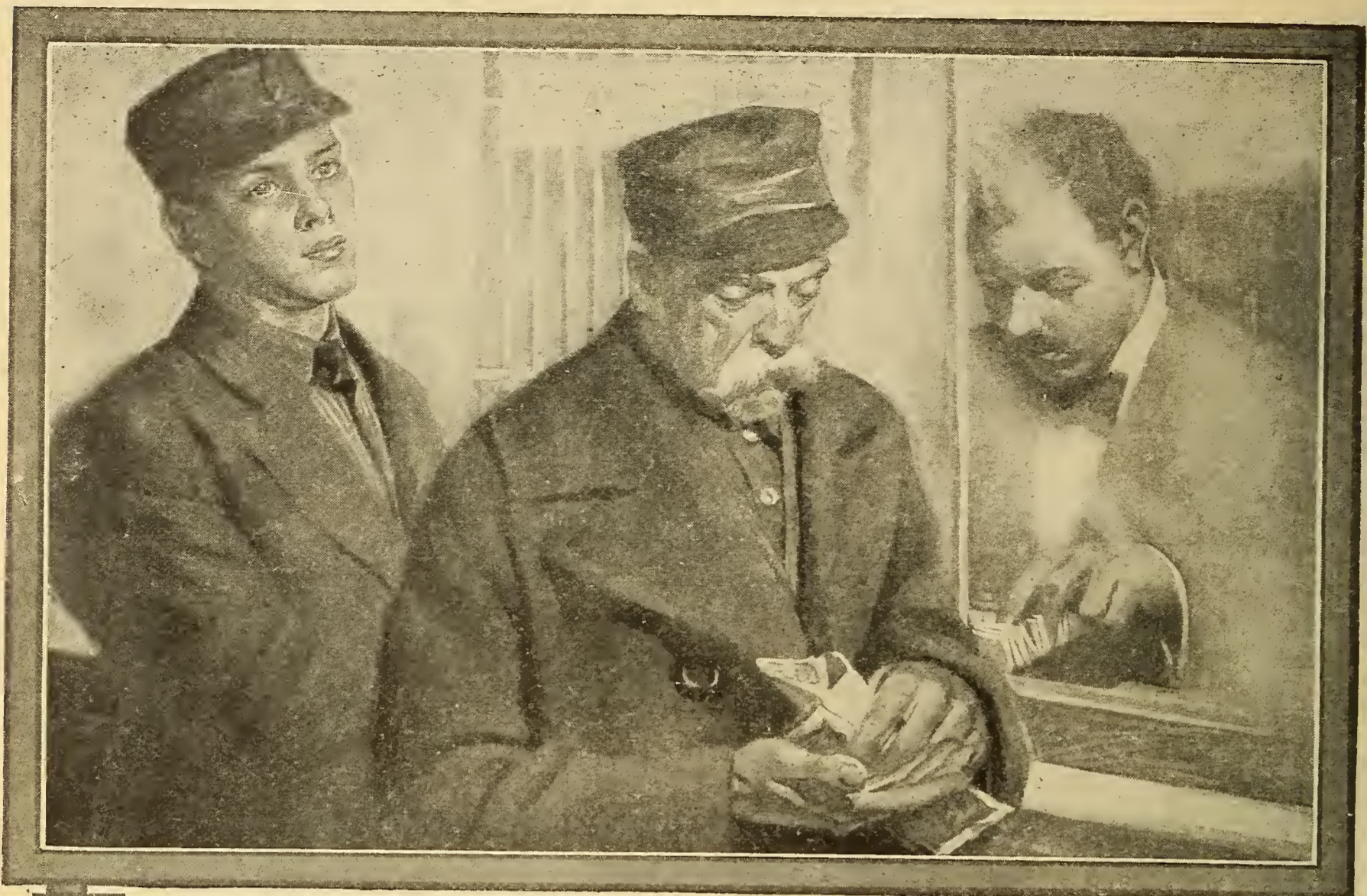

Story of the Pay Envelope

Whether young or old, if you're untrained, your pay envelope will tell the same old story — skimping along on a small salary — living expenses advancing year by year — no hopes of a raise — Why? Because you lack the *training* that makes promotion sure.

Training makes the difference in men and in salaries. The untrained man of sixty, in spite of his years of service, can earn no more at a common job than the untrained youth beside him.

FREE INFORMATION COUPON

American School of Correspondence:

Please send me your Bulletin and advise me how I can qualify for position marked "X."

- | | |
|---------------------------|--------------------------|
|Book-keeper |Draftsman |
|Stenographer |Architect |
|Accountant |Civil Engineer |
|Cost Accountant |Electrical Engineer |
|Systematizer |Mechanical Engineer |
|Cert'f'd Public Acc't |Sanitary Engineer |
|Auditor |Steam Engineer |
|Business Manager |Fire Insurance Eng'r |
|Commercial Law |College Preparatory |

NAME

ADDRESS

OCCUPATION.....

Pop. Elect. 4-'10

The American School of Correspondence trains men to fill well-paid positions in business and engineering. If you want to get ahead—to get bigger pay—check, in the coupon below, the position you want to hold—and mail today.

The coupon will bring *no agent*—we employ none; it will bring specific information and sound advice. Tell us frankly your condition—your ambitions—and let us show you how to get a better position and better pay.

AMERICAN SCHOOL OF CORRESPONDENCE
CHICAGO, U. S. A.



Hot Water and Steam Heat For New or Old Buildings

Our Wonderful offer! It's Within the Reach of All

Our prices on first class brand new Hot Water and Steam Heating Apparatus are lower than you can possibly obtain anywhere else. All we ask is for an opportunity to demonstrate the absolute truth of this statement.

Above all we will furnish you a *binding guarantee covering 365 days*, which will guarantee that every article used in our plants is absolutely brand new, perfect and free from defects and also that the plant installed according to our plans and instructions will give you absolute satisfaction.

We allow you 365 days to prove it. If at the end of that time you have not received what you bargained for, we give you permission to return all material to us and you will receive a refund of the purchase price. We stand all return freight charges.

30 to 50 Per Cent Saved if You Buy from Us

We can furnish you all the necessary apparatus for the installation of either a Hot Water or a Steam Heating Plant in your building, whether it be new or old at a saving of from 30 to 50 per cent. We ask that you furnish us a sketch of the building you have to heat, and supply us with such additional facts regarding its construction as will intelligently enable us to understand all conditions. Upon receipt of such information we will prepare a proposition covering the material you need to correctly install the plant. We will make you a price on application that will be freight prepaid in full to your shipping point.

We Furnish All Necessary Instructions

Including Blue Prints, Sketches and Drawings. Any ordinary mechanic can install these plants. Our proposition will include all necessary blue prints, sketches and detailed drawings, so that any man handy with the use of tools and possessing average intelligence can easily install the plant. We will also loan you the necessary tools.

Learn From the Experience of Others! Here's the Proof of the Pudding

We have hundreds of unsolicited testimonials in our possession. Postoffice addresses of any of below furnished on application.

INSTALLED PLANT WITHOUT PLUMBERS' AID

Chicago House Wrecking Co., Chicago, Ill.
Dear Sir:—I have my heating plant installed and it works fine. Can heat my place red hot if I want to.
Yours very truly, (Signed) L. A. NEFF.

HERE IS ONE IN NOME, ALASKA

Chicago House Wrecking Co., Chicago, Ill.
Dear Sirs:—The heating plant you sent me is installed and is working fine. Everything is entirely satisfactory in every way. Wishing you entire success, I remain,
Yours truly, PAUL H. FITZGERALD

Our Free Book of General Information

Write at once for our free book "Cold Weather Comfort," a book of 128 handsomely illustrated pages. We send it absolutely free if you mention the name of this publication. Besides covering fully every phase of the heating question, it contains many valuable suggestions covering the care of your heating plant. It also contains full information regarding hot air furnaces. There are fifty pages devoted to Plumbing in all its phases. It is the best and most valuable publication of its kind ever produced and will cost you absolutely nothing if you mention where you have seen this advertisement.

Our 500-Page Book of Bargains Mailed Free to You. Ask For No.891.

Besides our Heating Catalogue we publish a grand free illustrated Catalogue containing a full history of our general lines. We carry in stock practically everything in the material line that is manufactured. Lumber, Sash and Doors, Structural Iron, Plumbing and Heating Apparatus; Furniture, Household Goods, Rugs and Office Furniture; Roofing, Wire and Fencing; Machinery, Electrical Apparatus and 10,000 other items.

We advise you to write us today

**CHICAGO HOUSE WRECKING
COMPANY,** 35th & Iron Sts., CHICAGO

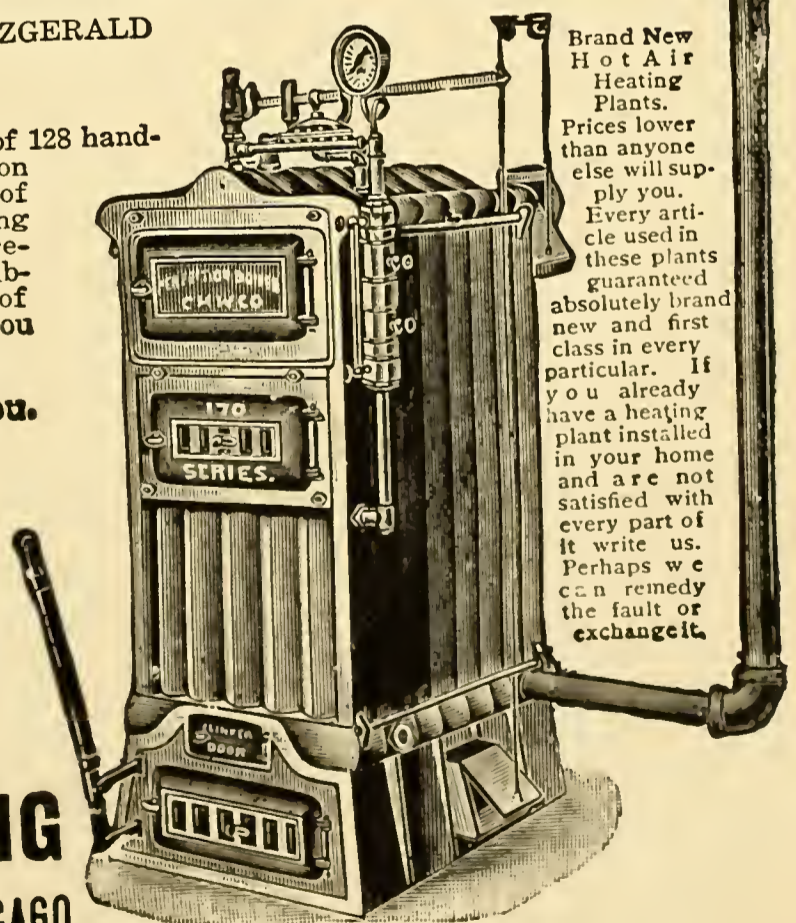

Brand New Hot Air Heating Plants. Prices lower than anyone else will supply you. Every article used in these plants guaranteed absolutely brand new and first class in every particular. If you already have a heating plant installed in your home and are not satisfied with every part of it write us. Perhaps we can remedy the fault or exchange it.



What Electricity Has Done for Humanity

The biggest week's washing done in 90 minutes at a cost of only 3 cents for electricity.

The THOR - Electric Laundry Machine is on the **Reversing Cylinder Principle** which is recognized by people that "know" as the only perfect way to wash clothes clean, without injury.

Operated from any Electric Light Fixture

The 'THOR No. 1, or family size, is on castors, will go thru any door, and can be used in kitchen or laundry. Is ready to work the minute it is received in your home.

Tied to the Washtub Inconvenience

No matter whether you do your own washing or have it done by servant or washerwoman—if you employ the old methods you are tied fast to washtub inconvenience—drudgery—loss of time and clothes.

This Coupon Brings Free Booklet

There are.....members in our family and I want to read your free booklet telling the entire story "How to Wash and Wring Clothes by Electricity."

Name.....

Address.....

HURLEY MACHINE CO.

CHICAGO
39 S. Clinton Street

NEW YORK
1013 Flatiron Building



Made in different sizes, adapted for any house or apartment