

JULY 1997

# POPULAR COMMUNICATIONS

## The Family Radio Service— Hot Half-Watt Handhelds

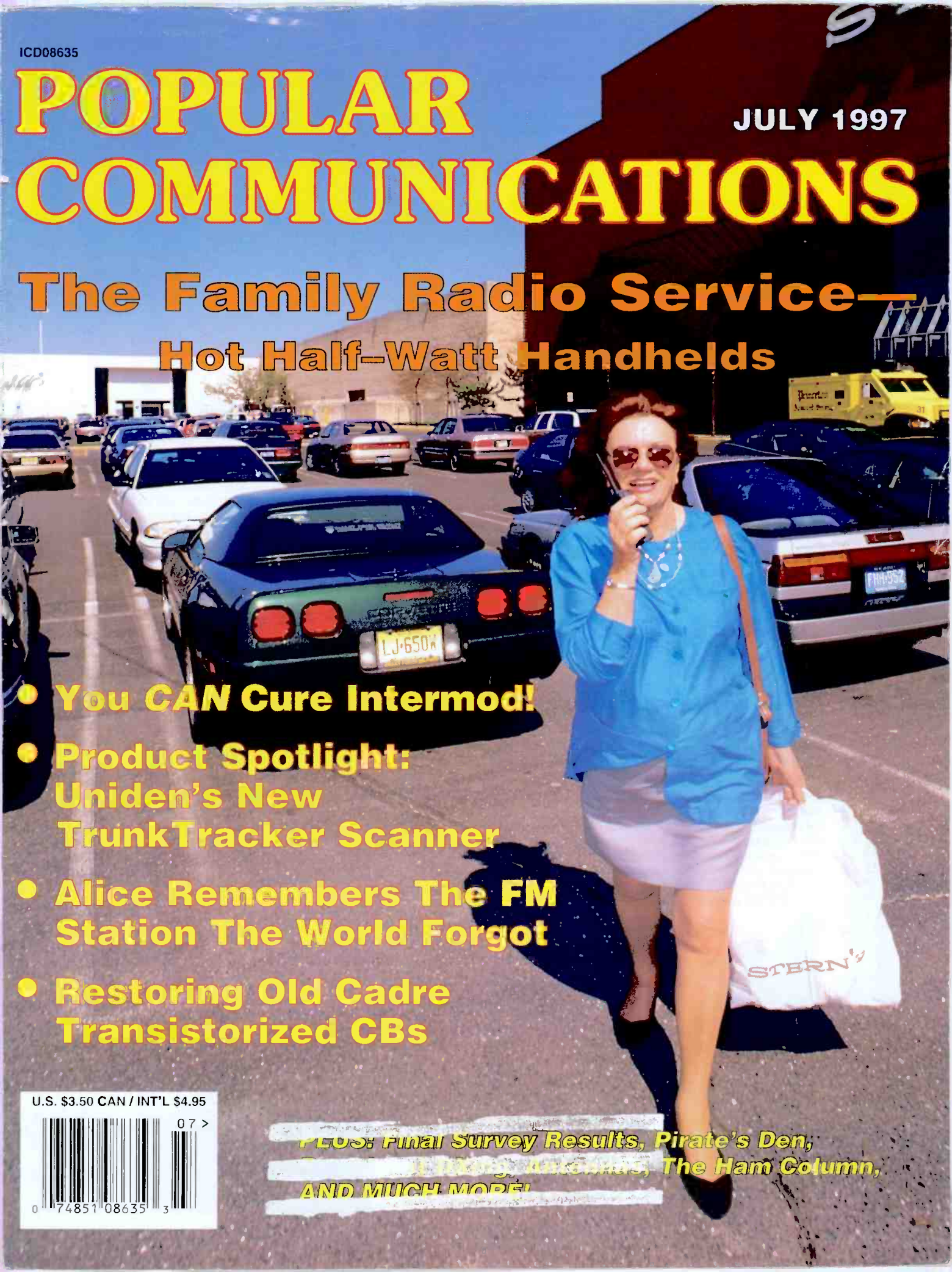

- You CAN Cure Intermod!
- Product Spotlight: Uniden's New TrunkTracker Scanner
- Alice Remembers The FM Station The World Forgot
- Restoring Old Cadre Transistorized CBs

U.S. \$3.50 CAN / INT'L \$4.95



**PLUS: Final Survey Results, Pirate's Den,  
Circuit Biting, Antennas, The Ham Column,  
AND MUCH MORE!**

**Look to AOR for the BEST in Radio Equipment!**

## AR5000 Cyberscan

10kHz - 2600MHz\*

### The Professional Scanner

AOR has advanced the frontiers of performance providing strong signal handling, high sensitivity and the widest coverage on the market. Advanced wide band front end design provides high sensitivity with auto tuning pre-selector from 500kHz to 1000MHz, plus manual override to read signal and store setting in memory. Every function of the AR5000 is micro processor controlled and receives instructions direct through the front panel or via RS232. I.F. filtering is unique. Filter selection controls 2 banks of filters, one at 10.7 MHz the other at 455kHz. This cascade filtering effect produces excellent shape factors and ultimate out of band signal rejection. There are 6 filter bandwidth provided 3,6,15,30,110, 220kHz with a seventh position for optional 500Hz cw filter in the 455 kHz IF. There are 1000 memory channels in 20 banks plus 20 search banks and an of 2100 pass frequencies.



## AR3000A

100kHz-2036MHz\*

### The Most Respected Scanner on the Market!

Compact, low cost wide band multi-mode reception. Small size has allowed the AR3000A to be used in many applications from battery powered brief case to multi-receiver rack-mounted installation to air born EWA systems. The AR3000A has proved itself as an easy to operate, rugged, low-cost and reliable contender for many requirements.

- Coverage: 100kHz-2036MHz\*
- Memory: 400 CH 4 banks
- Sensitivity: NFM 2.5-1.800MHz .35NV
- Selectivity: 2.4, 12, 180 KHz
- Power: 13.8VDC < 5A AC Adaptor included
- Size: 5.4 x 3.15 x 7.9", 2.4 lbs
- Modes: FM, FMW, AM, LSB, VSB, CW
- Scan Speed: up to 50 CH/Sec.
- Antenna: BNC 50 Ω

## AR3030G

30kHz - 30MHz

### Enhanced Coverage Receiver

A favorite of commercial and industrial applications. Same great features as the AR3030, but with these added features to further enhance your operation or special requirements.

**FEATURES:** The AR3030G boasts a wide frequency coverage from 30kHz to 30MHz and all mode reception 'as standard' AM, S.AM (synchronous), NFM, USB, LSB, CW & FAX. There are 100 memory channels which allows data to retain frequency, mode, bandwidth, AGC, attenuator and tone etc. There are rear panel connections for low level audio output and tape recorder remote switching. I.F., output and AGC is also available through a rear panel connector. Computer control is possible through the RS232 rear panel port.



## AR8000 - Still the Best!

500kHz - 1900MHz\*

AOR made every effort to incorporate the latest technology into this scanner:

The Ultimate Handheld Receiver! "Welcome to the world of the AR8000"! It incorporates the latest PLL technology and offers a multitude of features including true carrier re-insertion SSB (CW) demodulation with 50Hz frequency steps. 4 level alpha numeric LCD indicates the frequency, signal strength, band scope and more. Selectable squelch system, auto-mode, auto-band plan, serial communication port are all standard. Internal ferrite antenna offers high performance reception below 2MHz. When frequencies are entered, ALPHANUMERIC comments may be stored along with the frequency, mode & attenuator status simplifying the job or recalling and identifying memory channels.



- Frequency: 1 - 1900MHz\*
- Modes: AM/NFM/WFM/USB/LSB/CW
- Stepsize: 50MHz to 999.995kHz
- Memories: 50ch x 20 banks=1000 total
- Size/Wt.: 6.1" x 2.6" x 1.5"/12.2oz. w/ NiCad

**distributed by:**

**Electronic Distributors Corp.  
Vienna, VA.**

**...See us at DAYTON!  
Booth #'s 575 - 579!**



AOR, LTD. 2-6-4 Misuji, Taito-Ku,  
Tokyo 111 Japan (c) 1995 AOR, LTD.  
Licensed under US. Pat. 4,270,217

CIRCLE 115 ON READER SERVICE CARD

\* Cellular blocked; Unblocked OK to FCC approved users.



# U.S. #1 RADIO OUTLET

## OUR 25th YEAR!!!

JULY '97



### NEW FAMILY RADIO



It's all in the family!

- NEW Family Radio Service (FRS).
- LICENSE FREE
- Push & Talk up to 2 miles.
- Crisp clear audio.
- No monthly fee!

Small walkie-talkies as low as \$109.95

**MAXON FRS114** CALL  
**MIDLAND 75-510** \$149.95  
**MOTOROLA Sport7\*** \$119.95  
**MOTOROLA Sport7X\*** \$139.95  
 Buy 2 or more and save!

**MOTOROLA**  
**maxon**

**MIDLAND**  
 CONSUMER RADIO

\*Available in black, camo, green & yellow

### AOR AR5000

NOTHING LIKE IT IN IT'S CLASS

- 10kHz - 2600MHz\*
- Superior Sensitivity
- Cascade I.F. filtering
- 6 Filter B.W. +1 Opt.
- Memory 1000 + 2100 pass ch.
- Built-in decoder DTMF
- Option CTCSS and Voice Inversion
- 2 Ant. ports, Opt. to 8 ports
- Scan/Search 25 & 45 ch/sec.
- RS232C of all functions
- Priced under \$2000. CALL!

Best Tested

\* Cell BLOCKED: UNBLOCKED model OK for FCC approved users.



Call for FREE 4 page detailed flyer w/ R8500 comparison

### SCANNER SALE

BearCat

BC120XLT	139.95
SC150Y/B	169.95
BC230XLT	239.95
BC235XLT	289.95
BC3000XLT	369.95
BC9000XLT	379.95
BC890XLT	229.95
BCT12	800MHz NEW!

ICOM

R10	NEW!	499.90
-----	------	--------

### SHORTWAVE SALE

GRUNDIG

YB400	179.95
-------	--------

SANGEAN

ATS 606P	169.95
ATS 808	139.95
ATS818	149.95
ATS909	249.95

SONY

ICFSW40	149.95
ICFSW100S	359.95
ICFSW600	59.95
ICF2010	355.95
ICFSW7600G	179.95

AOR

AR3030G	849.95
AR7030	1099

LOWE

SRX100	229.95
HF150	499.95
HF250	1149

DRAKE

SW1	279.95
SW2	499.95
SW8	689.95
R8A	1079

### DAVIS WEATHER WIZARD II SUMMER SALE

The Weather Wizard II offers sophisticated, professional quality at a surprisingly affordable price. It monitors and stores data about the most essential weather conditions:

- Inside & outside temp (Hi/Lo)
- Wind speed (Hi/Lo)
- Wind chill (Lo)
- Wind Direction
- Wind speed
- Alarms for temperature, wind speed, wind chill, and time



**DAVIS**

#7425 NOW \$159.95

### CB RADIO SALE

COBRA\*

HH70	96.95
2010GTL	339.95

MIDLAND\*

79-290	249.95
75-810	119.95
75-784	69.95

\*Only partial listing... CALL for other models and all accessories are discounted.

1. Cell blocked, no blocks OK for FCC qualified users

### BAYGEN FREEPLAY RADIO Take Anywhere Radio!

The Baygen free play radio... battery FREE for life!  
 The world's first clockwork radio. 60 turns of the crank provides approximately 40 minutes of playing time. AM/FM/SW (5.8 - 18MHz), large 3.5" speaker, power handcrank or AC adaptor (incl.), 13.5" x 8" x 5", weighs 6.75lbs.



SALE \$99.95

### GE SUPERADIO III

Larger ferrite rod antenna, 6.5" woofer, 2" tweeter, 4 I.F. stages and wide/narrow filters for superior reception. Separate controls for bass and Treble. Uses 120VAC or 6 "D" cells (not incl.) Everyone needs this great sounding radio.



SALE \$59.95

Puts the fun back in the AM/FM DX'ing!

JUNE '97 SALE

JUNE '97 SALE

JUNE '97 SALE

SALE ENDS 28 JUNE '97  
 JUNE '97 SALE

### Yaesu FT50RD/41B Hottest Ham HT!



- up to 5 W
  - Dual Band,
  - Exceptional Wideband receive capability
  - Airband & 800MHz<sup>1</sup>
  - Built in CTCSS & DCS Enc/Dec & Digital Voice Recorder.
- Accessories:  
 EDC5B - Cig Lite Plug  
 RH1 - Rubber Holster  
 MH34B4B - Spkr. Mic  
 4 modes to choose from... Call for Special Price

SAVE OVER \$100

JUNE '97 SALE



323 Mill St.  
 Vienna, VA.  
 22180  
 FAX: 703 938 6911

Orders: 800 368 3270

INFO/Metro: 703 938 3350

WWW: www.eebradio.com

E-mail: eeb@access.digex.net

- Prices subject to change
- Prices do not include freight
- Returns subject up to 20% restock fee
- FREE 1997 Catalog, 3rd Class, U.S.



# POPULAR COMMUNICATIONS

JULY 1997

VOLUME 15, NUMBER 11



page 20

**ON THE COVER:** A New Jersey shopper uses her new Family Radio Service radio to call her husband from the mall. For more information on this new service, check out Gordon West's feature "Family Radio Service on the Air!" on page 8. (Photo by Larry Mulvehill.)



## FEATURES

### Family Radio Service on the Air!

8

This new radio service is causing a lot of excitement for a lot of people. With no test, no license and plenty of fun—find out what the stir is all about!

By Gordon West

### The FM Station The World Forgot

12

In 1945 the FCC claimed that FM was the "preferred" mode of broadcasting! Join Alice as she takes a look back at AM and FM radio stations around the time of World War II.

By Alice Brannigan

### Radio Resources

16

Public safety pros and scanner users—you *can* cure intermod interference. Gordon West offers his cures for this communications plague.

By Gordon West

### Product Spotlight

30

The BC235XLT "Trunk Tracker" is the first handheld scanner on the market able to follow or "track" the conversations on Motorola 800 MHz trunked radio systems. Now find out what it does *and* how it does it.

By J. T. Ward

## COLUMNS

The Radio Connection .....	20
Antennas & Things .....	24
Scanning The Globe .....	34
World Band Tuning Tips .....	40
Product Parade (Now Including "Books You'll Like") .....	42
CB Scene .....	44
The Old CB Shack .....	47
Clandestine Communiqué .....	50
Broadcast DXing .....	52
The Ham Column .....	58
Communications Confidential .....	60
Communications Enroute .....	67
The Listening Post .....	70
The Pirate's Den .....	75
The Loose Connection .....	80

## DEPARTMENTS

Tuning In .....	4
Pop'Comm P.O. ....	6
How I Got Started .....	33
Pop'Comm Survey: The Results Are In .....	38
Reader's Market .....	78



page 70



page 12

# QUALITY COMMUNICATIONS EQUIPMENT SINCE 1942



**Shortwave Receivers Past & Present** is your guide to over 500 communications receivers made from 1945-1996. This huge 351 page Second Edition includes 80 chapters representing: Collins, Cubic, Dansk, Drake, Eddystone, Galaxy, Gonset, Hallicrafters, Hammarlund, Heathkit, Icom, JRC, Kenwood, Knight, Lowe, Mackay, McKay Dymek, Morrow, National, Plessey, Racal, RME, Rohde & Schwarz, Sony, Squires-Sanders, Ten-Tec, Vigilant, W-J, Yaesu and many more. Entry information includes: receiver type, date sold, photograph, size & weight, features, reviews, specifications, new & used values, variants, value rating and availability. Become an instant receiver expert! #0002 \$19.95 (+\$2)

## COMMUNICATIONS RECEIVERS

**YAESU KENWOOD JRC**

**DRAKE**

**LOWE**

**ICOM**



Universal Radio carries an excellent selection of new and used communications receivers. The new **Japan Radio NRD-345** is shown above. **Only \$799.95 (+\$10)**

The new American made **Drake SW-2** features SSB, Sync. Det., 100 mems., keypad and optional remote (shown).



**In stock now!**

## RTTY AND FAX DECODERS

### ◆ Universal M-8000v7 Decoder



Designed primarily for the military or commercial user, the M-8000 can be used



by the hobbyist who requires professional capability. The color VGA output includes a spectral display & simulated tuning scope. Modes include: **CW, Baudot, FAX, SITOR, ARQ-M2/4, ARQ-E/E3, ARQ6-90, ARQ-S, SWED-ARQ, FEC-A, FEC-S, POL-ARQ, GMDSS, ASCII, Packet, Pactor, Piccolo, VFT, ACARS, POCSAG & GOLAY.** Monitor & printer optional. #0087 \$1399.00 (+\$11)



The self-contained Universal M-450 reader decodes: **Baudot, SITOR A & B, FEC-A, ASCII, SWED-ARQ, Weather FAX** (to the printer port), **ACARS** aviation teletype, plus **GOLAY** and **POCSAG** (512/1200/2400) digital pager modes. Even off-the-air decoding of **DTMF, CTCSS** and **DCS.** Big two-line, 20 character LCD and bi-dir. parallel printer port. The M-450 runs from 12 VDC or with the supplied AC adapter. No computer or monitor is required. Now with serial port. #0450 \$399.95 (+\$8)

### ◆ Universal Upgrades

Upgrades are now available for the M-400v2, M-8000v5 and the M-1200. Contact us for details.

## SPECIALTY



The **BayGen Freeplay** radio combines the ingenious Baylis generator with the latest in radio technology. Winding the handle for 20 seconds provides 30 minutes of listening. Here is assured radio performance, day or night without the worry (and expense!) of batteries. The analog dial covers AM, FM and SW from 3 to 12 MHz. Made in South Africa. #3123 \$99.95 (+\$5)

## HUGE FREE CATALOG

The new **1997 Universal Communications Catalog** covers everything for the shortwave, amateur and scanner enthusiasts. This informative **100 page catalog** is **FREE** by bookrate or \$2 by First Class mail. Rising postage costs prevent us from sending this catalog out automatically so please **request your free copy today!**



## COMMERCIAL RECEIVERS



The Watkins-Johnson HF-1000 is *the* ultimate receiver! Advanced D.S.P. technology, 58 bandwidths, 1 Hz display. Under \$4000. Please contact us to receive a spec. sheet.

## PORTABLE RECEIVERS

**SANGEAN**

**SONY ICOM**

**GRUNDIG**



Universal offers over 40 portable receivers from \$50 to over \$500. Our **free** catalog fully describes & prices all models. The new deluxe Sangean ATS-909 shown above is on sale for \$249.95 (+\$8). This includes the AC adapter and ANT-60.

## COMMUNICATIONS BOOKS

- **Passport To Worldband Radio 1997** By L. Magne  
Graphic presentation of all shortwave broadcast stations. Equipment reviews, too. #1000 \$19.95 (+\$2)
- **Passport To Web Radio** By L. Magne **Brand new!**  
Here is everything you need to know to hear hundreds of AM, FM and SW stations on your PC! #3000 \$19.95 (+\$2)
- **Worldwide Aeronautical Frequency Dir.** By R. Evans  
The definitive guide to commercial and military, HF and VHF-UHF aeronautical communications including ACARS. Huge Second Edition 260 p. #0042 \$19.95 (+\$2)
- **Guide to Utility Stations** By J. Klingenfuss  
Clearly the best guide to non-broadcast HF stations. With 13,800 current frequencies. 585 p. #2019 \$39.95 (+\$2)
- **Discover DXing!** By J. Zondlo  
An introduction to DXing AM, FM & TV. #0009 \$4.95 (+\$2)
- **Understanding ACARS** By E. Flynn  
Learn the ACARS aviation format. #0012 \$9.95 (+\$2)

Be sure to include \$2 per title for shipping.

### VISIT UNIVERSAL RADIO ON THE INTERNET

<http://www.universal-radio.com>

- Visa
- MasterCard
- Discover
- Prices and specs. are subject to change.
- Returns subject to a 15% restocking fee.
- Used equipment list available on request.

**Universal Radio, Inc.**  
6830 Americana Pkwy.  
Reynoldsburg, Ohio  
43068-4113 U.S.A.

☎ 800 431-3939 Orders & Prices  
☎ 614 866-4267 Information  
➔ 614 866-2339 FAX Line  
✉ dx@universal-radio.com

**universal radio inc.**

# Tuning In

AN EDITORIAL

BY HAROLD ORT, N2RLL, SSB-596

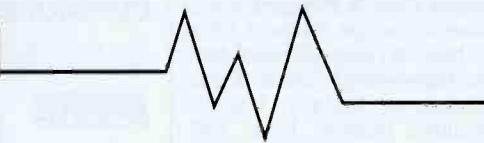

## The FRS, GMRS and the FCC Doing Battle

It seems the entire General Mobile Radio Service (GMRS) community is losing sleep over the new Family Radio Service (FRS), and frankly I couldn't figure out why—until I started looking at the FRS facts. Apparently there's more to this battle than the entry of the new FRS transceivers into the marketplace. Let's examine the issue.

The FCC has set aside 14 low-power UHF channels for the new FRS: these are designed for license-free, short-range voice communications that's seen as an alternative to the more technically oriented ham radio, the also-licensed GMRS, and the more crowded unlicensed CB radio service.

The 14 channels are wedged between (and somewhat overlap) licensed GMRS repeater input frequencies. As you might imagine, there's the problem—or is it? These FRS frequencies are as follows:

CH 1.....	462.5625
CH 2.....	462.5875
CH 3.....	462.6125
CH 4.....	462.6375
CH 5.....	462.6625
CH 6.....	462.6875
CH 7.....	462.7125
CH 8.....	467.5625
CH 9.....	467.5875
CH 10.....	467.6125
CH 11.....	467.6375
CH 12.....	467.6625
CH 13.....	467.6875
CH 14.....	467.7125

These new FRS transceivers are pocket-sized walkie-talkies that fall under the new FCC Part 95 UHF/FM rules. They typically cost from \$130 to \$200 and come complete with the non-removable rubber duck antenna and belt clip. Higher-priced units will have CTCSS tones that allow the user to set a sub-audible tone giving the added benefit of the user hearing his or her own units. Range for these one-half watt units is also fairly consistent at about a mile. OK, I'm sure there's someone out there who has gotten 385.5 miles over Lake Superior or in the

---

*"My family and I talked on several FRS channels until the batteries died."*

---

Gulf of Mexico, but typically outdoors you'll find pretty good local neighborhood/downtown comms of about a mile. Much beyond that and you'll find yourself standing on truck roofs to increase your range! Of course out in the open with no obstructions—over the water, for example, you can get better range, often several miles. Ironically, the big guys—the full-featured GMRS handhelds with more power and with the added benefit of detachable antennas, longer-life battery packs and adaptability to mobile/base antennas cost nearly the same. The rub is the \$60 fee for a five-year license (soon to be \$70).

So there you are with Grandma and Aunt Wilma in downtown Willoughby using your new FRS transceivers. Unknown to you is the GMRS repeater on 462.675 MHz. This repeater's input frequency, 467.675 MHz lies right near FRS channel 12—the same channel you're using that afternoon. Is this a problem for either user? Yes, and no. The receiver of a GMRS repeater is designed to capture a relatively weak signal that is within a certain bandwidth; if the received signal is "off" slightly, there's a good chance the repeater might still pick up the signal, thereby possibly preventing a licensed GMRS mobile user out in the boondocks from accessing the repeater. The operative word here is "possibly."

Certainly each case would have to be individually checked out. You could take the better part of a beautiful summer afternoon testing for interference; have an FRS user begin transmitting, then simultaneously have a distant mobile try to access the repeater. You could stand a quarter mile from the repeater site and key up on the FRS channel nearest the repeater input frequency. You could do all these things repeatedly and possibly bring

(Continued on page 77)

## POPULAR COMMUNICATIONS

### EDITORIAL STAFF

**Harold Ort, N2RLL, SSB-596**, Editor  
(Internet e-mail: PopularCom@aol.com)  
**Tom Kneitel, K2AES/SSB-13**, Senior Editor  
(Internet e-mail: K2AES@juno.com)  
**Nancy Barry, SSB-931**, Associate Editor  
(Internet e-mail: NancyPCmag@aol.com)  
**Richard S. Moseson, W2VU**, Online Coordinator

### CONTRIBUTING EDITORS

**Richard "RD" Baker**, Utility Communications  
**Ed Barnat, TCA-44**, CB SSB  
**Peter J. Bertini, K1ZJH**, Restoration/Electronics  
**Joe Carr, K4IPV**, Antennas  
**Gerry L. Dexter**, Shortwave Broadcast  
**Jock Elliott, SSB-734**, Citizens Band  
**Bob Evans**, ACARS  
**Ed Griffin**, Computer-Aided Radio  
**Chuck Gysi, N2DUP**, Scanning  
**Don Johnson**, International Shortwave  
**Kirk Kleinschmidt, NT8Z**, Amateur Radio  
**Tim Kridel**, AM/FM Broadcasts  
**Chuck Mankin**, Scanning  
**Pat Murphy**, Pirate Radio  
**Don Patrick**, CB Restoration  
**Bill Price, N3AVY**, Humor/Communications  
**Edward Teach**, Pirate and Alternative Radio  
**J.T. Ward**, Spotlights and Scanning  
**Gordon West, WB6NOA**, Radio Resources  
**Bonnie Zymunt**, Computer-Aided Radio

### BUSINESS STAFF

**Richard A. Ross, K2MGA**, Publisher  
**Donald R. Allen, W9CW**, Advertising Mgr.  
**Emily Kreutz**, Sales Assistant  
**Frank V. Fuzia**, Controller  
**Catherine Ross**, Circulation Manager  
**Melissa Nitschke**, Operations Manager  
**Jean Sawchuk**, Data Processing  
**Denise Pyne**, Customer Service

### PRODUCTION STAFF

**Elizabeth Ryan**, Art Director  
**Barbara McGowan**, Associate Art Director  
**Edmond Pesonen**, Electronic Comp. Mgr.  
**Dorothy Kehrwieler**, Production Manager  
**Emily Kreutz**, Assistant Production Manager  
**Pat Le Blanc**, Phototypographer  
**Hal Keith**, Technical Illustrator  
**Larry Mulvehill, WB2ZPI**, Photographer

A publication of



CQ Communications, Inc.  
76 North Broadway  
Hicksville, NY 11801-2953 USA

Offices: 76 North Broadway, Hicksville, NY 11801. Telephone (516) 681-2922. FAX (516) 681-2926. Popular Communications (ISSN-073-3315) is published monthly by CQ Communications, Inc. Periodical class postage paid at Hicksville, NY and additional offices. Subscription prices (payable in U.S. dollars): Domestic—one year \$22.95, two years \$41.00, three years \$60.00. Canada/Mexico—one year \$32.95, two years \$61.00, three years \$90.00. Foreign Air Post—one year \$40.95, two years \$77.00, three years \$114.00. U.S. Government Agencies: Subscriptions to Popular Communications are available to agencies of the United States government, including military services, only on a cash with order basis. Requests for quotations, bids, contracts, etc. will be refused and will not be returned or processed.

Entire contents copyright © 1997 by CQ Communications, Inc. Popular Communications assumes no responsibility for unsolicited manuscripts, photographs, or drawings. Allow six weeks for change of address or delivery of first issue.

Printed in the United States of America.  
Postmaster: Please send change of address to Popular Communications, 76 North Broadway, Hicksville, NY 11801.

# the Best for Test

\$319. Save \$30

Take advantage of OPTOELECTRONICS' frequency counter SALEBRATION!!!

Whether you are testing, calibrating, or aligning you need a good quality frequency counter. Optoelectronics the leader in frequency counters continues in its tradition of engineering the **highest quality test equipment**. Whatever your application may be, **OPTOELECTRONICS has a counter for you**. If you want the **BEST IN TEST**, look no further than **OPTOELECTRONICS**.

## 3000A+ MULTI-FUNCTION COUNTER

- 10Hz-3GHz frequency range
- 10 digit LCD display w/ bargraph and EL backlight
- Measures Period, Ratio, and Time Interval
- Built-in RS232 interface
- Patented Digital Filter and Auto Capture
- Fast 250 million counts per second
- +/- 1ppm accuracy w/ .2ppm option
- Dual high impedance amplifiers for ratio and time interval counting
- 5-6 hour battery life
- Built-in NiCads w/ charger
- Dual 50 Ohm and 1 Meg Ohm inputs

Antennas shown are optional accessories



U.S. Patent No. 5,471,402

\$119. Save \$30



**CUB MINI COUNTER**

- 1MHz-2.8GHz frequency range
- 9 digit LCD display
- 8 selectable gate times
- High speed .0001 second gate
- Patented Digital Filter eliminates false counts
- Patented Auto Capture locks frequency display until cleared
- Direct and Pre-scaled ranges
- 50 Ohm input impedance
- 1ppm timebase
- 10 hour discharge time
- Built-in NiCads and charger included

\$219. Save \$30



**MH MICRO COUNTER**

- 10Hz-2.8GHz frequency range
- 10 digit LCD display w/ bargraph and backlight
- Patented Digital Auto Filter and Auto Capture
- Digital Communications port for datalogging using optional OptoLinx and OptoLog software
- High speed 250MHz direct count with 1Hz per second resolution
- 1ppm timebase
- 1 meg Ohm and 50 Ohm inputs (switchable)
- NiCad batteries and charger included

**8040 BENCH COUNTER** \$899. Save \$100



U.S. Patent No. 5,471,402

- 10Hz-3GHz frequency range
- 10 digit LCD display w/ bargraph and EL backlight
- Measures Period, Ratio, and Time Interval
- Built-in RS232 interface
- Patented Digital Filter and Auto Capture
- Fast 250 million counts per second
- +/- .05ppm ovenized timebase
- Internal clock output/External clock input
- Built-in low pass filter
- Built-in rapid-charge NiCads

**FACTORY DIRECT ORDER LINE: 800-327-5912**

# OPTOELECTRONICS®

CIRCLE 151 ON READER SERVICE CARD

5821 NE 14th Avenue • Ft. Lauderdale, FL • 33334

Visa, Mastercard, C.O.D. • Prices and Specifications are subject to change without notice or obligation

Telephone (954) 771-2050 Fax (954) 771-2052

**MADE IN THE U.S.A.**

www.  
optoelectronics.  
com

# Pop'Comm P.O.

LETTERS TO THE EDITOR

## Sharing Knowledge, Frequencies and Techniques

Each month we select representative reader letters for our Pop'Comm P.O. column. We reserve the right to condense lengthy letters for space reasons and to edit to conform to style. All letters submitted must be signed and show a return mailing address or valid e-mail address. Upon request, we will withhold a sender's name if the letter is used in Pop'Comm P.O. Address letters to: Harold Ort, N2RLL, SSB-596, Editor, Popular Communications, 76 N. Broadway, Hicksville, NY 11801-2909, or send e-mail via the Internet to <popularcom@aol.com>.

### Talk About Scanning!

Dear Editor:

Let me take this opportunity to pontificate on the topics of promoting understanding and expansion of our scanning hobby. We all love to take every chance we get to seem like an expert on topics of which we are interested, myself included. So when someone sees me with my AOR handheld and inquires about what it is, I give them the answer in layman's terms, "It's a police scanner." That's when the questions really start to fly. "Aren't they illegal?" NO. "Can I listen?" YES. "How much do they cost?" I reply that some are less than \$100. "Where can I buy one?" I tell them any good electronics or radio shop. What usually ends any further conversation on my part is the statement "Wow, that would be great to help rob a bank!"

This is where the promotion ends and the policing begins. It's our responsibility to make sure our hobby doesn't become someone's criminal enterprise. Recently in the county where I live, two men committed an armed robbery of a business in the southern part of the patrol district. While the local police were chasing them, another group, armed with guns and a scanner committed a robbery in the northern part of the patrol district. This to ME is no small coincidence.

For my part in policing our hobby, I have a couple of rules: Do not loan your scanner to anyone. Do not give law enforcement frequencies to anyone. Do not share any information you have gained about police procedures and routines with anyone. I only make exceptions to

these rules for close friends and family whose reputation I can vouch for.

These rules should also be followed by dealers and mail order vendors of monitoring equipment. A local radio chain store gives out a printed sheet to scanner customers with all the local frequencies and voice codes for the area law enforcement agencies. This is totally irresponsible as well as poor business practice since they also sell a soft cover book with all the frequencies the novice could ever use, and it sells for no small change either. If you want to help someone get started, give them local fire/rescue, taxi, or airport frequencies. Make the criminal users work for their information the way we did when we started out. They probably won't make the extra effort because they don't want to work for anything as it is.

As you already know, 99.99 percent of monitors are good people ready to help if possible. For my own part, my listening lead to the apprehension of three armed car jacking suspects . . . score one for the good guys. It's up to all of us in the hobby to ensure the lawful use of the airwaves is not misused.

Joseph Walling  
Riverdale, MD

Dear Joseph:

You're right, 99.99 percent of monitors are good people ready to help. But in all my years of promoting the hobby, people I've had the pleasure of talking with haven't even hinted at criminal use of a scanner. Typically they're concerned about the legality of listening and the cost factor. Perhaps you should refrain from dubbing the radio "a police scanner." Why not say it's a scanner that receives police, aircraft, government and even marine communications. That way you're sure to pique your listener's interest about *some* aspect of radio monitoring, not only police or public safety.

The use of a scanner in the commission of a crime goes way back to pre-programmable days, just like the use of guns, crowbars, flashlights, knives and all kinds of equipment that can be used for dastardly deeds. Think about it for a minute: If someone's intent on a life of

crime, there's no textbook telling them where to get the guns, ammo, knives, rope, wire cutters, or scanners. They don't need one. These characters seem to instinctively sniff out the tools of their trade without any help from you and me. So keeping good, law-abiding citizens from monitoring the public airwaves accomplishes nothing. I think it's very important to share our knowledge, frequencies and monitoring techniques with interested newcomers. When I got my first scanner some 30 years ago, the dealer also gave me a sheet of frequencies (along with an address for obtaining crystals!) that helped me make sense of my new hobby.

Joseph, thanks for promoting our hobby and helping our law enforcement officials! That's what citizen monitoring is all about.

### Call to Action

Dear Editor:

I've never had the need to write to your publication until I read J.T. Ward's article "Scanning Becomes Extinct." I believe that a dangerous precedent was set when the ECPA was enacted. This, for the first time, gives the government the power to tell a free people what we can and cannot listen to! This would be like the first Congress of the United States telling the people of the 13 states they couldn't read publication "A"!!

I agree and share Mr. Ward's concerns about the future, although my solution is a bit different. As a ham radio operator, I think it would be a waste of time to coax the ARRL to take up the battle. It should be an organization such as *Pop'Comm*. Now I know the first reaction is—"that will cost too much money" or "we don't have the time to do it!" I disagree. I believe that you should ask your readership in the next survey what their feelings are. For example: "Would you support financially *Pop'Comm*'s efforts to lobby to amend the ECPA to exempt law-abiding citizens?" Would you support *Pop'Comm*'s efforts to lobby Congress to keep the airwaves free from government encroachment?" . . . The



time is now for all of us to put our money where our mouths are. Let's stop complaining about it and do something!

Without some movement by those of us who believe in a free nation, eventually the day will come when the only thing my BC-3000, BC-9000 and PRO-2006 will be good for is listening to NOAA weather radio broadcasts!

Bob Reynolds, WB3DYE  
Wilkes-Barre, PA

**Dear Bob:**

Here's what we'll do; we'll run your letter and see where it goes. Also, in your letter you suggested raising subscription prices to cover the cost of a paid lobby who could testify before Congress on behalf of the radio listening community. While a noble cause, we're not about to ask readers to underwrite such a task. It would probably cost much more in additional money and time I feel could be better spent by a massive letter-writing campaign as Bob has suggested. Writing and calling your representatives, local media and speaking with influential community leaders will, in my opinion, get better long term results. Sure it will take time—efforts like this always do, but it has to start somewhere.

Friends like officer Stefan Jagoe in KY who can attest to the value of citizen monitoring are vital in an effort such as this. How about it readers? Let's hear from the public safety professionals who recognize the value of citizen monitoring and disagree with the ECPA and other anti-monitoring laws!

**Give 'Em Heck, Dave!**

**Dear Editor:**

It's nice to know that I can always count on you hams not to disappoint when it comes to being high-handed. I speak, of course, of your never-ending drone about 11 meters.

You guys all sit there and talk like citizens band operators are so much dirt under your nails and come up with all these schemes to get your frequency band back. Newsflash!!! What, in God's name, makes you think that you'd get it back? There are around 30 to 40 million 11 meter radios out there and what, 600,000 hams? Are you really elitist enough to think that we'd stop using equipment we've got a lot of money invested in just because you say so?

Look guys, CB is here to stay, so get used to it. Sure, we've got some bad apples. But no more than you do. Some of

the foulest language I ever heard on a radio was on 28.045, coming from operators with five-digit callsigns.

As for your precious licenses, big deal! I've got enough graduation certificates from Air Force Electronics Technical schools (I'm a retired HF communications technician) to wallpaper most of your hamshacks, but I don't wave them around like a Holy Grail and say I'm the only one who knows anything 'cause I've got one of these. You need to grow up and by the way, get rid of that anachronistic form of communi-

cations and grab a microphone. People won't laugh at your voice.

Dave Waits  
OH

**Dear Dave:**

You've covered a lot of territory in your letter, but I think it's important to note that our mutually-enjoyable hobbies are all about *having fun*, communicating and serving our community in the process. Once we start taking ourselves too seriously, it's time to step back and examine the motivation for our actions. ■



**World's Most Powerful CB and Amateur Mobile Antenna\***

**Lockheed Corp. Test Shows  
Wilson 1000 CB Antenna Has  
58% More Gain Than The  
K40 Antenna (on channel 40).**

In tests conducted by Lockheed Corporation, one of the world's largest Aerospace Companies, at their Rye Canyon Laboratory and Antenna Test Range, the Wilson 1000 was found to have 58% more power gain than the K40 Electronics Company, K40 CB Antenna. This means that the Wilson 1000 gives you 58% more gain on both transmit and receive. Now you can instantly increase your operating range by using a Wilson 1000.

**Guaranteed To Transmit and Receive  
Farther Than Any Other Mobile  
CB Antenna or Your Money Back\*\*  
New Design**

The Wilson 1000 higher gain performance is a result of new design developments that bring you the most powerful CB base loaded antenna available.

**Why Wilson 1000 Performs Better**

Many CB antennas lose more than 50% of the power put into them. The power is wasted as heat loss in the plastic inside the coil form and not radiated as radio waves.

We have designed a new coil form which suspends the coil in air and still retains the rigidity needed for support. This new design eliminates 95% of the dielectric losses. We feel that this new design is so unique that we have filed a patent application on it.

In addition, we use 10 Ga. silver plated wire to reduce resistive losses to a minimum.

In order to handle higher power for amateur use, we used the more efficient direct coupling method of matching, rather than the lossy capacitor coupling. With this method the Wilson 1000 will handle 3000 watts of power.

**The Best You Can Buy**

So far you have read about why the Wilson 1000 performs better, but it is also one of the most rugged antennas you can buy. It is made from high impact thermoplastics with ultraviolet protection. The threaded body mount and coil threads are stainless steel; the whip is tapered 17-7 ph. stainless steel. All of these reasons are why it is the best CB antenna on the market today, and we guarantee to you that it will outperform any CB antenna (K40, Formula 1, you name it) or your money back!

\*Inductively base loaded antennas  
\*\*Call for details.

**Lockheed - California Company**  
A Division of Lockheed Corporation  
Burbank, California 91520

Wilson Antenna Company Inc.  
3 Sunset Way Unit A-10  
Green Valley Commerce Center  
Henderson, Nevada 89015

Subject: Comparative Gain Testing of Citizen's Band Antennas  
Ref: Rye Canyon Antenna Lab File #670529

We have completed relative gain measurements of your model 1000 antenna using the K-40 antenna as the reference. The test was conducted with the antennas mounted on a 16' ground plane with a separation of greater than 300' between the transmit and test antennas. The antennas were tuned by the standard VSWR method. The results of the test are tabulated below:

FREQUENCY (MHZ)	RELATIVE GAIN (DB)	RELATIVE POWER GAIN (%)
26.965	1.30	35
27.015	1.30	35
27.065	1.45	40
27.115	1.80	45
27.165	1.50	41
27.215	1.60	45
27.265	1.75	50
27.315	1.95	57
27.365	2.00	58
27.405	2.00	58



Individual test results may vary upon actual use.

**CALL TODAY**

TOLL FREE: 1-800-541-6116

FOR YOUR NEAREST DEALER

**Wilson 1000**

DEALERS Exclusive dealer areas still open

- Roof Top Mount.....59<sup>95</sup>
- Trunk Lip Mount.....69<sup>95</sup>
- Magnetic Mount.....79<sup>95</sup>
- 500 Magnetic Mount .59<sup>95</sup>
- Wilson 5000 Baseload — NOW AVAILABLE!
- Little Wil.....29<sup>95</sup>
- Wilson 2000 Trucker .59<sup>95</sup>
- Wilson 5000 Trucker .79<sup>95</sup>
- Call About Fiberglass!!!

**Wilson**  
ANTENNA INC.

1181 GRIER DR., STE. A  
LAS VEGAS, NV 89119

# Family Radio Service on The Air!

## No Test, No License and Plenty of Radio Fun

By Gordon West

There is BIG excitement over a little radio the size of a deck of cards. They have one-half watt output on UHF, narrow-band FM, 14 channels, phased lock loop synthesis, and full squelch, plus continuous tone coded squelch system (CTCSS). Minimum range within steel buildings is about 3,000 feet. Mountain top point-to-point range is greater than 80 miles! No license is required; there's no theory or code test. Welcome to the Family Radio Service!

Family Radio Service, abbreviated "FRS," is authorized by the Federal Communications Commission under Part 95, Subpart B, FRS Rule 3, Part 95.193 which says:

(A) You may use an FRS unit to conduct two-way voice communications with another person. You may use the FRS unit to transmit one-way communications only to establish communications with another person, send an emergency message, provide traveler assistance, make a voice page, or conduct a brief test.

The rules also indicate that tone signaling is perfectly acceptable, phone patch to interconnect to the public-switched network is not acceptable. Also noted is authorization to operate anywhere in the 50 United States and its territories, with no specific rules on what you can and cannot say over the airwaves, other than you can't use your little FRS unit to conduct any activity which is against federal, state, or local laws.

### Is It Like CB?

Sounds a bit like Citizens Band? Actually, the Family Radio Service falls under the same Part 95 Personal Radio Services that the common Citizens Band is also under. And if you think about it, 40 years ago there was a Class A Citizens Band on UHF frequency pairs 462.xxx MHz/467.xxx MHz; the rules back then were much like the new rules today for Family Radio Service.

The whole idea of a short-range, no-license, no-skip, UHF Family Radio Ser-



Motorola drew big crowds to their booth during FRS demonstrations.

vice was developed by RadioShack's Robert Miller, K2RM. Miller saw the need for a multi-channel synthesized handheld with a minimum of one-half mile range to keep people in touch. Miller, an active ham radio operator, was looking for a radio service that would fulfill the requirements of family members and friends to stay in touch without having to pass a ham test, or without having to fill out complicated FCC licensing

forms. Miller suggested frequencies that would straddle the already-in-place General Mobile Radio Service channels.

These 8-plus-8 GMRS frequencies are authorized under FCC Part 95.29 for repeater and "talk-around" communications by licensed GMRS users. The General Mobile Radio Service is an offshoot of that original 40-plus year-old Class A CB radio service on UHF. GMRS is a nonsense, well-disciplined, radio service

### GMRS Frequencies

Base Station, Mobile Relay Station, Fixed Station, or Mobile Station

CH 1 - 462.550 MHz  
CH 2 - 462.575 MHz  
CH 3 - 462.600 MHz  
CH 4 - 462.625 MHz  
CH 5 - 462.650 MHz  
CH 6 - 462.675 MHz  
CH 7 - 462.700 MHz

Mobile Station, Control Station, or Fixed Station Operated in the Duplex Mode

CH 1 - 467.550 MHz  
CH 2 - 467.575 MHz  
CH 3 - 467.600 MHz  
CH 4 - 467.625 MHz  
CH 5 - 467.650 MHz  
CH 6 - 467.675 MHz  
CH 7 - 467.700 MHz

# DRAKE PUTS THE WHOLE WORLD IN YOUR HANDS...



## WITH THE SW2 SHORTWAVE RECEIVER.

Drake puts the whole world in your hands with the SW2 Shortwave Receiver. Tune in AM broadcast, amateur, CB or shortwave bands with continuous coverage from 100 kHz to 30,000 kHz. Single sideband operation and AM selectable sideband synchronous detection, brings the world closer to you. And with the optional infrared remote control, the world is in your hands even when the receiver is out of reach.

To find out how to get your hands on the world, call Drake at 1-800-937-2531.

CIRCLE 160 ON READER SERVICE CARD

**DRAKE**<sup>®</sup>

230 Industrial Dr. Franklin, Ohio 45005  
phone: 513-746-4556 fax: 513-743-4510  
on-line: <http://www.rldrake.com>





*FRS equipment transmits one-half watt on UHF simplex frequencies, +/- 3 kHz deviation FM. (Courtesy Alinco)*



*Motorola's TalkAbout two-way FRS radios are designed specifically for active families. (Courtesy Motorola)*

repeater input, using the same tone," comments Bob Leef, well-known communications expert and member of REACT. "The repeater gets activated, and although voice was not always passed, the interference takes the form of repeater keying where licensed GMRS users must put up with the sound of repeater 'kerchunking'. This is a serious condition when the repeater was FRS-activated at seven miles from the site, and another at over 13 miles away from its site," comments Leef. "We hope people using FRS equipment will STAY OFF Channels 8 through 14," added Leef.

He raises a good point for FRS users to stay off of the higher channels when operating in commercial areas near potential GMRS repeater sites. It would also help to not necessarily run tone-coded squelch on transmit unless absolutely necessary in order to protect licensed adjacent-channel GMRS repeaters.

### **A Look at FRS Equipment**

Family Radio Service equipment is readily available in the \$149 per unit price bracket. You can spend less, but you may only get five or six channels. You can spend more and get all of the options. And no doubt, you will recognize many of the brand names: Motorola, RadioShack, Midland, Standard, Kenwood, Alinco, Maxon, and Cobra.

Almost all of these sets put out the maximum limit of one-half watt into their built-in antenna. Antennas are not allowed to be removable, and you are not allowed to extend your range by going to a bigger outside antenna system. All units operate frequency modulation (FM), 3 kHz deviation, and most also offer quiet channel monitoring using sub-audible tone decode.

The little Family Radio Service equipment will run about a day on internal alkaline "AA" or "AAA" batteries. Most also feature a battery-saving circuit which minimizes current when there is no one

serving thousands of professional radio operators and REACT units throughout the USA. The well-disciplined GMRS service is guided by the Personal Radio Steering Group, Inc., P.O. Box 2851, Ann Arbor, Michigan 48106, phone 313-MOBILE-3 (313-662-4533). The PRSG deserves much credit in keeping a radio service, created by the Federal Communications Commission, orderly and useful, and always on track by advice from their regular newsletter. Call or write the PRSG for more details if you're looking for a well-run repeater radio system for personal communications.

Family Radio Service communications operate *simplex only*, not through repeaters like GMRS. But as you can see by the frequency allocations, the Family Radio Service simplex communications stagger GMRS repeater output frequencies and mobile input frequencies. The FRS "interstitial" channels also duplicate seven simplex frequencies granted to GMRS low-power base stations and portable stations. The new Family Radio Service 14 UHF channels are sandwiched in between licensed users on GMRS frequencies.

The little Family Radio Service transceivers operate the same type of frequen-

cy modulation as GMRS units on these frequencies, but FRS equipment is limited to one-half watt output. FRS equipment also runs tighter deviation at 3 kHz. If there is a GMRS user on one of these frequencies running 5 watts at 5 kHz, they will definitely command the channel.

Since most Family Radio Service equipment is synthesized for all 14 channels of operation, things will undoubtedly be quieter on FRS Channels 8 through 14. But what is good for FRS unit-to-unit communications on Channels 8 through 14 may not necessarily be good to GMRS repeater inputs which straddle these higher FRS channels.

"Tests showed an alarming problem with a FRS radio with CTCSS when operated on a frequency adjacent to a GMRS

### **FRS Channels**

FRS Channel 1 – 462.5625 MHz  
 FRS Channel 2 – 462.5875 MHz  
 FRS Channel 3 – 462.6125 MHz  
 FRS Channel 4 – 462.6375 MHz  
 FRS Channel 5 – 462.6625 MHz  
 FRS Channel 6 – 462.6875 MHz  
 FRS Channel 7 – 462.7125 MHz

FRS Channel 8 – 467.5625 MHz  
 FRS Channel 9 – 467.5875 MHz  
 FRS Channel 10 – 467.6125 MHz  
 FRS Channel 11 – 467.6375 MHz  
 FRS Channel 12 – 467.6625 MHz  
 FRS Channel 13 – 467.6875 MHz  
 FRS Channel 14 – 467.7125 MHz

## Shared GMRS/FRS Frequencies

462.5625 MHz	462.6625 MHz
462.5875 MHz	462.6875 MHz
462.6125 MHz	462.7125 MHz
462.6375 MHz	

coming through your squelched channel.

Typical range in a residential neighborhood is about one mile between FRS units. Inside shopping malls, range may drop down to 300 yards, but out in the open, one-half watt on 462 MHz, 467 MHz channels goes line-of-sight plus about 20 percent from refraction over snow, ice, and water. It's not unusual for a family to stay in touch from an open fishing skiff back to base camp over five to seven miles. This is generally a lot better than what you could do with a pair of five-watt, Class D, 27 MHz, CB walkie-talkies, and it's a lot further than what you could ever expect with a pair of 49 MHz low-power handhelds.

When it comes to maximum range, the record is well over 100 miles between a pair of FRS units from one mountain top to another on a line-of-sight basis. I expect to see radio hobbyists try to punch through 200 miles on a hot summer after-

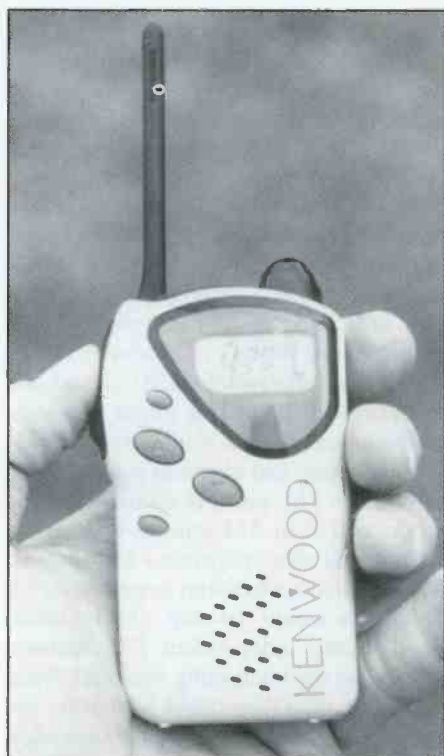

The new Kenwood 14-channel FRS transceiver. (Courtesy Kenwood)



FRS is a great way to stay in touch at conventions. (Photo by Gordon West)

noon, taking advantage of tropospheric ducting. One-half watt goes a heck of a long way!

Some Family Radio Service operators have turned their little handhelds into quasi-repeater stations. They use voice-activated transmit circuits, and create their own input and output portable repeater system.

There are also digital store-and-forward simplex "repeaters" that will listen for 30 seconds, and then digitize the conversation back out on the same frequency. There have also been attempts to inductively couple external antennas onto the little rubber antenna—and as long as you don't make a direct connection, this method could possibly extend your range if you can do it just right. But remember, going into the actual antenna circuit on an FRS unit would not be allowed.

The intent of the FRS is a family radio service where mom and dad can chat, and still keep track of the kids out on the lake, or in that big shopping mall. FRS can satisfy the needs of small shop owners that may need to communicate from the front room to a warehouse next door. FRS is a great way to stay in touch when visiting a theme park, or a huge shopping mall where kids might get separated from the rest of the party.

It's thought that FRS will soon be one of the hottest hobby bands around for those operators wanting a taste of no-license radio, and an introduction on what they might do with more powerful equipment if they were to obtain their amateur radio ticket or realize the capabilities of



The Midland 75-510 14-channel FRS transceiver has many features including auto power save. (Courtesy Midland International)

other commercial radio services. FRS is hopefully not going to turn into whistles, hoots, and howls that presently create chaos on Class D Citizens Band. Since FRS base stations are not allowed on an outside antenna, it's doubtful it will appeal to those type of operators. However, to the radio hobbyist wanting to break a new long-range record on UHF, FRS is a fun way to get started out on the airwaves. ■

# The FM Station The World Forgot

*Gone for Nearly 50 Years, We Locate Its Old Antenna!*

By Alice Brannigan

Although several FM broadcast stations had been operated beginning in 1941, prior to World War II, it was the war itself that forced this exciting new technology to develop at an enhanced pace. Mobile communications systems were deployed in combat areas—virtually all using FM by war's end in 1945. And then, FM was being promoted to the public as the next major advancement in radio broadcasting, providing several distinct advantages over AM broadcasting, static-free reception, nighttime reception unaffected by fading and interference from distant stations, and improved audio fidelity. In 1945, the FCC even claimed FM was the “preferred” mode of broadcasting, vaguely hinting that they would allow it to phase out AM.

The 1941 FCC allocations for FM broadcasting had been in the 42–50 MHz band. In May, 1945, the old band was replaced by 100 channels in a new 88–108 MHz FM band. Broadcasters were pleased to learn that it would cost less to put an FM station on the air than an AM station. Early FM supporters saw the potentials for quality programming of classical music and operas in order to take fullest advantage of the high fidelity that FM provided.

Equipment manufacturers carefully began testing the new market with expensive FM tuners, receivers, and a few AM/FM receivers. The public was not stampeding to buy these, being somewhat confused about what FM was, or would be when it eventually developed with many stations to be heard.

The 42 MHz stations shifted to the new 88 MHz band. Many radio industry eggheads predicted a rosy future for FM. Broadcasters were intrigued by FM's potentials, with a rugged contingent willing to face the risks involved in trying to establish their own early foothold on a fledgling band with an as yet undeveloped audience. By 1946, only 55 American commercial and educational FM stations were in operation, with 401 more authorized, but not yet in operation, plus



*The old KONG-FM tower and five-bay antenna shown at the right in this photo taken last year, nearly half a century after the station went dark! (Photo by Jan Lowry, Castaic, CA).*

250 pending. About 85 percent of the new FM licenses were granted AM licensees as either a hedge against the demise of AM radio or to discourage potential local competition from another broadcaster.

## Enter KONG-FM

In early 1946, California had only two commercial FM broadcasters; KHJ-FM and KMGM in Los Angeles. On November 20, 1946, the FCC gave a Conditional Grant for the state's next commercial broadcaster. This was for the first commercial FM station in the Bay area, and was issued to Abraham and Sara F. Kofman, doing business as the Times-Star Publishing Company.

Authorized operation was on 105.9 MHz with 750 watts, thus providing coverage of the metropolitan area. The proposed station (to use the call letters KONG-FM) was to be located in the Alameda Times-Star Building, 1516 Oak Street, Alameda. On June 12, 1947, just prior to going on the air, KONG-FM was reassigned to operate on 104.9 MHz.

The station's 278-foot tall tower and five bay antenna were installed at the three story “art deco” style newspaper building on Oak Street, under the direction of Chief Engineer Merlin W. Hagg.

KONG-FM scheduled its initial air-date for Friday, Sept. 19, 1947. When it commenced operations, KONG-FM had an initial roster of 22 advertisers. But the Bay area had too few FM receivers in operation for KONG-FM to build an audience. Industry pundits had indeed been too enthusiastic in their initial forecasts of the general public's interest in static-free reception and classical music.

Pioneer FM stations owned by networks and local AM stations were often willing and able to operate FM outlets at a financial loss while they hoped their FM audiences would develop. On the other hand, many independent FM stations found that the continuing financial drain was more than they could sustain for an indefinite period. Such was the case with KONG-FM.

After only about a year of operating, it was decided to withdraw KONG-FM

**JRC**

# NRD-345

*Japan Radio Quality. Synchronous Detection. Great Price.*



**F**amous for its top-gun DX receivers, Japan Radio once again pioneers with a new receiver. Only the NRD-345 offers Japan Radio performance and quality at a surprisingly affordable price.

The NRD-345 delivers hour-after-hour of listening pleasure with synchronous AM detection to help tame fading, dual IF filter bandwidths (with a third optional), and high dynamic range. Compact, light, and refined, the NRD-345 offers advanced multifunctions, 100 memory channels, and even personal computer control. The NRD-345 brings shortwave listeners an outstanding value in a high-performance receiver for under \$1,000.

**JRC**

*Japan Radio Co., Ltd.*

Japan Radio Company, Ltd., New York Branch Office — 430 Park Avenue  
(2nd Floor), New York, NY 10022, USA Fax: (212) 319-5227

Japan Radio Company, Ltd. — Akasaka Twin Tower (Main), 17-22,  
Akasaka 2-chome, Minato-ku, Tokyo 107, JAPAN Fax: (03) 3584-8878

- Synchronous AM, AM, CW, SSB, and FAX modes.
- 0.1 to 30 MHz coverage.
- Dual IF filter bandwidths, 4 kHz and 2 kHz, with optional filter position.
- High sensitivity and wide dynamic range. The RF amplifier and first mixer in the front-end incorporate four low-noise junction-type FETs with excellent cross modulation characteristics to ensure both high sensitivity and high dynamic range.
- 100 memories that store frequency, mode, AGC time constant, ATT on/off, VFO, IF filter bandwidth, and NB status.
- Noise blanker.
- Clock/Timer.
- High/low antenna inputs.
- Memory scan and frequency scan functions.
- Personal computer control with optional RS-232C interface cable.
- One-chip DDS-IC in PLL circuit to enhance carrier-to-sideband noise ratio.



# THE KANSAS CITY STAR.

DAILY  
COMBINED CIRCULATION  
MONDAY THROUGH SATURDAY  
OVER 475,000

SUNDAY  
CIRCULATION  
235,000

WEEKLY  
CIRCULATION 385,000  
PAID ADVERTISE  
SUBSCRIBERS

RADIO  
DEPARTMENT

Dear Listener:

The Star desires to thank you for your communication, just received. We are pleased to know that you tune in on our station and are enjoying our broadcasting.

WDAF is one of the world's largest broadcasting stations. It is a 500-watt Western-Electric transmitter, using two 250-watt tubes in series in the modulator circuit, and two in series in the oscillator circuit. Its speech amplifier is the regulation type, and it employs in addition a 50-watt speech amplifier tube in the transmitter. Fourteen volts on the filament and 1,600 on the plate are generated from motors run off The Star's own dynamos.

The Star wants you to consider this a personal invitation to visit its building and equipment, as well as WDAF, its studio and operating rooms, whenever you are in Kansas City. We want you to feel welcome here any time.

WDAF is dedicated to the people of the Southwest, and to the country generally. Its purpose is to broadcast entertainment, education and amusement for those people, and if they find those things in this station, The Star will feel that its mission in installing a radio station has been fulfilled.

Thanking you again for your interest in WDAF and trusting to hear from you in the near future, we remain,

Very sincerely yours,  
The Radio Department,  
THE KANSAS CITY STAR,

By \_\_\_\_\_

P. S. A Schedule of our broadcasting hours is enclosed.

*An enthusiastic letter to a DX listener from WDAF, extending an invitation to visit the studios.*



*Close view of WDAF's fabled Nighthawk, wearing headphones.*

U.S. today, plus more than 2,700 translators and boosters.

KONG-FM had come and gone so quickly that it must surely have had one of the briefest careers in the annals of American commercial broadcasting. No wonder the world has all but forgotten KONG-FM. Forgotten, but not completely forgotten! Nearly half a century later, the old KONG-FM 278-foot tower, complete with its long-silent five-bay FM antenna, weathered but still intact, defiantly remains in place atop what is now the Kofman Building in downtown Alameda. The Alameda Times-Star offices and presses have moved to new facilities in nearby Oakland.

Thanks to Broadcast Pro-File for permitting us to extract information about KONG-FM from their research report on this pioneer FM station. BP-F is a professional service that can, for a reasonable fee, prepare highly detailed historical profiles of any American AM or FM broadcaster, past or present. Their complete catalog of services and fees is \$1 from Broadcast Pro-File, 28243 Royal Road, Castaic, CA 91384-3028.

## By Contrast, AM Was a Different Story

Let's compare broadcasters' cautious reaction to FM with their enthusiastic entry into AM radio less than 25 years earlier. The period of late-1921 to 1935 was the dawn of broadcasting. Radio was the electronic marvel, novelty, and rage of the era. In early 1922, there were some 30 stations on the air. By the end of the

from active broadcasting. The Times-Star Publishing Company permanently closed down the station, and on December 13, 1948, the license was voluntarily returned to the FCC for cancellation. The 104.9 MHz spot on the FM dial remained vacant in the Bay area until June of 1960 when it was assigned to a new station in Fremont, CA.

By 1949, the initial enthusiasm about FM broadcasting was generally considered to have ended. AM had not died, and was doing better than ever. FM license applications dwindled, and by 1950 active FM stations began pulling the plug in ever-increasing numbers. In only five years, 86 of the 616 stations on the air in 1952 had gone dark. There was virtually no money being made in FM broadcasting; most stations ran at a loss. After the

1940s, FM was kept alive primarily in large cities by FM outlets duplicating the programs of the AM stations that owned them, also by a dedicated handful of classical music stations serving the relatively small hi-fi market.

In 1957 FM broadcasting was reborn anew as AM frequencies in larger markets became saturated with licensees. This happened at about the same time popular-priced imported FM receivers and cheap AM/FM transistor portables began arriving in American stores. Also, the new transistorized receivers incorporated circuitry that no longer had the irritating problem tube-type FM receivers had of drifting off frequency. Stereocasting and SCA further added to turning FM into a popular and profitable mass medium with some 7,300 basic licensees in the





Membership card in WDAF's Nighthawks Club for DX'ers.



KDYL provided these great cards to members of its "Nite Owls' Club." (Courtesy Tom Buckley, Washington, D.C.)

year at least 500 more had scrambled to get on the air in the U.S., most of them using 832 kHz. There were at least 100,000 factory-made radios sold in 1922 alone. In addition, countless thousands of homebrewed crystal and vacuum tube sets were in use.

Practically everyone who owned a radio became a night owl, staying up to all hours seeing how many different AM stations they could log, and how far their equipment could pick up. This was by design, not by chance. A number of stations aggressively tried to build the radio audience by attracting distant nighttime listeners with innovative special programming and ideas such as QSL cards, DX tests, clubs, EKKO verification stamps, pennants, souvenirs, etc. They created the DXing hobby.

One very popular station encouraging DXers was 500-watt WDAF, Kansas City, MO. WDAF was one of the first licensed American stations, having begun operating on Feb. 16, 1922. WDAF's late-night "Nighthawks" program issued a "Nighthawks Club" membership card to every DXer who sent a reception report.

The WDAF program featured live broadcasts from Kansas City's Muehlbach Hotel, with music played by Carleton Coon and Joe Sanders' "Kansas City Nighthawks" 10-piece jazz band. A wonderful CD reissue of their rare original recordings is called "The Coon-Sanders

*"Industry pundits had indeed been too enthusiastic in their initial forecasts of the general public's interest in static-free reception and classical music."*

Nighthawks: Everything is Hotsy-Totsy Now" (Living Era ASV 5199). On their 1924 song, "Nighthawk Blues," the lyrics refer to people from coast-to-coast staying up all night tuned to their radios just to hear the "Nighthawks" play. They weren't kidding!

The WDAF slogan was, "The Nighthawks, Enemies of Sleep." Unfortunately for WDAF, the station had made the band so popular that the group was eventually lured to Chicago to broadcast at night over 15 kW clear channel station WGN. Their WGN broadcasts made the band even more well-known, and they ended up with their own program on the NBC Radio Network. Shows you how many folks were DXing in those days!

Another station aggressively pursuing DX listeners was Salt Lake City's 1 kW KDYL, which had also started in 1922. Well into the 1930s, KDYL ran a nightly program for DXers called the "Nite Owls' Club," issuing ID cards and other inducements to attract listeners to their signals.

WDAF, WGN and KDYL are good examples, though they aren't unique. Surely, every early AM broadcaster who sent out popular late-night programming, QSL cards and letters and EKKO stamps participated in encouraging the establishment of a large and enthusiastic audience for their medium. WDAF, WGN, and KDYL all remain in operation, more than 70 years after they began. Today, there are more than 4,800 American AM stations.

Today we can still directly contact the early flickerings of the AM service by listening to a CD of the actual "Nighthawks" singing about DXing in 1924. We can still see the intact antenna of an obscure and long-dark pioneer FM broadcaster. And we can keep those memories alive in *Popular Communications*.

That's a wrap for this month. Hope you'll join us next time. Meanwhile, we look forward to receiving your old time radio and wireless QSL cards (originals or good copies), picture postcards or photos of old stations, station lists and news clippings. At long last, if you have anecdotes or memories to share, or column suggestions, you can send an e-mail to me at <radioville@juno.com>. See you on the road to Radioville! ■

## FREEPLAY® ...FREE POWER NO BATTERIES REQUIRED

**BAYGEN** is...The leader in personal power generation. **Just wind it up and turn it on!**



FREEPLAY RADIO

The World's *only* completely battery-free, wind up AM/FM and Shortwave radio!

The power source is an internal B-Motor carbon steel spring driving a generator that is powered by hand..

**Put the power back in your hands and contact BayGen today.**

Dealer inquiries welcome.

# 1 800 WIND 234

CIRCLE 63 ON READER SERVICE CARD

# Radio Resources

INTERESTING THOUGHTS AND IDEAS FOR ENJOYING THE HOBBY

## Public Safety Pros and Scanner Users—You CAN Cure Intermod Interference. Here's how . . .

Greetings fellow *Pop'Comm* readers and radio enthusiasts! I was never very far away from the pages of *Pop'Comm*, but was just gathering more great ideas and columns for you during the past few months.

Let's begin our Radio Resources column by talking about curing intermod interference. It's certainly something that plagues scanner listeners and emergency communicators, alike!

Emergency communicators are often on standby, and this requires monitoring the main call-out channel, plus the associated public safety frequencies to stay abreast with routine activity that could instantly turn into a call-out. Monitoring or scanning using a base station antenna can sometimes pull in too much activity, and some calls are drowned out by intermodulation interference. Intermodulation interference arises from non-linear mixing of two or more powerful signals that are pulled in by that big base station antenna and ultimately saturate the front end of your receiver. Older base stations may offer multiple shielded stages of intermod elimination, but newer base station transceivers, which are really mobile units on a power supply, and almost all handheld transceivers, have few if any physical internal cavities to reduce the effects of intermodulation. Scanner receivers with "open-end" RF amplifiers are especially prone to the problems of signal mixing.

The symptom of intermodulation interference is a constant chattering of the squelch with two or more stations being heard at the same time. Other problems may be two distinct separate signals coming in with the desired signal from a mobile or portable unit on channel. Most common are the paging tones that override your squelch circuit, and drown out almost anything else on your frequency.

### Those Darn Paging Transmitters!

It is the nearby paging transmitters that create the greatest amount of intermodu-

lation interference potential. Pagers are assigned frequencies at 152–153 and 157–158 MHz. The typical effective radiated power output of some of these paging transmitters may exceed 1,000 watts! When two or three of the paging transmitters are on the air at the same time, sums and differences of their frequencies may create the perfect mix within your receiver to pass the signals through to your audio output stage. And if you're a public safety professional and your radio system is operational with CTCSS tone squelch always on decode, you might not hear the intermod, but the intermodulation could be canceling incoming weak stations from making it through your tone squelch circuit.

### Fixing The Problem

Two different types of filters can help the small handheld or inexpensive mobile/scanner receiver to minimize intermodulation interference. A band-pass filter, such as the Sinclair Labs SBP 155 MHz series for special emergency VHF high-band channels, or the Sinclair Labs SBP 144 MHz series for CAP and 2-meter amateur radio operation will significantly roll off (attenuate) frequencies 3 MHz above and below the desired band pass. The Digital Communications, Inc., DCI 146 MHz and 155 MHz series band-pass filters may offer up to 40 dB attenuation on each side of its 2 MHz wide band-pass peak. Insertion attenuation is less than 1/2 dB, so adding this four-cavity filter in series with your incoming antenna lead won't cut down on your on-frequency desired reception. DCI is located in White City, Canada at 306-781-4451 and SINC Labs is in Tonawanda, New York at 716-874-3682.

Inside these shoebox-sized band-pass filters are tuned cavity networks; usually four individual compartments which are pre-tuned by the factory for your specific operating frequency, your desired band spread, and the deepest and fastest drop-off possible to attenuate interference



Notch filters will help on handheld radios used on large base station antenna systems.

coming in from powerful transmitters 4 MHz and high above, and 4 MHz and lower below your operating frequency. The band-pass filters cost about \$100, and they also can produce filters for the UHF bands, too.

"Our 156.8 MHz reception was getting pounded by paging transmitters and business radio calls on frequencies just a few MHz away," comments a Sea Tow marine emergency boat dispatcher located near Los Angeles "intermod alley". "The DCI filter was tuned specifically to the VHF marine band Channel 16, 156.800 MHz, and crystal-clear reception instantly came in after we put the filter in line with our base station transceiver," adds Sea Tow. "At first we thought our radio wasn't working because we didn't hear the normal ear-crunching tones, whistles, and triple conversations."

Sometimes 30 or 40 dB attenuation is

# FULL-FEATURED!

## RadioShack's 45-watt 2-meter FM mobile Amateur Radio transceiver

# Only \$299<sup>99</sup>



RadioShack's HTX-242 brings you top-notch 2-meter FM performance and an array of handy features at a value price. Automatic Memory Store finds active frequencies and stores them in memory—including correct repeater offsets—great for new Hams and travel. The tracking-type receiver front end quashes intermod interference and true FM transmit provides excellent voice quality. You get 40-channel memory, built-in subaudible tone encoder **and decoder**, 10 DTMF memories and group calling. HTX-242 includes a detailed owner's manual *written by U.S. Hams* to get you up and talking fast. It's backed by a one-year limited warranty, and a low-cost service plan is available. You can extend warranty coverage to **5 full years** at time of purchase.

**At your fingertips:** Selectable 45/10-watt transmit power. Multifunction scanning. Memory scan skip. Priority channel. Dual VFOs. Extended receive 136-174MHz. Transmit range extendable to 142.5-149.5MHz for CAP/MARS operation. Programmable frequency step. 1 $\frac{1}{8}$ "x5 $\frac{1}{16}$ "x6 $\frac{3}{16}$ ".



**RadioShack**  
You've got questions. We've got answers.®

Price applies at participating RadioShack stores and dealers. Items not available at the advertised price at a participating store can be special-ordered (subject to availability) at the advertised price. A participating store will offer a comparable value if the product is sold out. Independent RadioShack dealers and franchisees may not be participating in this ad or stock or special-order items advertised.

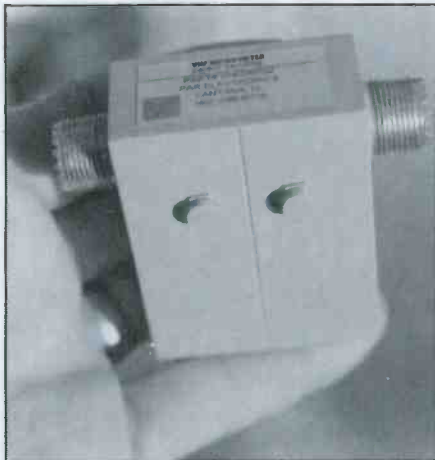

*This Par Electronics notch filter is easily added between your radio and an antenna.*

not enough, and this calls for the notch filter. Notch filters are incredibly small—about the size of a deck of cards. The filter can yield a stop-notch in excess of 45 dB while maintaining a VSWR of under 1.2:1 on special emergency frequencies, or the amateur radio 2-meter band, and even low SWR on UHF frequencies from a dual-band transceiver. The most common notch filter is centered around the 152–153 MHz pager band. Although it

---

***“At first we thought our radio wasn’t working because we didn’t hear the normal ear-crunching tones, whistles, and triple conversations.”***

---



---

***“In severe cases, you can piggyback a notch filter and a band-pass filter on your equipment to see whether or not this cures the intermod problem.”***

---

has no effect on 157–158 MHz pager frequencies, the elimination of the strong 152 MHz signals dramatically reduces the mixed capabilities between the two pager bands.

The notch filters from Par Electronics, Lantenna, Florida, phone 407-586-8278, are unlike most other notch filters. Par Filters offer wide transmission and reception bandwidth on almost ALL frequencies above and below the notch giving them the capability of working with wide-band scanners as well as combination VHF and UHF transceivers. Par filters may be specifically tuned to any one of the known mixed frequencies to help notch out the intermodulation potential. This may require several days of scanning higher and lower than your operating frequency, identifying the actual frequency that is part of the intermod component that comes through your squelch circuit. Tests of the Par filters show less than 1/2 dB loss at operating frequencies, which is negligible when compared to the tremendous amount of filtering they offer to powerful pager transmitters just a few MHz away.

In severe cases, you can piggyback a notch filter and a band-pass filter on your equipment to see whether or not this cures the intermod problem. Since the filters come with coaxial cable connectors or

BNC connectors, it’s no big deal to add or subtract the different styles of filters to see whether or not band-pass or notch filters will have the best results.

When the interference occurs at the distant transmitter sites where an on-channel real phantom signal is generated, filters at your end of the circuit won’t help. The best way to test for this is have several different radios tune into your main dispatch frequency; and if all of the different radios with their own individual differently designed receivers pick up the same offending signal, then the signal is indeed on your frequency and you’ll need to do some detective work to figure out which transmitters are mixing together creating the undesired interference. In cases like this, the Federal Communications Commission may sometimes get involved, especially if the signal is causing interference to an emergency radio service system. But don’t be calling the FCC until you make darn sure that the signal is coming from out of the air on your channel, rather than mixing inside your own set covering up your channel. These are two different problems.

Notch filters and band-pass filters work. They work well on both VHF with separate filters available for UHF, too. Call these manufacturers for their latest technical sheets. ■

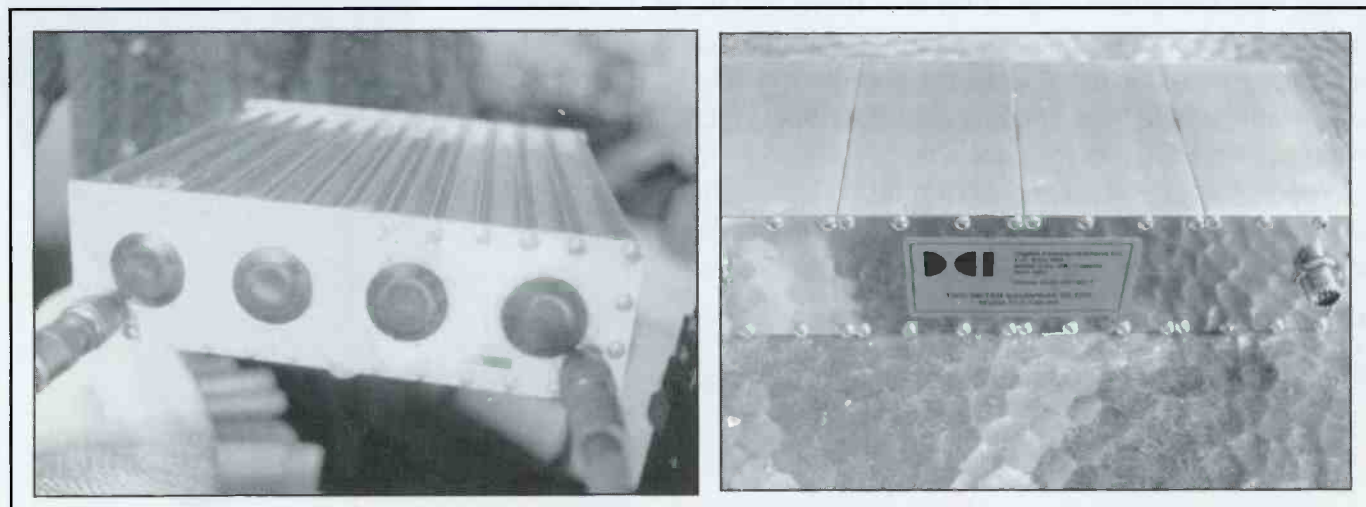

*Bandpass filters are the first step in reducing out-of-channel interference and intermodulation. Shown here is the DCI filter (on left) and Sinclair filter on right.*

# KNOW the TONE

**NEW**



The all  
New **DC442**  
**CTCSS,**  
**DCS,** and  
**DTMF**  
tone decoder!

Easy multi-function  
POWER/MODE  
button

ICOM R100 not sold or distributed by Optoelectronics

You can't be without the **ALL NEW DC442 TONE DECODER**. Use with any receiver for instant **CTCSS, DCS, and DTMF** decoding. The DC442 has the competition











An asterisk appears next to an active tone, this ensures accurate tone decoding

beat with its **ALL MODE DECODE** function. Switching between functions is no longer necessary. With built-in RS232 and CI-5 receiver compatibility the DC442 becomes the ultimate instrument for computer controlled receiver applications. The DC442 is versatile enough for the bench and portable enough for the field. If you want **KNOW THE TONE** you **NEED** an **OPTOELECTRONICS DC442 DECODER**..... **\$259.00**

**\$299.00 w/ NiCads**



## FEATURES

-  Decodes 52 CTCSS tones, 106 DCS codes, and 16 DTMF digits
-  Built-in RS232 / CI-5 compatible interface
-  ALL MODE DECODE. Decode any CTCSS, DCS, or DTMF automatically without switching functions
-  Two line LCD display with EL backlight
-  DTMF Memory: 1,023 scrollable digits
-  User adjustable CI-5 address and Baud Rate
-  One button POWER/MODE control
-  Compatible with any receiver or service monitor
-  NiCad option for portable operation
-  Size: 1.8"high x 4.5"wide x 4"deep

**FACTORY DIRECT ORDER LINE:**  
**800 • 327 • 5912**

**OPTOELECTRONICS®**

5821 NE 14th Avenue • Ft. Lauderdale, FL • 33334  
Telephone • 954-771-2050 Fax • 954-771-2052

Prices and Specifications are subject to change without notice or obligation

CIRCLE 150 ON READER SERVICE CARD

# The Radio Connection

BY PETER J. BERTINI  
<RadioConnection@juno.com>

A LOOK BEHIND THE DIALS

## Your Search for Custom Dial Covers Is Over!

Many vintage radios have plastic dial covers that have become discolored, warped or cracked with age. Fortunately, you can have custom dial covers made to make your set look good as new.

### Meet Rita Hutchings!

I first learned of Rita's radio dial cover replacement service while browsing through the Internet newsgroups devoted to antique radios. After seeing numerous posts from satisfied customers extolling Rita's craftsmanship I had to contact Rita for more information. Here is Rita's response to our inquiry for more informa-

tion about herself and her home-based radio dial cover factory.

"Dear Peter,

"I began collecting radios about six years ago. My collection now has over 150 wooden, bakelite, transistor and console radios, among others. I acquired my love for vintage radios from my father, who was an electronics engineer. He taught me all about radio when I was a young girl, and it has stayed with me throughout the years. I repair and restore my own sets.

"In 1994, I was diagnosed with cancer at the age of 39. After undergoing two major surgeries and several weeks of radiation treatments, I am now cancer-free

---

*"After seeing numerous posts from satisfied customers extolling Rita's craftsmanship I had to contact Rita for more information."*

---

and doing quite well. Although I was left disabled, I sought ways to keep myself busy and productive. My career as professional artist was over since I was told I could no longer risk further exposure to the materials I had once used for sculpting and painting.

"I immersed myself in my radios. While restoring some of them, I found it



Rita Hutchings with one of her Zenith consoles. Note the fine veneers used in this classic set.



Rita and a small sampling of her radio collection. Note the diversity—there are wooden sets, plastics, bakelites, and even some early transistor radios!



←  
Rita at work! Various shop tools in background are used to make the custom molds for the dial covers. In front of Rita is a vacuum heat table used to form the plastic over the molds.

The Radio Connection's Emerson set now sports a new dial cover courtesy of Rita! Note the old cover is discolored, warped and cracked by age. ↓



was difficult to find sources for replacement custom-made plastic dial covers. I decided to learn how to make my own, and had to design and develop my own machines to do the job!

"I took one of my radios to a Memphis Antique Radio Club meeting, and mentioned that I made the dial cover myself. I soon found myself bombarded with requests for dial replacements from other members. At their urging, I expanded my little factory and can now offer my dial cover reproduction services to collectors 'all over the world.'"

Rita goes on to mention she is working hard on perfecting methods to reproduce early radio knobs. She promises to keep us posted on her progress. I have no doubt this talented young lady can do anything she sets her mind too! Information for contacting Rita is given later in the column.

### An Unusual Zenith

I suppose a lot of readers would love owning a big Zenith console like the ones we have shown in this column. There is something magical about those big black Zenith dials with the Zenith legend emblazoned in lightning bolts and the promised "long distance" reception.

---

***"There is something magical about those big black Zenith dials with the Zenith legend emblazoned in lightning bolts . . ."***

---

If you can't own a Zenith, I guess the next best thing is to own one of these nifty Zenith dial face wall clocks, the handiwork of Joe Smolski of Antique Radio. I saw his display at a vintage radio show, and I was impressed with the quality and workmanship! The 10-inch Zenith classic radio wall clock is \$19.95, and that includes priority mail shipping to anywhere in the U.S! Massachusetts residents, please add \$1 sales tax.

### Where We Left Off . . .

In June, I promised to talk more about capacitor voltages, and some not so obvious pitfalls that trap even experienced restorers. We are getting into the nitty-gritty of restoration—a basic knowledge of how things work. So let's get to it!

Take a look at **Figure 1** which shows a fullwave rectifier circuit and a single-ended class A audio stage. Many radios

from the 1930s and 1940s use similar designs—the tubes and parts values may be different, but the principle is the same.

The rectifier tube is a 5Y3. Notice this tube does not use a cathode, instead the filament acts as the emitter. Because the filament is at the B-plus voltage potential, a separate 5-volt filament winding is needed on the power transformer.

Last month I said that the negative side of a filter capacitor may not always go directly to ground—it depends on the biasing scheme used by the audio amplifier. Note that the negative side of filter capacitor C1 illustrates this fact.

Let's look at the circuit when everything is running. You may wish to jot down some notes on the schematic in pencil as we go along. The 6F6 audio tube is running class A. My GE tube manual shows the plate current will be about 40 mA with a plate voltage of 285 volts. The screen grid is also at 285 volts and draws another 7 mA of current from the power supply. Class A stages always draw a constant current. The cathode current is the sum of the screen grid and plate currents, or about 47 mA.

Note that the speaker field coil is connected between the center tap of the power transformer and ground. Its resistance is in series for any current supplied by the

**"We are getting into the nitty-gritty of restoration—a basic knowledge of how things work. So let's get to it!"**

by the power supply. If the audio stage is drawing 47 mA, 47 mA will also flow through the field coil. The field coil has a resistance of 300 ohms as shown on the schematic. Ohms law for resistance shows the voltage drop across the coil is about 14 volts.

$$E = I R$$

Where I in amps is 47 milliAmperes, or .047 Amperes. Where R is resistance, or 300 ohms.

$$E = .047 \times 300, \text{ thus } E = 14.1 \text{ volts.}$$

Note that this voltage is **NEGATIVE!** My GE tube manual shows that the 6F6 in class A with 285 volts on the plate and screen requires a bias voltage of negative 20 volts on the control grid for class A service. The negative voltage developed across the speaker field coil is used to bias the control grid of the 6F6, setting it for

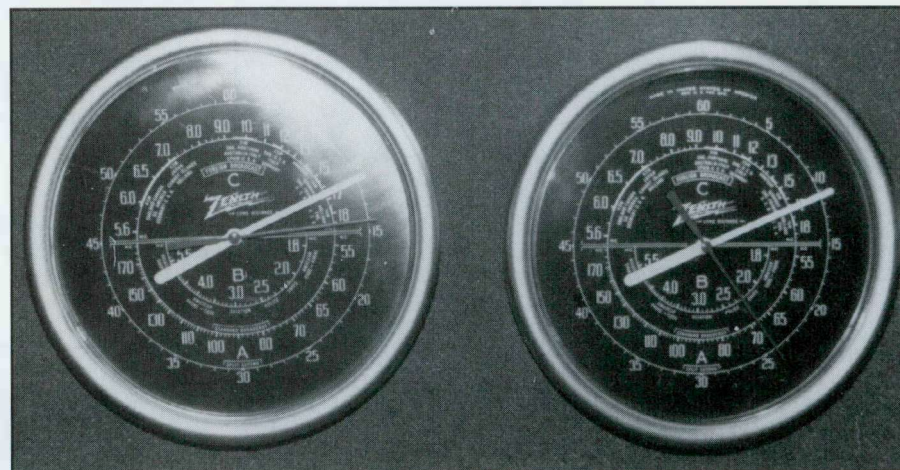

Zenith classic radio wall-clock features a 10-inch dial reproduction, and a quartz movement. A second hand even emulates the Zenith "sweep second" 0 to 60 logging-scale pointer!

Class A service. 14.1 volts is a bit low, but we forgot to include whatever current is being drawn by the other tubes in the radio! If we allow another 20 mA for those stages, the total drawn by all stages is 67 mA. Using Ohms laws again, we see the actual bias voltage is 20.1 volts—more than close enough!

$$20.1 = .067 \times 300$$

I see a few hands raised! "What about the voltage drop across that 1 megohm resistor feeding bias voltage to the control grid?" Good question! The control grid of a vacuum tube will not draw current until it goes in a positive direction as measured to the cathode potential. The 6F6 cathode goes directly to ground. The potential between the cathode and control grid is 19.5 volts negative. Ohms law will prove the voltage drop across a resistor carrying no current is 0 volts. You will see

grid current only in class C stages; these are more common to radio transmitters than receiver circuits.

Alas, that's all for this installment of the Radio Connection! We will continue our discussion of capacitor voltage ratings in a future column. Next month the Radio Connection takes to the road and visits Radio XXVIII, the greater Boston antique radio meet!

#### Custom Dial Covers

Rita Hutchings  
P. O. Box 382331  
Germantown, TN 38183-2331  
e-mail <sally@netten.net>

#### Zenith Classic Radio Wall-clock

Antique Radio  
835-A Pleasant Street  
Framingham, MA 01701  
508-879-2778

**Quality Microwave TV Systems**  
WIRELESS CABLE - ITFS - MMDS  
ATV - INTERNATIONAL - S-BAND  
Amplifiers • Antennas • Books • Components  
Filters • Systems • Video Products

- RF Frequency 1990 - 2700 MHz
- Cable Ready - VHF - UHF Outputs
- SASE For "FREE" Catalog or Send \$1

**PHILLIPS-TECH ELECTRONICS**  
PO Box 8533 • Scottsdale, AZ 85252

ORDER LINE 800-880-MMDS  
CATALOG/INFO 602-947-7700  
FAX LINE 602-947-7799

CHALLENGER SYSTEM  
33-Channel 5208+ Gain  
Complete Grid \$255  
Five Year Warranty  
FREE SHIPPING Visa • MC • Amx • Disc • COD's • Qty Pricing

CIRCLE 73 ON READER SERVICE CARD

**FREE SAMPLE COPY!**

**ANTIQUE RADIO CLASSIFIED**  
Antique Radio's Largest-Circulation Monthly Magazine

Articles - Classifieds - Ads for Parts & Services  
Also: Early TV, Ham Equip., Books, Telegraph, 40's & 50's Radios & more...  
Free 20-word ad each month. Don't miss out!

1-Year: \$38.95 (\$55.95 by 1st Class)  
6-Month Trial - \$19.95. Foreign - Write.

A.R.C., P.O. Box 802-T12, Carlisle, MA 01741  
Phone: (508) 371-0512; Fax: (508) 371-7129  
Web: www.antiqueradio.com

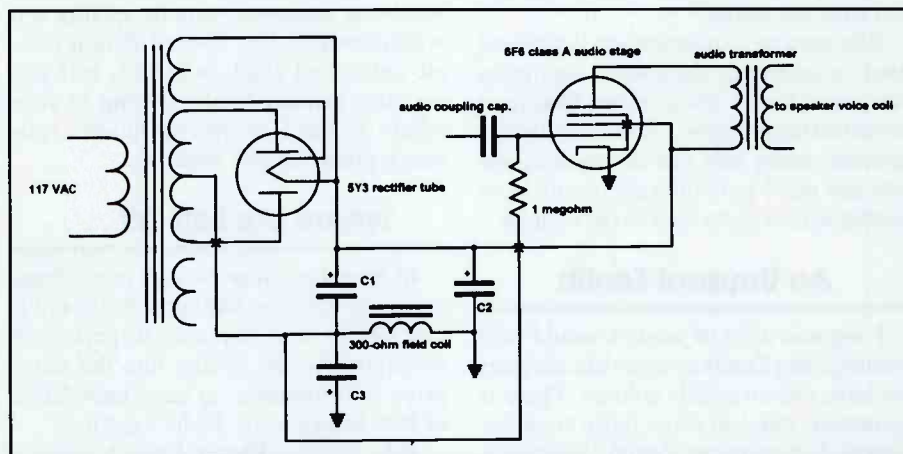

Fig. 1: Power supply and class A audio stage. Biasing voltage comes from voltage drop developed across the speaker field coil resistance. Note "floating" ground on the first filter capacitor.



# CQ Books, Calendars, Videos

## The Quad Antenna by Bob Haviland, W4MB

**Second Printing**  
An authoritative book on the design, construction, characteristics and applications of quad antennas.

Order No. QUAD... **\$15.95**



## The VHF "How-To" Book

by Joe Lynch, N6CL  
This book is the perfect operating guide for the new and experienced VHF enthusiast.

Order No. BVHF...  
**\$15.95**



## Building and Using Baluns and Ununs

by Jerry Seveck, W2FMI  
This volume is the source for the latest information and designs on transmission line transformer theory. Discover new applications for dipoles, yagis, log perimeters, beverages, antenna tuners, and countless other examples.

Order No. BALUN... **\$19.95**

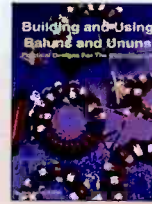

## 1997 Amateur Radio Almanac

by Doug Grant, K1DG  
This volume is filled with over 600 pages of ham radio facts, figures and information. CQ's Almanac is a resource you'll refer to over and over again. If it's ham radio, it's in The Source!

Order No. BALM97... **\$19.95**

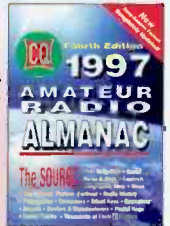

## The Packet Radio Operator's Manual

by Buck Rogers, K4ABT

CQ has published an excellent introduction and guide to packet operation. It's the perfect single source, whether you're an advanced user or just starting out.

Order No. PROM... **\$15.95**



## The NEW Shortwave Propagation Handbook

by W3ASK, N4XX & K6GKU  
The most comprehensive source of information on HF propagation is available from CQ! Read about propagation principles, sunspots, ionospheric predictions, with photography, charts and tables galore—it's all in this unique reference volume!

Order No. SWP... **\$19.95**



## McCoy on Antennas

by Lew McCoy, W1ICP  
This is truly a unique antenna book that's a must for every amateur. Unlike many technical publications, Lew presents his invaluable information in a casual, non-intimidating way for anyone!

Order No. MCCOY... **\$15.95**

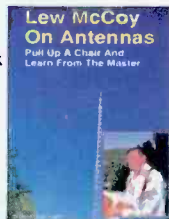

## 1997/98 Calendars

**Summer Special**  
**\$6.95 ea.**  
**Save \$3**



## The Vertical Antenna Handbook

by Paul Lee, N6PL  
Learn basic theory and practice of the vertical antenna. Discover easy-to-build construction projects for anyone!

Order No. VAH...  
**\$9.95**



## W6SAI HF Antenna Handbook

by Bill Orr, W6SAI  
Nearly 200 pages filled with dozens of inexpensive, practical antenna projects that work! This invaluable resource will guide you through the construction of wire, loop, yagi and vertical antennas.

Order No. HFANT... **\$19.95**



## 33 Simple Weekend Projects

by Dave Ingram, K4TWJ

A wide range collection of do-it-yourself electronics projects from the most basic to the fairly sophisticated, with a measure of practical tips and electronics added. This information-packed book will keep you busy for many a pleasant weekend.

Order No. 33PROJ... **\$15.95**



## Videos



These videos are filled with easy to understand advice and tips that can't be found anywhere else.

Only \$19.95 each!

Ham Radio Horizons: The Video.....Order No. VHOR  
Getting Started in VHF.....Order No. VVHF  
Getting Started in Ham Radio.....Order No. VHR  
Getting Started in DXing.....Order No. VDX  
Getting Started in Packet Radio.....Order No. VPAC  
Getting Started in Amateur Satellites...Order No. VSAT  
Getting Started in Contesting.....Order No. VCON

**YES! Rush me my book(s), calendar(s), video(s) right away!**

Qty	Item #	Description	Price	Total Price
Please add \$4 shipping & handling. FREE shipping & handling for orders \$50 and over. NY State Residents add applicable sales tax.			Shipping/Handling	Total

Name \_\_\_\_\_  
 Callsign \_\_\_\_\_ Phone/Fax No. \_\_\_\_\_  
 Street Address \_\_\_\_\_  
 City \_\_\_\_\_ State \_\_\_\_\_ Zip \_\_\_\_\_

Please phone or fax your orders to:

**CQ Communications, Inc.**

76 North Broadway, Hicksville, NY 11801, Phone: 516-681-2922/Fax: 516-681-2926

**or call toll-free 800-853-9797**



# Antennas & Things

SIMPLE ANTENNAS AND ACCESSORIES FOR SIGNAL IMPROVEMENT

## Antennas for VLF RadioScience Observing

“RadioScience Observing” is a word that I coined to cover all forms of scientific observation using radio receivers. Although it could cover professionals as well as amateurs, this column is mainly for the amateur community (and not just “ham” radio operators - all amateurs). Recently I agreed to write a book on RadioScience Observing for Howard W. Sams/PROMPT (2647 Waterfront Parkway East Drive, Indianapolis, IN, 46214-2041; 1-800-428-7267 or 1-317-298-5400. Look for it early in 1998.

### Observing Phenomenon With a Radio Receiver

Let’s check out radio propagation and SIDs. Radio signals travel from point-to-point following certain rules, but those rules are often not well understood. Some of the most interesting propagation for observing occurs in the high frequency (HF) and very high frequency (VHF) bands, but there are observable anomalies in all bands.

SIDs are Sudden Ionospheric Disturbances. They occur when events on the sun, such as flares, send a large amount of energy towards Earth. When the energy hits the ionosphere, it will wipe out HF and some VHF communication for long periods of time, often several days. Oddly enough, even though SIDs reduce signal levels -they can drop the bottom out! - they also tend to enhance very low frequency (VLF) reception quite a bit, especially in the 15–30 kHz range. If you are interested in VLF SID hunting, I’d recommend the columns by Peter Taylor that appeared in our sister publication, *Communications Quarterly*, for several years. Back issues are available from the publisher of this magazine at 1-800-853-9797. Also look for articles by Art Stokes, who is the technical guru behind a lot of the receivers.

### Jupiter Hunting

Radio signals from Jupiter are surprisingly accessible. They occur in the range

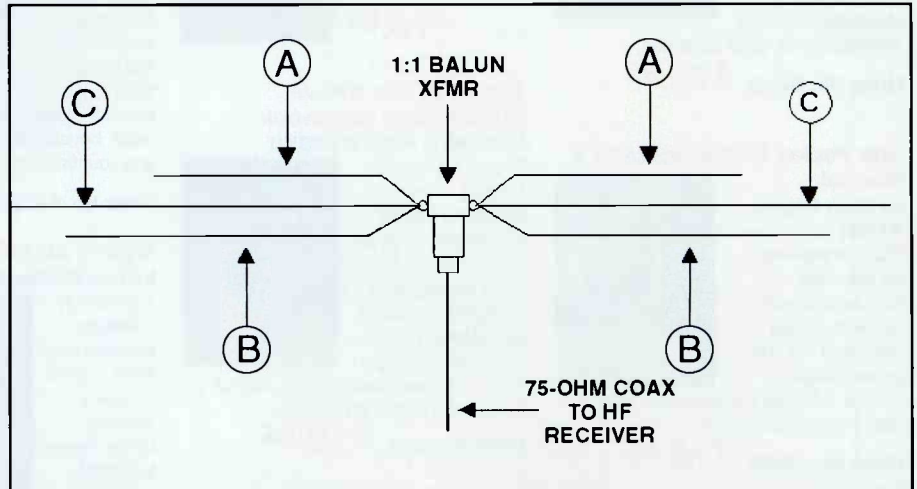

Fig. 1: Wideband dipole for Jovian signal reception.

11 to 40 MHz, with particular concentrations in the 18 to 24 MHz band. In other words, you can receive them on any decent shortwave general coverage receiver! Use the widest bandwidth setting on your filters. The “wave crashes” and “pebble on tin roof” sounds don’t occur across the entire band all the time, so one has to hunt for them. They also don’t occur all the time, and are only audible when Jupiter is above the local horizon. Unlike optical astronomy, Jupiter hunting is often done during the day.

### Whistler Hunting

Whistlers and spherics are VLF signals that occur in the 1 to 10 kHz region. They are sliding tones that start at a high pitch (towards 10 kHz) and slide down towards 1 kHz over a second or so. These sounds were heard as early as the 1880s. When long telephone lines began to web the cities together, operators and users would occasionally report descending pitch howls.

Although whistlers are in the “audio” range of human hearing, you cannot hear a whistler without a radio receiver tuned to those frequencies. The reason is that your ear responds to acoustical waves - vibrations in the air - while whistlers and related phenomena are electromagnetic

---

**“Whistlers and spherics are VLF signals that occur in the 1 to 10 KHz region.”**

---

or radio waves. Receivers for this band are essentially audio amplifiers with sharp front-end filtering to limit the bandwidth to the 1-10kHz region (which helps suppress 60 Hz signals that would inevitably get into the receiver.

A high school project called the INteractive Space Physics Ionospheric Radio Experiments, or INSPIRE (c/o Bill Pine, Science Department, Chaffey High School, 1245 N. Euclid Avenue, Ontario, CA, 91762) publishes an occasional newsletter. They ask for a donation for the newsletter in order to defray expenses (\$15 is about right, although they asked for a bit less in their last newsletter). By the way, Project INSPIRE can sell you a newly redesigned kit for a whistler hunting receiver for a small fee.

### Antennas

So what about antennas. You’ve seen those massive dish antennas used for radio astronomy, but do you need anything so massive in your own hobby

observations? Not at all. In fact, the VLF antennas are going to surprise you.

For Jupiter reception, an ordinary dipole or HF gain antenna will work if it is pointed towards Jupiter at a time when the planet is above the local horizon. One common form of antenna is the wideband dipole. Because the band of interest is 6 MHz wide (18 to 24 MHz reception), you can make a triple dipole (Fig. 1). These antennas are three parallel dipoles all on the same transmission line and all installed in the same vertical plane.

To broadband the wideband dipole antenna to optimize for 18 to 24 MHz, cut the sections as follows:

Section	Frequency	Half	Whole
A	23 MHz	0.2 ft.	20.4 ft.
B	21 MHz	11 ft.	22 ft.
C	19 MHz	12.3 ft.	24.6 ft.

The lengths of each section on either side of the BALUN transformer are shown in the "half" column, while the overall length for both sides of the BALUN are shown in the "whole" column. If you notice that these dimensions are suggestive of a ham band 15-meter dipole, then congratulations - you win the gold doobie button!

## VLF Antennas

OK, so now let's look at antennas for VLF SID and whistler hunters. We all know that antenna lengths are inversely proportional to frequency, so antennas for 1 to 30 kHz are measured in miles not feet, right? Wrong. While it's true that resonant antennas have such lengths, other forms of antenna are not so limited. For example, one SID hunter told me that he simply uses the HF vertical antenna that he uses on the ham bands as the antenna. He also told me that he has used the rain downspout (simple clip-lead connection) and the aluminum roof of a shed he uses for optical astronomy. If you are really pressed for an antenna for SID hunting, then go out and get an eight-foot section of one-inch diameter aluminum tubing, and mount it outdoors in a manner that it is insulated from the ground. A piece of coax can be used as a shielded wire to connect the pipe to your SID receiver.

Whistler hunters typically use telescoping whip antennas from portable "transistor" radios for their receivers. You can buy these antennas as replacement items from radio parts distributors. I've

**Motron** 310 Garfield St Suite 4  
PO Box 2748  
Eugene, Oregon 97402  
<http://www.motron.com>

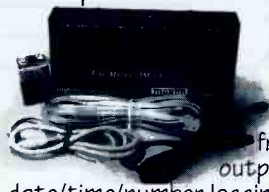

## DTMF & ROTARY TEST DECODERS

### TONE-MASTER™ TM-16A & TM-16A Plus

Decode and display DTMF from nearly any audio source; scanner, tape recorder, etc. And now decode and display either DTMF or Rotary digits from a telephone. TM-16A PLUS with RS-232 serial output includes Logger Software for optional automatic date/time/number logging using your IBM Compatible computer. Prices and specifications subject to change without notice.

TM-16A DTMF & Rotary Decoder \$179.00 TM-16A Plus with RS-232 output \$249.00



S/H: \$8 USA, \$11 Canada, \$16 Foreign. Premium shipping available for an additional charge. Visa, MasterCard, Discover & American Express Accepted. COD on Cash or Money Order basis only: \$5.

Orders: (800) 338-9058 Info: (541) 687-2118 Fax: (541) 687-2492

Get online with POP'COMM on Delphi!

**DELPHI**  
INTERNET™

To sign up dial  
**1-800-365-4636**  
with your computer & modem,  
and enter **ELECTRONIC** at the  
signup password prompt!  
You can find  
**POPULAR COMMUNICATIONS**  
in the Radio & Electronics Forum  
(GO RADIO).

CIRCLE 66 ON READER SERVICE CARD

**VIDEO SYNC GENERATOR**

Restores Horizontal and Vertical Sync Lines from Distorted Analogue Video Formats

For Free Information Package on Completed Units and Pricing

• Call 219-236-5776 •

R.C. Distributing • PO Box 552 • South Bend, IN 46624

CIRCLE 74 ON READER SERVICE CARD

## "DON'T GET CAUGHT OFF GUARD!!"

Avoid death or injury due to severe weather with IMMEDIATE notification via alphanumeric pagers.



WeatherPage provides immediate severe weather watches and warnings, real-time storm movement and speed, severe weather statements, hurricane advisories, and even daily forecasts wherever you go. Any alphanumeric pager from any paging company will work with WeatherPage.

Find out what hundreds of emergency managers, television and radio stations, storm spotters, and weather enthusiasts already know... WeatherPage is the quickest and most efficient technique to receive life-threatening severe weather information. WWS developed the WeatherPage System to provide maximum flexibility and affordability to all users via alphanumeric pagers.

WeatherPage's flexibility allows you to determine your own customized county-specific coverage region. Not only can you choose the specific counties for notification, but you can also choose from our extensive list of over 25 severe weather products.

Know what its like to be notified immediately of severe weather wherever you are....  
Know WeatherPage!!

Only From Widespread Weather Services

**1-800-845-0383**

<http://www.io.com/~weather/>

CIRCLE 80 ON READER SERVICE CARD

# Great Books!

## Radio Monitoring

The How-To Guide T.J. "Skip" Arey  
NEW for 1997 WB2GHA

The complete hands-on guide to the world of communications, including mediumwave, shortwave, VHF/UHF scanning, and much more! Find out who's listening, how they do it, what equipment "works." The #1 book in scanning and monitoring today!

"...covers it all, from DC to daylight."

NEW! World Scanner Report

ISBN 1-56866-101-0 344 pages, \$19.95

**ULTIMATE SCANNER** Bill Cheek  
Scanner modifications - THREE 240 pages, large format, \$29.95

Bill Cheek is the master of scanner modification, as Editor of the *World Scanning Report* and author of *Scanner Modification Manuals*.

**SCANNERS & Secret Frequencies** Henry Eisenson  
320 pages, \$19.95

"Must reading." *Electronics Now* "Useful, knowledgeable..." *PopComm*  
"A giant undertaking...authoritative" *Monitoring Times* "You can't miss!" *ASG*  
"Absolutely the best..." *Norm Schran* "A high point!" *RCMA*

### Beyond Scanning!

**Underground Database** 100 pages, large  
Everything that's sort of legal. "Fascinating" *ASG* format, \$23.75

**Television GRAY Market** Henry Eisenson  
Cable & satellite chips, descramblers, etc. 160 pages, \$23.75  
"Explores this shadowy fringe area in depth... good info." *PopComm*

[www.electrictiti.com/~ipgbooks](http://www.electrictiti.com/~ipgbooks)

s/h \$4 1st book, then \$2 ea. CA add tax

**INDEX** Publishing Group, Inc. MO/check via mail, or  
3368 Governor Drive, Suite 273P MCard, Visa, Amex  
San Diego, CA 92122 800-546-6707

CIRCLE 68 ON READER SERVICE CARD

## WORLDS SMALLEST TRANSMITTERS

**XWB1000E-Z kit \$46.95**  
MICRO FM TRANSMITTER

Voice transmitter kit. Transmits 88 to 108MHz. Range up to 1/2 mile. Includes mic and battery. Uses surface mount components

**XTL1000E-Z kit \$69.95**  
CRYSTAL CONTROLLED TRANSMITTER

Voice transmitter kit. Range up to 1/2 mile. Super sensitive mic. Transmits at 143.790MHz. Uses surface mount components

**XTL3000E-Z kit \$99.95**  
LONG RANGE CRYSTAL CONTROLLED TRANSMITTER

Voice transmitter kit. Range up to 1 mile. Super sensitive mic. Transmits at 143.790MHz. Uses surface mount components

**XLC900(C) \$49.95**  
SCANNER CONVERTER KIT  
Uninterrupted coverage of the 800 to 950MHz band. Works with any 400 to 550MHz scanner.

**XBD500E-Z KIT \$129.95**  
BUG DETECTOR

Professional quality. Covers 1MHz to 2GHz. Uses new microwave integrated circuit amplifier. Adjustable sensitivity. Earphone jack for quiet operation.

ASK ABOUT OUR CRYSTAL CONTROLLED TRACKING TRANSMITTER XTR300(E-Z) \$79.95

**ORDER LINE**  
1-800-336-7389



CHECK, VISA, MC, MO,  
or COD, S&H EXTRA

Call for FREE Catalog



**XANDI ELECTRONICS, INC.**  
SATISFACTION GUARANTEED  
SERVING THE PUBLIC SINCE 1981  
1270 E. BROADWAY RD., # 113  
TEMPE, AZ 85282

28 CIRCLE 81 ON READER SERVICE CARD

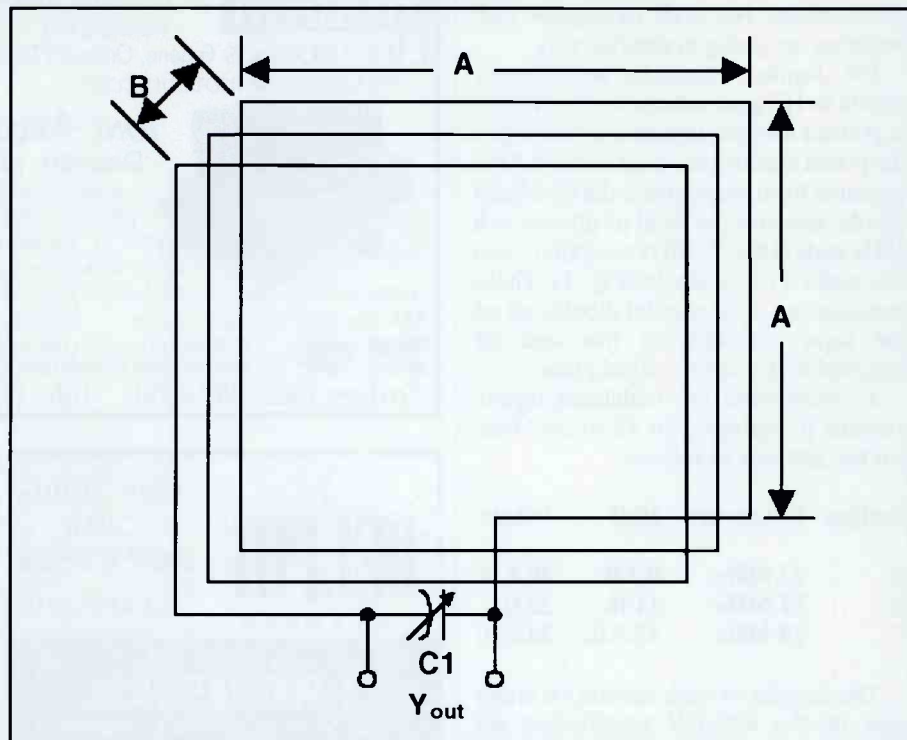

Fig. 2: Loop antenna construction.

*"Whistler hunters typically use telescoping whip antennas from portable 'ransistor' radios for their receivers."*

also seen them at RadioShack. These antennas will work wonders, and are less likely to pick up 60 Hz interference. Whistler hunting, by the way, is best done many hundreds of yards from power lines, so is usually something one does out in the country.

Another antenna useful for VLF RadioScience Observing is the loop (Fig. 2). These antennas have an overall wire length that is less than 0.15 wavelength, to respond to the magnetic component of the electromagnetic signal rather than the voltage component. As a result, they are less sensitive to 60 Hz interference. The typical loop used in the VLF range is about 2 feet square, and has between 60 and 150 turns of wire. I've built such loops using 50 conductor (25 pair) intercom and telephone cable, as well as 64 conductor computer "ribbon cable" (use the colored type - it's easier to work with when you solder everything together).

The capacitor will resonate the antenna to a specific frequency. It will also greatly increase the signal output voltage.

But it also limits the frequency coverage. But since you will tend to pick up a single frequency (e.g. 25 kHz), then it is reasonable to set the antenna once and then forget it.

If pick-up from 60 Hz power lines is severe, then shield the antenna. Use copper foil to wrap the loop over its entire length (all four sides), except for a gap of two inches along any one side (usually the top side). The gap is necessary to ensure that the antenna will respond to the magnetic component of the signal.

The signal pick-up on a small loop is along the plane of the loop. When the antenna is broadside to the signal (i.e. in the direction in or out of the page, as shown in Fig. 2), the signal is in the null of the loop, so it disappears.

## Conclusion

RadioScience Observing is a lot of fun. It serves both the radio enthusiast and the amateur scientist. It also is a great activity for high school and junior high school-age proto-scientists. I hope as a result of this article a number of RadioScience Observing projects are seen in next year's round of science fairs around the country!

I can be contacted, SPAMed, shot at or queried at P.O. Box 1099, Falls Church, VA 22041, or via e-mail at <CAR-RJJ@AOL.COM>.

# You may not know our name . . .

## but our history gives us away!



While the name RELM Communications (formerly Regency Electronics) may not make you think of scanners, it soon will. We're re-entering the scanner market with top-quality, professional scanners. With that goal in mind, we're excited to introduce the HS 200 portable scanner. The HS 200 covers 13 bands including aircraft and 800 MHz. Other features include:

- 200 Channels, 10 Banks
- **PL/CTCSS**
- Fast Scan
- Bank Scan
- Priority Scan with Hierarchy
- Direct Channel Access
- Search Hold
- Birdie Lockout
- 10 Priority Channels
- **DPL/DCS**
- Scan Delay
- Weather Scan
- Priority
- Search
- Channel Lockout
- LCD Display

**Call for more information  
on our complete line!  
800-821-2900**



*Pictured Right:  
The HX 1000 was a popular scanner  
under the Regency Electronics name.*

**RELM**<sup>TM</sup>

COMMUNICATIONS

7505 Technology Drive  
West Melbourne, FL 32904  
407-984-1414  
Fax: 407-984-0434

# Product Spotlight

POP'COMM REVIEWS PRODUCTS OF INTEREST

## Product Spotlight: Uniden BC235XLT - TrunkTracker

It's here, it's real, and it works! The new Uniden Bearcat 235XLT "TrunkTracker" is arguably the greatest technological advance in scanning in nearly 20 years. This new scanner promises to have as much impact on the hobby as the development of the programmable scanner.

The BC235XLT "TrunkTracker" is a 300-channel handheld scanner that's the first on the market to be able to follow or "track" the conversations on Motorola 800 MHz trunked radio systems.

To understand what makes this scanner so phenomenal you have to understand a little bit about trunking technology itself. Unlike conventional radio systems in which a handful of frequencies are assigned to a particular user, a *trunked* radio system can have many users, all sharing the same frequencies. Trunked system users — police departments, fire departments, etc. — are divided into "subfleets" or "talkgroups" with each group and each radio assigned its own ID code. While talkgroups and subfleets are not exactly the same, the TrunkTracker treats them the same, so the terms are being used interchangeably here.

When a radio within a talkgroup is keyed to transmit, a central computer reads the radio's ID code, selects an open frequency from those available and transmits a data burst on a control channel that automatically switches all the other radios within that talkgroup or subfleet to the selected frequency. Once the transmission is complete, the computer releases the frequency for use by another agency. This happens each time a transmission takes place, making it likely that each portion of a conversation will occur on an entirely different frequency. In systems with both public safety and other users, such as the utilities, parks, water and sewer departments, it's impossible when using a conventional scanner to lock out the agencies you don't want to hear. This combination of frequency hopping and multiple users makes it extremely difficult to follow a particular conversation using a conventional scanner.



### Identifies Talkgroups

The Uniden "TrunkTracker" is the first scanner to allow the user to identify the various talkgroups or subfleets being used and to program the radio to monitor only those talkgroups the user wants to hear. It also allows you to hold on a single talkgroup and monitor the conversation even as it jumps from frequency to frequency. Up to 10 different trunked systems can be programmed, but only one system can be monitored at a time. Thirty frequencies can be entered for each system, and up to 50 talkgroups can be saved to programmable scan lists for each system. Once the scan lists are programmed, the radio scans talkgroups much like a conventional scanner scans frequencies, and you can activate - or lock-out - particular talkgroups at will.

So far, the 235XLT is compatible only with Motorola-type trunking systems,

and only 800 MHz systems can be tracked. Users who want to monitor trunked systems in the 400 and 900 MHz bands, and those wanting to listen to GE/Ericsson trunked systems will have to wait for the next breakthrough.

---

*"Those wanting to listen to GE/Ericsson trunked systems will have to wait for the next breakthrough."*

---

The "TrunkTracker" is in effect a dual receiver. One side of the receiver monitors the data flow from the site controller and tunes the other side of the receiver to follow the conversation as it hops from frequency to frequency. Although the user must figure out which department or division is assigned to which talkgroup, in practice this isn't particularly difficult, requiring only that the user listen to the conversations and note the talkgroup ID, which is shown on the radio's display panel - and the corresponding agency. A basic knowledge of how the system is structured can help. For example, many urban police departments are divided into patrol zones. Each patrol zone usually has its own sub-fleet, as does the detective division, the vice squad, the narcotics unit and so on. If on one talkgroup you keep hearing patrol cars dispatched to a certain area of the city then you can assume that talkgroup is used by cars in that patrol zone. Alternatively, if you hear the city ambulances dispatched on one talkgroup and ladder trucks and fire engines on another, it's not too hard to figure out which is the medic subfleet and which is the fire subfleet. Cities with other than public safety agencies sharing the system may be a little more difficult. For example, it may take a while to distinguish the building inspectors from the code enforcement department.

OK, now that you know "what" the TrunkTracker does, the question becomes, "how well does it do it?" To check out the TrunkTracker in the "real world"

***"Think of the talkgroup IDs as frequencies and the scan lists as you would banks in a conventional scanner."***

I took field trips to Lakeland and St. Petersburg, Florida, both communities which have been using Motorola trunked systems for several years. Programming the radio to monitor a Motorola Type II system such as St. Petersburg's is easy, although several steps are involved. First the 15 repeater output frequencies are entered into a bank of memory channels the same way they are entered into memory on a conventional scanner. Each bank holds up to 30 frequencies.

Once the repeater output frequencies were entered and stored, a trunking search was initiated by first pressing the TRUNK key, then the SEARCH key. It took the radio only a couple of seconds to search the frequencies and lock onto the data channel. Almost immediately talkgroup ID numbers began appearing on the radio's LCD display panel. Within 30 minutes I had identified nine different police talkgroups including one being used for surveillance.

Once you've identified the various talkgroup IDs you can store them in up to five scan lists for each trunked system. Each scan list holds 10 talkgroups. Think of the talkgroup IDs as frequencies and the scan lists as you would banks in a conventional scanner. Whole lists can be added or removed from the scan sequence just the way banks are used in a conventional scanner, and individual talkgroups can be added or locked out, just like frequencies in a conventional scanner. Once the scan lists are set up, monitoring a trunked system is just as easy as monitoring a conventional radio system. You simply turn the radio on and activate or lock out banks (scan lists) and channels (talkgroups) as you've been used to doing.

Monitoring a Motorola Type I system such as used in Lakeland is not quite as easy. The repeater frequencies are entered and searched just as with a Type II system, but to truly customize the radio to a Type I system (or to a Type III hybrid sys-

***"Once the scan lists are set up, monitoring a trunked system is just as easy as monitoring a conventional radio system."***

Rave Review  
Pop Comm  
April '96

SEE US ON THE WEB!  
www.vikingint.com



# Professional 10 HOUR RECORDER

"BUILT LIKE A BATTLESHIP"

- Heavy duty commercial recorder - NOT improvised from consumer models
- 12, 14, and 16 hour models also available
- BUILT-IN voice activation (add \$30)
- Applications information included
- Dimensions: 11.5 x 7.0 x 2.75"

SPECIAL  
Pop Comm  
Price..

**\$159**

FREE  
40-PAGE  
SPECIAL EQUIPMENT  
CATALOG!

COD's OK. Calif. residents add tax. Sorry, no credit cards. Free catalog USA only, other countries \$5

..Includes UPS to 48 States

**Viking International**

Factory Direct

150 Executive Park Blvd. #4600 San Francisco, CA 94134

Phone: (415) 468-2066 • Fax: (415) 468-2067 "Since 1971"

CIRCLE 79 ON READER SERVICE CARD



WE'VE GOT THE FIELD COVERED!

**JO GUNN**

Antennas



Route 1 Box 32C, Old Hwy 82.

Ethelsville, Alabama 35461

(205) 658-2229 fax (205) 658-2259

Hours: 9am - 5pm (CST) Tuesday - Friday

**Other Models & Sizes Available in 10 or 11 Meters**  
Call or send \$2 for Complete Catalog and Pricing of Antenna  
**DEALER INQUIRIES, PLEASE CALL**

tem) you've got to assign a so-called fleet map to the system being monitored. Without an assigned fleet map, the TrunkTracker will still do a pretty good job of tracking, but it will miss an occasional frequency change so parts of some conversations will be missed. How do you tell if a system is Type I or Type II? If you are searching a Type II system, all the talkgroup IDs will be even numbers, i.e. 8244, 8966 etc. If you are searching a Type I system while still in the default (Type II) mode you will see a mix of odd and even numbers. Simply switch to Type I mode and the proper sub-fleet IDs will begin appearing, i.e. 100-7, 200-14, etc.

### Uniden's TrunkTracker is Pre-Set With 16 Common Fleet Maps

Determining the fleet map which is correct for your local Type I trunked system is a matter of trial and error. For the rare system that doesn't use one of the pre-set fleet maps, Uniden has allowed the user to program custom fleet maps.

This is where things become challenging. Each fleet map has eight blocks, and each block must be assigned a size code which defines the number of fleets and subfleets being used. There are 15 available size codes and matching the proper size code to each block is again a matter of trial and error. If you program a block and are still missing parts of the conversations, then try a different size code. Since there are thousands of possible combinations, this could take some time.

However, as the radios become widely available and people begin to figure out the fleet maps for their areas, expect this information to start showing up on the Internet scanning forums as well as in magazines and frequency guides.

Once you have the radio properly programmed, the subfleet IDs can be stored in scan lists and the radio used just as described above. While all the attention is focused on the 235XLT's trunking ability, it's worthwhile to mention that the TrunkTracker is also a fully capable 300-channel conventional scanner as well. (You can't monitor a trunked system and a conventional system at the same time.)

### It's Triple Conversion!

The 235XLT may resemble the 220XLT on the outside, but Uniden has upped the ante by making this unit (and the 895XLT base model expected later this year) triple conversion. By adding this third step Uniden has gone a long way toward eliminating the intermod and images that were a problem with the 220XLT.

I took the 235XLT driving around downtown Tampa and in areas where my PRO-206 was flooded with intermod from strong pager signals, the TrunkTracker remained well-behaved and quiet. That's not to say the radio is perfect. By removing the antenna and searching the entire 29 to 956 MHz coverage range (not continuous) I located about 30 "birdies," or internally generated signals which caused the scanner to pause on certain frequencies. I also found television audio images around 111.00 MHz in the VHF aircraft band and at around 406 MHz in the land mobile band.

*"The 235XLT is one of the first radios built to meet Uniden's proposed 38db cellular image rejection standard now under consideration by the FCC."*

Noticeably missing are cellular telephone transmission images. The 235XLT is one of the first radios built to meet Uniden's proposed 38db cellular image rejection standard now under consideration by the FCC. Reportedly, FCC inspectors were unable to locate cellular images anywhere in the radio's tuning range.

There's been a great deal of speculation that Motorola would take legal action to block sales of the TrunkTracker. While things may have changed between when this article was written and the time you read it in early June, the latest word from Motorola is no legal action has been filed. The company's only comment was "we are aware of the radio and we are looking at our options."

The 235XLT comes complete with a rubber ducky antenna, a battery charger and two NiCd battery packs. Both the pack inside the radio and the spare pack can be charged at the same time. Although the suggested retail price is \$429.95, the TrunkTracker is typically selling for \$270 to \$300, depending upon the dealer. ■

## The ZEIT by ARCRON RADIO-CONTROLLED CLOCK

- All World Time Zones with Precise Time
- Tell Time by the Atomic Clock that governs time for radio stations and space flights
- Sets Self By The NIST Radio Waves - WWVB Signal

**NEW SPECIAL!**  
**\$129.95**

- Time, Hours, Minutes, Seconds
- Reception/Signal Strength
- Date or 2nd Time Zone
- BackLight Dial for Night
- US and World Time
- All World Time Zones
- ARC Program Symbol
- Dual Alarm Function



**-YOU'LL NEVER HAVE TO SET THE TIME AGAIN**

**Keeping Exact Time HASN'T BEEN EASIER!!—Automatically sets accurate time, date and adjusts for the start and end of daylight savings time**

- Receives Radio Signal from US Atomic Clock
- Superior Signal Sensitivity (Below 20µV/m)
- Continuous Oscillator Calibration
- Internal Quartz Oscillator
- Integrated Internal Ferrite Omnidirectional Antenna
- Battery Operated with Low Battery Indicator
- High Tech Design
- Warranted
- 2.60" x 5.30" x 4.45"

**ORDER YOURS DIRECT FROM ARCRON ZEIT**

**CALL TOLL FREE 24 HOURS 1-800-985-TIME (8463)**

630-472-9999 International  
<http://www.arctime.com>

M/C • VISA • DISCOVER • AMEX 2ND DAY DELIVERY AVAILABLE

**Radio-Controlled Wall Clocks ONLY \$79.95**  
(12" Diameter)



# How I Got Started

## Self-Proclaimed "Neophyte" Takes Class Notes in Morse Code!



Sumeet Kishnani of Flushing, NY at his monitoring post.

**P**opular Communications invites you to submit in about 150 words how you got started in the communications hobby. Entries should be typewritten, or otherwise easily readable. If possible, your photo (no Polaroids, please) should be included.

Each month we'll select one entry and publish it here. Submit your entry only once; we'll keep it on file. All submissions become the property of *Popular Communications*, and none will be acknowledged or returned. Entries will be selected taking into consideration the story they relate, and if it is especially interesting, unusual or even humorous. We reserve the right to edit all material for length and grammar, and to improve style.

The person whose entry is selected will receive a one-year gift subscription (or one-year subscription extension) to *Popular Communications*. Address all entries to: How I Got Started, *Popular Communications*, 76 North Broadway, Hicksville, NY 11801-2909 or e-mail your entry to <popularcom@aol.com>, letting us know if you're sending photos.

### Our July Winner

Sumeet Kishnani of Flushing, NY contacted us via e-mail with his very inter-

esting radio story. Last December I purchased my first scanner after months of consideration. I now utilize it to its fullest! Soon, I opened the gates to a different world—shortwave.

The amount of literature on the topic was a glut compared to that on scanning, still insufficient and frustrating, but I managed to get mailing addresses for several publications, previously unknown to me. I wrote to all of them requesting information. *Popular Communications* and *National Scanning* were the first to reply. I still haven't received anything from the rest. But at last I had the resources to build upon my newly found hobby, which had been motivated by curiosity alone.

I found the ham bands to be very interesting on my scanner, and I soon inundated my bookshelves with study materials for licenses of all classes. I even started taking class notes in CW. (Many perplexed sources can actually verify this). A few days later, scanning the ham bands again, I heard a station express his lack of interest in the hobby after 52 years of listening!! My first thoughts were, "I hope I never get tired of this hobby." However, if radio still has over 50 years of fascination left for me, then this neophyte made the right decisions in purchasing that scanner. ■

## The #1 Ham Study Guide

There has **NEVER** been a better time to get your first Amateur Radio License!

Amateur Radio activity is on the increase and it's time to have some fun.

If the goal is your first Amateur Radio License, you'll want the **new edition** of *Now You're Talking! All You Need to Get Your Ham Radio Technician Class License*. Thousands of licensed Amateurs have used *Now You're Talking!* to study for their entry level exam.

No Morse code test is required for the Technician license, so *Now You're Talking!* really **IS** all you need to prepare! You'll find clear and easy explanations and all the up-to-date questions and answers you'll see on your exam. No surprises.

**This edition contains all the new question pool material for exams taken after June 30, 1997.**

*Now You're Talking!* will also provide invaluable assistance once you have your license in your hand.

It will help you select and set up radios, accessories and antennas for your ham radio station. It will also guide you through your first contacts on all the popular operating modes, including FM repeaters and packet radio.

***Now You're Talking! All You Need to Get Your Ham Radio Technician Class License.***

ARRL Order No. 5978. \$19 plus \$4 for shipping and handling.

Call the ARRL toll-free order number, 1-888-277-5289, to order or to find a dealer near you!

Check out ARRL on the World Wide Web: <http://www.arrl.org/>

**The American Radio Relay League  
225 Main St.  
Newington, CT 06111**



# Scanning The Globe

MONITORING THE 30 TO 900 MHz "ACTION" BANDS

## *Amused at These Frequencies!*

It's summertime, and a favorite pastime is visiting amusement parks large and small. If you head to an amusement park this summer or fall, you may want to pack along a handheld scanner to check out the communications action behind the scenes.

What frequencies are used by amusement parks? A lot of scanner hobbyists will be visiting the fun parks this summer and if you take along a scanner, you can keep abreast of the action. Most amusement parks use business radio frequencies for operations such as security, maintenance, ride operations, entertainment and paging. Typically, it's easy to find amusement park channels.

First, check out the routine VHF business band channels. Some may use the itinerant channel of 151.625. Also, check the other 151 MHz business channels from 151.685 to 151.955. There also are several channels from 154.515 to 154.625. If you don't find any operations there, be sure to check the UHF segments, especially 461 to 465 and 466 to 470 MHz. Be sure to search in 12.5 kHz steps in case low-power channels are being used. These low-power channels are offset 12.5 kHz from routine, normal power channels. For instance, 461.6125 is offset 12.5 kHz from 461.600 and 461.625. The maximum power output allowed on these low-power channels is 2 watts and repeaters are allowed as long as they follow the same power restrictions. There also are some low-power channels at 457.525 to 457.600 MHz.

Keep in mind that your scanning activity may appear to be suspicious to amusement park security guards trying to do their jobs. If they request that you keep your radio out of the park, respect their wishes. After all, you are their guest. However, one trick that seems to work a lot of times is to disguise your scanner as a Walkman™-type of radio. Use your scanner as normal - clipped to your belt, but use a pair of Walkman-type headphones. In fact, you probably could get away without using the rubber duck on your scanner while within the park, too, so go ahead and remove it. You'll hear all the nearby action without an antenna. In

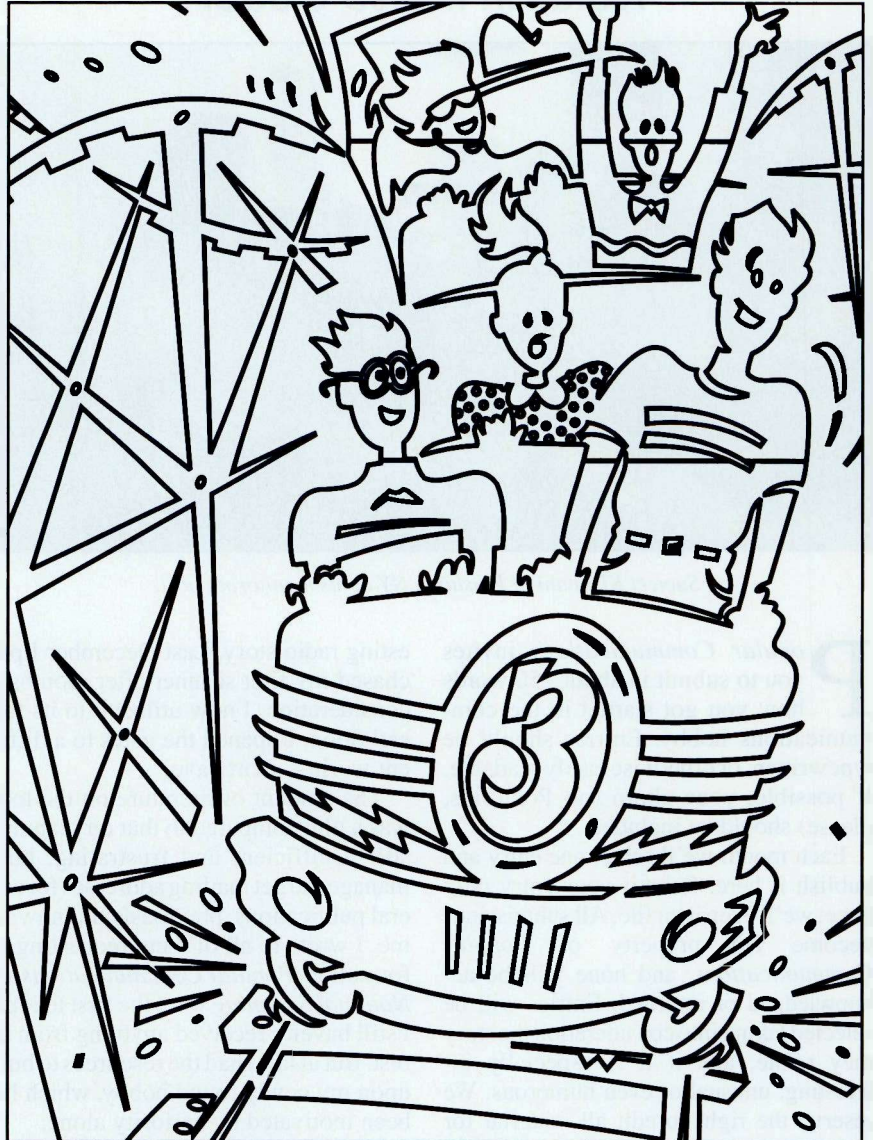

fact, it will eliminate a lot of communications from outside the park such as a nearby city that you'd rather not hear anyway.

### Summer Action

Don't forget you'll find business frequencies active at various other events during the summer, too, such as baseball games (stadium security is a primary user), auto races (hear the drivers talk to their pit crews), Special Olympics (464.500 and 464.550 are favored by these groups), fairs and festivals (support

crews and security will use radios a lot) and more.

The frequencies of 151.625, 464.500, 464.550, 469.500 and 469.550 are reserved for itinerant users and you can almost always find folks using these frequencies for everything from surveying to bridge building to football teams and more. No matter where you live in the United States, you are bound to find someone using one of those itinerant frequencies at any given time during the year, if you keep a constant watch on the channels. In addition, the frequencies of

## AR7030... "Superior by Design"

# AOR

The introduction of the all new AOR AR7030 shortwave receiver is geared to the discerning and dedicated

listener. The AR7030 is the result of a combined project between AOR and a UK designer. The AR7030 represents the very latest and best design, featuring exceptionally strong signal handling and bristling with enhanced features, with coverage from 0 - 32MHz. The AR7030 has been targeted to handle strong signals that are of prime concern of European listeners. It offers greater than +35dBm IP3 (Intercept Point 3) and greater than 100dBm dynamic range. The DMOS FET QUAD first mixer with NCO drive DDS offers the ultimate performance. All this and great sensitivity better than 0.5µV for 10dB S/N in AM mode and better than 0.3µV for 10dB S/N in SSB. Selectivity too is razor sharp offering greater than 90dB @ 10kHz SSB and greater than 100dB @ 20kHz. No other receiver "in the class" nor indeed at considerably higher price can match the sheer performance excellence of the AR7030.



## AR3000A... "The Professional Communications Receiver"

# AOR

Your listening horizons are truly extended with receiver coverage from 100kHz all the way up to 2036MHz. The high level of

performance is achieved by 15 band pass filters before the GaAs FET RF amplifiers. It will allow listening in any mode: NFM, WFM, AM, USB, LSB and CW. An RS232 port is provided enabling remote control via most computers. OFV Frequency, Receiver mode, Frequency steps, Writing to/from memory, Signal strength, RF attenuator, Memory bank change over and more, the LCD provides a multitude of information such as Search, Scan, Frequency, Memory and additional functions such as Memory bank and Second function. The display includes a real time clock for accurate log keeping; there is also a timer and tape output socket for unattended monitoring.



### SPECIFICATIONS:

Receiver coverage:	100kHz - 2036MHz*
Receiver mode:	USB, LSB, CW, AM, NFM, WFM
Memory channels:	400 (4 banks of 100 channels)
Scan rate:	50 channels/second
Search rate:	50 steps/second
Receiver selectivity:	2.4kHz/ -6dB, 4.5kHz/ -60dB(USB/LSB/CW)
	12kHz/ -6dB, 25kHz/ -70dB(AM/FM)
	180kHz/ -6dB, 8000kHz/ -50dB(WFM)
Dimensions/Wgt.:	5.52" w x 3.2" h x 8 1/2" l. 2kg

\* Cellular Blocked - Unblocked OK to FCC approved Users

# WINRADIO™

## Your Window to the World



Tune in the world from the monitor of your PC, with the latest receiver technology! Just a mouse click or a keystroke can take you around the world to diverse cultures in hundreds of languages. PC screen shows entire receiver with all controls, including tuning dial for easy tuning and control. The WinRadio package includes the receiver card, software, handbook and indoor antenna. Microprocessor PC plug-in card is PLL synthesized with triple conversion super-heterodyne and connectors for external antenna and speaker/headphone.

- Scan for exotic stations from faraway places
- Eavesdrop on aircraft and maritime communications
- Intercept clandestine stations
- Monitor emergency services
- Receive satellite and Space Shuttle signals
- Witness combat transmissions making history

### Features:

- 500kHz to 1.3GHz • Tuning steps from 1kHz to 1MHz
- Up/down, direct entry or tuning dial via mouse or keys
- Modes are AM, FMW, FMN, SSB • Long wire antenna included
- Requirements - 386 or higher, DOS 3.3 or Windows 3.1/ Windows 95, 640kB Ram for DOS or 4 MB for windows use, and a vacant 16 bit card slot.



## THE LOWE SRX100 RECEIVER

The new LOWE SRX100 is an economy communications receiver intended for the newcomer to shortwave listening, or as a second receiver for the more experienced enthusiast. It sells for well under half the cost of our most popular receiver, the HF150, but nevertheless has an excellent specification for the price.

The SRX100 is extremely simple to operate, and can receive AM, CW and SSB signals. Some of the key features are shown below:



- Frequency range 30kHz to 30MHz
- 1kHz tuning steps
- Clarifier for SSB tuning ±800Hz
- 1µ sensitivity
- 2 watt audio output
- Modes available: USB, LSB, AM
- Liquid crystal display
- Built in speaker
- Dual conversion superhet design
- Signal frequency readout to 1kHz
- Digital frequency readout to 1kHz
- British made
- 12VDC power adaptor supplied
- Dimensions: 7.3"W x 7.5"D x 2.5"H

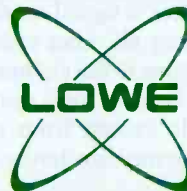

**For Product and Technical information  
Call Your Local Dealer.**

For the Dealer Nearest You call: 703.938.8105  
or FAX: 703.938.4525

**Electronic Distributors**  
325 Mill St.  
Vienna, VA. 22180  
[www.elecdist.com](http://www.elecdist.com)



154.570 and 154.600 MHz are reserved for low-power use (2 watts) and often are used for purposes such as security at stadiums and facilities such as museums and more. You won't find more than walkie-talkies on these two channels, though.

And when searching through the 461-465 MHz band, remember to search in 12.5 kHz steps so you don't miss all the potential activity on the low-power (2-watt) splinter frequencies offset by 12.5 kilohertz from normal full-power channels. The low-power channels can be used for repeaters, phone calls, paging, walkie-talkies, data or telemetry, and any other conceivable use. These splinter channels fall between the full-power channels.

## Unlocking Trunking Data

John Stephens from Passaic, NJ says he wants to monitor trunked communications in his area, but heard that he needs to lock out so-called data channels. He asked via e-mail for an explanation on how to lock and unlock these data channels. It's pretty basic stuff, but it's important for those who monitor trunked communications systems.

In most trunked systems, one of the many channels being used for the system will have "noise" on the channel. It will sound like that dreadful alarm clock that shakes you out of bed every morning. It sounds like a chainsaw that needs oil. It's a horrible noise and you don't want to monitor it! This data channel is sending out data, or computer information, to every radio in the radio system's fleet. For instance, if a New Jersey State Police trooper on the statewide system in New Jersey is ready to transmit a message, the radio sends out its own data signal 45 MHz below the data channel, and the controller at the trunked radio system sends back a signal on the data channel instructing all other radios in the same fleet to tune to the channel the unit transmitting is on. In some systems, these data channels switch from one channel to another every few hours, or at least once a day.

It is a signal you don't want to monitor because your scanner will stop on this channel and stay there because of the noise. Thus, you lock out this channel when it pops up on your scanner. Use the lockout button on your scanner so the scanner doesn't stop on this channel each time it passes by the frequency. However, when a new data channel pops up on your scanner and it locks onto it, it's time to lock out that channel and go back and

unlock the other channel that had been in use as the data channel.

## Tone Tip

Here's a tip I like to pass along: If an agency uses digital encryption in your area and you have a CTCSS (continuous tone-coded squelch system) or subaudible tone-capable scanner, you can screen out that awful racket.

In systems that use digital encryption, it sounds like static the entire time the station is transmitting. It gets awfully annoying to hear that static. However, if there also are clear-voice communications on the channel, you can screen out that static and hear all the clear calls. First you must determine the CTCSS tone being used by the agency you wish to monitor. Federal agencies have a tendency to use the same CTCSS tone on a nationwide basis. For instance: FBI, 167.9 Hz; Secret Service and White House Communications Agency, 103.5 Hz; and Drug Enforcement Agency, 156.7 Hz. By using the CTCSS capability on your scanner, it will not stop on the channel if it hears the digital encryption, however, it will allow clear voice calls to pass through the scanner's speaker. You may want to try this neat trick if you are tired of hearing static day and night because your local police department is using digital encryption to call in lunch orders to the dispatcher!

## Extenders Explanation

Ted Riley from East Stroudsburg, PA, inquired about monitoring highway patrol speed traps. He was curious if scanners can receive radar signals.

No, police radar does not operate on conventional VHF/UHF frequencies. Most police radar operates on 10525 and 24150 megahertz — or even laser. I don't think you'll find any receivers readily available that can receive signals that high except for radar detectors. What you can hear on a scanner related to radar is the frequencies that police radar teams use to catch speeders. In many states, the troopers have certain frequencies in their two-way radios allocated specifically for radar patrols. For instance, Pennsylvania State Police use 154.755, their car-to-car channel, for catching speeders. Units can be on the ground as well as in an airplane. In Iowa, 155.505 is set up as an "air" channel and is used to catch speeders from Iowa State Patrol airplanes. Knowing these frequencies and listening to them while mobile will tip you off as to where

radar patrols (a/k/a "speed traps") are set up. That's how you can use a scanner to find out where radar is up the road.

Another trick is to know when patrol cars are near you. In many states, mobile extenders are used by troopers, especially when they step out of their vehicles. These mobile extenders operate like this: When the trooper leaves his or her cruiser, he or she takes a walkie-talkie along. The walkie-talkie transmits on a dedicated frequency to the patrol car and the patrol car retransmits the signal from the walkie-talkie on the car's mobile transmit channel. The advantage is that by using a handheld radio, the trooper has the full power of the mobile radio behind his or her signal.

Whereas a handheld radio may not reach the dispatcher, the patrol car radio most likely would. By having the patrol car's radio retransmit the handheld's radio signal, the trooper has a better chance of reaching the dispatcher, especially on crowded radio channels.

In addition, the mobile extenders often will relay the signal from the dispatcher to the handheld radio carried by the trooper. If the trooper were in a ravine assisting an accident victim, he or she may not be able to hear the dispatcher while away from the vehicle. However, the extender will retransmit that signal from the patrol car to the trooper's handheld radio. The extender's primary purpose is to offer extended range for handheld radios used while the trooper is outside his or her vehicle.

Not all extenders operate the same, however. For instance, in California, mobile extenders retransmit signals they hear from dispatchers onto the handheld channels all the time. Thus, if you are anywhere within a mile or more from a highway patrol car, you will hear the signal. There have been some scanners made that detect communications heard on these mobile extender channels to alert the motorist that there is a trooper nearby. In other states such as Iowa, the mobile extenders are turned on only when the troopers exit the cruiser.

## Write In!

Do you have questions about scanning? What tips can you pass along to your fellow readers? What frequencies do you find the most interesting? We also welcome photos of listener's shacks and two-way systems. Write to: Chuck Gysi, N2DUP, Scanning the Globe, Popular Communications, P.O. Box 11, Iowa City, Iowa 52244-0011. ■

# WHEN THEY'RE ON THE GO... SEND **maxon** ALONG!

Maxon's new Family Radio Service radio has made it easier than ever to keep in touch with your family and friends... no matter where life takes them!

Indoors or out, these lightweight, palm-sized FRS two-way radios provide up to a 2 mile communication range\*, and offer single channel operation on 14 license-free channels.

For safety, convenience and just plain fun - communicate with Maxon's FRS!



Shown Actual Size  
Also available in Sport Yellow!

\* Range will vary, depending on terrain and environment  
CIRCLE 91 ON READER SERVICE CARD

**MAXON'S MODEL FRS-114  
IS PERFECT FOR ANY  
INDOOR OR OUTDOOR  
COMMUNICATIONS!**

## FAMILY VACATIONS

- Beaches
- Bicycling
- Boating
- Campgrounds
- Carnivals
- Child Safety
- Church Groups
- Climbing
- Fishing
- Hiking
- Inline Skating
- Neighborhood Watch Groups
- Playgrounds
- Pools

## AMUSEMENT PARKS

- Recreational Areas
- Schools
- School Bus Stops
- Social Gatherings
- Zoos... And  
*Much More*

## SPORTING EVENTS

# maxon<sup>®</sup>

*A World of Communications*

Maxon America, Inc.  
Consumer Products Division  
10828 NW Air World Drive  
Kansas City, Missouri 64153  
Toll Free: 800-821-7848, Ext. 399

# Final Survey Results Are Here!

by Harold Ort, N2RLL, Editor

**C**ongratulations to all of the readers who received a free one-year subscription or subscription extension in our monthly random drawings! *Everyone* who answered our questions on the Reader Service Card helped us tremendously as we try to mold *Pop'Comm* into an even better radio enthusiast magazine. A special thanks to those who even sent personal letters with many valuable comments and ideas in addition to mailing the free Reader Service Card.

We've learned a great deal about you during the past few months; information that will be used to plan future columns, articles and the general direction of *Pop'Comm*. We're still compiling the results, translating what the computers and folks at Berkshire Computer told us into plain English that everyone can understand.

Take for example what you told us about your radio spending habits; many of you spent between \$250-500 during the past year or so on communications gear, while relatively few of you spent more than \$2000. Looking at those who spent between \$500-700 and those who spent under \$250, the final results showed that 32 percent of you spent under \$250, while fully 70 percent spent between \$500-700.

## Where You Live

Interestingly, a great majority of our readers are in both the northeast and midwest—actually nearly the same numbers of folks responded from each of those areas. On the other hand, respondents from the south central U.S. were about 5 percent of the total. Other percentages break down like this: Our friends to the north in Canada amount to about 3 percent of those folks sending in the Reader Service Card; readers in the southwest U.S. numbered about 8 percent; northeast and midwest amounted to about 23 percent each; middle Atlantic, 6 percent; southwest, 8 percent; metro area readers are about 7 percent of our readers; while suburban readers are about 14 percent.

Readers outside the U.S. and Canada and in "other" areas—possibly military stationed overseas, and reader's in other overseas areas, amount to about 3 percent.

Taking a look at exactly *where* you live in these large geographic areas, we find the pie divided nearly into five equal parts between large cities, small cities, suburbs, and small towns/rural areas.

## Other Interesting Info

I've read the Internet postings about the state of the hobby and the opinions—and they are just that, opinions—naturally, they run the spectrum, as you might imagine. So a while ago we asked you how YOU felt about the state of the hobby. Your responses were quite interesting.

There's no question that an overwhelming majority feel the entire radio hobby is in a state of change. Nearly the same number of respondents—about 35 percent—feel that hobby is also in a period of slow, but steady growth. Twenty-two percent of you feel the hobby is "prosperous." Conversely, those enthusiasts (if you wish to use that word literally!) who feel our hobby is experiencing minimal growth and expansion, are about 10 percent of the total.

Another "hot potato" topic these days is Morse code; should it be retained in its present form as a licensing factor, eliminated altogether, replaced with a hands-on test, have a single 10-wpm test for HF operation, or should the requirement be lowered in each license category? Now, some things in life are just a puzzle, and the responses to this question were no exception. Then again, some might contend the responses were predictable.

Considering any slight margin of error, nearly the same number of folks saying they had "no opinion" on this topic said the code requirement should be eliminated. And nearly the same number of readers responding to the question said they'd keep the code in its present form also said they'd completely eliminate the code requirement!

So as percentages, 25 percent of you reported you'd eliminate the code requirement; 24 percent favored keeping it in its present form; 13 percent said they'd eliminate the code and replace it with a hands-on test; only 5 percent favor lowering the wpm standard; more than twice that number—10 percent of our readers would have a single 10-wpm test for HF operation; and 23 percent have no opinion on the subject.

## What Our Neighbors Think About Hams

Talk to your neighbor down the street about our hobby; ham radio, CB, shortwave, and scanning—what will they say? When you talk to non-hams (and if you're not a ham, please don't be offended; often non-hams down the street who don't know a scanner from a supermarket scanner lump radio hobbyists into one radio basket anyway.)

Based on personal observations over many years, I've always thought folks who aren't radio hobbyists think we're all "CBers" or even "hams." Let's examine the results together.

Of all the respondents to our question in the May issue, 29 percent of the non-hobbyists you talk to know little about the hobby, although 7 percent have seen hams on TV helping during disasters. The question, or perhaps more accurately, the *answer* of the day—indicates that 10 percent of our non-ham friends think ham radio is like CB. (Sorry 'bout that, but I just *had* to ask the question.)

Nearly 20 percent of you think those you talk to about ham radio believe it is too technical. Another 15 percent believe it is too expensive. Looks like we've all got some work to do, because another 7 percent would like more information on the ham radio hobby. When I see a figure that high, I see potential hams, scanner enthusiasts, CBers and much more. Manufacturers and dealers see dollar signs,

(Continued on page 76)

# Tap into secret Shortwave Signals

Turn mysterious signals into exciting text messages with this new MFJ MultiReader™



**MFJ-462B** Plug this self-contained MFJ MultiReader™ into your shortwave receiver's earphone jack.

Then watch mysterious chirps, whistles and buzzing sounds of RTTY, ASCII, CW and AMTOR (FEC) turn into exciting text messages as they scroll across your easy-to-read LCD display.

You'll read interesting commercial, military, diplomatic, weather, aeronautical, maritime and amateur traffic . . . traffic your friends can't read -- unless they have a decoder.

## Eavesdrop on the World

Eavesdrop on the world's press agencies transmitting *unedited* late breaking news in English -- China News in Taiwan, Tanjung Press in Serbia, Iraqi News in Iraq -- all on RTTY.

## Super Active Antenna

"World Radio TV Handbook" says MFJ-1024 is a "first rate easy-to-operate active antenna . . . quiet . . . excellent dynamic range . . . good gain . . . low noise . . . broad frequency coverage."

Mount it outdoors away from electrical noise for maximum signal, minimum noise. Covers 50 KHz to 30 MHz.

Receives strong, clear signals from all over the world. 20dB attenuator, gain control, ON LED. Switch two receivers and aux. or active antenna. 6x3x5 in. remote has 54 inch whip, 50 ft. coax.

**\$129<sup>95</sup>** MFJ-1024 MFJ-1312, \$129.95.

## Indoor Active Antenna

**MFJ-1020B**  
**\$79<sup>95</sup>**

### Rival

outside long wires with this *tuned* indoor active antenna. "World Radio TV Handbook" says MFJ-1020 is a "fine value . . . fair price . . . best offering to date . . . performs very well indeed."

*Tuned* circuitry minimizes intermod, improves selectivity, reduces noise outside tuned band. Use as preselector with external antenna. Covers 0.3-30 MHz. Has Tune, Band, Gain, On/Off/Bypass Controls. Detachable telescoping whip. 5x2x6 in. Use 9 volt battery, 9-18 VDC or 110 VAC with MFJ-1312, \$129.95.

## Compact Active Antenna

**MFJ-1022**  
**\$39<sup>95</sup>**

Plug this new compact MFJ all band active antenna into your general coverage receiver and you'll hear strong clear signals from all over the world from 300 KHz to 200 MHz -- including low, medium, shortwave and VHF bands. Also improves scanner radio reception on VHF high and low bands.

Detachable 20 in. telescoping antenna. 9 volt battery or 110 VAC with MFJ-1312B, \$129.95. 3/4x1/4x4 in.

Copy RTTY weather stations from Antarctica, Mali, Congo and many others. Listen to military RTTY passing traffic from Panama, Cyprus, Peru, Capetown, London and others. Listen to hams, diplomatic, research, commercial and maritime RTTY.

Listen to maritime users, diplomats and amateurs send and receive error free messages using various forms of TOR (Telex-Over-Radio).

Monitor Morse code from hams, military, commercial, aeronautical, diplomatic, maritime -- from all over the world -- Australia, Russia, Hong Kong, Japan, Egypt, Norway, Israel, Africa.

## Printer Monitors 24 Hours a Day

MFJ's exclusive *TelePrinterPort™* lets you monitor any station 24 hours a day by printing their transmissions your Epson compatible printer.

Printer cable, MFJ-5412, \$9.95.

## MFJ MessageSaver™

You can save several pages of text in 8K of memory for re-reading or later review.

## High Performance Modem

MFJ's high performance *phaselock loop* modem consistently gives you solid copy -- even with weak signals buried in noise. New threshold control minimizes noise interference -- greatly

improves copy on CW and other modes.

## Easy to use, tune and read

It's easy to use -- just push a button to select modes and features from a menu.

It's easy to tune -- a precision tuning indicator makes tuning your receiver easy for best copy.

It's easy to read -- the 2 line 16 character LCD display with contrast adjustment is mounted on a sloped front panel for easy reading.

Copies most standard shifts and speeds. Has MFJ *AutoTrak™* Morse code speed tracking.

Use 12 VDC or use 110 VAC with MFJ-1312B AC adapter, \$12.95. 5/4x2 1/2x5 1/4 inches.

## No Matter What Guarantee

You get MFJ's famous one year *No Matter What™* unconditional guarantee. That means we will repair or replace your MFJ MultiReader™ (at our option) *no matter what* for a full year.

## Try it for 30 Days

Order an MFJ-462B MultiReader™ from MFJ and try it in your own setup -- compare it to any other product on the market regardless of price.

Then if you're not completely satisfied, simply return it within 30 days for a prompt and courteous refund (less shipping).

Order today and try it -- you'll be glad you did.

## Receive Color News Photos, Weather Maps, RTTY, ASCII, Morse Code

**MFJ-1214PC**  
**\$149<sup>95</sup>**

Use your

computer and radio to receive and display *brilliant full color* FAX news photos and incredible WeFAX weather maps with all 16 gray levels. Also RTTY, ASCII and Morse code.

Animate weather maps. Display 10 global pictures simultaneously. Zoom any part of picture or map. Frequency manager lists over 900 FAX stations. Automatic picture capture and save.

Includes interface, easy-to-use menu driven software, cables, power supply, comprehensive manual and Jump-Start™ guide. Requires 286 or better computer with VGA monitor.

## Super Hi-Q Loop™ Antenna

The Super Hi-Q MFJ-1782 Loop™ is a **\$269<sup>95</sup>**

professional quality remotely tuned 10-30 MHz high-Q antenna.

It's very quiet and has a very narrow bandwidth that reduces receiver overloading and out-of-band interference.

## High-Q Passive Preselector

**MFJ-956**  
**\$39<sup>95</sup>**

The MFJ-956 is a *high-Q* passive LC preselector that lets you boost your favorite stations while rejecting images, intermod and other phantom signals. Covers 1.5-30 MHz. Has preselector bypass and receiver grounded position. 2x3x4 in.

## Mobile Scanner Ant.

Cellular MFJ-1824BB/BM

look-a-like. Covers 25-1300 MHz. High - est gain on 406-512 and 108-174 MHz, 19 in. Magnet mount. MFJ-1824BB has BNC/UHF plug; MFJ-1824BM has Motorola plug.

**\$19<sup>95</sup>**

## MFJ Antenna Matcher

**MFJ-959B**  
**\$99<sup>95</sup>**

Matches your antenna to your receiver so you get maximum signal and minimum loss.

Preamp with gain control boosts weak stations 10 times. 20 dB attenuator prevents overload. Pushbuttons let you select 2 antennas and 2 receivers. Cover 1.6-30 MHz. 9x2x6 inches. Use 9-18 VDC or 110 VAC with MFJ-1312, \$129.95.

## High-Gain Preselector

**MFJ-1045C**  
**\$69<sup>95</sup>**

High-gain, high-Q receiver preselector covers 1.8-54 MHz. Boost weak signals 10 times with low noise dual gate MOSFET. Reject out-of-band signals and images with high-Q tuned circuits. Pushbuttons let you select 2 antennas and 2 receivers. Dual coax and phono connectors. Use 9-18VDC or 110 VAC with MFJ-1312, \$129.95.

## Dual Tunable Audio Filter

**MFJ-752C**  
**\$99<sup>95</sup>**

Two separately tunable filters let you peak desired signals and notch out interference at the same time. You can peak, notch, low or high pass signals to eliminate heterodynes and interference. Plugs between radio and speaker or phones. 10x2x6 in.

## Easy Up Antennas Book

How to build MFJ-38 and put up **\$16<sup>95</sup>**

inexpensive, fully tested wire antennas using readily available parts that'll bring signals in like you've never heard before.

Covers receiving antennas from 100 KHz to almost 1000 KHz. Includes antennas for long, medium and shortwave, utility, marine and VHF/UHF services.

**MFJ-107B**  
**\$9<sup>95</sup>**

**MFJ-108B**  
**\$19<sup>95</sup>**

**MFJ-105B**  
**\$19<sup>95</sup>**

MFJ-108B, dual clock displays 24 UTC and 12 hour local time *simultaneously*. MFJ-107B, single clock shows you 24 hour UTC time. *3 star rated* by *Passport to World Band Radio!*

MFJ-105B, accurate 24 hour UTC quartz wall clock with large 10 inch face.

## MFJ Antenna Switches

**MFJ-1704**  
**\$59<sup>95</sup>**

MFJ-1704 heavy duty antenna switch lets you select 4 antennas or ground them for static and lightning protection. Unused antennas automatically grounded. Replaceable lightning surge protection device. Good to 500 MHz. 60 dB isolation at 30 MHz.

## World Band Radio Kit

**MFJ-8100K**  
**\$59<sup>95</sup> kit**

**MFJ-8100W**  
**\$79<sup>95</sup> wired**

Build this *regenerative* shortwave receiver *kit* and listen to shortwave signals from all over the world with just a 10 foot wire antenna.

Has RF stage, vernier reduction drive, smooth regeneration, five bands.

## Free MFJ Catalog

Write or Call tollfree . . . 800-647-1800

Nearest Dealer/Orders: 800-647-1800

Technical Help: 800-647-TECH(8324)

• 1 year unconditional guarantee • 30 day money back guarantee (less s/h) on orders from MFJ • FREE catalog

MFJ ENTERPRISES, INC.

Box 494, Miss. State, MS 39762

(601) 323-5869; 8-4-30 CST, Mon.-Fri.

FAX: (601) 323-6551; Add s/h

Internet: <http://www.mfjenterprises.com>

MFJ . . . making quality affordable

Prices and specifications subject to change ©MFJ Enterprises, Inc.

# Pop'Comm's World Band Tuning Tips

July 1997

This listing is designed to help you hear more shortwave broadcasting stations. The list includes a variety of stations including international broadcasters beaming programs to North America, others to other parts of the world, as well as local and regional shortwave stations. Many of the transmissions listed here are not in English. Your ability to receive these stations will depend on time of day, time of year, your geographic location, highly variable propagation conditions and the receiving equipment used.

AA, FF, SS, GG, etc. are abbreviations for languages (Arabic, French, Spanish, German). Times given are in UTC, which is five hours ahead of EST, i.e. 0000 UT equals 7 p.m. EST, 6 p.m. CST, 4 p.m. PST.

UTC	Freq.	Station/Country	Notes	UTC	Freq.	Station/Country	Notes
0000	5890	Radio Vilnius, Lithuania via Germany	GG/EE	0230	6200	Radio Sweden	
0000	5930	Radio Prague, Czech Republic		0230	7160	Radio Tirana, Albania	
0000	9705	R. Mexico Int'l	SS	0243	7210	Qatar Broadcasting Service	AA, s/on
0030	4980	Ecos del Torbes, Venezuela	SS	0250	6095	Vatican Radio	
0030	7325	Austria Radio Int'l		0250	7200	Republic of Sudan Radio	AA
0030	9022	VOIRI, Iran	GG	0300	3220	Channel Africa, South Africa	
0030	9540	Radio Exterior Espana, Spain		0300	3396	Radio Three, Zimbabwe	
0100	4805	Radiodifusora Amazonas, Brazil	PP	0300	4875	Rdf. Roraima, Brazil	PP
0100	4919	Radio Quito, Ecuador	SS	0300	4955	Radio Nacional, Colombia	SS
0100	5030	Adventist World Radio, Costa Rica	SS	0300	4960	Voice of America relay, Sao Tome	
0100	5498	Radio Lajas, Peru	SS	0300	4976	Radio Uganda, Uganda	
0100	6010	RAI, Italy		0300	5009.5	Radio Malagasy, Madagascar	0259 s/on
0100	6135	Swiss Radio Int'l		0300	5025	Radio Rebelde, Cuba	SS
0100	6190	Radio Budapest, Hungary		0300	5055	RFO, French Guiana	FF
0100	6260	Voice of Greece	GG/EE	0300	9690	China Radio International, via Spain	
0100	7105	Radio Tashkent, Uzbekistan		0300	9700	Radio Bulgaria	
0100	7115	Radio Yugoslavia		0300	15270	Radio Pilipinas, Philippines	
0100	7180	Radio Ukraine		0330	4760	Trans World Radio, Swaziland	GG
0100	7345	R. Prague, Czech Republic	EE	0400	3270	Namibian Broadcasting Corp.	
0100	9545	Deutsche Welle, Germany		0400	3330	Christian Voice, Zambia	
0100	9650	Emisora Ciudad de Montevideo, Uruguay	SS	0400	4820	La Voz de Evangelica, Honduras	SS
0100	9745	HCJB, Ecuador		0400	4991	Radio Ancash, Peru	SS
0100	15167	Radio Tahiti	FF	0400	7300	Voice of Turkey	
0127	7250	All India Radio, Goa (India)	Nepali	0430	6165	Radio Netherlands via Bonaire	
0130	5960	Voice of Germany via Canada		0500	4850	CRTV, Cameroon	FF
0130	7290	Radio Sweden		0500	4904.5	Radiodiffusion National Tchadienne, Chad	FF
0200	3250	Radio Luz y Vida, Honduras	SS	0500	6105	Radio Universidad, Costa Rica	SS
0200	4418	Radio Bambamarca, Peru	SS	0500	6185	R. Educacion, Mexico	SS/EE
0200	4755	Radio Edu. Rural, Brazil	PP	0500	7255	Voice of Nigeria	
0200	4930	Radio Internacional, Honduras	SS	0500	7480	R. Bulgaria	
0200	5077	Caracol Colombia	SS	0500	9475	Kol Israel	
0200	5970	Radio Exterior Espana via Costa Rica	SS	0500	9485	Radio Bulgaria	EE
0200	6000	Radio Havana Cuba	EE	0500	9580	Africa No. One, Gabon	FF
0200	6025	Radio Amancer, Dominican Republic	SS	0530	4750	Voice of America relay, Sao Tome	FF
0200	6045	Deutsche Welle, Germany		0600	3290	GBC Radio, Guyana	SS
0200	6150	Adventist World Radio, Costa Rica	SS	0600	4815	RadioTV Burkina, Burkina Faso	FF
0200	9735	R. Nacional Paraguay	SS	0600	4870	ORTB, Benin	FF
0200	11780	Radio Nacional/Radiobras, Brazil		0600	4915	GBC, Ghana	
0230	6140	Radio Tirana, Albania		0600	6090	Caribbean Beacon, Anguilla	
				0600	7125	RTV Guineene, Guinea	FF



UTC	Freq.	Station/Country	Notes	UTC	Freq.	Station/Country	Notes
0600	7215	RTV Ivoireenne, Ivory Coast	FF	1330	13770	Radio Austria Int'l	
0600	9660	Vatican Radio		<b>1400</b>	9405	FEBC, Philippines	CC
<b>0630</b>	6015	R. Austria Int'l, via Canada		1400	13580	Radio Prague, Czech Republic	
<b>0700</b>	4783	Radio TV Malienne, Mali	FF	1400	13610	R. Vlaanderen Int'l, Belgium	
0700	5860	HCJB, Ecuador		1400	15160	Radio Algiers Int'l, Algeria	
0700	7155	RTV Malagasy	FF	1400	17560	Radio France Int'l, via Gabon	
0700	11730	Trans World Radio, South Africa		1400	17780	RAI, Italy	II
<b>0730</b>	9660	Radio Australia		1400	17830	Qatar Broadcasting Service	AA
<b>0800</b>	5980	Radio Guaruja, Brazil	PP	<b>1430</b>	9485	Radio Sweden	
0800	6070	Radio Japan-NHK World, via Fr. Guiana		1430	9535	Radio Japan NHK World	
0800	6100	R. New Zealand Int'l		1430	21515	Radio Portugal Int'l	
0800	9500	Trans World Radio, Swaziland	EE	<b>1500</b>	9785	China Radio Int's	
<b>0900</b>	6030	Radio Globo, Brazil	PP	1500	9835	All India Radio	Urdu
0900	6160	CKZU, Canada	PP	1500	9910	All India Radio	
0900	9505	Radio Record, Brazil	PP	1500	11580	Trans World Radio, Guam	
0900	9885	Swiss Radio Int'l	II	1500	11605	Kol Israel	
<b>0930</b>	4895	Radio Bare, Brazil	PP	1500	11890	Radio Oman	AA
<b>1000</b>	4780	Radio Oriental, Ecuador	SS	1500	13635	Swiss Radio Int'l	
1000	4790	Radio Atlantida, Peru	SS	1500	17545	Reshet Bet, Israel	Hebrew
1000	4996	Radio Andina, Peru	SS	<b>1600</b>	11750	Qatar Broadcasting Service	AA
1000	6030	Radio Vlaanderen Int'l, Belgium		1600	11900	Channel Africa, South Africa	Swahili
1000	6065	Colmundo, Colombia	SS	1600	15160	Radio Algiers Int'l, Algeria	
1000	6106	CKZN, Canada		1600	15240	Channel Africa, South Africa	
1000	6115	La Voz del Llano, Colombia	SS	1600	21560	Deutsche Welle, Germany	GG
1000	6155	Radio Fides, Bolivia	FF	<b>1630</b>	15395	UAE Radio, Dubai	EE
1000	21605	UAE Radio, Dubai		1630	21700	R. Japan NHK World, via Gabon	JJ
<b>1030</b>	5020	Solomon Islands Broadcasting Corp.	EE	<b>1800</b>	11850	Voice of the Great Homeland, Libya	AA
<b>1100</b>	3305	Radio Western, Papua New Guinea	Pidgin	1800	11975	VOA relay, Sao Tome	
1100	3340	Radio Altura, Peru	SS	1800	13780	All India Radio	
1100	4770	Radio Centinela del Sur, Ecuador	SS	1800	15265	Radiobras/Radio Nacional, Brazil	
1100	4890	NBC, Papua New Guinea	Pidgin	1800	15450	RTT Tunisia	AA
1100	6175	Faro del Caribe, Costa Rica	SS	<b>1830</b>	11645	Voice of Greece	
1100	7455	KSDA-Adventist World Radio, Guam	CC	1830	11705	Radio France International	FF
1100	9580	R. Australia		1830	11990	Radio Kuwait	
1100	9730	Voice of Vietnam		<b>1900</b>	9870	BSKSA, Saudi Arabia	AA
<b>1130</b>	3260	Radio Madang, Papua New Guinea	Pidgin	1900	15345	RAE, Argentina	
1130	6120	R. Japan via Canada		1900	17785	VOA via Morocco	
1130	9650	R. Korea, S. Korea, via Canada		<b>1930</b>	15505	Radio Kuwait	AA
1130	9700	Radio New Zealand Int'l		<b>2000</b>	11805	Radio Globo, Brazil	PP
<b>1200</b>	5975	Radio Tashkent, Uzbekistan		<b>2030</b>	7500	Radio Moldova Int'l, via Romania	
1200	9645	VOA relay, Thailand		2030	9525	Voice of Indonesia	
1200	9810	Radio Thailand		2030	11960	HCJB, Ecuador	
1200	13790	R. Bulgaria		2030	12085	Radio Damascus, Syria	
1200	13800	Radio Norway		2030	15476	R. Nac. Archangel San Gabriel, Antarctica	EE/SS
1200	15115	HCJB, Ecuador		<b>2100</b>	11915	Radio Gaucha, Brazil	PP
1200	15400	R. Finland Int'l	Finnish	2100	13725	Radio Havana Cuba	USB mode
<b>1230</b>	11615	Radio France Int'l		<b>2200</b>	9445	Voice of Turkey	TT/EE
1230	11735	Radio Finland Int'l		2200	9555	BSKSA, Saudi Arabia	AA
1230	12020	Voice of Vietnam		2200	9570	R. Portugal	PP
1230	12085	R. Ulaan Bataar, Mongolia		2200	17795	Radio Australia	
1230	15195	Radio France International		<b>2230</b>	5945	Radio Austria Int'l	
1230	15430	Voice of Russia via Moldova		2230	9855	Radio Kuwait	AA
<b>1300</b>	7145	Radio Thailand	various	<b>2245</b>	9600	Vatican Radio	
1300	7365	KNLS, Alaska		<b>2300</b>	7475	RTV Tunisienne, Tunisia	AA
1300	9440	Voice of Asia	unid	2300	9755	Radio Canada Int'l	
1300	9590	R. Norway	NN	2300	9900	Radio Cairo, Egypt	
1300	9985	KHBN, Palau		2300	11700	Radio Pyongyang, North Korea	
1300	11815	Polish Radio		2300	11795	UAE Radio, Dubai	AA
1300	15445	FEBA, Seychelles	unid	2300	9275USB	Iceland National Broadcasting	Icelandic
1300	15605	Radio Norway Int'l	NN/EE	<b>2330</b>	7105	Radio Romania Int'l	
1300	17745	R. Romania Int'l		<b>2355</b>	9925	R. Vlaanderen Int'l, Belgium	GG
<b>1320</b>	21520	RAI, Italy	s/on; Sun.				
<b>1330</b>	11650	R. Sweden					
1330	13675	UAE Radio, Dubai					

# Product Parade

BY NANCY BARRY  
AND R.L. SLATTERY

REVIEW OF NEW, INTERESTING AND USEFUL PRODUCTS

## New Compact Dual-Band Handheld

ICOM has introduced an ultra-slim, dual-band handheld. The IC-W32A offers a total of 200 memories that may be displayed by either frequency or alpha name. Up to eight alphanumeric characters can be programmed for quick and easy identification on the LCD. Each band has 100 memory channels and four DTMF memories have up to 16-digit capability. The IC-W32A's memory management allows you to transfer memory contents to either VFO or to other memories while an EEPROM prevents memory loss if the battery runs low.

The ICOM IC-W32A can receive both VHF and UHF bands simultaneously with both frequencies displayed or you can use the V/V and U/U functions to receive two frequencies on the same

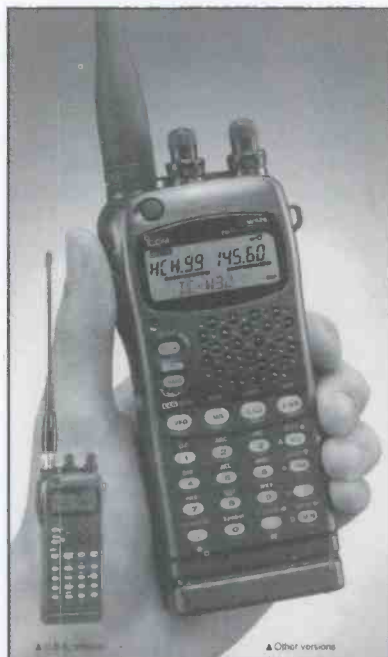

band. You can transmit on either operating band. The unit has separate tuning and volume controls for each band on the top panel to allow independent adjustment of each band and the VHF/UHF exchange function allows you to assign VHF/UHF tuning and volume to either knob. Frequency coverage is 144-148 MHz and 440-450 MHz transmit, and 118-174 MHz and 400-470 MHz receive.

For further information, contact your local amateur radio dealer or ICOM America, Inc., 2380-116th Avenue N.E., Bellevue, WA 98004; or phone them at 206-454-8155.

## Pocket Size Morse Code Tutor from MFJ

MFJ is now offering the MFJ-418 pocket size Morse Code Tutor™ with custom character sets, beginner's course

DEDICATED TO THE SCANNING AND SHORTWAVE ENTHUSIAST. WE'RE MORE THAN JUST SOFTWARE!

## COPYCAT-PRO

The ONLY Commercially Available Computer Control Program for the Universal M-7000 & M-8000.

Also, AEA's PK-232 and the MFJ-1278.

### COPYCAT-PRO FEATURES

- 32K incoming text buffer.
- Pull down menus.
- Mouse support (but not required).
- Runs on any 640K PC-Compatible.
- New improved online help.
- Control BOTH your TNC and radio simultaneously!
- Multiple pop-up windows for HELP, frequency files, and text editor.
- Supports ALL SCANCAT files.
- Easier, "Plain English" MACRO language for control of all radio and TNC functions.
- Supports most radios. Call for info!

Discover our revolutionary COMPUTER CONTROL PROGRAM for the M-7000, M-8000, PK-232, and MFJ-1278. Let COPYCAT-PRO free you FOREVER from remembering all those buttons and keys. COPYCAT-PRO does it all! Simple "PULL-DOWN" menus control all functions. ALL commands are in plain English "PLUS" COPYCAT-PRO has a fully editable text buffer, with cut & paste, 20 PROGRAMMABLE macros and much more. COPYCAT-PRO supports ALL of the above units within ONE program.

**COPYCAT-PRO \$79.95, UPGRADES \$24.95**

S/H \$5.00 (\$7.50 Foreign)

Specially wired cable for the M-7000/8000 \$24.95

## CAT-WHISKER

TIRED OF YOUR HANDHELD SCANNER ALWAYS FALLING OVER JUST TO KEEP THE ANTENNA "VERTICAL"?



Try our unique, swivel base, telescopic scanner antenna. Our new CAT-WHISKER lets you lay your handheld scanner on its back and still keep the antenna vertical!

- Swivels to ANY angle.
- Easily adjusts to any length AND frequency.
- Fits ANY scanner with a BNC antenna connector.
- Fits on BACK or TOP mount scanner antennas inputs.

CAT-WHISKER #1 (5 to 23 inches) **\$19.95**

CAT-WHISKER #2 (6 to 36 inches) **\$24.95**

(plus \$2.50 S & H)

## HOKA CODE-3 USA Version

"The Standard Against Which All Future Decoders Will Be Compared"

Many radio amateurs and SWLs are puzzled! Just what are all those strange signals you can hear but not identify on the Short Wave Bands? A few of them such as CW, RTTY, Packet and Amort you'll know - but what about the many other signals?

There are some well known CW/RTTY Decoders but then there is CODE-3. It's up to you to make the choice, but it will be easy once you see CODE-3. CODE-3 has an exclusive auto-classification module that tells YOU what you're listening to AND automatically sets you up to start decoding. No other decoder can do this on ALL the modes listed below - and most more expensive decoders have no means of identifying ANY received signals! Why spend more money for other decoders with FEWER features? CODE-3 works on any IBM-compatible computer with MS-DOS with at least 640kb of RAM, and a CGA monitor. CODE-3 includes software, a complete audio to digital FSK converter with built-in 115V ac power supply, and a RS-232 cable, ready to use. CODE-3 is the most sophisticated decoder available for ANY amount of money.

26 Modes included in STANDARD package include:

- Morse \*
- RTTY/Baudot/Murray \*
- Sitor CCIR 625/476-4
- ARQ - Navtex \*
- AX25 Packet \*
- Facsimile all RPM (up to 16 gray shades at 1024 x 768 pixels) \*
- Autospec - Mk's I and II
- DUP-ARQ Artrac
- Twinplex
- All modes in typical baud rates with possibility of changing to any desired value of speed and shift.
- User can save incoming data to disk in either ASCII or raw bit form.
- ASCII \*
- ARQ6-90/98
- SI-ARQ/ARQ-S
- SWED-ARQ-ARQ-SWE
- ARQ-E/ARQ1000 Duplex
- ARQ-N-ARQ1000 Duplex Variant
- ARQ-E3-CCIR519 Variant
- POL-ARQ 100 Baud Duplex ARQ
- TDM242/ARQ-M2/4-242
- TDM342/ARQ-M2/4
- FEC-S • FEC100A/FEC101
- FEC-S • FEC1000 Simplex
- Sports info 300 baud ASCII
- Hellsreiber-Synch/Asynch \*
- Sitor • RAW (Normal Sitor but without Synch.
- ARQ6-70
- Baudot F788N
- Pactor \*
- WEFAX \*
- Piccolo .....
- Coquelet .....
- 4 special ARQ & FEC systems: TORG-10/11, ROU-FEC/ RUM-FEC, HC-ARQ (ICRC) and HNG-FEC .....
- SYNOP decoder .....

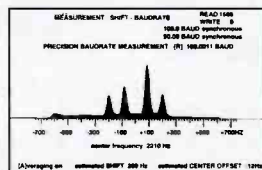

Simulated Speed Measurement Module

### EXTRA OPTIONS

- REG. PRICE
- Piccolo .....
- Coquelet .....
- 4 special ARQ & FEC systems: TORG-10/11, ROU-FEC/ RUM-FEC, HC-ARQ (ICRC) and HNG-FEC .....
- SYNOP decoder .....

### STANDARD CODE-3 DECODER

\$595.00 + S & H

Includes: ALL Modes, Plus Oscilloscope\*, ASCII Storage, Auto Classify\*, and PACTOR\* Options

with ALL EXTRA OPTIONS \$795.00 + S & H

### CODE 3 - GOLD VHF/SW DECODER

\$425.00 + S & H

Includes POCSAG & ACARS Plus \* Modes/Options

with ALL EXTRA MODES/OPTIONS \$595.00 + S & H

ALSO AVAILABLE - HOKA CODE-30 DSP-based Professional Decoder - CALL FOR PRICE

INTERNET WEB ADDRESS - <http://www.scancat.com> WEB E-MAIL - [scancat@scancat.com](mailto:scancat@scancat.com)

(S & H \$10 US, \$15 Foreign)

Order direct or contact your favorite dealer

COMPUTER AIDED TECHNOLOGIES

P.O. Box 18285 Shreveport, LA 71138

Phone: (318) 687-4444 FAX: (318) 686-0449

Live Tech Support (318) 687-2555 (9 am - 1 pm Central M-F)

FREE DEMOS ON THE WEB

Orders Only  
**888-SCANCAT**  
888-722-6228



For more information, contact MFJ Enterprises, Inc., 300 Industrial Park Road, Mississippi State, MS 39762; phone 601-323-5869; fax 601-323-6551; Visit their Web site at <<http://mjfenterprises.com>> or order toll-free by calling 1-800-647-1800.

### New Add-On ADSP Unit from SGC

based on the ARRL method and Word Recognition Mode™. The new Morse Code Tutor allows users to learn Morse code anywhere.

MFJ's Word Recognition Mode gives you hundreds of commonly used words in amateur radio allowing you to learn whole word recognition instead of individual letters.

The MFJ-418 allows you to select letter, number, punctuation, prosign or code test sets, random call signs, random words, QSOs, combination sets or to make up your own practice sessions. The Interactive Mode™ lets you decide when to copy the next or previous group and how many. You can select normal or Farnsworth spacing. Farnsworth character speed is adjustable 10 to 60 words per minute. You can also use fixed length or more realistic random length groups.

The new PowerClear add-on ADSP unit from SGC Inc. utilizes the same DSP technology found in the SG-2000 Power-Talk control head. This add-on unit can be used with any non-DSP transceiver (HF or VHF/UHF) or other audio device to improve audio quality and noise and interference reduction.

Two input jacks are provided for both low-impedance (8 or 16Ω) and high-impedance (600Ω) audio. This means audio from a variety of sources (e.g., transceiver, telephone, scanner, cassette tape recorder) can benefit from ADSP enhancement. High and low impedance jacks are provided for ADSP-enhanced audio as well. Inserting a plug into the rear-panel speaker jack disables the internal speaker, and a PTT connection mutes audio during transmit when used with transceivers.

The PowerClear offers operator-controlled tailoring of the low-, center-, and high-cut audio filters. Push-buttons activate the notch filter as well as noise reduction and SNS (Spectral Noise Subtraction). An internal audio amplifier (approx. 5W) with front-panel volume control allows room-filled audio even when driven from line-level sources. The unit measures approximately 3.75 x 605 inches and contains a built-in speaker, red and green LEDs that provide a precise visual tuning field for high, mid and low frequency corners; and preset and user-programmable memories that allow quick recall of ADSP, SNS, and high, center, and low notch filter settings.

For more information, contact your local SGC dealer, or call SGC directly at 1-800-259-7331, for the name of a dealer near you.



**DEDICATED TO THE SCANNING AND SHORTWAVE ENTHUSIAST. WE'RE MORE THAN JUST SOFTWARE!**

## INTRODUCING... SCANCAT GOLD for Windows

Since 1989, The Recognized Leader in Computer Control

Once you use SCANCAT with YOUR radio, you'll NEVER use your radio again WITHOUT SCANCAT!

SCANCAT supports almost ALL computer controlled radios by: AOR, DRAKE, KENWOOD, ICOM, YAESU and JRC (NRD) Plus PRO-2005/6/35/42 (with OS456/535), Lowe HF-150, and Watkins-Johnson.

### SCANCAT'S BASIC FEATURES

- Search between any 2 frequencies.
- Search by ANY increment.
- Create Disk files.
- Import from most text formats to a working SCANCAT file.
- Unattended Logging of frequencies to files while scanning.
- Scan Disk Files.
- Spectrum Analysis to Screen OR Printer.
- Supports PerCon & Mr. Scanner CD Roms.

### PLUS

- LINK up to 15 Disk files.
- Scan VHF & HF Icom's Simultaneously.
- Print to ANY printer or Disk files.
- MULTIPLE search filters for Diskfile Scanning.
- Search by CTCSS & DCS tones with OS456/535 or DC440 (ICOM only).
- INCLUDES several large shortwave and VHF/UHF databases

### POWERFUL COMMERCIAL FEATURES SUCH AS:

- Demographic search for frequency co-ordination and 2-way Usage Analysis.
- Detailed logging to ASCII type files with DATE, TIME, Sig Str, Air Time.
- UNLIMITED file sizes with our exclusive SCANCAT filing method.
- Exclusive "MACRO" control by frequency of Dwell, Hang, Resume, Sig. Threshold and even 6 separate programmable, audible alarms.
- Command line options for TIMED ON/OFF (Unattended) logging/searches.

SCANCAT IS NOT COPY PROTECTED — USE ON AS MANY COMPUTERS AS YOU NEED • SCANCAT (DOS) will run on virtually ANY 640K computer, EVEN HP-100XLT PALMTOP!

### EXCLUSIVE WINDOWS FEATURES

All the features you EXPECT from a true Windows application such as:

- NO MORE CONVERSION! DIRECT scanning of most DBASE, FOXPRO, ACCESS, BTRIEVE files WITHOUT "importing" Our Exclusive "AUTO-PLAN" even sets the mode and increment on the fly!
- UNIQUE database management system with moveable columns. Even SPLIT columns into doubles or triples for easy viewing of ALL important data on one screen.
- VERSATILE "Functional" spectrum analysis. NOT just a "pretty face" Spectrum is held in memory for long term accumulation. Simply "mouse over" to read frequency of spectrum location. "CLICK" to immediately tune your receiver. You can even accumulate a spectrum from scanning DISKFILES of random frequencies!
- Exclusive "SLIDE RULE" tuner. Click or "skate" your mouse over our Slide-Tuner to change frequencies effortlessly! OR use our graphical tuning knob.
- INTERACTIVELY have database, MAPS or Scanning functions on screen simultaneously.
- MAPS - Load virtually ANY map or GRAPHIC Image In "BMP" format (several included with Scancat). Program "hot spots" with your favorite frequencies. Up to 1000 frequencies per map. Click on Hotspot to immediately tune your receiver.
- A Complete Modern/Terminal with support for most current modems. Full X-Y-Zmodem download upload support up to 28.800.

SCANCAT GOLD FOR DOS.....\$94.95 + s & h\* SCANCAT GOLD FOR WINDOWS.....\$99.95 + s & h\* UPGRADE from any version.....\$29.95 + s & h\* \*\$5 U.S. \$7.50 FOREIGN

### MAGIC for Windows

PUT SOME ORDER IN YOUR LIFE!

MAGIC takes any ASCII text file from virtually any source, and any format, and creates "frequency files" or ordered lists.

- Corrects Inconsistent column alignment
- Looks for single or multiple frequencies embedded in ASCII text.
- Print to file or printer.
- Reads or writes to: SCANCAT, plain text, comma delimited, and dBase.

MAGIC for Windows \$34.95 (plus \$5.00 S & H)

### "UNI-VERSATILE" INTERFACE

- Supports ICOM, AR8000/2700, YAESU and SCOUT-40.
- Comes with 6 FOOT cable, and adapters to fit all units within a single package (Must Specify Yaesu)
- Unlike "single radio" adapters, can be used with ANY radio supported, simply change the adapter, then "Plug and Play."
- Expandable in future with a simple add on adapter.
- No external power required. Draws power from computer.
- "Reaction Tune" scout with NO modifications to radio.

CAT-232C "UNIVERSAL INTERFACE".....\$99.95 + s & h



NOW IN STOCK

INTERNET WEB ADDRESS - <http://www.scancat.com> WEB E-MAIL - [scancat@scancat.com](mailto:scancat@scancat.com) DEALER INQUIRIES INVITED

Order direct or contact your favorite dealer

COMPUTER AIDED TECHNOLOGIES

P. O. Box 18285 Shreveport, LA 71138

Phone: (318) 687-4444 FAX: (318) 686-0449

Live Tech Support (318) 687-2555 (9 am - 1 pm Central M-F)

FREE DEMOS ON THE WEB

Orders Only

888-SCANCAT  
888-722-6228

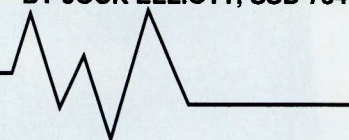

## Freebanding Stirs the Pot!

You folks sure know how to make a fella feel at home. Last time we had a chance to visit, we ran out of time and space before I could get around to addressing some of the mail you have sent since I started writing for *Pop'Comm*. I sincerely appreciate your questions, comments, suggestions and especially the words of encouragement. While I have already replied to each of you individually, I would like to share a few them with the rest of you.

### Brave Vs Stupid

It appears that our two-part article on the Freeband (February and March) really got people talking and typing. At least it did for "Lil Mac" <lilmac@mail.tcbi.com> and the CBers in his area. "We think it is great," says Lil Mac, "that you had the guts to write about such a controversial subject. Most magazines try to stroll around it."

Well, Mac, there is a thin line between bravery and stupidity. I am glad you saw it as the former. The goal was to be honest and informative. Judging by your note and others, we hit the mark with that one. I'll do my best to do so in the future. Please hold me to it! I, however, can't claim all the credit. Much, if not most, of it belongs to editor Harold Ort and the *Pop'Comm* staff! Without them the article would have never made it into print.

### CQ, CQ

Judging by all the mail I receive and personal experience, it seems that the biggest problem keeping most people from enjoying our hobby remains: Finding someone to talk to! That seems like a strange statement, especially when you consider that the hobby of radio is basically a one of communications! But it is true. All too often it is difficult or nearly impossible to strike up a conversation. So, if you find yourself with a radio and a little free time, don't feel alone even if you find yourself alone!

It doesn't matter what branch of the hobby you pursue. "Rebel," from the

# RADIO AMERICA

305 IRISH STREET BRADY, TEXAS 76825

"WORLD CLASS RADIO"



From Station:

Name	Call
Address	
City	State
Country	ZIP

USA

Pse QSL Tnx

CONFIRMING STATION	DATE			UTC	MHZ	R S T	MODE 2-WAY
	DAY	MONTH	YEAR				

Washington/Baltimore area admits, "I really don't know how to initiate something with a callout on Ch. 19 while mobile, keeping in mind a prolonged chat there would not go over very well." He asks for guidance. Steve Horowitz <horowitz@mail.idt.net>, a sideband operator from Broward County, Florida is also looking for on-air contacts. Do you have any tips or suggestions? If so, please send them in and I'll pass them along in future columns.

### Q-Codes

I was glad to hear from a number of SSB operators who were at least hearing, if not participating in, conversations. Several had questions about the Q-Codes. Q-Codes are three letter codes, most beginning with the letter Q, that early amateur radio operators developed as a kind of shorthand to help speed their "CW" or Morse code communications. A few of these codes have found their way into SSB. On SSB, plain English is preferred, although in some instances an occasional Q-Code may be helpful. But, they should be used sparingly.

Bill Smith, SSB-123Z <smitty@shol.com> has set up a home page on the World Wide Web <<http://www.shol.com/>

smitty> which is dedicated to SSB operation. In addition to having links to a number of useful sites, Bill's page offers a list of the most popular SSB Q-codes:

- QRM: Man made interference (from other stations on frequency)
- QRN: Ignition noise, static, powerline noise
- QRT: Shutting down the station and NOT listening or replying
- QRX: Leaving the air briefly (QRX-1: Back in 1 minute)
- QRZ: Who is calling me? I missed your ID. Please repeat.
- QSX: Standing by for any calls
- QTH: Location
- CQ: Request for reply from any station

To these I would add two more. QSL: Written acknowledgment, usually a post or QSL card and the ever popular QRX alternative—QPP (nature call). For a complete list of Q-Codes and more, visit <<http://www.arrl.org/field/forms/fsd218.html>> at the ARRL's Web site.

### Shopping Around

Of course I have received inquiries from folks looking for guidance on where to buy radios and related equipment. Both

*"He and several others, are seeking advice on just how to 'encourage' some of their local problems to find that 'other hobby'."*

from amateurs looking for CB and from CBers looking for amateur gear.

To amateurs looking to expand into CB I say go for it. You'll have a good time, and both branches of the hobby will benefit. CB needs more good operators to serve as examples and role models. Your time on CB could also help the amateur service lose its "snobbish old codger" image, not to mention inspiring folks to pursue their license!

As for the CBers looking for "exotic" equipment (translate foot warmers and out-of-band radios), I have mixed emotions. Everything they are looking for is probably as close as their nearest truck stop. Certainly anyone with access to the Internet can find all they want by following a few links on some of the CB/SSB home pages. I, however, refuse to be of assistance. Yes, I know many operators who use this type of equipment. Some of them you would never suspect, just by listening to them. These fine operators really know how to use a radio. Others, of course, are "Royal Pains." With them, the extra capabilities only amplify the problem. We would all be better off if they could be persuaded to find another hobby.

### Let's Party

Obviously, quite a few of you know the kind of jerks I'm talking about. Chuck Stinson <crwchuck@shianet.org>, president of Community Radio Watch of



4091 Viscount Street  
 Memphis, TN 38118  
 (901) 794-9494  
 Fax: (901) 366-5736

ANTENNAS • POWER SUPPLIES • CABLE ASSEMBLIES

HIGH PERFORMANCE and MADE IN U.S.A.

ALL MACO BASE STATION ANTENNAS are made of aircraft alloy 6063-T5 aluminum tubing—.050 wall. Elements are made of harder 6005 alloy.  
 NOTE! To prevent fatigue failure, no holes are made in any boom or element.

MACO  
V-Quad  
Beam

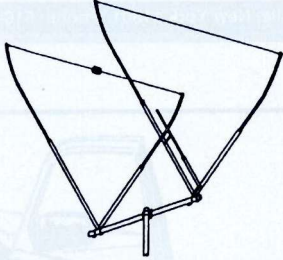

V-Quad  
Specifications:

Boom Length .....	6'
Boom OD .....	1.5"
Number Elements .....	2
Longest Element .....	12'
Turn Radius .....	7'
Surface	
Area .....	3.2 (sq. ft.)
Wind Survival .....	90 mph
Tuning (MHz) .....	26.5-30
Gain .....	11 dB
VSWR .....	1.1-1 or less
Power Multiplication ..	14X
Front-to-Back	
Separation .....	25 dB
Weight .....	8 lbs.
Stacking Kit .....	VQSK

PERFORMANCE EQUAL TO M103C IN A SMALL PACKAGE FOR PUSHUP MOUNTING

Directional-Combined Vertical-horizontal polarization plus high gain of 11dB (14 dB stacked) makes the V-Quad an ideal inexpensive beam for push-up mounting (stacks, too).  
 Weighs only 8 lbs. (stacked complete 24 lbs.)

Call or write for free catalog and name of reseller near you.

CIRCLE 71 ON READER SERVICE CARD

Shiawassee County (state unknown) certainly does. He and several others, are seeking advice on just how to "encourage" some of their local problems to find that "other hobby".

Well, Chuck, as you are well aware, there are no easy, or for that matter quick, answers. The situation, however, is not hopeless! While it would take several articles the size of this one to even begin exploring the possibilities, here are a few brief insights I hope you will find useful.

Perhaps the most direct method is the traditional "antenna party". You know the type? A small group of dedicated operators arrive at the loudmouth's station in the wee small hours. Next, with no small amount of stealth and daring, a sturdy cable or rope is firmly affixed between your intended's coax and the bumper or trailer hitch of a waiting vehicle. Sufficient slack is left in the line to ensure a good running start. Then, once all are well clear of the cable, a short (500-1000 feet), quick (45-60 mph), drive down the road is usually sufficient to free the coax from the radio. That is unless the station has soldered, rather the crimped, connectors. In which case you could wind up with not only an antenna and coax, but a radio and several accessories as well! In rare cases, due to the shock induced by the sound of squealing tires, the whistle of coax in motion and the sudden and unexpected movement of equipment, some operators have been unable (or unwilling) to let go of the mic. It is this trip through the hole in the wall, originally designed to accommodate the coax, that accounts for some of the very tall and thin people seen at coffee breaks.

Despite the effectiveness, not to mention instant gratification, this method

# WINDRIVER MODULATORS



LANDER, WYOMING

Int.
C.B.
Club.

Tune In  
With...

**CQ VHF**

Ham Radio  
Above 50 MHz

The NEW magazine for all ham radio operators who are active or interested in operating on the bands above 50 MHz!

In every issue you'll find: Operating articles, Technical articles, Beginner's articles, Product reviews, Projects you can build, News and columns and New things to try. All year long, each issue of **CQ VHF** guarantees to show you **WHAT, WHY** and **HOW** to do more above 50 MHz.

If mailing in subscription order, please enclose check or credit card information with expiration date (MasterCard, Visa, Amex and Discover accepted).

US—1-year \$21.95, 2-years \$39.95,  
Can/Mexico—1-year \$31.95, 2-years \$59.95,  
Foreign Air Post—1-year \$39.95, 2-years \$74.95.

CQ VHF, 76 North Broadway, Hicksville, New York 11801 Phone: 516-681-2922 FAX:516-681-2926



## When seconds count, **REACT**® needs you...

...to summon help for an injured motorists, an elderly woman trapped in a fire, a trucker stranded in a blizzard, a drowning child!

As a REACT volunteer CB radio monitor you may be the only communications life-line for someone in serious trouble. You relay messages from those desperate for help to police or other emergency services.

Your REACT Team will also use CB and other radio services to provide safety communications for events like parades, marathons and even balloon races. The fellowship with other REACT members at Team meetings and annual conventions is an added bonus.

Volunteer. Join Today!

**Add a New, Exciting  
Challenge to Your Life.  
Help Save Lives  
and Property!**

**REACT**® International, Inc.

Tel (316) 263-2100

FAX (316) 263-2118

P.O. Box 998, Wichita, KS 67201



*"It is this trip through the hole in the wall, originally designed to accommodate the coax, that accounts for some of the very tall and thin people seen at coffee breaks."*

affords, I can, of course, for a number of reasons, in no way recommend or endorse it. First, think how you would feel if you picked the wrong house. Second, your team's insurance may not cover this type of activity (better check the policy first). Third, I'll bet it is illegal.

What I would recommend is that you *locate, document and positively identify* the offending operators. Then have someone contact them. Keep the tone of the visit friendly and helpful. Sometimes, the mere fact that their anonymity is no longer ensured is enough to minimize or even eliminate the problem. You may find that they are unaware of the problem. Perhaps they are aware of the problem but don't know how to cure it. I am currently corresponding with just such an operator. He is running legal equipment, has installed filters, had the phone company in and is still interfering with some of his neighbor's electronics. Both he and I would welcome suggestions!

Check with your state and local government. They may have laws governing interference to communications or electronic entertainment equipment. If there are any threats of physical harm or damage being aired, then it's possible the regular criminal codes may apply. Find out who owns the property where the station is located, then let the owner know that they could be sued. This is especially true when there is interference to emergency public safety communications.

Finally, the FCC is still in the enforcement business. True, their actions are rare, but they do happen. Once you have located, identified and documented the offending operator, you have a much better chance of enticing the Commission to take the case. You can further increase the possibilities by appealing to your Congressman, Senator, the President or, as in one recent case, the First Lady!

Well, that's it for this month. I look forward to hearing from you. Please send your comments, questions and suggestions to me in care of the magazine. I can also be reached on the internet where my address is <edbarnat@global2000.net> (note new e-mail address). Better yet, if you can, catch me on the radio. ■

73—Ed.

CIRCLE 86 ON READER SERVICE CARD

# The Old CB Shack

BY DON PATRICK

GIVING LIFE TO YESTERDAY'S RELICS

## Working on Old Transistorized Cadre CBs

Sometimes change isn't always better, but is mainly a change for novelty sake or to achieve a very important single goal at the expense of other features. This was the case with the first transistorized CB radios.

The only need to utilize transistors in 1961 and '62 CB radios was in portable (walkie-talkie) units that could be operated with a dry-cell battery pack. Keep in mind that these were the days of carbon-zinc dry cell batteries; the rabbit didn't go nearly as far as today's alkalines, so battery drain on a walkie had to be low! The fact that the first walkies were very poor performers, bulky, unreliable and had few features was not really important. At least a walkie was available if you had a need for one. Back then, there was a small need for a few walkies.

But with the Genie out of the bottle, someone just had to make a transistorized CB mobile or base unit. The fact that the radio would only be marginally smaller than a tube unit was immaterial, and the fact that it had lower power output on transmit, poorer receive, lower reliability, and cost more than many good tube units was offset by the feeling of having a "state-of-the-art" radio. You see the same thing today, in many cases, with computers. The fact that the one you have now will do everything that you need to do, as fast as you need to do it, is offset by the fact that the new model will do things even faster. So you trade in your present unit thinking you're gaining performance. But the first transistorized CBs had *lower* performance. The early transistors were crude, large and slow in performance by most any standard today and the circuits were also poor. The first engineers simply tried to replace a tube with a transistor instead of re-designing the circuits in order to make use of all the devices good points and getting around the weak areas. However, like all new technology, the design engineers soon began to bring transistors into their own with new circuits. At the same time, the transistors were being improved quickly. Each month saw the introduction of new

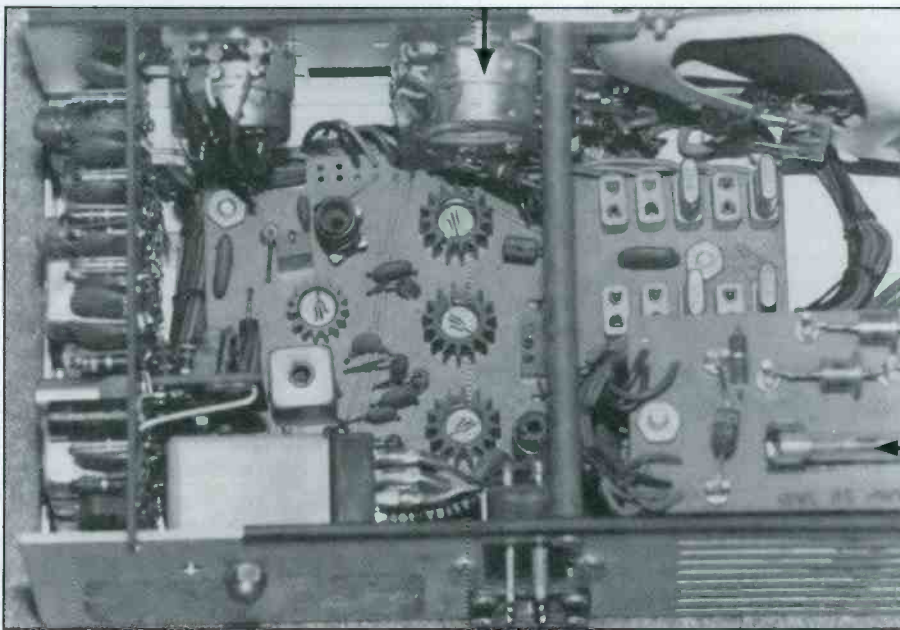

Note the 117 volt fuse at the right of the old Cadre CB and the three finals near the top of the photo.

types that were faster, smaller and able to handle more power and operate efficiently at higher frequencies.

### The First Transistorized CBs

The first pretty good transistorized CB radio to hit the market was the Cadre model 510 made in Endicott, New York in 1962. It was a five-channel, crystal-controlled transmitter and receiver along with a tunable 23-channel receive capability. It would operate as a base with its built-in 117 volt power supply, as a mobile on 12 Vdc or as a portable with a Model 500-1 battery pack/carrying case with built-in antenna and charging circuit. It was bulky *but* it was portable.

First let's consider the transmitter portion of the CB. It was a three-stage (OSC, driver, finals) design using three transistors in parallel for the final amplifier stage. It was necessary to use three transistors to get five watts because an affordable single transistor that would handle the heat generated was not available. These three transistors operated real

close to their limits, and any appreciable VSWR would cause their destruction. This was before the days of automatic excessive VSWR shutdown circuits that would have protected them.

With good voltage input (13.8–14.4 Vdc), the radio would develop its full 5 watts input power (FCC limit) and after efficiency factors and coupling losses, you had 2 1/2 to 3 1/2 watts at the antenna connector. The Cadre had a good audio/modulator design, but the engineers had to use speech clipping starting at 80 percent modulation which reduced your range. The clipping was necessary for two reasons: a non-linearity problem in the transistor itself, and the difference between one of the finals compared to either of the other two. Manufacturers could not hold tolerances as close as they are able to now. Without the speech clipping at 80 percent modulation (positive or negative), one of the three transistors would be driven outside of its operating envelope and cause distortion. Extreme overdriving could even result in wild swings in power and generate harmonics.

## RAILROAD RADIO GUIDE

### HEAR AND UNDERSTAND RAILROAD RADIO COMMUNICATIONS & SYSTEMS

**Railroad Radio** by Vincent Reh is the definitive guide to hearing and understanding railroad radio communications and systems. In 208 illustrated, perfectbound pages, you get all the information you need to monitor railroad radio *and* understand what you hear.

You'll learn about railroad radio history, railway operations, modern radio systems, system use, and the future of railcomms. Plus, you get numerous hints and tricks to maximize scanner performance.

**Don't miss any of the action!** Order your copy from your favorite dealer or direct from the publisher today. Send \$19.95 plus 3.50 shipping (7.50 outside N.A.) in USD to Byron Hill Publishing Co., PO Box 197L, Grand Isle, Vt. 05458. (802) 893-1315 e-mail rehvince@together.net

**VISA/MASTERCARD ACCEPTED**

CIRCLE 64 ON READER SERVICE CARD

## YOU AIN'T HEARD NOTHIN'...YET

Since 1967, CRB Research has been the world's leading publisher and supplier of unique hobby and professional books and information including:

- Scanner Freq. Guides
- Military/ Federal Comm.
- Broadcast Station Registries
- Undercover Communications
- Shortwave Freq. Guides
- & Other Related Topics!



Ask for our latest FREE catalog.

CRB RESEARCH  
P.O. Box 56, Commack, NY 11725  
Ph: (516) 543-9169 FAX: (516) 543-7486  
e-mail: crbbooks@aol.com

CIRCLE 11 ON READER SERVICE CARD

## RadiMax Windows Scanning

SERIOUS RADIO & SCANNER CONTROL Win 3.1 / 95

Powerful, high speed scanning with more features! High res. graphics let you see what's happening in real time. Search, sort, scan, log, tape by frequency, comments, hit times, rudes etc. PC can even speak the frequency and hit time! PerCom file support. Intelligent tape control and delays. Download free demo at [www.futuresscanning.com](http://www.futuresscanning.com) or call

**RadiMax (includes 60 page manual) \$79.90 + \$6 S/H**  
CI-V interface with Squelch Detect and Tape Control \$89.90 + S/H  
VISA FUTURE SCANNING SYSTEMS M-C  
6105 SE Nowata Road Unit 6, Bartlesville, OK 74006  
TEL 918-335-3318 FAX 918-335-3328

## Scanner Buffs

We've Got The Goods!

We have a great selection

of full-coverage scanners including AOR, Radio Shack, and Yupiteru. We also carry scanner interfaces for the ultimate scanning experience!

- 1000 channels (20 banks of 50 channels)
- full coverage from 500KHz-1.9GHz AM-WFM-NFM-U/L/SB-CW
- scans a maximum of 30 channels/sec
- comes with rubber duck ant, nicads, charger, lighter plug, more.

AOR  
AR8000



Send \$3.00 for our new 68 page catalog

Durham Radio Sales & Service, Inc.  
350 Wentworth St. E., Oshawa, Ont. L1H 7R7  
Ph: (905)436-2100 Fax: 436-3231

Web: <http://www.durhamradio.ca> e-mail: [info@durhamradio.ca](mailto:info@durhamradio.ca)

CIRCLE 82 ON READER SERVICE CARD

## PATENTS

PATENT AND TRADEMARK APPLICATIONS  
PATENT SEARCHES • LITIGATION  
LEGAL ADVICE ON INVENTIONS AND IDEAS

**1-800-333-IDEA**

STEPHEN D. CARVER (K5PT)  
SUITE 800 P.V.C.C. WWW.ARKPATENT.COM  
2024 ARKANSAS VALLEY DR. FAX: (501) 224-8831  
LITTLE ROCK, AR. 72212-4139

CIRCLE 83 ON READER SERVICE CARD



If your Cadre is a 510A it will have a tunable receive knob located here.

The receiver design was pretty good. It had dual conversion to reduce image signal interference, and three low IF amplifiers stages to reduce adjacent channel interference (bleed-over). Its sensitivity was good. The receiver had two weak points. First, a real strong signal (like another car or base within a few hundred feet) on the same channel would overdrive the receiver to the point of distortion or even to where no audio was developed. It would be like someone keying a microphone and not saying anything. This wasn't a serious problem and could be avoided by having your friend in the other car stay a quarter-mile behind you.

The second problem was serious. Cars in the 1960's and early '70s radiated a lot more ignition noise than cars of today. This is due to today's wide use of radio suppressive ignition (spark plug) wire and better bonding, grounding and design. The Cadre, with its poor automatic

noise limiter circuit, gave the mobile CBER lots of unwanted noise—not only from your own vehicle, but from others around you.

Considering the limitations of the early transistors, coupled with a few design weaknesses, the Cadre 510 was the first serviceable all-transistor CB we came across. As long as you had a good antenna with low VSWR, avoided real strong signals and suppressed your car's ignition noise, it gave reasonable service. As you can see from the picture, it was not a small unit by today's standards (11 3/8" x 5 3/8" x 3 1/8"), but it was smaller than a tube unit.

Restoration of a Cadre 510 should only present a couple of problems because of the lack of a few parts that have been out of manufacture for quite some time. Most parts have standard replacements, but you might run into a problem with the modulation transformer and the transmitter

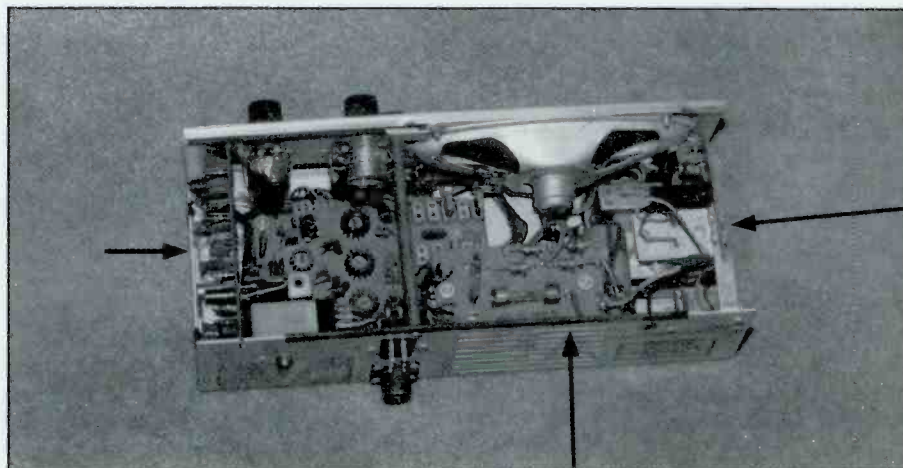

This inside view of the Cadre shows the receive section on the left, audio stages on the right and 117 volt power supply. (Photos by Don Patrick).



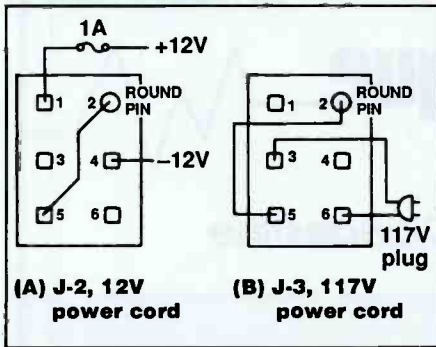

Plug wiring for both 12 and 117 volt power cords.

finals (Q9, 10 and 11). Outside of these, you can get either an exact replacement or a substitute that will work with some minor mounting or connection modifications. If you have to replace the radio's audio output speaker, be sure to use a 3.2 ohm one.

The tune-up and alignment is simple and straight forward if you have the service manual or the Sam's Photo-Fact for the unit. First, give the unit a good cleaning as described in the January issue with the additional step of giving the top side of the printed circuit board and parts a cleaning with plain old rubbing alcohol and a 1/4 to 1/2-inch paint brush, if needed. After cleaning, let it set for 12 to 24 hours to thoroughly dry out before applying any power. Don't try to clean the bottom side unless it's really dirty or contaminated. You have to remove the boards from the chassis to get to that side and it's quite a job.

## Applying the Power

When you apply power, try 12 volts DC first if available. By the way, this unit used a 1/4-amp slow-blow fuse internally on 117 volts AC power and a regular one-amp fuse in the power cord externally on 12 volts DC. We have included drawings of the plug wiring for both cords in case you are missing one or both. Now ensure that the fuses aren't larger than specified. Connect to the 12 volt source carefully, positive to the fused lead going to pin 1 of the plug and negative going to pin 4. Either disconnect the microphone, in case it's defective or incorrectly wired, or connect the antenna connector to a suitable 50 ohm dummy load. It wouldn't make your day if it keyed up and destroyed the transmitter finals.

Turn it on and see if you get noise out of the speaker when the squelch control

is turned down. If so, turn it off and if you don't have a signal generator, connect it to a good base/mobile antenna. Turn it back on and see if you can pick anything up on crystal receive and/or tunable receive. For proper operation of the tunable receive, you MUST have either a channel 9, 10, 11, 12, or 13 crystal in position "C." Channel 11 is best, because if any of the others are used, special alignment is required. If your unit does not have the variable tune knob in the lower right corner, then it is not a Model 510A. They deleted the variable tune because few CBers used it, and if you left it tuned to the wrong part of the dial, it hurt your receive on the crystal position. The models 510A, 510C, 515, 520 and 525 were all of the same general family, so most of what we've covered applies to all of them. Assuming the tunable works, if your unit has it, turn it off and connect to a watt meter. Turn it back on and see if it will transmit any power and if it will modulate. Be sure to have the channel selector on a position that has a crystal plugged into the transceiver properly.

If all the above were positive, now try it on 117 volts if you plan to use it that way. Repeat the above tests. Assuming it still checks OK, all you have to do now is use the proper test equipment or take it to someone for proper tuning and making sure it works to specification.

If the proceeding tests failed at some point, it's time to get out the test equipment or take it to a qualified shop. Transistorized units are not as easy to restore as a tube CB unit as there is less that you can do yourself especially if you are not technically qualified.

In the next article, we will look at some of the myths, senior married women's stories (old wive's tales) and funny/strange ideas or products that have been around over the life of the Class D CB radio service. Then we will get back to restoring the old tube-type CBs. I'm not sure which brand we'll do—maybe a Johnson I or II (white face, black face) or a Courier or such. When you write to me at Don W. Patrick, 3701 Old Jenny Lind, Fort Smith, AR 72901—and we are getting a lot of letters—and want a reply, be sure to include a SASE, preferably a No. 10 envelope. Right now, I'm able to answer most letters the same day I receive them. Special thanks to Walter Niemeyer of Shell Rock, IA for sending us a copy of his original Cadre operating manual. We have an original service manual, but did not have the owner's manual. Until next time, this is the Old Timer saying 73!

## SE SIGNAL ENGINEERING'S High Performance CB & 10 Meter Antennas

### SUPERHAWK

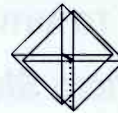

### WHITE LIGHTNING THE Four Element Antenna

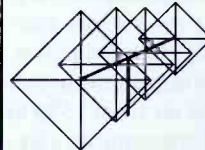

### LIGHTNING 6

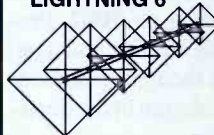

**Goldenrod 45 Spyder A+**  
Broadband Hi powered MOBILE

**THUNDER 8**  
Hi Gain Bi-Directional OMNI Electronically Steerable

**And, also, NEW QUAD LIGHTNING 8**  
THE most POWERFUL CB base in the world today!

ALL SE PATENTED rotary beams are true quads and OUTPERFORM their counterparts (quad/yagi types). SE's patented SFS matching system makes SE QUADS the most technologically advanced antennas in the world today.

If your dealer doesn't have SIGNAL ENGINEERING, write or call for full specs. DEALER inquiries invited. MasterCard, VISA, AMEX, Discover

## SIGNAL ENGINEERING

1172 Aster Avenue, #E, Sunnyvale, CA 94086  
Phone: (408) 247-2300

## ELECTRONIC COMPONENTS

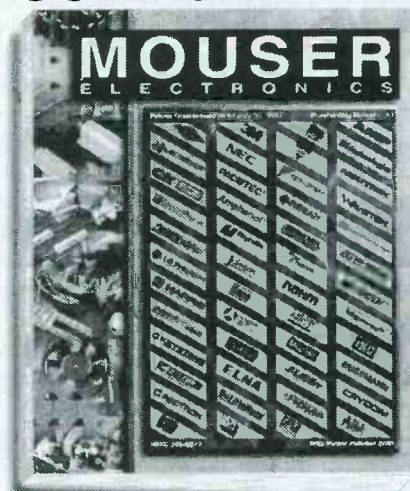

Call for your **FREE 348 page catalog TODAY!**

- 68,000 + Products
- 130 + Manufacturers
- All Orders Ship Same Day
- No Minimum Order

**800-992-9943**

817-483-6828 FAX: 817-483-0931  
www.mouser.com catalog@mouser.com

958 North Main St., Mansfield, TX 76063

# Clandestine Communique

TUNING IN TO ANTI-GOVERNMENT RADIO

## *Afghan Stations and a New Kurdish Clandestine*

There is a station which calls itself **Radio Afghanistan**, but which is not the voice of the current government run by the Taliban guerrillas. Instead, it broadcasts in opposition to that government. It is on the air from 1330 to 1430 and 0730 to 0830 operating on a frequency somewhere **between 7080 and 7100**, sometimes settling on **7082**. Programs are aired in the Pashto and Dari languages. This one is thought to be coming from the town of Taloqan in the northern part of Afghanistan.

Another new anti-Afghan government station is Radio Balkh, operated by the anti-Taliban National Islamic Movement of Afghanistan, supposedly broadcasting from the Afghanistan town of the same name. The station may be receiving support from the government of Turkey. At this writing no information is available about times and frequencies being used by the new station.

**The Voice of the Revolution of Tigray**, which seeks independence for the Tigray (Tigre) province of Ethiopia, is now operating on **6315** (ex 7515), in addition to **5500**. Sign on is at 0400 or a minute or so prior to that, although the transmitter is often placed on the air quite some time before programming begins. The broadcasts are largely in the Tigray language and, although signal strengths are not what you'd call powerful, the station can be received in North America, given patience, the right conditions and a reasonably good receiving set up.

Perhaps a new Kurdish clandestine is on the air, calling itself **Harim Radio Station**—the Voice of the Regional Government of Iraqi Kurdistan. It is using **4070** around 1400 to 1530 and may actually be operated by the Kurdish government in that part of Iraq.

Another new Kurdish station is **Freedom Radio Station**—the voice of the Communist Party of Iraqi Kurdistan, which is operating **between 3905 to 3955**, and also on **7695**. Unfortunately, reception of both of these stations appears to be next to impossible for North American listeners.

The **Voice of Iranian Kordestan** is

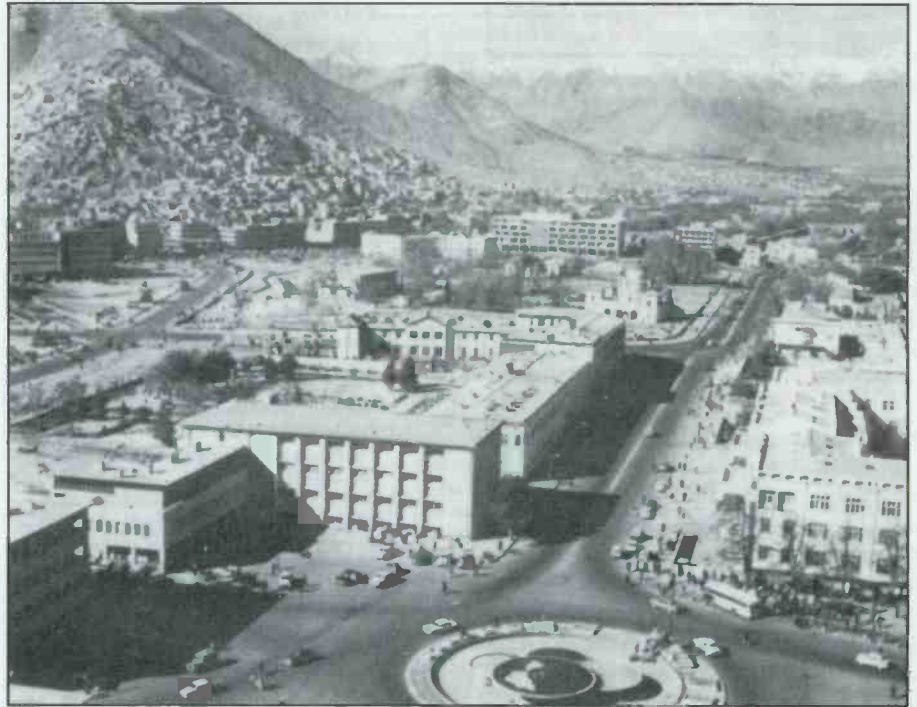

*Two new clandestines are on the air opposing the Taliban government in Kabul.*

operating in Kurdish and Persian from 1300 to 1430 and 0230 to 0400 on a frequency varying **between 3942 and 4200**.

The **Voice of Free Tajikistan** (a former Soviet republic) has changed its schedule so that broadcasts are now aired from 0300 on **5965** and at 0600 on **7100**.

The **Voice of Free Azerbaijan** (another former Soviet republic) is operating between 1530 and 1630 on **7093**.

Iraq's government-run radio continues to carry some "services" which are semi-clandestine in nature. **Mother of Battles** radio is being aired on **3935** at 2000, which makes it impossible to receive in North America. It also claims to be using **9745** from 1700 to 2000. It may be aired on shortwave at other times as well. At its inception during the Gulf crisis it was widely heard using higher frequencies.

The **Voice of the Iraqi People**, which is the mouthpiece of the Iraqi Communist Party, is now scheduled from 0400 to 0530 and again at 1730 to 1830 on **7695** and on a frequency varying **between 3905 and 3955**. Note the suspicious frequen-

cy match with the Kurdish Freedom Radio Station mentioned earlier. This almost certainly indicates that the two stations are using the same transmitter.

The **Democratic Voice of Burma** program continues to air via the facilities of Radio Norway. It's currently being broadcast on **15170** from 1100 (or slightly later) to closing at 1125. They confirm reports with a nice QSL card. Write to: Democratic Voice of Burma Radio, P.O. Box 6720, St. Olavs Plass, N-0130, Norway.

Here's the most recent schedule for the U.S. gov't's **Radio Free Asia** broadcasts—In Vietnamese: 1400 to 1500 on **9455, 9910, 9930, 11590, 11600, 13825 and 15660**; 2330 to 0030 on **9975, 11570, 11580, 13710**. In Mandarin: 1500 to 1600 on **9455, 9805, 9910, 11565, 11590, 11880**; 2100 to 2200 on **9395, 9420, 9455, 9910, 11765, 15515**; 2300-0000 on **9395, 9910, 11785, 13800 and 15515**. In Burmese at 0030 to 0130 on **11580, 11590, 11600, 13710, 13820**; 1500 to 1600 on **11605 and 13820**. In Tibetan: 1300-1400 on **11575 and 11590**; 2300-0000 on **7410**

on 11575 and 11590; 2300-0000 on 7410 and 9365. In Korean at 1530 to 1630 on 5855, 9980, 13810 and 15660; 2200-2300 on 7470, 9365, 9420, 9455 and 11590. Radio Free Asia is transmitted from a number of sites, both in the USA and from various foreign countries. Reception reports should be sent to 1201 Connecticut Avenue, NW, 4<sup>th</sup> Floor, Washington, DC 20036.

The anti-Chinese **Voice of Tibet** program, aired from a Russian government transmitter, is now broadcasting on 11570 (formerly 7400). The Tibetan language broadcasts are aired from around 1230 to 1300, although the time sometimes slides five minutes earlier at both ends. The producers of this service can be reached at Welhavensgate 1, N-0166, Oslo, Norway.

Commercial station WRMI in Florida continues to carry a couple of anti-Castro programs. La Voz de la Fundacion, presented by the Cuban-American National Foundation, airs in Spanish Monday through Saturdays at 1000 to 1300 on 9955. The address is 7300 NW 35<sup>th</sup> Terrace, Miami, FL 33122. They verify with a QSL card.

Junta Patriotica Cubana is on from 0200 to 0230 Saturdays and Sundays (UTC) on 9955. Also worth a check is something called Foro Militar Cubano, scheduled in Spanish on Saturdays at 1900 to 2000 and Sundays at 1400 to 1500. QSLs for these two can be had by writing to WRMI at P.O. Box 526852, Miami, FL 33152.

That covers things for this time. Remember that we always welcome your informational input on clandestine broadcasting subjects. This can be in the form of reception loggings, QSL information, (and copies of QSLs we can use as illustrations), broadcast schedules, general information about the stations and their backers and so on. Your interest, support and participation is greatly appreciated.

Until next month—good hunting!

# Get A New Image

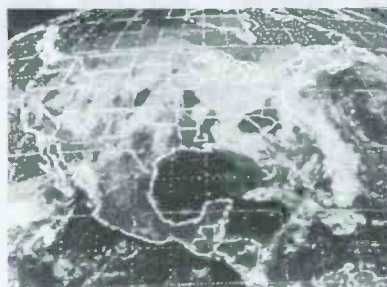

## PC HF Fax Plus \$129

PC HF Fax Plus is a simple, yet comprehensive HF system that receives Fax, RTTY, CW, and AMTOR on an IBM PC or compatible. It includes an FSK demodulator, advanced signal processing software, tutorial audio cassette, and complete reference manual. Just plug the demodulator into a serial port, install the software and get text and vivid images on your PC.

## PC SSTV \$149.95

PC Slow Scan Television is a complete system for sending and receiving full color amateur SSTV. The package includes an SSTV FSK modem, SSTV software, image capture utilities and reference manual. All popular formats are supported including Robot, Scottie, Martin and AVT. The system requires a 286, 386 or faster PC with VGA or super VGA display.



## Have It All For Only \$199.95

For a limited time we are offering both software packages with a single FSK modem for under \$200. This combination offer will let you send and receive the popular HF image and text transmission modes.

Call or write for our free catalog. Visa and Mastercard welcomed.

## Software Systems Consulting

615 S. El Camino Real, San Clemente, CA 92672

Tel. (714) 498-5784 Fax. (714) 498-0568

website: <http://www.sscorp.com> e-mail: [support@ssccorp.com](mailto:support@ssccorp.com)

CIRCLE 77 ON READER SERVICE CARD



# LENTINI COMMUNICATIONS, INC.

# Toll Free 1-800-666-0908

## RELM HS 200

### Multi-Band Programmable Scanner

- Multi-Band, Programmable Scanner, 13 Band Coverage From 26.000 MHz Thru 960.000 MHz.
- Includes 6 Meters and Aircraft.
- **PL/CTCSS and DPL/DCS included!**
- 200 Channels, 10 Banks, 10 Priority Channels.
- Birdie Lockout, Channel Lockout.
- Scan Speed Up To 100 Channels Per Second.
- HS200 Comes With A Metal Belt Clip, AC Adapter, Ear Piece, & Carrying Strap. (4 AA Batteries Not Included).
- Many Other Features.

**\$239.95**  
UPS included



## YAESU FT-50RD/5 Watt

### Ultra Compact Dual Band Handheld \*NOW WITH CTCSS ENCODE AND DECODE BUILT-IN!

Receive: 76-200MHz, 300-540MHz  
590-999MHz cellular blocked  
Transmit: 144-148MHz  
430-450MHz

- AM Aircraft Receive
  - Digital Coded Squelch
  - High Speed Scanning
  - 112 Memory Channels
  - Much, Much More!
- Full line of accessories in stock such as speaker mikes, rapid charger, DC cord, cases, etc.

Ask About Battery Special



Conn Sales Infor. & Tech Help  
**860-666-6227**

**21 Garfield St. Newington, CT 06111**

C.O.D.'s OK — SAME DAY SHIPPING

HOURS: M-F 10am - 6pm  
SAT 10am-4pm  
UPS Ground (48 states)

### Deluxe Leather Cases w/Quick Disconnect Swivel Belt Loop for All Handheld Scanners - \$29.95

## GMRS 210+3 MAXON

10 UHF Channels,  
CTCSS  
2 Watts Output  
(5 watts at 12VDC)

**\$179.95** UPS incl.



• For Business or GMRS Use

• 40 Watt, 16 Channel Model \$369.95

• Handheld Units Available-Call For Info.

## SM-2000 Series

Synthesized Scanning Mobiles  
UHF & VHF Versions Available

- 25 Watts
- 4 Channels
- CTCSS/DCS

**\$289.95**  
UPS inc.

### PROGRAMMING INCLUDED ON ALL MAXON RADIOS

#### SM-4000 Series Mobiles

- 40 Watts
- 16 channels
- CTCSS/DCS
- Other HT's

**\$329.95** VHF **\$369.95** UHF  
UPS Included

#### SP-2000 Series

5 Watt 4 Channel  
**SL-70W Series**  
5 Watt, 16 Channel

Starting at **\$299.95**

### NEW!

#### SP-120 Handhelds

UHF & VHF  
Versions Available

- 2 Watts
- 4 C channels
- CTCSS/DCS

Programmable,  
Scanning Portable

**\$199.95**

Complete  
w/Wall Charger

#### CHEROKEE & COBRA CB

CHEROKEE

• CBS-1000 AM/SSB base  
**\$279.95**

AH-27 40 Channel  
Handheld

AH-100 AM/SSB  
Handheld

COBRA 29L TDST  
"Soundtracker" Mobile

CALL FOR PRICING

### FOR BUSINESS OR GMRS USE

**NEW! Maxon** • Family Radio Service **\$89.95**  
**FRS-114** • No License Required **each**

#### BC9000XLT

**\$379.95** delivered

#### UNIDEN

**NEW! BC235XLT**  
"Trucktracker"

**\$269.95** UPS Incl.

#### BC3000XLT

**\$359.95** delivered

#### AOR

AR8000

#### ICOM

IC-8500  
IC-R10

#### SANGEAN

ATS909  
New From Sangean

AM/FM/SSB Shortwave

#### GRUNDIG

Shortwave

Yacht Boy 400

CALL FOR PRICING

# Broadcast DXing

DX, NEWS AND VIEWS OF AM AND FM BROADCASTING

## Expanded AM Band: Third Time's The Charm?

The FCC's third attempt in four years to choose which stations can move to the expanded AM band is out, and broadcasters and commissioners alike must be hoping that this one will pass muster. The Commission's revised allocation plan, released in March, picked 88 stations in the United States, Puerto Rico and the Virgin Islands to move to the 10 new channels between 1605 kHz and 1705 kHz.

And what a difference a year makes: Although the 1996 plan listed 87 stations, nine stations who received allocations under the 1996 plan—KAPR, KDDR, KFVR, KIDR, KNRB, KRGI, KSVP, WONX and WWHL—were dropped from the 1997 plan. That made room for 10 new stations—KDSX, KENN, KILR, KKAR, KKSO, KLAT, KNST, KQXI and KXEX. Some 688 stations had originally applied for slots in the expanded band.

Another major difference is the 19 stations which survived both the 1996 and 1997 cuts, but with different channel assignments. Vallejo, CA's KXBT will have to move from its current home of 1630 kHz back to 1640 kHz, the frequency it originally used in March 1996 when it became the second station to broadcast in the expanded band. Elizabeth, N.J.'s WJDM, the first station to broadcast in the expanded band, will remain on 1660 kHz. Costa Mesa, CA's KNNZ, meanwhile, was supposed to have started up on 1650 kHz earlier this year. That move, which will include new calls KBTL, has been pushed back yet again, probably to this summer.

Eligible stations have until June 17 to apply for a construction permit for their new frequencies. Those stations will have a maximum of five years to use both their old and new frequencies before they must choose which of the two to call their permanent home. Stations broadcasting in the expanded band are limited to 10 kW days and 1 kW nights, both with a nondirectional antenna.

The 1994 and 1996 allocation plans were scrapped by the FCC after each generated complaints from stations not included—complaints that both times revealed flaws in the processes and



Big Apple disco outlet WKTU has a nifty Web page at <[www.wktu.com](http://www.wktu.com)>, complete with a throbbing "Beat of New York" slogan. (Courtesy Bob Gilbert, Portland, Maine)

databases the Commission used to determine which stations could migrate. All but one of eight separate petitions for reconsideration criticizing the 1996 plan were granted by the FCC.

In its successful petition, Newburgh, N.Y.'s WGNY questioned the Second Harmonic Interference Standard, which attempts to prevent interference to stations operating on 1620, 1640, 1660, 1680 and 1700 kHz. For example, a station couldn't receive an allocation for 1640 kHz if there was a nearby station on 820 kHz. While acknowledging WGNY's charge that it had misapplied the standard, the Commission concluded that correctly applying the standard still wouldn't allow any more stations to migrate to the channels above 1600 kHz.

What did significantly change the allocations, however, were corrections in the software used to determine which stations could move. The FCC modified the program to account better for existing federal travelers information stations operating on 1610 kHz and for international treaties that restricted allotments for stations in Florida and the Virgin Islands.

### Down For The Count

Alberta's provincial radio network CKUA finally shut down—probably forever—on March 20. It would have celebrated its 70th anniversary on Nov. 21.

"I walked in today to work and chatted with the manager and he said we're off the air as of midnight," CKUA DJ Tony Dillon-Davis told the Edmonton Journal. "All I can kind of figure from it is they want to shut it down at this point so they can have enough money to pay out the obligations of staff and whatever else is going on. The reason of course is that there wasn't sufficient money coming in. Of course, that begs the question why."

Indeed it does. As recently as February, station officials were optimistic—at least outwardly—about CKUA's future. "Changing CKUA into a cash-flow operation and adopting the disciplines of management has been a rigorous task," said Gail Hinchliffe, station board chairman and CEO, in February. "Our work is starting to pay off. This year will be a fundamental year for CKUA."

Unfortunately, 1997 instead turned out



WERZ is Exeter, N.H.'s Top-40 station. (Courtesy Bob Gilbert, Portland, Maine)

## Seeking Permits to Construct New FM Stations

AR	Batesville	99.5 MHz	
AR	Fayetteville	90.1 MHz	16 kW
AR	Springdale	88.5 MHz	
AZ	Oraibi	98.9 MHz	
AZ	Tuba City	97.9 MHz	
CA	Livingston	88.3 MHz	6 kW
CA	Ukiah	100.7 MHz	
CO	Burlington	99.3 MHz	
CO	Glenwood Springs	88.9 MHz	2 kW
CO	Hayden	107.3 MHz	
CO	Lakewood	88.1 MHz	125 watts
CO	Westminster	88.1 MHz	130 watts
GA	Cairo	90.1 MHz	8 kW
GA	Elberton	105.1 MHz	
IA	Fairfield	88.1 MHz	250 watts
IA	St. Ansgar	105.1 MHz	
ID	Burley	88.5 MHz	
ID	Pocatello	91.1 MHz	
IL	E. St. Louis	89.7 MHz	250 watts
IL	Kewanee	91.1 MHz	21 kW
KS	El Dorado	88.1 MHz	400 watts
KS	Medicine Lodge	91.5 MHz	25 kW
LA	Broussard	91.9 MHz	25 kW
LA	Kaplan	91.9 MHz	50 kW
LA	Kinder	92.1 MHz	
MN	Sebeka	89.3 MHz	100 kW
MO	Cedar Hill	89.5 MHz	300 watts
MO	Otterville	107.7 MHz	
MO	Potosi	89.7 MHz	2.3 kW
MO	St. Joseph	91.9 MHz	750 watts
MO	Wheeling	105.9 MHz	
MS	Duck Hill	91.9 MHz	3 kW
MS	Indianola	88.7 MHz	
MS	Prentiss	104.9 MHz	
MT	Plains	91.5 MHz	
Mt	Shelby	97.9 MHz	
MT	Sidney	93.1 MHz	
NC	Ashokie	91.7 MHz	45 kW
ND	Tioga	104.1 MHz	
ND	Williston	98.5 MHz	
NH	Nashua	88.3 MHz	
NM	Peralta	90.5 MHz	100 kW
NM	Santa Rosa	95.9 MHz	
NY	Utica	90.3 MHz	
OH	Hicksville	106.7 MHz	
OH	Lima	89.3 MHz	
OH	Shelby	88.3 MHz	
OH	Steubenville	88.9 MHz	150 watts
OK	Lawton	91.1 MHz	16 kW
OK	Piedmont	88.5 MHz	60 watts
OK	Tishomingo	88.3 MHz	
PR	Pastillo	90.1 MHz	200 watts
SD	Redfield	97.7 MHz	
TN	Clarksville	88.3 MHz	6 kW
TN	Henry	104.7 MHz	
TN	Middleton	100.7 MHz	
TN	Parkers Crossroads	96.5 MHz	
TX	Big Lake	98.3 MHz	
TX	Charles City	89.7 MHz	2.9 kW
TX	Kerrville	91.1 MHz	300 watts
TX	Madisonville	91.5 MHz	6 kW
TX	McCamey	95.3 MHz	
TX	Plainview	90.5 MHz	
UT	Logan	107.5 MHz	

VA	Danville	91.1 MHz	18 kW
WA	Mt. Vernon	91.7 MHz	170 watts
WA	Wenatchee	88.1 MHz	100 watts
WI	Cuba City	89.7 MHz	
WI	Sister Bay	89.7 MHz	3.4 kW
WI	Sister Bay	91.9 MHz	3.4 kW
WI	Two Rivers	98.9 MHz	
WV	Beckley	88.1 MHz	600 watts
WY	Albin	107.3 MHz	
WY	Casper	91.3 MHz	420 watts
WY	Gillette	89.7 MHz	250 watts

## Granted Permits to Construct New FM Stations

HI	Hilo	90.3 MHz	
IN	Hartford City	88.1 MHz	
MA	Nantucket	91.1 MHz	2 kW
NM	Jal	107.1 MHz	100 kW
TN	Lake City	90.7 MHz	
WY	Casper	97.3 MHz	900 watts

## Granted Permit to Construct New International Broadcast Station

GA	Macon	(various)	
----	-------	-----------	--

## Granted Permit to Construct New AM Station

OH	Cincinnati	1660 kHz	Experimental DAB
----	------------	----------	------------------

## Revoked, Cancelled, or Otherwise Deleted

KLZE	Owensville, MO	95.3 MHz	
KMRV	Blair, NE	97.3 MHz	
KRKL	Yountville, CA	840 kHz	2.5 kW/25 watts
KYEG	Canadian, TX	94.9 MHz	
WNRJ	Circleville, OH	1540 kHz	
WQQW	Waterbury, CT	1590 kHz	

## Sent Notices of Apparent Liability for Monetary Forfeiture

KUAD-FM	Windsor, CO	\$5,000;	sponsorship ID rules.
WTEM	Bethesda, MD	\$5,000;	sponsorship ID rules.

## Requesting Modifications to AM Facilities

KILE	Port Lavaca, TX	1560 kHz	Seeks move to Bellaire, 800 watts.
KSML	Diboli, TX	1260 kHz	Seeks increase to 1.8 kW.
KVSN	Tumwater, WA	1500 kHz	Seeks to change power, freq., add nights.
WMUF	Paris, TN	1000 kHz	Seeks to change power, freq., add nights.
WSTK	Colonial Hghts, VA	1290 kHz	Seeks to increase to 25 kW.

## Modified AM Facilities

KOKE Giddings, TX 1600 kHz Moved to Pflugerville,  
5 kW/500 watts.  
WADO New York, NY 1280 kHz Increased to 50 kW.  
WGBB Freeport, NY 1240 kHz Changed night power.  
WLVN Brantley, AL 1080 kHz Moved to 1030 kHz,  
3 kW/400 watts.  
WRPT Peterborough, NH 1050 kHz Change power, freq., city.

## AM Modification Rescinded

KTMG Deer Trail, CO 1370 kHz Frequency change.

## Changed FM Facilities

KTKC Springhill, LA 92.9 MHz Frequency changed.  
WIOV Reading, PA 105.1 MHz Relocated booster.

## Pending AM Call Letter Changes

New	Old	
KTKZ	KMJI	Sacramento, CA
WLKY	WAVG	Louisville, KY

## Changed AM Call Letters

KBLV	KXPA	Pasadena, CA
KCHN	KPXE	Liberty, TX
KDDS	KQDS	Duluth, MN
LGO:	KNNS	San Fernando, CA
KJOK	KEZC	Yuma, AZ
KKGO	KNNZ	Costa Mesa, CA
KKHI	KNOB	San Rafael, CA
KLTX	KGER	Long Beach, CA
KLVB	KRVC	Medford, OR
KLVP	KEZF	Tigard, OR
KNOB	KKGO	Costa Mesa, CA
KOCR	KFSB	Joplin, MO
KSFS	KCGN	Sioux Falls, SD
KXPA	KBLV	Bellevue, WA
WAQV	WMRE	E. Longmeadow, MA
WEZE	WBNW	Boston, MA
WJLT	WBIV	Natick, MA
WJZZ	WKNX	Frankenmuth, MI
WKNX	WJZZ	Bay City, MI
WKRE	WMAF	Monroe, NC
WNTF	WXRG	Mt. Dora, FL
WNWC	WMAD	Sun Prairie, WI
WODZ	WFRY	Rome, NY
WPZE	WEZE	Boston, MA
WWLZ	WQIX	Horseheads, NY

## New FM Call Letters Issued

KAFN	Gould, AR
KAKA	Salina, KS
KASZ	Fairfield, CA
KAUB	Reedsport, OR
KAUF	Kennett, MO
KAUG	El Dorado, AR

KCVQ	Knob Noster, MO
KLVP-FM	Cherryville, OR
KPRB	Brush, CO
WAQV	Crystal River, FL
WAQW	Christiansted, VI
WARN	Culpeper, VA
WCAF	Carabelle, FL
WGBV	Glasgow, KY
WQKZ	Ferdinand, IN
WRBK	Richburg, SC
WTBF-FM	Brundige, AL
WZEA	Ogdensburg, NY

## Changed FM Call Letters

Old	New	
KBON	KAHK	Mamou, La
KBUA	KYKF	San Fernando, CA
KCKK	KQKS	Longmont, CO
KDDG	KASM-FM	Albany, MN
KELE-FM	KCMG-FM	Mountain Grove, MO
KFAT	KWQJ	Anchorage, AK
KFSD	KOWF	Escondido, CA
KHQJ	KQNC	Susanville, CA
KLJZ	KJOK	Yuma, AZ
KLVK	KLVS	Kingsburg, CA
KMKX	KSIT	Rock Springs, WY
KPQZ	KPVY	Amarillo, TX
KPTY	KBZR	Gilbert, AZ
KQKS	KHHT	Lakewood, CO
KQTN	KXKK	Lordsburg, NM
KRTK	KOND	Cleveland, TX
KTBT	KDEA	New Iberia, LA
KXGL	KFSD-FM	San Diego, CA
WAKS	WUKS	Tampa, FL
WALC	WKBQ-FM	Jerseyville, IL
WATQ	WVXD	Chetek, WI
WCHA-FM	WKSL	Greencastle, PA
WCIZ-FM	WTNY-FM	Watertown, NY
WCRS-FM	WSCZ	Greenwood, SC
WGBK	WMWA	Glenbrook, IL
WGIC	WHUB-FM	Cookeville, TN
WGVT	WXGC	Milledgeville, GA
WHQK	WAKS	Marysville, OH
WIST-FM	WFAZ	Thomasville, NC
WJAE	WLPZ	Westbrook ME
WNWC-FM	WNWC	Madison, WI
WPCL	WXLJ	Spangler, PA
WRLT	WRLT-FM	Franklin, TN
WTBF-FM	WTDP	Brundige, AL
WTRY-FM	WYSR	Rotterdam, NY
WVPI	WIYC	Charlotte Amalie, VI
WVRR	WNBX	Lebanon, NH
WVTI	WAKX	Holland, MI
WVXI	WNDY	Crawfordsville, IN
WXJY	WSCA	Georgetown, SC
WZNG	WHAL	Shelbyville, TN

## Rescinded FM Call Letter Change

New	Old	
KRLD	KOJJ	E. Porterville, CA

## VERIFIED RECEPTION OF PROGRAMS

ON August 5, 1986

# W J J D

**1160 KHz 50,000 WATTS**  
**180 NO. MICHIGAN AVE.**  
**CHICAGO, ILLINOIS 60601**

BY  CHIEF ENGINEER

to be what looks like the final year for the CKUA. Its most recent near-death experience was in 1994, when the Alberta government began weaning CKUA off public funds by cutting the station's 1995 budget in half. Layoffs ensued, and the salaries of remaining staffers were rolled back as much as 50 percent. Nearly all of CKUA's 1998 budget was to have come from advertising, program sponsors and listeners, who the station said donated over \$600,000 a year.

"CKUA has a really fanatically loyal listenership," CKUA reporter Bill MacLoughlin told the Journal. "It was a unique product in Canada both in music and news, so one really has to wonder why we couldn't make a go of it."

CKUA, whose calls originally stood for the University of Alberta, served 85 percent of Alberta's population via 17 transmitters on AM and FM. Its format was an eclectic mix of classical, jazz and folk music, and news, information and educational programs. A February station press release noted several CKUA Canadian radio milestones, including first public broadcaster, first stereo broadcaster and first to simulcast real time over the Internet. Jann Arden and k.d. lang are two singer-songwriters who made their radio debuts on CKUA.

### In Brief

In a sweeping move that privatizes the technical operations of one of the worlds most respected public broadcasters, the transmitters and antennas for BBC's Home Service were sold February 28 to Houston, Texas-based Castle Tower Corp. Price: 224 million British pounds, according to the London Daily Telegraph.

The 738-transmitter domestic network includes television and AM, FM and long-wave radio outlets. Proceeds from the deal, which includes a 10-year contract to broadcast BBC programming, will go toward planned digital services. Castle Tower operates 1,200 similar facilities in the U.S. and the Caribbean.

Chicago's WJJD on April 6 ended nearly 73 years of service on 1160 kHz. Taking over its frequency is WSCR, in a move that will allow the all-sports station to expand to 24-hour programming and substantially increase its coverage area. Meanwhile, a "Personal Achievement Radio" format moved into WSCR's former home at 820 kHz. The moves were necessitated by Westinghouse's purchase of WJJD owner Infinity Broadcasting last year, which left the company with too many stations in the Chicago market. In order to get back under the FCC's cap of eight stations, Westinghouse sold WSCR's frequency to Douglas Broadcasting.

Call it sleeping with the enemy. Phila-

delphia's WYSP had to share a studio with rival WMMR for four hours while WYSP was making the move to its new home downtown with new sister station KYW. The two stations swapped studios on March 29 following a trade between CBS Radio and Greater Media. WMMR moved from Philadelphia's Independence Mall into WYSP's old home in Bala-Cynwyd, which it will share with WMGK and WPEN.

### Thanks

The May column included an incorrect caption for "The Edge" ad. It should have read, " 'The Edge' is one of seven Australian expanded AM band stations. They run 400 watts with a format of techno-pop dance music. *Pop 'Comm* reader Gary V. Jackson heard them at his monitoring post in Sacramento, CA." *Pop 'Comm* regrets the error.

Your news clippings, bumper stickers, station and shack photos and QSLs are always welcome, as are your questions and comments. Send 'em to "Broadcast DXing" at *Pop 'Comm*'s Hicksville address. Until next month, 73. ■

## Synchronous AM !

Greatly improve reception with the time-proven High-Fidelity SE-3 MK III product detector. Eliminates selective-fade distortion and garbling through phase locked synchronous detection. Can receive one sideband at a time to minimize interference.

All radios adaptable to SE-3 external detector / amplifier. Presently used with Collins, Drake, Icom, JRC, Kenwood, Racal, and Watkins-Johnson. SE-3s start at \$449.00

ICom R-9000 6, 4, and 3 kHz AM filter set

Racal & JRC filters: 16, 8, 6, 3.5, 2.1, 0.4, 0.25 KHz.

JRC NRD-535 & SE-3 Mk III package: \$2049.00.

Includes NRD-535, two additional custom filters for a total of four filters, and our external SE-3 Deluxe detector.

**Sherwood Engineering, Inc.**

1268 South Ogden Street

Denver, CO 80210

(303) 722-2257. FAX (303) 744-8876

CIRCLE 76 ON READER SERVICE CARD

**+30db**

The Original .... **Select-A-Tenna** ★★★★★



- AM RADIO ANTENNA WORKS WITH THE BUILT-IN ANTENNA IN YOUR RADIO
- NO WIRES TO CONNECT
- NO BATTERIES
- HIGH-Q SUPER GAIN AND SELECTIVITY
- PROVEN WORLD-WIDE FOR OVER 22 YRS
- SATISFACTION GUARANTEED
- THIS ONE REALLY WORKS!

**\$59.95 PLUS SHIPPING**

INTENSITRONICS CORP. P.O. BOX 562 DEPT. Q HALES CORNERS, WISC. 53130	TOLL-FREE 1-800-382-4155 FAX 1-317-883-7555
--	--

MADE IN USA

CIRCLE 69 ON READER SERVICE CARD

July 1997 / POPULAR COMMUNICATIONS / 57

# The Ham Column

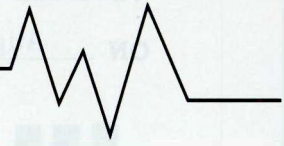

GETTING STARTED AS A RADIO AMATEUR

## QSL Cards: Printing, Sending and Receiving

With the present solar cycle starting its relatively brisk journey toward outstanding propagation, now is the perfect time to get your QSL cards printed. It's also a great time to learn the do's and don't's of getting them and sending them. Here are some tips to make the process a little easier.

### Your QSL Card Printer

Many QSL card printers advertise in amateur radio publications. The larger companies have display ads—but don't forget to look in the classifieds; it's where you'll find ads for most printers. Spend a few dollars and send away for information kits and samples. Looking through sample kits is fun and educational! It can also make choosing a design more difficult, so be prepared.

Choosing a QSL card printer may be trickier than you think. Most commercial printers produce "stock" cards; that is, the only customized part is your name, call sign and other personal information. The design of the card may be used by hundreds or even thousands of other hams!

If that's not a problem, you're in luck. Most beginning hams start this way. The cards are inexpensive, and you're sure to end up with a QSL card that contains all the necessary information—something that may not happen if you "go it alone."

Whether you choose a standard card, a photographic card or a one-of-a-kind masterpiece, make sure you don't buy too many right off the bat. Beginning hams have a habit of upgrading! And although the discount on 3,000 cards may seem attractive, buy with caution!

### *"Choosing a QSL card printer may be trickier than you think."*

To reduce costs, consider putting together a group order with your friends or fellow ham club members. Try limiting your cards to plain white stock and blank ink. Starting out with a plain vanilla QSL card is perfectly acceptable.

Here's the information that should appear on whatever card you choose: Call sign, name, mailing address, and your country. You may also want to include your county to please the many county hunting hams you'll encounter on the air. The blanks where you fill in QSO information should be large enough to easily write in the other operator's call sign, date, year, time (in UTC), band, mode and signal report. Most hams also include a "PSE QSL TNX" line; circle either PSE or TNX to indicate whether you're requesting a card or responding to a received card.

Feel free to include other personal data, too—but don't get carried away. Junky, cluttered QSL cards complicate matters. Clean, straightforward designs work best. Be sensible about the artwork and forget about stuff that may be offensive or humorous. Something that's funny in sunny California may not play in Peoria—much less Persia! Think twice about graphic themes that are overly political or religious.

Do yourself and your QSL recipients one last favor and make sure all QSO information is on the front side of your

QSL card. Remember: The easier you make the QSL card process, the greater your chance of getting a card in return.

### Filling Out a QSL

By the way, there are two ways to fill out a QSL card—perfect and wrong. Be careful, be accurate and be neat. If you make a mistake, toss the card into the trash and start over. Marked-over or altered cards—even if made in good faith—do not count for awards programs. What if you're that op's only New Hampshire contact?

### Sending and Receiving

Want to improve your QSL return rate? Remember that hams in rare states (and rare places) are often inundated with QSL card requests. Make sure yours is sent with a self-addressed, stamped envelope. Being patient also helps, especially with cards sent overseas or via the QSL bureau.

In case you haven't used it yet, the "bureau" is an excellent, cost-effective way to send and receive QSL cards to and from DX stations. Instead of going







# Communications Confidential

YOUR GUIDE TO SHORTWAVE "UTILITY" STATIONS

## Project HAARP Studies Ionosphere

Some readers may have been lucky enough to catch recent signal tests from Project HAARP. The tests were announced on short notice via several amateur/SWL nets recently. The HAARP facility transmitted a signal on 3400.0 kHz and 6990.0 kHz to allow listeners the opportunity to listen for the HAARP signal, and then send in a signal strength for a QSL card. The transmission consisted of a carrier and CW transmission. The signals seemingly were widely heard, although I didn't catch them drifting into Ohio that night. Since HAARP cannot transmit above 10 MHz, they scheduled this listening test after sunset in Alaska so that propagation conditions were best for listeners in the "lower 48." The transmission beginning at 0450 was primarily devoted to Alaskan hams and SWL's.

What is HAARP? The HAARP (High frequency Active Auroral Research Program) facility will be used for basic and applied research related to the study of the Earth's ionosphere. According to a release, HAARP is to be a major Arctic facility for upper atmospheric and solar-terrestrial research. Scheduled for completion in 2002, HAARP is being built on a Department of Defense-owned site near Gakona, Alaska. Technical expertise and procurement services as required for the management, administration and evaluation of the program are being provided cooperatively by the Air Force (Phillips Laboratory) and Navy (Office of Naval Research and Naval Research Laboratory). Since HAARP consists of many individual items of scientific equipment, both large and small, there is a "considerable list" of commercial, academic and government organizations which are contributing to the building of the facility by developing scientific diagnostic instrumentation and by providing guidance in the specification, design and development of the IRI. Other organizations which have contributed to the program include the University of Alaska, University of Massachusetts, UCLA, MIT, Stanford University, Clemson Uni-



Prototype antenna array at Project HAARP  
(Photo courtesy Project HAARP web site).

versity, University of Tulsa, University of Maryland, Cornell University, SRI International, and Geospace, Inc. Despite DoD involvement, the HAARP program is completely unclassified.

Principal instruments to be used in the project include a high power, high-frequency (HF) phased array radio transmitter (known as the Ionospheric Research Instrument, or IRI), used to stimulate small, well-defined volumes of ionosphere, and an ultra-high frequency (UHF) incoherent scatter radar (ISR), used to measure electron densities, electron and ion temperatures, and Doppler velocities in the stimulated region and in the natural ionosphere. To further the scientific capabilities and usefulness of the IRI and

ISR, HAARP is supporting the design and installation of the latest in modern geophysical research instruments, including an HF ionosonde, ELF and VLF receivers, magnetometers, riometers, a LIDAR (Light Detection And Ranging) and optical and infrared spectrometers and cameras which will be used to observe the complex natural variations of Alaska's ionosphere as well as to detect artificial effects produced by the IRI.

At the present time the U.S. operates two ionospheric research sites, one in Puerto Rico, near the Arecibo Observatory, the other (known as HIPAS) in Alaska near Fairbanks. Both of these employ active and passive radio instrumentation similar to that being built at HAARP. Interest in the ionosphere is not limited to the U.S.: a five-country consortium runs the European Incoherent Scatter Radar site (EISCAT), a premier world-class ionospheric research facility located in northern Norway near Troms. Facilities also are located at Jicamarca, Peru; near Moscow, Nizhny Novgorod ("SURA") and Apatity, Russia; near Kharkov, Ukraine and in Dushanbe, Tadjikistan. All of these installations have as their primary purpose the study of the ionosphere.

If you would like to learn more about



Reader John Whitehead saw the log of the M/V Gunay A a few months back and thought readers would like to see her. John lives near the St. Lawrence and photographs ships as they travel by. (Photo courtesy John Whitehead's Color Prints).

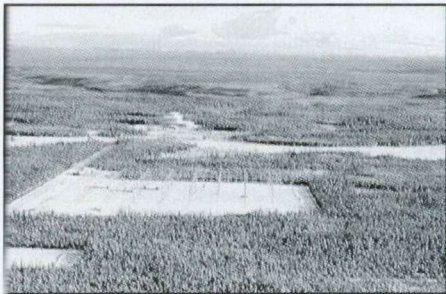

Overhead view of Project HAARP site, Gakona, Alaska (Photo courtesy Project HAARP web site).

this project and have internet availability, check the HAARP Home Page out at: <<http://server5550.itd.nrl.navy.mil/haar.p.html>>. Hopefully we'll get a little more notice for future tests.

## More News

STS-85 with the space shuttle Discovery (OV-103) is still scheduled for launch July 17 at 1406 UTC (10:06 a.m. EDT). The mission is to last 10 days, 20 hours, 48 minutes. Monitoring 10780.0 USB (Cape Radio primary) as early as 1100 UTC could net you the working frequencies for the range safety and booster recovery nets. The assets that will be working these nets (U.S. Navy vessel, USCG cutter, booster recovery ships, etc.) usually check in with Cape early on to obtain their frequencies. I have found them checking in as early as 16 hours prior to the scheduled launch time.

The U.S. Air Force has realigned all stateside C-130's from Air Combat Command (ACC) to Air Mobility Command (AMC) as of April 1. The shift is part of an effort to create a "seamless mobility system". Overseas theater mobility assets, including KC-135s, theater airlift C-130s and operational support airlift fleets, will continue to be assigned to Pacific Air Forces and U.S. Air Forces in Europe. The 60th Air Mobility Wing's last scheduled mission to Antarctica lifted off March 2, closing the books on Travis Air Force Base's role in one of the Air Force's most unique missions. For more than 40 years, Travis crews have flown Operation Deep Freeze supply missions from Christchurch, New Zealand, to McMurdo Station, on Ross Island near the southern polar ice cap. But the ongoing retirement of the C-141 Starlifter from the Air Force inventory means Travis will give up this mission while remaining Starlifters at McChord AFB,

WA will take over. McChord is to have C-141's for several more years. Two EC-135 aircraft will be moving to MacDill AFB, FL, when they transfer from Robins AFB, GA, by this month. The Office of the Secretary of the Air Force announced the aircraft will transfer to the 91st Air Refueling Squadron, 6th Air Refueling Wing, from their current unit, the 99th Air Refueling Squadron. The two aircraft support the commander in chief of United States Central Command. Since the primary mission of these aircraft is to support USCENTCOM, the move will improve airlift support responsiveness and save money. Last October the 6th Air Refueling Wing (ARW) activated at MacDill with 12 KC-135R Stratotankers you may recall. These aircraft have been noted using the call sign "BOLT" on GHFS while their command post became "LIGHTNING OP's".

On the U.S. Navy side of things, the F/A-18E/F "Super Hornet" test program continues on track. Carrier suitability trials were recently conducted aboard the USS John C. Stennis (CVN-74). A total of seven Super Hornets (three single-seat F/A-18E models and four F/A-18F models) are operating from Naval Air Station Patuxent River in the three-year program that will verify the aircraft's capabilities and performance. The Navy plans to buy 1,000 of the new long-range, all-weather, day-and-night, multi-mission strike fighter aircraft by the year 2016.

The first operational F/A-18F squadron will take the place an F-14A squadron in 2001. The F/A-18 community will consist of 10 active and one reserve squadrons, each with fourteen aircraft assigned. Normally this would not be of interest to us HF fans, however reportedly the HF radio package in these aircraft has survived budget cuts. So it may be possible to hear a "Super Hornet" on HF soon. The Coastal Mine Hunter USS Falcon (MHC-59) was commissioned early February at Port Arthur, Texas. Falcon is the 9th ship of the Osprey-class. Falcon measures 188 feet long, 36 feet wide and displaces approximately 895 tons when fully loaded. Falcon will join the Atlantic Fleet and will be homeported in Ingleside, Texas. No call sign information yet on her. The A-6 Intruder was retired from the Navy's inventory of combat aircraft at a ceremony recently. There had been two A-6 squadrons in active service. Both were retired on the same day. VA-75 stood down on the East Coast at NAS Oceana, VA and VA-196 at NAS Whidbey Island. The aircraft had been in

service for more than 30 years. The guided-missile frigate USS Oliver Hazard Perry (FFG-7) was decommissioned in late February. The ship was lead ship of the Navy's largest ship class, and was named for Commodore Oliver Hazard Perry. So you can scratch her from your lists on U.S. Navy ships as well as your A-6 call signs.

I caught the end of a NMC, USCG CAMSPAC Point Reyes sitor broadcast. Included was this announcement "AS PART OF THE USCG COMMUNICATIONS SYSTEM 2000 PLAN, COMMSTA HONOLULU (NMO) IS SCHEDULED TO RELINQUISH OPERATIONAL CONTROL OF ALL MF/HF ASSETS TO CAMSPAC POINT REYES CA (NMC) BY 01JUL97. ALL OF THE SERVICES CURRENTLY PERFORMED BY NMO WILL CONTINUE BUT WILL BE PERFORMED REMOTELY BY NMC. THE REMOTING OF NMO CIRCUITS TO NMC WILL BE ACCOMPLISHED IN SEVERAL PLANNED PHASES STARTING 19MAY97. DURING THIS SERVICE-BY-SERVICE CUTOVER, NMO WILL CONTINUE TO MONITOR ALL CIRCUITS AND BE READY TO ANSWER CALLS OR PERFORM BROADCASTS IN THE EVENT THAT NMC CANNOT. AS SERVICES ARE REMOTED TO NMC, VOICE CALLS TO COMMSTA HONOLULU WILL BE RESPONDED TO AS CG CAMSPAC PT REYES, NON-VOICE CALLS WILL BE ANSWERED AS NMO/NMC." That will leave NMG, CommSta New Orleans, La. and NOJ, CommSta Kodiak, AK as the only remaining non-remoted CommSta's.

Recent monitoring has revealed an added station using 11175.0 kHz on the USAF Global High Frequency System (GHFS) system. Thule GHFS, Greenland, is now using the frequency 24-hours-a-day. This was confirmed per the latest DoD Flight Information Publication (Enroute), Flight Information Handbook (FIH). Meanwhile, Croughton, England, which had been a 24 hour station, is now listed as 2300 to 0500 UTC only. Next month we'll look at the GHFS system, and the various unclassified DoD aero publications which you Air Force/aero fans may purchase.

## Reader Mail

Scott Diback, MI uses a RadioShack DX-390 and a Grundig Satellit 700 to

cover his specialty area of Longwave. Scott has been making some fine catches recently. Craig MacKinnon in Halifax, Nova Scotia writes about an interesting frequency he has found. Craig found Eastern Canada Towing (ECTUG), a tug company based in Halifax on 5403.0 USB (see log). Since Craig uses an analog tuner he would like to confirm this as the correct frequency. Anyone?

Steve Fisher, OH noted GIANT KILLER, the Virginia Capes FACSFAC (Fleet Area Control and Surveillance Facility) at Naval Air Station Oceana heard regularly on 4372.0 USB was recently in the news. Steve sent an article in the Virginia Pilot Ledger Star newspaper website by columnist Tom Holden that detailed the incident involving New Jersey Air National Guard F-16s and a Nations Air 727 commercial aircraft off the East Coast of the U.S. that recently occurred. The article indicated that investigators from the National Transportation Safety Board were to do an inquiry into the incident and that "the civilian inspectors will interview officials at the Fleet Area Control and Surveillance Facility Virginia Capes, whose personnel had control of the fighters during the encounters." The article goes on to describe GIANT KILLER as "an unremarkable block of a building, two towers topped with dimpled domes, and an array of antennas on poles. But inside is enough electronic equipment to monitor a whopping 94,000 square-mile chunk of airspace off the eastern seaboard. From Narragansett Bay, RI to Charleston, SC, the powerful radar beams that sweep from the facility can track all traffic - civilian and military - and monitor ship and submarine movement up to 200 miles from shore."

Ian Julian has been a ute monitor for nearly 20 years and was recently connected to "cyberspace" via the internet. His monitoring station is located in Hamilton, New Zealand and consists of an ICOM R72, Sony 6800w and a Sangean ATS 803A. HF Antennas are a 47ft T2fd and a 62-foot longwire, while his decoders are a Wavecom 4010 and a Universal M400. Ian has sent some logs and news of a mystery signal that he heard late last year on 17925, 18042, 18160, 18278, 18396, 18514, 18631, 18749 and 18866 at 2230 UTC, and a week later another group on 15677, 15912, 16030, 16266 and 16384 at 0630 UTC. They made a kind of "gurgling oscillating" kind of sound and all freqs were active together. Ian wonders if it might be a frequency hopping system.

Allan Rosewarne has taken on the duties as utility station columnist for the Chicago Area DXers (CADX) club. If you would like more info on CADX, write: Chicago Area DXers, c/o Ed Stroh, 53 Arrowhead Dr., Thornton, IL 60470. Membership is open to anyone in the greater Chicago area.

Jim McLeod, MD checks in for the first time using a Yaesu FRG100, Drake R4, and a DX440 for his military monitoring. Thanks for the note, Jim.

Tom Severt (KS) notes that the mystery "quick brown fox" RTTY station reported last month has gone off the air. No ID was ever noted on any of the frequencies. Tom has started a new column for ACE (Association of Clandestine Radio Enthusiasts) called "Covert Comms" as of the May issue. The column will cover numbers stations and other unidentified communications. For more information about ACE, write Association of Clandestine Radio Enthusiasts, P.O. Box 12112, Norfolk VA 23541. A tip of the old ute hat to Allan and Tom for their club efforts. Now, on with the show...

#### UTE Logging's SSB/CW/DIGITAL All Times in UTC

- 212: UCF, NDB Cienfuegos, Cuba heard at 0455. (WP)
- 224: GVA, NDB Henderson (Geneva) Ky at 0503. (WP)
- 227: SNL, Shawnee, OK at 0443. (RH) SZO, Freyburg, Me at 0709, 145m. (AH)
- 230: Unid NDB VA in CW at 0355. (SD)
- 259: YLP, Mingan, PQ at 0440. (RH)
- 284: TEH, Bogota, Col at 0716, 2556m. (AH)
- 290: YNP, Managua, Nic heard at 1016, 2222m. (AH)
- 310: MCR, Manicore, B heard at 0859, 3332m. (AH)
- 330: A9- Liverpool, NS, Can heard at 0920, 374m. (AH)
- 338: Unid B in CW, w/space between the 2nd/3rd dash at 0400. (SD) 340: BOG, Bogota, Col at 0437, 2542m. (AH)
- 342: At 0404, "Y", Gallantry Head LS, STPM, 831m. (AH)
- 346: LI, NDB Logan Airport Boston MA 2122. (FD)
- 350: 1F- Anta-Bathurst, NB, Can at 0928, 501m. (AH)
- 353: QQ in CW at 0402, last dash in the second Q is very long. (SD)
- 354: UUV, NDB Sullivan, MO at 0037. (RH)
- 356: AR, NDB TF Green Airport, Providence RI at 2135. (FD)
- 359: AMT, NDB West Union, OH at 2225. (RH) TPX, Tepexan, Mexico at 0943. (WP)
- 368: IMR, NDB Marshfield, MA heard at 2050. (FD)
- 375: BO, NDB Logan, Boston, MA heard at 2040. (FD)

#### Abbreviations Used For Intercepts

AM	Amplitude Modulation mode
BC	Broadcast
CW	Morse Code mode
EE	English
GG	German
ID	Identification/led/location
LSB	Lower Sideband mode
OM	Male operator
PP	Portuguese
SS	Spanish
tfc	Traffic
USB	Upper Sideband mode
w/	With
wx	Weather report/forecast
YL	Female operator
4F	4-figure coded groups (i.e. 5739)
5F	5-figure coded groups
5L	5-letter coded groups (i.e. IGRXJ)

- 382: LQ, NDB w/voiceover a/c wx, Logan, Boston, MA at 2025. (FD)
- 371: TZT, NDB Belle Plaine, IA at 0203. (RH)
- 373: UQN, NDB Vidalia, Ga (where the Vidalia onions come from) at 0525. NDB 2R, Tyendinga, PQ, Canada at 0525. (WP)
- 375: BO, NDB Logan, Boston, MA heard at 2040. (FD)
- 402: MQ- Miquelon, STPM at 0657, 829m. SJE, San Jose del Guaviare, Col at 1015, 2694m. (AH)
- 407: LET, Leticia, Col at 0622, 3160m. (AH)
- 420: CFY, NDB Lake City, SC at 0403. (RH)
- 423: AU, NDB Auburn, AL at 0306. (RH)
- 1619.5: PCH, Scheveningen Radio, The Netherlands at 0415 w/sitor free signal & CW ID. (KS)
- 1620: Unid, male voice TIS, call letters were WDBF404 (or at least it sounded like it) and it mentioned Interstate 64 being clear and later something about "Fine Dining and Accommodations" at 0415 in AM. (KS)
- 2182: Unid stn, sounded like 'Manchako Radio', at 0325 w/'PAN-PAN' broadcast re poss vsl in distace, location appeared to be in the Bay of Biscay (43052N/00325W). (RK)
- 2201: VIM, Melbourne Radio, Aus, at 0945 in USB w/wx forecast for Victorian coast. (EW)
- 2354.6: FOXTROT TANGO, USN Link-11 Coordination NCS at 0535 in USB wkg INDIA re track 2743 is call sign N3D; other SLC's in net also. (Ed.)
- 2429: MKL, British Military, UK at 0607 in CW w/METAR wx. (AWH)
- 2670: NQSP, USCGC Vigorous (WMEC-617) at 0740 in USB wkg Group Moriches (NY), adv getting underway momentarily re F/V James Michael; at 0752 wkg F/V James Michael re on-scene wx, POB, etc...vsl has unid distress. (Ed.)
- 2844: BRAVO WHISKEY, USN Net at 0700 in USB w/BW as NCS w/USS John F. Kennedy battlegroup comms, H+00 net summary. Comms were hrd over a week as the JFK group went thru work-ups prior to deployment. Also see 5338.6 & 7988.6 logs. (Ed.)
- 3116: Irkutsk Volmet (YL/RR) in USB mode at 1456. "Irkutsk Mityor" ident & down at 1459. Weaker & mostly unreadable YL up at 1500. Believe this is Russian language Volmet

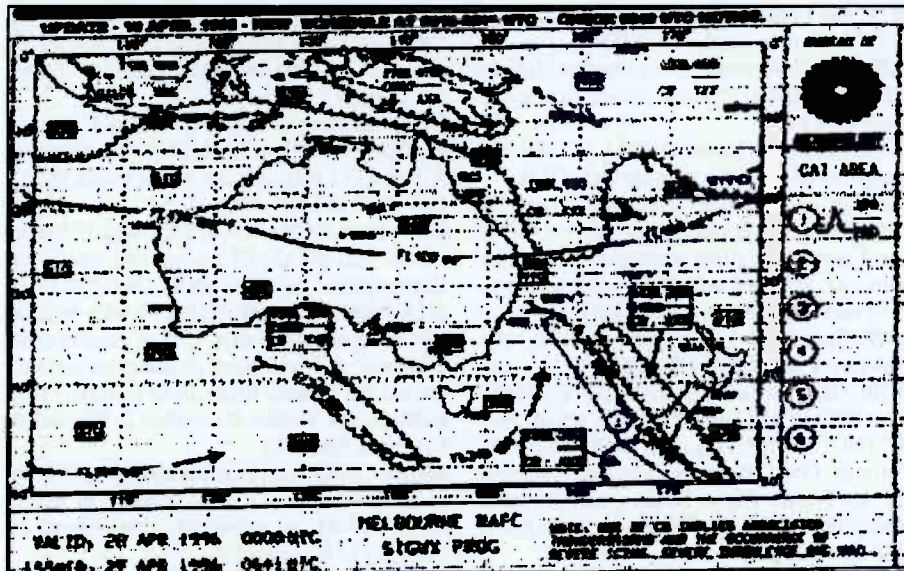

WeFax from the collection of Ronald Tull of AXM34, Melbourne Meteo on 11030.0 kHz.

"Network D". On another occasion, Khabarovsk Volmet signing on in RR. USB at 1515. Was YL/RR, w/very clear "Khabarovsk Mityor" ID. //5691, caught the sign-off ident on both freqs at 1520. (DS) Khabarovsk Volmet at 1225 and Irkutsk Volmet at 1245, both in USB w/avian wx report in RR. (TY)

3407: YL/RR Volmet in USB mode from 1838-1839. Weak, unid. (DS) (poss Aktyubinsk, Kaz at this time slot -Ed.)  
 3438.5: Unid CW stn 2RC8 rptng "V 8L6S DE 2RC8" at 1135. (TY)  
 3440: Unid stn 4XML Rptng "V BFR7 DE 4XML" at 1450 in CW. At 1045, U/i CW stn 6PXJ rptng "V ABYZ DE 6PXJ". (TY)

3455: Tokyo Radio wkg Japan Air flights 777 & 74 at 1412: Flight 74, selcall EG-JK, reported would be at 31N/160E at 1500. At 1413, Qantas-60 notified Tokyo that he had reached FL 370. All USB mode, great copy on all stations. (DS)  
 4214: ZSC, Capetown Rdo, RSA at 1705 in FEC w/Navarea warnings. \ 12601.0 & 16816.0 kHz. (RH2)  
 4268: VTG4, Bombay Comcen rdo, India at 1325 in CW w/marker. (EW)  
 4326: "R". Russian Navy, Ustinov, RUS at 2246 in CW w/channel marker. (AB)  
 4357: WAH, St.Thomas Radio, U.S. Virgin Islands at 0211 in USB w/Caribbean wx in progress read by YL to 0221. (Ed.)  
 4416: P7X in CW at 0221 w/5L msg. Sent numerous msgs, but never sent all 120 grps of any of them. (TS)  
 4447: Unid French Forces C.I. UMF (Souge) at 2132 in ARQ-E 72/400. (DG)  
 4478: YL/SS in AM at 0415 to 0420 weak but Readable. (GS)  
 4610: SAM 31681 heard at 2116 in USB w/pp CROWN via Andrews AFB (AN) (C-9C 73-1681 -Ed.)  
 4663: Khabarovsk Volmet in USB w/avian wx report in heavily accented EE at 1205. (TY)  
 4724: REACH 241 at 0606 wkg McClellan. At 0632 NAVY PF675 w/pp Tinker Ops via McClellan. Both in USB. (AN)  
 4745: 'Andrews' in USB at 0800 clg 'SPAR 99,' no joy. (TS)

# THE REVOLUTIONARY CHEROKEE® CB RADIOS

"Now You're Talking"™

World's First  
 AM/SSB  
 Handheld  
 Only 6 1/2" Tall!

CM-5  
 AM Mobile in  
 a Miniaturized  
 Design

AH-27F  
 Now With  
 Built In  
 Frequency  
 Counter

AH-27-YL  
 Sports Yellow Version

AH-100

CBS-1000 AM/SSB Base Station

Cherokee, the new technology leader in CB radios, offers a full line of innovative, exciting new CB's. From our first model, the revolutionary AH-27 miniature handheld, all the way to our CBS-1000 AM/SSB base station, Cherokee stands alone in our commitment to quality, advanced technology, and performance. With a Cherokee CB radio, "Now You're Talking"™

**For More Information on these radios and where you can purchase them, call us a 1-800-259-0959, or visit us on the web at <http://www.wirelessmarketing.com>**

Cherokee is a registered trademark of the Wireless Marketing Corporation, Schaumburg, Illinois 60008

**5018:** France? RFFEDFE (GROUPFORCE ALFA) at 0630 in ARQ-E 72/400, w/test tlsx to RFFEDFM (GROUPFORCE BRAVO) on ckt UMF; another station same mode noted on 5243, no tfc though. (AWH)

**5064:** 9MB, Malaysian Navy, Georgetown w/CW marker at 1825. (IJ)

**5095:** Unid French Forces, C.I. UFE/RFFEDFE, unlocated, at 2055 in ARQ-E 72/400. (DG)

**5291:** Cuba? CW net at 1415 w/"CCN" wkg "IJK" w/SS plaintext, didn't copy enough of it to figure out the subject matter. First time this net noted in a while, though the call signs have literally been around for years and years. Also noted the peculiar SELCAL or tune-up pulsing noted on other Cuban freqs. (AWH)

**5331:** Cuban voice net at 1602 in USB, QSO w/251, 252, 075, 700, all weak. The typical Cuban SELCAL or tuneup pulsing noted here also. (AWH)

**5338.6:** BRAVO WHISKEY, USN Net at 2125 in USB wkg LIMA WHISKEY (a 2nd NCS station on freq) relaying tfc from c/s LIMA. USS John F. Kennedy battlegroup comms as JFK performed work-up's prior to deployment. (Ed.)

**5340:** Unid CW stn L9CC rptng "V CP17 DE L9CC" at 1425. (TY)

**5403:** Eastern Canada Towing (ECTUG) "Tug Office" at 0335 in USB wkg tug Point Carroll. They are based in Halifax & rarely use HF. (CM)

**5407:** ZKST, New Zealand Civil Defence, Christchurch net control, w/weekly check-ins clg ZKST33 Chatham Islands at 2230 Thursdays in USB. (IJ)

**5427.8:** Unid G-TOR connect mode at 2334, EBMBPT clg PAPIPO, no reply. Has been here frequently since. (AWH)

**5450:** RAF Drayton volmet, UK at 2029 in USB w/wx info for European airports. (EW)

**5468.9:** RFHWWO, French Forces Tahiti at 1230 in ARQ-M2 128.5/85, w/Ch.B running SYNOP wx to Muraroa. (AWH) (circuits to the Muraroa test site all seem to use this odd 128.5 baud -Ed.)

**5502:** PBC, Dutch Navy, Goeree Island at 2222 in 75/850 RTTY. (DG)

**5541:** N480EV at 2200 in USB wkg Stockholm, (selcal CJ-LM) departed Rota 2113, ETA OBBI/Bahrain 0347. (TO)

**5547:** Philippines 105 at 0830 in USB wkg San Francisco rdo, ARP DOLFF at 0828, FL 310, est 46N140W 0909, spd mach .85. (TO)

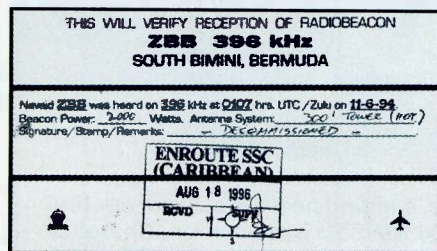

PFC from the collection of Jill Dybka for Beacon ZBB. Beacon fans on the internet are invited to check out Jill's website at <<http://funnelweb.utcc.utk.edu/~jtdybka>>

**5574:** San Francisco rdo at 0929 in USB wkg DELTA 16 re posn report. (EW)

**5629:** SYN2, Mossad, Israel heard at 2047 in USB, YL repeats "sierra yankee november two." (EW)

**5634:** Mauritius Radio at 0211 in USB clg Mauritius 057 no joy, very strong!. (TO)

**5637:** Cuban Spook?, Babbler at 1256, SS/OM w/long counts, poss same OM as heard testing on 5688 a couple of minutes prior. At 1532 SS w/babbler, still going at 1552 recheck. Both in USB. (AWH)

**5649:** Speedbird 179 at 2131 in USB wkg Gander for selcal (BP-CE). (TO)

**5670:** THAI 307 at 1617 w/Madras @ "PPB" (Port Blair VOR 11-40N/92-46E), selcal "FH-JL" (DC10-30ER), reg. HS-TMB, Bangkok-Colombo (JSM) Bombay radio, India at 2014 clg Air France flight. Kuala Lumpur radio, Malaysia at 1318 clg Singapore 747. All in USB mode. (EW)

**5680:** Kinloss Rescue, G at 1050 in USB w/SRG 128. RC and pos.rep. (AB)

**5687:** BOLT 64 (or DOLT?) at 0248 in USB wkg PLANTATION OPS (USAF 16th SOW Hurlburt Field). (AWH)

**5693:** ARCHITECT, RAF Strike Command at 0800 in USB w/H+00 pressure readings. New here. (Ed.)

**5696:** RESCUE 2104 at 0300 in USB wkg CAMSLANT re at 2225 local spotted two strobes at location 1402.8N/06041.9W. Made two low passes, saw a small boat with sail, 2-3 people on board w/white flashing signal. Reported vsl in distress to "Emergency 44", a French-accented operator who needed many repeats. Emergency 44 offered help by 1:00 AM but 2104 had contacted Coast Guard "Protector" out of St. Lucia on 7850.0 MHz and reported they could be on site within one hour. (BN) (7850.0 is a Caribbean Police frequency - Ed.)

**5700.5:** 'Habitat' in USB at 0500 wkg U0A. USN Link-11 coordination comms. (TS)

**5841:** At 1815, 205 wkg PANTHER in USB re the intercept of a vsl, PANTHER reqs 51 ALPHA pass the posn, heading & speed of the vsl they are tracking. 51 ALPHA ltr reqs PANTHER to have duty agent stop & board vessel as enters marina. (MF)

**5879.5:** P7X here at 0922 // w/ 4416. (TS)

**6224:** KCE270 wkg vsl Atlantic Breeze at 1250 in USB, latter near Great Inagua. (AWH) (Maritime Enterprises Inc., N. Miami, FL -Ed.)

**6344:** Unid at 2041 in FEC w/traffic list, unable to determine ID because of multiple call signs, gave WLO/WSC/KLB as calls. (SW) (WLO here - Ed.)

**6382:** TBA6, Turkish Navy, Ankara, Turkey at 2204 in CW. (DG)

**6397:** JMC3, Tokyo meteo, Japan at 0923 in CW w/wx info. (EW)

**6556:** Qantas 62 at 1715 wkg Bali, posn KEONG 1710, FL 370, selcal ck (LQ-CD). Koreanair 981 at 1716 wkg Calcutta, can't read each other. ATC req QSY to 3491??. Singapore 229 at 1722 wkg Perth, FL 370, posn PD. Mandarin 801 at 1723 clg Ujung Pandang, no joy. All in USB mode. (TO)

**6589:** Cuban strange relay was active again, 1600+ w/mostly just hum, at 1615 USTACA (?) clg ROMANO, otherwise very little activity. (AWH)

**6628:** Cubana 473 at 2102 wkg Canarias w/ARP, 29N25W at 2102, FL 310. Lufthansa 537 at 2143 wkg NY for selcal check (CM-LS). Both in USB. (TO)

**6637:** Fine Air N44UA at 0537 wkg Houston LDOC (selcal AK-HL) posn 140 mis S. of Barranquilla: departed BOG 0445/59 ETA MIA 0800. At 0540, N160GC wkg Miami LDOC re arrival at dest. CYGK, mention of Canpass? and will need customs on arrival. Global Air Charter flight. Both in USB. (TO)

**6658:** Sierra Yankee November 2, Mossad at 0147 in USB. (CS)

**6661.7:** Unid Egyptian Embassy w/ATU-A msgs & selcalling TVVM at 1830 in ARQ. (IJ) (TVVM is reportedly the Egyptian embassy in Kuwait - Ed.)

**6676:** Bangkok Volmet at 0940 and Sydney Volmet at 1000 both in USB w/avian wx report in EE. (TY)

**6683:** SAM 787, E-4B tail 74-0787 at 2359 in USB wkg Andy VIP on "731" for incoming pp, had SecDef on board. (Ed.)

**6715:** SPAR 63 at 2359 in USB w/pp via Thule. (AN) (VIP flt -Ed.)

**6745:** "UNII" AFTN Yenisek Air, Russia, w/Wx synopsis at 0900 in 50/425 RTTY. (IJ)

**6760:** "Tired Hand" spook station in CW, heard from 1920-1930 repeating "540 540 540 65897 65897", 20wpm keyboard send, 0 as long T, first time heard in months, at least they finally bought the poor sap something other than an old brass manual key. Off w/out fanfare. (AWH)

**6768:** SS/YL at 0428 in AM w/5FG# Station (Fri). (AN)

**6780:** Russian Man, in progress at 0208 in USB. (CS) Unid ETS w/RVRY at 1810 in 50/425 RTTY. (IJ) (Addis Ababa Air -Ed.)

**6786:** YL/SS at 0659 in AM w/5FG# Station (Wed). (AN)

**6823:** "SA" and "KE" Tongan Defence Force mentioned that U.S. Marines arriving Tonga 'tapu for exercise at 1930 in USB. (IJ)

**6826:** YL/SS w/5FG 0300 to 0338, Atencion x3, w/3 5FG's in between each Atencion. The carrier remained open for approximately 20 minutes after the numbers ceased. (GS)

**6840:** Unknown YL 'Counting' station at 2005 in USB w/7LG. Broadcast ended abruptly at 2010Z. (BOZ) (should be Mossad "JSR" station here - Ed.)

**6855:** SS/YL at 1600 in USB w/5FG, poor signal. (CS)

**6869:** SS/OM in progress at 1506 in USB, "Atencion Atencion Atencion 7 2 29 7 2 29 1 2 3 4 5 6 7 8 9 10" The 29 was one word "biente nueve". Then at 1509 heard "Atencion 7 2 90 final final" w/the 90 again as one word, "noventa". Curious how this station does not just use the digits 0 to 9. (CS)

**6900:** Unknown YL 'Counting' station at 2011 in USB w/5FG. Different operator than 6840KHz. (BOZ) (poss Lincolnshire Poacher here - Ed.)

**6908:** Philippines Army counter-insurgency net gave a large list of names and mentioned they all belonged to the Christian Liberation Front at 1100 in USB. (IJ)

**6925:** KKN50 in CW (USB) on WED, Hrd from 0611 to 0612. (KM) (c/s officially listed as U.S. Department of State on 6925.5, real user? - Ed.)

**6936.7:** RFLI, French Forces, Fort de France at 0640 in ARQ-E3 192/342 idling. (RH2) (circuit ID "LIJ" - Ed.)

**6986:** Andrews at 1855 in USB conducting radio check NAVY 511, 511 also he was carrying code 2 plus 5. (MF) (VP-3A bureau #150511 used by USMC HQ - Ed.)

**7070:** Unid CW stn L9CC rptng "V CP17 DE L9CC" at 1415. (TY)

**7535:** USS Portland (LSD-37) at 1451 wkg Norfolk SESEF for transmitter tests. At 1550 SESEF wkg "Magnolia" (unheard). Poss went to ANDVT type comms. At 1656 USS Normandy (CG-60) working SESEF for transmitter tests. (MK) Other ships hrd wkg SESEF: NEBP, USS Wasp (LHD-1) at 1825; NIGP, USNS Apache (T-ATF-172) at 1815; NKID, USS Kidd (DDG-993) at 1540; NKSZ, USNS Capable (T-AGOS-16) at 1639; NRAR, USS Monterey (CG-61) at 1420; PCU Hopper (DDG-70) at 1520 (Pre-Commissioned Unit); NBTC, USCGC Aquidneck (WPB-1309) at 1800; USS Barry (DDG-52) at 1935; USS Firebolt (PC-10) at 1401. Primary mode is USB. (Ed.)

**7540:** YL/EE in USB mode at 1432 repeats "JSR" copied in NATO phonetics until 1433, then announces 2 messages, has been heard //5091, and also at 1200, 1300, and 1530 skeds. (DS)

**7634:** P6Z, France at 0553 in FEC-A 192/400 for P8C, O9B, etc, 5LG telexes from RFGW. (AWH)

**7685:** Telecom, Tokelau Islands, caught one of the last phone calls on HF before closing down. Have now switched to Satellite at 0400 in USB. (IJ)

**7693:** 3BT3, Vacaos Meteo, Mauritius, w/WX synopsis at 1830 in 75/425 RTTY. (IJ)

**7841.7:** RFFXI, French Forces Bangui, Central African Empire at 2047 in ARQ-E3 96/425 idle. (EW)

**7878:** 4XZ, Israeli Navy, Haifa, w/CW marker at 1810. (IJ) Same at 0145 w/"NR.6 JJJ KDJKD", into 5LG's, fol by CQ marker "DE 4XZ". (Ed.)

**7890:** YL/SS in AM at 0211 w/5F msg. (TS)

**7988.6:** Unid at 1510 BW wkg T, ments Halley 41, Scale 31, others. USN tracking net of some sort, strong. (AWH) BRAVO WHISKEY at 2357 wkg GULF, others w/USS John F. Kennedy battlegroup work-up comms. (Ed.)

**8001.7:** RFLI, French Forces, Fort de France, Martinique at 1122 in ARQ-E3 96/425 idling. (EW)

**8014:** YL/EE in AM mode at 1103 repeats 1-0 counts & "345-345- 345". Noted with 3/2F groups at 1115 //10597. On another day, YL/EE in AM mode at 1514 with 3/2F groups. At 1530, "repeat... count 215 . . . count 215" and into 3/2F again. "End" at 1550. (DS)

**8016.7:** MFA Cairo, Egypt at 2004 in ARQ msgs in Arabic atu-80. (EW)

**8020:** HMF85, KCNA Pyongyang, N.Korea at 1545 in 50/250 RTTY w/nx. (DG)

**8026:** Air Force One at 2206 in USB w/Andrews, rx ck (a couple of times thereafter) as Bill made his way back from Helsinki. (HO)

**8039.5:** P7X in CW at 0455 w/5L msgs & data burst xmissions. QRM'ed by WEFAX. (TS)

**8150:** Unid OM/SS at 0110 in USB clg SAN CLEMENTE 54 (callword is a maybe). (DW)

**8157:** Unid spook, interesting CW one; 1630 had 50 wpm autokeyed 5FGs w/cut zero=T; then into hand-keyed 5LG tfc around 20 wpm. VERY strong. Mid msg at 1646 threw in a "QSY 5814" but kept going here. At 1650 w/out warning suddenly QSY'd to 5814 w/little interruption, then soon back into fast (now 41 wpm) 5FGs. Couldn't stick with it, but checking capture file after-the-fact found another "QSY 6866" a few minutes later, followed by several minutes more traffic again before the actual QSY. (AWH)

**8390:** UWEC, NISP Professor Khromov at 0133 in 50/170 RTTY, Ukrainian Antarctic hydrometeorological research vs1 w/RYRY to RNO, Moscow meteo Antarctica section, & passes sev admin TG's. (Ed.)

**8423.5:** DAN, Norddeich Radio, Ger at 1759 in FEC. (DG)

**8445:** XSX, Keelung radio, Taiwan at 1044 w/CW wx broadcast. (EW)

**8525:** WNU33, Slidell Radio at 2159 in CW clg CQ. (SW)

**8819:** Alma Ata Volmet w/avian wx report in RR at 1219. (TY)

**8846:** TANK 19 at 1807 in USB wkg NY reporting FL 210 & below, still Due Regard and squawking. (TO)

**8879:** United 917 at 1532 in USB wkg Iceland Radio posn 6145N/ 3057W; ETA Keflavik 1609Z. 'Requesting decent ASAP' re medical emergency on board. (BOZ)

**8891:** Speedbird 283 at 1744 w/Churchill rdo @ 80W polar track "GULF", selcal BP-AK,

reg. G-BNLE, 747-400. (JSM)

**8903:** Nigeria 9909 heard at 2317 in USB w/Kano @ "SEMIT" (13-44.5N/ 008-2.3E) FL330, reg 9G-MKE, DC-8 Freighter (self-ID'd). (JSM)

**8906:** United 917 at 1445 in USB wkg Gander re medical emergency; posn 58N/034W, diverting to Gander. After a few minutes, pilot adv have re-considered & will divert to Keflavik, Iceland. They wish to turn ASAP & climb. Gander adv them to standby. After waiting a few minutes, 917 asks reason for delay, must turn now, if necessary he will declare a medical emergency. Again, Gander adv them to standby. 917 promptly declares a medical emergency. Gander asks nature of emergency & services required upon arrival. Pilot adv emergency was heart attack. (see 8879 log also) (BOZ)

**8948:** Air-to-ground traffic heard in EE in USB mode from 1212-1216. Based on the accents of the stations heard, probably India domestic/regional network, but copy wasn't good enough to hear any firm idents. (DS)

**8968:** CHUCK 96 at 2056 in USB wkg Thule GHFS w/pp to 440 DSN. 96 asked for TOM-CAT 02 who was not available. Asked for rescheduling of AR02. (BOZ)

**8971:** BLUE STAR (?) clg TRIDENT 04 (?). No joy. FIGHTING TIGER 720 wkg Hotel 4 Romeo. Both parties having a hard time hearing ea other. (RK) (BLUE STAR is NAS Roosevelt Roads, PR; TRIDENT calls are P-3C's of VP-26 "Tridents" at NAS Brunswick, Me; F.Tiger is most likely P-3C of VP-8 "Tigers" also at NAS Brunswick -Ed.) **9063:** YL/SS w/5FG 0220 to 0242. (GS)

**9126.7:** RFTJD, French Forces, Libreville, GAB at 0501 in ARQ-E3 192/385 w/FF tfc to unid sta. (RH2) (is C.I. HAI to Paris -Ed.)

**9152:** GYU, Gibraltar at 2340 in Piccolo-6 w/op chat "BLUE DE GYU LO PAL CIP CIP" into idle. (AWH)

**9251:** Lincolnshire Poacher at 2111 in USB w/5FG's, // 6959 (Jamming), // 5746. (BOZ)

## READER SERVICE CARD

Use Your Free Reader Service Card For More Information On Companies Advertising In This Issue.



## We Have Scanners with 800MHz Coverage!

ICOM R9000, R8500, R10, R100

Yupiteru MVT-7100, MVT-8000, MVT-9000

AOR AR-8000, AR-5000, AR-3000A, Scout hook-up's

WinRadio for PC-500Khz-1300Mhz continuous coverage

### AR-8000 Wide Range Receiver

500KHz~1900MHz coverage AM/NFM/WFM/USB/LSB/CW

1000 Memory Channels (50 x 20) • Computer Interface

Ferrite Rod Antenna for below 2MHz • Selectable Step Size

### ATLANTIC HAM RADIO Ltd.

(416) 636-3636

(416) 631-0747 fax

<http://www.interlog.com/~ahr>

368 Wilson Ave  
Downsview, ON  
Canada M3H 1S9



All U.S. Orders Shipped Air

Same, YL/EE 5F msg at 2004 //11545. (TS)  
**9438:** JM3, Tokyo meteo, Japan, at 0913 w/120/576 FAX wx map. (EW)  
**9865:** SS/YL at 0811 in AM w/5FG# Station (Sun). (AN)  
**9927.5:** RXA76, Almaty Meteo, KAZ at 1045 w/60/576 FAX, chart. (DG)  
**10051:** New York Radio with aviation wx at 2005 in USB. (SW)  
**10121:** SUU, Cairo meteo, Egypt at 1850 w/120/576 FAX wx map. (EW)  
**10126:** SS/YL at 0135 in AM w/5FG# Station (Thu). (AN)  
**10314:** SNN299, MFA Warsaw, POL at 1110 in POL-ARQ 100bd w/msg to Madrid. (AB)  
**10420:** "MUH6", MUH6B" & various units Australian Army exercise at 0600 in USB. (IJ)  
**10426:** Lincolnshire Poacher at 1630 in USB // 11545. (CS)  
**10452:** Lincolnshire Poacher nbr stn in USB at 1005 in EE, also on 17499 kHz. (TY)  
**10456.6:** CLP1 MFA Havana Cuba w/circulars at 0430 in 50/500 RTTY. (IJ)  
**10529:** YL/EE in AM at 1323 w/3+2FG's, also on 7547 kHz. (TY)  
**10536:** CHF, Canadian Forces, Halifax at 1546 w/75 bd RTTY aviation wx, followed by coastal wx forecasts, off at 1552. (SW)  
**10584:** Russian FAPSI station KUL, unlocated, at 1539 in 75/500 RTTY. (DG)  
**10626:** "RFFXL" French Forces Naquora, Lebanon w/Controle de Voie at 0630 in ARQ-E 184Bd. (IJ)  
**10639:** NPX, South Pole, Antarctica w/daily Meteo reports at 0700 in USB. (IJ)  
**10650:** BJZ23, Wuhan meteo, China copied at 0945 in 75/425 RTTY w/wx info for Chinese cities. (EW)  
**11175:** SAM 31682 at 2235 w/pp via MacDill, GORDO 12 at 1653 w/pp NIGHTWATCH 01 via unid GHFS. EXECUTIVE ONE FOX-TROT at 2012 w/pp via Ascension. (AN) (31682 is C-9C 73-1682 -Ed.) DRAGNET TANGO at 1930 in USB w/kg Offutt w/pp to 339 DSN, adv Offutt to use C/S "Charlie Flight", was given the go ahead on the pp, but terminated because signal quality was poor. (BOZ) REACH 67956 at 1800 w/flt info & "basic & nav mode of auto pilot is inop in lateral axis. Can hold altitude but must steer plane manually. (HO) Navy JA05 (P-3) at 1741 w/kg Offutt w/pp to Patrick Ops. ADMO (Army boat?) at 1509 clg any station w/no joy. (MK) (ADMO is the USAV El Chaney (LCU-2017), This is a Army Transportation Corp Runneymeade-class 'Landing Craft Utility' - Ed)  
**11176:** Unid British operator at 1952 in USB testing xmitter in a jovial voice. Followed by un-encrypted RYRYRY. Two different xmtrs were tested. (BOZ)  
**11177:** Belgian Navy in USB at 2358, u/i patrol in EE "we are altering course to intercept fishing vessel. other OM/EE replies "Oostende out." (RK)  
**11220:** SPAR 63 at 2029 in USB clg Andrews AFB (AN)  
**11244:** Andrews at 1755 in USB advising an unknown station of the NIGHTWATCH frequencies: Z165 6757KHz (Primary) & Z175 9016KHz (Secondary). (BOZ)  
**11309:** 'New York' w/kg 'Speedbird 257' in USB at 1610 w/selcal check. (TS)  
**11342:** USAir 1970 at 2100 in USB w/kg NY ARINC re selcal ck PQ-FM, SJU-BWI/737-400. (TO)  
**11460:** Andrews at 2100 in USB w/kg SAM 365 re VIP flight. Mention was made of a different A/C meeting them. (BOZ) (C-20H tail 92-0375 - Ed)  
**11476:** HMF52, KCNA Pyongyang, N. Korea received at 0015 w/FAX in 60/288, wirephoto of person seated at radio, Korean text to 0020. (Ed.)  
**11570:** YL/EE "Cherry Ripe" stn rptng 09828 & 5F msg at 1300. (TS)  
**11585:** VZ8SK, School for Distant Education, Katherine NT, Australia, w/kids doing their lessons at 0400 in USB. (IJ)  
**11631.7:** RFTJ, French Forces, Dakar, SEN at 1230 in ARQ-E3 192/400, idle, at 1312 Controle de Voie message w/C.I. TJI. (AWH)  
**12134.2:** DOR, MFA Sofia, Bulgaria at 0956 in 212/500 RTTY. (DG)  
**12196:** Unid stn copied in RTTY 75/425 w/5LG's at 1951. Stn ended msg w/NIL, then sent CFM TKS GB SK SK. Poss SOUD stn. (TS) (should be link 00125 MIG Havana to WFO Managua - Ed.)  
**12568:** UUZC, BATM Admiral Padorin at 1709 in 50/170 RTTY, Ukrainian-flagged "Bolshoj Avtonomnyj Tral'shchik Murilzhnik" (BATM) or Large Autonomous Trawler, Freezer, w/admin tfc to Murmansk Tralflot FRPZ from master KMD Korsakov, using hull#/ID MA-0065. (Ed.)  
**12709:** FJP23, Noumea radio, New Caledonia at 0821 in CW w/cq de fjp23. (EW)  
**12950:** Fishing vessel comms in USB at 2137. (TS)  
**13158:** OM/cc w/repeating ann for Beijing (?) Radio, blur went something like, "Cho li shieh Beijing ontai (2X), shen dai wu shieh (2X), chon tai (3x)." Medium sigz and not very clear, but strong, clean sigz on //8812. Was USB mode, and abruptly down in mid-sentence at 1439. (DS)  
**13212:** OZU25, MFA Copenhagen, Denmark w/Msgs to various embassies at 0730 in Twinplex-ARQ. (IJ)  
**13264:** Shannon Volmet in USB at 2151 w/WX. (TS)  
**13538:** ZRO3, Pretoria Meteo at 0813 in FAX w/120/576 excellent Antarctic ice chart analysis. (RH2)  
**13621:** Cuba? probably ex-SOUD, at 2242, in 75/500 RTTY, w/5LGs into SK SK and gone. (AWH)  
**14363:** DKR, unid Russian FAPSI station at 0841 in 75/500 RTTY. (DG)  
**14469:** Lincolnshire Poacher nbr stn in USE at 1120 w/5FG's. (TY)  
**14708.5:** MKK, British Military, copied at 1330 in Piccolo-6, mostly idle, finally ID'd at 1611. (AWH)  
**14734:** Polish Embassy, Algeria at 1130 in POL-ARQ 100/250. (DG)  
**14871:** Lincolnshire Poacher nbr stn in USB at 1015 w/5FG's in EE, also on 15682 kHz. (TY)  
**14941.7:** FJY3, DTRE Durmont D'urville, Antarctica w/Msgs at 0300 ARQ-E 96Bd. (IJ)  
**15034:** Trenton Military at 1930 in USB w/wx broadcast. (AN)  
**15682:** Lincolnshire Poacher nbr stn in USE at 1015 w/5FG's in EE, also on 14871 kHz. (TY)  
**15970.5:** KKN50 in CW at 1809 w/QRA DE KKN50 mrkr. (TS)  
**16118:** HBD20, MFA Berne at 1650 in ARQ w/5LG'S to unk. (RH2)  
**16313:** CLP1, MFA Havana, Cuba w/nx in EE at 2045 in 50/500 RTTY. (IJ)  
**16432:** 3EIMC, Zanzibar Rdo at 0830 in USB clg MV Pina, no reply. (RH2)  
**16801.6:** UUIV, RKTS General Petrov at 1153 in 50/170 RTTY reporting fish catch from Las Palmas. (RH2)  
**16956:** XVS, Hochiminhville radio, Vietnam copied at 0952 in CW w/de xvs traffic list at 0950. (EW)  
**17428.5:** SAM, MFA Stockholm at 1203 in SWED-ARQ 100/400 w/Swede tfc to Ambassador, Kampala. (RH2)  
**18173.5:** STK, "HSSS" AFTN Khartoum air, Sudan w/RYRY copied at 0130 in 50/425 RTTY. (IJ)  
**18552:** MFA Bucharest at 1151 in ROU-FEC 164.5/400 w/circulara tfc. (RH2)  
**18801.7:** MFA Jakarta, Indonesia w/Msgs to Hanoi, Vietnam in 50/250 RTTY. (IJ)  
**19095:** YL/EE in AM mode at 0015 passes 3/2F groups. "Repeat, repeat" at 0030. Strong! //16198. (DS)  
**19692.5:** ZSC, Capetown Rdo copied at 1054 w/ARQ & CW ID, new frequency. (RH2)  
**19961:** Two unid white noise signals at 2000, one in USB & the other in LSB. (TS)  
**20140:** SOUD stn in RTTY 75/500 w/ 5L grp msg for YBU. Had better copy on this stn on its repeat freq of 17480. (TS)  
**22589.5:** SVA7, Athens radio, Greece at 0906 in CW w/cq de sva7. (EW)

This months contributors: (AB) Ary Boender, The Netherlands; (AH) Al Hemmalin, RI; (AN) Anonymous, Midwest USA; (AWH) Albert W. Hussein, FL; (BN) Bob Nickels, IL; (BOZ) Richard in Iceland; (CM) Craig J. MacKinnon, NS, Canada; (CS) Chris Smolinski, MD; (DG) Dave Gentile, UK; (DS) Dave Sabo, South Korea; (EW) Eddy Waters, Australia; (FD) Francis D. Donovan, MA; (GS) Gary Seven, NY; (HO) Harold Ort, NJ; (IJ) Ian Julian, New Zealand; (JSM) Steve McDonald, BC, Canada; (KM) Ken McWatters, TX; (MF) Mike Fink, FL; (MK) Mark Kirker, NY; (RH) Russ Hill, MI; (RH2) Robert Hall, Capetown, South Africa; (RK) Rich Klingman, NY; (SD) Scott Diback, MI; (SW) Sue Wilden, IN; (TO) Tony Orr, VA; (TS) Tom Severt, KS; (TY) Takashi Yamaguchi, Nagasaki, Japan; (WP) Walt Petersen, FL; and (Ed.) ye editor in Ohio. Thanks to all. ■



# Communications Enroute

YOUR LINK TO PERSONAL COMMUNICATIONS

## Has Your Number Come Up?

A few weeks ago I called a fishing buddy at home from my boat's cellphone. He asked where I was calling from. I was surprised at the question because he'd never before asked. He went on to explain that when he gets cellphone calls, his Caller ID always reads out "Unavailable," which is also how most long-distance calls show up. What confused him with my call that day, was the appearance of a phone number displayed on his Caller ID box. He thought I might be calling from a pay phone or other exotic locale.

When I asked him to read back the number being displayed, it was my cellphone number! I was curious. No, actually the operative word was flabbergasted. I then tried my handheld and confirmed that number appeared on the Caller ID, too.

A fellow who keeps his boat in a slip near mine has his cellphone account with the service reseller I use. I asked him if he knew about this, but he didn't. He called his home to check, only to find out that his cellular number suddenly appeared on the Caller ID. Talk about freaking out! He didn't enjoy learning his number had become so readily available to everyone he called. He told me he's on his cellular a lot.

For whatever reasons, our cellular service supplier had obviously instituted a new policy whereby this data became available on-line when customers placed calls. Customers were never told! What a dirty trick. Given all of the media attention about cellphone numbers being stolen, this stunt seemed all the worse.

My understanding has always been that cellphone numbers are the same as "unpublished" numbers. Directory Assistance won't give them out. Users, themselves, reveal them very sparingly to avoid receiving and paying for calls from people they can wait to hear from later by landline.

Promptly, I called my service supplier and presented a litany of reasons why I didn't want my cellphone number transmitted to Caller ID machines. The customer rep offered no explanation, de-



The Panasonic RY-P1000 alphanumeric pager not only receives your personal messages, but can bring you sports, news, stock prices, weather, and other services.

fense, or argument about why the numbers were made available in this manner. I was politely told that the company would accommodate my wishes if I wanted my number blocked so that it would no longer appear on Caller IDs. I told them to sign me up, pronto. But why should someone need to *specifically* request their cellular number be blocked this way?

The next day I checked to see if the change was made. It was, and the call came through reading "Anonymous." This is the way blocked landline calls show up. My friend with the Caller ID box keeps his own cellphone account with another local service reseller and (so far) his cellphone calls go through shown as "Unavailable."

This incident is passed along for whatever interest and possible relevance it might have to you. I can't imagine that anyone would want their service supplier to freely disseminate their car phone

number to all of their callers. It was only because of an observant friend that my company's changed policy even came to my attention.

Hopefully your service supplier or reseller isn't a weasel like mine, and you will have nothing to worry about. It's worth occasionally checking to see if your cell phone number pops up on a Caller ID box. Doesn't cost anything to dial-up, let it ring a couple of times, and find out. If your number appears, my suggestion is to demand that it be blocked. We're interested in your opinion of these matters, also in learning if you have had a similar experience.

### The Beat Goes On

A Mayo Clinic medical researcher conducted a survey and determined that persons with heart pacemakers should be aware that digital cell phones could cause the pacers to malfunction or turn off. The

---

***“My understanding has always been that cellphone numbers are the same as ‘unpublished’ numbers.”***

---

problem is most serious when the antenna is near the chest area, such as if the cell phone is carried in a shirt pocket, although it was still noted to be a potential risk even when held at ear-level.

In the survey, digital cellulares used at chest or ear level, produced interference to pacemakers in nearly 54 percent of the 975 patients tested. Analog cellulares caused interference to slightly more than three percent. The Mayo Clinic recommended that persons wearing pacemakers avoid carrying either digital or analog cellulares in their shirt pockets.

This information from the Mayo Clinic, useful as it is, stopped short of being as helpful as it might have been. For instance, can pacemaker wearers safely use digital 900 MHz cordless telephones? Also, do digital cell phones affect implanted heart defibrillators?

In light of the Mayo Clinic's test results with digital cell phones on pacemakers, certainly further study is warranted.

These cautions appear reasonable. Twenty years ago we were warning CBers with pacemakers about the possible dangers of using big juice linear amplifiers with their radios.

Additional information about radiofrequency (RF) emission hazards can be obtained through several FCC sources, such as the one on Web at <<http://www.fcc.gov/oet/faqs>>. RF safety questions are answered and further RF documents and information are contained under the Cellular Telephony Section.

FCC OET Bulletins 56 and 65 concerning effects and potential RF hazards may be requested through the Radiofrequency Safety Program at (202) 418-2464. Additionally, when you call, the FCC will respond to any specific questions about RF hazards.

The FCC maintains a Communications and Crisis Management Center which is staffed 24-hours-a-day, seven days a week. In the event of an emergency, such as an RF hazard threat to the general public's safety or health, you may call (202) 632-6975. The watch officer at that number can contact compliance personnel in your area and dispatch them within a matter of hours.

The FCC uses RF exposure standards and guidelines developed by those with the appropriate expertise. Since 1985, the FCC had relied upon the RF exposure guidelines set in 1982 by the American National Standards Institute (ANSI). In 1991, the Institute of Electrical and Electronic Engineers (IEEE) issued guidelines intended to replace the 1982 ANSI guidelines. ANSI adopted them, and the newer guidelines were recently adopted by the FCC.

---

## Getting Rooked, and Enjoying it!

---

What with beepers so popular and plentiful, and the service so inexpensive, there are now some quirky things being done with them. This takes them far beyond their original purpose of asking for calls to be returned. Remember, messages don't need to be phone numbers!

A reader in Minn., who gave only the initials W.L., tells us about the nationwide paging service that he and several of his friends subscribe to. Paging messages are placed by dialing up a toll-free telephone number. That allows W.L. and his pals to play long-distance chess, with all the moves specified over the pagers. Great idea. With a bit of imagination, this could easily be adapted to many other games or even sports endeavors.

Here's an idea I picked up from a reader: A couple of other area scanner freaks and I use beepers to instantly alert one another to active frequencies when we discover something especially hot taking place on police, fire, federal, aero, maritime, media, military, or other bands. Their beeper dial-up numbers are programmed into my speed dialer, and then all I need do is simply enter a frequency instead of a call-back number. They do the same. They learn the frequency wherever they are located. This way, all can keep current even if someone's scanner was turned off, or if that frequency was missed, or if someone is at or in the mobile with the handheld. A couple of these people have nitty-gritty jobs, and have turned up very wild frequencies to feed into our little *scannerlert* net.

This is such a simple and inexpensive convenience that we use it frequently. The more we use it, the better it becomes. With beeper service available in many areas for only a couple of bucks a month, this is something any local group of scanner enthusiasts can readily put to use.

If you have a new or novel use for beepers, let us know.

---

## An Odd Idea

---

We regularly receive catalogs from many communications related companies, plus mailings from companies like J.C. Whitney auto supplies, Johnson Smith & Co., even one offering marine hardware. Few catalogs equal the trendy array of pricey trinkets shown in the Hammacher Schlemmer catalog. The items are presented so dazzlingly that you may have to think hard to decide if something is actually going to be the best way to meet your needs. One such item was brought to our attention by Louis E. Hitchcock, of Wake Island, Hawaii. It's called the *SOS Quick Rescue Phone*, and it sells for about \$100.

According to the clipping Louis sent, this is essentially a portable cellular emergency callbox designed to summon aid. It's an attractive gizmo, even designed to look like a highway callbox. It doesn't receive calls, but it can make outgoing calls to three factory preset numbers. It has potentials for use by motorists, cyclists, campers, hunters, backpackers, mountain climbers, or as a backup safety system on small boats in case the VHF-FM fails. It will work anywhere cellular service is available.

In an emergency, you flip it open, turn it on, and press one of its three automatic dial-up buttons. You can then talk with 9-1-1, or a tow truck, or an "SOS Agent." The SOS Agent is an operator who can put you in touch with a family member, friend, physician, or other person on your list (you may specify 10 numbers).

The simple unit has a volume control, a low battery light, a roaming light, and a "no service available" light. The catalog states there is a one-time \$35 service activation charge. It says there is a nominal (unspecified) monthly charge.

Here's an emergency-only portable personal callbox for persons who don't want to yak, but will feel reassured at knowing they can summon help with the simple press of a panic button. I quickly thought of several friends and relatives who would consider this a safety device they would definitely want to own.

The catalog mentioned that calls to 9-1-1 are free. But wait! Does that make you wonder about the other calls? Why weren't they mentioned? It was a clue to give this a closer look. When we spoke to Hammacher Schlemmer, they said that all

other calls require payment for air time. Whoa! That turns out to be at a staggering \$1.45 per minute. Oh, and the nominal monthly charge to have the service, they revealed, was \$10.

Think about it. When you add it up, you are paying about \$100 to buy a limited-function no frills cell phone. You pay \$35 to activate it, \$120 per year in service fees, plus \$1.45 per minute for air time, AND . . . you can't receive incoming calls on the thing. All it's good for is to dial-up only three factory pre-programmed numbers, one of which puts you through to an operator. That operator will connect you to no more than 10 other numbers, with the meter running while it happens.

For a fraction of the cost of buying and using *The SOS Quick Rescue Phone*, a person would probably be better served signing a one year service contract package deal with any local carrier. Just shop around and see what they're offering.

Compare this against the SOS phone. My local paper today has the following special cell phone package offer: A full featured cell phone for 95 cents, with no activation fee. It can receive incoming calls, and also directly dial-up any numbers you wanted. Calls to 9-1-1 are free. You pay a \$20 monthly service charge. This package includes a year's worth of unlimited local weekend air time, 20 minutes air time per month, with additional air time no more than 49 cents per minute depending upon day/hour. They sweeten the deal with a cigarette lighter adapter, 20 hour nickel hydride battery, and hands-free package.

Everyone knows what emergency highway callboxes are, so the public is pre-sold on their usefulness. The novel perception of carrying around one's own personal emergency callbox as a safety measure has a valid logic that will appeal to many. It's an excellent marketing approach. Yet, it seems to me that most SOS phone users are probably people who remain uninformed about the significantly better potentials at lower cost of full cell phone service.

### Wireless E-Mail

Panasonic is now offering three new multi-function alphanumeric pagers, the RY-P1000, RY-P700 and RY-P500. The devices are marketed in collaboration with Access Global Communications Corp., a pioneer in the field of Radio Broadcast Data System (RBDS).

In addition to typical business and personal messages left by subscribers, the new pagers can scroll extended messages, with the RY-P1000 able to store up to 2,000 characters in its mailbox memory. Owners of the units can call a toll-free number shown on the units and request subscription activation of various services that will be sent to their pagers. These include stock market news (NYSE/NASDAQ), Reuters news headlines, NWS weather, sports and entertainment, plus others.

The Panasonic units can be programmed to accept programming for various combinations of services. For instance, the RY-P1000 has 10 service codes which the user can designate for personal messages, business messages, or different information services. The RY-P700 has five slots, while the RY-P500 offers two.

These units have extensive memory storages. Each memory slot can store up to 80 characters. The RY-P1000 has 120 memory storage slots, while the RY-P700 can store up to 60 messages. The RY-P500 can store 20 messages of up to 32 characters per message. Messages can be locked in to protect against overwriting. In addition, the RY-P1000 can store and alphabetically sort up to 100 phone numbers, names and addresses. Each incoming message is provided with a date/time stamp by the station sending the message.

Access Global provides the radio paging and will ultimately have the service nationwide, so that the same pager device would work in New York, or Los Angeles, or anywhere there is an RBDS signal. RBDS is sent out over subcarriers of FM broadcast station signals.

MSRP of the three units ranges between about \$100 and \$150. The units are being introduced in the Western states. They might be available in all areas by the time you read this. To receive more information, contact Panasonic Consumer Electronics Company, One Panasonic Way, Secaucus, NJ 07094. Phone (800) 489-8989.

You are invited to provide any comments, opinions, news clippings and product information relating to cell phones, cordless phones, beepers, air/ground phones, PCS or any of the personal communications services. Please indicate your submission is for "Communications Enroute" in the address of any mail sent to the column. Our direct e-mail address is <K2AES@juno.com>.

## WE HAVE IT ALL!

### Surveillance

Infinity Transmitters  
 FM Wireless Transmitter Kits  
 Vehicle Tracking Systems  
 Bug Detectors  
 Caller I.D.  
 Wired Mikes  
 Telephone Register with Printer  
 Long-play Recorders  
 Shotgun Mikes  
 Telephone Recording Adapters  
 Alcohol Testers  
 Telephone Scramblers  
 Hidden Video Cameras  
 Telephone Tap Detectors  
 Drug Testers  
**MUCH, MUCH, MUCH MORE.**

#### Our 27th Year!

Small catalog FREE  
 Larger catalog send \$5.

Mail Order only. Visa, MasterCard and C.O.D. accepted for equipment only.

Inquire for dealers' prices.

### A.M.C. SALES, INC.

193 Vaquero Dr. • Boulder, CO 80303  
 Mon. - Fri. 8 a.m.-5 p.m. Mtn. Time

**800-926-2488**

(303) 499-5405 • Fax (303) 494-4924

Internet: <http://www.siteleader.com/catalogdepot/AMCSC-home.html>

E-Mail: [amc-sales@siteleader.com](mailto:amc-sales@siteleader.com)

## YOU AIN'T HEARD NOTHIN'... YET

Since 1967, CRB Research has been the world's leading publisher and supplier of unique hobby and professional books and information including:

- Scanner Freq. Guides
- Broadcast Station Registries
- Shortwave Freq. Guides
- Military/ Federal Comm.
- Undercover Communications
- & Other Related Topics!



Ask for our latest FREE catalog.

#### CRB RESEARCH

P.O. Box 56, Commack, NY 11725  
 Ph: (516) 543-9169 FAX: (516) 543-7486  
 e-mail: [crbbooks@aol.com](mailto:crbbooks@aol.com)

CIRCLE 11 ON READER SERVICE CARD

## C. CRANE COMPANY

### COMMUNICATION EXCITEMENT



The Sangean ATS 909

- Shortwave
- Scanners
- Antennas

• Sangean • Lowe • Drake • Uniden  
 The most powerful loop antennas for shortwave / MW and much more!  
 558-10TH ST. FORTUNA CA 95540  
 Free Catalog FAX 707-725-9060  
 Website: [ccrane.com](http://www.ccrane.com)

**800-522-(TUNE) 8863**

CIRCLE 65 ON READER SERVICE CARD

# The Listening Post

BY GERRY L. DEXTER

WHAT'S HAPPENING: INTERNATIONAL SHORTWAVE BROADCASTING BANDS

## Monitor Radio News Operation and Two SW Stations For Sale

The shortwave broadcasting scene never lacks for news, and sometimes the happenings really pin the needle on the Humdinger Meter. Here's what we mean: The Christian Science Monitor has announced its intention to sell its "Monitor Radio" news operation and to sell or lease its two shortwave stations—WSHB in Cypress Creek, SC and KBHI on the island of Saipan.

In a news release to *Pop'Comm*, Monitor Editor, David Cook said that the church had to "balance its desire to service a radio audience with the need to support its worldwide healing ministry and strengthen our newspaper."

Monitor Radio began in 1984 and is the second largest provider (behind National Public Radio) of news broadcasts to some 200 radio stations with a combined audience of over one million. Monitor Radio will continue with its current schedule at least through the end of June. Any future radio efforts of the Christian Science Church will be on a smaller scale, with the aim of making them self-supporting.

Discussions are underway with several buyers. The "Monitor Radio" name will not be a part of any deal. The sale or lease of the two shortwave stations is a move separate from the sale of the news operation and will be handled by George Jacobs and Associates. If the news operations are sold before the stations, the Church will continue to air its religious programs on its shortwave stations until they are sold or leased. After that, the programs will be placed via paid time on shortwave stations in Africa, South America and Asia.

The first Christian Science shortwave station, WCSN, Scotts Corners, ME went on the air in 1987 and was sold off a couple of years ago.

Twenty years ago privately owned United States shortwave broadcasters could claim to be one of the world's most exclusive clubs, there being exactly three such animals in existence back then. Today, U.S. private shortwavers are about as hard to find as guitar players in a rock

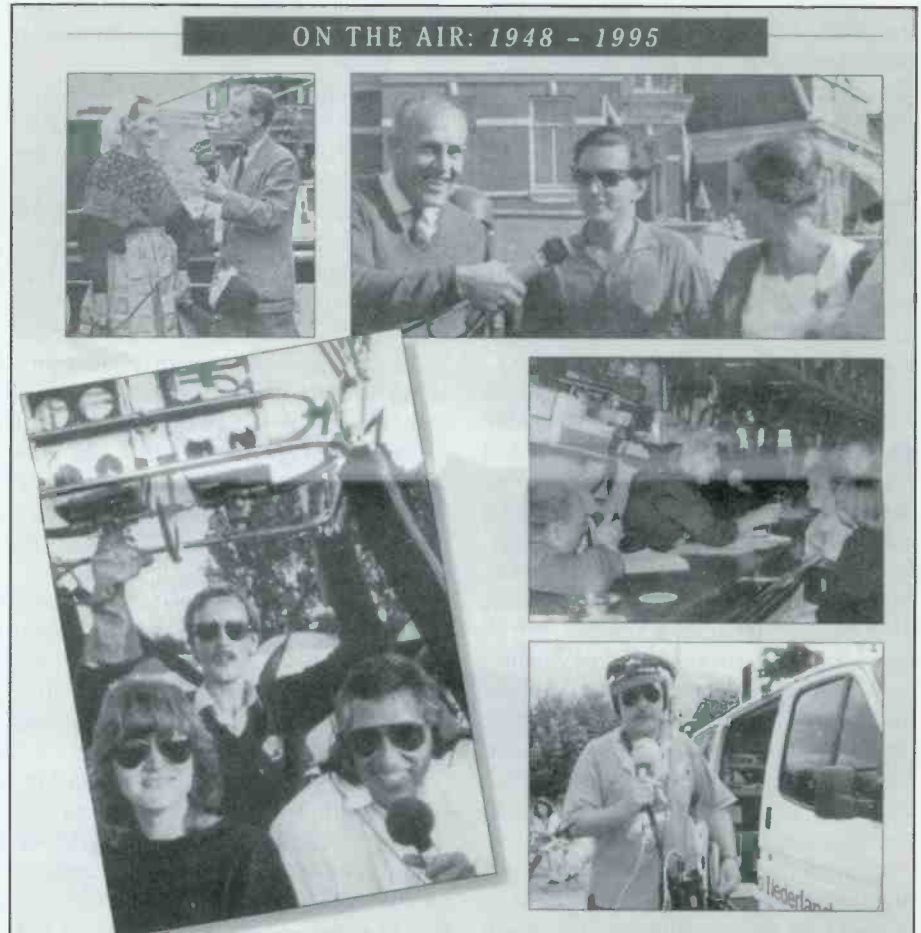

*Congratulations to one of the best of the best—Radio Netherlands celebrating its golden anniversary this year!*

group. And there is yet another one on the way!

### Another Privately-Owned U.S. SW Broadcaster?

Charles C. Josey, who holds ham license K4LNL, has been granted a license for a new shortwave station at Macon, Georgia, targeted to go on the air early in 1998. The new station will use a 50 kW transmitter and is scheduled to operate on **11910**. The format is expected to be commercial religion (how'd you guess?) and it's planned the station will start with a schedule of 1900 to 0700. No call letters

have been assigned. The name of the company is Oil and Wine Ministries and they can be reached at P.O. Box 18174, Macon, GA 31209.

### The Investment Channel is On The Air

The Investment Channel, mentioned a couple of months ago, is now on the air via South African government transmitters at Meyerton. The broadcasts are scheduled at 0200-0555 on **6195, 7175, 9775, 11985, 15225**; 0530-0755 on **11985, 15225, 17735**; 0600-0725 on **9670**; 0930-1130 on **17735, 21745**;

Abbreviations Used in Listening Post

AA	Arabic
BC	Broadcasting
CC	Chinese
EE	English
FF	French
GG	German
ID	Identification
IS	Interval Signal
JJ	Japanese
mx	Music
NA	North America
nx	News
OM	Male
pgm	Program
PP	Portuguese
RR	Russian
rx	Religion/ious
SA	South America/n
SS	Spanish
UTC	Coordinated Universal Time (ex-GMT)
v	Frequency varies
w/	With
WX	Weather
YL	Female
//	Parallel Frequencies

# Vatican Radio

# 1997

*fm* (in Rome): MHz 93.3, 96.3, 103.8, 105.0  
*mw* KHz 1530, 1611, 527  
*sw* in the 75, 49, 41, 31, 19, 16, 13 metre bands.

**satellites**

EUTELSAT II-F1 13° East, 10.987 GHz  
 INTELSAT ATLANTIC 325.5° East, 4097.75 MHz  
 INTELSAT INDIAN 63° East, 4097.10 MHz

**Keep in touch!**

**Write, phone or fax**

Vatican Radio - 00120 Vatican City  
 Tel. 39-6-6988.3551 - Fax 39-6-6988.4565  
 e-mail MC6778@MCLINK.IT



Vatican Radio's 1997 calendar cover has all the station basics. (Thanks to Andy Johns, TX)

0930-1225 on **11985**; 1130 to 1355 on **17735** and **21745**; 1500-1725 on **17735** and **21745**; 1800 to 2055 on **7270** and **9670** and 1800-2155 on **15240**, **17735** and **17890**. Programming consists of business news items about various companies around the world, investment information and the like. (They've referred to themselves as the Home Shopping Network of the financial world.) The address is P.O. Box 1250, FL-9490, Vaduz, Liechtenstein. The broadcasts are being heard very well on some channels, especially during our evening hours.

## Other SW News

The California-based High Adventure Ministries, which operates the Voice of Hope in Lebanon, KVOH in California and KHBN, Palau Island is now being aired over a transmitter in the former Soviet Republic of Georgia. The broadcasts are running from 1800 to 2000 or later on **9310** (they were using 7520 briefly) serving a European audience. The transmitter is 100 kw, located at Dusheti, Georgia. The address for this service is Voice of Hope, P.O. Box 109, Hereford, HR4 9XR, England.

Colombian station Radio Mira has been reactivated on **6015** (slightly lower). The station is located in Tumaco and is a member of the Caracol network.

The crisis in Albania caused Radio Tirana to be off shortwave for two or three days. For monitors who want to try to track the situation there, here's the station's current English language schedule: 0145 to 0200 on **6115** and **7160**; 0230 to 0300 on **6140** and **7160**; 1845 to 1900 on

**7270** and **9570** and 2100 to 2130 on **7110** and **9515**. Another example of the short-wave activity shrinkage of a former Communist government broadcaster.

The Sudan Interior Mission, which operated the now destroyed ELWA in Liberia, is part of a group attempting to get a license to put a station on the air from the Ivory Coast. It's proving to be very slow going, however, so it's a coin toss as to whether this will ever really happen. If it were to happen, however, it would mean at lot of folks would finally be able to verify this country. The government station is notorious in that department.

The recently reactivated Radio Guaira in Paraguay on **5975** signs on as early as 1000 and as late as 1200, and runs until 0000 or so (sometimes later). Fall/winter are probably better than summer to log this one.

Radio Miami International (WRMI) has received the OK to add a new antenna which will beam signals to North America beginning in just a few months. Once the new antenna is in operation the station will add a second 50 kw transmitter. WRMI's current broadcasts (on **9955**) are beamed from Miami towards the Caribbean and Latin America. The facility additions should allow WRMI to cover the entire Western Hemisphere.

Remember that we always welcome your informational input for this column. Shortwave loggings should be listed by country, be double spaced, and include your last name and state abbreviation after each. We also seek station schedules, news, news of changes in station QSL policies or addresses, other station items (brochures and the like), photos of you



and your shack and anything else you think would be of interest.

Here are this month's loggings. All times are in UTC, which is five hours ahead of EST, i.e. 0000 (midnight) UTC equals 7 p.m. EST, 6 p.m. CST, 4 p.m. PST. Double letters such as SS, PP, AA, RR, etc. are language abbreviations (Spanish, Portuguese, Arabic, Russian, etc.) If no abbreviation is given the broadcast is assumed to have been in English. **ALASKA**—KNLS, **6150** with Diana Ross songs at 0845. (Barton, AZ) **ANGOLA**—Radio Nacional, **3375** at 0500 in PP. (Johns, TX) **ANGUILLA**—Caribbean Beacon, **11775** at 1540 with Gene Scott. (Jeffery, NY) **ARMENIA**—Voice of Armenia, **9965** heard at 2139 with Armenian history feature. (Miller, WA) **ASCENSION ISLAND**—VOA relay to Africa at 0300 on **7105**. (Provencher, ME) BBC relay to Africa on **9600** at 0324, 9825 with English by Radio (EE/SS) at 2344 and **11750** to the Americas at 0030. (Jeffery, NY) **AUSTRALIA**—Radio Australia, **5995** at 1623. (Miller, WA) **6020** at 0915 in Pidgin with pops. Hit hard by Radio Netherlands IS at 0928. (Barton, AZ) **BENIN**—Radiodiffusion du Benin, Cotonou, **4870** at 0511 in FF. Music, man announcer. (Jeffery, NY) **BOLIVIA**—Radio Fides, **4845** at 0450 in SS with ranchera music, anthem, ID. (Rausch, NJ) **9625** in SS at 0500 sign off. (Johns, NY) **BOTSWANA**—VOA relay, **7340** to Africa at 0330. (Provencher, ME) **7415** at 0432 with Africa news. (Foss, AK) **BRAZIL**—Radio Marajoara, **4955** at 0000 in PP. (Johns, TX) Radio Educacao Rural, **4755** at 0100 in PP. (Johns, TX) Radio Bandeirantes, **11925** in PP at 2330. (Johns, TX)

### RADIO KUWAIT FREQUENCY SCHEDULE (SW)

TARGET AREA	Meter Band	UTC																							
		02	03	04	05	06	07	08	09	10	11	12	13	14	15	16	17	18	19	20	21	22	23	00	01
1	49m	6555 KHz																							
2	19m	15110 KHz												15110 KHz											
3	19m	15505 KHz																							
4	31m													9890 KHz											
	19m	15495 KHz																							
5	19m													15495 KHz											
	19m	15505 KHz																							
6	16m	17885 KHz																							
7	31m													9855 KHz											
	25m													11990 KHz											
	22m	13620 KHz																							
8	19m	15505 KHz																							
	25m	11675 KHz																							

#### GUIDE TO PROGRAMME CODES

	Main Arabic Programme		English Programme
1	GULF AREA	5	CENTRAL, NORTH & WEST AFRICA
2	SOUTH & SOUTH EAST ASIA	6	FAR EAST AREA
3	WEST ASIA	7	EUROPE & NORTH AMERICA
4	MIDDLE EAST	8	NORTH AMERICA (WEST)

Note: Kuwait Local Time = UTC + 3 HOURS

Radio Kuwait's frequency schedule fits in your vest pocket. (Thanks to Andy Johns, TX)

Radio Liberal, **4775** at 0700 in PP. (Johns, TX)  
 Radiodifusora de Roraima, **4875** at 0000 in PP. (Johns, TX)  
 Radio Brazil Central, **4985** at 0000 in PP. (Johns, TX)  
 Radio Clube do Para, **4885** at 0000 in PP. (Johns, TX)  
 Radio Gaucha, **11915** heard at 2330 in PP. (Johns, TX)  
 Radio Anhaanguera, **4915** in PP at 0000. (Johns, TX)  
 Radiodifusora de Amazonas, **4805** at 0000 to 0059 in PP with continuous music and a couple of possible IDs. (silvi, OH)  
 Radio Gazeta, presumed, **15325** at 0011 in what sounded like PP with talk by a man. (Jeffery, NY)  
 Radio National San Gabriel da Cachoeira, **3375.3** at 1025 in PP with time check, ID and mention of transmitter power. (Rausch, NJ)  
 Radio Nacional da Amazonia, **11780** at 2355 in PP with music. (Miller, WA)  
**CAMBODIA**—National Voice of Cambodia, **11940.4** at 1250 in language with SE Asian vocals by woman, 2 plus 1 time pips to ID by woman. (Rausch, NJ)  
**CANADA**—CHNX, **6130** at 1629 to 1830. Relaying local "Oldies 96." (Silvi, OH)  
 CKZN, St. Johns, **6160** at 1800 with talk show, CBC news. (Silvi, OH) 0338 with "As It Happens." (Miller, WA)  
**CHAD**—Radiodiffusion National Tchadienne, **4904** heard at 0529 with talk in FF. (Jeffery, NY)  
**CHILE**—Radio Patagonia Chilena, tentative, **6080** at 1118 in SS with Latin music. (Miller, WA)  
**CHINA**—CPBS, **12120** at 0542 in CC with Chinese songs. (Foss, AK)  
 China Radio Int'l, **6110** at 1537 with folk

music. CC. (Foss, AK) 11875 (via Mali, editor) in SS at 2236. (Moser, IL)  
**COLOMBIA**—Caracol bogota, **5077** in SS at 0150. (Miller, WA)  
 Ondas del Ortuquaza, 0025 in SS with futbol pregame show, national and provincial anthems prior to the start of the match. (Rausch, NJ) (Presume on **4975**, editor)  
**COSTA RICA**—Adventist World Radio, **5030** at 1112. (Boulden, CA)  
 RFPI, **7385** at 0520. (Foss, AK)  
 Radio Reloj, **4832** at 0505 in SS with ID, music, man announcer. (Jeffery, NY)

**CROATIA**—Croatian Radio, **5895** at 0402 with ID, IS, news. (Bannar, FL)  
**CUBA**—Radio Havana Cuba, **6000** in EE at 0232. (Miller, WA)  
**CYPRUS**—BBC relay, **7140** in AA at 0410. (Foss, AK)  
**ECUADOR**—Radio Oriental, **4779.8** in SS with romantic ballads and listener greetings. "Radio Oriental sintonia mas popular." (Rausch, NJ)  
 Radio Centinella del Sur, **4770** at 2350 in SS with religious ballads, time check, ID. (Rausch, NJ)  
 Radio El Buen Pastor, **4815** at 0130 in SS with romantic ballads, ID and anthem at 0205 sigh off—one hour later than before. (Rausch, NJ)  
**ENGLAND**—BBC, **6175**, via US, at 0526. (Foss, AK) **6195** (listed via Singapore, Editor) at 1607 with news. (Miller, WA)  
**FRANCE**—Radio France Int'l, **3965** in FF at 0644. (Foss, AK)  
**FRENCH GUIANA**—Radio France Int'l relay, **9790** at 1045 in FF. (Barton, AZ)  
 Radio Japan relay, **9660** at 0343 in JJ with Japanese music (Jeffery, NY)  
**GABON**—Radio Japan NHK relay, **15355** at 1510 to South Africa, //9535 to Western North America. (Silvi, OH)  
**GEORGIA**—Voice of Hope, on new **7520** at 1900–2100 "You are listening to the European broadcast service of High Adventure Ministries." Transmitter site was confirmed via fax from the station. Voice of Hope, P.O. Box 109, Hereford, NH4 9XR, England. (Rausch, NJ)  
**GERMANY**—Voice of Germany, **6170** via Sri Lanka at 1605 with news. 7195 via Rwanda at 1614 with news. (Miller, WA) 6185 (via Antigua) in GG at 0735. (Barton, AZ)  
**GREECE**—VOA relay, Dodecanese Islands, **7115** at 0400 with EE ID; AA ID "Huna VOA" and into news. (Rausch, NJ)  
**GUATEMALA**—Radio Mam, **4825** at 0235

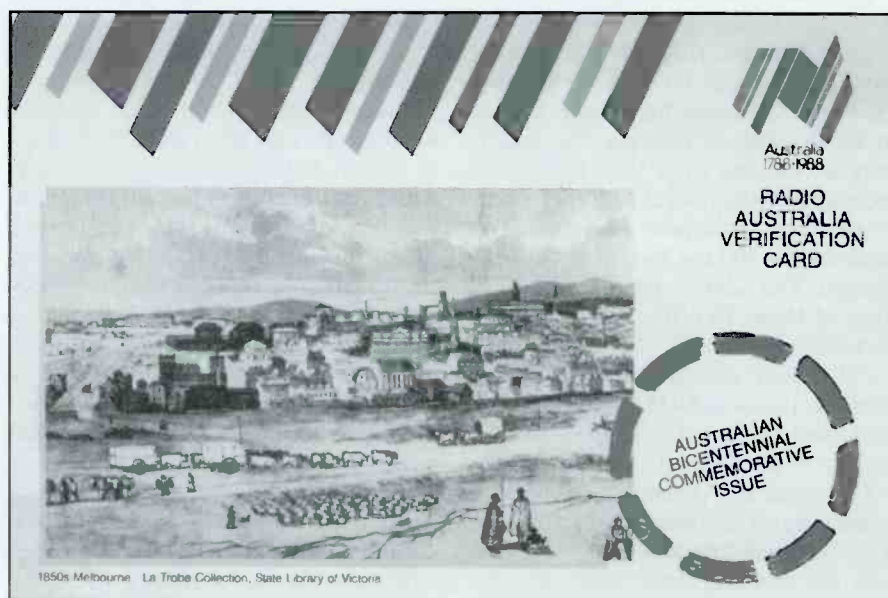

Back in 1998 Radio Australia celebrated the country's bicentennial with this special QSL. (Thanks to Michael Matus, NM)

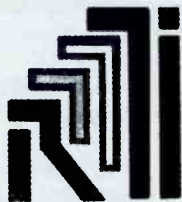

**Radio México  
Internacional**

**49 Mts. 5985 kHz.  
31 Mts. 9705 kHz.**

**TM:** 07 to 11 Hrs. and 14 to 23 Hrs.  
**UTC:** 13 to 17 Hrs. and 20 to 05 Hrs.



**Q S L**

**ANDY JOHNS**

Thanks for your signal reporting code.

We have the pleasure of confirming your report on  
our broadcast in 5985 kHz. Date 2/XII/96  
Hour 15:30  
SINPO 45544

**WRITE US!**

Radio México Internacional  
Apartado Postal 21-300  
Código Postal 04021  
México D.F.

*Radio Mexico International, which formerly verified with a printed letter, now has a multi-color QSL card. (Thanks to Andy Johns, TX)*

with a live band, ID, applause, some religious talk. On late. (Paszkievicz, WI) (Presume SS or local Indian language. Editor)  
**GUYANA**—Guyana Broadcasting Corporation, **3290** at 0530. (Johns, TX)  
**HAWAII**—KWHR, **9930** at 0500 with ID. (Bannar, FL)  
**HONDURAS**—Radio MI, Tegucigalpa, **5890** at 0247 in SS with religious message. (Miller, WA)  
**HUNGARY**—Radio Budapest, **9840** at 0350 with DX program. (Paszkievicz, WI)  
**ICELAND**—ICBS, **11402** at 2300 in Icelandic. (Johns, TX)  
**INDIA**—All India Radio, Delhi, **4860** at 0030 with IS, ID, news, subcontinental music. (Rausch, NJ) **15075** at 1705 in presumed Swahili. Mostly talk. (Silvi, OH)  
**AIR**—Guwahti, **4940** at 0020 with sitar music, 5+2 time pips, ID by man to presumed Delhi news. Parallel to Shillong on **4970**. (Rausch, NJ)  
**AIR-Shillong**, **4970** at 0025 with men's chorus which sounded more mideastern than subcontinental. Pips to ID by woman to Delhi news. (Rausch, NJ)  
**AIR-Bangalore**, **11585** heard at 1512 in local language, with Indian music, talk by man. (Jeffery, NY)  
**AIR, Lucknow**, tentative, **4880** at 0039 with IS. Poor. (Paszkievicz, WI)  
**INDONESIA**—Radio Republik Indonesia, Jambi, heard at 1140 on 4927 in II with EE pop program, ID by woman, "Song of the Coconut Islands" (SCI) at 1159. (Rausch, NJ) (4927? Editor)  
**RRI Ujung Pandang**, **4753** at 1420 in II. (Barton, AZ) 2300 in II with SCI IS and Jakarta news. (Rausch, NJ)  
**RRI Jakarta**, **15150** at 2325 in II with man talking. (Miller, WA)  
**RRI Bangkulu** on **3625** at 1230 in II with rock. (Miller, WA)

**RRI Ternate**, **3345** at 1236 in II with rock. (Miller, WA)  
Voice of Indonesia, presumed, **9525** at 1905 in what sounded like FF with religious music, what appeared to be regional music, then an interview. Off at 2000. (Jeffery, NY)  
**IRELAND**—West Coast Radio, via Julich, Germany, Wednesdays at 0100 (Thurs. UTC) with English to North America. Also Thursdays at 1800 to Africa, Australia, New Zealand on **11665** and to Europe Saturdays at 1500 on **5970**. (Provencher, ME)  
**ITALY**—RAI, **9685** at 2230 with sign on in II to South America. **11800** at 2326 with Italian opera. **Parallel 6010**. (Moser, IL)  
**IVORY COAST**—RTV Ivoirienne, **7215** in FF at 0600. (Johns, TX)  
**JAPAN**—Radio Tampa, **3925** in JJ heard at 1125. (Barton, AZ) **6055** at 1544 in JJ with heavy splatter from Radio Australia-6060. (Foss, AK)  
Radio Japan NHK, **9535** at 1429 with EE to Western North America, //12045 to Asia. (Silvi, OH) 1449 with "Media Roundup." (Miller, WA)  
**KENYA**—Kenya Broadcasting Corporation, **4935** at 0345 with stock market report. (Paszkievicz, WI)  
**LITHUANIA**—Radio Vilnius, **5890** to North America via Germany at 0000 in Lithuanian and 0030 in English. (Ceplius, PA)  
**MADAGASCAR**—RTV Malagasy, **5009.5** at 0030 in FF. (Johns, TX)  
**MALAYSIA**—Radio Malaysia, Kajang, **7295** heard at 1618 with western style pops. (Miller, WA)  
**MALI**—China Radio Int'l relay, **9710** at 0000 with ID, news. (Jeffery, NY)  
**MEXICO**—Radio Mexico Int'l, **9705** at 1600 with talk show in EE. (Silvi, OH) 2332 in SS with IDs, music. (Jeffery, NY)  
**MOROCCO**—Radio Medi Un **9575** at 0500 with ID in FF, listener greetings in AA.

(Rausch, NJ) Tentative, 1824 to 1900 in FF with music in English, French and possible Arabic. (Silvi, OH) (Counts as Spanish Morocco on the North American SW Association's Country List—editor)  
RTV Marocaine, **17595** heard at 1530 in FF. (Johns, TX)  
**NAMIBIA**—Namibian Broadcasting Corp., **3270/3290** at 0430. (Johns, TX)  
**NETHERLANDS**—Radio Netherlands, **6020** at 0030. (Wallesen, IL) **9895** at 0711 in Dutch. (Foss, AK)  
**NETHERLANDS ANTILLES**—Radio Netherlands Bonaire relay, **9820** at 1037 with news in DD. (Barton, AZ)  
**NEW ZEALAND**—Radio New Zealand Int'l, **11905** at 0532. (Foss, AK) **15115** at 2300 with news. (Moser, IL) 0001 with sports and 0433 with live cricket match. (Jeffery, NY)  
**NIGER**—La Voz du Sahel, **5020** at 0500 with Koran in AA, ID in FF. (Rausch, NJ) 0535 in FF with music, man announcer. (Jeffery, NY)  
**NIGERIA**—Voice of Nigeria, presumed, **15120** at 1729 with African-sounding music. No apparent IDs. (Silvi, OH)  
Radio Nigeria, Kaduna, **4770** at 0505 in EE with ID, news. (Jeffery, NY)  
**NORTH KOREA**—Radio Pyongyang, **11700** at 2300. (Johns, TX) 2310 with talk on agreements with the South. (Moser, IL)  
**NORWAY**—Radio Norway Int'l, **9650** at 0800 with ID and announcement in EE, into NN. (Foss, AK)  
**PAKISTAN**—Radio Pakistan, **9545** at 1453. (Miller, WA)  
**PALAU**—KHBN, **9985** at 1433 with religious programming. (Silvi, OH)  
**PARAGUAY**—Radio Nacional, **9737.1**, nominal **9735**, concertina music and SS announcer at 0742. (Barton, AZ)  
**PORTUGAL**—Deutsche Welle relay, **6120** at 0539. (Foss, AK)  
**PAPUA NEW GUINEA**—NBC, Port Morseby, **4890** at 1104 with news, weather, ID. (Boulden, CA) "National Service" ID at 1200. (Barton, AZ)  
Radio East New Britain, **3385** at 1020 with pidgin preacher, tribal drums to ID by woman, and provincial news. (Rausch, NJ)  
Radio Manus, **3315** at 1120 with preacher, ID 1130. (Rausch, NJ)  
Radio Madang, **3260** at 1130 with 40s country/western, time check, ID by woman. (Rausch, NJ)  
Radio East Sepik, **3335** at 1120 with man and woman in pidgin with public service announcements, ID. (Rausch, NJ)  
**PERU**—Radio Atlantida, presumed, **4790** in SS at 0230 to 0323 close. (Silvi, OH)  
Radio Lider, presumed, **4845** at 1027 in SS with talk by woman followed by talk by a man. No ID. (Jeffery, NY)  
Radio Tarma, **4775**, presumed, at 0501 in SS with music and talk. No ID. (Jeffery, NY)  
Radio San Juan, **5775.2** in SS heard at 0300 with ballads, ID and anthem at 0330 sign off. (Rausch, NJ)  
Radio Horizonte, **5020** at 1000 in SS with

# THE 10TH ANNUAL WINTER SWL FEST

March 13-15, 1997



**Holiday Inn**  
Kulpsville, Pennsylvania  
United States of America

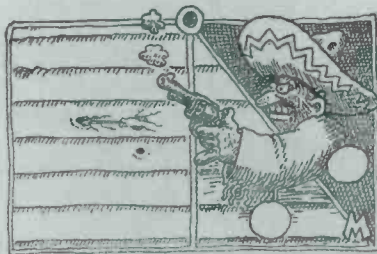

Pancho dice, "¡Hola Oyentes!"

Some 200 SWLs, DXers, hams and scanner buffs attended the 10<sup>th</sup> annual Winter SWL Fest. The 1998 Fest will be March 13-15.

national anthem, canned ID. (Rausch, NJ) **5019.8** at 0100 in SS. (Johns, NY)  
Radio Bambamarca, **4419.5** in SS at 0235 with Peruvian folk music, concert promo, ID. (Rausch, NJ)  
Radio Union, **6115** in SS heard at 0536. (Miller, WA)  
**RUSSIA**—Voice of Russia, **5930** (via Petropavlovsk) at 0553 with pop/rock. **7330** at 0550 interview with classical singer/composer. (Foss, AK) 6145 (Khabarovsk) in CC at 1557. **7330** (Yekaterinburg) in EE heard at 1620. (Miller, WA) **7125** at 0500 with news. (Moser, IL)  
Radio Rossi, **7335** at 0421 in RR. (Foss, AK)

*"The California-based High Adventure Ministries . . . is now being aired over a transmitter in the former Soviet Republic of Georgia."*

**RWANDA**—Deutsche Welle relay, **7195** at 0453 in GG. (Foss, AK) **15275** at 0004 in GG. (Jeffery, NY)  
**SAO TOME**—VOA relay, **6035** at 2100 to Africa. (Provencher, ME) QSL received from Charles L. Lewis at the relay site who notes he had been replying (on his own time) to reports with return postage but has now left Sao Tome so further direct replies may not be forthcoming. Address is Voice of America, Sao Tome Relay Station, Box 522, Sao Tome e Principe, West Africa. (Silvi, OH)  
**SAUDI ARABIA**—BSKSA, **11870** at 0528 in AA. (Foss, AK)  
**SEYCHELLES ISLANDS**—BBC relay African stream, **9610** at 0332 with "Network Africa." (Jeffery, NY)  
**SINGAPORE**—Radio Singapore, **6015** at 1340 with discussion. (Foss, AK) **6155** (Kranji) at 1603. (Miller, WA)  
**SLOVAKIA**—Radio Slovakia Int'l, **5930** in unidentified language at 0146. (Miller, WA)  
**SOUTH AFRICA**—Channel Africa, **15240** heard at 1623 with news, features, sports. (Moser, IL)  
The Investment Channel (new) **6195** and **7175** at 0200 sign on with business news in slow EE. 6195 wiped out by budapest at 0230. Also **9775** at 0300 sign on. (Rausch, NJ)  
**SOLOMON ISLANDS**—SIBC, **5020** at 0733 with music. (Foss, AK) 1115 with pops and warning about a tropical storm for Guadacanal province in EE and Pidgin. (Rausch, NJ) 1105 with news. (Barton, AZ)  
**SWITZERLAND**—Swiss Radio Int'l, **9885** at 0708 in Italian. (Foss, AK)  
**SYRIA**—Radio Damascus, **12085** at 2020 with news, EE/AA music, ID. (Bannar, FL)  
**TAIWAN**—Voice of Free China (via WYFR) **9985** at 2200 in EE with ID, anthem, news, "Music Box." (Jeffery, NY)

**THAILAND**—Radio Thailand, **9530** at 1400 to 1429 close, news and festival info. (Silvi, OH) **11905** at 0030. (Johns, TX)  
**VANUATU**—Radio Vanuatu, **3945** at 0700 with ID, news of Vanuatu and the South Pacific. (Foss, AK)  
**VATICAN**—Vatican Radio, **6095** at 0313 in FF with IS and religious program. (Miller, WA)  
**VENEZUELA**—Ecos del Torbes, **4980** heard at 1115 in SS with doorbell-like chime. (Barton, AZ)  
YVTO time station, **5000** at 1050 with time checks. Usually overpowered by WWV. (Boulden, CA) Time announcements in SS and IDs at random times every minute. Clearly audible over WWV/WWVH from 0400 to 0430. (Silvi, OH)  
**VIETNAM**—Voice of Vietnam, **4960** in VV with Asian music at 1120. (Barton, AZ)  
**5950** at 0337 with ID, news. (Bannar, FL (Via Russia, editor) **15009.9** at 1230 with ID, news, cultural program. (Rausch, NJ)  
**YUGOSLAVIA**—Radio Belgrade, **7115** at 0051 in Slavic language with apparent regional news. **7130** at 0220 in EE. QRM from co-channel DW. (Miller, WA)  
**ZAMBIA**—Radio One, **4910** at 0250 with national anthem. Also at 0500 with news. (Johns, TX)  
Radio Christian Voice, **3330** heard at 0400. (Johns, TX)

And that's the lot! Hat's off and a high-rise toast to the folks who did the good thing this month: Lee Silvi, Mentor, OH; Sheryl Paszkiewicz, Manitowoc, WI; Brian Boulden, Fairfield, CA; Michael J. Miller, Issaquah, WA; Andy Johns, Mansfield, TX; Ed Rausch, Cedar Grove, NJ; David Bannar, Ormand Beach, FL; Marty Foss, Talkeetna, AK; Al Cepulis, Philadelphia, PA; Elmer Wallensen, LaGrange, IL; Edouard S. Provencher, Biddeford, ME; Dave Jeffery, Niagara Falls, NY and Rick Barton, Phoenix, AZ. Thanks to each of you!

Until next month, good listening! ■



China Radio International marks its 55th anniversary this year. The station dates back to the beginning of the revolution when the New China Broadcasting Station operated from Yan'an. Then, for years, Radio Peking, later Radio Beijing and still later CRI operated from the building shown in the center photo. Now, CRI has a brand new building. (right)



# The Pirate's Den

BY EDWARD TEACH

FOCUS ON FREE RADIO BROADCASTING

## Pirates Take to the Airwaves During Daytime!

**L**et's see what's in the mail bin this month: **Radio Garbonzo, 6956** at 2145 to 2150, closing their broadcast with the phrase "tuning down our antenna and up yours!" (Eric Hudgins—location unknown)

**WWWLIS, 6957 USB** at 0120 with a mention that reception reports should be sent to P.O. Box 28413, Providence, RI 02908. (Hudgins)

**Radio Three, 6955 USB** at 1917 to 1935 with alternative selections including "Everything Falls Apart" by Dogs Eye View. (Hudgins) 2109 with music of Village People, big band music, plenty of songs from "Barney and Friends." Reports requested to the ACE. Off at 2125. (Jeffery, NY)

**WMPR 6955** at 1641 with electronic/ techno music to sign off. No QSL address given. (Hudgins) 1609 playing what the ACE calls techno dance music. (Dick Pearce, VT)

**Radio Free Speech, 6955** at 2310 to 2343 sign off, announced as a farewell broadcast. They read the name of nearly every listener who had ever sent a report. (Jerry Coatsworth, Ontario) Around 1430 with "Bill 'O Rights" announcing it was his final program. I was so dumfounded I didn't even note the time. He thanked everybody for a total of 350 reception reports and said he will still relay programs. (Pearce)

**Radio Azteca, 6955 USB** at 1914 with listener's letters, DX program spoof, funny news stories and "Dr. Radio" answering funny radio questions, gave Belfast address. Off at 1943. (Jeffery) 1430 to 1435 close. They signed off with gunfire sound effects and the standard "Rocky and Bullwinkle" interval signal. (Coatsworth) 0035 with Bram Stoker. Repeat of an earlier show. (Kenny Love, SC) 1637 and 2220 with listener mail. (Pearce)

**WLIS, 6955 USB** at 2239 to 2304 sign off with a different interval signal. Most of the broadcast was lost in an illegal side-band QSO on the same frequency. Also their 7<sup>th</sup> anniversary broadcast heard from 1558 and featuring interval signals of All India Radio and Deutsche Welle. (Coatsworth) 0000 with anniversary special. Super signal and audio. (Love)

**Stereo Sound Radio, 6955 USB** at 0001 to fade at 0004. Colonel Billy Bob said they were broadcasting to North America and the Caribbean on the 43 meter band. (Coatsworth)

**KAOS, 6955** at 0052 tune with a '70s retro tribute program featuring snippets of Presidents Nixon and Carter, music by the Doors. (Coatsworth)

**Radio Tellus, 6955 USB** heard at 0115 with ID as "Radio Tellus, the Earth station." Music by Fleetwood Mac. Deep fades and unsure if sign off was 0130 or 0140. (Coatsworth)

**Free Hope Experience, 6955 USB** at 2221 to 2233. The announcer signed off but the programming continued. A bit over modulated. (Coatsworth)

**WAERR, 6955 USB** at 0006 with a feature on how to modify your VCR so it can be used as a transmitter. They gave the Belfast address (P.O. Box 1, Belfast, NY 14711) and closed at 0051. (Jeffery)

**Voice of Helium, 6955 USB** at 2148 to 2215 sign off. (Jeffery)

### PIRATE RADIO STATION NINE



The West Coast's Only  
**ALL BAND**  
Pirate Radio Station

Bringing To You A Mixture Of Music  
(Classical to Modern)  
From All Over The Globe

Domestic & International Political Views

2600

**PLUS: Re-broadcasts of "COVERT" Police & Federal Radio  
Communications  
For Your Enjoyment**

*Station 9 is active from the west coast on longwave, medium wave, FM and shortwave and says they hope to have QSL cards and "various goodies to give away" in the future.*

**Radio Doomsday, 6955 USB** at 2218 with rock, rap, funny sound effects. Reports requested to Box 1122, Brampton, MO. Off at 2244. (Jeffery) **6955 LSB** at 1926 with a cacophony of sounds and I was unsure if I was hearing one station or two. Heard a Radio Doomsday ID and then Quantum States Lab and someone saying "that's great" repeatedly while Nemesis was talking and lots of chicken sounds were heard in the background. Said "you've been listening to Radio Doomsday, Spam Radio, Radio Free OJ, Outhouse Radio, Freedom 40, Radio 43. The loud sound effects made the address uncopyable. (Pearce)

**K-2000, 6955 USB** at 2215 with comedy skits, funny commercials. Off at 2050. (Jeffery)

**Radio Free East Coast, 6955 USB** at 1817 with hard rock, funny commercials, parodies of rock and roll songs. Reports to either the Belfast or Blue Ridge Summit addresses. (Jeffery)

**Radio Anteatr, 6955 USB** at 0117 testing signals and audio. "Peter" made some reception report checks. (Love, SC) 1900 with parodies on Ginsu, Mr. Whipple. "You're listening to the 50 watt blowtorch of Anteatr Radio." and to "include three stamps or a single female daughter with your report." (Pearce)

**WREC, 6955 USB** at 1441 with Doors tune, telephone busy signal, talk about Michael Jackson. Repeated several days later at 1855. (Pearce)

**Lounge Lizard Radio, 6955 USB** at 1545 with host Dean Soundgarden from the Flamingo lounge playing selections including Dean Martin "Volare." He gave the Providence, RI address for reports. (Bill Kent, location unknown)

**Void Radio, 6953 LSB** at 2127, very weak, with Morse IDs, comments, parodies. Dropped out for about five minutes near the beginning. This broadcast was a repeat of a test broadcast heard about a year earlier. (Pearce)

**WKND, 6954.8** heard at 1810 with the "Plymouth Rock" program. "Now preparing to broadcast from a wrecked ship." They played Santana and Hendricks tunes, among others. Finally said they had to "hit the road" but would be back later. (Pearce)

Thanks for the great support again this month. It appears that lately pirates are doing daytime broadcasts as much, or more than they are during the evening. Of course **6955 remains the most popular frequency** so if you spend as much time as possible parked there, especially on the weekends, you should manage some great loggings.

Keep those reports coming (and if you are sending reports to HQ via e-mail please let me know where you're located). Thanks for participating!

More next month! ■

## Final Survey Results Are Here!

(from page 38)

while you and I should be seeing an opportunity to make new friends and help others join our hobby, whether it's ham radio or scanning!

### Thanks for Responding!

We've asked lots of questions over the past few months, and we'll be getting to those answers again next month. As usual, we invite your comments, ideas and suggestions for future issues of *Popular Communications*. Most of the letters we've received during the past year have been very positive, indeed. Still others believe we could devote even more pages to reader's letters, expand the magazine to give more CB coverage, more frequencies, loggings and photos, QSL photos, and much more. If it were possible, we'd love to add pages to *Pop'Comm*, but it isn't that simple. We'd also like to give everyone more loggings, but in order to give more loggings, our columnists need to *get more loggings*. So, send in good photocopies of your QSLs, shortwave broadcast, utility, broadcast band and pirate loggings, and anything else you would like to see in *your* magazine. While we can't beef up the page count, we can tweak *Pop'Comm*, giving "something to everyone" as we mold and shape your magazine into the best monitoring publication around! See you next month. ■

# New from CQ 33 Simple Weekend Projects

ALL NEW FUN FROM  
DAVE INGRAM, K4TWJ!

"33 Simple Weekend Projects for the Ham, the Student, and the Experimenter" gives only a hint at the fun and satisfaction to be found between the covers of this little book. Dave Ingram, K4TWJ, has pulled together a wide ranging collection of do-it-yourself electronics projects from the most basic to the fairly sophisticated, and even touching on the frivolous.

You'll find an interesting and very do-able array of useful devices: station accessories for VHF FMing, working OSCAR satellites, joining the fun on HF, trying CW, building simple antennas, even a complete working HF station you can build for \$100.

Add a measure of practical tips and techniques on how to build electronic projects yourself, and you've got an information-packed book that will keep the newcomer or the most experienced home-brewer busy for many a pleasant weekend.

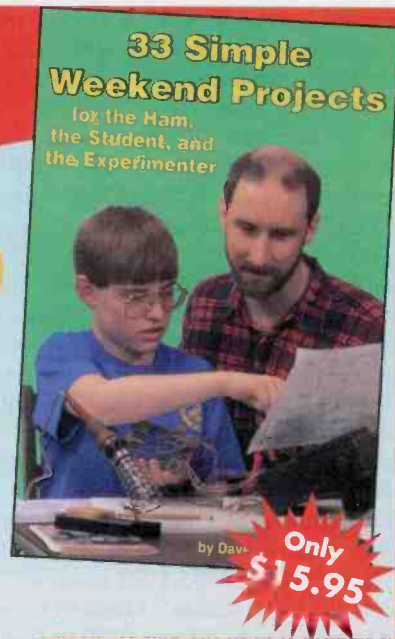

Please send me \_\_\_\_\_ copies of 33 Simple Weekend Projects.

Name \_\_\_\_\_ Call Sign \_\_\_\_\_

Address \_\_\_\_\_

City \_\_\_\_\_ State \_\_\_\_\_ Zip \_\_\_\_\_

( ) Check ( ) MasterCard ( ) VISA ( ) AMEX ( ) Discover

Card No. \_\_\_\_\_ Expires \_\_\_\_\_

Signature \_\_\_\_\_



Please phone or fax your orders to:

**CQ Communications, Inc.**  
76 North Broadway  
Hicksville, NY 11801  
Phone: 516-681-2922  
Fax: 516-681-2926

or call toll-free  
**800-853-9797**

## Tuning In (from page 4)

up the repeater, but you'd never know it unless you were listening with a scanner to the repeater's output frequency. Or you could simply stay away from FRS channels 8-14 completely and cool off at the pool. That would be the *right* thing to do, and it's a whole lot more fun!

## Our Not-So-Technical Tests

Both RadioShack and Midland were kind enough to provide me with their versions of the FRS transceivers to use for a couple of months. Each performed very well; range was about a mile in a suburban environment. The radios are simple to operate and audio was excellent considering their small size. Over a period of nearly two months I put the little gems through their paces and during that time heard no other users on *any* of the 14 frequencies! True communications heaven!

After talking to Corwin Moore, Administrative Coordinator for the Personal Radio Steering Group, I took my scanner, searching between 462.55 and 462.725 MHz (repeater output frequencies) while using the FRS transceivers at a nearby city that has a licensed GMRS repeater on 462.70 MHz. I didn't spend time looking for the actual repeater site, but went to one of the highest points in the city and still nothing. We live about an hour south of New York City in a heavily populated suburban town, where, on the CB frequencies, it's frequently mayhem, but on the FRS frequencies it was dead! My family and I talked on several FRS channels until the batteries died.

So knowing about the possible interference problem with licensed users of the spectrum, why would the FCC even *consider* such a frequency scheme? Well, it turns out that the Personal Radio Steering Group—the national user advocacy organization for GMRS raised the red flag back in 1994, informing the FCC of their concerns. According to Moore, "GMRS was mugged. We don't have the resources to bring in a lobby representing our interest," he told me, continuing "... the decisions the FCC makes are no longer based on the public interest, but rather on what private enterprise wants..." What he's talking about is what he called "the FCC's general abandonment of the concept of a disciplined and structured personal radio service." It's got the GMRS folks all fired up, the FCC pulling

its head into it's bureaucratic shell, and the FRS manufacturers seeing dollar signs.

Moore feels that the handwriting is on the wall; that most of the Steering Group's recommendations to the FCC went unheeded and that the FCC has, for the first time, allowed a licensed and unlicensed user to share co-primary status without protection being afforded to licensed users. You can't help wondering if the FCC is, in their own bureaucratic bungling way, nudging GMRS into a completely license-free service. After all, the Commission has made it perfectly clear that by licensing users of the spectrum comes the direct message: "Hey, get licensed, or keep out; licensing is there to protect the current users." But has the FCC turned a deaf ear on the GMRS? It would seem so, given the fact that the Steering Group's concerns went in one bureaucrats ear and out another. We won't give names here, but they know who they are; the old fuddy-duddies that were around when the FCC abandoned real rules compliance issues in the early '70s on the Citizens Band. The same authors of the language are at it again!

So sit back and wait. Give it a couple of years and there's a good bet that the GMRS will become unlicensed with its users running the gamut from Jack's Pizza to Dom's Delivery Service. In the meantime, the new FRS has been positioned by the manufacturers to be the hottest communications tool to come along in years.

What about the often-heard argument about the FRS stealing potential hams? Nonsense! If anything, the FRS might help the ham community get much-needed newcomers when FRS users find they really can't use repeaters and talk further than across town. FRS users, like many CB walkie-talkie users will buy the radios for short-range communications to stay in touch while hiking, shopping, camping, boating, and for avoiding Uncle Ralph at his 50th birthday party—but not as a substitute for ham radio.

But the marketplace is, as Moore correctly points out, "... too young to demonstrate or disprove repeater interference." But one thing is for sure: While GMRS users around the country scream from the top of the highest repeater sites they can find, the FRS, like CB channel 14 walkie-talkies, is reality, although I wouldn't like it one bit if the FCC suddenly let unlicensed users set up shop on 2-meters. But then again the FCC would never do that, would they? ■

## HF-VHF Receiver Multicouplers

\*\*\* 100 KHz to 1 GHz range \*\*\*

Are you using several HF radios or VHF/UHF scanners at your monitoring site??  
Diversity Reception antenna systems??

...consider including a multicoupler.

Specially designed for demanding monitoring applications and for the dedicated hobbyist with multiple monitoring radios. Our 2 and 4 port couplers are 50 ohms units with better than 22 dB of port-to-port isolation. BNC connectors standard, type-N and SMA also available. Other port configurations on special order.

Please contact us for a Data Sheet and pricing  
\$70 to \$90 range - VISA/MC accepted

**Stridsberg Engineering, Inc.**  
PO Box 5040, Shreveport, LA 71135-5040  
(318) 861-0660 FAX: (318) 861-7068

CIRCLE 78 ON READER SERVICE CARD

## FREE PRODUCT GUIDE NEW 1997 EDITION

**WORLDWIDE FIRESTIK!**

—VISIT OUR NEW WEB SITE—

★ COMPLETE ON-LINE CATALOG ★

★ VALUABLE TECHNICAL HELP ★

[HTTP://WWW.FIRESTIK.COM](http://www.firestik.com)

FOR PRINTED COPY WRITE OR CALL:

**FIRESTIK COMMUNICATIONS**

2614 E ADAMS, PHOENIX, AZ 85034

TEL: 602-273-7151 FAX: 602-273-1836

CIRCLE 67 ON READER SERVICE CARD

## PAY TV AND SATELLITE DESCRAMBLING

all new information 1996 Edition VOLUME 7

Pay TV and Satellite Descrambling Volume 1-7 (all different). Satellite & OBS hacking, Wireless Cable Hacking, Complete Wizard, Buying Surplus, Seized & Distressed Goods, Cellular Phone Hacking, Computer & Phone Hacking, all new Hacker Video. \$15.95 each, any 3/\$34.95 or any 5/\$52.95. American Hacker Magazine \$29.95 includes BBS. Our Best Deal is everything listed here and lots more for only \$129.95. New product catalog \$1. Add \$6 for C.O.D.'s.

### SCRAMBLING NEWS

3494 DELAWARE AVE., #123, BUFFALO, NY 14217-1230  
Voice/FAX (716) 283-6910 BBS (716) 871-1016  
<http://www.scrablmgnews.com>

CIRCLE 85 ON READER SERVICE CARD

**YOU  
AIN'T  
HEARD**



Ask for our  
latest FREE  
catalog.

Since 1967, CRB Research has been the world's leading publisher and supplier of unique hobby and professional books and information including:

- Scanner Frequency Guides
- Shortwave Freq. Guides
- Military/Federal Comm.
- Broadcast Station Registries
- Undercover Communications
- & Other Related Topics!

New titles are constantly being added to our exciting catalog. If it's interesting and unusual, we've got it.

**YOU'LL SEE.**

## CRB RESEARCH

P.O. Box 56, Commack, NY 11725  
Ph: (516) 543-9169 FAX: (516) 543-7486  
e-mail: [crbbooks@aol.com](mailto:crbbooks@aol.com)

CIRCLE 11 ON READER SERVICE CARD

# Readers' Market

**Advertising Rates:** Non-commercial ads are 30 cents per word, including abbreviations and addresses; minimum charge \$6.00 per issue. Ads from firms offering commercial products or services are \$1.00 per word; minimum charge \$20.00 per issue. Boldface words are \$1.20 each (specify which words). Leading key words set in all caps at no additional charge. All ads *must be prepaid in full* at time of insertion; a 5% discount is offered for prepaid 6 time insertions. All ads must be typewritten double spaced.

**Approval:** All ad copy is subject to Publisher's approval and may be modified to eliminate references to equipment and practices which are either illegal or otherwise not within the spirit or coverage scope of the magazine.

**Closing Date:** The 10th day in the third month preceding date of publication. Because the advertisers and equipment contained in Readers' Market have not been investigated, the Publisher of *Popular Communications* cannot vouch for the merchandise listed therein. Direct all correspondence and ad copy to: PC Readers' Market, 76 N. Broadway, Hicksville, NY 11801, Attn: Nancy Barry.

**CB MODIFICATIONS! 10M, frequencies, sliders, FM, amplifiers, books, plans, kits, high-performance accessories. The best since 1976. Find out why! Catalog \$3. CBC INTERNATIONAL INC., Box 31500A, Phoenix, AZ 85046.**

**TUNE In On Telephone Calls! New 3rd Edition, by Tom Kneitel. Latest freqs., info., and effective scanner accessories for serious recreational eavesdropping on cellular, 46 and 900 MHz cordless, air/ground phones, digital pagers and more. The original, official, controversial 160-page source book, now updated! Only \$16.95, plus \$5 s/h (\$6 to Canada). NY State residents add \$1.81 tax. Order from your favorite dealer or CRB Research Books, Inc., P.O. Box 56, Commack, NY 11725. MC/ VISA accepted. Phone orders: (516) 543-9169.**

**CABLE DESCRAMBLER! Build for \$12 with seven RadioShack parts. Instructions \$8. F.A.S.T., Box 369-U74, Pt. Salerno, FL 34992-0369.**

**"FORBIDDEN SECRETS OF THE LEGION OF DOOM HACKERS!" Big 224-page handbook. The infamous LOD's condemned programs and amazing techniques, from the LOD's now shut down in BBS. Hacking, phreaking, and more! Hard to locate information, now in this limited edition. For reference and informational purposes only, \$20.95, plus \$5 s/h (Canada \$6). NYS add \$2.21 tax. VISA/MC okay. CRB Research Books Inc., Commack, NY 11725. Phone orders: (516) 543-9169.**

**VHF AERO SCANNER GUIDE: Kneitel's Air-Scan, sixth edition. Great new edition of the new comprehensive and popular USA/Canada VHF aero band directory ever published: Civilian, Military, Private Airports, Heliports & Seaplane Bases. Control Towers, ARTCC, Weather, Approach/Departure, FSS, Ground Control, ATIS, Unicom, National & Air National Guard freqs., etc. Many listings for airport security, fire/rescue, airline ground services & more beyond the aero band. One "must have" guide to tens of thousands of aero related monitor frequencies! Only \$18.95, plus \$5 s/h (\$6 to Canada) from CRB Research, P.O. Box 56, Commack, NY 11725. VISA/MC accepted. Phone orders: (516) 543-9169. (NYS res. add \$2.04 tax.)**

**LEARN MORSE CODE IN 4 HOURS! Taught the military method. Send \$9.95 to: J.L. Steiger, 375 Hillside, Seven Hills, OH 44131.**

**SCANNER MODIFICATION HANDBOOK VOL.1** by Bill Cheek. The famous original 160-page books. Performance improvement modifications. Simple step-by-step instructions, many photos. Primarily PRO-2004 & PRO-2005, some for PRO-34, BC-200/205XLT, BC-705XLT, BC-705XLT. Restore blocked-out bands, speed up scanning rate, disable "beep," increase number of channels, improve squelch action, add an S-meter, interface with short-wave receivers, etc. Make the PRO-2004 & 2005 into a 6,400 channel scanner; put 3,200 channels into the PRO-34! Plus, cellular frequency charts, antenna info & mods, inside info on frequency management, operating hints, emergency power supplies, scanners & the law, lots more! Only \$18.95, plus \$5.00 s/h (Canada \$6). Residents of NY State add \$2.36 tax. Big 220 page **VOL. 2** with more mods for PRO-2004/5/6, PRO-34, PRO-2022, BC-760/950XL, BC200/205XL, also available, \$18.95 plus \$5.00 s/h (Canada \$6). NY State residents include \$2.36 tax. **NEW! The Ultimate Scanner, VOL. 3.** Giant 240-page edition. Many more mods! Picks up where the first two books ended. \$29.95 plus \$5 s/h (Canada \$6), residents of NYS add \$2.97 tax. Order from CRB Research Books, Inc., PO Box 56, Commack, NY 11725. Visa/MC welcome. Tel: (516) 543-9169.

**RADIO SHACK SCANNERS LOWEST PRICES** all catalog items. NEW-FRS 105 Family Radio Service 2-way HT reg. \$180—OUR PRICE \$150. Join our buying club and save. No tax. Call 1-800-848-3004 (orders only). COTRONICS, Inc., 2250 S.E. Federal Hwy., Stuart, FL 34994.

**CB RADIO HACKER'S GUIDE!** Big 151 page book; pictorials, diagrams, text. Complete guide to peaking, tweaking, & modifying 200+ CB radios for enhanced performance & more features. Which screws to turn, which wires to cut, AM & SSB radios: Cobra, Courier, GE, Midland, Radio Shack Realistic, SBE, Sears, Uniden/President. Get the most from your CB radio & operations. Only \$19.95, plus \$5.00 shipping (\$6.00 to Canada). NY State residents add \$2.12 tax. Order from CRB Research Books, Inc., PO Box 56, Commack, NY 11725. Visa/MC OK. Tel: (516) 543-9169.

**Cable Television equipment** — Replacement converters and accessories for most major brands. Call for unbeatable prices. Quantity discounts. Same day shipping UPS or FedEx. COD's allowed. **QB Video 1-800-249-3025.**

**TOMCAT'S BIG CB HANDBOOK**, by Tom Kneitel. 221 large pages, fully illustrated. Complete guide to worldwide AM, SSB, Freeband, 27 MHz operations. Everything they never told you (legal & otherwise) from world's leading CB authority. Only \$15.95 plus \$5.00 s/h (Canada \$6.00) from CRB Research Books, Inc., PO Box 56, Commack, NY 11725. (NYS residents add \$1.78 sales tax). Visa/MC orders call: (516) 543-9169.

**DX TOOLS** for the serious radio listener. Quantum Loops, Q-Sticks, more. Stamp for catalog. Radio Plus+ Electronics, 3635 Chastain Way, Pensacola, FL 32504. (904) 434-3635.

**WORLD'S MOST UNUSUAL Communications Books!** A large selection of outstanding titles covering scanners, "confidential" frequency registries, bugging, wire tapping, electronic surveillance, covert communications, computers, espionage, monitoring, and more! New titles being added constantly! Ask for our big FREE catalog. CRB Research, BOX 56-PC, Commack, NY 11725.

**CB MODIFICATION SECRETS**, big new 200-page guide by Kevin Ross, author of "CB Radio Hacker's Guide." More great easy-to-do Am/SSB CB equipment upgrades and enhancements applicable to Cobra, Realistic, Uniden, President, etc. Freq. expansion, VFO, clarifier unlock, VOX, Roger Beep, anti-theft device, receive signal preamp, much more. Only \$21.95, plus \$5 s/h (\$6 to Canada) from CRB Research Books, P.O. Box 56, Commack, NY 11725. NYS residents add \$2.22 tax. VISA/MC orders call: (516) 543-9169.

**MILITARY RADIOS:** Easily made battery adapters for military radios & other electronics. Get **POWER UP!** Big new 96-page manual of instructions, diagrams. Use readily available commercial batteries in PRC-6, -8, -9, -10, -25, -28, -47, -74, -77, TRC-77, AN/PRC-9, AN/PRT-4, RT-77, URC-68, more; also mine detectors, night scopes, radiacs, field telephones, etc. Only \$14.95, plus \$5 s/h (\$6 Canada). NYS residents add \$1.53 tax. CRB Research Books, Box 56-PC, Commack, NY 11725. VISA/MC accepted. Phone (516) 543-9169.

**CABLE DESCRAMBLERS—BELOW WHOLESALE PRICES ALL BRANDS, 30 DAY MONEY-BACK GUARANTEE ABSOLUTELY THE LOWEST PRICES—NOBODY BEATS US. THE CABLE STORE 1-800-390-1899.**

**WANTED: CB RADIO EQUIPMENT**—I'm looking for all types of old/vintage CB radios, amps, manuals, magazines, mics, etc. **PLEASE CALL** anytime. **WALTER 818-297-7249.**

**GE SUPERADIO III** with up to four SCS bands is the DX'ers choice. AM modification included. Low as \$85. 800-944-0630.

**CABLE DESCRAMBLERS FROM \$99.00. TEST DEVICES FROM \$15.00. CALL US WITH YOUR QUESTIONS. 1-800-449-9189. NO FLORIDA SALES. ANYONE IMPLYING THEFT OF SERVICE WILL BE DENIED ASSISTANCE.**

**MILITARY TECHNICAL MANUALS** for sale. Basic Electricity, Basic Electronics, Antenna Theory and mechanical books. Write or call for listing: **ART'S BOOK WORLD, INC., 6822 22nd Ave. N., Ste. 175, St. Petersburg, FL 33710; phone 813-525-4880; or TOLL-FREE 1-888-414-BOOK.**

**NEED HELP!** Radio Shack can't repair/replace band switch and FET amp on analog geezer's like-new Realistic DX-200. Can anyone? Joseph Burgess, 407 Hiawatha, Frankfort, KY 40601, (502) 695-3016.

**LEARN CODE BY HYPNOSIS**—<http://www.qth.com/cweasy/>; or 1-800-425-2552.

**CABLE TV DESCRAMBLER.** Build your own. Complete plans. Parts list. Diagrams. Circuit board. Schematics. Send \$9.95 to A. Gray, P.O. Box 1223-E Station 28, Route 6, Halifax, NS B3L-4P4.

**CABLE TV DESCRAMBLER! ANYONE CAN BUILD IN SEVEN EASY STEPS WITH RADIO SHACK PARTS. PLANS/KITS FROM \$5.00 PLUS FREE BONUS.** 1-800-818-9103.

**RADIO STUFF SALE:** Books, magazines, club bulletins, radio station items, old time radio & more. \$1 for list. G. Dexter, 213 Forest St., Lake Geneva, WI 53147.

**CABLE DESCRAMBLER** anyone can build for under \$12 in 7 easy steps with Radio Shack parts! Plans \$10. R.L. International, 12917 Jefferson Ave., Suite H-162, Newport News, VA 23608.

**WANTED: TUBE-TYPE** audio equipment, speakers. 1930's-1960's. Microphones, amplifiers, mixers, etc. Western Electric, Macintosh, Marantz, Altec, J.B.L., etc. 1-800-251-5454.

**NOW YOU CAN DEAL DIRECT WITH THE 'SHED!** We only deal with CB's—We have to be good! The CB Shed, P.O. Box 565, Chouteau, OK 74337; 918-476-8656.

**NEW SCANNING USA,** from the publishers of Scanning Illinois. Nationwide newsletter with Public Safety, Aircraft, Railroad, Shortwave, Federal/Military, Tech, more! Samples 3.00. Twelve issues for \$19.95. SASE checks to: 2054 Hawthorne, Joliet, IL 60435. Make checks payable to Alex Blaha.

**WANTED: EARLY MILITARY RADARS.** Aviation, marine, fire control, bombing, missile. Also parts, training courses, TM's. RADAR: Box 10215, Bloomfield, PA 15232.

**WANTED: NORWOOD XLP** 4-track tape recorder. Must be in good working condition. Contact RLN, P.O. Box 238, Chicopee, MA 01014-0238.

**RF TRANSISTORS, TUBES** 2SC2879, SAV17, 2SC1946A, MRF247, 2SC1969, MRF455, MB8719, MRF454, 2SC2312, 2SB754, SRF3749, 4CX250B, 572B, 3-500, ETC. WESTGATE 800-213-4563.

**POOR RECEPTION ON YOUR AM RADIO?** Our signal booster will help. Guaranteed! Version 1601 tunes 530-1600 kHz. \$39 + \$5.50 s/h. If not satisfied within 30 days, we'll refund your money, less s/h charge. FALA ELECTRONICS-5, P.O. Box 1376, Milwaukee, WI 53201-1376, 414-671-5203.

**INTERNATIONAL SSB-CB CLUB**—looking for members in Georgia, Mississippi, Missouri, and Tennessee. You get callsign, directory, member card, award program, contest program and club magazine. We issue separate QSL cards for each state/country. Fee is \$20 money order mailed to A.S.A. DX-Group, P.O. Box 685, S-521 21 Falkoping, Sweden.

**TOP DOLLAR PAID. WANTED.** used (but not abused) Regency MX-3000 scanners (30 channel communications receiver) for back-ups and parts bins. Check your shack and vehicles for surplus or unused units (MX-3000's only). Advise condition and price wanted to Jan D. Lowry, 28243 Royal Road, Castaic, CA 91384-3028. (No calls please).

**EarthSound:** A portable listening device to hear the Earth. \$39.95 plus \$4 S&H. Humanform, P.O. Box 158486, Nashville, TN 37215.

**NOW YOU CAN DEAL DIRECT WITH THE SHED!** We only deal with CB's - we have to be good! The CB Shed, PO Box 585, Chouteau, OK 74337, 918-476-8656.

1997 CATALOG, SCANNERS, CB radios, microphones, power supplies, hard-to-find electronics, catalog \$1.00 (refundable). 10 yrs. in business. GALAXY, BOX 1202, Akron, OH 44309.

**STEEL BUILDINGS - SUPER SALE** Equipment storage, workshop, garage, easy to erect, designed for do-it-yourselfer. 20x20, 25x30, 30x40. Large discounts. Limited quantities. 1-800-409-5382.

**HAM location,** beautiful all brick rancher, 4700 sq. ft. home includes home office, HAM shack (radio room), antennas, 3 tiled full baths, 3 or more bedrooms, 3 dens. The 3 car garage and smoking room are not included in the 4700 sq. ft. Sturdy quality construction. Type of heat is great for sinuses and very warm. Acre lot, back fully fenced and very quiet and private, secure gates, separate dog kennel, Olympic size well kept swimming pool. Located on mountain ridge, quiet prestigious neighborhood, nice homes all around, great schools. Located 55 miles from Baltimore and Washington, D.C. Ideal location to work in DC, with easy accessibility by train. House and property will be inspected, one year warranty. Pictures, property plot, layout, amenities list, and features in a booklet available to serious buyers for \$5 cash, check or money order. Contact W3BAG, Box 609, Braddock Heights, MD 21714, or call 301-473-5825.

**TUBE-TYPE CB RADIO COLLECTION** sale! Free List. Ed Clink, WA9PFB, 1285 New Salem Church Rd., New Berlin, IL 62670.

1997 PICTURE CATALOG, CB RADIOS, SCANNERS, INCLUDING NEW TRUNKING UNITS, POWER SUPPLYS, METERS, MICROPHONES AND HARD TO FIND ELECTRONICS. \$1.00 (REFUNDABLE). GALAXY ELECTRONICS, BOX 1202, AKRON, OHIO 44309. (13 yrs. IN BUSINESS).

**RTTY Decoder,** Universal M-900V2, AMTOR, CW, FAX, FEC, SITOR and Sanyo 9" Green Monitor. Very easy to use, Both like new \$250. John (907) 337-9168.

**Michael Faraday,** Relativity, Free Energy, UFO's, a biography. Also strange relationships in electromagnetic fields, unipolar motors, free energy devices. UFO's. 221 pages. \$20.00 to Frank Fite, 1914 Billy Drive, Fort Wayne, IN 46818.

**FOR SALE: SONY CRF-V21** visual World band receiver with built-in printer. One year old, rarely used. Price as of 1991 \$7,000, YOURS FOR \$1500. Call Yassin Abdela: (808) 841-1793 or write to: 963 Robello Lane #46, Honolulu, Hawaii, 96817.

**R9000 RECEIVER \$4000 CALL** (314) 947-3917.

**START YOUR OWN COMMERCIAL RADIO STATION WITH ONLY \$5000 OR LESS!** Yes it's possible & legal. Part 15 of FCC rules allows low power AM radio stations to operated without a license!! Cover an entire town & bill \$1500 a month!! It has been done!! Order the newsletter booklet that tells you all you need to know to get started for \$29.99. Send check or money order payable to: WCTD AM 1620, 4 Canal St., Westerly RI 02891 or call 401-348-9222 for information.

**CB and 10 METER equipment:** Ranger, Galaxy, Mirage, Super Star, and Much More! Send 3 stamps to EDS, P.O. Box 343, Howell, NJ 07731.

# Advertisers Index

33 Simple Weekend Projects .....	76
A.M.C. Sales, Inc. ....	69
AOR, LTD. ....	Cov II
A.R.R.L. ....	33
Antique Radio Classified.....	22
Arcron-Zeit .....	32
Atlantic Ham Radio .....	65
BayGen USA .....	15
Byron Hill Publishing Co. ....	48
C. Crane Company .....	69
CQ Books & Video.....	23
CQ VHF Magazine.....	46
CRB Research .....	48,69,77
Carver Patent Law Ltd. ....	48
Computer Aided Technologies.....	42,43
Delphi Internet.....	27
Delta Research.....	59
Drake, R.L. Company.....	9
Durham Radio Sales & Service, Inc....	48
EDCO .....	35
Electronic Equipment Bank.....	1
Firestik Antenna Company.....	77
Future Scanning Systems .....	48
Index Publishing Group, Inc. ....	28
Intensitronics Corp. ....	57
Japan Radio Co., Ltd. ....	13
Jo Gunn Enterprises.....	31
Lentini Communications, Inc. ....	51
MACO Mfg. Div./Majestic Comm.....	45
MFJ Enterprises, Inc. ....	39
Maxon America, Inc. ....	37
MoTron Electronics .....	27
Mouser Electronics .....	49
Optoelectronics, Inc. ....	5,19,Cov. IV
Phillips-Tech Electronics.....	22
R.C. Distributing .....	27
REACT International, Inc. ....	46
RELM Communications.....	29
RadioShack.....	17
SGC, Inc. ....	59
Scrambling News .....	77
Sherwood Engineering, Inc. ....	57
Signal Engineering, Inc. ....	49
Software Systems Consulting.....	51
Stridsberg Enginnering, Inc.....	77
Universal Radio, Inc. ....	3
Viking International.....	31
Widespread Weather Services, Inc. ....	27
Wilson Antenna, Inc. ....	7
Wireless Marketing Corp. ....	63
Xandi Electronics, Inc. ....	28
Yaesu U.S.A. ....	Cov. III

**Reach this dynamic audience with your advertising message, contact Don Allen, W9CW at 217-344-8653, FAX 217-344-8656, or e-mail: PopComAds@aol.com**

# The Loose Connection

RADIO COMMUNICATIONS HUMOR

## Bill's Phonetic Alphabet



Before we begin this month's example of how any fool with a beard and a word-processor can write a column, please allow me to rise to a point of personal privilege and publicly apologize to our Associate Editor, Nancy Barry, for calling her on April 1 and trying to imitate Steve Stoddard, who appeared on the May '97 cover. As my contribution to the April Fool's Day tradition, I tried to convince her that she'd run the wrong cover photo, and I went on to tell her (as Steve) that I'd surely be fired for appearing on a magazine cover with aviator sunglasses and my shirt-collar unbuttoned. If the truth be known, it was our editor, Harold ("I'll act innocent; you take the blame") Ort who made me do it. Since he's out of the office as I drop this column into the basket for typesetting, it'll probably make it into the magazine un-noticed. As an aside, the best voice I could make up to imitate Steve sounded like Uncle Joe from the Hooterville Hotel, and I doubt it was very convincing. [Bill, on any other day, under any other editor, you would have been very convincing—Nancy]

Moving right along, many of you have written and asked me, "Bill, can you give us an alternative to the ICAO phonetic alphabet used by pilots, hams, and the military? That "Alfa, Bravo, Charlie" stuff is boring—got any ideas to liven it up?"

Well, indeed I do. Based on an idea given me years ago by Cushcraft's own K1GW (Knife One Gnat Wrench) and my friend Dave at George Mason University, I have searched the world (and many dictionaries) to give *Pop'Comm* readers a phonetic alphabet that's a bit more fun than the one our Civil Aeronautics folks came up with.

Now you've all heard the alphabet that the local police use ("L-Lincoln, N-Nora, I-Ida), and you've heard hams use "Boston" instead of Bravo, but I doubt you've heard one quite like this. Remember, as boring as it might be, *Pop'Comm's* Dr. Safety still recommends you always use the standard ICAO phonetic alphabet during any real emergency.

And again, taking advantage of the absence of our editor, Harold ("What—and break a quarter?") Ort, I thought he'd like to sponsor a little competition to come up with better phonetic equivalents for the letters "F" and "L."

Interesting answers will be published in a future issue, and the first entrants who submit the chosen winners will receive our undying gratitude (for about a week) and a copy of the latest something or other, or something else neat that I can find in Harold's desk. Decision of me is final; void where prohibited, taxed, or regulated in any way. So there.

A	AYE	(say "EYE")
B	BDELLIUM	(say buh-DELL-ee-um)
C	CAY	(say "KAY")
D	DJIBOUTI	(say juh-BOO-tee)
E	EWE	(say "YOO")
F	FEW	(say "FYOO")
G	GNUS	(say "NOOZ"—exception—broadcasters say "NYOOZ")
H	HORS D'OEUVRE	(say "orr-DERV")
I	IGOR	(say "EE-gor")
J	JUNTA	(say HOON-tah)
K	KNEW	(say "NOO"—broadcasters see "GNUS")
L	LESS	(say "LESS")
M	MNEMONIC	(say "nuh-MOHN-ik)
N	NEWS	(say "NOOZ"—broadcasters see "GNUS")
O	OEDIPUS	(say "ED-uh-puss")
P	PNEUMATIC	(say "NOO-mah-tic"—except for those annoying broadcasters)
Q	QUEUE	(say "KEW")
R	RWANDA	(say "ruh-WAND-uh")
S	SEE	(say "SEE") see?
T	TSUNAMI	(a tough one—spit out the S when you say "soo-NAHM-ee")
U	USBEKISTAN	(say "iz-BEK-ih-stan)
V	VENI, VIDI, VICI	(say WEN-ee WID-ee WIK-ee")
W	WHY	(say "WI")
X	XERXES	(say ZERK-zeez")
Y	YVES	(say "EEV")
Z	ZERO	(say "ZEE-ro") (also "ZIP, NAH-duh, or in Northeastern PA, say "stoo-GAAHTZ")

# One tough little dual bander!

## Features

- Frequency Coverage  
Wide Band Receive  
RX: 76-200 MHz, 300-540 MHz, 590-999 MHz\*  
TX: 144-148 MHz, 430-450 MHz
- AM Aircraft Receive
- MIL-STD 810 Rating
- Digital Coded Squelch (DCS)
- 112 Memory Channels
- 12V DC Direct Input
- High Speed Scanning
- Alphanumeric Display
- CTCSS Encode/Decode
- Auto Range Transpond System™ (ARTS™)
- Dual Watch
- Direct FM
- High Audio Output
- ADMS-1C Windows™ PC Programmable
- Four Battery Savers:  
Automatic Power-Off (APO)  
Receive Battery Saver (RBS)  
Selectable Power Output (SPO)  
Transmit Battery Saver (TBS)
- Time Out Timer (TOT)
- 2.5 and 5 Watt Versions Available
- Built-in Digital Voice Recording System (DVRS)
- Full line of accessories

**NOW WITH BUILT-IN DELUXE KEYPAD**



"You notice how loud this HT's audio is?"

"Yeah, it's Mil Spec tough like a commercial HT."



"Easy to operate, small, great price!"

"Yaesu did it again!"

The foremost in top-performing, durable, dual band handhelds now includes the FTT-12 DTMF keypad with CTCSS enc/dec, DCS enc/dec, DVRS and paging/coded squelch. Manufactured to rigid commercial grade standards, the FT-50RD is the only amateur dual band HT to achieve a MIL-STD 810 rating. Already a winner: the deluxe keypad makes this stand-out HT even better! Water-resistant construction uses weather-proof gaskets to seal major internal components against the corrosive action of dust and moisture. And, the rugged FT-50RD withstands shock and vibration, so throw it in with your gear!

Exclusive features set the FT-50RD apart, too. Wide Band Receive includes 76-200 MHz (VHF), 300-540 (UHF), and 590-999 MHz\*. Dual Watch checks sub-band activity while receiving on another frequency. Then when a signal is detected, shifts operation to

that frequency. Digital Battery Voltage displays current operating battery voltage. Digital Coded Squelch (DCS) silently monitors busy channels. Auto Range Transpond System™ (ARTS™) uses DCS to allow two radios to track one another. And, the FT-50RD is ADMS-1C Windows™ PC programming compatible, too. To round out the FT-50RD, it has four battery savers, and super loud audio—remarkable in an HT this size.

A reliable companion where ever you go, the FT-50RD is one tough little dual bander with all the features you want!

**YAESU**  
...leading the way <sup>SM</sup>

For the latest Yaesu news; hottest products, visit us on the Internet! <http://www.yaesu.com>



**FT-10/40R**  
Ultra Compact Handhelds  
VHF or UHF. Similar to FT-50RD including MIL-STD 810, and other exclusive features.

© 1997 Yaesu USA, 17210 Edwards Road, Cerritos, CA 90703 (562) 404-2700  
Specifications subject to change without notice. Specifications guaranteed only within amateur bands. Some accessories and/or options are standard in certain areas. Check with your local Yaesu dealer for specific details. \*Cellular blocked

Reaction Tune the  
NEW  
ICOM IC-R10

# iCan Reaction Tune Another Receiver!

Use the OptoLinx for computer controlling the ICOM IC-R10 \$129.00



Computer Not Included

Another radio to tune, another reason to purchase the Scout.

Until now the AOR AR8000/2700 were the only hand held scanners to take advantage of the Scout's Patented Reaction Tune function. The Scout can now tune the new ICOM IC-R10 hand held scanner (shown below). Connection is easy: No modifications required - No custom cables to buy - Just plug and play.

Scanner hobbyists and communication professionals benefit from the Scout's unique functions. Whether you're searching for new frequencies in your neighborhood, or testing for interference, the Scout is the ultimate communications tool.

Armed with a 400 frequency memory register, the Scout does not record duplicate frequencies, instead it coordinates repeated frequencies into a hit register storing up to 255 hits per frequency. Attach it to your belt and begin your day, the Scout will alert you when a signal is received by its beeper or vibrator function.

You won't miss a thing with Reaction Tune. The Scout's CI-V compatible output allows it to interface to the AOR AR2700/AR8000, ICOM R7000, R7100, R8500, R9000 and now the new IC-R10 (shown opposite). The Scout captures the frequency, then sends the serial data to the receiver and tunes the scanner to the frequency for instant monitoring in less than one second. Recorded frequencies can be downloaded to a PC using the optional OptoLinx universal interface •

## SPECIFICATIONS

- ▶ 10MHz - 1.4GHz frequency coverage
- ▶ Stores and records 400 frequencies in memory with 255 hits for each
- ▶ Interface to a PC for frequency download using optional OptoLinx PC interface
- ▶ Distinctive beeps indicate frequency hits, pager style vibrator for discreet recording
- ▶ Automatic EL backlight for night operation
- ▶ 16 segment RF signal strength bargraph
- ▶ Frequencies are automatically saved when unit is turned off
- ▶ Reaction Tune the ICOM R7000, R7100, R8500, R9000, IC-R10, and AOR AR2700, AR8000, and the Radio Shack Pro 2005/6 using the Optoelectronics OS456, Radio Shack Pro 2035/42 using the Optoelectronics OS535



U.S. Patent No. 5,471,308

Radio Not Included

Scout with ICOM IC-R10 Mono Cable required (shown)

**FACTORY DIRECT ORDER LINE 800-327-5912**

# OPTOELECTRONICS®

INNOVATIVE PRODUCTS FOR A MODERN PLANET

5821 NE 14th Avenue • Ft. Lauderdale, FL • 33334

Telephone • (954) 771-2050 Fax • (954) 771-2052

CIRCLE 152 ON READER SERVICE CARD

Visa, Mastercard, C.O.D. Prices and specifications are subject to change without notice or obligation



The ICOM logo is a registered trademark of ICOM Inc. ICOM IC-R10 not distributed by OPTOELECTRONICS. contact ICOM for information and availability.