

ICD0E635

POPULAR COMMUNICATIONS

JANUARY 1992 \$2.95

\$3.95 CANADA

**The Excitement Of Monitoring
Scanners & Worldwide Shortwave**

Also in this issue:

- **End Your Car Phone Problems!**
- **Eavesdropping On Africa's Hot Spots**
- **Getting Ready For TV DX**
- **Scanning The Army's National Training Center**



**Plus: CB, Satellites, Mediumwave,
Nostalgia, & More!**



YOU EXPECT THE WORLD FROM ICOM RECEIVERS

ICOM's IC-R71A and IC-R7000 are the professional's choice for receiving international broadcasts, aircraft, marine, business, emergency services, television, and government bands. These people demand the finest in communications and so do you. ICOM puts the world at your fingertips with the IC-R7000 25-2000MHz* and IC-R71A 0.1-30MHz commercial quality scanning receivers.

Incomparable Frequency Control. Both the IC-R71A and IC-R7000 feature **direct frequency access** via their front keypad, main tuning dial, optional infrared remote control and/or computer interface adapter. **Incredible Flexibility!**

Full Coverage, Maximum Performance. The superb IC-R71A is your key to world-wide SSB, CW, RTTY, AM and FM (optional) communications plus foreign broadcasts in the 100kHz to 30MHz range. It features IF Notch, low noise mixer circuits and a 100db dynamic range. The pacesetter **IC-R7000** receives today's hot areas of interest, including aircraft, marine, public services, amateur, and satellite transmissions in the 25MHz

to 2000MHz* range. It includes **all mode operation** low noise circuits plus outstanding sensitivity and selectivity. The IC-R71A/R7000 combination is your window to the world!



The IC-R71A is a shortwave listener's delight. Its **32 tunable memories** store frequency and mode information, and they are single-button reprogrammable **independent of VFO A or VFO B's operations!** Dual width, an adjustable noise blanker, panel selectable RF preamp, and selectable AGC combined with **four scan modes** and all-mode squelch further enhance the IC-R71A's HF reception!

The IC-R7000 features 99 tunable memories and **six scanning modes.** It even scans a band and loads memories 80 to 99 with active frequencies without

operator assistance! Additional features include selectable scan speed pause delays, wide/narrow FM reception and high frequency stability.

Options. IC-R7000: RC-12 remote control, EX-310 voice synthesizer, CK-70 DC adapter, MB-12 mobile bracket. IC-R71A: RC-11 remote control, EX-310 voice synthesizer, CK-70 DC adapter, MB-12 mobile bracket, FL-32A 500Hz, FL-63A 250Hz and FL-44A filters.

See these quality ICOM receivers at your local authorized ICOM dealer today.

CORPORATE HEADQUARTERS
ICOM America, Inc., 2380-116th Ave. N.E., Bellevue, WA 98004
Customer Service Hotline (206) 454-7619
CUSTOMER SERVICE CENTERS
18102 Sky Park South, Ste. 52-B, Irvine, CA 92714 /
1777 Phoenix Parkway, Suite 201, Atlanta, GA 30349
ICOM CANADA, A Division of ICOM America, Inc.,
3071 - #5 Road, Unit 9, Richmond, B.C. V6X 2T4 Canada

All stated specifications are subject to change without notice or obligation. All ICOM radios significantly exceed FCC regulations limiting spurious emissions. RECEIVER791

ICOM
First in Communications

Take Advantage Of Our **NEW** Extended Warranty Plan . . . **Call Today!**

**SONY
ICFSW77**



From the genius of Sony, the world's most advanced portable Receiver. Factory programmed, 100 of the most popular SWL stations which you can reprogram yourself.

- 15-30MHz AM/CW/SSB
- 76-108MHz FM (Stereo)
- Station Name Tuning
- 160 Memory Pre-set
- Synchronous Detection
- Wide-Narrow Filters
- Multi Function Scan
- Multi Function Clock/A arm
- 120VAC Adapter Incl.
- 10.8x6.8x1.8 in. Wt. 52oz.

List \$624.95 **EEB \$499.00 + sh.**

It's Time To Upgrade!

**SONY
ICF2010**



Big Receiver performance in a portable, take with you package. Thousands of satisfied users make the ICF2010 Sony's Biggest Seller!

- 15-30MHz AM/CW/SSE
- 76-108MHz FM Band
- 116-136MHz Air Band
- Synchronous Detection
- 32 Program Memories
- Direct Keyboard Entry
- Multi Scan Functions
- Multi Clock Functions
- 4.5 VDC (3D) & (2) AA not incl.
- 120VAC Adapter Incl.
- 6.25x11.3x2.2 Wt 48 oz.

List \$429.95 **EEB \$349.95 + sh.**

A True Classic!

**SONY
ICFSW7600**



This is our number one selling mid-sized portable. Explorers and travelers will love the versatility of the ICF SW7600.

- 15-30MHz AM/CW/SSB
- 76-108MHz FM Band
- 10 Station Memory
- Full SW Coverage 1-30MHz
- Dual Conversion
- AN61 Antenna Incl.
- Clock, Timer, Alarm
- AM/SSB/FM/FM Stereo
- Direct Keyboard Entry
- Power (4) AA Not Incl. AC adptr. incl.
- 7 1/4 x 4 3/4 x 1 1/4 wt. 22 oz.

List \$399.95 **EEB \$219.95 + sh.**

#1 Compact Portable!

**SONY
TCM38V**



Turns your scanner into a logging receiver. Let the TCM38V run unattended. Play back later. You won't miss any action.

- Logging cassette recorder
- CH1 audio, ch 2, time date
- Records date, time & play back to LCD readout
- Ideal for scanner monitorin
- VOR voice/audio auto start
- Auto record level
- Built in microphone or Ext.
- Power (2) AA not incl.
- Opt. AC adapter PA3N 13 \$9.95
- 3 1/2 x 5 1/4 x 1 1/4 wt. 10 oz.

List \$129.95 **EEB \$99.95 + sh.**

NEW Innovative Recorder!

**JRC
NRD535D**



The NRD515 then 525 now 535D. Each generation has introduced state-of-the-art features to satisfy the most discerning listener.

- 1-30MHz AM/CW/SSB/FM
- New Exalted Carrier
- New Selectable Sidaband (ECSS)
- Phase Lock Detection
- Variable Bandwidth Control (EWC)
- Tuning Steps 1Hz DDS (10Hz readout)
- 100dB Dynamic Range
- 200 station memory
- RTTY Demod Option
- 4 Filter Position 3 Supplied 1.2, 6kHz
- 13x5x11 in. Wt. 20lbs.

List \$1999 **EEB \$1599 + sh.**

**ICOM
R71A**



Setting World Standards! Versatile, Reliable, Rugged. Our Top Selling Desktop Receiver!

- 1-30MHz AM/CW/SSB Opt. FM
- Pass Band Tuning
- 100dB Dynamic Range
- Filters 6 & 2.4kHz Opt. CW 500Hz
- 120/240 VAC Opt. 12VEC
- 32 Programmable memories
- Dual VFO
- Multi Scan Functions
- IR. Remote Option
- Computer Control Option
- Many EEB Filters & other Options
- 11.3x4.3x10.9 in. Wt. 16.5 lbs.

List \$999 **EEB \$849.95 + sh.**

**DRAKE
R8**



Getting Rave Reviews From The Experts! EEB welcomes Drake back to the shortwave market. The R8 promises to be a big hit with the serious listeners.

- 1-30MHz AM/CW/SSB
- VHF Opt. 35-55/108-174MHz
- 100 Memory Channels
- Synchronous Detection
- 5 filters .5, 1.8, 2.3, 4, 6 kHz
- All Mode AM, CW, SSB, RTTY, FM
- Band Pass Tuning
- RS232 Serial Interface
- Dual Antenna Inputs
- 13.2x13x5.25 in. Wt. 13lbs.

EEB \$979.00 + sh.

**FREE ^{in U.S.A.}
NEW 1992 CATALOG**



- All New expanded SWL
- New Amateur Section
- Enlarged Scanner Section
- New Specialty Section
- Expanded Book Section

This is our largest catalog ever! If you received our 1991 catalog your on our mailing list. Watch for your copy! If you never received an EEB catalog call-write or FAX (703-938-6911) today! Our Catalog is free in U.S. \$1.00 in Canada/Mexico. All others are \$3.00.

POPULAR COMMUNICATIONS

JANUARY 1992

VOLUME 10, NUMBER 5



16



46

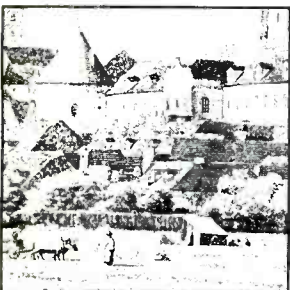

72

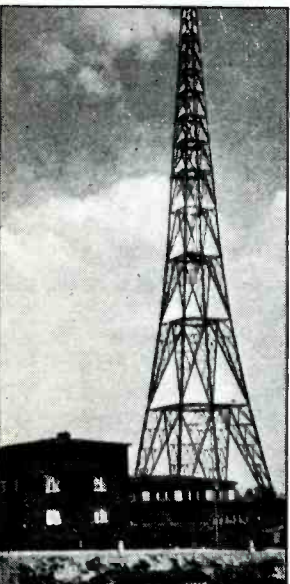

20

FEATURES

- End Your Car Phone Problems!** 9
What To Do When The Car Phone Balks At Completing Your Call. Getting The Best Of Common Cellular Annoyances!
By Ken Sperry, KCA6BK
- Scanning The Army's National Training Center** 12
Tune In On The Most Sophisticated Wargames Battlefield In The World!
By Chuck Robertson
- DXing Africa's Hot Spots** 16
Radio Sheds Light On The Dark Continent
By Gerry Dexter
- Radio's Golden Age** 20
A Stroll Down Memory Lane—With Stops Along The Way
By Alice Brannigan
- Books You'll Like** 28
Handy Hints For The Hobbyist, and Gripe and Get Results
By R. L. Slattery
- High Performance TV DX "Tool"** 30
Now Is The Time To Prepare For The Coming TV DX Season
By Bob Cooper, Jr.

COLUMNS

CB Scene	34
You Should Know	38
Ham Column	42
How I Got Started	43
Satellite View	44
Emergency	46
Telephones Enroute	48
Pirates Den	51
RTTY	52
Broadcast DXing	54
Washington Pulse	60
Listening Post	64
Communications Confidential	68
Clandestine Communique	72
Scanning VHF/UHF	74

DEPARTMENTS

Beaming In	4
Mailbag	6
Worldband Tuning Tips	40
New Products	50
Communications Shop	77

This month's cover: USA—Microwave towers for telephones in the outback of New Mexico. Photo by Larry Mulvehill.

EDITORIAL STAFF

Tom Kneitel, K2AES/KNY2AB, Editor
Jeanine M. O'Connor, Associate Editor

CONTRIBUTING EDITORS

Gerry L. Dexter, Shortwave Broadcast
Robert Margolis, RTTY Monitoring
Gordon West, WB6NOA, Emergency
Don Schimmel, Utility Communications
Edward Teach, Alternative Radio
Harold A. Ort, Jr., Military Consultant
Janice Lee, Radar Detectors
Chuck Gysi, N2DUP, Scanners
Roger Sterckx, AM/FM Broadcasts
Harry Helms, AA6FW, Thoughts and Ideas
Donald Dickerson, N9CUE, Satellites
Kirk Kleinschmidt, NT0Z, Amateur Radio

BUSINESS STAFF

Richard A. Ross, K2MGA, Publisher
Donald R. Allen, N9ALK, Advertising Mgr.
Emily Kreutz, Sales Assistant
Dorothy Kehrwieler, General Manager
Frank V. Fuzia, Controller
Catherine Ross, Circulation Director
Melissa Kehrwieler, Data Processing
Carol Minervini, Data Processing
Denise Pyne, Customer Service

PRODUCTION STAFF

Elizabeth Ryan, Art Director
Barbara Terzo, Assistant Art Director
Susan Reale, Artist
Dorothy Kehrwieler, Production Manager
Emily Kreutz, Production
Pat Le Blanc, Phototypographer
Florence V. Martin, Phototypographer
Hal Keith, Technical Illustrator
Larry Mulvehill, WB2ZPI, Photographer

A publication of

 CQ Communications, Inc.
76 North Broadway
Hicksville, NY 11801-2953 USA.

Offices: 76 North Broadway, Hicksville, NY 11801. Telephone 516 681-2922. FAX (516) 681-2926. Popular Communications (ISSN 0733-3315) is published monthly by CQ Communications, Inc. Second class postage paid at Hicksville, NY and additional offices. Subscription prices: Domestic—one year \$19.95, two years \$38.00, three years \$57.00. Canada/Mexico—one year \$22.00, two years \$42.00, three years \$63.00. Foreign—one year \$24.00, two years \$46.00, three years \$69.00. Foreign Air Mail—one year \$77.00, two years \$152.00, three years \$228.00.

U.S. Government Agencies: Subscriptions to Popular Communications are available to agencies of the United States government, including military services, only on a cash with order basis. Requests for quotations, bids, contracts, etc. will be refused and will not be returned or processed.

Entire contents copyright ©1992 by CQ Communications, Inc. Popular Communications assumes no responsibility for unsolicited manuscripts, photographs, or drawings. Allow six weeks for change of address or delivery of first issue. Printed in the United States of America.

Postmaster: Please send change of address to Popular Communications, 76 North Broadway, Hicksville, NY 11801.

UNIVERSAL SHORTWAVE

Monitor More With Advanced Equipment From Universal!

COMMUNICATIONS RECEIVERS

☐ Japan Radio NRD-535D



Triple conversion power with ECSS, Bandwidth Control and 3 filters included. The new standard in HF receivers. \$1589.00 (+\$16)

☐ Japan Radio NRD-525

Rated five stars and *Editor's Choice* by Larry Magne in *Passport '91*. \$1099.00 (+\$15)

☐ Drake R-8

A state-of-the-art receiver for the 90's. Five bandwidths, Syncro., etc. \$959.95 (+\$11)

☐ Kenwood R-5000

A powerful receiver for the serious DXer. An exceptional value. \$879.95 (+\$12)

☐ Kenwood R-2000

Many features: mems., scan, sweep, FM mode, 24 hr. clock etc. \$649.95 (+\$10)

PORTABLE RECEIVERS

☐ Panasonic RFB-45



Keypad, 18 memories, scan and search functions, S.S.B., fine tuning knob, clock-timer, S-METER, etc. \$169.95 (+\$5)

☐ Sony ICF-2010

Super high performance and features. VHF air too. \$359.95 (+\$6)

☐ Sony ICF-SW77

The *state-of-the-art* in portables. Write for the incredible details. \$499.95 (+\$6)

☐ Grundig Satellit 500

Hi-tech with beautiful fidelity and style. Synchronous tuning. \$539.95 (+\$6)

Note: Radios listed above are all LW-MW-SW-FM digital. Contact us for other models

SPECIAL RECEIVERS

☐ Icom R-9000



Solid all-mode coverage from .1 to 1999.8 MHz. Multi-function CRT with spectrum analyzer. The ultimate receiver! **CALL FOR PRICE.**

SHORTWAVE ANTENNAS

☐ Alpha Delta DX-SWL Sloper

MW +120-13 meter bands (60')... \$67.95 (+\$5)

☐ Alpha Delta DX-SWL Sloper-Short

90-13 meter bands (40')... \$57.95 (+\$5)

☐ Eavesdropper Specify twin lead or coax type 9 SW bands (60-10 meters). \$74.95 (+\$5)

☐ McKay Dymek DA100D Active Antenna

The Cadillac of active antennas! \$179.95 (+\$5)

☐ B&W ASW-90 Full Coverage Dipole

Covers 3.5-30 MHz solid! \$89.95 (+\$6)

Note: Many more antennas available. See catalog.

MULTI-MODE CONVERTERS

☐ Universal M-7000



The Universal M-7000 will permit you to intercept and decode Morse code, various forms of RTTY, FDM and FAX. Simple connections to your receiver and video monitor will enable you to monitor with the most sophisticated surveillance decoder available. No computer is required. See the world of shortwave excitement you have been missing. Requires 115/230 AC 50/60 Hz. With video fax and real time clock only \$1159.00 **Please write for full details.**

- ◆ Morse Code (CW)
- ◆ Regular Baudot RTTY
- ◆ Bit Inverted & Var. Baudot
- ◆ ASCII Low & High Speed
- ◆ Sitor Mode A & B
- ◆ ARQ-M2 & M4 (TDM)
- ◆ ARQ-E and ARQ-E3
- ◆ FEC-A and FEC-S
- ◆ SWED-ARQ and ARQ-S
- ◆ VFT Modes (FDM)
- ◆ Russian 3rd Shift Cyrillic
- ◆ Facsimile (FAX) AM/FM
- ◆ Packet 300 & 1200 AX.25
- ◆ Remote Terminal
- ◆ Literal & Databit Modes
- ◆ Variable & Standard Shift
- ◆ Automatic Tuning
- ◆ Diversity Reception

MULTI-MODE CONVERTERS

☐ Universal M-900



Here is a compact, easy to use decoder that copies all the most important shortwave transmission modes. The M-900 covers Morse code for monitoring hams, ships and coastal stations. Baudot RTTY is included for decoding weather and international press broadcasts. Both Sitor A and Sitor B are supported for monitoring the extensive maritime and diplomatic traffic. Facsimile (to the printer only) lets you receive maps and pictures from around the world. Requires 12 VDC @ .8A Text output to video monitor. **\$499.95 (+\$8)**

- ◆ Morse Code (CW)
- ◆ Regular Baudot RTTY
- ◆ Sitor Mode A (ARQ)
- ◆ Sitor Mode B (FEC)
- ◆ FEC-A
- ◆ Facsimile (FAX) FM
- ◆ Variable & Standard Shift

M-900 System Components

A complete M-900 system would require:

- Universal M-900
 - 12 VDC Power Supply
 - Your SW Receiver
 - Video Monitor
 - Parallel Printer
 - Cables for above
- Please write to Universal for full information on the M-900 and the above optional items.

COMMUNICATIONS BOOKS

☐ Passport To Worldband Radio

By *L. Magne*. Graphic presentation of all SWBC stations. Equipment reviews too. \$16.95

☐ Shortwave Receivers Past & Present

By *F. Osterman*. Your guide to 200 receivers with new-used value, specs, features. \$8.95

☐ Aeronautical Communications Handbook

By *R. Evans*. A mammoth book on all aspects of shortwave aero listening. 266 pages. \$19.95

☐ Complete SWL's Handbook Third Edition

By *Bennett, Helms, Hardy*. Nearly 300 pages on all aspects of SWL'ing. \$16.95

☐ Guide To Utility Stations

By *J. Klingenfuss*. The definitive guide to utility stations- CW, SSB, FAX and RTTY. \$33.95

☐ Easy-Up Antennas for Listeners & Hams

By *E. Noll* Low cost, easy to erect antennas for LW, MW, FM, SW, SCAN and HAM. \$16.95

☐ World Radio TV Handbook

All SWBC stations by country with schedules, addresses, power, etc. Reviews too. \$19.95

✓ **Please add \$1 per title for shipping.**

COMMUNICATIONS CATALOG

Universal now offers a new combined communications catalog covering shortwave, amateur and scanner equipment. There is also an unbeatable selection of antennas, books, parts and accessories. This huge **92 page** (8½" by 11") publication covers everything for the radio enthusiast. With prices, photos and full descriptions.

Available FREE by fourth class mail or \$1.00 by first class mail.

STORE HOURS

Monday - Friday 10:00-5:30
 Except Thursday 10:00-8:00
 Saturday 10:00-3:00

- We ship worldwide
- Visa, MC, Discover
- Prices & specs. are subject to change.
- FAX: 614 866-2339
- In business since 1942!
- Used equip. list available

Universal Radio

1280 Aida Drive Dept. PC
 Reynoldsburg, Ohio 43068 U.S.A.

Info.: 614 866-4267 Orders: 800 431-3939

AN EDITORIAL

Cashing In On Radio

The extent of my usual involvement with the world of economics primarily centers around the realization that balancing my checkbook is something I can accomplish no more than twice out of every nine attempts. Secondly, I never cease to be amazed every time I need to face up to the reality that 10-cent pay phones no longer function unless I drop in a quarter.

Luckily, thoughtful readers are kind enough to give me an elbow in the ribs when events in the alien world of economics require my attention. So it was when John Rouse, KA3DBN, of Bowie, MD sent me some comments that appeared in a publication entitled *The Economist*, which John describes as "one of the world's saner news magazines." I am unfamiliar with this magazine, and I think that it may be published outside of the USA.

Public resources here in the USA include about half the land area, which is administered by several agencies of the government. That land can't be sold because it is owned by the public. This protects national parks, forests, grasslands, waterways, and other public areas from gross uses.

In the USA, the airwaves have also been considered to be a natural resource belonging to the public. For the last fifty years, their use has been administered on behalf of the public by the FCC, a government agency. The agency, on the government's behalf, decides who will and will not use these airwaves.

The Economist notes that in many instances, such as with ship, ham radio, public safety, aeronautical, and industrial licenses, the agency can issue licenses in large numbers. However, certain types of licenses don't work that way and are more or less exclusive franchises. A broadcasting license for a specific frequency, for a set license period (renewable), in a particular city, or a cellular service license would be examples of this type of license.

Applicants seeking to establish and build new broadcast stations have long needed to compete against one another to prove to the agency who will best serve the public before one applicant is selected to receive the coveted franchise to build the station and set up operations.

When the cellular industry started in 1982, the FCC was swamped with requests from companies that wanted to establish operations. With only one non-wireline license to be issued in each service area, each license amounted to a franchise. Rather than administer the processing of competing applicants, as in the broadcast services, the agency came

up with an idea that was the easiest way out, and also the most unfair to the public. This was to select the franchise holder by means of a simple lottery.

Essentially, being picked as the winner of these lotteries is better than winning just about any state *Lotto* game. That's because *The Economist* notes that Uncle Sam is giving away valuable chunks of public frequencies that can be rather painlessly converted into hard cash by applicants for cellular systems who spent nothing to win the lottery, then never put one single cell site into operation.

They cite one FCC cellular lottery winner in eastern Massachusetts who took only ten months to turn around and peddle his free FCC franchise to someone else for \$41.5-million. He never had to put up an antenna, or do anything more than be there to win the luck of the FCC's draw.

The Economist reminds us that broadcasters have dealt in the market values of these frequency franchises since the 1950's. This means that when an existing broadcast station sells for millions of bucks, the station's audience, dusty studios, old transmitter, and rusty tower with the peeling paint counts for only a minor part of the price. Most of the price is for the new owner to purchase the right to gain access to the station's coveted spot on the dial—that is to say, the license, or FCC franchise.

A typical example would be Boston FM'er WBOS/92.9, according to information from Maine DX'er Bob Gilbert, who regularly reports to *POP'COMM* on New England AM/FM doings. After two years of losing money on the station and finding that its "rock without the hard edge" format had low ratings, last summer its Seattle-based owners decided to look for a buyer. No asking price had been set, but WBOS was purchased in 1989 for a cool \$19-million. That's what a spot on the Boston FM dial is worth! Compare that price against KFNC/100.9, of Sulphur, OK that recently sold for \$40,000, or KTRQ-FM/104.3, of Tri City, OR that just found a new owner for \$65,000.

So, we have one type of case where a broadcast licensee earns the exclusive right to locally use a frequency and may then cash it in by selling its availability to another party. Then, in the case of cellular lottery winners, the government essentially gives away (with a license fee) the right to commercially use the public's frequencies for a period of time. The recipients can either use them or peddle them, unused, as they see fit.

(Continued on page 76)

**AUSTIN AMATEUR
RADIO SUPPLY**

Friendly Service
Texas Style!

1-800-423-2604



**Order
Now!**

SONY



ICF-SW77 • ICF-2010



ICF-SW7600



**The
World
In
Your
Pocket!**

ICOM



IC-R1



IC-R100

**Bring
The
World
To
Your
Car!**



**RainWise
Remote Reading
Rain Gauge!
1/100" Read Out**

MSP \$79.95 **\$ 69.95**

Requires Two 9V Batteries-Not Included

**Super Store
Pricing!**

**AUSTIN AMATEUR
RADIO SUPPLY**

5325 North I-35
Austin, Texas 78723
512-454-2994

1-800-423-2604

Now, You Can Eavesdrop On The World. Introducing the new Drake R8 Communications Receiver. It's world class, world band radio, made in the U.S.A. From Perth to the Persian Gulf, Moscow to Mozambique, local or global, you hear events *as they happen* with amazing clarity. Since 1943, Drake



has been setting the standards in electronic communications . . . and then raising them. Today, there's no better shortwave receiver than the Drake R8. **Out-Of-This-World Performance.** The new Drake R8 has more standard features than other shortwave radios. You get wide frequency range (100 KHz to 30,000 KHz), coverage of all world and local bands, and excellent dynamic range. But you also get important features you won't find on receivers costing hundreds of dollars more. A multi-voltage power supply. Pre-amp and attenuator. Five bandwidth filters and synchronous detector. Dual mode noise blanker and passband offset. Non-volatile 100 channel memory. All designed to give you the best reception with the least distortion. **Down-To-Earth Design.** The ergonomic design of the R8 gives you real ease of operation. You have convenient keypad entry, with large, legible controls. The face is bold. Uncluttered. And the liquid crystal display (LCD) is backlighted for easy reading. **Try The R8. . . At Our Risk.** If you're not impressed by Drake's quality, performance and ease of operation, return the R8 Receiver within 15 days and we'll refund your money in full, less our original shipping charge. For more information, or to order, call **TOLL-FREE, 1-800-9-DRAKE-8**. Telephone orders may be placed on a major credit card. \$979.00 (Shipping and handling \$10 in continental U.S. Ohio residents add 6½% tax.) Call **TOLL-FREE, 1-800-9-DRAKE-8** today. You can't lose.

DRAKE

In touch with the world.

R.L. Drake Company • P.O. Box 3006 • Miamisburg, Ohio 45342 U.S.A.

CIRCLE 50 ON READER SERVICE CARD

MAILBAG

LETTERS TO THE EDITOR

Each month we select representative reader letters for our Mailbag column. We reserve the right to condense lengthy letters for space reasons. All letters submitted for consideration must be signed and show a return address. Upon request, we will withhold sender's name should the letter be used in Mailbag. Address letters to Tom Kneitel, Editor, Popular Communications Magazine, 76 North Broadway, Hicksville, NY 11801.

New Age Observations

I greatly enjoyed reading your editorial (September issue) discussing "New Age" electronic gadgetry. While electromagnetic (EM) fields do affect organic matter, the bio-medical community faces a formidable task in its efforts to sort out which combinations of frequencies, power levels, and modulation modes are harmful and which are beneficial. Unfortunately, the general public has lost interest in funding science education and research, which in turn retards our gaining knowledge of EM field effects. Thanks again

for that editorial, you're performing a public service by smoking out worthless pseudoscientific gadgetry.

Brad Thompson, N1JJJ,
Maynard, MA

Those New Age psychotronic electronic devices in the September issue made a lot of sense to me, even if they didn't to you. Crystals are powerful psychic devices. Just what do you think crystal was used for before it was designed into radio transmitters?

Buck Henley,
Mokelumne Hill, CA

Granny's Sunday dinner stemware?—Editor.

Piggyback Signal

While most TV broadcasters have been very slow to implement the use of the Second Audio Program (SAP) channel available in their transmission, it's often useful and interesting to scan them. Most current TV sets and VCR's can access this sub-channel. In New York City, for example, the WNET/13 (the PBS station) usually simulcasts the 162 MHz

NOAA weather broadcasts during the day. At night, they run the BBC World Service satellite feed. Every once in a while one of the other local TV stations runs something interesting on their SAP channel. If stations would put ASCII or FAX over this channel, lots of useful things could be done. How about continuously printed news summaries? They should get their acts together now that they have the potential.

Danny Burstein,
Flushing, NY

At times, I have found that premium cable channels use their SAP channel for running Spanish or Italian language sound tracks, while the English language audio goes out on the main audio channel. The premium cable services do this quite often.—Editor.

What Counts?

My question is how to count QSL's. For instance, if you get a QSL from station WWCR, and then a separate QSL from *Radio New York International* (heard via the WWCR facilities), would you count these as two QSL's? This is confusing to a newcomer.

Billy Horstmann,
Midwest City, OK

It would really depend on what they were being counted towards. If a person were qualifying towards a certain award, then the rules for the specific award would have to be checked to see how verifications were being counted. On the other hand, if it was simply for your own reference (or bragging) purposes, then you're free to regard them as either one or two QSL's, as you saw fit. In fact, there are several programs on WWCR and other stations that issue their own QSL's. I like to collect these. Personally, though, for my own statistical purposes, I count the veri from WWCR itself as the only actual QSL, regardless of how many other program-issued cards I also accumulate.—Editor.

Charged With Battery

Isn't it about time that scanners came equipped with a useful test circuit that shows the actual battery voltage upon the press of a button? The present low battery indicators are of little value because they don't give enough advance warning. Is there a scanner user who hasn't had batteries fade out at a crucial time?

Ken Greenberg,
Skokie, IL

When it comes to effective multi-band DX antennas for limited space applications, it comes to the world class ALPHA DELTA DX-SWL family of High Performance SLOPERS!

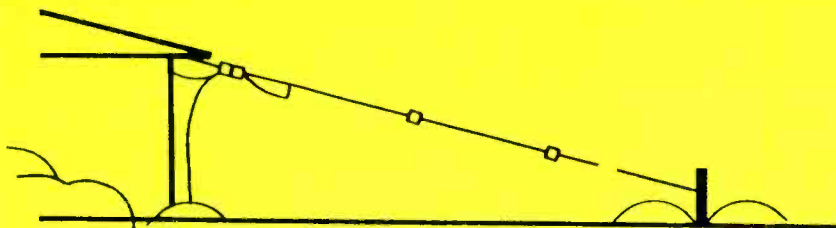

- Fully assembled, ready to use and built for long life. So strong, it can even be used to transmit—up to 2 kW!
- Superior multi-band performance on 13, 16, 19, 21, 25, 31, 41, 49, 60, 90, 120 meters plus the AM broadcast band (5-1.6 MHz). All in a single compact antenna. Alpha Delta first!
- Efficient multi-band frequency selection by means of special RF choke-resonators—instead of lossy, narrow band traps.
- Overall length just 60 feet. Requires only a single elevated support—easier to install than a dipole.
- 50 ohm feedpoint at apex of antenna for maximum DX reception. A UHF connector is provided on the mounting bracket for easy connection to your coax.
- A top overall rating in Radio Database International's hard-hitting White Paper, "RDI Evaluates the Popular Outdoor Antennas."

- Model DX-SWL, AM broadcast thru 13 mtrs, 60' long. \$69.95
- Model DX-SWL-S, as above but 90 thru 13 mtrs, only 40' long. \$59.95

Available from your local Alpha Delta Dealer or direct. Add \$4.00 shipping and handling (U.S.A. only) Exports quoted.



ALPHA DELTA COMMUNICATIONS, INC.



P.O. Box 51117, Phoenix, AZ 85076 • (602) 966-2200



BECOME WELL TRAVELED



AM/FM/Shortwave Cassette Stereo For Your Car



YOU'VE ALWAYS WANTED SW BUILT INTO YOUR CAR

The Philips DC-777 packs a sophisticated AM/FM/Shortwave (SW) tuner, cassette player and powerful amplifier into a single compact car stereo unit. The DC-777 can be fitted into cars, trucks, mobile homes or boats, providing access to the world of shortwave from almost any location. The DC-777 covers the shortwave frequencies from 3170 kHz to 21910 kHz (13 to 90 meter bands). The commercial shortwave bands are just part of the frequency range covered by the DC-777. By means of the manual search function, any frequency between the commercial bands can be selected. Some shortwave transmitters may be less accurate; so the Philips DC-777 allows manually or 'search' tuning of the frequency adjustable in 1 kHz steps to optimize reception.

WITH 20 SOFT TOUCH DIGITAL PRESETS & A NARROW IF BAND

Since a SW station often transmits at different times, on different frequencies, to different continents, depending on the weather conditions, one frequency may give better reception than the other. The DC-777 lets you take advantage of this by offering the possibility to program up to 5 frequency settings on each of the four presets. You can then run through the frequencies to select the best reception.

Philips also incorporates a narrow IF band to counter transmitter problems. When the treble control is set to its lowest level, shortwave sound quality is optimized and the IF Band is automatically switched to a higher selectivity level.

YOU'LL GET GREAT SOUND

The Philips DC-777 features 50 Watts RMS for superb quality sound with low distortion and extended frequency response. It also has an Audio Super Control (ASC), which makes it possible to compensate for the variation in sound between different radio wavebands and the radio and cassette sections.

AND A HIGH-END CASSETTE DECK TO BOOT

The DC-777 features an autoreverse cassette deck that gives you the convenience of non-stop cassette play, avoiding the necessity of flipping the cassette over when one side is finished. Autostart sets the tape running as soon as it's inserted and radio reception automatically **CUTS IN** whenever a tape is being rewound or forwarded.

**THE DC-777 IS THE CAR STEREO
WITH SHORTWAVE RECEIVER THAT WILL
MAKE YOU WELL TRAVELED AND WELL RECEIVED.**

For more information about the Philips DC-777
and the names of dealers near you, call toll-free;

1-800-328-0795

CIRCLE 134 ON READER SERVICE CARD

Weather FAX

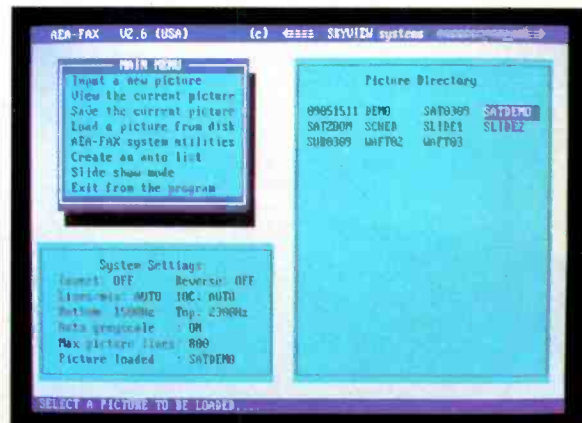

AEA-FAX is menu-driven and mouse compatible for ease of use.

AEA-FAX is all you need to interface with your HF receiver and PC-compatible computer to pick up great looking, information packed weather maps, photos and charts.

Its features include an on-screen Miniscope tuning display, unattended image capture, slide show mode for showing multiple images, disk and printer interface, 16 grey levels (VGA) or false-color separations (EGA), and much more.

If you have an interest in the weather, look no further. The device plugs into your existing COM port (1 or 2) and into your HF receiver's External Speaker jack for quick and easy setup; just plug & play!

For more information on AEA-FAX, contact your favorite ham radio dealer.

To receive a catalog of our complete product line, call toll free (800) 432-8873.

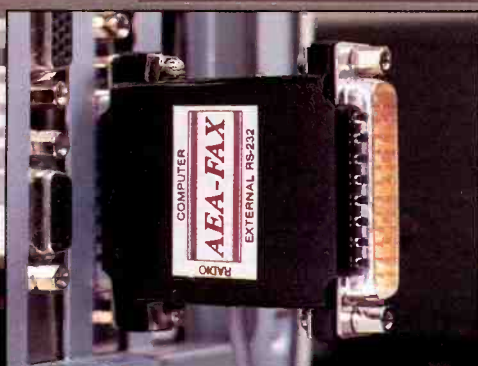

The compact AEA-FAX hardware includes a "daisy-chain" RS-232 input.



Advanced Electronic Applications, Inc.

P.O. Box C2160/Lynnwood, WA 98036-0918

Customer Service (206) 775-7373, Upgrade Hot Line (206) 774-1722

Catalog Request line (800) 432-8873, CompuServe User ID 76702,1013

Specifications Subject to Change Without Notice or Obligation. © Copyright 1991 by AEA, Inc. All Rights Reserved.

End Your Car Phone Problems!

What To Do When The Car Phone Balks At Completing Your Call. Getting The Best Of Common Cellular Annoyances!

BY KEN SPERRY, KCA6BK

Marty F. was involved in a minor traffic accident last Thanksgiving as he was driving his Mercedes not far from his home in a suburban California community. When he tried to call the police, his car phone kept telling him he was in a "no service" area. Yet he knew that cellular service was always available throughout his county.

Still, he complained to me that he's had calls abruptly disconnect right in the midst of a conversation, as well as having had to put up with voices that sound fuzzy, distorted, scratchy, and noisy.

Marty isn't alone. Is there any car phone user who, after being told by the salesperson that the device is going to be as convenient and reliable as a home phone, finds out that this isn't completely true?

Ah, the magic and mystery of cellulars. Maybe we can improve the magic if we remove some of the mystery surrounding the most common service problems reported by cellular phone users.

Cell Sites

Cell sites are the least noticed component of a cellular system. They are the link between handheld, portable, mobile cellulars and the outside world. Cell sites, on the average, are separated between 2.5 and 10 miles, with closer spacings found in urban areas. They cost upwards of \$1-million each to install.

To optimize coverage, most cell sites are positioned on high vantage points (usually tall buildings or hills and mountains). Each cell site may incorporate several sets of antennas for transmitting and receiving in different directions.

Each site utilizes dozens of receive/transmit channel pairs, although they are different pairs than are used by all immediately-adjacent cell sites. This allows callers accessing the facilities of one site to use a particular pair of channels, while callers two sites away may use the same channels without interference.

Problem Line

Even though cellular technology has im-

proved greatly, there remain occasional system difficulties that can interrupt service. Most often these are related to the situation in which the phone is being used. Here are a few of the most common problems and what to do about them.

Bad Connections?

Occasionally, any phone system, cellular or conventional, will produce a bad connection. With cellular service, this normally happens when you're calling from or receiving a call on the fringe of a system's service area and there aren't any other cell sites to take over the call. Natural terrain may also cause a bad connection.

Although you can often carry on conversations with these annoyances, they may cause you to completely lose your connection. This is caused by signal dropouts—your phone losing the signal coming from the cell site, or the signal from your phone not reaching the cell site. You might even hear the other party, but they can't hear you. Or just the opposite.

In most cases, modern phones will ignore momentary dropouts and you won't become disconnected. If you're moving through an area where a series of dropouts occur, however, your call will probably disconnect.

At times, there are ways you can tell if this is about to happen. As with all phone systems, you hear your own voice through the earpiece while you are speaking. When you don't hear this feedback, when your phone sounds "dead," it's a good idea to warn the person to whom you're speaking that there's a temporary problem. Then call them back in a few minutes.

Dead Spots

While dropouts are areas where your phone's signal is temporarily interrupted, dead spots are regions where cellular service doesn't extend or exist. They may be small islands of radio silence in the midst of large areas of abundant service.



Cellulars have become enormously dependable, but the length of the antenna is a dead giveaway that they operate in the 800 MHz band, where signal propagation is tricky. Sometimes 800 MHz signals flutter, or disconnect calls, or play other annoying pranks on people using car phones. Here's how to live with it.

All cellulars are designed to transmit on channels in the 829 to 849 MHz band (30 kHz spacing), and receive on paired frequencies in the 869 to 894 MHz band. Frequencies in the 800 MHz band have some of the properties of light waves in that they may be interrupted by things like certain terrain and man-made obstacles, moisture in the air, and even heavy vegetation. In some cases, you can drive into, or park in, areas that are simply dead to cellular signals.

You'll most often find dead spots in mountainous regions or heavily wooded areas. Urban settings can also produce dead spots, often the results of man-made objects blocking your signal or of multipath reception (when two or more signals interfere with one another).

At times, there may be nothing you can do about dead spots. They may be momentary or extended. The best approach is to remem-

ICOM™ R7000 Sweeping 1300 Channels/Min.

DELTA COMM™ 1.04 gives you a custom interface and optimized software that will not just control but will maximize the potential of your R7000. Spectrum log at speeds in excess of 1300 channels/min. while automatically generating a histogram of frequency/activity. Advanced priority channel monitoring and program control, by channel, of remote tape recorders during scanning. Here are a few (there are many more) examples of the advanced features DELTA COMM has to offer:

- Birdie log during frequency search automatically characterizes your R7000, then locks out those frequencies
- Auto histogram and scan file creation during spectrum log
- Scan file channel lock-out feature allows scanning around channels without removing that frequency from database
- Resume scan and maximum monitor values unique on each channel scanned
- Each frequency within a scan file has an area (40 characters wide) for channel information
- Auto frequency detection and storage during search and spectrum log
- User friendly installation program reduces need for DOS knowledge
- Full support of serial ports COM1, COM4
- On-screen HELP reduces need to refer to user manual
- REQUIREMENTS: MS-DOS microcomputer with minimum 512K memory. DELTA COMM's performance is proportional to baud rate setting, style of display card and type of computer used.



\$299 Incl. Ext. Interface & Components for Cabling
 Check, MO, VISA or MASTER
 Accepted + \$4 for S&H
 (WI Res. Add 5% Sales Tax)



DELTA RESEARCH
 PO Box 13677 • Wauwatosa, WI 53213
 FAX or Phone Weekdays (414) 353-4567

CIRCLE 98 ON READER SERVICE CARD



Dead spots caused by signal-blocking terrain or buildings may sometimes occur. You can often solve this transmitting obstacle by moving a slight distance from where you're calling. (Courtesy STS, St. Louis, MO.)

ber where such spots are, then chart your future routing accordingly. Simply moving a few feet to one side, or driving down the block can often cure the problem.

Intermittent Effects

At times, your phone will initially act as though it's ready to make a call, then it will indicate there's no available cellular service. This happens when the phone accesses the cell site, then either the phone or the cell site decides that the signal isn't good enough to complete or maintain the call.

You may also discover that there are areas where you can maintain a conversation, but can't initiate a call. In this case, the cell site refuses to carry your signal because you are on the fringes of the service region. The cell site will allow you to continue an existing call as long as possible, but won't let you initiate one that is likely to be disconnected.

Another disturbance you may encounter is called *picket fencing* or *flutter*. This occurs when you drive through an area of strong and weak signals. Slowing down or speeding up will chance the rate of flutter. While flutter is annoying, most calls can be continued without much interference.

Building interiors can cause your handheld or bag phone's signal to weaken or disconnect. Steel used in high-rise buildings acts as a barrier to radio waves. This means that the phone may need to be placed near an outside wall or window in order to use it, but you'll notice a significant drop-off in performance as you move into the interior of the building. Standing by a building's ventilation ducts may help.

Hopefully this will take some of the mystery out of the problems that many cellular users report encountering.

The author wishes to acknowledge that some of the information herein was obtained from literature furnished by Satellite Technology Services (STS), St. Louis, MO.



World's Most Powerful CB and Amateur Mobile Antenna*

Lockheed Corp. Test Shows
Wilson 1000 CB Antenna Has
**58% More Gain Than The
 K40 Antenna (on channel 40).**

In tests conducted by Lockheed Corporation, one of the world's largest Aerospace Companies, at their Rye Canyon Laboratory and Antenna Test Range, the Wilson 1000 was found to have 58% more power gain than the K40 Electronics Company, K40 CB Antenna. This means that the Wilson 1000 gives you 58% more gain on both transmit and receive. Now you can instantly increase your operating range by using a Wilson 1000.

**Guaranteed To Transmit and Receive
 Farther Than Any Other Mobile
 CB Antenna or Your Money Back****
New Design

The Wilson 1000 higher gain performance is a result of new design developments that bring you the most powerful CB base loaded antenna available.

Why Wilson 1000 Performs Better

Many CB antennas lose more than 50% of the power put into them. The power is wasted as heat loss in the plastic inside the coil form and not radiated as radio waves.

We have designed a new coil form which suspends the coil in air and still retains the rigidity needed for support. This new design eliminates 95% of the dielectric losses. We feel that this new design is so unique that we have filed a patent application on it.

In addition, we use 10 Ga. silver plated wire to reduce resistive losses to a minimum.

In order to handle higher power for amateur use, we used the more efficient direct coupling method of matching, rather than the lossy capacitor coupling. With this method the Wilson 1000 will handle 3000 watts of power.

The Best You Can Buy

So far you have read about why the Wilson 1000 performs better, but it is also one of the most rugged antennas you can buy. It is made from high impact thermoplastics with ultraviolet protection. The threaded body mount and coil threads are stainless steel; the whip is tapered 17-7 ph. stainless steel. All of these reasons are why it is the best CB antenna on the market today, and we guarantee to you that it will outperform any CB antenna (K40, Formula 1, you name it) or your money back!

*Inductively base loaded antennas
 **Call for details.

Lockheed - California Company

A Division of Lockheed Corporation
 Burbank, California 91520

Aug. 21, 1987

Wilson Antenna Company Inc.

3 Sunset Way Unit A-10
 Green Valley Commerce Center
 Henderson, Nevada 89015

Subject: Comparative Gain Testing of Citizen's Band Antennas
 Ref. Rye Canyon Antenna Lab File #870529

We have completed relative gain measurements of your model 1000 antenna using the K40 antenna as the reference. The test was conducted with the antennas mounted on a 16' ground plane with a separation of greater than 300' between the transmit and test antennas. The antennas were tuned by the standard VSWR method. The results of the test are tabulated below:

FREQUENCY (MHZ)	RELATIVE GAIN (dB)	RELATIVE POWER GAIN (%)
26.965	1.30	35
27.015	1.30	35
27.065	1.45	40
27.115	1.60	45
27.165	1.50	41
27.215	1.60	45
27.265	1.75	50
27.315	1.95	57
27.365	2.00	58
27.405	2.00	58

**58%
 MORE
 POWER GAIN
 THAN THE
 K40**

CALL TODAY

TOLL FREE: 1-800-541-6116
 FOR YOUR NEAREST DEALER

Wilson 1000

Available in Black or White

- Roof Top Mount 59⁹⁵
 - Trunk Lip Mount 69⁹⁵
 - Magnetic Mount 79⁹⁵
 - Wilson 1000 Trucker 59⁹⁵
- DEALERS Exclusive dealer areas still open

Wilson

ANTENNA INC.

1181 GRIER DR., STE. A
 LAS VEGAS, NV 89119

HASTA LA VISTA BABY!

Terminate your Search for a Handi-Counter™. We're going to blow you away with this offer! *\$100. off our full range Model 2810.
 *Limited time only, no discounts and no trade ins. Made in the U.S.A.

\$159.

**Don't Wait,
 This Offer Can't Last!
 Reg. Price, \$259**



- Full range -10Hz to 3GHz.
- LCD display (daylight visibility).
- True state-of-the-art technology with the high speed ASIC.
- NiCads & Charger included.
- Ultra-high sensitivity. • 4 gate times.
- Extruded metal case. • Compatible with MFJ207.

Suggested options

- TA100S: Telescoping Whip Antenna..... \$ 12.
- CC30 Vinyl Carry Case..... \$ 14.
- BL10: LED Backlight..... \$ 15.
- BL28: EI Backlight for use in roomlight and low light..... \$ 45.
- BG28: Bargraph Signal Level Indicator..... \$100.
- TCXO 30: Precision ±0.2ppm 20 to 40°C temp. compensated time base..... \$100.

Universal Handi-Counter™ Model 3000, \$375. and Bench Model 8030, \$579. Both offer frequency, period, ratio and time interval.



OPTOELECTRONICS

Call for free catalog - Factory Direct Order Line:

1-800-327-5912

FL (305)771-2050 • FAX (305)771-2052

5821 NE 14th Ave. • Ft. Lauderdale, FL 33334
 5% Ship/Handling (Max. \$10) U.S. & Canada.
 15% outside continental U.S.A.
 Visa and Master Card accepted.

Scanning The Army's National Training Center

Tune In On The Most Sophisticated Wargames Battlefield In The World!

BY CHUCK ROBERTSON

Have you ever searched the 30 to 50 MHz band when skip stations are coming through? If you have done it with any regularity, chances are that you have heard stations from the National Training Center (NTC), for they are very prolific and easily monitored.

Concealed in the alternately scorched and frozen Mojave Desert of southern California, the Army's premier high-tech NTC battlefield, at Ft. Irwin, occupies 1,000 square miles. There's nothing else quite like it anywhere in the world.

In 1978, the US Army began searching for a site to establish its NTC. The remote area of Ft. Irwin was selected, in part, because of its quiet and unobstructed electromagnetic spectrum, thus creating an ideal environment for radio-controlled wargames and electronic warfare operations.

The NTC, at Ft. Irwin, was activated in 1981. A steady stream of task forces from all parts of the nation, and from friendly nations around the world, have subsequently gone to the NTC to sharpen their battle skills in the desert terrain.

To the benefit of scannists, much of the communications in use at the NTC is by voice, and takes place between 30 and 76 MHz. From my monitoring station, in Illinois, the NTC stations usually begin showing up around 9:30 a.m. CST (1530 UTC), and they just keep going, and going, and going. . .

Our purpose here is to help you get started in zeroing in on these fascinating wargames comms, and get a handle on what you're hearing.

Tour de Force

Every 20 days, more than 1,000 vehicles and troops are transported to the NTC for two weeks of intensive wargame training. Three days are required for *ramp-up* (arrival, equipment issue), and another three days for *ramp-down* (equipment return; maintenance; re-deployment).

Visiting task forces engage a realistic enemy motorized regiment comprised of 1,500



Drop in on the Army's National Training Center. All it takes is a scanner! (U.S. Army photo.)

American soldiers thoroughly trained in Soviet tactics and operating in the form of a Soviet military unit. This opposing force (OPFOR) uses American tanks, vehicles and other equipment that has been modified to offer the visual appearance of Soviet equipment.

The visiting task force is subject to coming under attack day or night, so must always be on guard. An OPFOR was monitored on 31.00 MHz congratulating his comrade, "Good shot! You caught one in the sleeping bag." Later, "Three Abrams Fighting Vehicles destroyed Richard Nixon Bridge."

Task force units scouting the valley floor for OPFOR's were copied on 34.70 MHz: "We are the only two tanks up here. Move nice and slow till you can just see over the top of the ridge."

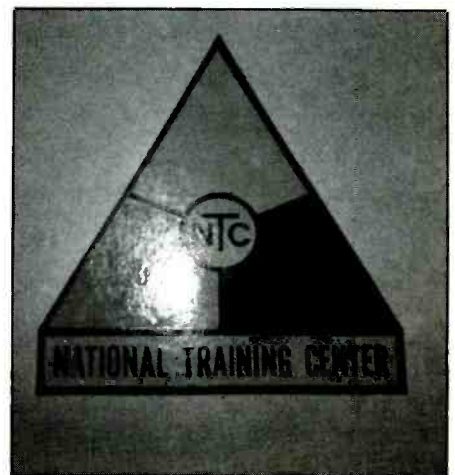

The NTC's logo.

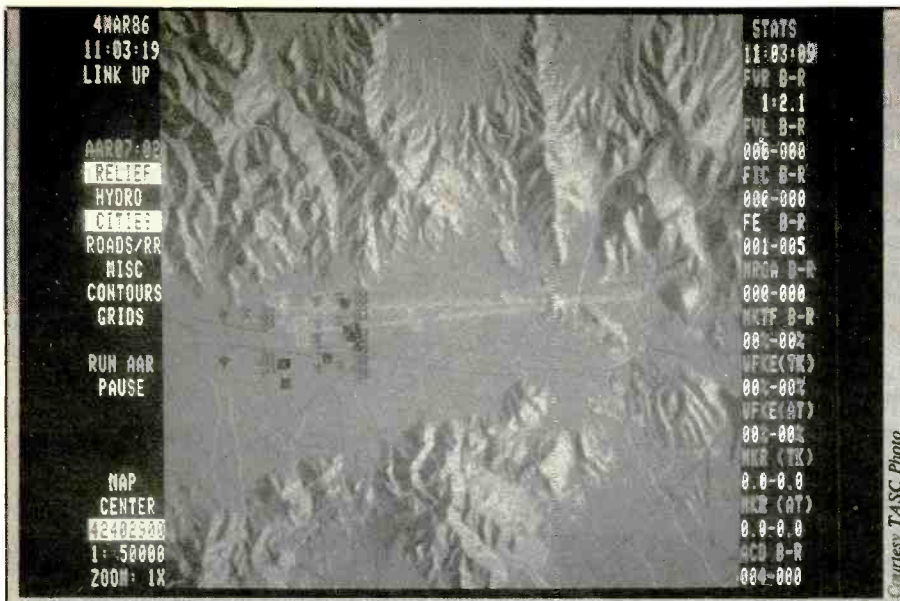

Courtesy TASC Photo

A computer graphic showing troop movements in the Valley of Death. This data is compiled from a variety of radio battlefield radio sources.

Tank battles take place somewhere with the name *Valley of Death*. On 36.50 MHz, I heard Sabre 7 report to Sabre Task Force: "I'm weaving my way through the mine field in the Valley of Death and the Hammerhead is coming at me!"

View To A Kill

Another unique aspect of the NTC training method is the presence of Observer Controllers (OC's). They are a combination of trainer-coach stationed in the field alongside the visiting units during exercises. The OC's are experts in Army tactical doctrine, and advise the wargames participants how to improve their performance.

Sometimes their advice isn't appreciated. On 36.40 MHz, I picked up a task force of ficer griping, "I want to see that OC that got me killed!"

Still, the OC's are to be heard offering their advice on many frequencies, like 32.10 MHz. That's where I monitored, "Cobra 3 to Tarantula 6. Give them a 30 minute head-start, then track them down."

Monitoring the OC nets offers a unique view of a battle that can't be had elsewhere. Some of their frequencies at the NTC are: 30.05, 30.25, 30.30, 30.35, 30.65, 30.85, 31.55, 31.75, 31.85, 31.90, 32.15, 32.35, 32.60, 32.70, 32.95, 33.00, 33.05, 33.35, 33.40, 33.45, 33.50, 33.95, 34.50, 34.95.

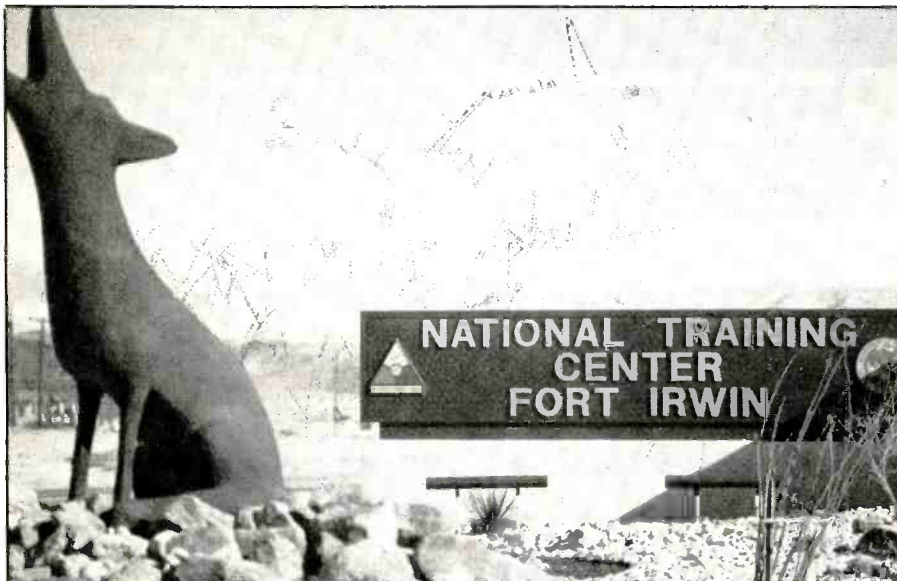

The NTC, at Ft. Irwin, CA is the location of the world's most sophisticated electronic battlefield.

NOW YOU'RE TALKING!

The Code-Free Ham License is Here

Enjoy all Amateur Radio privileges above 30 MHz without having to pass a code test. All you have to do is pass a 55-question exam on basic radio and the FCC regulations. ARRL's new book, **Now You're Talking** makes understanding what is required on the test a snap! And there are exams given all over the country every weekend.



Just think how much fun you'll have communicating through repeaters, enjoy Sporadic E skip and worldwide communications on six meters when conditions are right. There's satellite communication and you can even talk to Astronauts and Cosmonauts in orbit. Enjoy friendly local communication both direct and through repeaters. Help with disaster drills and the real thing! Sound like fun? It is! Order your copy of **Now You're Talking** below: Enclosed is \$19 plus \$4 for shipping (a total of \$23) or charge \$23 to my () VISA () Mastercard () Discover () American Express

Signature _____
 Acct. No. _____
 Good from _____ Expires _____
 Name _____
 Address _____

 City State Zip PC

THE AMERICAN RADIO RELAY LEAGUE
 225 MAIN STREET
 NEWINGTON, CT 06111

CIRCLE 154 ON READER SERVICE CARD

36.50, 36.90, 36.95, 37.50, 37.80, 38.85, 39.85, 44.25, 48.85, and 56.85 MHz.

Laser Bullets

At the heart of this battlefield is the Multiple Integrated Laser Engagement System (MILES). MILES-equipped weapons fire eye-safe "laser bullets" in the form of invisible encoded messages. If one of these bullets finds its mark, an alarm sounds and a strobe light flashes. There's no doubt who or what got hit.

Selected personnel, vehicles, and weapons systems are also equipped with transponders (140 to 174 MHz, 25 kHz steps) that relay the encoded laser messages to one of the 44 "interrogator" stations. The data is then relayed on wideband FM channels (245 to 400 MHz, 500 kHz steps) to a mountain top computer station. That's where the data is processed to determine the locations of the various units. Other data, such as type of vehicle, number of rounds fired, number of

hits, type of weapon, etc., are sent via landline to the Ft. Irwin computer ops center, 13 miles away. That's where the data is analyzed and edited for After Action Review (AAR) that follows each battle.

"MILES Teams" keep the equipment in operational condition. Listen for their comms about laser guns, target data, relay stations, and antenna problems on 34.09 (base), 34.11, 34.29, 34.31, and 34.49 MHz, NFM mode.

MILES technology is starting to crop up at other military facilities. The Ft. Campbell, KY live fire control on 50.00 MHz has mentioned MILES.

Remote Controlled Battlefield

Like the king-size *Nintendo*, there's a live fire range at the NTC where the targets shoot back! Visiting troops engage a Soviet-style rifle regiment represented by more than a thou-

sand radio-controlled targets deployed in successive bands to simulate movement.

All targets are radio-controlled (140 to 174 MHz, 25 kHz steps) and equipped with "shoot back" charges to simulate tank fire, or even to fire off "Smoky Sam" styrofoam missiles.

Targets are MILES-equipped, so the computer can regulate the pace of the advancing enemy based upon the foe's success.

This live fire range, sometimes called "Dragon Control," is on 48.45 MHz. Live fire OC's use Dragon ID's, and are heard on 37.80 MHz.

Smile, You're On Vulture Camera

Eight TV crews follow the wargames and send live pictures back to the Ops Center. Remote-controlled and manpack TV cameras are used. The code name for these units is "Vulture."

In addition, eighty channels in the 30 to 76 MHz band carry live tactical comms for monitoring and recording purposes. Check this band in 50 kHz steps for these action channels.

The video and radio recordings are used during the AAR's that follow each exercise. I heard one such AAR session, offering a critique of the day's tactics. This was heard on 31.05 MHz.

Other NTC Activity

Forces of friendly nations use the NTC for training, and on 32.10 MHz I heard an OC mention that, "The Israeli Defense Force 06 is supposed to be out there."

Bicycle Army Air Field is near the middle of the NTC. "Bike Lake Metro" sending weather information to aircraft can be heard on 32.45, 34.45, and 49.05 MHz. The aircraft also use these channels for air/air use. Weather teams contact Bike Lake on 32.20 MHz. Bike Lake flight advisories are on 41.50 MHz.

There's a Ft. Irwin Range Control on 38.89 MHz, and the base Medevac on 40.90 MHz. Listen for "Thunder Dome," the maintenance ops during ramp-up and ramp-down on 32.35 and 32.60 MHz. Chemical wargames personnel (ID's as "Nerve" followed by numbers) on 31.70, 33.85, 35.85, and 35.00 MHz. Stations on these frequencies with "Werewolf" ID's are fire support OC's.

Frequency 30.30 MHz appears to be common to all participants at the NTC. At times, speeches are broadcast over this channel.

Ready, Aim, Scan!

Now that you know about the NTC, program your scanner to search through the 30 to 76 MHz band in 50 kHz steps and get ready for the action. This time of year, the NTC should be skipping to listeners in the midwest and the east, and even overseas.

Thanks to those who helped with information for this story.



CODE SCANNER

ADVANCED MULTI-MODE DECODER

Two Line, 32 Character LCD Display

Copies Morse, Baudot and ASCII Codes from your Radiol Automatic Morse Code tracking: 3-70 WPM. Built-in Code practice oscillator for hand key with readout to display. Built-in speaker. Advanced Analog and Digital filtering with AGC. Special practice mode to learn Morse characters. Compact size: 3 1/2" x 5 3/4". Operates from 12 VDC or 120 VAC adapter provided. Easy hook-up to Radio speaker or headphone jack. Made in U.S.A.

Call or write for **FREE** brochure or order Factory Direct.

CODE SCANNER Model CSCAN \$ 189.00

Add \$6.00 shipping for continental U.S. Send check, money order, VISA or MasterCard.

Microcraft Corporation Telephone: (414) 241-8144
 P.O. Box 5130, Thiensville, Wisconsin 53092

CIRCLE 93 ON READER SERVICE CARD

SCORPIO

ID(S)at GR36 (PORTISHEAD RADIO) Location: England
 Date: 02-27-91 Begin Prog: 03:17:35 End Prog: Prog 17:22:00
 Mode: FSK Signal: Aggr/Svc: Coastal (sea) QSL:
 Remarks: SITOR traffic - carq-
 Date: 23 / > / 17:22:00 FSK / Signal() 12002
 [Radio] [PRE] [CLR] Terminal Mode: [CHG] [ELD] [SIF] [UW/O]
 -Last Call- Log of John Doe

MODE NOW ALLIST
 ... THIS IS AN AUTO TELEX MESSAGE SYSTEM
 TRAFFIC FOR THE FOLLOWING VESSELS:
 USS FREEDOMS
 HMS UINC...
 GA+?
 <carq FILE LOADED>

[Manual] [2 Func] [3 Func] [4 Func] [5] [Sub] [6 Time] [7] [TimeOff] [8] [Data] [9] [Log] [10] [Done]

Integrated Multi-Function Communications Software for IBM PCs

Simultaneous

- Radio Control/Scanning
- Log Database Management
- TU Digital Control/Disp

> LogScan, AutoLog and AutoTU functions > Interfaced with All Mode Terminal Units
 > Mouse/Function Key control of Kenwood & Icom Receivers & RS232 Digital Terminal Units
 > Search Log by any field including Remarks > Scan Receiver based on Log Search criteria
 > Copy RTTY & other DIGITAL signals > AutoTU sets TU mode as needed during scan
 > LogScan has real-time UTC and FREQ time options > AutoLog builds database from "this"
 > Run other programs (DOS) within Scorpio > Includes "Top 100" HF database & Manual

Optional Log Databases available for only \$19.95 each include:
 English Language SW Broadcast - MidEast - Utility - Others

\$89.95 + S&H

ash-ton
 PO Box 830 - Dandridge, TN 37725 - (615) 397-0742
 Fax: (615) 397-0466 Computer # 72557, 3560

CIRCLE 94 ON READER SERVICE CARD

1-800-666-0908

NEW EQUIPMENT ORDERS & PRICES ONLY, PLEASE

SHORTWAVE RADIOS

SONY - All Popular Models including the ICF2010 and the NEW SW77
 SANGAN - ICOM - JRC - YAESU - GRUNDIG - and the NEW DRAKE R8

SCANNING RADIOS

Featuring the NEW ICOM R1 Handheld and R100 Mobile/base • SHINWA
 SR001 • UNIDEN BEARCAT • AOR models including AR1000XC

Factory Authorized Dealer for: ALINCO - ICOM - JRC - STANDARD - YAESU
 DIAMOND - CUSHCRAFT, etc. Amateur Equipment
 Commercial 2-way from ICOM - MAXON - STANDARD - YAESU, etc.

FOR INFO AND TECH HELP CALL (203) 666-6227
 OUT-OF-STATE SALES CALL 1-800-666-0908
 CONN SALES CALL (203) 667-9479

LENTINI • COMMUNICATIONS • INC

21 Garfield Street Newington, CT 06111









C.O.D.'S OK
 Same-Day UPS Shipping

CIRCLE 95 ON READER SERVICE CARD

MAXIMUM RANGE MAXIMIZED SENSITIVITY

We've Carefully balanced the amount of gain used in our input amplifiers - too much or too little results in poor performance. **OPTOELECTRONICS' HANDI-COUNTERS™** with maximized sensitivity give you the maximum range for antenna pick-up.

Made in the USA

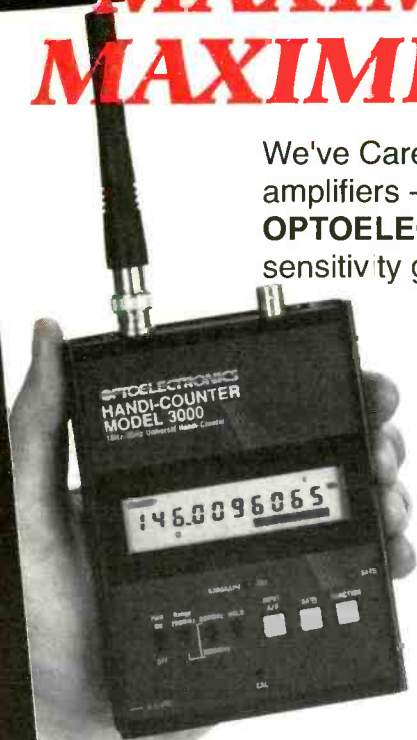

MODEL 3000
Multi-function Counter
10Hz-3GHz, 10 Digit LCD with
frequency, period, ratio, interval
& signal level bargraph....\$375.



Maximum Security Device.
Increase your frequency finding™ by 10 times the distance or more.

Tunable Preselector APS-104
\$995.

Counter Sold Separately

MODEL 8030

With all the features of the 3000 plus enhanced input signal conditioning and enhanced TCXO time base \$579.



OPTOELECTRONICS

\$199.



Model 2210A
10Hz-2.4GHz Full range counter. Price includes Nicads & AC charger/adaptor.

The Original Pocket-Sized LED Handi-Counter™

All of **OPTOELECTRONICS'** LED Handi-Counters™ will:

- Count frequencies above 2.4GHz.
- Have display saving Power Switch

(avoids premature LED burn-out, leading cause of counter failure.)

Accept no substitutes - Look for the **OPTOELECTRONICS** name on the label!

Only **OPTOELECTRONICS** offers you **MAXIMIZED SENSITIVITY.**

Factory Direct Order Line **1-800-327-5912**

FL(305)771-2050 • FAX(305)771-2052

5821 NE 14th Ave. • Ft. Lauderdale, FL33334 • 5% Ship/Handling (Max. \$10) U.S. & Canada. 15% outside continental U.S.A.

VISA and Master Card accepted.

\$99.



Model 2300 - 1MHz-2.4GHz Available with NiCads and AC Charger Adapter. Complete Package only....\$128.

DX'ing Africa's Hot Spots

Radio Sheds Light On The Dark Continent

BY GERRY DEXTER

Crisis and war in the middle east and the collapse of communism in Eastern Europe have dominated the foreign news over the past couple of years. As a result, events in Africa have been given even less coverage than normal. But, recognized or not, there's been a lot of African action over the past year or so. These include coups and attempted coups, riots, famine, civil war—all the things that not only put the brakes on a nation's forward progress, but often send it into reverse, sometimes for decades.

Many shortwave listeners have what seems to be an almost inborn affinity for DX'ing African stations. So here's a look at Africa's current and recent hot spots and how to find signals from those countries on your shortwave radio dial.

Liberia: There was something especially sad about Liberia's civil war. Many African nations didn't become independent until the 1960's and one expects there to be a period of ups and downs; however, Liberia has been independent since 1847, longevity, it appears, is no guarantee of stability. For months the government fought the steady advance of a rebel group headed by Charles Taylor who invaded from the Ivory Coast in December, 1989. A second rebel group headed by Prince Yormie Johnson split from Taylor's National Patriotic Front and the two ended up fighting each other as well as the government forces of President Samuel K. Doe who was eventually killed by Johnson's forces. Over half of Liberia's 2.5 million people were uprooted and some twenty thousand were

killed. The government managed to hold power and eventually a peacekeeping force consisting of many thousands from five neighboring countries moved in to keep order.

The extensive war damage included all of Liberia's shortwave radio stations: The Liberian Broadcasting System's ELBC, the religious station ELWA and the Voice of America's relay at Careyburg, near Monrovia. The peacekeeping force, officially the West African Ceasefire Monitoring Group, put a station on the air it called Liberty Radio, apparently using the old ELBC facility. Indeed, the station soon began using the ELBC call letters. A number of North American DX'ers have heard this station on its 7275 frequency. Sign on time is at 0758. There are no details as to how to go about QSL'ing this because the mail situation is uncertain; you may try using the old ELBC address which is PO Box 10-0192, Monrovia.

Ethiopia: The Liberian civil war was mercifully short compared to the endless horrors which Ethiopians have suffered over three long decades. Rebel forces seeking independence for the Ethiopian province of Eritrea have been fighting the government for longer than most of us have even owned shortwave sets, and they've been having increasing success. The government of Lt. Col. Mengistu Haile Mariam has seen its end predicted by experts on more than one occasion recently.

Besides the Eritrean People's Liberation Front, there is the Tigre People's Liberation Front which wants independence for Tigre

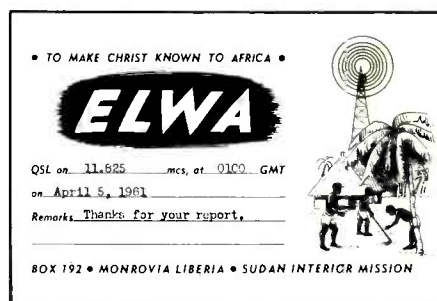

Liberia's civil war silenced ELWA which had been on the air for many years.

Province which it controls, along with Gogjam, Gondar and parts of others. Ironically, when the Mengistu regime deposed Emperor Haile Selassie in 1974 it adopted a Marxist line, which it clung to until just a year or so ago. The two main rebel groups, though, are thought to be very much Marxist in nature. Both sides have largely lost the help of foreign benefactors, the government's army is now virtually non-existent and much of the country is, again, facing famine.

The government's Voice of Ethiopia, though always a difficult catch, has been marginally easier to hear during the past DX season. The national service operates with 100 kilowatt transmitters and a good bet is to look for the 0330 sign on (0400 on Sundays) in Amharic on 7110. The external service is best heard on 9560, running from 1200 sign on

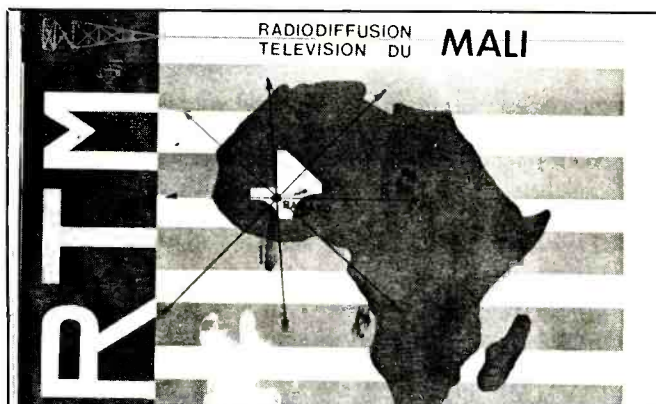

Radio Diffusion Television du Mali was one of several African stations to carry announcements of coups during the last year.



Libyan radio still QSL's with their multi-color Radio Jamahiriya card.

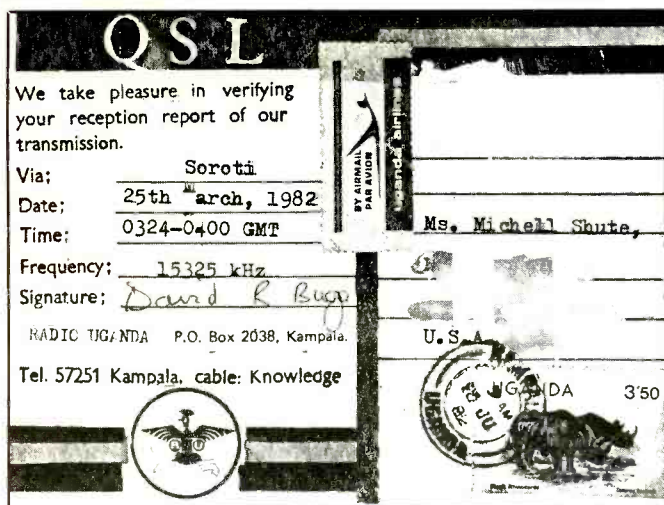

QSL'ing Radio Uganda isn't a snap and neither is hearing the station.



ORTS from Senegal shows up now and then, but it seems mostly inactive.

through to 1800, except for 1300-1400 which is on 7165. Each one hour segment is in a different language, beginning with Somali and followed by Afar, Arabic, English, Amharic and French. Sometimes the 1500 English segment can be heard fairly well. QSL's from Ethiopia are invariably a chancy affair. Reports on the domestic service go to PO Box 1020 and for the external service to PO Box 645, both in Addis Ababa.

Sudan: Like Ethiopia, civil war and famine are an old story and almost seem to feed upon each other. The Islamic fundamentalist government has been at war with the Sudan People's Liberation Movement for seven years. The SPLM and its military wing, the

SPLA ("A" for "army") wants independence for the southern area where people—in contrast to the north—are mostly African and animist. A coup in 1989 brought to power Lt. General Omar Hassan Ahmed al-Bashmir who has largely prevented or held up relief efforts by other governments and private agencies, accusing them of using the aid as a front for helping the SPLA.

The Sudan National Broadcasting Corporation's Radio Omdurman can be a difficult catch. The reason isn't so much a matter of weak signals or QRM as it is one of erratic operation and "what frequency's it to be this week?" Over the past year or so Omdurman has used 9435, 9535, 9540, 11625, 11632v and 11655. Just as soon as you spot a logging on one frequency it changes to another or goes inactive again. 1300 or 1400 is when many of the loggings of this station take place, so try then, checking all of the above frequencies. The broadcast will be Arabic. On occasion Omdurman has relayed the regional station Radio Juba at 1400. National Unity Radio, another name or service of the government broadcaster, has been reported in the past at 1400 on 9535 in both Arabic and English. QSL'ing the government station is usually a difficult job. Try reporting in care of the Director General of Engineering and Technical Affairs, Abbas Sidig, who has answered a handful of reports in the past couple of years. The address is PO Box 572, Omdurman.

The rebel's Radio SPLA is sometimes heard as well as or even better than Omdurman. Look for it signing on at 1300 on 11710. The first half hour is in English. There's still no known path to QSL this one since no one has been able to track down a mailing address.

Angola: Here, too, the story is one of civil war, rooted in the guerrilla campaign to oust the Portuguese before Angola gained its independence. After independence two of the rebel factions were forced out of power and went back to war against the government

which, by then was backed by Soviet aid and Cuban troops. We may be into the final chapter now. Agreements covering the removal of the Cuban troops were reached in 1988, and off and on peace talks continue between the government and the remaining guerrilla forces, the US-backed UNITA, headed by Jonas Savimbi. The government in Luanda is in the process of moving away from its Marxist-Leninist philosophy, and has even offered UNITA a role in drafting a new constitution. There are, however, no guarantees that any agreements reached will hold up. There are decades of war and distrust to be overcome on both sides.

Angola's shortwave stations also represent some pretty challenging DX. You might have a try at the 25 meter band Radio Nacional de Angola outlet on 11955 which is scheduled in Portuguese from 0500 to 1800. 9720, slightly variable, has been heard now and again at 0400 sign on. The so-called international service on 9535 is heard even less often. It runs from 1900-2300 with an hour each of French, Spanish, English and Portuguese in that order. 9535 carries the domestic "B" program between 0400-1900. Reports to Radio Nacional go to C.P. 1329, Luanda.

At times the lower power Angolan regional stations offer as good an opportunity as the higher power Luanda transmitters. Recently, Emissora Provincial de Benguela from the city of that name has been heard on variable 5040 at 0400 (sign on is listed for 0350). Reports to C.P. 19, Benguela.

Like the Sudan, the guerrilla's clandestine station is heard as easily or more so. La Voz Resistencia do Galo Negro (Voice of the Resistance of the Black Cockerel) has been noted on 7100 around 2300 in Portuguese. It has also been logged some afternoons around 2100 with excellent signals during tests on 17890 (Earlier it was testing on 15500 so you may want to check there, too). These tests are not being conducted daily but seem to be on at least a couple of days each week. Reception reports on the Black Cockerel can

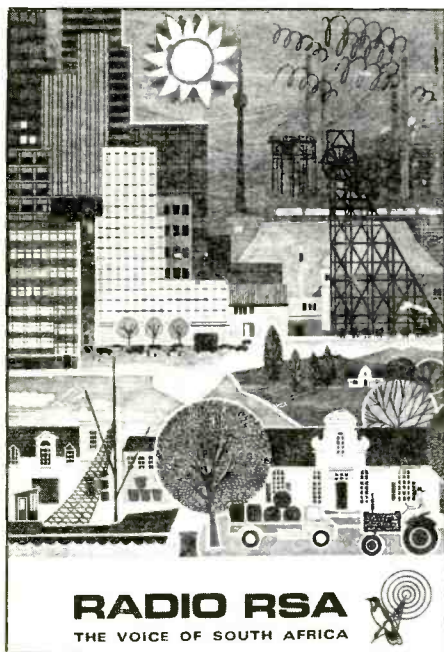

You can still hear Radio RSA in English, even though it no longer broadcasts to North America.

High Performance

800MHz • CORDLESS
FREE CELLULAR OR CORDLESS
FREQUENCY CHARTS



MAX 800 GROUND PLANE

- Enjoy the best possible reception
- Hear signals other antennas miss
- Astounding performance outside
- Hear 10 times more signals when mounted directly on scanner
- Use on any scanner with optional adaptor or cable

50 ft. RG6—\$35.00 Only **\$19.95**
Base Adaptor—\$15.00
Hand Held Adaptor—\$12.00

MAX CELLULAR MAG MOUNT

- Receive 800 MHz in car.
- Place on car roof and connect BNC cable to scanner
- 3dR - 14 inches high—GREAT!!

Only **\$39.95**



MAX 46-49 MHz DIPOLE

- Be amazed by number of conversations heard
- Includes 50 ft. RG-8X
- THE BEST!!

Only **\$49.95**

SASE for brochure
US shipping & handling—\$4.00

MAX System™

GROUND PLANE ANTENNAS

CK-MO-MC-VISA Accepted (MA add 5% sales tax)

Send payment to: Cellular Security Group,
4 Gerring Rd., Gloucester, MA 01930
Or charge by phone: (508) 281-8892

IMPROVE RECEPTION



ANTENNA PLUS
Only \$90

Make your receiver spring to life! Receives like the large antennas yet sits on your table! Models for ALL BANDS, SCANNER or SHORTWAVE. Strong internal 15-22db amp! 115VAC pwr. Cable to receiver. INCLUDED!
ANTENNA PLUS-1 0.5-130MHz "All Bands" (for wide coverage rxvrs.)
ANTENNA PLUS-2 0.3-30MHz "Short-Wave" (peaked for SWL's)
ANTENNA PLUS-3 30-200MHz "Scanner" (peaked for VHF-UHF)

SUPER SCANNER STICK



Only \$80
Get great scanner reception with our SUPER SCANNER STICK. Covers all scanner bands (25-100MHz) Only 35" long. Powerful 15db booster amplifier. 25' of coax cable supplied with connector for your scanner.

SCANNER STICK Same as above but without booster amplifier \$40

SHORTWAVE ANTENNA

Brings in signals as only a large antenna can. 130" long and with four wire elements for optimum reception on all SWL bands 0.3-30MHz. Come with 50' coax feedline, 100' rope and a Static Bleed MULTIWIRES—\$100

SIGNAL INTENSIFIER

SUPERCHARGE YOUR RECEPTION with our RFP-40! STRONGER SIGNALS for scanners, shortwave, AM-FM-TV, cable and more. 115VAC pwr. Choice of BNC, UHF or F connectors RFP-40 \$70

LISTEN TO HOURS OF SCANNING IN MINUTES!
Our TAPE SAVER interface makes your recorder operate only when there's action on your scanner. Tape Saver TS-1 \$50

Continous US Shipping/Handling \$6. Canada, AK, HI, PR \$8. NY and MI add sales tax.

MANY MORE PRODUCTS
SEND FOR DETAILS!

EP ELECTRON PROCESSING, INC.
PO BOX 68 CEDAR, MI 49621 (616) 228-7020

CIRCLE 149 ON READER SERVICE CARD

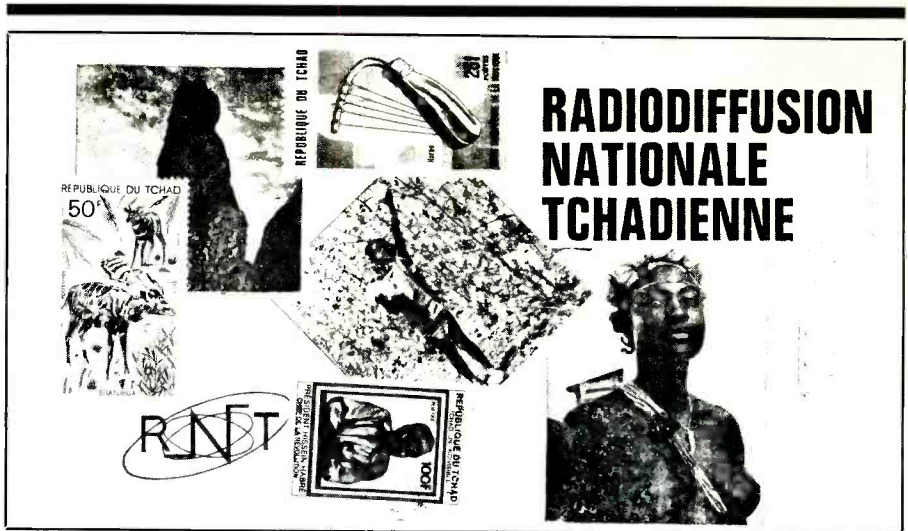

Radiodiffusion National Tchadienne shows up fairly regularly on 4904.5.

be sent in care of Mr. Jardo Muekalia, 1850 K Street NW, Suite 370, Washington, DC 20006-2202.

South Africa: The tale here is familiar to all and can be capsualized in one word: apartheid. But, like communism, apartheid is a dying philosophy and South African government now seems determined to be rid of it. But, as the white government gives in to the demands of its blacks and of world opinion, the country's blacks are raging against each other. Zulus and Xhosas, the latter largely members of the African National Congress and the former largely of the Inkata Freedom Party. Ironically, the black vs. black antagonism is slowing down the government's progress toward bringing equal treatment to all.

The loss of Radio RSA's service to North America, always heard loud and clear, is still regretted by most SWL's, never mind the politics. Radio RSA is still on the air but now confines its target areas to Africa so reception in North America isn't as reliable as it once was. Radio RSA has English at 0400-0500 on 7270 and 11900; 1100-1200 on 9555, 11805, 11900 and 17835 and 1500-1800 on 7230, 15270 and (from 1700) 17790. Try the domestic outlets, too: Radio South Africa in English at 0300 on 3320 and 4810 and 9685 from 0525, 11770 from 0530. Radio Oranje on 3215 from 0300-0505 and 7285 from 0510 sign on. Radio Orion runs 3320 up to 0300 when Radio South Africa takes over. All can be addressed in care of the South African Broadcasting Corporation, PO Box 4559, Johannesburg 2000.

Somalia: After 21 years in power President Said Barre fled the presidential palace in a tank, just minutes ahead of a rebel force which took power in Mogadishu last January. The United Somali Congress, which chased Barre out, was one of three rebel groups vying for control of the country. The Somali Congress represents the Hawiyi people who are based in the center of the country. The Somali National Movement is centered with the Isaak clan in the north. The third group, the Somali Patriotic Movement, is based in

the south and made up of Ogadenis. Each group controls part of the country. Despite the fact that Somali has become a true national language and despite the fact that most Somalis are Sunni Moslems, tribal hatreds are old and intense. Experts on the area don't see an easy solution to how to govern the country, to say nothing of getting it on its feet economically.

Radio Mogadishu's 50 kilowatt transmitter is heard quite often by DX'ers. Tune 7200 (slightly variable) for the station's sign on, which occurs just before 0300. Most of the programming is in the Somali language. Reports go to the Ministry of Information and National Guidance, Private Postbag, Mogadishu. Considering the country's situation, you can consider yourself very lucky if you get a reply.

Chad: Last December, President Hissen Habre ran for sanctuary in the Cameroon, ending an eight year regime which, with French aid, had fought off several local rebellions and armed Libyan efforts to overthrow the government. The Popular Salvation Movement, under the leadership of General Idriss Deby, a former member of Habre's government, came into power two days later. He has promised to lead Chad to a multi-party democracy, though without specifying when or how. Libya's Qadafi has a history of messing with Chad and, in fact, there were numerous reports that he had provided aid to the rebels. Deby, then, may be just a new variation on an old theme.

Radiodiffusion Nationale Tchadienne from N'Djamena is a pretty easy catch when the Africans are doing well on 60 meters. Check 4904.5 for the 0430 sign on. QSL's are a 50-50 proposition. Reports (and it helps a lot if you can do them in French) should go to B.P. 892, N'Djamena.

A second government station, Radio Moundou, is harder to hear but still logged quite often. It signs on at 0500 on 5286, running just 5 kW. Its address is B.P. 122, Moundou. All programming is in French.

Libya: The Colonel is said to again be busy

stirring his hand in many pots. He was a main backer and supplier of Charles Taylor's rebel force in Liberia, although the backing has apparently now been withdrawn. In addition to his Chadian adventures, Qaddafi is said to have increased the strength of his ties with the Sudan and to have had a hand in an uprising in Niger some months back.

The English foreign service of Libyan Jamahiriyah Broadcasting was once heard fairly widely, but currently this mix of pop music and quotes from the Colonel's Green Book isn't to be found. Only broadcasts in Arabic seem to be aired. The home service is scheduled at 0500-2300 on 9600 and 1315-1645 on 15235, 15415 and 15450. The external service—the Voice of the Great Homeland—runs from 1115-1315 and 1745-0430 on 15235, 15415 and 15450. Libyan radio has been a good verifier for several years and still sends out its multi-color Radio Jamahiriyah card. Reports to the station's Malta office, PO Box 17, Hamrun.

Rwanda: Early 1991 saw rebels on the move in Rwanda, too. A few months earlier, in October, a 1,000 man exile army moved in from Uganda. Comprised of the minority Tutsi tribe which used to hold power, they oppose the majority Hutu, which hold power. The two peoples have a long history of antagonism. About half a million Tutsi are exiled in neighboring nations and want to come home. Most have lived outside the country for some 30 years after the Hutu overthrew the Tutsi government. The Hutu blame what are called "demographic pressures" and a poor economy for not allowing the return, though the Tutsi believe it's a fear that the Tutsi would soon end up running things again.

The Rwandan government station, Radiodiffusion de la Republique Rwandaise, is one of the toughest pieces of DX from the continent. It'll be necessary to check 3330 (yes, right under the Canadian time station CHU) for the 0255 sign on whenever it appears that African conditions are exceptionally good. The higher powered 50 kW outlet on 6055 is virtually never reported in North America. Reports go to B.P. 83, Kigali.

It'll be far easier to hear Rwanda via the Deutsche Welle relay there. Unfortunately, DW no longer indicates transmitter sites in their program schedule so it's hard to be sure of times and frequencies for Kigali. However, you might try the following, all in German: 1800-2000 on 9735 and 17860; 2000-2200 on 17860; 2200-0000 on 15270 and 17860; 0000-0200 on 11795, 15270, 17860; 0200-0250 on 11795 and 15270. Try English from 0400-0450 on 7225 and 9565; 0900-0950 on 9650 and 15410; 1100-1150 on 15410 and 17800 and 1500-1550 on 9735 and 11965. DW normally gives a site ID at sign on. As for QSL's, the usual DW practice is to issue a no-data card, although, at this writing they are issuing cards with sites in honor of their taking over the former RBI sites in former East Germany. Reports go to PO Box 10 04 44, D-5000 Koln 1.

Uganda: Certain Ugandan army officers had a hand in the Rwandan invasion. That

was one more problem stuck in the "in" basket on the desk of Ugandan president Yoweri Museveni, who came to power at the head of a guerrilla army six years ago. He fights severe corruption and an economy that doesn't seem to click no matter how hard its worked at or what approaches are taken. He worries over an increasingly less controlled national army and a guerrilla force, the Ugandan People's Army. In Uganda things are still better than the days of Idi Amin but, still . . .

Radio Uganda is normally a tough log though it does pop through on occasion, showing up on one of its 60 meter band frequencies. Check 4976 for a sign on around 0300. Or try 5026, slightly variable, but be prepared to make a lot of attempts as this one will likely be hard work. Reports go to PO Box 7142, Kampala, to the attention of the Chief Engineer.

Mali: Bamako was the site of still another coup this year, when the dictator General Moussa Traore was overthrown. He had run the show in Mali for 23 years until the army decided he had to go. The new government, a 17 member National Reconciliation Council, has promised democracy. Coup leaders called his regime "bloodthirsty and corrupt."

Radiodiffusion Television du Mali is a fairly easy catch, especially when conditions for Africa are good. It's largely a matter of parking on 4783 a bit before the scheduled 0555 sign on. Of Mali's several shortwave frequencies, 4783 is the most reliably heard. You might also try 7285. During months of shorter daylight eastern and central time zone listeners can also hear 4783 to sign off at

0000. If you just want to add Mali to your "heard" list and don't care how you do it the easiest way is just to go for the Radio Beijing Mali relay, used for English to North America at 0000-0100 and 0300-0400 on 9770 and 11715.

Senegal: It looks like trouble could be brewing here. The Movement for the Democratic Forces of Casamance is seeking independence for the Casamance area of southern Senegal. Casamance is divided from parts of the rest of Senegal by the country of Gambia which slices right into Senegal. Casamance was long dominated by Portugal while France dominated the rest of the area. There are differences in language and religion, too, and a feeling that the north has left Casamance behind economically and educationally. The government in Dakar is accused of torturing people it believes are rebels or sympathizers.

ORTS-Dakar, once an African shortwave regular, is only a faint shadow of its former self today. It has long used 4890, signing on at 0600, but the broadcasts seem to be very irregular now. So about all one can do is keep checking and hope they will turn up there one night. The station did make a few appearances there earlier this year.

That's our tour of current and recent African hot spots. The way things have been going it may be that one or two more have developed by the time you read this. Nearly all of them can be logged, though a fair number may require a generous dose of patience, persistence and DX prowess. Ditto for QSL'ing them. But, it can be done so, good luck!



MICRO-CHOKE™ grabs those 800MHz signals you've been missing.

Antenna Specialists all-band scanner antennas, with our exclusive MICRO-CHOKE, offer pinpoint resonance at 800MHz and excellent performance from 25 to 1000MHz. Now—base or mobile—all police, fire, emergency and other FM communications (even portables) are within earshot. Start hearing more by sending for the FREE 16-page A/S Personal Communications Antennas catalog today!

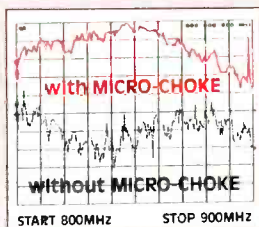

Tenfold signal improvement at 800 MHz!



MON-53 Mobile Roof/Deck-Mount Antenna



MON-52 Mobile Trunk Lid Mount Antenna



MON-58 Base Station Antenna

the antenna specialists co.
30500 Bruce Industrial Parkway • Cleveland, OH 44139-3996
TEL: 216/349-8400 • FAX: 216/349-8407

a member of The Allen Group Inc.



© "Stripes of Quality"

© Copyright 1990 by The Antenna Specialists Co.

CIRCLE 151 ON READER SERVICE CARD

Radio's Golden Age

A Stroll Down Memory Lane – With Stops Along The Way

BY ALICE BRANNIGAN

Last September we looked into the history of CBS' Los Angeles powerhouse KNX. That brought in a big response, like the note from Ray D. Ferguson, retired from NBC in Los Angeles, and now living in Lake City, FL.

Ray said we did a "great job" with KNX, and mentioned that NBC's studios in Los Angeles were only a block away, on Sunset and Vine. Even so, he said the NBC and CBS staffers seldom visited back and forth between the two facilities.

We thought, then, we might peek in on the early days of NBC's primary Los Angeles outlet, KFI. This station, which was the second station to begin operating in Los Angeles, started up on April 16th, 1922. Its first broadcasts were via a homemade 5 watt transmitter on 833 kHz, although within a few months the station had increased power to 500 watts on 640 kHz.

KFI was put on the air by Earle C. Anthony, who owned the local dealership for luxury Packard cars at 1000 South Hope St. Station KFI was also licensed as Experimental station 6XY. KFI was an immediate success, and found that its opera broadcasts (began in 1924, and sponsored by Standard Oil) attracted a wide audience. Other early KFI program sponsors included General Mills, Owl Drug Stores, and Walter Murphy Motors.

In 1926, KFI's full-length broadcast of the opera *Die Walkure* attracted considerable attention because it was networked to KPO, San Francisco, for live simulcasting.

The year 1926 also saw KFI increase its power to 5 kW, although its 500 watt signals had been reported in both England and Australia. But the best was yet to come!

In July of 1931, KFI upped its power to 50 kW and became the first 50 kW broadcaster west of Chicago. The new KFI 50 kW transmitting facility was a superb engineering feat, the talk of the broadcast industry, and the envy of most stations.

The transmitting site was set up on a 30 acre tract near Buena Park, 21 miles southeast of Los Angeles. A pair of 400 ft. high steel frame towers were constructed, 700 ft. apart. The two-story brick transmitter building was located 475 ft. from the midpoint of a line joining the two towers, so that the building and two towers formed an approximately equilateral triangle. The radiation pattern was circular.

The transmitter itself was a 37-tube RCA 50-B type. The final amplifier unit of this



The 5 kW transmitter of KFI is checked out by movie producer Sol Lesser in the late 1920's.

transmitter was designed around two UV-862 100-kW tubes arranged in a linear balanced power amplifier circuit. The UV-862 was run with 17,500 volts (at 4.2 amps) on the plate in the RCA 50-B. Mercury vapor rectifier tubes were employed, and the rectifier was designed so that when the voltage is first thrown on the tubes it was only 10,000 volts, after which the regulator automatically brought it up to the full 17,500 to protect the tubes.

A two-wire line connected the transmitter with the antenna coupling and tuning apparatus. This was located in a separate building directly beneath the antenna itself. The transmission line had nearly 100% efficiency, with negligible loss in the conductors.

The results from this installation were immediately successful for KFI. Later in the 1930's, NBC would further enhance KFI's image and reputation by constructing the network's western headquarters and studios as an imposing structure on the busy corner of Sunset and Vine.

Earle C. Anthony, KFI's founder, also ran Los Angeles station KECA, which had 1 kW on 1430 kHz, then moved to 790 kHz with 5 kW in 1941. When ABC was formed as a split off from NBC, KECA became the ABC outlet in Los Angeles. This is the present KABC. KECA began operation in Hollywood, April 15, 1925 on 1440 kHz as Clarence Juneau's station, KFVF. It was acquired by Anthony in November, 1929 and owned by him until the formation of ABC. Earle Anthony was 81 when he died in 1961.

KFI continues on 640 kHz with 50 kW and a talk format. Since 1973, it has been owned by Cox Enterprises, which operates the station from 610 South Ardmore.

We have a couple of interesting old cards from KFI, including ones displaying the special verification stamps the station issued and affixed to its QSL's. One stamp is for KFI alone, while the other is for KFI/KECA.

Verification Stamps?

The use of stamps in connection with QSL's brings us mail from time to time, and the KFI veri stamps offer a good opening for an inquiry from R. A. Gove, Clarksville, MD. R. A. writes that his dad, Leroy Gove, was an active DX'er in the 1920's when he lived in Lynn, MA. After his father passed away in 1984, R. A. was sorting through some of his dad's old radio papers and came across an EKKO stamp album.

R. A. has been in and out of DX'ing himself for a number of years, but he admits to being stumped by the EKKO stamp album, since his father had never mentioned it to him. He hopes we can shed some light on the subject.

The EKKO album was filled with stamps of various colors which bore the call signs of American and Canadian broadcasting stations. The album, which is dated 1924, had blank spaces marked with the call letters and locations of stations where the stamps were to be pasted into the album.

Stamp designs were mostly identical, although different for stations of American and Canadian origin. The American stamps all showed an eagle between two antenna towers, while the Canadian version showed a beaver between two towers. The letters EKKO appeared in the four corners, with the call signs appearing as a black overprint on the stock designs.

EKKO was a company that supplied these

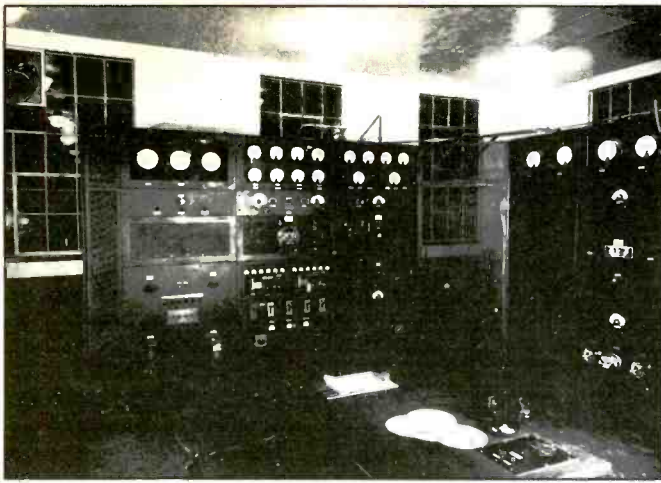

The RF units of KFI's 50 kW transmitter, installed in 1931.

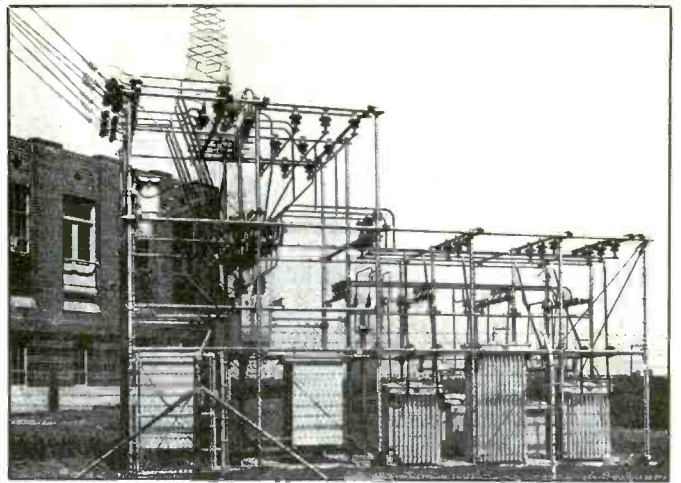

The KFI power distribution frames with one of the 400 ft. towers in the rear.

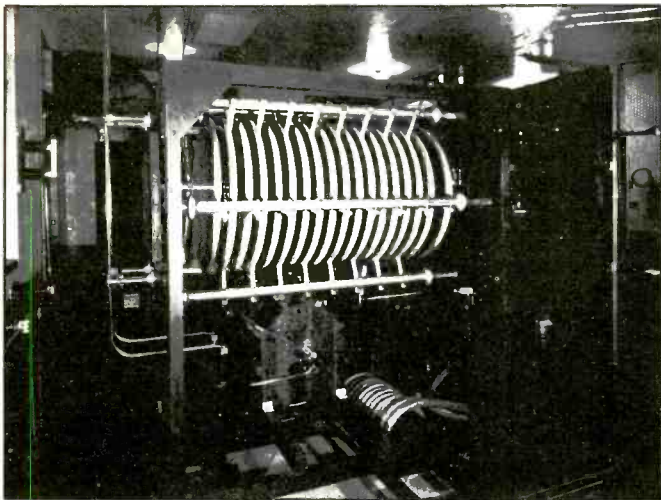

One of KFI's tuning capacitors used in the final stage of the 50 kW transmitter.

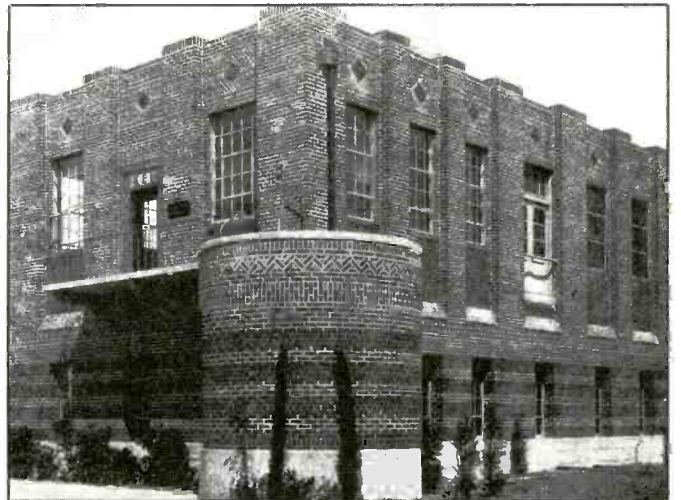

Transmitter building for the 50 kW KFI installation built in 1931.

stamps to broadcasters in the 1920's, and into the 1930's. Stations sometimes sold them for a dime each with their QSL's, and many DX'ers attempted to fill their albums with the stamps. Not that a full album attested to anything in particular, since many stations didn't offer the stamps. DX'ers didn't need to get the stamps from the stations, anyway. The EKKO company would sell the stamps directly to DX'ers to cover stations that refused to carry them. Also, as in the case of KFI, WSB, WDAE, etc., there were numerous stations that bypassed the EKKO company and printed QSL stamps of their own design (at times, looking similar to the EKKO stamps) for sale (or to be given at no cost) to DX'ers.

This is a brief summary of EKKO stamps. A complete, in-depth look at the EKKO stamp collecting fad that swept the DX'ing hobby in the 1920's was the subject of a POP' COMM feature that appeared in our April, '86 issue.

Catching Up On Old Business

In the October issue, we discussed the four AM high fidelity stations that were establish-

ed in the 1930's. One of these was W9XBY, in Kansas City, MO on 1530 kHz, with 1 kW. We mentioned that the station was operated by First National Television, Inc., which later obtained commercial license KXBY for the station, and eventually operated it under the call letters KITE, although it was a short-lived operation. First National operated a radio and TV school for technicians, in addition to their own broadcasting stations.

One of the students at First National in 1939, was Nick Ferrari, who is now a retired research engineer in industrial electronics. Nick lives in Canton, OH and is a POP'COMM reader, who enjoyed reading about KITE in the October issue, also about W9XAL, which was First National's early TV station (discussed in our July, '91 issue). Nick was 23 years old in 1939, and he put in some time working in the KITE studios, as well as at the transmitter. He also worked at W9XAL, First National's TV station.

Nick was kind enough to share with us photos taken in May of 1939. One shows the exterior of the KITE transmitter building and tower. The other photo shows Nick, himself,

operating one of the TV cameras at W9XAL.

Also, in the October issue we ran a photo of the 450 ft. wooden radio tower used in 1934 by the 100 kW broadcaster in Hamburg (904 kHz), Germany. We speculated that the signals were radiated by a wire element inside the tower, but wondered if anybody knew the reason for the unusual use of wood in constructing the large tower.

That brought in a letter from Guenther Daub, KC6TWP, an electronics engineer from Redondo Beach, CA. Guenther told us that during the 1970's, he read an article in a German publication that discussed the use of a wooden broadcast tower at *Heissischer Rundfunk*, and its main transmitter near Frankfort am Main, Germany during the 1930's.

He tells us that the German broadcast service (Rundfunk), prior to WWII was providing extended service coverage using a few primary, high-powered mediumwave transmitters. Normally, towers associated with the primary mediumwave transmitter sites consisted of self-supporting steel towers. As the power and the ground wave coverage service area of the mediumwave transmitters increased

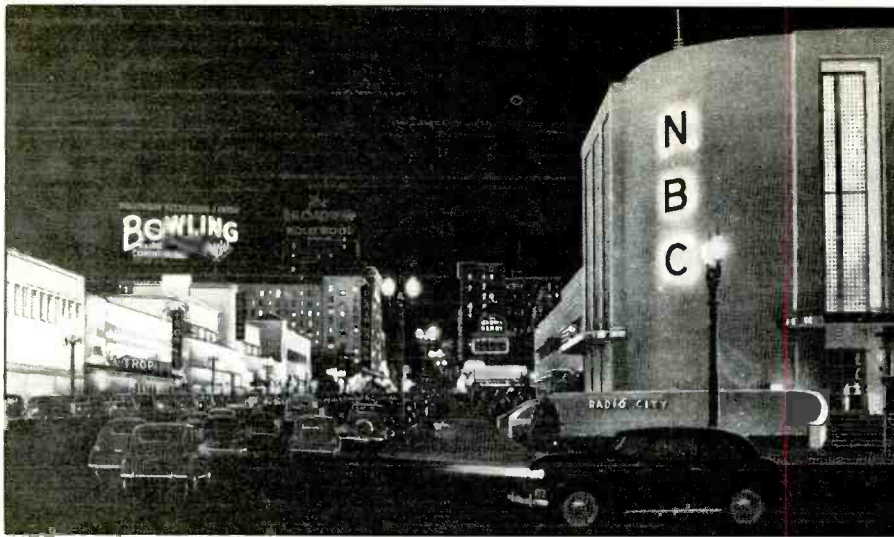

NBC built this impressive structure to house its west coast headquarters and KFI in Hollywood. This view is on Vine Street, looking north from Sunset Boulevard.

during the 1930's, there were many complaints received regarding severe fading during the daily diurnal transition in the regions of ground/sky wave interaction.

Experiments determined that the fading could be minimized by a suspended, constant diameter, vertical wire. The wooden towers were therefore built to support a ver-

tical radiating element consisting of a single steel/copper wire, which was end-fed at the bottom in the normal manner. Wood didn't interact with the suspended wire and was thought to be the only suitable material from both mechanical and electrical aspects.

The variable cross section of a steel tower, very large at the base and decreasing with height, resulted in a radiation impedance variation as a function of height. The very large base cross section of the massive self-supporting towers resulted in a non-uniform current distribution along the vertical radiator and a less than desirable elevation radiation pattern, believed to enhance the sky/ground wave interaction at the first reflection zone. The self-supporting steel tower would have a higher radiation angle and less smooth vertical radiation pattern. The higher radiation angle would place the region of sky wave/ground wave interaction closer to the transmitter, i.e., the normal groundwave service area.

The wooden tower's suspended wire provided a constant radiation impedance (i.e., constant cross section), constant current distribution, and a more suitable, elevation pattern. The lower radiation angle of the single, vertical wire moved the first skip zone further

We have received your communication and attach herewith a KFI verification stamp.

Your reception of our program was correct.

468.5 Meters



KFI

A NATIONAL INSTITUTION

OWNED AND OPERATED BY

Earle C. Anthony, Inc.

This 1927 QSL card made reference to KFI as "A National Institution." The stamp was of the station's own design.

Dear Radio Friend:

This card, with stamp attached, verifies your reception of KFI ✓, KECA. We are happy to number you in our audience.

You may be interested in the following facts about KFI-KECA:



KFI

640 kilocycles—468.5 meters—50,000 watts

Operates daily from 6:45 A. M. (Pacific Standard Time) until midnight. Transmitter (most powerful West of Chicago) located at Buena Park, 21 miles southeast of Los Angeles. Studios at 1000 South Hope St., Los Angeles.

KFI has been in operation since April, 1922. Its daily programs include variety reviews, exclusive news dispatches by leased wire, finance, health and home economic talks, symphony, chamber and popular dance music.

KECA

1430 kilocycles—210 meters—1000 watts

Operated daily from 9:00 A. M. to 11:00 P. M. (Pacific Standard Time). Transmitter at Eighth and Beacon Streets, studios at 1000 South Hope Street, Los Angeles.

KECA has operated since November, 1929. Its daily programs correspond in quality and character to those of KFI.

BOTH KFI AND KECA ARE OWNED AND OPERATED BY EARLE C. ANTHONY, INC., CALIFORNIA DISTRIBUTOR OF PACKARD MOTOR CARS, AND ARE ASSOCIATE STATIONS OF THE NATIONAL BROADCASTING COMPANY.

In 1930, Earle Anthony's QSL's did double duty for both of his Los Angeles stations, KFI and KECA. Both sets of call letters appear on the station's stamp affixed to the QSL.

ILLINOIS

 Chicago WORD, BATAVIA			

A page from an EKKO stamp album that was filled by R. A. Gove's dad, Leroy, in the 1920's.

Computer Aided Scanning

a new dimension in communications from Datametrics



Now Radio Shack PRO 2006 owners for the first time have access to the exciting world of Computer Aided Scanning with the highly acclaimed Datametrics Communications Manager system. Computer Aided Scanning is as significant as the digital scanner was five years ago and is changing the way people think about radio communications.

- The Datametrics Communications Manager provides computer control over the Radio Shack PRO2006 receiver.
- Comprehensive manual includes step by step instructions, screen displays, and reference information.
- Powerful menu driven software includes full monitoring display, digital spectrum analyzer and system editor.
- Extends receiver capabilities including autolog recording facilities, 1000 channel capacity per file, and much more.
- Uses innovative Machine State Virtualizer technology (patent pending) hardware interface by Datametrics.
- Simple 4 step installation - no soldering or modification to normal receiver operations.

Datametrics, Inc

- Computer Aided Scanning system \$ 349
 - PRO2006 receiver w/interface installed and CAS system \$ 749
 - Manual and demo disk \$15
- Requires Radio Shack PRO 2006 receiver and IBM PC with 360K memory (640K for full channel capacity) and parallel (printer) port.

Send check or money order to Datametrics, Inc., 2575 South Bayshore Dr, Suite 8A, Coconut Grove, FL, 33133. 30 day return privileges apply.

CIRCLE 132 ON READER SERVICE CARD



This is a 1920's EKKO stamp. WCBZ was a 50 watt station on 1210 kHz in Chicago Heights, IL.



KITE was a short-lived high-fidelity broadcaster in Kansas City, MO. One of our readers worked there! (Courtesy Nick Ferrari, OH.)

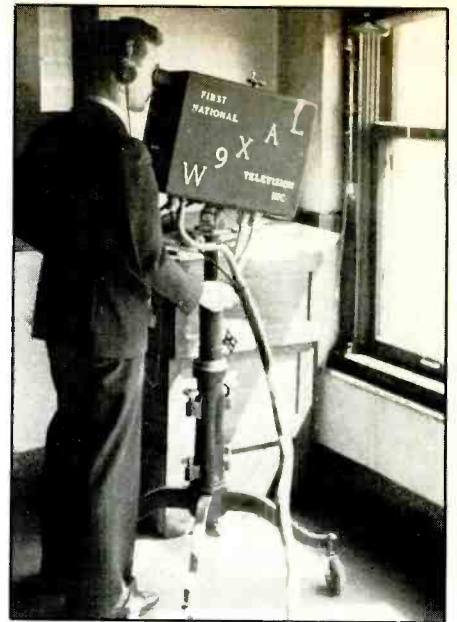

This 1939 TV camera operator at Kansas City's W9XAL is present day POP'COMM reader Nick Ferrari.

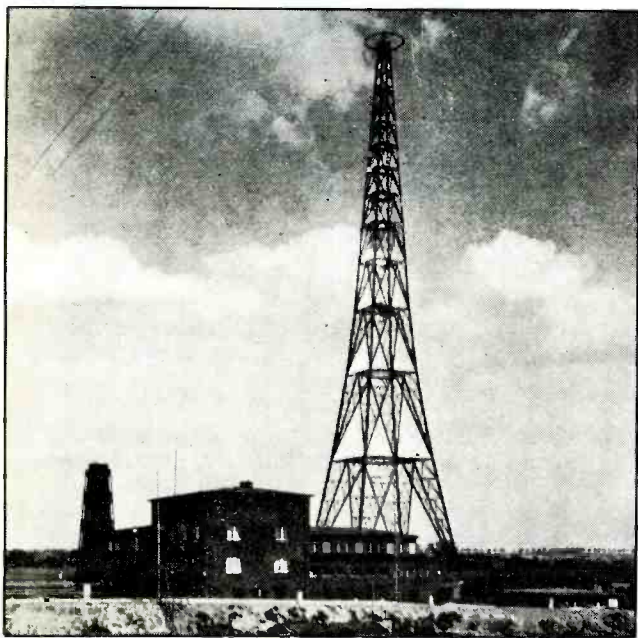

Why was this 1930's broadcast tower in Hamburg made out of wood? The mystery has finally been solved by one of our readers.

Right after they wrote this March, 1949 QSL letter from Newfoundland's VONH, they threw out the letterheads. That's when Newfoundland became a part of Canada and the the Broadcasting Corporation of Newfoundland was absorbed into the CBC. (Courtesy Oru Lyttle, BC.)

away from the transmitter, providing reduced diurnal interference within the ground-wave region.

Several expensive wooden towers such as Hamburg's were eventually built, so early tests must have been encouraging. WWII came along and ended the possibilities of long-term performance testing. The wooden

tower at the Frankfort station was destroyed during the war and was replaced by emergency steel towers for the duration of the war. When the war ended, Frankfort's wooden tower was not rebuilt.

To say we have readers with unusual occupations would be an understatement. Walter Schivo, KB6BKN, of Novato, CA

works as a movie extra and has appeared on the TV shows *Midnight Caller* and *Over My Dead Body*, and in many films, including *Class Action*, *Pacific Heights*, and *The Doors*. Walter, who is somewhat of a *Wolfman Jack* lookalike, was photographed by the Youth Law Center of San Francisco as the "Poster Bad Guy" for their anti-drug campaign.

BROADCASTING CORPORATION OF NEWFOUNDLAND

Telephone No. 6047
P. O. Box No. E5372

St. John's,
Newfoundland
March 9th., 1949.

Mr. R.O. Lyttle
North Bay, Ontario.,
Canada.

Dear Mr. Lyttle:

Thanks a lot for your letter of February 5th., which has just been passed to me for acknowledgement.

Your report is quite accurate when checked with our operations Log. We might add here that similar reports received from other listeners in your range divulge the same information with respects to interference etc.

In answer to your query at the end of the letter - after Union, the Broadcasting corporation of Newfoundland will become the Nfld. Region of the CBC. The set-up will be thus:

VONF and VONH: 10,000 - 300 -	CBN 640 Kc - 49M
VONN, Corner Brook - 1,000 -	CBY 790 Kc
VORG, Gander - 300 -	CBG 1450 Kc
Grand Falls (New Station) - 1,000	CBT (?)

As this is possibly one of the last letters to be written on this stationery, I hope it will serve as an interesting souvenir.

CB- ing you soon,

Yours truly
Dick O'Brien
DICK O'BRIEN,
PROGRAMMES

Receive digital signals on shortwave

See AP wire news photos, weather maps, news over RTTY, Amtor ship-to-shore, Navtex, slow scan TV, ASCII, Morse code and packet radio -- all on your computer screen!



MFJ-1278

\$279.95

See tomorrow's news today on your computer screen when you copy crisp, clear AP news photos. You'll also enjoy high resolution WeFAX weather maps, multi-gray SSTV pictures and full color packet radio pictures. You'll also copy the digital text modes: RTTY, Amtor, Navtex, ASCII, Morse and packet.

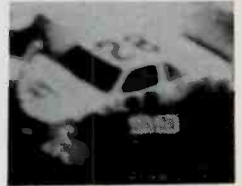

AP wire photo received on 20.738 MHz using MFJ-1278 with MFJ-1289 Multicom.

All you need is the MFJ-1278 multimode data controller, HF and/or VHF/UHF receiver and your computer with MFJ software.

Don't be confused by a barrage of unknown digital signals -- let Automatic Signal Analysis™ tell you what they are

MFJ-1278's ASA™ detects RTTY, Amtor, ASCII and HF Packet signals. After ASA tells you what you're hearing, you just type an "OK" command to display the copy on your computer screen.

MFJ Multicom™ and MFJ Multicom64™ -- software that brings out the full power of your MFJ-1278 with multi-gray modem

MFJ Multicom™ for IBM compatible computers (MFJ-1289, \$59.95) gives AP photos and weather

maps with up to 8 gray levels. MFJ Multicom64™ (MFJ-1282B \$39.95) gives you multiple gray levels on your Commodore 64/128.

These programs include a computer cable and friendly instructions -- everything you need to get started fast.

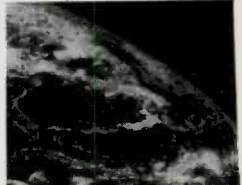

Weather map received on 16.410 MHz using MFJ-1278 with MFJ-1289 Multicom.

To enjoy receiving text modes off the air with your MFJ-1278, you can use any computer with a serial port and simple terminal program.

Feature packed for superb operation

Dual radio ports let you connect two radios (each HF or VHF/UHF); 20 LED precision tuning indicator lets you tune in signals to an incredible 10 Hz accuracy -- even if you don't have digital readout; free AC power supply (or use 12 VDC); RS-232 and TTL serial ports make it easy to use with virtually any computer; one year unconditional guarantee and much, much more.

Enjoy an exciting new world of SWLING

Enjoy thrilling multi-gray AP news photos, weather maps and digital text with the MFJ-1278 multimode data controller. Get yours today!

Nearest Dealer/Orders: 800-647-1800

MFJ MFJ ENTERPRISES, INC.
Box 494, Miss. State, MS 39762
(601) 323-5869; FAX: (601) 323-6551
Add \$5 each product ordered s/h.
MFJ . . . making quality affordable

CIRCLE 143 ON READER SERVICE CARD



POPULAR COMMUNICATIONS

FREE READER SERVICE CARD

ENTER MONTH AND YEAR OF THIS ISSUE:

Month _____ Year _____

(REQUESTS CANNOT BE PROCESSED WITHOUT DATES)

1	2	3	4	5	6	7	8	9	10	11	12
13	14	15	16	17	18	19	20	21	22	23	24
25	26	27	28	29	30	31	32	33	34	35	36
37	38	39	40	41	42	43	44	45	46	47	48
49	50	51	52	53	54	55	56	57	58	59	60
61	62	63	64	65	66	67	68	69	70	71	72
73	74	75	76	77	78	79	80	81	82	83	84
85	86	87	88	89	90	91	92	93	94	95	96
97	98	99	100	101	102	103	104	105	106	107	108
109	110	111	112	113	114	115	116	117	118	119	120
121	122	123	124	125	126	127	128	129	130	131	132
133	134	135	136	137	138	139	140	141	142	143	144
145	146	147	148	149	150	151	152	153	154	155	156
157	158	159	160	161	162	163	164	165	166	167	168
169	170	171	172	173	174	175	176	177	178	179	180

Did you purchase this issue of Popular Communications from either a newsstand or magazine store? Yes No

Name _____

Company Name _____

Address _____

City _____ State _____ Zip _____

(Please note: This card expires 3 months from cover date.)

communications station has been pro- (6BKN.)

n VONF of 640 kHz. The VONH received in March of 1949, when in North Bay, Ontario.

akes the QSL special is that Newfoundland was a British colony until co-federation in March of 1949. The VF/VONH was the Broadcasting of Newfoundland, and their mentioned that it was one of the mail from this independent company it faded into history and became Newfoundland Region of the CBC. did the company go out of existence did the distinctive Newfoundland used by the company's stations. ame CBN; VOWN/790 in Corner became CBY; and VORG/1450, rned into CBG.

lian postage stamp was placed at of the letter, reminiscent of the old ap fad, and was hand stamped by onnel twice with the words *Broad- corporation of Nfld.*

interesting momento, just as the dicted it would be in their letter forty years ago. We were pleased e opportunity to share it here. closing the dusty scrapbook until When we again open it, we trust e here to turn the pages with us. s appreciate contributions from e can use old radio/wireless photostcards, memories, QSL's (copies ginals can't be spared, since they rned), clippings about old time stations, old station directories, and related material.

Best wishes for a happy new year. ■

British Columbia is the one from 300 watt VONH, 5970 kHz, of St. John's, Newfoundland. VONH relayed 10 kW medium-

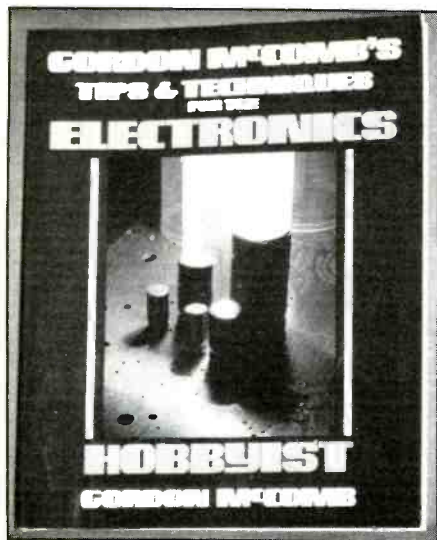

Make A Big Thing Out Of Nothing

Many people feel that a goodly portion of their enjoyment of electronics and communications is their ability to build projects and perform some or even more advanced simple equipment repairs, read schematic diagrams, work safely with electricity, know what different components do, and work with the primary formulas that relate to electronics.

Probably there would be lots more folks who would like to get involved in this aspect of radio, except that they don't know how to get started. We came across a fine book that solves that problem. It is Gordon McComb's *Tips & Techniques for The Electronics Hobbyist*, a 273-page illustrated (photos, diagrams) volume that provides excellent information. While written so that it is useful to the entry-level novice, there is such an abundance of well-prepared information in the book that it's also a fine reference source for the more experienced hobbyist.

There are ideas and hints galore, shortcuts, sources, and even sixteen test equipment and useful hobby accessory projects to build from easy-to-obtain components.

Of the twenty chapters, one of my own favorites was the one relating to a components layout on a circuit board. This has always been something that has given me fits, while also offering some amusement to those who see my handiwork. My projects worked, but seldom looked like others thought they should. McComb's book took the mystery out of this, explaining the logic behind circuit board layout in such a clear manner that it straightened out my little problem very painlessly.

McComb's book is easy to read, useful, and does a good job of covering an area that offers many potentials for learning and accomplishment.

Gordon McComb's *Tips & Techniques for The Electronics Hobbyist* (book #3486) is \$17.95. It comes from TAB Books, Blue Ridge Summit, PA 17294-0850.

Everybody Wants To Get Into The Act

There was a time when one paragraph of a single federal law was all that was necessary to govern the public's tuning in on the radio spectrum. Forget that now. The federal government keeps trying to shave off chunks of the spectrum because well-lobbied special interest groups have convinced politicians you and I shouldn't be allowed to tune in.

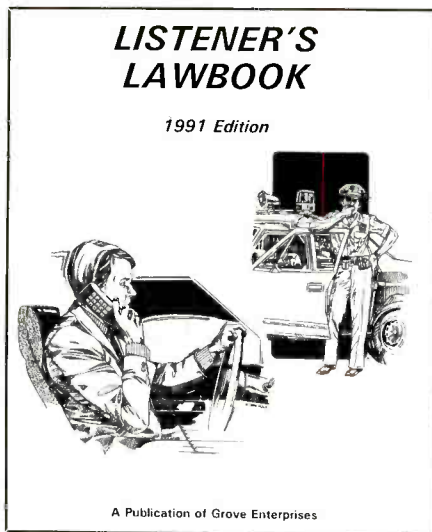

Furthermore, virtually all states have concocted legislation that seek to somehow regulate certain uses of scanners within their respective jurisdictions. These vary from state to state, and many concern mobile scanner installations, or scanners used to monitor cellular or other telephone-related unscrambled transmissions.

Like them or not, the laws are on the books. That caused Frank Terranella, an attorney, to assemble all of these various pieces of legislation into a book entitled, *The Listener's Lawbook*. He presents the entire text of each law, then offers summaries and opinions based upon those laws as they have been treated in court. This 48-page book is intended for the hobbyist to use as a guide and clarification as to just what these laws are.

In looking through the laws, it's plain that many were concocted by legislators who had no knowledge of communications, nor any way of putting their ideas into meaningful language. For instance, one that is particularly laughable is New York's Vehicle and Traffic law 397. It states, in part, that (unless you're a police officer, peace officer, or ham radio operator) it's a misdemeanor to have a police receiver in your vehicle unless you have a special permit issued by the person authorized to do so from your local community or county government. The law is violated when someone "knowingly uses a motor vehicle so equipped or in any way knowingly interferes with the transmission of radio messages by the police without having first secured a permit to do so . . ."

The way this is worded, the legislators thought a receiver could transmit interference. Not only that, the permit they want you to get authorizes you to transmit interference to police messages. It may all be moot, since we understand that the permits mentioned in this legislation have never been issued by any local or county agency.

This is only one example of a badly conceived and poorly worded scanner law, such as the public is expected to suffer. Such laws exist from coast to coast. You are supposed to understand them, and live within them. I'll grant you, it's not a simple matter. Terranella's book has them all.

The Listener's Lawbook is \$11.95, post-paid, from Grove Enterprises, P.O. Box 98, Brasstown, NC 28902.

Inside Mission Control

The Johnson Space Center, Houston, TX is the communications headquarters for NASA. That large facility is where signals are sent and received in conjunction with the Space Shuttle, and also with deep space probes and NASA's orbiting satellites.

R.H. Nicholson's book, *Inside The MCC: A Technical Guide to The Mission Control Center at The Johnson Space Center*, is a behind-the-scenes tour of this center. Illustrated with charts and diagrams, Nicholson's 96-page book, offers a comprehensive, technical description of the communications and data processing systems at Johnson.

There's a short history of NASA and also some insight on how manned spaceflight operations are conducted. If you are intrigued about how the shuttle program works, this book should fill in the blank spaces. Some general frequency information is provided.

A glossary of NASA terminology, acronyms, and abbreviations, plus an index,

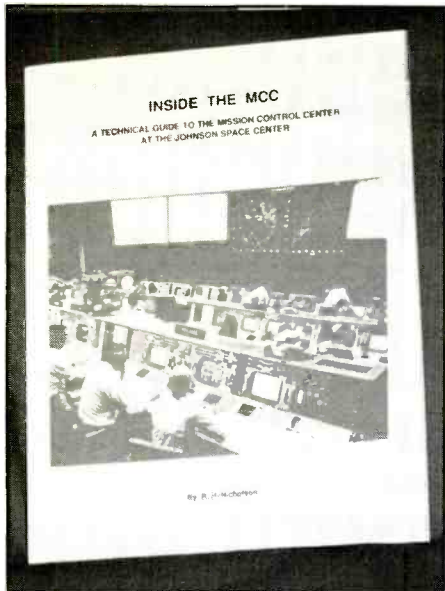

rounds out Nicholson's well-written book. By the way, the author spent ten years with NASA as a MCC communications tech and tech writer, so he's well qualified to have written this book.

Inside The MCC is \$11.95, plus \$1 shipping, from Universal Radio Research, 1280 Aida Drive, Reynoldsburg, OH 43068.

Arise!

The Great American Gripe Book, by Matthew Lesko, is a thick 374-page volume that puts you in easy phone and mail contact with more than 1,000 free state and federal services.

Fortified with this ready-access information, you can communicate very accurately

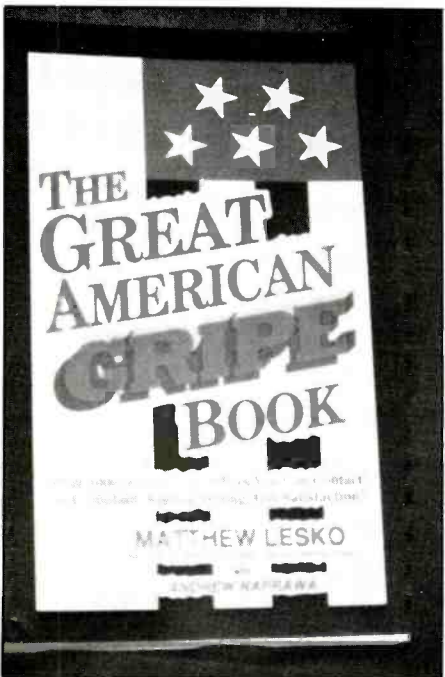

with the desired agency to get all sorts of action on your behalf. Saves a lot of wasted time and effort, most of it simply trying to learn where to take your problem, complaint, or request for action, advice, or assistance.

Now, with one single phone call, you can tackle faceless giant corporations; settle neighborhood disputes; get insurance companies to pay claims; get collection agencies off your back; get polluters fined; get a car dealer punished for selling you a lemon; clean up filthy food sellers; report dangerous truckers; settle Social Security and disability claims; keep money lenders honest; stop price gouging; shut down porno shops; root out crooked politicians; get drug dealers out of your neighborhood, and lots more!

Lesko's dynamic reference book tells you whom to contact, also how to gripe to get the quickest and most effective results. Gripping with deadly success, it turns out, is an art that must be learned. If it's not done properly, you might as well not bother.

Here are thousands of names, addresses, and phone numbers of agencies willing and able to try and help. Lesko's *Great American Gripe Book* has all the information in one place.

The Great American Gripe Book is \$9.95, plus \$3.50 for UPS shipping (sent by 1st Class mail to HI, AK, PR, VI, GU, APO, FPO, and Canada) from CRB Research Books, Inc., P.O. Box 56, Commack, NY 11725. Residents of NY State, please add \$1.08 tax.

Jo Gunn Enterprises

- CB Antennas
- Mobile Antennas
- 10 Meter Antennas
- Coax

3 STAR
"Local-Groundwave-DX"
11 Meter

Specifications:
TYPE: Horz. & Vert.
Polarization Twin Feed
GAIN: 14.5 DB
FRONT to BACK RATIO:
40 DB True
SIDE REJECTION:
40-45 DB True
BACK REJECTION:
40 DB True
WEIGHT: 28 Lbs.
LENGTH: 8 Ft.
SWR: 1.1
HORZ. to VERT.
SEPARATION: 20-25 DB
WIND SURVIVAL: 100 MPH
POWER MULTIPLICATION:
40X
AUDIO GAIN: 18 DB
WIND LOAD: 2.8

HILLBILLY
"Horizontal and Vertical
10 Meter Omni"

Specifications:
FREQUENCY RANGE:
26,000-29,500
GAIN:
Horizontal - 5.25 DB
Vertical - 4.75 DB
MULTIPLICATION FACTORS:
Horizontal - 17 Times
Vertical - 15 Times
HORZ. to VERT.
SEPARATION: 20-25 DB
POWER RATING:
2000 CW, 4000 PEP
HEIGHT: 11 Ft.
WEIGHT: 10 Lbs.
MATERIALS:
6063 T-6 Aircraft
Aluminum Tubing
Requires 2 Separate Coaxial
Cables for Hook-Up

UPS SHIPPABLE

Call or send \$2.00 for Complete Catalog and Pricing of Antennas.

JO GUNN
Antennas

Route 1 - Box 32C, Hwy. 82
Ethelsville, AL 35461
(205) 658-2229
FAX: (205) 658-2259
Hours: 10 am - 6 pm (CST)
Monday - Friday

DEALER INQUIRIES, PLEASE CALL

Made in USA

SOMERSET ELECTRONICS

Announces... THE MICRODEC™ 'SERIES'

NOW IT'S YOUR CHOICE! You select the Model and the features to meet your decoding and budget needs*! Each choice is fully upgradeable to the top of the line! With our new VIP50 Interface you can choose an expanded display (32x16 characters on your television) and hard copy -- with or without a computer!

FEATURES:	MD100 BASIC <i>List: \$229.95</i>	MD200 PLUS <i>List: \$329.95</i>	MD300 MAXIM <i>List: \$429.95*</i>
MORSE: DECODES CW WITH			
Autospeed, software filter, speed display	★	★	★
RTTY (60,67,75, 100 WPM) (major shifts)	★	★	★
RTTY (bit inversion)	★	★	★
ASCII (110 & 300 BAUD)	★	★	★
ASCII (bit inversion)	★	★	★
AMTOR/SITOR Mode A-ARQ	★	★	★
AMTOR/SITOR Mode B-FEC	★	★	★
Smart display/intensity control	★	★	★
On/Off with volume	★	★	★
Serial Interface	★	★	★
Code Oscillator	★	★	★

AVAILABLE OPTIONS:

Display Colors: (Green standard--no charge) Red, or Yellow (your choice) \$15.00
 NICAD Batteries for portability \$29.95 Model VIP50 Adaptor \$189.95*
 *MD300 price includes the VIP50 Interface Adaptor.

(TV Stations, phone companies, and public utilities are selecting MICRODEC™ for their operational and FCC requirements - FCC Docket 86-337.)

Call us for special introductory prices and orders at 1-800-678-7388.
Fax orders: 1-407-773-8097 • Technical assistance: 1-407-773-8097
VISA • MASTERCARD • PERSONAL CHECKS • MONEY ORDERS
SOMERSET ELECTRONICS, INC. • 1290 Hwy. A1A, Satellite Bch., FL 32937

High Performance TV DX "Tool"

Now Is The Time To Prepare For The Coming TV DX Season

BY BOB COOPER, JR. ZL4AAA/K6EDX/VP5D

Not everyone is addicted to long distance television reception. But in this day and age of instant worldwide satellite TV "connection," there is still a charm involved in seeing a far away station direct, via 'natural' as opposed to artificial 'propagation.'

During this period of high sunspot numbers with the F layer riding a crest of peak MUF's (maximum usable frequency), 40 to 50 (+) MHz signals from many TV transmitters are finding their way a quarter, even half way around the world. In some portions of the world, television stations still operate in this frequency region; New Zealand, for example, has its visual carriers in the 45.25 MHz region.

Six meter (ham) enthusiasts are finding video transmitter carriers from New Zealand and Australian, Far East, African and European transmitters are excellent "propagation indicators." When the skip reaches into the 45 + MHz region, these TV carriers bounce over distances of thousands of miles, and with transmitter powers as high as 300 kilowatts, the F layer propagated signals often reach incredible strengths. Tuned in on a six meter ham transceiver or a scanner receiver capable of tuning the 30-50 MHz range, the presence of these distant carriers on a receiver signals the likelihood of 50 MHz DX signals as well.

Now, if you can hear the carrier on your receiver, could you not also watch the video?

The first problem is the frequency. An American-intended NTSC format TV receiver starts out tuning in channel 2; 55.25 MHz video carrier frequency. Worldwide, New Zealand TV channel 1 at 45.25 MHz, Australian TV channel 0 at 46.25 MHz, European/African/Asian channel E2 at 48.25 MHz, and Russian channel (R) 1 at 49.75 MHz are all below the varactor-diode-tuned front ends on American TVs. Yes, you could climb inside your \$800 Sony to re-tune it, but

The second problem is the audio carrier (or sub-carrier). NTSC video, the U.S. kind, places the audio carrier 4.5 MHz above the visual carrier. New Zealand, Australia, and much of the rest of the world place their audio 5.5 or 6.5 MHz above the video. NTSC re-



D-100 Deluxe DX TV Converter fits into the palm of your hand but extends the reach of your TV set to worldwide proportions.

ceivers have IF amplifiers and audio discriminators based upon the +4.5 MHz format, so even if you do retune your TV tuner to cover 45-55 MHz, you won't recover audio if the distant TV transmitter audio is outside of the passband (and away from the discriminator) of the receiver.

A Solution?

Television DX'ing enthusiasts in Europe have faced this sort of problem for several decades since TV transmission standards in Europe are mixed across national borders. Even casual viewing of neighboring country transmissions often requires "standards conversion"; a change in the TV set's method of handling signals. Today, multiple-standard TV sets abound on the European market; even simplistic black and white portables are often switchable between two or three formats.

There is another solution; a special "front

end" created by European TV DX designers. It's called the DX-TV converter (model D100) and for around (US\$) 200 your NTSC TV set with no external modification(s) can tune-in both the video and audio from virtually any TV transmitter in the world.

The D-100 (see footnotes) is a tool for the serious distant-TV reception enthusiast; it was designed that way. Modern TV sets do virtually everything for you, automatically. All this automation reduces not only what you do but more importantly what you *can* do. The D100 returns to you those operator adjustments that may make the difference between logging Television New Zealand and being frustrated with snowy lines of interference.

1) The D-100 has a continuously tuned front end in three bands; 45-108 MHz, 165-230 MHz and UHF 460-870 MHz.

2) The incoming RF single is IF processed and up-converted to a UHF TV channel between 470 and 630 MHz.



Talk of the Town!

The First-Ever Realistic® 2-Meter Ham Transceiver

The word is out! This all-new handheld is available now at Radio Shack. It's a solid performer and a dynamite value—built to tough commercial standards set by Radio Shack's own hams.

We've included features and accessories that cost extra with most other brands. True FM transmit provides superior voice clarity. A super-selective receiver front-end fights intermod. You get multifunction scanning. Built-in 5-memory DTMF dialer. Subaudible tone encoder and decoder. DTMF squelch. And 12 memory, three priority and one calling channels. Ready to use with high-capacity Ni-Cd battery pack, case for alkaline AAs, AC charger, belt clip and duck.

Here's one more reason to choose Realistic. The HTX-202 is backed by a one-year limited warranty honored at our 7000 locations nationwide. Now it's your turn to talk. Visit your nearby Radio Shack store today!

Only **259.95**



NEW! Speaker/
microphone for
HTX-202 and
many others
19.95



NEW! 5/8-wave
magnet-mount
mobile antenna
for 2 meters
37.95

Radio Shack® SINCE 1921
AMERICA'S TECHNOLOGY STORE™

A Division of Tandy Corporation. Prices apply at participating Radio Shack stores and dealers. You must have an FCC Amateur Radio license of appropriate class to transmit with the HTX-202 transceiver.

An antenna delivered signal between 45-108, 165-n-230 MHz or 460-870 MHz is down converted to the IF, amplified, and with a front panel control the bandwidth of the IF amplifier may be reduced from around 6.5 MHz to as little as 1.5 MHz. Like any IF bandwidth reduction system in a ham receiver, reduction in bandwidth improves weak signal reception (at some loss of picture detail information, of course). This IF bandwidth control can be an important tool in resolving specific DX pictures under weak signal or interference laden reception conditions, so loss of detail is secondary.

3) The up-converted TV signal tuned in with the front end is fed to your NTSC (or other) TV receiver on an unused (in your area) UHF TV channel between 470 and 630 MHz. An adjustment internal to the D-100 allows you to select the UHF 'output' channel you require at your house.

To this point we have a frequency but not a standards converter. If the sound is +5.6 or +6.5, or the video is 625 lines/25 frames (versus NTSC's 525 lines/30 frames per second), you still will have unresolved video and audio, even after tuning in the distant signals.

Pure standards conversion (ie. translating 625 lines/25 frames to NTSC/30 frames) remains an expensive proposition; although a recently released 'world standards' Panasonic VCR gives it a go at around \$2,000 U.S. Let's look at the video first.

A 625 line/25 frame video will lock up (hold stable) on an NTSC receiver provided you can activate a vertical hold control on the TV set. The pictures will flicker just a bit because of the frame difference, but if the TV set you will use has a user-adjustable vertical-hold, it will no longer 'roll' on you. Of course, it will not recover in color since 625 line systems use a different color creation technique (called PAL) but you will hardly notice this as you tune in tomorrow morning's news from Television New Zealand at 4 in the afternoon east coast time.

The sound. Here the designers of the D-100 "Deluxe" version have done a very creative thing. As the TV video and sound (ie. composite signal) passes through their IF for gain and filtering, they couple off energy at the TV sound (sub) carrier frequency, feeding it back to you on an FM (radio) band frequency between 95 and 108 MHz. A cable coming from the D-100 is connected to the antenna input on your FM tuner/receiver, or merely looped around the FM rod antenna of your portable FM receiver. You locate a clear (not in use locally) FM channel between 95 and 108, and slowly adjust a knob on the D-100 until you magically hear the TV sound on your FM receiver. That's it!

Additional Controls

The D-100 is available in standard and "deluxe" versions. Unless you happen to own a

multi-standard TV set capable of resolving +4.5, +5.5 and +6.5 MHz audio (sub) carriers, the "deluxe" version with the FM band sound reproduction is recommended.

Both versions have an RF gain and an IF gain control, a main tuning plus a fine tuning control, switch selectable IF bandwidth. The main tuning knob is calibrated with the TV channel selections of 'the world' to help you know where you are tuning at all times. The literature/instructions provided is brief but concise with many useful bits of information and long distance reception tips. The D-100 is well designed, skillfully built, and pleasant to use. Those are the positives.

There are two negatives for a North American buyer:

1) It is presently only available from a European (English) source (see footnotes; they will ship air parcel post anywhere) and you'll need a VISA card or an English pounds bank draft to acquire one.

2) Standard power supply mains in Europe are nominally 240 volts AC and your home is wired for 110 volts AC. They can supply a 110 volt AC version on request, or you can request 12 VDC and power it yourself.

Solar Activity

The present sunspot cycle (called 'Cycle 22') will produce long distance TV reception as described here through at least the spring of 1993. The next chance for such reception will not return until around 2000 so if this subject intrigues you, the clock is running! ■

**YOU
AIN'T HEARD
NOTHIN...
YET!**

CRB RESEARCH
P.O. Box 56, Commack, NY 11725

Since 1967, CRB Research has been the world's leading publisher and supplier of unique hobby and professional books and information including:

- Scanner Frequency Guides
- Shortwave Frequency Guides
- Military/Federal Communications
- Broadcast Station Registries
- Undercover Communications
- Survival Communications
- Covert Operations
- Electronic Espionage
- Surveillance

CIRCLE 16 ON READER SERVICE CARD

CELLULAR TELEPHONE MODIFICATION HANDBOOK



How are hackers making cellular phone calls for free? Techniques for decoding and changing cellular phones, the "roaming technique", chip supplier's phone numbers, etc. Schematics for most cellular phones, and diagrams to find and change phone numbers on all models.

Complete Manual \$79.95

MO or COD to Spy Supply, Inc., 7 Colby Court, Bedford, NH 03110
(603) 645-6244

Sold for educational purposes only!



What You May See!

Europe: Sweden, Norway, Portugal, Spain, Germany, Czechoslovakia, Hungary, Poland, Latvia, Lithuania, and Russia.

Asia: Russia, China, Malaysia, Thailand.

Middle East: UAR, Iran, Iraq, Saudi Arabia.

Africa: Zimbabwe, Ghana, Kenya, Sierre Leone, Guinea

South Pacific: New Zealand, Australia.

For "pure quality", New Zealand and Australia during mid-February to mid-April will be best for most U.S. enthusiasts although the eastern half of the continent will do very well with European reception in the fall period. With South Pacific reception, the quality is traditionally 'better' (than Europe) because there are fewer TV transmitters on these low channels in these areas, resulting in less interference for you from multiple transmitters.

References/Sources:

1) D-100 Deluxe DX TV Converter: Available only from HS Publications, 7 Epping Close, Derby DE3 4HR England.

2) World Radio TV Handbook, available at leading book and ham radio electronic stores sources.

3) Club of TV DX enthusiasts, publishes monthly newsletter: Worldwide TV-FM DX Association, P.O. Box 514, Buffalo, New York 14025-0514. Request sample bulletin, membership application.



POP'COMM's BOOK BUYER'S GUIDE

(800) 457-7373 8AM-5PM EST CALL TOLL FREE



Shipping and handling: \$4.00 to US and Canadian address via US mail. Shipping via UPS Brown \$5.00 to US address only. No COD orders. UPS Red or Blue cost plus \$5.00 handling. All other orders shipped via US mail F.O.B. Greenville, NH, USA plus a \$5.00 handling charge. Prices subject to change.

KEYS, KEYS, KEYS, by Dave Ingram, K4TWJ
Sending Morse code by hand has become a lost art in this day of keys and computerized code machines. Loaded with pictures, this new book shows just about every key that was ever used - from simple "cootie keys" and miniature spy keys to gold plated presentation models. Also gives you insights on how to collect, restore and use your classic keys. Great for the collector, old timer or newcomer. ©1991.
 CQ-KEY Softbound \$9.95

PROPAGATION HANDBOOK
Principles, Theory, Prediction
by Ted Cohen, N4XX and George Jacobs, W3ASK
Includes a complete explanation of ionospheric propagation principles; what are the D, E and all those F layers and what do they mean, as well as two sections on the Sun and how it affects radio wave propagation. 2nd Edition. 150 pages. ©1991.
 CQ-PH Softbound \$9.95

THE AMATEUR RADIO VERTICAL HANDBOOK
by Cpt. Paul H. Lee, USN (Ret.), N6PL
Based upon the author's years of work with a number of different vertical antenna designs, you'll get plenty of theory and design information along with a number of practical construction ideas. Included are designs for simple 1/4 and 5/8 wave antennas, as well as broadband and multi-element directional antennas. ©1984, 2nd edition.
 CQ-VAH Softbound \$9.95

PRACTICAL ANTENNA HANDBOOK
by Joe Carr, K4IPV
A comprehensive blend of theory and practical antenna applications make this book by noted author Carr, a valuable book to have on hand. Features detailed analysis and construction information for all kinds of antennas, an explanation of the secrets of radio propagation, theory and use of transmission lines, a comprehensive overview of the radio spectrum as well as 22 BASIC programs for designing antennas. Learn from an expert - get this book today. ©1990 1st edition 448 pages.
 T-3270 Softbound \$21.95

THE WORLD IS YOURS 3rd Edition by Sam Alcorn
This is one of the best beginner's books on SWL'ing we carry! No techno-jargon or incomprehensible babble to confuse the newcomer. Begins with a complete overview of what is available in the international broadcasting world. Lists the twenty most popular stations and gives you a full explanation of their programming. Simplified band by band listening guide and local time to UCT found anywhere. ©1991 Third Edition 80 pages
 GL-WIY Softbound \$9.95

1991 ANTENNA BUYER'S GUIDE
Looking for the latest in antennas? It's all here in the CQ Antenna Buyer's Guide. Crammed full of articles, product information and a who's who section listing all of the manufacturers and importers. Get your's now and start planning for antenna projects. ©1991
 CQ-ANT91 Softbound \$4.95

1992 EQUIPMENT BUYER'S GUIDE
Fully up-to-date. Complete listing of equipment available from the various equipment and accessory manufacturers. Includes radios and accessories plus helpful hints and tips and a complete listing of addresses and telephone numbers. ©1991
 CQ-EQP92 Softbound \$4.95

PACKET USER'S NOTEBOOK
by Buck Rogers, K4ABT
Written with the beginner in mind, the Packet Notebook is full of handy tips, hints and suggestions on how to get the most out of your packet system. Includes a brief history, a how to get started section, standards, flow control and information on radio to TNC to computer interconnections for just about every radio. ©1989. 1st edition. 132 pages.
 CQ-PKT Softbound \$9.95

NO-CODE TECHNICIAN PACKAGE
MS-DOS study disk included
Computer generated instructional book from the folks at W5YI. Contains all the questions for the Novice, element 2 and Technician, element 3A, exam with clear explanations and correct answers. Also includes illustrated 200 page Ham Radio Handbook by Don Stoner and FCC Part 97 Rules and Regulations. No prior knowledge of electronics is necessary with this complete, easy-to-use study guide. ©1991
 FHC-NCT (MS-DOS 5.25" disk only) \$21.95

At Last!

JPS now offers two interference reduction products using Digital Signal Processor technology:

Use our new NF-60 to knock out all heterodynes and tune-ups.

The NF-60 is an automatic DSP audio notch filter that connects to the audio output of your receiver or transceiver and includes a built-in speaker amp. It automatically removes tones which last longer than a few milliseconds, so it knocks out Tune-Ups, CW and RTTY. And it isn't limited to removing just one tone as are conventional notch filters.



JPS' new NF-60 Notch Filter.

Use our NIR-10 if you're troubled by more than just heterodynes.

The NIR-10 is a Noise/QRM Reducer for SSB VOICE. This unique device contains white noise reduction, variable bandpass filtering and automatic notch modes. It reduces noise and removes heterodynes occurring in the presence of speech. Real-Time Digital Signal Processing (DSP) using a 40 MHz DSP chip makes this possible.

NF-60 Introductory Price: \$149.95.

For 115VAC to 12VDC Adapter add \$12. Charge to MasterCard or Visa. Allow 1 week for personal checks. COD additional. We pay surface shipping in the Continental United States. NC residents add 6% sales tax.

NIR-10: Still \$395.



JPS Communications, Inc.
P.O. Box 97757 Raleigh, NC 27624

TOLL FREE ORDER LINE 1-800-533-3819
Technical Info 1-919-790-1048 FAX 1-919-790-1456

CIRCLE 133 ON READER SERVICE CARD

27 MHz COMMUNICATIONS ACTIVITIES

High on the list of things readers ask about is GMRS, which at one time used to be known as the Class A CB Radio Service. In some ways it's like 27 MHz CB, at least in that it's a personal two-way radio service. But you need an FCC license, it uses FM, and repeaters that operate on 462 MHz. Many REACT teams make use of GMRS for their own internal communications and dispatching.

Any individual can easily obtain a GMRS license, and the band has become popular with hunters, golfers, hikers, campers, boaters, sportsmen, as well as many business people. Owners of handhelds and mobile units are permitted to work through repeaters belonging to others so long as they have the permission of those operators.

We recently got a look at a new GMRS handheld transceiver and thought you'd like to know about the unit. It is the Maxon GMRS-21, a two-channel set that weighs 12 oz. and puts out 1-watt. The UHF band assigned to the GMRS gives this transceiver a range of up to about three miles, allowing the signals good penetration of steel and concrete structures.

You get about eight hours of operation out of a single battery charge, and the charging unit is supplied with this transceiver. The necessary FCC license application is packed in with each set. The MSRP for the Maxon GMRS-21 is \$249.95.

Further information can be obtained from Maxon Systems Inc., 8610 N.W. 107th Terrace, Kansas City, MO 64153, or circle 101 on our Readers' Service.

Friends Heard From

We received a letter and QSL's from our friends Michael, 46AT102, and Adelheid, 46AT111, of Berlin. Germany, who used to live on the east side of the wall before it was torn down. They told me that political changes in eastern Europe have put many new CB'ers on the air from Poland, Hungary, Russia, and elsewhere. These stations are using a wide assortment of frequencies, modes, and all sorts of power.

Michael and Adelheid can be reached at P.O. Box 884, 1064 Berlin-East, Germany. Tony Malec, from Mansfield, OH writes



Maxon's GMRS-21 handheld operates in the 460 MHz version of the CB band.

Adelheid, 46AT111, tells us she likes finally getting on the air after the imposed silence "behind the wall" all those years!

Michael, 46AT102, of Berlin, sent along his new QSL card.

GRUPPO RADIO ITALIA
ALFA TANGO
INTERNATIONAL DX GROUP
DIVISION: GERMANY
46AT102
OP. MICHAEL
P.O. BOX 884
1064 BERLIN EAST

Berlin
In the heart of Europe

-Calling all over the world-

The final courtesy of QSO/DX is a QSL
La cortesia final del QSO/DX es la QSL

Only radio operators with ascertained DX'er qualification can belong to this Group.

GRUPPO RADIO ITALIA
ALFA TANGO
INTERNATIONAL DX GROUP
Division GERMANY - Special Berlin-QSL

46AT111
OP. ADELHEID
P.O. BOX 884
1064 BERLIN EAST

Berlin
In the heart of Europe

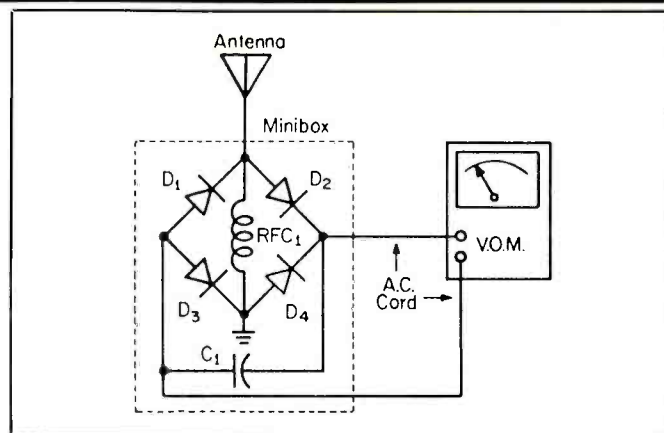
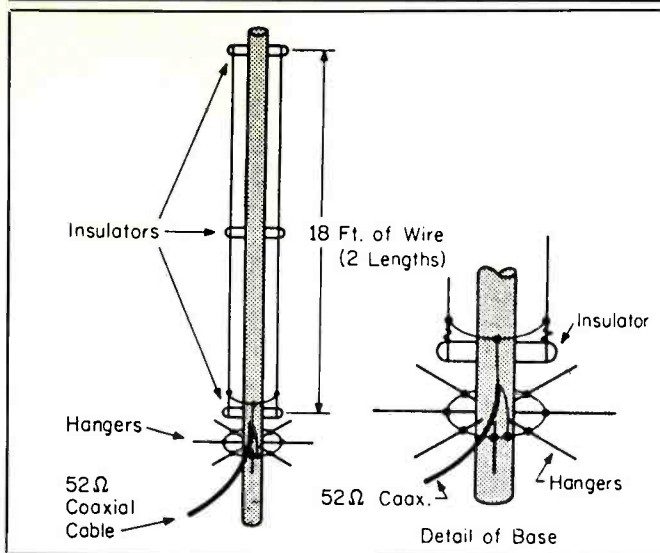

This simple RF meter has many uses around the shack.

Hang out your signal on this homebrewed coathanger antenna!

that at different hours (but especially around dusk) the CB channels seem to load up with Spanish language CB conversations, which he assumes are arriving at his location from points beyond North America. He wonders if these are from Mexico, or if we can tell him from where since he is now quite curious.

No way of knowing for certain, Tony. There are many nations in the Caribbean, Central America, and South America where Spanish is spoken. Local band conditions in your area at different times of the year could

be bringing in signals from any of these nations, including Mexico. It's a fact of life on 27 MHz. If you can pick out a couple of the stronger signals to monitor, you may be able to catch the operators mentioning their locations—even if you don't speak the language.

I'd also like to mention that there is absolutely no shortage of Spanish language CB'ing from the USA, itself. Don't forget that in some areas of the USA, Spanish is the primary or secondary language of local residents.

REACT has even prepared a new plain-language Spanish edition of the FCC's CB regulations in order to accommodate American CB'ers who speak Spanish. Copies are \$2 each from: "Spanish CB Rules," REACT International, Inc., P.O. Box 998, Wichita, KS 67201.

A Quick Look Back

Few will recall the Kaar Model TR-327 "D-Phone," which was briefly on the scene in

Improve Your Scanning Coverage!

GRE America is proud to introduce a new family of products to enhance your scanning pleasure! First, GRE has designed the new **Super Converter 9001** for base model scanners. The 9001 converts 810 MHz - 950 MHz down to 410 MHz - 550 MHz. The 9001 is the perfect alternative to buying a new, expensive scanner covering the 800 MHz band. Next, GRE announces the new **Super Amplifier 3001** for base model scanners. The 3001 will increase gain by as much as 20 dB, and is engineered to help scanners with low sensitivity pull in weak signals. Both products use BNC connectors, (1) 9 volt battery and have an off/pass switch for returning to normal operation.

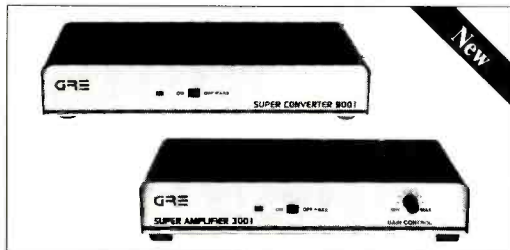

Super Converter 9001 & Super Amplifier 3001



Super Converter II



Super Amplifier

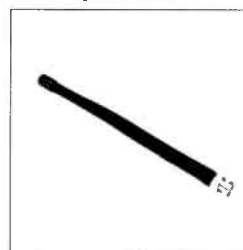

All-Band Antenna

U.S. & International Distributorship inquiries welcome. Please call GRE for further information!

Let GRE Manufacture Your Radio Products!

GRE America, Inc. is a leading OEM developer and manufacturer of radio telecommunications products such as:

- Cordless Telephones
- CB & Marine Radios
- Spread Spectrum "engines"
- Remote Monitoring Systems

If you need a high quality, cost competitive, reliable manufacturer, GRE will provide you with a free production quotation.

For more information, please call GRE at (800) 233-5973. GRE is a subsidiary of General Research of Electronics, Inc.

GRE GRE America, Inc.

GRE America, Inc.
425 Harbor Blvd., Belmont, California 94002
(415) 591-1400 Outside California: (800) 233-5973

YOU AIN'T HEARD NOTHIN...YET!

THE "TOP SECRET" REGISTRY OF U.S. GOVERNMENT RADIO FREQUENCIES

25 TO 470 MHZ
BY TOM KNEITEL, K2AFS

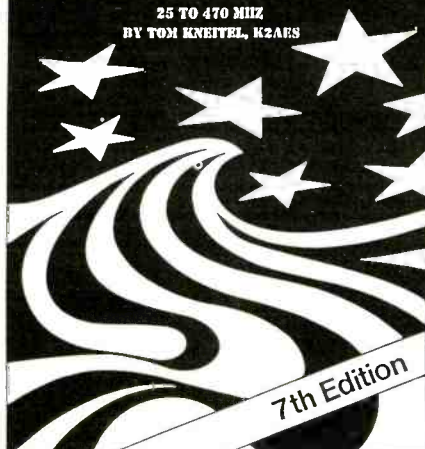

7th Edition

Since 1967, CRB Research has been the world's leading publisher and supplier of unique hobby and professional books and information including:

- Scanner Frequency Guides
- Shortwave Frequency Guides
- Military/Federal Communications
- Broadcast Station Registries
- Undercover Communications
- Survival Communications
- Covert Operations
- Electronic Espionage
- Surveillance
- Monitoring
- Cryptography & Codes
- Bugging
- Wiretapping
- Communications Antennas
- Electronics & Projects
- Computer Technology
- & Other Related Topics!

Ask For Big Free Catalog!

New titles are constantly being added to our exciting catalog. If it's interesting and unusual, we've got it. You'll see! Ask for our latest FREE catalog.

CRB RESEARCH

P.O. Box 56 Commack, NY 11725

CIRCLE 16 ON READER SERVICE CARD

1962. This was made by Kaar Engineering, Palo Alto, CA, a fine company that produced high caliber industrial two-way communications equipment, and decided to enter the CB market.

The TR-327 had four crystal controlled channels. A TR-327B version (shown in our photo) also had a tunable 23-channel receiver. A TR-327A version included the AM broadcast band.

Basically, the TR-327 had an 8-tube dual-conversion receiver with an RF stage and an ANL. The transmitter had 2 tubes with a 6AQ5 final. The front panel meter showed received signal strength and relative transmitter output. The rear deck had metering jacks for testing its various circuits. It could operate from 6VDC, 12VDC, and 117VAC. The basic TR-327 cost \$179, with the two deluxe versions pegged at \$199 each.

Kaar ran into some unfortunate and nagging problems with the FCC that prevented the company from being able to adequately continue marketing its excellent equipment.

Coat Hanger Antenna

Many people are hung up on antennas, and reader Paul Vossey, SSB-377D, of AL even designed an antenna using metal coat hangers. We admit that we can't figure out the theory behind this oddball home-brew skyhook, but Paul insists that he gets reliable 30 mile contacts out of the thing from his poor location. He suggests it as a "poor man's base station antenna, or a temporary antenna rich men."

The main feature of this antenna is a wooden pole 20 feet long. The lower two feet of its length are for mounting purposes. The pole can be painted or varnished for protective purposes.

As shown in the illustration, two 18 ft. lengths of wire run downwards from the top of the pole and are held away from the pole by insulators.

Eighteen feet down from the top, where the wires end, drill 8 or 10 small holes evenly spaced around the pole. Straighten out some metal coat hangers and fit one snugly into each of the drilled holes.

The 52-ohm coaxial cable used to feed the antenna is attached as follows: center conductor soldered to each of the 18-ft. wires; shielded braid connected to all coat hangers. Remember to scrape any paint off the coat hangers at the solder points before making your connections.

We haven't built one of these ourselves, but we suspect that it could develop a bit of a high SWR. We think it might be interesting to see how it would work with the 18-ft. wires reduced to 13.5 ft. in an effort to cut the SWR and improve the efficiency of the antenna. Ultimately, an antenna matcher might also help, too.

Sensitive RF Meter

Here's a meter that let's you know for sure that your rig is actually radiating a signal. Once you know the normal level your transmitter reads, then you'll always know if some-



The Kaar "D-Phone" had a good reputation in 1962, but its manufacturer ran into some FCC problems and stopped production before it got well-known.

thing is wrong and your signal has started to drop off.

A sensitive meter is shown in the diagram. Two binding posts are provided for attaching the two-conductor line that connects to the indicating meter. Ordinary AC zip-cord or TV twin-lead can be used. The indicating meter can be a VOM set to one of its sensitive control scales, or a 0-1 milliammeter. In the later case, a potentiometer may be used to control the sensitivity of the instrument, preventing the meter from pinning over with strong signal pick-up.

The entire unit can be constructed in a small metal box. For most applications, a base-loaded telescoping antenna may be used. You might even want to mount the antenna on your roof a couple of feet away from your CB antenna.

If a permanent weather-proofed installation is made, the whole unit can be mounted on your roof, with the VOM remotized right at your operating position in the shack. When your transmitter is modulated properly, there will be an upward kick of the meter as you speak. You will also immediately know that a sharp drop in your usual reading means there's trouble somewhere in your rig or antenna system.

If you have a rotatable beam antenna, this will also be useful in checking out the antenna. If the device is located at a fixed spot and the beam is rotated, you should be able to get an idea of your directional lobes and front-to-back performance.

Located on the service bench, it is useful for peaking and tuning transmitters.

Diodes D1, D2, D3, and D4 are 1N34 types. You can substitute other crystal diode types, including 1N34A or 1N38B. C1 is a 240 pfd. mica capacitor. RFC1 is a Miller RFC-50 or any equivalent choke with a range between about 25 and 110 MHz.

With a bit of imagination, you should be able to find a dozen uses for this around the shack.

Good wishes for a happy 1992, and we hope you come up on channel here next month. In the mean time, pass along your QSL, or any interesting DX QSL's (good copies are OK), questions, opinions, newspaper clippings, and anything related to CB radio.

COMMUNICATIONS ELECTRONICS INC.

Emergency Operations Center

has expanded to our new two acre facility and World Headquarters. Because of our growth, CEI is now your one stop source for emergency response equipment. When you have a command, control or communications need, essential emergency supplies can be rushed to you by CEI. As always, for over twenty three years, we're ready, willing and able to help. For 1992, we're introducing new products from Uniden, Shinwa, ICOM, Ranger Communications Inc., Grundig, Sangean, Magnavox and RELM.

NEW! Shinwa SR001-B

List price \$799.95/CE price \$479.95/SPECIAL Continuous coverage from 25,000 through 999,995 MHz. If you're looking for an excellent synthesized scanner designed for mobile surveillance use, the new Shinwa SR001 scanner offers features never before offered at such a low price. When you purchase the wide band scanner from CEI, you'll get a free infrared wireless remote control that allows you to control your scanner from over 20 feet away. Selectable frequency steps of 5.0/10.0/12.5/20.0/25.0/50.0 or 100.0 KHz. are available. Dual antenna inputs terminating in an "N-type" and "BNC" connectors are included. Other features include 200 memory channels grouped in 10 banks of 20 channels, easy to read multi color LCD display, lithium battery for memory back-up, 35 channel per second high speed scanning, priority, timer and even an alarm to alert you to transmissions on your choice of one special frequency. We even include a mobile mounting bracket. The SR001 can be used for base station use with the purchase of the ACS-B 12 volt DC power supply for only \$34.95 each. A great sounding external speaker #SPE-B is available for only \$24.95.

SHINWA POCKET PAGERS

The fire department hazardous materials response teams and police department SWAT crews who need a reliable radio alerting system stake their lives on Shinwa. We offer a two-tone pocket pager with monitor feature and even a voice storage option at an affordable price. To order, we need your paging frequency as well as tone and frequencies. For other configurations or two-way radio information, please fax us your specifications to 313-663-8888 or phone 313-996-8888.

ICOM ICR1-B

List price \$799.95/CE price \$529.95/SPECIAL Continuous coverage from 100 kHz through 1,300 GHz. The ICOM ICR1 keeps you in touch with the world when you're on the go. The palm-size ICR1 is equipped with AM, FM and wide-FM modes to fully answer your monitoring needs. With 100 memory channels and a dual frequency selection system, you get a top-class communications receiver. Not only can you program scan searches only for signals within a specified frequency range, it's also possible to write frequencies of received stations automatically into memory. In addition, unwanted frequencies can be skipped. Order ICBC72-B battery rapid charger for \$99.95 and a BP84 1,000ma. battery pack for \$74.95.

ICOM ICR100-B

List price \$799.95/CE price \$579.95/SPECIAL Continuous coverage from 100 kHz through 1856 MHz. Now you can bring a wider world of broadcasting, VHF air and marine bands, emergency services and many more communications into your vehicle. Icom's advanced ICR100 fully covers all the stations worth hearing with up to 100 memory channels and a multitude of features.

SCANNERS/CB/RADAR UNIDEN

PRO310E-B Uniden 40 Ch. Portable/Mobile CB	\$72.95
PRO330E-B Uniden 40 Ch. Remote mount CB	\$99.95
GRANT-B Uniden 40 channel SSB CB mobile	\$152.95
WASHINGTON-B Uniden 40 Ch. SSB CB base	\$229.95
PC122-B Uniden 40 channel SSB CB mobile	\$113.95
PC66A-B Uniden 40 channel CB Mobile	\$78.95
PRO510XL-B Uniden 40 channel CB Mobile	\$39.95
PRO520XL-B Uniden 40 channel CB Mobile	\$54.95
PRO535E-B Uniden 40 channel CB Mobile	\$69.95
PRO538W-B Uniden 40 ch. weather CB Mobile	\$78.95
PRO810E-B Uniden 40 channel SSB CB Base	\$174.95

UNIDEN RADAR DETECTORS

RD3000ZX-B Uniden 3 band suction mount radar	\$129.95
RD2400ZX-B Uniden 3 band radar detector	\$109.95
RD80-B Uniden 2 band radar detector	\$64.95
CARD-B 3 band credit card size radar detector	\$99.95
RD3XL-B Uniden 3 band radar detector	\$109.95
RD9XL-B Uniden "micro" size radar detector	\$69.95
RD27-B Uniden visor mount radar detector	\$39.95



19 PLUS-B Cobra CB radio	\$36.95
18RV-B Cobra CB radio	\$54.95
41PLUS-B Cobra CB radio	\$72.95
70LTD-B Cobra remote mount CB radio	\$99.95
19LTD-B Cobra Classic series CB radio	\$44.95
21LTD-B Cobra Classic series CB radio	\$54.95
25LTD-B Cobra Classic series CB radio	\$89.95
29LTD-B Cobra Classic series CB radio	\$109.95
146GTL-B Cobra AM/SSB CB radio	\$129.95
148GTL-B Cobra AM/SSB CB radio	\$149.95
90LTD-B Cobra Base station	\$89.95
142GTL-B Cobra AM/SSB Base station	\$199.95
2000GTL-B Cobra Deluxe AM/SSB Base station	\$379.95

COBRA RADAR DETECTORS

RD3163-B Cobra 3 band radar detector	\$109.95
RD3175-B Cobra 3 band radar detector	\$129.95
RD3173-B Cobra 3 band radar detector	\$139.95
RD3183-B Cobra 3 band radar detector	\$139.95

Bearcat 200XL-B

List price \$509.95/CE price \$239.95/SPECIAL 12 Band, 200 Channel, Handheld, Search, Limit, Hold, Priority, Lockout Frequency range: 29-54, 118-174, 406-512, 806-956 MHz.

Excludes 823,9875-849,0125 and 868,9875-894,0125 MHz. The Bearcat 200XL sets a new standard for handheld scanners in performance and dependability. This full featured unit has 200 programmable channels with 10 scanning banks and 12 band coverage. If you want a very similar model without the 800 MHz. band and 100 channels, order the BC100XL-B for only \$179.95. Includes antenna, carrying case belt loop, ni-cad battery pack, AC adapter and earphone. Order your scanner from CEI today.

Bearcat 800XL-B

List price \$549.95/CE price \$239.95/SPECIAL 12-band, 40 Channel, Nothing excluded in the 800 MHz. band. Bands: 29-54, 116-174, 406-512, 806-956 Mhz. If you do not need the 800 MHz. band, order the Bearcat 210XL-B for only \$178.95.

Magnavox® Satellite Phone

CE price \$48,880.00/Special order - allow 45 days for delivery. When war broke out in Iraq, you heard all the action because CNN had a satellite telephone. When a disaster such as an earthquake or a hurricane strikes your community and communications are disrupted, you can depend on instant reliable communications, just like CNN did using your Magnavox MagnaPhone. Inmarsat communication satellites are in geostationary orbit along the equator. They beam two-way voice and data transmissions between your satellite phone and fixed earth stations. In most instances, telephone calls are dialed directly once you have selected the satellite serving your location. No matter where you are on the planet, the MagnaPhone automatically selects the Land Earth Station (LES) nearest the destination called. This makes placing a call as easy as using a standard telephone. Dual ID numbers permit a separate Inmarsat telephone number to be used to route calls to one of the external telephone ports which could be used for a fax machine or a computer data line. For telephone, telex, fax and data communications anywhere in the world, the new MX2020P MagnaPhone is the most compact Inmarsat-A, Class 1 terminal available today. Like a cellular phone, airtime will be billed to your account. The new MagnaPhone weighs just 47 lbs (21 kg), including the antenna. Add the optional ruggedized case (only \$950.00) and it can travel as airline baggage on commercial carriers. When you arrive at your destination, installation can be done in less than 5 minutes. For more information call our Emergency Operations Center at 313-996-8888.

CIRCLE 10 ON READER SERVICE CARD

RELM UC202-B 2 Watt transceiver on 154.57 MHz	\$114.95
RELM RH256NB-B 25 Watt VHF transceiver	\$299.95
RC12950-B Ranger Comm. 25 Watt 10 Meter xcevr.	\$229.95
MR8100-B Uniden surveillance scanner .CALL FOR PRICE	
BC55XL-B Bearcat 10 channel scanner	\$114.95
AD100-B Plug in lighter charger for BC55XL	14.95
PS001-B Cigarette wall charger for BC55XL	14.95
VC001-B Carrying case for BC55XL	14.95
BC70XL-B Bearcat 20 channel scanner	\$159.95
BP70-B Ni-Cad battery pack for BC70XL scanner ..	\$39.95
BC142XL-B Bearcat 10 channel 10 band scanner ..	\$84.95
BC147XL-B Bearcat 16 channel 10 band scanner ..	\$94.95
BC172XL-B Bearcat 20 channel 11 band scanner ..	\$124.95
BC177XL-B Bearcat 16 channel 11 band scanner ..	\$129.95
BC590XL-T-B Bearcat 100 channel 11 band scanner	\$194.95
BC760XL-T-B Bearcat 100 channel 12 band scanner	\$254.95
BC002-B CTCSS tone board for BC590/760XL	\$54.95
BC003-B Switch assembly for BC590/760XL	\$22.95
BC855XL-T-B Bearcat 50 channel 12 band scanner ..	\$199.95
BC560XL-T-B Bearcat 16 channel 10 band scanner ..	\$94.95
BP205-B Ni-Cad battery pack for BC200/100XL	\$39.95
TRAVELLER2-B Grundig shortwave receiver	\$84.95
COSMOPOLIT-B Grundig shortwave receiver	\$179.95
SATELLIT500-B Grundig shortwave receiver	\$499.95
SATELLIT650-B Grundig shortwave receiver	\$849.95
ATS800-B Sangean shortwave receiver	\$89.95
ATS803-B Sangean shortwave receiver	\$159.95
74102-B Midland emergency weather receiver	\$34.95
77116-B Midland CB with VHF weather & antenna ..	\$66.95
77118-B Midland CB mobile with VHF weather	\$62.95
77913-B Midland CB portable with VHF weather	\$79.95
76300-B Midland CB base station	\$92.95
NPD-B Uniden National Police Directory	\$19.95
FBE-B Frequency Directory for Eastern U.S.A.	\$14.95
FBW-B Frequency Directory for Western U.S.A.	\$14.95
RFD1-B MI, IL, IN, KY, OH, WI Frequency Directory ..	\$14.95
RFD2-B CT, ME, MA, NH, RI, VT Directory	\$14.95
RFD3-B DE, DC, MD, NJ, NY, PA, VA, WV Directory ..	\$14.95
RFD4 AL, AR, FL, GA, LA, MS, NC, PR, SC, TN, VI ..	\$14.95
RFD5 AK, ID, IA, MN, MT, NE, ND, OR, SD, WA, WY	\$14.95
RFD6 CA, NV, UT, AZ, HI, GU Frequency Directory ..	\$14.95
RFD7-B CO, KS, MO, NM, OK, TX Freq. Directory ..	\$14.95
PWB-B Passport to World Band Radio	\$16.95
ASD-B Airplane Scanner Directory	\$14.95
TSG-B "Top Secret" Registry of U.S. Govt. Freq.	\$16.95
TTC-B Tune in on Telephone Calls	\$14.95
CBH-B Big CB Handbook/AM/FM/Freeband	\$14.95
TIC-B Techniques for Intercepting Communications ..	\$14.95
EEC-B Embassy & Espionage Communications	\$14.95
SMHV1-B Scanner Modification Handbook/Volume 1 ..	\$18.95
SMHV2-B Scanner Modification Handbook/Volume 2 ..	\$18.95
LIN-B Latest Intelligence by James E. Tunnell	\$17.95
A60-B Magnet mount mobile scanner antenna	\$39.95
A70-B Base station scanner antenna	\$39.95
USAMM-B Mag mount VHF ant. w/ 12' cable	\$39.95
USAK-B 3/4" hole mount VHF antenna w/ 12' cable ..	\$34.95

Add \$5.00 shipping for all accessories ordered at the same time. Add \$15.00 shipping per radio and \$6.00 per antenna.

BUY WITH CONFIDENCE

Michigan residents please add 4% sales tax or supply your tax I.D. number. Written purchase orders are accepted from approved government agencies and most well rated firms at a 10% surcharge for net 10 billing. All sales are subject to availability, acceptance and verification. Prices, terms and specifications are subject to change without notice. All prices are in U.S. dollars. Out of stock items will be placed on backorder automatically or equivalent product substituted unless CEI is instructed differently. Shipments are F.O.B. CEI warehouse in Ann Arbor, Michigan. No COD's. Not responsible for typographical errors.

Mail orders to: Communications Electronics, Box 1045, Ann Arbor, Michigan 48106 U.S.A. Add \$15.00 per radio for U. P.S. ground shipping and handling in the continental U.S.A. For Canada, Puerto Rico, Hawaii, Alaska, or APO/ FPO delivery, shipping charges are two times continental U.S. rates. If you have a Discover, Visa, American Express or MasterCard, you may call and place a credit card order. 5% surcharge for billing to American Express. For credit card orders, call toll-free in the U.S. Dial 800-USA-SCAN. For information call 313-996-8888 FAX anytime, dial 313-663-8888. Order from Communications Electronics today. Scanner Distribution Center™ and CEI logos are trademarks of Communications Electronics Inc. Sale dates 11/1/91 through 4/30/92 AD #101691-B Copyright © 1991 Communications Electronics Inc.

For more information call 1-313-996-8888

Communications Electronics Inc.
Emergency Operations Center
P.O. Box 1045, Ann Arbor, Michigan 48106-1045 U.S.A.
For orders call 313-996-8888 or FAX 313-663-8888

“Sweet Spots” And Other Propagation Oddities

It's easy to fall into the trap of thinking that we've discovered basically everything there is to know about the shortwave frequencies from 1600 to 30,000 kHz. After all, these have been heavily used for decades, and we understand everything there is to know about how a signal gets from point A to point B, right?

Wrong! In the past couple of years, evidence has been developed showing that the magic time for best DX is not necessarily at sunrise or sunset, but instead involves one end of a reception path being in either sunrise or sunset while the other end is, believe it or not, around 9:00 p.m. local standard time! This magic hour of about 9:00 p.m. at either the receiver or transmitter site is becoming known as the sweet spot, and some really spectacular DX is being heard by DX'ers who are mastering it. (And a special notice to my fellow ham radio operators—this technique also works for two-way communications!)

The sweet spot effect is most pronounced on frequencies below 5 MHz during the winter. There's a lot more still to be learned about how this propagation method works, but it's clear something remarkable is happening in the ionosphere. And the best part is that this effect wasn't discovered in some taxpayer-funded research center or high-level corporate engineering lab. Instead, a group of energetic, curious, and very smart SWL's deserve the credit!

Things Get Heard When They Shouldn't

Most of the work in discovering the sweet spot effect was done by shortwave DX'ers associated with the *Fine Tuning* group. *Fine Tuning* is the name of a newsletter published weekly during the fall and winter DX season; most of the top shortwave DX'ers in North America participate. They are knowledgeable about propagation theory, and by sharing their loggings and comparing notes, they began to notice something curious: peak reception of some signals were taking place at times when they shouldn't, and at times when peak reception was supposed to be happening, it wasn't!

One of the most curious phenomena involved reception of tropical band broadcast stations (those operating on frequencies below 5060 kHz) located in the tropics. Such stations include some of the rarest DX of all, so it's no surprise that top DX'ers focus a lot of their time and energy on them. Conventional propagation theory holds that the best time for reception at such frequencies is along the *gray line*. The gray line is the termi-

VNG
LLANDILO NEW SOUTH WALES AUSTRALIA
<i>Harry L. Helms AA6FW</i>
Your reception report of station VNG
of <i>4 July 1991</i> at <i>0613</i> UTC
on <i>8.638</i> MHz
is confirmed with thanks.
<i>Marion Leiba VK1VNG, VK1BNG</i>
for VNG Users Consortium

nator between night and day running across the globe. When it's sunset at your location, it's sunrise someplace else (and, of course, the reverse it also true). Supposedly, reception below 10 MHz or so is best when you're in sunrise or sunset and the station you're trying to hear is experiencing the opposite.

So far, so good. A lot of DX'ers (including this one) accepted the theory as gospel. But when the *Fine Tuning* DX'ers began to compile their receptions, they noted something funny. It was true the DX'ers along the east coast of North America frequently had best reception of tropical band stations from Indonesia, Papua and New Guinea, and India around local sunrise. But DX'ers along the west coast noticed something peculiar: for them, best reception was sometimes three hours before local sunrise! While such stations could still be heard at west coast sunrise (provided, of course, that they hadn't signed off the air), the peak signal strength usually happened a few hours earlier.

More receptions were analyzed and it soon became clear that peak reception of many stations in the tropical broadcasting bands didn't depend on the gray line at all. To be sure, there were some cases where enhanced reception happened when the transmitter and receiver sites were in the gray line. But most receptions didn't. Something unusual was definitely going on!

The DX Comes Out At 9 P.M.

Two *Fine Tuning* participants named John Bryant and David Clark did the bulk of researching tropical band DX reported in the *Fine Tuning* newsletter and analyzing it. After plotting the locations of transmitters and receivers for various receptions, they came up with a startling observation:

As long as the time at your listening site is

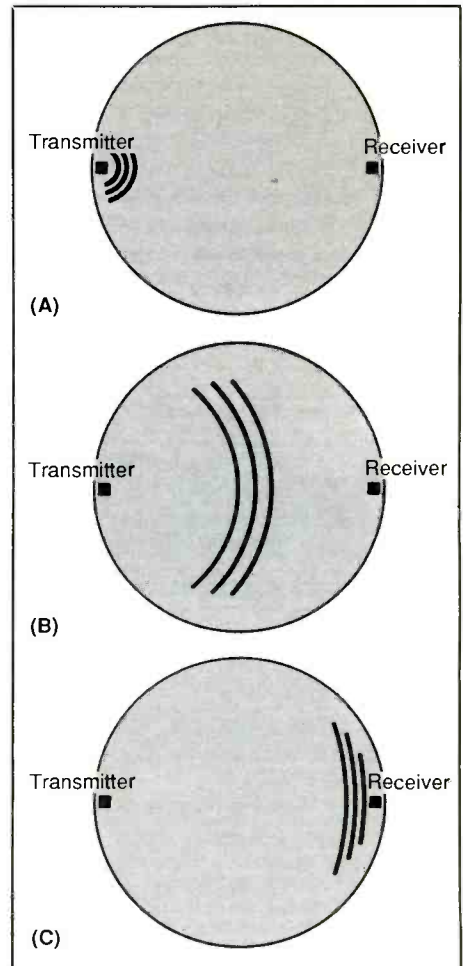

Figure 1

dawn or earlier, the peak reception of tropical band stations located to the west of you happens at 9 p.m. local standard time at the station's transmitter site.

That 9 p.m. period at the station's transmitter site is the sweet spot.

Now things are a little more complicated than we've just described. The sweet spot is centered on 9 p.m. local standard (not daylight savings!) time at the station, and that is when most peak receptions are reported. However, the actual period of peak reception can take place anywhere from 8 p.m. to 10 p.m. local time at the station. The sweet spot isn't the same all year. During winter in the northern hemisphere, the sweet spot "arrives" earlier at the transmitter (that is, before 9 p.m. local time) for stations located north of the equator while it arrives later (after 9 p.m. local time) for stations located south of the equator. During the northern hemisphere summer, this pattern is reversed. But by and

large the pattern holds—tune for tropical band stations located to the west of you when it's 9 p.m. their local time, and odds are that when you'll hear them best, if at all.

Is This On The Level???

I must admit I was more than a little skeptical when I first read the Bryant and Clark report about the sweet spot. It was so contrary to everything I had been taught and believed. But after examining some of my better Asian and Indian tropical band station receptions, including my east and west coast loggings, and computing the local time at the transmitter site, I noticed the same pattern! Something definitely weird happens when you're in darkness and it's 9 p.m. at the station to the west of you!

Since I'm an all-band DX'er, I was curious if the sweet spot phenomenon also worked on the AM broadcast band. I went back and checked my logs from the mid-1970s when I DX'ed the AM band from the east coast. My best catch to the east back then was the station at Istanbul, Turkey, then operating on 1016 kHz. That frequency was normally dominated by a German station operating all night. When I heard the station, it was the result of several nights of trying until one evening when it abruptly surfaced above the German station, dominated the channel for about 20 minutes, and then faded away. I noticed that the time of my reception was centered around 9:00 p.m. EST. Wait a second . . .

I did a little computation with the aid of my trusty "DX Edge" sunrise/sunset determination tool, and . . . sonofagun! My reception took place roughly 20 minutes before sunrise at Istanbul!

Back then, there were several channels that were clear on Monday mornings, and Hawaiian stations on 650, 830 and 1040 kHz would often make it to the east coast. Looking back on my logs from that period, I noticed that best reception more often than not would center around 9 p.m. Hawaiian time.

You had better believe that I'm going to spend a lot of time this DX season at the dials around 9 p.m. PST!

More Weird Stuff

The *Fine Tuning* gang has come up with another couple of corks. One is called *spherical convergence*, which is a fancy way of saying there's plenty of evidence that the received strength of a signal gets weaker the farther you are from a station, until you're more than 6,250 miles away—at that point, the signal starts getting stronger, and gets stronger the farther away you are!

How can this happen? Take a look at figure 1. As the signal moves away from the transmitter, it "spreads out" and gets weaker. At the equator, the signal is most spread out and is weakest. But look what happens as the signal crosses the equator. The signal is spread across a gradually shrinking area and becomes "compacted" into a smaller area.

The *Fine Tuning* gang has also compiled evidence that shows the conventional "multi-hop" method of propagation may not always be applicable to DX reception. In some cases, a DX signal may not be refracted off the ionosphere; instead, it seems that the ionosphere may actually *conduct* signals in a "single-hop" method of propagation.

Read For Yourself

I've only scratched the surface of the things the *Fine Tuning* gang has come up with. While a lot of their findings must still be labelled as preliminary at this point, it's apparent they are onto something big here, and I wouldn't be at all surprised if a lot of propagation texts are going to have to be extensively rewritten over the next few years.

This summary really doesn't do justice to the research, and if you're interested in this subject I suggest that you obtain the original reports by John Bryant and David Clark. These were published in the 1990 and 1991 editions of *Fine Tuning Proceedings*. For prices and ordering information, send a self-addressed stamped envelope to Fine Tuning Special Publications, c/o John Bryant, Route 5 Box 14, Stillwater, OK 74074. For a sample copy of the *Fine Tuning* newsletter, send a dollar to Mitch Sams, 779 Galilea Ct., Blue Springs, MO 64014.

You've got to excuse me now. It's getting near 9 p.m., the sunrise terminator is crossing Africa, and I'm going after some DX!

ICOM's IC-R9000 The Best Of Both Worlds

The pacesetter IC-R9000 truly reflects ICOM's long-term commitment to excellence. This single-cabinet receiver covers both local area VHF/UHF and worldwide MF/HF bands. It's a natural first choice for elaborate communications centers, professional service facilities and serious home setups alike. Test-tune ICOM's IC-R9000 and experience a totally new dimension in top-of-the-line receiver performance!

Complete Communications Receiver. Covers 100kHz to 1999.8MHz, all modes, all frequencies! The general coverage IC-R9000 receiver uses 11 separate bandpass filters in the 100kHz to 30MHz range and precise-tuned bandpass filters with low noise GaAsFETs in VHF and upper frequency bands. Exceptionally high sensitivity, intermod immunity and frequency stability in all ranges.

Multi-Function Five Inch CRT. Displays frequencies, modes, memory contents,

operator-entered notes and function menus. Features a subdisplay area for printed modes such as RTTY, SITOR and PACKET (external T.U. required).

Spectrum Scope. Indicates all signal activities within a +/-25, 50 or 100kHz range of your tuned frequency. It's ideal for spotting random signals that pass unnoticed with ordinary monitoring receivers.

1000 Multi-Function Memories. Store frequencies, modes, and tuning steps. Includes an editor for moving contents between memories, plus an on-screen notepad for all memory locations.

Eight Scanning Modes. Includes programmable limits, automatic frequency and time-mark storage of scanned signals, full, restricted or mode-selected memory scanning, priority channel watch, voice-sense scanning and scanning a selectable width around your tuned frequency. Absolutely the last word in full spectrum monitoring.

Professional Quality Throughout. The revolutionary IC-R9000 features IF Shift, IF Notch, a fully adjustable noise blanker, and more. The Direct Digital Synthesizer assures the widest dynamic range, lowest noise and rapid scanning. Designed for dependable long-term performance. Backed by a full one-year warranty at any one of ICOM's four North American Service Centers!

The ICOM logo consists of a large, stylized 'O' with a smaller circle inside it, followed by the letters 'I', 'C', 'O', and 'M' in a bold, sans-serif font.

First in Communications

ICOM America, Inc., 2380-116th Ave. N.E., Bellevue, WA 98004
Customer Service Hotline (206) 454-7619
3150 Premier Drive, Suite 126, Irving, TX 75063 /
1777 Phoenix Parkway, Suite 201, Atlanta, GA 30349
ICOM CANADA, A Division of ICOM America, Inc.,
3071 - #5 Road, Unit 9, Richmond, B.C. V6X 2T4 Canada

All stated specifications are subject to change without notice or obligation. All ICOM radios significantly exceed FCC regulations limiting spurious emissions. 9000489

POP'COMM's World Band Tuning Tips

January, 1992

This PopComm feature is designed to help you hear more shortwave stations. Each month, this handy, pull-out guide shows you when and where to tune to hear a wide variety of local and international broadcasts on shortwave.

The list includes broadcasts in many languages besides English. Most of the transmissions are not beamed to North America. Keep in mind that stations make frequent changes in their broadcast times and frequencies. Changes in propagation conditions may also make some stations difficult or impossible to receive. Your own equipment and receiving location will also have a bearing on what stations you are able to hear.

Note: EE, SS, FF, etc. are abbreviations for English, Spanish, French and so on. Some frequencies may vary slightly. All times are in UTC.

Freq.	Station/Country	UTC	Notes	Freq.	Station/Country	UTC	Notes
2310	ABC, Alice Springs, Aust	1130		5025	Bhutan Bc. Service	1230	
3200	Trans World Radio, Swaziland	0400	GG/EE	5030	R. Catolica Nacional, Ecuador	0200	SS
3210	R. Mozambique	0400	PP	5035	R. Aparecida, Brazil	0030	PP
3215	Radio Oranje, South Africa	0300	Afrikaans	5035	RTVC, Central African Rep.	0428	sign on, FF
3235	R. West New Britain, P.N. Guinea	1130	Pidgin	5050	R. Jesus del Gran Poder, Ecuador	0100	SS
3235	R. Clube Marila, Brazil	0200	PP	5066	R. Candip, Zaire	0500	FF
3250	R. Luz y Vida, Honduras	0230	SS	5286	R. Moundou, Chad	0500	sign on, FF
3255	BBC	0400	via Lesotho	5950	Guyana Bc. Corp.	0703	
3270	Ecoss del Oriente, Ecuador	0300	SS	5965	R. Havana Cuba	0400	
3280	La Voz del Napo, Ecuador	0300	SS	5975	BBC	0030	via Antigua
3300	R. Cultural, Guatemala	0230		6005	BBC	0530	via Ascension
3320	R. Orion, South Africa	0245		6005	CFCX, Canada	0700	
3339	R. Altura, Peru	0100	SS	6010	R. Mil, Mexico	0300	SS
3355	R. Botswana	0400	SS	6010	R. Bahrain, Bahrain	0300	AA
3360	La Voz de Nahuala, Guatemala	0200	SS	6010	R. Mil Cuarenta, Venezuela	1000	SS
3366	R. Rebelde, Cuba	0245	SS	6015	R. Austria Int'l	0530	via Canada
3905	R. New Ireland, P. New Guinea.	1100	SS	6030	R. Globo, Brazil	2330	PP
3945	R. Vanuatu, Vanuatu	0930		6040	Deutsche Well, Germany	0100	via Antigua
3980	Voice of America	0600		6060	R. Nacional, Argentina	1000	SS
4000	R. Bafoussam, Cameroon	0500	EE	6045	R. Libertad Sport, Uruguay	0000	SS
4279	R. Inca, Peru	0930	SS	6075	Deutsche Welle, Germany	0230	GG
4460	R. Baghdad, Iraq	0100	AA	6085	R. San Gabriel, Bolivia	0853	sign on, SS
4753	RRI Ujung Pandang, Indonesia	1200	II	6090	R. Bandeirantes, Brazil	0800	PP
4760	Yunan PBS, China	1130	CC	6115	R. Union, Peru	0945	QRM-Colombia
4765	RTVC, Congo	2200	FF	6160	CKZN, Canada	0930	
4783	RTV Bamako, Mali	0550	FF	6230	R. Patria Libre, (clandestine)	0101	(freq. varies)
4799	R. Buenos Nuevas, Guatemala	1030	SS	6250	R. Nac. Malabo, Eq. Guinea	0500	SS
4809	Rdf. Libertad, Bolivia	1030	SS	6305	La Voz del Cid (clandestine)	0600	SS
4810	R. San Martin, Peru	0930	SS	6400	R. Venceremos (clandestine)	0215	SS
4815	RTV Burkina, Burkina Faso	0600	FF	6907	Africa 2000, Eq. Guinea	2100	SS
4820	La Voz Evangelica, Honduras	0300	SS	6724	R. Satelite	0130	SS
4830	R. Tachira, Venezuela	0330	SS	7100	A Voz do Galo Negro (clandestine)	0045	PP
4835	R. Tezulutlan, Guatemala	0130	SS	7113	Lao National Radio	1130	Lao
4845	R. Cabocla	0100	PP	7140	R. Australia	1030	
4845	RTVM, Mauritania	2330	FF	7145	R. Algiers, Algeria	2200	FF
4850	CRTV, Cameroon	0430	FF/EE	7160	RTV Malaysia, Sarawak	1100	
4865	La Voz del Cinaruco, Colombia	0300	SS	7190	R. Africa, Eq. Guinea	2100	
4865	Gansu PBS, China	1130	SS	7200	Somali Bc. Service, Somalia	0259	sign on
4870	ORTB, Benin	0457	sign on, FF	7205	Voice of America	0200	via Greece
4885	R. Clube do Para, Brazil	0300	PP	7215	RTV Ivoirienne, Ivory Coast	2300	FF
4890	NBC, Papua New Guinea	1230		7235	Deutsche Welle, Germany	0400	AA, via Malta
4890	ORTS, Senegal	2345	FF	7245	R. Nacional, Angola	2330	PP
4895	R. Brazil Central	0030	PP	7255	Voice of Nigeria	0457	sign on
4900	La Voz de Saquisilil, Ecuador	0230	SS	7270	R. Polonia, Poland	2330	
4904.5	R. National, Chad	0427	sign on, FF	7275	ELBC, Liberia	0650	sign on
4910	LV de Mosquitia, Honduras	0130	SS	7315	Croatian Radio	0000	via WHRI
4925	Em. Meridiano 70, Colombia	0100	SS	7350	R. Baghdad	0200	AA
4930	R. Barahona, Dominican Rep.	0300	SS	7355	WRNO, Louisiana	0100	
4934	R. Continental, Venezuela	1000	SS	7375	R. for Peace Int'l, Costa Rica	0600	
4951	R. Nacional, Angola	0000	PP	8770	R. Cairo, Egypt	0500	AA
4970	R. Rumbos, Venezuela	0300	SS	9022	VOIRI, Iran	0100	Farsi
5005	R. Libertad, Bolivia	1000	SS	9265	Icelandic Ntl Bc Svc	0730	EE
5010	R. Garoua, Cameroon	0500		9420	Voice of Greece	0200	GG
5020	Solomon Is. Bc. Corp.	1030		9435	Kol Israel	0000	
5020	ORTN, Niger	0500	FF	9445	Voice of Turkey	2330	TT

Freq.	Station/Country	UTC	Notes	Freq.	Station/Country	UTC	Notes
9455	WCSN, Maine	0200		11865	R. Cairo, Egypt	0230	EE
9465	KFBS, Saipan	1530		11910	R. Australia	1800	
9480	TWR, Monaco	0645		11910	R. Budapest, Hungary	0030	
9486	R. Tacna, Peru	0400	SS	11920	R. RSA, South Africa	0445	
9520	R. Veritas, Philippines	1200	II	11935	BSKSA, Saudi Arabia	0400	AA
9530	KHBS, Saipan	1400		11940	R. Singapore	1100	
9535	TWR, Bonaire	0345		11950	R. Havana Cuba	0000	
9540	R. Nacional, Venezuela	0030	SS, others	11955	Voice of Turkey	0400	TT
9545	Solomon Is. Bc. Corp.	0730		11965	R. France Int'l	0100	SS
9545	R. Tirana, Albania	0530	sign on	11975	R. Tashkent, Uzbekistan	0100	EE
9555	R. Portugal, Portugal	0200	PP	12000	R. Jordan	0330	AA
9560	V of Ethiopia	1300		12005	RTT, Tunisia	0430	AA
9565	R. Universo, Brazil	0100	PP	12070	Georgian R., Georgian SSR	1659	sign on
9570	Voice of Nigeria, Kaduna	0430		12085	R. Damascus, Syria	2110	
9575	RAI, Italy	0100		12127	British Forces Bc Svc	0130	via BBC Cyprus
9580	R. Australia	1200		12160	WWCR, Tennessee	2330	
9580	R. Tirana, Albania	0130		13605	Capital Radio, via Voice of UAE	2230	
9590	BBC	0030	via Canada	13610	Deutsche Welle, Germany	0100	
9600	V of UAE, Abu Dhabi	2200	EE	13630	R. For Peace Int'l, Costa Rica	0200	
9610	Vatican Radio	0300		13635	Swiss Radio Int'l	2130	
9620	Spanish Ntl Radio	1130	SS via China	13655	BRT, Belgium	2330	
9630	Spanish Ntl Radio	0000		13670	R. Canada Int'l	0245	
9635	R. Portugal	2200	PP	13675	UAE Radio, Dubai	2000	AA
9640	R. Pyongyang, N. Korea	1500	EE	13700	R. Netherlands	2030	
9660	R. Australia	1100		13710	BRT, Belgium	2330	
9670	Adventist World R., Portugal	0815		13745	BBC	2000	RR
9690	R. Beijing, China	0330		15010	Voice of Vietnam	2000	VV
9695	R. Sweden	0330		15020	All India Radio	1000	unid lang.
9700	Voice of America	1730		15030	R. For Peace Int'l	1900	
9700	R. New Zealand	1100		15090	Vatican Radio	2100	
9720	Sri Lanka Bc. Corp.	1230		15095	R. Damascus, Syria	2110	
9725	Adventist World R., Costa Rica	1250		15110	Spanish Ntl Radio	2000	SS
9735	R. Nacional, Paraguay	0000	SS	15120	R. New Zealand Int'l	2206	
9735	Cyprus Bc. Corp.	2230	wknds, Greek	15140	R. Havana Cuba	0300	
9740	R. Beijing, China	2200		15160	R. Sofia, Bulgaria	0300	
9745	R. Bahrain	0500	AA, QRM-HCJB	15180	R. Vilnius, Lithuania	2300	
9755	R. Monte Carlo Middle East	0400	via Canada	15185	WINB, Pennsylvania	2130	
9765	V of the Mediterranean, Malta	0600		15200	R. France Int'l	0100	SS
9780	Voice of UAE	2200	sign on	15205	Voice of America	2300	
9815	Italian R. Relay Service, Italy	0700		15208	R. Bangladesh	1240	
9835	R. Budapest, Hungary	0200		15210	Radio RSA, South Africa	1700	
9860	R. Netherlands	2030		15250	R. Romania Int'l	1500	
9870	R. Austria Int'l	2230	SS	15295	R. Nac. del Ecuador	1730	SS, via HCJB
9885	Swiss R. Int'l	1845		15310	BBC	1300	via Oman
9900	R. Cairo, Egypt	0300	AA	15325	R. Japan	1500	via Fr. Guiana
9905	BRT, Belgium	2100		15345	RAE, Argentina	2300	SS
9900	R. Cairo, Egypt	0300	AA	15345	RTM, Morocco	1400	Berber
9905	BRT, Belgium	2100		15350	R. Luxembourg	0100	
9942	La Voz del CID (clandestine)	0200	SS	15365	R. Australia	1100	
9965	R. Caiman (clandestine)	0200	SS	15415	R. Cairo, Egypt	2000	
9977	R. Pyongyang, N. Korea	1100		15425	ABC, Perth, Australia	1100	
11455	R. Kisangani, Zaire	0400	s/on, FF	15475	Africa No. One, Gabon	1800	FF
11500	R. Beijing, China	2130		15480	FEBC, Philippines	0200	
11580	Kol Israel	1715	FF	15485	R. Vilnius, Lithuania	2300	
11587	Kol Israel	1715	FF	15510	R. Afghanistan	1900	FF, via USSR
11590	V of the Strait, China	1100	CC	15560	R. Netherlands	0050	
11625	Vatican Radio	0030	PP	15585	R. Moscow	2300	
11660	R. Sofia, Bulgaria	2130	PP	15610	Adventist World R./KSDA, Guam	2300	
11685	FEBC, Philippines	1030	EE	15640	Kol Israel	1900	
11710	R. Romania Int'l	0330		15670	British Forces Bc Service, England	0030	feeder
11715	R. Beijing, China	0300	via Mali	17555	R. Beijing, China	0100	sign on
11715	KNLS, Alaska	0800	sign on	17590	R. Moscow	1900	FF
11715	R. Korea, S. Korea	1030	via Canada	17680	RTBF, Belgium	0500	FF
11730	R. Sofia, Bulgaria	0300		17695	R. Netherlands	1900	
11735	R. Yugoslavia	0000		17725	Libyan Jamahiriya Bcsting	1900	AA
11730	BBC	0300	via Seychelles	17730	R. Alma Ata, Kazakhstan	2130	
11730	Spanish National Radio	0500	SS	17740	R. Yugoslavia	1200	
11740	TWR, Swaziland	0527	sign on	17770	R. New Zealand	0400	
11740	R. Portugal	1900	EE	17795	RAI, Italy	0530	AA
11755	R. Finland Int'l	2130		17810	FEBA, Seychelles	0400	
11760	R. Tbilisi, Georgian SSR	2000		17810	R. Japan	2330	
11780	Voces en Libertad, Argentina	1400	SS, ex-Belgranc	17830	BBC via Hong Kong	to 0044	sign off
11790	R. Kiev, Ukraine	0000		17860	Qatar Bc Service	1300	AA
11795	UAE Radio	1600		17865	R. Nac. Colombia	2100	SS (varies widely)
11795	Cyprus Bc. Corp.	2213	s/on weekends	17875	R. Sweden	1530	
11805	R. Globo, Brazil	2300	PP	17902	R. Nacional, Colombia	2300	SS
11815	Trans World R., Bonaire	1230		17950	V of Free Iraq (clandestine)	2245	AA
11825	R. Tahiti	0345	FF/TT	21465	R. For Peace Int'l, Costa Rica	2330	
11835	R. El Espectador	2300	SS	21550	R. Finland Int'l	1400	
11840	R. Moscow	1430	via Cuba	21690	R. Moscow	0800	RR
11845	R. Afghanistan	1800	via USSR	21705	R. Norway Int'l	2200	NN
				21740	R. Australia	0200	

GETTING STARTED AS A RADIO AMATEUR

What Can You Do With Packet Radio?

Back in November we looked at the basics of transmitting personal computer data to others via Amateur Radio using an exciting and fast-growing mode called packet radio. Now that you know it's possible—and easy to do—the next step is finding out what you can do once you're on the air.

Most computer hobbyists are familiar with modem operation. Using a simple device that connects your computer's serial port to a standard telephone line, your PC can dial into any other computer that will accept the connection. The most useful applications are commercial information services and private bulletin board systems (BBSs). Once you're on-line, you can read and send messages, upload (send) and download (receive) program files, participate in conferences, play games and search exhaustive data bases.

Many of these activities are available on packet radio—instead of a modem, your computer talks to your radio through a terminal-node controller, or TNC. There are packet bulletin board systems (PBBSs) all over the world, and most are configured to pass mail to any other packet "address" in the system. It may seem strange to be "connected" to another computer when no wires are used to span the intervening distance, but it just takes getting used to—and it's really half the fun!

Check In And Check It Out

When you connect to a PBBS, you can look at personal mail, sift through bulletins of general interest to hams, download ASCII text files and join conferences with other keyboarders. Some PBBSs feature call sign data bases that enable you to look up the names and address of other hams—just like an over-the-air, on-line *Callbook*, and some even let you take practice Amateur Radio license exams if you're working on an upgrade. PBBSs carry handy text files of FCC rules, radio modification and repair data, club membership rosters, satellite elements and frequencies, and almost anything else in the non-business realm. If you have compatible software, you can connect directly to any fellow hams within your station's range and exchange program files, send text messages or just type to each other.

Some PBBSs are devoted to emergency and public service operation and maintain indexes of official emergency management personnel, members of the Amateur Radio Emergency Service (ARES) and the Radio Amateur Civil Emergency Service (RACES), hazardous materials data, lists of citizens evacuated from disaster sites to shelters, elec-



A typical packet station: A VHF-FM transceiver and a terminal-node-controller, or TNC. You supply the personal computer and an antenna, and "Wallah!" you're on the air!

tronic mail sent to request aid, supplies, or to report on conditions or send health-and-welfare messages to families of people living in disaster areas. If you're a member of your local Amateur Radio Emergency Service (ARES) organization, you may be asked to participate in periodic drills to test the capabilities of the local packet network.

If you're too far away for a direct radio connection to a PBBS or ham friend, you can use another amateur packet station in the middle as a go-between to relay your transmissions. A station that performs this relay function is called a digital repeater or *digipeater*, and any station with a TNC and radio can digipeat for others. The digipeater does just what its name implies—it receives your digital transmission and repeats it, thereby extending your coverage area.

A more sophisticated way to reach distant computers or PBBSs is via *nodes*. Nodes are stations that use software that's a bit "smarter" than that in a plain TNC. A node can store the call signs of PBBSs, digipeaters and other nodes, and information about the path required to reach them. When you use a node, you don't need to worry about shepherding your data transmissions through a labyrinth of "invisible" digipeaters and gateways. You connect to the nearest node, tell it to connect you to the node nearest your "destination," and sit back and watch.

Beyond The Boundaries

If your amateur license allows HF operating privileges (below 30 MHz), try connecting to a local PacketCluster. These highly specialized stations cater exclusively to the DX'ing community. A large number of stations con-

nect to a central "server" station, and as any one of the users types in information about a rare or desirable DX station that they've found on the air, showing its call sign and frequency, all stations connected to the PacketCluster receive an immediate DX "flash" on their screens and can try to contact the spotted DX station. The software that drives a PacketCluster was written by Dick Newell, AK1A, of Bolton, MA and offers conferencing facilities, a bulletin board, QSL information, propagation data and other features.

Other PBBSs use software called *APLINK*, developed by Vic Poor, W5SMM, of San Antonio, TX. *APLINK* allows you to leave mail for distant hams via VHF packet. Rather than standard packet mail, which is normally forwarded via a relay chain (or *backbone*) of VHF and UHF PBBSs, *APLINK* lets the control operator transfer the mail via HF AMTOR (an HF digital mode similar to radioteletype) to another *APLINK* station, which makes the mail available to the addresses via a standard VHF packet port.

What Are You Waiting For?

Most packet action is on VHF FM, so you'll typically use local-area networks (LANs) to serve as your gateway to the rest of the world. You'll find the majority of 2-meter packet around 144.95, 145.01, 145.03, 145.05, 145.07 and 145.09 MHz. Aside from a computer, radio and a TNC, your Technician (or higher) class license is all you need to get started.

As always, send your letters, photos and questions to me at ARRL HQ, Department PCN, 225 Main Street, Newington, CT 06111. See you on 144.95 MHz (my local PacketCluster node . . .)! ■

HOW I GOT STARTED



Ronald R. Thomas, of Atlanta, GA.

We invite readers to submit the stories of how they got started in the communications hobby. Try to keep the story down to 150 words (more or less). If you can send it typewritten, all the better; otherwise please make it easily legible. If you have a photo of yourself taken recently (or when you began in radio), please include it. We can't return or acknowledge material, whether or not it is used. Your story need be submitted only once. We'll keep it on file and consider it for future issues. All submissions become the property of *Popular Communications*.

Entries will be evaluated taking into consideration if the story they tell is interesting, amusing, or unusual. We reserve the right to make any necessary editorial changes to improve style or correct grammar.

Each month we will select one story and run it in *POP'COMM*. The person whose story is used will receive a 1-year gift subscription (or subscription extension if already a subscriber) to *Popular Communications*.

Address all entries to: How I Got Started, *Popular Communications*, 76 North Broadway, Hicksville, NY 11801.

Our Winner For January

This month we picked Ronald R. Thomas, of Atlanta, GA. Ron told us:

"I began my communications career in 1950 at the age of 9 with a crystal radio, a telegraph key, and a library book about radio. At age 11, I received my Amateur Radio license (W8QYR). Then, at the age of 16, I received my First Class Commercial Radiotelephone and Second Class Radiotelegraph licenses.

"While attending college, I worked as a

broadcast engineer for WBBW. After graduation, I entered the USAF and served as a communications officer, holding the rank of Captain. I was stationed at Cape Canaveral and was actively involved with the U.S. space program to place a man on the moon.

"After the military, I held professional telecommunications positions with several organizations. While working for the Bell System in Washington, DC (late 1960's), I

was involved with the engineering of telecommunications systems for the White House and other federal agencies.

"I have written more than a hundred articles on telecommunications, plus two books. Presently, I am a telecommunications analyst in Atlanta, where I enjoy listening to my SONY 2010 shortwave receiver, working 2 meter FM, and reading *POP'COMM*."

MODEL SG-2000 HF SSB RADIOTELEPHONE GLOBAL COMMUNICATIONS FOR DATA AND VOICE

You're in contact anywhere, anytime with the power packed SG-2000 HF SSB transceiver. Engineered for simple operation, the SG-2000 features an alarm generator, 644 factory programmed ITU voice and data channels, 100 user programmable channels and 100 memory channel scanning. Receive and transmit strong clear voice signals. Manage data communications easily on RTTY, ARQ, PACKET and telegraphy. Utilize up to 8 front panels as full function remote stations. A user-friendly American product, sophisticated housing and the SGC technical superiority and quality workmanship make the SG-2000 your radio of choice.

TOUGH TALK!

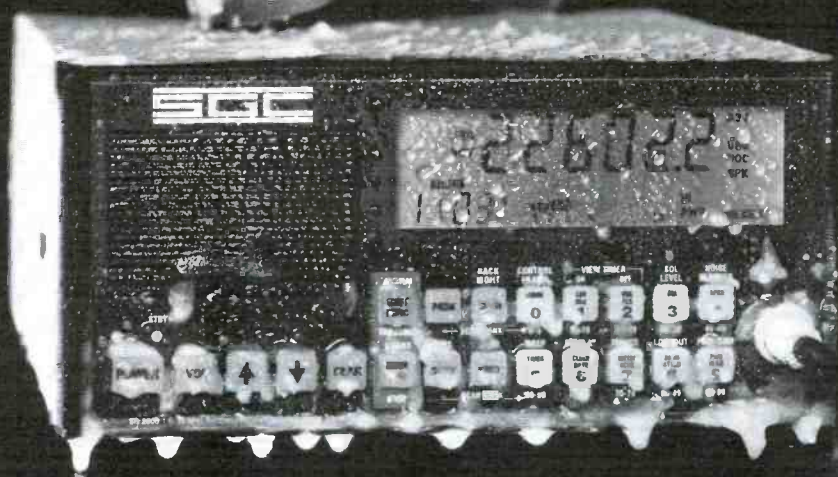

SGC Building, 13735 S.E. 26th St. P.O. Box 3526, Bellevue, WA 98005 USA
Telex: 328834. Fax: 206-746-6384. Tel: (206) 746-6316

SGC

INSIDE THE WORLD OF SATELLITE COMMUNICATIONS

When Less Is More

The military is scaling down the size of its communication satellites. With our huge deficits, the recession (or depression if you are unemployed), DOD budget cuts and disarmament, we have had to find ways to do more with less.

DARPA (the Defense Advanced Research Projects Agency) is beginning to think small again. I say again because all early satellites were small. Those small, inexpensive, easily-replaced satellites of simple design are again coming off the drawing boards.

The Armed Forces had been working on a new class, high-tech, Cadillac of communications satellites called Milstar. This system was to have taken us into the middle of the next century. The funding for Milstar, however, was cut last April, even though two prototypes have been completed and several research packages have flown on the last several Fltsatcoms (Fleet Satellite Communications system). The Milstar spacecraft would cost over \$1 billion each. Literally hundreds of small satellites, can be built for what one Milstar costs. They can provide the military with the same communication capability and anti-jamming, laser and nuclear safe guards as Milstar.

These small sats, Microsats, Lightsats, Macsats or Cheapsats, as they are sometimes called, will weigh as little as 55 lbs. They will be capable of handling 32 voice and data channels that will be compatible with existing Milstar, Fltsat or DSCS III systems. They are even small enough to be launched on the new Taurus and Pegasus rockets. Pegasus is carried aloft under the wing of a B-52 and

launched like a missile. These Microsats can even be equipped to out maneuver anti-satellite missiles and use spot beam antennas to avoid being intercepted.

Elements of the 2nd Marine Aircraft Wing were the first to experiment with a new Microsat system. They call their satellites Macsats. This system was deployed in the Persian Gulf and got its first real test under fire during the Gulf War. Macsats was responsible for keeping the troops in the field in contact with their home base in North Carolina.

The Navy is experimenting with its own program called Spinsats. Spinsats stands for Special Purpose Inexpensive Satellite (Macsats stands for Multiple Access Communication Satellite).

The Army is working on an intelligence gathering version of the Microsat. They are currently working on a EHF version of the satellite. The Microsats will be placed in a Molniya orbit. This means the spacecraft will have an orbit which brings it very close to the Earth's surface on perigee and takes it to hundreds or thousands of miles above the Earth on apogee. Several constellations of four to eight spacecraft would provide world-wide coverage and allow omni-directional antennas which would eliminate tracking.

Of course, this Microsat technology is not going unnoticed by the SDI (Strategic Defense Initiative) office. They are trying to develop a high-tech micro-satellite killer. These small weapons would tail competitors' satellites and detonate on command. Soviet satellites would, of course, be the beneficiaries of this technique as they have a world-wide

fleet of small satellites already in orbit.

Microsats can be used for intercept of radios, radar, and telemetry signals or even as infrared, photo intelligence, weather, environmental and research satellites.

Microsat technology has largely been ignored until recently. The only exception has been the Intelligence community which has made limited use of extremely small spacecraft. Why haven't we taken advantage of this technology before now. The people who build satellites are a lot like the people who build cars, in some cases, they actually are the same people. When you walk onto a car lot, does the salesman try to sell you the Lincoln or the Escort first? Well, a lot of Lincolns have been bought in recent years. Now all we can afford is the Escort. The buying of Lincolns may be the reason we only have one geo-stationary weather satellite left in operation. Their replacements are over budget, over-due and having the same trouble with mirrors that the Hubble telescope had.

The microsats have often used a variation of the Packet data communication protocol. In 1987, the military began experimenting with packet on their current satellite systems. The exercise, called Bright Star, allowed Packet communications between Ft. Bragg NC and troops in the field in Egypt at speeds of up to 2,400 baud. Each radio terminal consisted of a URC 12 radio, a KY57 encryption unit and a lap-top computer.

The Navy is also looking into another alternative to expensive orbital satellites. They have discovered an inexpensive way to establish communications over a battle field or

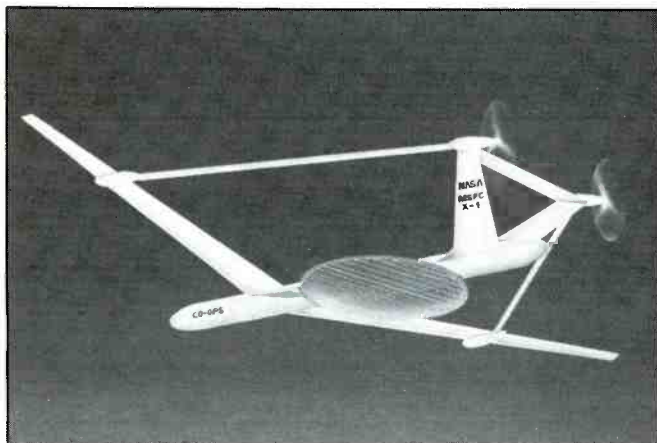

NASA's ultra-light communications platform. (Courtesy NASA)

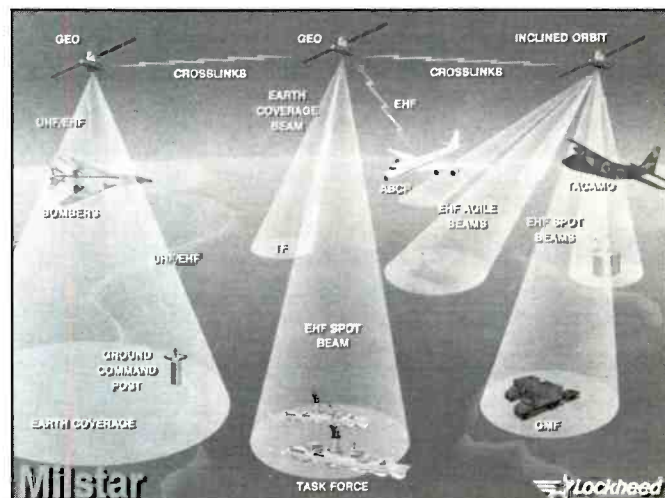

Milstar communication capabilities are similar to current Fltsat and Gapsat systems with addition of EHF/SHF. (Courtesy DOD)



Solar Max is a considerable contrast to the MacSats. (Courtesy NASA)

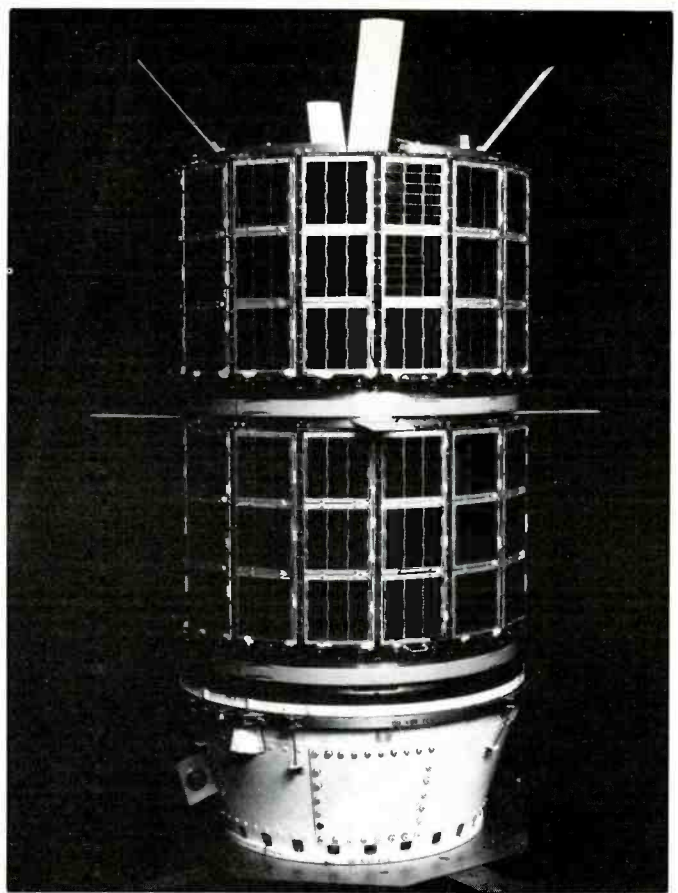

DARPS' first two MacSats were stacked and launched together on a Scout launch vehicle. Each MacSat weighs 150 lbs. They were placed in a circular polar orbit at 400 nautical miles. (Courtesy DOD)

for special operations. The idea was to come up with an inexpensive vehicle to get the needed radio gear high enough to be of practical use. They decided to attach their equipment to high altitude balloons. The program is called Zephyr. The hydrogen filled balloons are launched from ships. Each of the 18 balloons used in the experiment were equipped with a UHF radio transponder. It had 10 watts RF and 25 kHz of frequency space. The balloons have a 24 hour lifespan and can provide communications between handheld radio up to 500 miles apart depending on altitude. Each balloon currently cost \$7,000.00. It is believed the cost would drop to \$1,000.00 each once the system is fully operational. This cost includes the electronic equipment.

Two altitudes are critical for the deployment of these balloon satellite systems. Near 70,000 feet the jet streams can be depended upon to carry these balloons in predictable patterns. At 120,000 feet the balloons are static and move very little and even have a longer lifespan at this altitude. A series of 18 balloons at 120,000 feet can provide global communications coverage. Each system can be crosslinked with other satellite systems the same way orbital satellites are crosslinked.

NASA has also come up with a unique high altitude platform which could replace or supplement certain satellite systems. Put in plain language, they have found a way to power an ultra-light model plane with a wing span

of 65 feet and keep it aloft for up to 90 days. The craft is powered by microwave ground stations which beam a signal at the craft which has what is called a rectenna on the underside. It is a combination of antenna and rectifier converting the microwave energy into usable power. It works much like a solar cell. With their long lifespan, when compared with the balloon system, this high altitude aircraft system could be practical and cost effective.

These platforms could find their way into use in other areas of communications. For example, Amateur Radio operators are already experimenting with balloons. Any of these platforms could be used for regional broadcasting, public service stations or any number of other uses.

That about raps it up for this go-around. Your loggings, QSL's, photos, comments, questions and suggestions are welcome.

NOW! No-Code Ham Radio License!

It's EASY!
Amateur
Radio
No-Code
License
Study
Course!



All the LATEST study materials needed for the New FCC / VEC NO-CODE exam are included. Join the ranks of newcomers & licensed hams using **DIAMOND SYSTEMS** course material.

All the LATEST study materials needed for the FCC / VEC No-Code Technician exam are included. Contains all questions and answers for this written test with ten (10) practice tests and the Federal Communication Commission application form. All study material prepared by Diamond Systems, Inc. Meets the latest FCC published specifications. Join the ranks of newcomers and licensed hams using **DIAMOND SYSTEMS** course material. No-Code Technician License Course (no computer needed)....\$ 24.95

DIAMOND SYSTEMS, INC

Call (312) 763-1722, or write to: P.O. Box 48301, Niles, IL 60648. Allow \$4.50 for shipping. If in Illinois, add 7% tax.

CIRCLE 152 ON READER SERVICE CARD

Portable VHF Call Letters

The Federal Communications Commission is cracking down on unlicensed marine radiotelephone operation. The U.S. Coast Guard will now inspect for a valid VHF radio license during a boarding inspection. If your license is expired—or non-existent—it could cost you!

The FCC rules are also clear on the legal use of a VHF handheld transceiver aboard a boat. If you use your handheld to communicate from dingy to only your boat, no additional license is necessary. But did you know your handheld really needs its own license if you regularly communicate from your dingy to any other boat! That's right, if you have a handheld VHF transceiver and you are out on a row boat, you technically need a license, too.

It's relatively easy to apply for a Federal Communications Commission ship radio station license. The form you use is FCC Form 506, dated February, 1991. This is a blue form that is available from most marine electronic specialty dealers, or directly from the FCC, 1270 Fairfield Road, Gettysburg, Pennsylvania 17325-7245. Ask for two, and give one to a friend!

To obtain a set of call letters for your ship or for that little VHF handheld, begin filling out the easy stuff on Page 1 of FCC Form 506. Items 1 through 4 simply ask about your name and address, and whether or not you are an individual or a partnership.

For Item 5, check the "new station" box if you have never had call letters before. If you are simply renewing, check the "renewal" box. If you are adding radar or EPIRB to your present license, check the "modification" box.

For Item 6, check the "regular" box if you are simply licensing your equipment aboard your boat. However, if you want to receive call letters specifically for your VHF handheld aboard anyone's boat, check the "portable" box.

If you check the "portable" box, you will need to add the following statement on the back side of Form 506:

I will be using a type-accepted VHF portable marine transceiver aboard many different boats and dingys. These boats and dingys may not have any other radio equipment onboard, and this is why I am applying for a portable license for my own handheld radio equipment. I will not use the VHF handheld on shore. My portable handheld will be used for both distress and safety calls, as well as for marine-related communications for safety.

What you have said is you will take your VHF handheld out on boats that might not have any other radio set. This way, if you need to place a call to the Coast Guard or har-

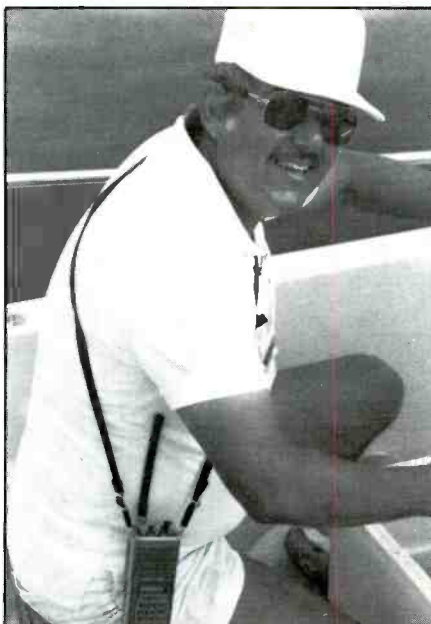

The portable VHF marine radio must have its own call letters when communicating with other boats or shore.



U.S. Power Squadron member operates his marine handheld and direction-finding station from his house boat with an FCC marine station license.

bor patrol, you have your own radio and call letters assigned to that radio. Remember, you are not allowed, by law, to transmit from a dock or on shore. Use your handheld on transmit only when aboard any boat.

If you checked the "portable" box, skip items 7 through 10. Simply put "DNA" (does not apply) in those boxes. However, if you are simply applying for your call letters for your boat, complete your vessel name (Item 7), your vessel registration number (Item 8), any call sign that you might have had (Item 9), and "PL" for a general type of pleasure boat, and "YAT" for the specific type of yacht you are licensing. On Item 11, indicate you are the owner, and for items 12 and 13, normally the "no" boxes are checked.

Skip items 14 and 15, but complete the following boxes for Item 16: "V" for VHF; "A" for EPIRB; "T" and "U" for SSB long-range radio; "R" for radar; and "C" for a new 406 MHz EPIRB (if you have one).

In box 18, please print "PLEASE ASSIGN" for a selective signaling call sign. As new VHF selective calling transceivers hit the marketplace, you will already have your new selective ringer number.

Finally, sign and print everything requested on the bottom of Form 506, plus print your name and address on the back side of Form 506. Doublecheck that everything is correct, and read over the enclosed instructions with that form to insure you didn't omit anything.

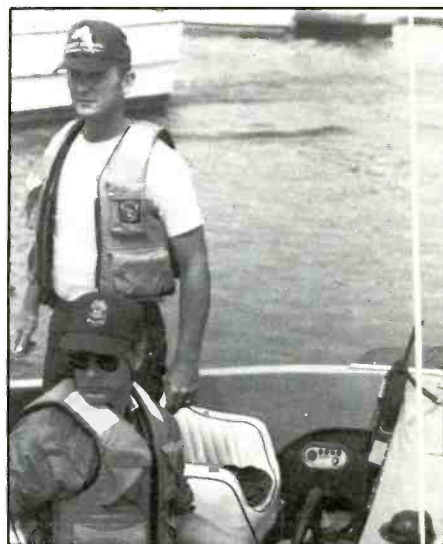

Rescue agencies on the water using marine VHF must have the FCC ship-station license. The Coast Guard will now check for it.

It's now a \$35 fee to attain a marine radiotelephone license. Mail this form, plus the fee, to FCC Marine Ship Service, PO Box 358275, Pittsburgh, PA 15251-5275.

For a regular ship station license, you can go on the air immediately using the letters "KUS" in front of your 6-digit documentation number, or the letter "K" in front of your state registration number. Same thing with the lit-



The one watt marine VHF handheld must be licensed aboard a boat.



Every ship station on marine VHF must have a valid FCC marine station license.

the portable license: temporarily use the numbers assigned to that dingy or ship.

It only takes a few minutes to fill out this form; if you cruise locally, no other personal operator permit is required. Take advantage of the capability of receiving call letters for a VHF handheld to be used on anyone's boat. This will cover you in case you need to go out on a search and rescue, carrying your marine VHF transceiver.

After you have received call letters for your portable VHF marine handheld, you may wish to take the next step for shore station licensing, and obtain FCC Form 503. This is an application for using your handheld on shore in connection with your search and rescue command post. If you follow the instructions on the Form 503 application, you should have the same success in obtaining shore side call letters which will be different from your new set of shipboard portable call letters. Get yourself licensed, and your emergency communications will be legal and a lot easier.

Secret Frequencies

VOLUME 2 884 98

FREQUENCY ASSIGNMENT MASTER FILE
FEDERAL ASSIGNMENTS

- DEPARTMENT OF AGRICULTURE
- DEPARTMENT OF THE AIR FORCE
- DEPARTMENT OF THE ARMY
- DEPARTMENT OF COMMERCE
- DEPARTMENT OF DEFENSE
- DEPARTMENT OF ENERGY
- DEPARTMENT OF HEALTH AND HUMAN SERVICES
- DEPARTMENT OF HOUSING AND URBAN DEVELOPMENT
- DEPARTMENT OF THE INTERIOR
- DEPARTMENT OF JUSTICE
- DEPARTMENT OF LABOR
- DEPARTMENT OF THE NAVY
- DEPARTMENT OF STATE
- DEPARTMENT OF THE TREASURY
- DEPARTMENT OF TRANSPORTATION
- 39 INDEPENDENT AGENCIES & COMMISSIONS
- FREQUENCY ORDER OF ALL ASSIGNMENTS
- TELEVISION, SATELLITE, TELEPHONE, PAGING & OTHER FREQUENCIES

© 1992, The Communications Research Council

Monitoring Times.

August 1990

"... this Compendium is the handiest and most comprehensive Reference for armchair monitoring of "Forbidden" Frequencies we've ever seen."

U.S. Scanner News..

August 1990

"Overall, we would have to rate this book three stars. It is a very good compilation of Frequencies and information for the scanner Hobbist."

Available in the finest Radio Stores or directly from:

Artsci (818) 843-4080
Artsci Publications
P.O. Box 1848
Burbank, CA 91507
(818) 846-2298 FAX
Visa, M/C, American Express
Discover, Checks, COD

CIRCLE 140 ON READER SERVICE CARD

PC HF FACSIMILE 6.0 \$99



NOW EVEN BETTER!

Version 6.0 has just been released. It is the most comprehensive fax image reception system for the IBM PC and compatibles. It includes an FSK demodulator, advanced signal processing software, tutorial cassette, and complete 250 page reference manual. The software includes the following advanced features:

Menu Driven
Start/Stop Tone Recognition
Unattended Operation
Tuning Oscilloscope
Resolution up to 1280x800x256 Levels
Programmable Colorization
Brightness and Contrast Control
Pixel Photometry and Histograms
Image Zoom, Scroll, Pan, Rotation

CGA,HGA,EGA,VGA & Super VGA
Time Lapse Frame Looping
Slide Shows
Export to PCX & GIF Files
Grayscale on all Popular Printers
Programmable I/O & Line Rates
Online Broadcast Database
Image Cropping
True Color Press photos

PC GOES/WEFAX \$250

PC GOES/WEFAX 3.0 is our finest fax imaging system. It is compatible with both HF and direct satellite broadcasts from GOES, METEOSAT NOAA, SOVIET APT and C-Band services. It includes all of the above features plus a complete prediction system and advanced multispectral analysis software.

Call or write for our catalog of products. Visa & MasterCard we come.

Software Systems Consulting
615 S. El Camino Real, San Clemente, CA 92672
Tel.(714) 498-5784 Fax.(714) 498-0568

CIRCLE 145 ON READER SERVICE CARD

THE MONITORING MAGAZINE

ART-1

ART-1: A complete interface system for send and receive on CW, RTTY (Baudot & ASCII) and AMTOR, for use with the Commodore 64/128 computer. Operating program on disk included.
\$199.00

AIR-1: A complete interface system for send and receive on CW, RTTY (Baudot & ASCII) and AMTOR, for use with Commodore VIC-20. Operating program in ROM.

AIR-1

\$99.95

SWL

SWL: A receive only cartridge for CW, RTTY (Baudot & ASCII) for use with Commodore 64/128. Operating program in ROM.
\$69.95

AIRDISK: An Air-1 type operating program for use with your interface hardware. Both VIC-20 and C64/128 programs on one disk.
\$39.95

AIRDISK

AIR-ROM: Cartridge version of AIRDISK for C64/128 only.
\$59.95

MORSE COACH

MORSE COACH: A complete teaching and testing program for learning the Morse code in a cartridge.
For C64 or C128. **\$49.95**
VEC SPECIAL **\$39.95**

G AND G ELECTRONICS
OF MARYLAND

8524 DAKOTA DRIVE, GAITHERSBURG, MD 20877

(301) 258-7373



CIRCLE 142 ON READER SERVICE CARD

January 1992 / POPULAR COMMUNICATIONS / 47

TELEPHONES ENROUTE

BY TOM KNEITEL, K2AES

WHAT'S HAPPENING WITH CELLULAR, MARINE & MOBILE PHONES

A new, completely transportable satellite/microwave/cellular telephone system for use during national emergencies anywhere in the world now exists. It can quickly restore or augment federal government communications to areas struck by natural disasters or civil emergencies when the public landline telephone system becomes disabled or non-existent.

The system was designed and built by Bell Atlantic Mobile Systems and COMSAT Systems Division for lease to the federal National Communications System (NCS). It is completely self-contained and, with local cellular carrier coordination, it can be flown or trucked to a disaster site and put into service in about two and a half hours, providing voice, FAX, telex, and low speed data capabilities.

The system is a complete package that can be deployed within 24 hours to any designated area. It is sized to fit in a C-130 cargo aircraft.

Called the National Transportable Telecommunications Capability (NTTC), the system is maintained at the COMSAT laboratory site in Clarksburg, MD for deployment by the NCS. The NTTC is a telecommunications service using commercial, off-the-shelf cellular and satellite hardware.

NTTC is expected to have additional applications useful in ecological emergencies, to

public and private disaster relief agencies, law enforcement, and other emergency preparedness organizations. Although this particular unit was designed to meet the demanding needs and technical standards set forth by the NCS, it isn't intended to provide general consumer service, although the concept could be developed into other fields with some modifications.

COMSAT provides the Ku-band (23 GHz) satellite links, fixed gateway earth station, digital telephone system and microwave components of the NTTC. In addition, COMSAT is responsible for integrating the cellular components of the NTTC into the public switched landline network. The SBS-2 satellite will be used for CONUS coverage to connect the Hub earth station in Clarksburg, MD. This Hub provides the gateway into the public switched landline telephone network is a terrestrial T1 interconnect.

Bell Atlantic Mobile Systems provides the Mobile Telephone Switching Office (MTSO) with co-located portable cell site, 100 ft. collapsible tower, antennas, and the fixed, transportable, and portable cellular phones.

Power is supplied by its own diesel equipment.

In use, fixed, transportable, and portable cellulars will be within range of the NTTC's deployed cell site and MTSO. The MTSO is



The Shinwa PageOne system is an in-house radiopager that is available for VHF or UHF use.

connected via digital microwave radio relay point to the NTTC's satellite earth station, which may be located a number of miles away. The earth station communicates through the satellite with the gateway access station in Maryland, where the calls are fed into the public switched network, the defense switched network, or other feeds as required.

A Civilian Version?

The PGA golf tournament last May at the White Manor Country Club, Malvern, PA

This portable cell site is housed in a trailer and can be moved to any location where high-density cellular coverage is required to brief periods. (Courtesy Bell Atlantic Mobile Systems.)

The NTTC is a self-contained, transportable satellite, microwave, cellular telephone system for use by the NCS during emergencies. See text for details. (Photo by Dan Katz, courtesy Bell Atlantic Mobile Systems.)



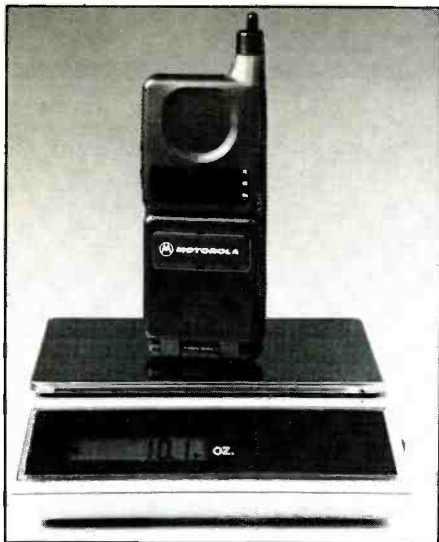

The Motorola MicroTAC Alpha Series Digital Personal Communicator weighs only about 10 oz.

had a test of what could well be regarded as a little brother of the NTTC.

The golfing event was a sea of cellu-lars. Cadillac, a sponsor of the event, had installed cellu-lars in 71 of their cars supplied to be used by tournament players and officials. Motorola supplied 20 Ultra Classic portables, and one was positioned at each hole so that scores could be called into a central location. There were many other cellu-lars there, too, being used by the staff and by visitors. In addition, Bell Atlantic Mobile Systems had a van in front of the hospitality tent where guests were given the opportunity to make a free cellular call.



An assortment of spike antennas from The Antenna Company.

To accommodate all of this activity and provide enhanced service, Bell Atlantic Mobile also supplied a portable cell site. The small cell allows Bell Atlantic Mobile to provide service where there may not be the time or physical space (or the long-term need) to locate a permanent cell. While permanent sites may be as large as 14 ft. by 40 ft., the portable cell is only 8 ft. by 20 ft., and can be towed like a camper or rental trailer. It's antennas are mounted on tripods set up on the trailer's roof.

While the country club area is normally served pretty well by cell sites in Newtown Square and Malvern, the topography is hilly, and the golf course itself had a couple of areas where regular service wasn't too good. The on-site portable cell site cured this problem during the tournament.

This portable cell site was previously used with success at the U.S. Seniors Open Championship in Latrobe, PA during the summer of 1989.

Bouncing Right Along

A company from Kent, WA known as Meteor Communications Corp. has developed a comms system intended to let long-haul trucks bounce radio signals off meteor trails in order to let their company dispatchers know their locations while enroute. This is intended to replace the traditional system that requires truckers to call in a couple of times per day via cellular or landline regular telephone.

The non-voice system is entirely automatic, and pinpoints the exact locations of the vehicles. The data is sent out in bursts from small transmitters located in the trucks. The signals reflect from the trails of meteors, which are about 60 miles above ground. They are received as far as 1,200 miles away at a ground station the size of a truck, which processes the data and relays it to the dispatchers.

Coast Guard Access via Cellular

A trial program in a limited East Coast area enables boaters to contact the U.S. Coast Guard quickly via shipboard cellu-lars. The program was working all of last summer and we assume it will continue this summer within the trial area, which is from Ocean County, NJ to Chincoteague Bay, VA, and in the upper Chesapeake Bay (Tangier Island and north). When a boater dials *CG (STAR-CG) on his cellular, the call will be automatically routed to either Coast Guard Group Baltimore, MD or Coast Guard Group Cape May, NJ, depending upon the location of the calling station.

The Coast Guard centers can evaluate the situation and direct any appropriate assistance from the nearest Coast Guard station. Cellular coverage and availability are not guaranteed, nor is the length of this trial program, so therefore *CG is not intended as a replacement for VHF-FM radio Channel 16.

All cellular subscribers within the trial area

can access the Coast Guard with the *CG service. Subscribers of non-wireline carriers must have cellu-lars with an A/B switch function in order to get through.

More Good News for Boaters

We heard from Martha Lstrom, KA1U00, who is the V.P. of marketing at *On Board*, the boater friendly computer-based information service. Martha, who has long been a POP*COMM subscriber, tells me that *On Board* is an excellent reason to take a computer and cellular aboard your boat.

On Line's data access number is 1-800-835-7899 (on your modem: 1200,2400,8,n,1). They offer a myriad of 24-hour cellular and landline computer-accessible services including NOAA weather information, E-mail, classified ads, and many special interest forums for boaters including ham radio, YL boaters, antique boats, search and rescue, new products, marine electronics, sport fishing, young boaters, and others.

There is a one-time \$35 charge for becoming a part of *On Board*, plus the basic on-line rate of 35 cents per minute. You may pay by credit card, and there's a newsletter, too. To become a part of *On Board*, set your modem to the parameters described and log on, then follow the instructions.

Or, you can write for more information to *On Line* at Ocean Connect, Inc., P.O. Box 776, Portland, ME 04104. The regular (voice) number there is 1-207-781-0950; the FAX number is 1-207-781-3492. Be sure to mention that you read about it in POP*COMM.

Turning the Page

The versatile in-house *PageOne* radio-paging system has been brought out by Shinwa Communications of America, Inc. The VHF (150 to 174 MHz) version puts out 2 or 5 watts, while the UHF (450 to 470 MHz) version runs 2 or 4 watts. These are two-channel units.

The system has a pager capacity of 100 units, but can be expanded to 6,000 with the use of an IBM PC or clone. Tone-only, tone and voice, talk-back, DTMF, and other popular paging formats may be employed, with local phone or dial access.

For more information on the *PageOne* system, contact Shinwa Communications of America, Inc., P.O. Box 26407, Oklahoma City, OK 73126.

Another Mighty Mite

Last month we showed you a tiny new cellular from Motorola. Here's another one they just introduced. It's called Motorola MicroTAC Alpha Series Digital Personal Communicator. It looks like something right out of *Star Trek*.

It weighs just a shade more than 10 oz., and it will fit into a shirt pocket or a purse. There's a dot matrix, color LED alphanumeric display. This makes for easy viewing of its

NEW PRODUCTS

REVIEW OF NEW AND INTERESTING PRODUCTS



New Frequency Counter

Optoelectronics Inc., announces a frequency detector/counter for use in secure installations, counter surveillance and police tactical situations; private investigations; two-way radio, ham radio, frequency monitoring and other applications where a dedicated frequency counter was previously too costly.

Dubbed the Handi-Counter Model 2300, Opto's new counter features full eight-place readout resolution, 10 mV sensitivity for signal detection at maximum distance from the transmitter, and a unique and convenient display-hold switch so the user won't have to remember or write down the detected frequency.

Adroit manufacturing techniques and state-of-the-art electronic design allows Opto to limit the price of this new product. Only two integrated circuits and a small number of MMIC amplifiers yield the lowest possible parts count.

One of the ICs is an entire frequency-counter chip in CMOS technology, and the other is a frequency-scaler chip in ECL technology; this allows Model 2300 to operate in the GHz range. The unit's printed circuit board is identified to another, highly popular Opto product, and so is its aluminum enclosure, right down to the configuration of drilled holes.

Only the highest quality parts are incorporated. Dual, high performance MMIC amplifiers support the input circuits. Expensive NPO trimmer capacitors are used throughout the oscillator circuits. The aluminum housing features a new high-tech paint which is far tougher and more durable than cheap anodizing. Even the advanced ink used for the precision silk screen legends cannot rub off. An optional 600 mAH battery pack incorporates the best, longest lasting NiCad batteries.

Opto's new Model 2300 Handi-Counter is priced at \$99 each in unit quantities. Delivery is quoted from stock. Optional NiCad battery pack is priced at \$29, also from stock.

For more information, contact: Optoelec-

tronics Inc., 5821 NE 14th Avenue, Fort Lauderdale, FL 33334, or circle 104 on our Reader's Service.

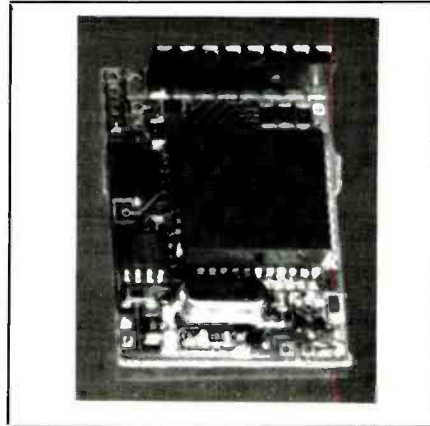

Miniature, Keyboard-programmable Morse Code Station Identifier

Midian Electronics' new ID-1 miniature Morse Code Station Identifier replaces the need to verbally or manually identify each transmission. The ID-1 will automatically send a 16-character station ID and/or 130-character message at user-programmable intervals. The ID-1 is easily programmed via a 12-button Touch-Tone® style keypad with alphanumeric characters. Other programmable features include front porch delay, code speed, Morse tone frequency, bypass for PTT queuing, wait period for loss of COR input, and automatic repeat intervals. If desired, the ID-1 can also send Morse code manually. The ID-1 takes the guesswork out of FCC-required radio user identification. Size: 1.4" x 1.1" x .25". Contact Midian Electronics for more information: 2302 East 22nd St., Tucson, AZ 85713-2024, or circle 103 on our Reader's Service.

Computer Control For PRO2006 Scanner

Datametrics Inc. has developed a version of its Computer Aided Scanning (CAS) system for the Radio Shack PRO2006 receiver. The system enables a PC compatible computer to control the PRO2006 and adds numerous benefits.

Datametrics stated that consumer requests for CAs control over the PRO2006 scanner, led to the development of the system. Because the manufacturer does not yet support computer control, Datametrics developed new technology named Machine State Virtualizer technology to implement the system.

The system is comprised of a hardware interface (utilizes the PC printer port) and software system. The unit retails for \$349.00.

Datametrics Inc., 2575 S. Bayshore Drive, #8A, Coconut Grove, FL 33133

Telephones Enroute continued

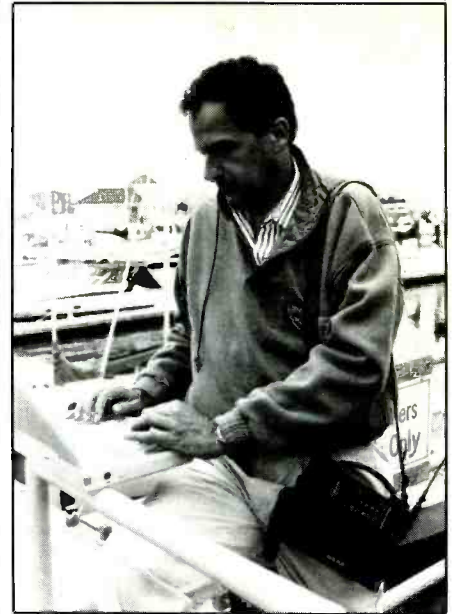

A laptop and a cellular connects boaters with the nationwide On Board nautical information service. Here, John Belliveau sets up for data with his Zenith notebook and cellular at the Spring Point Marina, Portland, Maine.

operating prompts, or for scrolling through its internal memory directory while looking for a name held in its storage.

It has a signal strength meter and auto answer, a retractable antenna, a noise canceling microphone, and it offers more than two hours of total talk time on a single battery charge, plus a carrying case. A charger accessory restores the batteries to full power in only an hour.

For more information, contact Motorola, Inc., Pan American Cellular Subscriber Group, 1475 West Shure Drive, Room N232, Arlington Heights, IL 60004.

Spiked

The new *Ultra Link* series of spike-type cellular antennas has recently been introduced by The Antenna Company. Those now available are a 1-inch quarter-wave spike, and a 6-inch elevated spike for weak signal areas (both custom-designed for use with Motorola handhelds). Also available are a 7-inch straight spike and a 9-inch right-angle antenna featuring a horizontal/vertical 180-degree swing with built-in stops. These two spikes have TNC connectors making them suitable for use with many brands and models of portable and transportable phones.

For information on these, contact The Antenna Company, 2525 Braga Drive, Broadview, IL 60153.

Later

Be with us again in February! Pass along your thoughts, comments, inquiries. Manufacturers and service suppliers are invited to keep us up-to-date on their products and activities.

FOCUS ON FREE RADIO BROADCASTING

It's been another busy month, both for pirate broadcasters and DX'ers so let's get right into the loggings.

A newish station seems to be KXXI (or KXXBI). Heard by several of you, including Frederick J. Porzelt of Illinois who had them on 7415 at 0400 announcing as "Interplanetary Radio, owned and operated by Clandes Corp with studios in outer space" and with such slogans as "Music at the speed of light . . . 450,000 cycles per second . . . XKXVI, Supersonic Radio. Mention was also made of a video entitled "Inside Pirate Radio" and an 800 phone number. Also heard by Pat Murphy in Virginia with numerous sound effects and heavy use of a "sampler" with repeating phrases and easy synthesizer music. William Hassig of Illinois also had this with "avant garde" programming and some interference. Also heard by Skip Harwood in California at the same time. This station is apparently not announcing any address.

Harwood also reports KCRN on 7406 at 0400 which, he says, is "another of the ever-changing call signs for a San Francisco area pirate." Skip says the programs are well done and feature classical and Pacific island music. Other calls noted being used have included KPUD, KCAN, KLOG and KPN-36.

William Rake reports hearing Tube Radio on 7416 at 0122. Pat Murphy had this one at 0121 with rock music and some interchange with a female DJ. Mention of "This is Ray Cathode on Tube Radio . . ."

WKND Radio was another station logged by Michael Kuentz who heard them on 7415 at 0253, several minutes after Action Radio signed off. The host was Radio Animal, also calling himself The Dog. The program included a telephone conversation with "Pirate Steve." Pat Murphy had this at 0321 and says it was more a talk show than anything, with mentions of the FCC, ad for the *Pirate Radio Directory* and ID "WKND . . . We're K-9 Dog." Terry Pack heard this one up to 0340 with ID "Weird K-9 Dog," talks about not leaving animals in cars with the windows all the way up, the dangers of lightning, FCC and free radio, etc. Address announced as PO Box 109, Blue Ridge Summit, PA 17214.

Robert Ross heard Radio Free America on 7415 at 0505 to 0511 close and ID as "Radio Free America is signing off on 7415 Mega-Hertz". The station says it is not a pirate but a free radio broadcaster. Apparently this station is not the same as the Radio Free America political program carried over WWCR.

A few recent QSL's: Frederick Porzelt has bagged replies from the Voice of Bono, Hope Radio and Radio USA. William A. Rake III got a card from He-Man Radio and Robert

Ross has replies from Radio Stella International in Scotland (on 11416).

Radio USA continues to be heard. Deron Lundy in Ohio had them at 0214 (Deron forgot to include the frequency but I expect it was on or near 7415) with what appeared to be a salute to the troops and rock music. Address announced as PO Box 452, Wellsville, NY 10895. Robert Ross, Ontario, had them on 7416.6 at 2258 sign on with punk rock and host Mr. Blue Sky. William Rake III in Pennsylvania had them at 0042.

Another active one has been Action Radio. Michael Kuentz in Ohio had this one on 7415 at 0232 with ID "Coming to you from off the west coast of Nebraska, this is Action Radio." Terry D. Pack in Ohio had them at 0215 with rock music and announcing the Wellsville, New York address. William Rake noted the station at 0130. Pat Murphy found them with rock music at 0200 "broadcasting from our new studio anchored off Nebraska."

Murphy heard the Revolutionary Voice of Plainsville on 7415 at 0458 with MOR standards, mailbag read with a Darth Vader type of voice. ID as "This is the Revolutionary Voice of Plainsville . . . Commandante John with the news." William Rake noted the station on 7416 at 0158.

Robert Ross continues his good fortune with reception of European pirates. Bob heard Radio Tower on 15050 from 0158 with



cartoon music themes, ID as "Radio Tower," jingles, rock and an address of Box 19074, Utrecht, Holland.

Bob also reports reception of WORK on 7412.6 at 0233 with a parody on evangelistic broadcasts, funny skits, "The Joe Show," ID as "WORK - Workers Operating Receiver Knobs." Gives the Wellsville address.

Another good and informative month! Thanks to all who participated and I hope you'll continue to keep sending in your logs, QSL news, clippings and other pirate news.

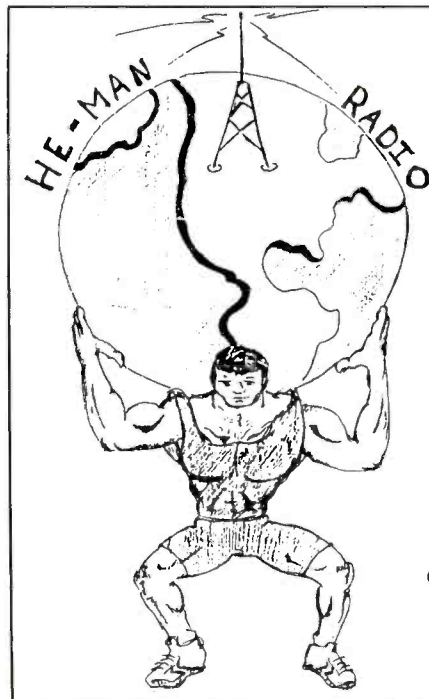

WILLIAM A. RAKE III

HE-MAN RADIO

QSL #23

DATE APRIL 21 1991.

TIME 00.30-00.55 UTC

FREQ 7.415 kHz.

YOUR REPORT MATCHES MY STATION
LOG. THX FOR WRITING.
CONTINUE TO BE MASCULINE.

v/s He-Man

He-Man Radio sent this QSL to William A. Rake, III.

THE EXCITING WORLD OF RADIOTELETYPE MONITORING

“**A**nd what is so rare as a day in June? Then, if ever, come perfect days,” penned the poet James Russell Lowell a long, long time ago. The answer these days must be in trying to get a decent RTTY signal in June. And in July. And in August and September.

Receiving conditions for RTTY monitoring over shortwave radio remained poor from late Spring through early Autumn. Major and minor solar storms were frequent, often preventing distant and sometimes local RTTY signals from being heard.

There were occasional signals, however. Not finding many RTTY signals to monitor, I turned my attention to radiofax. Several times I picked a clear, clean signal from the weather station in Melbourne, Australia, but, at the same time, I found it most difficult getting clear reception from commercial maritime station WLO in Mobile, Alabama, which runs a fax signal on the 9 MHz band. Printouts of WLO's maps always appeared dark grey on my printer. Occasionally, weather maps from NAM, the U.S. Naval base at Norfolk, Virginia, would be zapped by atmospheric noise pollution. For weeks the noise I heard resembled sizzling bacon.

Toward the middle of September, I was able to pull in the fax signal of LRB72, the weather station at Buenos Aires, Argentina. It was sending a nonstop series of weather charts from 2220 to 0006 UTC on 10720 kHz. Output was legible but of fair quality that still topped WLO's signal.

A couple of times, while I was watching the Cable News Network, the signal became briefly scrambled. Part of a recorded announcement told viewers that the signal loss could have been caused by the effect of solar activity on CNN's satellite, and that such activity was expected to continue into the Autumn months. This was discouraging news, indeed, knowing that this would also affect shortwave radio transmissions.

This couldn't have come at a worse time. While reception was terrific during the Persian Gulf war a year ago, and one could find lots of diplomatic RTTY activity relating to that war, poor radio reception occurred during the breakup of the Soviet Union and the turmoil in Yugoslavia. Nothing could be heard at my listening post on any diplomatic channels during these major events.

One would have had to look long and hard to find transmissions worthy of interest during this period. All shortwave bands appeared to be either void of RTTY signals or the signals were just too faint to decode no matter the time of day. The strongest transmissions always were that of U.S. Military stations sending either encryption or MARS traffic, or WLO's numerous RTTY channels.

But there were some slim pickings, for instance, a station identifying itself as “Lynx”

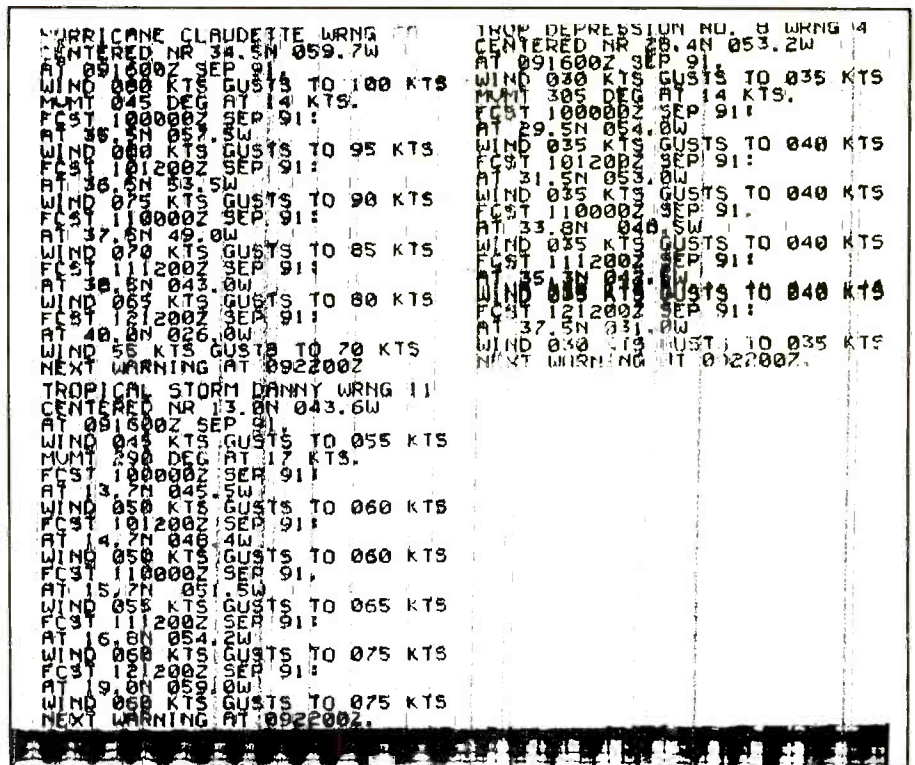

Whenever tropical storms brew in the North Atlantic Ocean, NAM, U.S. Navy, Norfolk, Virginia, issues special radiofax warnings. A “hat trick” of storms, hurricane Claudette, tropical storm Danny, and tropical storm Erika, occurred at the same time last September, causing the issuance of this special broadcast. It ran at 1645 UTC on 10865 kHz, 120/576. (Monitored by Robert Margolis)

repeatedly sent out an ARQ phasing signal and its ID in CW. It was heard periodically during August and September on 10231.7 and 11198.7 kHz at around 0330 UTC. This station shows its face every now and then on various shortwave bands, but I have yet to get it while it's sending anything beside a phasing signal. Past reports from contributors of loggings to this column have also shown no signs of any traffic ever being sent. Even after searching numerous references to utility stations and frequencies, I could find no clues to who is operating this station.

I spent some of the time analyzing a RTTY signal on 16220 kHz, which I heard daily during the daylight hours. There used to be an ARQ-M2/96 (TDM) circuit on this frequency between RBI74, PTT, Moscow, USSR and Havana, Cuba, but for two years now, I have been unable to get any of my decoders to lock onto that mode. The transmission is still at 96 baud, has a 396 Hz shift, and has a 64 bitblock cycle. The ITA3 alphabet is used. I have watched this station for hours on end but have only seen it idling, never with any traffic.

I don't think it's coming from Moscow because the signal strength is always strong, even during periods of bad propagation. I sus-

pect the station to be in Cuba and is possibly being beamed to Moscow.

This was one of my first tries at analyzing a RTTY signal when I had no prior knowledge of its characteristics. Manuals that accompany decoders say one has to be experienced in data signal analysis in order to understand how to use the decoder's analysis feature. How right the manuals are! It's tough going but, I'm beginning to get a hang of it.

One problem I find in learning how to analyze RTTY signals is in finding suitable textbooks that teach the subject. The data communications textbooks that I found at a local university bookstore discuss the signal characteristics of SITOR-A, SITOR-B, and TDM (time division multiplex) modes, which have been in use for a very long time. However, I haven't been able to find textbooks that have been updated to include the more recent modes such as: ARQ-E, ARQ-E3, ARQ-6, ARQ-N, Autospec, Piccolo, Coquelet, DUP-ARQ, SWED-ARQ, FEC-A, FEC-S, POL-ARQ, ROU-FEC, TOR-G, and numerous others that are heard on a daily basis (at least they were before this solar storm thing began). Presumably, the textbooks don't mention those modes because they were developed by European computer pro-

grammers and are not in use yet in the United States. If any reader knows where I may obtain a textbook that discusses those "foreign" modes, please send me the title and from whom I can order the book. It would be most appreciated.

Since not much could be heard during the solar storm period, I thought I would see if a couple of U.S. stations I logged within the past year were still on the air. They were. Monitoring 48.2 kHz at 0345, I saw RY's plus a "quebec kilo gulf" coded message in phonetics at 50 baud. No ID was seen but previous loggings say that this station was either the Strategic Air Command, Silver Creek, Nebraska, or Whitman AFB, Missouri. It used a very narrow shift of 38 Hz. The other station was reported in this column nearly a year ago on 1742.5 kHz. The station, whose identity I still haven't learned, was sending data in connection with the Navstar Global Positioning System. Now it was sending encryption in ASCII mode, 150 baud.

Abbreviations Used In The RTTY Column

AA	Arabic
ARQ	SITOR mode
BC	Broadcast
EE	English
FEC	Forward Error Connection mode
FF	French
foxes	"Quick brown fox . . ." "test tape"
GG	German
ID	Identification/led
MFA	Ministry of Foreign Affairs
nx	News
PP	Portuguese
RYRY	"RYRY . . ." "test tape"
SS	Spanish
tfc	Traffic
w/	With
wx	Weather

RTTY Intercepts

Here are the foreign transmissions that are able to cut through high noise levels.

- 5847.5:** TUH55, ASECNA, Abidjan, Ivory Coast, w badly garbled RY's 50 baud at 0107.
- 8123.2:** TNL48, ASECNA, Brazzaville, Congo, w/aero wx on channel B at 0424, and then on channel A at 0441, ARQ-M2/96.
- 9068.2:** Un-ID idling, 2330-2355, then off the air, autospec/68.5.
- 9071:** Another sta found idling in autospec/68.5 mode, 2355. Sig slowly faded away but still could be heard more than an hour later.
- 10283:** FUF, French Navy, Fort de France, Martinique, w "controle de voie," ARQ-E3/100 at 0113. Uses RFLI c/s.
- 10493.7:** RFTJF, French Military, Port Bouet, Ivory Coast, w/a 5L msg at 0202, ARQ-E3/48.
- 10749.5:** Un-ID w/encryption, ARQ-E/192 at 0124.
- 10918.7:** RFTJ, French Navy, Dakar, Senegal, w "controle de voie" at 0420, ARQ E3/48.
- 11541.7:** RFLI, French Navy, Fort de France, Martinique, w "controle de voie," ARQ-E3/96 at 0930.
- 12192:** DFZG, MFA, Belgrade, Yugoslavia, w/nx in SC, FEC-A/144 at 2317.
- 12315.2:** RVW57, Tass, Moscow, USSR, w/RYRY, 50 baud at 1654.
- 13393:** Un-ID w 5L msgs, 75 baud at 1417. Headers begin w "11177 . . ."
- 13425.2:** Un-ID w "van indiohmver daele ao nnnn," ARQ at 1503. Obviously very garbled. Was buried under heavy QRN during solar storm period.
- 13575.2:** HBD46, Swiss Embassy, Havana, Cuba, w "This is HBD46. Tks for calling. Ere qru. Best 73. Bibi." Was ARQ at 1145.
- 14626.7:** RFLI, French Navy, Fort de France, Martini-

- que, w "controle de voie," ARQ-E3/100 at 2233.
- 14845.8:** MKK, RAF, London, England, w/RYRY, foxes, & 10 count, 50-baud FDM at 1834.
- 15715.3:** CNM66, MAP, Rabat, Morocco, w/nx in EE, 50 baud at 1400.
- 15801.5:** Un-ID idling, ARQ6-90/200 at 1230, and off the air at 1237.
- 16010:** CLP1, MFA, Havana, Cuba, w/telexes to the Cuban Embassy at Managua, Nicaragua, 50 baud at 1500.
- 16133.2:** Un-ID w/a 5F msg, 1254-1310, 50 baud. Header to msg began "11166 . . ."
- 16300:** NNN0MGB, USMC MARS, Guantanamo Bay, Cuba, w/MARSgrams, 75 baud at 1400.
- 16345.7:** CLN530, PL, Havana, Cuba, w/nx in SS, 50 baud at 2107.
- 16518:** Un-ID w/the last two lines of a 5F msg, then "QRU QRU SK SK," 75 baud at 1405.
- 17020:** UDK2, Murmansk R., USSR, w/telegrams in RR, 50 baud at 1930.
- 17458.7:** CLP1, MFA, Havana, Cuba, w/5F msgs at 2234, 75 baud.
- 17491.7:** GYU, Royal Navy, Gibraltar, w msgs to an un-ID sta., 2037-2059, 50 baud
- 18039.5:** CLP1, MFA, Havana, Cuba, w/UPI, EFE, and PL nx items, 50 baud at 2225.
- 18230:** GFL25, Bracknell Meteo, England, w coded wx at 1543, 50 baud. Although an easy-to-get station that is often heard, during solar storms last summer it could be hardly heard at all.
- 18297.4:** Un-ID sends only a BMRF selcal in ARQ mode at 1521.
- 18310:** RDT57, Tass, Moscow, USSR, w/nx in FF at 1551, 50 baud.
- 18405:** RCT57, Tass, Moscow, w/nx in EE, 50 baud at 1556.
- 18496:** CNB80, MAP, Rabat, Morocco, w/nx in AA, 50 baud at 1559.
- 18632:** CLP1, MFA, Havana, Cuba, w/EFE, UPI, and PL nx in SS, 50 baud at 1335.
- 18768:** Un-ID w encryption, ARQ-E/192 at 1423.
- 20470.8:** CXR, Montevideo Navrad, Uruguay, w RYRY & SGSG to OBC at 1608, 75 baud.
- 20845.2:** RFQP, French Navy, Djibouti, w/a 5L msg on channel A at 1712, and aero wx on channel B at 1718, ARQ-M2/200.
- 23052:** CLP1, MFA, Havana, Cuba, w crypto after ZZZZ & telexes in SS to Mozambique, 75 baud at 1907.
- 23681:** Un-ID French diplo sta w 5L grps at 2016, ARQ-90/200.
- 25420.7:** German Consulate, Sao Paolo, Brazil, w/tfc in GG to Bonn, Germany, ARQ-E/96 at 1623.

AMIGA + ICOM

create the Ultimate Scanning Combination!

The ONLY system that can directly generate speech. The Amiga may directly control a tape recorder. Over 1000 channels per file. By channel control lockout, mode, tape, frequency, say the time, say the frequency, even say the users comment! Range scan may generate custom scan files. Automatic time and date stamping of hits. Auto lockout mode. Scan by comment (ie infinite banks) High resolution graphics show all hit activity. Scans at over 1300 channels per minute on ANY speed Amiga. Generates ASCII scan files. Programmable delays fix all of Icoms scan delay problems! Built in mouse driven editor for all channel information. No radio modifications required, does not need Icoms CI V or speech options. Includes the custom hardware interface for the radio and cassette player, software, manual, example scan files and stepping in the U.S.

R7000 or R71A (needs UX-14) \$149 (check / money order / VISA / M-C)
 Future Scanning Systems Manual + Demo Disk
 PO BOX 854 \$15
 Bartlesville OK 74005

BOOK II HOW TO GET ANYTHING ON ANYBODY

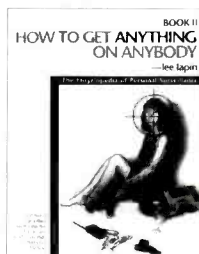

ALL NEW LEE LAPIN!

Best Bugs On A Budget to super secret CIA fine wire kits. How the FBI sees thru walls to low cost starlight scopes. Electronic and mechanical tailing tricks, surveillance photography, intelligence kits. **Cutting edge** audio/video surveillance, HOW TO crack computers, bypass passwords, obtain unlisted phone numbers, intercept cellular calls, pagers, and faxes, trace and track anyone, surveillance proof any room, tap any phone, and more! **WHEW!** "Really scary stuff." Charles Jaco CNN. \$38.50 postpaid.

ORDER TODAY!

ISECO, 2228 El Camino Real, #349-23, San Mateo, CA 94403. 415-513-5549.

SHORTWAVE LISTENERS

Create customized listening schedules on any IBM-compatible PC using:

PC SHORTWAVE MONITOR™

Printouts by COUNTRY - or by any combination of LANGUAGE, PROGRAM, and BC DIRECTION codes.

\$19.95 + 2.50 S/H - or DEMO \$3.50

Please specify 5-1/4 or 3-1/2 disk format.

S. Giltln 86-29 155th Ave., Ste. 5N
 (718) 738-8943 Howard Beach, NY 11414

CIRCLE 157 ON READER SERVICE CARD

SE SIGNAL ENGINEERING'S High Performance CB Antennas

SUPERHAWK
\$114.95



Goldenrod 45 Mobile Antenna



SPYDER A
\$35.95

WHITE LIGHTNING
\$199.95

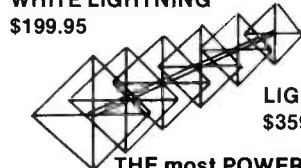

LIGHTNING 6
\$359.95

THE most POWERFUL CB base in the world today!

All SE PATENTED rotary beams are true quads and OUTPERFORM their counter parts (quad/yagi types). SE's patented SFS matching system makes SE QUADS the most technologically advanced antennas in the world today. If your dealer doesn't have SIGNAL ENGINEERING, write or call for full specs. DEALER inquiries invited.

SIGNAL ENGINEERING

2624 Fayette Drive, Mountain View, CA 94040
 (415) 948-3833

CIRCLE 156 ON READER SERVICE CARD

BROADCAST DX'ING

BY ROGER STERCKX, KVT1JH

DX, NEWS AND VIEWS OF AM AND FM BROADCASTING

Ask & You Won't Receive: A couple of dozen letters have come in during the past few months mentioning that late-night DX'ers used to be able to call up stations they were hearing from across the nation and get record requests played. In the last couple of years that has gotten increasingly difficult, as stations don't seem to appreciate record requests as much as they used to. Is this a fact, or merely a misconception?

I think it's a fact of life, based upon my own work within the broadcasting industry. It's a misconception of the public that most commercial stations have late night deejays playing the music they want.

A great many stations don't even program their own music at night when they can now stay on the air with only a minimum of bother and staff. They subscribe to satellite-delivered program feeds furnishing them in advance with computer-generated playlists which tell the titles of the songs that are going to be played, hour by hour. If you tune across the nighttime AM band, you're liable to hear the same satellite-fed narcoleptic elevator music playing simultaneously over a whole slew of stations. The announcer is also part of the satellite feed, with local station breaks and commercials automatically fed in by machine.

The local announcer who used to play those late-night requests for listeners is either out of a job, or else has become little more than a telephone answerer or night watchman. Sadly, some stations operate this way around the clock, not only at night.

Blast From The Past: Oklahoma City's KOMA/1520 is a 50 kW powerhouse that

kicks out a big signal throughout 22 western states and Canada. POP'COMM reader Bob Eckart produces KOMA's *Solid Gold Time Machine*, which airs every Saturday night from 9 p.m. to 3 a.m., as hosted by Ricky the K (Richard Kaufman). He also produces KOMA's *Doo-Wop Shop*, which follows *Solid Gold* until 5:30 a.m.

These aren't satellite feeds, but live shows, backed by thousands of golden oldies discs, and a complete recreation of the great sound of those famous classic "boss" AM rock stations of the 1960's. If you want to hear live late nite deejays, here's one to try for!

Station Bits 'n Pieces: We have previously mentioned KA2XXZ/107.9, the 250 watt Walt Disney World experimental FM station at Columbia, FL. The station had a temporary license (expired last August) to transmit weather, traffic, and other similar information. When last heard from, the Disney people were trying to get the FCC to give the OK for some digital broadcasting tests on 107.5 MHz, adjacent to the KA2XXZ channel. The idea is to see if the digital transmissions affect the KA2XXZ operations. This means that KA2XXZ operations may continue for a while longer, with FCC approval.

Boston's WBMX/98.5 used to be WROR-FM. Under its old callsign and format, the station wasn't pulling in much of an audience. When it became WBMX, it shed its loser image and format, switching over to a hot adult contemporary mix. That pulled its ratings up from 12th to 6th place in only five months. 'Nuff said! Changing formats also seemed like a good idea at Boston's WEEI/590, which

Requesting FM Call Letter Change

Now	Seeks	
KDWD	KKMI	Burlington, IA
KRCD-FM	KRSS	Chubbuck, ID
WCBZ	WBZD	Bowling Green, KY
WDLE-FM	WQMR	Federalsburg, MD
WGEC	WQQT	Springfield, GA
WKTW	WWNJ	Dover Twp., NJ
WKTX	WXTD	Cortland, OH
WOCB-FM	WXTK	W. Yarmouth, MA
WTRL-FM	WBOG	Tomah, WI

Changed FM Call Letters

New	Was	
KAGR	KAXX	Ventura, CA
KCRN-FM	KTEO-FM	San Angelo, TX
KEZP	KRBG	Bunkie, LA
KFIA-FM	KLIQ	Shingle Springs, CA
KHID	KXGZ	McAllen, TX
KHIH	KSSP	Boulder, CO
KFIX	KBWL	Roosevelt, UT
KIQN	KTOQ-FM	Rapid City, SD
KKMI	KDWD	Burlington, IA
KNDD	KMGI	Seattle, WA
KOJJ	KPOR	Porterville, CA
KOOC	KYZZ	Belton, TX
KQNN	KOPY	Alice, TX
KQSN	KQYT	Green Valley, AZ
KRBG	KEZP	Canadian TX
KSJQ	KXGY	Savannah, MO
KSOS-FM	KSOS	Brigham City, UT
KSTM	KQMJ	Henryetta, OK
KTEO	KCRN-FM	Wichita Falls, TX
KTHN	KSNN	Los Banos, CA
KTHS-FM	KSSC	Berryville, AL
KUCU	KMYI	Armijo, NM
KUSN	KQQF	Coffeyville, KS
KVAY	KNIC	Lamar, CO
KZOQ-FM	KZOQ	Missoula, MT
KZZX	KINN-FM	Alamogordo, NM
WAKB	WRDW-FM	Wrens, GA
WBCM	WCLX	Boyne City, MI
WBNF	WSEJ	Marianna, FL
WBUB	WKQB	N. Charleston, SC
WCCZ	WQHN	Spangler, PA
WFXX	WQON	Grayling, MI
WGRF	WGR-FM	Buffalo, NY
WHKZ	WYYS	Cayce, SC
WJAW	WYBH	McConnellsville, OH
WJOC	WDXB	Chattanooga, TN
WKLZ	WJML-FM	Petoskey, MI
WLLF	WKTU-FM	Mercer, PA
WMEG	WSRA	Guayama, PR
WMXS	WCLN-FM	Clinton, NC
WMYA	WKSU	Cape Charles, VA
WNKX-FM	WHLP-FM	Centerville, NM
WODE-FM	WHXT	Easton, PA
WRBR-FM	WZZP	South Bend, IN
WQBX	WXJF	Omega, GA
WTRV	WLEL	Leland, MI
WXLO-FM	WXLO	Fitchburg, MA

Call Letter Assignments And Changes Rescinded

New	Was	
KLMC	KQIV	Litchfield, MN
KQBD	(new)	Preston, ID
KTRN	KDAN	Williams, AZ

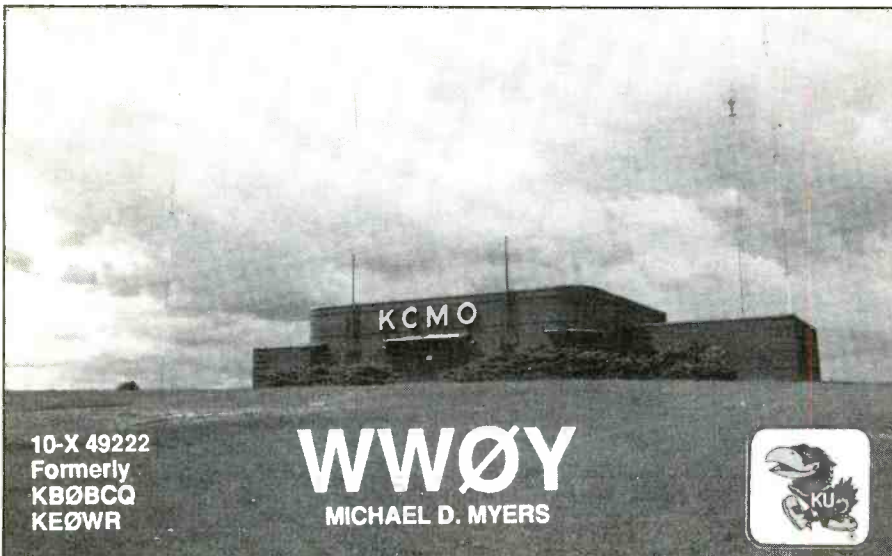

Michael D. Myers, WWOY, picked a good photo for his ham QSL. It's KCMO/810, of Kansas City, MO.

Applications Filed to Build New FM Stations

IA	Burlington	103.1 MHz
IL	Monee	88.9 MHz 10 kW
MI	Marquette	91.5 MHz 200 watts
MI	Stephenson	106.3 MHz 50 kW
WY	Laramie	104.5 MHz 3 kW

Permits Issued To Build New FM Stations

AR	Hot Springs Vlg.	92.9 MHz 3 kW
AR	Little Rock	99.5 MHz 3 kW
AR	N. Little Rock	101.1 MHz 3 kW
CA	Avalon	92.7 MHz 200 watts
CA	Orcutt	95.7 MHz 3.4 kW
CA	Oxnard	102.1 MHz 3 kW
CA	Santa Rosa	91.1 MHz 170 watts
FL	Panama City Bch.	105.1 MHz 50 kW
FL	Quincy	100.7 MHz 3 kW
GA	Hogansville	97.5 MHz 3 kW
IL	Augusta	101.1 MHz 1 kW
IN	Ft. Wayne	92.1 MHz 2 kW
IN	Greenwood	106.7 MHz 3 kW
KS	Copeland	98.1 MHz 100 kW
KS	Liberal	105.1 MHz 50 kW
KS	Minneapolis	92.7 MHz 6 kW
KS	Minneapolis	99.1 MHz 100 kW
KY	Wilmore	96.3 MHz 3 kW
ME	Dennyville	102.9 MHz 3 kW
MI	Essexville	97.3 MHz 3 kW
MI	Walker	100.5 MHz 3 kW
MN	Rushford	99.3 MHz 6 kW
NC	Highlands	104.5 MHz 350 watts
NH	Hampton	102.1 MHz 3 kW
NH	New Durham	91.7 MHz 300 watts
NH	Walpole	96.3 MHz 1.2 kW
NY	Middletown	91.7 MHz 750 watts
NY	Montauk	94.9 MHz 3 kW
OK	Nowata	101.5 MHz 6 kW
OR	John Day	91.9 MHz 1.5 kW
OR	Medford	91.7 MHz 1.3 kW
VA	S. Boston	95.3 MHz 2.7 kW
WA	Davenport	102.5 MHz 3 kW
WI	Green Bay	88.1 MHz 50 kW
WI	Green Bay	88.5 MHz 3 kW

Permits Issued To Build New AM Stations

OR	Eugene	860 kHz
OR	Junction City	650 kHz
OR	Troutdale	860 kHz

Applications Filed For AM Facilities Changes

KAOK	Lake Charles, LA	1400 kHz	Drop to 900 watts
KCBR	Monument, CO	1040 kHz	Drop to 1.9 kW
WSMX	Winston-Salem, NC	1500 kHz	Drop days to 1 kW
WXGM	Gloucester, VA	1420 kW	Drop days to 740 watts

AM Facilities Changed

WAGE	Leesburg, VA	1200 kHz	Increased days to 10 kW
WESO	Southbridge, MA	970 kHz	Increase to 500 watts, add nights.
WULA	Eufala, AL	1240 kHz	Drop days to 600 watts.

Application To Change FM Frequency

WTJU	Charlottesville, VA	91.1 MHz	Seeks 91.1 MHz, 750 watts
------	---------------------	----------	---------------------------

FM Frequency Changed

KBEK	Mora, MN	95.3 MHz to 95.5 MHz, 17.2 kW
------	----------	-------------------------------

New AM Call Letters Issued

KZTU	Junction City, OR
KZTW	Troutdale, OR
KZTY	Winchester, NV
KZTZ	Eugene, OR

AM Call Letter Changes Requested

Present	Seeks	
KISZ	KVFC	Cortez, CO
WBXT	WCER	Canton, OH
WKDY	WYYR	Spartanburg, SC
WKTG	WXTD	Cortland, OH



This European bumper sticker is from RETE-3, "Radio Della Svizzera Italiana." It was sent in by Michael Kelly, HB9OAE, Purasca, Switzerland.

dumped its all-news format and switched over to all-sports, like New York's WFAN. That left Boston as one of the few major metro areas without an all-news station. Well, WEEI is owned by the Boston Celtics, so maybe it wasn't so shocking. Some non-sports WEEI personnel were sent to the showers, though, in the format change.

The most radical addition to the Boston air-

waves was on WZLX/100.7 MHz. Last summer the station added almost inaudible mosquito repeller sounds to the background of its normal programming some weekend evenings. WZLX's program director said that the commercially sold device kept the mosquitoes at bay when he tried it in his home, and that the audio signals also were effective when broadcast on WZLX's sister station in Atlan-

ta. For broadcasters wanting to try this next summer, the mosquito repeller they used was the Transonic IXL Pest Repeller. Thanks to Bob Gilbert, of Portland, ME for these tidbits.

Mark Henning, N2DUJ, of Hamburg, NY advises that CJFT hasn't dropped operations on 530 kHz in order to open up on 101.1 FM, as one of our readers suggested here in the September issue. Mark reports CJFT simulcasts on both frequencies and plans to remain on 530 kHz, according to people he spoke to at the station in Erie, Ontario. Mark tells us that the confusion may have arisen from the fact that Canadian stations don't appear to have to announce their actual call letters with the same regularity as American stations. If you listen for anybody ID'ing as CJFT on 530 kHz, you'll mostly be disappointed. The station usually ID's only as *Rich Blend FM 101.1*, with nary a reference to CJFT.

Jim Devan, President of WZAL/1540, McDonough, GA received a fatal electrical shock while servicing the station's 2.5 kW transmitter. As at many small stations, the chief wore several hats. He was the manager, the news director, and performed many

If you enjoy Amateur Radio, you'll enjoy CQ.

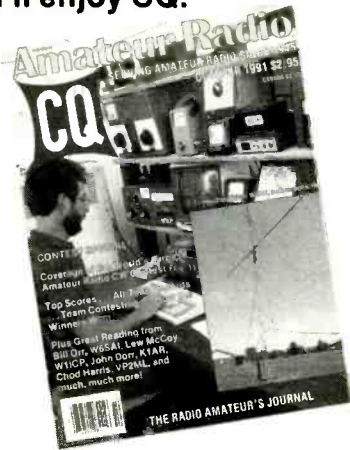

It's a different kind of ham magazine. Fun to read, interesting from cover to cover, written so you can understand it. That's CQ. Read and enjoyed by over 80,000 people each month in 116 countries around the world.

It's more than just a magazine. It's an institution.

CQ also sponsors these thirteen world famous awards programs and contests: The CQ World Wide DX Phone and CW Contests, the CQ WAZ Award, the CQ World Wide WPX Phone and CW Contests, the CQ World Wide VHF WPX Contest, the CQ USA-CA Award, the CQ WPX Award, the CQ World Wide 160 Meter Phone and CW Contests, the CQ Five Band WAZ Award, the CQ DX Award, and the highly acclaimed CQ DX Hall of Fame. Accept the challenge. Join the fun. Read CQ.

Also available in a Spanish language edition. Write for rates and details.

SUBSCRIBE TODAY!



The Radio Amateur's Journal
76 North Broadway
Hicksville, NY 11801

Please start my CQ subscription with the next available issue. Enclose payment or charge information with order. Term and Rate (check one):

	USA	VE/XE	Foreign
1 Year	<input type="checkbox"/> 22.95	<input type="checkbox"/> 25.	<input type="checkbox"/> 27.
2 Years	<input type="checkbox"/> 43.	<input type="checkbox"/> 47.	<input type="checkbox"/> 51.
3 Years	<input type="checkbox"/> 63.	<input type="checkbox"/> 69.	<input type="checkbox"/> 75.

Paid by: Check Money Order
 VISA MasterCard

Card Number:

--	--	--	--	--	--	--	--	--	--

Allow 6-8 weeks for delivery of first issue

Name _____
Street _____
City _____
State or Country _____ Zip _____

Changed AM Call Letters

New	Was	
KAPL	KITH	Apple Valley, CA
KCMZ	KDBN	Dallas, TX
KCRN	KTEO	San Angelo, TX
KISP	KAMJ	Phoenix, AZ
KKLE	KVFW	Winfield, KS
KSOS	KNKK	Brigham City, UT
KSUR	KJOY	Soledad, CA
KSWD	KRXA	Seward, AK
KTLD	KKLC	Pineville, LA
KVAR	KFHM	San Antonio, TX
KYET	KDAN	Williams, AZ
WDAK	WTXN	Lafayette, AL
WDGY	KDWB	St. Paul, MN
WJBW	WRBK	Cantonment, FL
WJOC	WDXB	Chattanooga, TN
WJZS	WDRG	Orangeburg, SC
WKMW	WDKT	Madison, AL
WNKX	WHLP	Centerville, TN
WNSS	WXRA	N. Syracuse, NY
WODE	WEEX	Easton, PA
WORG	WMNY	Santee, SC
WTKZ	WRVC	Huntington, WV
WUNI	WBCM	Bay City, MI
WVEI	WFTQ	Worcester, MA
WVLC	WJOT	Salt Lake City, UT
WXLO	WFGL	Fitchburg, MA
WXTC	WCSE	Charleston, SC

New FM Call Letters Issued

KACH-FM	Preston, ID
KBQA	Salt Lake City, UT
KBQB	Princeville, HI
KGAS-FM	Carthage, TX
KGDP-FM	Orcutt, CA
KJIL	Copeland, KS
KLSM	Oxnard, CA
KOUG	Avalon, CA
KOUH	Nowata, OK
KOUI	Lucerne Valley, CA
KOUJ	Groveland, CA
KOXA	Le Sueur, MN
KQXB	Claude, TX
KQXC	Wichita Falls, TX
KQXD	Pearsall, TX
KVRE	Spring Village, AR
KWNO-FM	Rushford, MN

KZTQ	Karedo, TX
KZTS	Huron, SD
KZTT	Central, NM
WAHI	Augusta, IL
WEHM	Mosinee, WI
WEIZ	Hogansville, GA
WEJF	Palm Bay, FL
WFEN	Rockford, IL
WHHH	Indianapolis, IN
WHLC	Highlands, NC
WIXC	Essexville, MI
WLGW-FM	Lancaster, NH
WLME	Hawesville, KY
WLWF	Webster, NY
WLMK	Horse Cave, KY
WLML	Montezuma, GA
WLMM	Woodbury, TN
WLMN	Bowling Green, VA
WLPL	Walpole, NH
WLQH-FM	Chiefland, FL
WLVO	Live Oak, FL
WNJN	Atlantic City, NJ
WORQ	Green Bay, WI
WOSR	Middletown, NY
WOTR	Lost Creek, WV
WPDA	Jeffersonville, NY
WRMY	Rocky Mount, NC
WSEA	Panama City Beach, FL
WTPS	Quincy, FL
WTSN-FM	Somersworth, NH
WVNI	Nashville, IN
WVNL	Ledyard, CT
WVNM	Cedar Key, FL
WVNT	Madisonville, TN
WVNU	Greenfield, OH
WVNV	Malone, NY
WVNW	Burnham, PA
WVNX	Charlotte Amalie, VI
WVYD	Mechanicville, NY
WVYE	Port Gibson, MS
WVYF	Sylvester, GA
WVYG	Jackson, TN
WVTH	N. Wyndam, ME
WVYI	Wilmore, KY
WVYJ	Greenwood, IN
WWPC	New Durham, NH
WYGO	Madisonville, TN
WZBK	Sylvania, GA
WZIO	S. Webster, OH
WZNX	Arcola, IL

necessary technical jobs. After the accident, Devan was rushed to the hospital, but doctors were unable to save him.

Dr. F. Simowitz, of St. Louis, MO passed along word of an odd event. Late one night, somebody pried open the back door at WANY 1390/106.3, of Albany, KY. Thereupon, they ripped off \$15,000 worth of newly installed equipment, including mikes, turntables, consoles, amplifiers, CD's and other items. The station was so cleaned out that it wasn't even able to go on the air when staffers showed up for work in the morning.

About a month earlier, thieves broken in at WSBI/1210, which is 5 miles away from WANY, and pulled off almost the identical burglary. They tried to get WSBI's console, but couldn't pry it loose, so WSBI didn't miss any air time.

From Yucaipa, CA we got a note from Tom Martin, Registered Monitor KCA6XQ,

telling us that oldies station KOLA/99.9, Riverside/San Bernardino, CA increased its power from 900 watts to 31 kW. The new signal is coming from a 200 ft. tower atop Box Springs Mountain, replacing the old 50-ft. antenna there previously in use. There's a new transmitter, and other equipment to substantially improve the station's signal coverage and sound quality. Reports on the new signal were coming in from first-time listeners in Burbank and Los Angeles.

FCC Stuff: Don't volunteer to hang by your thumbs until new TV station WVUW/51, Pittsfield, MA comes on the air. A construction permit was issued in 1985 for the station to be built. After things got bogged down, the FCC canceled the permit in 1987. In August of 1988, the permit was reinstated when a new company took over the construction permit, telling the FCC that the station would go on the air within five months. The FCC told



Who's this guy? It's Coyote Calhoun, the afternoon jock on country music WAMZ/97.5, Louisville, KY. (Courtesy R. C. Watts, Louisville, KY.)

them that they had until February of 1990 to go on the air. In January of 1990, the owners requested an extension in order to acquire a state-of-the-art transmitter. In August of 1990, the FCC canceled the permit. In October of 1990, the station owners asked the FCC to reinstate the permit so that Pittsfield could get its first local TV outlet. The FCC turned it down, but they appealed in April of 1991. The FCC has now turned down the appeal, canceled the construction permit, and deleted the call letters.

Another new TV station you won't see is KCEO-TV/28, Oroville, CA. They were denied an extension of time to put the station on the air. The construction permit has been canceled, along with the call letters.

The FCC told the licensees of Albany, GA TV station WFXL, and holder of construction permits for four low power TV stations, to show cause why their licenses should not be revoked. The FCC contends that a principal owner "has been convicted of the felony of laundering money from the proceeds of illegal drug-related activity." After his conviction, the licensee (who is Hispanic) requested FCC approval to sell these properties under the FCC's Minority Distress Sales Policy. The FCC didn't go along with the proposal and, instead, asked the licensee to prove he is fit to remain a licensee.

The FCC's initial decision to revoke the license of WKSP/1090, Kingstree, SC has been upheld. The FCC said that the stations controlling stockholder had been convicted of "possessing cocaine with intent to distribute and of conspiring to commit that offense, crimes which are classified as felonies, and had been sentenced to five years imprisonment."

FCC Form 349 (Application for Authority to Conduct or Make Changes in an FM Translator or FM Booster Station) was revised. The old forms are no longer being accepted by the FCC. All forms submitted must

The Best* Just Got Better!

The Eavesdroppers™ now includes our new Zap Trapper™ Electronic Gas Tube Lightning Arrestors. Receive-only design shunts damaging transients to ground at only 1/7th the voltage buildup of the available 200 watt transmit-type arrestors, providing maximum solid state receiver protection.

Protect your investment - combine an excellent shortwave receiving antenna with the best receiver protection money can buy.



- Completely assembled and ready to use
- Only 42' overall length
- 8 trap circuits permit reception on all shortwave bands, 11-90 meters
- All connections soldered and enclosed in ultrasonically-welded, hermetically-sealed trap covers
- Includes 50' of 450 lb. test nylon rope

Model T includes 100' twinlead feedline

Model C includes weatherproofed center connector for your coax & coax sealant

- Either model \$79.95
- UPS for lower 48 states \$4.00
- COD add \$3.00, IL add 7% sales tax
- Foreign shipping quoted

"The best...built like an antenna should be." -Larry Magne in *World Radio TV Handbook*

"Our best seller." -EEB in their recent ads and catalogs.

"Now in use in 45 countries." -Gilder Shortwave in 1983

Antenna Supermarket

PO. Box 563 Palatine, IL 60078 Tel (708) 359-7092 Fax (708) 359-8161

At your dealer or direct • Visa & Mastercard accepted

Satellite-TV

SAVE 40% - 60%

All Major Brands, Systems, Upgrades, Components & Accessories
Huge Savings, Easy Installation and Complete Instructions

FREE 48 page Catalog

800-334-6455
218-739-5231 Int'l

SKYVISION INC. 1066 FRONTIER DRIVE
FERGUS FALLS, MN 56537

INSTALL OR UPDATE YOURSELF!

CB RADIO OWNERS!

We specialize in a wide variety of technical information, parts and services for CB radios. 10-Meter and FM conversion kits, repair books, plans, high-performance accessories. Thousands of satisfied customers since 1976! Catalog \$2.

CBC INTERNATIONAL
P.O. BOX 31500PC, PHOENIX, AZ 85046

be the edition revised as of May, 1991. The current forms may be obtained from the FCC's Form Distribution Center, 2803 52nd Avenue, Hyattsville, MD 20781, or by calling (202) 632-FORM and leaving your request on the answering machine.

See You Soon?: We will be here next month. Please keep us posted with AM/FM broadcast station bumper stickers, station photos, recent QSL's, news clippings, comments, format change data, and anything else you feel is of interest. Happy 1992 to all!

KHIT

104.5 FM

Reno's 12 in a row hit country station!

In Reno, KHIT/104.5 simulcasts on 1590 kHz. Nice bumper sticker, too. (Courtesy Pete Grenier, Sparks, NV.)

WASHINGTON PULSE

FCC ACTIONS AFFECTING COMMUNICATIONS

Equipment Seized From Pirate Radio Network

Assistant United States Attorney (AUSA) Jan Hartung announced that agents of the United States Marshals Service, assisted by agents of the United States Border Patrol, Officers of the Odessa Police Department and Ector County Sheriff's Office executed search and seizure warrants culminating an investigation conducted by the Dallas Office of the Federal Communications Commission (FCC), under the direction of AUSA Hartung, into the unlicensed operation of two FM radio stations in the Odessa, Texas, area.

The United States Marshals Service seized radio transmitting equipment along with associated audio production equipment and programming material from two residences. The unlicensed FM stations, identified as the "Pirate Radio Network," used the call signs "KROX" and "KFRE." The call signs used at the unlicensed radio stations are assigned by the FCC to licensed AM broadcast stations outside of Texas. Those stations had no involvement in the unlicensed operation. The unlicensed operations occurred on radio frequencies 95.1 MHz and 107.7 MHz.

Unlicensed operation of a radio station creates serious potential for harmful interference to the operation of licensed radio stations and is a violation of Section 301 of the Communications Act. Operators of unlicensed radio stations are subject to penalties of up to one year's imprisonment or fines of up to \$100,000 for each violation or both.

FCC And Colorado Police Locate Source of Interference To Police Radios

Grand Junction, Colorado, Police arrested Ernest Robert Jones of Grand Junction and accused him of interfering with law enforcement and fire department radio communications.

The FCC's Denver Office monitored transmissions based on complaints from Grand Junction's Police and Fire Departments and the Mesa County Sheriff's Department regarding interference to their radio communications. The interference consisted of noises, music, catcalls, rebroadcasts of official communications, and inflammatory remarks. The interfering radio signals were traced to Jones.

Mr. Jones was charged under several Colorado State statutes, including criminal tampering and obstruction of government operations. He may also be charged with violating Sections 301 and 333 of the Communications Act by operating an unauthorized radio station and intentionally interfering with authorized radio transmissions.

Chicago Pirate Station Shut Down

The FCC's Field Operations Bureau, in a coordinated effort between its monitoring network and the Chicago Office, shut down an unlicensed Illinois pirate broadcast station. Thomas J. Wells of Chicago, Illinois, was fined \$1,000 for illegally operating on radio frequency 7.415 MHz, which is allocated for use by the international fixed public radio communication service. Wells' program format was commentary and music. He identified the station as "Chicago Tunnel Company."

Unlicensed operation of a radio transmitter constitutes a violation of Section 301 of the Communications Act of 1934, as amended. Sanctions may include administrative fines of up to \$10,000, criminal penalties of up to \$100,000 and/or imprisonment for up to one year. Such misuse of radio frequencies is a serious offense because of the potential for interfering with safety-of-life services such as aviation, marine and law enforcement.

Reallocates Spectrum For Use By The Civil Air Patrol

The Commission amended its rules to reallocate the frequency 143.75 MHz for use by the Civil Air Patrol (CAP), a voluntary civilian auxiliary of the United States Air Force.

This action was taken in response to a request by the National Telecommunication and Information Administration and the United States Air Force (USAF), through the Interdependent Radio Advisory Committee. The USAF indicated that the CAP needed additional spectrum to support communications for disaster, emergency, search and rescue, and training.

The Commission concluded that reallocating this frequency would not adversely affect existing or future FCC licensees because 143.75 MHz currently is allocated exclusively for use by agencies of the Federal government. Consequently, a public notice and comment is unnecessary.

Fined \$36,250 For Signal Leakage

The FCC notified TCI Cablevision of Maryland, Inc., that it has incurred an apparent liability for forfeiture of \$36,250 for excessive cable signal leakage at its system serving Elkton, North East and Charleston, MD.

The Commission's Field Operations Bureau (FOB) inspected the system and found signal leakage. The leakage constituted a threat to aeronautical communications, predicated upon Cumulative Signal Leakage In-

dex calculations. FOB issued a cease operation order to TCI, with which the cable operator complied by curtailing service in the relevant frequency bands.

In determining the amount of the forfeiture, the Commission was guided by its recently adopted Standards for Assessing Forfeiture, released August 1, 1991. Under these standards, \$12,500 is the base forfeiture for unauthorized signal emissions. In this case, serious leakage problems were discovered on the first day of inspection. On the second day, the leakage was a more substantial aggravating factor, because of the serious threat to the public safety caused by such operation. Consequently, because the violation was repeated and egregious, a forfeiture of \$36,250 was determined to be appropriate by applying the adjustment factors of the standards.

Report On Measurements Of Electric And Magnetic Fields Near AM Broadcast Towers

The FCC Office of Engineering and Technology of the Federal Communications Commission (FCC) and the Office of Radiation Programs of the U.S. Environmental Protection Agency (EPA) have completed a report entitled, "Electric and Magnetic Fields Near AM Broadcast Towers." This report documents the results of a study performed jointly by the FCC and EPA as part of an ongoing agreement between the two agencies to cooperate in activities related to human exposure to electromagnetic fields created by FCC-regulated facilities.

The study consisted of measurements of electric and magnetic field strength within 100 meters of eight different AM broadcast towers. The purpose of the study was to acquire data that can be used to more accurately assess the potential for human exposure to radiofrequency radiation near AM towers. The Numerical Electromagnetic Code (NEC) computer program was used to model the towers for prediction of field strength levels and comparison with measured values.

Major conclusions of the study were: (1) measured values were generally in good agreement with NEC predictions; (2) electrical height of an AM tower is important in determining whether electric or magnetic fields predominate near the tower base; (3) significant effects on close-in electric field strength can result from conductive objects such as chain-link fencing; (4) field strength from a non-directional tower at a given distance may differ depending on radial direction from the tower; and (6) recommended distances from a tower given in FCC Bulletin No. 65 for compliance with safety limits tend to be conservative with respect to values measured in the study.

The number of the report is EPA/520/6091/020. Copies will be available for purchase from the National Technical Information Service (NTIS) and can be ordered by calling NTIS at (800) 336-4700. Call (202) 653-8169 (FCC) or (202) 260-8386 (EPA) to obtain the NTIS order number. Copies can also be purchased from the FCC's contractor for public records duplication, Downtown Copy Center, (202) 452-1422.

Amendment Of Part 15 Proposed To Enable Introduction Of Home Automation & Comms Systems

The Commission proposed amending Part 15 of its rules to allow the introduction of home automation and communications systems designed to integrate communications and control systems within the home environment and create the so-called "smart house."

Although consumers now have a variety of separate communications devices available, an amendment in the rules would mean that a single system could be used to help prevent fire and theft, control household energy use and distribute radio and television signals throughout the home.

Petitions for changes in the rules were filed by the Consumer Electronics Group of the Electronic Industries Association (EIA/CEG) and Smart House Limited Partnership.

The Commission said it recognized that there was considerable interest in the new technology offered by home automation and communications systems and said it appeared the country was on the threshold of mass introduction of such systems. In the future, it said, home communication systems may be as much an integral part of the home as plumbing, heating and electrical systems. It said it was initiating this rulemaking looking toward removal of unnecessary impediments to these systems while examining potential concerns about interference, particularly to AM broadcasting.

The Commission proposed establishing a uniform limit on radio frequency (RF) energy that can be conducted into the AC power lines by carrier current transmitters operating under Part 15 of the rules. It said it was concerned that the existing rules unfairly restrict carrier current transmitters that operate on frequencies below 450 kHz, thereby impeding home automation efforts; and the rules may not provide adequate and appropriate protection to AM broadcasting. The Commission also proposed clarifying the Part 15 television interface device requirements as they apply to TV distribution systems used in the home.

Private Radio Bureau Issues New Application Form

The FCC's Private Radio Bureau began issuing computer generated renewal notices for the Marine Coast and Aviation Ground Radio

Services (CFR Parts 80 and 87) on FCC Form 452R.

An application for Renewal of Private Radio Station License (FCC 452R), will be sent to licensees approximately 90 days prior to license expiration date. Marine Coast and Aviation Ground licenses may file this form in lieu of FCC 405A to renew, change mailing address, change licensee name (without change of ownership) or cancel their license. Fee information and mailing instructions are included on the applications for renewal.

For more information, contact the Private Radio Bureau's Consumer Assistance Branch at (717) 337-1212.

Policy On Private Printing Of FCC Forms

The FCC established a policy regarding the printing of blank FCC forms by private companies if they elect to do so as a matter of expediency to their clients or consumers. The policy is as follows:

(a) Blank FCC forms may be reproduced by private companies at their own expense provided the following conditions are met:

(1) Use a printing process resulting in a product that is at least comparable in quality to the original document, without change to the page size, image size configuration of pages, folds or perforations, and matching as closely as possible the paper weight, paper color and ink color.

USE
YOUR
FREE
INFORMATION
CARD

SUPER LONG PLAY TAPE RECORDERS
12 Hour Model — USES 120 TAPE
\$119.00*
 Modified Panasonic Slimline, high quality AC-DC provide 6 continuous hours of quality recording & playback on each side of cassette for 12 hours total. Includes • Voice level control • Digital counter, etc. TDK - 120 Cassette Furnished.

PHONE RECORDING ADAPTER
 Records calls automatically. All Solid state connects to your telephone jack and tape recorder. Starts recording when phone is lifted. Stops when you hang up. **\$28.50*** FCC APPROVED

VOX VOICE ACTIVATED CONTROL SWITCH
 Solid state. Self contained. Adjustable sensitivity. Voices or other sounds automatically activate and control recorder. Uses either recorder or remote mike. **\$28.50***

* Add for ship. & handling. Phone Adapter & Vox \$2.00 each. Recorders \$5.00 each. Calif. Res. add tax. Mail order. VISA, M/C, COD's OK. Money Back Guarantee. Quantity discounts available. Dealer Inquiries invited. Free data.

AMC SALES INC. Dept. P 9335 Lubec Street
 Box 928, Downey, CA 90241
 Phones (213) 869-8519 1-800-926-2488
 FAX (213) 923-1478
 Mon-Fri 8-5 PAC TIME

CIRCLE 118 ON READER SERVICE CARD

WEFAX To The Max



PC GOES/WEFAX 3.0 \$250

PC GOES/WEFAX 3.0 is a professional wefax image reception and analysis system for the IBM PC and compatibles. The product includes a demodulator that handles both AM and FM fax signals, advanced signal processing software, tutorial cassette, and complete 325 page reference manual. The software includes the following advance features:

Menu Driven	CGA, HGA, EGA, VGA & Super VGA
Start/Stop Tone Recognition	Orbital Prediction and Display
Unattended Operation	Time Lapse Frame Looping
Tuning Oscilloscope	Slide Shows
Resolution up to 1280x800x256	Export to PCX & GIF Files
Programmable Colorization	Grayscale on all Popular Printers
Brightness and Contrast Control	Programmable IOC & Line Rates
Pixel Photometry and Histograms	Infrared Thermal Analysis
Image Zoom, Scroll, Pan, Rotation	APT Latitude & Longitude Grids

PC HF FACSIMILE 5.0 \$99

PC HF Facsimile 5.0 is a complete reception system for shortwave FSK facsimile on the IBM PC and compatibles. The product includes an FSK demodulator, tutorial audio cassette, 250 page manual and signal processing software. The product includes many of the advanced features of PC GOES/WEFAX 3.0 but at a fraction of the price. Call or write for a complete catalog of products.

Software Systems Consulting
 615 S. El Camino Real, San Clemente, CA 92672
 Tel: (714) 498-5784 Fax: (714) 498-0568

CIRCLE 130 ON READER SERVICE CARD

(2) Delete in its entirety any and all U.S. Government Printing Office (GPO) indicia that may appear in the margin(s).

(3) If the printer wishes to identify a foreign country in which the forms are printed, a marginal notation must be added stating "No U.S. Government funds were used to print this document."

(4) Do not add to the form any other symbol, word or phrase that might be construed as personalizing the form or advertising on it.

(5) Except as specified above, do not delete from or add to any part of the form, or attach anything thereto.

(6) Assure that the form being reproduced is an edition currently acceptable by the Commission, which will endeavor to keep the public advised of revisions to its forms, but cannot assume responsibility to the extent of eliminating any element of risk against the use of obsolete forms.

(b) These guidelines do not apply to forms

which respondents may wish to reproduce as completed facsimiles on automated equipment to satisfy application or report requirements. Requests for permission to submit such forms to the Commission should be addressed to the Office of Managing Director, Information Resources Branch, Room 416, 1919 M Street, NW, Washington, DC 20554. This information is also referenced in 47 CFR 0.409.

For further information on computer-generating FCC forms, contact Judy Boley, telephone (202) 632-7513.

For information concerning FCC applications and licenses, contact the FCC Consumer Assistance and Small Business Division, telephone (202) 632-7260.

For questions concerning ordering blank FCC forms, contact the FCC Forms Distribution Center (202) 632-FORM.

**For 25 years,
our people have
endured long hours
and tough
working conditions
for no pay.**



**And 9 out of 10 would
do it again.**

TO FIND OUT WHY

call

(316) 263-2100

or write

REACT INTERNATIONAL, INC.

242 Cleveland

Wichita, KS 67214

CIRCLE 117 ON READER SERVICE CARD

Reconsideration Denied Concerning Operation Of Radio Freq Devices Without An Individual License

The Commission denied Linear Corporation reconsideration of the Report and Order revising Part 15 of the rules regarding the operation of radio frequency devices without an individual license.

As part of the revision, the Commission increased the number of frequencies available for the operation of Part 15 devices and established a number of frequency bands where emissions from Part 15 intentional radiators are restricted. The restricted bands were established to protect against interference to services involving safety-of-life and services using very low received signal levels. To ensure that emissions that fell in the restricted bands were attenuated sufficiently and to provide additional protection to authorized services against interference from Part 15 devices, the Commission also increased the frequency range over which measurements were to be performed for most Part 15 transmitters.

Linear, a manufacturer of control and security alarm devices, requested partial reconsideration of the restricted bands and measurement requirements imposed by the Order. According to Linear, the rules, as adopted, will cause great economic impact on the future production of Part 15 devices.

Denying reconsiderations, the Commission found that Linear had failed to produce any additional information that would warrant reversing or modifying any of its decisions in this proceeding. The Commission noted that the information in this proceeding indicated that there are valid test procedures available that such measurements are in fact necessary, and that the protection of the safety-of-life services and other services which operate with low received signal levels is necessary. Consequently, the Commission said that the public interest would not be served by granting Linear's request. ■

Excuse me, but do you like having ears?

Think about it...you, sitting at home, listening to the pilot of that airplane that just flew overhead. I'm talking about radios-- not stereos, but radios-- able to hear everything from police and ambulances in your town all the way to broadcasts from Moscow, all from your own home! That's right, and it doesn't even require a license.

Grove Enterprises is here to help you on your way to the fascinating hobby of scanner and shortwave listening.

If you have ears and enjoy using them, let us entice you.

Write or call us today for your free catalog.

Grove Enterprises Inc.
140 Dog Branch Road
Brasstown, NC 28902
1-800-438-8155



Wait...There's More!

Monitoring Times...What more is there to say?

As one of the leading magazines for shortwave and scanner hobbyists, from it's upbeat news to it's up-to-date frequency lists, Monitoring Times is one listening tool you can't afford to be without. Join 30,000 other subscribers who are enjoying the benefits of unparalleled writing and reviews.

Don't delay any longer. Order your subscription today.

- * International Broadcasting
- * Utility Monitoring
- * Frequency Lists
- * Ham Radio
- * Broadcasting Schedules
- * Scanning
- * News And Features
- * Interviews With Experts
- * Electronic Projects
- * Equipment Reviews
- * Listening Tips
- * Shortwave And Longwave Listening

1 year for only \$19.95 (US)

Have your Mastercard or Visa card ready and call:

1-800-438-8155

or write us at:
Monitoring Times
PO Box 98
Brasstown, NC 28902



For a sample copy of Monitoring Times, send \$3.00 to the above address.

WHAT'S HAPPENING: INTERNATIONAL SHORTWAVE BROADCASTING BANDS

Last month we passed the word that Bahrain had begun broadcasts on shortwave. But so far the hunt for this one hasn't gone well for most shortwave listeners, including yours truly. Radio Bahrain is relaying a local FM station and running from 0300 to sign off around 2110 on two frequencies: 6010 and 9745, the latter often QRM'd by HCJB. Programs are all Arabic except for an English newscast at 2100. The station is running a fairly healthy 60 kW and its schedule is such that we should be able to hear it around sign on and sign off, at least at certain times of the year.

Check 5960 and 9755 for Radio Monte Carlo Middle East, a Cyprus mediumwave outlet. It has arranged a time exchange with Radio Canada International and should be on from 0400-0415 now. RCI will have a time segment on the 1223 kHz mediumwave outlet. Reports go to B.P. 2026, Nicosia, Cyprus.

Radio Netherlands Media Network reported that four employees of Belgisch Radio en Televisie (BRT) have been accused of being KGB spies! In addition, the patriotic music played on Radio Pyongyang in North Korea is supposed to somehow convey instructions to secret agents, probably in the South.

The money squeeze in the USSR (and maybe the name's been changed by now!) is going to mean further cutbacks at Radio Moscow. Several have already been dropped, i.e., Tagalog, Malayan, Malagasy. We can probably expect a huge shake-up in the broadcasting picture if all these republics that are claiming full independence actually achieve it.

Iran is planning a further expansion of its shortwave broadcast which will eventually add 16-500 kW transmitters at a place called Sirjan.

The VOA has probably begun construction

on a new relay site in Sri Lanka which will feature 3-500 kW blasters. Meantime, the relay site in Israel's Negev region has been delayed again. Israel's High Court of Justice ruled that a study of the environmental impact such an installation might have has to be completed first. The proposed site is the location of an army firing range and residents fear that relocating the range elsewhere in the region would create numerous harmful side effects.

Radio Nacional de Venezuela's international service has English Monday through Friday at 1140, 1440, 1840, 2140, 0040 and 0340, all on 9540. The English segment consists of a newscast Mondays through Thursdays. On Fridays it's "Venezuela! Week in Review." The Saturday English program is "Crosstalk" a current affairs show. No English is carried on Sundays. Thanks to Kevin Story, Texas for the info he received direct from the station.

Miguel Angel Reyes in Mexico says that several Mexican shortwave stations have closed. XEWW, Mexico City, which relayed mediumwave XEW on 6165, 9515 and 15160; XEQQ which relayed XEQ-940 on 9680 are inactive.

He also notes that Radio Educacion-6185 and La Hora Exacta-9555 are off the air due to technical problems.

Radio Korea's DX show offers a printed one page sheet containing the items read on the air. It's available at no cost by writing to Radio Korea DX Report, 18, Yoido-dong, Youngdungpo-gu, Seoul, Republic of Korea. Unfortunately, there's no mailing list so you have to write each time you want a copy. The show is on the air every two weeks in several different time slots. One of the best for North America should be Sundays at 1245 on 9750.

IN THE MAIL: Rene A. Matthijssen of Ed-

monton, Alberta noted the photo of the Radio Netherlands complex in the August issue. Rene says he is very familiar with this facility since he used to live very close by and both his father and uncle worked there! He says the location is in an area with a lot of pastures and the water table is only 204 inches below the surface. The building sits on solid sand and the whole complex is "on a floating slab of concrete."

The property does not belong to Radio Netherlands, Rene says. How come? "Many hundreds of years ago a king of Holland traveled in the area and was attacked by robbers. The local farmers helped save the king. The king showed his appreciation by donating a parcel of land to the farmers, called "het Gooi." Some of the stipulations were that the land could never be sold, only males could benefit from the land and when a male moved off the land he would lose his rights to the land and its benefits. The direct descendants of these farmers still share in the property and its rental proceeds. They get a royalty every year." The Radio Netherlands facility sits on this land and is thus leased from the descendant of these farmers. Fascinating stuff, Rene. Thank you!

Regular reporter Marty Foss sends in a couple of photos of his shack. He's now located at Pitkas Point, Alaska which he says is a remote, small, very small community in the western part of the state. Anything like the fictional community of "Northern Exposure" fame, Marty?

Christian "Chris" Labelle of St. Jerome, Quebec recently got a Realistic Dx-380 and must feel his career with that receiver is off to a good start. The first station he tuned in was Vatican Radio broadcasting a message from the Pope, in French (Christian's mother tongue) which ended with the Pope blessing everyone who was listening.



Two shots of shacks belonging to Clifford C. Duncan of Cut Knife, Saskatchewan. In addition to shortwave, Cliff is a country and blue-grass fan and does a lot of recording. Note all the tapes.



Robert A. Babin in Shrewsbury, Massachusetts has a lot of top flight receivers and RTTY/CW decoders in his installation, and more than one antenna to pull those signals in!

William G. Roseboro of Hamlet, North Carolina wonders about the so-called New Star Broadcasting Station he hears on 8300 at 1230. No one is totally sure just what this is, William. But it mostly seems to be some sort of spy/numbers broadcast in Chinese, coupled with some music here and there and

apparently some anti-Beijing comments, too. It's likely that it comes out of Taiwan.

Your letters, with comments, questions, miscellaneous information about stations, schedules and what-have-you are always welcome. We need shack photos and spare QSL's you don't need returned to use as il-

lustrations. And, of course, your loggings! Please remember to list them by country, double space (one side of the paper only) and please add your last name and state abbreviation after each item! Thanks for your contributions and your cooperation!

Here are this month's logs. Broadcast

ESTABLECIDA EN 1934
LA VOZ DE VERACRUZ
 EL PRIMER PUERTO DE MEXICO
 VERACRUZ
 1230 KHZ. 9545 KHZ.
 APARTADO POSTAL No. 21 OFICINAS, ESTUDIOS Y PLANTA TELS. 32-22 50 y 32-22-90
 91700-4H. Veracruz, Ver. a Julio 8 de 1991.
 Dn. Miguel Angel Reyes.
 Muy estimado señor Reyes:
 Su amable y grata correspondencia del 24 del pasado mes de Junio de 1991, reportandonos haber escuchado nuestra onda corta X-R-F-T.
 Ha sido muy agradable recibir su reporte el cual coincide en todo con la realidad de nuestra programación. Para su historia, esta radiodifusora de onda corta, 9,545 kilohertz, -- banda de 31 metros, es un equipo "hechiso", fabricado o mejor dicho -- armado por el fundador de estas radiodifusoras, don José Rodríguez López (QEPD). Originalmente era un transmisor de 12 watts, que comenzó a trabajar en 1936, 2 años después de nuestra onda larga, fundada en -- 1934, y dos años después, se armó el equipo actual, ahora ya modernizado, con la potencia de 250 watts. Por su antigüedad y por la desaparición de ondas cortas mexicanas, ahora es la DECANA, es decir, la -- más antigua. Nuestro técnico actual, Ing. Erasto Altamirano Martínez -- es quien la ha puesto nuevamente "en el Aire", y esperamos sea por -- mucho tiempo.
 Desearo nos siga escuchando y al pendiente de sus proximas notas, lo saludamos muy cordialmente. Además, -- como es natural, muchas gracias por escucharnos.
 Radiodifusoras
 XEFT y XEPT "LA VOZ DE VERACRUZ"
 Ó XEFT "LA JARUCHA".
 Juan de Dios Rodríguez Díaz, jdy/rh
 Director-Gerente.
 VERACRUZ. LA CIUDAD MAS ALEGRE Y BULLICIOSA DE LA REPUBLICA. VISITELA EN SUS VACACIONES

Here's a recent QSL from La Voz de Veracruz, XEFT in Veracruz, Mexico, received by Miguel Angel Reyes. When they began in 1936 they used only 12 watts!

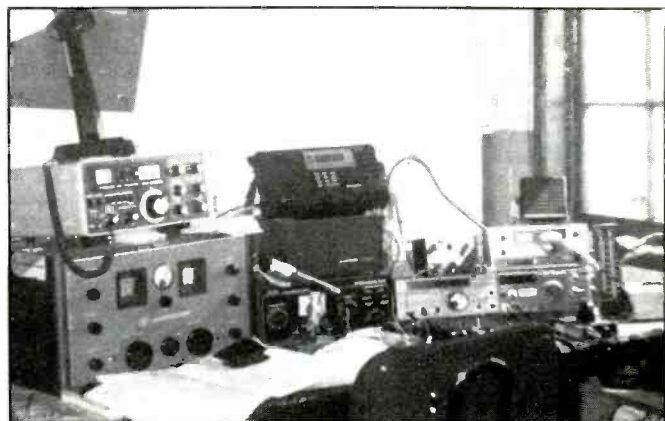

Another two for the price of one shack visit, this time to the lair of regular reporter Marty Foss in Pitkas Point, AK which, in addition to modern equipment, sports one of those great old Hammarlund receivers.

**FREE
SAMPLE
COPY!**

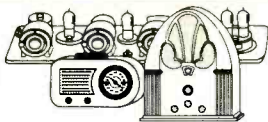

ANTIQUE RADIO CLASSIFIED

**Antique Radio's Largest-Circulation
Monthly Magazine**

Articles - Classifieds - Ads for Parts & Services
Also: Early TV, Ham Equip., Books,
Telegraph, 40's & 50's Radios & more...

Free 20-word ad each month. Don't miss out!

1-Year: \$27 (\$40 by 1st Class)
6-Month Trial - \$15. Foreign - Write.

A.R.C., P.O. Box 802-T7, Carlisle, MA 01741

CB TRICKS OF THE TRADE I & II

Tricks I and Tricks II, plus a free set of
plans for CB Super Modulation.

Special: \$40.00

Order each book separately for \$19.95

C.O.D. Orders Accepted

Medicine Man CB

P.O. Box 37

Clarksville, AR 72830

(501) 754-2076



CIRCLE 158 ON READER SERVICE CARD

**TOUCH-TONE DECODER/DISPLAY
& ASCII CONVERTER BOARD**



Model TDD-8 decodes and displays all 16 DTMF digits and provides an ASCII serial output. Digits are displayed on eight LEDs. 32 character memory can be scrolled. It will accept almost any audio source, such as a scanner, tape recorder, telephone answering machine, etc. Serial output can be connected to your computer. IBM compatible software included for displaying, storing and/or printing time, date and number for automatic logging.

TDD-8 DTMF DECODER/DISPLAY/ASCII \$99
CAB-1 AUDIO & COMPUTER CABLES \$20
PS-12 110VAC TO 12VDC POWER PACK \$10
add \$5 S/H - VISA/MC ACCEPTED

MoTron Electronics TEL: 1-800-338-9058
310 Garfield St.#4 (503)-687-2118
Eugene, OR 97402 FAX: (503)-687-2492
(Touch-Tone is a trademark of AT&T)

**SUPER-MINIATURE
FM TRANSMITTER**

NEW! POWERFUL! XST500
SUPER-MINIATURE transmitter
uses Surface Mount Technology
(SMT)! Smallest high performance
FM transmitter available anywhere.
Transmits whispers to any FM
receiver up to a mile away. Uses 9V
battery. Complete, easy to
assemble, kit with all SMT parts
already assembled to circuit board.
Call our free 800 order number and
order one today!!

XST500



\$39.95 CHECK, VISA, or MC
COD ADD \$5.00

TECH INFO 1-602-829-8152
ORDERS ONLY 1-800-336-7389

XANDI ELECTRONICS, Dept PC
201 E Southern Ave, Suite 114
Tempe, AZ 85282



CIRCLE 159 ON READER SERVICE CARD

language is assumed to be English (EE) unless noted otherwise (SS = Spanish, FF = French, AA = Arabic, etc.) All times are in UTC.

SWBC Loggings

Afghanistan: Radio Afghanistan in EE at 1845 on 115510. (Rocker, NY) (via USSR, editor)

Alaska: KNLS noted with music at 0805 on 11715. (Rocker, NY)

Argentina: Radio Nacional at 0740 in SS with tangos. (Bednarski, BC)

RAE, 11710 at 0238 with EE news. (Rocker, NY)

15345 at 0200 with football in SS. (Bednarski, BC)

Armenian SSR: Radio Yerevan on 11675 and 11790 at 0210. (Rocker, NY)

Australia: Radio Australia, 9580 at 1000 with "International Report." (Serraon, GA) 1018. (Labelle, PQ) 9710 at 1012 in Pidgin English. (Also at 0720 on 15240. (Foss, AK) 13605 at 1619 with Asian Affairs program. (Zamora, CA)

Belgium: BRT International at 2330 with news on 13655. (Mead, ME)

Bolivia: Radio Fides, 6155.3 at 0116 with Latin Music in Spanish. (Reyes, Mexico)

Radio Santa Cruz, 6135 at 0057 sign off in Spanish. (Reyes, Mexico)

Brazil: Radio Universo, 6060 in PP at 0051 with religious program in PP. QRM from Argentina, co-channel. (Reyes, Mexico) 0235 with commentaries and echo commercials. Also on 9565 at 0710 in PP. (Bednarski, BC)

Radio Cultura do Para, 5045 at 0833 with music in PP. (Reyes, Mexico)

Radio Globo, 9585 at 0236 with PP commercials. (Reyes, Mexico)

Radio Clube Paranaense, 6040 at 0055 with sports in PP. (Reyes, Mexico)

Radio Nacional, 11780 in PP at 0951. (Pappas, SD)

Bulgaria: Radio Sofia, 11720 at 0305. (Rocker, NY) 2100 with news on 15375. (Serraon, GA)

Cameroon: CRTV, Garoua, 5010 with EE at 0520. (Story, TX)

Canada: Radio Canada International with CBC programming at 0104 on 9755. RCI in FF at 2100 on 15425. (Serraon, GA) 11855 at 1425 and 11955 at 1448. (Labelle, PQ)

CHNX, Halifax, 6130 with rock at 1010. (Bednarski, BC)

CKZU, Vancouver on 6160 at 0800 with country/western. (Bednarski, BC)

Chile: Radio Nacional, 15140 in SS with football. (Reyes, Mexico)

China: Radio Beijing, 11715 via Mali at 0045 with CC language lesson. Moscow QRM. OH 0057. (Zamora, CA) 11840 at 0452. (Labelle, PQ) 11710 at 0928, 17533 in CC. (Foss, AK)

Colombia: Caracol Bogota, 6075 in SS at 0707. (Cabellero, Mexico) 0725 with phone-in program. (Bednarski, BC) 0810 with Caracol network commercials, IDs Banco commercials, news, Latin music. (Story, TX)

Costa Rica: AWR/Radio Lira, 9725 with "Voz de Esperanza" at 0318 in SS. (Labelle, PQ) SS religion at 0144, 0440. (Reyes, Mexico; Bednarski, BC)

Cuba: Radio Havana Cuba, 11760 at 0440 with "DX'ers Unlimited." (Zamora, CA) At 0758. (Pappas, SD) 15140 at 0318. (Labelle, PQ) 17795 with news, "Dateline Havana." (Serraon, GA)

Czechoslovakia: Radio Prague International, news at 0100 on 5930. (Mead, ME) News at 0300 here and on 7345. (Cabellero, Mexico) 11685//11990 at 2232. (Labelle, PQ)

Denmark: Radio Denmark, 0130 with ID in EE, program in Danish on 11925//15360. (Rocker, NY) (via Radio Norway, editor)

Dominican Republic: Radio Amanecer International, 6025 with SS and music and 0050. (Reyes, Mexico)

Ecuador: Radio Quito, 4920 in SS at 0435. (Cabellero, Mexico) HCJB, 9745 with listeners letters at 0120. (Zamora, CA) 15115 with "Morning in the Mountains" at 1333. (Zamora, CA) DX Party Line at 0325 on 15155. (Labelle, PQ) 0248 in SSB on 21455. (Cabellero, Mexico)

England: BBC via Hong Kong relay on 7180 with news at 1300. (Zamora, CA) 7325 at 0200 with news.

Abbreviation Used in Listening Post

AA	Arabic
BC	Broadcasting
CC	Chinese
EE	English
FF	French
QG	German
ID	Identification
IS	Interval Signal
JJ	Japanese
mx	Music
NA	North America
nx	News
OM	Male
pgm	Program
PP	Portuguese
RR	Russian
rx	Religious/ious
SA	South America/n
SS	Spanish
UTC	Coordinated Universal Time (ex-GMT)
v	Frequency varies
w/	With
WX	Weather
YL	Female
//	Parallel frequencies

8925 at 0412 with news in SS. (a feeder? editor) and 11775 with news at 1504. (Bednarski, BC) 11775 at 0045 and 15220 at 2212. (Serraon, GA) 15070//15220 at 1150. (Pappas, SD)

Finland: Radio Finland International, in Finnish at 1258 on 15400. (Pappas, SD)

France: Radio France International, 9800 at 0330. (Labelle, PQ) 17705 via Japan at 1054 in FF. (Foss, AK) 21535 at 1230 sign on in EE to North America. (Cooper, OH)

French Guinea: Radio France International relay at 0500 in SS with time check and news in SS on 11670. (Zamora, CA)

Gabon: Africa Number One, 9580 at 0555 with FF, African music, mentions of Gabon. (Story, TX)

RFI Gabon relay, 4890 at 0454 in FF. (Caballero, Mexico)

Germany: Radio Free Europe in Russian at 0922 on 11875. (Foss, AK)

Deutsche Welle on 9545 in GG at 0501. (Labelle, PQ) 9565//11890 at 0101. (Serraon, GA) 1377- at 0055 with news. (Mead, ME)

Greece: Voice of Greece, 9395//9420 in EE, off at 0350. (Serraon, GA) 0420 at 0213. (Pappas, SD) (Presume in Greek, editor) 0310. (Bednarski, BC) 11645 at 0312 in Greek. (Labelle, PQ)

Guam: KTWOR on 11650 with ID and address (PO Box CC, Agana, Guam, 96910), religious program at 1601. QRM from R. Beijing sign on. (Zamora, CA)

AWR/KSDA on 11980 at 1130 with religious program in Chinese dialect and station ID. (Solomon, ON)

Guatemala: La Voz de Atitlan, 2390 at 0318 with music and announcements in SS. Into local language at 0332 and sign on at 0334. (Caballero, Mexico)

Honduras: La Voz del Junco, 6075 at 0039 in SS with commercials and Kaliman novel. (Reyes, Mexico)

Indonesia: Radio Republik Indonesia at Ujung Pandang, 4753 at 1100 with Indonesian pops, station ID, all in II. (Story, TX)

Iran: VOIRI, 9580 at 0231. (Rocker, NY)

Israel: Kol Israel 9435 at 0142 in SS. (Caballero, Mexico) 11588 at 1900 with music, ID. (Solomon, OH) 17685 at 1925 with news. (Serraon, GA)

Italy: RAI, 9575 at 0100 with news and music. (Serraon, GA)

Japan: Radio Tanpa, 9595 at 1005 in JJ. (Foss, AK) Radio Japan, 5960 (via Canada) at 0100 with news. (Mead, ME) 6120 at 1110 with Ian McFarland. Off 1158. (Labelle, PQ) (also via Canada) 9535 via Sri Lanka with sign on and news at 1400. 11865 with DX program at 1533. EE ended 1600 and into JJ. (Zamora, CA) 11840 via Sri Lanka at 0000 close. 15960 at 0114. (Serraon, GA)

Luxembourg: Radio Luxembourg, 15350 with continuous rock. (Christian, LA)

Madagascar: Radio Netherlands relay on 15570 at 1902 with the Happy Station program to 1925 sign off. (Zamora, CA)

Malaysia: Radio Malaysia, 4950 at 1359 with ID and

sign on, 1400 time check and news by woman. (Zamora, CA)

Malta: Voice of Mediterranean at 0600 on 9765 with news. (Christian, LA)

Mexico: "La Jarocha," XEFT relaying XEFT medium-wave at 2243 on 9545 with SS commercials. (Reyes, Mexico)

Monaco: Trans World Radio, 9480 at 0740. (Rocker, NY)

Morocco: RT Marocaine, 15335 at 1116 with music and man in AA. (Foss, AK)

Netherlands Antilles: Trans World Radio, Bonaire, 11930 at 0350. (Labelle, PQ)

Radio Netherlands Bonaire relay, 6165 at 0100. (Mead, ME) 9590 at 0350 ending "Newline." (Serraon, GA)

New Zealand: Radio New Zealand at 0840 with Arthur Cushin's DX report. (Foss, AK) 0812 with "Pacific Beat." (Pappas, SD) 17770 at 0520 with music. (Foss, AK) 0625 with Kiwi Music Show. (Zamora, CA)

Nigeria: Radio Nigeria, Kaduna, 4770 at 0510 with news. (Story, TX)

Voice of Nigeria on 7255 at 0507 with music. (Labelle, PQ) 0514 with "Music of the People of West Africa." (Christian, LA)

Northern Marianas: KHBI, Saipan at 0905 on 9530. (Story, TX) 17555 at 1100 with news, "Letterbox." (Christian, LA)

KFBS on 11650 at 0925 in RR. (Pappas, SD)

North Korea: Radio Pyongyang, 7580 at 0904 in JJ. (Foss, AK) 15115 at 2300 in SS. (Bednarski, BC)

Pakistan: Radio Pakistan, 9645 at 1008 with man in unidentified language. (Foss, AK)

Papua New Guinea: Radio West New Britain, 3235 at 1030 in Pidgin English.

Radio West Sepik, 3205 at 1104 in Pidgin.

Radio Madang, 3260 in Pidgin at 1035.

Radio Northern, 3345 in Pidgin at 1045.

Radio Simbu, 3355 in Pidgin at 1130.

Radio Western Highlands in Pidgin at 1130 on 3375.

Radio New Ireland on 3905 at 1104 in Pidgin. (All from Duncan, SASK)

Paraguay: Radio Nacional in SS on 9735 with music. (Caballero, Mexico)

La Voz de Cutervo, 5660.5 at 0218 in SS with music. (Reyes, Mexico)

Radio Tacna, 9505 at 0009 with sports program in SS. (Reyes, Mexico)

Philippines: Radio Veritas Asia, 9555 with ID in EE at 1257, into Korean at 1300 and off 1325. (Zamora, CA) EE ID at 1200 and into an Asian language. (Story, TX)

FEBC, 11685 at 1551 with religion, 1553 with ID, program preview, sign off with IS at 1559. (Zamora, CA)

Poland: Radio Polonia, 7270 at 2340 with news. (Rocker, NY)

Portugal: Radio Portugal, 9555 at 0240 with news, "Portugal, Past and Present." Into PP at 0300. (Serraon, GA)

Romania: Radio Romania International, 9510//11830//11940 at 0205 with newscast. (Rocker, NY)

Singapore: Radio Singapore/Radio One on 5010//5052 at 1257 with ID "This is Radio One on 90.5 FM." News and weather at 1300, 1303 "Nightflight" with music, call-ins and dedications. (Zamora, CA)

Solomon Islands: SIBC at 0700 on 9545 with news and many commercials. (Christian, LA)

South Korea: Radio Korea, 9750 at 1312 with news highlights, off at 1315. (Zamora, CA) 11715 via Canada at 1049. (Pappas, SD) 15170 at 0640. (Foss, AK)

Spain: Spanish National Radio, 9630 at 0104. (Zamora, CA) 9630//11880 at 0305 in SS. 15110 in Catalan at 2250. 17755//17815 at 1850 in SS. 17845 at 2010 in SS. (Bednarski, BC) 17870 at 1915 in SS. (Serraon, GA) 21570 at 1625 in SS. (Labelle, PQ)

Sri Lanka: SLBC on 11800 at 1217 in unidentified language. (Pappas, SD)

Sweden: Radio Sweden, 9695//11705 at 0200. (Rocker, NY) 11705 at 0330. (Labelle, PQ)

Switzerland: Swiss Radio International, 9885 at 0130, into SS at 0230, via Brazil. (Serraon, GA)

Syria: Radio Damascus, 12085 at 2353 with news in SS. (Reyes, Mexico) 15095 in AA at 2200, off with martial music at 2207. (Bednarski, BC)

Tahiti: Voice of Turkey, 11825 at 0800 in FF. (Bednarski, BC)

Taiwan: Voice of Free China, 5950 at 0710. (Bednarski, BC) 9680 at 0338 with recipes, CC language lessons.

(Zamora, CA) 17750 at 2210. (Serraon, GA) 17845 at 0207. (Labelle, PQ) (all via WYFR, editor)

Thailand: Radio Thailand, 6070 in EE at 1200. (Duncan, SASK)

Turkey: Voice of Turkey, 9445 at 2241 to North America ending at 2247 with ID and sign off 2248. (Cooper, OH)

Ukraine: Radio Kiev, 11790 at 0019 to North America. 0030 ID "This is Radio Kiev..." (Cooper, OH)

United Arab Emirates: UAE Radio, Dubai, 13675 at 0230 in AA. (Rocker, NY) 21605 in AA at 1527. (Pappas, SD)

Voice of the UAE, Abu Dhabi, 15305 at 2319. (Pappas, SD) 15400 at 2237. (Serraon, GA)

United States: AFRTS (via xmtr in Britain, ed) 9333 USB with baseball game. (Rocker, NY)

La Voz de la OEA (Organization of American States) via VOA transmitter in SS at 2340 on 11830. (Bednarski, BC)

Radio Miami International via WRNO on 7395 at 0330 in SS with "Hablemos de Negocios." (Caballero, Mexico)

USSR: Radio Moscow, 96885 at 2303. (Labelle, PQ) 11710 at 0300 with news. (Reiser, IL) 11840 (via Cuba, editor) and 15425 at 1545. 17605 at 1920. (Serraon, GA)

Magadan Radio, 9600 at 0916 in RR. (Foss, AK)

Vatican: Vatican Radio 7125 at 0234 with the Pope. (Labelle, PQ) 9605 at 0358. 17730 in FF to Africa at 0430. (Bednarski, BC) 15090 in unidentified language at 0558, into FF at 0600. (Foss, AK)

Venezuela: Radio Nacional, 9540 at 1152 with brief EE ID, back to SS. (Story, TX)

Radio Tachira, 4830 at 0130 in SS. (Caballero, Mexico)

Radio Valera, 4840 at 0400 sign off in SS. (Caballero, Mexico)

Radio Rumbos, 9660 at 0248 in SS. (Bednarski, BC)

Vietnam: Voice of Vietnam, 9840 at 1245 in EE, into Vietnamese. (Pappas, SD)

Yugoslavia: Radio Yugoslavia, 11785 sign off in E at 0045. (Serraon, GA)

That does it for this month. Many thanks to all our reporters, including several first timers: Miguel Angel Reyes, Morelia, Mexico; Manuel Fernando Caballero S., Monterrey, Mexico; Clifford C. Duncan, Cut Knife, Saskatchewan; Daryl E. Rocker, Frankfort, NY; Marty Foss, Pitkas Point, Alaska; Marina Pappas, Huron, SD; A.E. Bednarski, N. Vancouver, BC; Larry R. Zamora, Highland, CA; Bob Christian, Livingston, LA; Steven D. Cooper, Worthington, OH; Laird Solomon, Oshwa, Ontario; Kevin Story, Midland, TX; Carol J. Serraon, Rome, GA; Kevin Mead, Cape Elizabeth, ME; Thomas J. Reiser, Chicago, IL; and Chris Labelle, St. Jerome, Quebec. ■

CABLE TV CONVERTERS
Why Pay A High Monthly Fee? Save \$100's A Year

- All Jerrold, Oak, Hamlin, Zenith, Scientific Atlanta, and more.
- Visa/MC and C.O.D.
- 60 Day Money Back Guarantee
- Shipment within 24 hours

WE WILL BEAT ANYONE'S PRICE
No Illinois Orders Accepted

Purchaser agrees to comply with all state and federal laws regarding private ownership of cable TV equipment. Consult local cable operator.

Electronic Engineering
P.O. Box 337, Barrington, IL 60011
Free catalog 1-800-542-9425 Information 1-708-540-1106

SATELLITE TV

NAME BRANDS AT 50% DISCOUNT
This FREE 24 page Consumer Buying Guide tells all about Satellite TV and lists guaranteed lowest prices.

Salman, Inc.
6310 N. University No. 3798 • Peoria, IL 61612

1-800-472-8626

CALL FOR

YOU AIN'T HEARD NOTHIN...YET!

Since 1967, CRB Research has been the world's leading publisher and supplier of unique hobby and professional books and information including:

- Scanner Frequency Guides
- Shortwave Frequency Guides
- Military/Federal Communications
- Broadcast Station Registries
- Undercover Communications
- Survival Communications
- Covert Operations
- Electronic Espionage
- Surveillance
- Monitoring
- Cryptography & Codes
- Bugging
- Wiretapping
- Communications Antennas
- Electronics & Projects
- Regency Scanner Directories
- Computer Technology
- & Other Related Topics!

THE 'TOP SECRET' REGISTRY OF U.S. GOVERNMENT RADIO FREQUENCIES

25 TO 470 MHZ
BY TOM KNEITEL, K2AER

7th Edition

New titles are constantly being added to our exciting catalog. If it's interesting and unusual, we've got it. You'll see! Ask for our latest FREE catalog.

CRB RESEARCH
P.O. Box 56 Commack, NY 11725

CIRCLE 153 ON READER SERVICE CARD

COMMUNICATIONS CONFIDENTIAL

YOUR GUIDE TO SHORTWAVE "UTILITY" STATIONS

A very interesting letter plus some photos were forwarded from Robert Ward, a member of the Canadian CG station in Halifax, Nova Scotia. "When I came to VCS in 1983, some of the receivers and traffic-list monitors had already been replaced with more up-to-date versions. Our entire operations building was renovated completely beginning in 1987, and the previous operations area is now an office/reception area for the station.

"The photos are those which appear on our latest QSL card. The larger photo shows some of the installed equipment. Not shown in the console picture are 3 positions dedicated to HF CW operations on 4 through 22 MHz (out of the picture, to the right), and the MF CW (500/484/446 kHz) position, which is behind the point of view of the camera."

Frequency limits of the new 8, 16, and 22 MHz CW working bands, previously mentioned in POP'COMM, are 8342.0 to 8365.5 kHz and 8371.0 to 8376.0 kHz, 16619.0 to 16683.0 kHz, and 22242.0 to 22279.0 kHz.

VCS has assigned a new CW frequency of 22619.5 kHz which replaces our old frequency of 22387.0 kHz. This is the only change to our HF CW frequencies, all the rest remaining the same.

All of our HF radiotelephone and radiotelex frequencies have been changed, although the channel designators for HF R/T have remained the same (channels 418, 605, 823, 1213, 1604, and 2213)."

Our thanks to Robert for these updated details regarding the Canadian Coast Guard radio station.

The next letter out of the mailbag was from Kurt Mueller who had monitored some of the SLHFB transmissions from his Switzerland location and then continued his coverage while on vacation in France using his SONY CRF-1 and the 2001D (2010). The latter receiver he finds useful for longwave listening because of its built-in ferrite loop antenna.

"Due to solar disturbances I made no great catches on shortwave. Instead, I spent many hours of my holidays searching for new longwave beacons. I found 55 new beacons which makes a total of 133 beacons from one location (100 km south of Lyon, France)! The most interesting beacons were as far away as Romania, Bulgaria, Czechoslovakia and Ukraine. I was most successful when listening after sunset between 8 and 10 pm.

Regarding the SLHFB's, there has recently been a change: for months only the "S" (and 1 "V") signals could be heard. Suddenly, during my holidays in Southern France I found "D", "P" and "C" plus a new one, an "F" transmission. These signals were not spaced at 500 Hz. There were approximately 200 Hz

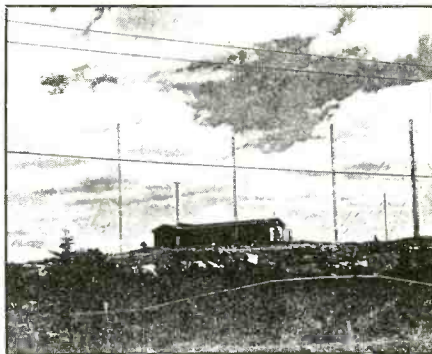

These photos of Halifax station VCS (Canadian Coast Guard) were provided by Robert Ward, a member of the station. This first view is of the VCS Transmitter site at Pennant, Nova Scotia.

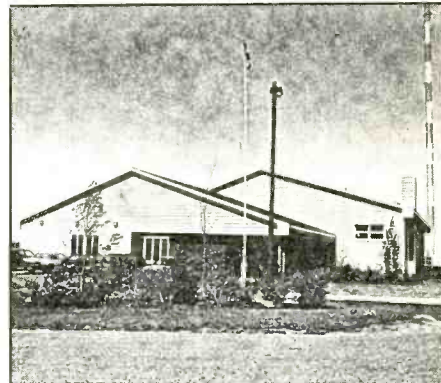

VCS Operations building located at Ketch Harbor, Nova Scotia.

apart with the exact spacing difficult to determine."

Here are the SLHFB observations made by Kurt: D,S,P and C were noted on 5305.5, 13635.5, 17015.5 (plus F) and 20991.5 kHz. S & V were heard on 7394.5 kHz; E on 14983 kHz; S on 6801.5, 8645.5, and 10643.5 kHz. The last observation was V on 10285 kHz.

David Sabo, CA furnished two QSL addresses. SAL AERADIO, ASA - Empresa

Nacional de Aeroportos e Seguranca Area E.P., Aeroporto do Sal, Cabo Verde. The other address was: HMS EDINBURGH (D97), BFPO Ships, London, England. "The reply from the HMS EDINBURGH came in 18 days and included a personal letter from the communications officer on ship's stationery and a color postcard of the ship. The reply from Sal Aeradio took six months. It came in an oversized official envelope, but bore U.S. postage and a San Leandro, CA

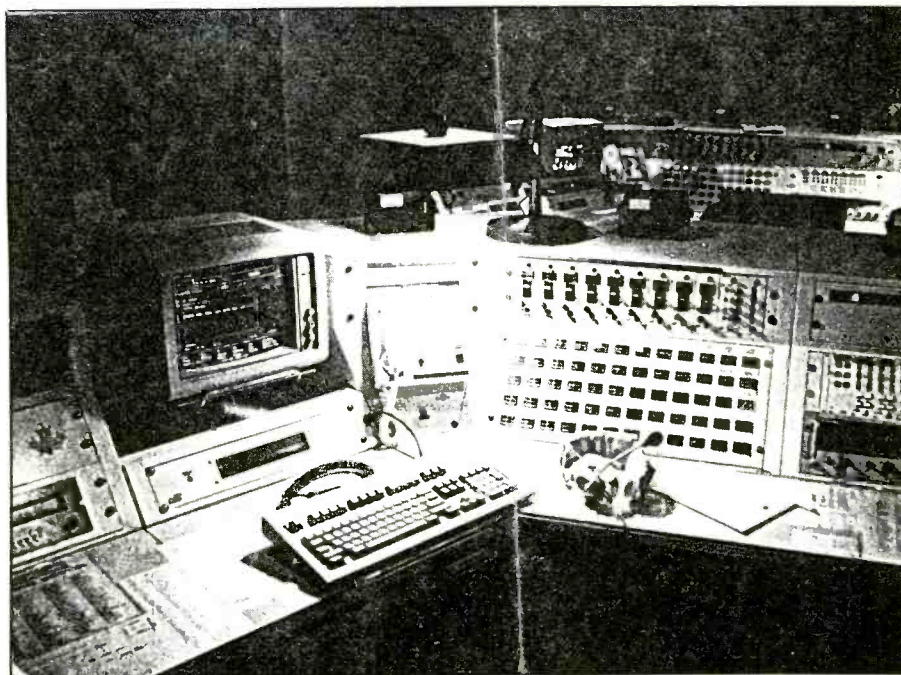

Console position at VCS. Contains HFR/T & SITOR on upper level of console. Lower level contains MF/VHF R/T.

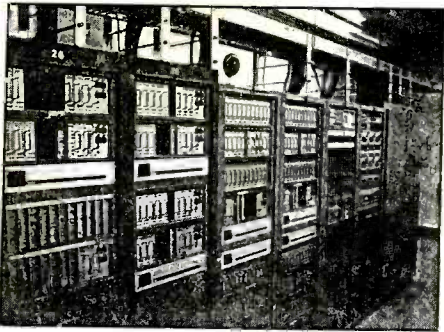

Equipment room in the VCS Operations building. The installation includes fixed-frequency receivers, VHF transmitters, switching units, etc.

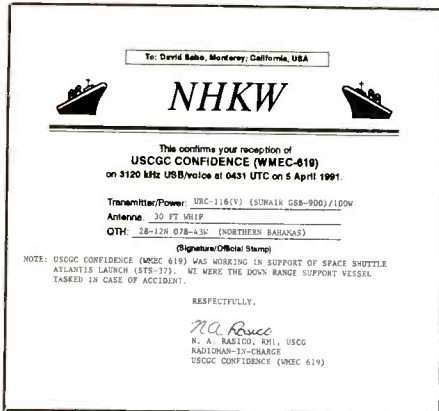

PFC from David Sabo, CA.

postmark (????). Both stations returned my IRCs. Generally speaking, I've noticed that if I don't get a reply within a month's time I can usually write it off. I keep track of my QSL's in a computer database, and right now it's showing a return rate of 67%."

Rick Fenlon, OH says he uses an ICOM R71A with a twenty foot longwire antenna for his monitoring.

Richard Weil, MN does a little SWL'ing with a 1962-vintage AIWA receiver in his bedroom using a telescoping whip antenna but results have been marginal, with only strong DX or North American stations coming through regularly.

The POP'COMM RTTY editor, Bob Margolis, has provided some possible IDs for loggings that appeared in the May Communications Confidential column; on 4232 kHz FUF, French Navy, Fort de France, Martinique; and HWN, Paris NAVRAD, France, have been logged this freq in the past. The station on 9218 kHz was probably RIT, Vaygach NAVRAD, USSR. Thanks Bob for the above clarifications.

Roger Hislop, MN reported he picked up two navigational beacons on a car radio. He heard RRQ, Rock Rapids, IA on 515 kHz and ORC, Orange City, IA on 521 kHz.

From Jack Pfister, NJ we heard that he particularly enjoyed the Aero bands during the Desert Storm operation. He monitored "scud missile alerts" broadcast on the first night of

the Allied bombing raids. He also caught a few hams making personal phone patches to home while they were returning to European bases following missions over Iraq. "Current crop of equipment for copying UTES includes a Kenwood R-5000 hitched to a trap dipole, a Yaesu FRG-8800 on a vertical, an ICOM R-7000 with a Diamond Discone with a mast mounted preamp and a Uniden CR-2021 on the desk at work! Had everybody gathered in my office listening during the war."

I have received some more queries for HF CW press in the English language. Such activity has been replaced by other modes or transmission. There is still a substantial amount of foreign press on HF RTTY with many schedules in the English language. A current reference for these is the World Press Services Frequencies (5th Edition) by Tom Harrington and available from various POP'COMM advertisers.

Earlier I had been advised that the MARS callsign for the USS George Washington was to be NNNONGW but I have just learned that this was not correct. The callsign will be NNNOCYA.

Ute Intercepts. All Times UTC

- 206: Beacon GLS, Galveston, TX at 1208. (Christian, LA)
- 212: Beacon HP, Hammond, LA at 1105. (Christian, LA)
- 246: Beacon PTN, Patterson, LA at 1155. (Christian, LA)
- 253: Beacon H8, Alma, PQ, Canada at 1122. New ID; ex-YTF. (Crabill, VA)
- 260: Beacon BYN, Bryan, OH at 0913; Beacon MTH, Marathon, FL at 1128. (Crabill, VA)
- 268: Beacon VKN, Montpelier, VT at 0911; Beacon URX, Bagotville, PQ, Canada at 1139. (Crabill, VA)
- 284: Beacon BT, Baton Rouge, LA at 0205. (Christian, LA)
- 292: Beacon MIQ, Maiquetia, Venezuela at 1014. (Crabill, VA)
- 302: Beacon EAG, Eagle Grove, IA at 1210. (Crabill, VA)
- 315: Beacon SL, Sevilla, Spain at 0029. (Mueller, France)
- 316: Beacon M, Southwest Pass, LA at 1130. (Christian, LA)
- 325: Beacon UT, Calcasieu Pass, LA at 0235. (Christian, LA)
- 326: Beacon PKZ, Pensacola, FL at 0244. (Christian, LA)
- 338: Beacon MS, New Orleans, LA at 1115. (Christian, LA)
- 349: Beacon OPE, Bucuresti-Otopeni, Romania at 0128. (Mueller, France)
- 353: Beacon YAW, Shearwater CFB, NS, Canada at 0149. (Crabill, VA)
- 371: Beacon FNA, Slidell, LA at 1125. (Christian, LA)
- 382: Beacon APT, Jasper, TN at 0431; Beacon RD, Raleigh, NC at 0252. (Crabill, VA)
- 392: Beacon DVN, Split, Yugoslavia at 2045. (Mueller, France)
- 413.5: Beacon GLT, Galati, Romania at 2032. (Mueller, France)
- 415: Beacon RUS, Ruse, Bulgaria at 2032. (Mueller, France)
- 418: Beacon PW, Poprad-West, Czechoslovakia at 2034. (Mueller, France)
- 429: OXB, Blaavand, Denmark in CW at 2250 w/tfc list. (Boender, Netherlands)
- 444: UVMA, MV Jak Djouklo clg Norddeich Radio in CW at 0935; TJFD, MV Bjoerg Jonsdottir clg Norddeich in CW at 1123. (Boender, Netherlands)
- 458: GND, Stonehaven, UK in CW at 0845 w/wx. (Boender, Netherlands)
- 490: Beacon LD, Staryava, Ukraine (USSR) at 2137. (Mueller, France)
- 491: Beacon HDM, Coleman AAF, Heidelberg, Germany at 2133. (Mueller, France)
- 492: Beacon TBV, Moravska Trebova, Czechoslovakia at 2137. (Mueller, France)
- 500: GNF, North Foreland, UK in CW at 1053 announcing Gale Warnings. (Boender, Netherlands)
- 2716: NMYO, USS James Madison SSBN627 (4-Uniform-Golf) clg Canaveral Control at 1000. Sub was using the range for tests and had pulled into Canaveral; NJJC, USS Clark FFG11 clg Newport Port Control at 1045; NCAR, USS Carr FFG52 clg Charleston Tug Control at 1045; NICK, USS Nicholson DD982 clg Newport Port Control at 1115. DD982 is homeported at Charleston, SC and was 'omg, omp' Newport for fuel. (Stuart, DE)
- 3069: ABNORMAL-10 (Vandenberg AFB, CA) w/short test counts and ID in USB at 0743. (Sabo, CA)
- 3179: K0I w/unanswered calls to POB, then cld 8GT (not hrd) and asked him if he had comms w/POB. USB at 0452. This is a USN channel. (Sabo, CA)
- 4010: DFD21 (DBP, Frankfurt, Germany), YL/GG w/5F grps at 1949. (Mueller, France)
- 4011: YL/EE w/1-0 count and 788 from 1900-1910 next to GG nbs stn DFD21 on 4010 kHz. At 1910 ten tones, Count 159 and into 3/2F grps. Also on 5137 kHz and rptd a week later. (Mason, England)
- 4066.1: NWPB, USS Dixon AS37 w/calls to San Diego CSS-1 (NPL) and request for p/p. San Diego advised vsl that he was weak and barely readable and to QSY to CSS-2 freq. USB at 0403 and duplex 4360.5 kHz. (Sabo, CA)
- 4376: USCG vsls S1E and K2M w/lots of talk of discrepancy in report in Miers light being extinguished, and how that would affect S1E's arrival at K2M. Went on for some time, during the course of which COMMSTA Portsmouth (NMN) came up and tried make contact with NHXX, USS El Paso LKA117 and NAFO, USCGC Cowslip WLB277. USB and intermittent comms 0351-0415. (Cabo, CA)
- 4555: OM/EE announcing Capital Switch operator 26 in LSB. On USB Vesper and Thunder w/discussion of switch boards. Hrd at 0329. (Willmer, MI)
- 4596: WHITE LIGHTENING w/rdo check to TROPICAL in USB at 0756 advising that he'd give him a rdo check on the tac command net night freq in 5 mikes. (Sabo, CA)
- 4637.5: KMZ322/Rowan Base, Houston, conducting net roll call of Rowan oil rigs. USB at 0852. Stns hrd incl WYU8967, Rowan Alaska; WHU8968, Rowan Louisiana; Rig 44; and Rig 4. Was still going strong at 0907. At 0902, WRB669, Houston (diff opr) came up and talked to Rig-28, Yorktown, but not sure if she was the same net. All very hard to hear. (Sabo, CA)
- 5080: PLEAD CONTROL (NTD, PMFR, Point Mugu, CA) w/kg N4K and Y1P in USB at 0005. Great sigs on all and hrd intermittently for about an hour. Y1P was apparently a USN vsl conducting firing practice at the range: talked about launching two "MARK-182-MOD-1's" at 2 min separation. (Sabo, CA)
- 5277: Scrambled speech, then u/i stn w/comms to PANTHER-02. 02 was apparently answering back in scrambled mode. USB at 0738. This is Customs Service "A" channel. (Sabo, CA)
- 5305.5: SLHFB "P" at 0325. (Mueller, France)
- 5426: KRH50, US Embassy, London, England in CW at 0454 w/QSX info and periodic breaks for high speed CW t/c. (Scalzo, PQ, Canada)
- 5430: CDG206, Alma, Quebec, Canada, w/Forest Fire warnings for lower North shore and areas. In FF USB 0440. (Scalzo, PQ, Canada)
- 5718: MEDEVAC-5453 in USB at 0636-0637 to Halifax Military (CFH) w/request for ambulance, oxygen, suction, monitor, and respiratory technician upon his arrival at RCCA but Halifax unable copy. St. Johns Military (CJX) then attempted contact w/5453 but a/c didn't answer. I had fivers on all. (Sabo, CA)
- 5754: U/i stn w/coded t/c in CW. RAF has been reported this freq. Hrd at 0558. (Scalzo, PQ, Canada)
- 5770: YL rptng Yankee Sierra w/elec ton 35 2000-2005. Then GG 5F grps for 635 and 027. (Mason, England)
- 5841: Weak scrambled comms hrd here in USB at 0738; this is Customs Service "B" channel. (Sabo, CA)
- 6371.5: GYU, Gibraltar Navrad Brazil in CW at 0321 w/mkr. (Scalzo, PQ, Canada)

SB	SAN BERNARDINO RADIO BEACON 397 kHz
	ROBERT C. HOMUTH, PHOENIX, ARIZONA: THIS CONFIRMS YOUR RECEPTION OF "SB" ON 1900Z ON 3 April 1986
POWER <u>50</u>	WATS
ANTENNA <u>Long wire</u>	
NOTES <u>Pe His "H" Marker</u>	
SIGNED: <u>Ronald V. Rudolph</u> F. Agency Coord. with San Diego Army Radio Center	

Bob Homuth, AZ used this PFC for verification of a beacon reception.

C. A. N. TELEFONOS DE VENEZUELA VENEZUELAN TELEPHONE COMPANY			
Confirmando el reporte de nuestro Sistema Internacional de Radio Confirming the report of our International Radio System			
Recibido de Received from	Fecha Date	Hora Time (GMT)	
<u>Bob Christian</u>	<u>May 30 10</u>	<u>0310</u>	
TRANSMITIENDO CON		TRANSMITTING WITH	
Potencia de Power at	Modo Mode	Frecuencia Frequency (kHz)	Antena Antenna
<u>30 KW (PEP)</u>	<u>SSB</u>	<u>73 ES DX</u>	<u>Antena</u>
Muchas gracias por su atención Many thanks for your attention			

QSL from the collection of Bob Christian, LA.

Abbreviations Used For Intercepts	
AM	Amplitude Modulation mode
BC	Broadcast
CW	Morse Code mode
EE	English
GG	German
ID	Identifier/led/cation
LSB	Lower Sideband mode
OM	Male operator
PP	Portuguese
SS	Spanish
tc	Traffic
USB	Upper Sideband mode
w/	with
wx	Weather report/forecast
YL	Female operator
4F	4-figure coded groups (i.e. 5739)
5F	5-figure coded groups
5L	5-letter coded groups (i.e. IGRXJ)

6385: PWR, Rio Grande Navrad Brazil in CW at 0321 w/V's and QSX info. (Scalzo, PQ, Canada)

6389: CTP, Oieras Navrad Portugal in CW at 0248 w/V's and QSX info. (Scalzo, PQ, Canada)

6506.4: ZLW, Wellington, New Zealand in USB at 0716 wkg F/V Amalal Explorer. Received full data PFC and nice letter on Company letterhead for this reception. Address: Wellington Marine Radio, GPO Heard Street, Wellington, New Zealand. (Sabo, CA)

6507: Music box playing tune "Swedish Rhapsody" here every Sat at 1900/2000 and also on 5340/4779 kHz. On this occasion at 1905 YL/GG w/headings 85447/25978/47357 and into 5F grps for each heading. (Mason, England)

6962: YL/EE in AM at 0215 w/5F (3/2F) grps. (Scalzo, PQ, Canada)

7394.5: SLHFB "V" at 2000. (Mueller, France)

7450: BROADWAY CONSUMER, Arizona National Guard-related net IN LSB at 0211. Incl 57Y, 57AB, & 65A (OM/STR). 65A explained his strong sigs as saying he had an 4,022 foot antenna. (Sabo, CA)

7475: WAR46, Ft. Richie, MD wkg ARCHIBALD w/rdo check on SAC W-104 channel. USB at 0405. (Sabo, CA)

7527: LONGHORN w/calls to "43" on Customs Service "ZB" channel. USB at 0027. (Sabo, CA)

7535: The foll USN units worked Norfolk SESEF to check equipment emission; NDIB, USS Briscoe DD977

at 1600; NRWS, USS Simpson FFG56 at 1700; NQSI, USNS Rigel T-AG-58 at 1735; NOTC, USS Caron DD9970 at 1630. (Stuart, DE)

7585: Music box "Swedish Rhapsody" every Sun at 1800. Tfc in 5F grps for 421812/41259/99881 in German by soft-voiced YL. (Mason, England)

7605: YL w/rpts of VLB in USB at 0413. Weak but very clear. 7445 kHz active w/KPA2 at same time. (Sabo, CA)

7752: YL rptng Echo Gulf w/elec-tones 2100-2105. Then 5F grps in GG for 472 and 795. (Mason, England)

7760.2: KWL48 (?Howl Kai?); KOJ638/Tern Island; and KAW63/Lake Sand hrd in USB between 0435-0506, w/first two stns in most comms. Apparently some sort of Marine Research net with lots of talk re turtle eggs and hatchings, molted seals, sending research data and samples back and forth, etc. Also a ref to a 12 MHz freq. All very interesting & best guess is a NOAA/National Marine Fisheries activity. All on weak to medium strength but fairly readable. (Sabo, CA)

7801.1: USCGC A3D passing ships registration info to Group Key West in USB at 0155. (Willmer, MI)

8120: YL/GG w/1-0 count and 399 from 2000-2010. After ten tones Gruppe 210 and into 4F grps. Simulcast w/10135 kHz. At same time on 7375/9465 kHz YL/GG w/1-0 count and 106. After ten tone Gruppe 154 and into 3/2F grps. Rptd week later. (Mason, England)

8241.5: GQIC, HMS Alacrity F174 clg Portishead Radio at 0830. Portishead should respond on 8765.4 kHz but no joy at this time. (Stuart, DE); US Army Vessel Klinger to Commsta Honolulu for rdo check, then asked for freq to check out RTTY gear. Commsta said to QSY 6455 kHz. USB at 0416 and duplex 8765. kHz; S/V Philadelphia (KYSP) wkg Commsta Portsmouth (NMN). Vsl headed for St. Croix, Virgin Islands. USB from 0502-0503 and duplex 8765.4 kHz. (Sabo, CA)

8247.7: USS Dixon (NWPB, AS37) w/calls to San Diego CSS-2. (NPL). CSS-2 hrd answering faintly on duplex freq 8771.6 kHz then nil more. USB at 0408. (Sabo, CA)

8270: YL/EE in AM at 0501 rptd 479 until 0505, then 678 x3 42 x2 and into 5F grps (each x2). Same YL w/same format noted this date also on 20250 and 9320 kHz. (Sabo, CA)

8291.1: Tidewater Marine, Morgan City, LA in USB at 1510 wkg M/V El Canaro Grande (seagoing tug) re vessel position, wx & sea conditions. FYI: Tidewater Marine is one of largest boat companies in world specializing in offshore supply vessels (OSVs), seagoing tugs and inland towing vessels. They also own a large fleet of barges. (Christian, LA)

8680: RMP, USSR Navy Kalingrad in CW at 1925 w/calls to UHEY. (Boender, Netherlands)

8718.9: COMSUPRON-8 w/unanswered calls to USS Papago (NZPU, ATF160) at 0148. Same nite from 0625-0627, COMSUPRON-8 in comms w/USS Papago w/query re current status of ship which was apparently having problems w/power system on board. USB mode. (Sabo, CA)

8828: KVM70, Honolulu Hawaii Vomet w/aero wx for major West Coast airports. USB at 0609. (Scalzo, PQ, Canada)

8891: Gander rdo to Canforce 01 w/msg relay to North Bay and freq change (11233 kHz). Later on VHF hand off to Moncton centre. USB at 2100. (Scalzo, PQ, Canada)

8912: HOMEPLATE wkg a/c 25 on Customs Service YC channel. Was USB at 0216. (Sabo, CA)

8930: Stockholm rdo wkg Scandinavian 932 w/patches to Copenhagen Dispatch re maintenance problems. Much talk re disparities between left-right engine readings. They QSY'd to 5541 kHz momentarily but stns unable make contact so QSY'd back to 8930 kHz. USB from 0311-0338. (Sabo, CA)

9197: FHWA/DOT Regions 6/7/8 net command roll call conducted by WWJ48/FHWA, Lakewood, CO. Others included WWJ63, 65, 70, 46, 82, 88 and 86. USB at 1406. This is FHWA F4 channel. (Sabo, CA)

9251: YL rptng 11483 w/tune "Lincolnshire Poacher" playing in between. At 1810 into 200 5F grps ending at 1845. Warble jammers on this freq at 1820 and also on the other two freqs - 7887/8464 kHz. (Mason, England)

10069: TWA 848 asks Berna Radio (Switzerland) for selcal check AEJL at 1157. (Mueller, France)

10125: CIO2 (Mossad) hourly callup at 45-50 mins past hour. (White, ME) Simulcast on 13291 kHz. (Sabo, CA)

10284: VVV DE 8BY (New Indonesia call???) w/short

coded msg (triname grps). Hrd at 0648 in CW. (Scalzo, PQ, Canada)

10285: SLHFB "V" at 0322. (Mueller, France)

10493: WGY912 (VIP Relocation Site, Mt. Weather, VA) attempting patch between 3525 and LEGAL LION from 0223-0227 but the two parties having trouble hearing one another. On another day at 1408 hrd WGY906 (FEMA, Denton, TX) wkg WGY938 (FEMA, Cheyenne, WY). This is FEMA F28 channel. (Sabo, CA)

10869: WGY912, Mt. Weather, VA (FEMA) w/3 char grps in CW at 2032. (Scalzo, PQ, Canada)

11090: YL/GG rptng 823 x3, 1-0 count. At 2310 ten tones and into 89 3/2F grps. (Willmer, MI)

11160: YL/EE rptng 425 until 0134 then 693 x2 122 x2 and into 5F grps x2. (Willmer, MI)

11214: Trenton Military wkg a/c CHALLIS-ALPHA w/pp to u/i party. Ground party couldn't hear a/c so Trenton relayed. Probably NORAD/AWACS activity. USB from 0401-0404. (Sabo, CA)

11215.5: RJ (NCS) advising Lab and Troop that C-11 Air Comm Terminal was available. Proceeded to pass data on USB at 1240. (Willmer, MI)

11226: Andrews AFB wkg Air Force One w/pp's to CROWN (White House Communications Agency) in USB at 0220. Intermittent patches and comms hrd until 0241. CARPET BAG w/calls to SOLDIER in USB at 2041 on SAC X-905 channel. (Sabo, CA)

11491: YL/SS in AM at 0103 announces 247 + 10 count. Then into 4F grp msg at 0110. (Margolis, IL)

12158: YHWA/DOT Regions 1/3/4 net command roll call conducted by WWJ48 (FHWA Lakewood, CO). Other stns incl WWJ41, Cairo, NY; KTX20, DOT Hq Wash DC; WWJ43, Berkeley Springs, WV; WWJ44, Dahlonge, GA; WWJ63, Nashville, TN; WWJ65, Raleigh, NC; WWJ70, Montgomery, AL; & WWJ68, Avondale, GA. USB from 1418-1423. This FHWA F6 channel. (Sabo, CA)

12342.3: NOAAS DISCOVERER (WTEA, R-102) wkg COMMSTA Honolulu (NM) at 0310; NOAAS MCARTHUR (WTEJ, S-330) wkg COMMSTA Honolulu at 0400. All USB and duplex 13113.2 kHz. (Sabo, CA)

12750.3: CWA, Cerrito/Puntas Radio, Arenas, Uruguay w/QSX info. CW at 0333. (Scalzo, PQ, Canada)

12790: URL, Sevastopol, USSR in CW at 0145 w/mkr and QSX info. (Scalzo, PQ, Canada)

12999.5: CTU2, Nunes Navrad, Ribiero, Portugal in CW at 0025 w/tfc. (Scalzo, PQ, Canada)

13244: An individual identifying as an American Escort aboard Aeroflot 4113 w/pp via MacDill to Air Force Operations Center w/ETA to Andrews at 1745. NOTE: This flight prob carried Boris Yeltsin when he made trip to States. (Willmer, MI)

13261: Tahiti wkg Hawaiian 485 at 0446; Nandi wkg a/c 24 at 0449. USB mode. (Sabo, CA)

13312: Rockwell in USB from 0141-0144 w/wx for various West Coast locations for a/c 003. A/c opr had heavy foreign accent. 8822 and 6550 kHz mentioned as alternate freqs. (Sabo, CA)

13560: BDD22, Taipei Meteo, Taiwan w/VVV/CQ CW mkr into PT wx in EE at 1600. ID'd itself as BMB. (Margolis, IL)

13635.5: SLJFB's "D", "P", "C" and "S" at 1042. (Mueller, France)

13815: KRH50, AmEmbassy, London, England in CW at 0448 w/QSX info. (Scalzo, PQ, Canada)

13940: YL opr w/Aussie accent ran patch from Scott Base (NZ Antarctic Base) to stateside location but only the non-Anarctic side was hrd. Prob Telcomm Int'l (Wellington), as QSL letter I received from Telcomm said they do this for Scott. USB from 0422-0437. (Sabo, CA)

14330: OM/EE in USB at 2106 w/5F grps x2. (Weil, MN)

14421: H4M w/QRA H4M GR 34 BT in CW at 1420 foll by 5L grps and rptd msg one time then BT AR at 1426. (Margolis, IL)

14441.5: NDFY, USS Sand Lance SSN660 NNNOCFL clg "Any Stateside MARS Station" at 0225. (Stuart, DE)

14535: OM/II dictates msg to another OM/II in USB at 0953. (Margolis, IL)

14686: ATLAS w/calls to 610 in USB at 1903. This is Customs Service "P" channel. (Sabo, CA)

14762: Stn in CW at 0730 w/5L grps. Later ID'd as DE E9T. Have hrd variety of calls here, poss UK Military drill net. (Scalzo, PQ, Canada)

14912: AAC2, Ft. Richie, MD wkg AADU at Nombre de Dios, Panama on USB at 1152. AADU gave his

location at time of the transmission. (Margolis, IL)

15004: RID, Irkutsk Time Signal Station, USSR hrd w/id in CW & time pips at 1250. (Margolis, IL)

15682: YL/EE w/72701 and Lincolnshire Poacher tune here and on 14487 kHz at 1800. Xmtr opr must have realized at 1802 that evening sked was in operation so these two freqs were shut down and 7887/8464/9251 kHz were started up. (Mason, England)

15843.5: NDU M rpid in CW at 1332. At 1335 in info 5L grps (cut nbrs) using ADGIMNRTUW. S/off at 1342 w/SK VA. (Margolis, IL)

15867: SLINGSHOT wkg ALMIGHTY in USB at 0227 on Customs Service ZE channel. (Sabo, CA)

16000: VNG, Canberra, Australia w/time signal and ID on the hour. Hrd in AM at 0710. (Scalzo, PQ, Canada)

16355: STING RAY (USAF) hrd in comms w/CARPENTER on USB at 1559. (Margolis, IL)

16459.7: OM/SS in USB at 2128 sending msg indicating they experiencing strong QRM from RTTY in the Mediterranean zone and it was affecting comms. Stn then requested of other end that they shift to CW but they stayed on voice and moved up to 16465.6 kHz USB. Poss Spanish Navy comms. (Ed.)

16861.5: 5OW17, Lago, Nigeria in CW at 1303. (Mueller, France)

16954.5: GKC, Portishead, England in CW at 2019 w/mkr. (Scalzo, PQ, Canada)

17015.5: SLHFB's "D", "P", "C" and "S" at 1500. (Mueller, France)

17016.2: SLHFB "F" at 0900. (Mueller, France)

17170.5: ZLB, Zwarua, New Zealand in CW at 0163 w/QSX an dtfc info. (Scalzo, PQ, Canada)

18010: 07 clg 41 (OM/EE oprs). 07 asking 41 if they wrkng tomorrow & if 41 ready to implement plan on Monday. 07 advising 41 to use hood on vehicle when working for ventilation reasons. USB at 0400. (Fenlon, OH)

18171: ATLAS wkg AMBUSH w/patch to CLIPPER-24 in USB at 1802. This is Customs Service "SI" channel. (Sabo, CA)

18532: GAS TUBE to BASS BOAT w/alfa-numeric tfc (3L/F grps). GAS TUBE passed two such msgs, then a 3rd in PT which he called a comm activity test msg. Totally u/i but BASS BOAT is a callsign used occasionally on SAC nets. USB from 1856-1913. (Sabo, CA)

18619: U/i US Navy stn in CW at 1258. Sent very long letter from Navy recruiter re life & career in Navy. Letter sent at 17.5 wpm. Dropped at 1430. (Margolis, IL)

19095: YL/EE in USB w/3 + 2F grps at 1501. (Margolis, IL)

19782: LPL, Gen. Pacheco, Argentina w/voice id tape in SS foll by tones. USB at 2244. (Scalzo, PQ, Canada)

20220: YL/EE in AM at 2141 w/3 + 2F grps. (Scalzo, PQ, Canada)

20250: YL/EE in AM at 2110 w/5F grps each x2. Super good sigs. (Sabo, CA)

20405: YL/EE on AM at 1800 w/758 758 758 & 1.0 count. Foll by 3/2F grps at 1810. (Margolis, IL)

20407: KICKBACK wkg u/i stn in USB at 1809. Advised him that this freq was primary and X-905 was 2ndary. Called this one W-117. (Sabo, CA)

20450: CLP1, Ensenada Mora, Cuba (MINREX) w/coded tfc in CW at 1910. Very poor tone quality. Also hrd on 20454 kHz but it not simulcast with this freq. (Scalzo, PQ, Canada)

20724: Possibly CLP1, MFA, Havana, Cuba w/5F grps. Zero cut as ltr T. CW at 1756. Xmsn ran for more than an hour. (Margolis, IL)

20737: AFC3RI wkg 472 and AGA2PX w/patches in USB at 1924. 472 was poss an a/c and AGA2PX is listed as a deployed element. (Sabo, CA)

20991.5: SLHFB's "D", "P", and "C" at 0900. (Mueller, France)

20994: AAV4AN and AAV6 in informal session 1850-1900 when AAT3PY (VA) broke in, advised he needed make his 1900 sked and old Saudi stns AEM3VA and AEM3BO. Never got an answer, and AAV4AN advised that those stns were on frequency Echo-6. USB mode. (Sabo, CA)

21750: YL/EE at 2128 w/groups of nbrs. A minute later what appeared be the same xmsn hrd on 17567 kHz. At 2202 I checked back on these freqs and hrd poss jamming (poss "Barrage" jamming) on 21750 kHz and the prev hrd sig could not be hrd. On 17550 kHz the sig was not hrd and there was some type of QRM present but not the same as that on 21750. (Brookman, AK)

23402.5: 452 wkg ATLAS in USB at 1809 on Customs Service "R" channel. (Sabo, CA)

12 HOUR RECORDER



- *excellent* audio quality
- trouble-free metal (NOT plastic) chassis
- 6 hours per side, C120 tape
- volume AND tone controls
- AC/DC operation
- digital counter
- BUILT-IN voice activation (no external box) - add \$19*
- scanner adapter cord - \$8*

\$129*

AUTOMATIC TELEPHONE ADAPTER

- starts/stops recorder automatically
- FCC approved



\$16*

*special prices for PopComm readers

NO shipping charges on prepaid orders.
COD's OK. California residents add tax.

FREE CATALOG



VIKING INTERNATIONAL

SINCE 1971
150 EXECUTIVE PARK BLVD #4600
SAN FRANCISCO, CA 94134
PHONE: (415) 468-2066
FAX: (415) 468-2067

CIRCLE 136 ON READER SERVICE CARD

RANGER SDM-1000

BASE MICROPHONE WITH UP/DOWN SCANNING

High-Fidelity Wide band frequency response give your station that broadcast studio sound!

- Electret element and high quality SMT-amplifier
- Modern slim line design - easy to use with minimum space requirement
- Designed for use with all amateur transceivers: HF-VHF-UHF-SHF
- Factory pre-wired for most popular transceivers
- Up-down buttons - locking type PTT switch
- Stable, heavy-duty, die-cast base
- Long-life watch type battery

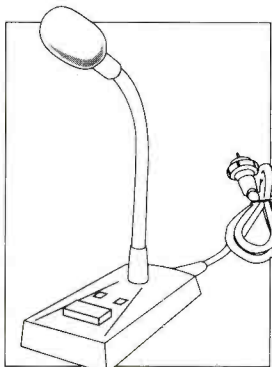

Pre-wired for:
AR3300-AR3500-YAESU 8 pin transceivers
Model F AR3300-AR3500-YAESU 8 pin transceivers
Model H HR-2510/LINCOLN
Model I RCI 2900/2950



CLEAR CHANNEL CORPORATION

PO Box 445
Issaquah, WA 98027
206-222-4295 FAX 206-222-4294

NEW PUBLICATION

MARITIME FREQUENCY DIRECTORY

LF - MF - HF - VHF - UHF

CW - FACSIMILE - FM - SITOR - SSB

THIS NEW PUBLICATION CONTAINS OVER 27,500 LISTINGS BY COMMUNITY AND INCLUDES NEW 1991 ITU FREQUENCY ALLOCATION CHANGES.

INCLUDED ARE GENERAL MONITORING INFORMATION, VHF FREQUENCY ALLOCATION CHARTS, COAST-SHIP FREQUENCY CROSS REFERENCE CHARTS, AND THE NEW 220 MHZ MARINE FREQUENCIES.

Coverage Includes:

Coast Guard	Weather Broadcast
High Seas Radio Telephone	VHF Marine Operators
Public Coast Stations	Limited Coast Stations
Utility Coast Stations	Operational Fixed Stations
Commercial Stations	Recreational Stations
Search and Rescue	Emergency and Distress
Port Operations	Mississippi River
Maritime-Aeronautical	UHF Dockside Channels
New Automated Maritime Information System	

\$ 24.95 PLUS \$ 3.05 SHIPPING

**OFFICIAL SCANNER GUIDE
Post Office Box - 712
LONDONDERRY, NEW HAMPSHIRE 03053**

CLANDESTINE COMMUNIQUE

WHAT'S NEW WITH THE CLANDESTINES

Last month we made brief mention of a program from Croatian Radio Zagreb being aired over WHRI. We have more information on this now, thanks to Harold Sellers of the Ontario DX Association. This program apparently comes from the legitimate Croatian Radio, (Hrvatski Radio in Croatian) now unable to reach a foreign audience via the shortwave service of Radio Yugoslavia as it once did. In fact, the station's literature claims it was the first radio station in southern Europe, having gone on the air from Zagreb on May 15, 1926 when Yugoslavia was the Kingdom of Serbs, Croats and Slovenes. The name Croatian Radio wasn't adopted until the summer of 1990. The program via WHRI is especially produced and intended for Croat ex-patriates who've lived in the Americas for generations, Croats who had to flee during the communist regime and other listeners in North and South America. Coincidentally, this service began on the 65th anniversary of the opening of the station. The program of information and cultural items airs at 0000 nightly on 7315. We're not sure how well the mails are working in Yugoslavia at the moment but you can try a report to Croatian Radio, PO Box 1000, 41000 Zagreb, Croatia (Yugoslavia).

Meantime, the Serbian minority in Sakra-ina, Croatia is reported to have a station in operation in the 41 meter band, on the air from approximately 1200-1300. No frequency has been discovered yet.

The Colombian clandestine Radio Patria Libre continues its nightly activity above 6200. There've been several loggings of this in the area around 6280 and 6290 between 0030 and 0115 sign off. It has also been active on 6230 and vicinity. The station often uses the slogan "La Voz de Nueva Colombia." We've not seen or heard much from El Pueblo Responde the station that was dogging Patria Libre, so it may have left the air. Unfortunately, there are still no clues as to an address for the National Liberation Army (ELN) guerrillas, the organization which operates Patria Libre.

Hans Johnson of Maryland notes the Voice of the Mojahed (Saday e Mojahed) using both 4750 and 6540 from around 0130. The same program is aired on both frequencies but 4750 signs on at 0130, five minutes before 6540. He thinks this anti-Iran effort is an origination of Saudi Arabia and/or Egypt.

Here's the latest schedule for Radio Free Afghanistan, aired via the facilities of Radio Free Europe/Radio Liberty: 0230-0330 on 9555, 11770, 15370 and 17895. 1300-1400 on 15445, 17780, 17835 and 21510. All broadcasts are in Pashto and Dari. A much more genuine Afghanistan clandestine is the

Voice of the Mojahed of Afghanistan which came on the air this past summer. It airs from 0100-0200 and 1415-1515 on 3250 and 5800.

Another anti-Afghanistan clandestine is the Voice of Unity a station that's been around for awhile and has been logged by many clandestine hunters in North America. Look for the Voice of Unity at 0130 sign on, using 11490, 12230 and 15685.

Radio Austria's "Shortwave Panorama" DX program recently noted that North Korea's Radio Pyongyang includes secret messages within the revolutionary music it broadcasts.

National Unity Radio, apparently broadcasting from the Sudan, has been reported active again on 9535 between 1500-1700 in a variety of languages, including English. It announces its location as Khartoum and, rather than its own programs, sometimes just relays Omdurman Radio. It is also quite frequently simply off the air. When it first came

on the air in 1986 it seemed to be designed as an alternate voice in competition with the Sudan People's Liberation Army station Radio SPLA and has used such SPLA frequencies as 9555 and 11710. National Unity Radio announces an address in care of the General Command, Moral Guidance Branch, PO Box 15, Khartoum, Sudan. Don't count on getting anything in the way of a reply, though. Our experience over several attempts has not produced any results.

That will do it for this month. We welcome your informational input to this column. We're interested in hearing about what you are hearing on the clandestine scene. What stations are you logging? When and where? Also your observations and opinions on the many unsolved clandestine mysteries, as well as information about station addresses and QSL's you may have received, literature from stations or their backers and news clippings related to clandestine broadcasting. All of it is useful and much appreciated. ■

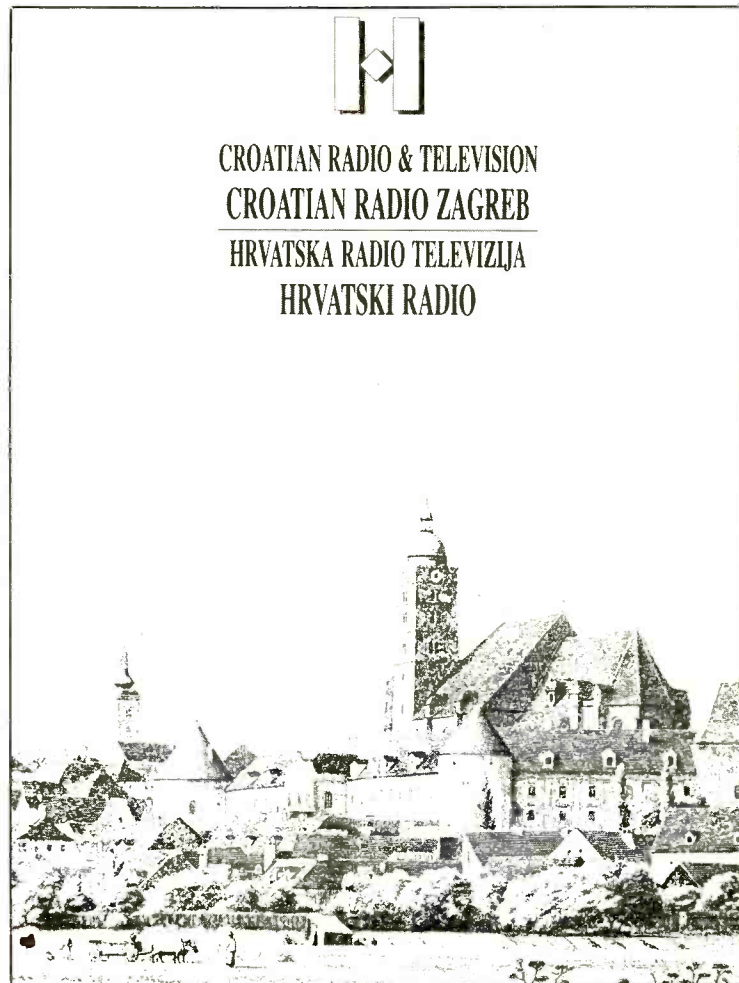

A one hour program from Croatian Radio Zagreb is aired nightly on WHRI.

"The Largest Dealer of Scanners in the World"

SCANNER WORLD, USA®

10 New Scotland Ave., Albany, NY 12208 • 518/436-9606

Scanner World, USA

SCANNER WORLD EXCLUSIVE UNIDEN BEARCAT BC205XLT

\$259.99 (\$7.00 shipping)

Digital programmable 200 channel hand held scanner with raised button keyboard for easy programming of the following frequency ranges: 29-54 MHz, 118-174 MHz, 406-512 MHz, 806-956 MHz. Features include: Scan delay, memory backup, key pad lock, sidellit liquid crystal display, channel lockout, 10 twenty channel banks, direct channel access, automatic search, full one year factory warranty, 10 priority channels, Ni-Cad battery pack, AC adapter/charger, flexible rubber antenna carry case are all included. Size is 2-11/16" Wx1-3/8" Dx7-1/2" high. (Optional extended 2 yr. warranty \$29.99, 3 yr. extended warranty \$39.99.) (* Excludes Cellular)

#CC-008 Heavy Duty Leather Carry Case \$27.99

RELM RH-256NB HIGH BAND TWO-WAY RADIO

\$339.99
SPECIAL PACKAGE DEAL



(Plus \$9.00 Shipping Each)

16 channel digital readout two-way radio. Covers high band frequency range of 148-162 MHz without returning. Perfect two-way radio for ambulance, police, fire, tow trucks, taxis, commercial companies who use this band. Features include CTCSS tones built-in, priority, 25 watts output, channel scanning, back lighted keyboard, message light, time out timer, scan delay, external speaker jack. Size is 2 3/4" Hx6 1/2" Wx10 1/4" D.

SPECIAL PACKAGE DEAL includes RH-256NB, mobile microphone, 1/4 wave body mount antenna, mobile mounting bracket and mobile power cord all for the low price of \$339.99

SPECIAL!! LOWEST PRICE EVER FOR A PROGRAMMABLE SCANNER



SR-901

AVAILABLE ONLY FROM SCANNER WORLD

ONLY! \$74.99 Each

(Plus \$6.00 Shipping Each)

\$69.99 (2 or more)

Features include: 10 programmable channels, one touch memory programming, external speaker jack, 29-54 MHz, 136-174 MHz, 400-512 MHz, squelch, lockout, full frequency digital readout, AC or DC operation, retains memory up to 3 days without power, scan button. Includes AC adapter, telescopic antenna, and complete operating instructions. Size: 7 1/4" W x 2" H x 7 1/4" D. One year factory warranty. (Optional mobile cigarette lighter cord #901MPC \$4.99)

REGENCY R-4010 \$106.99

(\$7.00 shipping each)

10 channel hand-held scanner. (Same Scanner as Bearcat 55XL1), 29-54 MHz, 136-174 MHz, 406-512 MHz, digital programmable, keyboard lock switch, lockout, includes rubber flex antenna. (Optional accessory SW-41, only \$19.99 includes rechargeable Ni-Cad batteries, AC adapter/charger and cigarette lighter cord.)

★ ALL MERCHANDISE NEW, IN FACTORY SEALED CARTONS

RADIO SCANNERS

BEARCAT BC55XLT	119.99	(7.00)
BEARCAT BC70XLT	139.99	(7.00)
BEARCAT BC100XLT	159.99	(7.00)
BEARCAT BC140	94.99	(7.00)
BEARCAT BC142XL	94.99	(7.00)
BEARCAT BC147XL	99.99	(7.00)
BEARCAT BC172XL	139.99	(7.00)
BEARCAT BC177XL	139.99	(7.00)
BEARCAT BC200XLT	269.99	(7.00)
BEARCAT BC205XLT	259.99	(7.00)
BEARCAT BC210XLT	139.99	(8.00)
BEARCAT BC310A	85.99	(7.00)
BEARCAT BC330A	109.99	(7.00)
BEARCAT BC400XLT	99.99	(7.00)
BEARCAT BC560XLT	109.99	(7.00)
BEARCAT BC760XLT	269.99	(7.00)
BEARCAT BC800XLT	249.99	(8.00)
BEARCAT BC855XLT	186.99	(8.00)
BEARCAT BC950XLT	249.99	(7.00)
REGENCY R3020	96.99	(7.00)
COBRA SR901	74.99	(6.00)
REGENCY R4010	106.99	(7.00)

MIDLAND CB Radios	In Stock
COBRA CB Radios	In Stock
UNIDEN CB Radios	In Stock
Two-Way Radio Batteries	In Stock
Scanner Antennas	In Stock
Power Supplies	In Stock

RELM RH606B	414.99	(9.00)
RELM UC202 (2 or more)	129.99	(6.00)

SCANNER ACCESSORIES

BCAD70	14.99	BP55	16.99
BCAD100	14.99	MA917	24.99
BCAD140	14.99	MA518	14.99
BCAD 580	16.99	MA501	14.99
BC003	7.99	ESP25	16.99
BC002	59.99	GRE8002	79.99
PS001	12.99	GRE-HH	54.99
UA502A	12.99	GRE9001	89.99
BP205/200	34.99	GRE 3001	62.99
BP70	16.99	FBE	4.00
VC001	12.99	FBW	4.00
BP4	24.99		

BOOKS

Covert Intelligence	8.95
Air Scan Directory	14.99
Betty Bearcat	4.00
Top Secret (7th)	15.99
Covert Techniques	9.95
Tomcat's Big CB	13.95
World Radio	18.99
Survival Directory	6.95
Rail Scan	7.95
Police Call	7.49
Scanner Modification	17.99

UNIDEN BEARCAT BC-400XLT



\$99.99

(\$7.00 shipping)

Our best selling mobile scanner, 16 channel, AC DC, programmable, digital, AC/DC cords, telescopic antenna, mobile mounting bracket, weather search, priority, 29-54 MHz, 136-174 MHz, 406-512 MHz, external speaker and antenna jack.

BEARCAT BC-100XLT

100 Channel Digital Programmable Hand-Held Scanner

\$159.99

(\$7.00 shipping)

Our best price ever on a full featured complete package hand-held scanner. Manufactured by Uniden. Features include 11 bands of weather, aircraft, public service, trains, marine, plus more (29-54 MHz, 118-174 MHz, 406-512 MHz), 10 channel banks, 10 priority channels, lighted LCD display, earphone jack, channel lockout, AC/DC operation, scans 15 channels per second, track tuning. Special package deal includes following accessories: AC adapter/charger, rechargeable Ni-Cad battery pack, flexible rubber antenna, carry case.

SANGEAN ATS-803A

SHORT WAVE RECEIVER **\$168.99**

(\$7.00 shipping)



AM/FM/LW and 12 shortwave bands plus FM stereo, BFO for SSB reception, clock radio. Includes AC adapter, telescopic antenna, stereo headphones, and shoulder strap.

—SHORT WAVE WORLD BAND RECEIVERS AVAILABLE—

Sangean ATS-800	\$92.99	(7.00)
Grundig Yacht Boy 220	99.99	(6.00)
Grundig Cosmopolit	189.99	(7.00)
Grundig Yacht Boy 230	149.99	(5.00)
World Radio & TV Handbook	18.99	(*)

BEARCAT 70XLT 20 CHANNEL DIGITAL HAND-HELD SCANNER

SPECIAL PACKAGE DEAL **\$139.99** ONLY (\$7.00 shipping)

Small size 6" Hx1"Dx2 3/4"W. Full digital readout, priority, search, channel lockout, scan delay, key lock. Covers following frequencies: 29-54 MHz, 136-174 MHz, 406-512 MHz. Package includes rubber antenna, rechargeable Ni-Cad battery pack, AC adapter/charger and vinyl carry-case. Optional Cigarette Lighter Cord #UA502 \$12.99 Heavy-Duty Leather Carry Case #CC002 \$22.99



UNIDEN BEARCAT BC-950 XLT



\$249.99 (\$7.00 shipping)

Digital Programmable 100 Channel Scanner

BC-950 XLT covers the following frequencies: 29-54 MHz, 118-174 MHz, 406-512 MHz, 806-954 MHz (excludes cellular). Features compact size of 6-5/16"Wx1-5/8"Hx7-3/8", scan delay, priority, memory backup, channel lockout, bank scanning, key lock, AC/DC power cords, telescopic antenna, mounting bracket supplied, one year factory warranty, search, direct channel access, track tuning, service search including preprogrammed frequencies by pushing a single button for police fire/emergency, aircraft, weather, and marine services plus exclusive optional features never available on any scanner before. First is an RF receive amplifier for boosting weak signals for only \$34.99 plus a CTCSS tone board is available for only \$59.99 to make this the number one scanner available in the USA. Optional cigarette lighter plug #950 MPC \$4.99.

BEARCAT BC210XLT \$139.99

(\$8.00 Shipping Each)



Scanning Radio Receiver

Digital programmable, 40 channels, 11 bands, including aircraft. AC/DC base, with raised letter keyboard for easy programming of the following frequency ranges: 29-54 MHz, 118-174 MHz, 406-512 MHz. Covering aircraft, police, fire, marine, trains, stock cars, weather, public service, plus much more. Features include: digital display, no crystals required, priority, external speaker or headphone jack, scan delay, auto weather button, channel lockout, search, squelch, memory backup.

BEARCAT BC-147XLT 16 CHANNEL BASE SCANNER

\$99.99 (\$7.00 Shipping)

Programmable, digital, AC/DC operation. Frequency coverage 29-54 MHz, 136-174 MHz, 406-512 MHz. Weather button, priority, lockout button, squelch includes AC adapter, telescopic antenna.

GM-1TM GLASS MOUNT SCANNER ANTENNA

—ONLY AVAILABLE FROM SCANNER WORLD—

Frequency coverage 25-1200 MHz — only 22 inches tall. NEW REVISED DESIGN — no holes to drill — no glue needed. Complete with 17 foot cable, Motorola connector, and mounting hardware. Swivels to vertical position — performance unaffected by moisture on the window. Made in USA.

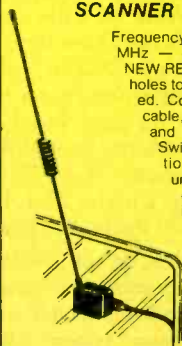

SPECIAL **\$39.99**

(\$3.50 Shipping Each)

ORDERING INFORMATION: Call (518) 436-9606 to place orders or mail orders to Scanner World, USA®, 10 New Scotland Ave., Albany, N.Y. 12208. Orders will be shipped within 24 hours by United Parcel Service if order is accompanied by MasterCard, Visa, cashier's check, money order, COD (COD shipped by United Parcel Service will be cash or money order only). (If a COD package is refused, customer will be billed for shipping and COD charges.) Mail orders with personal or business checks enclosed will be held 4 weeks for bank clearance. Prices, specifications, and terms subject to change without prior notice. If items are out of stock we will backorder and notify you of delivery date. All shipments are F.O.B. Scanner World® warehouse in Albany, N.Y. We are not responsible for typographical errors. All merchandise carries full manufacturer's warranty. Bid proposals and purchase orders accepted from government agencies only. Free full line catalog mailed 4 times per year. Merchandise delivered in New York State add 7% sales tax. No returns accepted after 7 days of merchandise receipt. *Add (\$5) per item, and \$3.50* for all accessories ordered at same time. COD orders will be charged an additional \$4.50 per package. Full insurance is included in shipping charges. All orders are shipped by United Parcel Service to street address only. (No P.O. Box). Shipping charges are for continental USA only. All others ask for quote on shipping charge.

SCANNING VHF/UHF

BY CHUCK GYSI, N2DUP

MONITORING THE 30 TO 900 MHz "ACTION" BANDS

Why not consider turning over a new leaf in 1992. With the new year here, consider changing your approach to the hobby. Investigate joining a new radio club. Add a new dimension to your enjoyment of the hobby.

Encrypted

Can't you hear your local TV or radio station's news team any more? Do you only hear static on their frequencies whenever they transmit? Well, the Federal Communications Commission has given broadcast stations permission to use digital encryption (such as Motorola's Digital Voice Protection) so their communications cannot be overheard in the cut-throat competition among stations to be first with a breaking story.

If a broadcast station uses DVP, it'll be required to transmit its callsign in Morse code or clear voice every 15 minutes. However, in response to a request by Capital Cities/ABC, the FCC agreed that instead of requiring a transmitter to identify its officially issued callsign for the base station, a broadcast station now may transmit its broadcast station's callsign on the remote broadcast system so interference problems can be targeted faster.

The first broadcast station to get special permission from the FCC to encrypt its signals was Gannett Co. Inc.'s WUSA-TV Channel 9 in Washington, DC. Several other broadcast outlets followed, resulting in the FCC's decision to allow broadcast stations to use digital encryption.

Today TV stations, tomorrow taxis, plumbers, race car drivers, and more. It's getting silly.

Letters

James and Pat Andrews, KC4TKD and KC4SSC, of Kissimmee, Florida, said they've noticed the distinctive callsigns of official registered monitors here in *POP'COMM* and want to know how they can get a call like mine, KPA3CA. Write to: CRB Research Books Inc., PO Box 56, Commack, NY 11725.

Paul W. Butler, N0FDQ, of Kansas City, Missouri, passes along some interesting frequencies for his area: 464.175, Worlds of Fun Park maintenance; 463.425, Worlds of Fun Park security; 464.775 and 464.325, Kansas City Chiefs; 154.400 (F1) and 155.085 (F2) Liberty, MO Fire Department.

John Pavlica, Jr., of Toledo, OH says his city is in the process of switching from VHF high band for fire and UHF for police to an 800 MHz trunked system. Like many such systems as they are put on the air for the first time, John notes that there were problems that needed to be solved. Many medium-size cities have been making the move to 800 MHz trunked radio systems.



Here's the listening post of Mark Dudak of Buffalo, NY. Mark's equipment includes a Uniden Bearcat 100XL, a 140XL and a 170XL. A CB station rounds out this station.

Peter K. Miller, KA1MKN, of Prospect, Connecticut, says that he's a ham, public safety dispatcher and long-time communications buff. He poses a question as to why scanner manufacturers don't make CTCSS decoding more readily available as a feature on their radios, as on the Uniden Bearcat 590/600XLT and 760/950XLT. Peter notes it's a nuisance monitoring many frequencies on VHF high band and UHF where many users are sharing the same frequency. The problem is particularly bothersome to those who live in major metropolitan areas or at high elevations. It's surprising that more scanners don't offer a CTCSS decode function. Good question, Peter. It sure would be nice to see subaudible tone decoding available on other types of scanners, too, which would allow the listener to screen out unwanted radio users. And for what it's worth, being capable of digital CTCSS, another form of signaling, would be nice, too.

Steve Ett of New York City says he has a Regency HX2200 scanner and he wondered whether there were plans for any modifications that could be made to this receiver especially performance, expanded memory and additional gain from the internal speaker. I haven't come across any published plans for such modifications, however, if anyone else knows of such mods, pass them along and we'll see that Steve is notified.

Robert Briggs of Port Orford, Oregon, is 17 years old and owns an impressive lineup of receivers: Uniden Bearcat 100XLT, Realistic PRO-57, ICOM R9000, AOR AR3000, Kenwood RZ1 and an Alinco 160. Robert says he lived in Los Angeles for 15 years and wants us to publish frequencies for that city. What we'd actually rather do, Robert, is have a reader in that area send in a list of verified frequencies that would be of interest to others.

With all the changes in southern California, with new TV bands for two-way and more, we'd be willing to publish some kind of update if someone wants to send along a current verified list of frequencies. That's what this column is all about.

Several readers passed along clippings and I spotted the story on the news wires about some police radio problems in Atlantic City, NJ. Apparently until earlier this year, the police department routinely broadcast the names of AIDS patients over its frequencies. However, officials of the American Civil Liberties Union stepped forward to note that such activity violated a 1990 state law in New Jersey. After city officials met to discuss the matter, police decided that such information would be aired only in the event of an emergency. A special radio code, which will be changed weekly, would be aired to warn officers of possible contact with a person who has AIDS or is infected with HIV. Other than in an emergency situation, police officers will be notified in advance by telephone if they are to deal with a patient who has AIDS. Meanwhile, an ACLU official says that the safest solution would be for officers to treat everyone as if they had AIDS.

Bill Bicizk of Cary, North Carolina, inquires about frequency counters and how they can be used to enhance scanning. These new-generation handheld frequency counters are, in essence, frequency finders. If you want to know a particular radio user's frequency, it could generate the information you need in a split second, literally. Basically, you need to get up close to the transmitter, more so for handheld portable two-way units. With base and mobile transmitters you won't need to get up as close because they have more power output than handhelds. When the microphone button is pushed and the transmitter

goes on the air, you'll get a digital readout of the desired frequency—quick and easy. Some frequency counters are more sensitive than others and some may cover only to 550 MHz, while others might go as high as 2 GHz. Make sure the counter you purchase is sensitive enough for your frequency finding and that the frequency range is wide enough for your detection interests. You may look a bit goofy carrying around something that looks like it could detonate a bomb, but you'll generate a lot of good info. Just be discreet when necessary so you don't get into trouble sniffing out a frequency someone would rather you not have!

A lot of readers write to ask what scanner is the best for them when they are in the market to buy a new radio. That's not an easy question to answer. Several things need to be taken into consideration when contemplating a purchase.

First of all, and most important, is your budget more 10-channel handheld or more like a super deluxe base monitor? The price you are willing to spend will dictate what features and functions will be included on the radio you buy. Next, what bands do you want to listen to? Is it important that you are able to listen to 225-400 MHz for military aviation and satellites? Do you need unencumbered 800 MHz operation for cellular? Do you have a desire to listen to hams as high as 1.2 GHz? Do you also want to listen to shortwave broadcasts and utility stations on HF bands below 30 MHz? That will help narrow your selection greatly, just by answering those two questions.

Next, what functions do you need? If you live in an area that has a lot of interference (i.e., intermodulation when living near a lot of two-way and paging transmitters), you should consider a radio that has an attenuator to eliminate some of the signal overload.

Do you want a handheld, mobile or base unit? There are some scanners that can't be used in a car because they operate on AC house current only. Do you want a tuning dial for do-it-yourself searching? Some low-budget scanners don't have the capability to search, so beware. Do you need more than one search bank? Some scanners can search up to 10 ranges at the touch of a button. How many channels do you need? If all you want to hear is the emergency services in town, a 10 or 16 channel scanner may suit you fine. If you live in a metropolitan area, you may have no problems filling up 400 or even 1,000 channels just in your own county. By taking these basic considerations into account, and by comparing technical specifications, you'll make a purchase that you won't regret. No one can tell you what the best scanner is. You've got to decide what scanner is best for you.

What are you hearing on your scanner? We welcome your frequency updates, listening tips, photos of your listening posts and antenna farms and more. Write to: Chuck Gysi, N2DUP, Scanning VHF/UHF, Popular Communications, 76 North Broadway, Hicksville, NY 11801-2909. ■

1992 POPULAR COMMUNICATIONS COMMUNICATIONS GUIDE



The most up-to-date buyer's guide for communications equipment—from communications receivers and scanners, to CB radio and amateur transceivers is finally here!

Complete with articles by experts in the communications field, including Dexter, Kneitel, Helms, Gysi, Orr, Zeller, Margolis and many more, the 1992 Communications Guide is *the* book you've been waiting for—Here's what's inside:

An introduction to the fascinating world of communications monitoring with: illustrated articles on scanning, utility monitoring, antenna selection and construction, pirate radio, QSLing and much MORE!

AS AN ADDED BONUS, noted ham Fred Maia, W5YI tells just how easy it is to get your HAM LICENSE. In plain English, Maia explains ham radio and how YOU can become a licensed ham. In addition, a product listing with PHOTOS of amateur radio transceivers for use by Technician class licensed hams is included . . .

Are you interested in Citizens Band radio? An interesting article on CB radio and COMPLETE product listing with PHOTOS is included at NO EXTRA CHARGE!

The Brand NEW 1992 Communications Guide includes the latest communications products on the market WITH detailed specifications and photos to make your buying decision easier. We've included shortwave receivers, scanners (BOTH base and handheld) and accessories to make your monitoring post complete.

IT'S ALL YOURS FOR JUST \$4.95 (please add \$2.50 shipping and handling; \$3.50 foreign).

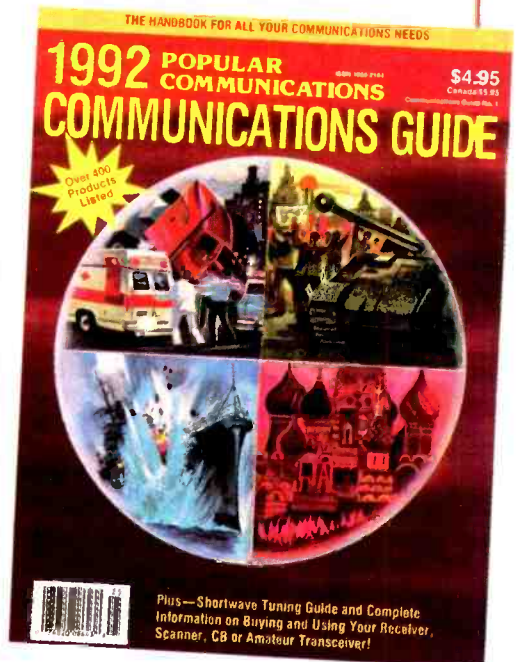

YES, please send me _____ copies at \$4.95 each:

Name _____ Call _____

Address _____

City _____ State _____ Zip _____

Send only \$4.95 each (plus \$2.50 shipping & handling; \$3.50 foreign) Check Money Order

MasterCard VISA Amex Card No. _____ Expires _____

Signature _____ (required on all charge orders)

**Mail to: CQ Communications, Inc., 76 North Broadway, Hicksville, NY 11801
Phone: 516-681-2922/FAX: 516-681-2926**

Beaming In

(from page 4)

The point of *The Economist's* editorial related to yet another concept, that of the government putting frequencies on the auction block and selling them to the highest bidder. This concept originated when the government began considering the reallocation of a chunk of RF spectrum 200 MHz wide that had been held for federal use. The idea was to release it for various needs the public has for the spectrum, now that so many new uses are being found for devices using the frequency spectrum. For example, Apple Computers is suggesting to the FCC that the band 1850 to 1990 MHz be set aside as a high-speed, local-area data communication channel between personal computers.

The Department of Commerce came up with the idea that the 200 MHz of spectrum could be put on the auction block and sold to the highest bidder. Some observers complained that you can't auction off what you don't own. Also, newcomers with limited funds would never be able to win any bids against well-heeled large corporations. Lastly, an argument against an auction concept is that it puts the stuffed wallet of the highest bidder above the needs of others whose uses of frequency spectrum might be in the best interests of the public.

If my understanding of their position is correct, *The Economist* flatly rejects these arguments and supports the idea of auctioning off frequency spectrum. They note the airwaves weren't actually purchased from anybody, as Alaska was. They appear to conclude that since nobody else claims ownership, then the public, via the government, may well own them. Yes, they say, the government manages them and has the right to say who will and will not use them so as to

maintain order. The government also has the right to auction them off.

They are unimpressed by the idea that one fat cat may come along and successfully bid for frequencies put up on the auction block, then keep struggling newcomers and/or competitors from using those frequencies. This is dismissed by observing that if someone couldn't afford to win the bid, then maybe the demand wasn't there for their proposed uses as it was for the uses intended by the one who won the bid. Also, *The Economist* notes that normal anti-trust laws could be used in instances of abuse.

Actually, they support a concept where the successful bidder will subdivide and then merchandise bands and frequencies to those who want to use them. They feel that since users will have to pay for their use instead of getting them as part of a free giveaway from the FCC (as in the past), frequencies will be used as sparingly as allowed by technology.

A Senate committee, which they observe is "in the pockets of a lobby . . .," came out against the frequency auction idea. This, *The Economist* observes, only proves that cash on the barrel-head rather than issued licenses is the best way "to decide between the many new uses of the radio spectrum," because otherwise it becomes a matter of political power rather than public demand. They say that if the government has some special sympathy for hams or other "deserving" spectrum users, a "small band" can be set aside by the government for such purposes before the rest of the spectrum is put up on the auction block for sale. They point out that, "Planning (zoning) laws work for land: why not for the airwaves?"

The Economist doesn't like the government giving away frequency bands and then insisting that they be used only for certain things. They feel that once a frequency has been turned over for someone's use, they

should be able to do with it what they will, without being restricted to certain portions of the spectrum for satellites, cellularity, television, etc.

They make the point that if the government were to give its land over to business users, it couldn't insist that the land be used only for certain limited purposes such as cattle ranching, for that "would prevent the growth of everything from theme parks to nature preserves." On the contrary, that's the only way the government permits the leased use of its land—just for specific purposes, such as grazing, timber, mineral extraction, and similar. It does not permit unbridled commercial exploitation. Maybe *The Economist* doesn't realize this.

In any event, the airwaves aren't land. They are something entirely different. Even so, to keep their analogy, on a piece of land, when your neighbor puts a fence on your property, you have a certified survey and a registered deed to kick him off.

On the airwaves, if you're experiencing interference when you have a federal authorization to be there that may be enough for the FCC to kick the unauthorized station off. But there is little chance that you are going to have quite the same recourse to kick the interloper out of the band you purchased, or are renting, leasing, or sub-leasing from a private party. If the interference is coming from across an international border, chances of seeing it resolved are even less.

And who will handle complaints from the public regarding interference caused by stations using these privately assigned frequencies? Who will see that transmissions meet acceptable technical standards? Who will remove unauthorized stations from the air? Does the owner of the frequency get to make the rules and establish standards? Will public safety stations have to purchase frequency space? Where will experimenters operate? Will there be any need for the FCC to exist once everything is auctioned off?

From the point of view of competent economists efficiently solving a complex situation in a technological field about which they know less than nothing, I'd say they came with an approach that was what might have been expected. Most likely, any good economist in the same position could easily appreciate their comparison of radio waves to real estate, and endorse a rosy view of replacing a federal agency with the private sector; ditching a giveaway in favor of a free market economy.

Let's put it this way. I suspect that I know at least as much about straightening out this or any other nation's economy as a qualified economist knows about the management and allocation of the radio spectrum. Just put a quarter in my pocket, then point me and my unresolved checkbook in the general direction of Wall Street. I'm certain I can come up with with some wonderful ideas for straightening out the fiscal woes of the world. Guaranteed, at the very least, I'll do as well as the economists did with fixing up the radio spectrum, and maybe even as well as they've done with the economy. ■

JRC NRD-535 HF Receiver

- Covers 100 kHz to 30 MHz
- Advanced ECSS Operation For Phase-Lock AM Operation
- 200 Memory Channels
- AM, FM, U/LSB, RTTY, FAX
- Multi Scan Feature

CALL TODAY!



ICOM IC-R71A
SUPERIOR PERFORMANCE RECEIVER

- USB, LSB, AM, RTTY and Optional FM
- Covers .1 to 30 MHz
- 32 Memory Channels
- Multi Scanning Functions
- Keyboard Frequency Entry

CALL TODAY!



ICOM IC-R9000
THE FINE ART OF LISTENING

- Continuous, All-Mode Receiver Covers 100 kHz to 2 GHz
- 1,000 Memories
- Advanced CRT Display
- Direct Digital Synthesizer System

CALL FOR ALL DETAILS!



KENWOOD R-5000
HIGH PERFORMANCE RECEIVER

- Covers 100 kHz to 30 MHz
- 100 Memories
- Keyboard or Main Dial Station Selection
- Programmable Scanning

CALL TODAY FOR DETAILS!



Amateur and SWL Accessories

HAMTRONICS, INC. M, T, W (9-6)
Th, F (9-8)
Sat (9-3)

4033 Brownsville Road, Treose, PA 19047
For Service & Info (215) 357-1400 For Orders (800) 426-2820 FAX 215-355-8958



CIRCLE 135 ON READER SERVICE CARD

COMMUNICATIONS SHOP

Advertising Rates: POP'COMM subscribers are entitled to one FREE 30-word, non-commercial classified ad per year. Enclose subscription name label with ad copy. For those people not in the previously mentioned group, non-commercial ads are 30 cents per word, including abbreviations and addresses; minimum charge \$6.00 per issue. Ads from firms offering commercial products or services are \$1.00 per word; minimum charge \$20.00 per issue. Boldface words are \$1.20 each (specify which words). Leading key words set in all caps at no additional charge. All ads must be prepaid in full at time of insertion; a 5% discount is offered for prepaid 6 time insertions. All ads must be typewritten double spaced.

Approval: All ad copy is subject to Publisher's approval and may be modified to eliminate references to equipment and practices which are either illegal or otherwise not within the spirit or coverage scope of the magazine.

Closing Date: The 10th day in the third month preceding date of publication. Because the advertisers and equipment contained in Communications Shop have not been investigated, the Publisher of Popular Communications cannot vouch for the merchandise listed therein. Direct all correspondence and ad copy to: PC Communications Shop, 76 N. Broadway, Hicksville, NY 11801.

TOMCAT'S BIG CB HANDBOOK, by Tom Kneittel. Just published, 221 large pages, fully illustrated. Complete guide to worldwide AM, SSB, Freeband, 27 MHz operations. Everything they never told you (legal & otherwise) from world's leading CB authority. Only \$13.95 (plus \$3.50 postage to North America) from CRB Research Books, Inc., P.O. Box 56, Commack, NY 11725. (NYS residents add \$1.40 sales tax). Dealer inquiries invited.

TUNE In On Telephone Calls. Tom Kneittel's new 160-page book. Everything you need to know to effectively use a scanner and communications receiver to eavesdrop on private telephone calls from homes, offices, cars, ships, aircraft, trains. Explanatory text, photos, extensive listings section covers USA/Canada on HF, VHF, UHF, and above; thousands of locations, frequency assignments. Explains equipment, best techniques, laws regarding monitoring cellular, cordless, ship/shore, high seas, Air Force 1, airliners, 1-way paging, more. Only \$12.95 (plus \$3.50 postage to USA/Canada/APO/FPO) from CRB Research. Box 56, Commack, NY 11725. NY residents add \$1.32 sales tax. Dealer inquiries invited.

WOW! UNDERSTANDING & REPAIRING CB RADIOS by Lou Franklin. Giant 380-page technical book picks up where THE "SCREWDRIVER EXPERTS" GUIDE leaves off. Includes circuit descriptions and troubleshooting guide for virtually all CB radios: 23 and 40-channel, crystal and PLL, solid-state and tube, AM, FM, SSB, CW, American, British and export models. Covers test equipment, transistor basics, synthesizers, receivers, transmitters, power supplies, T/R switching, antennas, interference, parts and accessory sources. Over 350 illustrations plus huge subject index. Moneyback Guarantee! Only \$29.95 plus \$3.50 U.S. & Canadian Air Mail, VISA/MC available. Free catalog of unique CB books, plans, and modification kits with order. Catalog only, \$2. CBC INTERNATIONAL INC., BOX 31500PC, Phoenix, AZ 85046. Thousands of satisfied customers since 1976.

RADIO MONITORS NEWSLETTER OF MARYLAND FOR THE SERIOUS SHORTWAVE AND SCANNER LISTENERS. PO Box 394, Hampstead, MD 21074. For a one year subscription: \$15.00. Sample copy: one dollar.

Radio Newyork International! Listen for us every Sunday night at 9 pm (Eastern), 8 pm (Central), 6 pm (Pacific) over WWCR, 7435 kHz. All of your favorites: Al Weiner, Steve Cole, Pirate Joe, John P. Lightning, & more! Live call-in at 1-(800)-736-9764. QSL's (send SASE) from RNI, 14 Prospect Ave., Yonkers, NY 10705. Spend your Sunday nights with RNI!

SCANNER MODIFICATION HANDBOOK VOL.1 by Bill Cheek ("Doctor Rigormortis"). New 160-page book. More than 20 performance improvement modifications. Simple step-by-step instructions, many photos. Primarily PRO-2004 & PRO-2005, some for PRO-34, BC-200/205XLT, BC-705XLT, BC-705XLT. Restore blocked out bands, speed ups scanning rate, disable "beep," increase number of channels, improve squelch action, add an S-meter, interface with shortwave receivers, etc. Make the PRO-2004 & 2005 into a 6,400 channel scanner; put 3,200 channels into the PRO-34! Plus, cellular frequency charts, antenna info & mods, inside info on frequency management, operating hints, emergency power supplies, scanners & the law, lots more! Only \$17.95, plus \$3.50 shipping to addresses in USA/Canada. Residents of NY State add \$1.72 tax. **Big 220 page VOL.2** with 18 more mods for PRO-2004/5/6, PRO-34, PRO-2022, BC-760/950XL, BC-200/205XL, now available, \$17.95 plus \$3.50 shipping. NY state residents include \$1.72 tax. If both books ordered at the same time, send only \$4.50 shipping. Order from CRB Research Books, Inc., PO Box 56, Commack, NY 11725.

PAN-COM INTL CATALOG. Over 350 Kits, Plans, Licensed/unlicensed AM/FM broadcasting, Ham/CB/SW/DX, 1750M transmitters, Surveillance devices, Computers/Software, Science Projects, MORE. Box 130-P01, Paradise, CA 95967

DESCRAMBLERS: OAK M35B, \$39.95. Also Jerrold, Zenith, Scientific Atlanta, etc. Guaranteed. Cable Plus, 14417 Chase #481-K Panorama City, CA 91402. 1-800-822-9955.

PRO-2004/5/6 OWNERS Search-and-Store finds unknown frequencies automatically. Internal no-holes installation - Keyboard control - Wired-tested-postpaid: Ten channel \$24.95 - Selectable to 255 channels \$44.95. US checks or MO. SASE for information. Key Research, POB 846P, Cary, NC 27512-0846.

PAY TV AND SATELLITE DESCRAMBLING. ALL NEW EDITION. Our best yet. The very best in descrambling circuits, bypasses, turn-ons, for cable, wireless and satellite. Only \$14.95. Other pay TV edition, VOL. 1 (Basics of all systems) \$14.95. 1989 edition \$14.95. Build Satellite Systems Under \$600 - \$12.95. Wireless Cable Handbook - \$9.95. Any 3/\$29.95 or 5/\$44.95. Scrambling News Monthly has all info on new "Plain Vanilla" descramblers which emulate B-MAC, VCI+ . Orion - \$19.95/yr. New catalog, \$1. Special this month. Everything including video and subscription for \$84.95. **Scrambling News, 1552 Hertel Ave., Buffalo, NY 14216.** For COD's (716-874-2088) Voice/FAX.

JEHOVAH'S WITNESSES: Amateurs, SWLs, please send full details, telephone number to: Bob Ellis, Post Office Box 7349, Winter Haven, FL 33883-7349.

IT'S HERE! SHORTWAVE LISTENING GUIDEBOOK by PopComm columnist Harry Helms! Over 320 pages on receivers, antennas, propagation, types of stations, QSLs, and more! Tells when, where, and how to listen to international broadcasters, utilities, hams, AM and FM DX, and more! PopComm called it "a hip, concise, astute, accurate, and honest guide to what's going on and how to get the most enjoyment from a receiver... very highly recommended!" Available from CRB Research, Universal Shortwave, and EEB, or send \$19.95 (CA residents add sales tax) to HighText Publications, 7128 Miramar #15, San Diego, CA 92121. Satisfaction guaranteed!

"TOP SECRET" INFORMATION! The Underground Frequency Guide by PopComm columnist Harry Helms gives over 500 active frequencies for numbers stations, smugglers, guerrilla forces, embassies, and more! Plus details you won't find anywhere else, like actual locations of numbers stations! Available from CRB Research, Universal Shortwave, and EEB, or send \$13.95 (CA residents add sales tax) to HighText Publications, 7128 Miramar #15, San Diego, CA 92121. Moneyback guarantee!

CB Radios, and accessories at discount prices. Cobra, Uniden, Wilson, etc. C.O.D. Visa and Mastercard accepted. Tollfree orderline, catalog available. C&H Distributing, PO Box 2286, Coeur d'Alene, ID 83814. (208) 667-5459.

R.S. DEALER. Lowest prices nationwide on all R.S. and Sangean equipment. PRO-2006 and DX440, COTRONICS, 2200 SE, FEDERAL HIGHWAY, STUART, FL 34994. Call 1-800-848-3004. Orders only.

SANGEAN DISTRIBUTOR. We carry all Sangean products. Call for lowest prices nationwide. 1-800-848-3004. COTRONICS Inc., 2200 SE, Federal Highway, Stuart, FL 34994.

DEALERS WANTED. Start your own electronics business. Call COTRONICS Inc., 1-800-848-3004, 2200 SE Federal Highway, Stuart, FL 34994.

PAY TV AND SATELLITE DESCRAMBLING 1991 EDITION IS OUR BIGGEST AND BEST EVER VOLUME OF DESCRAMBLING CIRCUITS, TURN-ONS AND BYPASSES FOR CABLE, WIRELESS AND SATELLITE TV. ONLY \$14.95. OTHER EDITIONS OF THE PAY TV SERIES ARE ALSO AVAILABLE. **VOLUME 1 (THE BASICS OF ALL SYSTEMS)** \$14.95. **BUILD SATELLITE SYSTEMS UNDER \$600** \$12.95. **WIRELESS CABLE HANDBOOK** \$9.95. ANY 3/\$29.95 OR 5/\$44.95. **SCRAMBLING NEWS MONTHLY** HAS THE LATEST INFORMATION ON THE "PLAIN VANILLA" DESCRAMBLERS WHICH EMULATE B-MAC, VCI+ PLUS AND ORION. PLUS THE LATEST NEWS, CIRCUITS ETC. \$19.95/YR. SAMPLE \$3. ALL NEW CATALOG \$1. C.O.D.'S ARE OK (716) 874-2088.

VIDEOCIPHER II/Satellite/Scanner/Cable repair manuals, modification books and software. Catalog - \$3.00. TELECODE P.O. Box 6426-PC, Yuma, AZ 85366-6426.

MID-CANADA'S LEADING DISTRIBUTOR of CB's, scanners, export gear and more. Uniden, Cobra, AOR, Wilson. Discounted prices. International orders welcome. **COMMTELCO ELECTRONICS**, P.O. Box 1551, Winnipeg, Manitoba, Canada R3C 2Z4. 1-204-774-9313.

Computer Control of Your Radio

with SCANCAT



Computer Aided Software Control
Never buy another program - SCANCAT runs ALL supported radios
LOOK WHAT WE NOW SUPPORT!
• KENWOOD R-5000, TS-440, TS-960, TS-711
• YAESU FRG-9600, 787GX/GXH/787GXII
• JAPAN RADIO NRD-525 and NRD-535
• AOR-3000 With SPECTRUM DISPLAY/ANALYSIS
• MOST ICOMs including R-71, R-7000 & R-9000

Icom signal detection / scan stop supported with inexpensive optional cable III

Once you use SCANCAT with your radio - You will never use your radio again without SCANCAT!

AOR-3000, NRD-535, ICOM FEATURES

- * Automatic signal detection/scan stop
- * Automatic logging to diskfiles
- * Spectrum Analysis - Terrific graphics!
- * Save/Load radio's memories to disk

UNIVERSAL FEATURES

- * Create Frequency Databases
- * Scan between any frequencies
- * Up to 400 Frequencies per file
- * Scan by ANY increment - by any Delay.
- * Built in Communications program for TNC
- * Share ANY radio's files with another radio

FREE INFORMATION - or - Send for our fully operational Demo (\$5.00). We're so convinced you'll buy SCANCAT, that when you do, we'll refund the cost of the Demo and even pay the postage!

IBM Compatible - Minimum 1 Serial Port & One Floppy (Game port required for Icom option)

\$ 49.95 PPD (Foreign add \$5.00) - **ICOM Cable \$19.95**

Visa - Mastercard - Discover - AmExp or COD
FREE FILE - (Specify your Choice) - CELLULAR or TOP500 UTILITIES
J&J Enterprises-4001 Parkway Dr.-Bossier City, LA 71112
PHONE 518-631-3081 (10-5) or FAX 318-631-3082

CIRCLE 99 ON READER SERVICE CARD

212-925-7000

SHORTWAVE RECEIVERS, HAM RADIOS, BOOKS, ANTENNAS, SCANNERS, Business Radios, ICOM, YAESU, KENWOOD, SONY, PANASONIC, MOTOROLA.

... our 40th Year ... Worldwide shipping. Sales ... Service. Large Showroom. Open 7 days.

Barry Electronics Corp.
WORLD WIDE NAME TELUS RADIO SINCE 1950
Your one source for all Radio Equipment!

Fax 212-925-7001

512 Broadway, NYC, NY 10012

CIRCLE 112 ON READER SERVICE CARD

The Radio Collection

EARLY BIRD SPECIAL!

1992 World Radio TV Handbook
\$16.95

(US Orders Postpaid, add \$2.00 for Priority Mail. Ships January. \$2.00 Bonus Certificate and FREE Radio Collection Catalog with each order.)
PO Box 149, Briarcliff Manor, NY 10510
Where Radio Is Fun Again!

CIRCLE 113 ON READER SERVICE CARD



FREE

AMATEUR RADIO-KING OF HOBBIES

This 16-page booklet is packed with information on the basics of ham radio... how to get a license and who to contact for your test. To obtain a free copy, call **NARA** at 1-800-GOT-2-HAM.

YOU CAN PASS THE CODELESS HAM RADIO TEST AND WE GUARANTEE IT!

It's easy and fun with the **NARA Education Package**. You get Don Stoner's Ham Radio Handbook, IBM or Macintosh compatible software to test your knowledge after you have studied the book; a complete list of Contact Volunteer Examiners, the FCC Rules and Regulations for ham radio, a copy of *Amateur Radio—King of Hobbies*, plus a bonus copy of our monthly journal, *The Amateur Radio Communicator*. The **NARA Education Package** is only \$29.95 for the IBM or \$49.95 for the Mac version (3.00 S&H).



CALL US TODAY!!

16541 Redmond Way, Suite 232
Redmond, WA 98052
Telephone Free 1-800-GOT-2-HAM

CIRCLE 90 ON READER SERVICE CARD

PAY TV AND SATELLITE DESCRAMBLING ALL NEW 1992 EDITION ALL NEW

It's up to the minute. All new update on cable, wireless and satellite. Turn-ons, bypasses, circuits, chipping, bullets, bags, dectec, liberty one, ECM's, data readers, programming, and lots more. Our best yet. Only \$15.95. Other (all different) editions 1991, 1989 Volume One (Basics) \$15.95 each. MDS Handbook \$9.95. Satellite systems Under \$600. \$12.95 Any 3/\$29.95 or 6/\$49.95. Video \$29.95. Scrambling News Monthly \$24.95/yr. Sample \$3. All New Catalog \$1. Shipping costs included.

Scrambling News, 1552P Hertel Ave.
Buffalo, NY 14216. Voice/FAX (716)-874-2088.
COD'S ARE OK. ADD \$6.

NEW RADIO BUFFS SPECIAL: ALINCO MONTH IS EVERY MONTH AT RADIO BUFFS. CALL FOR ALINCO QUOTES! ALSO BEST PRICE ON ALL TEN-TEC, JRC, AMERITRON, MFJ, B&W, BENCHER, AOR, KLM/MIRAGE, COMET, BUG CATCHER, SPI-RO, HAM STICK, AMECO, SANGAN, DAIWA, OUTBACKER, ASTRON, RAMSEY KITS, ARRL PUBLICATIONS, GEOPHON CLOCKS, PALOMAR WE STOCK A COMPLETE LINE OF AMATEUR, SWL, AND MARINE RADIO EQUIPMENT AND SUPPLIES. ORDERS ONLY 1-800-828-6433.

FOR SALE: Signal Corps Radio Receiver, Model BC 248 R 28 volt DC Serial #17175-CDL-WF 43. With power supply & ext. speaker. Make offer, WORKS GREAT. Write Skips Tackle, PO Box 5392, Galveston, TX 77554.

NEW DEVICE INTERPRETS CELLULAR DATA transmissions (voice and control). Follow frequency changes and much more. Send SASE: CCS, PO Box 11191, Milwaukee, WI 53211.

Nishaka 3-D camera. Includes strap, case, twin bounce flash. Uses regular 35mm film. 6 months old! (EC) \$240.00. Peavey Studio Pro guitar amp. Rated at 50 watts RMS. (EC) \$175.00. Send MO/PO to Wall, PO Box 2456, Reidsville, NC, 27323-2456.

KENWOOD R-5000 with AM and SSB filters. Less than 5 hours use. \$700.00. Call Jim 319-754-6072.

AM BROADCAST BAND INTERFERENCE?? Reject broadcast band interference from HF and VLF bands with a precision filter from NCL. Provides 40+ db rejection. Write or call for FREE tech sheet. **NORTHWEST COMMUNICATIONS LABORATORIES**, Dept PC, 813 SW Highland, Suite 310C, Redmond, OR, 97756. (503) 923-2540.

ICOM RECEIVERS new in box R-71A - \$550.00. R-7000 - \$6750.00. W.R. Stansbury, VP, Northwest Georgia Bank, PO Box 5377, Ft. Oglethorpe, GA 30742. 404-365-3337/404-861-3012.

SCANNER/HAM RADIO MODIFICATION HANDBOOKS; FREQUENCY DIRECTORIES - UNIDEN, AERONAUTICAL, GOVERNMENT, MILITARY books by CRB, TAB, GROVE, ARRL; others. GRE products. Phone orders. VISA/MC. CATALOG \$1.00 (refundable) **DOYLE COMMUNICATIONS-DPC, Route 8, Box 18, Lake Pleasant, NY 12108. (518) 548-5515.**

CABLE TV DESCRAMBLERS - all major brands. Have make/model used in your area when calling. 1-800-327-3407. For a free catalog write K.D. Video, PO Box 29538, MLPS, MN 55429.

RECORD RADIO PROGRAMS. When Away or Home Using Your VCR! Record 8 hours worth on one tape. Easy Hookup Instructions. \$3 and SASE. Jed Jenkins, 1867 Tustin, Dept-PC, Costa Mesa, CA 92627.

TOUCH-TONE DECODER. Decode those tones you've heard on your telephone or scanner! The HB-16 Decoder decodes, stores, and displays touch-tone (DTMF) digits directly from your scanner, tape, recorder, or telephone line. Decode dialed numbers received on cordless, cellular! Plans, PC board and all IC's for only \$29.95! Send SASE for more information. HB Technologies, POB 2771-P, Spring Valley, CA 91979.

CANADIAN FREQUENCY DIRECTORIES! New Ontario Scanner Frequency Directory, gigantic 434 pages, 11,600 Frequencies - \$21.00. Atlantic Provinces Scanner Frequency Directory 2nd edition, 158 pages, over 4,000 Frequencies - \$15.95. Add tax and \$3 postage. Free catalogue. Canscan, PO Box 3009, Tecumseh PS, Windsor, Ontario N8N 2M3.

EAVESDROP ON PC'S! Intercept signals from PC's and see what's on someone's screen from a half mile away! Easy to assemble from a detailed manual, or purchase the ready to use system. Manual, \$39.95, complete systems from \$995.00. MO or COD to Spy Supply, Inc., 7 Colby Court, Bedford, NH 03102. (603) 645-6244.

SHOCKING MANUALS!! Survival Electronics, Computers, Telephones, Energy, Weapons, Financial, Medical 100+. Plus Special Projects, Technical Research Services. Confidentiality Guaranteed! Send \$3 for catalogs. By John Williams, (CBS "60 MINUTES" fame). Since 1971. **CONSUMERTRONICS**, 2011 Crescent Dr., PO Drawer 537, Alamogordo, NM 88310

CELLULAR TELEPHONE MODIFICATION HANDBOOK - How are hackers making cellular phone calls for free? Techniques for decoding and changing cellular phones, the "roaming technique," chip suppliers phone numbers, etc. Schematics for most cellular phones, and diagrams to find and change phone numbers on all models. Complete manual \$79.95. MO or COD to Spy Supply, Inc., 7 Colby Court, Bedford, NH 03110. (603) 645-6244 **SOLD FOR EDUCATIONAL PURPOSES ONLY!**

FREE CATALOG: Scanner and shortwave books and accessories. Firecom, PO Box 61-P, New York, NY 10011. Dealer inquiries. (212) 989-5773.

SELL: KENWOOD R-5000 with VHF '89 Model (request complete description). Write Martineau, 401 Central, Sidney, MT 59270.

The **SOUTHFIELD HIGH SCHOOL AMATEUR RADIO CLUB** is sponsoring their 26th ANNUAL HAMFEST/ELECTRONICS/COMPUTER SWAP & SHOP ON SUNDAY JANUARY 26TH, 1992, at Southfield High School, 24675 Lahser, Southfield, MI 48035. Doors open at 6 AM for exhibitors. Open to the public at 8 AM to 3 PM. Admission is \$4 (children 12 and under free). Reserved tables are \$13 for each 8 foot table (reserved and paid in advance). Table rental does not constitute admission. Last year all 380 tables were reserved prior to January 9th.

MILITARY ANTENNAS FOR SALE vhf/uhf discones, biconicals, broadband dipoles and satcom type. 30-1000 mc, 225-400 mc and 240-320 mc. Custom hardline cables. Call (419) 726-2249.

MILITARY RECEIVER REPAIR minor repair to complete overhaul, all models FRR, SRR, URR, GRC, SRC, URC. CEI, DEI and WJ. Specialize in R-390 A, reasonable. Call (419) 726-2249.

BEARCAT 200XLT w/all 800 MHz. Excellent condition - \$200.00. Midland 40 channel mobile CB w/Pyramid power supply - \$40.00. Will consider trading CB for SW radio. Bob. (708) 526-0973.

Advertiser's Index

AMC Sales, Inc. 61
ARRL 13
Ace Communications, IN 80, Cov. III
Acme Enterprises 79
Advanced Elec. Applications 8
Alpha Delta Communication 6
Antenna Specialist 19
Antenna Supermarket 59
Antique Radio Classified 66
Artsci Publications 47
Ashton ITC 14
Austin Amateur Radio Supply 4
Barry Electronics Corp. 77
C.B. City International 59
CRB Research 36, 67
Cellular Security Group 18
Communications Electronics 37
DECO 79
Datametrics 23
Delta Research 10
Diamond Systems, Inc. 45
Drake, R.L. Company 5
Electron Processing 18
Electronic Engineering 67
Electronic Equipment Bank 1
Future Scanning Systems 53
G & G Electronics 47
GRE America, Inc. 35
Gilfer Shortwave 79
Gitlin, Scott 53
Grove Enterprises 63
Hamtronics 76
ICOM America, Inc. Cov. II, 39
ISECO, Inc. 53
J & J Enterprises 77
JPS Communications, Inc. 33
JoGunn Enterprises 29
Kenwood USA Corporation Cov. IV
Lentini Communications 14
MFJ Enterprises, Inc. 27
Medicine Man CB 66
Microcraft Corporation 14
Moonbeam Press 77
MoTron Electronics 66
National Amateur Radio Assoc. 78
OEI OPTOelectronics 11, 15
Official Scanner Guide 71
POP'COMM Bookshop 33
POP'COMM Communications Guide 75
RF Limited 71
Radio Shack 31
React International 62
SGC, Inc. 43
Satman, Inc. 67
Scanner World, USA 73
Scrambling News 78
Signal Engineering 53
Skyvision, Inc. 59
Software Systems Consulting 47, 61
Somerset Electronics 29
Spy Supply, Inc. 32
Universal Shortwave Radio 3
Viking International 71
Wilson Antenna 10
Xandi Electronics 66

Reach this dynamic audience with your advertising message, contact Don Allen, N9ALK at (217) 344-8653, FAX 217-344-8656.

Directory of U.S. Army Forts, Camps, & Airfields (1789-1945). A 144 page illustrated book; more than 5,400 listings of named army installations from the Revolutionary War era right to end of WWII, includes Army Air Corps fields. Gives locations. Only \$15.95 plus \$3.50 shipping. NY State residents add \$1.56 sales tax. Order from CRB Research Books, P.O. Box 56, Com-mack, NY 11725.

NEW AOR-1000XC with cellular - \$395; **AOR-2500 w/cellular** - \$465; **AOR-3000 w/cellular** - \$885; **AOR-2800 w/cellular** - \$395; **BC-200XLT** - \$249; **BC-760XLT** - \$279; **ICR-1** call!! **ICR-100** call!! **Sony ICF-2010** - \$349, scanner, shortwaves, books, antennas, more!! New and used picture price sheets \$1.25, we ship COD daily! **GALAXY**, Box 1202, Akron, Ohio 44309. (216) 376-2402. Our 10th year!

SCANNER GUIDE TO MONROE COUNTY AND THE FINGER LAKES REGION 2nd edition. Frequencies, codes, maps, numbering for eleven NY counties \$17.15 NYS or \$16.10 elsewhere includes postage.

MEN OF ACTION AND ADVENTURE - Order our 50-page catalog! Books and videos on surveillance and counter-surveillance, espionage, private investigation, new identity, improvised explosives, revenge, firearms, survival, and many other outrageous and controversial subjects. Get your today! Send \$1.00 to: **PALADIN PRESS**, PO Box 1307-2BP, Boulder, Colorado 80306.

UNIDEN MODIFICATION INSTRUCTION MANUAL. A complete collection of modifications for the BC100XLT, BC200/205XLT, BC855XLT, BC580/600XLT, BC760/950XLT, REGENCY 4020, 4030, TS-1, TS-2. Includes cellular mods, adding 50 to 200 channels, increase scan speed to 250 percent, more battery time, remote control, transportable power, frequency charts, pictures and more. **ONLY \$12** to: **RF PRODUCTS**, PO Box 1084, Montgomery, Alabama 36101 (205) 244-2050.

WANTED: E.H. Scott Radios from 1925-1948. Early Scott Radios were often copper shielded and used the names "World Record," "Scott Transformer Co.," and "Selection" brand coils. Radios in any condition wanted. Literature also pursued. I am attempting to preserve the history of this company and your help is appreciated. **John T. Meredith**, 1792 Nemoke Trail, Haslett, MI 48840, (517) 349-4348.

NEW LED S-Meter chart for radios with signal lights. Lets you read all signal light meters. 100% accuracy. Send \$22.00 certified check to: **Thomas Scalfaro**, 4622 James St., East Syracuse, New York 13057.

HIDDEN SIGNALS ON SATELLITE TV. There is more than television on the satellites: Press services, financial services, stock services, SCPC, audio music, data, teletext systems and more. Third edition shows you how to receive on your dish. 240 pages, hundreds of diagrams. \$23.00 delivered UPS. **Universal Electronics, Inc.**, 4555 Groves Road, Suite 13-Dept. PC, Columbus, Ohio 43232, Phone: 614-866-4605. FAX: 614-866-1201.

MAKE BIG \$\$\$! Become an American Electronics Dealer! Great profit opportunities for new businesses since 1965. Call **Todd Parker**, 1-800-872-1373.

MILITARY RADIO SET, RT-505/PRC-25, GOOD CONDITION, WITH HANDSET AND BATTERY BOX. \$235 EA. PAYMENT WITH U.S. POSTAL MONEY ORDER ONLY. LIST OF EQUIPMENT FOR SALE SHIPPED WITH ORDER. **MICHAEL P. MURPHY**, 11621 VALLE VISTA RD., LAKESIDE, CA 92040-1041. (619) 561-2726/FAX 390-8611.

CW Lite is the **easiest** Morse code training method in the world, bar none! And it is the **fastest**, too. Just close your eyes and relax. This powerful **hypnosis cassette tape** does the rest. **Subliminals** speed you along! Only \$14.95 ppd in US (NY residents add \$1.20 tax). Order today! **PASS Publishing**, Box 570, Stony Brook, NY 11790. Info: 516-584-8164.

BOOK II HOW TO GET ANYTHING ON ANYBODY - ALL NEW Lee Lapin! Tricks from engineers, top cops, agents—cutting edge audio/video surveillance, HIGH PRICED "OFFICIAL" METHODS (and inexpensive counterparts) to read computers from a distance, bypass passwords, obtain unlisted phone numbers, intercept cellular calls, pagers, and faxes, trace and track with new data bases, surveillance proof any room, tap any phone, WHEW! "Really scary stuff-Charles Jaco CNN." \$38.50 postpaid ISECO, 2228 El Camino Real #349-4, San Mateo, CA 94403.

CW? NO PROBLEM. You can increase your speed, no matter how many times you've failed before. **Results guaranteed** when you follow the instructions. **PASS Publishing's CW Mental-Block Buster** program helps you **explode mental blocks** that hold you back. Based on 40 years of research, the **CW Mental-Block Buster** uses guided meditation, dynamic visualizations, and powerful affirmations to blast through mental blocks. **You can do code!** That means new bands, more contacts, more fun! (This is not a CW practice tape.) The **CW Mental-Block Buster** audio cassette and practice booklet are only \$24.95 ppd. in the US (NY residents add \$2.00 sales tax). (Quantity discounts available for classes.) **PASS Publishing**, P.O. Box 570, Stony Brook, NY 11790. Info: 516-584-8164.

SURVEILLANCE TRANSMITTER KITS tune from 65 to 305 MHz. Mains powered duplex, telephone, room, combination telephone/room. Catalog with **Popular Communications, Popular Electronics and Radio-Electronics** book reviews of "Electronic Eavesdropping Equipment Design." \$2.00. **SHEFFIELD ELECTRONICS**, 7223 S. Stony Island Ave., Chicago, IL 60649-2806.

225-400 MC RECEIVERS Tunable, Government Reconditioned. Satcom Antennas 240-270 MC Military Helical Type. New (419) 726-2249.

WORLD'S MOST UNUSUAL Communications Books! A large selection of outstanding titles covering scanners, "confidential" frequency registries, bugging, wire tapping, electronic surveillance, covert communications, computers, espionage, monitoring, and more! New titles being added constantly! Ask for our big **FREE** catalog. **CRB Research**, Box 56-PC, Com-mack, NY 11725.

SATELLITE and cable descrambling. Build your own descramblers. Surveillance and countermeasures. Build your own transmitters, detectors. How to modify your scanner. Eavesdrop for fun manual. Send stamp for free catalog to: **Communications Engineering**, 76 Boulevard, Hudson Falls, NY 12839.

THE NEW YORK MONITOR NEWSLETTER—a monthly Newsletter that provides CB'ers with the latest up-to-the-minute Technical information—Radio Repair and Modification—Phase Lock Loop (PLL) Circuit/Expander—**2 YEAR COURSE IN ELECTRONIC COMMUNICATION** and much more!! \$24 per year mail to **LORD/WYATT COMMUNICATIONS, P.O. Box 030128PC, Brooklyn, NY 11203-0001.**

BIG AIR-SCAN 5TH EDITION by Tom Kneitel. Complete guide to aero comms. Now in gigantic 192-page large size format containing 60,000 + listings, including 2-30 MHz HF, 118 to 174 MHz VHF, 406 to 512 MHz UHF, and 800 MHz listings. Covers civil, military, private, and unlisted landing areas, heliports, and seaplane bases. Control towers, ground, approach/departure, FSS, unicoms, multicomms, crop dusters, air-ambulances, federal ops, traffic copters, aviation business, airline enroute, airport security/fire, etc. throughout USA. All Canadian mil, civilian airports and seaplane bases listed, plus lots more, including how-to text on aero monitoring. Most comprehensive aero frequency guide ever compiled. Only \$14.95 + \$3.50 postage to USA/Canada/APO/FPO. NY State residents add \$1.48 sales tax. From: **CRB Research Books, Inc.**, P.O. Box 56, Com-mack, NY 11725, or ask your favorite communications dealer.

COMMODORE 64 HAM PROGRAMS—8 disk sides over 200 Ham programs—\$16.95. 29¢ stamp gets unusual software catalog of Utilities, Games, Adult and British Disks. Home-Spun Software, Box 1064-PC, Estero, FL 33928.

MORSE code got you down? Why let a mental block stand between you and upgrading? Use **PASS Publishing's CW Mental-Block Buster** to blast through those barriers. Just follow the instructions for 30 days—**Results Guaranteed!** Based on 40 years of research, the **CW Mental-Block Buster** uses guided meditation, dynamic visualizations, and powerful affirmations to blast through mental blocks. **You can do code!** That means new bands, more contacts, more fun! (This is not a CW practice tape.) The **CW Mental-Block Buster** audio cassette and practice booklet are only \$24.95 ppd. in the US (NY residents add \$2.00 sales tax). (Quantity discounts available for classes.) **PASS Publishing**, P.O. Box 570, Stony Brook, NY 11790. Info: 516-584-8164.

SURVEILLANCE-COUNTERMEASURES! Transmitters, detectors, phone security, night vision, stunguns, secret devices, restricted books. **MORE! GUARANTEED LOWEST PRICES! HUGE CATALOG \$5.00 (REFUNDABLE)** Protector, P.O. Box 520294-D, Salt Lake City, UT 84152.

BIG 7th Edition: Top Secret Registry of Government Radio Frequencies, by Tom Kneitel. Grown to gigantic 240-pages! 1000's of new listings, frequencies, stations for all scanner owners, nationwide. Includes: FBI, DEA, Customs, Secret Service, FCC, Immigration, Border Patrol, U.S. Attorney, ATF, Treasury, Fed. Prisons, U.S. Marshal, CIA, Postal Service, NSA, NORAD, USAF, USN, Army, USMC, FAA, NASA, DOE, NRC, FEMA, Dept. Agriculture, National Parks, USCG, EPA, DOT, V.A., UHF aero (225 to 400 MHz) listings, bugs & surveillance freqs, agents' lingo, codes, many more agencies. "lots more info! Expanded Canadian listings. Only \$19.95, plus \$3.50 postage to N. American addresses. NY State residents add \$1.88 sales tax. Order now from **CRB Research Books**, P.O. Box 56, Com-mack, NY 11725. Dealer Inquiries Invited.

COMMUNICATION AT ITS BEST AR900 \$245, AR1000XC \$405, AR2500 \$469, AR2800 \$419. We also sell a variety of CBs, Radar Detectors, Phones, Ans. Machines and Accessories. **FREE SHIPPING.** V/MC, Diners. **Turbo Electronics**, PO Box 8034, Hicksville, NY 11802. Questions Welcome. (516) 938-1946. To order call 1-800-33TURBO.

Satellite Receiver GI Super 2730R, VCII-Plus, unused in original box. Make offer. Will consider trade for communications receiver of comparable value. 212-777-1332.

GILFER — first in Shortwave



The Best Active Scanner Antenna Gets Better and Better...**DRESSLER** ara-1500.

Latest model in the evolution of this famous series, the 1500 offers wider freq. coverage (50-1500 MHz), high gain (11-16dB), and easy installation (indoors or out, vertically). Ideal for the ICOM R7000 and other wideband VHF/UHF receivers. Includes 12 vdc power supply, coupler, 25' coax, and mounting hardware \$189.95 (+\$8).

VISIT GILFER'S STORE

Easy to find, accessible from New York City. Take Garden State Parkway (NE portion of N.J.), Exit 172. Gilfer is in the center of Park Ridge, opposite the Borough Hall. Store hours: M-F 10am-5pm, Sat. 10am-3pm.



Order operators: 1-800-GILFER-1 (1-800-445-3371) NJ 201/391-7887
GILFER SHORTWAVE
52 Park Ave. • Park Ridge, NJ 07656

CIRCLE 128 ON READER SERVICE CARD



The complete manual of Pirate Radio, includes schematics and kits. Send \$10 to:

ACME ENTERPRISES
1356 Coney Island Avenue
Suite 200Z
Brooklyn, NY 11230

PICKS UP A WHISPER 50 FEET AWAY!

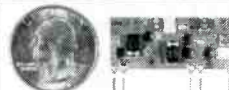

NEW! High-power miniature transmitter on a single chip assemblies in only 5 minutes!

Simply attach the **VT-75** microtransmitter to any 3V to 12V battery and you can hear every sound in an entire house over 1 mile away! Super-sensitive circuit on a single chip even picks up footsteps from across a large room. Tunable from 80 to 130 MHz. Hear everything on any FM radio or wideband scanner tuned to the "secret" frequency you select. Unlimited uses for security, baby monitor, remote mic, etc. **Not a toy.** The **VT-75** meets many U.S. Gov't Military Specs and with **100mW RF output**, it is the smallest, most powerful miniature transmitter you can buy. Easily assembled even by a youngster in only 5 minutes and performs so well that it is the only miniature transmitter available **anywhere** that comes with a **full unconditional moneyback guarantee!** Dealers welcome. Law Enforcement inquiries invited. **VT-75** microtransmitter chip with miniature microphone, 9V battery connector and instructions. **\$49.98 + \$1.50 S&H** or save: buy 2 for \$45.00 each with free S&H! Call us toll free or send money order, Visa, or Mastercard for immediate shipping by U.S. Mail. COD's add \$4. Personal checks allow 21 days.

DECO INDUSTRIES. BEDFORD HILLS, NY 10507
800-759-5553

The leader in wireless design since 1976

CIRCLE 96 ON READER SERVICE CARD

AOR Scanners.

Great Performance. Great Service. Great Value.

Free Freight
25-Day Money-Back Guarantee
Toll-Free Service and Support
No Credit Card Surcharge
One Year Warranty



**NEW!
EXTENDED
COVERAGE!**

AR950/AR900 \$259/\$269



AR1000

\$429

1000 Channels. 500KHz to 1300MHz

Standard Features:

- Extremely compact size.
- Continuous coverage.
- Antenna attenuator switch, 10db.
- Manual tuning knob.
- Earphone jack, 3.5mm.
- AM, FM and wide band FM tuning modes.
- Backlighted LCD display.
- 10 Scan Banks, 10 Search Banks.
- Selectable Priority Channel.
- Delay, Hold Features.
- Selectable Search Increments, 5-955KHz.
- Permanent memory backup.
- 4 AA Ni Cad batteries included.
- AC adaptor/charger.
- Carry Case.
- Cigarette Lighter Charger.
- Belt Clip.
- Earphone.

Options:

External Speaker. Mobile Mount. MS190 \$19.50
Extended Warranty. 2/3 yrs \$45/\$55

Specifications:

Coverage: 500KHz-1300MHz
Sensitivity: .35uV NFM, 1.0uV WFM, 1.0AM
Speed: 20 ch/sec. scan. 40 ch/sec. search
IF: 561.225, 58.075, 455KHz or 10.7MHz
Increments: 5 to 955KHz selectable/ 5 or 12.5 steps.
Audio: .4 Watts
Power: Input 9 - 13.8 V. DC
Antenna: BNC
Display: LCD
Dimensions: 6 7/8H x 1 3/4D x 2 1/2W. 12oz wt.

100 Channels. Low, Air, High, UHF & 800MHz.

Standard Features:

- Extremely compact size.
- Unrestricted 800MHz coverage.
- 100 channels permanent memory.
- Earphone Jack.
- Delay, Hold features.
- Channel 1 Priority.
- 5 Scan Banks, 5 Search Banks.
- Two antennas included.
- AC & DC Power cord w/mobile mnt. hrdwr. (AR950)
- NiCad battery w/chgr adapter. (AR900)
- One Year Limited Warranty.

Options:

Base type antenna	
25 to 1000MHz w 50' coax.	AS300 \$59.95
Mag Mnt Mobile Antenna. 15' coax.	MA100 \$25.00
Cigarette Lighter power adaptor.	CP100 \$5.00
Wide band preamp	GW-2 \$89.00
Extended Warranty. 2/3 yrs	\$40/\$55

Specifications:

Coverage: 27-54, 108-174, 406-512, 830-950MHz
Sensitivity: .4uV Lo, Hi. .8uV Air. .5uV
UHF. 1.0uV 800
Scan Speed: 15 ch/sec.
IF: 21.4MHz, 455KHz
Increments: 10, 12.5, 25, 30
Audio: 1W
Power: 12.8VDC, 200MA
Antenna: BNC
Display: LCD w/backlight
Dimensions: 2 1/4H x 5 5/8W x 6 1/2D. 14oz wt. (AR950)
5 3/4H x 2W x 1 1/2D. 12oz wt. (AR900)

We offer 100's of communications products.

Unbelievable Price.

AR2500

\$499



2016 Channels. 1 MHz to 1500 MHz

Standard Features:

- continuous coverage.
- AM, FM, wide band FM, & BFO for SSB, CW.
- 64 Scan Banks.
- 16 Search Banks.
- RS232 port built in.
- Includes AC/DC pwr crd. Antenna, Mntng Brckt.
- One Year Limited Warranty.

Options:

Earphone.	EP200	\$2.00
External Speaker. Mobile Mount.	MS190	\$19.50
Extended Warranty. 2/3 yrs.		\$65/\$75
Mobile Mounting Bracket.	MM1	\$14.90
RS232 Control Package	SCS2	\$295.00
(software & cable) offers spectrum display and database.		
Wide band preamp	G-W2	\$89.00

Specifications:

Coverage:	1MHz-1500MHz
Sensitivity:	.35uV NFM, 1.0uV WFM, 1.0AM/SSB/CW
Speed:	38 ch/sec. scan. 38 ch/sec. search
IF:	750.00, 45.0275, 5.5MHz 455KHz
Increments:	5,12,5,25 KHz
Audio:	1.2 Watts at 4 ohms
Power:	Input 13.8 V. DC 300mA
Antenna:	BNC
Display:	LCD, backlighted
Dimensions:	2 1/4H x 5 5/8W x 6 1/2D Wt. 1lb.

AR3000

\$1095



400 Channels. 100KHz to 2036MHz.

Standard Features:

- Extremely compact size.
- Continuous coverage.
- Attenuation Programmable by Channel.
- Manual tuning knob.
- Tuning increments down to 50Hz.
- AM, FM, wide band FM, LSB, USB, CW modes.
- Backlighted LCD display.
- 4 Scan and Search Banks, Lockout in Search.
- 4 Priority Channels.
- RS232 control through DB25 connector.
- Delay, Hold Features.
- 15 band pass filters, GaAsFET RF amp.
- Sleep and Alarm Features.
- AC adaptor / charger. DC power cord.
- Telescopic Antenna
- One Year Limited Warranty.

Options:

Earphone.	EP200	\$2.00
External Speaker. Mobile Mount.	MS190	\$19.50
Extended Warranty. 2/3 yrs.		\$65/\$75
Mobile Mounting Bracket.	MM1	\$14.90
RS232 Control Package	SCS3	\$295.00
(software & cable) offers spectrum display and database.		
Wide band preamp	G-W2	\$89.00

Specifications:

Coverage:	100KHz-2036MHz
Sensitivity:	.35uV NFM, 1.0uV WFM, 1.0AM/SSB/CW
Speed:	20 ch/sec. scan. 20ch/sec. search
IF:	736.23, (352.23) (198.63) 45.0275, 455KHz
Increments:	50Hz and greater
Audio:	1.2 Watts at 4 ohms
Power:	Input 13.8 V. DC 500mA
Antenna:	BNC
Display:	LCD
Dimensions:	3 1/7H x 5 2/5W x 7 7/8D Wt. 2lb 10oz.

To Order Call 1•800•445•7717

In All 50 States and Canada. 24 Hours a Day. Fax Orders: 1-800-448-1084, 24 Hours a Day.

ACE Communications Monitor Division 10707 E. 106th Street, Fishers, IN 46038

Int'l Voice# 317-842-7115. Int'l Fax# 317-849-8794.

Service and Support Lines: Mon-Fri 9a.m. to 9p.m., Saturday 10-4. EST

MasterCard, Visa, American Express, Checks, Approved P.O.'s. & C.O.D. (add 5.00)

Prices and specifications subject to change.

KENWOOD

Hear it All!



R-5000

R-2000
High performance receivers.

Scan the world bands with Kenwood's R-5000, R-2000 and RZ-1. Listen in on foreign music, news, and commentary. Monitor local police, fire, and other public safety services, as well as the Marine channels, and the many other services.

(The VHF converter options must be used in the R-5000 and R-2000.)

R-5000

The R-5000 is a high performance, top-of-the-line receiver, with 100 memory channels, and direct keyboard or main dial tuning—makes station selection

RZ-1

Wide-band scanning receiver



The RZ-1 wide-band, scanning receiver covers 500 kHz-905 MHz, in AM, and narrow or wideband FM. The automatic mode selection function makes listening

super easy! Other useful features include programmable scanning, large, built-in speaker, 110 volt AC or 12 volt DC operation (with optional DCK-2 cable), VHF capability (108-174 MHz) with the VC-20 option, dual 24-hour clocks with timer, and even voice frequency readout with the VS-1 option.

easier. One hundred memory channels with message and band marker, direct keyboard or VFO frequency entry, and versatile scanning functions, such as memory channel and band scan, with four types of scan stop. The RZ-1 is a 12 volt DC operated, compact unit, with built-in speaker, front-mounted phones jack, squelch for narrow FM, illuminated keys, and a "beeper" to confirm keyboard operation.

Optional Accessory
• PG-2N Extra DC cable

R-2000

The R-2000 is an all band, all mode receiver with 10 memory channels, and many deluxe features such as programmable scanning, dual 24-hour clocks with timer, all-mode squelch and noise blankers, a large, front-mounted speaker, 110 volt AC or 12 volt DC operation (with the DCK-1 cable kit), and 118-174 MHz VHF capability with VC-10 option.

Optional Accessories R-2000:

- VC-10 VHF converter
- DCK-1 DC cable kit for 12 volt DC use.

R-5000:

- VC-20 VHF converter
- VS-1 Voice module
- DCK-2 for 12 volt DC operation
- YK-88A-1 AM filter
- YK-88SN SSB filter
- YK-88C CW filter
- MB-430 Mounting bracket.

Other Accessories:

- SP-430 External speaker
- SP-41 Compact mobile speaker
- SP-50B Mobile speaker
- HS-5 Deluxe headphones
- HS-6 Lightweight headphones

KENWOOD U.S.A. CORPORATION
COMMUNICATIONS & TEST EQUIPMENT GROUP
P.O. BOX 22745, 2201 E. Dominguez Street
Long Beach, CA 90801-5745

KENWOOD ELECTRONICS CANADA INC.
P.O. BOX 1075, 959 Gana Court
Mississauga, Ontario, Canada L4T 4C2

KENWOOD

...pacesetter in Amateur Radio

CIRCLE NO. 1 ON FREE INFORMATION CARD