

ICD-08635

POPULAR COMMUNICATIONS

NOVEMBER 1987 \$2.50
\$3.50 CANADA

Incorporating SCAN Magazine The Official Publication of the Scanner Association of North America

"Pirate" Radio Rides The Waves



OCT 28 1987

SARAH

Also in this issue:

- Peruvian Shortwave Profile
- Life Flight To The Rescue
- Touch-Tone Telephones
- We Review: The EEB 2020
- Plus: Radio History, Scanners, CB, And More!



uniden

Get Tomorrow's Headlines, Not Yesterday's News.



With a Bearcat® Scanner, You'll be the First to Know

When you're looking for news of the minute instead of news of the day, nothing beats a Bearcat. Uniden Bearcat Scanners deliver the news as fast as it happens. Heart-pounding police and fire runs. Airliners on final approach. Instant updates on hazardous weather.

It's everything you'd expect from Bearcat, the world's best-selling name in scanners. With unmatched quality and reliability from the world leader in radio communications—Uniden.

The Choice of Jack Nicklaus
Winner of 20 Major Golf Championships
©1987 Uniden Corporation of America



uniden®
A New Generation of Communications



GILFER SHORTWAVE

our 35th year

RECEIVERS

SWL BOOKS

ANTENNAS



KENWOOD R-5000

"Excellent... very good audio... best receiver ever offered by Kenwood" - R. Lichte. Dual superhet/100 memories/analog-digital display/noise blanker/attenuator/dual timer/100-29999 kHz/options: SP-403 speaker, VC-20 VHF converter, DC cable.



ICOM R-7000

"Super scanner of the decade... unbelievable range (25MHz - 2GHz with small gap from 1000 to 1025MHz)... multitude of functions is simply overwhelming... performance leaves nothing to be desired" - R. Lichte. All modes, all bands (low band, aircraft, marine, business, FM broadcast, amateur radio, emergency, government, TV bands)/options: RC remote control, EX-310 speech synthesizer, MB-12 mounting bracket, AH-7000 scanning antenna.



YAESU FRG-8800

"as tested in the lab, gave results which substantially exceeded manufacturer's specs" - R. Lichte. CPU control/3 scan modes/CAT system/12 memories/150-29999 kHz/all modes/options: FRT-7700 ant. tuner, SP-102 spkr., FIF-232C computer interface, FRV-7700 VHF converter.

GRUNDIG Satellit 400

"full cpu control... exceptional conveniences... above average performance" - R. Lichte. 150-30000 kHz, scan, 24 memories.



GRUNDIG Satellit 650

"ingenious design, modular construction, motor driven tuned preselector, excellent reception, excellent sound, 60 memories, clock/multi-timer" - R. Lichte. 150-30000 kHz.



All receivers in the Gilfer showroom are operational with rooftop antennas.



JRC NRD-525

"No. 1 receiver outside the commercial/military bracket... way ahead of the competition... outstanding results in all modes... a best buy" - R. Lichte. CPU control/150-30000 kHz/computer interface/200 memories/PBT/noise blanker/notch filter/clock-timer/tuned preselector/scan-sweep/options: UHF/VHF converter, speaker, headphones, 0.3/0.5/1/1.8 kHz filters, RTTY demod.

GILFER IS AN AUTHORIZED DEALER FOR: Yaesu, Japan Radio Company (JRC), ICOM, Kenwood, Panasonic, Sony, Grundig, Datong, Dressler & more.

THE RECEIVER BOOK THEY DON'T WANT YOU TO READ.



"Radio Receiver - Chance or Choice" by Rainer Lichte. Published by GILFER, this is the book to read when you want to know about the receiver you have and the receiver you want to buy. Lichte says it straight, warts and all, about all the famous brands of receivers, making his own tests on the same set of instruments for direct comparability. This famous radio engineer has the engineering background to do the job right, the writing ability to communicate clearly, and the integrity to be objective on all points. Order this 256p. book now and get the straight stuff on 75 receivers plus the FREE NRD 525 review. \$19.95

"MORE Radio Receivers, Chance or Choice" by Lichte. SEQUEL: 14 more receiver reviews/Grundig 400 & 650/ICOM R-7000/Kenwood R-5000/JRC NRD 525 & more. \$12.95



"Radio Hacker's Code Book" Computer do-it-yourself book for SWL; world of codes and ciphers; how to program etc. 240pp. \$13.95

"Radio Beacon Handbook" 252p. listing of over 9000 mw and lw radio beacons (150-1900 kHz); inc. call signs, freq., etc. \$14.95



"Confidential Frequency List" 6th ed., 2nd printing. Compiled by O.P. Ferrell of GILFER. Best list of secret stations. \$15.95

"Better Radio/TV Reception" Explains radio/tv/long wave/medium wave, antennas, satellites; definitions. \$14.95



EAVESDROPPER TWO \$66.95 (+ \$3) Now with built-in lightning protection. 45' Dipole made the right way according to a famous handbook. Center-fed trapped dipole w. coax terminal. Best sensitivity for SWL bands.

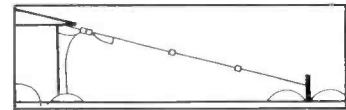

SLOPER ANTENNA. \$65.40 (+ \$3) World class antenna/assembled/needs just one support/resonator design/60' long/covers 13 through 120M plus AM broadcast.

DRESSLER

ara-30 Active Indoor/Outdoor HF Antenna . . . \$159.95 (+ \$8)
ara-900 (formerly ara-500) Active VHF/UHF Scanner Antenna. 50-650 MHz \$189.95 (+ \$8)

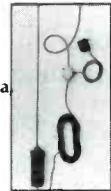

DATONG

Outdoor Active Antenna, listed as best in famous handbook, AD-370. Sale Price \$129.95 (+ \$4)
Indoor Active Antenna, same as above but flexible elements, AD-270. \$114.50 (+ \$3)



FL-3 AUTOMATIC AUDIO FILTER . . \$229.95 (+ \$4) 12 poles of tunable filtering usable 6 ways for making weak signals audible, removing noise, heterodynes/two notch filters + variable hi and lo pass filters.

ISOTRON "60" . \$75.95 (+ \$5) 60M omnidirectional antenna, no radial grounds needed; just 4' tall; requires 50 ohm coax; performs like full half-wave dipole. Unassembled.



Money-back guarantee. PANASONIC RFB-60 Dual conversion/rotary dial plus keyboard tuning/36 memories/LCD digital display of freq., battery condition, dual time/tunes FM, LW, MW, SW/fits Case I. \$229.95 (+ \$3)



SONY 2010 High tech dual PLL synthesis/rotary plus keyboard tuning/150-29999 kHz + FM + Air band/32 memories/scanning/clock/programmable on-off timer/LCD digital display. Fits Case II. \$329.95 (+ \$4)

SONY 2002 10 key direct tuning/10 memories/auto scan/LCD display/clock/tunes 153-29999 kHz. Fits Case I. \$229.95 (+ \$4)



TRAVEL CASES GILFER exclusive/rugged, padded waterproof cases. CASE I \$29.95 (+ \$2.50) CASE II \$32.95 (+ \$2.50)



Order phone 1-800-GILFER-1
9 a.m.-5 p.m. - U.S. Only

Add \$2 for 1st book, \$3 for 2 or more • Prices subject to change w/o notice • Ph. 201/391-7887 for orders 5-11 pm

GILFER SHORTWAVE • 52 Park Ave. • Park Ridge, NJ 07656 • Ph 201/391-7887

POPULAR COMMUNICATIONS

Now Incorporating
SCAN Magazine

NOVEMBER 1987

VOL. 6, NO.3



14



28



48

FEATURES

- Scanning Today** 8
 The "forgotten" service has suddenly been discovered. by Robert A. Hanson
- Radio Newyork International: The Inside Story** 10
 The most talked about "pirate" station of the decade. by Edward Teach
- Radiola** 14
 It's time to tune in on the golden years of radio and wireless. by Alice Brannigan
- Peruvian Pursuits** 20
 A look at shortwave broadcasting in Peru. by Gerry L. Dexter
- SCAN Public Service Award** 26
 Cable installer saves woman from dog attack.
- SCAN Photo Contest Winners** 26
 Want to win a BMI Nitelogger? Send in a photo!
- Life Flight To The Rescue** 28
 San Diego County's aeromedical service. by Brian M. Johnson III
- Books You'll Like** 32
 Settle in for the winter with these: *More Radio Receiver, Chance or Choice; The Hacker's Handbook; Official Maine Scanner Guide; and Stay Tuned, A Concise History of American Broadcasting.* by R.L. Slattery
- POP'COMM Reviews: The EEB 2020** 44
 by POP'COMM Staff

This month's cover: The short-lived broadcasting "pirate" ship, and crew, of Radio Newyork International. Photo by Dick Kraus/Newsday.

DEPARTMENTS

Beaming In.....	5	Better Signals.....	51
Mailbag.....	6	RTTY.....	53
Clandestine Communique.....	34	On The Line.....	58
Pirates Den.....	36	Communications Confidential.....	60
The Ham Column.....	40	Scanner Scene.....	64
POP'COMM Products.....	43	Emergency.....	66
Satellite View.....	46	Listening Post.....	69
CB Scene.....	48	Communications Shop.....	73

- EDITORIAL STAFF**
 Tom Kneitel, K2AES/ZF2JO
Editor
 Elisa Nudelman
Associate Editor
- CONTRIBUTING EDITORS**
 Gerry L. Dexter
Shortwave Broadcast
 Robert Margolis
RTTY Monitoring
 Gordon West, WB6NOA
Emergency Communications
 Don Schimmel
Utility Communications
 Edward Teach
Alternative Radio
 Harold A. Ort, Jr.
Military Consultant
 Janice Lee
Radar Detectors
 Chuck Gysi, N2DUP
Scanners
 Julian Macassey, N6ARE
Telephone Accessories
 Mark J. Manucy, W3GMG
AM/FM Broadcasts
 Ed Noll, W3FQJ
Antennas
 Donald Dickerson, N9CUE
Satellites
 Dave Newkirk, AK7M
Amateur Radio
- BUSINESS STAFF**
 Richard A. Ross, K2MGA
Publisher
 Jim Gray, W1XU
Advertising Manager
 Dorothy Kehrwieder
General Manager
 Frank V. Fuzia
Controller
 Arlene Caggiano
Accounting
 Catherine Ross
Circulation Director
 Melissa Kehrwieder
Subscriber Services
- PRODUCTION STAFF**
 Elizabeth Ryan
Art Director
 Barbara Scully
Artist
 Dorothy Kehrwieder
Production Manager
 Pat Le Blanc
 Florence V. Martin
Phototypographers
 Hal Keith
Technical Illustrator
 Larry Mulvehill, WB2ZPI
Contributing Photographer

Offices: 76 North Broadway, Hicksville, NY 11801. Telephone 516 681-2922. Popular Communications (ISSN 0733-3315) is published monthly by Popular Communications, Inc. Corporate officers: Richard A. Ross, Pres.; Thomas S. Kneitel, Vice Pres.; Alan M. Dorhoffer, Secretary. Second class postage paid at Hicksville, NY and additional offices. Subscription prices: Domestic—one year \$16.00, two years \$31.00, three years \$46.00. Canada/Mexico—one year \$20.00, two years \$39.00, three years \$58.00. Foreign—one year \$22.00, two years \$43.00, three years \$64.00. Foreign Air Mail—one year \$75.00, two years \$149.00, three years \$223.00. Entire contents copyright ©1987 by Popular Communications, Inc. Popular Communications assumes no responsibility for unsolicited manuscripts, photographs, or drawings. Allow six weeks for change of address or delivery of first issue. Printed in the United States of America.
 Postmaster: Please send change of address to Popular Communications, 76 North Broadway, Hicksville, NY 11801.

Curier

GALAXY IV

DELUXE AM/SINGLE SIDE BAND
MOBILE TRANSCEIVER

GALAXY IV, a sophisticated AM/SSB Mobile Transceiver, with advanced features and superior performance, incorporates Phase Lock Loop circuitry for precision control of 120 channel frequencies (AM, Upper Side Band and Lower Side Band). Its superb adjacent channel rejection of better than 70 dB, automatic gain control to prevent "overloading" of strong signals, noise blanker/noise limiter for reducing background noises, all result in the clearest reception possible. Its convenience features include large, easy to read, digital LED channel indicator, Channel 9 priority switch, RF gain control, microphone gain control, SWR calibration control, clarifier control, squelch control and PA capability — all combined to offer the most up-to-date, high performance, heavy duty SSB unit on the market.

OUT OF THIS
WORLD!!



FANON CURIER

50 YEARS OF EXPERIENCE IN COMMUNICATIONS

14281 Chambers Road,
(714) 669-9890

Tustin, California 92680
FAX: (714) 669-1081

CIRCLE 25 ON READER SERVICE CARD

CLOSEOUT SPECIALS
SAVE 75% OFF ORIGINAL COST!!!

* **MU7700** Memory unit for the FRG-7700
NOW 7700 owners can have the convenience of 12 channel memory at a fraction of original cost. List price was \$119.95 on this unit!
SPECIAL \$29.95 + \$4 ups

* **FRV7700 VHF** Converters designed to mate with 7700 but works on any radio tuning 20 to 30 MHz (12VDC required-supplied from 7700)
FRV7700F 118-130 & 150-170 MHz
FRV7700A 118-150 MHz
List price was \$149.95 on these units!
SPECIAL \$29.95 ea + \$4 ups.
DON'T MISS THIS OFFER!
(Supplies are limited to stock on hand)

FREE! FREE! FREE!
ORDER ANY SHORTWAVE RADIO ADVERTISED BY EEB IN THIS ISSUE AND RECEIVE A FREE 1987 RADIO DATABASE BOOK!

This offer good only while supplies last!
A \$12.95 value!

RANGE EXTENDERS!
EEB introduces 2 converters to expand frequency coverage of the **YAESU FRG-9600**. Simple to use and install on your radio.

KURANISHI CONVERTERS
FC965 500 KHz to 60 MHz. \$139.95.
FC965DX 20 KHz to 60 MHz. \$149.95.
FC1300 8 to 1.3 GHz. \$199.95.
WA965 VHF/UHF Amp to 1500 MHz. \$109.95.
CC965 Converter control console. \$119.95.
Converters will also work with the **ICOM R7000** or any receiver tuning 60 - 170 MHz.
Add \$4 UPS shipping on the above items.

DX-SLOPER ANTENNA
The antenna from Alpha Delta that has the experts excited! Larry Magne's popular 'White Paper' on SWL Antennas, (see our other ad), gives the DX Sloper a #1 rating!

- * Covers .5 to 1.6 Mhz for optimum AM DXing!
 - * Covers 11 shortwave bands, 2 TO 26 MHz
 - * All Stainless Steel hardware, fully assembled.
 - * Overall length only 60".
 - * You must provide 50 Ohm coax.
- Order DXSWL \$69.95 plus \$4 ups**
Coax in 25/50/75/100' lengths w/connectors - Call

RADIO DATABASE INTERNATIONAL
NEW 1988 EDITION!

Your Passport to World Band Radio.
* More than 300 pages. * At a glance: Names, locations, frequencies, operating times, languages, and more! * Cross index of major stations alphabetically by country. * Buyers guide to over 50 SWL radios! * Reviews on indoor/outdoor antennas!
NEW 1988 RADIO DATABASE INTERNATIONAL is only \$14.95 + \$1.95 UPS. TO RECEIVE YOUR COPY JUST CALL US TOLL FREE AT 800-368-3270



COMPUTER CONTROL
YOUR RADIO WITH C.R.I.S.
(Computer/Radio Interface System)

All you need is C.R.I.S., your computer and one of these radios:
ICOM: R71A, R7000, 271, 275, 375, 471, 475, 575, 735, 751, 761, 1271. **KENWOOD:** R5000, TS-440S, TS-940S, 811, 711. **YAESU:** FT757GX, 757GX II, FRG8800, 9600, FT-980, 767, 727.

CRIS

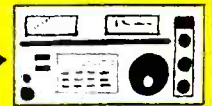
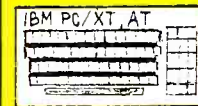

FUNCTIONS:

- * **AUTO LOG:** Log frequency, mode, signal strength¹, date, time and your comments to a file.
- * **AUTO SCAN:** Scan up to 800 channels or between upper/lower limits (programmable). Scan terminates on strong signal and resumes on signal loss¹, operator intervention, or programmable delay.
- * **AUTO TRACKING:** Tracks dual VFO's for splits.
- * **EDIT MODE:** Read disk file or radio memory into computer RAM; edit computer RAM; write computer RAM to disk file or radio memory.

OPTIONS:

CALL FOR PRICE AND DETAILS

- * **EEB-SDA:** Data acquisition for spectral analysis, store to memory/disk and display on CRT or printer.
- * **EEB-DBS:** Shortwave Broadcast Database.
- * **EEB-DBU:** Database of Utility stations/channels.
- * **EEB-RCM:** Remote control via modem.

UNDER DEVELOPMENT: Multi receiver control, **C.R.I.S.** for: AR2002, NRD-525, PARAGON

HARDWARE REQUIREMENTS:

IBM PC/XT, AT or compatible with MS-DOS 2.11 or later, serial port, a DSDD floppy disk drive, 256K bytes of user memory and a monochrome or color monitor. Interface requires 13.8 Vdc @ 1 Amp. Optional D.C. adapter #571512 @ \$19.95 + \$4 UPS.

¹ Some radios may require modification.

THE ELECTRONIC EQUIPMENT BANK OF VIENNA, VIRGINIA, IS PLEASED TO ANNOUNCE THE ADDITION OF TWO NEW RECEIVERS TO ITS GROWING FAMILY OF SHORTWAVE RADIOS. NOW WITH CLASSIC EUROPEAN STYLING AND UNCOMMON ATTENTION TO DETAIL. THE NEW GRUNDIG SATELLIT 650 AND SATELLIT 400 SWL RECEIVERS!

\$995

GRUNDIG®

\$399



SATELLIT 650

The Satellit 650 International is the Ultimate in German crafted Portable radios. Along with excellent Audio performance the Satellit 650 also has these fine features: • AM, SSB, CW and FM. • Covers 510—1620 KHz, 1.6—30 MHz AM and 87.5 to 108 MHz FM. • Direct keyboard frequency entry. • PLL Quartz Crystal Synthesized for precise tuning and stability. • 60 Programmable memories (16 FM, 8 MW, 4 LW & 32 SW) • Up to 30 Watts peak audio output power. • Built in Ferrite and Telescopic Antennas. • Dual speaker/switchable. • World Power: 110-127/220-240V 50/60 Hz. • DC power with batteries (not provided) or you can use Nicad Batteries (optional/can be recharged while the radio is playing in the AC position!). • Dimensions 19 3/4 x 9 1/2 x 8. • Weight 19 lbs.
Manufacturers List \$1149.00 EEB Introductory Price \$995 + \$12 UPS

SATELLIT 400

The Satellit 400, with its rounded corners and smooth lines is the obvious "style leader" in personal portables. Beautifully crafted, this small portable covers all Shortwave bands plus MW and FM. It's unexcelled audio will surprise you! • Direct keyboard frequency entry. • 24 Programmable memories. • Scanning. • 2 Clocks (turn on/turn off). • World power 120/240 V 50/60Hz. • Battery powered (not supplied) • Dimensions 12" x 7" x 3" • Weight 5 Lbs.
Manufacturers List \$449.95 EEB Introductory Price \$399 + \$6.00 UPS

PRICES & SPECIFICATIONS ARE SUBJECT TO CHANGE WITHOUT NOTICE



Monday to Friday 10 A.M. to 5 P.M.
Thursday 10 A.M. to 9 P.M.
Saturday 10 A.M. to 4 P.M.

ELECTRONIC EQUIPMENT BANK

516 Mill Street, N.E.
Vienna, VA 22180



ORDER TOLL FREE: 800-368-3270

VIRGINIA RESIDENTS: 703-938-3350

The Impossible Dream

Radio hobbyists don't often make local headlines or the evening TV news. I think that until now, the last such coverage of that nature I can recall was when some CB'er got tired of the TV interference he was receiving from a neighbor's overpowered CB rig and decided to take a hacksaw to the tower that supported the offender's beam antenna—which promptly fell, crushing in the roof of another neighbor's house!

The most recent coverage made the local news media and also turned up on all national news services, CNN, as well as the network TV news. Moreover, it managed to stay there for a while. That would be the events surrounding the very brief career of America's very own offshore broadcasting ship. It was a story that was, in most instances, handled as a somewhat humorous event. Moreover, various renditions of the plight of RNI ("Radio Newyork International") had conflicting and erroneous information.

In discussing the history of unauthorized offshore broadcasting, some of the media announced that RNI was the first American offshore broadcaster and, as such, was merely a clone of similar stations that originated the idea off the British coastline more than twenty years ago. One reporter said RNI was descended from another unauthorized station off the New Jersey shore that the FCC closed down in the mid-1970's. None seemed to know that, in fact, RNI was the latest echo of the world's very first offshore pirate broadcaster, station RXKR, that generated headlines when it dropped anchor and started broadcasting from the harbor in Santa Monica, CA. That station

ran 5 kW and operated in mid-1933. *POP'COMM* told its story in the August '83 issue on page 10.

One of the more blatant foul-ups came on the second night of RNI's career. The local ABC-TV affiliate was reporting how RNI, after only one night on the air, was silenced by the FCC. This was totally incorrect; the station was going full blast (and had been for hours) during the newscast's obituary for RNI.

RNI was located a mere eighteen miles from the *POP'COMM* offices, it was practically in our backyards. In fact, some of the personalities reported to be involved in RNI's operations should have been familiar to our readers. For instance, Al Weiner, RNI's engineer. Our readers should recall Al from our May '85 issue (page 50) when we reported how he and another fellow tested the FCC's rules and sense of humor by obtaining a license for a two-way broadcast auxiliary (remote pickup) station, KPF941 on 1622 kHz, and then operated the 100-watt transmitter as if it were a regular broadcast station. Al said that it was an inexpensive (less than \$1,000) way of finally bringing a broadcasting station to Yonkers, NY (with a population of almost 200,000, it's New York State's fourth largest city, yet it has no broadcasting stations). When the FCC realized the use to which the license for KPF941 was being put, it cried *foul* and cancelled the authorization.

RNI, its staff said, was to provide the type of programming and format that audiences in the New York metro area couldn't find on any of the area's AM or FM broadcasting stations. To be sure, they were certainly cor-

rect in that respect. Several of the *Big Apple's* best known rock music DJ's congratulated RNI for its approach and even hoped that they might get a chance to appear behind the RNI microphone.

Being located four and a half miles off the south shore of Long Island, RNI contended that it was in international waters and therefore beyond the jurisdiction of the FCC and all other American agencies, especially since the vessel was flying the flag of Honduras. The FCC was of a different opinion when they boarded RNI's vessel accompanied by the Coast Guard, the U.S. Attorney, the Customs Service, etc. From the decrepit appearance of the ancient, leaking, and totally rusted old hulk called the *M/V Sarah*, home of RNI, the easiest approach would have been to get the EPA to condemn the ship as a public eyesore.

Eventually the RNI matter was placed on court agendas. The FCC was talking about penalties that included five year prison sentences and \$250,000 fines. RNI's people clung to their position that they hadn't done anything wrong, that they were boarded illegally, and that the FCC deliberately caused \$20,000 in damages to RNI's equipment.

This should be an interesting drama as it unwinds in a court. Personally, I thought that RNI invited its problems when it anchored so close to the shoreline of a densely populated metropolitan area, then sought to become a competing factor in the volatile

(Continued on page 72)



RNI's Al Weiner, surrounded by police officers, USCG personnel, and assorted federal agents was unceremoniously handcuffed and led off the *M/V Sarah*. It was a pathetic example of overkill for the benefit of the news media.



RNI DJ's Hank Hayes (center) and Randi Steele (right) shown at the microphone of station WNYG after their ship was boarded by the FCC.

MAILBAG LETTERS TO THE EDITOR

The most interesting questions we receive will be answered here in each issue. Address your questions to: Tom Kneitel, Editor, Popular Communications magazine, 76 North Broadway, Hicksville, NY 11801.

FCC = Federal Cheshire Cats?

In the September '87 *Pirates Den* column, it talks about how the FCC has been "battling" pirate broadcasters and how only a few of the many unlicensed broadcasters are actually caught. What about the FCC's "unwritten law" regarding such stations?

Laurance Wilson
Washington, DC

You didn't specify what that "unwritten law" was, but possibly you're asking about the alleged FCC attitude that so long as an unlicensed broadcaster runs low power, stays on 1620 kHz, and doesn't generate complaints from listeners or legit broadcasters, then the FCC won't offer any hassles. That one has been circulating for several years, although the FCC denies any such policy, written or unwritten. I once asked an FCC engineer for his opinion of this "unwritten law" and all I received for a reply was a wink and a smile—which I interpreted as meaning that, in any case, it was his personal unwritten law and possibly an unofficial attitude also held by others of his ilk. If that's the law you mean, and you can figure out the FCC man's response, then you've got your answer. Still, RNI (see our feature story in this issue) operated on 1620 kHz and was given a citation. —Editor

Every Bit Adds to the Data Base!

The new 6th Edition of *The Top Secret Registry of U.S. Government Radio Frequencies* has been very helpful. Using the information in this directory, I've found many federal frequencies I never guessed existed. In the book, it is requested that monitors send in additional listings, so here are some. While I was monitoring the USAF "Thunderbirds" on one of the frequencies in the directory, I heard them say that they were also operating on 388.0 MHz (which isn't listed). Also, I recently heard the NY National Guard on (listed) 41.00 MHz from Long Island MacArthur Airport (Islip, NY). The ground station base was asking a National Guard helicopter pilot to check reception of their "newly installed equipment" operating on 123.475 MHz (unlisted). Hope this is of help. I'll send more information as it becomes available.

W.F. Harmon
East Hampton, NY

All such information is gratefully received and graciously acknowledged. Federal communications are in a constant state of change, that's why the new 6th Edition contains about twice as much information as the previous edition. —Editor

Which Ride Is Worse?

This is to protest POP'COMM's flippant July editorial about UFO's. While I'm sure that your readers laughed heartily at this material, you neglected to take into account that the people of our planet are actually being preyed upon like laboratory mice by visitors from the cosmos. *The New York Times* (July 8, 1987 issue) took this seriously enough to run a story headlined, "Group Therapy For the Victims of Space Aliens." This tells of therapy sessions being held in New York City for those who are UFO abductees. About twenty people show up for these monthly therapy sessions and describe their abductions as "a severe, nightmarish thing" that none of them wanted to happen. Come now, Mr. Kneitel, why don't you tell your readers the truth about UFO's instead of making light of this serious issue?

Evelyn Rieger
Brooklyn, NY

Most people describe a ride in the New York City subway system in exactly the same terms. —Editor

UFO Foes?

Your July *Beaming In* comments on UFO's poked fun at objects that have appeared on radar screens. It's not sheer imagination. Radar doesn't lie, sir.

Andrew Kovacs
Worcester, MA

The comments poked fun at those Earthlings who claim to regularly visit the cosmos as guests of UFO crews, and who talk to UFO's via radio. I still have an open mind on the existence of UFO's and serious scientific research into this phenomena. Insofar as the omnipotence of radar, in the Red Sea and Persian Gulf, all sorts of false and unexplained radar echoes are common, often being associated with bioluminescent phenomena. According to a recent issue of *Marine Observer*, on August 1, 1985, in the Red Sea, the M/V Botany Bay, at 1800 UTC, observed "a crescent-shaped trace of echoes about 15 n.m. ahead of the vessel. This gradually developed, in an encircling manner, until, by 1845 the echoes had totally surrounded the vessel. . . . The echoes were significant with strong contrast and could have been mistaken for land on the radar. The effect could not be removed or diminished by changing range scales, motion modes, gain, tuning or perhaps most

significantly, altering the pulse lengths. An identical affect was observed on the vessel's independent ARPA radar. . . . By 1935 UTC the false echoes had dissipated into isolated batches splayed randomly across the screen." While radar may not lie, it can show misleading or unexplained images under certain conditions. Keep an open mind, but remain skeptical, my friend. —Editor

Frequency Finds

While monitoring two ships on VHF Channel 70, one told the other to switch to Channel 61, then they both vacated Channel 70. I scanned the entire VHF marine band from top to bottom (156.275 to 157.425 MHz) and couldn't locate these stations, and Channel 61 isn't shown in any frequency listings I can find. What and where is VHF Channel 61?

Hector de la Vega
Opa Locka, FL

For one reason or another, some synthesized all-channel VHF marine radios (the *Sea Ranger M-780*, for instance) offer simplex frequencies designated as Channels 60 through 64. The FCC doesn't carry such channel designators in its VHF marine channel list, nor are the frequencies associated with those channel designators authorized for marine use in waters of the United States. Essentially, they are phantom or unauthorized frequencies that seem to exist only as extra capabilities of certain pieces of equipment. These line up as (Channels 60 through 64, respectively) 156.025, 156.075, 156.125, 156.175, and 156.225 MHz. Actually 156.075 and 156.225 MHz are allocated for highway maintenance uses, the other three frequencies aren't FCC-allocated at all. None of these frequencies even lie within the limits of the VHF marine band and are most probably by-products of the synthesizer designed to cover that band.

Some boat owners who don't realize the tenuous status of these frequencies use them because they're relatively uncrowded. Other boaters have figured out that they officially don't exist and are therefore a somewhat hidden oasis of privacy. The ease with which equipment for these frequencies can be obtained, combined with the quiet and lack of monitoring by various agencies, has also brought them into use by smugglers, paramilitary groups, campers, and assorted other individuals and organizations of miscellaneous intent. The "insider" scanner monitoring crowd has had the word on these channels for a while now and quite a few startling things have been heard along with unauthorized marine communications of a routine nature. You might try listening there yourself. —Editor

PC

Hear It "Live" On a Radio Shack Scanner

Get Fast-Breaking News Firsthand...As It Happens



29-54 MHz ■ 136-174 MHz
406-512 MHz

25-520 MHz ■ 760-824 MHz
852-869 MHz ■ 896-1300 MHz

The Ultimate in Radio Excitement! Realistic® programmable scanners bring you all the latest news. You'll hear local police and fire departments at work, ambulances, railroads, Ham radio operators, 24-hour weather broadcasts, taxis, and more. Direct keyboard access—you never have to buy crystals! Advanced PLL tuning locks-in each frequency for precise reception with less noise.

Breakthrough Price! PRO-38 portable stores 10 frequencies for instant selection or automatic scanning. Has review key to see stored frequencies on the LCD display. Keyboard lock prevents accidental entries. With flexible antenna. Only \$139.95

Our Best! PRO-2004 scans up to 300 channels. You can access over 200,000 frequencies, including CB and military aircraft bands. Search mode helps find new frequencies. Scan-delay avoids missed replies. Sound-squelch control prevents lockups on unmodulated carriers. Lighted LCD display simplifies operation. For home or car* Only \$419.95

Backed by Our One-Year Limited Warranty. Five-year Extended Service Plan also available. Come by Radio Shack today and hear a "live"-action report on the PRO-2004 and PRO-38.

Radio Shack®
The Technology Store™

A DIVISION OF TANDY CORPORATION

Send for Your FREE 1988 Catalog!

Mail to Radio Shack, Department 88-A-208,
300 One Tandy Center, Fort Worth, TX 76102

NAME _____
STREET _____
CITY _____ STATE _____ ZIP _____

*Mobile use of scanners in some areas may be unlawful or require a permit. Check with local authorities. Batteries extra. Prices apply at participating Radio Shack stores and dealers.

OFFICIAL NEWS COLUMN OF THE SCANNER ASSOCIATION OF NORTH AMERICA

The "Forgotten" Service Has Suddenly Been Discovered

What was once called "Class A" CB, then renamed the General Mobile Radio Service, has been a service that very few people have used or even heard about. When the service began, equipment was either very expensive, or crude and unreliable. Then came "Class D" CB out of the old 11-meter Amateur assignment and it totally eclipsed any attention that the General Mobile Radio Service (GMRS) might have received.

Over the years many things happened to GMRS, some good and some bad. One of the best things that happened was the evolution of high performance equipment at reasonable prices. Not the price of a CB radio, but nonetheless within reason for many people. Unfortunately, it also has become much more difficult to get a license and users are no longer free to use all of the available GMRS frequencies. Instead they are usually assigned just one frequency "pair" for repeater operation. On top of that, the FCC now allows large commercial users to invade the GMRS channels. Typically, a new system needs to find a home on a frequency that is already being used by someone else—there just aren't any vacant UHF radio channels left. Often new systems, with perhaps 40 or 50 mobile units, are dumped on top of some poor GMRS users. Can you imagine the frustration of having invested in a GMRS repeater system only to have a delivery service suddenly show up on the frequency making it unusable most of the time?

Over the years the frustration level of GMRS users has grown. There was strong suspicion that the FCC's long range plan was to let GMRS quietly die. Even today you can hear battles raging on some GMRS channels between the personal communications users and commercial users. The problem in many cases is that while the GMRS users politely share the system, the truck drivers and dispatchers often have no such etiquette. When they hear a casual conversation on the channel they don't wait for a chance to break in . . . they try to talk right on top of what they feel is just idle chatter that doesn't belong on "their" channel.

In fact, there have been numerous cases where the commercial users have accused the GMRS users of "illegal" operation, even though the FCC rules for GMRS permit both business and personal communication. Adding to the frustration was the fact that nobody seemed to take notice or care about GMRS. Rarely did one see any mention of GMRS in the press. And each FCC rule change seemed to make it more impractical for the average citizen to obtain a GMRS license and frequency assignment.

FCC Discovers Demand For GMRS

GMRS users haven't given up, and their persistence through the Personal Radio Steering Group seems about to pay off. As the FCC has itself noted in PR Docket No. 87-265, GMRS offers high quality FM transmission, repeaters, and freedom from "skip" interference. No wonder the GMRS users wanted to keep the service for themselves and are refusing to be driven out! Finally, the FCC is proposing to act and correct past mistakes. Among the proposals in the FCC Docket are:

1. *Limit the eligibility of new licenses to individuals.* Business use of GMRS would still be permitted, but no new licenses would be given to businesses themselves. Large commercial users are expected to find a home in the Business Radio Service, not GMRS.
2. *Liberalize operator eligibility.* The GMRS licensee could designate other operators for whom he/she would be responsible. That means that family members could all operate under the license.
3. *Travel and "open" repeaters to be permitted.* Rather than re-

stricting use to a specific area, the GMRS license would permit transient use anywhere in the country and repeaters with open access to any traveler would be permitted.

4. *Additional frequencies.* The FCC proposes to "shoehorn" in three additional frequencies for low power voice communications between handy-talkies, mobiles, and small base stations (see below). The range of these signals could not be extended via repeaters.

5. *Small base stations.* As the name implies, these would be small base stations with power not to exceed 5 watts and antennas not to exceed 20 feet in height over an existing structure, such as a house or tree. Presumably and GMRS license would allow operation of these base stations.

That's really a revolutionary change in thinking about GMRS! Our hats off to the Personal Radio Steering Group for their work in making this happen. It is interesting that we will have come full circle, and much closer to the original intent of Class A CB when it was conceived 40 years ago!

Scanning GMRS Today And In The Future

It might be fun right now to listen in on what the GMRS channels are like in your area. It's easy to do since almost all synthesized scanners cover the frequencies, which are basically in two groups at 462 and 467 MHz. No telling what you'll find there. . . routine business band dispatching type communications, personal communications (including emergency communications groups like REACT), and even occasional verbal wars between the two camps of business and personal users! Here are the frequencies you will want to search or program in for scanning (all in MHz):

462.550	467.550
462.575	467.575
462.600	467.600
462.625	467.625
462.650	467.650
462.675	467.675
462.700	467.700
462.725	467.725

The 462 and corresponding 467 MHz channels are often paired for repeater use. In the future, the FCC proposes the following "split" channels for low power non-repeater use: 462.5625, 462.6125, 462.6375.

Your scanner may not be able to read out the last digit, so in the case of 462.5625 you would enter 462.562 or 462.563. That will be close enough to work. Of course, these new frequencies are not supposed to be active yet. But then, you never know!

More On 800 MHz Police "Trunking Systems"

Last month we discussed the coming widespread use of trunking systems for public safety communications and the concerns many departments have about turning over control of the radio transmissions to a computer-driven system. It appears as though the trunking system used by your local police and fire departments will be significantly different from those currently in use for business radio, thanks to the efforts of the Associate Public-Safety Communications Officers (APCO).

(Continued on page 65)

NEW! CB Radios & Scanners

Communications Electronics™, the world's largest distributor of radio scanners, introduces new models of CB & marine radios and scanners.

NEW! Regency® TS2-RA

Allow 30-90 days for delivery after receipt of order due to the high demand for this product.

List price \$499.95/CE price \$339.95
12-Band, 75 Channel • Crystalless • AC/DC
Frequency range: 29-54, 118-174, 406-512, 806-950 MHz. The Regency TS2 scanner lets you monitor Military, Space Satellites, Government, Railroad, Justice Department, State Department, Fish & Game, Immigration, Marine, Police and Fire Departments, Aeronautical AM band, Paramedics, Amateur Radio, plus thousands of other radio frequencies most scanners can't pick up. The Regency TS2 features new 40 channel per second Turbo Scan™ so you won't miss any of the action. Model TS1-RA is a 35 channel version of this radio without the 800 MHz. band and costs only \$239.95.

Regency® Z60-RA

List price \$299.95/CE price \$148.95/SPECIAL
8-Band, 60 Channel • No-crystal scanner
Bands: 30-50, 88-108, 118-136, 144-174, 440-512 MHz. The Regency Z60 covers all the public service bands plus aircraft and FM music for a total of eight bands. The Z60 also features an alarm clock and priority control as well as AC/DC operation. Order today.

Regency® Z45-RA

List price \$259.95/CE price \$139.95/SPECIAL
7-Band, 45 Channel • No-crystal scanner
Bands: 30-50, 118-136, 144-174, 440-512 MHz. The Regency Z45 is very similar to the Z60 model listed above however it does not have the commercial FM broadcast band. The Z45, now at a special price from Communications Electronics.

Regency® RH256B-RA

List price \$799.95/CE price \$329.95/SPECIAL
16 Channel • 25 Watt Transceiver • Priority
The Regency RH256B is a sixteen-channel VHF land mobile transceiver designed to cover any frequency between 150 to 162 MHz. Since this radio is synthesized, no expensive crystals are needed to store up to 16 frequencies without battery backup. All radios come with CTCSS tone and scanning capabilities. A monitor and night/day switch is also standard. This transceiver even has a priority function. The RH256 makes an ideal radio for any police or fire department volunteer because of its low cost and high performance. A 60 Watt VHF 150-162 MHz. version called the RH606B-RA is available for \$459.95. A UHF 15 watt, 10 channel version of this radio called the RU150B-RA is also available and covers 450-482 MHz. but the cost is \$439.95.

Bearcat® 50XL-RA

List price \$199.95/CE price \$114.95/SPECIAL
10-Band, 10 Channel • Handheld scanner
Bands: 29.7-54, 136-174, 406-512 MHz. The Uniden Bearcat 50XL is an economical, handheld scanner with 10 channels covering ten frequency bands. It features a keyboard lock switch to prevent accidental entry and more. Also order the new double-long life rechargeable battery pack part # BP55 for \$29.95, a plug-in wall charger, part # AD100 for \$14.95, a carrying case part # VC001 for \$14.95 and also order optional cigarette lighter cable part # PS001 for \$14.95.



PC 22

NEW! Scanner Frequency Listings

The new Fox scanner frequency directories will help you find all the action your scanner can listen to. These new listings include police, fire, ambulances & rescue squads, local government, private police agencies, hospitals, emergency medical channels, news media, forestry radio service, railroads, weather stations, radio common carriers, AT&T mobile telephone, utility companies, general mobile radio service, marine radio service, taxi cab companies, tow truck companies, trucking companies, business repeaters, business radio (simplex) federal government, funeral directors, veterinarians, buses, aircraft, space satellites, amateur radio, broadcasters and more. Fox frequency listings feature call letter cross reference as well as alphabetical listing by licensee name, police codes and signals. All Fox directories are \$14.95 each plus \$3.00 shipping. State of Alaska—RL019-1; Baltimore, MD/Washington, DC—RL024-1; Chicago, IL—RL014-1; Cleveland, OH—RL017-1; Columbus, OH—RL003-2; Dallas/Ft. Worth, TX—RL013-1; Denver/Colorado Springs, CO—RL027-1; Detroit, MI/Windsor, ON—RL008-2; Fort Wayne, IN/Lima, OH—RL001-1; Houston, TX—RL023-1; Indianapolis, IN—RL022-1; Kansas City, MO/ KS—RL011-2; Los Angeles, CA—RL016-1; Louisville/Lexington, KY—RL007-1; Milwaukee, WI/Waukegan, IL—RL021-1; Minneapolis/St. Paul, MN—RL010-2; Nevada/E. Central CA—RL028-1; Oklahoma City/Lawton, OK—RL005-2; Pittsburgh, PA/Wheeling, WV—RL029-1; Rochester/Syracuse, NY—RL020-1; Tampa/St. Petersburg, FL—RL004-2; Toledo, OH—RL002-3. A regional directory which covers police, fire ambulance & rescue squads, local government, forestry, marine radio, mobile phone, aircraft and NOAA weather is available for \$19.95 each. RD001-1 covers AL, AR, FL, GA, LA, MS, NC, PR, SC, TN & VI. For an area not shown above call Fox at 800-543-7892 or in Ohio 800-621-2513.

Regency® Informant™ Scanners

Frequency coverage: 35-54, 136-174 406-512 MHz. The new Regency Informant scanners cover virtually all the standard police, fire, emergency and weather frequencies. These special scanners are preprogrammed by state in the units memory. Just pick a state and a category. The Informant does the rest. All Informant radios have a feature called Turbo Scan™ to scan up to 40 channels per second. The INF1-RA is ideal for truckers and is only \$249.95. The new INF2-RA is a deluxe model and has ham radio, a weather alert and other exciting features built in for only \$324.95. For base station use, the INF5-RA is only \$199.95 and for those who can afford the best, the INF3-RA at \$249.95, is a state-of-the-art, receiver that spells out what service you're listening to such as Military, Airphone, Paging, State Police, Coast Guard or Press.

Regency® HX1500-RA

List price \$369.95/CE price \$218.95
11-Band, 55 Channel • Handheld/Portable
Search • Lockout • Priority • Bank Select
Sidelit liquid crystal display • EAROM Memory
Direct Channel Access Feature • Scan delay
Bands: 29-54, 118-136, 144-174, 406-420, 440-512 MHz. The new handheld Regency HX1500 scanner is fully keyboard programmable for the ultimate in versatility. You can scan up to 55 channels at the same time including the AM aircraft band. The LCD display is even sidelit for night use. Includes belt clip, flexible antenna and earphone. Operates on 8 1.2 volt rechargeable Ni-cad batteries (not included). Be sure to order batteries and battery charger from the accessory list in this ad.

Bearcat® 100XL-RA

List price \$349.95/CE price \$178.95/SPECIAL
9-Band, 16 Channel • Priority • Scan Delay
Search • Limit • Hold • Lockout • AC/DC
Frequency range: 30-50, 118-174, 406-512 MHz. Included in our low CE price is a sturdy carrying case, earphone, battery charger/AC adapter, six AA Ni-cad batteries and flexible antenna. Order your scanner now.

★★★ Uniden CB Radios ★★★

The Uniden line of Citizens Band Radios transceivers is styled to compliment other mobile audio equipment. Uniden CB radios are so reliable that they have a two year limited warranty. From the feature packed PRO 540e to the 310e handheld, there is no better Citizens Band radio of the market today.

PRO310E-RA Uniden 40 Ch. Portable/Mobile CB ... \$85.95
NINJA-RA PRO310E with rechargeable battery pack \$99.95
B-10-RA 1.2V AA Ni-cad batt. for Ninja (set of 10) ... \$20.95
PRO520E-RA Uniden 40 channel CB Mobile ... \$59.95
PRO540E-RA Uniden 40 channel CB Mobile ... \$119.95
PRO710E-RA Uniden 40 channel CB Base ... \$119.95
PC22-RA Uniden remote mount CB Mobile ... \$99.95
PC55-RA Uniden mobile mount CB transceiver ... \$59.95

★★★ Uniden Marine Radios ★★★

Now the finest marine electronics are available through CEI. The Unimetrics SH66-RA has 50 transmit and 60 receive frequencies with 25 or 1 watt power output. Only \$169.95. The Unimetrics SH88-RA is a deluxe full function marine radiotelephone featuring 55 transmit and 90 receive channels and scanning capability for only \$259.95. The Unimetrics SH3000-RA is an excellent digital depth sounder, good for 300 feet. It has an LCD continuously backlit with red light display and a 5 ft. or 10 ft. alarm. Only \$189.95. Order today.

Bearcat® 800XL-RA

List price \$499.95/CE price \$289.95/SPECIAL
12-Band, 40 Channel • No-crystal scanner
Priority control • Search/Scan • AC/DC
Bands: 29-54, 118-174, 406-512, 806-912 MHz. The Uniden 800XLT receives 40 channels in two banks. Scans 15 channels per second. Size 9 1/4" x 4 1/2" x 1 1/2"

OTHER RADIOS AND ACCESSORIES

Panasonic RF-2800-RA Shortwave receiver ... \$179.95
RD55-RA Uniden Visor mount Radar Detector ... \$98.95
RD9-RA Uniden "Passport" size Radar Detector ... \$169.95
NEW/BC 70XL-RA Bearcat 20 channel scanner ... \$168.95
BC 140-RA Bearcat 10 channel scanner ... \$92.95
BC 145XL-RA Bearcat 16 channel scanner ... \$98.95
BC 175XL-RA Bearcat 16 channel scanner ... \$156.95
BC 210XL-RA Bearcat 40 channel scanner ... \$196.95
BC-WA-RA Bearcat Weather Alert™ ... \$35.95
R1080-RA Regency 30 channel scanner ... \$118.95
R1090-RA Regency 45 channel scanner ... \$148.95
UC102-RA Regency VHF 2 ch. 1 Watt transceiver ... \$117.95
P1412-RA Regency 12 amp reg. power supply ... \$189.95
MA549-RA Drop-in charger for HX1200 & HX1500 ... \$84.95
MA518-RA Wall charger for HX1500 scanner ... \$14.95
MA553-RA Carrying case for HX1500 scanner ... \$19.95
MA257-RA Cigarette lighter cord for HX12/1500 ... \$19.95
MA917-RA Ni-Cad battery pack for HX1000/1200 ... \$34.95
SMMX7000-RA Svc. man. for MX7000 & MX5000 ... \$19.95
B-4-RA 1.2 V AAA Ni-Cad batteries (set of four) ... \$9.95
B-8-RA 1.2 V AA Ni-Cad batteries (set of eight) ... \$17.95
FB-E-RA Frequency Directory for Eastern U.S.A. ... \$14.95
FB-W-RA Frequency Directory for Western U.S.A. ... \$14.95
ASD-RA Air Scan Directory ... \$14.95
SRF-RA Survival Radio Frequency Directory ... \$14.95
TSG-RA "Top Secret" Registry of U.S. Govt. Freq. ... \$14.95
TIC-RA Techniques for Intercepting Comm. ... \$14.95
RRF-RA Railroad frequency directory ... \$14.95
EEC-RA Embassy & Espionage Communications ... \$14.95
CIE-RA Covert Intelligence, Elect. Eavesdropping ... \$14.95
MFF-RA Midwest Federal Frequency directory ... \$14.95
A60-RA Magnet mount mobile scanner antenna ... \$35.95
A70-RA Base station scanner antenna ... \$35.95
MA548-RA Mirror mount Informant antenna ... \$39.95
USAMM-RA Mag mount VHF ant. w/ 12' cable ... \$39.95
USAK-RA 3/4" hole mount VHF ant. w/ 17' cable ... \$35.95
Add \$3.00 shipping for all accessories ordered at the same time.
Add \$12.00 shipping per shortwave receiver.
Add \$7.00 shipping per radio and \$3.00 per antenna.

BUY WITH CONFIDENCE

To get the fastest delivery from CE of any scanner, send or phone your order directly to our Scanner Distribution Center* Michigan residents please add 4% sales tax or supply your tax I.D. number. Written purchase orders are accepted from approved government agencies and most well rated firms at a 10% surcharge for net 10 billing. All sales are subject to availability, acceptance and verification. All sales on accessories are final. Prices, terms and specifications are subject to change without notice. All prices are in U.S. dollars. Out of stock items will be placed on backorder automatically unless CE is instructed differently. A \$5.00 additional handling fee will be charged for all orders with a merchandise total under \$50.00. Shipments are F.O.B. Ann Arbor, Michigan. No COD's. Most products that we sell have a manufacturer's warranty. Free copies of warranties on these products are available prior to purchase by writing to CE. Non-certified checks require bank clearance. Not responsible for typographical errors.

Mail orders to: Communications Electronics™, Box 1045, Ann Arbor, Michigan 48106 U.S.A. Add \$7.00 per scanner for R.P.S./U.P.S. ground shipping and handling in the continental U.S.A. For Canada, Puerto Rico, Hawaii, Alaska, or APO/FPO delivery, shipping charges are three times continental U.S. rates. If you have a Discover, Visa or Master Card, you may call and place a credit card order. Order toll-free in the U.S. Dial 800-USA-SCAN. In Canada, order toll-free by calling 800-221-3475. FTCC Telex anytime, dial 825333. If you are outside the U.S. or in Michigan dial 313-973-8888. Order today. Scanner Distribution Center* and CE logos are trademarks of Communications Electronics Inc.

† Bearcat is a registered trademark of Uniden Corporation.
‡ Regency and Turbo Scan are registered trademarks of Regency Electronics Inc. AD #080187-RA
Copyright © 1987 Communications Electronics Inc.

For credit card orders call
1-800-USA-SCAN

COMMUNICATIONS ELECTRONICS INC.

Consumer Products Division

P.O. Box 1045 □ Ann Arbor, Michigan 48106-1045 U.S.A.
Call 800-USA-SCAN or outside U.S.A. 313-973-8888



Aerial view of the M/V Sarah shows the antenna mast located towards the vessel's bow, and heavily guyed.

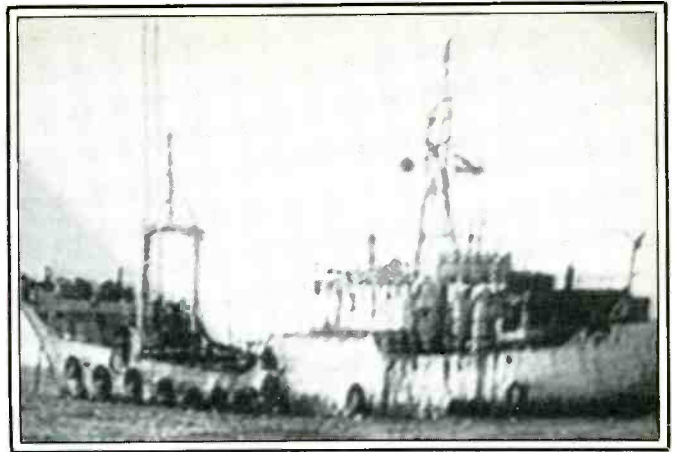

As vessels go, the M/V Sarah, home of RNI, was no beauty. Its sides lined with old tires, rust streaks show through its peeling paint.

RNI: The Inside Story

The Most Talked About Pirate Station Of The Decade

BY EDWARD TEACH

"Hello George? This is Bill."

"Hi, Bill, how ya doing?"

"Great. Listen, I gotta get right back to the receiver but I thought I'd alert you to this new pirate that just came on, in case you hadn't heard about it."

"No, what pirate is that?"

"They're ID'ing as Radio Newyork International and claiming to be on a ship off the coast of New York City. I'm hearing them really well right now, on both 1620 and 6240."

"No kiddin'? Thanks. I'll get right on it!"

●

Something akin to that scene took place any number of times during the last hot days of July, as shortwave listeners alerted friends to the new pirate and enjoyed some excitement in an otherwise dull DX summer scene.

Indeed *Radio Newyork International* (RNI) made quite a splash. Where the ordinary pirate broadcaster might only get mentioned after the FCC closes it down (and then only in the local newspaper), RNI was the subject of a flood of news stories and features printed and aired by local New York media. The wire services fed the story to newspapers around the country; CNN, ABC, CBS and NBC took us flying over the radio ship and in one or two instances right into the studios on board.

But it was over very fast. *Radio Newyork International* was, like a shooting star, noted by many but met a quick end.

The Idea They said they had been working on it for 15 years, inspired by a philosophy of programming that was missing on the New York area airwaves. It needed its own outlet. RNI's people believed that the pop/rock music broadcasting scene in the city was stagnant, due to song playlists handed down by the program management departments and not under the control of the disc jockeys. RNI also protested against the expense and difficulty involved in getting a broadcast license from the FCC. But mainly, it wanted to create what it called a "free form" format where the disc jockeys called the shots. So the prime movers, backers and supporters of the *Radio Newyork International* idea set to work to create the kind of station they wanted on the air.

The People Some 20 people are said to have backed the idea with time and or money. Together they came up with the rather astonishing amount of \$100,000 to invest in the pirate radio station.

RNI's main man was Al Weiner, 34, of Monticello, Maine. Weiner is a veteran of previous pirate radio adventures and runs with the FCC. He operated a pirate station from Yonkers, NY when he was only 16 years old. The FCC shut him down. By 1985 he had gone legit, owning stations WOZI in Presque Isle, Maine and WOZW in

Monticello, Maine. However, Weiner got into trouble with the FCC again, this time for using an FCC-licensed auxiliary transmitter (KPF-941 on 1622 kHz which was intended as a remote pick-up unit), as a regular broadcasting outlet in Yonkers, NY which had no assigned station. When the FCC stopped this practice it also revoked the licenses for Weiner's two Maine stations.

Another principal was Randi Steele, 30, of Queens, NY (real name Randall Ripley) who served as the RNI Manager/Program Director. Steele is alleged to have been involved in a number of pirate stations during the past. He was also the station's technical whiz as well as a DJ.

Another staffer was Ivan Rothstein of Brooklyn who, under the name Ivan Jeffries, served as a station disc jockey. Richard Hertz, 25, also from Brooklyn, NY, was an RNI DJ too. It is possible that this name may only be his "on air" name.

Most of the remaining backers have kept their names and participation out of the limelight, remaining silent partners in the pirate operation. Rumors persist that several backers are well known within the radio hobby.

The Ship At least half of the \$100,000 went to buy the ship used as the transmitter base. The ship, dilapidated and full of rust, was originally a Japanese fishing vessel built in Japan 27 years ago. Previously it was the *L. Lopez II* whose owner was listed as Inter-



Ivan Jeffries (left) and Randi Steele (those are their "on the air" names) were two of the talented DJ's on the RNI staff.

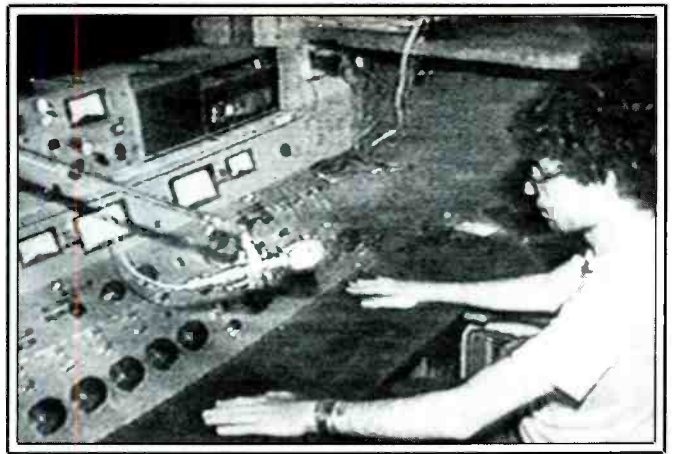

Jeffries seated at the RNI control board.



Al Weiner, RNI's Chief Engineer, has run up against the FCC in the past. POP'COMM readers should recognize his name from the curious "KPF941" incident two and a half years ago.

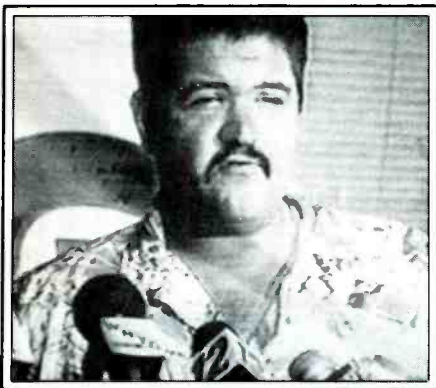

Hank Hayes, one of RNI's DJ's.

national Ship Owner on Sarasota Avenue, Yonkers, NY, though that company was not listed in area phone books. The RNI group purchased the ship in Boston but registered it under the Honduran flag on July 3. A State Department official later said this appeared to have been a "provisional registry," meaning the paperwork on it had not yet been fully completed. They named it the

Sarah since several of the staff have or had girlfriends by that name. There are also a couple of rock songs with that title. It seemed a natural name for the ship. *Sarah* sailed from Boston with a crew of six and dropped anchor 4½ miles off Long Beach, on the south shore of Long Island. This strategic placement outside the three-mile limit of U.S. territorial waters was, of course, meant to foil the FCC.

The Station They signed on the air at 6 p.m. Eastern Daylight Time on Thursday, July 23 and broadcast for five or six hours each evening through the following Monday, missing broadcasts only on Saturday night. On board was a 1,000-watt medium-wave transmitter operating on 1620 kHz. (According to observations of several monitors, the frequency was closer to 1619.7 kHz.) An FM transmitter operated on 103.1 MHz but was reportedly heard poorly, even on the closest land point. An experimental broadcast was carried out on 190 kHz in the longwave band but there were no known reports of reception on that frequency. On shortwave, RNI was on 6240. That frequency, along with the 1620 frequency, was providing fair to excellent reception all over the eastern and midwestern parts of the country. Midwest monitors said the mediumwave outlet was often as good as or better than 6240 shortwave. Listeners in Florida were among the first to report reception of the station and the FCC monitoring station at Allegan, Michigan had no difficulty in picking up RNI. Other tests were announced for 530 kHz but not reported.

The Sound of RNI "Unbelievable, unstoppable, unboardable, unsinkable, unbeatable—RNI—it's unavoidable" went one of the station's promotional announcements. The station's main fare was rock classics from the 1960's and 70's by the Beatles, Chicago, the Monkees, and others. Another bent in the music and in the talk was an anti-war theme. The deejays aired their views and played John Lennon's "Give Peace a Chance." One announcer spoke about AIDS and safe sex.

Listeners noted identifications that went

"Stronger than ever, RNI, the wet one" and "Radio Newyork International, the new sound from outside U.S. territorial waters." The station also claimed to be America's first commercial "auxiliary" station and pointed out that persons or companies with products to sell should write to the station's offices (496 La Guardia Place, Suite 451, New York, NY 10012) for advertising rates. Reception reports were also welcomed at that address. Reporters were asked to include a self-addressed, stamped envelope in order to insure a reply. RNI's QSL appears at the end of this article.

The Feds Once the FCC became aware of RNI, with its monitoring offices direction-finding the location, official wheels began turning. It soon became apparent that this was going to be one of those rare times when a governmental agency wastes no time in getting things done.

On Saturday, July 25th, two FCC agents sailed on the 95-foot Coast Guard cutter *Cape Horn* to the *M/V Sarah*. Also on board were agents from the Immigration and Naturalization Service and the Customs Service. Both agencies wanted to be certain that no United States rules and regs were being broken. Once on board the *Sarah*, the FCC people issued a citation to RNI for broadcasting without a license, saying the station had been found "tentatively" in violation of the FCC's rules and regulations.

Steele, however, was adamant that RNI was breaking no laws. The ship was outside U.S. waters, registered under a foreign flag and thus not subject to the FCC, he maintained. Steele said RNI would resist any future attempts to board by the FCC. He would resist interference with RNI's right to broadcast in that the station would soon start selling advertising and would expand its hours of operation. However, for whatever reason, RNI did not go on the air that night. A generator fire was rumored.

By Monday the FCC was vigorously pursuing means by which the RNI broadcasts could be halted. Working through the State Department, the government of Honduras was advised that the *Sarah* was being used

as something other than the use for which she was registered—fishing. The Honduran government then issued a statement of “no objection” to a boarding by United States officials. Meantime, the FCC was preparing a case based on Article 30 of the International Telecommunications Union which forbids any type of broadcasting from ships outside territorial waters.

The Raid It happened in the hours around dawn on Tuesday. The *Cape Horn*, armed with two 50-caliber machine guns, sailed out to the *Sarah*. On board were four FCC agents and six armed Coast Guardsmen. Subsequently, Weiner and Rothstein were both arrested and placed in handcuffs, as was RJ Smith, the music critic of the *Village Voice*, who had spent the night on board the *Sarah* in covering the story. The three were left sitting in the broiling sun for many hours while the Commander of the *Cape Horn* communicated with officials via two-way radio. Apparently the plans hadn't covered what to do with people found on the *Sarah*.

Eventually Smith was released and the two broadcasters were brought before U.S. Magistrate John Caden of the U.S. Court for the Eastern District of New York, charged with conspiring to impede the lawful governmental functions of the FCC and for operating a broadcast station on board a ship, outside national territorial waters. Together, the offenses carry maximum penalties of five years in jail and a fine of \$250,000. Weiner and Rothstein were arraigned and released on their own recognizance after promising that they would no longer broadcast without an FCC license. A second court appearance was set.

The FCC saw the affair as a deliberate attempt to test its authority and said the Commission would enforce the regulations for which it is responsible. Weiner insisted that the broadcasts were not intended as a challenge to the FCC's authority but simply an attempt to get alternative programming on the air. One authority believed taking the case through the court system was not the government's prime objective, that the government would be satisfied with a promise not to do it again.

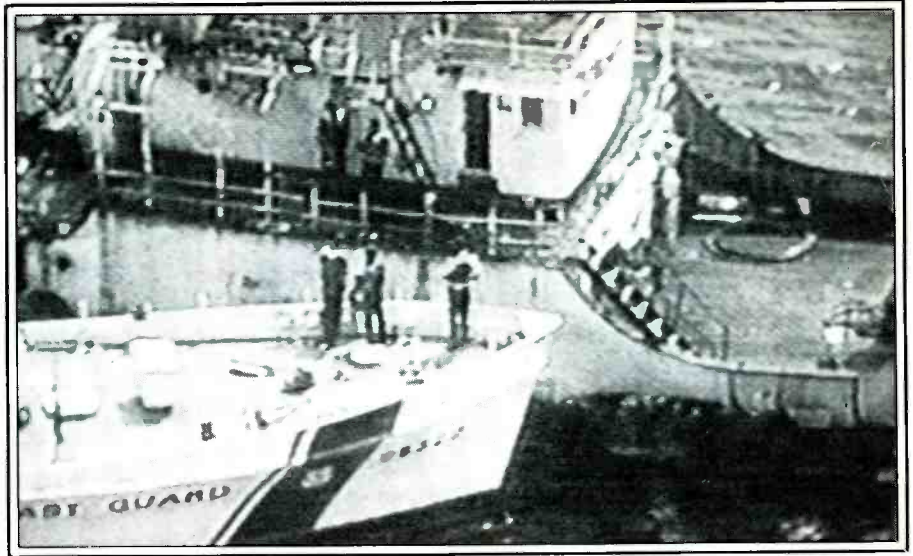

The Coast Guard, accompanied by the FCC, the Customs Service, the Immigration Service, and other federal officials, board the M/V Sarah even though the vessel's owners contended that it was located outside of American territorial waters.

The Aftermath The Editor of the *Village Voice*, Martin Gottlieb, objected to the way his reporter had been treated and had his lawyers looking into the feasibility of a false arrest suit.

The Coast Guard took temporary custody of the *Sarah*, with the USCG Cutter *Raritan* maintaining a watch over the vessel. The *Sarah* did not have a winch powerful enough to hoist its five-ton anchor so the *Sarah* wasn't moving.

On Thursday, July 30th, Weiner and Rothstein were taken out to the *Raritan* where they signed papers returning the *Sarah* to them. That completed, the two boarded the *Sarah*. The *Raritan* left for its home base on Governors Island.

Weiner and Rothstein were shocked at what they found on board. They said that federal agents had cut wires, removed tubes and stacked audio units. Weiner estimated that it would cost about \$20,000 to put things back together. Much of the equipment, he noted, had been home-built.

The ex-broadcasters then had the prob-

lem of what to do with the ship and were unsure of whether to leave it where it was for the time being or to cut the anchor chain and sail it somewhere else, especially since it was beginning to leak.

As this is being written, it's clear that the final lines have not yet been put to paper on the RNI affair. At the very least there is the question of what the courts will decide regarding the charged faced by Weiner and Rothstein. At most, there must be some wondering if the world of radio has heard the last of these determined fellows.

Even though these things are still up in the air, there is one lesson to be learned by future pirate broadcasters. It boils down to a no-win situation. You might get away with pirate broadcasting (probably) in the fashion of *Radio Clandestine* and a few others, simply by being extremely cautious, anonymous and sporadic about your operations. Or you can go the RNI route, making a big splash and getting yourself noticed by lots of folks including, for pirate purposes, the wrong ones. In order to provide a real ser-

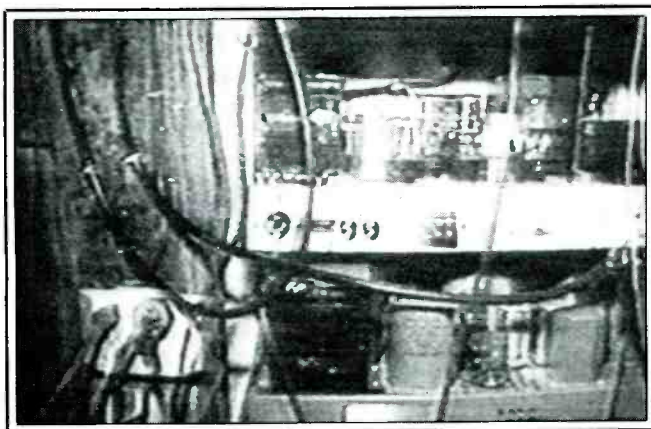

Close-up view of some of the tube-type equipment used at RNI.



A better look at RNI's master control board.



R.N.I.
496 LaGuardia Place
Suite 451
New York, N.Y. 10012

Joseph A. Sabat

Dear Joseph,
Hi! Thanks for your letter and reception report! I'm really happy you were able to pick us up!
As you've probably heard by now, R.N.I. was closed down when our ship the Sarah was boarded by the United States Coast Guard along with the F.C.C. Two of our staff members have been brought up on charges and they have their next court date on August 27th. We'd really like it if you'll support us through this and if you'd like to help us, you can write to your congressman, write to the F.C.C. and most of all, WRITE US!! Let us know you're still out there and with us from time to time.
Enclosed is our QSL card, again, thanks alot for your reception report which we really appreciated! R.N.I. was operating on several frequencies including 6.240 shortwave, 1620 medium wave (AM), 103.1 FM Stereo and 190 KHZ longwave. If you would like technical information on R.N.I., write us back and put the letter to the attention of the engineer. Please send us return postage when you write us. Thanks!!!
Anyway, thanks again and thanks for your continued support and keep in touch!!

Andrew Steele

Andrew Steele
Radio New York International

confirming your reception of
R.N.I. on 103.1 FM, 1620 AM
and 6.240 shortwave on July 27, 1987.
Thanks alot for listening Joseph,
and thanks for your continued
support!
R-N-I
"The Wet one"
QSL + QSL + QSL



An RNI QSL received by POP'COMM reader Joseph A. Sabat, Bethpage, NY.

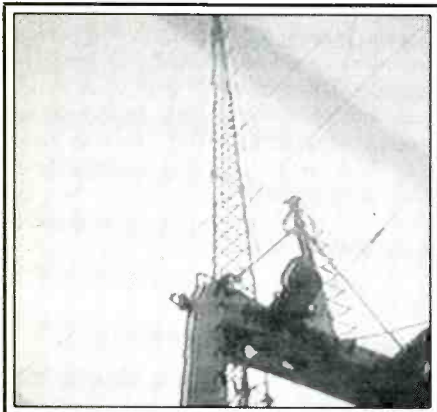

RNI's main antenna mast, as seen from the deck of M/V Sarah.

vice to listeners, those listeners have to know when you'll be on the air and you have to have a strong enough signal to be heard well and consistently. Those necessities, on the other hand, are the very things that draw the attention of the FCC. In short, notoriety has an extremely high price. And Radio New York International paid it.

This report was based upon various accounts (including press) of the people and events surrounding the broadcasts and closedown of Radio New York International, as well as on RNI's broadcast content, as monitored by listeners around the country.

RECEIVE RTTY/ASCII/CW on your Personal Computer



**RTTY/ASCII/CW
SWL COMPUTER INTERFACE** MFJ-1225
\$ 69.95

FREE MFJ RTTY/ASCII/CW Software
TAPE AND CABLE FOR VIC-20 OR C-64. ORDER MFJ-1225/
MFJ-1264 FOR VIC-20 OR MFJ-1225/MFJ-1265 FOR C-64.

Receives commercial, military, and amateur RTTY/ASCII/CW using your personal computer. The MFJ-1225 Computer Interface plugs between your receiver and VIC-20, Apple, TRS-80C, Atari, TI-99, Commodore 64 and most other personal computers. Requires appropriate software. Copies all shifts (850, 425, 170 Hz shift and all others) and all speeds. Automatic noise limiter suppress static crashes for better copy. 2 LED tuning indicator makes tuning fast, easy, positive. 4 1/2 x 1 1/4 x 3/4 in. 12-15 VDC or 110 VAC with optional adapter, MFJ-1312, \$9.95.

INDOOR TUNED ACTIVE ANTENNA

MFJ-1020
\$ 79.95



MFJ-1020 New Indoor Active Antenna sits on your desk ready to listen to the "Rivals", often exceeds, reception of outside long wire. Unique Tuned Active Antenna minimizes intermode, provides RF selectivity, reduces noise outside tuned band. Also use as preselector for external antenna. Covers 300 KHz to 30 MHz in 5 bands. Adjustable telescoping antenna. Controls: Tune, Band Selector, Gain, ON-Off/By-pass. LED. FET, bipolar circuitry. Phono jack for external ant. 6x2x6 in. 9-18 VDC or 9V battery. 110 VAC with adapter, MFJ-1312, \$9.95.

REMOTE ACTIVE ANTENNA

54 inch remote active antenna mounts outdoor away from electrical noise for maximum signal and minimum noise pickup. Often outperforms longwire hundreds of feet long. Mount anywhere atop houses, buildings, balconies, apartments, mobile homes, on board ship. Use with any radio to receive strong clear signals from all over the world. 50 KHz to 30 MHz. High dynamic range eliminates intermodulation. Inside control unit has 20 dB attenuator, gain control. Switch 2 receivers and auxiliary or active antenna. "On" LED. 6x2x5 in. 50 ft. coax. 12 VDC or 110 VAC with MFJ-1312, \$9.95.



MFJ-1024
\$ 129.95

Order from MFJ and try it. If not delighted, return within 30 days for refund (less shipping). One year unconditional guarantee. Order yours today. Call toll free 800-647-1800. Charge VISA, MC. Or mail check, money order. Add \$4.00 each for shipping and handling.

CALL TOLL FREE ... 800-647-1800

Call 601-323-5869 in Miss., outside continental USA, tech/order/repair info. TELEX 53-4590

MFJ ENTERPRISES, INCORPORATED
Box 494, Mississippi State, MS 39762

CIRCLE 11 ON READER SERVICE CARD

Radiola

It's Time To Tune In On The Golden Years Of Radio And Wireless

BY ALICE BRANNIGAN

Couple of issues ago I mentioned that a reader had asked about the history of NBC's interval signal consisting of the famed chimes that go *bong-bong-bong-g-g-g*. I said that someone at NBC thought that they were the letters G-E-C on the musical scale and stood for the initials of the General Electric Company (relating to a long-ago, and present, corporate tie-in with RCA, the parent company of NBC). Somehow, I doubted that answer and I asked readers to come up with the true (or at least, a better) answer.

Answers, I got. Thomas Borawski, Lansdale, PA sent a tape recording of an old H.V. Kaltenborn broadcast in which he tells how the chimes got their start. The tape served several purposes. Firstly, it let me hear H.V.'s voice, which I had never heard. Second, on Side Two of the tape was a hilariously funny 1930's radio commercial for Stroh's Beer. Lastly, H.V. told his version of the start of the NBC chimes.

Kaltenborn's story was that network announcers were in the habit of regularly reading off the call signs of each individual station in the NBC network during every station break—"WEAF, WJR, WTAG, WTIC, WLIP, WCSH, etc." By 1926, he observed, there were so many NBC affiliates that the list became too lengthy to read. That's when someone went out and spent \$48.50 for a set of electric chimes as a substitute for the reading of the many call signs.

John Faulkner, Reno, NV notes that RCA was founded by a consortium of AT&T, GE, Westinghouse, and the United Fruit Co. At first, this was for the purpose of owning many radio patents, but soon RCA began manufacturing and distributing equipment. AT&T pulled out early, and the government split up the other owners under anti-trust laws. GE had several stations and became the nucleus of NBC (along with some AT&T and Westinghouse stations). The chimes were originally Degan dinner chimes and related to the letters G-E-C. He agrees that it was a device to make it easier on the announcers, noting that by the late 1930's, the sound was reproduced when an engineer pushed a button on the control console.

Rod Phillips, Vice President of the Antique Radio Club of America, who hails from Bryn Mawr, PA, is a professional broadcast historian. In a recent issue of *The Antique Radio Gazette* (official publication of the ARCA), Rod wrote a history of the NBC chimes. It's a lengthy and complex history, to be sure, but Rod asserts that citing

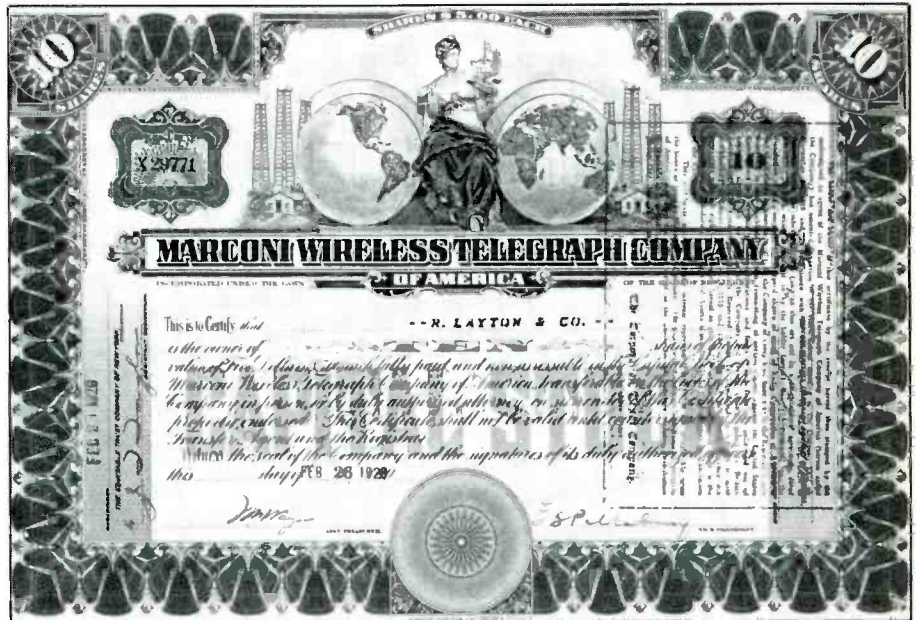

If you had been a stockholder in the Marconi Wireless Telegraph Company, you'd have had one of these to show your friends. It's very showy. Collectors tell me that you can still buy these from certain dealers who sell stock certificates from old time companies.

the musical notes G-E-C as representing the General Electric Co. is popular, but a total myth. Rod reports that NBC commenced operation on 9 September 1926.

On the evening of 15 November 1926 the first network programs went out over a 24-station chain, but there was much confusion within the network about providing adequate and appropriate identification. It was decided to use chimes on the hour and half-hour. These would not only be the network's signature but would also alert individual member stations as to when they should announce their individual call signs.

In 1927-28, they experimented over the air with a seven-note chime signal (G-C-F-E-G-C-E), but it was too complicated for practical use. That was sliced down to four notes (G-C-F-E), and on 29 November 1929 the G-E-C chimes made their appearance. These were Degan dinner chimes, sounded automatically by an "electronic music box" from 1932. Starting in 1937, and for the duration of WWII, an extra chime was sounded (G-E-C-C) to alert the NBC news department of war bulletins.

Rod says that the three-note G-E-C signature was written into a piece of music in 1949. It was called *The NBC Polka*. In

1951, Meredith Willson used the musical signature in the composition, *Three Chimes of Silver*, a 25th anniversary tribute to NBC.

Even POP'COMM's own Tom Kneitel offered his thoughts on the subject, asking if anybody yet recognized the eerie similarity between the NBC chimes and a 1940's novelty tune called *One Meat Ball*. I questioned the actual existence of such a ditty, but he assures me that as a youth he *did* hear this song about a "little man" who went to a restaurant. Having only 15 cents in his pocket, he ordered a single meatball with bread on the side. This made him the object of ridicule, with the waiter laughing and loudly advising, "You get no bread with one meatball!" Tom insists that not only did this song exist, but its melody sounds just like the NBC chimes, theorizing that it was stolen from NBC. Guess I'll have to take his word for this!

Taking Stock Of Marconi

A look at a stock certificate from the Marconi Wireless Telegraph Company is provided by William Torkel Clark, Chico, CA. This certificate for ten shares is dated 1920. It has a red-orange border. The pictorial and

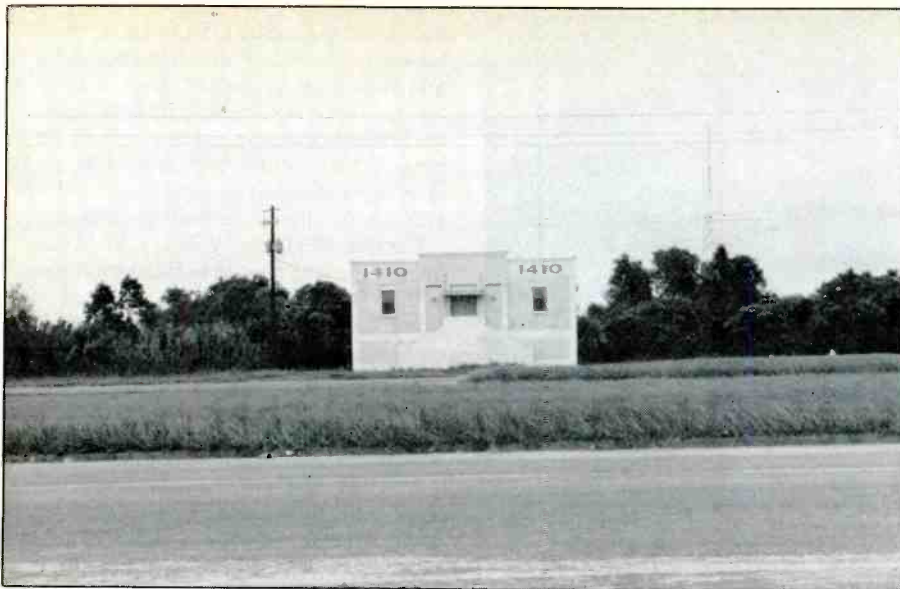

A reader recalled station WALA from his childhood. He recently took this photo of the old WALA transmitter site, observing that the familiar callsign no longer adorns the transmitter building.



You needed a fast receiver to hear short-lived station KGFH located in lovely Hotel Glendale, "Where the Beds are Soft."

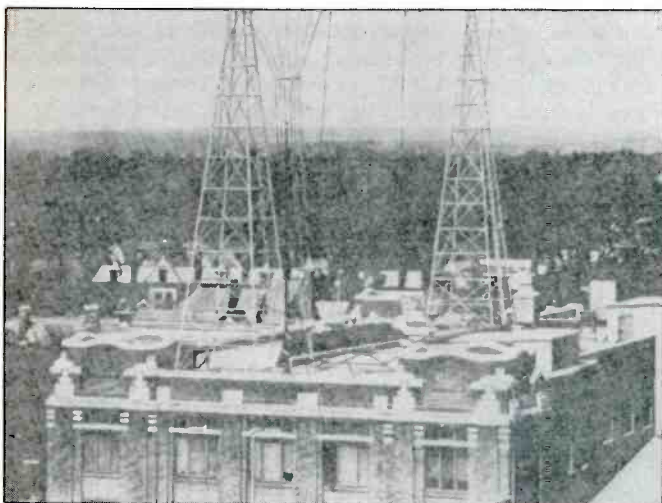

The WGAZ towers on the roof of the South Bend Tribune Building in 1924. (South Bend Tribune photo)

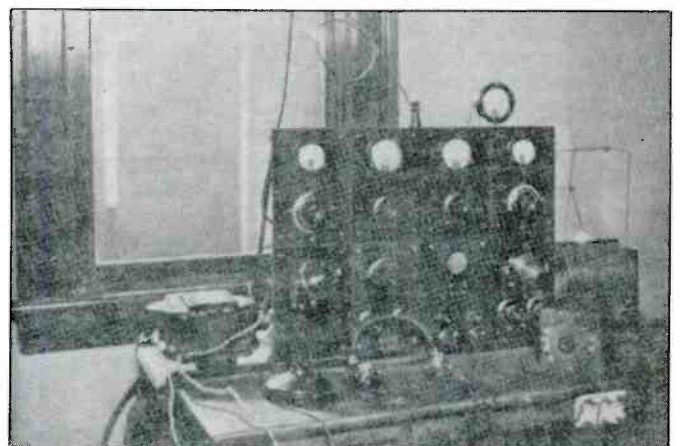

The WGAZ studios/transmitter were anything but fancy in the early days. (South Bend Tribune photo)

lettering is black. This is a steel engraving produced by the American Bank Note Co.

The allegorical female figure in the pictorial holds a down-pointed sword in her right hand. She gazes at her left hand holding aloft balanced scales. She is poised between eastern and western hemispheres of the globe which, in turn, are bracketed by radio towers of the type used by some of the early Marconi stations. The lowered sword and raised scales possibly symbolizes (in the era right after WWI) replacing the military uses of radio with commercial operations.

Mr. Clark (who is N6KKA, ex-W6BFI) was once a Crypto Watch Officer at a small Navy communications facility in Okinawa. A member of the American Cryptogram Association, he is a Ham, SWL, scanner buff, and computernik. He says that, through cryptographic methods, he thinks that my

real name is A.W. Buckley. An interesting try, Mr. Clark!

Alabama Bound

Tony Haley, of Sparks, NV, passes along a recently-taken snapshot of the old WALA (1410 kHz) transmitter building and towers located on what used to be known as the Mobile Causeway (presently known as the Battleship Parkway). This site is about three miles from Mobile, AL. When Tony was growing up in Daphne, AL, this station always fascinated him. He asks if we can tell him anything about its history.

Looks like WALA first cranked up in 1930 as WODX with 500 watts on 1410 kHz. With studios at Royal and St. Francis Streets in Mobile, the transmitter was in Springhill, AL. The station's original li-

censee was the Mobile Broadcasting Corp., Scott Holt, Trustee.

Within only a short time after the station commenced operation, it was sold to the Pope Broadcasting Corp. (W.O. Pope, President). The callsign was changed to WALA, the frequency became 1380 kHz. The major national frequency shuffle just prior to WWII moved the station back to 1410 kHz, but permitted an increase in power to 5 kW. In 1946, after the end of the war, WALA was operating with studios at 106 St. Joseph St. in Mobile. The transmitter was located at the Cochran Bridge Causeway (Baldwin County).

Tony recalls that the callsign WALA was once written out in large letters on the front of the building shown in the photo. As you can see they have since been removed. That's most likely because this station now



The two founding fathers of WGAY Joseph Brechner (left) and John Kluge (right). They planned the station as GI's during WWII, but didn't realize the long road to putting WGAY on the air.

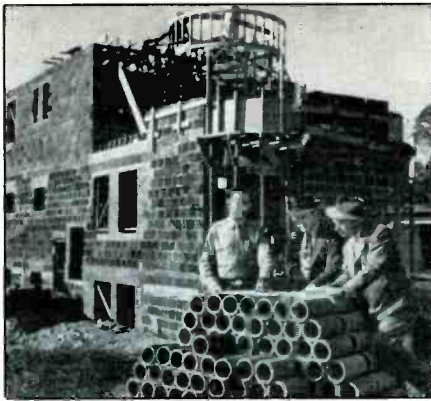

This much of WGAY had been built before the FCC agreed to permit the station to operate! This type of enthusiastic planning put WGAY on the air in the shortest possible time, all things considered.

operates under the callsign WUNI (1410 kHz, 5 kW).

Beautiful Downtown Glendale

"From high atop the beautiful Hotel Glendale, KGFH presents for your dancing pleasure, the syncopated rhythms of Ray Noble and his band." That's a rough approximation of what you might have heard had you tuned in KGFH or many other stations located in hotels.

KGFH flipped the main power switch on in 1928 running 250 watts on 1000 kHz. Although located in the Hotel Glendale, it was licensed to Frederick Robinson, Box 163, La Crescenta, CA. Our view of KGFH (sent courtesy of Will Jensby, CA) shows a six-story structure topped by two steel towers that look to be about fifty feet tall. Strung between the towers is a four-wire antenna.

The Hotel Glendale (located at the corner of East Broadway and Glendale Ave. in Glendale) had 160 rooms, offered a 50-cent lunch and a dollar dinner during the late 1920's. The slogan of this establishment was "Where the Beds are Soft."

This didn't last very long. By 1929 KGFH was gone, replaced by 1-kW station KPLA (which didn't last too long, either). In short order, KPLA moved to 1430 kHz and became KECA.

Indiana's First

Memories of Indiana's very first commercial broadcaster were sent in by James M. McAuliff of South Bend, and also Doug Wilkens (N3ENU), the Commercial Sound Marketing Manager of Electro-Voice in Buchanan, MI. Both passed along a well-researched newspaper story from a recent issue of the South Bend Tribune. Written by Tom Philipson, it tells the story of station WGAZ, the 10-watt ancestor of present day station WSBT.

WGAZ, in South Bend, went on the air July 3, 1922. Its frequency was 833 kHz,

and its facilities consisted of a wind-up phonograph standing in front of a microphone. All of this was located in the third-floor ballroom of the Tribune Building in South Bend. WGAZ was operated by reporters and other staff members of the Tribune in its early days. These people were mostly radio hobbyists and had formed a radio club.

By October of 1922, WGAZ was running 100 watts. In 1924, the station was rebuilt and two antenna towers were erected on the roof of the Tribune building. The callsign WGAZ (stood for World's Greatest Automotive Zone) was changed to WSBT (South Bend Tribune) in 1925, when the



Delores Dupont on the air over WGAY. "Live" studio musical entertainment isn't often heard over local independent stations, but WGAY was determined to be a success when it went on the air in 1946, the idea worked!

station moved to 952 kHz. In 1931, the Tribune purchased LaPorte, IN station WRAF and moved it to South Bend, calling it WFAM. With two stations in South Bend, the Tribune could expand its schedule. Day-timer WSBT (which had moved to 1090 kHz) was on during daylight hours; WFAM (1200 kHz) operated sunset to midnight.

Later in 1931, the WSBT/WFAM transmitting site was moved to Western Avenue in the Belleville area east of Mayflower Road. This vastly improved the signal and coverage of the stations.

When FM broadcasting arrived on the scene, the Tribune got its station WSBF on the air in 1943. WSBF was the early incarnation of station WSBT-FM.

In 1941, the Tribune's transmitting site was moved to Ironwood Road, near Ireland Road. That also marked the occasion of another frequency change, this time to 960 kHz, a channel that allowed fulltime operation. WFAM was then no longer needed and was dropped. The WSBT studios remained in the Tribune Building until 1956 when they were moved to a new Broadcast Center a few blocks away. The Tribune, today, is not directly affiliated with WSBT's broadcasting operations. A while back, WSBT, as well as the Tribune itself, came under the banner of Schurz Communications, which operates communications facilities in many areas of the country.

Presently, WSBT operates on 960 kHz with 5 kW.

WGAZ Reminded Us

All of this talk of WGAZ reminded us of a station that was assigned call letters only one letter away from the, but decades later. That was WGAY, one of the many stations that went on the air shortly after WWII. The story of WGAY's efforts to get itself on the air was told in *The Saturday Evening Post* of January 25th, 1947.

WGAY (1 kW, 1050 kHz), of Silver Spring, MD was the dream of two Army buddies who had known each other since their high school days. Joe Brechner and John Kluge had spent their spare time talking about the day when they'd be able to put a station on the air. They had no idea how complicated it would be to actually accomplish the feat—it involved engineers, surveys, accountants, lawyers, bureaucrats, permits, real estate agents, construction companies, and a seemingly limitless amount of money and equipment.

WGAY finally went on the air in 1946. There was the 325th AM construction permit granted by the FCC that year. With a total of only 1319 AM permits granted up to that date, in 1946 it represented almost 25% of all of the commercial AM broadcast stations since the industry began!

If you're passing through Silver Spring, tune to 1050 kHz and you'll still hear WGAY. It's been on the air for more than forty years. During wartime, GI's constantly build castles in the air. Mostly it's just idle talk intended to escape from reality. Few really



Two early DJC announcers, Conrad Stadler and Hans-Juergen Maraun.

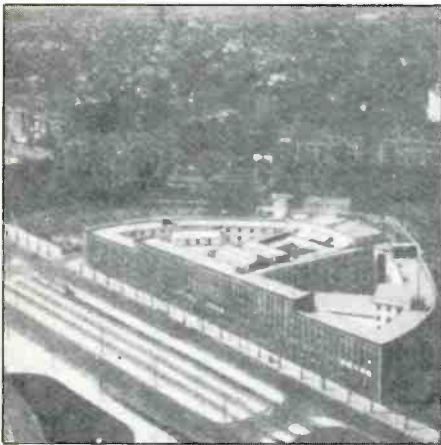

Broadcasting House, Berlin, nerve center of Hitler's broadcast propaganda activities.

expect that anything will ever come of those grandiose plans—the diner, the farm, the TV repair shop, the car wash, the fishing station, the recording studio, the rock band that will challenge the fame of the Beatles. Here was one of those plans that did actually come true, and was very successful! Thanks to Paul J. Barron, San Antonio, TX for bringing it to our attention!

Short Waves, Long Raves

The WWII broadcasting efforts of Nazi Germany became infamous textbook examples of radio propagand. But that nation's effective wartime broadcasting arm wasn't built-up overnight, it took years. These shortwave stations commenced operations on April 1, 1933, shortly after Adolf Hitler became Germany's leader.

Headquarters for the station was Broadcasting House, in Berlin. This imposing structure housed the studios for that station and also the Deutschlander and the Reichs-

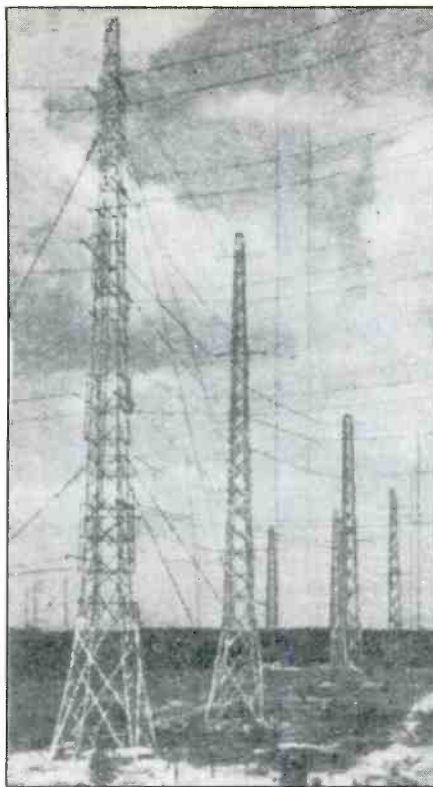

The DJC towers at Zeesen in pre-war days.

sender Berlin stations. The transmitters for Nazi Germany's radio voice were located in Zeesen, a village near Berlin. Overlooking Zeesen's Brandenburg firwoods loomed an enormous antenna farm containing directional antennas beamed towards North, Central and South America, Africa, Australia, and the Far East. The antenna system was so efficient that few listeners realized that the transmitters (in pre-WWII years) ran only 5 kW!

Usually the collective callsign DJC was used to describe this station, but in actuality, each of the station's frequencies had its own individual callsign. When the station opened for operation these were: DJA 9560 kHz, DJB 15200 kHz, DJC 6020 kHz, DJD 11760 kHz, DJE 17760 kHz, DJM 6079 kHz, DJN 9540 kHz, DJO 11795 kHz, DJP 11855 kHz, DJQ 15280 kHz, and DJR 15340 kHz.

Listeners in North America received the bulk of the pre-WWII programming and, in general, reported strong signals and excellent programming which (at that time) was political on a very subtle level and orchestrated to be especially appealing to German expatriates residing in the United States. Of course, as time went on and the late-1930's saw Hitler's military forces making a shambles of Europe, DJC's operations became an important part of that blitzkrieg.

This month we have photos of Broadcasting House in Berlin, some of the Zeesen antenna site, as well as two of the station's announcers.

Low Band VHF Arrives

Heralded in the mid-1930's as a techno-

HAM RADIO IS FUN!

It's even more fun for beginners now that they can operate voice and link computers just as soon as they obtain their Novice class license. You can talk to hams all over the world when conditions permit, then switch to a repeater for local coverage, perhaps using a transceiver in your car or handheld unit.



Your passport to ham radio adventure is TUNE-IN THE WORLD WITH HAM RADIO. The book tells what you need to know in order to pass your Novice exam. Two cassettes teach the code quickly and easily.

Enclosed is my check or money order for \$15.00 or charge my

() VISA () Mastercard () Am. Express

Signature _____

Acct. No. _____

Good from _____ Expires _____

Name _____

Address _____

City _____ State _____ Zip _____

THE AMERICAN RADIO RELAY LEAGUE
225 MAIN ST.
NEWINGTON, CT 06111

CIRCLE 19 ON READER SERVICE CARD

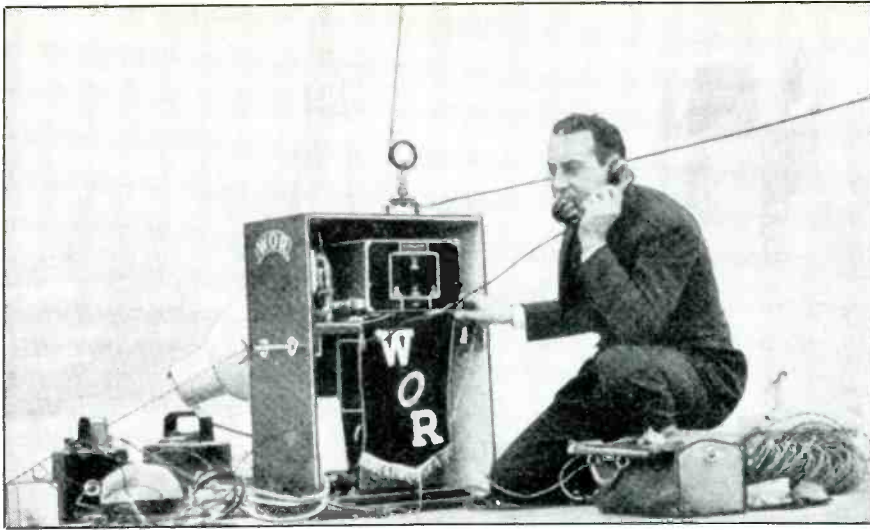

The 5-watt remote broadcast station used by WOR operated in the 30 MHz band, using an antenna that looked like a TV "rabbit ears" dipole. It did the job and got the drop on all other area stations with an important shipboard interview.

logical breakthrough, the practical two-way applications of what we now call the VHF low band were coming into their own. New York broadcast station WOR (710 kHz, 50 kW) wanted to offer its listeners the first interview with the city's mayor when he returned from a European vacation aboard a large ocean liner.

Realizing that other New York stations would have their reporters waiting on the pier when the *S.S. Manhattan* docked,

WOR had assembled a relatively compact battery-operated 5-watt portable station that was taken out to the ship and set up while the vessel was at quarantine prior to docking.

With another similar station located on the roof of WOR's studios, the station was able to interview the Big Apple's popular Mayor "Gentleman Jimmy" Walker ahead of everyone else. They even fed the interview out over the Mutual Broadcasting Sys-

tem network (CKLW, WCAE, WGAR, WGN, and WLW). For 1935, this was quite a feat!

Using a Western Electric type 18A transmitter and companion type 18 receiver, the portable station transmitted on 34.60 MHz and received on 37.60 MHz. The transmitter and receiver each measured 6" by 9" by 7" and had plate voltages supplied by a battery-driven dynamotor. One 6-volt storage battery supplied all of the power required for both pieces of equipment. These units were crystal controlled and could be operated between 30 and 42 MHz.

The transmitter used four type 306A tubes performing the functions of oscillator, harmonic generator, modulating amp, and audio amp. The receiver was a 7-tube superhet. This used two type 78 tubes, and one each of types 6A7, 79, 75, 41, and 6F7.

WOR permitted newspaper reporters to use these facilities to file their stories from aboard the ship. The other New York City broadcasters were the only ones left standing on the dock!

It's That Time

Again, it's a wrap for this month. If you have any olde tyme radio QSL's, photos, or that sort of material, why not send it along for use here? Rather than sending the originals of one-of-a-kind QSL cards or letters, you can submit good quality copies. We'll be looking forward to hearing from you! **PC**

Over 75,000 active amateurs in over 125 countries throughout the world read and enjoy a different kind of ham magazine every month. They read CQ.

It's more than just a magazine. It's an institution.

SUBSCRIBE TODAY!



CQ
The Radio Amateur's Journal
76 N. Broadway, Hicksville, NY 11801

Please send me CQ for Life 3 Years 2 Years 1 Year
 New Renewal Start with _____ issue

Name _____ Call _____
Street _____ State _____ Zip _____
City _____
Charge My Order To: Payment Enclosed \$ _____
 MasterCard VISA My account number is _____

<input type="checkbox"/>	1 year - 12 issues	\$18.00
<input type="checkbox"/>	2 years - 24 issues	\$35.00
<input type="checkbox"/>	3 years - 36 issues	\$52.00

(Save \$12.00)
(Save \$25.00)
(Save \$38.00)

FROM TOP-RATED PERFORMANCE COMES THE SMALLEST RADAR DETECTOR IN THE WORLD.

Introducing The Uniden RD9 XL

The legendary RD9 is one of the most widely acclaimed radar detectors on the market today. Now, this big performance comes in an even smaller package—the RD9 XL.

It's even more discreet. Yet, no less sensitive.

More than half the size of most other units, this detector packs enormous performance. Dual conversion superheterodyne technology. X & K Band sensitivity. Exclusive E.D.I.T.™ (Electronic Data Interference Terminator) circuitry, and much more.

Uniden's RD9 XL. The smallest in the world. From the world's leading manufacturer in personal communications.



The Choice of Professional
Golfer Jack Nicklaus.
Winner of 20 Major Championships.



uniden®
A New Generation of Communications

Small Talk

For more information about Uniden Radar Detectors, or any other Uniden products, write Uniden Corp. of America, Consumer Products Division, 6345 Castlaway Court, Indianapolis, IN 46250.



Broadcasting has come to many new places in Peru, such as the small town of Celendin in Cajamarca Department, which has had several stations in recent years.

Peruvian Pursuits

BY GERRY L. DEXTER

All of us have seen the pictures, on postcards, in travelogues: Macchu Picchu, the ancient lost city of the Incas, nestled high in the mists of the towering Andes. Even we, with our modern high-tech civilization, still find room for a little awe at what the Inca civilization achieved. And we all know at least a smattering of the story of the Spanish conquest and the Incas' downfall. So the seeds of curiosity are there within us. They need only a germinating agent.

That can occur late some night when you stumble across a Peruvian broadcaster with a better than usual signal, playing hour after hour of the haunting, almost mournful sounds of huayno music (preferably listened to with the receiver's illumination as the room's only light). The music seems an aural interpretation of the pictures we've seen.

Sometimes that's all it takes to implant the lure of Peru, the call of a long-gone empire—and create a lifelong infatuation with DX'ing Peru—a pursuit that is unmatched in shortwave broadcast DX'ing for its fascinations as well as its frustrations.

It is not an endeavor to be followed by the

impatient, or those seeking overnight success. One does not "do Peru" as though on one of those "If This Is Tuesday" tours. That is true both from a DX'ing standpoint and in actually visiting the country.

DX'ing Peru is an eternal game of hide and seek. New kids can and do join in without making themselves known. Others tire of the play and go home to dinner. We are left in a constant state of never really knowing everyone who is in the game at any one time. If Peruvian DX'ing were a race, there would be no finish line, only markers along the way.

Until eight or ten years ago Peru was much like any other country as far as DX was concerned. The broadcast activity was relatively stable. By exercising a reasonable amount of time and effort, one could expect to hear and QSL the great majority of the stations. Not that it was easy, mind you. It still required a lot of effort over a period of several years. But, if you made the effort, you could expect to eventually reach a point where you had perhaps only a handful of the really difficult ones left to log.

Then, during the late 1970's and 80's (and continuing today) things changed radically, producing a singular situation for Latin American DX aficionados. Peru began to encourage development of its northern area, and as population and cities and towns grew, radio stations began coming on the air. DX'ers were sent scurrying to maps to look up great new names like Celendin, Bambamarca, Cutervo and Huancabamba.

So far the story sounds like the DX'ers fondest dream—a romantic, historic land with a growing number of DX targets. True enough. But there was also the dark underbelly of nightmare.

The new stations were (and are) often rather rustic operations. A far cry, technically, from the BBC. A photo of the equipment at one of the earliest of the new stations, Radio Cotoruni, reveals something a lot less impressive than your stereo set! Transmitter powers are small as well, usually a kilowatt but often running in the 100 or 200 watt range. A couple are rated at but 12 or 15 watts and have been heard in the U.S.!

Even so, the DX'er can hardly expect to



Saqsaywaman, the famous Inca fortress near Cusco.

find signals from these stations banging into the shack. One can probably say with a fair degree of safety that only a handful of Peruvian outlets can be received in North America with anything approaching regularity and good strength. The truth is, though, at any one period there are between 50 and 70 active Peruvian shortwave broadcasters on the air!

This situation, needless to say, makes identifying stations often very difficult and sometimes impossible. Radio Cotoruni, mentioned earlier, is a classic example. In fact, no one ever *did* positively identify the station. Although its location was certain, some of the country's top DX'ers heard the station name in a variety of ways. It wasn't until a reception report reached the station and was verified that the actual name and correct spelling became known!

Change is the only constant in Peruvian DX'ing. Stations come on the air and they go off—sometimes for good, sometimes only for a while. Frequencies, names, locations, ownership fluctuate. As this is written Peruvian DX'ers are puzzling over whether the disappearance of Radio Frecuencia San Ignacio from 5800, and the appearance of Radio Nueva Cajamarca on that frequency is a name change, a move in location or what. Perhaps the most extreme case of identity crisis belongs to the now apparently inactive La Voz de Cochon, Radio Continental and Radio Andabamba, each at a different time! How does one stay up with this kind of situation when often the best we have to work with is just a sometimes signal, invariably weak and sometimes QRM'd?

The lifesaver is information that comes from closer to the scene of the action—a practice pioneered by DX'er Juan Carlos Codina when he was living in Lima a few years ago. Various other DX'ers who live in or around Peru, or DX'ers traveling in the country have taken up the slack so *Norteamericanos* remain fairly well informed. Another plus is the fact that many of the new Peruvians operate on odd, out-of-band frequencies where no other broadcasters exist. The presence of a Latin station on 4039

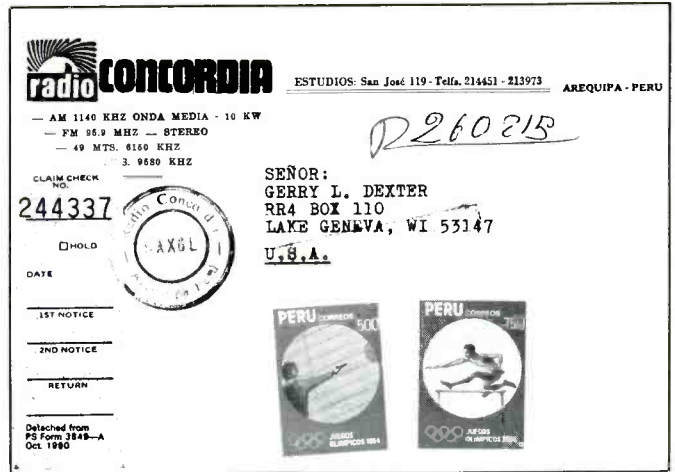

Hard won success—a letter from a Peruvian station appearing in your mailbox.

A Peru DX Starter Package

- 4459—Radio Norandina
- 4790—Radio Atlantida
- 4935—Radio Tropical
- 4996—Radio Andina
- 5010—Radio Eco
- 5030—Radio Los Andes
- 6011—Radio America
- 6115—Radio Union
- 6724—Radio Satellite
- 6791—Radio Sensacion

means it's likely to be Radio Marginal, assuming your info is fairly well up to date.

Another Peruvian problem is that sometimes a station won't even have a hometown. Like the traveling medicine shows of the Old West, the station will move from one town to another in the district or province, exhausting the advertising possibilities in one and then moving to the next, perhaps completing the circuit and ending up where it began. The stations, being minimal operations, can be loaded into the back of a truck and transported. The station might change its name when it changes location as well.

Some stations just can't make it economically; they go off the air. Sometimes the facility is purchased and moved to a new town. Some go silent due to a lack of spare parts and come back on only after the needed items have finally arrived. Occasionally the government will close down a station, as it did Radio El Porvenir (3950) some months ago.

But the government broadcast authority seems generally to be more lenient than it is tough. Many of the newer stations are operating without a license, although most have applied for one. But the process is so slow that stations with equipment ready and advertisers and audience waiting, figure that they've done their part and go on the air without call letters having been issued. That may explain the use of so many offbeat frequencies. Some Peruvian DX'ers maintain that the stations actually have tacit approval to begin operations once the formal-



Like other Latin American stations, some Peruvians have fabulous pennants.

ty of making application has been seen to. The theory being that the government recognizes the delays involved and also recognizes the importance of providing a broadcast service to the developing areas.

So what's the best way to go about building up a log of Peruvians heard? For starters: listen, listen, listen. Check every frequency listed as active as often as you can. Keep in mind that, in addition to reception in our evenings, Peruvian reception also occurs in the early morning hours around 1000 and 1100 UTC—normal sign-on times for most Peruvians. Indeed, reception during these hours is often better than in the evenings.

Sign-on times can vary quite a bit and

YOU AIN'T HEARD NOTHIN...YET!

THE 'TOP SECRET' REGISTRY OF U.S. GOVERNMENT RADIO FREQUENCIES

35 TO 470 MHz
BY TOM KNEITEL, K2ARS

6th Edition

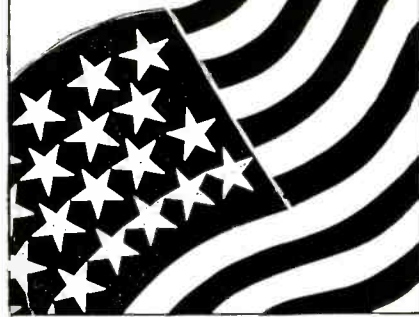

Since 1967, CRB Research has been the world's leading publisher and supplier of unique hobby and professional books and information including:

- Scanner Frequency Guides
- Shortwave Frequency Guides
- Military/Federal Communications
- Broadcast Station Registries
- Undercover Communications
- Survival Communications
- Covert Operations
- Electronic Espionage
- Surveillance
- Monitoring
- Cryptography & Codes
- Bugging
- Wiretapping
- Communications Antennas
- Electronics & Projects
- Fox Scanner Directories
- Computer Technology
- & Other Related Topics!

New titles are constantly being added to our exciting catalog. If it's interesting and unusual, we've got it. You'll see! Ask for our latest FREE catalog.

CRB RESEARCH

P.O. Box 56 Commack, NY 11725

CIRCLE 32 ON READER SERVICE CARD

Peruvian Shortwave Broadcasters

Freq.	Station	Location	Notes
3230	R. El Sol de los Andes	Juliaca, (Puno)	v. to 3229
3240	R. America	Lima	
3250	R. Qollosuyo	Juliaca (Puno)	possibly inactive
3260	LV de Oxapampa	Oxamampa (Pasco)	
3280	Emisora Huari	Ayacucho (Ayacucho)	
3290	Radio Tayabamba	Tayabamba (La Libertad)	
3310	R. Bagua	Bagua (Amazonas)	
3330	Ondas del Huallaga	Huanuco (Huanuco)	
3339	R. Altura	Chaupinamarca (Pasco)	
3499	R. America	Lima	
4005	R. Grau	Huancabamba (Piura)	often 4004
4025	R. Frecuencia Popular	Rioja (San Martin)	reported moved to 4010
4039	R. Marginal	Tocache (San Martin)	
4194	R. Uchiza	Uchiza (San Martin)	former R. Origenes
4300	R. Moderna	Celendin (Cajamarca)	
4459	R. Norandina	Celendin (Cajamarca)	
4519	R. El Puerto	Trujillo (La Libertad)	reported new
4607	R. Ayaviri	Melgar (Puno)	
4731	R. San Juan	Caraz (Ancash)	
4755	R. Huanta 200	Huanta (Ayacucho)	perhaps inactive
4760	R. Tingo Maria	Tingo Maria (Huanuco)	perhaps inactive
4762	R. Inca del Peru	Lima	
4775	R. Tarma	Tarma (Junin)	
4785	R. Cooperativa Satipo	Satipo (Junin)	
4790	R. Atlantida	Iquitos (Loreto)	one of most easily heard
4810	R. San Martin	Tarapoto (San Martin)	
4825	LV de la Selva	Iquitos (Loreto)	
4825	R. Moquegua	Moquegua (Moquegua)	probably inactive
4826	R. Sicuani	Sicuani (Cusco)	
4840	R. Andahuaylas	Andahuaylas (Apurimac)	
4850	R. La Peca	La Peca (Amazonas)	
4855	Radio Pampas	Pampas (Huancavelica)	
4860	R. Chinchaycocha	Junin (Junin)	
4885	R. Huancavelica	Huancavelica (Huancavelica)	
4890	Radiodifusora Huanta	Huanta (Ayacucho)	newly licensed
4895	R. Chanchamayo	La Merced (Junin)	
4910	R. Twantinsuyo	Cusco (Cusco)	
4919	R. Central	Bellavista (San Martin)	
4921	Ondas del Titicaca	Puno (Puno)	
4935	R. Tropical	Tarapoto (San Martin)	sometimes 4934
4941	R. Abancay	Abancay (Apurimac)	
4950	R. Madre de Dios	Puerto Maldonado (Madre de Dios)	sometimes 4951
4955	R. Cultural Amauta	Huanta (Ayacucho)	
4966	Radio San Miguel	Huanchac (Cusco)	
4970	Radio Imagen	Tarapoto (San Martin)	
4975	R. del pacifico	Lima	
4977	R. La Hora	Cusco (Cusco)	
4992	R. Ancash	Huaraz (Ancash)	
4996	R. Andina	Huancayo (Junin)	
5010	R. Eco	Iquitos (Loreto)	
5015	R. Moyobamba	Moyabamba (San Martin)	
5025	R. Quillabamba	Quillabamba (Cusco)	
5030	R. Los Andes	Huamachuco (La Libertad)	
5040	R. Libertad de Junin	Junin (Junin)	
5045	R. Rioja	Rioja (San Martin)	

sign-off times even more. On weekends, sign-off may be two hours later and sign-on an hour later. Evening reception may peak in the early evening, then drop and later come up again so it's a good idea to check frequencies more than once.

Frequencies often vary, at least slightly, even on the older, established stations. Radio Tropical, for example, will be found on 4934 as often as on its assigned 4935, Radio Ancash on 4992 instead of 4990. A receiver with digital frequency readout will be a definite plus in trying to tune in odd channels such as 5274 or 6791.

It's advantageous to pick out two or three

Peruvians which are received fairly often to use as "beacons"—indicators that can alert you to above average reception conditions by their stronger than usual signal strengths. The technique is a general one, by no means foolproof. Often there are "pocket areas" from which stations are being heard which your marker may not reflect. Or, your marker may be off the air, which is why it's a good idea to rely on two or three.

But all the monitoring you can fit into your schedule isn't going to do a whole lot of good if you don't have up-to-date information. The situation in Peruvian broadcasting is so fluid that some of the information can

Freq.	Station	Location	Notes
5060	R. Amazonas	Iquitos (Loreto)	probably inactive
5120	R. Mundo	Cusco (Cusco)	possibly inactive
5190	R. Nueva Continente	Cajamarca (Cajamarca)	
5235	R. San Antonio de Padua	Miraflores (Arequipa)	only 1000, 1700, 2300
5235	La Voz Catolica de America	San Antonio de Padua	
5270	R. Onda Popular	Bambamarca (Cajamarca)	listed here, currently 5274
5274	R. Onda Popular	Bambamarca (Cajamarca)	
5274	R. San Jaun de Chota	Chota (Cajamarca)	
5452	R. Vision	Juanjui (San Martin)	
5617	R. Ilucan		
5661	LV de Cutervo	Cutervo (Cajamarca)	
5724	R. Onda Popular	Bambamarca (Cajamarca)	
5800	R. Nueva Cajamarca	(Cajamarca)	see next listing
5800	R. Frecuencia San Ignacio	San Ignacio (Cajamarca)	both ID's heard, status uncertain
5816	LV de Altiplano	Puno (Puno)	
5950	R. Arequipa	Arequipa (Arequipa)	
5955	R. Huancayo	Huancayo (Junin)	
5970	R. El Sol	Lima	
5995	R. Melodia	Arequipa (Arequipa)	believed returned here from 6260
6011	R. America	Lima	
6020	R. Victoria	Lima	
6035	R. Landa	Arequipa (Arequipa)	reported returned to air
6045	R. Santa Rosa	Lima	
6055	R. Continental	Arequipa (Arequipa)	possibly inactive
6060	R. JSV	Huanaco (Huanuco)	possibly inactive
6115	R. Union	Lima	
6155	R. Pucallpa	Pucallpa (Loreto)	may be inactive
6175	R. Twantinsuyo	Cusco (Cusco)	
6190	R. Oriente	Yurimaguas (Loreto)	
6191	R. Cusco	Cusco (Cusco)	nominal 6195
6201	LV de Huamanga	Ayachucho (Ayachucho)	possibly inactive
6242	R. Municipal de Calca	Calca (Cusco)	
6272	R. Huayabamba	Mendoza (Amazonas)	possibly inactive
6281	R. Huancabamba	Huancabamba (Piura)	Possibly inactive
6297	R. Chota	Chota (Cajamarca)	
6324	Estacion C	Moyabamba (San Martin)	
6571	R. Tacna	Tacna (Tacna)	
6724	R. Satelite	Santa Cruz (Cajamarca)	
6791	R. Sensacion	Huancabamba (Piura)	
6815	R. Universo	(Cajamarca)	exact location uncertain
7010	R. Sudamerica	Celendin (Cajamarca)	ex-R. Frecuencia 7, inactive?
7315	R. Ondas del Oriente	Nueva Progreso (San Martin)	possibly inactive
7410	R. Senor de los Milagros	San Pablo (Cajamarca)	new
7435	R. Omega del Peru	Cajamarca (Cajamarca)	possibly inactive
8065	R. Paraiso de los Andes	unknown	
8515	R. Amistad	Soritor (San Martin)	
8929	R. Continente	Jaunjui (San Martin)	
9665	R. Norperuana	Chachapoyas (Amazonas)	
9988	Estacion 2000	Rioja (San Martin)	
10243	Futura la Radio	La Calzada (Moyobamba)	

Note: R = Radio, LV = La Voz. All frequencies should be considered slightly variable. Departments, the equivalent of states, listed in parenthesis.

be out of date by the time it reaches us, never mind the time it takes to get it published. The list you'll find here is as complete and accurate as we can make it, but if you are going to be serious about DX'ing Peru, you will have to keep it updated. Two clubs seem to provide the most information about Peruvian station changes in their bulletins. They are the North American SW Association, 45 Wildflower Rd., Levittown, PA 19057, information and sample bulletin \$1, and the Danish Shortwave Clubs International, Tavleager 31, DK-2670 Greve Strand, Denmark, sample bulletin \$3 via airmail.

It then becomes largely a matter of patience and persistence and, to a lesser degree, how well equipped your listening post is and whether you are operating with an indoor antenna in an apartment house or from a farm with lots of wire strung out—which is true no matter what DX you are seeking. You will soon find there is a big difference between hearing a station, i.e., picking up some kind of signal, and receiving it well enough to pick out various identification elements. Of course, if you understand Spanish you're a step ahead of the rest but even with a knowledge of Spanish it can still be tough. Think positive. If a station can make

it through in weak condition it's likely to come through stronger, sooner or later.

There are no bad times of the year for DX from Peru, but some periods, such as the Spring and Fall equinoxes, are better than others. Good reception from the Andes region often occurs in mid-Summer, when the static levels are at their worst.

On the QSL front, trying to get verifications out of Peru these days can be enough to make a grown man cry. Theories about the Peruvian economy, poor mail delivery (the old standby!), reluctance of still-unlicensed stations to QSL, and a growing dislike for North Americans are all advanced to explain the recent drop off. Whether any of those reasons are right or not doesn't change the fact that you should expect to work hard for the QSL's you get. Obviously, reporting in Spanish is a prerequisite. If you aren't equipped to do this we suggest you get a copy of the Spanish edition of *Language Lab—The Foreign Language Reporting Guide*, (\$13.95 with shipping, \$14.95 foreign, from Tiare Publications, P.O. Box 493, Lake Geneva, WI 53147).

Successful Peruvian DX'ing is not achieved without a lot of effort. A few DX'ers who have that special love for this particular game, have managed to hear and QSL well over 100 Peruvians! How much effort you put forth depends on how hard the bug has bitten. Many are never bitten at all, but for some, chasing the Peruvians is always number one on the list of things to do. Good luck!

SE SIGNAL ENGINEERING's
High Performance CB Antennas

SUPERHAWK
\$114.95

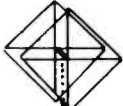

Goldenrod 45 Mobile Antenna



WHITE LIGHTNING
\$199.95

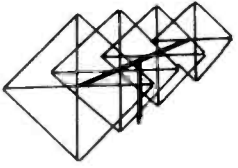

SPYDER A
\$35.95



LIGHTNING 6
\$359.95

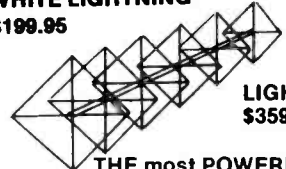

**THE most POWERFUL
CB base in the world today!**

All SE PATENTED rotary beams are true quads and OUTPERFORM their counter parts (quad/yagi types). SE's patented SFS matching system makes SE QUADS the most technologically advanced antennas in the world today.
If your dealer doesn't have SIGNAL ENGINEERING, write or call for full specs. DEALER inquiries invited.

SIGNAL ENGINEERING
2624 Fayette Drive, Mountain View, CA 94040
(415) 948-3833

Please send all reader inquiries directly.

Cable Installer Saves Woman From Dog Attack

Stan Johnson's common sense told him not to get involved when he saw a woman being attacked by two pit bull terriers. But he did get involved—and managed to rescue the woman.

"My common sense told me to stay away but my human nature told me to get involved," the 30-year-old Johnson told the *Roanoke Rapids (NC) Daily Herald*.

SCAN PUBLIC SERVICE AWARD

Johnson, a cable television installer, was driving by the Sunnysdale Trailer Court near Roanoke Rapids on his way to a service call when he heard a woman's cries and saw her on the ground in front of a trailer, struggling with two dogs. The woman, Margaret Ward, was trying to enter the trailer of a friend when the dogs, who were inside the trailer, attacked.

Johnson told the *Daily Herald* that he didn't have time to be frightened, and immediately grabbed a pair of coveralls and a 15-inch crescent wrench from his truck. "It was one of the situations where it freaked me out so bad that I didn't have time to be scared," Johnson said.



He pushed the coveralls into the faces of the dogs so they would let go of Ward and bite the material instead. The pit bull terriers then turned their attention away from the woman, allowing her to reach safety in her car. Johnson was able to get back to his truck safely.

"They tried to bite me several times but they never succeeded," Johnson told the *Daily Herald*. He added that he would have hit the dogs with the wrench if it became necessary.

Clarence Powell, owner of the trailer park, said that no one was home in the trailer when Ward tried to enter. When she

opened the door, the dogs, a female with seven puppies and a male, jumped out at her. There is a leash law for the trailer court, Powell said, and the owner of the dogs was not violating any law.

"However, I didn't know she had the female dog or the puppies," Powell said. "When she moved here last year, she said she had one dog, and she kept him in the trailer. The only other incident involving her dog occurred several months ago when a young boy approached the dog, which was chained up outside the trailer, and (the dog) snapped at him."

After her rescue from the dogs, Ward drove to Halifax Memorial Hospital where she was treated and released. The dogs were taken to the county pound, where they were kept for observation for rabies for 10 days.

"It was fortunate Johnson was passing by and could help," Powell told the *Daily Herald*. Johnson said that he was also glad he was able to help out. "It could have turned out much, much worse," he said.

For his fast thinking and timely rescue, Stan Johnson will receive the SCAN Public Service Award. The award consists of a special commendation plaque and a cash prize. For making the nomination, Darrell Taylor of Roanoke Rapids will also receive a plaque. Congratulations to both of you.

Best Equipped

Clarence J. Kerous of New Buffalo, Michigan, writes that he has been interested in radio communications for over 30 years, and he has collected quite a variety of equipment in that time.

Clarence uses a Regency HX-1200 scanner, Regency ACT-R-106, JIL SX-200, Midland 13-925 and Robyn hi-low bander for VHF/UHF monitoring. For shortwave listening, he uses a Yaesu FRG-7, Hallcrafters SX-100 and a Collins R-390A, which he describes as a "venerable old" unit.

A licensed Amateur operator (KX8N is his call), Clarence's Amateur gear includes a Yaesu FT-1012D, Yaesu FT-225, Yaesu FT-757 (which is also used for SWL'ing), Heathkit SB-110 for six meters, and Heath HR-1680 and HX-1681 twins for HF CW. He also uses a Robot model 70 and 80 for SSTV monitoring. Antennas include a

SCAN PHOTO CONTEST WINNERS

three-element beam for 10-15-20 meters, dipoles for 40-80-160 meters, and a 915-foot longwire for shortwave listening. Clarence also has the ubiquitous Commodore 64 computer and CP-1 interface.

Congratulations, Clarence!

Best Appearing

They say you can easily divide the world into cat lovers and cat haters. It seems that Dave Unkles of Woburn, MA, is in the first category.

The backdrop for his good-looking (and slightly perturbed) kitty includes an impressive array of listening equipment. He

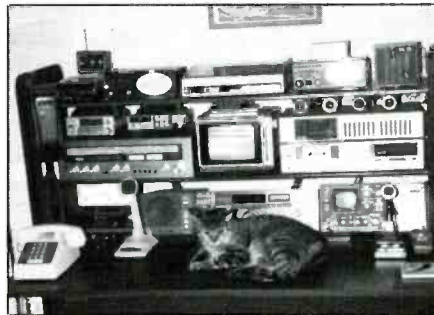

uses a Bearcat 800XLT scanner, Kenwood TS-940 Amateur transceiver (Dave is a licensed Amateur and is known as KC2LT on the Ham bands), Kenwood TW-4000 dual band VHF/UHF transceiver, and Tactec TAC-310 UHF transceiver. Dave also has his stereo equipment and a television monitor mounted in his shack.

While it is obvious that Dave enjoys a wide range of scanning and listening activities, what about the cat? Well, allow us to make a guess. What's the dog catcher's frequency in Woburn?



Winners in the Photo Contest this month receive the BMI "NiteLogger" tape recorder activator. Plugged into a cassette recorder and a scanner, it gives a complete record of all communications with no "dead time" on the tape. If you would like to enter the contest, just send a sharp black/white print to SCAN Photo Contest, P.O. Box 414, Western Springs, IL 60558.

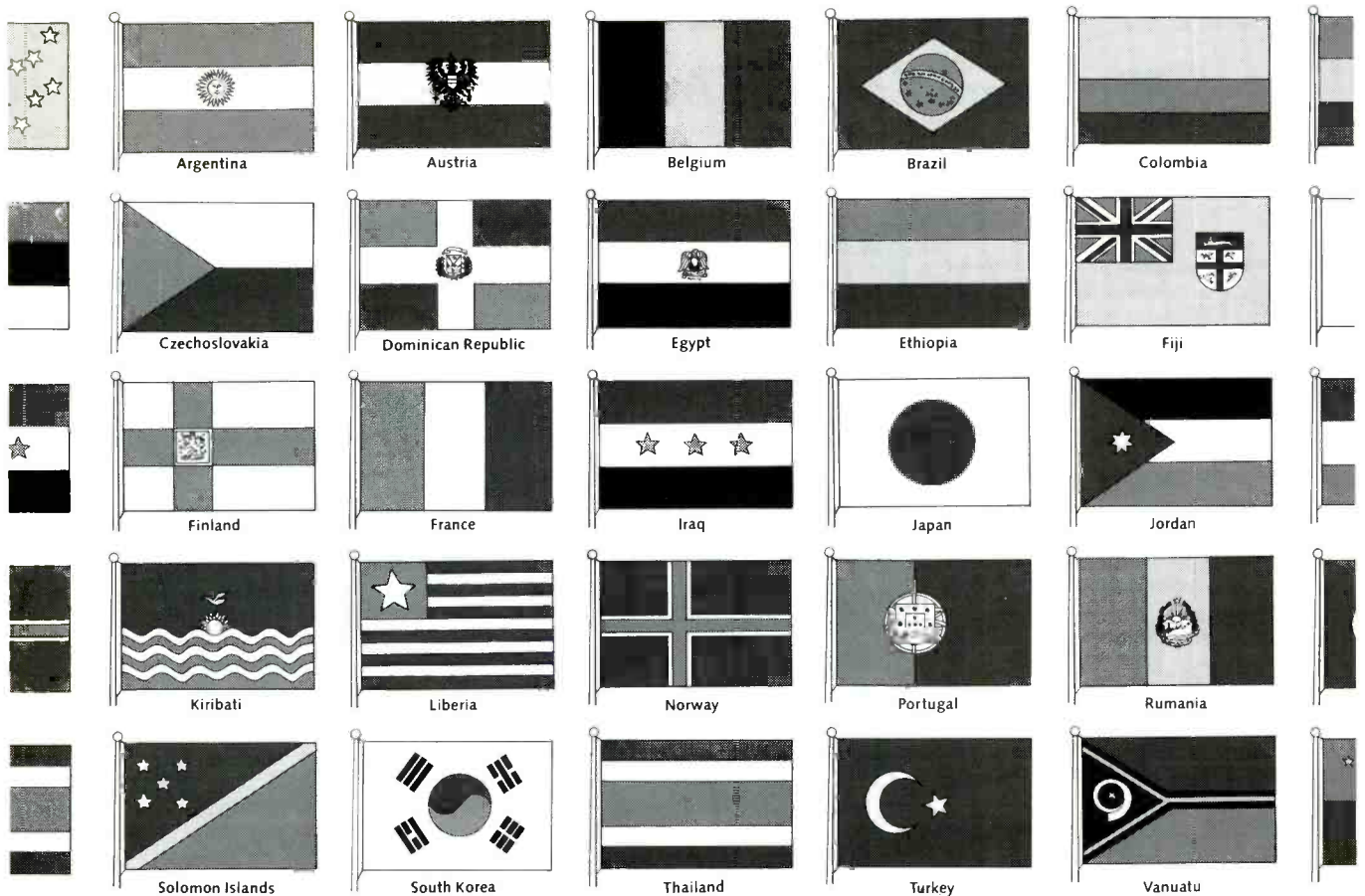

With a Sony World Band Radio, each country clearly has its own voice.

Sony presents synchronous detection circuitry so you can enjoy clear connections with less interference.

Synchronous detection circuitry is a tiny mechanism with global proportions. It locks onto the frequency you've chosen and travels with it, letting you clearly hear one country at a time, with less interference all of the time. Which means if you happen to be listening to Ping-Pong from Peking, São Paulo soccer shouldn't break in.

Inventing the transistor radio was just the beginning.

Thirty years ago, Sony put the world on its ear with the very first transistor radio. In 1967, Sony unveiled the world's first integrated circuit radio, and then made history again with the shortwave transistor. Ever since then, Sony has been fine-tuning world band radios with world-famous technological advancements.

Sony is the world leader that can put the whole world at your fingertips.

Only Sony has the kind of technology that lets you clearly listen to over 100 languages in 160 countries. Sony World Band Radio units around the

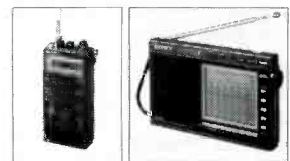
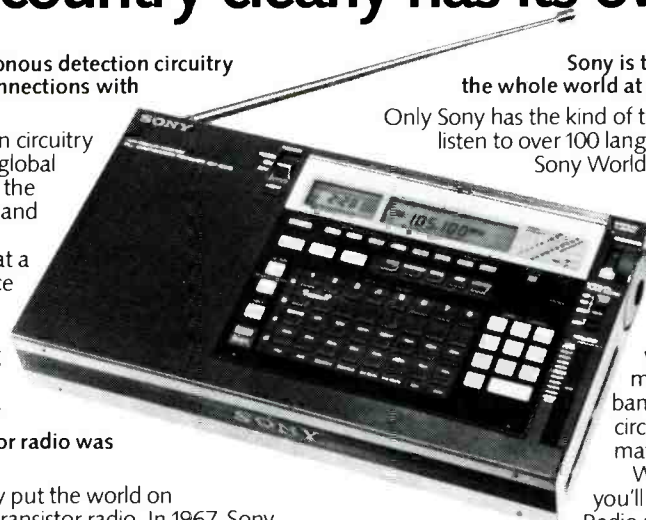

world are clearly receiving air, marine, longwave and shortwave bands, with synchronous detection circuitry, quartz tuning and automatic search and scan.

When it comes to globe-trotting, you'll find any of our five World Band Radio units handier than a passport.

And you'll also find that you understand what's being said around the world more clearly than ever before.

World Band Radio. SONY.
THE ONE AND ONLY.

© 1987 Sony Corporation of America. Sony, World Band Radio and The One and Only are trademarks of Sony. No endorsement by any country where flag is displayed is implied.

CIRCLE 38 ON READER SERVICE CARD

Life Flight To The Rescue

San Diego County's Aeromedical Service

BY BRIAN M. JOHNSON III

“Life Flight One, you’re on stand-by for a motor vehicle accident in the Spring Valley area.” The helicopter pilot-communicator replies, “Life Flight One, copy.” A large radio console at UCSD Life Flight Communications Center (the base station) springs into a flurry of activity. A dispatcher (communications coordinator) has received a phone call on the “hot line” from the San Diego County Sheriff’s Department. A sheriff’s ambulance requests that UCSD Medical Center’s Life Flight helicopter respond to a motor vehicle rollover in an area of the east county.

First responders to the scene are the sheriff’s ambulance crew who have now made the initial determination to put a call in for the aeromedical helicopter. In this case, the victim is near critical condition and it would take too long to transport via ground ambulance.

The helicopter crew has already assembled on the hospital’s helipad. Then, over the radio, comes word, “Life Flight One, respond to a one vehicle, single injury rollover in the Spring Valley area on State Route 94, two miles east of the Kenwood off-ramp.” The pilot-communicator responds, “Life Flight One, roger.” A whine of the ‘copter’s jet engine signals lift-off. The chopper is en route to the scene with a full complement of personnel including a flight nurse, paramedic assistant and a flight doctor.

During the late 1970’s, physicians at UCSD Medical Center in San Diego, California began dealing with the possibilities of an aeromedical transport system. One of the first programs in the country, at Denver, was born in October 1972. This was a hospital-based radio-dispatched helicopter transport system designed primarily for airlifting critically injured patients to a medical facility for immediate treatment. Many programs have been initiated since that time and today there are close to 170 aeromedical helicopters in service nationwide.

The UCSD Life Flight program began March 17, 1980 with only one helicopter. The main objective was to be able to transport a trauma patient to the hospital operating room within an hour. This hour is known as the “Golden Hour.” If an injured victim is twenty or more minutes away from a hospital trauma center, a call is usually placed for assistance from Life Flight. In San Diego County, if a victim is located in the Tecate area (on the U.S.-Mexico border), he or she would be at least forty-five minutes away from the closest hospital via ground ambulance. Also, in outlying areas, paramedic

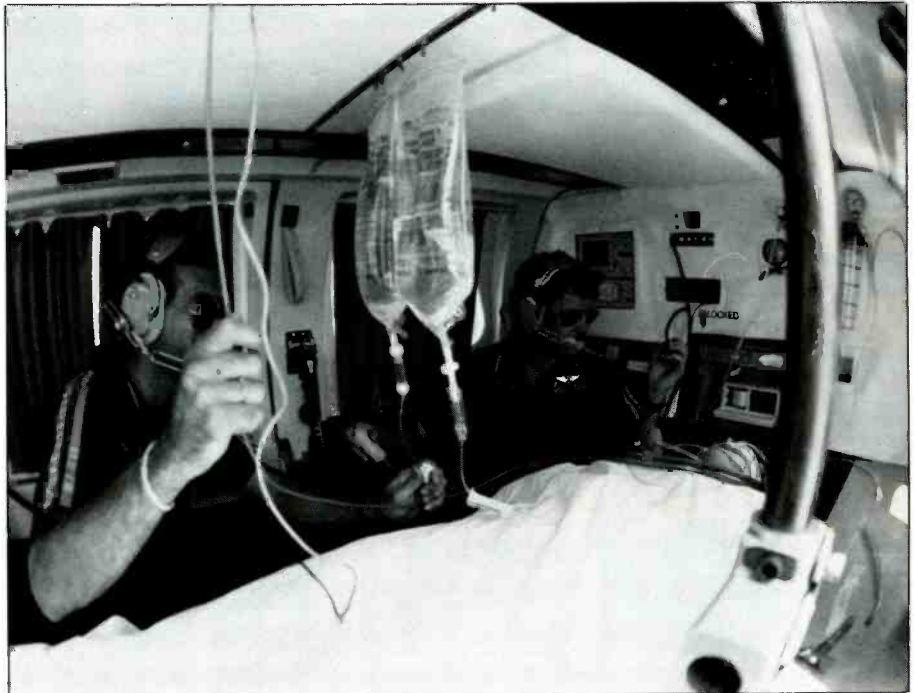

Life Flight paramedics keep victim in stable condition while en route to an area trauma center such as the UCSD Medical Center. There are six trauma centers in San Diego County. (Photo courtesy of UCSD Medical Center.)

service is scarce. The Life Flight program fills that gap by providing the highest level of care in the field. In this way, a physician and nurse can be in the field to help expedite delivery of critical patients to a nearby (in air miles) medical center.

Life Flight currently has three helicopters—two MBB-Bolkow Bo. 105s and one SA.319B Alouette III. One is stationed atop the UCSD Medical Center in San Diego. Another is based at the Palomar airport and can quickly respond to incidents in the north

section of the county. The third helicopter is based at Gillespie Field near El Cajon and is able to serve points in the east county. These helicopters make as many as 200 flights a month carrying patients to area trauma centers. Close to ninety-five percent of the flights are dispatched to accident scenes. The remainder of the flights are usually inter-hospital transfers.

Within San Diego County, the primary service area, Life Flight has lived up to expectations by lowering the mortality and

Frequencies for San Diego County Sheriff's Department

			<i>Callsigns</i>
Frequency 1	453.725	(Car to car)	KNCJ 404
Frequency 2	453.750	(North Coastal)	KNCJ 415
Frequency 3	453.925	(North Inland)	KNCJ 417
Frequency 4	453.500	(East and Desert)	KNCJ 416
Frequency 5	453.950	(Southern Area)	KNCJ 412
*Frequency 6	453.400	(Administration)	KNCJ 413
Frequency 7	453.575	(Inquiry Channel)	KNCJ 406
Frequency 8	453.100	(Emergency)	KNCJ 402
Frequency 9	453.425	(North Tactical)	KNCJ 401
Frequency 10	453.825	(Southern Tactical)	KNCJ 405

*This frequency is often used for regular traffic when one of the normal dispatch channels has an emergency involving sheriffs' units.

San Diego Area Fire Frequencies

155.085	<i>County Mutual Aid Channel</i>	
154.415	<i>South Bay Dispatch</i> (several communities) Bonita-Sunnyside Fire Protection District Chula Vista Fire Department Coronado Fire Department Imperial Beach Fire Department Lower Sweetwater Fire Protection District Montgomery Fire Protection District National City Fire Department	"South Bay"
154.205	<i>Central Dispatch</i> (several communities) Alpine Fire Protection District Bostonia Fire Protection District Crest Fire Protection District El Cajon Fire Department Lakeside Fire Protection District La Mesa Fire Department Lemon Grove Fire Department	"Heartland"
154.385	<i>North Coastal Dispatch</i> (several communities) Carlsbad Fire Department Del Mar Fire Department Encinitas Fire Protection District La Costa Fire Department Oceanside Fire Department	"Coastal"
154.235	<i>North Inland Dispatch</i> (several communities) Borrego Springs Fire Protection District Escondido Fire Department (Frequency 2) Fallbrook Fire Department Pauma Valley Volunteer Fire Department Ramona Fire Protection District	"Avocado"
154.175	<i>County Volunteer Fire Services</i> Campo Volunteer Fire Department Lake Morena Volunteer Fire Department Pine Valley Fire Protection District Rainbow Fire Protection District	"County Fire"
154.325	Escondido Fire Department (Frequency One)	
153.890	Fallbrook Fire Department (Tactical)	
46.460	Jacumba Volunteer Fire Department Lake Morena Volunteer Fire Department (Tactical) Lemon Grove Fire Department (Tactical) Rancho Sante Fe Fire Protection District (Tactical)	

Copy FAX Signals

with the FAX-1000
Facsimile Converter



- Allows you to print out facsimile photos and weather charts on your Epson graphics compatible dot matrix printer.
- Easily connects between your receiver and printer.
- Copies both AM (Satellite) and FM (HF) facsimile signals.
- Line mode for weather charts and gray scale mode for weather satellite pictures and press photos.
- Bargraph for precise tuning.
- Made in USA.

Order Yours Today Only \$299.00 (add \$5 shipping)

Send for Free Information

DGM

ELECTRONICS, INC.

901 Elmwood Ave.

Beloit, WI 53511 (608) 362-0410



Please send all reader inquiries directly.



A Life Flight crew is preparing to board their helicopter with an injured victim. Once in the air, their objective will be to get the patient to the hospital operating room within the hour. (Photo courtesy of USCD Medical Center.)

★★★★★PRESENTING★★★★★

CABLE TV DESCRAMBLERS

★★★★★ STARRING ★★★★★
JERROLD, HAMLIN, OAK
AND OTHER FAMOUS MANUFACTURERS

- FINEST WARRANTY PROGRAM AVAILABLE
 - LOWEST RETAIL/WHOLESALE PRICES IN U.S.
 - ORDERS SHIPPED FROM STOCK WITHIN 24 HOURS
- FOR FREE CATALOG ONLY 1-800-345-8927
FOR ALL INFORMATION 1-818-716-5914



PACIFIC CABLE CO. INC.
7325 1/2 RESEDA BLVD., DEPT. 1120
RESEDA, CA 91335



Free Catalog Features Hard-To-Find Electronic Tools

Page after page of hard-to-find electronic tools and test equipment. Also contains a complete line of tool kits and tool cases. Send for your **free** copy today!

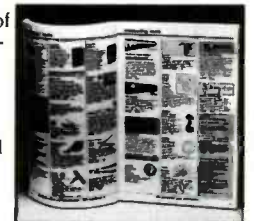

JENSEN TOOLS INC.

7815 S. 46th St. Phoenix, AZ 85044
(602) 968-6241

CIRCLE 20 ON READER SERVICE CARD

MED Channels In Use Throughout San Diego County

MED 1—463.000	Scripps Memorial Hospital—La Jolla	MED 5—463.100	San Diego County—Common Channel
MED 2—463.025	Mercy Hospital—San Diego	MED 6—463.125	Donald Sharp Hospital—San Diego
MED 3—463.050	Grossmont Hospital—La Mesa	MED 7—463.150	U.C.S.D. Medical Center—San Diego (Hillcrest)
MED 4—463.075	Paradise Valley Hospital—National City	MED 3—463.175	Bay General Hospital—Chula Vista
	Tri-City Hospital—Oceanside		Palomar Hospital—Escondido



Two trauma victims are being readied for transport aboard a Life Flight helicopter. This accident occurred on a busy stretch of Interstate Highway 8 in the eastern section of San Diego County. (Photo courtesy of UCSD Medical Center.)

morbidity rates considerably. Annually, this aeromedical transport service moves about 4,000 patients . . . most of them considered to be trauma cases.

The program, including its communications facilities, serves as an example for others throughout the state and in various sections of the nation. Recently, communications personnel from a similar program in Lubbock, Texas visited the Life Flight base station to obtain some first-hand ideas. In California, the Stanford Medical Center aeromedical service, the Cal-Star program and the Med-Star program have sent pilots, nurses and radio room personnel to train with the Life Flight program. In fact, all three aeromedical units have patterned their ef-

forts along the lines of the program at UCSD Medical Center. According to Life Flight Senior Communications Coordinator Richard M. Fletcher, "San Diego is one of the optimum programs . . . and a lot of people in aeromedical medicine try to move theirs to what we do."

The primary unit in the Life Flight Communications Center is the Motorola Centracom One, designed for two-way communications on one UHF channel and three VHF channels. The primary frequency for base and helicopter is MED 10 (462.975 MHz). A system of four repeaters spaced throughout the county enables base-to-copter communications anywhere within its boundaries. One repeater is located centrally, atop

the UCSD Medical Center in the Hillcrest area of San Diego. For communications in the east part of the county, two repeaters are located on Mount Los Pinos to the south, and on Monument Peak to the east. For communications in the county's northern areas, a repeater is situated on Mount Palomar. The Monument Peak repeater is also used to contact Life Flight helicopters operating in Imperial County.

Centracom One is also capable of transmitting on the UCSD Medical Center security channel (154.515 MHz). This frequency is used to alert and to communicate with hospital security agents anywhere in the eleven-story hospital complex. In addition, two hospital-to-ambulance channels (155.175 and 155.325 MHz) are available but are not in regular use by the communications center.

When communicating with area emergency ground units and other agencies such as law enforcement, the dispatchers stay tuned to a Uniden Bearcat 300 scanner monitor. This enables smooth communications down the line in many instances. Communications co-ordinator Fletcher says, "The dispatcher monitors the frequencies of the ground units that the Life Flight helicopter will be in contact with. If I hear Life Flight One calling the ground contact and the ground contact calling his base and saying he hasn't heard from Life Flight, to me, it means that either their private line (PL) is not on or we're not talking in direct communication with their frequency."

The Bearcat 300 is also handy when communicating with several agencies at a time during larger incidents. The Communications Center monitors all San Diego area fire frequencies and the police mutual aid channel called CLEMARS (154.920 MHz). Fletcher adds, "If one agency requests Life Flight, we can call that agency directly by phone to try and get the communications coordinated all the way around."

One other important piece of equipment in the communications center is the aircraft UNICOM radio. Dispatchers monitor 123.075, the helicopter common frequency, twenty-four hours a day. All aeromedical programs throughout the nation monitor this channel. It is most often referred to as ASHBEAMS which stands for the American Society of Hospital Based Emergency Aeromedical Services.

Direct telephone lines are hooked up in the communications center ("hot lines") for instant access to such agencies as the California Department of Forestry (CDF), Hartsons Ambulance base operations, San Diego County Sheriff's Department, San Diego City Fire dispatch, Inland Fire dispatch and Heartland Fire dispatch. The center can also

San Diego City Fire Department

Frequency 1 (Fire Dispatch)	154.310	KME 357
Frequency 2 (Data Transmit)	154.145	KLD 717
Frequency 3 (Paramedic Response)	153.785	WQS 487
Frequency 4 (Fireground)	154.430 (mobiles)	
Frequency 5 (White-Channel 1)	154.280	
Frequency 6 (Red Channel)	155.085	KTX 766
Frequency 7 (Fireground)		
(White-Channel 3)	154.295 (mobiles)	
Frequency 8 (Fire Response)	154.085	KNAO 535

Note: San Diego City Fire dispatches for the Poway Fire Protection District, and the Rincon Del Diablo Fire Department. San Diego City Fire and other county departments may use the following tactical operations frequencies: 154.250 East Tactical, 154.355 North Tactical 153.890 South Tactical.

Life Flight Pre-set Channels

Channel One	155.025	County EMS Channel	"Station X"
Channel Two	155.325	EMS ambulance to hospital (F1)	"Station X"
Channel Three	155.175	EMS ambulance to hospital (F2)	"Station A"
Channel Four	153.785	San Diego Fire (Paramedic Response)	
Channel Five	155.085	San Diego County Mutual Aid (Red channel)	
Channel Six	154.920	C.L.E.M.A.R.S. (Police Mutual Aid Channel)	
Channel Seven	154.250	County Fire (East Tactical Channel)	
Channel Eight	154.175	County Volunteer Fire Departments	
Channel Nine	154.415	South Bay Fire (Dispatch and Response)	
Channel Ten	155.685	San Diego Police Department (Tactical)	"Station A"
Channel Eleven	154.515	U.C.S.D. Medical Center (Security Channel)	
Channel Twelve	155.205	Hartsons Ambulance and East County Emergency Services	
Channel Thirteen	154.235	North Inland Fire (Dispatch and Response)	
Channel Fourteen	154.385	North Coastal Fire (Dispatch and Response)	
Channel Fifteen	154.280	Mutual Aid Fire Channel (White 1)	

All three Life Flight helicopters carry the Wolfsberg 500 radios. Fifteen channels are pre-set in these units. This is the list of frequencies currently programmed.

Motorola MT-500 portable handheld transceivers which may be used directly from the scene of an accident where paramedics are working to stabilize a patient before transport. The pilot often has to stay with the bird.

Seven dispatchers serve in the Life Flight Communication Center. Assisting with the program are about 25 paramedics, 20 nurses and numerous doctors. Eight pilots are provided by Evergreen Aviation (based out of the Los Angeles area) for two shifts. There are usually about three and a half pilots per helicopter depending on the shift requirements. Most pilots in the program are seasoned fliers who served in the Vietnam conflict. UCSD Medical Center has one of the highest requirement standards for aeromedical pilots in the nation. One pre-requisite is that pilots have at least 4,000 hours of flight time accrued.

When conversing with the communication center, to make situations safer and easier to understand, dispatchers and pilots do without the standard radio codes used by the police and other agencies. Communications are usually relayed via "clear text." Fletcher said, "We try to keep our communications as short as possible." This avoids the use of such codes as "ALPHA" and "BRAVO" types which could easily be confused by the pilots, who were used to hearing these kinds of communications in Vietnam. By the way, the whole concept of aeromedical helicopter service was initially developed in Korea in 1950 and later, in Vietnam.

PC

contact the sheriff's ASTREA helicopter to seek additional assistance. However, the sheriff's helicopter is primarily used for surveillance and rescue operations and is not equipped with the necessary features as those that are found in the larger helicopters in Life Flight's fleet. But, if there appears to be an overflow of emergency calls at the Life Flight base, UCSD will ask ASTREA if they can transport a patient from the accident scene.

The Life Flight Communications Center also utilizes other equipment including two television monitors—one to keep a 24-hour eye on the helipad and the other, to watch

the hospital's emergency room for security purposes. A traumatized patient may become violent while awaiting treatment in the emergency room.

Primary radios used in the three helicopters are Wolfsberg 500's which are capable of transmitting and receiving on fifteen pre-set channels (see frequency list). The PL (private line) is already burned in for all fifteen channels. The two Bolkow Bo. 105 'copters have a separate UHF radio for making contact on the Life Flight primary frequency. For this, the Alouette III helicopter uses a Motorola Converticom. Two members of the helicopter crew are provided with



Other Area Frequencies To Monitor

Ambulance Services		123.100	National Air Search and Rescue frequency
47.580	Schaefer Ambulance (San Diego)	122.900	Search and Rescue Multicom
155.160	American Ambulance (San Marcos)		
155.205	Hartsons Ambulance (San Diego County)		
155.220	Chalet Ambulance (Oceanside)		
	Schaefer Ambulance (La Mesa)	138.600	U.S. Government
	Tri-City Ambulance (Vista)	156.800	Marine Corps Fire and Ambulance (Camp Pendleton)
155.265	Aaron Ambulance (National City)	157.100	U.S. Coast Guard/Maritime Distress and Emergency (Ch. 16)
155.280	Bay Cities Ambulance (San Diego)	157.150	U.S. Coast Guard/Civilian Liaison (Ch. 22)
155.220	Goodhew Ambulance (Escondido)		U.S. Coast Guard/San Diego Primary and Coast Guard Air (Ch. 23)
155.325	Schaefer/Gold Cross Ambulance (Imperial County)		
Aircraft		153.995	Mutual Aid
118.300	San Diego Lindbergh Field (Tower)	155.475	San Diego County (Blue Channel)
119.200	San Diego Montgomery Field (Tower)		N.A.L.E.M.A.R.S. (Nationwide Mutual Aid frequency)
120.700	El Cajon Gillespie Field (Tower)		
119.600	San Diego Brown Field	42.880 (B)/42.660 (M)	California Highway Patrol
121.500	National Emergency frequency (ELTs)	42.120 (B)/42.200 (M)	San Diego
123.075	ASHBEAMS (Life Flight helicopters)/Heliport UNICOM	42.340 (B)/42.180 (M)	Oceanside and El Cajon
		154.905 (B/M)	Statewide and El Centro Extenders



BOOKS YOU'LL LIKE!

BY R. L. SLATTERY

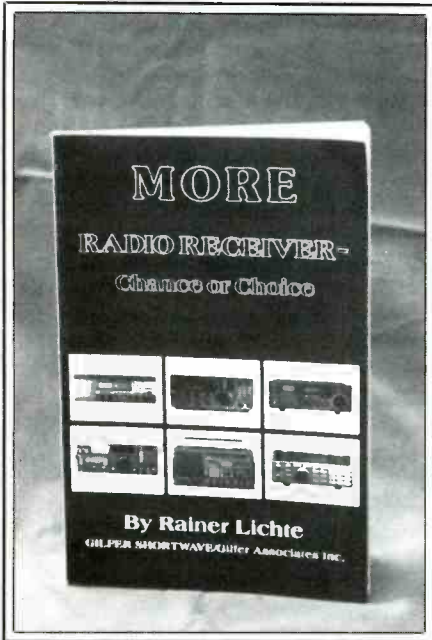

Testing 1 . . . 2 . . . 3 . . .

Rainer Lichte, whose book *Radio Receiver, Chance or Choice* made such a big hit last year, has struck again with a book probing the relative merits and any demerits of many of the newer communications receivers. Named, appropriately, *More Radio Receiver, Chance or Choice*, Lichte lays it on the line in this 96-page book.

The author has had twenty years' experience in military electronics, backed by a radio engineering degree. He puts this to good use in his probing bench tests and field tests of about fourteen popular receivers, each ending with his down-to-earth and candid opinions on individual features and the receiver as-a-whole. Lichte's text is supplemented with photos, specs, pictorials, block diagrams, charts and other aids.

Included in this volume are receivers such as the Grundig Satellit International 400 and Satellit 650, ICOM IC-R7000, JRC's NRD-525, Kenwood R-5000, Sony Air-8 scanner, Ten-Tech RX-235, Yaesu FRG-9600, and others. As you can see, this is a well-rounded selection of portable and base units, even including scanners.

If you're interested in knowing how your favorite piece of gear (or the one you're thinking of buying) stacks up when probed by a genuine expert, you'll find this a fine source of information. Lichte's opinions are objective without being hypercritical for the sole sake of appearing either witty or super-selective. Of a receiver that doesn't cut the mustard, he simply reports, "Contrary to

other opinions, I can not recommend this receiver for DX." On another piece of gear, he enthusiastically expounds that the set "is bound to become a collectors item . . . it also is an unbelievable attention getter."

Lichte knows his stuff, and appears to be at ease in talking in the language of his audience. The book is available at \$12.95 (plus \$2.00 postage/handling) from Gilfer Shortwave, 52 Park Avenue, Park Ridge, NJ 07656.

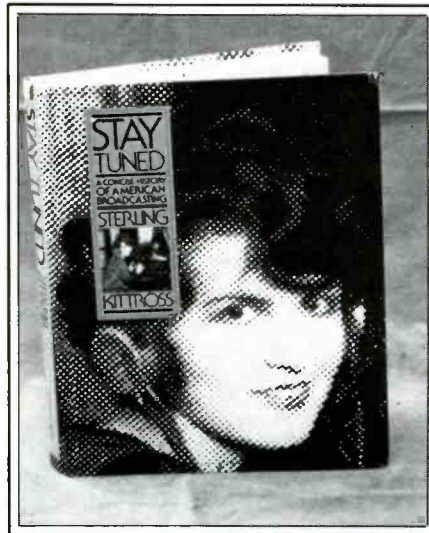

Stay Tuned

For the legions of radio history fans, the book *Stay Tuned: A Concise History of American Broadcasting*, by Christopher H. Sterling and John M. Kitross, should cause paroxysms of alternating joy and delight.

Sterling and Kitross are two college professors who undoubtedly created this massive 562-page hardcover volume as a college-level textbook. While it is easily suitable for such lofty purposes, it is equally suitable for non-academics who are looking for a very thorough and entertaining treatise on the beginnings and eventual growth of AM/FM/TV broadcasting in this nation.

It's one of the many excellent books that are created for a specific use (in this case, as a textbook), yet unfortunately too seldom encountered by the general public. We happened to hear about the book from a reader who mentioned that it was being used in one of his college courses.

This book covers the first broadcasts, the early stations, programs, personalities, regulations, problems, lawsuits, interference, patents, industrial giants, networks, frequency allocation matters, audience surveys, and pretty much everything else that is relevant. There are many historic photos,

numerous graphs, reproductions of early advertising, reproductions of scripts and important letters, and many other fascinating extras, topped off with a lengthy bibliography and a complete index.

There's especially fascinating detail on all aspects of broadcasting during WWII, including shortwave propaganda broadcasts and the early stirrings of the Voice of America. The section on the TV quiz-program scandals of the 1950's is a fine examination of the confused and confusing search for an adequate dividing line between ethics and entertainment. At the time of the scandals, it looked as though the sky was about to fall; today, in retrospect, it looks more humorous and tame than cause for the outrage and hysteria it generated. Same thing with the scandals that broke out when famous rock music DJ's were accused of taking payola from recording companies (also discussed in this book).

It's all there in Sterling and Kitross' book, *Stay Tuned, A Concise History of American Broadcasting*. This book costs \$31.25. It is published by the Wadsworth Publishing Co., Inc., 10 David Drive, Belmont, CA 94002.

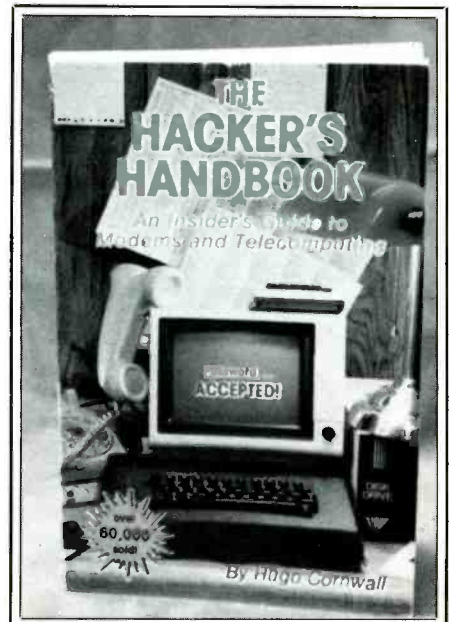

Hacking It In The World Of Computers

Hugo Cornwall's *The Hacker's Handbook* describes itself as "an insider's guide to modems and telecomputing." *Is it ever!* Here's a 168-page book that reveals a world of information on how to figure out passwords, protocols, access codes, operating systems, etc., of remote location computers.

The Hackers' Handbook provides telephone, programming, and hardware tricks for zeroing in on unlisted numbers, identifying and analyzing signals with *no physical phone tap!* The famous/infamous "salami," "trap door," and "Trojan Horse" techniques are meticulously explained. This edition delves deeply into shortwave radio hacking, then goes on to detail networking, packet switching, bulletin boards, Videotex systems, and plenty more.

The information-filled book includes charts, tables, and lists of bulletin boards, insights on equipment, how modems work, and lively inside tips and private tricks of the world's most adept and successful hackers. Inspired by the film *War Games*, many thousands of people have started to explore the possibilities of plugging their computers into telephone systems and dialing remote computers, not to cause World War III, but for the sheer challenge. Whether you're just getting started, or else are a hacker veteran, you'll find plenty to think about and do in Cornwall's informative book. If you operate a Local Area Network or bulletin board, you'll definitely want this book for security purposes.

The Hackers' Handbook is available at \$12.95 per copy, plus \$1 postage/handling to addresses in USA/Canada/APO/FPO, from CRB Research, P.O. Box 56, Com-mack, NY 11725.

OFFICIAL
MAINE
scanner guide

Police, Fire, Emergency & Much More
Robert A. Coburn, Editor
Steven C. Donnell

- State Police
- County Sheriff
- Local Government
- Ambulance
- Aircraft
- Security Agencies
- Police Radar
- Forestry Service Conservation
- Power Companies
- Amateur Radio
- Business Radio Service
- General Mobile Radio Service
- Ski Phones
- 800 MHz Business
- Marine Radio Service
- Railroads
- Hospitals
- Cordless Phones
- Highway
- National Weather Service



Alphabetical Listing by Community
Cross Reference Listing by Frequency and Call Sign

Cover Design By: © 1987 Coburn & Donnell

Our Maine Man

Bob Coburn, W1JJO, well-known as the compiler of the *Official New Hampshire Scanner Guide*, has come out with a 304-page *Official Maine Scanner Guide* that contains 7,500+ listings. The frequencies

are listed by each community, then followed by a master cross reference index by frequency, call sign and licensee name.

The *Official Maine Scanner Guide* also contains plenty of descriptions, frequency assignment/usage tables and data, and system maps. Included are all law enforcement agencies (state, county, local), fire departments, EMT units, security agencies, Ham repeaters, business licensees, GMRS, ski patrols, marine radio, hospitals, and much more, including all of those new 800 MHz systems that have generated so much interest of late.

About this time of the year, if you're located in Maine, the best way to wait out the next

few months is either on skis or seated near a fireplace monitoring the radio. A hot toddy will improve either activity, but Coburn's *Official Maine Scanner Guide* will substantially enhance the monitoring activities taking place. It's a well-prepared directory put together with insight and care by scanner fans Coburn, and Steve Donnell, WA1YKL, and several other monitoring enthusiasts who hang out in the northern climes.

This book is available from *Official Maine Scanner Guide*, P.O. Box 712, Londonderry, NH 03053. The price is \$14.95 per copy, plus \$2.05 shipping and handling. Bob's an avid *POP*COMM* reader, so be sure to tell him you read about it here! **PC**

THE SHORTWAVE PROPAGATION HANDBOOK Second Edition

George Jacobs, W3ASK
and
Theodore J. Cohen, N4XX

You have a receiver—you've got an antenna—now let the experts share with you the secrets of long-distance communications. Take advantage of signal propagation techniques. Whether you are tuned in with a scanner, a communications receiver, a Ham or CB rig, this is the vital information you need to have.

The all new revised 2nd edition of *The Shortwave Propagation Handbook* is here. Authors W3ASK and N4XX explore the whys and wherefores of how radio signals between 3 and 300 MHz travel over long distances under the influence of sunspots, the ionosphere, meteor trails, auroral ionization, sporadic-E, scatter phenomena, and other factors. Through fascinating text, amply supplemented by many charts, photos, and illustrations, you find out how to predict and use to your communications advantage the various types of skip openings—whether you're using a scanner to monitor the low or high VHF bands, an HF communications receiver or transceiver to pinpoint that hard-to-hear station, or are a 27 MHz operator or an Amateur operator looking for that rare country—the information in this book will tell you what you need to know so that you can take the fullest advantage of your communications facilities.

The all new 2nd edition of *The Shortwave Propagation Handbook* is only \$8.95, postpaid (sent by Book Rate Mail—allow time for delivery). Order now.

Popular Communications
76 N. Broadway, Hicksville, NY 11801

Please rush me my copy of the 2nd Edition of *The Shortwave Propagation Handbook*:

\$8.95 for the book plus \$2 for shipping & handling.

Name

Address

City State Zip

Mastercard VISA

My account number is:

--	--	--	--

CLANDESTINE COMMUNIQUE

WHAT'S NEW WITH THE CLANDESTINES

BY GERRY L. DEXTER

For three or four years now, clandestine hunters have been expecting the appearance of some kind of clandestine broadcasts aimed at Guatemala. There have been predictions, there have been rumors, but no action until this past May when a station identifying as La Voz Popular began transmitting on 6950.

The new station is the official voice of the National Guatemalan Revolutionary Unity (URNG) which, in turn, represents a collection of groups and political parties which oppose the present right-wing government in Guatemala City.

Information from URNG and its U.S. representatives, the Network in Solidarity with the People of Guatemala, indicates that the radio station had a "public initiation," a fact which URNG sees as a challenge to the Guatemalan army as well as proof of the URNG's strength. Broadcasts are "directed to the whole population in Guatemala" and give special attention to Nicaragua, El Salvador and International Solidarity, according to materials received from NISGUA. The programs are said to have special messages for different sectors of the Guatemalan population and international press and call for all to "continue struggling for a new Guatemalan society."

Reception of this new clandestine station is not very reliable and signal levels so far have been generally quite weak. The operating schedule is extremely limited—just one half hour per week at 0015-0045 UTC on Saturdays (Friday evenings local time in the North America). Although 6950 was used for the first few weeks, 6965 variable has been used more recently and it's possible, at this writing, that the station may be looking for a better frequency. Incidentally, the sign-on and sign-off times may vary by a minute or two.

Direction finding has placed the transmitter somewhere within a 40 mile by 19 mile ellipse along the Mexican-Guatemalan border (either side) in the mountains east of the small Mexican town of Motozintla de Mendosa. The station says it broadcasts "from someplace in the Sierra Madre Mountains, on shortwave at 41 meters, No. 7 on the radio dial."

If you are able to log La Voz Popular you can try sending a reception report to NISGUA, the Network in Solidarity with the People of Guatemala, 930 F Street NW, Suite 720, Washington, DC 20004.

The hodgepodge of voices clamoring for the overthrow of Iran's Khomeini has a new entry—The Voice of the Worker. This one is operated by the Iran Revolutionary Worker's Organization and operates on 4167 variable, which is the same frequency used by



Radio Freedom of the African National Congress receives financial and other support from groups in Holland.

the Voice of the Feda'i, another anti-Iran station. There appear to be two transmissions per day, one from 0300-0400 and another which may begin as early as 1500 and run to 1915 with the last 15 minutes made up of coded messages (numbers and letters) in Farsi. The new station went on the air about 15 June and seems to be another of the several communist-run anti-Iranians. It signs off with the "Internationale." Unfortunately, there's little chance it will be heard in the U.S. due to its frequency and schedule. Thanks to Finn Krone in Denmark and Jean-Jacques Bloch in France for the information.

A few months ago we discussed Radio Freedom, the broadcasts of the African National Congress. We can now, at last, report a QSL from this one. Mr. Don Ngubeni, Director of Radio Freedom, wrote confirming reception of the broadcast carried over the Voice of Revolutionary Ethiopia (9595) and

noted that Radio Freedom is also aired on government radio stations in Zambia, Angola, Tanzania and Madagascar. Radio Freedom can be contacted c/o the African National Congress, Department of Information and Publicity, P.O. Box 31791, Lusaka, Zambia.

The program aired on Gabon's Africa Number One, which we also mentioned a while back and which also seemed a Radio Freedom or variation, isn't really. This is a weekly program in French (plus some English) called "Ligne de Resistance" and although it effectively supports the ANC, it is not an official ANC program. Ligne de Resistance is aired at 1910 and 2000 on Saturdays on 15475. Africa No. One has not replied to a reception report on this broadcast.

Loggings: La Voz del CID is heard on 9940 during the evenings, 6305 around 0900, 11635 as early as 1228 and as late as 2355 and via Radio Clarin, 11700, around

2200, all by Robert L. McKenney, Jr., of Florida. Barbara Harris in Tennessee wonders about the location of CID's transmitters. The general consensus is Guatemala, based on direction-finding efforts.

Barbara heard Radio Nejet-e-Iran (now called Iran's Flag of Freedom Radio) on 9027 at 0400-0435.

Dave Bush in Ohio notes the Voice of Unity on 11490 at 0145 and on that frequency plus 12230 at 0215.

Bush also discovered the anti-Cuban La Voz de Alpha 66 on 6668 at 0123 and Radio Venceremos, or its clone, on 6555 at 0137 though it later popped up to 6560.

The puzzler, Radio Caiman, was heard by Harris on 9960 (no time given) and by McKenney on 7470 at 1335 and 0235—that was before the move to 9960.

Nicaraguan clandestine Radio Quince de Septiembre was noted by McKenney on 5950 at 1305. La Voz de la UNO was heard by him on 5890 at 0230. Harris heard a broadcast of the mediumwave Radio Liberacion on the 5890 frequency to 0300 sign-off, so perhaps UNO has a relay now.

Finally, McKenney spotted Radio SPLA on 11700 at 1300 in English with news about the Sudan People's Liberation Army, music and identification. (In case anyone is wondering, we still haven't made any progress towards a contact address on this one!)

That's all for this month. Please keep the clandestine news, loggings and associated information coming. We do appreciate your input.

PC

CB Thoroughbreds with winning credentials.

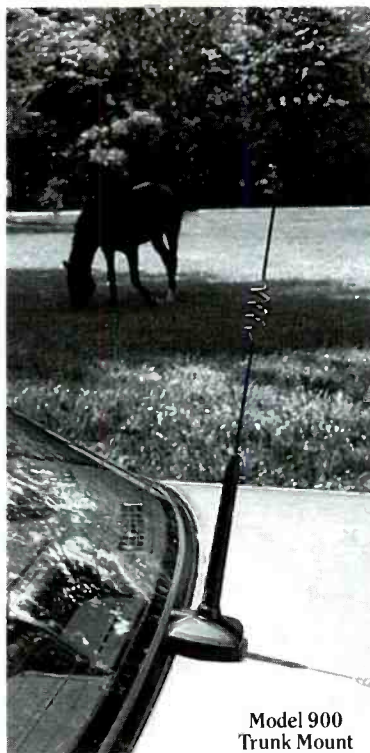

the  **Black Stallions™**

Sleek and spirited, the new A/S Black Stallion™ CB antennas have an unfair advantage over all other brands—the long, proud heritage of the most respected name in professional communication antennas. With the finest 17-7PH stainless steel whips, high-tech protective black DURA-COAT™ finish, and contemporary styling, these exceptional antennas have no peers for strength and beauty.

Now's the time to catch a Black Stallion for yourself. Send for your free 16-page "CB/Monitor Antennas" booklet today.



Model 900
Trunk Mount

Model 902
Trunk Mount

Model 904
Magnet Mount

Model 906
On-Glass®

the antenna specialists co.

A member of The Allen Group Inc.

30500 Bruce Industrial Parkway • Cleveland, OH 44139-3996 • 216/349-8400

© 1987 by The Antenna Specialists Co.



CIRCLE 152 ON READER SERVICE CARD

SHORTWAVE BARGAINS FROM THE WORLD RADIO MARKETPLACE

The 1988 Radio Database International • The "bible" of shortwave listening is here again with an all new, completely updated 1988 edition. It's the ultimate frequency guide. 400+ pages arranged by frequency for at-a-glance identification of everything on shortwave from 2 to 27 MHz. Includes Larry Magne's acclaimed Buyer's Guide to shortwave radios. **\$14.95 plus \$2.16 UPS.**



SAVE \$2.00! Now Accepting Pre-publication orders for the 1988 World Radio TV Handbook! Station names, addresses, schedules, and more. 42nd annual edition. Order now. Ships January, 1988. **Just \$17.95 plus \$2.39 UPS.**

Order now!

HAVEN'T RECEIVED ONE OF OUR MAILINGS AND WANT TO GET ON THE LIST? SEND US A POSTCARD WITH YOUR NAME AND ADDRESS.

The Phillips/Magnavox D2935 You saw it in the 1988 Radio Database International: "Best value in a portable." Full LW, AM and SW, coverage from 146-29999 kHz plus FM, large digital frequency display, pushbutton and manual tuning, 9 memories, switchable 2.7 kHz filter, clock and more. Now available for the first time in the US at the ridiculously low price of **just \$169.95 plus \$4.00 UPS.**



Latin American DXing • The ultimate booklet for serious Latin American DXers is available now! 293 pages of station schedules, verifications signers, station IDs, and fifty station profiles and articles. New 4th edition imported from Japan. **\$18.00 plus \$2.16 UPS.**



Get your Novice License with the ARRL's **Tune in the World Ham Radio Course!** Complete step-by-step guide book and tape makes taking that first step a snap. **Just \$15.00 plus \$2.16 UPS.**



The World on the Air • 75 minutes of pure bliss for the SWL! Stations IDs, interval signals and more from stations around the world—some no longer even on the air! Imported from Finland. **\$8.95 plus \$1.95 UPS.**



Latin America on the Air • More bliss for the SWL. Station IDs, interval signals, program excerpts and a handy guidebook. **\$9.95 plus \$1.95 UPS.**

Shortwave Listening with the Experts • 25 chapters of DXing information by some of the biggest names in the business. From getting started to the fine points of listening. Over 500 pages in a large format book. **\$21.95 plus \$2.39 UPS.**



Sangean ATS-801 • A quartz synthesized LCD frequency display portable for under a hundred bucks? Yep. And we've got it. AM, FM and 5800-15000 kHz SW coverage with hi-lo tone control, clock/timer and 5 kHz up/down tuning. List price: \$149.95 plus shipping. **Our price: \$98.95 plus \$3.25 UPS.**



The Eavesdropper Antenna • Rugged, completely assembled and ready to use 40 foot shortwave listener's dipole. Specially tuned trap circuits bring in the best reception for whatever band you're listening to. Rated "The best... built the way an antenna should be." 1987 Radio Database International. List: \$64.95 plus shipping. **Our price: \$59.95 plus \$2.62 UPS.**

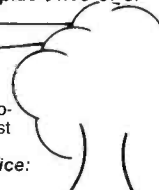

The Sloper Antenna • Just as good as the Eavesdropper but has better coverage of the tropical bands. 60 ft. long and ready to connect to your coax. List: \$69.95 plus shipping. **Our price: \$64.95 plus \$2.86 UPS.**

Panasonic RF-B60 • The perfect hi-tech shortwave portable. Continuous coverage in a sleek package. Includes pushbutton and manual tuning. LCD frequency display, clock, memories and more. **Our low price: \$229.95 plus \$4.00 UPS.**

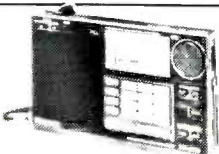

DX Smarter! You won't get far in DXing until you develop your language recognition skills! That's why we offer the **Listen and Learn Language** series. Home-study language courses complete with 90 minutes tape and convenient manual. Specify French, German, Italian, Japanese, Modern Greek, Modern Hebrew, Portuguese, Russian, Spanish or Swedish. **\$8.95 plus \$1.95 UPS.**



Shortwave Listening Handbook • A complete, easy-to-use introduction to shortwave listening by former **Pop Com** editor Harry Helms. Comprehensive and the best we've ever seen! **\$17.95 plus \$1.95 UPS**

Use your Mastercard or Visa and order Toll-Free: 1-800-323-1776, ext. For same-day shipping and questions about prices, inventory and technical information, call the warehouse direct: 215-383-1150. Or send your check or money order to: **Imprime, The World Radio Marketplace, P.O. Box 241, Radnor Station, Radnor, PA 19087.**

CIRCLE 33 ON READER SERVICE CARD

PIRATES DEN

BY EDWARD TEACH

FOCUS ON FREE RADIO BROADCASTING

You may never have heard of **Galaxy Radio** but once I tell you about it, you'll have to admit that this pirate is really a high flyer!

The operator of Galaxy Radio lives in Mississauga, Ontario, Canada, and his letter to *Pirates Den* oddly includes his full street address—but not his name!

Anyway, this pirate operator says that he builds his own shortwave transmitters, running powers of about one watt each. The broadcasts are then claimed to be made from the sky; transmitters attached to several helium-filled balloons! Also included in the payload is an auto-reverse cassette player with a pre-recorded program. The antennas are 72 feet of copper wire wound over a plastic pipe of about four feet in length.

Galaxy Radio has made several flights—using different names—and operates on either 6.49 or 12.8 MHz. Galaxy's operator has been able to monitor the broadcasts from his on the ground position for up to an hour and a half. But, unfortunately, he has no way of knowing how high the balloons carry the transmitter or how many miles distant.

Have any of you ever heard a broadcast from Galaxy Radio? I'm sure the operator would be interested in knowing, as would I. It certainly represents an inventive form of pirate radio broadcasting—if it's all true!

David Glow of Townsend, MA is an SWL as well as a Ham (KB1ZK) and is looking for information about the ships used for a couple of the European pirate broadcasters of years past. Specifically, the *Mebo II* used by **Radio Nordsee International** and the *Norderney* used by **Radio Veronica**. He needs data about the type of vessel, length, the year each was built and anything else he can learn about the history of the ships.

Well, David, I can tell you that the *Mebo II*, previous to its use as a radio ship, was the freighter *Silvretta* and belonged to a Swiss shipping firm. See *POP'COMM's* October '87 issue for more details. All I can add is that after the demise of Radio Nordsee International the ship was purchased by Libya and it then aired the Libyan government's broadcasts on a test basis for a few months. Eventually, though, this usage was discontinued and I have no idea what happened to the ship after that.

It was good to hear again from Minnesota's Mace Twiggs this month. Mace has to be one of the most successful pirate DX'ers around. His log shows receptions of over 100 pirate broadcasts from some 30 to 40 different stations. I suppose you could question this number because of the tendency of some pirates to relay the broadcasts of others while not always specifying who is who. Mace graciously offers to share some of the



Galaxy Radio is airborne and ready for another broadcast!

QSL's and other materials he's received from pirates. I can only say, Mace, that anything you care to send would be very welcome. I'm sure the readers would enjoy seeing some of this material featured in the months ahead.

Mace says he had a logging of **WDOG**, 0351 to 0401, sign-off on 7475. Programs were oldies music and ID's as "WDOG." *POP'COMM's* address was given for QSL's before going off in mid-song at 0401. (But we don't forward or confirm pirate station reception reports, we file 'em!) Mace would like his reception QSL'd. His address is Rt. 3, Box 1300, Crosby, MN 56441.

Mace also had a tentative logging of **Radio North Coast International** at 0354-0404 on 1622 kHz. No ID was noted but the Hilo, Hawaii mail drop address was given for reports. Mace says the announcer sounded like The Captain featured on North Coast International.

Bradley C. Lucken sends along copies of his reception report on the **Voice of Tomorrow**, heard on 7410 from 0054 to 0106. The program included talk about someone held in an asylum and the station's special brand of political philosophy. They played "Conquistador," then the drumbeats, with the wolf-call interval signal at sign-off.

Michelle Shute of Pensacola, Florida heard the station at 0015 on 7411. The station had a talk on some aspect of the Civil War and also made a request for speeches and music on record, cassettes or reel to reel tape to be sent in. An address of P.O. Box 20039, Ferndale, MI 48220 was announced. Note that Bradley addressed his reports to P.O. Box 786, Bristol, VA 24203, so the station may be using two different addresses.

Jay Rosen in Floral Park, NY hears a stereo FM pirate in his area. **WFPR** operates from 6 to 9 p.m. Eastern time on Sunday evenings using 92 MHz. The format is album rock and the announcer identifies himself simply as "Joe." Jay says he has also heard the station during the same time period on other evenings but those days are variable.

That takes me to the bottom of the basket for this month. I hope you'll send along logs on any pirates you happen to catch on the air—whether mediumwave, shortwave, FM or even the occasional TV pirate! Pirate news, information and clippings are also welcome and pirate operators are urged to keep this column up to date on activities. The pirate radio fans who read this column are interested in your station so why not fill all of us in on your past, present and future.



Introducing scanners from the name that needs no introduction.

Cobra.

You've seen it on state-of-the-art CB radios, radar detectors, corded and cordless telephones and answering systems.

And now, Cobra excellence in personal communications systems comes to scanners.

With not just one model. But four different units, all equipped with the latest in user-friendly features including crystal-free, multi-band electronic digital tuning.

No matter which model your customers select, the top-of-the-line hand-held SR-12 with 16 programmable channels or the 10-channel SR-10; Cobra's premium desk-top SR-925 with 16 channels or the SR-900—they'll be getting the very same Cobra quality and service that comes from 25 years in personal consumer electronics.

Contact your Cobra distributor or Cobra directly.

And get all the scoop much too long to scan here.



CIRCLE 12 ON READER SERVICE CARD

Cobra Consumer Electronics Group, 6500 W. Cortland, Chicago, IL 60635



SHORTWAVE HEADQUARTERS

Our 17th Year! Order Toll Free 800-368-3270
EEB—The Nation's Leading SWL Supplier



SMALL PORTABLES

DIPLOMAT 4950 \$99.95 VALUE
INTRODUCTORY PRICE
\$69.95
\$4.00 UPS

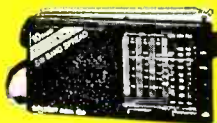

The perfect radio for the person on the go!

- Medium wave AM 550-1670 kHz.
- FM 88 to 108 with stereo head set out.
- Shortwave 2.3 to 5 MHz continuous 120, 90, 75 and 60 meter bands (not covered by Sony ICF 4910) and 49, 41, 31, 25, 19, 16 and 13 meter band each expanded for easy tuning.

"AC Adapter Optional \$9.95 (SPA4.5)"



SONY ICF-4920
\$99.95
+ \$4.00 UPS
LIST \$129.95!

- FM & AM
- Seven Short Wave Bands!
- FREE earphone, carrying case & shortwave guide.
- OPTIONAL AC Adapter AC-39 \$14.94

SANGEAN ATS-801

\$99.95
+ \$4.00 UPS
LIST \$199.95



- SW 5.8-15.5 MHz FM 88-108 MHz
- LW 155-281 MW530-1620 kHz
- 25 Program Memories
- Digital Frequency & Clock Readout
- Manual or Autotone
- Same Weight and Size as SONY ICF 2002
- Free 100 Page SWL Book

Optional A.C. Adapter SPA-6 \$9.95

DXers Dream

TOSHIBA RP-F11

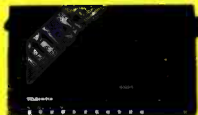

- Covers all International & Tropical Bands
- S Meter, Safety Off Lock

SAVE \$40.00 SALE \$79.95

"One of the finest receivers available under \$130.00"
List \$129.95 **\$4.00 UPS**
Optional AC wall adapter TAC 64 \$11.95

SONY ICF 2003

\$4.00 UPS

- Ultimate compact HiTech at an affordable price
- 25% size of famous SONY ICF 2001, SONY's best seller
- 150 kHz - 30 MHz
- AM, FM
- Memories
- Keyboard entry
- Scan
- 24 hour clock



Sale Price **\$239.95** A.C. Adapter SPA6...\$9.95

DATA BASE INTERNATIONAL
1987 Edition \$9.95

- Up-to-date Picture of SW Broadcasting.
- Frequency by Frequency, Hour by Hour.
- Station Name, Location, Frequency, Time, Language, Target Area, Power.
- Innovative Computer Display. Makes Easy Reading of Complex Information.
- In-depth Equipment Review.



NOW while supplies last \$9.95 + \$1.95 UPS

LARGER PORTABLES

EEB 2020

NEWEST HIGH TECH RECEIVER

\$299.95 VALUE
INTRODUCTORY PRICED

\$179.95 \$6.00 UPS

- High stability for good CW-SSB-RTTY reception.
- AM button allows full coverage of 150 kHz to 30 MHz.
- FM button allows full coverage of 88-108 MHz.
- Multimode AM-FM-CW-SSB allow full coverage of commercial traffic, Amateur, aircraft, ship at sea, & more!
- 9 programmable memories.
- Same size & weight as SONY ICF 2010.



FREE
AC Adapter &
Radio Stand
Mention this AD
(\$24.90 value)

FREE ONE YEAR WARRANTY!

SONY ICF 2010

FREE RADIO STAND
(\$9.95 value)

- 150 kHz to 30 MHz, AM, CW, SSB
- 76 MHz to 108 MHz FM
- 116 MHz to 136 MHz AM Air Band
- 32 Programmable Memories
- 4 Event Timer
- Synchronous Detector
- Wide/Narrow Bandwidth

\$6.00 UPS



IN STOCK!

"This is one of the finest receivers available today under \$500."

A.C. Adapter Included **Sale Price \$329.95**

DESK TOP RADIOS

R-2000
KENWOOD
\$499.95
\$8.00 UPS



Kenwood offers a communication receiver to suit your listening pleasure. It covers the full spectrum: Long, Medium, and Shortwave. AM-CW-SSB-FM Wide-Narrow Selectivity, Noise Blanker, and more.

VHF Converter (VC-10) \$149.95

YAESU FRG-8800

\$619.95
+ \$8.00 UPS

150 KHZ-30 MHz



- CAT computer compatible
- 12 memories—scan—RIT
- Keyboard frequency entry
- Dual 24 hour clock timer recorder control
- Optional FRV8800 VHF converter 118-174 MHz \$119
- All mode AM-SSB-CW-FM
- Green LCD display
- 150 KHz to 30 MHz

KENWOOD R-5000

\$749.95
\$8.00 UPS



All-Band All-Mode Receiver Covers
100 kHz-30 MHz (108-174 MHz with VC-20 option)

- 100 Memory Channels
- Direct Keyboard Frequency Entry
- Programmable Scanning (Center-Stop Tuning)
- Computer Control Option
- Built-In Power Supply
- Many More Options Available.

Special Introductory Price...\$749.95
VC-20 Option...\$169.95 **Service manual order: SMR5000 price: \$25.00**

DESK TOP CONT.

ICOM R71A **\$799.00**



- 100 kHz to 30 MHz • Keyboard entry
- 32 programmable memories • SSB-CW-AM-RTTY (FM optional) • Wide dynamic range
- Digital PLL • Memory scan • Band pass & notch tuning • Computer control via MEC 71A & C64 • See ICOM's ads for more details

ICOM Options Free installation when purchased with your R71A from EEB

- CK-70: DC Kit for 13.8 VDC operation
- CR-64: High stability oscillator
- EX309: Computer interface connector
- EX310: Voice synthesizer
- FL32A: CW narrow filter (500 Hz)
- FL44A: Crystal filter (2.4 KHz)
- FL63A: CW narrower filter (250 Hz)
- RC-11: Infrared remote control

Service Manual SMR71A \$25.00 + \$4.00 UPS

EEB HP Options

R71 (HP) High Performance. EEB has the reputation of excellence when it comes to R71A modifications. Many of our modifications are proprietary and not offered by any other source. EEB now offers a package deal including our most popular option—known as the R71(HP) High Performance and includes the following:

- 24 hour bench test.
- Narrow filter (choice of 3, see below). Replaces stock ceramic SSB filter. Improved selectivity and shape factor.
- Front end upgrade—improves dynamic range (plus) preamp enabled below 1600 KHz.
- 4 KHz filter replaces stock. 6 KHz wide filter—improves AM selectivity.
- Audio output modification—increases audio output; reduces distortion.
- AGC time constant changed to better suit SW listening.
- Spike protection added.
- RFI line filter.
- Installation of ICOM options purchased with your R71A HP.
- Final alignment and overall checkout.
- Free extended 6 month warranty.
- R71HP (MF) Mechanical Filter add \$200
- R71HP (XF) 8 Pole, 2.4 KHz xtal filter add \$250
- R71HP (XFS) Super 2.1 KHz filter add \$300

NRD-525 General Coverage Receiver

- 90 kHz to 34 MHz
- Options for 34-60 MHz, 114-174 MHz and 423-456 MHz
- 200 Memory Channels
- 2 Clocks/Timer To Control Radio & Extra Equipment (tape recorder)
- Computer Interface Option.



\$8.00
Sale Price UPS
\$1179.00

IBS WHITE PAPER

Larry Magne - a name you can trust - 'speaks out' with detailed test reports. Know the facts before you buy!

- RD2: ICOM ICR71A
- RD3: KENWOOD R5000
- RD4: HOW TO Interpret Specifications
- RD5: JAPAN RADIO NRD 525
- RD6: YAESU FRG8800
- RD7: LOWE HF125
- RD8: SWL ANTENNAS
- RD9: SONY ICF2010

\$12.00 FOR 3 + \$1.95 POST

NEW

ORDER DESK HOURS (Eastern):
MONDAY-FRIDAY 10 A.M. to 5 P.M.
SATURDAY 10 A.M. to 4 P.M.
 Technical and VA orders call (703) 938-3350

Electronic Equipment Bank
 516 Mill Street N.E., Vienna, VA 22180
 Telephone (703) 938-3350

STORE HOURS (Eastern):
 Same as Order Desk Hours
 Closed Mondays
 Thursday 10 A.M. to 9 P.M.

Electronic Equipment Bank—Order Toll Free 800-368-3270

VHF - UHF

SCANNERS CONT.

NEW FROM EEB

YAESU FRG9600 60-905 MHz

 Service manual order: SM9600 price: \$25.00
\$499.95

A premium VHF/UHF scanning communications receiver.
 + \$7.00 UPS
 • You won't miss any local action with continuous coverage from 60 to 905 MHz.
 • You have more operating modes to listen in on: upper or lower sideband—CW, AM wide or narrow, and FM wide or narrow.
 • Plus there's much more, including a 24-hour clock, multiplexed output, LCD readout, signal strength graph, and an AC power adaptor.

OPTIONS: FIF-232C for RS232 compatible computers; \$69.95. VU-9600 for tuning in TV stations with your 9600 and video monitor, \$25.00. 99 memories.

ICOM R-7000
\$949.00
 + \$10.00 UPS

Commercial Receiver VHF-UHF 25-2000 MHz Service manual order: SMICR7000 price: \$25.00
 • 25-2000 MHz coverage
 • Precise frequency entry via keyboard
 • 96 programmable memories
 • Scan-memory-mode-select memory-frequency
 • 5 tuning speeds: 1, 1.0, 5, 10, 12.5, 25 KHz
 • Narrow/wide filter selection
 • Memory back-up • Noise blanker
 • "S" meter or center meter for FM
 • AM & FM wide, FM narrow, SSB, CW

EEB HP OPTIONS

1. Front end upgrade improves sensitivity.
2. Audio mod for better volume, less distortion.
3. Spike protection on AC line.
4. 24 hour bench test, Final alignment & overall checkout. Numbers 1 through 4 above for \$200.00
5. Power Supply mod: A completely new power supply reduces the heat buildup & lowers the noise floor for longer component life and increased sensitivity. Price is \$150.00.
6. Multiplex output mod for SCA and Subcarrier Analysis. Price: \$50.00

SCANNERS

RADIO SHACK!
PRO 31A
 Handheld 10 channels, \$189.95 + \$4.00 UPS
PRO 32A
 Handheld 200 Channels, \$289.95 + \$4.00 UPS
PRO 2021
 Tabletop/Mobile 200 Channels,
 \$279.95 + \$6.00 UPS
PRO 2004
 Tabletop 300 Channels, \$379.95 + \$6.00 UPS

SPECIAL SALE LIMITED QUANTITIES
J.I.L. SX-200 SX-400
 • 26-88, 108-180, 380-512 MHz • 26 - 520 MHz
 • 16 Memory Channels • 20 Memories
 • Table/Mobile • 13.8 VDC • Converters for up 1.4 GHz - call
 • Dual Scan Speed • AM, FM
 • Metal case • DX Local switch
\$599.95
 \$199.95 + \$6.00 UPS \$4.00 UPS

AR2002 SCANNER
 • 25 MHz to 550 MHz & 800 MHz to 1300 MHz
 • FM (wide & narrow) and AM
 • LED "S" meter • Scanning
 • Optional RS232 socket on rear!
 • Professional class performance
\$449.95 \$6.00 UPS

RTTY-CW-FAX

RTTY - CW - AMTOR SPECIAL SALE WHILE SUPPLIES LAST!
AEA CP-1 Computer Patch

 As Low As: \$215.00!!

* Copy Morse Code, 5-99 wpm, RTTY, Ascii, Amtor. All you need is a stable Receiver, a computer, a CP-1 & the Software. Choose one of our package Deals for best price break. CP-1 Interface and software for the following: C64/C128 \$269.00 IBM PC \$229.00 APPLE II, IIe \$215.00 + \$4.00 UPS. AC Adapter is included

AMECO Tunable Pre Amp-Antenna

 • Matches Most Any Antenna
 • Improves Gain and Noise Figure
 • 9V Battery PWR (not included)
 • AC Adapter Optional (\$9.95) (Order - P9T)
 • 200 kHz-30 MHz
 • Preselector
 • Indoor Active Antenna
\$74.95 + \$4.00 UPS

ANTENNAS

EAVESDROPPER SALE
\$59.95 + \$4.00 UPS
 • Balanced trapped Dipole
 • Maximum performance, Minimum local noise
 • All SW Bands 60-11 meters
 • Only 43 feet long - 100 ft. feed line
 • Complete - Everything you need.
MFJ 1024 \$119.95 + \$5.00 UPS
 A.C. Adapter \$9.95
 • Outdoor active antenna
 • Performs as well as units costing \$180.00
 • WRTVH rates it high
ICOM AH7000
\$89.95 + \$4.00 UPS
 Discone Antenna for ICR7000/others w/type 'N' antenna connector. 25-1300 MHz!
50' of Lo-Loss Coax Cable Included.
D-130 ANTENNA
\$79.95 + \$4.00 UPS
 Same as above but with PL-259 connector.
50' of Coax Cable Included.

ALL NEW FROM SONY! WORLD BAND RADIO THE NEW ICF-7700

 • 15 Bands-12 SW, MW, LW & FM
 • 15 Station memory presets
 • LCD Frequency readout
 • Built in clock & sleep timer
 • 4 1/2" x 7 1/2" x 1 1/4"
 • Earphone, carrying case, SWL book included.
 AC-D4L Optional AC Adaptor \$21.95
\$249.95 + \$4.00 UPS

DON'T LET ITS SMALL SIZE FOOL YOU! A FULL FEATURED RADIO THAT WILL FIT IN YOUR POCKET. THE ULTIMATE IN PORTABILITY!

SONY ICF—PRO80
\$349.95
 + \$4.00 UPS

SONY CALLS THIS RADIO THE 'PRO80' & HERE'S WHY:
 • Covers 150 kHz to 216 MHz!! (with supplied converter)
 • AM, FM, (wide & narrow); SSB • 40 Station Memories!
 • Memory scan, Program scan, Limit scan, up/down manual scan and priority scan!
 • Automatic and manual squelch!
 • Handheld radio 3 1/2" x 7 1/4" x 2" and weighs 1 lb. 7 oz.
 • Rechargeable battery Pak (opt) • Comes with telescopic antenna, shoulder belt, carrying case, wave book, frequency converter and BNC adaptor.

PANASONIC RFB60
Compact multi-band radio **\$249.00**
\$4.00 UPS
 • PLL synthesized receiver
 • 6-way tuning system
 • Clock/Timer with Sleep
 • LCD Readout

DATONG ACTIVE ANTENNA
 • Constant sensitivity from 200 kHz to 30 MHz.
 • No need for tuners or antenna matchers.
 • Compact and unobtrusive, only 10 feet long!
 • Optional DC supply (model MPU) available - call
INTRODUCTORY PRICE
ONLY \$129.95 + \$4 UPS

SIGNAL DISPLAY UNIT! FOR THE ICR7000 & OTHERS
\$1295.00
 + \$8.00 UPS

SPECIFICATIONS FOR THE SM1071
 • Frequency range 10.2 to 11.2 MHz
 • Sensitivity: 0.5uV min discernable signal
 • Gain control range: 70 dB min.
 • 2.5" x 2.0" Screen
 • Log range: approx 60 dB
 • 50 ohm nominal input impedance
 • Size is 6" x 4" x 10.5
 • Log range is approx 60 dB

 • We ship world-wide
 • Shipping charges not included
 • Prices & specifications subject to change without notice

10 miles west of Washington, D.C.
 Sorry—No COD's
 10-5 Tues., Wed., Fri. 10-9 Thursday
 10-4 Saturday Closed Sunday and Monday

ELECTRONIC EQUIPMENT BANK
 516 Mill Street, N.E.
 Vienna, VA 22180
 Order Toll Free: 800-368-3270
 Technical and VA Orders (703) 938-3350

THE HAM COLUMN

GETTING STARTED AS A RADIO AMATEUR

They're Called Contests

To some Hams, they're like walking into a buzz saw. To other Hams, they're a total-immersion means of increasing Morse-code speed and general operating savvy over a few hours, a day, a weekend or several days—a means of working (contacting) counties, states and countries not worked before. For other Hams, they test station efficiency, operating technique and operator stamina like no other Amateur Radio activity—good preparation for disciplined high-speed emergency operation. They're called contests, and autumn's as good a season as any to introduce you to them if you haven't already listened to or participated in an Amateur Radio contest.

Simply put, a Ham radio contest is an on-the-air activity in which the participants try to contact as many stations as possible within a limited period of time. Saying that contesting is just contacting a zillion other Ham stations in no time flat doesn't tell the whole story. Fact is, most Ham contests aren't just

high-speed chases; they're also good excuses to get on the air and meet other people with the same radio interests. Every Ham contest is a radio *celebration*—a festival of skill, equipment and the magic of long-distance radio propagation.

What Contests Sound Like

If you've tuned through one of the high-frequency Amateur bands and heard a whirring code melee or scads of voice signals speaking callsigns and terse alphanumeric groups at high speed, you've experienced a Ham radio contest. Each contact you heard may have gone something like this: "W1AW, you're 5-9 Illinois, over." "Roger, K9CJU. You're 5-9 Connecticut, over." "Roger; thank you. QRZed contest from Kilo Nine Charlie Juliett Uniform—contest." Just *what* are these guys saying?

Well, translated and expanded a bit, the exchange actually went something like this:

"W1AW, the strength and readability of your signal are 5 and 9 (perfectly readable and very strong) in Illinois." W1AW comes back with "I read you, K9CJU. You're perfectly readable and very strong in Connecticut." K9CJU returns with "I read you, W1AW; thanks for the contact. Who else is calling me in this contest? This is K9CJU (phoneticized). Other stations in the contest only, go ahead."

That's the nitty gritty of each contest *exchange*. The form of the exchange varies with the mode (depending on the contest, this can be voice, code, radioteletype or another emissions), but the message is pretty much the same. Sometimes, testers also send a serial number for each contact, the power of their transmitters, the year they were licensed, their ZIP code or any one of several cryptic means of indicating where they are on the surface of the planet. (No, I haven't yet heard of a contest where you have to send your shoe size!)

HUGE

70 PAGE

SHORTWAVE CATALOG

SEE WHAT'S NEW IN . . .

- COMMUNICATIONS RECEIVERS
- PORTABLE SHORTWAVE RADIOS
- ANTENNAS & SUPPLIES
- RADIOTELETYPE EQUIPMENT
- FACSIMILE (FAX) EQUIPMENT
- COMMUNICATIONS BOOKS
- PARTS & ACCESSORIES

SEND \$1.00 (OR 3 IRCs)
REFUNDABLE



UNIVERSAL SHORTWAVE RADIO
1280 Aida Drive
Reynoldsburg, Ohio 43068
Phone 614-866-4267

Please send all reader inquiries directly.

WORLD CLOCKS, INC.

A UNIQUE GIFT ITEM.

SALE PRICE
\$37.95
Reg. \$44.95
M-8201 (G)
GOLD

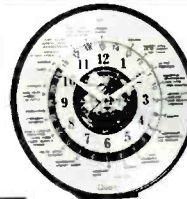

SALE PRICE
\$39.95
Reg. \$49.95

M3111
(S/S) Smoke/Silver
(S/G) Smoke/Gold
(C/S) Clear/Silver
(C/G) Clear/Gold

- Specify Color Combinations When Ordering
- Gold or silver time piece handsomely displayed in a smoke or clear acrylic stand

- 12/24 Hour Time Piece
- Dual Dial World Time Clock
- Easy to read local time in cities around the world
- Daylight/Nighttime shown on 24-hr. dial
- Accuracy assured to ± 15 seconds per month with quartz movement.
- Time piece diameter 6 1/2"
- Uses 1 "AA" battery not included.
- Guaranteed for one year.

ORDERS ONLY CALL 24HRS/7 DAYS
Please have model number and credit card information ready

1-800-624-2232
Ext. 960

Florida residents add 5% sales tax.
Within the Continental U.S.A. please add \$2.50 shipping and handling

SALE PRICE
\$69.95
Reg. \$79.95
M3202 W(G)
WOOD/GOLD



SALE PRICE
\$79.95
Reg. \$89.95
M3104L
LUCITE

WORLD CLOCKS, INC.
2065 Range Rd., Clearwater, FL 34625
(813) 442-5741



OR SEND CHECK BY MAIL

**DAVE NEWKIRK, AK7M
AMERICAN RADIO RELAY LEAGUE HQ**

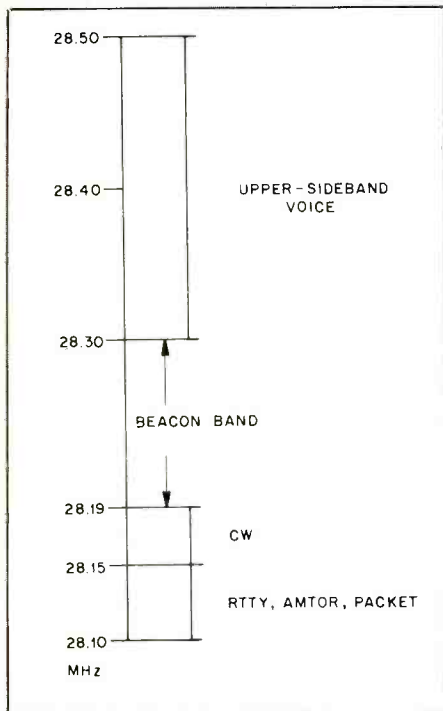

Here's where to find Novices and Technicians in the 10-meter band. Conscientious Hams avoid using frequencies between 28.19 to 28.30 MHz to keep from interfering with the international beacon network presently operating there. RTTY, AMTOR and packet are digital modes; we'll discuss them in a future Ham Column.

Many contest contacts start with "CQ," the general call to all stations. K9CJU calls: "CQ contest, CQ contest, CQ contest from K9CJU, Kilo Nine Charlie Juliet Uniform. Contest, over." In high-speed contests, many operators use mechanized means of calling CQ and sending as much as possible of the exchange. Voice operators use tape or digital-storage voice recorders, and code testers use automatic sending devices ("memory keyers") that can record a message and play it back on demand. Contesters also use computers for logging, Morse-code generation and checking for duplicate contacts.

Contesting At A Stroll

But hold on. Ham radio contests aren't all blood and guts and adrenaline, and you don't need a robotized mega-station or toothpicks to prop your eyelids open if you want to participate in or enjoy listening to a contest. From slow to just a bit faster, here are three upcoming popular contests enjoyable by Novice and old-timer alike:

Straight Key Night. No matter how many memory keyers and automatic code readers

you heap on your radio table, the essence of Morse code is shorting and unshorting a couple of wires to send human thoughts through space. The basic means of doing this is the hand-operated *straight key*. For the 24-hour period beginning at 7 p.m. EST on New Year's Eve, Hams dig out their straight keys for leisurely Morse code contacts in the 80, 40 and 20-meter Ham bands. Look for SKN participants upwards from 3560, 7060 and 14060 kHz. *Novices* working SKN can be found upwards from 3710 and 7110 kHz. You can find the Straight Key Night rules in the December issue of *QST*. (*QST* is published by the American Radio Relay League, 225 Main St., Newington, CT 06111.)

Novice Roundup. Novice and Technician class Hams, this one's for you! During the nine-day Roundup, the Novice bands buzz with Novices and Technicians trying to contact as many stations as possible. Hams holding higher-class licenses get into the action, too. Now that Novices can work 10-meter phone and use VHF/UHF repeaters, the 1988 Novice Roundup (January 30 to February 7) promises to be an all-mode Novice Enhancement celebration stretching from 3.7 to 1295 MHz! Watch for the NR rules in January *QST*.

ARRL 10-Meter Contest. Amateur Radio's highest HF band gets a shot in the arm each year during the 10-Meter contest. Now that Novices and Technicians can operate 10-meter voice, digital and image modes, this year's bash promises to be *amazing!* And this contest happens *soon*: December 12 and 13 are the magic days, and you can find the complete rules in November *QST*. Listen for Novices and Technicians between 28.1 and 28.5 MHz. Who will contact the most Novices and Technicians in the most states in the 1987 ARRL 10-Meter Contest?

Where To Find Out More

The results of major contests are usually published by the sponsor: *QST* publishes ARRL-contest results, and *CQ* publishes scores of *CQ* contests. ARRL also publishes the *National Contest Journal*, a magazine specializing in contest coverage. For the "how to" of contests, see *The ARRL Operating Manual*, available at your dealer or from ARRL. For contest times, dates and rules, check *CQ* magazine's *Contest Calendar* (76 North Broadway, Hicksville, NY 11801) and *QST's Contest Corral*. And keep that tuning dial in motion. Because there's at least one contest nearly every weekend of the year, even without a contest schedule you can usually turn on your radio and scan the Amateur Bands for Hams having contest fun.



Free
Satellite TV
BUYING GUIDE



FREE Consumer Buyer's Guide With Guaranteed Lowest Prices

- Explains all about 100 channel Satellite TV and how to shop for an earth station!
- Lists **GUARANTEED LOWEST PRICES...we will not be undersold, save 30-50% over local dealer prices!**

SYSTEMS (receiver shown, Orbitron 10 ft. C-10 black mesh dish, motor drive, feedhorn, 75K LNB). Complete system is UPS shippable. The dish can be installed in an hour and has a five year warranty.

Chaparral Sierra II + SCALL	Genl. Inst. 2400 IRD\$1249
Chaparral Sierra I SCALL	Panasonic 4400 IRD\$CALL
Chap. Cheyenne IRD SCALL	Panasonic C2600 \$ 999
Chan. Mast. 6441 IRD\$1299	STS 100 IRD \$1489
Drake 2400 IRD	\$1599 Hou. Tracker VIII IRD\$1839
Drake 9241	\$1079 Hou. Tracker VII IRD\$1518
DX 800	\$1145 Hou. Tracker VI IRD\$1359
Echostar 8000 IRD	\$1999 Hou. Tracker II/III \$ 769
Echostar 7000 IRD	\$1755 Uniden 9900 IRD \$CALL
Echostar 4000 IRD	\$1259 Uniden 7700 IRD \$CALL
Genl. Inst. 2500 IRD\$1369	Uniden 6600 \$ 989

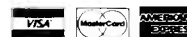

The new SATMAN Buyer's Guide is a *necessity* for any prospective or current earth station owner who wants to save big money on name brand satellite products. Buy direct, Do-It-Yourself, and save with SATMAN. Toll free ordering, no sales tax (IL only), major credit cards accepted, huge in-stock inventories available, and fast UPS shipping anywhere in U.S. Check with SATMAN before you buy... *We will not be undersold!* Call now for your free 20 page SATMAN Buyer's Guide.

1-800-472-8626
1-309-692-4140 Illinois



clip and save

OPTOelectronics inc

**NEW
POCKET SIZE**

**SIZE: 4" H x 3.5" W x 1" D
MADE IN USA**

**FREQUENCY
COUNTERS
TO 1.3 GHz**

\$99⁹⁵ - \$150⁰⁰

**8 LED DIGITS • 2 GATE TIMES
ANODIZED ALUMINUM CABINET
INTERNAL NI-CAD BATTERIES INCLUDED
AC ADAPTER/CHARGER INCLUDED**

**EXCELLENT SENSITIVITY
& ACCURACY**

**AC-DC • PORTABLE
OPERATION**



#TA-1005

#P-100

#AC-1200
AC ADAPTER
CHARGER

#1200H 1.2 GHz

Small enough to fit into a shirt pocket, our new 1.2 GHz and 1.3 GHz, 8 digit frequency counters are not toys! They can actually out perform units many times their size and price! Included are rechargeable Ni-Cad batteries installed inside the unit for hours of portable, cordless operation. The batteries are easily recharged using the AC adapter/charger supplied with the unit.

The excellent sensitivity of the 1200H makes it ideal for use with the telescoping RF pick-up antenna; accurately and easily measure transmit frequencies from handheld, fixed, or mobile radios such as: Police, firefighters, Ham, taxi, car telephone, aircraft, marine, etc. May be used for counter surveillance, locating hidden "bug" transmitters. Use with grid dip oscillator when designing and tuning antennas. May be used with a probe for measuring clock frequencies in computers, various digital circuitry or oscillators. Can be built into transmitters, signal generators and other devices to accurately monitor frequency.

The size, price and performance of these new instruments make them indispensable for technicians, engineers, schools, Hams, CBers, electronic hobbyists, short wave listeners, law enforcement personnel and many others.

STOCK NO:

- #1200HKC Model 1200H in kit form, 1-1200 MHz counter complete including all parts, cabinet, Ni-Cad batteries, AC adapter-battery charger and instructions \$ 99.95
- #1200HC Model 1200H factory assembled 1-1200 MHz counter, tested and calibrated, complete including Ni-Cad batteries and AC adapter/battery charger \$137.50
- #1300HC Model 1300H factory assembled 1-1300 MHz counter, tested and calibrated, complete including Ni-Cad batteries and AC adapter/battery charger \$150.00

ACCESSORIES:

- #TA-1005 Telescoping RF pick-up antenna with BNC connector \$12.00
- #P-100 Probe, direct connection 50 ohm, BNC connector \$18.00
- #CC-70 Carrying case, black vinyl with zipper opening. Will hold a counter and accessories \$10.00



1.3 GHz

#1300H

FLA (305) 771-2050

**ORDER FACTORY DIRECT
1-800-327-5912**



OPTOelectronics inc
5821 N.E. 14th Avenue
Ft. Lauderdale, Florida 33334

AVAILABLE NOW!

Orders to US and Canada add 5% of total (\$2 min., \$10 max)
Florida residents add 5% sales tax. COD fee \$2.

PRODUCTS

REVIEW OF NEW AND INTERESTING PRODUCTS



Create Artificial RF Ground

Don't we all sometimes have problems with not having a good RF ground? Decidedly unpleasant problems. Problems like RF "hot spots" that "bite" our lips or fingers when we transmit, like RF feedback that causes our rigs to quit working on certain bands, like excessive RF coupling to AC lines that causes everything to quit working, like our neighbors screaming about TVI and RFI, like our computers computing gibberish or like we simply can't talk across town because of extreme ground losses or radiation pattern distortion.

"Hey, my rig is on the second floor, there's no way I can get a good ground," you're thinking, or "I already have an excellent ground but the long ground connection wire causes reactance and acts like a high impedance circuit, isolating my rig from true RF ground."

What to do? Let the new MFJ-931 create an artificial RF ground with a random length of wire thrown along the floor. It's very effective at placing your rig at or near actual earth ground potential even if your rig is on a second or higher floor.

That's not all—the MFJ-931 can also electrically place a far away ground directly at your rig, no matter how far away it is. It tunes out the reactance of the wire that connects your existing ground to your rig. How does it do that? The MFJ-931 connects between the ground connection of your transmitter or antenna tuner and a random length of wire thrown along the floor. Two knobs on the MFJ-931 are adjusted for maximum RF ground current using its built-in RF ammeter. This resonates the random wire, converts it into a tuned counterpoise and presents an effective low impedance near ground potential to your rig thus creating an artificial RF ground.

To electrically place a far away ground directly at your radio equipment simply connect the MFJ-931 between your rig and connecting ground wire and adjust its two knobs for maximum RF current using its RF ammeter. This tunes out the reactance of the connecting wire, reduces the electrical ground lead length to virtually zero and electrically places your far away ground directly at your rig.

The MFJ-931 covers 1.8 to 30 MHz and has a built-in RF ammeter for indicating RF ground current. It's ruggedly built in an all aluminum cabinet with a brushed aluminum front panel and measures 7½ × 3½ × 7 inches. The MFJ-931 retails for \$79.95. It comes with a one year unconditional guarantee and if ordered directly from MFJ Enterprises, Inc. it can be returned within 30 days for a full refund (less shipping and handling) if not satisfied.

For additional information circle #101 on the reader service card or contact MFJ Enterprises, Inc., P.O. Box 494, Mississippi State, MS 39762.



New Mid-Priced IRD

The new mid-priced, integrated receiver/decoder (IRD) from the R.L. Drake Company has been designed to bring the convenience of viewing satellite TV with an IRD to a broader base of consumers.

"Our research shows there are many people who would like to buy an IRD but who are balking at the high prices of these components," said Michael Brubaker, Vice President of Sales. "We're introducing our new Model ESR2024 for those who are willing to give up some of the bells and whistles of a full-featured IRD for a significantly lower price tag."

With a suggested retail price of less than \$1,400, Model ESR2024 boasts most of the features found on Drake's top-of-the-line IRD, Model ESR2400. But because the unit has a less sophisticated display and does not offer full analog stereo and dynamic noise reduction, its suggested retail price is about \$250 less than the deluxe model.

Aside from these differences, Model ESR2024 provides the same outstanding reception and ease of use as Drake's state-of-the-art IRD. The unit incorporates an antenna positioning system, a VideoCipher® II decoder and such advanced features as on-screen display, priority view to 20 channels and positioning programmability with up to 36 satellite memories. In addition, Model ESR 2024 is microprocessor-controlled and contains its own built-in power supply. And the unit's audio circuit produces digital stereo output when receiving an authorized VideoCipher signal.

The receiver's on-screen display shows all pertinent functions and parameters, such

as channel, satellite, polarity and signal strength. This information comes on the television screen whenever a function is changed and can be recalled with just the touch of a button on the remote control panel.

Model ESR2024 also features priority view, which allows up to 20 channels to be preprogrammed for instant viewing. Once the viewer's favorite channels have been preprogrammed, all he or she has to do is press one button on the remote control and the right satellite, channel, polarization and audio format will be selected automatically.

Other key features include parental lock-out; Ku-band compatibility; block system technology; full-functioned, infrared remote control; and signal strength indicator (on the on-screen display) for precision tuning. The receiver's advanced design, boasting composite video input and IF loop-through for TI filters, ensures crystal clear video reception.

Utilizing a 950-1450 MHz block input frequency, this block conversion model features dual input switching to eliminate the need for external relays or switching splitters. Model ESR2024 can accommodate either two C-band LNBs or one C-band and one Ku-band LNB and is compatible with all Drake LNBs and its BDC24 block down-converter.

For more information circle number 104 on the reader service card or contact R.L. Drake Company, P.O. Box 112, Miamisburg, OH 45342.

Auto Racing Head Set

Stewart D. Ervin of Kinston, NC recently invented the "Auto Racing Head Set," a special radio receiver headset for racing fans that would enable them to hear radio transmissions from race drivers and pit crews in communication with one another during races. The radio headset would be tuned to various certain frequencies used by race drivers to pick up the transmissions desired. The inventor of this device feels that it would enable the racing fan to participate more fully in the race by being able to hear the details of events and anticipate race developments, thus adding greatly to enjoyment of the race.

The Invention has been filed under the U.S. Patent and Trademark Office's "Disclosure Document Program" in Washington, D.C., to be held for a period of two years.

American Patent Research & Development is acting as a publicity and licensing agent for the Inventor and the described Idea. For an interview with the Inventor or additional information, call American Patent Research & Development (Publicity Department) at (202) 628-4335.

POP'COMM Reviews:

The EEB 2020



The EEB 2020 is a World Band Receiver in the \$200 to \$300 price range that meets the needs of a particular segment of the shortwave listening audience. Let us consider what it is *not* so that we can focus more clearly on what it is. It is *not* a full-blown communications receiver with all the bells and whistles. It is *not* one of the cheapie off-shore products intended to receive FM, AM and one or two shortwave bands. The EEB 2020 is a very capable shortwave listener's delight that falls somewhere between these two extremes. It is modestly priced, and it represents real value of the money.

Physical Description

The 2020 is compact and lightweight, measuring 12"W x 6"H x 2½"D and weighing in at exactly three lbs., less batteries. The case is made from high-impact black plastic with grey and silver accents. Bright orange and turquoise highlight the most-used controls. The main tuning knob is on the right-hand end of the receiver as you face the dial, and the telescoping whip antenna folds neatly along the top of the case in its stored position. On both ends near the top are the retaining clips for the carrying strap. Yes, this is a true portable receiver of the go-anywhere, do-almost-anything variety with features that belie its simple appearance.

On the back of the receiver is a metal tilt-bail that allows you to place the receiver on its back when the bail is pivoted out of its stored position. There is a storage compartment door hinged at the bottom which opens to reveal the battery box (six "D" cells and two "AA" buffer cells). Provision is made on the left-hand end for a tape-recorder output (five-pin keyed socket), ear-

phones output (standard jack), and DC power input (center negative) jack. On the top of the receiver case you will find the controls for setting the clock with timer and sleep alarm.

The operating controls are located in two related areas. The vertical column on the right-hand side of the front panel includes the on-off power push-bar, the volume slide bar, stereo balance slide bar, treble and bass slide bars, BFO pitch and RF gain rotary controls, and the AM, FM, and Lock slide switches. The second area is a keypad "block" below the left end of the frequency display. The 4¾"W x 2"H frequency display area includes a centered LCD frequency readout surrounded by an escutcheon of brushed aluminum. The LCD digits which display frequency or time are ½" high and easy to read in black on a grey background.

Just to the left edge of the frequency readout display area, there is a vertical column of LED signal-strength indicators numbered from 1 to 5. On the right edge of the display are two LED's; one for power on/off indication and the other for stereo indication. (Note: stereo FM reception is available with earphones only as the single speaker does not produce stereo audio output.)

One attractive feature is the inscription (in black on brushed aluminum) of the band and frequency coverage for quick reference, with the mode indicated in silver with-in black boxes. For example: FM, LW, MW and AM, all with frequency range, appear along the top above the display. The SW bands are spaced along the bottom of the escutcheon with their band designations in black on aluminum.

Immediately below the frequency display area you will find the direct-entry pushbuttons/pushbars in light grey against the matte black background. You can set FM,

AM, LW, MW, SW at the touch of a button, and you can select a particular desired frequency on the key-pad (1-0) plus an "Execute" pushbar. The six pushbars located to the right of the keypad allow you to select mode, store frequencies, start/stop scanning, call memo, and up or down scanning.

Functional Description

The EEB 2020 has 37 different controls and indicators that regulate and display its operational features. Let's consider a typical day's use. To turn the set on, press the power bar and note the LED light up on the display panel. Press one of the wave band buttons for FM, AM, LW, MW, or SW depending on your choice of bands and/or frequencies. If you press the AM button, you can tune the full range of frequencies from 150 to 29,999 kHz continuously, or enter a particular frequency by the direct entry method. Note that the shortwave band (SW) is subdivided into 12 sub-bands, and each time you press the SW button, you select the next lower sub-band, beginning with 120 meters.

Let's suppose you select SW (shortwave) and want to listen to a station in the 49 meter band. You continue pressing the SW button until the 49 meter band shows up in the display (5800-6200 kHz). Let's further suppose that the station you wish to hear is located at 6015 kHz. You now have a choice of using the tuning knob to tune up to that frequency, or using the direct entry method, which is faster. Push the buttons 6-0-1-5-0 in succession and then press the Execute bar. Presto! Your desired frequency is now displayed and can be stored in memory for future reference.

To store that station in a memory register, you merely press Store, and note that a "STORE" display flashes for about five seconds. During this time, you press one of the keypad keys (1-9) and the frequency of 6015 goes into that memory for later recall. When you want to recall that frequency, press the Call Memo button, and the "MEMO" display flashes for five seconds; press the memory button on the keypad in which the frequency is stored, and it will be displayed on the readout. This works for any frequency in any band, including FM.

If reception is poor on the frequency you select, it is possible that the station you want has not been precisely tuned in. If that's the case, you can use the manual tuning knob to increase or decrease the frequency in small increments, or you can use the Up/Down buttons on the dial face. The LED indicators on the dial face (numbered 1-5) will give you a rough idea of received signal strength. Tune for maximum display (5) on the dial.

A couple of really neat features will become apparent as you get used to your new EEB 2020. For example, the Lock control on the bottom right side of the front panel will lock in a displayed frequency so that it can't be mistakenly removed to mistuned.

However, the Lock button has another function: when you remove the power cord from the wall (even with the power switch on) and try to turn the set back on when you plug it back into the AC mains, you will find that it won't turn on! That's a safety feature used primarily to save the batteries when you are not using them. It prevents battery drain should you happen to forget to turn the radio off.

In most cases the built-in antennas (ferrite rod for AM broadcast inside the case, and telescoping whip antenna mounted to the case) are more than satisfactory for all your listening requirements. They will furnish strong signals in most locations—even from far away stations. The EEB 2020 gives you the choice of using an external, outdoor antenna if you choose. There is an input jack for an external antenna, and you slide a nearby switch to the EXT position and plug your external long wire, dipole, etc., into that.

An adapter is supplied that will allow you to use a connector of your choice between your antenna lead-in and the 2020 receiver input. I made up one from a short piece of coaxial cable and a PL-258 connector. A coaxial "barrell" (double female) connector joins the PL-258 plug on my antenna to the PL-258 plug on the adapter cable and now all of my external antennas can be plugged into the radio. I used this feature on one occasion, but found that in most cases the external antenna provided too strong a signal for the 2020's sensitivity. In this case I used the RF Gain control to decrease the incoming signal to a more suitable level.

You'll probably find as I did that FM reception is particularly good, and that the stereo headphone reception is a delight with the proper earphones connected.

Although I didn't find any use for the clock, my wife did, and she had no problems setting it properly for alarm wake-up. She referred to the operating manual for instructions. You will be happy to know that the book of operating instructions that comes with your EEB 2020 receiver is exceptionally useful. It is written clearly and simply, describing all of the features and functions of your receiver in a manner that will help you get the most out of this equipment. We STRONGLY recommend that you read it thoroughly before operating your receiver.

Some of us like to hear single sideband (SSB) signals or CW (Morse telegraphy) signals, that is where the BFO comes in handy. It is switched on to provide a variable "whistle" or audio frequency that "beats" against the received signal to provide a clear tone on CW, or it "beats" against the "quacking" voice signals of SSB to produce intelligible reception. The BFO knob is turned until the signal comes in clearly and can be used to receive either upper or lower sideband signals (USB, LSB).

You will find that on most shortwave bands that the RF Gain control is very useful, and enables you to receive the strongest

stations without garbling or increasing the volume of a very weak station. When receiving broadcast stations or most shortwave stations, the AM wide-narrow switch will be in the wide position, but when receiving CW or SSB stations, the switch will be in the narrow position for clearest reception. Here again, your operating instructions manual is indispensable.

Another thoughtful feature included at no extra cost is the *Wave Handbook* which lists most of the times and frequencies used by the various international shortwave broadcasting stations. One shortcoming, however, is that these are listed for foreign buyers rather than U.S. buyers. The times for best reception of these stations in the U.S. are not given. However, you can often hear signals "beamed" to other countries at the listed times because of the sensitivity of your receiver. I like to use the *World Radio TV Handbook* and the *Radio Database International* to give me the latest update on times and frequencies used by these stations. Because of seasonal changes and time changes, these shortwave broadcasters will often change their frequencies slightly to make up for the differences in radio signal propagation.

Technical Description

The EEB 2020 is a double-conversion superheterodyne receiver using phase-locked loop circuitry to provide frequency selection on the AM bands (LW, MW, SW). The IF or intermediate frequencies are AM1-55845 kHz; AM2-450 kHz; and FM-10.7 MHz. On AM, the bandwidth is 6.5 kHz. IF suppression is 50 dB on AM and 60 dB on FM. Stereo channel separation on FM is 25 dB, and AM suppression is 30 in the FM mode. The tone control provides ± 8 dB at 10 kHz, and at 100 kHz. Audio output power is 1200 mW according to DIN standards at a distortion factor of 10%. You will be able to receive almost any frequency and mode between 150 kHz and 30 MHz with the Ambassador 2020, far more than most people would ever want to listen to in a lifetime.

Conclusions

The EEB 2020 is an excellent value for the money because it provides reception far beyond what its modest-looking exterior exhibits. The reception is adequate for most ordinary SWL purposes. It does not have variable bandwidth controls, product detectors, or selectable IF filters, but for most purposes (unless you are a fanatic), you won't need (or expect) these features in a receiver of this kind. For those of us who are fanatics, we have the choice of spending a thousand or two for all the goodies that we feel we must have.

As a Ham radio operator, I find that the 2020 will bring in many Amateur radio stations, here and abroad, that I expect to find on my communications receiver. Not quite as well or as easily perhaps, but satisfactorily.

If you're like us here at the magazine,

you'll not want to be far away from a receiver at any time, whether it be for news broadcasts, for emergencies, for easy listenin' of good music, or for just plain fun snooping around the bands. Best of all, you can take this one with you—easily, simply and compactly. It fits in luggage, in an attache case, or hanging from your shoulder. It will take hard knocks, but not abuse. The 2020 conveys the impression of business-like performance which it fulfills handsomely. Whether or not it's for you depends upon your needs and desires and, of course, your pocketbook. As for me, I wouldn't want to be without it, even though I don't use (or anticipate using) it 24 hours a day. I do like the feature of waking up to music or going to sleep to music, and the 2020 makes it easy because of its automatic turn-off and turn-on functions which YOU can set to suit yourself.

The only annoying feature is the phase noise generated by the phase-lock loop circuitry; but that only intrudes when I am in the manual-tuning mode, and hear a "click" every 100 kHz or so. Otherwise, it's silent. I do worry a little about bumping the exposed manual tuning knob while I carry the EEB 2020 around with me, but I try to be extra careful, and so far have had no problems.

Your EEB 2020 is distributed exclusively by Electronic Equipment Bank Inc., 516 Mill Street, N.E., Vienna, VA 22180; Telephone: (703) 938-3350.

—Reviewed by POP'COMM Staff

<p>SUBSCRIBER SERVICE CHANGE OF ADDRESS</p> <p>Planning to move? Please let us know six weeks in advance so you won't miss a single issue of POPULAR COMMUNICATIONS</p> <p>Attach old label and print new address in space provided. Also include your mailing label whenever you write concerning your subscription to insure prompt service on your inquiry</p> <p>POPULAR COMMUNICATIONS 76 N. Broadway, Hicksville, NY 11801</p>	<p>ATTACH LABEL HERE</p>	<p>PLEASE PRINT</p>
	<p>NEW ADDRESS HERE</p> <p>NAME _____</p> <p>ADDRESS _____</p> <p>CITY _____ STATE _____</p> <p>DATE _____ ZIP _____</p>	

INSIDE THE WORLD OF SATELLITE COMMUNICATIONS

Amateur Radio Satellites – Soviet Style

On June 23, 1987, two new Soviet Amateur Radio satellites were launched, the RS-10 and RS-11. They are unique in two respects; for the frequency bands they use and the fact that they will be the first Amateur satellites launched from the USSR in more than six years.

The Soviets began their Amateur satellite program in 1976. It was the year after the historic Apollo-Soyuz space mission during which an American and Soviet spacecraft docked for a joint three-day space mission. Relations between the two space agencies were cordial. It may have been this cooperation which encouraged the Soviets to begin their own program after coming in contact with U.S. Amateurs who were members of NASA. U.S. Amateurs have been in space since 1963.

It took two years for the Soviets to build and launch their first two satellites, Radio Sputnik 1 and 2. Both were launched in October of 1978. In that they were experimental in nature and worked quite well, they became the foundation on which the next generation spacecraft were to be built. Five of these second generation satellites, RS-3 through RS-8, were launched simultaneously from a single launch vehicle in 1981. Each carried a single 2 to 10 meter transponder. RS-5 and RS-7 are still operational but on a very limited schedule. Both are turned on for one orbit a day. The present schedule calls for them to be on during orbits nine or ten each day. Both satellites have operated past their normal life spans.

RS-10/11

During the summer of 1986 the Soviets had planned to launch two more satellites in this series, RS-9 and RS-10. RS-10 would be the first of a new third-generation spacecraft. Since that time, Moscow has decided to scrap RS-9 and has instead built two of the newer satellites, now designated RS-10 and RS-11.

Each satellite carries two transponders, a

15 to 2 meter and a 2 to 10 meter. The 15 to 2 meter transponder should prove interesting. With better propagation on 15 meters as sun spot activity increases, the access range of a ground station may be increased. This same effect could be expected to weaken the downlink signals, especially on 10 meters. To overcome this and to improve the downlink signal in general, the RF output of the satellites has been increased. The 10 meter transponder will have 3 watts output and the 2 meter downlink will have 5 watts. Earlier satellites had a standard 1-watt output.

The choice of frequencies for the 15 meter transponders will also prove interesting. For example, RS-10's 15 meter uplink falls in the CW only portion of the Amateur band. The uplink frequencies for RS-11 fall into the Extra/Advanced class portion of the band, limiting their use by U.S. stations. This will not be the case on the standard 2 to 10 meter transponders.

Though RS-10 and 11 are labeled as two separate spacecraft, only one satellite will be operational at a time. This could mean that RS-10 and 11 are separate equipment packages on the same satellite, or that the transponders could be carried by a "host" spacecraft. It could also mean that Moscow is simply trying to conserve energy and prolong the life of the satellites. Trying to operate all of the transponders at the same time could be difficult considering the frequency combinations, if they are on one satellite.

The orbit of RS-10/11 is similar to that of earlier Radio Sputnik's. The parameters are as follows:

Orbit	Polar
Altitude	1,000 km
Inclination	83°
Period	105 minutes

Robots and Beacons

Both RS-10 and 11 carry a robot and beacon. The beacons are used to identify the



Intercosmos is the name of the Soviet Union's International Agency for Space Cooperation.



This colorful QSL card confirms a QSO with the RS-7 spacecraft robot.

RS-10 Frequencies			RS-11 Frequencies		
	Downlink	Uplink		Downlink	Uplink
Transponders	29.360 to 29.400 MHz 145.860 to 145.900 MHz	145.860 to 145.900 MHz 21.160 to 21.200 MHz	Transponders	29.410 to 29.450 MHz 145.910 to 145.950 MHz	145.910 to 145.950 MHz 21.210 to 21.250 MHz
Robots	29.403 MHz 145.903 MHz	145.825 MHz 21.120 MHz	Robots	29.453 MHz 145.953 MHz	145.830 MHz 21.130 MHz
Beacons	29.357 145.857		Beacons	29.407 145.907	

Soviet RS-7, RS-8 Satellite Telemetry

Code Group	Information	Formula
EK-##	Transponder RF output	$0.2 \times \#^2 = \text{mW}$
ED-##	Power supply voltage	$\# \times 2 = \text{Volts}$
EO-##	Power supply current	$20 \times (100 - \#) = \text{mA}$
EG-##	TLM calibration	
EU-##		
ES-##	Voltage regulator temperature	$\# = \text{temperature in Celsius}$
EW-##	10 meter transmitter temperature	$\# = \text{temperature in Celsius}$
SK-##	Transponder RF output	$0.2 \times \#^2 = \text{mW}$
SD-##	TLM calibration	
SO-##	Beacon RF output	$0.2 \times \#^2 = \text{mW}$
SG-##	Transponder sensitivity	$\# = -\text{dB}$
SU-##	Signal strength of 1st signal per pass	$0.1 \times (\# - 10) = \text{"S" units}$
SS-##	First robot signal strength per pass	$0.1 \times (\# - 10) = \text{"S" units}$
SW-##	Second signal strength	$0.1 \times (\# - 10) = \text{"S" units}$
UK-##	Transponder RF output	$0.2 \times \#^2 = \text{mW}$
UD-##	Transponder line voltage	$0.1 \times \# = \text{voltage}$
UO-##	Transponder supply voltage	$0.1 \times \# = \text{voltage}$
UG-##	Stabilizer power supply voltage(9V)	$0.1 \times \# = \text{voltage}$
UU-##	Stabilizer power supply voltage(7.5V)	$0.1 \times \# = \text{voltage}$
US-##	Second 9V stabilizer supply	$0.1 \times \# = \text{voltage}$
UW-##	End 7.5V stabilizer supply	$0.1 \times \# = \text{voltage}$
WK-##	Transponder RF output	$0.2 \times \#^2 = \text{mW}$
WD-##	Number of robot QSO's	number = #
WO-##	Heater control	$\# \times 0.1 = \text{watts}$
WG-##	Robot input power	$20 \times \# = \text{mW}$
WU-##	TLM/service transponder power	$20 \times \# = \text{mW}$
WS-##	Robot sensitivity	$\# = \text{dB}$
WN-##	TLM/service transponder sensitivity	$\# = \text{dB}$

N and R code groups are classified service and command data and not available.

EK-18 is an active group or current data

K-18 is an indication of old data, often the mode used when the spacecraft is over the U.S. and western Europe. This is true of any single letter code group.

spacecraft and keep the ground stations informed of the satellite's condition. They transmit information on the satellite's onboard systems in coded CW. With the decoding formula you can determine the temperature of the spacecraft, number of QSO's in the computer's memory, voltage and current of the power supply, etc. If you don't know CW, the information can be received and decoded with the proper computer program.

The robots are even more interesting. They allow an Amateur Radio operator to communicate directly with the spacecraft's onboard computer. Both sides of the QSO can be heard on the robot downlink. Again, as with the beacon, CW is used. The robot is smart enough to tell you to speed up or slow down your code. It will instruct you what frequency to call in on, issue you a QSO number and give you a signal report. The QSO number will qualify you for a QSL card from the satellite. As with earlier RS satellites the robots and transponders are very sensitive systems and designed for low-power operation (QRP), no more than 10 watts on uplink.

What's Next?

The future of Soviet Amateur space activity looks promising. If their track record is any indication, they will occupy a place on the Amateur satellite bands for some time to

come. Moscow announced in May that the next satellite project will be international in nature. The Eastern Bloc countries of Poland, Czechoslovakia, Hungary and East Germany will join the USSR in an Amateur Radio version of Intercosmos. It is the organization which coordinates all international space projects in the USSR, both manned and unmanned. Joint funding and construction is expected as a result of this move. It will be interesting to see what changes, if any, will take place in the Soviet program as a result of this cooperation.

It is still possible that the ISKRA satellite program will be reactivated. The first three ISKRA satellites failed to reach usable orbits, the last one launched from the Salyut 7 space station. A new ISKRA or the new Intercosmos Sputnik is expected to be launched from the Mir Space Complex when completed. With the formation of Intercosmos, the ISKRA program may be dropped completely.

The Soviets also have plans to operate an Amateur Radio station from Mir by the end of this decade. More details on these upcoming events will be presented as they become available.

Let me know what you want to see in upcoming installments of *Satellite View*. Send your questions, comments and suggestions to *Satellite View*, 3796 S. State Ave., Indianapolis, IN 46227. **PC**

QSLs! Increase your collection faster, more efficiently with Gerry Dexter's **SECRETS OF SUCCESSFUL QSL'ING** - The Complete Guide to Reception Reporting and QSL Collecting. This highly acclaimed 128 page book gives you all the information you need to write first rate reports, pull in those tough replies and build a collection others envy! Foreword by Ian Mc Farland of Radio Canada International. Illustrated. **\$9.95** plus \$1 shipping.

WRITE IT in Spanish, Portuguese, French or Indonesian. **LANGUAGE LAB** - The Foreign Language Reporting Guide makes it easy to send reception reports in another language. Over 800 words, sentences and phrases frees you from report forms and let you tailor your reports individually. Now available in Spanish, French, Portuguese and Indonesian editions. **\$12.95** each. Any two for **\$23**, any three for **\$33**, or get the complete set for **\$42** (Plus \$1 per book shipping).

THE NUMBERS, THEY ARE A MYSTERY! Read all about these strange broadcasts in **UNO, DOS, CUATRO** - A Guide to the Numbers Stations, by "Havana Moon." New revelations from the recognized expert. Plus a complete frequency/time listing. **\$13.95** plus \$1 shipping.

JUST STARTING? Pick up **SO YOU BOUGHT A SHORTWAVE RADIO!**, a light 'n easy get acquainted guide to the wide wild world of shortwave. Gerry Dexter gets you on the fast track to full enjoyment. Includes frequency ranges, receiver controls, clubs, more information, dealers and the cartoon adventures of "O.H." **\$6.95** plus \$1 shipping.

NEWS JUNKIE? Find out how to get the news you've been missing! **MUZZLED MEDIA** by Gerry Dexter is the perfect introduction to shortwave for the news hound! Compares the news reported on some two dozen international stations with what was carried by CBS-TV the same date. 96 pages, illustrated. **\$8.95** plus \$1 shipping.

SHORTWAVE RADIO LISTENING WITH THE EXPERTS - 25 chapters on listening and monitoring by 25 top experts in their fields. Over 500 pages, over 200 illustrations. Pub. by Howard W. Sams Co. **\$22.95** plus \$2 shipping.

THE WORLD HAM NET DIRECTORY helps you find and monitor or participate in special interest ham groups. DX'ers, missionaries, pilots, foreign service personnel, many more. Compiled by Mike Witowski and listed by name, frequency and airtime. **\$9.95** plus \$1 shipping.

Foreign orders \$2 shipping per book. Payment in US funds only. Send \$1 for current titles list.

Tiare Publications
P.O. Box 493
Lake Geneva, WI 53147

27 MHz COMMUNICATIONS ACTIVITIES

A commonly heard piece of CB advice says that a coaxial feedline for any mobile installation, in order to be properly tuned, must be trimmed to a certain length. This length is usually stated in multiples of a specific number of feet or inches. So the saying goes, when an SWR bridge (meter) is inserted into such a feedline it will show a 1:1 reading, indicating a "perfect match" of the antenna system to the transceiver.

My own experience is at variance with this advice. Unless an antenna manufacturer actually specifies that the feedline be a particular length for a specific antenna, you should be able to get a reading of 1.2:1 or lower with the feedline cut to the *minimum* length required for the installation. Although you should be striving to tune the antenna system for the lowest possible SWR (which is 1:1), any reading less than 2:1 is generally acceptable.

SWR measurements higher than 2:1 indicate poor transfer of RF between the transceiver and the antenna; the antenna is refusing to accept the amount of signal the transceiver is attempting to pass. The rejected RF is "backing up" in the feedline, just like the plumbing in your house backs up when the lines are partially obstructed. In the case of an antenna system, the blockage could be any number of things including a poorly wired connector, a bad ground connection, faulty antenna design or installation, or the transmitter in need of adjustment by a technician.

A high SWR reading means that your installation is neither sending nor receiving with maximum efficiency. If the reading is too high (for instance, 3:1 or more), serious damage could be done to your transceiver when you attempt to transmit. Compare the result to a complete blockage of the drain-

age lines in the plumbing of your home. That gives you some idea of what's involved.

By following the old CB axiom cited above, it is possible to "fool" an SWR bridge into showing a lower-than-accurate reading. This could mislead you into thinking that you had an adequate antenna system or installation when, in fact, something is drastically wrong. A good system and installation, properly tuned, should show a low SWR reading (that is, have no "standing waves") regardless of the length of the feedline—10 feet, 11.5 feet, 14 feet, or whatever. Many operators insist that antenna installations (base or mobile) should be checked out with an SWR meter before they are certified as being completed.

Speaking of Mobile Antennas

Midland International Corp., Kansas City, MO 64120, came out with a good looking mobile whip that's a dead-ringer for a CMT (cellular mobile telephone) antenna, complete with the little corkscrew in the center of the shaft.

Called the Model 18-2985, this is a base-loaded whip with a heavy-duty 5-oz. magnetic base. It comes blister-packed with its several major components ready to screw together in a jiffy without tools. The base, coil, and whip are black. The whip is tuned to your specific installation by means of adjusting its height within the ferrule and fixing the position with a set screw. An SWR bridge is required for proper tuning. Since this antenna system was designed to be efficient with a feedline of specific length (as are many self-contained magnet-mount mobile antennas), the manufacturer suggests that the cable not be cut or trimmed from the length supplied.

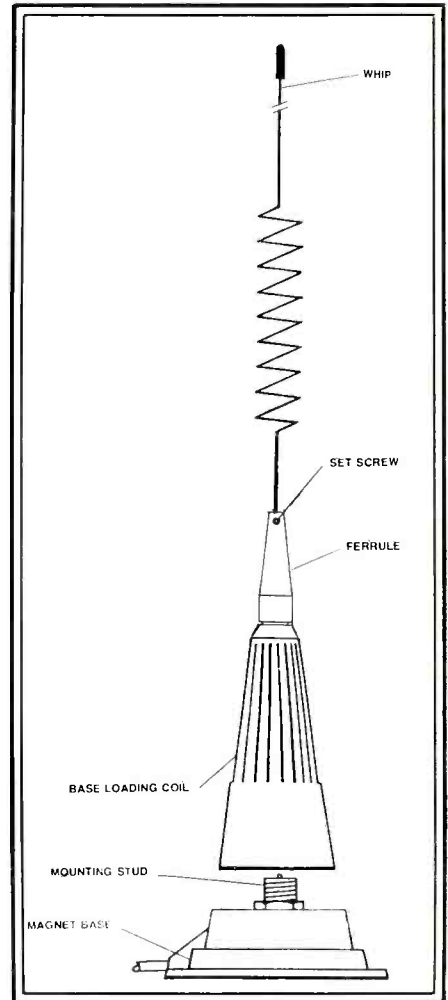

Midland International's CB mobile whip #18-2985 is intended to look like a cellular antenna. This picture shows its individual components.

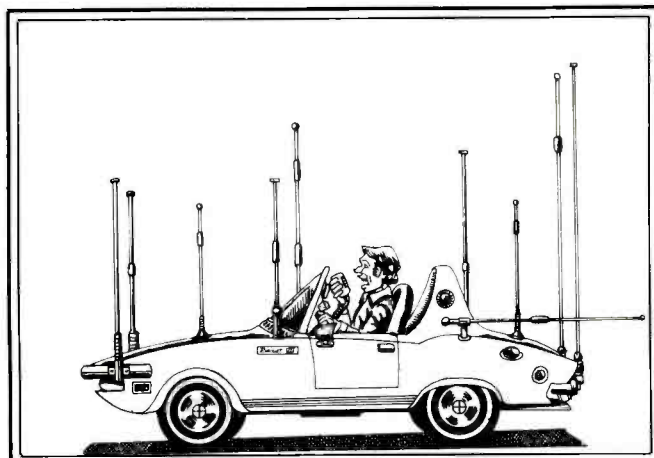

Mobile whip placement can be used to concentrate signal coverage into a desired direction from the vehicle. But where's the best location?

SSB-068
FINN3-UN200
(B2)TRC.001

SUOMI - FINLAND

73's Mon. 5

» RUBBER «
DUCK «

2000 GTL

OIVA PIJOLA
RYDYNKATU 64
SF 33400 TAMPERE 40
FINLAND

STATION	DATE	TIME	MODE	FREQ.	MY RIG	ANTENNA
					COBRA 2000 GTL	HY-GAIN PENETRATOR

Our CB QSL of the month is from Oiva, in Finland. His ID number in the SSB Network is SSB-068. Why not send us your CB card?

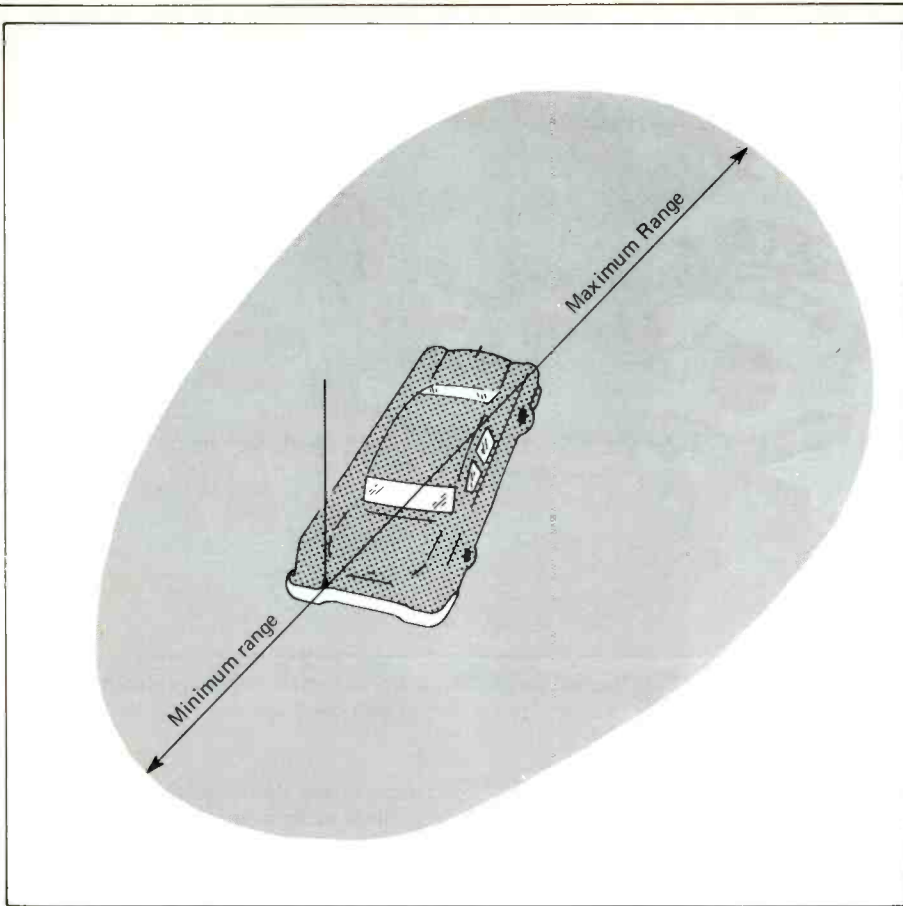

Maximum communication potential is in the direction opposite the mounting point on the vehicle.

The cable being supplied means that the entire antenna can go from its package to complete operation in a relatively short time and with very little fuss. It's really only a matter of adjusting the length of the whip for lowest SWR or maximum field strength, whichever peaking method you prefer.

We found that we were able to tune it to an SWR of 1.5:1 in our mobile unit. This was substantially better than the SWR reading we got when we tried using a CMT look-alike mobile CB antenna that was designed for through-glass installation on the windshield. Installed, it does look like a cellular antenna (although perhaps slightly taller).

The manufacturer suggests mounting in the center of the vehicle's steel roof or trunk lid for "best all-directional performance." My own personal preference hasn't been for omnidirectional performance from a mobile CB installation; I'm mostly interested in concentrating my coverage ahead of the vehicle so that I can communicate with distant oncoming vehicles on the Interstates and parkways. That's needed for gathering information on detours, accidents, tie-ups, construction zones, and smokey reports.

I like to add some degree of directivity to mobile whips by creative placement of the whip on the vehicle. By placing the whip towards the rear of the vehicle, the signal is

concentrated towards the front of the vehicle. Positioning it to the right side of the rear tends to beam coverage to the front left. In other words, maximum coverage is opposite the side of the vehicle where the mobile whip is located. Not the way people would guess it works, but that's the way it goes.

Maximum coverage towards the forward left is best for communicating with oncoming traffic. That's how I decided to install this Midland. Although my vehicle is an 4 x 4 RV and doesn't have a trunk, I mounted it on the right rear corner of the roof. No matter, the added altitude over the height of a trunk lid is a plus!

The Midland 18-2985 gave me plenty of coverage, with good signal reports from other mobiles w-a-a-y off in the distance. I was able to work base stations from at least ten miles away. The magnetic mount held tight at 60 mph and over the bumpiest terrain I had the courage to try.

Nine Is Fine

From near San Diego comes a letter signed "Paul." He inquires about the use of CB Channel 9, which the FCC has designated for the exclusive use of stations engaged in offering assistance to mobile units.

Our correspondent claims that in his local

CTM

The magazine for Computerist & Amateur Radio
Your #1 source of Packet info.

... received my moneys worth with just one issue ...

—J. Trenbick

... always stop to read CTM, even though most other magazines I receive (and write for) only get cursory examination ...

—Fred Blechman, K6UGT

U.S.A. \$18.00 for 1 year

Mexico, Canada \$32.00
Foreign \$43.00 (land) - \$68.00 (air)
(U.S. funds only)
Permanent (U.S. Subscription) \$150.00
Sample Copy \$3.50

CHET LAMBERT, W4WDR
1704 Sam Drive • Birmingham, AL 35235
(205) 854-0271

CIRCLE 16 ON READER SERVICE CARD

**TUBES — 2000 TYPES
DISCOUNT PRICES!**

Early, hard-to-find, and modern tubes. Also transformers, capacitors and parts for tube equipment. Send \$2.00 for 20 page wholesale catalog.

Antique Electronic Supply
688 W. First St. • Tempe, AZ 85281
602/894-9503

CIRCLE 15 ON READER SERVICE CARD

Shortwave Receivers, Antennas

ICOM • KENWOOD • YAESU Etc.

Call 212-925-7000

Open 7 days a week, Mon.-Fri. 9am-6pm,
Thurs. until 8pm, Sat. & Sun. 10am-5pm

Barry Electronics

512 Broadway • New York, NY 10012
Sales & Service Commercial Radio For 35 Years

Please send all reader inquiries directly.

PICKS UP A WHISPER 50 FEET AWAY!

The model WAT-50 miniature FM transmitter uses a 4-stage circuit NOT to be confused with a simple wireless microphone. Simply snap the unit on top of a 9V battery and you can hear every sound in an entire house up to 1 mile away! Use with any FM radio. Tunes to any frequency from 70mhz - 130mhz. Easy to assemble kit includes all parts and instructions. Only 29.98 tax incl.

The **WIRELESS TELEPHONE TRANSMITTER** model WTT-20 is only about the size of a dime, yet transmits both sides of a telephone conversation to any FM radio with crystal clarity. Completely automatic. Uses power from the telephone line itself - never needs a battery! Up to 1/4 mile range. Tunes from 70mhz - 130mhz. Easy to assemble kit includes all parts and instructions. Only \$29.98 tax incl.

Call or send MO, VISA, MC for immediate delivery. Single kit orders include \$1.50 S&H. FREE SHIPPING on orders of 2 or more. All orders shipped by U.S. Mail. COD add \$4.00. Personal checks allow 21 days.

DECO INDUSTRIES
BOX 607, BEDFORD HILLS, NY 10507
914-232-3878

CIRCLE 13 ON READER SERVICE CARD

area, there is a well-organized and efficient group that uses this channel but somehow feels that it has priority, if not completely exclusive, use of the frequency. Non-members have occasionally been requested or told to "take it to another channel," even when the group isn't handling an actual emergency or giving road instructions. Paul asks for some clarification regarding whether any group or organization can lay claim to special rights on CB Channel 9.

This neither a new problem, nor is it localized in Paul's area. No person or group has priority or exclusive rights to the use of Channel 9, although some would prefer to imply otherwise. Any person or group has the ability to properly use this channel on a shared basis with all other stations. Obviously, courtesy and reasonable operating practices would preclude one jumping onto Channel 9 (or any other channel) while other local stations are actively engaged in providing aid to a mobile unit.

It's an old trick, however, for some groups to attempt to tie up Channel 9 with lengthy and frequent roll calls, apparent practice drills, even "parade control" and other activities that don't belong on this channel—but would be perfectly acceptable on other channels.

Don't let anybody bully their way into letting you think that they have a special claim on Channel 9. If they press the point, contact the nearest field office of the FCC and file a formal complaint citing deliberate in-



Several groups sponsor CB Channel 9 monitors, but all expect that affiliated local teams will use the channel properly and with courtesy.

terference. Specify the dates, times, and complete details of each incident. You may also wish to furnish the FCC with tapes showing typical examples of the misuse of the channel. Since the several national organizations that sponsor some of these

groups/teams don't like their local representatives to attempt to illegally hog Channel 9, complain to them, too.

This is *your* column. Please let us hear from you with information, photos, 27 MHz QSL's, and other CB-related material. **PC**

10 Meter Enhancement Is Here

For the first time novices and technicians have HF phone privileges and what better way to enjoy DXing than with the all NEW AR-3500 ALL MODE 10 meter mobile transceiver.

- Computer controlled for greater ease of operation and more standard features.
- Switchable ANL and high gain NB



- Improved circuit designs help eliminate strong signal interference and SSB selectivity is now 2.6 KHz.
- Two models fit both your power requirements and pocketbook – 30 & 100 watts.

Available accessories:

CW break-in circuit board, with all mode power level control

SP-1 Audio speech processor, raises average "TALK POWER" to within 10% of power peaks without clipping or compression



RF PARTS
COMPANY
1320 Grand San Marcos
California 92069

For Same-Day Shipment

Call: (619) 744-0728

Visa/Mastercard/C.O.D.

CIRCLE 10 ON READER SERVICE CARD

ANTENNAS AND SIGNAL IMPROVING ACCESSORIES

Strictly Ham Radio Listening Part One

Never has there been such a sharp rise in Ham radio listening among radio listeners. Never have there been better reasons for tuning the Ham bands. The increase of repeaters on the 144 MHz (2M) and 450 MHz (70CM) bands bring a lot of interesting listening for scanners, especially during the evening hours. These activities will rise sharply with the long-term increase in Ham activities as a result of the FCC grant of Novice phone privileges on 220 MHz (1.25 M).

In turn, many current and new Novices are expected to put the pressure on themselves to obtain their Technician's licenses so they can occupy the other VHF/UHF bands. Novices and Technicians can now also operate phone on 10 meters which will make things more interesting there and put more signals on the air as well. In fact, activities are increasing at an amazing rate because many of the receivers used previously by Novices for CW use only are already equipped for immediate phone operation on 10M. These licensees, too, are now pushing for their general license so as to increase DX'ing variety and for more complete operating privileges.

And there is more. Modern receivers now come equipped with the sideband mode. Unfortunately, sideband is seldom used by the strictly radio listener. Give it a try and enjoy two-way radio contacts among radio Hams. Sideband is a mode that is free from the audio distortion that occurs with "selective fading" when you tune in shortwave AM stations. Thus the sideband mode can often be used to improve the intelligibility of shortwave radio broadcast reception when there is serious fading.

And last but not least, sunspot activity is on the rise and will peak some time in the early 1990's. This means more receivable long-distance signals that will be stronger, more reliable and more consistent for longer periods of time. The radio Amateur bands 10M, 12M and 15M bands are especially exciting during the years of high solar flux. Expect more activity on the 11 and 13 meter shortwave bands as well.

You can have evenings of enjoyment listening to the various activities that are a part of repeater operations. In most areas there are at least several receivable repeaters, mostly on 2M and 70CM now. There will be more to come with the rise in operations on the 1.25M band.

One of the favorable attributes of the various bands from 70CM to 15M is that very simple antennas do extremely well. They are much smaller. Even on 15 meters, which is the lowest frequency band, a half-

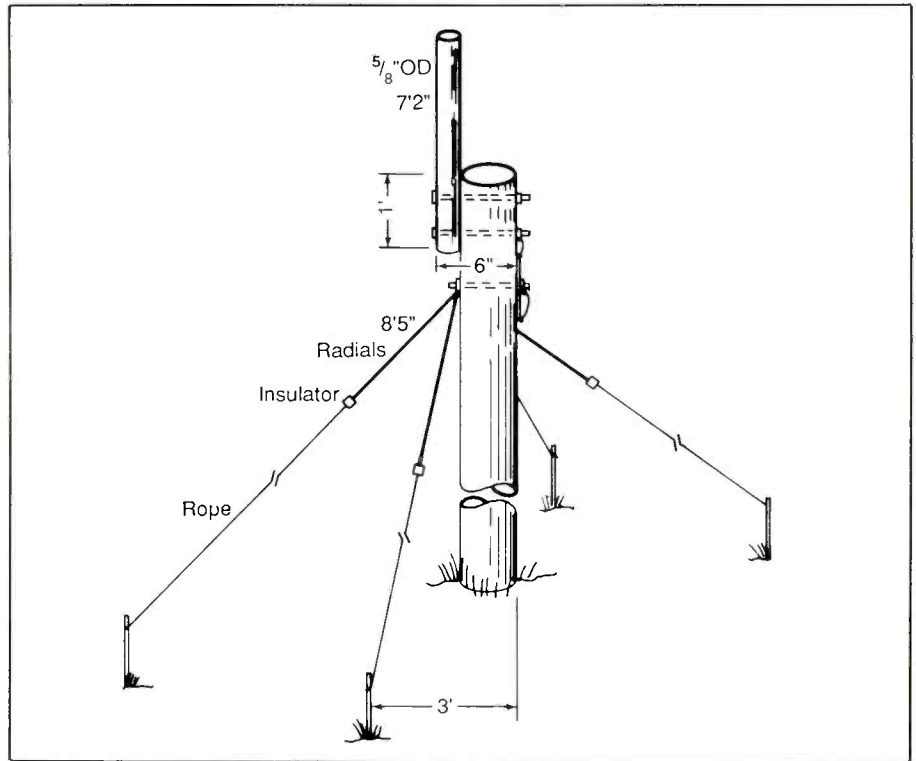

Figure 1: $\lambda/4$ -10M vertical ground plane.

wave dipole is only 23' in total length. On 70CM a quarterwave vertical is less than 7'. In this article, a home-brew 10 meter vertical ground plane is described. Excellent on this band, it can be used as a reasonably good antenna on a number of other bands, too. Next month the topic will be antennas that can be used for VHF/UHF Ham band reception.

An easy-to-erect and inexpensive 10M ground-plane vertical, Fig. 1, consists of a PVC mast, a 7'2" length of $\frac{5}{8}$ " OD aluminum tubing, some #16 vinyl-covered hook-up wire, four end insulators, coaxial line-to-dipole connector and coaxial cable. The aluminum tubing was bolted to the mast top and again approximately 1' down from the top of the mast, Fig. 2. The inner conductor of the dipole connector is connected to this lower bolt of the aluminum tubing.

First, the two wires of the coax-to-dipole connector were cut back to a length of only $\frac{1}{2}$ ". Short 3" lengths of #14 wire were soldered to these $\frac{1}{2}$ " extensions to provide more flexibility in making connections to the bottom of the aluminum radiator and the bolt that supports the four wire radials, Fig. 3. The connector plastic body was bolted to the PVC pipe. Next the ground side of the flexible lead as well as the four wire radials

were attached to the same bolt using ring lugs. The flexible wire of the inner conductor side of the connector was attached to the bottom bolt of the aluminum radiator. Attach the PL-258 plug of the coaxial line to the coaxial line-to-dipole connector. Tape the coaxial line down the mast to the point where it branches off to the radiator.

Next, the four 8'5" radials were attached to their individual end insulators. A rope was attached to the other end of each insulator. Four short ground stakes were spaced equidistantly around the mast and 3' out from the mast. Driven into the ground, they serve as tie-points for the rope ends that space the radials a proper distance away from the mast, Fig. 4.

The length of the aluminum radiator tubing is 7'2". When added to the wire that connects to the coaxial connector it results in an overall radiator length of 7'8". Each radial is 8'5" from the bolt to each end insulator. The length of the radiator is several inches shorter than the formula value because of the relatively large diameter of the tubing. The larger diameter tubing improves the bandwidth of the antenna and you can enjoy good reception over a wider span of frequencies.

Writing in terms of Amateur operation just

briefly, the antenna has an SWR ratio of less than 1.15 to 1 between the band extremities of 28 and 29.7 MHz. This is quite a good bandwidth and permits the radio Amateur to load up the antenna with high efficiency on any frequency, one band end to the other. If you acquire a Novice license, you will be able to use this antenna on 10 meters.

As a receiving antenna only, it performs very well over a greater span of frequencies. In fact, I used it to work DX on 15 meters with the use of a transmitter antenna tuner. However, such a tuner is not required for reception only and the antenna performed well on 10 meters, 11, 13 and 15 meters; two of these are Ham bands and the other two are shortwave broadcast bands. The most disappointing band was 11 meters because of the absence of international shortwave broadcast stations on this band. It is quite possible that international broadcasting will lose this band if a higher level of activity is not maintained.

What can you learn by tuning 10 meters?

The activities to be heard on the 10M band are several. Presently, operations are active between 28.3 and 28.5 MHz. Since Novices and Technicians operate in this frequency span you can hear them chatting among themselves as well as making contacts with higher level General, Advanced and Extra Class licensees. What a great way to bring all of these Ham licensees together. Local and regional contacts are possible most of the day. Set your receiver on upper sideband (USB) and tune finely.

When sunspot conditions are right much longer distance QSO's are possible around much of North America and Central America. South American and transoceanic contacts are possible less frequently. The latter long-distance radio communications will certainly increase as solar flux rises in the years to come.

You can enjoy a new form of DX'ing by identifying the numbers of states and countries you can receive. The results will amaze you when sunspot activity is high. Listen for a group of 10 meter operators that belong to the 10-10 Club. They try to contact as many stations as possible. In a way, this is the same as the strictly receiver listening type of DX'ing you do. You might wish to try and



Figure 2: Mast tap arrangement showing lower part of aluminum radiator, four radial wires, and dipole-to-line connector.

collect as many 10-10 numbers as you can. Each 10-10 member has his/her own specific number.

The phone operations on 10M occupy a span of frequencies between 28.3 and 29.7 MHz. When sunspot conditions are good, and often at other times, there are additional worldwide DX activities that occur between 28.5 and 28.7 MHz, especially during worldwide contests, field day and other activities. CW is permitted over the entire band but is largely concentrated between 28.0 and 28.3 MHz.

Satellite down frequencies extend from 29.5 to 29.7 MHz. If you are lucky you may hear a foreign sideband signal drop down into your area from a radio Amateur satellite.

If you have a scanner you can listen for



Figure 3: Coax line to dipole connector bolted to mast. Rear side of top bolt holds radiator; rear side of bottom bolt holds the four radial wires.

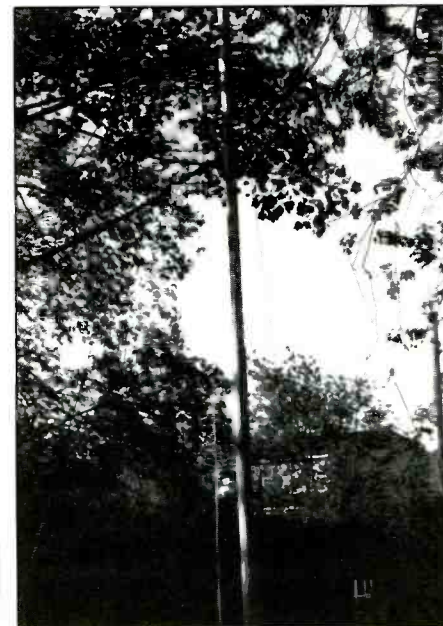

Figure 4: Four radials dropping down to ground level.

FM activities on 10 meters. The recommended FM repeater frequencies are 29.620, 29.640, 29.560 and 29.680 MHz. In recent years activities were light on the 10M band because of the minimum sunspot conditions. However, solar flux readings are beginning to rise which will make 10 meters more active and exciting. The rise will continue steadily, building up to the super years of the early 1990's. **PC**

SPECIAL!! BIG "D" Sale Prices



Regularly \$389.95

SONY ICF-2010

SALE PRICE

\$306.50

plus \$5.00 Shipping U.S.A.

- 150 kHz to 20 MHz AM, CW, SSB
- 76 MHz to 108 MHz FM
- 116 MHz to 136 MHz AM Air Band

ICOM R7000A
KENWOOD R-2000
KENWOOD R-5000
YAESU FRG 8800
YAESU FRG 9600

ICOM R71A

Prices ON REQUEST

1-800-441-0145 (IN TEXAS) 1-800-527-2156 • ask for Ham Dept.

ALSO ASK ABOUT super saving prices on Kenwood, Icom, Encorn, Yaesu and all ham items.

electronic center, inc.
ROSS AT CENTRAL EXPRESSWAY, DALLAS, TX 75201

CIRCLE 154 ON READER SERVICE CARD

and forth between the two stations. Soon you'll be able to hear the difference in speed.

Don't try, at first, to listen to the pitches of the sounds. The pitches have something to do with the shift of the signal, i.e., 170 Hz, 425 Hz, 850 Hz, etc., not the speed. Next, tune to a Ham Radio RTTY frequency, or a U.S. Army frequency (especially one of its MARS stations). They usually broadcast at 45 bauds (50 words per minute). Compare this with a 50-baud station. The difference between the two stations, although slight, is noticeable.

From time to time I make an appeal for a steady supply of loggings because there are certain times during the year in which RTTY monitoring enters a lull. This time of year, with the approach of Thanksgiving, Christmas and the New Year, is one of them. This lull results in my having to supply many of my own listings rather than yours to make up for the loss. I prefer to use your contributions because this column is "of you, by you, and for you," to paraphrase Abe Lincoln.

If our readers would send me a minimum of five loggings each during this period, I would have enough material for a hefty loggings section. The issues of *POP/COMM*, where the loggings are printed, will show an abundance of reader material, not a scarcity. Please see what you can do!

New contributors this month are: Matt Briggs, Japan; Rod Sievers, Illinois; and Frank Spierling, California. Still waiting for contributions from a RTTY monitor in Montana and one from Luxembourg!

Until next month, may all of you have an enjoyable Thanksgiving holiday. Be sure to give thanks for the improving RTTY DX'ing conditions.

Now for the main "stuffing" of this column—the RTTY loggings—none of which are "turkeys."

Abbreviations Used In The RTTY Column

AA	Arabic
ARQ	SITOR mode
BC	Broadcast
EE	English
FEC	Forward Error Connection mode
FF	French
foxes	"Quick brown fox..." test tape
GG	German
ID	Identification/led
MFA	Ministry of Foreign Affairs
nx	news
PP	Portuguese
RYRY	"RYRY..." test tape
SS	Spanish
tfc	traffic
w/	with
wx	weather

RTTY Loggings (Settings—Shift/Baud/Polarity)

4255.1: UGH, Petrapavlovsk R., USSR in 170/50N at 0735 (Patrick Sullivan, CA).
4271.4: CFH, Canadian Forces, Halifax, NS w/wx at 0730, 850/75R (Sullivan, CA).
4489: GFL26, Bracknell Meteo, England, w/coded wx at 0227, 425/50R (Editor).
4570.5: HZN46, Jeddah, Saudi Arabia w/coded wx at 0219, 850/100N (Editor).
4613.5: ELRB, Roberts Field, Montrovia, Liberia w/RYRY tape at 0212, 425/50R (Editor).
4813: LZ4A, Sofia Meteo, Bulgaria w/coded wx at 0153, was 425/50N (Editor).
4818: Tours Prefecture, France in ARQ at 0019. Heavy QRN caused garbling (Editor).

HFA3959
R GOL ;3139 HFA

-NATO KONSEYI

REYKJAVIK TOPLANTILARI YARINBAY&14

BYPZRL (A.A) A NATO DISISLERI BAKANLARUTKONSEYPCUXS 4 590)-,58)-48 YARIN 8")-,-DA'NIN BASKENTI REYKJAVIK'TE BASLIYOR. GUNDEMIN EN ONEMLI IKI MADDESINI NUKLEER SILAHSIZLANMA VE KONVANSIYONEL ISTIKRAR KONUSUNUN TESKIL ETTIGI TOPLANTI, NATO'NUN, SOVYETLERIN AVRUPA'NIN NUKLEER SILAHLARDAN ARINDIRILMASI ONERISINE CEVAP HAZIRLAMA ASAMASINDA BULUNMASI ACISINDAN DA ONEM TASIYOR. ANCAK NATO'YA YAKIN KAYNAKLAR, BU KONOUDA ITTIFAK UYEPERI ARASINDA HENUZ TAM BIR GORUS BIRLIGI SAGLANAMAMIS OLMASINA DIKKATI CEKIYORLAR. TOPLANTIDA GUNDEME GELECSK OLAN DIGER BIR KONU DA KORFEZ SAVASI VE OZELLIKLE AMERIKAN ''STARK'' FIRKATEYNINE YAPILAN SALDIRIDAN SONRA ORTAYA CIKAN DURUM. ABD'NIN KORFEZI DENIZ TRAFIGINI ACIK TUTMA KONUSUNDA NATO MUTTEFIKLERINDEN DAHA FAZLA YARDIM ISTEYECEGINE KESIN GOZUYLE XAKAN UZMANLAR, KONUNUN ABD DISISLERI BAKANI GEMRGE SHULTZ TARAFINDAN GUNDEME GETIRILMBSININ BEKLENDIGINI BELIRTTILER.

The attack on the American frigate, the USS Stark, is mentioned in this Turkish news broadcast from Anadolu Ajansi, the press service at Ankara, Turkey. This item was monitored on 18040 kHz at 1227 UTC, 50/850R. (From the collection of Robert Margolia.)

4268.6: SAB23, Goteborg R., Sweden w/tfc in ARQ at 0111 (Editor).
4489: GFL26, Bracknell Meteo, England w/coded wx at 0231, 425/50R (J.M., KY).
5118: TYE, ASECNA, Cotonou, Benin w/RYRY QJHI marker at 0155, 170/50N (Jerry Brumm, IL).
4288: 98BGL of the Japanese Navy w/RYRY & SCSG at 0532, 850/75R (J.M., KY).
6736: ETD3, Addis Ababa, Ethiopia w/coded wx at 0105, 850/50N (Editor).
6935: RFLI, French Navy, Fort de France, Martinique idling w/o tfc for many hours, TDM 850/96 after 0400 (Editor).
7524: Un-ID sta w/encryption, ZCZC header on each msg, was TDM 550/96 at 0419 (Editor).
7657: 6VU, ASECNA, Dakar, Senegal idling at 0545, TDM 425/96 (Editor).
7808: 4UZ, UN Geneva, Switzerland w/msg in EE "Nolan to McGregor" at 0134, 425/75R (Editor).
7830: AFA2ER, a USAF MARS sta w/tfc for AFAIDA at 0110, 170/45R (A. Nonymous).
7887: 4UZ, UN Geneva, Switzerland w/RYRY & QRA tape at 0459, 425/75R (J.M., KY).
7980: Y3I, Potsdam Meteo, GDR w/coded wx at 0326, 850/100R (Editor).
8007: Y7A35, MFA Berlin, GDR w/GG text that mentions chemical warfare. Was 100R at 1440 (Peter T., England).
8022.2: FT12HI, AFP Paris, France w/AA nx at 0336, 425/50N (Editor).
8023.6: FT12H3, AFP Paris, France w/nx in FF at 0337, 425/50N (Editor).
8028.4: Un-ID sta, possibly of USN w/"Very Quick Brown Fox" marker at 0358, 170/75N (Editor).
8060: RAW71, TASS Moscow, USSR w/RYRY at 0408, 425/50R (Editor).
8081: SOI208, PTT Warsaw, Poland w/Telexes to PTT Beijing. Was 50R at 1505 (Peter T., England).
8105: Volograd, USSR to Kaliningrad, USSR w/tfc in RR at 0520, 425/50N (Editor).
8123: TNL, ASECNA Brazzaville, Congo idling at 0617, TDM 425/96 (Editor).
8154: SNN299, MFA Warsaw, Poland w/tfc in Polish at 0627, 170/75N (Editor).
8175: JAE58, Kyodo, Tokyo, Japan w/RYRY & foxes, 50R at 0050 (Matt Briggs, Japan).
8302: 99PAB, another Spanish Navy fantasy ID w/RYRY & SCSG & foxes at 0240, 100/75N (J.M., KY). Must be getting to be about 100 of these ID's. Maybe we should put up a sign with an official count, like McDonald's hamburgers--Editor.
9041: 5YE, Nairobi Meteo, Kenya w/coded wx at 0450, 850/75N (J.M., KY).
9047.5: Y2J, DP Berlin, GDR w/RYRY & QRA at 1523, was 50N (Peter T., England).
9070: 6VU, ASECNA Dakar, Senegal w/RYRY at 50 bauds (Dave Alpert, NY); Same at 0306, 170/50N (Brumm, IL).
9117.7: PCW1, MFA The Hague, Netherlands w/CW ID followed by ARQ phasing sig at 0010. On this way for hours w/o tfc (Editor).
9133: ZAA6, ATA Tirana, Albania w/nx in EE at 0909, 425/50R (Dollas Williams, CO).
9223.2: TJK, ASECNA, Douala, Cameroon at 0334 w/RYRY-QJHI, 425/50R (Editor).

9347.5: STK, Khartoum Aero, Sudan w/RYRY at 0200, 170/50R (Brumm, IL).
9846: TUH98, Abidjan Aero, Ivory Coast w/RYRY at 2314, 425/50N (Editor).
9848: SUA, ASECNA Niamey, Niger w/RYRY-QJHI at 0152, 425/50N (Editor).
9886.5: GFL23, Bracknell Meteo, England w/coded wx at 1203, 425/50R (Editor).
9909: Un-ID sta w/RYRY, Now Is The Time For All Good Men... & foxes (jumping over a dog's tail, no less), at 1156 in 425/50N (Editor).
9994: CSY, Santa Maria Aero, Azores w/aircraft pas rpts & coded wx at 0115, 50 bauds (Aplert, NY).
10436: ZAY, ATA Tirana, Albania w/nx at 1450, 500/50N (Williams, CO).
10489: 5KM, un-ID sta w/RYRY & "Esta Es Una Cinta de Prueba de 5KM," was 170/75N at 1930 (Brumm, IL). 5KM is Bogota Naval R., Colombia. Readers should write down this call sign since it's never shown in popular RTTY monitoring directories--Ed.
10524: HMF45, KCNA Pyongyang, N. Korea w/nx in FF at 1211, 425/50N (Williams, CO).
10536.5: CFH, Canadian Forces, Halifax, NS at 1975 w/wx plaintext & coded, 850/75R (Tom Kneitel, NY).
10640: AZAP nx in FF dram Kinshasa, Zaire at 0708, 425/50R (Editor).
10710: JAG30, PL Tokyo, Japan at 1109 w/nx in SS, 850/50R (Williams, CO).
10900: Text in un-ID language, TTY designators in EE, however MFA Jakarta, Indonesia listed here in Kneitel's "Guide To Embassy & Espionage Communications" (Editor).
10916: RFTJ, French Navy, Dakar, Senegal idling w/occasional ID after 0714, TDM 850/96 (Editor).
10960: 3MA28, CNA Taipei, Taiwan w/nx item re fishing talks w/Argentina, noted at 1515, 850/50N (Brumm, IL).
10971: VOA Tangier, Morocco w/European File nx in EE at 0030, 75 bauds (Alpert, NY).
11027.5: 9PL, Kinshasa Aero, Zaire w/coded wx at 2250, 425/50R (Thomas Yingling, MD).
11063: LZU2, Sofia Meteo, Bulgaria w/coded wx at 1757, 425/50R (Kneitel, NY).
11070: PTT Havana, Cuba w/RYRY & foxes to PTT Shanghai, PRC at 1207, 425/50R (Editor); At 1150 ID'ing as "Radio Havana" testing to Shanghai ("Shai"), 425/50R (Kneitel, NY).
11100.5: CAK, Santiago Aero, Chile w/aviation wx at 0723, 850/50N (Editor).
11380.5: Un-ID sta w/5L ifc, 75R at 2245 (Briggs, Japan).
11420: VNAB6, VNA Hanoi, Vietnam w/nx in Vietnamese at 1430, 500/50R (Editor).
11431: HMF55, KCNA Pyongyang, N. Korea w/nx in FF at 2251, 170/50N (Briggs, Japan).
11493.2: SOL249, PWP Warsaw, Poland w/test tape in RR & RYRY at 1502, 425/50R (Editor).
11502: BTA Sofia, Bulgaria w/EE nx 1346 to s/off 1350, 425/50N (Editor).
11536: HMF49, ATCC (KCNA) Pyongyang, N. Korea w/nx in FF starting abt 1145, 275/50R. Was //HMF36 on 13580 kHz (Fred Hetherington, FL).
11541: 70C, Khormaksar Aero, S. Yemen w/RYRY at 2243 to 0000 s/off, 425/50N (Editor).

11638: DDKB, Hamburg Meteo, FRG w/coded wx at 1025, 425/50R (Editor).

12108: IRJ21, ANSA Rome, Italy at 1107 w/nx in FF, 425/50N. Weak & garbled (Kneitel, NY).

12175: FDY, French Air Force, Orleans, France w/RURY at 2008, 425/50R; on another day HMF42 of KCNA Pyongyang, N. Korea w/nx in EE at 2130, 425/50R (Yingling, MD).

12275.4: JAL82, Kyodo, Tokyo, Japan w/RURY at 0551, 850/50R (Sullivan, CA).

12493.2: CGCFB, ship **Viking Merlin** in ARQ at 1640 w/nx items in Swedish. Why is a ship sending nx? Possibly acting as a relay for R. Goteborg, Sweden (Editor).

12494: Ship **Atiserv-x** calling FFL for a selcall check, ARQ at 1145 (Kneitel, NY).

12693.4: 980QJ, Spanish Naval unit, calling 95XRA & RURY at 1033, 850/75R (Kneitel, NY).

12750: NMO, CG Radio, Honolulu w/plaintext nx/wx from AFRTS Los Angeles at 1734, 170/75R (Editor).

12760: UFB, Odessa R., Ukrainianian SSR w/wx in GG at 1908, s/off in RR, was 170/50N (Editor).

12840.8: PBC312, Dutch Navy, Goeree Island, Netherlands w/RURY at 1932, 850/75R (Editor).

13021: One of the traditional exasperations of RTTY monitoring is tuning to a sta only to find it going silent when you finally get your demodulator adjusted properly. Here I tuned an FEC sig at 1650 that was found to be idling for maybe 30 sec before s/off. My guess is that it was SPE63, Szczecin R., Poland which is listed here with RTTY (Editor).

13054: UJY, Kaliningrad R., USSR w/telegrams to ships at 1641, 170/50N (Editor).

13071.5: UMV, Murmansk R., USSR w/RR t/c to a ship at 1025; ARQ on this new freq (Hetherington, FL).

13076: VIP40, Perth R., Australia w/callsign in CW while idling in FEC at 1226 (Hetherington).

13077: NRV, USCG, Apra Harbor, GU in FEC at 0905 w/Hydropac notice of rocket firings by Japan in East China Sea (Hetherington, FL).

13077.5: VPS63, Victoria Island R., Hong Kong at 1220, FEC mode (Hetherington, FL).

13078: VIS67, Sydney R. Australia, idling in FEC w/call in CW, 1230 (Hetherington, FL).

13082: EAD, Aranjuez R., Spain w/callsign in CW at 1633 followed by ARQ phasing sigs (Editor).

13086: UKA, Vladivostok R., USSR w/RR t/c to ships at 0925, 170/50N (Hetherington, FL).

13092: UMV, Murmansk, USSR at 1015 w/RR t/c to ships, 170/50N (Hetherington, FL).

13095: LZW, Varna R., Bulgaria w/callsign in CW while idling in ARQ at 1300 (Hetherington, FL).

13128: HJN2, Bogota R., Colombia in ARQ to ships at 1300 (Hetherington, FL).

13145: PCW1, MFA The Hague, Netherlands idling in FEC while calling CW at 2215 (Hetherington).

13440: YZJ5, TANJUG Belgrade, Yugoslavia w/nx in EE, 425/50R (Editor).

13510: CFH, Canadian Forces, Halifax, NS at 1155, 850/75R w/RURY & freq data. Said they used 13510 from 1000-2200; that freqs 122.5, 4721, 6330, 10536 were used around the clock, 122.5 shut down for maint 2nd Thurs of each month 1200-1600 (Kneitel, NY).

13530.4: RVW53, Moscow Meteo, USSR w/RURY & coded wx, 950/50R at 1226 (Editor).

13563.1: 3MA22, CNA Taipei, Taiwan w/nx in EE at 1342, 850/50R (Editor).

13580: HMF36, KCNA Pyongyang, N. Korea w/nx in FF at 1204, 225/50N (Williams, CO); Same logged at 1226 but 225/50R (Kneitel, NY).

13585: HBD20, MFA Berne, Switzerland w/RURY at 1326, nx in FF at 1330, FEC mode (Editor).

13647: OL15, CTK Prague, Czechoslovakia w/nx in FF at 1203, 425/50N (Williams, CO); Same at 1200 (Kneitel, NY).

13649.5: RFFP, French Air Force, Paris, France at 1522 idling in TDM 425/96 (Editor).

13728.3: FPN72H1, AFP Paris, France w/nx in FF at 1512, 425/50N (Yingling, MD).

13737: 5YD, Nairobi Aero, Kenya w/coded wx at 1838, 425/50N (Editor).

13752: HZJ, Jeddah Meteo, Saudi Arabia w/coded wx at 1835, 425/50N (Editor).

13770: VOA nx in FF at 1138, 425/75N (Kneitel).

13779: BCA95, PTT Shanghai, PRC at 1133 w/RURY asking "ZHC?", 425/50R (Kneitel, NY).

13780: HMF35, KCNA Pyongyang, N. Korea w/nx in RR at 1245, 225/50R (Williams, CO).

13822: CLA1, MFA Havana, Cuba at 1135 w/SS telegrams to Embacuba Mozambique, Ethiopia, Benin, Guinea Bissau, etc.

13940.2: USMC HQ Washington, DC w/msg that "7301 kHz is available for us," 170/75N at 1456, then into crypto, 425/45N (Editor).

13975.5: NPG, USN Commsta, Stockton, CA w/msgs, 170/45R at 0345 (A. Nonymous).

13992.8: 5LA, VOA Monrovia, Liberia from 2330-0200 w/nx, editorials & advance text of Presidential speech, 425/75R (A. Nonymous)

14367: BZP54, XINHUA Beijing, PRC w/nx item re output of notion's breweries, 1150 in 425/50R (Editor).

14497.5: CSY, Santa Maria Aeradio, Azores w/coded wx at 1919, 50N (Brumm, IL).

14622: Raws & rows of "ADWWRSF" at 1730, 425/100N (Frank Spierling, CA). What you snagged here, Frank, was a Time Division Multiplex (TDM) xmsn which needs a special demodulator such as an Info-Tech M-6000 to decode. There are several RTTY stas on or near this freq, so I can't pin down the one you copied. But since it appears that you were monitoring this w/the rcvr set to USB mode, accounting for a lower kHz reading, it's entirely possible that it's FUF, the French Navy at Martinique-- not long ago Fred Hetherington logged FUF on 14625 w/a 850/96 TDM xmsn. I've never personally logged anything but idling on the freq-- Editor.

14642.2: Czech Embassy in Havana, Cuba w/t/c in Czech to Brno, Czechoslovakia at 1323, 425/75N (Editor).

14663.5: MFA, Bonn, FRG idling in TDM 170/96 at 1112 (Editor).

14760: CNM61, MAP Rabat, Morocco w/RURY & sked info at 1149, 425/50R (Kneitel, NY).

14824: XVH w/freq list at 0920, 170/50N (Briggs, Japan). XVH is either PTT Hanoi or Hanoi Meteo, Vietnam-- but my ref books don't show XVH here at all-- Editor.

14824.2: RURY w/o ID at 1100, 425/50N. At 1107 sent "Mira GA en la PL 203 Linea Nr 198..." then at 1113 RURY & similar msg. My guess is either PTT or PL Havana (Editor).

14944.5: CLP1, MFA Havana, Cuba w/Prensaminex nx in SS at 1353, 425/50N (Editor).

15508.5: SOP250, PAP Warsaw, Poland w/RURY & QRA at 1652, 425/50R. Was //SOT265 on 18650 kHz (Editor).

15580: Un-ID sta w/RURY & nx in EE at 1515, 425/50R (J.M., KY). It's REM58, TASS Moscow, USSR-- Ed.

15667: FDY, French Air Force, Orleans, France w/RURY & the ol' brick test tape, 1713, 425/50N (Williams, CO).

15670: HGM36, MTI Budapest, Hungary w/nx

in SS at 1616, 50R (Rod Sievers, IL).

15710: RWN76, TASS Moscow, USSR, w nx in FF at 1345, 50N (Sievers, IL).

15930: RB178, TASS Moscow, USSR w/nx in FF at 1230, 425/50R (Kneitel, NY).

16119.8: HBD20, MFA Berne, Switzerland w/nx in FF at 1540, ARQ (Editor).

16134: CNM71-9X, MAP Rabat, Morocco w/nx in FF at 1625, 425/50R (Editor); w/RURY & skeds at 1158 (Kneitel, NY).

16150: 9VF205, Jiji, Singapore w/nx in EE at 1332, 425/50N (Editor).

16187: 4UZ, UN Geneva, Switzerland w/telexes at 1218, 425/75R (Williams, CO).

16209.5: SOQ221, PAP Warsaw, Poland w/RURY & QRA at 1524, 425/50R (Editor).

16292.2: UN t/c going from Addis Ababa, Ethiopia to Rome, Italy at 1227, 425/75R (Editor).

16348: CLN530, PL Havana, Cuba w/nx in EE at 1620, 425/50N (Yingling, MD).

16356.3: Y7L, GDR embassy in Havana w/5L t/c to Mexico, 350/50N at 1604; then to 350/100N for nx in GG (Editor).

17364: "MUN" w/5L t/c at 1319, 600/50R; "DRILL/BT" at end of msg & various Q & Z code sigs, then "DE MUN", more Q/Z codes, RURY & foxes w/ID. Comms ended at 1345 (Editor).

18257.5: Un-ID idling in ARQ 1258-1400, then come "Negativo 192-197 KK," a pause until 1410 then "QSL AR QRU VA KIO KK BS HR QRU OK HE GAP," and s/off (Editor).

18697: DFS70, DPA Hamburg, FRG w/nx in EE, 50N at 1429 (Sievers, IL).

18965: RFL1, French Navy, Fort de France, Martinique idling or sending "Controle de voie," TDM 850/96 at 1731 (Editor).

20430: IRS24, ANSA Rome, Italy w/RURY-QRA at 1549, 425/50R (J.M., KY).

20840: Y7A82, MFA Berlin, GDR w/5L t/c, 525/50 at 1335 (Kirk, CT).

20863: FDY, French Air Force, Orleans, France w/le bricks at 1336, 425/50R (Kirk, CT). **PC**

NEW 20-PAGE CATALOG FREE

7 MILLION TUBES

Includes all current, obsolete, antique, hard-to-find receiving, transmitting, industrial, radio/TV types. **LOWEST PRICES.** Major brands in stock.

Unity Electronics Dept. P
P.O. Box 213, Elizabeth, N.J. 07206



CIRCLE 14 ON READER SERVICE CARD

SWL Receivers, Antennas, Books
ICOM KENWOOD YAESU

Michigan Radio

Sun, Mon — Closed
Tue, Wed — 10-6
Thu, Fri — 10-9
Sat — 10-4

313-469-4656

We accept Visa, Mastercard & COD's

28360 South River Rd. • Mt. Clemens, MI 48045



BUGGED ???

Find hidden radio transmitters (bugs) in your home, office or car. The TD-17 is designed to locate the most common type of electronic bug—the miniaturized radio transmitter—which can be planted by anyone, almost anywhere.

The TD-17 warns of the presence of nearby RF transmitters, within the frequency range of 1 MHz to 1,000 MHz, when the RF Alert LED turns on. The flashing Range LED and audio tone give an indication of the distance to the bug. The Sensitivity control, used in conjunction with the two LEDs, helps you quickly zero in on hidden bugs.

The hand-held TD-17 weighs less than 7 oz. and is housed in a high-impact plastic case. Furnished complete with battery, antenna, instruction manual and one year Limited Warranty. Save \$100 to \$200 and order at our factory direct price of only \$98. Satisfaction guaranteed or your money back. Catalog \$1 or FREE with order.

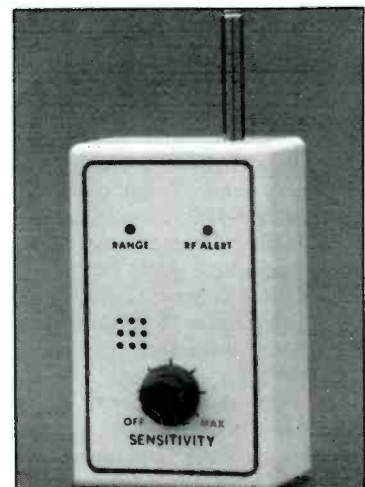

CAPRI ELECTRONICS
P.O. Box 589G
Bayfield, CO 81122
(303) 884-9084

Please send all reader inquiries directly.

NEW AND EXCITING TELEPHONE TECHNOLOGY

Touch-Tone And The Phone System

These days it is difficult to find a telephone that is not Touch-Tone. Some residential phones that have been in place for some years are rotary; very, very few business phones are Touch-Tone. It is almost impossible to find a rotary pay phone, as they are universally Touch-Tone.

Touch-Tone is the AT&T registered name of the dialing system that uses two tones rather than dial pulses. Some U.S. phone companies refer to it as "Touch Dialing" or "Tone Dialing." The technical name for Touch-Tone is Dual Tone Multi-Frequency (DTMF). In Europe, Touch-Tone is referred to as Multi-Frequency (MF).

Do not confuse European MF Touch-Tone with what is called MF in the U.S. phone system. In the U.S., the tones used for control of long-distance calling and billing information are known as Multi-Frequency (MF). You can often hear MF signalling in the U.S. as a train of rapid pulses that follow the completion of your dialing a long distance number.

The notorious "blue box" dialers of the Sixties that allowed you to make "free" long distance calls were MF generators. These days, most telephone exchanges have been modified to ignore or disallow any MF signals generated from a subscriber's phone line. Today's radicals have to pay their phone bills. Gone are the happy days of the Sixties when you could call home from college for more money while cheating the phone company.

The old style of dialing (rotary or pulse) has many disadvantages. The most obvious disadvantage is, of course, speed. A rotary dial produces pulses at a rate of about eight to ten per second, this means dialing a zero takes about one second. Dialing 998-9008 takes ten seconds. With Touch-Tone, it takes the same length of time to dial a one as a zero. The minimum length of time a digit may be dialed is 100 milliseconds or one-tenth of a second. Using the same example above, it would take about one second to dial 998-9008. The average dialing time for a long-distance call is 18 seconds for pulse and three seconds for Tone.

The other great advantage with Touch-Tone is that microprocessor-controlled equipment can generate and recognize the Touch-Tone numbers. This feature has not been ignored by the companies providing banking by phone services.

The real advantage of Touch-Tone is that it can travel the length of a circuit and control equipment at the other end of the earth. Pulse dialing is an interrupted DC system, it will only work on copper wire with DC volt-

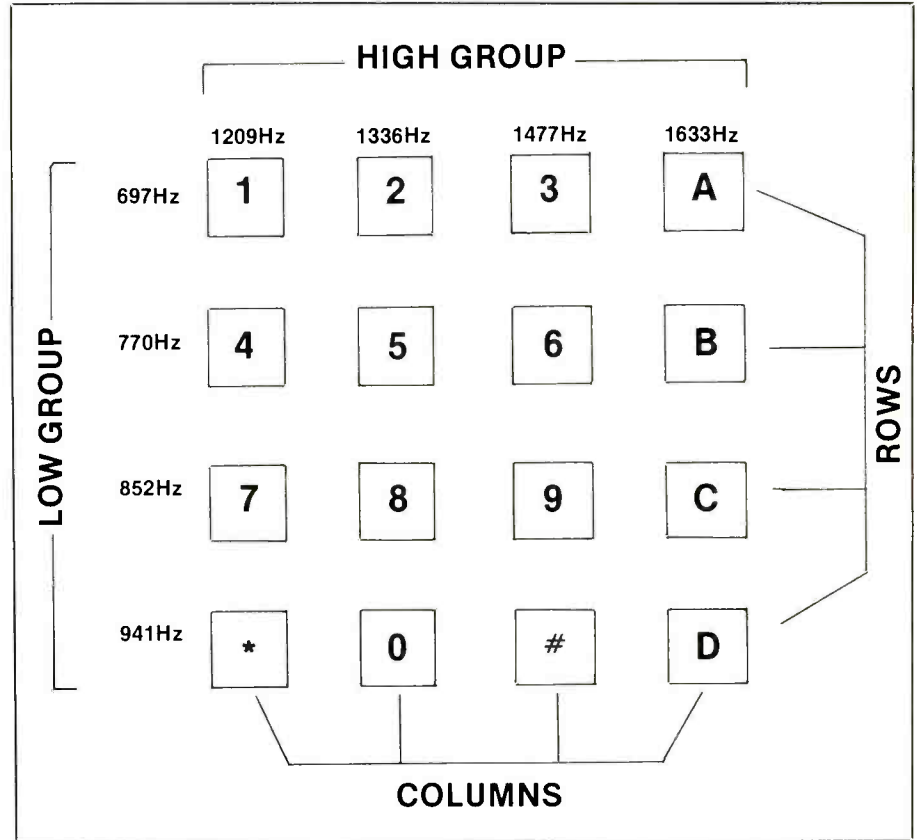

Figure 1: Touch-Tone pad, rows and columns.

age on it and then only to the nearest exchange. If you dial a number with a rotary dial while connected, all the other end will perceive is a dull clicking. Touch-Tone will work over radio circuits, digital circuits, modulated light or any mode that will also carry voice. With the introduction of microwave circuits, digital encoding and mobile phones, the telephone industry needed Touch-Tone.

The sound that a caller hears when dialing a Touch-Tone phone is a mixture of two tones. Tones called the "low group" make up the "rows." (See Fig. 1.) The other tones called the "high group," occupy the columns. When the button 5 is pushed, 770 Hz and 1336 Hz are generated. These tones are within three dBm of each other in level. The difference in level between the two tones is called "Twist."

The total level sent down the phone line is between zero and -12 dBm. In telephone use, zero dB is 1 milliwatt across 600 ohms or 0.775 volts across 600 ohms. This level is loud, although when dialing it doesn't seem loud because the telephone receiver is mut-

ed. The transmitter or microphone is usually muted also. The transmitter is muted to prevent "talk-off," which means the falsing of dialing caused by extraneous voice frequencies. If you want to hear how loud Touch-Tone can be, listen on an extension phone while someone else dials on another phone.

The first Touch-Tone pads were strictly mechanical, a hodge-podge of cams and gears that plucked metal reeds that generated the tones. The next generation was composed of cams that selected switches for muting the handset and tuning an LC circuit to generate the tones. Modern Touch-Tone pads are usually a single Integrated Circuit. Selection of tones and muting is done electronically. Some of these circuits have added features such as Pulse or Tone generation, memory or redial. The early pads cost about \$16. each. Modern pads cost about \$6.

The standard Touch-Tone pad has only three columns. There is a fourth column, it has a frequency of 1633 Hz. The fourth column buttons are given letters not numbers: They are A, B, C and D. Pads with a fourth column are rarely seen and they are used by

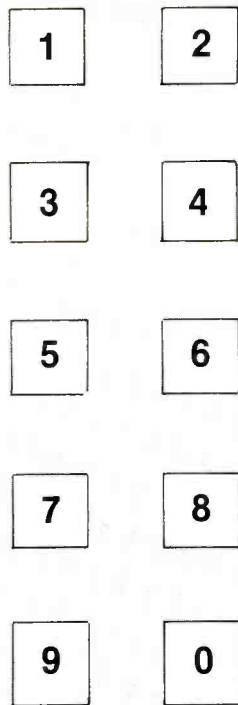

Figure 2: The 2 x 6 Touch-Tone pad. This is the easiest style to use.

the U.S. military for the "Autovon" phone system. Hams and two-way radio users use such pads for control purposes. In Europe, some PBX's use the four column pads for accessing features. Although the last column buttons are not normally found on consumer telephones, the circuitry is capable of generating the tones.

Most accountants and bookkeepers looking at Touch-Tone phones wonder why the numbers are left to right and top to bottom, the opposite from adding machines. They think that telephones are really dumb because, "Everyone knows how to work a ten key (adding machine), so why are phone keypads upside down?" Actually telephone keypads are the right side up, they are laid out the way a reader of the Roman alphabet would read them. If you don't like the layout of your Touch-Tone pad, blame Bell Labs. Before you dash off a nasty-gram, read on to find out why the pad is the way it is.

Back in the old days when modern telephones had rotary dials, the boffins at Bell Labs had to figure out how to lay out the buttons. Bell approached the problem in its usual way; round up a few Ph.D's and set them to work. They took the ten buttons, 0 to 9 (there was no * or # in the early days), and tried various ways of laying them out. They tried every possible way, running from 1 to 0 and backwards from 0 to 1. All their solutions were then tried on ordinary members of the public, not accountants who used adding machines.

What they found was that the best way to lay out a pad so that dialing could be fast and

error-free was two columns and five rows (see Fig. 2). The snag with this layout was that it would not fit well onto a standard desk phone. Instead, Bell Labs plumped for the second-best pad layout for speed and accuracy; the three column pad that is now on your phone. Accountants should also bear in mind that the Touch-Tone pad was invented about thirty years ago—some time before the electronic calculator found its way into every briefcase. They should also bear in mind that the most error-free pad layout is on phones, not adding machines. Worrying isn't it? Because Denmark didn't get Touch-Tone until the late 1970's, their phones have the numbers on their pads upside down, just like adding machines.

Sooner or later, most phone users worry about the funny little marks on each side of the zero. The * mark, usually called "star," is "asterisk." The correct name for the # mark is "octothorpe" so most people just say "pound." These two little keys are usually used for control purposes. Many interactive computer systems will ask you to enter star or pound for various functions.

One universal use for the octothorpe is for international dialing. Every country has their own limit of digits that make a complete long distance telephone number. In the U.S. it is eleven—1(234)-567-890A. Britain, for example, has several standards with area codes of varying lengths—London's area code is 01, Brighton's is 0273.

So how does the phone equipment know you have finished dialing? Either it times out assuming you have finished if no digits are detected after a certain time, or you enter an octothorpe at the end of the number. The octothorpe tells the equipment that the number has been entered and to start processing it. Phone subscribers with custom calling will also know that for some features they can dial the octothorpe to tell the Central Office they are finished rather than waiting five seconds or so for the time-out.

Touch-Tone was invented by the phone company for the convenience of the phone company. One thing it does for the phone company is save them money by tying up their equipment for less time allowing more fee-paying subscribers to use it. Also, the new electronic exchanges are designed to work with Touch-Tone; that they work with pulse dialing is an afterthought. So why does the phone company charge subscribers up to \$2.21 per month to allow them to use Touch-Tone? They claim the money is to pay for the equipment they need to add to the line of Touch-Tone subscribers. This was true in 1961, but is a patent lie today. In the old days, if you were on an ancient step-by-step switch, your line had to have a "Tone to Pulse" converter hung on it. There are almost none of these obsolete exchanges left in the U.S.

The other type of exchange in use in the late Fifties and early Sixties was the Cross-Bar. With a Cross-Bar exchange, one "Tone to Pulse" converter is needed for every one hundred numbers. This means

that if all 100 subscribers pay for Touch-Tone, the phone company is being paid over 99 times their usual rental fee. The computerize exchanges are designed for Touch-Tone, and work best with Touch-Tone, but you have to pay up to \$20 for a phone company employee to sit at a keyboard and tell the computer to allow you to use Touch-Tone for which you will pay a monthly fee forever. This is like charging people for the right to breathe air.

On some of the electronic exchanges, the phone company plays tricks, because they can tell if Touch-Tone has been used on the line. One scenario goes like this: the phone company leaves the feature turned on and when you use a Touch-Tone phone on the line, they send you a nasty letter telling you to pay up. If you don't pay up so they can "officially" turn you on, they sit at a keyboard and deny you the service—there is no "service charge" for turning off this feature—I wonder why?

The other scenario develops when they leave it off. Then, if you try to use Touch-Tone, a "We know you tried to use Touch-Tone" letter arrives explaining how they can turn it on for a fee. How generous of them! It is an inconvenience to the telephone company to have people dial through their fancy computerized exchanges with rotary dial phones. Maybe they should charge all those subscribers with 1920's technology rotary phones and not the people using modern Touch-Tone.

PC

Signal Intensifier \$29.⁹⁵

(ADD \$3 S/H)
(NYS ADD 7.5% TAX)

A HEARING AID FOR YOUR RECEIVER OR SCANNER!

- : Hear ALL the action with your receiver!
- : Make small antennas perform like BIG ones!
- : The State of the Art in WIDEBAND preamps!
- : Make those distant stations seem nearby!



BUILT TO LAST!
FULLY ASSEMBLED!
110 VAC POWERED!
MADE IN THE USA!

RFA-16B 30MHz - 1000MHz
VHF Low / VHF Hi / UHF / FM Bndst
TV / Aviation / Cellular Telephone
F Connectors standard. 15 DB gain!

RFA-20 300kHz-50MHz
SW / AM Broadcast / Maritime / Ham
CB / MF / HF 13 DB gain!
SO 237 Connectors standard.



ELECTRON PROCESSING INCORPORATED
P.O. BOX 708
MEDFORD, NY 11763 (516) 764-9798
ADD \$3 S/H NY ADD 7.5% TAX CHECK / COD

CIRCLE 17 ON READER SERVICE CARD

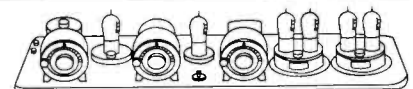

**IF YOU BUY, SELL OR COLLECT
OLD RADIOS, YOU NEED...**
ANTIQUE RADIO CLASSIFIED
**Antique Radio's Largest-Circulation
Monthly Magazine**

Articles - Classifieds - Ads for Parts & Services
Also: Early TV, Ham Equip., Books,
Telegraph, 40's & 50's Radios & more...

Free 20-word ad each month. Don't miss out!

Sample - Free. 6-Month Trial - \$10.

1-Year: \$18 (\$24 by 1st Class). Foreign - Write.

A.R.C., P.O. Box 2-T3, Carlisle, MA 01741

CIRCLE 18 ON READER SERVICE CARD

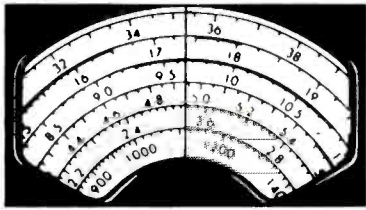

COMMUNICATIONS CONFIDENTIAL

BY DON SCHIMMEL

YOUR GUIDE TO SHORTWAVE "UTILITY" STATIONS

The mailbag was again overflowing this month and we were joined by some more new contributors. I would, of course, like to present all of the loggings that come in during the month but due to space limitations it's simply not possible. I am sure readers can understand that such restrictions are a fact of life. I do try to use something from each contributor but sometimes the submitted format or lack of details precludes the use of the material. Please remember to use *only one side* of your reporting format and place your last name and State on each logging entry. Thanks.

An extensive QSL collection has been put together by Dr. Adrian Peterson, IN, who has gathered nearly 12,000 QSL's since 1945. The total includes cards representing all bands and all modes of transmission. Accompanying the note from Dr. Peterson was a batch of loggings he heard while using a Grundig 3400 (with digital readout) and a whip antenna.

Dave Sabo, Korea, advised he heard a YL on 8640 kHz in AM mode with a callup of MIKE INDIA WHISKEY TWO at 1717 UTC and he wondered what this activity was related to. Dave, these Phonetic Alphabet Stations (often abbreviated as PAB's or PAS's) are reportedly the communications of Mossad, the Israeli Intelligence Service. In the past, MIW has also been heard on other frequencies. (See our article about Mossad which appeared in the July 1984 POP'COMM on page 35.)

Simon Mason, England, mentioned that

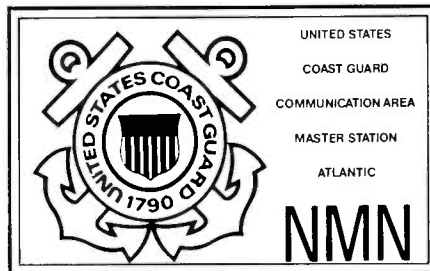

J.D. Stephens, AL, provided this QSL from the Coast Guard station at Portsmouth, VA, and included the address which was: Commanding Officer, USCG COMMSTA Portsmouth, c/o NAVSECGRUACT Northwest, Chesapeake, VA 23322-2598.

in the March 1987 column, POP'COMM's Editor, Tom Kneitel, had reported a station on 16450 kHz repeating "Asung Shadung Noir." Simon identified this transmission as a Czech numbers station which was sending the figures "Osm Sedm Nula" or "870."

Ross Bennett, OK, informed us that the National Bureau of Standards Station WWV has been announcing a survey they are circulating to listeners who call or write the NBS Office in Boulder, Colorado. "The survey is directed to users of WWV, WWVB, WWVH, and the GOES satellite system. Perhaps readers have heard this same announcement at three and four minutes past each hour on WWV.

POP'COMM readers should be interested in completing the survey. In these times



Tom Klusty, TX, shares this Ecuadoran Time Signal QSL with us.

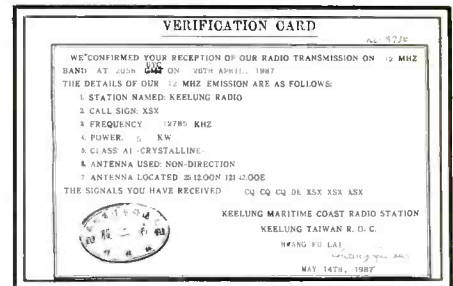

Verification card from Taiwan submitted by Patrick O'Connor, NH.

of government 'cost cutting,' a service like the NBS undoubtedly has to justify its expenses to keep its services operating. I've used the service, I would hate to think that some of the announcements during the hour might be stopped because many of us would not fill out the survey to justify their broadcast. A copy of the survey may be ob-

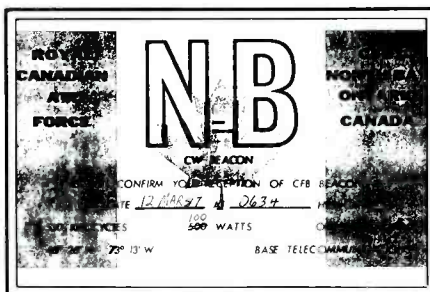

As often happens, the contributor's name was not on the back of the QSL card and it became separated from the envelope, thus we are unable to credit this item. The QSL address was: Canadian Forces Base, c/o Base Telecommunications Officer, North Bay, Ontario, Canada.

Frequency kHz	Mode	Time UTC	Station & Identification
4025	LSB	0227	AIR (2045th Information Systems Group, Andrews AFB)
6994.8	CW	0128	AIR
14373	USB	1745	NPG (Naval CommSta, Stockton, CA)
14383.6	USB	1736	NPL (Naval CommSta, San Diego, CA)
14388	USB	1905	NAV (HQ Navy-Marine Corps MARS Radio Station, Cheltenham, MD)
14403.5	USB	1431	WAR (HQ Army MARS Radio Station, Ft. Meade, MD)
14478.5	USB	1544	NZJ (Marine Corps Air Station, EL Toro, CA)
20994.2	USB	1800	WAR
20997.5	USB	1853	NMH (Coast Guard Radio Station, Alexandria, VA)

An anonymous contributor in Missouri sent in these loggings made on Armed Forces Day of military stations working Hams.

tained by writing to Time and Frequency Division, National Bureau of Standards, 325 Broadway, Boulder, CO 80303. Our thanks to Ross for bringing this matter to the attention of POP'COMM readers.

Jerry Brumm, IL, supplied some fine loggings and said, "We'll be relocating our QTH and I'm looking forward to trying ute monitoring from a 33rd floor condo near Lake Michigan just north of Chicago's Loop. Hopefully, the noise 'intermod' distortion won't be too bad."

Larry Marshall, CA, tells of starting out in SWL in the late 50's and commented on the tremendous reduction over the years in the size of receiving equipment.

Thomas Klusty, TX, forwarded some QSL addresses:

Instituto Oceanografico de la Armada
P.O. Box 5940
Guyaquil, Ecuador

VNG: Telecom Australia Research Labs
Box 249
Clayton, Vic. 3168
Australia

ZLO: Station Supervisor
Naval Receivers
HMNZ A Irirangi
Waiouru, New Zealand

Tom also sent in a interesting voice item he monitored on 10213 kHz on USB at 2140. A Mr. Opey was in a phone patch to a Mr. Rooster and they were discussing Honduran Air Missions. During the communication the stations mentioned frequencies "BE" and "BK" but these were not identified further.

For you QSL collectors, Ary Boender of the Netherlands says he has some 2300 addresses on file and is willing to help fellow DX'ers as he can. Accompany your request for a specific station's address with an IRC. Ary will see if he has that particular address on file and get an answer off to you right away. His address is: Ary Boender, Lobeliastraat 33B, 3202 HR Spijkennisse, The Netherlands.

**Utility Station Intercepts
(All Times Are UTC)**

- 308: Beacon OK, Okinawa Shima (Naha), Japan at 1454 (Briggs, Okinawa).
- 340: Beacon MY, Miyako Jima Island, Japan at 1454 (Briggs, Okinawa).
- 371: Beacon ROR, Palau Island, Koror, Carolines, US Pacific Islands, at 1454 (Briggs, Okinawa).
- 380: Beacon YU, Korenka North, Taiwan at 1454 (Briggs, Okinawa).
- 385: Beacon GUM, Agana NAS, GU, Marianas (Briggs, Okinawa).
- 405: Beacon MD, Minami Daito, Japan at 1454 (Briggs, Okinawa).
- 415: Beacon KW, Ko-Shun, Taiwan at 1454 (Briggs, Okinawa).
- 2670: NMF, USCG Commsta, Boston, MA in comms re working with Canadian CG towing disabled vessel (A. Nonymous, NH).
- 2716: NOHP, USS Oliver Hazard Perry (FFG-7), a guided missile frigate, at 0325 in USB calling Norfolk Tug Control for radio check (O'Connor, NH).
- 3535: 6YI, Kingston, Jamaica in CW at 0259 w/VVV marker (Peterson, IN).
- 3712: SXA33, Greek Naval R., Piraeus in CW at 0300 w/call marker. Their freq is in the Novice Ham band and several Novices were noted attempting to establish contact w/SXA33 (Borawski).



Jerry Brumm

Chicago, Illinois
USA

Communications Centre Whitehall
Old Admiralty Buildings
Spring Gardens
Whitehall
London SW1A 2BE

RECEPTION VERIFICATION

Thank you for your letter dated 11th January 1987.

I am pleased to be able to verify your reception of the Royal Navy Wireless Station at Plymouth.

STATION/CALLSIGN.....	PLYMOUTH/MTI
FREQUENCY.....	4310 khz
POWER OUTPUT.....	1 KW
AERIAL.....	OMNI
TIME/DATE.....	0325GMT/11 January 1987
EMISSION.....	CW call tape

M.J. Warriner
M.J. WARRINER
CRS Operations 3
Commcen Whitehall

British Navy QSL received by Jerry Brumm, IL.

- 4020: WAR, Ft. Meade, MD in LSB at 0140. Opr John monitoring 3950 kHz for X-band aps (Dave Alpert, NY).
- 4024: AIR, Andrews AFB, MD in LSB at 0145, calling CQ & listening for X-band replies on 3965 kHz (Alpert, NY).
- 4090.9: GBTT, cruise ship QE II at 2217 in USB w/patch via WOO (O'Connor, NH).
- 4125: On a very active nite around 0700: WHU664, Ketchikan R., AK wkg a ship; WRA8434, ship Majestic Explorer wkg WYB6183, ship Nicolle N; USCG Valdez, AK with security PAN 11c re missing vessel; NOJ, CG Commsta Kodiak, AK repeats this msg; KZDB04, Alomar Dillingham wkg HYDK, M/V Swallow along w/HYDK, Pilot Boat Inspector re ETA Dutch Harbor; M/V New Zealand Caribbean wkg Kingston R., Jamaica for held hf; NMN, CG Commsta Portsmouth, VA, & NMG, CG Commsta New Orleans, LA wkg un-ID vessel in distress. All comms USB mode. A good freq to monitor (Hall, WA).
- 4143: NMA, CG Commsta Miami, FL wkg tug Break of Dawn taking the famous "garbage" on its world tour. USB at 0530 (Hall, WA).
- 4230: A7D, Doha, Qatar in CW at 1950 w/VVV (Mason, England).
- 4582: Eagle 11, Eagle 7, Sourdough 4, Beaver Fox 68 & others in Pacific Region CAP net, USB at 0403 (Hall, WA).
- 4606: 960QZ calling 970MR in CW at 0455, apparent Spanish Navy units (Borawski, PA).
- 4611: TAU, an un-ID sta w/5L gps in CW at 0501. Msg header was TPLOAD QRA de T4R Nr 40-P-T 170500Z Gr120 (J.M., KY).
- 4747: OM in USB mode fading in/out w/wx bc for USAF bases in Pacific. Possibly Kadena

Abbreviations Used For Intercepts

- AM Amplitude Modulation mode
- BC Broadcast
- CW Morse Code mode
- EE English
- GG German
- ID Identifier/edication
- LSB Lower Sideband mode
- OM Male operator
- PP Portuguese
- SS Spanish
- tfc Traffic
- USB Upper Sideband mode
- w/ with
- wx Weather report/forecast
- YL Female operator
- 4F 4-figure coded groups (i.e. 5739)
- 5F 5-figure coded groups
- 5L 5-letter coded groups (i.e. IGRXJ)

- AB, Okinawa. Hrd at 1800 (Sabo, S. Korea).
- 5045: "467" w/cut #'s from 0000-0010, then a tone & "52 52" & into 5F cut #'s. Off at 2033 & nil hrd (Panak, NC).
- 5175: NNNN in CW from 1900-1905, then YL/FF w/5F gps. YL seems to be a Scot; she also does 5F in GG (Mason, England). Not stated if YL was using AM or SSB mode - Ed.
- 5238: YL/SS in AM mode 0000-0051 w/058 058 058, 1-0 count. At 0015 a series of beeps followed by 4F gps. USB sent X2, ended w/"FIN" (Panak, NC).

5320: NOK, C-130 Commsta Key West in USB at 0110 wkg 185 who just arrested a ship captain on warrant (Symington, OH).
 5433: USN tactical net in USB at 0151 asking one another for authentication series. Stas were aboard ships (Krizanek, NJ).
 5574: American 8 at 0656 wkg San Francisco w/pos rpt; Northwest 52 at 1320 wkg Honolulu; United 818 at 1504 wkg San Francisco, all USB (Szalony, CA).
 5628: JAL 28 at 1313 wkg Honolulu; United 810 wkg Honolulu at 1326; United 150 wkg Honolulu at 1304; United 90 at 1357 wkg Honolulu, all USB (Szalony, CA).
 5658: Khartoum, Sudan wkg Lufthansa 570 in USB at 0251 (Ross, Canada).
 5680: RCAF Commsta, Yellowknife, NWT wkg Papa Alfa, a survey flite over Cambridge Bay. USB at 0352 (Hall, WA).
 5696: CG 1481 helo hoisting ops re sinking vessel, USB at 0533 (A. Nonymaus, NH); CG New Orleans wkg CG aircraft 2102 (HU-25 jet a/c) at 0533 (Hamuth, AZ).
 5806: ZKLF, Auckland Meteor, New Zealand calling CQ in CW at 0520 then into 5F coded wx bc. Sent phrase "Level Analysis" followed by long coded info (Borowski, PA).
 6338: ZRQ, South African Navy, Cape Town in CW at 0200 w/VVV marker (Peterson, IN).
 6428: VHP, Australian Navrad, Canberra, Austr., in CW at 1250 w/VVV marker (Peterson, IN).
 6464: VIS, Sydney R., Australia in CW w/VVV marker at 1255 (Peterson, IN); Same at 1008 (Tom Kneitel, NY).
 6655: Singapore 12 at 1401, Canadian 4 at

1407, Northwest 28 at 1439-- all in USB to Honolulu R. w/pos rpts (Szalony, CA).
 6673: Aircraft NOAA 43 giving wx info to KJY74, NOAA in Miami, FL. USB at 0318 (J.M., KY).
 6705: Trenton Military (Canada) & Rescue 460 in comms re radio drop to survivors of downed a/c; USB at 1403 (A. Nonymaus, NH).
 6745: Phonetic Alphabet sta, YL voice in USB. Off at 0353 (Alpert, NY).
 6762: Kilgore (hrd here previously) w/ffc for Butter(?) in USB at 1845. Apparently bored op at Kilgore passed following msg: 13184Z Groups 6 ICA NTW AIT TOG OHO MEX. Used standard phonetic alphabet (J.M., KY). Note that msg is really plaintext EE-- Editor.
 6769: USN stas in USB at 0324 re SEAL team ops (Marshall, CA).
 6802: Very active 4F freq. Try it evenings, on the hour. All YL/SS; 0400 // on 5812 kHz; 0600 // on 5812 kHz. AM mode (Marshall, CA).
 6818: Andrews AFB wkg Air Force 2. Latter requesting East Coast wx at 0120, then gives ETA. Andrews testing 3 different xmtrs (Lorenz, IL).
 6840: YL/SS w/4F gps, AM mode at 0235. Also hrd // on 4670 & 5812 same time, but 6840 s/off at different time (Marshall, CA).
 6970: YL/EE in AM at 0645 w/5F gps, slight Scandinavian accent. Ended w/546 546 122 122 TTTT-- was the strongest #'s station logged in 3 years of monitoring! (Marshall, CA).
 8148: OVG8, Danish Navrad Frederikshaven, Denmark w/VVV marker in CW at 0500 (Hall, WA).
 8195: Foxtrat Whiskey w/tracks for various

targets, USB at 1432. Other stas in net included FR, FB, TW & FF (J.M., KY).
 8291.1: ONAR, ship Coral Temse at 2032 in USB wkg ONEL, ship Helen (O'Connor, NH).
 8294.2: WYR8681, ship Belcher Port Everglades (integrated barge/tug/tanker) at 0309 in USB wkg KHT, Cedar Rapids, IA (O'Connor, NH).
 8300: YL/CC hrd w/4F gps, each said X2, AM mode at 1634. This frq active several times throughout the day with this activity on a daily basis (Sabo, S. Korea).
 8369: VCS, Halifax CG R., NS wkg a Soviet ship w/callsign UHRY, CW at 0540 (Borowski, PA).
 8385: PDHE, Dutch flag vessel Atlantic Sea wkg SXB w/telegrams in CW at 0430 (Hall, WA).
 8390: SQGP, Polish vessel Mustel wkg KFS, CW at 0642 w/pos rpt (Hall, WA).
 8418: YL/SS in USB at 0642 w/4F gps (Kline, CA).
 8441: 70A, Aden, S. Yemen in CW at 1645 w/VVV tape (Mason, England).
 8448: A9M, Hamala, Bahrain in CW at 1702 w/VVV marker (Mason, England).
 8449: VRT, Hamilton, Bermuda in CW at 1355 running VVV marker (Peterson, IN).
 8484.5: HZG, Daman, Saudi Arabia at 2110 in CW w/call marker (O'Connor, NH).
 8492: JNA, Tokyo, Japan in CW at 1117 w/VVV (Ross, Canada).
 8516.3: SAT, Tripoli, Libya in CW at 0608 w/VVV marker (Ross, Canada).
 8539: VPS, Capr D'Aguiar, Hong Kong in CW at 1217 w/call marker (Ross, Canada).
 8765.4: USCG Commsta Honolulu, HI s/on w/high seas wx in USB at 1149 (Sabo, S. Korea).
 8728.5: YL (sounded like an Aussie, mate) reading random letters in grps of 2, 3 & 5. Msg acknowledged by an OM (Briggs, Okinawa).
 8737.5: 5BA42, Nicosia, Cyprus in USB at 0306 w/voice mirror (Ross, Canada).
 8989: USAF a/c ID as Blackwater, 1 hour from March AFB enroute Hickam AFB. Having mechanical problems. USB at 1712 (Marshall, CA).
 8990: 6WW, Dakar Senegal in CW at 0417 w/VVV marker (Mason, England).
 9240: Strange tune w/six repeating notes hrd at 2000. Played a different melody at 2010, s/off at 2015 (Mason, England).
 9723: YL/CC w/4F gps, each said X2, AM mode at 0810 (Sabo, S. Korea).
 9996: RWN, Moscow, USSR w/time pips at 0410 (Alpert, NY).
 10121: V91 w/5L gps in CW at 1547. Header was QRA de V91-P-T 061545Z Gr120 BT (J.M., KY). Compare similarity w/4611 kHz logging-- Ed.
 10390: YL/EE in USB at 0820 running voice mirror of test xmsn for circuit adjustment purposes from Tokyo International circuit control station of JDD (Sabo, S. Korea).
 10454: VOA, Greenville, NC feeder of RR pgm, USB at 1918 (Kneitel, NY).
 10582: Repeating CW tape at 1252: 555 555 555 555 T68 T68 T68 36 415 415 34. The "T" in T68 represents a cut zero (Kneitel, NY).
 10809: YL/EE in USB from 0900-0945 w/voice mirror from Korean Central Wireless Station, Pyongyang, North Korea (Sabo, S. Korea).
 11179: TAC HQ's (not heard) being called by TAC-01 in USB at 1900, negative contact, then called MacDill AFB and switched over to 8989 kHz (A. Nonymaus, MO).
 11180: Aircraft 971 & Andrews AFB in USB at 2218 w/test xmsn. This freq was referred to as "341U" (A. Nonymaus, MO).
 11242: A/c APEC-43 wkg ground sta Shoelace in USB at 0055. Called this freq "Channel Alfa" (Kobylski, MD).
 11246: Pakistani AF 119 wkg MacDill AFB in USB at 2315. Asked for patch thru to Dover Ops & asked if repair service was available for defective radar-- Dover said it wasn't (Kobylski, MD).
 11255: AOU to O8N in USB 0852-0904 w/comms re freq change. AOU passed encrypted freq info made up of 7F grp then clarified it as "shore receive, the station's receive freq." Same op at AOU later hrd with sig reports to 18S on 18009, USB at 1049 (Sabo, S. Korea).
 11288: Rockwell Flight Test to 73-CR in USB at 1525. This frq seems to be shared with anti-smuggler operations in Caribbean area (A. Nonymaus). According to the new 6th Edition of Kneitel's "Top Secret" Registry, the anti-smuggler units refer to the frequency as "Yankee Delta"-- Editor.
 11430: YL/CC w/4F gps, each sent X2, AM mode at 1055 (Sabo, S. Korea).
 12135: NAM, US Navrad, Norfolk, VA calling CQ in CW at 1222 (Kneitel, NY).
 12328: Beacon U, FSK at 0120 (Borowski, PA).
 12432: WHU947, Seattle, WA in USB at 1830 wkg fishing fleet consisting of trawlers Ocean Bounty, Aleutian Bounty, & Amfish for morning status reports. These are in AK waters going after Halibut & Turbot (Hall, WA).
 12570: D9FK, Korean vessel Pan Zenith wkg VAI in CW at 2329 for AMVER reports (Hall, WA).

POPULAR COMMUNICATIONS

SUBSCRIBE NOW & SAVE! **\$16**

Twelve Issues

POPULAR COMMUNICATIONS

76 N. Broadway, Hicksville, NY 11801

Yes! The NEW POPULAR COMMUNICATIONS is just the magazine I've been looking for. Start sending it to me now! I understand that I may cancel at any time for any reason, and receive a full refund on my unused subscription.

Paid by: Check Money Order MasterCard Visa
 My account number is

--	--	--	--

Name _____ Canada and Mexico - one year \$20.00 US, two years \$39.00 US, three years \$58.00 US Foreign - one year \$22.00 US, two years \$43.00 US, three years \$64.00 US.
 Street _____
 City _____ State _____ Zip _____

- 1 year - 12 issues \$16.00 (Save \$14.00)
- 2 years - 24 issues \$31.00 (Save \$29.00)
- 3 years - 36 issues \$46.00 (Save \$44.00)

A Great Gift Idea

Send the following gift subscription to my friend at my expense.

Please indicate your name above. A gift card will be sent.

Paid by: Check Money Order MasterCard Visa
 My account number is

--	--	--	--

Name _____ Canada and Mexico - one year \$20.00 US, two years \$39.00 US, three years \$58.00 US Foreign - one year \$22.00 US, two years \$43.00 US, three years \$64.00 US.
 Street _____
 City _____ State _____ Zip _____

- 1 year - 12 issues \$16.00 (Save \$14.00)
- 2 years - 24 issues \$31.00 (Save \$29.00)
- 3 years - 36 issues \$46.00 (Save \$44.00)

12625: JEKN, a Japanese vessel wkg JPO2, Tokyo in CW at 2150 w/ETA info re passage from Balboa to Nagoya (Hall, WA).

12673: JOU, Nagasaki, Japan in CW at 1155 w/VVW tape (Peterson, IN).

12743: NRV, USCG Agana, GU calling CQ in CW at 1852 (O'Connor, NH).

12790.5: PKB, Belawan, Indonesia calling CQ in CW at 1930 (O'Connor, NH).

12887.5: EAD44, Aranjuez R., Spain in CW at 1237 w/call marker & looking for replies (QSX 12 MHz) (Kneitel, NY).

12908: VIX5 (ID as VIX2/3/4/5/6), Australian Navrad, Canberra w/CW VVW marker at 1206 (Kneitel, NY).

13063: JDB, Nagasaki, Japan in CW at 1215 w/VVW marker (Peterson, IN).

13092.5: UAH, Tallinn, Estonian SSR in CW at 1244 w/callsign marker (Kneitel, NY).

13116: Miami R., FL in USB at 0703 w/tfc list for cruise ships (Marshall, CA).

13138: PCH, Scheveningen, Netherlands w/tfc list in USB at 2108 (J.M., KY).

13364: GG press items from 1623-1655; one item was about sports, another on exchange rates. CW mode (Bob Margolis, IL).

13384: During lengthy monitoring of QRA/QSX marker from KKN39 in CW from 1850-2100, KKN39 called un-ID sta 6DJY (Margolis, IL).

13630: WHX50, loc unknown, to KDM50, Hampton, GA, & KLO24, loc unknown, in USB at 1945. This is an FAA net (A. Anonymous). WHX50 is the FAA Sector Ops in Miami, FL-- Editor.

14445: VXV9, Canadian Forces, Golan Heights cly CIW660 & CIX660. USB at 2300 (Alpert, NY). This net is similar in operation & mission to US MARS operations-- Editor.

14478.5: NZJ, USMC Air Station, El Toro, CA at 1834 in USB w/kg various sts (O'Connor, NH).

14564: 6BC68, Cyprus R., Nicosia, Cyprus with EE/Greek anct in USB at 1948. Were listening on 16442 kHz (Brumm, IL).

14730: VE9LHF, un-ID sta calling VE9LHE in USB at 1931. Included some RTTY xmsns. Possibly Canadian military (Hall, WA). Our guess is Canadian Experimental licensees-- Editor.

14764: K2P w/SL ops in CW at 1717. Heading was QRA DE K2P-P-T 281715Z Gr120 BT (J.M., KY). Similar entries this month on 4611 & 10121 kHz-- Editor.

15000: JJY, Tokyo Time Station, Japan, in CW & AM at 1209. ID was YL/JJ (Ross, Canada).

16587: KHT, Collins R., USB at 1905 w/patches for American flag tankers including Exxon Benicia, & Exxon New York (Hall, WA).

16661: SZML, Greek ship Filia Sea in CW at 2008 w/kg KFS w/telegrams (Hall, WA).

16750: ABWX, Japanese car carrier Southern Cross in CW at 2021 w/JPO2. Enroute Long Beach from Japan (Hall, WA). Here comes another consignment of Toyotas!-- Editor.

16760: HOGM, M/V Altair, Panamanian flag vessel in CW at 2115 wkg JPO w/telexes. Apparently a Japanese owned vessel (Hall, WA).

16763: SXDT, Greek vessel Golden Spear in CW at 2004 wkg WCC w/telegrams (Hall, WA).

16769: 3EFK, a Panamanian ship, colling JCS in CW at 2215 (Barowski, PA).

16771: C6AT, Bahamian flag vessel M/V Atacamba in CW at 2240 w/telegrams to Intercean Valparaisoan Flata (Hall, WA).

16775: DUVY, M/V Crystal Grace wkg WCC in CW w/telegrams at 2140. Phillipine registry (Hall, WA).

16780: HBDV, Swiss flag vessel M/V Azalea in CW at 2200 relaying tfc & telegrams to DZJ. Even relayed telegrams from 2 other ships (Hall, WA).

16787: 3EOR, M/V Olive Ace in CW at 2220 to MNM w/AMVER info (Hall, WA).

16890: J8CA, St. Vincent & the Grenadines registry allocation called by SPH (Poland) in CW at 2150 (Barowski, PA).

17048: DAF, Norddeich R., FRG w/callsign marker in CW at 1503 (Brumm, IL).

17060: 4XO, Haifa, Israel in CW at 1509 (Brumm, IL).

17066: UAT, Moscow R., USSR calling CQ in CW at 1230 (Kneitel, NY).

17127: ZLP, New Zealand Navrad, Waiouru sending VVW in CW at 0215 (Peterson, IN).

17131: UJQ7, Kiev, Ukrainian SSR w/CW marker at 1232 followed by tfc (Kneitel, NY).

17194.4: SVB6, Athens, Greece in CW at 1617 w/callsign marker (Brumm, IL).

18002: Anderson AB, GU setting up phone patch for un-ID loc in Thailand, followed by OM w/Yakota AB (Japan) Valmet bc before fade at 0547 (Sabo, S. Korea).

18009: T9K, relaying F2J * for A30 w/comms re inability to comply w/F2J request for change of freq because it was "too close to the tactical circuit." Later they moved to an alternate freq, but didn't seem to work out as later T9K & A30 hrd on 6721 kHz w/similar comms. Noted 18009 around 1734-1754; 6721 heard at 1956 (Sabo, S. Korea). **PC**

POPULAR COMMUNICATIONS BOOK SHOP

Ameco Amateur Radio FCC Test Manuals

Each book contains the latest FCC VEC test questions, plus ARRL multiple-choice answers followed by a complete, simplified discussion of each question written in an easy-to-understand style.

Novice Class, 96 pages, paperback, \$4.95. Order #H221.

General Class, 128 pages, paperback, \$4.95. Order #H034.

Advanced Class, 128 pp., paperback, \$4.95. Order #H035.

Extra Class, 128 pages, paperback, \$4.95. Order #H220.

The Joy of QRP
by Adrian Weiss, K8EEG/W0RSP

For QRP enthusiasts, this new book by QRP expert Ade Weiss covers everything from the basics through the fine points in 8 chapters. Includes approximately 50 tables, photos, and drawings. 151 pages, paperback, \$10.95. Order #H222.

The Radio Publications Group—The "Bill Orr Series"

These easy reading classics belong in the library of any active ham. Loaded with practical how-to information, with tables, charts, and formulas arranged for handy reference.

Beam Antenna Handbook, 200 pages, paperback, \$9.95. Order #H143.

Wire Antennas, 192 pp., paperback, \$7.95. Order #H144.

Antenna Handbook, 192 pp. paperback, \$9.95. Order #H145.

Cubical Quad Antennas, 112 pages, paperback, \$7.95. Order #R146.

Vertical Antennas, 192 pages, paperback, \$10.95. Order #H303.

VHF Handbook, 336 pp. paperback, \$11.95. Order #H147.

Interference Handbook, 247 pages, paperback, \$9.95. Order #H172.

World Radio TV Handbook 1987

The world's only complete directory of international broadcasting and TV stations—the established, authoritative guide endorsed by the world's leading broadcasting organizations. A comprehensive country-by-country listing of short-, medium-, and long-wave stations revised and updated to reflect actual conditions. Also includes special features on The Future Regulation of High-Frequency Broadcasting, Solar Activity in 1985, Technical Innovations at Radio Nederland's New Transmitting Station, and more. 600 pages, paperback, \$19.50. Order #H097.

Radio Handbook, 22nd ed.

by Bill Orr, W6SAI

A state-of-the-art, single-source reference on radio communications and theory for hams, professional ops, techs, and engineers. New coverage includes solid-state devices, Yagis and quads, and h.f. amplifier designs. A hands-on instruction manual, as well. 1168 pages, hardcover, \$39.95. Order #S197.

World Press Services Frequencies

by Thomas Harrington
A comprehensive manual covering the field of radioteletype news monitoring—antennas, receivers, terminal units, monitors, and more. Contains 3 master lists of times of transmission, frequencies, plus ITU list of over 50 news services worldwide. 72 pages, paperback, \$8.95. Order #H173.

Computer Programs for Amateur Radio

by Wayne Overbeck and James A. Steffen
A comprehensive collection of BASIC programs for radio amateurs that can be used on the Apple, TRS-80, and Commodore 64, with conversions for the IBM PC. Includes contest logging, VHF operation, antenna design improvement, gray-line calculations, and more. 224 pages, paperback, \$16.95. Order #H218.

The Shortwave Propagation Handbook, 2nd ed.

by George Jacobs, W3ASK, and Theodore J. Cohen, N4XX
A new, revised edition of the popular guide to all your propagation needs. Contains up-to-the-minute information and charts, and guides you through producing your own propagation data. 154 pages, paperback, \$8.95. Order #H137.

Ameco Novice Code and Theory Package

A complete training package containing the 128-page Novice theory course and a 60-minute code cassette, which teaches how to send and receive code up to 8 words per minute, and a 32-page book. Also included are FCC-type code and theory examinations to help even a rank beginner get a ticket fast! \$8.95. Order #H024.

RTTY Today

by Dave Ingram, K4TWJ
A brand new, completely up-to-date handbook on RTTY, covering the latest developments and techniques, plus use of the home computer for RTTY. Illustrated with photos, diagrams, station setups, and RTTY gear. 112 pages, paperback, \$8.95. Order #H211.

Vertical Antenna Handbook, 2nd ed.

by Paul H. Lee, N6PL
Out of print for several years, this classic has been reprinted with updates, including an addendum on antenna design for 160 meters. Other sections include feeding and matching, short verticals, ground effects, and much more. 139 pages, paperback, \$9.95. Order #H208.

The Complete DX'er

by Bob Locher, W9KNI
Covers every significant aspect of DXing from how to really listen to how to snatch the rare ones out of the pileups. Also includes advice on siting, equipment selection, and antennas. 187 pages, paperback, \$10.95. Order #H209.

POPULAR COMMUNICATIONS 76 N. Broadway, Hicksville, NY 11801

QTY. ORDER # TITLE PRICE TOTAL

QTY.	ORDER #	TITLE	PRICE	TOTAL

Book Total	
Shipping Charge	
Grand Total	

Shipping charges \$2.00 per order. Shipping charges waived on orders of \$50.00 or more. Books shipped best way. All orders are processed the day they are received, but please allow 30 days for delivery within North America.

Name _____

Address _____

City _____

State _____ Zip _____

Check MasterCard VISA

Card No. _____ Expires _____

X _____

Signature required on all charge orders:

SCANNER SCENE

BY CHUCK GYSI, N2DUP

MONITORING THE 30 TO 900 MHz "ACTION" BANDS

Did you know that there are secret frequencies that police can use without having to obtain a license from the FCC? No, there's no hitch and it isn't anything like CB or the 49 MHz unlicensed band.

A while back, a friend of mine had an opportunity to look at a police walkie-talkie. In doing so, he checked out the plate that the manufacturer attached to the radio. This plate indicates which frequencies were installed in the handheld. In addition to the regular dispatch channel, one really odd channel was staring him in the face—155.030 MHz.

Well, 155.030 is not a normal channel for any licensed user. In fact, the frequency just happened to fall between two local government radio service channels—155.025 and 155.040 MHz. What was this rural police department up to?

A little monitoring of this secret channel revealed that department was using this frequency in its handheld radios only for surveillance activities—in between rounding up cows and writing speed tickets, naturally.

I did a little checking around. It seems that police departments have the expressed privilege in FCC rules to generally use whatever frequency they darn well please, so long as they meet certain guidelines. This allows departments to place bugs on oddball frequencies and to use splinter channels in handheld radios for surveillance activities—all without filing for an FCC license! Consequently, it allows them to escape us real frequency buffs who pore through frequency guides for special channels. In fact, if a department used frequency-synthesized programmable radios, they could very well come up on a different channel every day of the year. Imagine trying to track down something like that!

However, in reality, most police departments don't know anything about this provision in the FCC rules. They know enough to say "10-4" and that Channel 2 is their car-to-car channel, and that's enough of the radio business for them. Still, there are some communications specialists employed by police departments who are very well aware of this provision in the FCC rules and take advantage of them.

How do you find out whether your police department is using any of these secret channels? Chances are you may never find out unless you have a good contact within the department itself or just happen to stumble across some surveillance activity in your immediate neighborhood.

Essentially, FCC rules stipulate that licenses in the police radio service (there is a hitch—they have to have a license on a regular channel first) may use, without special

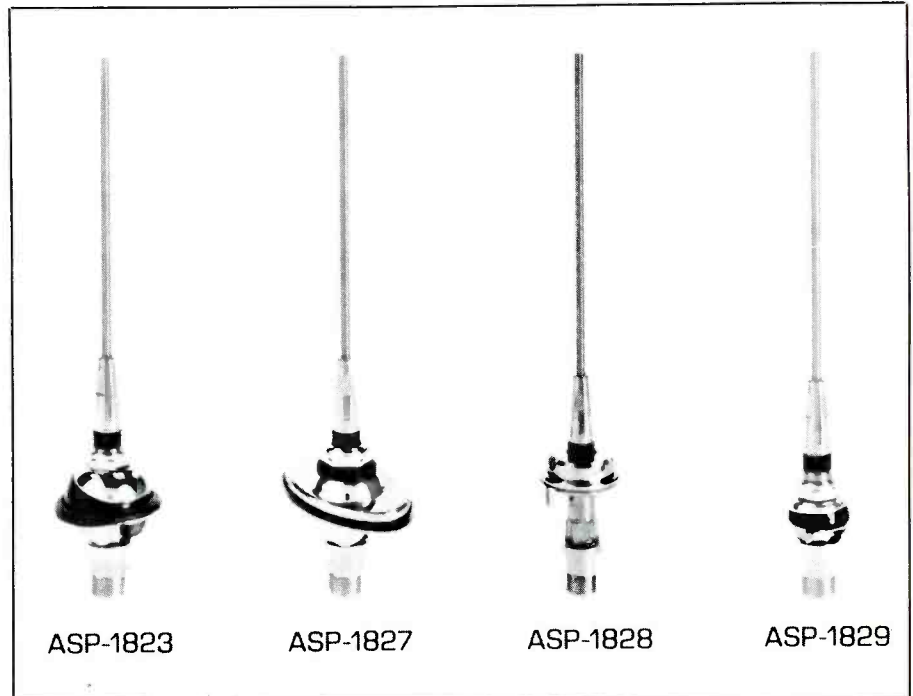

Police departments carrying out surveillance activities don't want antennas on their vehicles giving them away, thus, disguise antennas, which look like normal AM/FM car antennas (and can receive AM/FM also) are used. These disguise antennas from Antenna Specialists operate on the 800 MHz band.

authorization, any frequency between 40 and 952 MHz on which mobiles are allowed to operate in the public safety radio services. These include the local government, police, fire, highway maintenance and forestry conservation radio services. Thus, if a department had the necessary equipment, they could pop up one day on 855.0875 MHz (public safety), another day on 47.22 MHz (highway maintenance), the next day on 154.070 MHz (fire), and even another day on 458.975 MHz (local government). Get the drift?

Chances are, however, that once a department picks its special surveillance channel, it will use the same channel, or set of channels, on an everyday basis. Unless it's for a very special investigation, police radio technicians are usually busy enough repairing walkie-talkies used to clobber suspects rather than reprogramming radios for surveillance channels.

Police departments that use the mobile public safety channels for surveillance, stakeouts and raids are limited to 2-watt transmitters. This is enough power to allow walkie-talkies to communicate within a several block radius or for a helicopter crew to talk to a ground crew. If a police department wants to use any public safety mobile service

frequency that is not in the police radio service, it also must obtain permission from the coordinator for the radio service that normally uses the channel. For instance, if a police department wants to use 159.465 for surveillance, it must obtain permission from the Forestry Conservation Radio Service's frequency coordinator to ensure that activity on that channel would not interfere with a park or state forestry crew that might be using the same channel.

In addition, police departments also have the privilege to use spread spectrum and frequency hopping transmitters, however, very few probably even would consider such an elaborate system. (Spread spectrum is where a very wide channel is used to transmit voice.) On the other hand, frequency hopping employs a system in which at least 20 frequencies are used and each channel is used for no greater than 1/10 of a second every two seconds. Unless you had 20 receivers all tuned to each of the 20 channels all at the same time, you would not be able to follow a frequency hopping transmitter. If you were to stumble across such a system, it wouldn't sound like much more than constant blips on a given channel.

Police also have other bands of frequencies available to them for non-voice opera-

tions, such as bugs that might be placed on vehicles so that they could be tailed. These frequencies fall in the VHF low and high bands, as well as UHF.

While many frequency directories may not bother to list it, police departments also can use 39.06 MHz for 2-watt operations. Some departments may use this frequency for surveillance purposes. One department I know of uses this frequency as a repeater input channel for handheld radios.

One last tip: we've all seen the TV shows where wireless microphones are placed on informants as the police move in to make the big bust. But what frequencies can you find the wireless microphones on? They could very well use the same channels that they use for stakeouts and raids, though there are frequencies set aside specifically for wireless microphones. While these channels can also be used by production companies, churches and others (imagine the person sitting in the back pew getting an earful of a stakeout), police are specifically authorized to use wireless microphone channels for their own use. These frequencies include: 169.445, 169.505, 170.245, 170.305, 171.045, 171.105, 171.845 and 171.905 MHz. Power output on these frequencies is limited to 50 milliwatts (1/20 of a watt), so unless you're sitting on top of a stakeout, don't expect to hear anything on these channels.

And while we're at it, while police formerly had to obtain an additional license to operate radar units in the 10.525 and 24.15 GHz (yes, that's GigaHertz) bands, any licensee in any of the public safety radio services is automatically allowed to operate radar units without a specific additional radio license. Many individuals were able to beat radar tickets in the past by proving a police department was operating an "unlicensed" radio station if it could not produce evidence that a license in the radio location service was obtained for the radar unit. Not anymore, leadfoot drivers.

One last comment on police communications. Don't overlook the obvious when trying to track down a mysterious police channel. Many rural and suburban departments may be using CB radios for car-to-car communications. Thus, if you hear an officer call another car and tell him to go to "25," chances have it they are switching to CB channel 25. Many departments in my area do this and may be doing the same in your community. Cellular phones are also used.

If you find some "secret" police frequencies being used in your community or city, we'd like to hear about it. You never know where those police communications may be taking place. We're also interested in receiving your comments, questions, frequency lists and listening and equipment tips. Black-and-white photographs also are welcome for inclusion in this column. You can write to *Scanner Scene* directly now at: Chuck Gysi, N2DUP, P.O. Box 544, New Hope, PA 18938-0544. I'm looking forward to hearing from you.





Delaware Amateur Supply

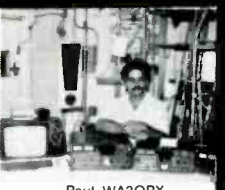

Rob. WA3QLS

Paul. WA3QPX

71 Meadow Road, New Castle, Del. 19720 **302-328-7728**

Factory Authorized Dealer! **9-5 Daily, 9-8 Friday, 9-3 Saturday**

AEA • ALINCO • AMERITRON • CUSHCRAFT • ICOM

• KANTRONICS • KENWOOD • MOSLEY • SANTEC

• TELEX HY-GAIN • TENTEC • YAESU • AND MORE!

Large Inventory. Daily UPS Service

Katherine. KA3IYO



800-441-7008

New Equipment Order & Pricing

Prices are subject to change without notice or obligation. Products are not sold for evaluation.

NO Sales Tax in Delaware! one mile off I-95

SERVICE, USED GEAR INFO: 302-328-7728

Please send all reader inquiries directly.

SUBSCRIBE NOW

& SAVE! - Twelve Issues \$16

USE

YOUR

F

R

E

E

I

N

F

O

R

M

A

T

I

O

N

C

A

R

D

SCANNING TODAY

(from page 8)

APCO has worked to help develop a system that incorporates the benefits of trunking, mainly frequency conservation, while minimizing the possible problems. For instance, in the APCO system the dispatcher overrides the computer channel assignments and assigns groups of users to a single channel. This would allow common channel communications when coordination of activities is important. Another feature is the assignment of communications priorities. This would allow lower priority users to communicate if a channel is open, but allow emergency traffic to proceed even if all channels are busy by interrupting lower priority messages when no other channels are available.

The FCC is apparently committed to bring trunking to public safety communications, like it or not. But they are being flexible enough to at least allow a different kind of trunked system be designed to minimize the risks. And the risks are substantial when the communications system becomes jammed in a widespread emergency! It may be time to step back and consider if frequency conservation must always be a top priority. Some mostly unused frequencies are a small price to pay if they end up being used to save lives in an emergency. Outside of major population centers, the FCC is apparently now willing to allow public safety communications on the new frequencies without trunking. In other areas, however, we'll see trunking moving ahead quickly in the years ahead.

Considering the fact that the original plans called for intermixing public safety and other communications on trunking systems, APCO has come a long way in modifying FCC positions. Public safety will now have exclusive bands (821-824 MHz and 866-869 MHz) plus a unique type of trunking control. The first widespread emergency that arises in a trunked system area will let us know if it was a wise move.

Class D Citizens Band Radio Service

Every emergency communications station, base and mobile, should have the ability to operate on the 40 Citizens Band channels. No other radio service in the United States has more operators than the 27 MHz Citizens Band. In a widespread emergency you've got a better shot at reaching the general public through CB operators than through any other means. *Everybody has a CB.*

For the past three years, Citizens Band equipment sales have increased by more than 10 percent a year. About 1,800,000 units were sold in 1986. That's 12 percent more units than radar detectors! Sixty-seven percent of those units were self-installed mobile transceivers that could also be used for emergency base station communications and portable installations running on battery power.

The CB radio service has just about made a complete circle. It began as a private, two-way, short-distance, voice communication service for personal or business activities. During the oil crisis, people used CB to find gasoline. CB was also a great way to escape the smokies. Then came the years that Citizens Band radio was an undisciplined party line. That's about when the FCC decided callsign issuance was not a practical way to go.

Now Citizens Band is fulfilling its original purpose—a short-range radio service that is not only a private party line with other CB'ers, but a useful tool for staying in touch when you need to get a short-range message through. While the usage of Citizens Band has changed, the channels remain the same. See Table 1.

You no longer need a license to operate a CB station. However, you are still required to abide by the rules. The rules are found in the Code of Federal Regulations, No. 47, Subpart D, part 95. They have been rewritten in plain English and are more understandable.

The rules permit you to operate Citizens Band anywhere in the United States and the Caribbean and Pacific insular areas. You can operate on any channel of your choice, but Channel 9 may be used *only* for emergency communications or for traveler assistance. You must, at all times and on all channels, give priority to emergency communication messages concerning the immediate safety of life and the immediate protection of property. No channels are assigned on an exclusive basis to any CB station or group of stations. However, you will need to do a little searching before you can

Channel	Freq (MHz)
1	26.965
2	26.975
3	26.985
4	27.005
5	27.015
6	27.025
7	27.035
8	27.055
9*	27.065
10	27.075
11	27.085
12	27.105
13	27.115
14	27.125
15	27.135
16	27.155
17	27.165
18	27.175
19	27.185
20	27.205
21	27.215
22	27.225
23	27.255
24	27.235
25	27.245
26	27.265
27	27.275
28	27.285
29	27.295
30	27.305
31	27.315
32	27.325
33	27.335
34	27.345
35	27.355
36	27.365
37	27.375
38	27.385
39	27.395
40	27.405

*Emergency Only

find your own "home" channel free from local interference.

Omnidirectional Citizens Band antennas for base station use must be of fiberglass construction. This eliminates danger near power lines. The highest point of the antenna must not be more than 20 feet higher than the highest point of the building or structure you mount it on. All this must not exceed 60 feet above the ground. If you live near an airport landing pattern, further restrictions may exist.

Citizens Band equipment is plentiful, rea-

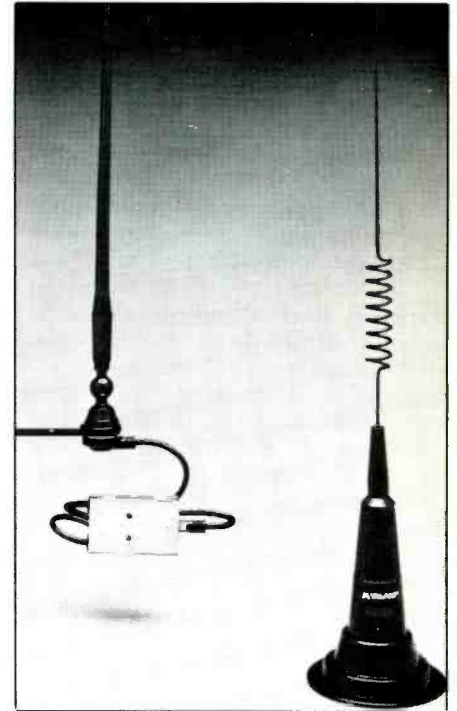

Midland models 18-236 and 18-2985 Tri-band and cellular look-alike antennas.



Radio room from Santiago REACT monitor station KGW-5290. (Courtesy Mr. Tad Kleindienst, CA.)

sonable in price, and extraordinarily rich in features. Some of the new models of Citizens Band sets I have tested feature some of the hottest receivers on the market. Their selectivity is razor sharp in discriminating between signal and adjacent channel interference. With less expensive sets you'll find less features, but usually a very good receiver and transmitter section. When you spend more for your set, you'll find more stages of conversion for added receiver selectivity. More bells and whistles allow you to shape the receiver for weak incoming signals while

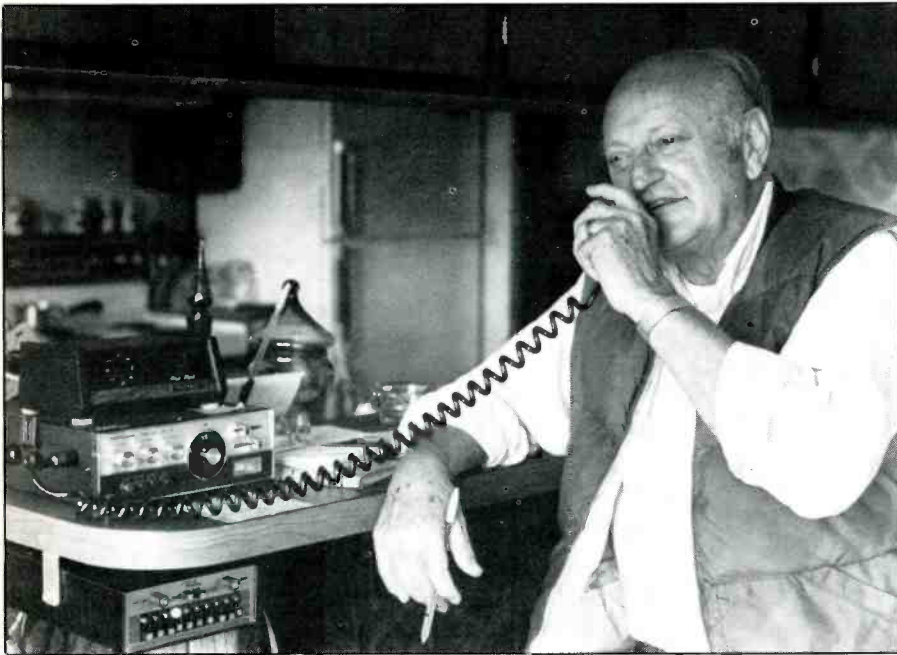

Fred Lion, "Mr. CB," operating from Friday Harbor in the San Juan Islands, Washington State.

simultaneously rejecting annoying whistles on an adjacent channel.

Power output is easily obtained to its maximum level on the cheap sets as well as the expensive sets. Four watts of carrier power are allowed for AM sets. Sets capable of single sideband operation are allowed 12 watts of peak envelope power. The AM-only transceivers are limited to a 10-watt input maximum dissipation rating of all of the semiconductors which supply radio frequency power to the antenna terminals of the set. This gives us an easy four watts output, even under low voltage situations, with added punch on modulation peaks.

Power amplifiers are not allowed on the Citizens Band service. Recent FCC raids continue to make power amplifiers a scarce item. Operators who buy Amateur Radio power amplifiers soon find out that minimum power levels of the Ham amps are usually 100 watts input. The Amateur Radio power amplifier won't help a bit when illegally used at 4 to 12 watts input drive power. Just owning a power amplifier is an FCC violation. "If it is in your possession or on your premises" can cause some serious FCC problems. Just because the FCC eliminated licensing of the CB radio service operators does not mean that rules aren't enforced.

You can talk about anything you want on CB except any activity which is against federal, state, or local law. Indecent language is not permitted. While there is still plenty of it out there, the more professional operators avoid indecent language and other operators who use it. Whistling, sound effects, music, and false signals are also prohibited.

The maximum range that you may legally operate at is 155 miles. For those of you emergency communicators using Citizens

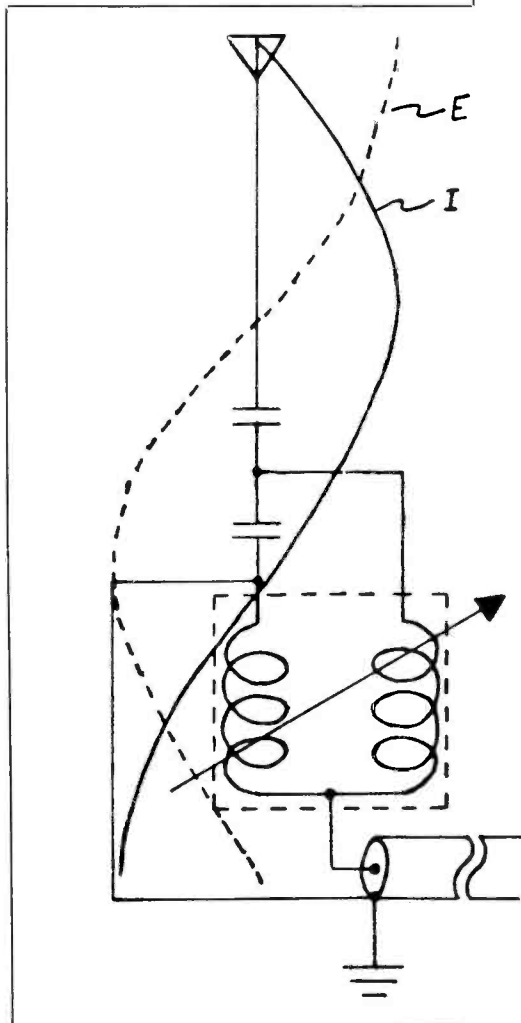

Fiberglass base antenna with electrical schematic on voltage and power distribution. (Courtesy Antron Antenna Research, P.O. Box 2744, Youngstown, OH 44507-0414).



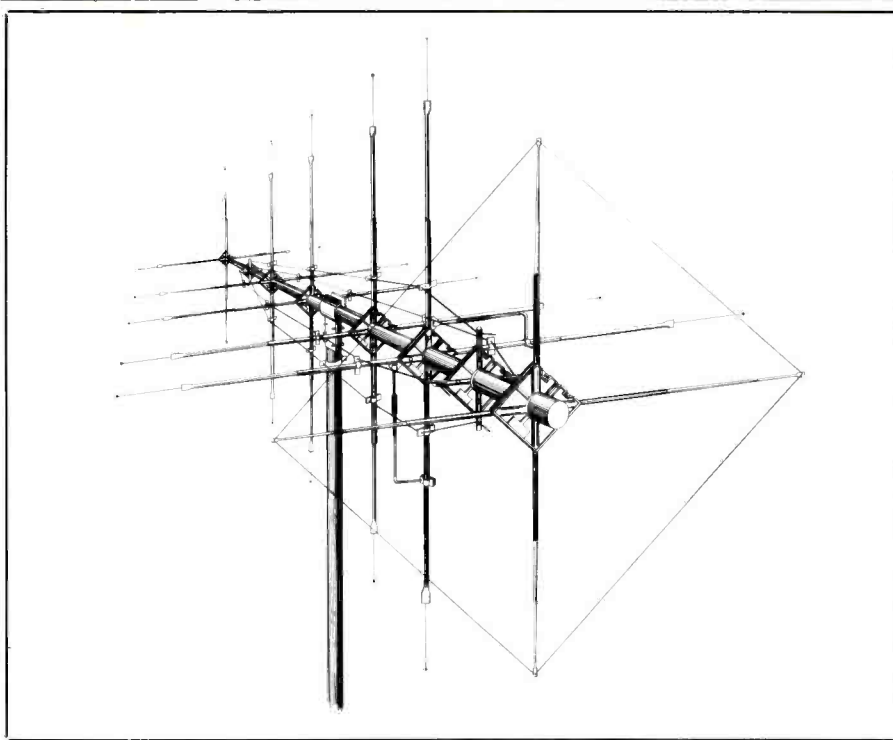

Beams will give the best CB range.

Band properly, this range, which can be easily achieved with a good antenna installation, should be fine. Of course, in an emergency, anything goes, including working DX to solicit a call for help.

The five-minute communications time limit is still in effect. You must leave at least one minute of open channel before resuming the conversation to let others come in. And it is perfectly legal to tie your Citizens Band transmitter into a telephone. This telephone connection must be made manually by another operator at the phone patch set. Phone patch equipment is readily available and easily modified for the CB radio service.

Unfortunately, the FCC does not allow digital data emissions in the Citizens Band radio service. You are limited to double sideband and single sideband as well as selective calling tones and tone-operated squelch to establish or alert another station for voice communications.

Surprisingly good range may be achieved on Citizens Band for emergency communications when skip conditions are not present. Skip is worse during the summertime (sporadic E) and also worse during the day (maximum E layer ionization). Skip is usually absent during the hours of darkness, and this is when excellent groundwave communications may take place.

Base stations that desire excellent groundwave coverage may use the omnidirectional, 20-foot, halfwave, fiberglass, vertical antenna. This antenna offers an extremely low angle of radiation, and is available for about \$50 from many manufacturers. Any base antenna shorter than 20 feet in length will not be as effective as a true full-

length halfwave system. The top part of the whip acts as the radiator, and the bottom portion of the antenna acts as the ground plane.

Directional Yagi antennas (beam antennas) are excellent and are used in conjunction with a rotator. A typical three-element beam for Citizens Band will increase your effective radiated power output by eight times (9 dB). They also boost incoming signal strengths by this same 9 dB amount also (approximately three "S" units).

Switching from small coax to top-quality RG213 or Belden 9913 base-station-sized coax will also decrease signal loss in the feedline. You can pick up an easy three dB (two times the power output) by simply going to bigger base station coax.

Mobile antennas come in a variety of sizes, shapes, and lengths. Generally, the longer the mobile antenna, the greater the effective range. This holds true when that mobile antenna is mounted high up on your vehicle with a good metal ground plane directly below it. Manufacturers of name brand mobile antennas have spent years perfecting designs that will allow your set to operate at maximum power output with minimum reflected power. If you follow the installation instructions carefully, you will obtain good results.

Make sure that all open connections to the mobile antenna are well-protected from the weather. Most mobile antennas never go bad—it's the connection point where the coax meets the antenna itself that gives out after a few years of exposure to sun and rain. Cover these connections with a coax sealant and you'll have a system that will perform for as long as you own the vehicle.

Mobile, base, and portable equipment is bountiful. The more you pay for your gear, the more pleasure you are going to receive in operating it. You can easily hear the difference in incoming audio when operating a \$300 set rather than a \$100 set. The more expensive sets are louder, clearer, more selective, and give a smoother audio response.

• • •

REACT continues to serve our nation as the largest emergency-associated communications team in the country. It is a non-profit 501(C)3 organization supported by team dues and donations. There are over 800 REACT teams that provide emergency assistance in their own communities through monitoring CB Channel 9. They assist disaster relief through the American Red Cross and Salvation Army, and they provide public service through many worthwhile projects. Their recently inaugurated "Return of Gifts" contributions program is an excellent way to support these REACT teams. This helps them to help you in a crisis.

Every emergency communications Citizens Band radio operator should subscribe to the *REACTer*, a bi-monthly publication of REACT International with a distribution of over 13,000 copies. The subscription is available at \$9 per year and is available from REACT International, 242 Cleveland, Wichita, Kansas 67214. Their publication lists excellent articles about Citizens Band, and also brings you the latest in CB radio equipment advertisements.

As a charter member of REACT back in the 50's, I can tell you this organization has hung in there when times were tough, while continuing to provide a central organization for monitoring emergency groups looking to serve other U.S. citizens. There are also countless other emergency Citizens Band groups that should be commended for their thousands of hours of service.

At every disaster, Citizens Band plays an important part of disaster relief communications. As an emergency communicator, you should have the ability to go on Citizens Band immediately without fussing with antennas or adjusting your equipment. Using amateur radio sets on CB radio frequencies is not only illegal, but complicated. Citizens Band communications are organized by channel numbers, not on direct frequency readouts. In an emergency, could you tell me, right this instant, where Channel 5 is in kHz? Someone's life could depend on it.

To the many Citizens Band emergency teams throughout the country, you are saluted for your efforts. But if you put your Citizens Band set away because you were disgusted with the things you heard on it, drag it out and give it another try. While the abusive people are still out there, you will find some new and refreshing operators who operate on the channels for the purpose CB was originally intended. Since *everyone* has a CB radio, it's your best bet for instant emergency communications. **PC**

LISTENING POST

BY GERRY L. DEXTER

WHAT'S HAPPENING: INTERNATIONAL SHORTWAVE BROADCASTING BANDS

Nary a month goes when we cannot consult the ledger and find that the appearance of new stations on the shortwave broadcast bands leaves us in a "profit" situation. Fortunately, the debit side of the ledger doesn't receive nearly as many entries. But we do have to make one this month, sorry to say. The Australian Broadcasting Commission has closed down the domestic shortwave broadcasting stations (VLH and VLR calls) at Lyndhurst. The final broadcasts of these transmitters were over the summer. The ABC said that time had passed the service by. These stations, which operated on 6150, 9680, 11880 and 15230, had been in operation since the 1930's.

The Aussies haven't put the axe away yet, either. Well known DX'er Geoff Cosier reports from Australia that the ABC outlet at Brisbane (4920 and 9660) will definitely close late this year. And Australia's Telecom has already announced the closing of the VNG time station at Lyndhurst which was due in October. We can't help but wonder if this is really necessary.

On a happier note, Radio Finland International should now be fully operational with its big 500-kilowatt transmitting complex next door to the long-time transmitter site at Pori and should, as a result, be providing even better signals.

The Bhutan Broadcasting Service raised the hopes of many DX'ers when it increased power from its former 400 watts up to a "whopping" 5 kilowatts and changed frequency to 6035. Well, there may have been one or two successes on the West Coast. The folks in Australia and New Zealand certainly had better luck, but for most of us it didn't make the slightest difference. There are more changes but they may not represent any favors either. 6035 has been replaced (for most usage) by 9615 and the station may, by now, have put its 50-kW transmitter into use. That's the good news. There's an ugly side as well. Seems KGEI occupies 9615 during the favorable morning shot we'd otherwise have, namely 1100-1400 (English is at 1330). Well, let's try, anyway.

The BBC's Hong Kong relay station should be on the air by now, although the tests which were scheduled to begin early in the summer were delayed. The Hong Kong installation will use a pair of 250-kW transmitter to beam the BBC into China and Japan. The Fall schedule calls for Japanese at 2200-2215 on 5965 and 7240; 1100-1145 on 5995 and 7180. World Service at 0845-0945 on 7180, 1245-1615 on 7160, 0345-0900 on 15280 and 2230-0430 on 15435. Meantime, the BBC Lesotho relay is putting a 100-kW transmitter in-



Here's SWL Mike Tarsney at his Alpena, Michigan listening post.

to service early next year. It will operate only on 6190.

A series of delays isn't at all unusual when building a shortwave station. In fact such delays occur far more often than not. So it's not surprising that the gremlins have struck Radio For Peace, the new station being built by the World Peace University. They were supposed to begin tests from Costa Rica late this past spring. Various equipment problems and shipping delays have slowed things down, but the station could be on the air by this time. Check 7380, though there may also be operations on the 49 and 19 meter bands. The headquarters address for the station is P. O. Box 188, Sweet Home, Oregon 97386.

It looks like there will be broadcasting switcheroos between Radio Beijing and Swiss Radio International, although no starting date has been announced. According to Johnathan Marks of Radio Netherlands Media Network, Radio Beijing planned to use the Swiss facilities daily at 2100-2300 for broadcasts in German, English, Spanish and French.

The United States and Israel have finally signed the agreement which will allow the construction of a Voice of America relay station in Israel. The station, which will require three to five years to build, will also relay Radio Free Europe and Radio Liberty. The cost of equipment and construction is estimated at \$300 million.

David L. Gregory, Manager and Chief Engineer for Adventist World Radio Latin America, tells us that AWR's Costa Rica station Radio Lira International was to conduct tests of its new, second transmitter late this Summer or early in the Fall. He says to watch the area between 5960 and 5980, especially after the 15460 frequency closes down for the day.

HCJB's new antenna, designed to put maximum signal strength into a north-south pattern, was dedicated on March 3. The station says that, in some areas at least, HCJB now has a fourfold increase in signal level.



One of Canada's top DX'ers is Andy Rugg, shown here manning an exhibit of the Ontario DX Association.

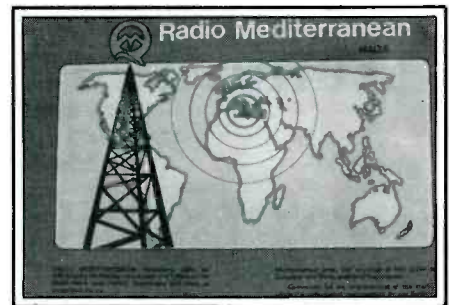

Radio Mediterranean broadcasts over the DW facility on Malta and sends a nice QSL card. (Courtesy: Gerard Van Dobben, Knoxville, TN)



Ron Seymour in St. Louis scans the world on a Sony 2001.

The mailman had it way too easy this month.

Sander J. Rabinowitz of Farmington Hills, MI checks in with his first *Listening Post* report. In fact, he provided it in two different formats, wondering which is preferred. We'll take the version which complies with the way we lay things out in our logs, Sander. And we'll look forward to regular reports from you. Thanks, and welcome!

John Miller (103 North Young Street,

Apt. D, Thomasville, GA 31792) is interested in forming a shortwave club for listeners living in the South Georgia/Northern Florida area. If you fit into that geography, drop John a note and help get something going. The Southern California Area DX'ers (SCADS) have a new schedule of their upcoming meetings and other events for 1988. If you live in Southern California or expect to be visiting the area, the group welcomes your visit. For the 1988 activity calendar send a business-size No. 10 SASE to SCADS, c/o Don R. Schmidt, 3809 Rose Ave., Long Beach, CA 90807-4334.

Have you checked in recently? Your letters, comments, questions, shack photos,

QSL's you don't need returned, schedules, and news clippings are always welcome. So, of course, are your loggings which should be by country with some space between each and your last name and state abbreviation after each. We look forward to your participation.

Here are the logs. Broadcasts are English unless noted otherwise.

**SWBC Loggings
(All Times Are UTC)**

Albania: R. Tirana, 6200 at 2337 w/nx & comment (Moser, PA); 7065 at 0230 s/on (Gilbert, CA). R. Tirana has now mostly abandoned their 7000-7100 kHz band ops, an activity that has always been a violation of international agreements--Editor.

Antigua: BBC Relay on 6040 at 0226 w/Top

Abbreviations Used in Listening Post

AA	Arabic
BC	Broadcast/ing
CC	Chinese
EE	English
FF	French
GG	German
ID	Identification
IS	Interval Signal
JJ	Japanese
mx	Muslc
NA	North America/n
nx	News
OM	Male
pgm	Program
PP	Portuguese
RR	Russian
rx	Religion/ious
SA	South America/n
SS	Spanish
UTC	Coordinated Universal Time (ex-GMT)
v	Frequency varies
w/	With
WX	Weather
YL	Female
//	Parallel frequencies

**For 25 years,
our people have
endured long hours
and tough
working conditions
for no pay.**



**And 9 out of 10 would
do it again.**

TO FIND OUT WHY

call

(316) 263-2100

or write

REACT INTERNATIONAL, INC.

242 Cleveland

Wichita, KS 67214

CIRCLE 9 ON READER SERVICE CARD

40; 6175 at 2133 w/World Service News (Moser, PA).

Argentina: RAE at 0205 w/nx on 9690 (Moser, PA); 0204 w/"News from Buenos Aires" on 11710 (Gilbert, CA).

Ascension Island: BBC Atlantic Relay on 6005 at 2136 w/nx (Moser, PA).

Australia: R. Australia, 9580 at 1330, also 0320 at 15160 w/soundtracks (Northrup, CT); 15320 at 2200 w/IS, nx to SE Asia (Rabinowitz, MI); //17795 at 2210 (Moser, PA); 17795 w/"Talkback" at 0310 (Miller, GA).

Austria: R. Austria Int'l., 0440 to Europe & NA on 6155 (Lingenfield, PA); 15320 at 1234 w/"Austrian SW Panorama" (Moser, PA).

Belgium: BRT on 9765 at 2100 & 2118 w/"Brussels Calling" including nx, DX pgm (Rabinowitz, MI, Moser, PA).

Benin: ORTB Cotonou on 4870 at 0515 w/mx, OM in FF (Moser, PA); 0600 in FF (Gilbert, CA).

Botswana: R. Botswana, 4820 at 0345 w/usual IS, but serious competition from HRVC (Moser)

Brazil: R. Record, Sao Paulo on 15135 at 1945 in PP w/nx & talk (Lingenfield, PA).

R. Cultura, Sao Paulo, 17815 at 2210, poss nx in PP (Lingenfield, PA).

R. Inconfidencia, Belo Horizonte, on 15190 in PP at 0251 (Lingenfield, PA).

Radiobras w/Brazilian pops at 0212 on 11745 (Moser, PA).

Bulgaria: R. Sofia, 11720 at 2318 w/feature about a festival (Moser, PA).

Burkina Faso: R. Burkina, 4815 at 2301 w/drums, OM in FF (Moser, PA).

Cameroon: R. Nacional, Yaounde, 4850 at 2158 w/mx, OM in FF, & ID (Moser, PA).

Canada: RCI, 6050 at 0525 to Europe w/nx, via relay at Skelton, England (Lingenfield, PA) 11955 at 1414 w/nx (Moser, PA); 15260 w/nx in African svc (Northrup, CT).

CBC Northern Quebec Service, 9625 w/nx relay from CCB sta CBM (Watts, KY); Here & //11720 in FF at 2126 (Moser, PA).

CFVP Calgary, 6030 at 1214 w/nx (Moser, PA).

CFRX Toronto, 6070 at 2140 w/nx, wx (Moser)

BBC Sackville relay, 15260 at 1542 w/nx (Moser, PA).

Canary Islands: Spanish Foreign R. relay on 15365 at 0103 in SS, ID's at 0115 (Moser, PA).

Chile: R. Sistema Nacional, 15140 at 1812 in SS (Moser, PA). Reported now to again be ID'ing as simply R. Nacional--Editor.

China: CPBS-2 domestic svc at 0235 in CC on 17700 (Lingenfield, PA).

R. Beijing, 9535 at 1100 w/clear ID (Moser)

Colombia: R. Nacional at 0105 on 11795 w/SS by OM & YL (Moser, PA).

Cuba: R. Havana Cuba at 1834 w/nx on 11795 (Moser, PA); 15270 at 1725 to Europe via Moscow (Lingenfield, PA). If the bc is via a relay in another country, it would probably be best for reporters to list the item under the relay country. Thanks!--Editor.

Czechoslovakia: R. Prague at 0100 on 5930 (Rabinowitz, MI); 7345 at 0121 w/press review (Moser, PA); 11990 at 0345 w/feature (Muterperl).

Denmark: R. Denmark at 1258 on 15165 w/EE into Danish (Moser, PA).

Dominican Republic: R. Clarin, 0030 on 11700 w/mx & talk in SS (Gilbert, CA); 1056 w/ID's, anthem & s/off (Moser, PA).

East Germany: RBI, 2309 on 9730 w/nx (Moser).

Ecuador: HCJB at 0110 w/mx, talk re business in Ecuador (Moser, PA); 15270//17790 at 2130

w/DX Party Line & host Clayton Haward (Miller, GA); 1935 w/Mailbag; 17890 w/"Inca Trail" at 1230 (Northrup, CT).

Egypt: R. Cairo on 9475 at 0217 w/"This news is coming to you from Radio Cairo" (Muterperl, PA); at 0220 (Moser, PA).

England: BBC (incl some relays) 5975 at 0310 w/News About Britain; 9510 at 1330 w/Sports Roundup & s/off; 11775 at 1235 w/Multitrack (Northrup, CT); 7325 at 2138 in World Service (Moser, PA); 12095 at 0516 w/24 Hours (McDonough).

Equatorial Guinea: R. Nacional, Bata, 5004 at 0537 in vernaculars. Heavy RTTY QRM plus some from WWV (Lingenfield, PA).

Finland: R. Finland Int'l., 11755 at 0432 w/Northern Report (Gilbert, CA); 0457 to NA (Lingenfield, PA); 15400 at 1415 w/Nordic Council News (Moser, PA).

France: RFI, classical mx at 1845 on 15300 (Northrup, CT); 9790 at 0314 in BF (Moser, PA); 17620 to Africa at 1635 (Lingenfield).

French Guiana: RFI relay, 0424 w/nx on 6055 (Moser, PA).

Gabon: Africa #1 at 1953 in FF on 15475 (Moser, PA); 4830 at 0516 in FF (Gilbert, CA). Swiss R. Int'l., via Africa #1, 9625 weak at 2300 w/Indonesian, into GG at 2330 (Watts, KY).

R. France relay via Africa #1, 11705 at 1604 w/nx (Moser, PA).

Ghana: GBC on 4915 at 0600 w/drumbeats, ID & s/on w/nx (Moser, PA).

Greece: V. of Greece, 7430 at 0350 w/nx. Poor quality audio (Lingenfield, PA); 15630 at 1542 w/nx (Moser, PA).

Guatemala: R. Cultural, 3300 at 0327 w/rx mx (Moser, PA).

Honduras: HRVC at 0332 w/inspirational mx on 4820 (Moser, PA).

Hungary: R. Budapest, 9520 at 0100 & 0200 in EE, at 0230 in Hungarian (Rabinowitz, MI); 0200 w/nx (Gilbert, CA).

India: AIR, 11620 at 2001 w/regional nx by OM (Moser, PA).

Indonesia: V. of Indonesia, 11790 at 0855 w/nx (Gilbert, CA).

Iraq: R. Baghdad at 2145 w/local mx, anncs, & s/off on 9875 (Moser, PA).

Israel: Kol Israel, 9435 at 0100 (Rabinowitz, MI); 9815 at 0407 w/nx (Moser, PA).

Italy: RAI w/nx at 0112, mx 0115 on 9575 (Moser, PA).

Ivory Coast: RT Ivoirienne, 11920 at 1759 w/xylophone IS, anthem, ID as "Abidjan" (Moser, PA).

Japan: R. Japan, 9560 (via Canada) at 0340 to NA (Lingenfield, PA); 0350 w/"Forests & Our Lives" (Muterperl, PA); 11800 at 2313 w/nx about Japan (Moser, PA).

Liberia: VOA relay, 6035 at 0313 w/nx (Moser).

Libya: R. Jamahiriya, 7245 at 2201 giving mailing address, then mx (Moser, PA); 15415 at 0115 in presumed AA (Gilbert, CA).

Lesotho: R. Lesotho, 4800 at 0506 w/YL & nx (Moser, PA).

Luxembourg: R. Tele-Luxembourg at 0057 on 6090 w/rock mx, nx, "Power Play" (Moser, PA).

Madagascar: R. Netherlands relay, 9715 at 2108 w/Happy Station (Moser, PA).

Mauritania: ORTM Nouakchott at 0719 on 4845 w/mx (Moser, PA).

Mali: R-TV Malienne, 2230 w/nx in FF on 4835 (Moser, PA).

Malta: V. of Malta, 2145 on 6110 w/FF to Europe (Lingenfield, PA). R. Mediterranean?--Editor.

DW relay on 6085 at 0117 w/YL anncr, mx (Moser, PA).

Monaco: TWR, 0625 w/rx pgm on 7105. Freq anncd as "7.1 MegaHertz" (Moser, PA).

Montserrat: DW relay on 9545/9565 with mx at 0120 (Moser, PA).

Morocco: RTM on 11920/15335 at 2221 w/African mx & OM in AA or Berber (Moser, PA).

Netherlands: R. Netherlands, 6020 at 0238 (Moser, PA); 7290 w/Newsline at 0400 (McDonough). 9715 via Madagascar at 2114 beamed to Africa (Lingenfield, PA).

Netherlands Antilles: R. Netherlands relay on 9590 at 0241 (Moser, PA).

TWR, 9535 at 0312 w/discussion (Moser, PA); 15355 at 2330 /Evangeliums Rundfunk in GG (Watts, KY).

New Caledonia: R. Noumea, 7170 at 0723 w/50's golden oldies mx, OM in FF (Moser)

New Zealand: RNZ, 11780 at 0505 w/national nx & wx (Gilbert, CA); 0515 w/nx (Lingenfield, PA); 15150 at 0205 w/wx, mx, ID at 0330 (Miller, GA); 0223 w/sports (Moser, PA).

Nigeria: V. of Nigeria, 7255 at 0500 s/on, OM w/local nx (Moser, PA).

Norway: RNI w/pop mx at 1330, DJ in FF on 15305 (Northrup, CT); 15310 at 1412 w/talk (Moser, PA).

Paraguay: R. Nacional, 9755 at 2120 w/mx, OM in SS (Moser, PA). Not 9735?--Editor.

Poland: R. Polonia at 0300 on 9525 w/LU, mx, comment (Rabinowitz, PA); 11815 at 0335 w/nx, wx, lessons in speaking Polish (Muterperl, PA).

Portugal: R. Portugal, 9705 at 0300, EE s/on & nx (Gilbert, CA); 0310 w/feature (Moser)

Romania: R. Bucharest, 0200 on 9510 (Rabinowitz, MI); 0207 w/nx (Gilbert, CA); 9570 at 0218 w/mx (Moser, PA).

Rwanda: DW Kigali relay at 1130 w/nx on 17800 (Moser, PA).

South Africa, Rep. of: R. RSA, 6010 at 0207 w/nx (Moser, PA); 9615 at 0200 w/ID & nx (McDonough, PA).

R. Orion, 3955 at 0257 w/ID (McDonough, PA).

South Korea: R. Korea, 15575 at 1304 w/nx (Muterperl, PA).

Sweden: R. Sweden Int'l., 9695 at 0230 w/Nordic News (Gilbert, CA); 15345 at 1404 w/Nordic Newsweek (Moser, PA).

Switzerland: Swiss R. Int'l., 9885 at 0200 w/Dateline (Gilbert, CA); 12035 at 2100 w/Dateline (Moser, PA); 0225 w/nx (McDonough, PA).

Syria: R. Damascus, 9950 at 2112 w/nx by OM (Moser, PA); 12085 at 2105 w/ID, nx, press review, Arab profile (Miller, GA); 15020 at 1850 w/AA mx, OM in GG (Northrup, CT).

Tahiti: RFO R. Tahiti, 15170 at 0355 w/native mx, nx in FF (Muterperl, PA); //11825 at 0611 w/nx (Moser, PA).

Taiwan: VOFC on 9690 at 0230 to Asia (Lingenfield, PA).

Togo: RTT Lome, 5047 at 0526 w/6-note chime IS, band mx, s/on, singing. All FF (Moser, PA)

Turkey: V. of Turkey, 9560 at 2210 to NA w/Turkish mx (Lingenfield, PA); 2212 w/essay contest nx, "Outlook" (Moser, PA).

Unidentified: 15405 at 0212 w/guitar, possibly anthem, YL anncr (McDonough, PA).

United Arab Emirates: UAE R. Dubai, 15435 at 0330 w/nx, wx, mailbag (Miller, GA); 0341 (McDonough, PA).

V. of UAE, Abu Dhabi, 15385 at 1940 in AA (Lingenfield, PA).

Ukrainian SSR: R. Kiev at 0308 at 7165 (Moser, PA); 0200 on 7260 (Muterperl, PA); 9800 at 0200 to 0230 when into different USSR svc (Rabinowitz, MI).

United States: WHRI on 5995 at 1200 (Northrup, MI); 7400 w/rx pgm at 0415 (McDonough, PA).

WINB on 15145 w/rx pgms at 0145 (McDonough,

PA); at 0203 (Moser, PA); at 0315 (Northrup, CT).

AFRTS at 0130 on 5130//6030 (Rabinowitz, MI); 15345 at 2132 w/nx (Moser, PA).

VOA on 9455 at 0140 (Moser, PA).

VOA feeder at 0043 on 7650 in USB mode, apparently to India, into Urdu at 0200 (Rabinowitz, MI); 10454 at 1700 in USB w/EE, LSB in AA, at 2100 RR in USB, EE in LSB (Watts, KY).

WYFR at 1844 w/"For Your Health" on 9535 (Moser, PA).

WRNO, 11705 at 2214 w/rx pgm (Moser, PA).

KVOH, 17775 at 2143, rx pgm (Moser, PA).

USSR: R. Moscow, 11840 at 1603 w/nx (Moser, PA); 15425 at 0338 w/nx (McDonough, PA); 17645 at 1230 (Northrup, CT).

Mayak svc on 4765 (via Cuba) //9470//11720 at 0311 in RR (Lingenfield, PA).

Un-ID Soviet sta in RR on 9685 at 2120 (Rabinowitz, PA).

Vatican: Varican R., 9645 at 1956 w/nx (Moser, PA); 2003 w/Newsdesk (Muterperl, PA); 11780 at 0050 re Pope's schedule, Newsdesk (Miller, GA).

Venezuela: R. Rumbos, 9660 at 1807 in SS (Moser, PA); 2317 in SS, w/mx (Gilbert, CA).

Vietnam: V. of Vietnam, 9840 at 1350 w/discussion of musical instruments in rural Vietnam (Gilbert)

West Germany: DW, 6145 at 0119 w/GG mx, EE anncs (Moser, PA); 7225 at 0439 (via Rwanda) (Lingenfield, PA).

Zaire: R. Lubumbashi (tentative ID), 7205 at 0529 in FF (Lingenfield, PA).

Thanks to this month's team: Henry Muterperl, North Wales, PA; William Moser, Pittsburgh, PA; R.C. Watts, Louisville, KY; Warren L. Gilbert, Sherman Oaks, CA; Pat McDonough, Pittsburgh, PA; Mark Northrup, Danbury, CT; Darrell Lingenfield III, St. Thomas, PA; John Miller, Thomasville, GA and Sander Rabinowitz, Farmington Hills, MI.

'Til next month, good listening!

PC

NOW! DX the World! WHEREVER YOU ARE

The only truly effective passive antenna in a portable, desk-top package. Just \$79.95 plus \$4.00 Shipping. (New York State Residents add appropriate sales tax)

FUNtenna™
COM-RAD INDUSTRIES
1635 West River Road
P.O. Box 554
Grand Island, NY 14072-0554
(716) 773-1445

CIRCLE 34 ON READER SERVICE CARD

RADIO WEST
SHORTWAVE AND AM RADIO EQUIPMENT
GREAT STOCKING STUFFER !!
THE "NEW" PANASONIC RF-B10

THE PERFECT GIFT FOR THAT "SOMEONE SPECIAL", THIS CHRISTMAS SEASON. THE RADIO IS THE SMALLEST SHORTWAVE MODEL ON THE MARKET. GREAT FOR THAT "ON-THE-GO" LISTENING. FULL FM/MW (AM) RECEPTION & SHORTWAVE FREQUENCY 5.95 TO 17.90 MHZ. EARPHONE AND CARRY CASE. DX/LOCAL AM SENSITIVITY SWITCH. OPERATION HOLD SWITCH. HIGH/LOW TONE SELECTOR. CHRISTMAS SPECIAL \$89.95 + \$4 S/H.

850 ANNS WAY DRIVE
VISTA, CALIFORNIA 92083
(619) 726-3910

CALL OR WRITE FOR A FREE CATALOG... TODAY !!
PLEASE ENCLOSE \$1.00 FOR POSTAGE
"Sail around the world with RADIO WEST"

CIRCLE 40 ON READER SERVICE CARD

SUBSCRIBER SERVICE

CHANGE OF ADDRESS

Planning to move? Please let us know six weeks in advance so you won't miss a single issue of POPULAR COMMUNICATIONS

Attach old label and print new address in space provided. Also include your mailing label whenever you write concerning your subscription to insure prompt service on your inquiry

POPULAR COMMUNICATIONS
76 N. Broadway,
Hicksville, NY 11801

ATTACH LABEL HERE

NEW ADDRESS HERE

PLEASE PRINT

NAME _____

ADDRESS _____

CITY _____ STATE _____

DATE _____ ZIP _____

Beaming In (from page 5)

New York City commercial AM/FM broadcasting markets. Notwithstanding RNI's sentiments about being outside a so-called "three mile limit," they were guaranteed to attract the sudden and dramatic FCC reaction that took place.

Certainly, for decades, our government has freely exercised apparent or *de facto* jurisdiction far past three miles in matters relating to national defense, mineral exploration and exploitation, fishing and treasure rights, environmental protection, navigation safety, searches and rescues, and other similar areas.

RNI's backers claim that they put more than \$100,000 into getting RNI on the air. If that's true, then they certainly seem to have been cavalier with their funds if they thought that RNI could exist for more than a few days under the conditions they established—even if the *M/V Sarah* hadn't started to take on water only twelve days after RNI's first broadcast. The FCC, Coast Guard, and the other raiders probably would have swooped down in response to RNI if it had been as far as 100 miles from any American coastal area, especially when it was making noises like it wanted a marketshare of a major audience.

To the casual observer, it might seem that a more prudent approach would have been for RNI to have forgotten about FM'casting, gotten a more powerful AM transmitter, plus shortwave, set up operations not addressed to a specific local market—and done it from 1,000 miles or more out in the ocean. Sounds like a great idea, doesn't it? Last year a European syndicate was all fired up with this idea. They asked me to be a consultant for their venture, my main function being to take them by the hand and tell them what had to be done to make it all happen. As it turned out, my primary purpose was to talk them out of moving ahead with their plans.

A sturdy ship would have to be obtained, one that could survive severe mid-ocean sea and weather conditions over an extended period of time. The vessel would need a captain and a crew. RNI's 27-year old broken-down *M/V Sarah* (which tried to sink after only two weeks of being anchored in calm coastal waters) cost \$50,000 and had neither captain nor crew—so you can guess the cost of obtaining and staffing an ocean-going ship. Since ITU Article 30 forbids broadcasting from international waters, it would be questionable if the ship could get and keep a valid registration from any member of the United Nations.

Furthermore, it could mean major problems in locating a nation that would host the pirate station's business offices or supply points. The United States and Canada were definitely out of the question. The costs and logistics of maintaining the mid-ocean station, plus ferrying ship crews, broadcast station staffers, food, equipment, program-

ming, and miscellaneous supplies were staggering obstacles.

There was no guarantee that some nation, group of nations, or even the U.N. itself wouldn't take steps to silence the station by direct (armed boarding) or indirect means (supply blockade, seizing funds, arresting shore-based personnel, etc.). The amount of money, effort, and arrangements required to place the station in position and operation, versus the risks and income potentials made the whole thing less than sufficiently appealing. The idea was scrapped. These reasons may well be why RNI decided to toss out the *M/V Sarah*'s five-ton anchor so close to shore.

RNI's owners said that they tried but couldn't get an FCC license to operate their station, that's why they established it past the three mile limit in what they perceived was beyond the jurisdiction of the American Government, its regulations and enforcement agencies. Possibly a reasonable approach, but it might have been inadvertently undermined by RNI itself. After the station was silenced, RNI left a guard aboard to keep an eye on things. When the *Sarah* started taking on water, the guard lost no time in calling upon the U.S. Coast Guard to come and pump the six feet of water out of the engine room—international territory or not!

The Coast Guard quickly complied. Yes, the same agency that only a few days earlier found it necessary to remove RNI staffers Al Weiner and Ivan Jeffries in manacles. The pumping efforts were heroic, but still didn't offset the inappropriate and totally unnecessary handcuffing incident. The two broadcasters had posed no threat of escape or physical violence. It was a disgraceful incident staged for the news media. Not one of the Coast Guard's most shining hours, to say the very least.

RNI, for all that it was and wasn't, and all that it hoped to be, had three days of great free-form, off beat, innovative DJ's playing lots of music. More than that, it managed to fill the fantasies of every backroom pirate station operator who ever lived. To its owners and staff, the *M/V Sarah* probably looked like the *Queen Elizabeth II*. The RNI equipment couldn't have appeared more elegant had it been a full 50-kW built by Gates or Continental.

Like many others, I was awestruck by RNI, even though they had more talent, audacity and brass than smarts in putting it on the air. It came across to me as having started out as a vague idea that a couple of radio freaks turned up while sitting around talking about their favorite subject. As the years passed, the more they talked of the idea—and the more plausible it seemed to become. Then one day, after the idea had infected everybody around them, it reached the point when it became so real that the only place it didn't exist was in the form of physical turntables, tape decks, control panels, microphones, transmitters, towers, and a ship to house the station.

At that point, after all of the talk and planning, that must have seemed the inevitable and necessary culmination of the idea. Regardless of the expenses, obstacles, risks, and possible consequences, RNI had become a concept that cried out for complete fulfillment and existence. It was what climbing Mt. Everest had become to Hillary, how Heyerdahl regarded *Kon-Tiki*, what the idea of a stainless steel car had become to DeLorean, and how the notion of the *Voyager* aircraft haunted Dick Rutan. It was Jimmy Stewart's hope of building the housing subdivision in *It's A Wonderful Life*.

The RNI staffers became instant folk heroes, a status they never would have attained had the station not been jumped on so heavily by the FCC, Coast Guard, etc. Still, I really hoped that RNI would have been found to be legal, had triumphed, and lived happily ever after—filling the air with its parody commercials, zany DJ's telling absolutely awful jokes, and records that included everything from the Moody Blues to Doug and the Slugs.

Maybe when they get around to making a TV movie out of this thoroughly incredible story, that's the way it will end at the fade-out. As the final credits crawl up the screen, accompanied by the sounds of RNI's Randi Steele announcing the Splat Cats' rendition of *Surfin' Hearse*, we see the scowling FCC agents (played by Jack Palance and Norman Bates) bailing the water out of their rowboat as they skulk back to shore in abject defeat.

But, dream or nightmare—however you may wish to regard RNI's short but colorful life, it *did* live, earning itself a permanent spot in the lore and legend of radio—right there with pirates RXKR and the *Voice of the Purple Pumpkin*, Dave Thomas' WUMS, Norman Baker's KTNT, Doc Brinkley's renegade "goat gland" stations KFKB/XER/XERA, and the other immortals.

For all of their troubles, and ensuing publicity, the RNI crew received an offer to demonstrate their talents and spin their platters over station WNYG (ex-WBAB, 1440 kHz, 1 kW), located not far from where RNI had been located offshore. For one day, RNI (sort of) lived again. Ironically, and for reasons not understood, about 20 minutes worth of the RNI/WNYG programming was repeated over the FCC's VHF two-way communications system.

MTV then jumped on the bandwagon and gave the RNI staff a spot, as other stations followed WNYG's noteworthy example. WNYG, a local station that normally plays "contemporary-adult/middle of the road" music, suddenly found itself being heralded in the national media for its rather bold offer to RNI.

As we approach the time of year when dreams and wishes have been known to come true, I couldn't hope to offer you anything more appropriate than the story of this impossible dream that, for a very brief and fleeting moment, came to be. From the start, it was the craziest damned thing I ever heard of.

COMMUNICATIONS SHOP

Advertising Rates: SCAN members and POP'COMM subscribers are entitled to one FREE 30-word, non-commercial classified ad per year. Enclose subscription name label with ad copy. For those people not in the previously mentioned groups, non-commercial ads are 30 cents per word, including abbreviations and addresses; minimum charge \$6.00 per issue. Ads from firms offering commercial products or services are \$1.00 per word; minimum charge \$20.00 per issue. Boldface words are \$1.20 each (specify which words). Leading key words set in all caps at no additional charge. All ads must be prepaid in full at time of insertion; a 5% discount is offered for prepaid 6 time insertions. All ads must be typewritten double spaced.

Approval: All ad copy is subject to Publisher's approval and may be modified to eliminate references to equipment and practices which are either illegal or otherwise not within the spirit or coverage scope of the magazine.

Closing Date: The 10th day in the third month preceding date of publication. Because the advertisers and equipment contained in Communications Shop have not been investigated, the Publisher of Popular Communications cannot vouch for the merchandise listed therein. Direct all correspondence and ad copy to: PC Communications Shop, 76 N. Broadway, Hicksville, NY 11801.

OLDTIME RADIO BROADCASTS. Classic programs from radio's golden age, on high-quality tapes. Mystery and adventure! Comedy! Drama! Music! Write for your free catalogue. Carl P. Froelich, 2 Heritage Farm, New Freedom, PA 17349.

BIG! AIR-SCAN 4th Edition by Tom Kneitel. At last, a complete directory of aero communications stations/frequencies! Now in gigantic 120-page large-size (8 1/2 x 11) format containing 40,000 listings (USA/Canada/Mexico/PR), including worldwide HF (2-30 MHz) freq. guide. In addition to 118-136 MHz VHF aero band scanner listings, also covers 30-50, 138-174, & 400+ MHz aero freqs. never before published. AIR-SCAN covers civilian/military airports, also "unlisted" airports not open to public, FAA freqs, FSS, towers, Unicom, airport security and operations freqs, new airborne air/ground telephone freqs, "hidden" business-band aero stations, military, traffic choppers, aero weather, federal agency aero, flight schools, aircraft mfrs., crop dusters, air ambulances and much more throughout USA. Largest directory of all-band aero radio communications ever published. Includes how-to text on aero monitoring and equipment selection. Only \$10.95 + \$1 shipping to USA/Canada/APO/FPO. Order from CRB Research, P.O. Box 56, Commack, NY 11725.

PROPAGANDA TAPES! Authentic, rare recordings of WWII German and Japanese shortwave broadcasts by "Tokyo Rose," "Axis Sally," others. Cassette \$9.95. D-W Research, 4548 Auburn Blvd., #231-B, Sacramento, CA 95841.

JUST ISSUED! HEAR YOUR GOV'T. IN ACTION! The gigantic new 6th Edition of Kneitel's TOP SECRET REGISTRY OF U.S. Gov't. Radio Freqs., the ultimate scanner directory. Revised/Expanded to cover 80+ agencies, 192 large-size pages, 125,000 listings: freqs., many locations, call signs, tactical ID's, codenames, agent buzzwords, freq. usage/designator codes, code signals. Latest info: FBI, DEA, Secret Service, FCC, ATF, Immigration, Customs, Border Patrol, CIA, NSA, Nat'l. Forests, Nat'l. Parks, GSA, FEMA, Treasury, Marshals, NASA, FAA, EPA, all Armed Forces, bug/surveillance freqs., much more, plus UHF Aero and many Canadian freqs. Extra: Most important 2-25 MHz HF freqs included. Contains more and digs deeper than ever before! New 6th Ed. is \$17.95, add \$1 postage for 4th Class mail to N. American addresses, or \$3 for First Class mail. You Ain't Heard Nothin' Yet! Get your copy now: CRB Research, P.O. Box 56, Commack, NY 11725. (Dealer inquiries invited—write on company letterhead.)

Advertiser's Index

ARRL	17, 75
Antenna Specialists	35
Antique Electronic Supply	49
Antique Radio Classified	59
Barry Electronics	49
CBC International	75
CRB Research	24
CTM	49
Capri Electronics	57
Cobra/Dynascan	37
Communications Electronics, Inc.	9
Com-Rad Industries	71
DECO	49
DGM Electronics, Inc.	29
Delaware Amateur Supply	65
EGE, Inc.	73
Electron Processing, Inc.	59
Electronic Center, Inc.	52
Elec. Equip. Bank	4, 38, 39
Fair Radio Sales	73
Fanon Courier	3
Giller Shortwave	1
Ham Station	75
Imprime	35
Jensen Tools	29
Kenwood U.S.A. Corp.	Cov. IV
MFJ Enterprises, Inc.	13
Michigan Radio	57
Monitoring Times	74
OPTOelectronics	42
Pacific Cable Co.	29
POP'COMM Book Shop	63
RF Limited	50
Radio Shack	7
Radio West	71
React, International	70
SONY Corp.	27
Satman	41
Scanner World, USA	76
Signal Engineering	25
Tiare	47
Uniden	Cov. II, 19
Unity Electronics	57
Universal SW Radio	40
World Clocks Inc.	40
Yaesu Electronics	Cov. III

BOOKS
ACCESSORIES
ANTENNAS

SWELL SWL DISCOUNTS

Factory Authorized
Service for Icom
Kenwood &
Yaesu

Extended
warranties
available

Orders & Quotes
Toll Free—

National:
800-336-4799

New England:
(except New Hampshire)
800-237-0047

Virginia:
800-572-4201

ege, inc.

Virginia

14803 Build America Drive
Building B
Woodbridge, VA 22191
Customer Service: (703) 643-1063
Service Dept.: (703) 494-8750
Hours—M-Th: 10-6;
Fri: 10-8; Sat: 10-4

ege, inc.

New Hampshire

8 Stiles Road
Salem, New Hampshire 03079
Customer Service & New Hampshire Orders: (603) 898-3750
Hours—MTuW-Sat: 10-4;
Th-F: Noon-8



KENWOOD

R-5000
All-mode listening 100 kHz -30 MHz. Optional converters to cover the 108-174 MHz range. 100 memories.

R-2000
150 kHz - 30 MHz for AM, FM, SSB, and CW listening. 10 memories.



ICOM

R-71A
Receive 100 kHz - 30 MHz. For AM, SSB, CW, RTTY, & optional FM. 32 memories.

R-7000
25-100 MHz (1.24-1.3 GHz) coverage for SSB, FM, & AM. 99 memories.



YAESU

FRG-8800
Listen to AM, SSB, CW, FM narrow and wide 150 kHz-30 MHz. 12 memories.

FRG-9600
Compact receiver for FM, AM, SSB with a range of 60-905 MHz (up to 460 MHz for SSB). 100 memories.



SANGEAN

SWL radios for AM/FM. Call for more information and quotes.

TEN-TEC

RX-325
Covers AM, SSB CW 100 kHz to 30 MHz. 25 memories.

SONY

ICF-2002, ICF-2010, and ICF-7600A are compact receivers for SWL. Call for quotes.

Scanners

Regency
Bearcat

At Super Discounts

CBs
& Radar
Detectors
Uniden, Cobra,
Midland, & Whistler

CIRCLE 153 ON READER SERVICE CARD

BANDE, A TO Z—HOW TO GET IN ANYWHERE, ANYTIME. The Most Dangerous Video Ever Produced. Almost 2 hours of actual, on-site trick techniques to get in any building, beat any lock, open any safe, enter any car. The real experts teach the real stuff. \$99.95 and worth every red cent. Specify VHS or Beta. CEP, P.O. Box 865-MCP, Boulder, CO 80306.

FCC COMMERCIAL GENERAL Radiotelephone License Correspondence Course. 60 individual lessons for \$89.50. Payment plan. Results guaranteed! Detail free. AMERICAN TECHNICAL INSTITUTE, Box 201, Cedar Mountain, NC 28718.

RADIOTELETYPE-SHORTWAVE-FACSIMILE Books, unusual, hard-to-find latest publications. Satellite communications, scrambling. Many titles. Free catalog. Universal Electronics, Inc., 4555 Groves Road, Suite 13A, Columbus, OH 43232. (614) 866-4605.

WANTED: Cash paid for used SPEED (TRAFFIC) RADAR EQUIPMENT. Write or call: Brian R. Esterman, P.O. Box 8141, Northfield, IL 60093, (312) 251-8901.

RECEIVERS FOR SALE: UHF military, satellite, tunable, programmable, scanners, antennas, test equipment. Call (419) 726-2249.

BROADBAND LOOP ANTENNA COVERS 100 kHz to 7 MHz. Rotable 11" shielded loop provides maximum sensitivity and noise rejection. Balanced design insures deep nulls for eliminating interference. Plugs into desk-top 24-dB amplifier. Specially designed for the LF/AM broadcast DXer. L10/A428 combination: \$99.95 + \$4.00 shipping. Interceptor Electronics, Inc., Route 1, Box 439, Round Hill, VA 22141. Telephone: (703) 338-4905.

CANADIAN HOBBYIST will pay cash for Hallicrafters receivers, transmitters, etc. What have you got hidden away? Charlie Hunter, 653 Trelawny Private, Ottawa, Ontario, Canada K2C 3M7. (613) 225-6538.

PROTECT YOUR SCANNER! Quality leather case for RS PRO-30 \$45 (add \$4 p&h) others available on request, send check or M.O., ALEXANDER, P.O. Box 1556, Kitchener, Ontario, Canada N2G 4P2.

CB RADIO OWNERS! We specialize in a wide variety of technical information, parts and services for CB radios. 10M FM, conversions, repairs, books, plans, kits, high-performance accessories. Our 11th year! Catalog \$2. CBCI, Box 31500PC, Phoenix, AZ 85046.

TELEVISION SETS made before 1946 wanted for substantial cash. Especially interested in "mirror-in-the-lid" and spinning disc sets. Finder's fee paid for leads. Arnold Chase, 9 Rushleigh Road, West Hartford, CT 06117. (203) 521-5280.

MILITARY ELECTRONICS: CPRC-26 Manpack Radio, compact, transmits-receives 46-54 MHz FM, with battery box, antenna, crystal \$17.50 apiece, \$32.50/pair. ARC-27 Guard Receiver, 220-250 MHz single channel: \$9.50. R-748 Receiver, 130-150 MHz single channel: \$22.50. Ballantine 9632A Multimeter: \$47.50 checked, \$22.50 complete/repairable. H-251 Communications Earphones: \$9.50. Patrol Seismic Intrusion Device ("PSID") TRC-3: \$42.50 apiece, \$147.50/set of four, mint condition. 45-Day Replacement Guarantee. Add \$4.50/piece shipping (except R-390A, shipped collect). Baytronics, Dept. PC, Box 591, Sandusky, OH 44870.

NORTH AMERICAN RADIO-TV STATION GUIDE by Vane Jones. 15th Edition! Thick 226-page book listing all US/Canadian/Mexican/West Indies AM/FM/TV broadcasters according to location/frequency/callsign, plus TV network affiliation, AM station day/night power, schedule data, etc. Painstakingly complete, accurate, up-to-date. The ultimate broadcast station directory. Only \$9.95 (plus \$1 postage) from CRB Research, P.O. Box 56, Commack, NY 11725.

VOICEGATE COMMUNICATIONS NOISE REDUCTION—A revolutionary new way to reduce the background noise found on today's crowded bands! (Reviewed in *Monitoring Times* 5/87). An SASE gets you our FREE brochure or send \$3.50 and we'll include our demonstration cassette! Voicegate \$109.95. Power pack \$9.95. JABCO, R1 Box 386, Alexandria, IN 46001.

The Austin TRI-BAND 2M/1.25M/70CM Metro antenna puts you on the three most active repeater bands with a single 15" antenna on your car roof and a single cable. Antenna functions as a low SWR patent-applied-for quarterwave vertical on 2M and 1.25M and a three-quarter wavelength antenna on 70CM. It's a good scanner antenna too. Antenna is priced a modest \$39.95. Matching magnet mount is \$22.50. Add \$4.50 P&H. PA 6%. Contact Ed Noll W3FQJ, P.O. Box 75, Chalfont, PA 18914.

LANDMOBILE AND MARINE RADIO TECHNICAL HANDBOOK has been written for current and prospective two-way radio technicians, operators, and engineers. It can be used as a radio-communications textbook for home study or classroom. Two-way fundamentals, circuit details, maintenance and installation data, test equipment types and practical usage, two-way services and frequencies, transmission characteristics and classifications, solid-state fundamentals as related to transmission circuits, modulation systems, digital and microprocessor circuits, test equipment types and usage, antenna systems, landmobile systems and circuits, repeater, trunked, and cellular radio, marine radiotelephone and radiotelegraph equipment, direction finders and loran, marine radar and FCC licensing information. 575-page SAMS book \$24.95 + \$2 P&H. Ed Noll, Box 75, Chalfont, PA 18914.

APEX® SCREWDIVING BITS. Any size. Complimentary illustrated list. S. Shockey's, 5841 Longford, Dayton, OH 45424. (513) 236-2983.

BUGGED? COUNTERMEASURE SWEEPS. Telephones, Offices, Watercraft, Aircraft. Confidentiality Assured. Write or call for a free eavesdrop brochure and estimate. Central States Investigations, 1007 West Jefferson Street, Suite 160, Sprfld., IL 62702-4835. AC/217 525-9499.

ARCO SOLAR POWER for all your radio gear!!! Ultra-low prices on all solar panels and accessories!!! Call us and see **HENRY RADIO INC.**, 2050 S. Bundy Dr., Los Angeles, CA 90025 or (213) 820-1234 and (800) 421-6631.

LEARN MORSE CODE in 4 hours. My method works \$5.25 to J.L. Steiger, 375 Hillside Rd., Seven Hills, OH 44131.

SCANNER FREQUENCY SEARCH SERVICE. Hear all there is to hear! SASE to: Heald, 6886P Jefferson, North Branch, MI 48461.

"WE TAKE TRADES!!" ICOM R-7000 \$959. FRG-9600 \$499. ICF-2010 \$319. R-2000 \$499. R-5000 \$769. NEW!! BC-300XLT. BC-100XLT CALL!! MFJ, Directories, USED GEAR, MORE!! Our BIG 31-page picture catalog is \$1.00 (refundable). Used gear List, One SASE. GALAXY ELECTRONICS. Box 1202, Akron, OH 44309. (216-376-2402) 9-5pm EST.

HISTORIC WIRELESS/RADIO ARCHIVES! Tom Kneitel's new book, "Radio Station Treasury (1900-1946)." Gigantic 176-page compendium listing stations that operated between the dawn of the spark era & the end of WWII. A profusion of frequencies, skeds, callsigns, slogans, licensee data, power, locations, etc. Covers the world's AM band & SW broadcasters, "utes," point/point, press, aviation, maritime, police, federal, military, experimental, longwave, early FM/TV, secret WWII propaganda stations, more! Comprehensive sourcebook directory packed with huge array of fascinating features & facts about tens of thousands of stations in every nation & category, of every size & type! Unique reference guide, nothing ever before like it! Research radio history in your own community & throughout the world. Personally autographed by the author (upon request when ordering). Only \$12.95 plus \$1 postage (USA/Canada/APO/FPO) from CRB Research, P.O. Box 56, Commack, NY 11725.

Fourteen Reasons To Subscribe To The World's Leading Magazine For Shortwave and Scanner Listeners

1. International Broadcasting
2. Utility Monitoring
3. Scanners
4. Shortwave and Longwave
5. Satellites
6. Electronic Projects
7. Listening Tips
8. Frequency Lists
9. Equipment Reviews
10. News-breaking Articles
11. Feature Articles
12. Exclusive Interviews
13. Insights by the Experts
14. New Product Reviews/Tests

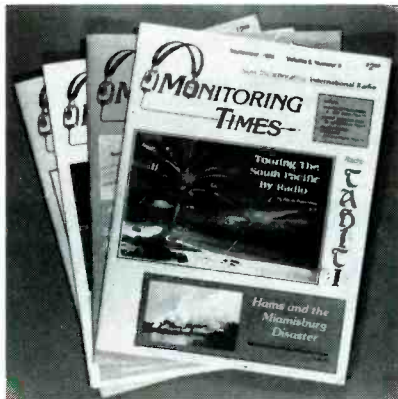

Yes, each month **MONITORING TIMES** brings you exclusive inside reports by the industry's top writers, along with accurate schedules of international broadcasters; announcements and tests of new equipment and accessories; profiles of government, military, police and fire networks; exclusive home projects; and tips on monitoring everything from air-to-ground and ship-to-shore to radioteletype, facsimile and the Space Shuttle.

MONITORING TIMES, considered indispensable reading by top government agencies, is your foremost guide to authoritative listening throughout the radio spectrum. Easy to read, **MT** brings you 64 giant tabloid pages of late-breaking information on every aspect of radio monitoring.

ORDER YOUR SUBSCRIPTION TODAY before another issue goes by: only \$16 per year in the U.S.; \$21 per year in Canada; and \$23 per year for foreign subscriptions. For a sample issue, send \$1 (foreign send 4 IRCs).

MONITORING TIMES

P.O. Box 98

Brasstown, N.C. 28902

ELECTRONIC SPYING is the name of the game. It's also the title of a startling book which reveals the closely guarded methods & equipment used by professionals & amateurs who eavesdrop on homes & businesses with (sometimes) legal and (usually) illegal bugs & wiretaps. Written in non-technical language everyone can easily understand, ELECTRONIC SPYING has photos & illustrations clearly revealing exactly how they do it & where they get the equipment (much of it inexpensive & easily available). Leaves nothing to the imagination! Latest techniques covered & offers an in-depth wealth of information on the ever increasing electronic invasion unavailable from any other source. This book is used by law enforcement agencies as a reference manual. Only \$8.95 (plus \$1.00 postage) per copy from CRB Research, P.O. Box 56, Commack, N.Y. 11725.

WORLD'S MOST UNUSUAL Communications Books! A large selection of outstanding titles covering scanners, "confidential" frequency registries, bugging, wire tapping, electronic surveillance, covert communications, computers, espionage, monitoring, and more! New titles being added constantly! Ask for our large new FREE catalog. CRB Research, Box 56-PC, Commack, NY 11725.

SIDE BAND OPERATORS! Join the oldest/largest network of 27 MHz SSB operators. Now more than 100,000 strong! Send self-addressed stamped long (#10) envelope for FREE details and application (no obligation). SSB Network, P.O. Box 908, Smithtown, NY 11787.

COMMUNICATIONS PLANS, BOOKS, KITS! AM/FM broadcasting (licensed/unlicensed), 1750 Meter transceivers, Ham/CB amplifiers, surveillance bugs, more. FREE catalog. PAN-COM, Box 130-P11, Paradise, CA 95967.

ROCKY MOUNTAIN SHORTWAVE SPECIALISTS. Drake, Ten-Tec, ICOM, Yaesu, Kenwood, etc. New and used equipment; books, magazines; discount prices. MasterCard and VISA. Open 7 days a week, M-F 9:30-5:30; Sat. 9:30-3:00; Sun. 12-5. (303) 761-7305. ALLIED APPLIANCE & RADIO, 4253 South Broadway, Englewood, CO 80110.

AMATEUR RADIO SERVICE. Quick and reasonable from tube through solid state. SIGMA TECH, UPS: 304 Pony Trail, Mt. Shasta, CA 96067. (916) 926-3777.

ESPIONAGE/EMBASSY Communications Guide, by Tom Kneitel. What's behind mystery "numbers" transmissions, coded embassy messages, and stations operated by foreign governments in the USA & Canada. How nations monitor each other's official codes and communications. Illustrated! Includes largest/latest registry of stations (frequencies/callsigns/locations/modes) operated embassies of the world's governments, intelligence agencies, U.N., Interpol, International Red Cross, U.S. State Department; HF/VHF/UHF. Now you can tune in on Embassy & Espionage Communications is \$10.95 + \$1 postage (USA/Canada/APO/FPO) from CRB Research, Box 56, Commack NY 11725.

WANTED: Dallas/Ft. Worth, Texas area and nationwide military aircraft frequencies. Frequency range 225-400 MHz. I will pay you. Michael Donworth, 1308 Shady Hollow Court, Euless, TX 76039.

WANTED: Good/bad meter for accurate Instrument Co. Tube Tester Model 257 or whole tester in working condition. Please state price incl. shipping. W.H. Voigt, 60 Russell Road, Albany, NY 12203.

ELECTRICAL ENGINEER WITH 36 years' experience selling his best receivers, reconditioned, better than new! Collins 51J-4, Collins R-390, Hammarlund SP-600 \$375 each, plus shipping. Call Gene; 809-726-1600, Puerto Rico.

FREQUENCY PROGRAMS. Looking for any frequency file-type programs for IBM compatibles. Willing to pay. Marc Schlessinger, P.O. Box 1407, Bensalem, PA 19020.

POP'COMM BACK ISSUES. First three years (missing only June '85), plus most issues since. Mint. \$75 plus UPS. MLP, P.O. 25828, Overland Park, Kansas 66225, or call (913) 469-1060.

WANTED: Articles from *Broadcast Programming and Production* magazine (1979) about border blasters super power stations by John Price. Will pay \$5 for magazine or copy of each article. James W. Feasel, 13549 Morse Road, Pataskala, OH 43062.

RITTY, CW, PACKET: Complete Commodore terminal. C-64 computer, PK-64 interface/TNC, disk drive, color monitor, modem, much software. \$700 complete. Jay Farlow, 1606 Southdale Ave., Ft. Wayne, IN 46816. (219) 447-1703.

WANTED: Frequency and code lists for Portland/Peaks Island, Maine area. Also marine frequency. M.E. Casey, Island Avenue, Peaks Island, ME 04108.

WANTED: Location chart and/or maps of locations of Los Angeles city and Los Angeles county fire stations. Will pay cost if any. Scott Sherkus, 23 Bretton Rd., Yonkers, NY 10710.

NEW REGENCY 230 and manual - 90. Want junk, SP600 Hammarlund, HQ180 Hammarlund for projects. Also want TMC GPR-92 receiver and 833A tube. J. Leary, 438 E. Hamilton St., Fortville, IN 46040. (317) 485-5128.



the HAM STATION

P.O. Box 4405
220 N. Fulton Avenue
Evansville, IN 47711

ORDERS : 800-523-7731
INDIANA : 812-422-0231

ICOM R71A



- Commercial Grade Receiver
- 100 kHz - 30 MHz
- 32 Memories
- See ICOM Ad For More Info.
- Call For Discount Price

SANGEAN 803



- Direct Freq. Entry 150 kHz - 30 MHz
- AC or DC
- All Mode: AM/FM/CW/SSB
- Programmable Memories
- Call For Discount Price

YAESU 9600



- 60-905 MHz
- Optional Video Output
- Now On Sale

R7000



- Commercial Receiver VHF-UHF
- 25-2000 MHz
- 99 Memories
- Special Price, Call

DIAMOND

D130

- 25-1300 MHz Super Discone Antenna.
- Transmit on 50, 144, 430, 1200 MHz
- Monitor 25-1300 MHz with one antenna



8800

- All Mode SW Receiver
- 150 kHz to 30 MHz
- VHF Converter Optional
- Call For Price

WANTED: Uniden Bearcat BC 140. Must be in good shape. Write Allan Koenig, 6838 Lupton, Dallas, TX 75225. Will pay shipping plus cost of scanner.

GRUNDIG RR-1140-SL shortwave receiver. Receives stereo broadcasts and has built-in cassette. Excellent \$700. Also interested in purchasing used traffic radar speed guns. Mark Hartman, 14 Silver, Kirkwood, MO 63122. (314) 966-3894.

WANTED: Scanner frequencies for Rhode Island, southeastern Mass. public service military aircraft all categories. Trade yours for mine. Jerry Laroche, Box 322, Warren, RI 02885.

CB RADIO OWNERS!

We specialize in a wide variety of technical information, parts and services for CB radios. 10M-FM conversions, repairs, books, plans, kits, high-performance accessories. Our 11th year! Catalog \$2.

CBC INTERNATIONAL, P.O. BOX 31500PC, PHOENIX, AZ 85046



SURPRISE!

You don't have to be a licensed ham to join ARRL and receive QST every month.

Join the over 10,000 radio enthusiasts who are unlicensed ARRL ASSOCIATE MEMBERS, and receive QST every month. It's jam-packed with articles and columns on ham-DX, VHF-UHF, "Making Waves" — for young hams, radio clubs, emergency communications, antennas and simple build-it yourself projects up through the cutting edge of communications technology. We hope to have you as a member!

MEMBERSHIP APPLICATION

Name _____

Street _____

City _____ Prov./State _____ PC/Zip _____

Yes! Sign me up as an ARRL member. Send me 12 big issues of QST and my membership certificate. Enclosed is \$25 (\$33 outside of the US).

Please send me information on how to become a licensed radio amateur.



Expires _____

Bank. No. _____ Expires _____

The American Radio Relay League

225 Main St. Newington, CT. 06111 USA ME

"The Largest Dealer of Scanners in the World"



SCANNER WORLD, USA®

10 New Scotland Ave., Albany, NY 12208 518/436-9606



Regency
MX-3000

Special \$169.99
(\$7.00 shipping)

30 CHANNELS—MOBILE/BASE

—SCANNER WORLD EXCLUSIVE—

Features include simple programming of the following frequency ranges: 30-50 MHz, 144-174 MHz, 440-512 MHz. Digital display, priority, search, lockout, delay, dim control, top mounted speaker, one year factory warranty. Includes AC & DC cords, mobile mounting bracket, telescopic antenna. All for only \$169.99 plus \$7.00 shipping (optional extended warranty: 3 years \$39.99; 2 years \$29.99.) MX3000 Service Manual \$5.00.

Cobra SR-15

\$219.99 (\$7.00 shipping)



100 channel pocket sized hand-held scanner (6" Hx2 3/4" W), no crystal, portable scanner, 29-54 MHz, 118-174 MHz, 406-512 MHz bank scanning, backlit LCD display, automatic search, lockout, scan delay, priority, key lock, plus much more. Includes rubber antenna, rechargeable Ni-Cad battery pack, AC adapter charger, earphone, and carry case. optional cigarette lighter adapter #15MPC \$12.99.

EEARCAT 100XL Hand-Held Programmable	194.99	(7.00)
FEGENY INF-1 Informant Scanner	\$249.99	(7.00)
EEARCAT 70XLT Programmable Hand-Held	169.99	(6.00)
EEARCAT 50XL Programmable Hand-Held	119.99	(5.00)
AD1000 AC Adapter/Charger for 50XL	12.95	(-)
EP55 Ni-Cad Battery Pack for 50XL	13.99	(-)
CA50 Carry Case for 50XL	11.99	(-)
FS001 Cigarette Lighter Adapter for 50XL/100XL	12.95	(-)
EEARCAT 140 AC Programmable Scanner	94.99	(5.00)
EEARCAT 145XL AC Programmable Scanner	99.99	(5.00)
EEARCAT 175XL AC Digital Scanner	159.99	(5.00)
EEARCAT 100XL Digital Hand-Held	194.99	(7.00)
EEARCAT Weather Alert	39.99	(4.00)
EEARCAT 210XLT AC/DC Digital Scanner	199.99	(7.00)
EEARCAT 800 XLT AC/DC Digital Scanner	299.99	(7.00)
FEGENY R1075 AC Digital Scanner	94.99	(6.00)
FEGENY MA-257 Cigarette cord for HX1000/1200	16.99	(-)
FEGENY MA-917 Ni-cad Battery for HX1000/1200	24.99	(-)
FEGENY HX-CASE Hwy Leath. case for HX1000/1200	19.99	(-)
FEGENY MA-549 Drop-in charger for HX1000/1200	89.99	(5.00)
FEGENY MX-3000 AC/DC Digital Scanner	169.99	(7.00)
FEGENY HX-2200 Digital Hand-Held Scanner	172.99	(7.00)
FEGENY Z-30 AC/DC Digital Scanner	129.99	(5.50)
FEGENY Z-60 AC/DC Digital Scanner	149.99	(7.00)
Mobile Mounting Bracket for Z Scanners	5.99	(-)
FEGENY ACT-R1 AC/DC Cryst. Single Channel	75.99	(4.00)
FEGENY RH-256B High Band Transceiver	359.99	(7.75)
FEGENY UC 102 Hi-VHF Hand Transceiver	119.99	(5.50)
FEGENY RH-600B High Band Transceiver	429.99	(7.75)
FEGENY R806 AC/DC Crystal Scanner	79.99	(5.00)
COBRA SR12 Digital Hand-Held Scanner	159.99	(5.50)
COBRA SR10 Digital Hand-Held Scanner	129.99	(6.00)
COBRA SR900 AC/DC Digital Scanner	109.99	(5.00)
COBRA SR925 AC/DC Digital Scanner	164.99	(6.00)
Eook "Top Secret Registry of Gov't Frequency"	12.95	(3.00)
Eook "Covert Intelligence, Electronic Eavesdropping"	8.95	(-)
Eook "Betty Bearcat Frequency Directory"	14.95	(-)
Eook "Rail Scan Directory"	7.95	(-)
Eook "Air Scan Directory"	12.95	(-)
FCD MRP-1 Single Channel Hand-Held	38.99	(3.00)
FANON M8HLU DC Crystal Scanner	89.99	(5.00)
FANON PSK-1 AC Adapted for M8HLU	12.99	(-)
FOX BMP-1060 AC/DC Digital Scanner	129.99	(5.50)
FOX Mounting Bracket for BMP-1060	9.99	(-)
ANT-1 Magnet Mount Mobile Scanner Antenna	29.99	(3.00)
ANT-6 Base Scanner Antenna w/50' cable	29.99	(3.00)

Regency Z30 30 Channel Automatic Programmable Scanner

Scanner World Special

\$129.99

(plus \$5.50 shipping each)

Optional Accessories:

Cigarette Lighter Plug RGMPC \$4.95
Z Mobile Bracket — Special ... \$5.99

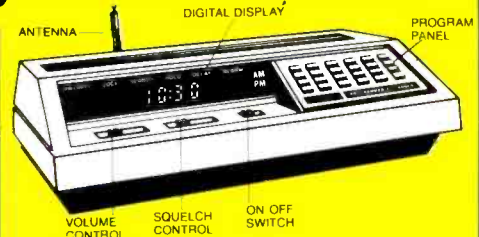

The Regency Z30 is a compact, programmable 30 channel, multi band, FM monitor receiver for use at home or on the road. It is double conversion, super heterodyne used to receive the narrow band FM communications in the amateur, public safety and business bands: 30-50, 144-174, and 440-512 MHz. Size 10 3/4" Wx2-7/8" Hx8-3/8" D.

Sophisticated microprocess-controlled circuitry eliminates the need for crystals, instead, the frequency for each channel is programmed through the numbered keyboard similar to the one used on a telephone. A "beep" acknowledges contact each time a key is touched. The Z30 scans approximately 15 channels per second.

Any combination of two to thirty channels can be scanned automatically, or the unit can be set on manual for continuous monitoring of any one channel. In addition, the search function locates unknown frequencies within a band.

Other features include scan delay, priority and a bright/dim switch to control the brightness of the 9-digit Vacuum-Fluorescent display. The Z30 can be operated on either 120 VAC or 12 VDC. Includes one year warranty from Regency Electronics (optional 3 yr extended warranty only \$39.99, gives you a total of 4 yrs complete warranty or 2 yr extended warranty only \$29.99, gives you a total of 3 yrs complete warranty.) Z-30 Service Manual \$5.00.

Regency HX2200

\$172.99

(Plus \$7.00 shipping each)

Digital Programmable 20 Channel Hand-Held Scanner with raised button keyboard for easy programming of the following frequency ranges: 118-136 MHz, 138-174 MHz, 406-512 MHz, 800-950 MHz (NOTE: This is the only hand-held portable scanner which will receive the 800-950 MHz range plus high band, air and UHF). Features include priority scan delay, memory backup, dual scan speed, channel lockout, jacks for external antenna and earphone, 90 day factory warranty, keyboard lockswitch, sidelit liquid crystal display for night use, program AM or FM mode, search or scan, size is 3" x 7" x 1 1/2". Complete HX2200 package includes Ni-Cad rechargeable batteries, wall charger adapter, protective carry case, and rubber antenna. All for the low price of only \$172.99 plus \$7.00 shipping each.



REGENCY HX1500

Digital programmable 55 channel hand-held scanner. Frequency coverage 29-54 MHz, 118-174 MHz, 406-420 MHz, 440-512 MHz. Covers Public Service bands plus aircraft, trains, marine, plus many others. Has priority, search, lockout, scan, banks, sealed rubber keyboard. 90 day factory warranty. Includes flexible rubber antenna, belt clip and earphone.

\$224.99 (Plus \$7.00 Shipping each)

Optional Accessories Available for HX-1500: Call For Price.

REGENCY RH-256 B PROGRAMMABLE TRANSCEIVER

RH-256B Transceiver. 16 channel 12 VDC 2-way Radio fully programmable in transmit and receive mode. Includes built-in CTCSS tones for encode/decode, time-out timer, scan delay, 25 watts transmit power, priority, plus more. Frequency spread as shipped 152-158 MHz. Package includes mobile mike, bracket, mobile antenna, and all cables and instructions for installation. **Special package deal only: \$359.99** (7.75 shipping) (2 year extended warranty \$49.99 - 3 year \$69.99)

ORDERING INFORMATION

Call (518) 436-9606 to place orders by phone or mail orders to Scanner World, 10 New Scotland Ave., Albany, NY 12208. Orders will be shipped same day received by United Parcel Service. Scanner World accepts VISA, MasterCard (COD shipments by United Parcel will be for cash or certified checks only). Mail orders with personal or business checks will be held 4 weeks for bank clearance. Orders with cashiers checks or money orders shipped same day received. Prices, specifications and terms subject to change without prior notice. If items are out of stock we will backorder and notify you of delivery date. All shipments are F.O.B. Scanner World warehouse in Albany, NY. We are not responsible for typographical errors. All merchandise carries full manufacturers warranty. Bid Proposals and Purchase orders accepted from Government agencies. Free full line catalogue available upon request. No minimum order. New York State Residents add 7% sales tax.

SHIPPING CHARGES

(* Add \$5 per scanner, and \$3.00* for all accessories ordered at same time. C.O.D. shipments will be charged an additional \$3.00 per package. Full insurance is included in shipping charges. All orders are shipped by United Parcel Service. Shipping charges are for continental USA only. Outside of continental USA, ask for shipping charge per scanner.

Scanner World, USA®

10 New Scotland Ave., Albany, NY 12208

(518) 436-9606

Most orders Shipped Same Day Received!

SCANNER WORLD EXCLUSIVE



Bearcat
BC-600 XLT

\$224.99 (\$7.00 shipping)

Digital Programmable 100 Channel Scanner

BC 600 XLT covers the following frequencies: 29-54 MHz, 118-174 MHz, 406-512 MHz. Features compact size of 6-5/16" Wx1-5/8" Hx7-3/8" D, scan delay, priority, memory backup, channel lockout, bank scanning, key lock, AC DC power cords, telescopic antenna, mounting bracket supplied, one year factory warranty, search, direct channel access, track, tuning, service, search including pre-programmed frequencies by pushing a single button for police, fire, emergency, aircraft, weather, and marine services. Plus exclusive optional features never available on any scanner before. First is an RF receive amplifier for boosting weak signals for only \$24.99 plus a CTCSS tone board is available for only \$59.99 to make this the unique one scanner available in the USA. Optional cigarette lighter plug #600MPC \$4.99.

Scanner World, USA • Albany, New York 12208 • (518) 436-9606

Scanner World, USA • 10 New Scotland Ave. • Albany, New York 12208 • (518) 436-9606



Yaesu has serious listeners for the serious listener

Yaesu's serious about giving you better ways to tune in the world around you.

And whether it's for local action or worldwide DX, you'll find our VHF/UHF and HF receivers are the superior match for all your listening needs.

The FRG-9600. A premium VHF/UHF scanning communications receiver. The 9600 is no typical scanner. And it's easy to see why.

You won't miss any local action with continuous coverage from 60 to 905 MHz.

You have more operating modes to listen in on: upper or lower sideband, CW, AM wide or narrow, and FM wide or narrow.

You can even watch television programs by plugging in a video monitor into the optional video output.

Scan in steps of 5, 10, 12½, 25 and 100 KHz. Store any frequency and

CIRCLE 1 - ON READER SERVICE CARD

related operating mode into any of the 99 memories. Scan the memories. Or in between them. Or simply "dial up" any frequency with the frequency entry pad.

Plus there's more, including a 24-hour clock, multiplexed output, fluorescent readout, signal strength graph, and an AC power adapter.

The FRG-8800 HF communications receiver. A better way to listen to the world. If you want a complete communications package, the FRG-8800 is just right for you.

You get continuous worldwide coverage from 150 KHz to 30 MHz. And local coverage from 118 to 174 MHz with an optional VHF converter.

Listen in on any mode: upper and lower sideband, CW, AM wide or narrow, and FM.

Store frequencies and operating modes into any of the twelve channels for instant recall.

Scan the airwaves with a number of programmable scanning functions.

Plus you get keyboard frequency entry. An LCD display for easy readout. A SINPO signal graph. Computer interface capability for advanced listening functions. Two 24 hour clocks. Recording functions. And much more to make your listening station complete.

Listen in. When you want more from your VHF/UHF or HF receivers, just look to Yaesu. We take your listening seriously.

YAESU

Yaesu USA

17210 Edwards Road, Cerritos, CA 90701
(213) 404-2700

Yaesu Cincinnati Service Center

9070 Gold Park Drive, Hamilton, OH 45011
(513) 874-3100



Dealer inquiries invited.

Prices and specifications subject to change without notice.
FRG-9600 SSB coverage: 60 to 460 MHz.

KENWOOD

...pacesetter in Amateur Radio

New
220 MHz

220: FM for All!



Kenwood brings you a wide range of 220 MHz gear designed for every need. Choose from two types of mobile and two types of HT. The TH-315A is a

TH-315A
Full-featured HT

full-featured HT covering 220–225 MHz. Ten memory channels and 2.5 watts of power. (5 W with PB-1 or 12 V DC.) Uses the same accessories as the TH-215A for 2 meters or TH-415A 440 MHz. For truly "pocket portability," choose the TH-31BT, a thumb-wheel programmable, 1 watt unit. For mobile use, select the TM-321A or TM-3530A.

The TM-321A is the 25 W, 220 MHz, 14-channel version of the super popular, super compact TM-221A. The 25-watt TM-3530A has 23 channels, a 15 telephone number memory and auto dialer. Direct keyboard frequency entry and front panel DTMF pad enhances operating convenience. Novice to Amateur Extra, these transceivers will put everyone on the air "Kenwood Style"!

TM-321A
Compact mobile transceiver

TH-31BT/31A
Pocket-held HT

New



New

TM-3530A
Full-featured mobile transceiver

KENWOOD

CIRCLE 90 ON READER SERVICE CARD

A complete line of accessories is available for all models.
Complete service manuals are available for all Kenwood transceivers and most accessories. Specifications and prices are subject to change without notice or obligation.

KENWOOD U.S.A. CORPORATION
2201 E. Dominguez St., Long Beach, CA 90810
P.O. Box 22745, Long Beach, CA 90801-5745