

VCD-08635

POPULAR COMMUNICATIONS

DECEMBER 1986 \$2.50
\$3.50 CANADA

Listening In On FAA Airline Communications

- Worldwide Shortwave Relays
- Decoding "That" Pearl Harbor Message
- Scanning The Federal Cops' School
- The History and Mystery of Radio, and more!

Now Incorporating



Magazine

The Official Publication of the
Scanner Association of North America





SHORTWAVE HEADQUARTERS

Our 16th Year! Order Toll Free 800-368-3270

EEB—The Nation's Leading SWL Supplier



R-2000 KENWOOD SALE



Kenwood offers a communication receiver to suit your listening pleasure. It covers the full spectrum: Long, Medium, and Shortwave. AM-CW-SSB-FM Wide-Narrow Selectivity, Noise Blanking, and more.

R-2000 Special Sale SALE CALL
VHF Converter (VC-10) SALE CALL

FREE EEB will extend your warranty from 3 to 6 months. EEB is a Kenwood Factory Authorized Service Center.

NEW

KENWOOD R-5000

NEW



SALE

SALE

All-Band All-Mode Receiver Covers
100 kHz-30 MHz (108-174 MHz with VC-20 option)

- 100 Memory Channels
- Direct Keyboard Frequency Entry
- Programmable Scanning (Center-Stop Tuning)
- Computer Control Option
- Built-in Power Supply
- Many More Options Available.

CALL FOR PRICE & AVAILABILITY

SONY ICF 2010

- 150 kHz to 20 MHz AM, CW, SSB
- 76 MHz to 108 MHz FM
- 116 MHz to 136 MHz AM Air Band
- 32 Programmable Memories
- 4 Event Timer
- Synchronous Detector
- Wide/Narrow Bandwidth

"This is one of the finest receivers available today under \$500"

A.C. Adapter Included

SONY ICF 2002

- Ultimate compact HiTech at an affordable price
- 25% size of famous SONY ICF 2001, SONY's best seller
- 150 kHz - 30 MHz
- AM, FM
- Memories
- Keyboard entry
- Scan
- 24 hour clock

A.C. Adapter AC9W Optional

AMECO Tunable Pre Amp-Antenna



- Matches Most Any Antenna
- Improves Gain and Noise Figure
- 9V Battery PWR (not included)
- AC Adapter Optional (\$9.95)

\$74.95 plus \$ UPS

SANGEAN ATS-801

Close-Out
Limited
Quantity



ONLY \$99.95 + \$4.00 UPS
LIST \$199.95

- SW 5.8-15.5 MHz FM 88-108 MHz
- LW 155-281 MW530-1620 kHz
- 25 Program Memories
- Digital Frequency & Clock Readout
- Manual or Autotone
- Same Weight and Size as SONY ICF 2002
- Free Stereo Hdset + 100 pg. SWL Book

Optional A.C. Adapter \$9.95

NEW

EMBASSY

NEW

Line of SWL Receivers

2 NEW Models
The Ambassador 2020
and
The Diplomat 4950

SEE OUR AD THIS ISSUE FOR FULL DETAILS.

DXer's Dream TOSHIBA

RP-F11
(KENWOOD R-11)



Full page in 1985 WRTV
Inside front cover for details

- Covers all International & Tropical Bands
- S Meter, Safety Off Lock

SAVE \$40.00 SALE \$89.95
+ 4.00 UPS

"One of the finest receivers available under \$130.00"
List \$129.95
Optional AC wall adapter TAC 64 \$11.95

NEW

Ten-Tec RX 325 RECEIVER

SALE



SALE

- 300 kHz to 29.999 MHz
- AM, LSB (CW), USB (CW)
- 25 Memories
- Programmable Band and Memory Scanning
- Quartz Clock with Timer
- ULTRA COMPACT—only 3 1/4" x 9 1/2" x 7". Weight 5 lbs. 5 oz!
- 115 VAC or 13.8 Capability
- Mobile Mounting Bracket (option)

CALL FOR PRICE

*G.E. WORLD MONITOR

Sale
\$169.95

List \$229.95
(\$5.00 UPS)



- Digital readout, wide and narrow selectivity BFO for SSB & CW.
- 3.5-31 MHz SW/MW/FM
- 120V/220V or battery

AEA CP-1 Computer Patch



SAVE \$90.00

SWL Test Software and your Commodore C-64 will turn your Communications Receiver into a CW/RTTY Intercept station.

- Determines RTTY Speed and ASCII or Baudot
- Copies Russian RTTY - Japanese RTTY & CW
- Copies AMTOR-ARQ-FEC
- Determines Bit inversion and Transposition Patterns.
- Complete Printer Control
- Copies Russian RTTY - Japanese RTTY & CW
- We checked them all. This is the best.

LIST \$359.95
PACKAGE DEAL \$269.95

NEW

WORLD RADIO TV HANDBOOK NEW 1987 EDITION



- Shortwave Listener's Bible
- All Worldwide SW Stations Listed
- Target Areas
- Equipment Reviews
- Every SWLer Needs One

ORDER TODAY
\$19.95 Postpaid US

DATA BASE INTERNATIONAL 1987 Edition



- Up-to-date Picture of SW Broadcasting
- Frequency by Frequency, Hour by Hour
- Station Name, Location, Frequency, Time, Language, Target Area, Power
- Innovative Computer Display. Makes Easy Reading of Complex Information.
- In-depth Equipment Review.

See Our Ad This Issue For More Details.

NEW

EEB's 1987 SWL CATALOG

Covering: Radios, Scanners, Antennas, Accessories, RTTY & CW, Books, and Much More!
Send \$1.00 For Your Copy.

Catalog Price Refundable With Your 1st Order!

Store Policies:

- Prices and Specs Subject to change.
- Prices do not include Shipping Charges.
- Payments: BankCard - Money Orders Personal Checks - will delay shipping
- 3 weeks - No CODs.
- Returned purchases subject to 20% Restocking Fee.
- We ship UPS Daily - Cost for U.S. Mail is 3 times more than UPS.

NRD-525 General Coverage Receiver



- 90 kHz to 34 MHz
- Options for 34-60 MHz, 114-174 MHz and 423-456 MHz
- 200 Memory Channels
- 2 Clocks/Timer To Control Radio & Extra Equipment (tape recorder)
- Computer Interface Option.

CALL FOR PRICE

ANTENNAS

SONY AN-1 \$79.95 + \$6.00 UPS
A.C. Adapter \$9.95

- Outdoor active antenna
- Pull In hard to capture signals
- Perfect for SWL where no outdoor antennas allowed.

EAVESDROPPER SALE
\$59.95 + \$4.00 UPS

- Balanced trapped Dipole
- Maximum performance, Minimum local noise
- All SW Bands 60-11 meters
- Only 43 feet long - 100 ft. feed line
- Complete - Everything you need.

MFJ 1024 \$119.95 + \$5.00 UPS
A.C. Adapter \$9.95

- Outdoor active antenna
- Performs as well as units costing \$180.00
- WRTVH rates it high

BUTTERNUT SWL 2-30
\$49.50 + \$4.00 UPS

- Tune the weak ones in
- Stub tuned Dipole Maximum S/N Ratio
- 73 feet long - 50 feet feed line



ORDER DESK HOURS (Eastern):
MONDAY - FRIDAY 10 A.M. to 5 P.M.
SATURDAY 10 A.M. to 4 P.M.
Technical and VA orders call (703) 938-3350

Electronic Equipment Bank

516 Mill Street N.E.,
Vienna, VA 22180
Telephone (703) 938-3350

STORE HOURS (Eastern):
Same as Order Desk Hours
Closed Mondays
Thursday 10 A.M. to 9 P.M.



Electronic Equipment Bank—Order Toll Free 800-368-3270

CIRCLE 30 ON FREE INFORMATION CARD

www.americanradiohistory.com

YAESU FRG9600

SAVE
\$180



60-905 MHz

SALE
\$499.95
+ \$7 UPS

A premium VHF/UHF scanning communications receiver.

- The 9600 is no typical scanner. And it's easy to see why.
- You won't miss any local action with continuous coverage from 60 to 905 MHz.
- You have more operating modes to listen in on: upper or lower sideband—CW, AM wide or narrow, and FM wide or narrow.
- You can even watch television programs by plugging in a video monitor into the optional video output—\$25.
- Scan in steps of 5, 10, 12½, 25 and 100 KHz. Store any frequency and related operating mode into any of the 99 memories. Scan the memories. Or in between them. Or simply "dial up" any frequency with the frequency entry pad.
- Plus there's much more, including a 24-hour clock, multiplexed output, LCD read-out, signal strength graph, and an AC power adapter.

YAESU FRG-8800

SAVE
\$80



150 KHZ-30 MHz

SALE
\$519.95
+ \$8 UPS

The FRG-7700 was a great receiver. Now the new generation FRG8800 takes you a step forward.

- CAT computer compatible
- 12 memories—scan—RTT
- Keyboard frequency entry
- Dual 24 hour clock timer recorder control
- Optional FRV8800 VHF converter 118-174 MHz \$119
- All mode AM—SSB—CW—FM
- Green LCD display
- 150 KHz or 30 MHz

EEB Exclusive Options

1. 24 hour bench test and complete realignment for optimum performance including double-extended warranty \$40.
2. 4 KHz ceramic filter replaces 6 KHz AM wide ceramic filter, installed \$50.
3. 2.4 KHz mechanical filter replaces SSB ceramic filter, installed \$95.
4. Spike protection, internal, \$25.



- We ship world-wide
- Shipping charges not included
- Prices & specifications subject to change without notice

THE BEST GETS BETTER AT EEB

The Most Exotic VHF-UHF Receiver Ever Offered To General Public

ICR 7000 ONLY \$949 + \$10 UPS



EEB introduces the new ICOM R7000 VHF/UHF receiver, which also is available as the R7000 HP (high performance) with EEB-designed modifications that remarkably improve the sensitivity, audio frequency response, selectivity, and more.

In conformance with their record as a responsible manufacturer, ICOM has done everything possible to hold down production costs while leaving open the potential for post-production modification (e.g., R71A) that can substantially improve performance and give the discriminating operator a more cost effective unit with enhanced specifications.

You have read about EEB's R71A modification in *World Radio TV Handbook*. Now we have done it again with the ICOM R7000 VHF/UHF receiver.

When you are making an investment in this kind of equipment, it only makes sense to maximize your options by selecting the ICOM R7000 and then to go that last yard toward ultimate performance by choosing the R7000 HP from EEB.

ICOM R-7000

Commercial Receiver VHF-UHF 25-2000 MHz

- 25-2000 MHz coverage
- Precise frequency entry via keyboard
- 96 programmable memories
- Scan-memory-mode-select memory-frequency
- 5 tuning speeds: 1, 1.0, 5, 10, 12.5, 25 KHz
- Narrow/wide filter selection
- Memory back-up • Noise blanker
- "S" meter or center meter for FM
- AM & FM wide, FM narrow, SSB, CW

EEB HP Options

- Front end upgrade improves sensitivity
- Audio mod—better volume, less distortion
- Optical band pass filters
- Power supply cooling mod to reduce chassis heat • Spike protection, on AC line
- IF output for spectral display 10.7 (STD) 21.4, 30 MHz others available
- 24 hour bench test and realignment for optimum performance
- Extended warranty to 6 months
- Final alignment and overall checkout.
- Installation of ICOM options purchased with your new R7000 at no charge
- More details next month's ad. Call or write for free flyer of EEB mods.

EEB'S FAMOUS R71A HP

EEB is ICOM's #1 R71A dealer and there is good reason. We offer more modification to enhance your listening pleasure and take better care of you. This is our 15th year. Buy with confidence.



ICOM R71A

ONLY
\$799
+ \$8 UPS

- 100 KHz to 30 MHz • Keyboard entry • 32 programmable memories
- SSB-CW-AM-RTTY (FM optional)
- Wide dynamic range • Digital PLL
- Memory scan • Band pass & notch tuning • Computer control via MEC 71A & C64 • See ICOM's ads for more details

ICOM Options Free installation when purchased with your R71A from EEB

- CK-70: DC Kit for 13.8 VDC operation
- CR-64: High stability oscillator
- CK-70: DC kit for VDC operation
- CR-64: High stability oscillator
- EX309: Computer interface connector
- EX310: Voice synthesizer
- FL32A: CW narrow filter (500 Hz)
- FL44A: Crystal filter (2.4 KHz)
- FL63A: CW narrower filter (250Hz)
- RC-11: Infrared remote control

EEB HP Options

R71 (HP) High Performance. EEB has the reputation of excellence when it comes to R71A modifications. Many of our modifications are proprietary and not offered by any other source. EEB now offers a package deal including our most popular option—known as the R71(HP) High Performance and includes the following:

- 24 hour bench test.
 - Narrow filter (choice of 3, see below). Replaces stock ceramic SSB filter. Improved selectivity and shape factor.
 - Front end upgrade—improves dynamic range (plus) preamp enabled below 1600 KHz.
 - 4 KHz filter replaces stock. 6 KHz wide filter—improves AM selectivity.
 - Audio output modification—increases audio output; reduces distortion.
 - AGC time constant changed to better suit SW listening.
 - Spike protection added.
 - RFI line filter.
 - Installation of ICOM options purchased with your R71A HP.
 - Final alignment and overall checkout.
 - Free extended 6 month warranty.
- | | |
|---|-----------|
| R71 HP (MF) Mechanical Filter | add \$200 |
| R71 HP (XF) 8 Pole, 2.4 KHz xtal filter | add \$250 |
| R71 HP (XFS) Super 2.1 KHz filter | add \$300 |

10 miles west of Washington, D.C.
Sorry—No COD's 10-5 Tues.,
Wed., Fri.
10-9 Thursday
10-4 Saturday
Closed Sunday and Monday

ELECTRONIC EQUIPMENT BANK

516 Mill Street, N.E.
Vienna, VA 22180

Order Toll Free: 800-368-3270

Technical and VA Orders (703) 938-3350

POPULAR COMMUNICATIONS

Now Incorporating
SCAN Magazine

DECEMBER 1986

VOL. 5, NO.4



18



24



58

FEATURES

- SCAN Scanning Today** 9
Frequency update news, a scanning and commuting scenario and "disaster book" news.
by Robert A. Hanson
- Relay Race** 10
Maybe that shortwave station isn't what it appears, after all! *by Gerry L. Dexter*
- The Pearl Harbor "Winds Execute" Message** 14
The war message was copied, but what then?
by Grayden A. Lewis, N7FCO
- SCAN Photo Contest Winners** 17
Send your photo soon!
- SCAN Public Service Award** 17
Firefighter rescues three-year-old from drainage cistern.
- ARTCC Remote Roundup** 18
The one and only, first time ever, master compilation of FAA Air Route Traffic Control Center frequencies and remote sites!
by Rick Maslau, KNY2GL
- Scanning The: Federal Law Enforcement Training Center** 24
Criminal investigators from 60 federal agencies learn it all here!
by Tom Kneitel, K2AES, Editor
- Radio: I Remember It Well** 28
A walk through the halls of history.
by Alice Brannigan
- POP'COMM Reviews: A World Time Clock** 49
by Jim Gray, W1XU

This month's cover: Robert David, engineer for F.A.A., working on the Huguenot V.O.R. in Orange County, New York. Photo by Larry Mulvehill, WB2ZPI.

DEPARTMENTS

- | | | | |
|---------------------------------------|----|----------------------------------|----|
| Beaming In | 4 | Better Signals | 54 |
| Mailbag | 6 | Clandestine Communique | 58 |
| Books You'll Like | 26 | On The Line | 60 |
| Emergency | 36 | Listening Post | 62 |
| Satellite View | 40 | Broadcast Topix | 66 |
| Pirate's Den | 45 | Scanner Scene | 70 |
| RTTY | 46 | Communications Shop | 72 |
| Communications Confidential | 50 | | |

EDITORIAL STAFF

Tom Kneitel, K2AES/ZF2JO
Editor

Elisa Nudelman
Associate Editor

CONTRIBUTING EDITORS

Gerry L. Dexter
Shortwave Broadcast

Robert Margolis
RTTY Monitoring

Gordon West, WB6NOA
Survivalist Communications

Don Schimmel
Utility Communications

Edward Teach
Alternative Radio

Harold A. Ort, Jr.
Military Consultant

Janice Lee
Radar Detectors

Chuck Gysi, N2DUP
Scanners

Julian Macassey, N6ARE
Telephone Accessories

Mark J. Manucy, W3GMG
AM/FM Broadcasts

Ed Noll
Antennas

BUSINESS STAFF

Richard A. Ross, K2MGA
Publisher

Jim Gray, W1XU
Advertising Manager

Dorothy Kehrwieler
General Manager

Frank V. Fuzia
Controller

Arlene Caggiano
Accounting

Cheryl Chomicki
Subscriber Services

PRODUCTION STAFF

Elizabeth Ryan
Art Director

Barbara Scully
Artist

Dorothy Kehrwieler
Production Manager

Pat Le Blanc

Florence V. Martin
Phototypographers

Hal Keith

Technical Illustrator

Larry Mulvehill, WB2ZPI
Contributing Photographer

Offices: 76 North Broadway, Hicksville, NY 11801. Telephone 516 681-2922. Popular Communications (ISSN 0733-3315) is published monthly by Popular Communications, Inc. Corporate officers: Richard A. Ross, Pres.; Thomas S. Kneitel, Vice Pres.; Alan M. Dorhoffer, Secretary. Second class postage paid at Hicksville, NY and additional offices. Subscription prices: Domestic—one year \$16.00, two years \$29.00, three years \$42.00. Canada/Mexico—one year \$20.00, two years \$37.00, three years \$54.00. Foreign—one year \$22.00, two years \$41.00, three years \$60.00. Foreign Air Mail—one year \$75.00, two years \$147.00, three years \$219.00. Entire contents copyright ©1986 by Popular Communications, Inc. Popular Communications assumes no responsibility for unsolicited manuscripts, photographs, or drawings. Allow six weeks for change of address or delivery of first issue. Printed in the United States of America.
Postmaster: Please send change of address to Popular Communications, 76 North Broadway, Hicksville, NY 11801.

ARRL BOOKSHELF

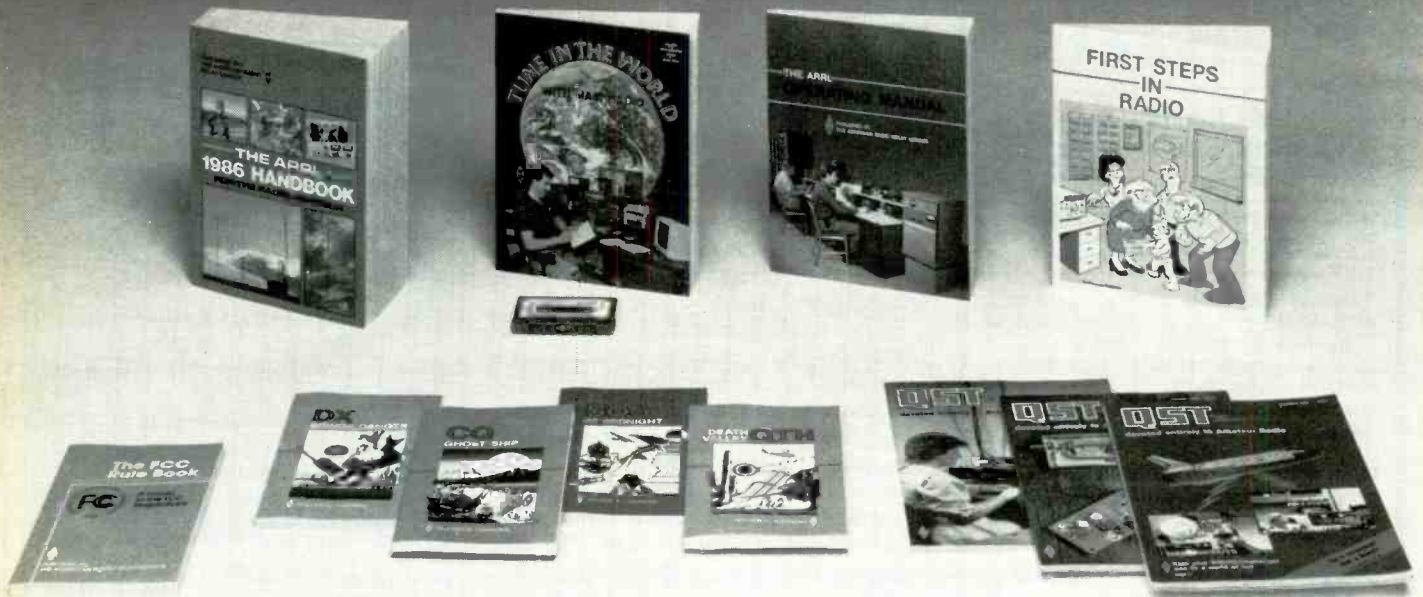

JOIN THE FUN - BECOME A HAM!

FOR THE BEGINNER HAM ADVENTURES ON THE AIR!

Our basic beginner's package is **Tune In the World With Ham Radio** which tells you how to obtain your Novice Amateur Radio License. It consists of a 208 page book which breaks the instructional material down into easy-to-learn bite-size chunks. A cassette is provided which teaches the code letter by letter. Thousands of hams owe their first licenses to the material learned from this package. For individual or classroom use. **First Steps in Radio** tells in simple terms in 95 pages how radio receivers and transmitters and their components work. **The FCC Rule Book** explains the regulations that all amateurs must follow in an easy to understand style. Every licensed radio amateur needs a copy of this book!

- Tune In the World With Ham Radio . . . \$10
- First Steps in Radio \$5
- The FCC Rule Book \$4

Tommy Rockford, K6ATX is back on the trail of high adventure! **In Death Valley QTH**, what starts as a typical field day operation becomes a matter of life and death for K6ATX and the Santa Bonita Amateur Radio Club. **SOS at Midnight** finds Tommy up against the Purple Shirt Mob and ham radio saves the day! The beachcomer seemed like a harmless character, but what did he have to hide in **CQ Ghost Ship**? Underwater adventure and ham radio join together to form the exciting conclusion to **DX Brings Danger**. The author of this series is Walker Tompkins who is K6ATX in real life. He is noted screenwriter, newspaper columnist, historian and biographer. His knowledge of the areas where these stories take place makes them even more true-to-life. You'll want to read all of these classics in Amateur Radio Fiction.

- SOS at Midnight \$5
- CQ Ghost Ship \$5
- DX Brings Danger \$5
- Death Valley QTH \$5
- All Four Adventures \$15

What makes ham radio fun are all of the different things you can do. **The ARRL Operating Manual** tells about emergency communications, how to talk through satellites, QSLing and awards, message handling, contesting and data communication including the use of computers. **The ARRL Handbook** has been updated every year since 1926 and over 5.7 million copies have been sold. It has 1186 pages and 40 chapters of practical technical information and projects that most hams can build. It is widely used by students, technicians and engineers. **ARRL Membership** isn't limited to hams alone. Each month you will receive **QST**, which is packed with articles and features on rf communication, operating and Amateur Radio "happenings".

- The ARRL Operating Manual \$7
- The ARRL Handbook for the Radio Amateur
- Paper edition \$18 US, \$19 elsewhere
- Cloth edition \$27 US, \$29 elsewhere
- ARRL Membership, 1 yr. \$25 US, \$33 elsewhere

PRICES ARE SUBJECT TO CHANGE WITHOUT NOTICE.
ALLOW 3-6 WEEKS FOR DELIVERY.

PAYMENT MUST BE IN U.S. FUNDS

Shipping/Handling Enclose \$2.50 For Book Rate or \$3.50 for UPS.

() Payment enclosed Charge to my: () MasterCard () VISA () American Express

Acct. # _____ Good from _____ Good to _____

Mastercard bank # _____

Date _____ Signature (charge orders only) _____

Name _____ (Callsign) _____

Address _____

City _____ State/Prov _____ Zip/PC _____

Have you fully completed your order form? Is your check (which must be drawn on a U.S. bank) signed or charge number indicated?

THE AMERICAN RADIO RELAY LEAGUE
225 MAIN ST., NEWINGTON, CT 06111

BEAMING IN AN EDITORIAL

A Dim Memory Of A Dimly Lit Gift

**RECEIVE
RTTY/ASCII/CW**
on your Personal Computer



**RTTY/ASCII/CW
SWL COMPUTER INTERFACE** MFJ-1225
\$ **69⁹⁵**

FREE MFJ RTTY/ASCII/CW Software
TAPE AND CABLE FOR VIC-20 OR C-64. ORDER MFJ-1225/
MFJ-1264 FOR VIC-20 OR MFJ-1225/MFJ-1265 FOR C-64.

Receives commercial, military, and amateur RTTY/ASCII/CW using your personal computer.

The MFJ-1225 Computer Interface plugs between your receiver and VIC-20, Apple, TRS-80C, Atari, TI-99, Commodore 64 and most other personal computers. Requires appropriate software.

Copies all shifts (850, 425, 170 Hz shift and all others) and all speeds. Automatic noise limiter suppresses static crashes for better copy. 2 LED tuning indicator makes tuning fast, easy, positive. 1/2 x 1 1/4 x 4 1/4 in. 12-15 VDC or 110 VAC with optional adapter, MFJ-1312. \$9.95.

INDOOR TUNED ACTIVE ANTENNA

MFJ-1020
\$ **79⁹⁵**



MFJ-1020 New Indoor Active Antenna sits on your desk ready to listen to the "Rivals, often exceeds, reception of outside long wire. Unique Tuned Active Antenna minimizes intermode, provides RF selectivity, reduces noise outside tuned band. Also use as preselector for external antenna. Covers 300 KHz to 30 MHz in 5 bands. Adjustable telescoping antenna. Controls: Tune, Band Selector, Gain, ON-Off/Bypass, LED, FET, bipolar circuitry. Phone jack for external ant. 6x2x6 in. 9-18 VDC or 9V battery. 110 VAC with adapter, MFJ-1312, \$9.95.

REMOTE ACTIVE ANTENNA

54 inch remote active antenna mounts outdoor away from electrical noise for maximum signal and minimum noise pickup. Often outperforms longwire hundreds of feet long. Mount anywhere atop houses, buildings, balconies, apartments, mobile homes, on board ship.

Use with any radio to receive strong clear signals from all over the world. 50 KHz to 30 MHz.

High dynamic range eliminates intermodulation. Inside control unit has 20 dB attenuator, gain control. Switch 2 receivers and auxiliary or active antenna. "On" LED. 6x2x5 in. 50 ft. coax. 12 VDC or 110 VAC with MFJ-1312, \$9.95.



MFJ-1024
\$ **129⁹⁵**

Order from MFJ and try it. If not delighted, return within 30 days for refund (less shipping).

One year unconditional guarantee.

Order yours today. Call toll free 800-647-1800. Charge VISA, MC. Or mail check, money order. Add \$4.00 each for shipping and handling.

CALL TOLL FREE 800-647-1800

Call 601-323-5869 in Miss., outside continental USA, tech/order/repair info. TELEX 53-4590

MFJ ENTERPRISES, INCORPORATED
Box 494, Mississippi State, MS 39762

CIRCLE 24 ON READER SERVICE CARD

The Holiday Season invariably causes me to spend a few moments reflecting back upon an earlier Holiday Season. I had spent many months DXing with a wonderful piece of junk called a Hallicrafters S-38 and, at the age of fifteen, I felt that I had definitely racked up enough time behind the dials to move out of the realm of beginners' short-wave equipment and into the big leagues, or at least *bigger* leagues.

At that time my dream rig was the Hallicrafters S-40A, not the top of the line, but a quantum leap upwards from the S-38, a hop from a \$40 receiver to one costing \$80, with an extra \$16 for the optional S-meter accessory. Beginning in September of that year I had a picture of the S-40A pinned to my wall; by December it was all I could think about other than Sally Andrews. The trick was to convince the Old Man that it was absolutely necessary for me to have this new receiver. Frankly, after the several dismal modification attempts I had made on the S-38, I really did need another receiver; an S-40A receiver would give me the jump on other DXers my age who were chugging along with beginners' receivers.

When the big morning arrived, I really wasn't quite prepared for actually getting this receiver as my gift. It was out of the carton and on my desk within minutes—the cruddy old S-38 having been unceremoniously shoved off the edge of the desk, hitting the floor with a loud *clunk*. It was then that I suddenly realized that the 15-foot piece of wire that sufficed as the S-38's antenna was obviously unsuited to this more elegant receiver. There was no doubt that a new and better antenna was needed. The instruction manual suggested a long wire antenna about 100 feet in length and strung on the exterior of the building. This I had to have right away, with the only possible barriers being that all the stores were closed that day, it was the dead of winter, and I was located on the 14th floor of an apartment house in New York City. Yet, I knew that it had to be done.

The Old Man's advice was for me to wait until April, or at least until the following day when the stores were open. One other suggestion, to temporarily use the S-38's old antenna, was immediately rejected as being too unreasonable to be taken seriously. A 15-foot indoor wire on an S-40A? Was he kidding?

I then realized that my desk lamp had a 6-foot power cord, and could be split apart and turned into a 12-foot length of antenna section. When added to my existing 15-foot antenna, I could be well on my way towards the establishment of a listening post not to be trifled with. If I only had a little more wire

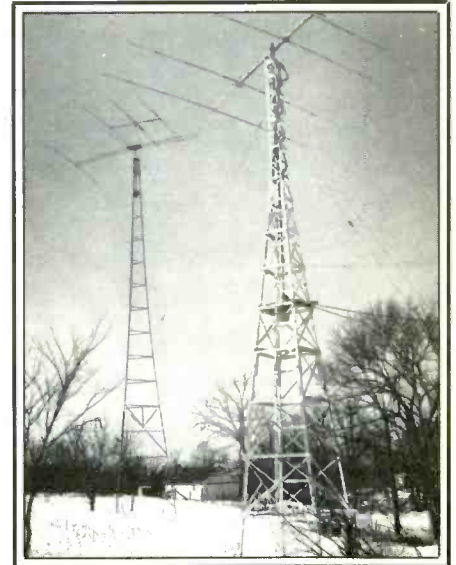

Happy Holidays to all at your station!

to add to this, I'd have the necessary 100-foot antenna that the manufacturer suggested be used with this receiver. By my calculations, this requirement could be completed with the power cords from the Old Man's desk lamp, two night table lamps, two floor lamps, and the living room radio.

Upon completion of my calculations I began rounding up the components, picturing myself like Richard Widmark in the film *Kiss of Death*, as he ripped the power cord off the floor lamp to tie up Victor Mature's wheelchair-ridden mother. Everything was anxiously patched together and taken up to the roof where it could be lowered down to my window and connected to the waiting S-40A. My fingers still numb from the bitter cold, I did the best I could to hook up the antenna and ready my installation for world class DXing.

I have to tell you it was dazzling—Brazzaville, Ankara, Stockholm, Quito, Melbourne, Manila, Montevideo all came spilling out of the speaker like locals—and I knew that the next day when I could get to the store to buy a proper antenna, things would be even better. Why, within a couple of weeks I'd have logged all of the easy countries and would tenaciously be pursuing Tibet, Zanzibar, and the difficult ones.

There I sat, sequestered in my room and riveted to my dream receiver, refusing to come out for lunch. It made no difference to me that a small brigade of relatives showed up and began milling around in another room in the hopes of exchanging gifts. Parental pleas for a more sociable attitude from

(Continued on page 76)

New! Radio Shack Scanner Breakthroughs!

OUR BEST EVER ■ NO CRYSTALS NEEDED ■ GREAT HOLIDAY GIFTS



399⁹⁵

Low As \$20 Per Month*

300 Channels ■ 25-520 MHz and 760-1300 MHz

A breakthrough in coverage and versatility! Realistic® PRO-2004 provides extended frequency coverage for monitoring military, law enforcement, CB and other services not received by most scanners. The programmable memory stores up to 300 channels, and a search mode makes it easy to find new channels. Also features automatic and manual AM/FM selection, easy-to-read LCD frequency/mode display and a special sound squelch control to prevent lockups on unmodulated carriers. UL listed AC or 12 VDC negative ground. #20-119



Programmable With 200-Channel Memory

299⁹⁵

Low As \$20 Per Month*

Keyboard Access to 23,684 VHF and UHF Frequencies

A breakthrough in performance at this low price! Realistic PRO-32 gives you state-of-the-art features in a rugged, take-anywhere portable. It has an easy-to-read LCD display, priority and search modes, scan delay to prevent missed replies, channel lockouts for temporarily bypassing any channel, two-speed scanning, and a lock key to prevent accidental entries. Covers 30-54 MHz, 108-136 MHz and 138-174 MHz VHF plus 380-512 MHz UHF. Uses regular or rechargeable batteries, extra. #20-133

The Shack® is Headquarters For Communications Gifts

Your nearby Radio Shack store stocks a huge selection of scanners, CBs, walkie-talkies, multiband radios, telephones and other gifts for every member of the family. Visit us today!

Radio Shack®
The Technology Store™

A DIVISION OF TANDY CORPORATION

FREE Radio Shack Catalog

Mail to Radio Shack, Department 87-A-220,
300 One Tandy Center, Fort Worth, TX 76102

NAME _____
ADDRESS _____
CITY _____
STATE _____ ZIP _____

*Credit plan available. Actual payment may vary depending on balance. Prices apply at participating Radio Shack stores and dealers. Mobile use of scanners in some areas may be unlawful or require a permit. Check with local authorities.

MAILBAG LETTERS TO THE EDITOR

The most interesting questions we receive will be answered here in each issue. Address your questions to: Tom Kneitel, Editor, Popular Communications magazine, 76 North Broadway, Hicksville, NY 11801.

Making Too Much Whoopie?

A few issues ago, POP'COMM carried a story about monitoring the VHF aircraft band. That inspired me to listen there and it's been a most enjoyable aspect of monitoring. This story suggested listening on 121.5 MHz, the aircraft emergency channel. Thusfar I've heard no actual emergencies, but once in a while I do hear a strange "whoop-whoop" type of signal. Perhaps you might discuss what this signal represents.

Helen Coulouris,
Chantilly, VA

The odd signals you hear are from aircraft emergency locator transmitters (ELT's), automatic devices intended to direct search and rescue teams to the sites where aircraft have crashed or made emergency landings. According to the Aircraft Owners and Pilots Association (AOPA), these gizmos seem to be activated a bit too easily and last year sent out 6,000 false alarms costing more than \$2 million to chase after. This represents a 96% false alarm rate, sending CAP and other searchers on far too many wasteful wild goose chases. ELT's can be false-triggered by hard landings and battery corrosion. Also, some pilots remove the small units from their aircraft when they land and take them home. Tossing them into car trunks or driving over a pothole can also set them off. The signals you describe on 121.5 MHz are pretty much what ELT's sound like. —Editor

The Bells Are Ringing

The telephone accessories discussed in POP'COMM are very inventive but one I'd like doesn't seem to have ever been manufactured. No matter how many times I've asked people not to call me late at night, it seems that there are always (what others consider) urgent reasons for people to ring me up at 2 a.m. or 4 a.m. Maybe I'd be sympathetic to discussing their problems with them at 9 a.m., but in the middle of the night I'm not even slightly interested. Telephones should be made with facilities for switching them off when you don't want calls.

Buck Richardson
Alpine, TX

One way of solving your problem would be to buy a standard clock timer and a 117-volt relay. Set the timer to activate during those hours you don't want to be disturbed by the phone, then connect the output of the timer to the relay. The secondary contacts of the relay can then be hooked up

to the bell coil of your telephone. If you've got it hooked up properly, during the hours you select, the bell on your phone simply will not ring. If you've hooked it up backwards, the only calls you'll receive are those which come in late at night. One additional refinement would be to put an answering machine in operation, one which would automatically switch on simultaneously with the telephone bell turning off—the answering machine can be powered from the same clock timer. Leave a message on the answering machine which thanks your friends for calling in the wee hours and suggests that they try you again after the sun comes up. The simplest solutions would be to either put a knife switch in the phone's bell circuit or else just unplug the phone from the wall altogether. Or, as a last resort, you could always buy a telephone with a bell switch (they do make them, although I think they are all hand-operated rather than automatic). Isn't it amazing how so many of life's problems seem to arrive between midnight and 9 a.m.? —Editor

Hearing 'em The Easy Way

I'm a fan of tapping in on marine telephone calls via my scanner. One of the things which has intrigued me is that I can hear the ships and yachts clearly while they are in contact with the Marine Operator on VHF Channel 25 (161.85 MHz) but when those same vessels operate on other channels they are very weak. Sometimes the Marine Operator calls the ships on Channel 16 and I can't hear the ship at all, but when they switch over to Channel 26 the ship comes in like a powerhouse. What causes this?

Vasile Batsu
Coos Bay, OR

When you're tuned to Channel 16, 22, or most of the VHF channels, you're listening in on the actual transmitting frequency of the ship or yacht. These are all simplex frequencies—the stations all operate on the same frequency when communicating with one another. Since these vessels have a range limited by line-of-sight, if they're far from shore they're probably out of range of your station.

When you're tuned to any of the Marine Operator frequencies (Channels 24, 25, 26, 27, 28, 84, 85, 86 or 87) you are no longer hearing the ships directly. Instead, you're hearing their signals being retransmitted through the facilities of the coastal station. The coastal station has a high-gain antenna mounted atop a tall structure and therefore can pull in VHF signals from far greater distances than you can, and it retransmits the ship signals from a high-powered transmitter located on shore. Hence, the strong signals which couldn't be copied when you attempted to read them directly. The ships

you hear being rebroadcast on 161.85 MHz are actually transmitting on 157.25 MHz.

If you wanted to try QSLing a ship you heard contacting a Marine Operator, in all fairness, you'd really have to copy it directly on its actual transmitting frequency. It would be a bit tacky to try to QSL it while monitoring it "by proxy." Stations communicating with Mobile Operators, many police stations, and via 2-meter Ham band repeaters would fall into this same "by proxy" category. —Editor

Duck, It's Peking

I've noticed that in POP'COMM the city in the People's Republic of China is at times spelled Peking and at other times spelled Beijing. It is my understanding that the PRC has demanded this city now be spelled "Beijing" and I was wondering why you continue to spell it the old (and incorrect) way.

Laura Questral
Hannibal, MO

At one time that city was spelled "Peiping" and I went along with a subsequent change of its spelling to "Peking." Basically, I'm a pretty agreeable fellow—I've learned that after 1950 I had to call the city of Hot Springs, NM by a new name ("Truth or Consequences," NM). I even agreed to call dungarees "blue jeans," and then later on, "jeans." Enough already! I have resisted the PRC's "demands" to call this city by yet another new name, mostly because their reasons for making the change seemed, to me, to be silly. I recognize their right to call it whatever they like, however, just as in this nation we refer to the United States and to New York—but in Latin America they refer to "Los Estados Unidos" and "Nueva York"—the localized Chinese phonetic pronunciation of their cities is alien to me and unsuited to my needs. POP'COMM authors are free to call it whatever they find most appropriate to their own preferences. —Editor

High Flyin' Chit-Chat

CBers have their Channel 19 (27.185 MHz) for exchanging chit-chat as they move from place to place; one issue of POP'COMM listed numerous VHF marine channels used for yacht owners and tug captains to exchange small talk, but I wonder why scanner owners aren't able to monitor aircraft pilots doing likewise. Why aren't there any equivalent chit-chat frequencies for pilots?

Sal Magliore, KNJ2PW
Hasbrouck Heights, NJ

Private pilots can often be monitored chatting with one another on 122.85 and 122.9, while airline pilots seem to have unofficially claimed 123.45 as their chit-chat frequency. —Editor

PC

"The Largest Dealer of Scanners in the World"



SCANNER WORLD, USA

10 New Scotland Ave., Albany, NY 12208 518/436-9606



Bearcat® 300

Special \$239.99 (7.00 shipping)

50 Channels — Mobile/Base

Features include simple raised button keyboard programming of the following frequency ranges: 32-50 MHz, 118-136 MHz, 144-174 MHz, 421-512 MHz. Vacuum fluorescent display, dim control, priority, count transmissions, non-volatile memory retains memory without power back-up, automatic search, scan speed control, automatic search, scan delay, lockout, service search, automatic squelch, crystal-less, digital clock, external speaker & tape jack, auxiliary equipment control, plus much more. Built inside the rugged metal cabinet. Includes AC & DC cords, telescopic antenna, mobile mounting kit, and one year factory warranty on the Bearcat 300 for only \$239.99 and \$7.00 shipping. (Optional extended warranty: 3 years \$39.99, or 2 years (29.99)

REGENCY HX1500

Digital programmable 55 channel hand-held scanner. Frequency coverage 29-54 MHz, 118-174 MHz, 406-420 MHz, 440-512 MHz. Covers Public Service bands plus aircraft, trains, marine, plus many others. Has priority, search, lockout, scan, banks, sealed rubber keyboard. 90 day factory warranty. Includes flexible rubber antenna, belt clip and earphone.

\$234.99 (plus 6.50 shipping each)

Optional Accessories:

B-8 Ni-Cad Batteries	15.99
Ma-518 Wall Charger/Adapter	12.99
HXCase HEavy Leather Case	19.99
MA256 Drop-in Charger	89.99
MA257 Cigarette Lighter Adapter	16.99
(3 year extended warranty \$39.99; 2 year \$29.99)	

BEARCAT 50XL Programmable Hand-Held	124.99	(5.00)
AD100U AC Adapter/Charger for 50 XL	12.95	(.00)
BP50 Ni-Cad Battery Pack for 50XL	12.95	(.00)
CA50 Carry Case for 50XL	11.99	(.00)
BEARCAT 180 AC Digital Scanner	126.99	(6.00)
BEARCAT 140 AC Programmable Scanner	94.99	(5.00)
BEARCAT 145XL AC Programmable Scanner	104.99	(5.00)
BEARCAT 175XL AC Digital Scanner	159.99	(5.00)
BEARCAT 100XL Digital Hand-held	199.99	(6.50)
BEARCAT 210XW AC/DC Digital Scanner	199.99	(6.50)
BEARCAT 210XL AC/DC Digital Scanner	159.99	(6.50)
BEARCAT 200 AC Digital Scanner	129.99	(6.50)
BEARCAT 155 AC Digital Scanner	124.99	(6.50)
BEARCAT Weather Alert	39.99	(4.00)
BEARCAT 20/20 AC/DC Digital Scanner	229.99	(5.50)
BEARCAT 260 AC/DC Digital Scanner	219.99	(6.00)
BEARCAT 300 AC/DC Digital Scanner	239.99	(7.00)
BEARCAT 800 XLT AC/DC Digital Scanner	319.99	(6.00)
BEARCAT DX-1000 Shortwave Receiver	284.99	(12.00)
REGENCY MA-257 Cigarette cord for HX1000/1200	16.99	(.00)
REGENCY MA-917 Ni-cad Battery for HX1000/1200	24.99	(.00)
REGENCY HX-CASE Hvy Leath. case for HX1000/1200	19.99	(.00)
REGENCY MA-256 Drop in charger for HX1000/1200	89.99	(5.00)
REGENCY R-1060 Programmable 10 chan. AC Scan.	94.99	(5.00)
REGENCY HX-2000 Digital Hand-Held	159.99	(7.00)
REGENCY MX-3000 AC/DC Digital Scanner	216.99	(6.50)
REGENCY HX-2200 Digital Hand-Held Scanner	172.99	(7.00)
REGENCY MX-5000 AC/DC Digital Scanner	329.99	(6.50)
REGENCY MX-4200 AC/DC Digital Scanner	186.99	(7.00)
REGENCY Z-30 AC/DC Digital Scanner	129.99	(5.50)
REGENCY Z-60 AC/DC Digital Scanner	189.99	(5.50)
Mobile Mounting Bracket for Z Scanners	5.99	(.00)
REGENCY D-810 AC Digital Scanner	178.99	(5.50)
REGENCY ACT-R1 AC/DC Crys. Single Channel	75.99	(4.00)
REGENCY RH-256 High Band Transceiver	399.99	(7.75)
REGENCY UC 102 HI-VHF Hand Transceiver	124.99	(5.50)
REGENCY RU150B UHF Transceiver	439.99	(7.75)
Book "Top Secret Registry of Gov't Frequency"	12.95	(.00)
Book "Covert Intelligence, Electronic Eavesdropping"	8.95	(.00)
Book "Betty Bearcat Frequency Directory"	14.95	(.00)
Book "Rail Scan Directory"	7.95	(.00)
Book "Air Scan Directory"	12.95	(.00)
RCD MRP-1 Single Channel Hand-Held	38.99	(3.00)
JIL SX-200 AC/DC Digital Scanner	189.99	(6.75)
FANON M8HLU DC Crystal Scanner	99.99	(5.00)
FANON PSK-1 AC Adapted for M8HLU	12.99	(.00)
FOX BMP-1060 AC/DC Digital Scanner	129.99	(5.50)
FOX Mounting Bracket for BMP-1060	9.99	(.00)
WHISTLER Spectrum II Radar Detector	239.99	(6.00)
WHISTLER Spectrum Radar Detector	199.99	(5.00)
WHISTLER Remote Spectrum Radar Detector	199.99	(5.00)
ANT-1 Magnet Mount Mobile Scanner Antenna	29.99	(3.00)
ANT-6 Base Scanner Antenna w/50' cable	29.99	(3.00)

Regency® Z30 30 Channel Automatic Programmable Scanner

Scanner World Special

\$129.99

(plus \$5.50 shipping each)

Optional Accessories:

Cigarette Lighter Plug RGMPC \$4.95
Z Mobile Bracket — Special ... \$5.99

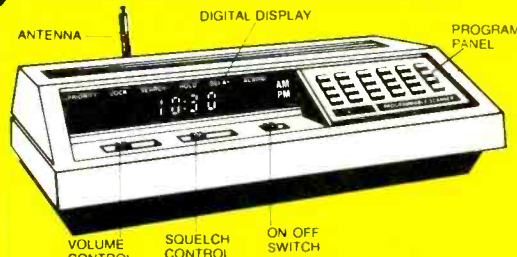

The Regency Z30 is a compact, programmable 30 channel, multi band, FM monitor receiver for use at

home or on the road. It is double conversion, super heterodyne used to receive the narrow band FM communications in the amateur, public safety and business bands: 30-50, 144-174, and 440-512 MHz. Size 10 3/4" W x 2-7/8" H x 8-3/8" D.

Sophisticated microprocess-controlled circuitry eliminates the need for crystals, instead, the frequency for each channel is programmed through the numbered keyboard similar to the one used on a telephone. A "beep" acknowledges contact each time a key is touched. The Z30 scans approximately 15 channels per second.

Any combination of two to thirty channels can be scanned automatically, or the unit can be set on manual for continuous monitoring of any one channel. In addition, the search function locates unknown frequencies within a band.

Other features include scan delay, priority and a bright/dim switch to control the brightness of the 9-digit Vacuum-Fluorescent display. The Z30 can be operated on either 120 VAC or 12 VDC. Includes one year warranty from Regency Electronics (optional 3 yr extended warranty only \$39.99, gives you a total of 4 yrs complete warranty or 2 yr extended warranty only \$29.99, gives you a total of 3 yrs complete warranty.)

Regency® HX2200

\$172.99

(Plus \$7.00 shipping each)

Digital Programmable 20 Channel Hand-Held Scanner with raised button keyboard for easy programming of the following frequency ranges: 118-136 MHz, 138-174 MHz, 406-512 MHz, 800-950 MHz (NOTE: This is the only hand-held portable scanner which will receive the 800-950 MHz range plus high band, air, and UHF). Features include priority, scan delay, memory backup, dual scan speed, channel lockout, jacks for external antenna and earphone, 90 day factory warranty, keyboard lockswitch, sidelit liquid crystal display for night use, program AM or FM mode, search or scan, size is 3" x 7" x 1 1/2". Complete HX2200 package includes Ni-Cad rechargeable batteries, wall charger adapter, protective carry case, and rubber antenna. All for the low price of only \$172.99 plus \$7.00 shipping each. (Optional extended warranty: 3 years \$39.99, or 2 years \$29.99)



Regency® MX4200

\$186.99 (Plus \$7.00 shipping each)

Digital programmable 20 channel scanner operates as a Base or Mobile unit or can be used as a portable with rechargeable Ni-Cad batteries included. MX4200 covers the following frequency ranges: 30-50 MHz, 118-174 MHz, 406-512 MHz, 800-950 MHz. Features compact size of 5 1/2" x 2 1/2" x 7 1/2", memory backup, scan delay, priority, dual scan speed, channel lockout, jacks for earphone and external antenna, keyboard lockswitch, one year factory warranty. Sidelit liquid crystal display for night use, program AM or FM mode, search or scan, reset button. Complete MX4200 package includes telescopic antenna, mobile mounting bracket, mobile power cord, rechargeable Ni-Cad batteries, wall charger adapter. All for the low price of \$186.99 plus \$7.00 shipping each. (Optional extended warranty: 3 years \$39.99, 2 years \$29.99). Optional cigarette lighter Plug #4200MPC \$4.99.

Bearcat 100 XL

\$199.99 (6.50 shipping) Handheld digital programmable, no crystal portable scanner. 16 channels, search feature, plus more! Frequency range: 30-50, 118-174, 406-512 MHz. Included in the package is a flexible rubber antenna, earphone, battery charger/AC adapter, 6 AA Ni-Cad rechargeable batteries and a heavy duty carry case. All for the low price of:

\$199.99 (6.50 shipping)

(3 year extended warranty only \$39.99, 2 year \$29.99)

REGENCY RH-256 B PROGRAMMABLE TRANSCIEVER

RH-256B Transceiver, 16 channel 12 VDC 2-way Radio fully programmable in transmit and receive mode. Includes built-in CTCSS tones for encode/decode, time-out timer, scan delay, 25 watts transmit power, priority, plus more. Frequency spread as shipped 152-158 MHz. Package includes mobile mike, bracket, mobile antenna, and all cables and instructions for installation. **Special package deal only: \$399.99** (7.75 shipping) (2 year extended warranty \$49.99 - 3 year \$69.99)

ORDERING INFORMATION

Call (518) 436-9606 to place orders by phone or mail orders to Scanner World, 10 New Scotland Av., Albany, NY 12208. Orders will be shipped same day received by United Parcel Service. Scanner World accepts VISA, MasterCard (COD shipments by United Parcel will be for cash or certified checks only). Mail orders with personal or business checks will be held 4 weeks for bank clearance. Orders with cashiers checks or money orders shipped same day received. Prices, specifications and terms subject to change without prior notice. If items are out of stock we will backorder and notify you of delivery date. All shipments are F.O.B. Scanner World warehouse in Albany, NY. We are not responsible for typographical errors. All merchandise carries full manufacturers warranty. Bid Proposals and Purchase orders accepted from Government agencies. Free full line catalogue available upon request. No minimum order. New York State Residents add 7% sales tax.

SHIPPING CHARGES

(*) Add (\$) per scanner, and \$30.00* for all accessories ordered at same time. C.O.D. shipments will be charged an additional \$3.00 per package. Full insurance is included in shipping charges. All orders are shipped by United Parcel Service. Shipping charges are for continental USA only. Outside of continental USA, ask for shipping charge per scanner.

Scanner World, USA

10 New Scotland Ave., Albany, NY 12208

(518) 436-9606

Most orders Shipped Same Day Received!

OFFICIAL NEWS COLUMN OF THE SCANNER ASSOCIATION OF NORTH AMERICA

Frequency Update Project On Track

For all of you who have been wondering where the next SCAN frequency list update is, please be assured that the project is again on a fast track. The Electronic Communications Privacy Act controversy, plus several state initiatives, took its toll on the limited resources of our non-profit association. Also, the lack of 800-900 MHz scanning equipment owned by volunteers caused us to seek out other volunteers in those areas who had the radios to verify frequencies in the new band. In fact, the sudden rush to new frequency assignments will make the update much more important than previous efforts—but also a much larger project than would normally be the case.

To those not familiar with the SCAN frequency project, here's a little background . . . When SCAN was formed back in 1978, the frequency information available was basically that which you could obtain from the FCC files. There were books available that listed some frequencies from these files, but there were several major problems with this data. First, the very nature of the FCC data is that it is "authorization" to use a frequency, but not actual use. Now, the FCC expects that the authorization will be used, and if they find out that it isn't they can give the assignment to someone else, but in the real world that is usually not the case. What happens is that Smalltown, Colorado and Bigville, Texas both get new operating frequencies to avoid sharing frequencies with other towns and provide, hopefully, a more efficient operation. Bang! It's listed in the FCC computer files as a supposedly active frequency. But is it? Chances are at least 50-50 that it is not. In the case of Smalltown they soon discovered that the mutual aid pact with neighboring towns was really important. With the towns on the same frequencies things were a little crowded at times, but they knew what was going on in the area and could get help when needed. The realization that they might now need two radios per car (the new assignments are rarely in the same frequency band) put a damper on the idea and it was put "on hold." Did Smalltown notify the FCC? Of course not. After all, they still intend to go ahead sometime in the future. But turn a scanner onto that frequency today and you'll get silence. Now lets look at Bigville, which really does need more frequencies and has less use for mutual aid. Everything was in place to go ahead, but Bigville is in a recession. The city council has put a freeze on new capital spending. Another project "on hold." Notify the FCC and loose your new frequency authorization? Not on your life! So you can see that the bottom line is that each FCC listing needs to be verified before it becomes information that you can rely on. A BIG job? You bet is!

We all owe a great deal to the volunteers who contribute their time to the project. Many have contributed 40, 50, or even 100 hours or more to help their fellow scanner enthusiasts. Our "hats off" to them! We know from the letters we have received that many of you are awaiting the results of these efforts.

Scanning and Commuting

If you are like a lot of scanner owners and live in a town where commuting is not a giant hassle, count your blessings. For the rest of us I firmly believe that scanning is the most overlooked aid to commuting that exists. Take the typical commuter car on the Chicago tollway system . . . standard equipment is a coffee mug, radio blaring the traffic report, and a look that alternately reflects boredom or panic. The traffic reports are listened to so that you can avoid the really big tie-ups, perhaps diving off at an exit for an alternate route, or staying to the left when they've told you that there is an accident in the right-hand lane. The problem is that by the time the radio traffic report reaches you it is almost always wrong, mainly because it is hopelessly out of date. A typical example . . .

8:05 a.m. — John, frustrated with slow moving traffic, is tailgating Sam's car ahead of him. Sam, already late for his shift at the factory, is within inches of a 4 x 4 that brakes suddenly. Brakes squeal . . . glass and metal fly . . . and John, reacting quickly heads for the next lane which is unfortunately already occupied. The typical morning fender bender. Nobody hurt, but two lanes of one of the busiest highways in the world is blocked.

8:08 a.m. — State Trooper Greenwald, reaching a backup, radios that he's "going to the shoulder at marker six two," indicating that he's going to race ahead on the shoulder of the road to investigate.

8:10 a.m. — John, Sam, and Mary are unhappily looking over their vehicles and exchanging insurance information. By now traffic is at a virtual stop for four miles behind them. The radio is saying "the usual slowness and tight spots on all major highways . . ." Nobody knows except the hapless people in the backup!

8:12 a.m. — A passing Amateur Radio operator, seeing no police on the scene of the accident, uses a Ham repeater "autopatch" to phone the state police with the report of a multiple car accident with lanes blocked at mile post 58.

8:13 a.m. — Trooper Greenwald arrives at the scene and jumps out to check to see if he needs to call for an ambulance.

8:19 a.m. — The state trooper calls for a tow truck and reports that there is major lane blockage. He will be assisting with traffic direction and trying to get the damaged vehicles off the road even before the tow truck arrives.

8:20 a.m. — The radio traffic report says "Just the usual delays, but we now have a report of an accident on I-294 . . . more details as they become available."

8:22 a.m. — All the vehicles are moved to the shoulder under their own power and all lanes cleared. The backup behind them now extends eight miles.

8:30 a.m. — Radio report: "There's a four vehicle accident with lane blockage on I-294 . . . consider an alternate route this morning . . ."

"A lot of good that does now!" snarls Bob, who is just now driving by the accident location. The radio report hasn't done him a bit of good . . . in fact, radio reports are likely to be warning people off the road long after the problem has cleared up and traffic is moving again. Since most radio stations use scanners to find out about accidents, why does this information take so long to reach the people who can use it? One reason is timing, like traffic reports scheduled every 10 or 15 minutes. A lot can happen in 15 minutes! Another is desire to report only major accidents and tie-ups; the first radio reports, like Trooper Greenwald's call that he was headed to the shoulder to drive ahead and investigate, was not enough for the station use. The Ham operator's report was not even heard by the station, because they are only scanning the "official" frequencies. So, by the time they heard the Trooper's report at 8:19 of the lane blockage, it was too late to get it on the 8:20 report that was already cued to go on air. Unless a decision was made to interrupt a news segment, the next shot was the 8:30 report . . . by that time not much use for Bob or thousands of other commuters.

But now let's ride along with Bill with a scanner in his car. At 8:02 he catches the Trooper report that warns him of trouble ahead. He signals and gets in the right hand lane while trying to decide whether or not to exit at the next exit a mile away. He also knows that several Ham operators using this route are using the repeater every morning, so these "advance scouts" are also useful for information. Sure enough, at 8:12, he hears the autopatch report to the state police about the accident one of these Amateur Radio operators is passing. Decision made: Exit. Exit, even though traffic is moving

(Continued on page 76)

Relay Race

Maybe That Shortwave Station Isn't What It Appears After All!

BY GERRY L. DEXTER

What's that old saying? "You can't tell the players without a scorecard?"

That is certainly no truer for athletic events than it is for someone who monitors the international shortwave broadcasting bands. Things can get confusing enough just trying to keep up with what country is using which frequencies at what times, broadcasting in what language to which areas of the world! As if that weren't bad enough, things get even more complex when you factor in this business of relay stations.

You are listening to the BBC from London. But, is it coming directly from London to you or are you hearing it via the BBC's South Atlantic Relay Station on Ascension Island or via the Caribbean relay on Antigua or the relay station in Singapore? The pure program listener undoubtedly hasn't much interest in which middlemen are involved, but the DXer who's counting countries or reporting his loggings to *POP'COMM* and club bulletins or trying to get a QSL from one of these stations needs to be aware of what's what and who's where.

The reason shortwave broadcasters use relay stations is obvious. By doing so they can put a stronger, clearer signal into a designated target area than they could if the listener had to receive the signal direct from transmitters situated in the country originating the broadcast. Normally, doing without a relay means a far greater distance between transmitter and listener so the chances for interference and signal deterioration during the long trip are that much greater. Mother Nature has a better chance of taking a healthy whack at the signal.

The traditional relay station is little more than a slave station of the main broadcaster. Programs are being satellite-fed to the relay stations more and more, although many still use an off-the-air pickup from a monitoring installation (which is a standard feature at most relay stations) and, if satellite-fed, off-air pickup is still maintained as a backup. A few landline feeds still exist as well.

There are several variations in the relay station business. The broadcaster may own and operate the relay with only that broadcaster's programming being aired.

In some situations part of the agreement allowing a relay station to be built on foreign soil includes a provision which allows the broadcaster of the host country use of the relay facilities for its own foreign service, a

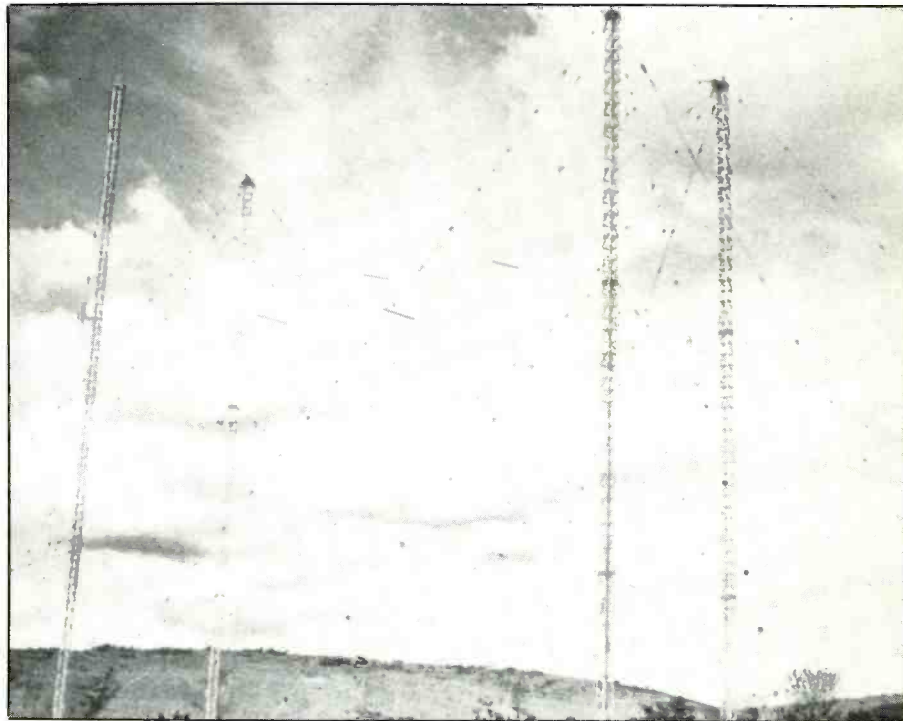

Transmitting towers at the Deutsche Welle Relay, Kagali, Rwanda.

practice which is often a part of Voice of America relay agreements.

In some cases the relay station may be built by the broadcaster but operated, at least in part, by a private, locally-based company. In still other instances, two international broadcasters will pool their funds and technical expertise to build the station and then they'll both share the facility. Deutsche Welle and the BBC did this in the case of the Antigua relay.

Occasionally, one government will agree to simply exchange time on its station for transmitter time on the station of another country so that both can put better signals into desired target areas. Paris and Beijing tried that briefly, until there was a change in the French government and Paris had a change of heart. At any rate, it's the "you scratch my back and I'll scratch yours" approach.

Radio Trans Europe in Portugal was constructed largely for the purpose of making money by supplying a relay facility to several different broadcasters and program producers. It would not be at all surprising, if,

one day, this kind of installation went up somewhere in the Northern Hemisphere!

Of course, there are relays and then there are relays. For this article we are dealing only with relay stations outside the country from which the programming originates. In order to cling to something approaching simplicity we won't get into relay transmitter sites within the country doing the broadcasting—the dozens of such sites within the USSR and the two or more in a number of other countries such as Sweden, East and West Germany, Spain, China, Bulgaria, Czechoslovakia, the Netherlands and so on.

So how can you tell when you have one of these carbon-copy stations and when you're hearing programs direct from the country involved? Ah, there are certainly easier questions to answer in this old world. It's akin to a coach putting in a substitute right guard during the third quarter with the replacement wearing the same number as the fellow he's replacing, while the announcers never bother to mention the switch! Unless you are watching for it, it can be pretty hard to spot.

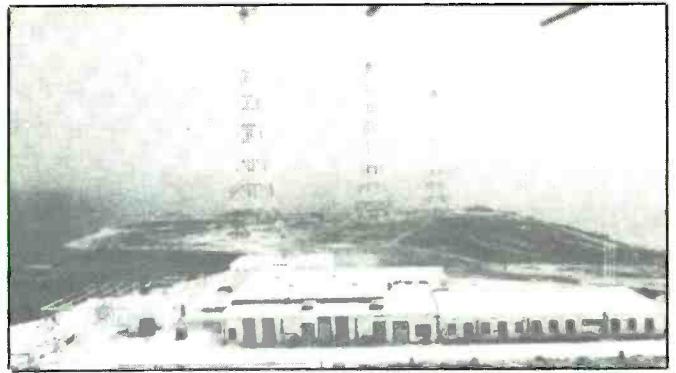

The Cyclops, Malta Deutsche Welle Relay consists of several towers and a large transmitting plant.



Something more than your average shortwave receiver is used to pick up broadcasts from the main station. This receiving installation is located at the Deutsche Welle Malta Relay.

One problem is that relays are just as vulnerable to having their times and frequencies messed with by some frequency coordinator in the main office as is the originating station. As a result, you can't always count on a particular channel always being occupied by a particular relay. In fact, more than one relay station belonging to the same broadcaster may use a particular channel during a 24-hour period.

For starters, though, you have to seek out shortwave's informational old reliables—*The World Radio and TV Handbook* and *Radio Database International*, both of which, in their individual formats, contain information about which relays are normally operating where.

Good as these sources are though, they cannot take into account changes which may take place after those books have made their annual trip to the presses. A more timely tool in some instances is program and frequency schedules which are available from the stations. Some, such as the BBC and Voice of America (The VOA's Frequency Schedule, in contrast to its *Voices* magazine program guide, is available to U.S. citizens) both contain detailed breakdowns of relay usage for the transmitting period covered. On the other hand, some stations totally ignore relay usage in their schedules.

You can also listen for the relay station's local identification announcement at sign-on or sign-off but here again, don't count on all stations making it that easy for you. Many don't make any relay site identifications on the air at all.

Fortunately, we still have common sense to draw upon. If, say, you are listening to Radio Netherlands beaming to North America and the signal is bending the pin on the S-meter, it's a very good bet that you're tuned to the Radio Netherlands relay station on Bonaire in the Netherlands Antilles, rather than to a broadcast direct from Holland. If you are at least aware of which stations are using relays you are already a step ahead in determining whether a broadcast is coming to you direct or via a spot far removed from the broadcaster's home base.

Another possibility offers itself when you are able to receive the same program on two frequencies simultaneously. If the programming on one frequency is running a second or so behind that of the other then the trailer is likely to be via satellite and thus via a relay station.

No one tool or method of identification works in every instance. You'll have to draw upon more source than one to cover all the eventualities.

Once you've identified one, what about QSLing it? There's no nice, smooth, unobstructed road ahead here, either. Some stations—the VOA, Radio Netherlands and Radio Sweden International come immediately to mind—are very kind to the listener and getting a relay site on a QSL card is usually no problem. Others, including the BBC, won't normally do it from the headquarters offices although sometimes the engineers at the relay station itself will respond. Some stations won't do it unless the circumstances are unusual. Like the other aspects of the

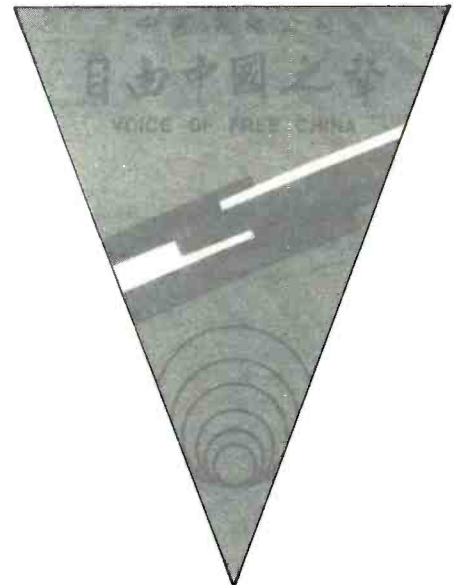

The Voice of Free China can be heard via the facility owned by WYFR in Florida.

Great QSL Game, there are nearly as many variations as there are stations! The best way is to catch a new relay station when it is still testing or hasn't much of a history yet. Both the main broadcaster and the relay station are likely to be more cooperative under such circumstances. The trouble is, of course, that those kind of things don't happen very often and there's no way to turn the clock back and get those which are already on in that fashion.

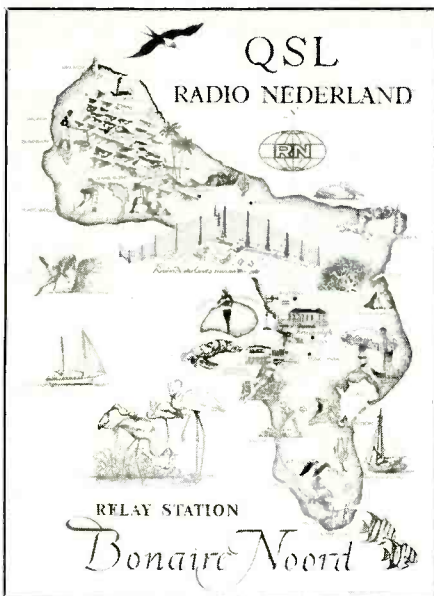

Most North American receptions of Radio Netherlands are via the Bonaire relay station.

As you can see from our POP'COMM Relay Rundown, there are a lot of these things on the air. And, as they say on certain late night TV shows, there's "more to come." The Voice of America is busy building new shortwave relay stations in Thailand, Israel, Puerto Rico and Sri Lanka and will, in addition, be modernizing and generating more watts at several of its long established relay

DIAMOND

D-130 SUPER DISCONE WIDEBAND

Suggested Retail
\$79.95

Features

25-1300 MHz Super-Discone Antenna. Transmit on 50, 144, 430, 1200 MHz Monitor 25-1300 MHz with one antenna

Description

All stainless steel discone and vertical radiator for TX. Rugged Construction, wide bandwidth.

Gain (dBi) **VSWR**
0 dB 1.5:1 or less

Input Power **Length**
50 Watts 1.7 M

Impedance **Weight**
50 Ohms 1 kg

Mount Model

Adapts to 25-50mm masts.



1506 CAPITAL AVENUE, PLANO, TEXAS 75074
NATIONAL DISTRIBUTOR

Relay Rundown

Station

Radio Afghanistan
Radio Canada International
Radio Havana Cuba
Radio France International
Radio Japan
Radio Monte Carlo
Radio Netherlands
Spanish Foreign Radio
Radio Surinam International
Voice of Free China
British Broadcasting Corp.

Relayed via:

Radio Moscow transmitter sites
Daventry, Rampisham, Skelton, England (BBC)
Radio Moscow transmitter sites
Moyobi, Gabon (Africa No. One)
Montsinery, French Guiana
Moyobi, Gabon (Africa No. One)
Sackville, Canada (RCI)
Nador, Morocco
Bonaire, Netherlands Antilles
Talata, Madagascar
La Mesa, Canary Islands
RadioBras, Brazil
Okeechobee, Florida (WYFR)
Ascension Island
Lesotho
Limassol, Cyprus
Masirah Island, Oman
Kranji, Singapore
Sackville, Canada (RCI)
Delano, California (VOA)
Greenville, N. Carolina (VOA)
Antigua
Kavala, Greece
Monrovia, Liberia
Tangier, Morocco
Poro, Philippines
Tinang, Philippines
Colombo, Sri Lanka
Ascension Island (BBC)
Rhodes, Greece
Munich, West Germany
Wooferton, England (BBC)
WYFR
Radio Moscow
Voice of Germany
Radio Free Europe/
Radio Liberty
Taipei, Taiwan (VOFC)
Plovdiv, Bulgaria (Radio Sofia)
Havana, Cuba (RHC)
Kigali, Rwanda
Sines, Portugal
Cyclops, Malta
Antigua
Montserrat
Trincomalee, Sri Lanka
Sackville, Canada (RCI)
Playa de Pals, Spain
Gloria, Portugal

sites. If things have gone according to schedule Radio Japan should now be using the facilities of Radio Canada International for programs to North America. At this point we don't know whether that agreement is reciprocal or not. Spain is building a relay station in Costa Rica and that should be on the air in 1987. The BBC will have new relay outlets on the air from the Seychelle Islands and Hong Kong before the decade is done.

But that's all in the future. There's plenty to sort out just the way things are now. If you

are a DXer an a QSL hound then hopefully these paragraphs have provided you with some extra ammunition to help you win the relay race. If your main interest is program listening and you really don't give a fig where the program is coming from so long as you can hear it reasonably well, we hope you are at least a little more aware that things aren't always what they seem to be on the international broadcasting bands.

Now, just wait until someone gets the bright idea of relaying a relay with no site IDs on either one!

PC

New From Spectronics!

The SONY AIR-8 Is Here!

Hand-Held Programmable PLL Scanner/Receiver For AIR BAND-2M/PSB-FM-AM(LW-MW-SW)

NOW ONLY
\$269⁰⁰
Plus \$4.00 UPS



Listen to 2 Meters, Forestry, Police, Fire, Air Traffic Control, LF and VHF Weather, 160 Meter AM & CW, and a whole lot more!

HERE ARE SOME OF THE AIR-8's OUTSTANDING FEATURES!

- Computer controlled PLL tuning system
- 40 memory presets
- Multi scan system (manual and auto)
- 11" Helical antenna w/BNC connector
- Priority channel
- Squelch (auto and manual)
- Direct tuning

HERE'S TRUE SONY QUALITY! Feel the rugged construction, and listen to the high quality sound, and you'll know it's a Sony! The new Air-8 can scan four different frequency ranges in either direction and can store a total of forty frequencies in its four memory banks. You can recall any memorized frequency with the touch of a key, and can scan the ten channels in each of its four memory banks in any order. The Air-8 also has a delay function that prevents dropout enabling you to hear both sides of a conversation, and also a priority feature that samples a chosen frequency every three seconds for a signal. The quick-disconnect BNC connector allows different types of antennas to be easily coupled to the Air-8 for maximum performance.

The Air-8 measures 3 1/8" x 7 1/8" x 2", and weighs just 21 oz. This is truly a sturdy little companion that will give you years of dependable performance wherever you go.

6 Frequency Bands

Band	Frequency range	Tuning interval
PSB	144 - 174 MHz	5kHz
AIR	108 - 136 MHz	25kHz
FM	76 - 108 MHz	50kHz
AM	SW 1601 - 2194kHz (1603 - 2194kHz)	1kHz
	MW 530 - 1600kHz (531 - 1602kHz)	10kHz (9kHz)
	LW 150 - 529kHz (150 - 530kHz)	1kHz

7 Functions on LCD Display

Indicates the band being received

Frequency being received

The large black dot indicates that the frequency is memorized to the 3 key

The small black dot indicates that the delay function is activated for the 3 key

Indicates that the input frequency is out of range

Indicates that the priority function is activated

Indicates that the program function is activated

NOW IN STOCK... BUT YOU'D BETTER ORDER EARLY!

PACKED WITH SONY STATE-OF-THE-ART TECHNOLOGY

(1) POWER Switch (2) Volume Control (3) 11" Helical Antenna (4) BNC Antenna Connector (5) Squelch Control. Features both manual and automatic modes. (6) Earphone Jack (7) AM External Ant Jack (8) Band Selector. Selects Air, PSB, AM, or FM. (9) LCD Display (See detailed illustration above) (10) Counter Keys. Used to program frequencies for direct tuning and memories, and also to recall memories. (11) EXECUTE Key (12) SCAN Keys. Used for scan tuning and manual tuning. (13) LIGHT Switch (14) KEY PROTECT. Locks out all keys on front face. (15) EXTERNAL DC INPUT (16) High Quality Speaker (17) ENTER Key. Used to memorize frequencies. (18) Battery Compartment (rear) (19) 9kHz/10 kHz Selector (Inside battery compartment). Used to change MW tuning interval. (20) DIRECT Key. Used for direct tuning. (21) LED Receive Indicator (22) MEMORY Scan Key. Used for scan tuning each memory bank. (23) PROGRAM Key. Used to initiate the program function. (24) DELAY Key (25) PRIORITY Key. Used for sampling a priority channel every 3 seconds. (26) Heavy Duty Body. Rugged military/industrial grade construction. AND DON'T FORGET... IT'S A SONY!

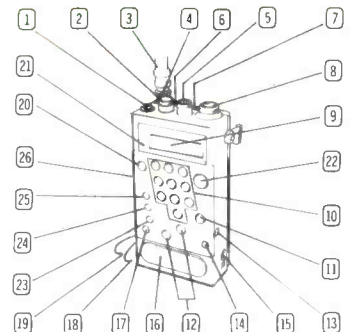

SPECTRONICS, INC.

1009 GARFIELD ST., OAK PARK, IL. 60304

PHONE **(312) 848-6777**



WORLD'S LEADING SONY COMMUNICATIONS SPECIALISTS!

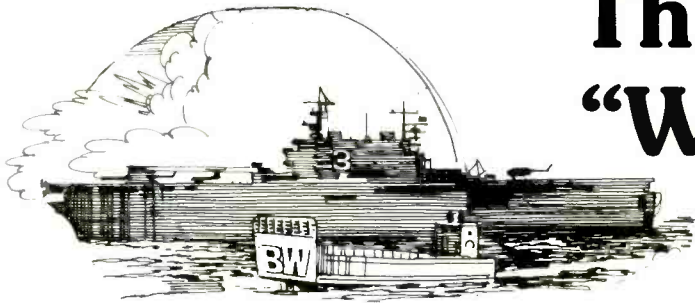

The Pearl Harbor “Winds Execute” Message

The War Message Was Copied, But What Then?

BY GRAYDON A. LEWIS, N7FCO

Naval Cryptologic Veterans Association

It was 4 December 1941 in Washington, D.C. A cold wind was blowing down from the Canadian Arctic. The Christmas decorations were up in all the downtown stores and businessmen were predicting the best Christmas season in years. With all the support for the war in Europe, the last vestiges of the Great Depression had finally ended. There was even talk ‘on the hill’ of raising the minimum wage to 45 cents an hour.

Near Washington, at the Navy Intercept Station at Cheltenham, Maryland intercept operator Ralph Briggs was glad for the warmth of his peacoat on the way to work, and was pleased with the big mug of Navy coffee which was the first item of business before sitting down at his intercept position.

Since 19 November, when the Winds Code Message, Japanese Circulars 2353 and 2354, had been transmitted by Tokyo and decrypted on the ‘Purple Machine,’ the head of Navy Communications Intelligence, Captain L.F. Safford, had directed that cards be made, and placed by the operating position of each operator.

Since it has been a routine watch so far, Ralph Briggs glanced at his card once more. Secured with tape on his operating position it read:

A. In case of Japan-U.S. relations in danger: HIGASHI NO KAZE AME

B. Japan-U.S.S.R. relations: KITANO-KAZE KUMMORI

C. Japan-British relations: NISHI NO KAZE HARE

The thick handleless coffee mug on Briggs’ position had been refilled more than once, and the watch continued routine until, on 11980 kHz station “JAP” Tokyo, sent the key weather message in Morse at 1330Z (UTC). Briggs copied the message on his RIP-5, the Underwood Code Machine, with Kana characters:

HIGASHI NO KAZE AME (East Winds Rain)

It was not expected. Everyone thought that when it came, it would be war with Britain, and not the United States. Briggs

checked his copy with the card, no mistake, and the next action was to be his.

Ralph Briggs rushed the short distance to the communications room, and stayed to watch the message transmitted to Intercept Headquarters in Washington a few miles away. Then he called his Watch Chief, who lived in the station, and said, “I think I’ve got what we’ve been looking for!” The Chief replied, “Good, I’ll be up shortly, get it on the TWX to Washington right away, priority precedence.” Briggs said, “I’ve already done that Chief.” Briggs hung up the telephone, entered the message in his log, and continued on watch.

On Nebraska Avenue in Washington, the teletype machine was beside the Watch Officer’s desk. A bell rang, and the Winds Execute Message, typed out on the Model 19 teleprinter. Captain Safford was called.

At the Pearl Harbor investigation which followed World War II, Captain Safford testified:

“... It meant War and we knew it meant War ... I saw the Winds Message typed in page form on yellow teletype paper, with the translation written below. I immediately forwarded this message to my Commanding Officer [Rear Admiral Leigh Noyes] thus fully discharging my responsibility in the matter.”

But the Winds Execute Message was lost.

The Hewitt Commission, led by VADM H. Kent Hewitt, was conducting a follow up to the Navy Court of Inquiry. Hewitt, in his examination of Captain Safford, said:

“... there is no evidence of a Winds Execute Message beyond your unsupported testimony. I do not doubt your sincerity, but I believe that you have confused one of the other messages containing the name of a wind with the message you expected to receive.”

Ralph Briggs, in this same postwar time period was again stationed in Washington. He was located by Captain Safford, and Briggs was willing to testify at Congressional hearings. But Briggs did not testify. He was given a direct order by his Commanding Officer, to talk no further with Captain Safford, and not to testify. Safford respected this,



Ralph Briggs, who intercepted the 4 December Winds Execute Message. (Photo courtesy NCVA by Tom Warren.)



Captain L.F. Safford, in charge of Navy Intercept, 1941. (U.S. Navy photo.)

and Briggs was not called to testify, to confirm that he did indeed, copy the Winds Execute Message.

Years later, Briggs was a commissioned officer, and was Officer-in-Charge of the Navy Depository for Communications Intel-



U.S.S. California after the attack on Pearl Harbor, December 7, 1941. An armed NAS detachment watches for any other enemy raiders. (National Archives photograph.)

ligence. He took the opportunity to search the old intercept files for his logs and the Execute Message. They were missing, and Briggs made an appropriate notation in the files that the logs and traffic were missing.

Today, historians are divided. Some claim that President Roosevelt was informed of the war message and ignored it. Others believe that Winston Churchill knew of the attack because of British intercept, and did not tell President Roosevelt, because Britain was foundering in the war with Germany. Other historians believe that the Winds Execute Message was never intercepted at all.

In recent months, a British researcher has found that the Winds Execute Message was also intercepted by the British Intercept Station on Stonecutters Island, near Hong

Kong. Perhaps for the first time, the original Winds Execute Message intercept can now be confirmed.

But even if the message copied by Briggs had not been 'lost' would it have made a difference? Most historians believe not. The Execute Message gave no indication of a Pearl Harbor attack. But considering that the Japanese fleet was apparently in radio silence should this have given a clue?

While the Freedom of Information Act in the United States has caused the release of considerable information about the subject, British Communications Intelligence files are still mostly covered by the Official Secrets Act. When the British eventually open their files, or when a historian takes a new look at existing U.S. information, we may find that the story has not yet ended. **PC**

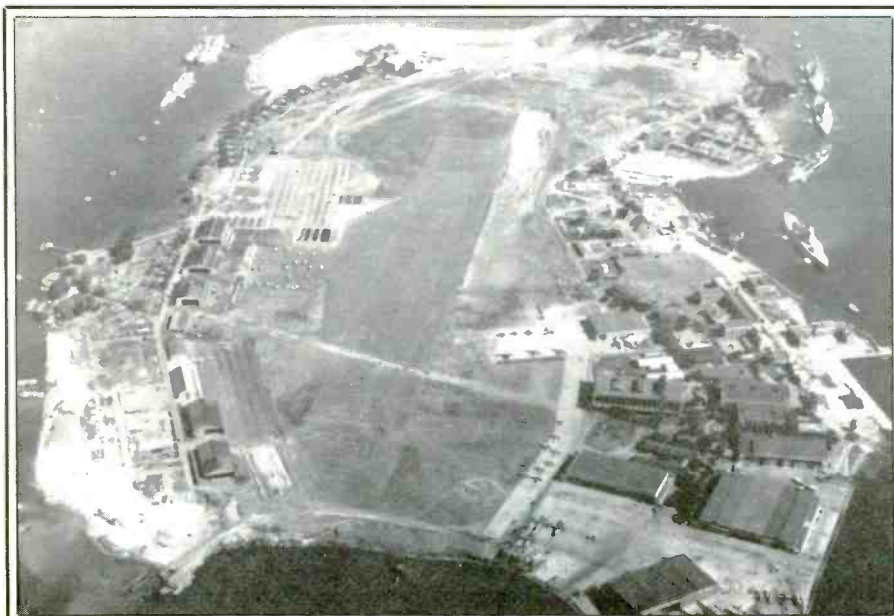

Ford Island, Battleship Row, Pearl Harbor, before December 7, 1941. U.S.S. Arizona is the third ship on the right. (Photo courtesy NCVA.)

THE JOY OF SATELLITE TV



800-4-SATMAN

FREE Consumer Buyer's Guide With Guaranteed Lowest Prices

- Explains all about 100 channel Satellite TV and how to shop for an earth station!
- Lists **GUARANTEED LOWEST PRICES...we will not be undersold, save 30-50% over local dealer prices!**

SYSTEMS (receiver shown, Raydx 10.5 ft. mesh dish, motor, feed/75K LNB, 125 ft. cable). All items UPS shippable and easy to install.

Chaparral Sierra II	\$1648	Macon T6	\$1608
Chaparral Sierra I	\$1548	Panasonic C2600	\$1398
Chaparral Cheyenne	\$1448	Panasonic C2000A	\$1198
Drake ESR 924I	\$1498	Tracker V	\$1498
Drake ESR 524	\$1298	Tracker II/III	\$1278
DX 800	\$1628	Uniden 9000	\$1558
DX 700S	\$1458	Uniden 7000	\$1398
Luxor 9900	\$1648	Uniden 6000	\$1238

The new SATMAN Buyer's Guide is a *necessity* for any prospective or current earth station owner who wants to save big money on name brand satellite products. Buy direct, Do-It-Yourself, and save with SATMAN. Toll free ordering, no sales tax (IL only), major credit cards accepted, huge in-stock inventories available, and fast UPS shipping anywhere in U.S. Check with SATMAN before you buy... *We will not be undersold!* Call now for your free 20 page SATMAN Buyer's Guide.

1-800-4-SATMAN

1-309-692-9582 Illinois



5017 N. MELODY • PEORIA, IL 61614 • 1 800-4-SATMAN

clip and save

EEB INTRODUCES THE NEW MARANTZ PORTABLES



PMD 430 Save \$104 SALE \$409.95

- Stereo Location Recording
- dbx Noise Reduction (75 db Dynamic Range)
- 3-Head off-the-tape monitoring while recording
- Dolby B Noise Reduction
- 4-Way Power
- Built-in Speaker/Channel Select
- Astonishing High Frequency Performance

**PMD 420 Save \$80
SALE \$319.95**

Many features of the PMD 430 such as illuminated VU meters, standard phono input/output jacks but without off-the-tape monitoring & dbx noise reduction



PMD 221 Save \$70 SALE \$259.95

- Monaural Location Recording
- 3-Head off-the-tape monitoring while recording
- 4-Way Power
- Direct Telephone Connective Jack
- 2-Speed (1-7/8 & 15/16 IPS) allows up to 2 hour unattended recording (on C-120 tapes)
- Built-in Speaker with Volume Control
- 3-Position mic attenuator
- Line IN/OUT

**PMD 201 Save \$70
SALE \$209.95**

Many features of the PMD 221 such as illuminated VU meter but without off-the-tape monitoring

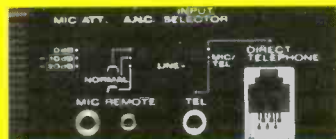

Direct telephone connective jack on PMD201/PMD221



PMD 420/430

Specifications

PORTABLE CASSETTE	PMD221	PMD430
Frequency Response (% ips)		
Normal tape	40Hz—12.5kHz (40Hz—6.5kHz)	35Hz—14kHz
CrO ₂ tape	40Hz—14kHz (40Hz—7.5kHz)	35Hz—15kHz
Metal tape	40Hz—15kHz (40Hz—8.5kHz)	35Hz—17kHz
Signal to Noise Ratio, NR off	57dB	51dB
Dolby B NR on	—	60dB
dbx NR on	—	75dB



ELECTRONIC EQUIPMENT BANK
516 Mill Street, N.E. Vienna, VA 22180

Order Toll Free: 800-368-3270

Technical and VA Orders (703) 938-3350

HUGE

70 PAGE

SHORTWAVE CATALOG

SEE WHAT'S NEW IN . . .

- COMMUNICATIONS RECEIVERS
- PORTABLE SHORTWAVE RADIOS
- ANTENNAS & SUPPLIES
- RADIOTELETYPE EQUIPMENT
- FACSIMILE (FAX) EQUIPMENT
- COMMUNICATIONS BOOKS
- PARTS & ACCESSORIES

**SEND \$1.00 (OR 3 IRCs)
REFUNDABLE**



UNIVERSAL SHORTWAVE RADIO
1280 Aida Drive
Reynoldsburg, Ohio 43068
Phone 614-866-4267

CIRCLE 72 ON READER SERVICE CARD

UTILI-CASTING?



While some mergers result in funny names, the recent merger of **Monitoring Times** and **International Radio** (formerly the **Shortwave Guide**) has resulted in an excellent new 60-page magazine covering full-spectrum utilities communications as well as worldwide shortwave broadcasting activities. To keep it simple, we've retained the name of one of the two partner companies—**Monitoring Times**. It's all new, bigger, more colorful and more informative. Clearly, it's the most comprehensive publication for the radio listener available today!



Send for a free "sample digest" or subscribe by contacting:

MONITORING TIMES

P.O. Box 98

Brasstown, N.C. 28902

704-837-9200

Rates: 1 Yr. \$14; 2 Yrs. \$25; 3 Yrs. \$36

CIRCLE 37 ON READER SERVICE CARD

Firefighter Rescues Three-Year-Old From Drainage Cistern

A three-year-old boy had fallen into a drainage cistern and lay under five feet of water. There was no way to tell where the child was, but that didn't stop Dayton firefighter Cary Haun from going down into the two-foot-wide hole to attempt a rescue.

SCAN PUBLIC SERVICE AWARD

According to an account of the rescue in the *Dayton Daily News* witnesses had seen the child, Troy Lowe, playing with three other children near the uncovered opening of the cistern when he was accidentally pushed into the opening.

A metal grate that should have covered the cistern had been loose since the parking area where the incident took place was re-paved a year earlier. The grate had been fastened down but children had dug holes in the pavement and freed the grate. Neighbors had reportedly complained about the open hole to city agencies but nothing had been done.

The child had been underwater for 12 to 15 minutes when the first fire crews arrived.



Firefighter Cary L. Haun of Dayton, Ohio is this month's Public Service Award winner.

Haun's crew was the first to arrive, and Haun was lowered feet-first into the narrow hole without boots and secured by a rope.

"They just said there was a kid down there and I thought I'd see if I could find him," Haun told the *Dayton Daily News*.

"I was trying to feel for the bottom of it," Haun said. "I swept around with my legs. I almost said I didn't feel anything down there." Haun said that he was prepared to

go into the cistern's murky water headfirst to search for the child, but then his foot touched the three-year-old.

Haun said that it felt like there might have been a drain near the bottom of the cistern that was holding the boy down. Haun was able to hook the child with his legs, pull him up to the opening and hand him up out of the cistern to other firefighters.

Cardiopulmonary resuscitation was started by firefighters Vern Holman and Les Young, then the child was taken to Good Samaritan Hospital and then transferred to Children's Medical Center.

After the rescue, Haun downplayed his own actions. "If it wasn't me, it would have been somebody else," he said. "There are a lot of caring guys on this department."

For his efforts, firefighter Haun will receive the SCAN Public Service Award, which includes a special commendation plaque and a \$100 cash prize. Greg Kojola, who made the nomination, will also receive a commendation plaque.

Congratulations to both of you!

Send all SCAN Public Service Award nominations to SCAN Public Service Award, P.O. Box 414, Western Springs, IL 60558. Please send a letter along with background information, such as a newspaper clipping.



Best Equipped

Our winner in this category this month can also be classified as a "plugged-in" scanner listener. Plugged into a computer, that is. In fact, Martin Jim Mayfield lists his Radio Shack TRS-80 model 4 first on his roster of equipment.

This Clayton, New Mexico monitor also uses a Regency MX3000 scanner tied to a two-element folded dipole antenna 45 feet above the ground. A Drake R4A receiver is used for HF listening, and a TX4 transmitter will soon join the R4A. A Regency HX1000



SCAN PHOTO CONTEST WINNERS

and a Bearcat Weather Warning Radio are included in this set-up.

Complementing the scanners and receivers are two power supplies, a homemade digital clock and a wind direction indicator that Martin rigged up himself. A mobile installation boasts a Wilson mobile phone, also set up by Martin, and a KDK FM-240 two-meter transceiver.

Best Appearing

Most scanner listeners have wondered what a big city newspaper uses to gather those big city stories. Here is the scanner set-up used by the Los Angeles Times San Fernando Valley Edition Photo Department, submitted by staff photographer Joe Vitti.

In this Chatsworth, California office (actually within the city limits of Los Angeles) the Times uses a Bearcat 210 scanner, Bearcat 4-6 and Robyn Hi-Low crystal scanners. The staff photo cars are equipped with a variety of Regency and Bearcat scanners, and a GE two-way radio. Staff cars for reporters are equipped with mobile phones.



The repeater system covers everything from Santa Barbara to San Diego with eight repeaters. From the San Fernando Valley to San Diego there are 52 staff photographers and many freelance and part-time photographers that use the system.

The Valley Edition of the Times covers everything from Burbank on the east to Camarillo on the west and from the Santa Monica Mountains on the south up through the San Fernando Valley, Simi Valley and the Canyon Country area of the Santa Clara Valley.

This office monitors Los Angeles City, Los Angeles County and Ventura County law enforcement and fire activities. If all the television programs we've seen over the years are any indication, the Times has a lot to monitor!





ARTCC Remote Roundup

***The One And Only, Original, First Time Ever,
Master Compilation Of FAA Air Route Traffic
Control Center Frequencies And Remote Sites!***

BY RICK MASLAU, KNY2GL

Airliners are required to fly within certain clearly defined air corridors that call for specific headings and altitudes. Communications relating to the use of such *vectors* (as they are called) take place between the captain (or pilot) of the airliner and various FAA traffic controllers located at ground facilities.

The FAA ground facilities are called Air Route Traffic Control Centers (ARTCC's) and are located in all areas of the nation. The Canadian government also operates similar facilities across that nation. These "centers" (as they are known) not only advise airliners regarding the proper vectors to traverse, they also keep track (by means of

radar) of the various aircraft as they progress along air corridors.

Each center is responsible for aircraft movement within a certain region of the nation, that region usually encompassing an area covering several states. Within each region, sectors have been established with individual controllers in charge of each. Therefore, an airliner passing through the zone covered by a center will undoubtedly pass through several different sectors. Moreover, the aircraft may well leave the region covered by one center and then enter the territory of another center. On a cross-country flight, an airliner will therefore cross a my-

riad of these established boundaries. This procedure requires an enormous amount of communication between the aircraft and the sector controllers at the various centers and is required for safety purposes. With the large number of commercial aircraft in the air day and night, and under almost all weather conditions, without such a carefully structured reporting/advisory system, pandemonium would reign.

These centers contact airliners on frequencies within the VHF aero band (118 to 136 MHz). Actually, in addition to airliners, the centers communicate with all aircraft flying under instrument flight rules (IFR) and

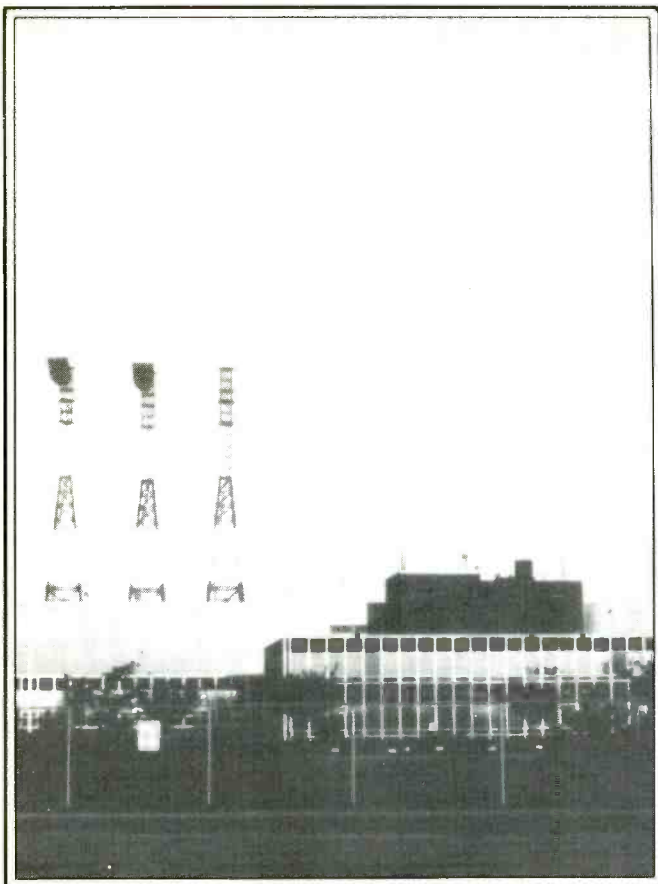

Here's what the control center for a major ARTCC Center looks like.

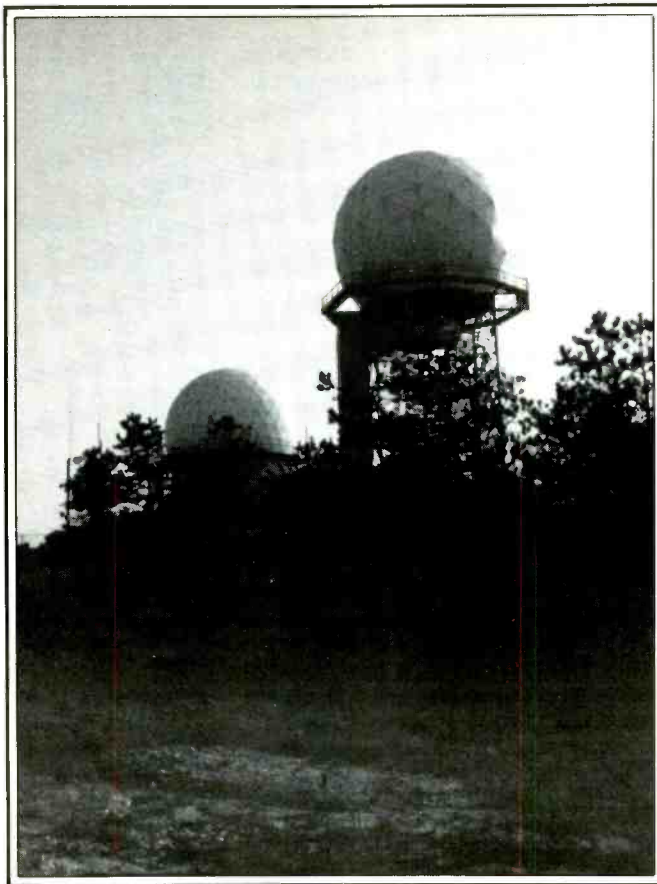

An FAA ARTCC radar installation.

that includes some non-airline craft such as larger corporate planes. Military aircraft also communicate with ARTCC centers, however, they use frequencies in the UHF aero band (225 to 400 MHz).

Like A Spider Web

When an aircraft prepares to leave one control sector and enter another, the ground controller hands off the craft to the controller of that new sector, advising the pilot of the frequency used for that sector. The same thing happens when an aircraft is to pass from the jurisdiction of one ARTCC to the control of an adjacent center.

With jet-powered commercial aircraft moving at many hundreds of miles per hour, it's usually necessary for air/ground communications to become established while the craft is at a considerable distance from the ARTCC's control point and far past the practical communications range that might be expected (even though airliners flying above 25,000 feet can normally communicate over more than a 200-mile range). An airliner moving at 750 miles per hour will move closer to (or away from) a ground station more than 6 miles during a 30-second exchange of communications. At normal urban speed limits, it would take a car about 15 minutes to travel the same distance!

ARTCC's tackle this problem by establishing a web of remote-controlled transmitters and receiving sites at considerable distances from their operating sites. Therefore, the station identifying as "Albuquerque Center" is located in Albuquerque, New

Mexico, but (depending upon the sector involved) it can receive and transmit via remote facilities located in many other locations in New Mexico, Texas and Arizona. The "Atlanta Center" (in Georgia) has remote sites throughout Georgia, and also in Alabama, North Carolina, South Carolina, Kentucky and Tennessee.

Under such circumstances, no listener on the ground could ever hope to monitor all active channels of a particular ARTCC center (unless they drove around a lot). On the other hand, it's not uncommon for scanner owners on the ground at one location to copy communications from more than one ARTCC center's remote sites—especially since those sites are often located atop mountains (where terrain permits, of course).

The Nature Of The Beast

One of the problems many scanner owners complain about when they seek to monitor ARTCC centers in earnest is that publications listing these stations usually have several deficiencies, and that includes official FAA listings. Oddly enough, some remote sites are left out, as are some frequencies. Official FAA lists often have misspelled locations and even inaccurate frequency information. Also, and perhaps most vexing of all, the remote sites are usually listed without any information given as to which states they are in. Given, for instance, the remote site "Bedford," and the fact that there are a dozen places with that name, the whole situation becomes far more complex than many scanner owners have felt is worth the trouble.

What we have done here, and we believe that it's a first, is assemble as much information as possible on American and Canadian ARTCC VHF facilities. We have listed the states (with but a few exceptions), added many seemingly "unlisted" frequencies, corrected frequencies that have been previously listed incorrectly, repaired the spelling of remote sites, etc., etc. The end result (we hope) is a relatively coherent and complete view of the beast in all of its glory. As you can see, there are hundreds of frequencies and remote sites in use. In some instances, a single remote site may be used by more than one ARTCC facility.

The headings indicate the de facto location of the ARTCC facility, although the exact location may not be within the borders of the major city shown. For instance, the Air Traffic Controllers working at the New York ARTCC are actually located about 45 miles east of The Big Apple. Beneath each heading are the remote sites, although the only identification you'll ever hear announced would be the name of the ARTCC facility—"Chicago Center," "Miami Center," "Denver Center," and so on. None of these stations have formal call letters assigned and the name of the ARTCC ground facility is their only authorized identification. Aircraft communicating with these stations operate on the frequency of the ground station with which they are communicating.

Things To Do

If you're a scanner owner, you can do several things when armed with our list. Ob-

viously, you can use it to listen to both sides of the contacts between aircraft communicating with a remote site that happens to be in your own community.

Use our roster as a checklist to see how many remote sites you can monitor from your nearest ARTCC "Center," or how many remote sites you can receive from various other "Centers." What is the most distant "Center" and/or remote site you can copy? You'd be surprised at how far away some of these stations can be copied by ground-based scanners. It's a good test of your station's receiving coverage, especially if you are comparing one scanner or antenna against another.

Don't forget that you'll be able to copy in-flight aircraft located at far greater distances from you than you'll be able to copy ground stations.

Naturally, if you expect to hear anything much outside of your immediate area you'll need an outside antenna mounted as high and in the clear (of obstructions) as possible.

It's possible that you haven't yet gotten into monitoring these ARTCC facilities because you didn't know about them, or because you didn't have the amount of data you felt was necessary. With 16,000 airline flights zipping across our skies every day, you've got plenty to listen for!

Air Route Traffic Control Centers
Showing remote transmitter sites

Albuquerque NM

Alamogordo NM	132.65
Amarillo TX	127.85 134.75 135.425
Animas NM	127.95 133.0
Carlsbad NM	132.55
Childs Peak AZ	125.25 126.45 132.45 135.15
Clines Corners NM	132.8 133.65
El Paso TX	126.0 132.55 133.275 134.45
Ft. Stockton TX	132.55 134.45
Globe AZ	124.5 125.4 132.35 133.85 135.15 135.725
Mesa Rica NM	135.05
Mt. Dora NM	127.85 133.05
Nambe NM	134.5
Prescott AZ	128.45 132.9 135.325 135.725
Raton NM	134.5
Roswell NM	132.65 133.8
Sandia Mountain NM	132.8
Seligman AZ	128.45 135.325
Truth/Consequenses NM	126.4
Tucson AZ	127.95 133.0
Tucumcari NM	125.6 133.55 135.7
Winslow AZ	128.45 126.9 132.9
Zuni NM	125.2 134.6 135.8

Anchorage AK

Anchorage AK	119.7 120.2 125.7
Annette Island AK	118.5
Barrow AK	135.4
Barter Island AK	120.6
Bethel AK	125.2
Bethel AK	125.2
Bettles AK	124.6
Big Delta AK	135.3
Big Lake AK	118.2
Biorka Island AK	126.6
Boswell Bay AK	119.3
Cape Newenham AK	127.6
Cold Bay AK	118.5
Deadhorse AK	134.4
Ft. Yukon AK	132.7 135.0
Galbraith AK	134.6
Galena AK	127.0
Gulkana AK	119.5 127.9

Gustavus AK	133.2
Homer AK	120.2 125.9
Honolulu Creek AK	120.1
Iliamna AK	120.0
Kenai AK	119.7 125.7 133.8
King Salmon AK	124.8
Kodiak AK	125.1
Kotzebue AK	119.2
Lena Point (Juneau) AK	133.9
Level Island AK	118.0
McGrath AK	125.4 128.1
Middleton Island AK	133.6
Murphy Dome AK	120.9 133.1
Nome AK	133.3
Northway AK	127.1
Point Lay AK	118.9
Port Heiden AK	132.9
St. Marys AK	124.0
St. Paul Island AK	127.8
Shemya AK	128.2
Sparrevohn AK	134.3
Talkeetna AK	133.7
Unimat AK	119.4
Yakutat AK	119.0

Atlanta GA

Albemarle NC	133.15
Aniston AL	134.95
Athens GA	124.45 127.5
Atlanta GA	125.9 128.0 135.0
Augusta GA	128.1
Birmingham AL	133.5 135.6
Black Jack Mountain	127.05
Charleston SC	128.4
Chattanooga TN	121.2 124.875 132.05 133.6 134.8
Columbus GA	120.45 133.175 134.7
Crossville GA	125.925 128.65 132.675 135.15
Dublin GA	123.95
Gadsden AL	133.8
Greensboro NC	128.8 132.75
Hampton GA	125.9 128.0 132.175 133.35 135.75
Hickory NC	125.15 132.975 134.55
Huntsville AL	133.975
Jonesville SC	128.75 132.625 135.35
Livingston TN	124.75
London KY	125.25 127.3
Macon GA	123.95 133.1 135.1
Millen GA	135.55
Monroeville AL	118.55
Montgomery AL	120.55 126.4 132.85 135.05
Mount Airy GA	126.775 127.85
Mount Oglethorpe GA	118.9 121.35
Newport TN	127.55 132.8
Owings SC	127.15 128.2 132.425 133.7 135.35
Pine Level AL	132.875 134.6
Shelbyville TN	126.75
Tri City TN	120.275 125.25 132.9 133.2 135.025
Uniontown AL	132.25
Vienna GA	132.775
Whitesburg GA	133.45

Boston MA

Augusta ME	134.95
Barnstable MA	128.75 132.9 233.45 134.175 135.475
Berlin NH	135.7
Bucksharbor ME	133.25
Calverton NY	133.3
Cambridge MA	133.85
Concord NH	134.3
Cummington MA	132.65
East Burke VT	127.75 135.7
Gardner MA	123.75
Houlton ME	120.25 128.05
Kingston NY	133.1
Lake George NY	126.35 127.8 133.625 134.85
Lebanon NH	134.85
Melrose MA	119.25 120.35 127.65 134.75
Millinocket ME	128.05
Mt. Mansfield VT	127.8 135.7
Pawling NY	132.65
Rockdale	134.55
St. Albans ME	120.25 124.25 128.05

Shelton CT	120.2 128.1 132.3 134.0 135.55
South Acton MA	118.55 128.2 134.85
Turin NY	125.45 127.8 132.75 135.25
Utica NY	127.9
Woodstock NY	121.35 123.95 124.85 133.85 134.7

Chicago IL

Aurora IL	123.75
Bloomington IL	118.05
Bradford IL	124.55 127.95 133.825 133.95
Burlington IA	135.6
Cedar Rapids IA	132.8
Chicago IL	125.2 127.8
Chicago Hts. IL	132.95
Danville IL	127.45
Dells WI	125.6 133.6
Des Moines IA	127.05
Des Plaines IL	120.35 128.65 133.2
Downers Grove IL	127.6 133.5 135.75
Dubuque IA	127.0 132.725 133.825 133.95 135.275
Ft. Wayne IN	119.85 128.2 132.15
Gary IN	125.2 127.8 133.7
Goshen IN	127.55 133.9 135.9
Grand Rapids MI	134.95 135.65
Hampshire IL	127.1 128.05 134.2 135.75

Cleveland OH

Algonac MI	132.25 134.3
Belmont OH	120.4 132.45 135.175
Blue Knob PA	121.2 124.4 128.45 132.075
Bradford PA	128.65
Carleton MI	119.95 134.775
Chardon OH	127.5
Detroit MI	128.35
Dunkirk NY	125.2
Findlay OH	127.9 133.8
Ft. Wayne IN	132.15
Grand Rapids MI	135.65
Holland MI	133.95 135.775
Jackson MI	127.3
Jones MI	133.425
Litchfield MI	120.45 134.65 135.725
Mansfield OH	134.9 133.375
Moon Township PA	126.95 133.075
Morgantown WV	125.1
Mt. Hope OH	120.6
Paris OH	128.15
Saginaw MI	127.7 133.525 133.875
Sandusky OH	125.6 133.525 135.1
Warren OH	121.4 132.925 134.125 135.6
Waterford OH	132.4
Waterville OH	123.9
Wayland NY	125.55 128.25 133.75

Denver CO

Akron CO	125.95 127.5
Alamosa CO	126.1
Aspen CO	128.5 133.525
Casper WY	134.65 135.6
Cheyenne WY	124.8 127.55 133.0 134.2 135.025
Colby KS	127.65 133.85
Crawford NE	127.2 135.025
Denver CO	124.1 124.8 125.95 126.5 128.2 128.65 132.85 133.75
Eastonville CO	125.8
Farmington NM	126.1 132.1 135.475
Goodland KS	132.5
Grand Island NE	132.7
Grand Mesa CO	127.8 128.5 132.125 132.85 135.65
Gunnison CO	127.8 133.525
Hanksville UT	135.375
Hayden CO	128.5 135.2
Hayes Center NE	135.5
La Junta CO	126.6 128.7 132.225
Lusk WY	135.6
Medicine Bow WY	126.5 133.0 134.2
Natoma KS	132.5
Ogallala NE	132.7 134.4
O'Neill NE	132.7 135.025

Pueblo CO 124.1 126.6 133.85
 Rapid City SD 127.2 134.65
 Rock Springs WY 128.5 133.0
 Sundance WY 135.6
 Tuba City AZ 134.325
 Winslow AZ 126.1 132.1 134.325

Fort Worth TX

Abilene KS 127.45 132.35 134.25
 Ardmore OK 128.1 132.95
 Big Spring TX 133.7
 Blue Ridge TX 127.6
 Brownwood TX 127.45
 Clinton-Sherman OK 128.4 132.45
 Dublin TX 127.15 132.2 134.25
 134.725
 El Dorado AR 128.2
 Farmerville LA 135.1
 Fort Worth TX 134.15 134.4
 Frankston TX 135.25
 Hobbs NM 133.1
 Keller TX 124.7 126.0 127.0
 Lubbock TX 127.7 133.35
 Marshall TX 128.7
 McAlester OK 127.3 135.45
 Midland TX 128.75 133.1 133.95
 Oklahoma City OK 132.45 133.9
 Paducah KY 126.45 127.9
 Paris TX 124.8
 Plainview TX 126.45
 San Angelo TX 126.15 135.0
 Scurry TX 127.95 133.5 135.75
 Texarkana AR 124.8 132.425 135.35
 Waco TX 133.3
 Wichita Falls TX 127.9 132.75 133.25
 134.55 135.6

Honolulu HI

Haleakal HI 119.3 124.1 126.0 127.6
 Honohina HI 126.6
 Honolulu HI 126.5
 Kokeekau HI 119.9
 Mt. Kaala HI 119.9 126.5

Houston TX

Alexandria LA 128.55 132.7
 Austin TX 127.35 132.725
 Beaumont TX 133.8
 Brownsville TX 134.7
 Cameron County TX 132.65
 College Station TX 120.4 125.15 126.75
 Fredericksburg TX 134.2 135.925
 Galveston TX 132.225 133.4 133.8
 Grand Isle LA 128.1 133.85
 Hattiesburg MS 126.8 135.2
 Houma LA 132.65
 Houston TX 124.2 125.0 127.0 127.8
 128.75 133.75 133.85
 134.35 134.7
 Intracoastal City LA 120.35
 Kingsville TX 128.3 133.75
 Lacombe LA 124.1 126.0
 Lafayette LA 127.9 128.4 133.65
 Lake Charles LA 126.4 132.95
 Laredo TX 127.8 128.6 132.5
 Lometa TX 128.2
 Lufkin TX 126.95 134.8
 Mobile AL 120.7 126.6 132.6
 Natchez MS 125.75
 New Orleans LA 127.0 127.9
 Newton 128.55 133.025
 Palacios TX 127.05 128.0
 Rockport TX 127.2 128.15 132.25
 135.05
 Rock Springs TX 127.75 132.4
 San Antonio TX 120.6 125.25 132.15 132.8
 134.6 134.95 135.65
 Sealy TX 127.05
 Uvalde TX 128.4 134.95
 Vermillion (Gulf of Mex.) 120.35

Indianapolis IN

Brookville OH 119.45 132.7 134.7 135.8
 Evansville IN 128.3 132.525
 Henryville IN 128.55 133.05 134.275
 Indianapolis IN 119.95 124.4 132.775
 135.25
 London OH 124.8 133.575 134.0
 Marietta OH 125.55
 Marmet WV 127.4 132.325 134.225

Merwyn OH 132.6 135.575
 New Hope KY 125.65
 Portsmouth OH 127.1 135.7
 Rossville IN 128.8 134.6
 Terre Haute IN 132.2 134.175
 Winchester KY 127.0 132.475 133.925
 Zanesville OH 124.45 126.35 132.825
 133.725

Jacksonville FL

Albany GA 127.2
 Alma GA 132.3 133.3 135.975
 Brooksville FL 127.3 128.05
 Brunswick GA 126.75 135.45
 Charleston SC 127.95 132.65 133.625
 134.25
 Columbia SC 124.7 135.675
 Crestview FL 120.2 134.15 135.4
 Daytona Beach FL 134.0
 Dothan AL 134.3
 Eustis FL 127.55
 Florence AL 133.4 134.35
 Gainesville FL 127.6 134.4 135.65
 Jacksonville FL 127.45 134.85 135.05
 135.25 135.4
 Millen GA 132.5
 Myrtle Beach SC 128.7 135.05
 Ocala FL 118.6
 Orlando FL 127.55
 Panama City FL 127.45
 Pensacola FL 127.8 132.15
 Raleigh NC 135.2
 Rocky Mount NC 133.25
 St. Augustine FL 120.6 125.45 126.35
 128.35
 Savannah GA 120.85 134.45
 Tallahassee FL 125.05 132.725
 Tampa FL 127.3 128.05
 Valdosta GA 125.95

Kansas City MO

Anthony KS 118.35 133.2
 Butler MO 125.55
 Chillicothe OH 125.25
 Columbia MO 118.4 133.475 134.5
 Decatur IL 124.3 132.1
 Edna KS 128.6
 Effingham IL 133.225 135.05
 Emporia KS 120.2 125.3 132.25
 Farmington MO 128.4 132.65
 Gage OK 126.95
 Garden City KS 125.2 133.45
 Hutchinson KS 118.8 134.3 135.9
 Kansas City MO 135.3
 Kirksville MO 132.6 135.0
 Liberal KS 134.0
 Manhattan KS 127.35
 Marion IL 125.3
 Mt. Vernon IL 127.7
 Natoma KS 124.4
 Oklahoma City OK 128.3
 Olathe KS 135.3
 Ponca City OK 127.8
 Quincy IL 133.15 133.725
 Richland MO 124.1 133.8
 St. Charles MO 121.25 125.9 133.4
 St. Joseph MO 127.9
 St. Louis MO 125.5 128.1
 Salina KS 134.9
 Sedalia MO 119.65
 Springfield MO 127.5 132.9 135.175
 Topeka KS 120.5 123.8 134.7
 Tulsa OK 128.8 135.55
 Vandalia IL 135.325

Los Angeles CA

Bakersfield CA 127.1 133.05 135.3
 Baldwin Hills CA 125.65 128.2 132.85
 Barstow CA 132.3 132.5 133.55
 135.575
 Blythe CA 121.35 135.45
 Boron CA 132.625
 Cedar City UT 124.2 127.35 135.25
 135.55
 Julian CA 125.85 127.4 128.15
 128.6 135.45 135.75
 Keeler CA 127.9 132.625
 Los Angeles CA 119.0 126.0 126.4 127.4
 128.05 132.15 132.5
 133.4 134.4 134.55
 135.45

Mt. Potosi NV 127.9 132.625
 Nelson NV 124.2 124.85 134.65
 Ontario CA 125.85
 Riverside CA 126.35
 Saddle Peak CA 127.4 132.6 134.75
 San Luis Obispo CA 124.15 128.05
 Santa Barbara CA 128.05 132.15 135.5
 Seligman AZ 124.85 133.2 134.95
 Tonopah NV 127.9
 Twentynine Palms CA 128.15 133.2
 Yuma AZ 121.35

Memphis TN

Brinkley AR 126.85
 Columbus MS 124.25 127.1 135.3
 Fayetteville AR 126.1 132.55
 Ft. Smith AR 119.25
 Graham TN 124.275 125.85 132.35
 Greenville MS 123.75 132.5 135.7
 Greenwood 132.5
 Harrison 126.85
 Hot Springs AR 118.85
 Huntsville AL 120.8
 Jackson MS 126.45 132.1 134.65
 Malden MO 135.5
 Memphis TN 119.3 120.85 124.35
 134.25 135.225
 Meridian MS 124.4 127.3 134.9
 Nashville TN 124.125 133.85 135.375
 135.775
 Paducah KY 133.65
 Pine Bluff AR 133.55 135.8
 Russellville AR 132.3 135.625
 South Fulton TN 128.05
 Tupelo MS 128.5 134.4 135.9
 Walnut Ridge AR 127.4 133.0

Miami FL

Avon Park FL 132.8 135.3
 Ft. Myers FL 128.25 134.95
 Grand Bahama Isl., Bah. 126.9 134.2
 Grand Turk Isl., Bah. 132.3
 Key West FL 132.2 132.7
 Melbourne FL 124.1 128.65 132.15
 133.65
 Miami FL 120.0 120.8 124.7 125.6
 125.7 126.4 127.0
 127.2 127.7 128.25
 128.5 128.75 132.15
 132.3 132.4 132.7
 133.2 133.8 134.35
 134.4 134.8 134.95
 135.5
 Nassau, Bahamas 125.7 134.8
 Orlando FL 132.05 133.5
 Pahokee FL 132.45 133.55
 Sarasota FL 132.35 133.9
 Tampa FL 134.35
 Vero Beach FL 127.85 132.25 135.7
 W. Palm Beach FL 127.2 133.4 135.875
 Windermere FL 132.05 133.5

Minneapolis MN

Aberdeen SD 120.6
 Alexandria MN 126.1 133.4
 Bemidji MN 134.75
 Brainerd MN 118.05
 Clark SD 133.8 135.8
 Crystal MN 120.3 134.45 135.7
 Dawin MN 125.5
 Des Moines IA 125.65 132.4 135.775
 Dickinson ND 126.8 133.55
 Duluth MN 127.9 134.55 134.675
 Eau Claire WI 125.3 133.75
 Escanaba MI 127.65
 Fairmont MN 127.75
 Fargo ND 127.35
 Farmington MN 134.85
 Ft. Dodge IA 134.0
 Grand Forks ND 127.8 132.15
 Grantsburg WI 126.45
 Green Bay WI 125.55
 Hastings NE 119.4 135.1
 Houghton MI 127.2
 International Falls MN 120.9
 Iron Mountain MI 121.25 133.45
 Ironwood MI 133.45 133.55
 Jamestown ND 124.2 125.6
 La Crosse WI 118.85 128.6
 Mankato MN 132.45

Marysville KS	126.4 134.225
Mason City IA	127.3 134.25
Minneapolis MN	120.3 125.5 134.45
Minot ND	118.9 127.6
Mosinee WI	124.4
Omaha NE	119.6 128.75 134.35
O'Neill NE	128.0
Pellston MI	133.85 134.6
Pierre SD	125.1 134.8
Redwood Falls MN	127.1 133.075
Rhineland WI	133.65
Saginaw MI	118.05
Sioux City IA	124.1 133.375 135.875
Sioux Falls SD	132.1 135.45
Traverse City MI	132.9
White Cloud MN	120.85 132.55

New York NY

Barnegat NJ	132.15
Barnstable MA	135.8
Big Flat PA	128.2 132.95 135.45
Cedar Lake	135.625
Douglaston NY	119.8 133.2 134.65
	135.8
Elk Mountain PA	118.45 128.5 132.2
	135.8
Flint Hill PA	125.4 127.45 132.95
	134.8
Huguenot NY	120.2
Joliet PA	118.45 132.5
Matawan NJ	120.95 133.05
Millville NJ	127.7 128.9 132.05
	133.8 135.275
North Mountain PA	126.85 132.6 133.5
	134.6
Phillipsburg NJ	132.125 133.15
Sayre NJ	132.1 133.35
Sayville NY	125.75 134.45
Ship Bottom NJ	125.6 128.3 133.475
	134.2
Wildwood NJ	133.7

Oakland CA

Angels Camp CA	120.2 124.2 126.85
	127.95 134.375
Fallon NV	128.8 134.45
Ferndale CA	134.15
Fresno CA	123.8 126.9 132.8
	133.7 134.375
Half Moon Bay CA	120.2 125.45 127.45
	132.65 134.15
Hollister CA	127.45
Mina NV	127.3 132.05
Mt. Tamalpais CA	127.8
Priest CA	126.9 128.7 132.8
	133.7 134.55
Red Bluff CA	120.4 132.2 132.95
	134.975
Reno NV	128.8 134.45
Sacramento CA	120.2 127.95 132.95
Tonopah NV	127.3 132.05
Ukiah CA	127.8 132.2

San Juan PR

El Yunque PR	119.9 125.0 128.6
	133.4 134.3
Mayaguez PR	135.7

Pico del Este PR	119.9 125.0 128.6
	133.4 134.3
San Juan PR	125.3

Salt Lake City UT

Ashton ID	132.4 134.5
Baker MT	126.35
Battle Mountain NV	126.1 132.25 134.825
Big Piney WY	134.5
Billings MT	135.25
Blackfoot ID	134.5
Bliss ID	118.05 128.55
Bozeman MT	132.4
Burley ID	118.05
Butte MT	132.4 133.4
Cascade ID	132.5
Cedar City UT	133.6
Delle UT	128.55 132.55
Delta UT	128.55 132.55 134.8
Elko NV	126.1 132.25
Emmett ID	124.5 132.5
Francis Peak UT	128.3 132.55 134.8
Glasgow MT	128.8
Great Falls MT	133.4
Hanksville UT	128.8 133.6
Jackson WY	133.25
Judith Mountain MT	128.1
Lakeside UT	132.55 133.4
Lovell WY	132.4 133.25 135.25
Malad City UT	128.3
Miles City MT	128.8
Missoula MT	133.4
Myton UT	128.3
Rock Springs WY	119.25 125.85 134.8
Rome	126.35
Salmon RCAG Site ID	132.4
Salt Lake City UT	132.55
Sheridan WY	135.25
Squaw Butte	126.35
Sunnyside UT	118.65 132.55 134.8
Thermopolis WY	119.25 133.25
Tonopah NV	133.45
Watford City ND	128.8
Wilson Creek NV	118.65 128.55 133.45
Winnemucca NV	126.1

Seattle WA

Auburn WA	120.3 125.1 125.6
	128.5
Beacon Hill	120.3
Cottonwood ID	124.1 134.75
Everett WA	125.1
Ferndale WA	124.85 135.15
Fort Lawton WA	125.6 128.5
Hoquiam WA	125.1 125.6
Horton OR	121.4 125.8 134.65
Kent WA	128.5
Klamath Falls OR	124.85 127.6
Lakeview OR	127.6 134.9
Marlin WA	126.1
Micah Peak WA	126.1
Medford OR	121.4 124.85 125.3
	135.15
Neah Bay WI	125.1
Pendleton WA	125.1
Redmond OR	119.65 127.6 132.35
	133.9
Scappoose OR	120.9 124.2 132.35

Seattle WA	120.3 126.6
Spokane WA	124.1 126.1 134.75
The Dalles OR	119.65
Walla Walla WA	126.1
Wenatchee WA	120.3 126.1
Whidby Island WA	125.1
Yakima WA	120.3 126.1 132.6
	134.75

Washington DC

Bucks Elbow VA	124.25 127.75 132.275
	134.625
Buena Vista VA	125.75 133.025 134.4
Clinton MD	132.025 135.0 135.525
Cumberland MD	132.95 134.15
Dunn Loring VA	120.35 123.9 133.9
Elkins MD	134.15
Falls Church VA	118.6 128.6 133.65
Flint Hill VA	132.875
Green Bay VA	124.05 125.45 133.725
	135.4
Hagerstown MD	134.5
Millville NJ	128.7 132.05 133.125
New Bern NC	127.1
Norfolk VA	128.15
Patuxent River MD	132.55
Raleigh NC	132.4 135.2
Rocky Mount NC	135.3
Sampson NC	133.85
Ship Bottom NJ	134.2
Somerville NJ	132.275 134.3
South Boston VA	125.85
Washington DC	120.3 123.85 127.1
	132.55 135.2 135.3
	135.4 135.5
Westminster MD	118.75
Whaleysville MD	123.85 132.225 134.025
	135.075
Wilmington DE	135.5

Canadian Centers

Moncton, N.B.

Fredericton NB	124.3
Moncton NB	132.2 132.5 132.7
	135.65
St. John NB	124.3
Yarmouth NS	123.9 135.2

Montreal, P.Q.

La Tuque, PQ	134.5
Mont-Joli PQ	134.65
Mont-Laurier PQ	132.85
Montreal PQ	132.35 133.225 134.4
Quebec PQ	135.025
Schefferville PQ	132.9
Sept-Iles PQ	135.55
Sherbrooke PQ	132.55
Val D'Or	125.9
Wabush PQ	132.25

Toronto, Ont.

Elliott Lake ONT	135.4
Hamilton ONT	133.3
Kitchener ONT	135.625
London ONT	135.3
North Bay ONT	132.375
Peterborough ONT	134.25
Sarnia ONT	134.375
Sault Ste Marie ONT	134.425
Stirling ONT	135.05
Timmins ONT	133.975
Toronto ONT	127.0 132.175 132.425
	132.475 134.575 134.925
	135.625
Wawa ONT	133.15
Warton ONT	132.575

Vancouver BC

Castlegar BC	134.2
Cranbrook BC	133.6
Princeton BC	135.0
Tofino BC	132.9
Vancouver BC	132.3 133.7 134.8
Victoria BC	133.85

Winnipeg MAN

Brandon MAN	123.7
Kenora ONT	124.0
Regina SASK	123.8 124.3
Swift Current SASK	132.8
Thunder Bay ONT	133.25
Winnipeg MAN	118.0 119.7 120.5
	134.4



The DX EDGE: The Hottest DX Aid Since Sunspots

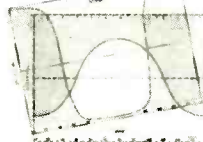
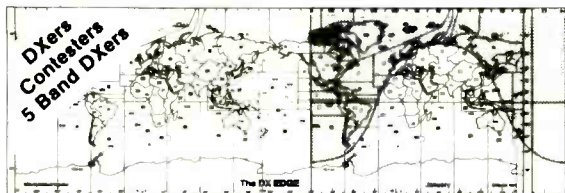

Improve Your DX Achievements on All Bands

See times of sunrise and sunset propagation peaks instantly for any QTH in the world. Know when to look for the DX you need. Long path and Gray Line possibilities seen at a glance. Slide to show Great Circle Bearings. \$3 with order. Specify your latitude. Plastic slide rule format—Easy to use—Large size

Price: \$19.95 in U.S., Canada, Mexico. \$23.95 elsewhere, by air. Please make check or M.O. in U.S. funds payable to the DX Edge and mail to:

The DX EDGE
P.O. Box 834, Madison Square Stn.
New York, N.Y. 10159

Computerized version for Commodore 64 and 128 \$34.95.

A product of Xantek, Inc. ©Xantek, Inc. 1986
Commodore 64 and Commodore 128 are trademarks of Commodore Electronics Ltd.

An information flyer is available free of charge.

Regency "Scanner Answer" Giveaway

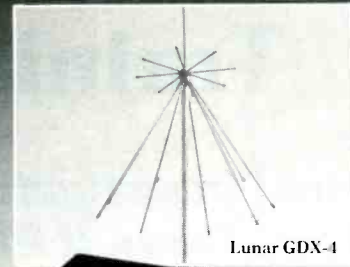

Here's your chance to win a complete monitoring package from Regency Electronics and Lunar Antennas. 18 scanners in all will be awarded, including a grand prize of the set-up you see above: the Regency HX1500 handheld, the Z60 base station scanner, the R806 mobile unit, and a Lunar GDX-4 Broadband monitoring/reference antenna.

55 Channels to go!

When you're on the go, and you need to stay tuned into the action, take along the Regency HX1500. It's got 55 channels, 4 independent scan banks, a top mounted auxiliary scan control, liquid crystal display, rugged die-cast aluminum chassis, covers ten public service bands including aircraft, and, it's keyboard programmable.

Compact Mobile

With today's smaller cars and limited installation space in mind, Regency has developed a new compact mobile scanner, the R806. It's the world's first microprocessor controlled crystal scanner. In addition, the R806 features 8 channels, programmable priority, dual scan speed, and bright LED channel indicators.

Base Station Plus!

Besides covering all the standard public service bands, the Regency Z60 scanner receives FM broadcast, aircraft transmissions, and has a built-in digital quartz clock with an alarm. Other Z60 features include 60

channels, keyboard programming, priority control, digital display and permanent memory.

Lunar Antenna

Also included in the grand prize is a broadband monitoring/reference antenna from Lunar Electronics. The GDX-4 covers 25 to 1300 MHz, and includes a 6 foot tower.



ELECTRONICS INC.
7707 Records Street
Indianapolis, IN 46226

Grand Prize (1 awarded)

- 1—Regency Z60 Base station scanner
- 1—Regency HX1500 Handheld scanner
- 1—Regency R806 Mobile scanner
- 1—Lunar GDX-4 Antenna

First Prize (5 awarded)

- 1—Regency Z60 Base station scanner
- 1—Regency R806 Mobile scanner

Second Prize (5 awarded)

- 1—Regency HX1500 scanner

Contest rules: Just answer the questions on the coupon, (all answers are in the ad copy) fill in your name and address and send the coupon to Regency Electronics, Inc., 7707 Records Street, Indianapolis, IN 46226. Winners will be selected from all correct entries. One entry per person. No purchase necessary. Void where prohibited by law. Contest ends June 30, 1987.

1. The Regency Z60 is
 - a digital alarm clock an FM radio
 - a scanner all of the above
2. The Regency R806 is the world's first _____ controlled crystal scanner.
3. The Regency HX1500 features
 - 55 channels Bank scanning
 - Liquid crystal display all of the above
4. The Lunar GDX-4 antenna covers _____ to _____ MHz.

Name: _____

Address: _____

City: _____ State: _____ Zipcode: _____

I currently own _____ scanners.

Brands owned: _____



Send in a photo (like this one of Mike Nikolich and his Regency monitoring station) and receive a free gift from Regency. Be sure to include your name, address and phone number.

CIRCLE NO. 158 ON FREE INFORMATION CARD

PC

Scanning The:

Federal Law Enforcement Training Center

Criminal Investigators From 60 Federal Agencies Learn It All Here!

BY TOM KNEITEL, K2AES, EDITOR



You may never have heard of the Federal Law Enforcement Training Center (FLETC), but nevertheless it has been on the job since 1970 training Federal enforcement officers and investigators from almost 60 agencies as well as (since 1982) personnel from state and local agencies.

FLETC, as an interagency training facility, is actually a bureau within the Department of the Treasury. It's located at the Glynco Naval Air Station near Brunswick, Georgia. Since 1984, FLETC has also operated the Indian Police Academy located at the Pinal Airpark, Marana, Arizona.

The majority of FLETC's training is devoted to basic programs for criminal investigators and police officers who have the authority to make arrests and carry firearms. Programs offer a combination of classroom instruction and practical "field" exercises. These exercises often involve hired role players who act as victims and suspects.

The eight-week course given to criminal investigators has students from agencies such as the Bureau of Alcohol, Tobacco and Firearms; Customs Service; Internal Revenue Service; Marshals Service; Secret Service; and the various staffs of the Federal Government's Inspectors General.

Included among the uniformed police personnel being trained are officers of the Border Patrol, Capitol Police, Customs Service, Federal Protection and Safety, National Park Service, Park Police, and Secret Service Uniformed Division. Basic courses for uniformed personnel last from five to seventeen weeks.

Advanced training programs are also given and are taught by FLETC staff personnel as well as experts from participating agencies. The Immigration and Naturalization Service, for instance, teaches courses in subjects such as the prevention of smuggling. In conjunction with the Department of State, anti-terrorism courses are given and are open to students from agencies in friendly, foreign nations.

There are eight major instructional areas covered for officers and investigators participating in FLETC programs. These are: Legal, Enforcement Techniques, Behavioral Science, Enforcement Operations, Com-

puter/Economic Crime, Firearms, Physical Techniques, Driver and Marine.

These courses are given with the aid of films, videotapes, weapons firing ranges, computers, criminal evidence equipment, and vehicle driving tracks. Instruction in the area of enforcement operations includes a course in radio communications. The firing range (used primarily for training with .38 caliber revolvers) is indoors and is actually eight separate ranges of 12 firing points each.

FLETC occupies a campus that takes up 1,500 acres and includes a training area consisting of a 34-duplex subdivision that at one time had been used by the Navy. During the week, this simulated typical suburban neighborhood is a hotbed of criminal activity exercises.

Communications

As you may have guessed, all of this requires a considerable helping of communications. In 1985, FLETC purchased new radio equipment for the driver training vehi-

cles and portables with compatible channels for driving instructors. In addition, new channels were added to the two that had been formerly added to the training division. That move significantly reduced radio congestion in an activity that relies on instructions being quickly transmitted to students over VHF, and has thus increased the Division's safety margin. This is especially critical at Glynco where multiple driver training areas are in use simultaneously.

The callsign KAE356 is assigned to all frequencies at FLETC Glynco. Frequency usage is as follows:

- Security—170.975 MHz
- Maintenance—170.10 MHz
- Surveillance Training—172.20 MHz
- Driver Training—169.55, 169.60, 170.00, 170.425, 170.60, 173.025, 173.075, 173.125 MHz

The FLETC has its own communications- equipped security force.





An anti-terrorism exercise at FLETC Glynco.



FLETC's driver training course requires several VHF channels.

Crowd control training at FLETC Glynco.

- Criminal Investigator Training—173.125, 171.50, 173.785; also in use is 170.825 MHz
 - Other frequencies—173.7375, 170.825, 170.925, 172.30, 173.175 MHz
- The frequencies used by the FLETC in Arizona aren't known. Possibly, that facility

uses some or all of the channels used at Glynco. Note that the FBI has its own training facility. It's at Quantico, VA; one of the frequencies used may be 149.37 MHz. The CIA school is at Camp Peary, VA and is believed to conduct air/ground communications on 135.975, 226.4 and 229.9 MHz.





BOOKS YOU'LL LIKE!

BY R.L. SLATTERY

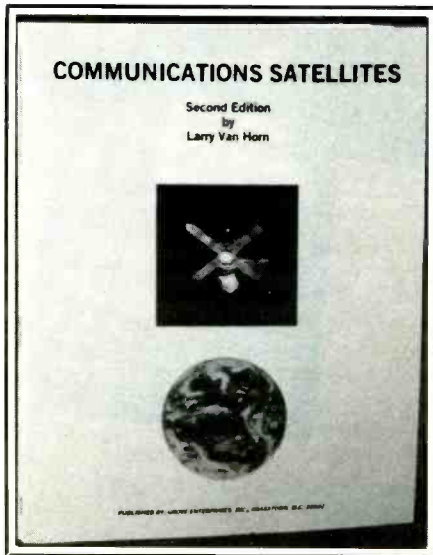

Look, Up In The Sky!

It's a bird, it's a plane, it's a communications satellite! There is no shortage of those gizmos zipping and zooming around overhead and Larry Van Horn has therefore decided to update his book *Communications Satellites* with a newly enlarged and revised Second Edition.

Essentially, this is a gigantic 255-page smart-looking frequency and information guide covering 1 MHz through 563 GHz, listing hundreds upon hundreds of frequencies you can tune on your communications receiver, scanner, or specialized receiving equipment. Chapters cover spy and surveillance satellites, U.S. and Soviet manned space missions, military, tactical, scientific, weather, oceanographic, communications, navigational, private, and broadcast satellites—even deep space probes. If it's in orbit or on the way to somewhere in the cosmos, it's listed in this painstakingly comprehensive directory.

More than a basic frequency listing, *Communications Satellites, Second Edition* includes chapters on channelization band plans, transponder identification, international satellites, a history of earth satellite development, and much interesting and useful information is provided on the individual satellites in regard to purpose, orbit or position, transmission modes, and other details of its communications systems and facilities.

Satellites are listed by types and cross-referenced according to frequency. There's a large bibliography and a glossary of terms and abbreviations. We found this new Second Edition to be a vast improvement over the earlier one and recommend it highly for

opening up new areas of listening to all DX-ers and scanner owners. You'll be amazed at the large number of frequencies in use within the tuning ranges of your existing equipment. There's also lots of information on the frequencies used by ground networks connected with space launches, observations, and recovery operations.

This large-format book weighs in at more than a pound-and-a-half; it's pure wall-to-wall, hard-core data with no irrelevant filler material. Top this off with plenty of charts and photos, and you've got a very useful and totally unique book that we feel will be used and enjoyed by every person interested in communications. The information provided on our nation's military and surveillance satellites, alone, makes this book well worth having. A great gift idea, too!

Communications Satellites, Second Edition, by Larry Van Horn, is available by mail at \$14.95 plus \$1 postage/handling (to addresses in USA/Canada/APO/FPO) from CRB Research, P.O. Box 56, Commack, NY 11725.

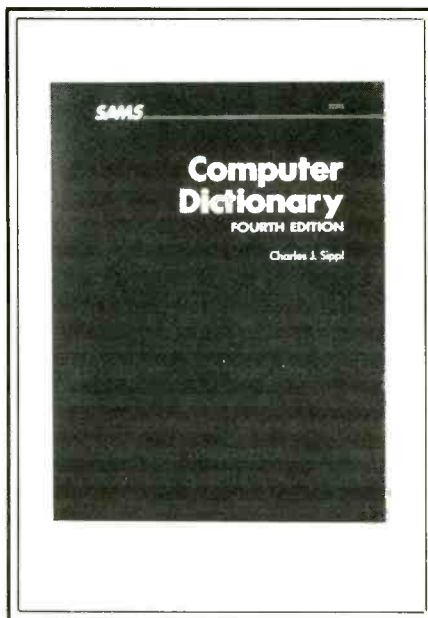

Computer Dictionary, Fourth Edition

Howard W. Sams & Co. has published the computer industry reference tool, the *Computer Dictionary*, which is now in its fourth printing.

This updated and expanded fourth edition is two books in one—a dictionary of basic computer terms and a handbook of computer-related topics. The author provides comprehensive details to give the reader a

clear understanding of computer terminology and topics including fiber optics, sensors and vision systems.

From computer novices, to seasoned professionals, from students to business executives, this 562-page softbound book is for everyone. It features more than 12,000 terms, definitions, and explanations of micro, mini, and mainframe computer technology. Scores of illustrations and photographs and the 1,000 new entries focusing on RAF classifications (such as robotics, artificial intelligence and factory automation) make this the most comprehensive computer reference source available.

Author Charles J. Sippl is a writer, educator, and consultant to the computer, communications, and solar systems industries. He is the author of more than 25 computer dictionaries, encyclopedias and video books. His newest, *Computer Dictionary* retails for \$24.95.

Books are available through bookstores, computer retailers, electronic distributors, or directly from Sams by writing to: Howard W. Sams & Co., 4300 W. 62nd St., Indianapolis, IN 46268.

Radio Team Directory

The Personal Radio Steering Group has published its directory of *Public Service Radio Teams*, an 82-page state-by-state listing of REACT and other similarly-motivated and oriented organizations. Listings show names, addresses, callsigns, frequencies, and telephone numbers.

This is a publication produced independently of REACT itself and a few of REACT's affiliated local groups seem to have declined to cooperate with what appears to be a noble and well put-together effort. Seeing as how REACT relies upon the public knowing how, when, and where to contact their "monitors," and also because such information has been publicized on a minimal level in recent years, you'd think that every team would jump at the opportunity to be included in this type of directory. My guess is that many REACT teams have gone into inactive status or have totally disbanded and those who refused to cooperate fit into one of these categories. It should be noted that the publishers have given the most recent information that was available on those REACT units whose current status is uncertain.

Frequencies listed include CB channels, also business band, GMRS, and even Ham band frequencies, as applicable. More than 1,000 man-hours were spent compiling this

information from FCC sources and by direct inquiry to communications teams and public safety agencies.

Information is also given on people to contact in each state if you want additional information, or information on affiliating with Ham networks, REACT, Neighborhood Watch, etc.

This is a worthwhile directory for those who travel, for scanner monitors, for emergency teams, and public safety agencies. It is available at \$6 per copy from the Personal Radio Steering Group, P.O. Box 2851, Ann Arbor, MI 48106.

In Addition . . .

The *Directory of Federal Surveillance Code, Terms and Slang* explains the meanings of abbreviations such as CIA, DMV, NASA, FCC, FBI, NSA, MP, etc. It contains some federal agent communications jargon, much of which has previously appeared verbatim in other publications (including *POP'COMM*). Also reproduced from previous publications is a listing of VHF bands reserved for exclusive use by federal agencies, in addition it offers two phonetic alphabets and fourteen signals noted as being "common federal 10-codes," some general information on voice scrambling and on the Communications Act of 1934.

This is a ten-page pamphlet consisting of loose pages in a no-punch plastic slide-on

report binder cover. It costs \$5.00 plus \$1.00 for shipping and handling from Communication Research, 534 Conkey Street, Hammond, IN 46324.

The *Northeast Scanning News* is a new newsletter from Les Mattson that crossed my desk. It seeks to address itself to the New England states and adjacent areas. The two monthly issues I saw contained some worthy scanner usage information. *NESN* is, however, still at a very early embryonic stage and has several hurdles to leap.

There's nothing quite as tiresome as someone who has no sense of humor trying to be jocular. That's a definite problem with *NESN's* Les Mattson, who obviously feels that he's hilarious. Maybe even his best friends don't know how to break the news to Les that he's as funny as strep throat. A bit less of Les would be an improvement.

Then there's something to be done about *NESN's* appearance. It's reproduced on duplicating equipment of the same calibre that schools use to run off permission slips for class trips to the zoo. Consisting of eight typewritten pages (four sheets) held together by a staple, it's very "homebrew" in all respects. Nevertheless, it does have good information and it does seek to fill a need. Perhaps as (and if) it continues to evolve it can eventually achieve its potentials. We wish it well.

NESN asks \$6.00 for five issues. It comes from Les Mattson, *Northeast Scanning News*, 212 West Broad St., Paulsboro, NJ 08066.

"For the Best in Performance and Quality..."

"Star" Series
JG 5 + 5 Star

"Cross" Series
JG 4 + 4 Cross



5 Star Specifications

TYPE: Horz. & Vert. Polarization Twin Feed
GAIN: 16.5 DB
FRONT TO BACK RATIO: 48 DB True
SIDE REJECTION: 50.55 DB True
BACK REJECTION: 40 DB True
WEIGHT: 37 Pounds
LENGTH: 17 Feet 6 Inches
SWR: 1:1
HORZ. TO VERT. SEPARATION: 25-30 DB
WIND SURVIVAL: 100 MPH
POWER MULTIPLICATION: 65X
AUDIO GAIN: 22 DB
WIND LOAD: 5.2

4 Cross Specifications

TYPE: Horz. & Vert. Polarization Twin Feed
GAIN: 15.5 DB
FRONT TO BACK RATIO: 45 DB True
SIDE REJECTION: 45.50 DB True
BACK REJECTION: 45 DB True
WEIGHT: 38 Pounds
LENGTH: 12 Feet
SWR: 1:1
HORZ. TO VERT. SEPARATION: 20-25 DB
WIND SURVIVAL: 100 MPH
POWER MULTIPLICATION: 50X
AUDIO GAIN: 20 DB
WIND LOAD: 4.0

Send \$2.00 to receive the new '86 Catalog on the complete line of Jo Gunns. **\$2.00 refundable on first order.**

Jo Gunn Enterprises

Route 1, Box 383 Ethelsville, AL 35461
205-658-2595

Hours: Mon.-Fri. 9 a.m. - 5 p.m. (CST)
FOR DEALER INQUIRIES, PLEASE CALL.

"YOUR EYES TO THE WORLD" M-800 FACSIMILE UNIT



Printer not included.

At last an affordable facsimile system that opens the exciting world of shortwave and satellite facsimile reception!

- Worldwide press and wire photos.
- Weather maps and charts.
- All marine weather services.
- Military & government FAX plus more!
- Prints all speeds and IOC's, AM/FM in black and white or 16 gray shades.
- Uses inexpensive Epsom™-type dot matrix printers.
- Prints on inexpensive plain paper.

M-800 Facsimile Converter
Introductory price \$499 (+ S&H)

UNIVERSAL SHORTWAVE RADIO

1280 Aida Drive
Reynoldsburg, Ohio 43068
Toll Free: 1 800 431-3939

FREE

"HOW TO RECEIVE FACSIMILE (FAX)
ON YOUR SHORTWAVE RADIO"

Send SASE now for your free copy!

Radio: I Remember It Well

A Walk Through The Halls Of History

BY ALICE BRANNIGAN

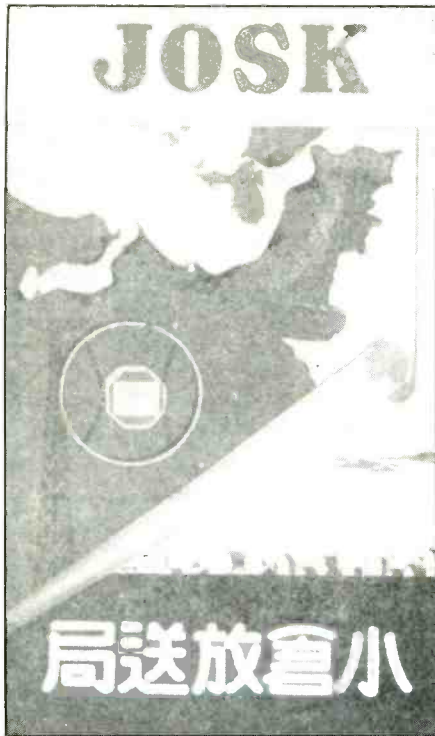

JOSK ran 1 kW on 740 kHz.



JBCK opted for a gold/black/lilac QSL card.

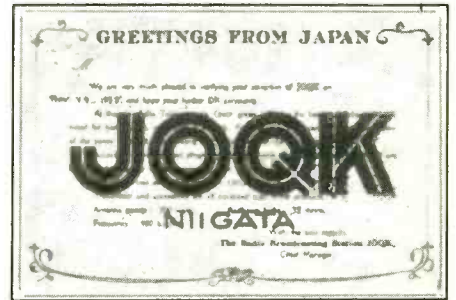

QSL from JOQK, another 500-watt station.



JOIG ran only 500 watts.

pan. This station, owned by NHK, is still operating and runs 5 kW on 648 kHz. The QSL from JOQK, Niigata (500 watts, 920 kHz) has large red letters. This NHK-owned station presently operates on 837 kHz with 10 kW.

Reader Howard Kemp, Nashua, NH provides us with a QSL from the group of Japanese shortwave stations in Nazaki that went on to become well known because of their propaganda activities after war was declared. Howard's card is for stations such as JVN (10660 kHz) and JVH (14600 kHz), both running 20 kW. *Radio Station Treasury* lists these as "Japanese propaganda stations" in 1942.

A lost bit of radio history: In 1937, the Japanese Association of America applied to the FCC for permission to erect a shortwave station in San Francisco "for the purpose of supplying Japanese farmers in central and

This month, the forty-fifth anniversary of the attack by Imperial Japanese Forces upon Pearl Harbor, Hawaii, has sent me to my files to dig out a few memories. It does seem that, at least before the outbreak of the war, there were QSL cards galore from Japanese broadcasters for American listeners.

A letter from a DXer in Seattle, Washington notes how easy it was to hear Japanese broadcast band stations in 1940 especially when their English language programming came on at 4:30 a.m. Eastern time (that's 0930 UTC). He noted that he had heard and reported to thirteen Japanese BCB stations, with QSLs promptly sent to him in return. He claimed that stations running 10 kW or more weren't too difficult to hear, "while the 500-watters are somewhat erratic and a catch-as-catch-can proposition."

Some rarely seen Japanese broadcast band QSLs from just before the outbreak of the war show the wide variety of cards that were arriving here from across the Pacific right until December 7th, 1941. Station JOSK from Kokura sent out a beautiful card verifying their 1 kW signal on 740 kHz. The card from JBCK, Seishin (10 kW on 850 kHz) should be seen in color to be fully appreciated. The photograph of the antenna towers is framed in metallic gold, and the so-

lar rays are light lilac in color. The callsign is black and spangled with many golden dots.

The QSL from JOIG, Toyama (500 watts, 1060 kHz) is printed on yellow-orange stock with black ink. It's quite similar to the card that was also sent out at the time by JOCK in Nagoya, with an illustration of Mount Tateyama and an outline map of Ja-

A multi-station QSL card from Japanese shortwave propaganda broadcasters.

Nazaki Station		Longitude 138°51'00" E	
		Latitude 36°10'44" N	

I Overseas broadcast for North America, Hawaii, etc.			
Transmitter:			
JVN	10660 K.C.	20 KW.	Beam Antenna
JVH	14600 K.C.	20 KW.	"
Program:			
0500—0600 GMT. News in English and Japanese, Music, Entertainment, Lecture, etc.			
II Relaying broadcast for Manchukuo and Formosa			
Transmitter:			
JVT	6750 K.C.*	20 KW.	Vertical doublet Antenna
JVP	7510 "	20 "	"
JVN	10660 "	20 "	"
JVM	10740 "	20 "	"
Program:			
0400—0410 GMT. Weather forecast, Market quotations			
0410—0415 Market quotations			
0415—0418 News, Market quotations			
0418—0420 Market quotations, News			
0420—0425 Children's Hour, News, Lecture, Entertainment, Music, Drama, etc.			
0425—0430 Time Signal, News, Weather forecast, etc.			
0430—0435 Physical Exercise			
20 KW. Transmitter			

III. Overseas Broadcasting Test			
Transmitter:			
JVP	7510 K.C.	20 K.W.	Beam antenna
JVN	10660 "	"	"
JVM	10740 "	"	"
JVH	14600 "	"	"
Program:			
I. For the East Coast of North America & South America			
2100—2200 G.M.T. Announcement, Gramophone music, Etc.			
For Europe			
1900—2000 G.M.T. Announcement, Gramophone music Etc.			

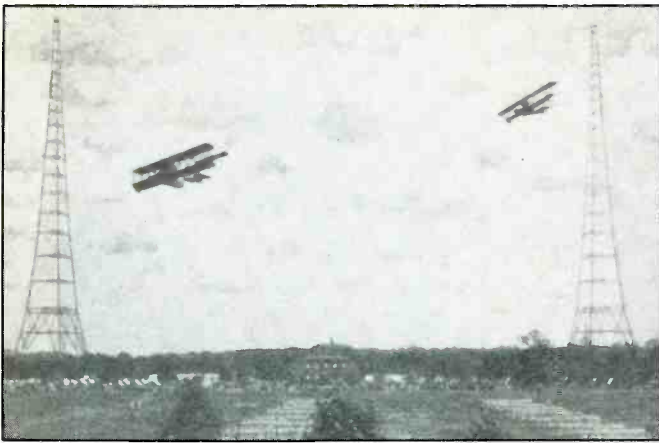

The USN station at Great Lakes, IL had the callsign NAJ in 1917.

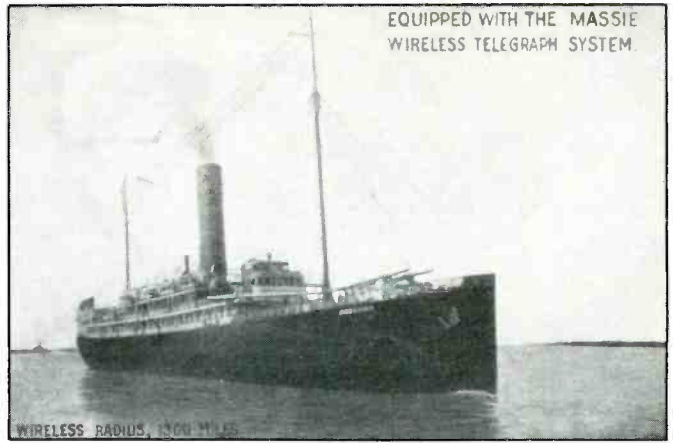

The S.S. President had the callsign WGP in the early 1900s.

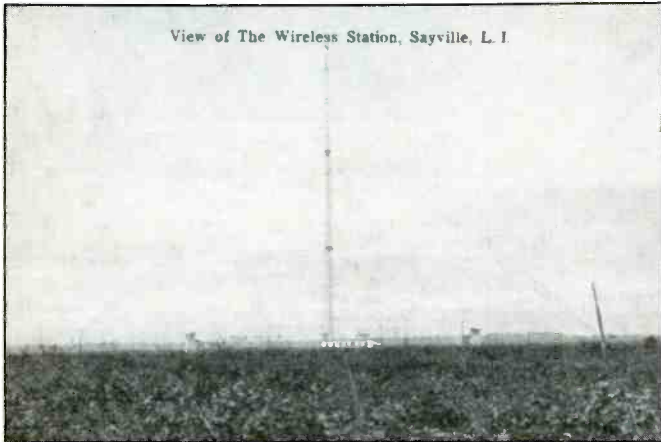

The Sayville, NY telegraph station was owned by Germans and used for sending coded espionage messages in the early days of WWI.



This unusual homebrew broadcaster on California's Catalina Island had the callsign KFWO. It was also a Ham and Experimental station!

northern California with agricultural and market news in their own language." The FCC denied the license application.

Early Military Radio

While on the subject of military communications, let's go back to 1917 and peek in on station NAJ, operated by the U.S. Navy at Great Lakes, IL. Most likely, many POP' COMM readers spent many delightful hours on the grinder at Great Lakes Naval Training Station.

According to *Radio Station Treasury*, in its earliest days NAJ operated on 52.6 and 198 kHz. By the early 1920s, the station was operational on 64.1, 75.9, 151 and 500 kHz.

Our 1917 photo of NAJ shows two amphibious biplanes flying between the towers. Probably these were artificially superimposed on the photo to give the viewer a good idea of the size of the towers. It's not apparent in the photo, but the two towers are probably about 350 feet in height. Also not obvious is a multi-wire antenna system strung between the towers and feeding into a two-story brick building at the center of the photo.

WWI Spy Stuff

In the January issue we discussed German espionage transmissions that took place in

the United States. With the aid of a device called the Telegraphone, the Germans sent ultra-high-speed CW out from commercial telegraph stations in Tuckerton, NJ and in Sayville, NY. Both of these stations were owned by German interests and were in communication with station POZ in Nauen, Germany—at least until the U.S. Navy took control of the situation.

In August, we had a photo of station WGG, Tuckerton, NJ. This time we have a photo of the other of the two German stations, the one in Sayville, NY. This station, once known as SL, then later as WSL, used the callsign NDD (25.9 and 30.6 kHz) after it was taken over by the USN. After the war ended, the station was returned to civilian ownership (Mackay Radio) and again used the callsign WSL. Eventually the station's low frequency transmitting site was moved to Amagansett, NY while its shortwave facilities were located at Brentwood, NY; these were operated under the ownership of ITT Worldcomm.

WSL went QRT about two years ago. Some of its interesting history appeared in POP'COMM's issues of March, June and October of 1984.

Our picture postcard of WSL shows the station when it was owned by Telefunken and being used for the spy transmissions. Interestingly, the postcard was printed in Germany but intended to be sold and used in

the U.S.A. The large tower in the photo dwarfs the one-story transmitter building. Today this site is the location of an FAA aeronautical communications station. Our photo has never before been published.

Ship Ahoy

In the early days, it was quickly realized that wireless was a great safety and commercial bonus to have aboard ships at sea, especially after the losses of ships such as the *Titanic* and the *Republic*. In addition to the potentials of wireless for sending distress signals, it could also be used for sending and receiving telegrams of a business or personal nature.

Perhaps that's why early promotional material for ships often made it a point to stress that there was a wireless aboard. We came across a picture postcard (undated) of a passenger vessel called the S.S. *President* that proudly declares the vessel to be "equipped with the Massie Wireless Telegraph System," also mentioning that the "wireless radius" was 1300 miles.

Records indicate that in 1919 this vessel was using the callsign WGP, but by 1924 it was no longer in service.

On An Island With You

Next, let's check out two stations on islands off the western and eastern edges of

BROADCASTING STATION
T.J.W.

Hamilton, Bermuda,
February 1931.

Owners: Thos. J. Wadson and Son.
Manager and Engineer: Major W. Cookson, M.A.I.R.E.
Studio Manager and Announcer: Vernon Freisenbruch.

900 miles

SPECIAL DX TEST for NEWARK NEWS RADIO CLUB
February 22nd 1931.

Sir:

This letter will acknowledge receipt of your communication informing us that you have received this test programme and will also confirm the fact that you did get us. Let us first thank you very much for taking the trouble to listen in.

Station T.J.W. was erected some 14 months ago with a view to filling in during the summer when reception from the U.S.A. and Canada is not all that could be desired. It has served its purpose.

The following are details of the set used:-

Call Signal -- T.J.W. K.c. -- 1490.
Power Used during test -- -- -- 7.5 watts (I-210 Arcturas)
Circuit -- Coupled Hartley Modulator (Heising system) I-210
Music Amplifier (for records) - two stage - I-101a and 2-171a push pull.
Voice Amplifier - an additional 101a in front of Music Amplifier.
Thermo-Amps in Aerial (theoretical) -- .6 amps.
Land Lines From Studio to Hamilton Hotel (in City).
do do to Inverurie Hotel (Paget Parish).

Time of Broadcasting (normal) - Monday, Tuesday, Wednesday and Thursday:
7 p.m. to 9 p.m. Atlantic Time
6 p.m. to 8 p.m. E.S.T.

Programmes: Hotel Orchestras, local talent, with the main programme of Victor records.

The actual times of the test were as follows:-

Commenced 3.29 a.m. (E.S.T.)
Closed Down 3.59 a.m.

Programme (Victor Records):
"The Venetian Suite," "Marschus," "The Country Dance,"
"To whom it may concern," "Lonesome Lover," "The Rosary," "Ave Maria."

We shall be very glad to carry out a further test on Sunday morning the 8th March at the same time, and announce all letters received.

We take pleasure in forwarding to you some "dope" on Bermuda which has been supplied to us by the Bermuda Trade Development Board.

Yours very truly,

VERNON FREISENBRUCH.

900 MILES ON 7.5 WATTS.

Additional Year. 4 A.M. - 4:30 A.M. E.S.T.



Lyle Thackery tunes up the 100-watt CFCO transmitter for a 1936 DX test.

ience large enough to warrant a year-round schedule. This station was strictly legit and sanctioned by the government—it's listed in the 1931 section of *Radio Station Treasury!*

T.J.W. had a Heising modulator, but no information on their effective antenna system was given in the QSL letter. Despite the station's miniature size, it maintained two broadcast pickup telephone lines to the Hamilton and Inverurie Hotels. The QSL (verifying reception of 900 miles) was signed by Vernon Freisenbruch, Studio Manager and Announcer.

Considering the program schedule, Joe Hueter's reception was quite an impressive feat. A 7.5 watt BCB station from 900 miles away during peak listening hours is something of which to be more than a little proud.

An Early Canadian

Station CFCO, Chatham, Ontario, was broadcasting in 1926 and is still going strong; a 60-year career! Even during an Ontario winter, that's nothing to sneeze at!

When the Western Ontario Better Radio Club (49 Park Avenue East) of Brantford first put CFCO on 1210 kHz, it had a puny 25-watt transmitter. Very soon, however, CFCO had gone to 50 watts and, by 1931, to 100 watts under the direction of its owner/operator John Beardall. Beardall had moved CFCO to the William Pitt Hotel.

In the mid-1930s, CFCO shifted frequency to 630 kHz, although it ran 100 watts until well after WWII. Today, still on 630 kHz, CFCO runs 10 kW days and 1 kW nights.

During the mid-1930s CFCO came under fire from DX clubs because of the way it broadcast special late-night DX test programs. Unlike other broadcasters, it refused to give any advance announcements about when the programs were going to take place. John Beardall said that he wanted the DX fan to get "a much greater kick out of

QSL letter from 7.5-watt broadcaster T.J.W. in Bermuda during the early 1930s.

our continent. From the western side we have station KFWO, late of Avalon, Catalina Island, California.

KFWO was one of those odd little combination Ham/Experimental/Broadcast stations that folks used to operate from their homes in bygone days. This station belonged to Major Lawrence Mott, U.S. Army Signal Corps, and was located at 346 Claressa Avenue, Avalon. When on the Ham bands it used the callsign 6ZW, as an experimental station it called itself 6XAD, and as a 250-watt broadcaster on 1420 kHz, it was KFWO! The station's slogan was "Catalina For Wonderful Outings," and for a couple of years it ran a broadcast schedule of several hours a day—off and on the air several times daily between noon and 10 p.m.

The station first began operation in 1925. By 1928 it had shifted to 1500 kHz and was running only 100 watts while time sharing with KWTC in Santa Ana. The following year, Major Mott's station was only a memory and KWTC changed its callsign to KREG.

Our photo of this little-known station shows it using a tower at the rear of a pic-

turesque bungalow. Two stately and quite dead trees adorn the walkway.

Next, from the Atlantic Ocean island of Bermuda, we have a 1931 QSL letter from a 7.5 watt station in Hamilton, Bermuda. How's that for unusual? This comes to us courtesy of reader Joe Hueter, Philadelphia, PA who earned his valued and interesting QSL by means of some deft dial-twisting during a special DX test put on for the Newark News Radio Club on February 22, 1931.

The station called itself T.J.W., a callsign consisting of the initials of its owner, Thomas J. Wadson. It commenced operating on 1490 kHz in January of 1930 and ran a regular schedule four days every week from 2300 to 0100 UTC. Programming consisted mainly of "Victor records" supplemented by local talent and "hotel orchestras."

T.J.W. was put on the air "with a view to filling in during the summer when reception from the U.S.A. and Canada is not all that could be desired. It has served its purpose." Undoubtedly a true statement because it appears as though it had assembled an aud-

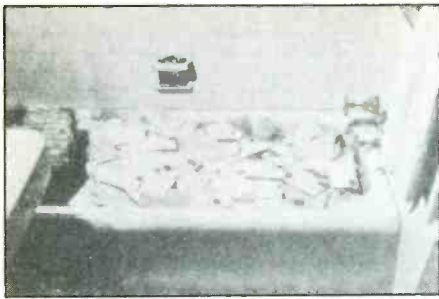

CFCO found that the hotel's bathtubs made great files for reception reports.

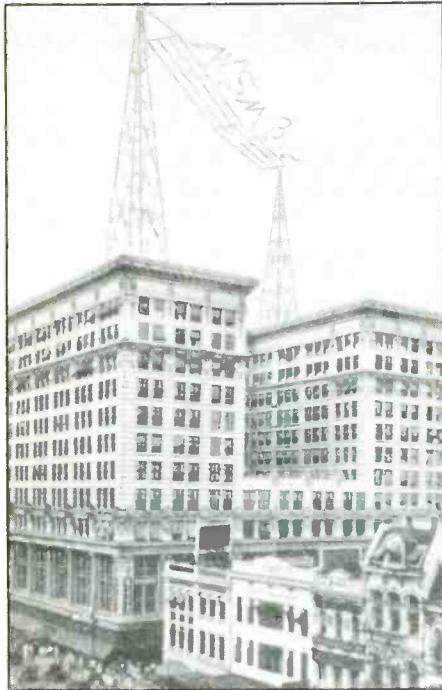

WSMB was originally located in a New Orleans department store.

reporting a station which appears to have come on the air by chance and endeavors to secure reports in a purely spontaneous manner."

When the special programs were transmitted, Beardall offered a \$5 gold piece to the listener sending in the most distant report. Between 1933 and 1936, ten special unannounced DX tests were broadcast—they yielded 14,000 reception reports! Remember, in those Depression years, a \$5 gold piece was more than many folks had to show for a full week's work! Out of the ten prizes, seven went to listeners in New Zealand. The other three gold pieces were won by shipboard "sparks." In 1936, the winner sent a cablegram from New Zealand, terse and to the point, giving only enough information to identify the program content. It read, "Test prize program. Reception good. Roll on Mississippi. Let's Get Together Again. Time on my Hands. Gordon Ramsay, Vogel Street, Dunedin, New Zealand."

So enormous was CFCO's mail that they used to pile it into the bathtubs at the William Pitt Hotel. Two tubs were in constant use according to Lyle Thackery, who had full



A FAX transmission from station W2XAR. It dates from 1934.

charge of CFCO's special DX test broadcasts. Still, DX clubs were most unhappy about not being given a chance to publicize the CFCO programs for DXers.

All we can say is, roll on CFCO, and let's get together again! May your next 60 years be as colorful and creative.

How's Bayou?

In 1925, station WSMB filled the New Orleans airwaves on 940 kHz with a 500-watt signal and the slogan, "America's Most Interesting City." This station was owned at the time by Saenger Theatres and the Maison Blanche Department Store, 1401 Tulane Avenue, New Orleans.

In a frequency shuffle that took place in the 1920s, WSMB jumped over to 1320 kHz and upped its power to 750 watts. By 1930 it was back to 500 watts, and soon thereafter its ownership was transferred to WSMB, Inc.

The mid-1930s saw WSMB try another power increase, this time to 1 kW, and when another national frequency shift took place right before WWII, WSMB ended up on 1350 kHz and had a 5 kW transmitter. By the late 1940s, the offices had moved to 901 Canal Street, and the transmitter was located in Algiers, LA. Presently, WSMB remains on 1350 kHz with 5 kW.

Our view of WSMB shows it when it was located in the Maison Blanche Department Store. Two steel lattice towers, each about 100 feet in height, support a four-wire an-

148 PAGES
100'S OF NEW
PRODUCTS

GET IT NOW!

More pages, more products—and it's hot off the press! Get the new 1986/7 DICK SMITH ELECTRONICS Catalog and find anything for the electronics enthusiast. The data section alone is worth the price of admission. Send for your copy today.

Please reserve my copy of the 1986 Dick Smith Catalog. I enclose \$1 to cover shipping.

Name

Address

City

Zip

612G

DICK SMITH ELECTRONICS INC.
P.O. Box 2249 Redwood City CA 94063
EVERYTHING FOR THE ELECTRONICS ENTHUSIAST!

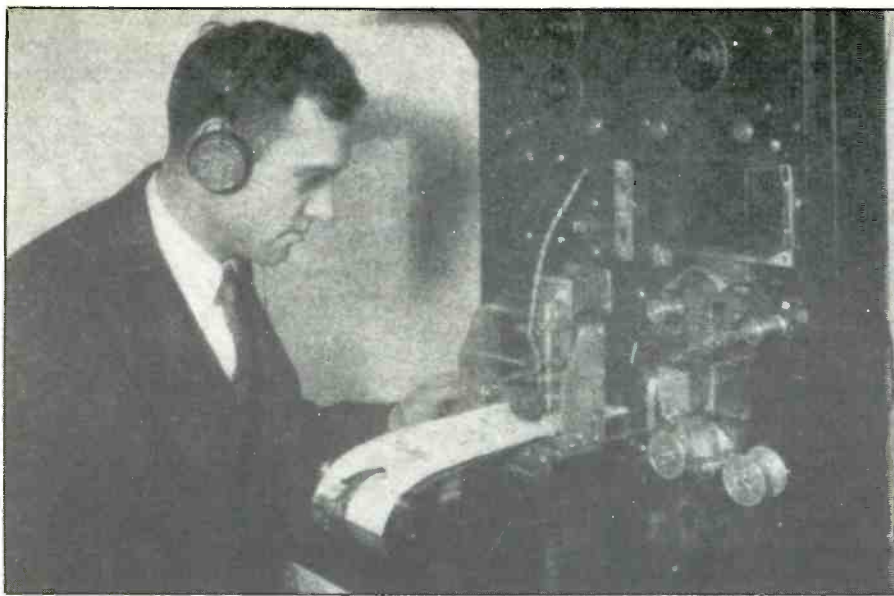

In 1934, Experimental FAX station W2XAR operated on 1594 kHz.



"Hey, guys and gals—have a Happy Holiday," says Alice.

Oh, you mean you didn't realize that the "new" invention called FAX was more than 50 years old?

A Wintry Aloha

I'll leave you with my best wishes for the best Holiday Season ever, and maybe Santa will be extra good to you this year. And just think, after all of the ice and snow, Spring arrives on March 21st! No more slipping and sliding on the sidewalks, like the poor lady on the 1912 wireless postcard. She had to send out a "CQD" (that's the ancestor of "SOS") when she took a slide in her "hobble" skirt. Thank goodness for *Jordache!*

PC

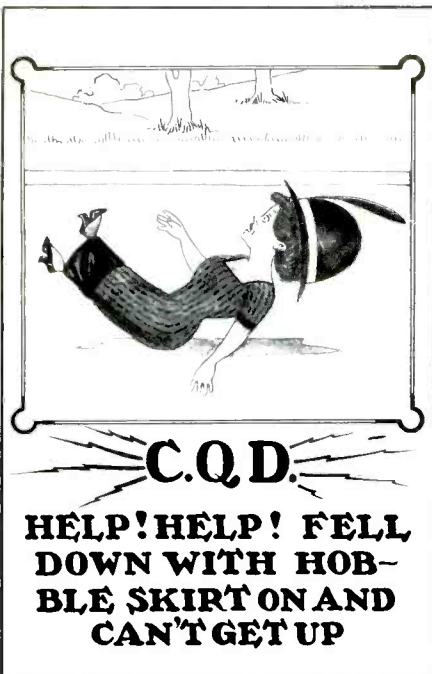

I can think of better things to shout than "CQD" after losing to a patch of sidewalk ice! Can't you?

tenna. The callsign crackles out of the antenna in letters formed by lightning bolts. Looks like the work of Marie Laveau!

Some Curious FAX

When I read Tom Harrington's story on FAX in the October issue, it reminded me of some early FAX experiments that I'd like to share with you.

In 1934, the Milwaukee Journal's station, WTMJ, was sending out a nightly edition of the newspaper that could be received in people's homes via FAX machines. A demonstration of this system was given in New York City when FAX transmissions were sent from Long Island City to receivers lo-

cated on the 23rd floor of New York's swank St. Moritz Hotel.

The signals were transmitted by station W2XAR. The graphics' signals were superimposed on a subcarrier of 2 kHz and that in turn was superimposed on an RF carrier of 1594 kHz. A sound program describing FAX and offering accompanying music for the demo was sent out over W2XBR on 1550 kHz, also from Long Island City.

It was a very successful demonstration. In case you couldn't make it there, (I didn't either), here's a look at what we both missed.

Historic Ham QSLs

Forty-five years ago this month, the destiny of the United States was thrown into turmoil by the attack upon Pearl Harbor, Hawaii. The Pacific had long been dotted with American Naval bases both large and small, and the war took its toll throughout the Pacific right from the start. So, while the national media spends this month drawing attention to the more well-known Naval facilities and battles of that dreadful war in the Pacific in which so many civilians and brave military personnel were wounded or killed, I would like to recall one of the smallest USN installations, the Naval Facility on Johnston Island.

Johnston Island is a tiny coral atoll with two small islets, Johnston and Sand, surrounded by a reef 12 miles in circumference about 100 miles southwest of Honolulu (17N by 168-30W). It was discovered in 1807 and claimed by the U.S. in 1858 when it was worked for guano. It was made a part of the U.S. defense system in 1934 and was turned into a Naval Air Station. Johnston Island, with only one square mile of land area, had a population of 300 in 1978 after it came under control of the Nuclear Defense Agency.

Our attention is drawn to Johnston Is-

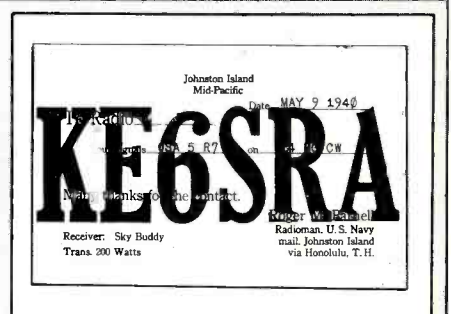

land in May of 1940, only a year and a half before war began in the Pacific. Roger M. Pamell, a U.S. Navy Radioman was stationed on Johnston and was licensed as KE6SRA. He ran a 200-watt CW transmitter on the 20 meter band.

Little known and small in size, Johnston was nonetheless the focal point of fierce fighting. There were many casualties. Therefore, I would like to honor this isolated and remote outpost as being symbolic of the many other similar American military outposts in the Pacific whose deeds and sacrifices have become overshadowed by more newsworthy places such as Wake, Midway, Guam, Tarawa, Guadalcanal, Corregidor, and the rest.

The present prefixes for Johnston Island are KJ and KH3.



Electronics Introduces Scanner Cases!

High Quality Leather Cases For
Scanners To Fit:

- **Realistic PRO 30, PRO 32**
- **Regency HX 1000, HX 1200**

Get the same high quality leather cases that we supply to the commercial two-way portable market, for your scanner.

Made From:

- High Quality Full Grain #1 Grade Leather.
- Heavy Duty Nickel Plated Brass Hardware.
- Genuine "Pull The Dot" Fasteners.
- Available With T-Strap or Full Cover for Maximum Protection.
- All Models Available With or Without Quick Disconnect Swivel, Which Allows the User to Remove Radio and Case from Belt.
- In Stock for Immediately Delivery.

Special SALE Price!!!

\$37.00 + Shipping and Handling

Protect Your Scanner with a
Quality "BEE" Case.

Call Today Toll FREE 1-800-336-3115



ELECTRONICS, INC.

2655 Gardner Road • Broadview, IL 60153



Coaxial Connections

The latest on new types of coax cable plus the inside story on the importance of non-contaminating coax

Your coaxial cable feedline plays a very important part in communications range and shortwave reception; it's critical for scanner reception beyond 400 MHz. You wouldn't wash your car with a leaky hose, so why choose coaxial cable that could leak half your signal away? If you switched from your present coax to some of the new coaxial cable that is extremely low-loss, chances are you could pick up some valuable range on your emergency communications set-up.

Let's take a look at some of the letters that make up coax cable, such as "RG58U." "RG" stands for radio government, and "U" stands for a universal application of the cable. Years ago, if you purchased some coax that had the "RG" designator on it, you could be assured that this cable was designed around "military specifications" (Mil Spec) and that it was of the highest quality. You can forget all that now—there's a ton of extremely poor quality coax cable available for sale that carry this "RG" designator, and this particular type of inexpensive cable is not even close to a military grade of coax.

There are about ten types of protective outer jackets that cover coax feedlines, but only two are typically found for general radio receiving and transmitting applications among hobby radio users.

Type I coax cable jackets feature a low temperature, plasticized, polyvinyl chloride (PVC) sheath that contains the plastic extender to keep the cable flexible. This plastic-type cable is found at most hobby radio stores and is suitable for short runs inside the house. A plastic-type coax cable is not designed for outside use. In a matter of months or about a year, the plastic will begin to get brittle, crack, and then allow moisture to seep in. Once that happens, your Type I coax starts leaking signals just like a garden hose leaks water.

This cable is also subject to "migration" where the plastic extender migrates through the shield braid and begins to attack the dielectric insulation that surrounds the center conductor. When this happens, the impedance begins to change, and again your coax begins to break down.

Type IIA coax is called "non-contaminating." This more rigid coaxial cable jacket

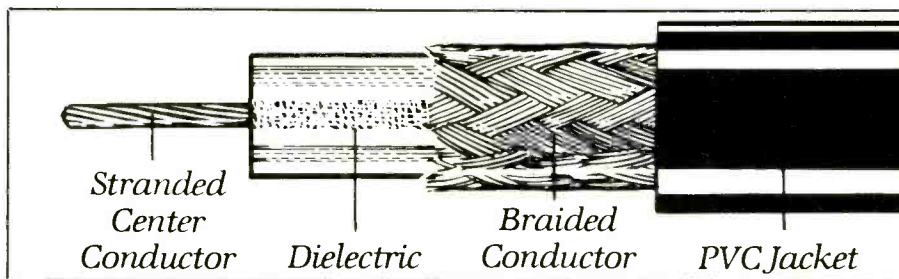

contains a non-contaminating, medium temperature, plasticized, synthetic resin jacket that has a minimum life of 20 years in the sun. The cable has been developed to be resistant to damaging sunlight UV rays. This cable also contains no extenders which would contaminate the dielectric surrounding the center conductor.

You have also heard about foam coax cable as opposed to coax with a solid dielectric. The foam is usually a popular choice because it has less loss at VHF and UHF frequencies. This may be true when the cable was manufactured, but the losses immediately escalate as the coax is put into place. The foam cables contain tiny air pockets that attract moisture. As the moisture accumulates within the cable foam, the velocity factor changes, the impedance goes south, and there's a big increase in RF attenuation.

The foam coax cable also changes impedance dramatically when left in the hot sunshine where the center conductor changes its spacing within the dielectric. If foam coax is run vertically unsupported, the foam, when it gets hot, will begin to migrate down to the bottom of the cable. You could have a characteristic impedance of 30 ohms at the top and 80 ohm at the bottom! Another

problem with foam coax is its susceptibility to impedance changes when coiled tightly or run around sharp turns. An impedance mismatch will cause a higher SWR, and this will also lead to signal attenuation.

Still another problem with inexpensive coax is the percentage of braid that surrounds the inside dielectric and center conductor. On less expensive cable, the manufacturers keep the price down by putting in less braid that ultimately leaks the signal out. The coax with 75 percent braid may leak as much as 25 percent of the signal! The best coax generally has 95 percent braid, and when you look at the braid, you can't see the inside dielectric at all. If you suspect a piece of coax has been constructed with insufficient braid, simply skin off the outside plastic jacket, and see whether or not you can spot large gaps in the weave.

Recommendations for Coax

Don't buy coaxial cable from a local hobby radio convenience store. Hobby radio coax is generally 60 to 75 percent shield, foam-filled, and comes with only a plastic-type jacket. This means it's going to leak a lot of your signal, change impedance, and break down rapidly in the sunlight. "Conve-

Comparison Chart for Coax Cable

Description	Center Conductor AWG	O.D. (MM)	% Shield	Ohms	Velocity	Hundred Feet Loss		
						50 MHz	400 MHz	900 MHz
RG58/U	20	4.95	78	53	66%	3.1 dB	10 dB	16 dB
RG8X	16	6.15	95	50	78%	2.5 dB	8.0 dB	12.8 dB
RG8/U	11	10.29	97	50	78%	1.2 dB	4.2 dB	6.7 dB
RG-213	13	10.29	97	50	66%	1.5 dB	4.7 dB	8.0 dB
9913	9.5	10.29	100	50	84%	1.4 dB	2.6 dB	4.2 dB

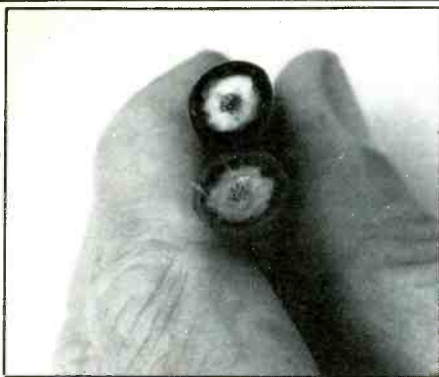

Foam coax (top) is not recommended. Water-damaged coax is shown on bottom.

nience store" coax is designed for the CB radio operator or the shortwave and scanner listener that may not demand the ultimate in a low-loss transmission and feedline. For the serious radio operator, hobby radio store coax should have no place at your emergency communications center.

RG58/U. This small coaxial cable should be avoided whenever possible for runs over 10 feet long. At 400 MHz, RG58/U exhibits over 10 dB (10X) loss. For transmitting, it can only handle approximately 85 watts on UHF frequencies. The suggested uses of RG58/U would be for jumper-leads only. Its nominal impedance is rated at 50 ohms for communications equipment purposes.

RG59/U. This small cable is used primarily for cable television jumper-lead applications. Its nominal impedance is 75 ohms, making it inappropriate for two-way radio applications. Running this type of cable for long television runs will also lead to dramatic decreases of incoming picture quality. Its loss per 100 feet is 9 dB.

RG8X. This cable is slightly larger than RG58/U cable and many times carries other designations such as "mini 8," "super 8," or simply "miniature 8." Up until recently, RG8X was only available in a plastic jacket and a foam dielectric. One manufacturer now produces a marine-grade-type of RG8X with a non-contaminating PVC jacket as well as a solid dielectric for outside use. Losses are less with RG8X than RG58, approaching 3 dB per hundred feet on shortwave frequencies, and .7 dB per hundred feet on UHF frequencies. RG8X is excellent for jumper leads, and is considered the best

for a small-type coax cable for professional applications.

RG8/U. This is the traditional large-style coax cable with a 50-ohm impedance used for long runs between a transmitter and antenna. There's a ton of bargain brand RG8/U with as little shielding as 60 percent and a foam interior construction that breaks down within months in the sunlight. One of the best ways to look for a quality piece of RG8/U is to simply strip back the protective layers and look for the type of construction on the inside. Typical losses for RG8/U would be 3 dB per hundred feet at VHF frequencies, and 6 dB per hundred feet at UHF frequencies.

RG-213. RG-213 can be considered "professional" coaxial cable with the same outside diameter as RG8/U. It is non-contaminating and constructed of PVC with at least a 95 percent braid. At shortwave frequencies, the loss is less than 1 dB, and at UHF frequencies, the loss is approximately 5 dB. If you were planning on running RG8/U, specify RG-213 when you're at the communications store for a better piece of coax with less loss, longer life, and a guaranteed thick shield with a guaranteed thick center conductor.

9913. This type of cable is manufactured by Belden and is the closest thing to hardline cable yet that is near the same size as RG213 and RG8/U. 9913 is designed specifically for VHF, UHF, and microwave applications. At UHF frequencies, it only exhibits a 1.5 dB loss per one hundred feet. Compare that to an almost 12 times increase in loss for RG58/U. It's rated at 50 ohms, is non-contaminating, and a special spiral dielectric core minimizes losses providing both ends of the coax are completely sealed. You'll have to work at getting a PL-259 onto the cable, but with a little whittling, it can be done.

An Overview

Whenever possible always try and use the largest size non-contaminating coax cable possible. I wouldn't go overboard and make jumper cables out of 9913, but nonetheless, use the largest size coax cable possible on medium and long runs that might be exposed to the elements. Take great care in sealing the weather end of your coax connector at the antenna. The best quality cable may rapidly lose performance if moisture is allowed to seep into the outside connector.



RG58 coax on top; RG8X on bottom.



Assorted coax cable . . .

Commercially available "Coax Seal™" is one of the best goes to cover your connectors. Black tape will work, but black tape usually begins to unravel after about a year up the mast.

Avoid splices. At UHF frequencies, coaxial cable splices using barrel connectors could result in as much as 2 dB loss. Also avoid sharp turns that could change the characteristic impedance of the coax.

Buy your cable only from the communications specialty outlet, or from a professional land mobile radio dealer. Unless you are an expert at microwave frequencies, you won't need to go to commercially available hardline because of the exceptional capabilities of 9913. If you're thinking of hardline, consider 9913 from Belden.

Most commercially available mobile and base station antennas don't require a specific multiple wavelength of coax cable in order for the antenna to work properly. Simply keep your cable runs as short as possible, and avoid coils of extra coax beneath your Ham or shortwave station set-up just because you were too lazy to resolder the supplied connectors. Chopping off 30 extra feet might give you just the edge you need to pull in that really weak station.

Once again, avoid buying bargain brand coax at a local hobby radio convenience store. If you're really serious about your hobby, choose the highest quality and largest feedlines possible. You will literally hear the difference. **PC**

***** PRESENTING *****

CABLE TV DESCRAMBLERS

***** STARRING *****

JERROLD, HAMLIN, OAK

AND OTHER FAMOUS MANUFACTURERS

- FINEST WARRANTY PROGRAM AVAILABLE
- LOWEST RETAIL/WHOLESALE PRICES IN U.S.
- ORDERS SHIPPED FROM STOCK WITHIN 24 HOURS

FOR CATALOG OR MERCHANDISE ORDERS ONLY **1-800-345-8927**

FOR ALL INFO REQUESTS - CALL (818) 716-5914

PACIFIC CABLE CO. INC.
7325 1/2 RESEDA BLVD., DEPT. 1109
RESEDA, CA 91335

VISA

Please send all reader inquiries directly.

SCOPE BUY-OUT!!!



OS-106/USM-117 PORTABLE SCOPE, rugged military DC to 6 MHz unit with MX-2996 high-gain plug-in. Sweep 0.1 us to 0.1 sec in 19 steps. Sensitivity 0.01 to 20 V/div in 11 steps. 115 VAC 60 Hz; 8.5x9.8x15, 20 lbs sh.

Used-reparable . . .	\$105 \$115	Checked . . .	\$205 \$175
OS-106 with MX-2995 dual-trace plug-in (less MX-2996), reparable . . .	\$165	Checked . . .	\$225
MANUAL for USM-117, partial repro . . .			\$15
MANUAL for MX-2995, partial repro . . .			\$12

Prices F.O.B. Lima, O. • VISA, MASTERCARD Accepted. Allow for Shipping • Write for latest Catalog Supplement Address Dept. PC • Phone: 419/227-6573

FAIR RADIO SALES
1016 E. EUREKA • Box 1105 • LIMA, OHIO • 45802

CIRCLE 73 ON READER SERVICE CARD

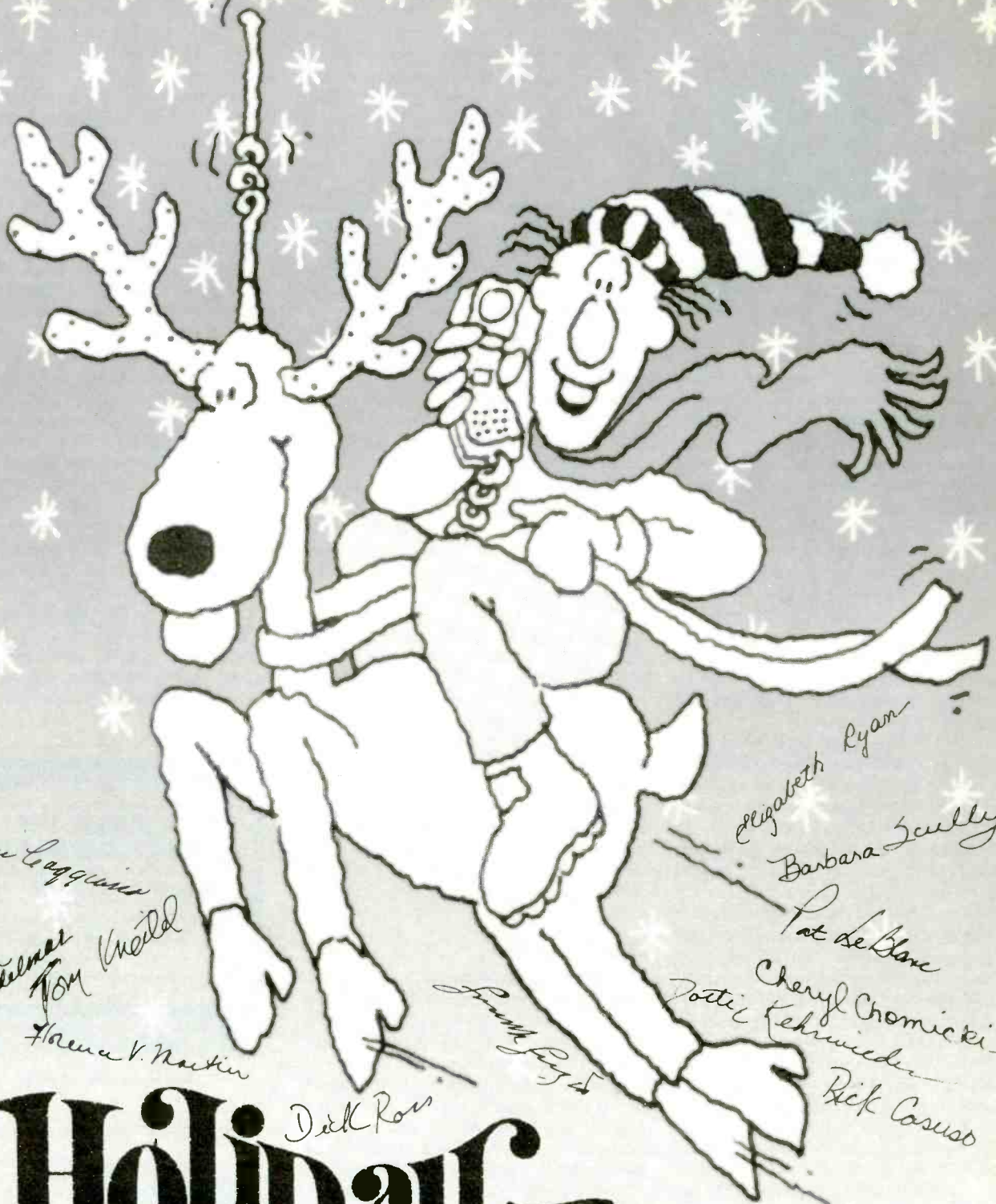

Olson Laggunes

Elizabeth Ryan

*Erica
Hudelman
Tom Knott*

Barbara Scully

Hanna V. Martin

Pat deBlanc

Frankly Foy

*Cheryl Chomici
Dottie Kehnieder*

Dick Ross

Rick Casuso

HOLIDAY CHEER!

from the Staff

of Popular Communications

**CALL TOLL FREE
& COMPARE**

COMMUNICATION DISCOUNTS



ICOM

R-7000

For listening to 25-100 MHz. 99 memory channels with back-up. Direct keyboard frequency access.



R-71A

General Coverage Receiver. All-mode with FM optional. 32 memories. Accessories available include filters, remote control, voice synthesizer, and extended service agreement.

KENWOOD



R-2000

General Coverage Receiver. Ask about extended service agreements.

YAESU



FRG-8800

All mode including FM. 150 kHz - 30 MHz. 12 memories with multi-function scanner. Keypad entry.

FRG-9600

New Receiver for 60 - 905 MHz. 100 keypad-programmable memory channels. Band or memory scan.

SW Listening

Additional Receivers by Sony, Panasonic, and Bearcat.

Books

Full selection of books in stock.

Scanners

Scanner models for mobile, base station, and handheld use.

Regency

HX 1500

55-channel Handheld.

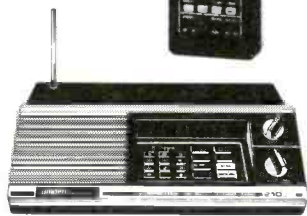

Bearcat BC 210XW

20 channels, 8 bands. Synthesized programmable scanner. Automatic search. Direct channel access.

Telephones

by AT&T, Southwestern Bell, Cobra, and Panasonic

CBs

By Uniden, Midland, and Cobra

Radar Detectors

By Uniden, Cobra, and Whistler

Get the whole story!

**Send \$1 for our
Current Buyer's
Guide-Catalog.**

Antennas

Indoor and outdoor antennas by Sony, MFJ, B&W, Butternut, and Antenna Specialist.

Interfaces

Decode Morse and RTTY. By MFJ or Kantronics. Packet equipment by MFJ and Kantronics.

More Helpers

- **Amateur** Radios and Accessories
- **Towers** and all types of antennas
- **Commercial Land Mobile** by Yaesu and others
- **Marine** By Icom and Regency Polaris

CIRCLE 79 ON READER SERVICE CARD

Visit EGE's
New England
Showroom
in Salem, New
Hampshire. Just 34 miles
north of Boston.

ege, inc.

VIRGINIA

13646 Jefferson Davis Highway
Woodbridge, Virginia 22191
Information & Service: (703) 643-1063
Service Department: (703) 494-8750

**Orders & Quotes Toll
Free: 800-336-4799**

(In Virginia: 800-572-4201)

Store Hours: MTT: 10 am—6 pm

WF: 10 am—8 pm

Sat: 10 am—4 pm

Order Hours: M-F 9 am-7 pm

Sat 10 am-4 pm

ege, inc.

NEW ENGLAND

8 Stiles Road
Salem, New Hampshire 03079
New Hampshire Orders,*
Information & Service: (603) 898-3750

**New England
Orders & Quotes:
800-237-0047**

NEW Store Hours

MTWSat: 10 am—4 pm

ThF: 12 noon—8 pm

Sun: Closed

*Order and we'll credit you with \$1 for the call.

LACOMBE

LOUISIANA

Our Associate Store:
Davis & Jackson Road, P.O. Box 293
Lacombe, Louisiana 70445
Information & Service: (504) 882-5355

Terms: No personal checks accepted. Prices do not include shipping. UPS COD fee: \$2.35 per package. Prices are subject to change without notice or obligation. Products are not sold for evaluation. Authorized returns are subject to a 15% restocking and handling fee and credit will be issued for use on your next purchase. EGE supports the manufacturers' warranties. To get a copy of a warranty prior to purchase, call customer service at 703-643-1063 and it will be furnished at no cost.

**Hard to get through on our
800 numbers?**

Call before 10 a.m. or after 5 p.m., or call one of our regular numbers. If you pay for the call and order, we'll credit your order with \$1.

Dealer Inquiries Invited

INSIDE THE WORLD OF TVRO EARTH STATIONS

Amateur Satellite Tracking

The Early Days

In the fall of 1957, signal strength recordings of SPUTNIK I were made from my basement amateur radio shack (formerly W8FKC) using a Navy TBS receiver as a tunable IF strip and a 6 meter band converter modified to cover 40 MHz with a short wire antenna. These results (Figure 1) created quite a stir among my amateur radio and amateur astronomy friends at Sohio Research (then Standard Oil of Ohio) where I was a research associate. To make a long story shorter, a group of us talked Sohio into some support of an amateur, after working hours, satellite tracking station located near Cleveland, Ohio.

A 500-foot baseline "MINITRACK II" interferometer-type antenna system was erected in the dead of winter with plans supplied by the U.S. Navy, and operating on 108 MHz. This frequency was agreed upon by nations supporting the "International Geophysical Year" efforts in anticipation of the first U.S. Vanguard satellite. The antenna and receiver systems were operational just in time to record the first orbits of the U.S. Explorer I satellite launched in early winter of 1958. A "rare QSL card" was obtained from the VOA which cooperated



R. W. Burhans at control console of Sohio Tracking Station, August 14, 1962.

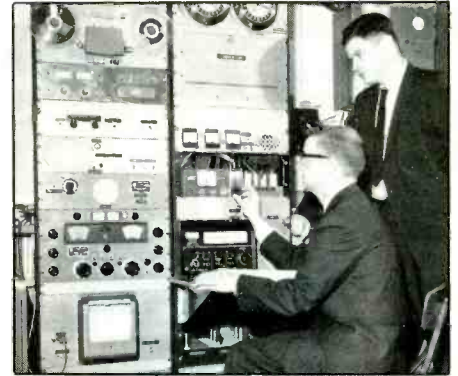

Robert A. Thompson (standing) and Ralph Burhans at Sohio Tracking Station.

with amateur observers by issuing one of their then standard blue cards overstamped with "EXPLORER" (see Figure 2).

The next 10 years or so (1957-1967) were filled with all kinds of new and exciting satellite events where we advanced our technology to include most all the satellite frequencies with both doppler and interferometer methods, and a variety of antenna systems including a 28' dish used to track the first RANGER moonprobes on 960

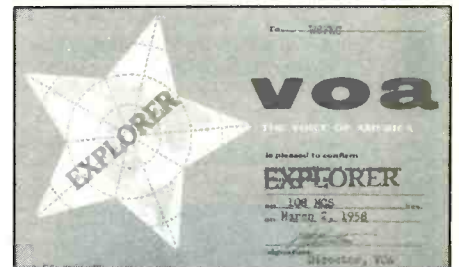

Figure 2. A rare QSL from the VOA.

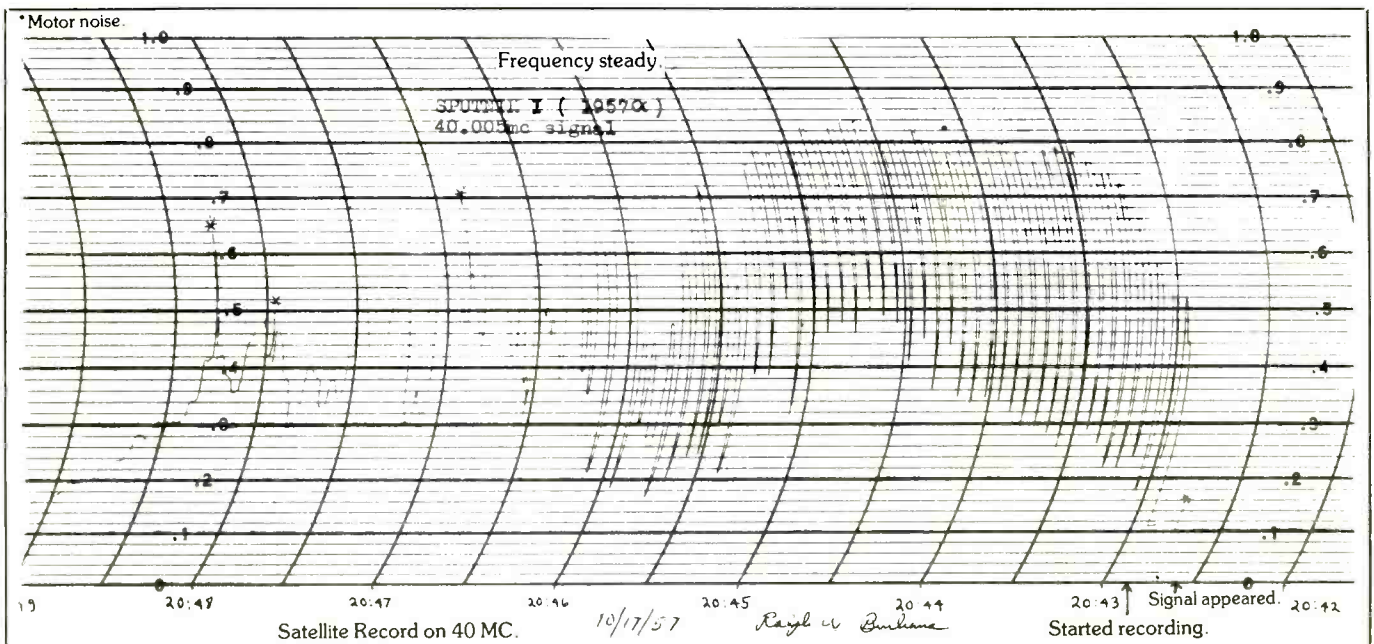

Figure 1. Signal amplitude of SPUTNIK I with a short antenna at 40 MHz. Note the fine structure in amplitude variation mostly due to the satellite spin. Time increases from right to left.

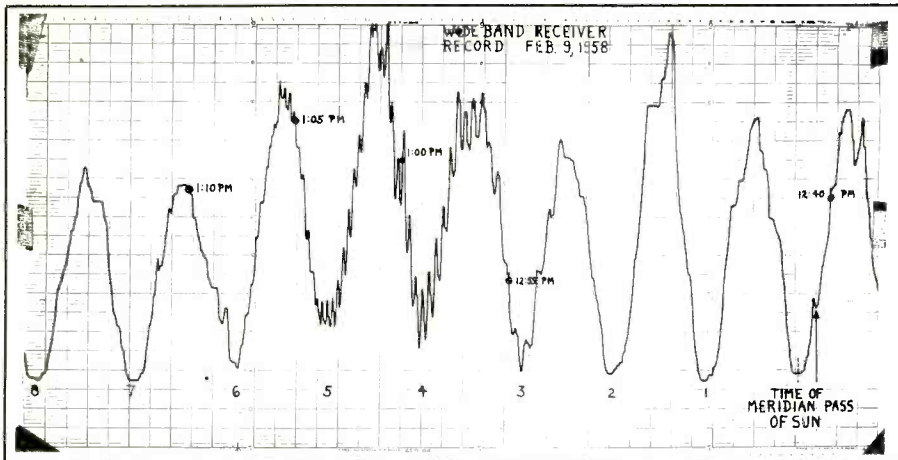

Figure 3. Interferometer record of solar noise and EXPLORER I moving through the lobe pattern of a modified MINITRACK II system. The close-spaced lobes are due to the satellite, while the wide-spaced lobe pattern is due to the sun. Here the spacing between the two ends of the baseline was 55 wavelengths at 108 MHz which produces a great many lobes in the received amplitude pattern. Time increases from right to left.

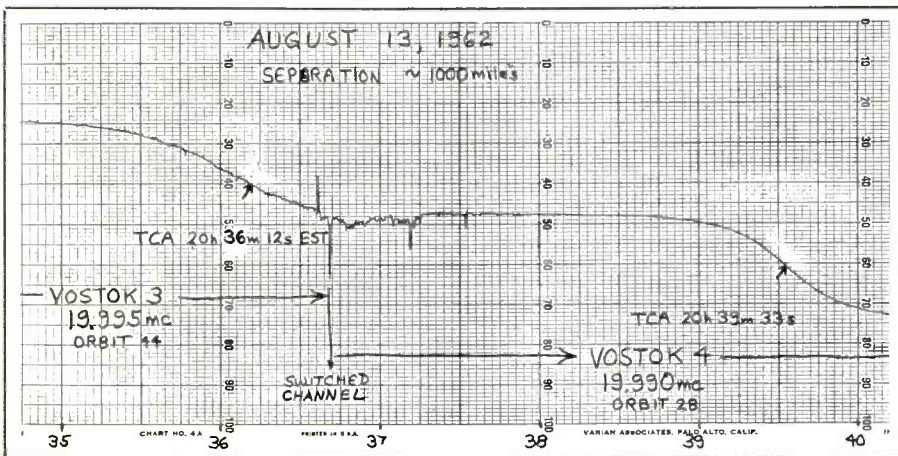

Figure 4. Doppler effect recording of beacon signals from two VOSTOK satellites indicating a separation of about 1000 miles. After recording the signal from VOSTOK 3, the receiver was returned to VOSTOK 4 allowing the signal to be recorded on the same chart. The phase-locked doppler tracking loop operating at the 455 kHz IF of the receiver results in quite narrowband performance and a smooth doppler frequency output signal. Time increases from left to right.

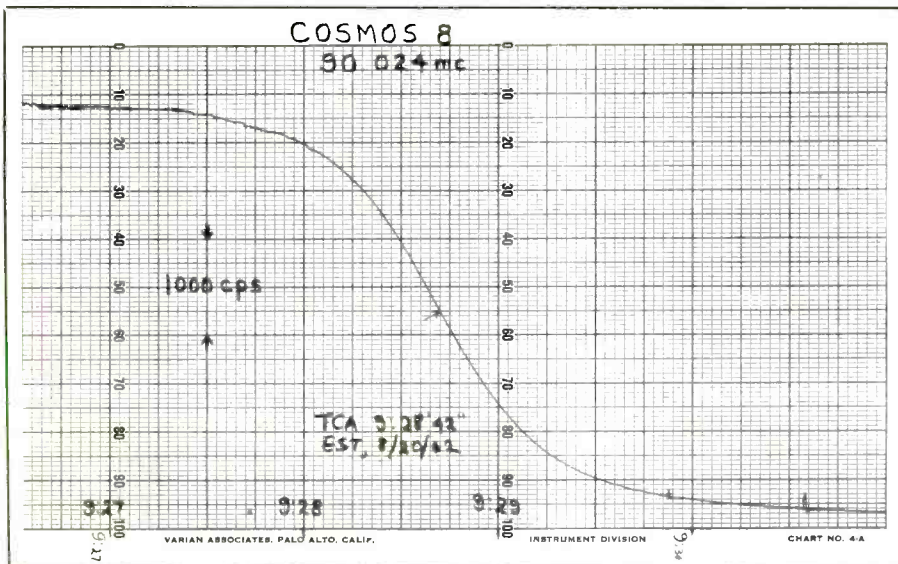

Figure 5. Doppler record of one of the USSR COSMOS series on 90 MHz illustrating the TCA or Time of Closest Approach inflection point of the curve. Time increases left to right.

SE SIGNAL ENGINEERING'S
High Performance CB Antennas

SUPERHAWK
\$114.95

WHITE LIGHTNING
\$199.95

DPX 2000A
\$149.95

LIGHTNING 6

LIGHTNING 6
\$359.95

THE most POWERFUL
CB base in the world today!

All SE PATENTED rotary beams are true quads and OUTPERFORM their counter parts (quad/yagi types). SE's patented SFS matching system makes SE QUADS the most technologically advanced antennas in the world today. If your dealer doesn't have SIGNAL ENGINEERING, write or call for full specs. DEALER inquiries invited.

SIGNAL ENGINEERING
2624 Fayette Drive, Mountain View, CA 94040
(415) 948-3833

SUPER LONG PLAY TAPE RECORDERS

10 Hour Model - \$95.00*
14 Hour Model - \$159.00*

Modified Panasonic Slimline. high quality, AC-DC Recorders provide 5 or 7 continuous hours of quality recording & playback on each side of cassette for a total of 10 or 14 hours depending on model. Built-in features include • Voice level control. • Digital counter. etc. TDK DC 180 Cassette Furnished.

PHONE RECORDING ADAPTER

Records calls automatically. All Solid state connects to your telephone jack and tape recorder. Starts recording when phone is lifted. Stops when you hang up. **\$24.50*** FCC APPROVED

VOX VOICE ACTIVATED CONTROL SWITCH

Solid state. Self contained. Adjustable sensitivity. Voices or other sounds automatically activate and control recorder. Uses either recorder or remote mike. **\$24.95***

*Add for ship & hdlg. Phone Adapter & Vox \$1.50 ea. Recorders \$4.00 ea. Cal. Res. add tax. Mail order, VISA, M/C, COD's OK. Money Back Guarantee. Qty. disc. avail. Dealer inquiries invited. Free data.

AMC SALES, Dept. 9335 Lubec
St., Box 928, Downey, CA
(213) 902-1196 869-8519

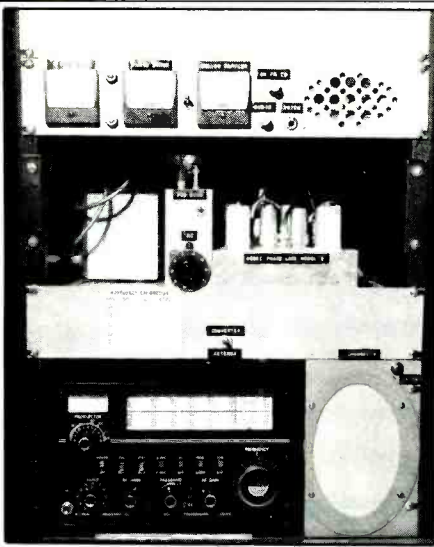

Doppler tracking filter using 455 kHz output from Drake receiver-converter.



28-foot dish with log-periodic feed for 90 MHz–1300 MHz, circa 1964.

MHz. We even published a paper in the science weekly *Nature* on determining orbits from single station tracking data based on our first observations of EXPLORER I, and tracked virtually all of the early satellites launched with known radio beacons including the first USSR manned VOSTOK satellites, and the early USA Mercury flight with John Glenn. Home-brew phase-locked tracking loops and low-noise receiving pre-amplifiers were fabricated long before these became popular. In those days our data was sometimes used by various government agencies and the press services for confirming satellite orbits or observational information. (See Figures 3-7 for examples of various data from doppler or multiple-lobe interferometer recordings.)

The Sohio satellite tracking hardware was finally given to Ohio University in Athens, Ohio in late 1965 where it was used for a few years for weather satellites and to augment tracking of the Echo Balloon reflection mode satellites in a cooperative program with Ohio State University in Columbus,

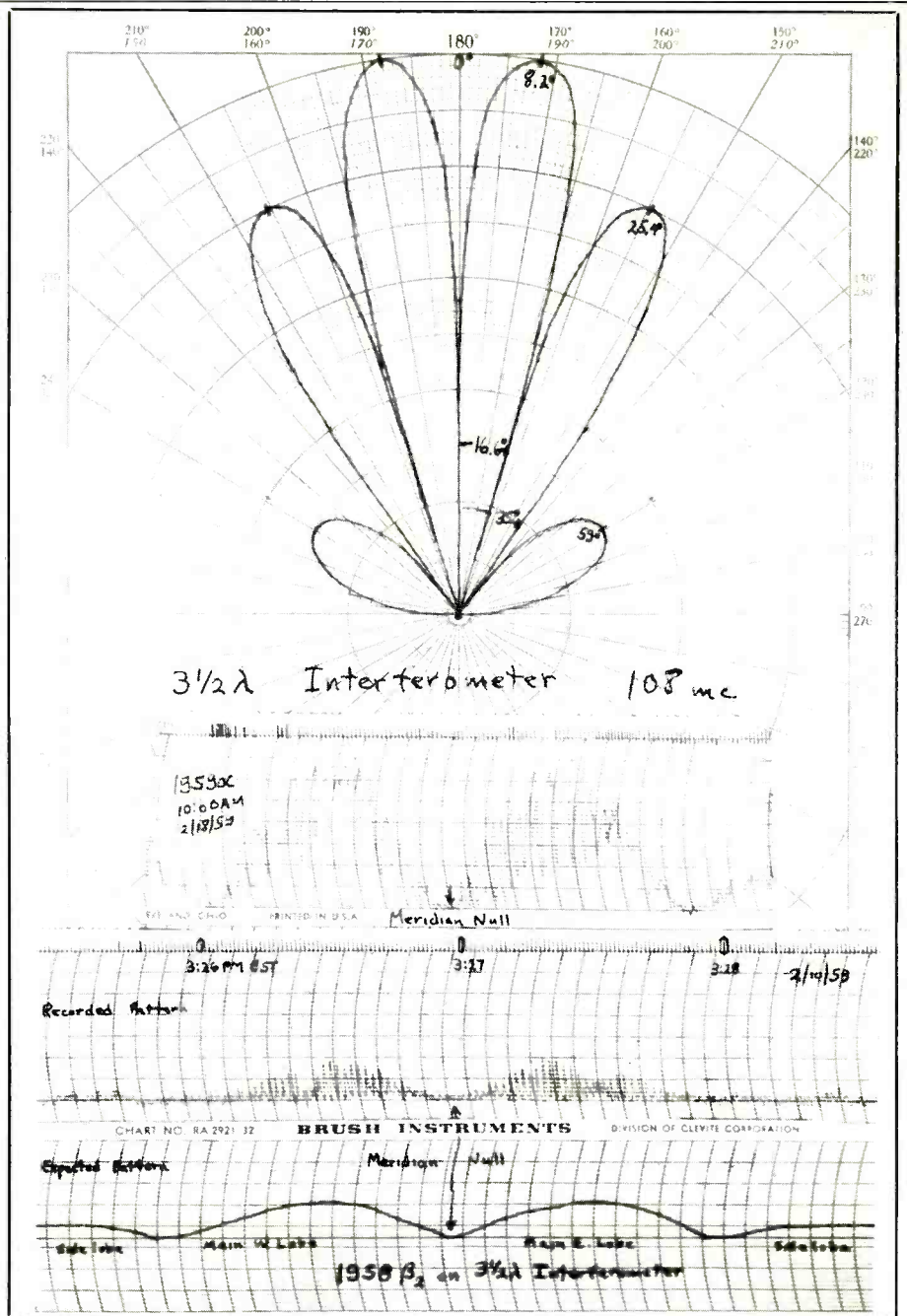

Figure 6. Various data from interferometer recordings.

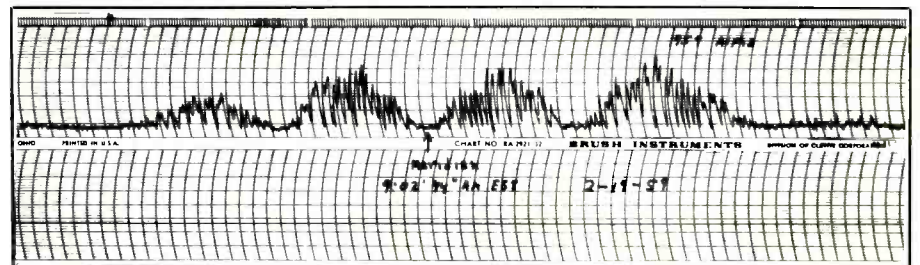

Figure 7. Lobe pattern of $3\frac{1}{2}$ wavelength, 108 MHz interferometer.

Ohio. The equipment and antennas are no longer around but memories of the early days of the "space era" and the exciting discoveries still persist. I am retired from lecturing and research here at Ohio University and have specialized in VLF-RF engineer-

ing problems for the past 20 years but still enjoy some SWL activity and particularly monitoring the VLF-LF bands from 10 kHz to 500 kHz. I note that the USSR still sometimes uses 20 MHz for satellite beacons, also used on the earliest SPUTNIKS. PC

PIRATES DEN

BY EDWARD TEACH

FOCUS ON FREE RADIO BROADCASTING

Let's start things off this month with some very interesting information supplied by Paul A. Rusling of Herne Bay, Kent, England who corrects and adds to some data on the European pirate situation carried here a few months back.

Laser 558—This station's ship, The Communicator, did not come close to sinking, despite earlier press reports. The captain was ill and, fearing for the safety of the crew, he brought her in under her own power. Paul says the writ on the ship was his, in the amount of 7,020 pounds sterling which was owed for his assistance [as Paul put it, "I sort of built it for him" (the owner)]. The ship, owned by an Irishman, was sold to East Anglian Productions for 35,000 pounds sterling and the U.S. connection was simply an advertising "front."

Radio Caroline is now running a Hits format, using 3 kilowatts on 558.

The Dutch station, **Monique**, is on 963 kHz with 17 kilowatts. The station's shortwave usage amounted to only a few evenings last January when a 20-watt ship-to-shore transmitter operated on 6273. The station owner, Ronan O'Rahilly, closed down the shortwave broadcasts, feeling that using shortwave might make it more likely that British authorities would act against the ship. A New York advertising salesman, Vincent Monsey, has said they will go on shortwave with 5 kw soon, but Paul says the third transmitter on board is very incomplete and impossible to use.

Stereo 531 was put together by Paul using a 50-kw RCA transmitter obtained from WZZD in Philadelphia and a 10-kw Collins rig formerly at WFNC in North Carolina. Both were purchased last December, shipped to Spain and installed on board the "Nannel" with a 240-foot tower. However, the ship's owners have run out of money and haven't taken delivery of the AM exciter. Frequency was to have been 576 kHz (not 531). Paul says he's no longer associated with this group. Thanks very much for the excellent information Paul and perhaps you can keep us updated with other pirate news from your part of the world.

A new pirate which was to have begun broadcasts around the first of August is **KLES** based in the Los Angeles, CA area. KLES was to use 250 watts into a half-wave dipole antenna and operate on 1600 kHz. The planned programming includes old time radio shows, jazz, big bands and polkas. The address is P.O. Box 178, Sunland, CA 91040.

TFTN, the widely heard Canadian pirate, continues to be reported by readers.

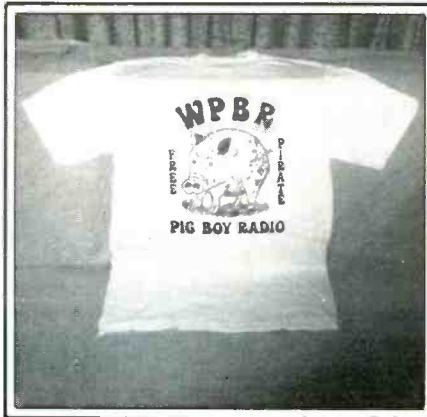

Elmer Cronkright got this attractive T-shirt from WPBR.

Don Feldman in California has noted them on a variety of frequencies, including 7228, 7374, 7415 and 7474 on Friday, Saturday and Sunday evenings. Don says TFTN planned to shut down or cut back on their broadcasts for the summer and resume again on 3 October. Neil Ragsdale in Mt. Shasta, CA talked to the station op who says the weekend broadcasts run from 2200-0200 UTC (though they've been reported far later into the night than that). Power on shortwave is 150 watts. Telephone requests to: (604) 537-4455 and mail goes to TF-TN, Dept. 16, Box 4276 Station A, Victoria, BC V8X 3X8. Also heard by Elmer Cronkright in Wyoming, MI on 3 July at 0348 on 7440 and by Mace Twiggs in Crosby, MN on several occasions on 7440, 7415, 7373, 7474, 7484, 7406 and 7420.

Apologies to Mace for assigning him the



Here's a typical pirate transmitter installation; this one belonged to KCFR.

wrong gender in a past column. Mace reported a number of pirate loggings and here are some of the more recent ones:

Canadian Club Radio heard 9 July at 0242 sign-on to 0401 on 7440 with Canadian rock. Address given was Box 140, 3090 Danforth, Toronto, ONT, M1L 1V1.

Voice of Foomar heard on 7 July from 0105 sign-on to 0137 sign-off on 7423. Reports go to the P.O. Box 245, Moorehead, MN 56560 address.

Radio North Coast International was found on 30 June from 0046 to 0103 on 7423 with jazz. Elmer Cronkright also had them on 7440 starting at 0045 and announcing the Moorehead address. The DJ was "Captain Willy" who played rock, country and TV themes.

Zepplin Radio Worldwide was heard on 7 July from 0046 to 0103 sign-off on 7423 playing jazz. Elmer Cronkright had them at his Michigan location from 0045. The Moorhead address works for this one as well.

Jeff Wieglos in La Grange Park, Illinois ran across an unidentified Candian pirate on 8 July using 7440 at 0252 and playing new wave rock. Sounds like Canadian Club Radio from your description, Jeff.

Several readers sent in copies of news stories about the capture of "Captain Midnight" who disrupted HBO's programming with a protest message last April. Since the story has been widely reported in the normal news media I won't go into any further details here, but thanks to those of you who sent the material in.

Speaking of sending in material, a reminder that your input is needed. Loggings, certainly. But also background information on pirate stations and any pirate-related news items you happen across. The illustration files are always in need of additions—particularly station photos and literature as well as QSLs. If you have extra QSLs which you can spare those are a real bonus, illustration-wise and "xerox" copies are okay.

Now that we are into the Fall listening season it is usual for pirate activity to increase. As most pirate DXers are aware, the place to look is the 7300-7500 area since that's where most of the pirate activity on shortwave occurs. Also keep an ear on the area just above the top of the AM band which can produce more localized pirate activity. Weekend afternoons and evenings are the most likely times. Christmas Eve and New Year's Eve should be very active.

I'll be back next month and we'll sail the pirate waters again. 'Til then, keep 'em flying!

PC

THE EXCITING WORLD OF RADIOTELETYPE MONITORING

Want to add some excitement to your RTTY monitoring? How about getting one of the new facsimile converters that have come on the market for the shortwave radio listener?

Imagine this: You've just finished getting a printout of news copy from a RTTY press station. Now you connect your FAX converter between your HF radio and printer and tune in the FAX signal of the same press station. Voila! You have an instant newspaper as you obtain a picture that accompanies the news item.

What agencies use FAX? Many of the ones you're used to viewing with RTTY traffic. There are the weather stations at Moscow, Paris, Grengel, Bracknell, Tokyo, and many others. Press photo senders include DPA, KCNA, UPI, Jiji, ADN, ANSA and PAP. Military stations are represented by the Navies of the United States, Chile, Great Britain, Argentina and France. You'll also find the U.S. Coast Guard; WLO Marine Radio at Mobile, Alabama; the U.S. Department of Interior and aero stations at Dakar, Senegal; Honolulu, Hawaii; and Lisbon, Portugal. The list is extensive.

HF radio is not the only place where you'll find FAX transmissions. They can also be monitored from satellites such as SATCOM F2 and Galaxy 1. By the way, RTTY copy is beamed down from these satellites as well as INTELSAT 4.

In the past, hobbyists sometimes had to buy very expensive equipment to receive FAX transmissions or possibly be plagued with poor quality pictures if they bought some of the cheaper units. But now enthusiasm is being shown for Universal's new Info-Tech M-800 Fax Converter manufactured by Digital Electronic Systems, and introduced to the public last August. It retails for \$599 and relies upon dot-matrix computer printers to provide clear pictures.

Drop a hint that you want a FAX converter to be your Christmas present. After you receive it, connect it to your receiver and printer, turn it on, and send us the resulting printouts for reproduction on these pages.

Bill Farley, WA5FLG, of New Mexico, asks for a guide to decode the coded RTTY weather data he monitors. Look for this in Joerg Klingenfuss's *Air and Meteo Code Manual*, available at several stores that cater to the SWL.

Thanks, Bill, for the supposed ID to the logging at 139.5 that appeared in last August's column. But 139.5 here is in kilohertz, not megahertz, and would not be from a satellite. David Wilson of Connecticut says the logging is that of Canadian military station CIF from Borden, Ontario. This

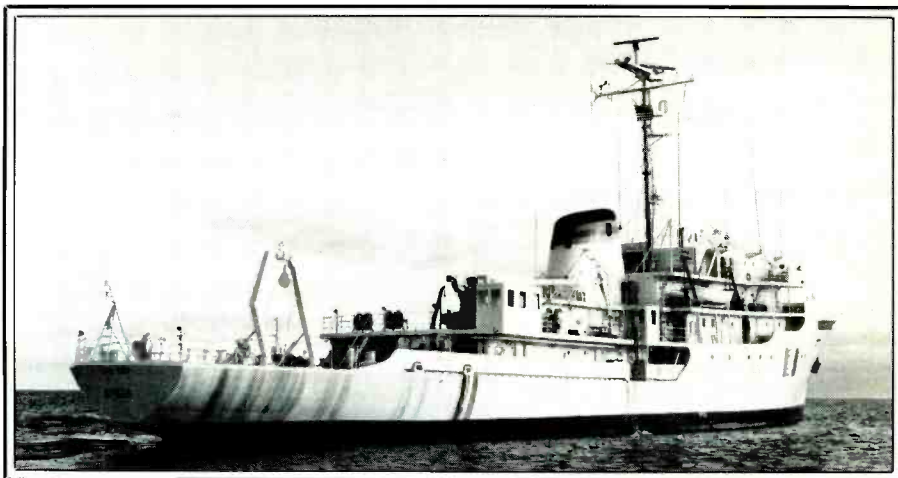

The USNS Wyman (T-AGS 34) uses RTTY comms as it surveys the ocean floor for the U.S. Navy Oceanographer. On board are 41 civilians and 20 scientists. (Photo courtesy U. S. Navy)

same station was also logged on 183 kHz, he says. He further identifies the transmission on 5022.5 as that of CHO from St. Hubert, Quebec. Wilson says that 5125.5 kHz, also cited in the loggings section, is a known Canadian military frequency but he has no definite ID. Thanks, Dave!

U.S. Army M/Sgt David C. Freed, stationed in West Germany, a regular contributor to these pages, writes to tell us that he is vying to become a licensed operator in the U.S. Army MARS program at his base. He is working in the media of voice and RTTY communications.

He adds that he is using two more antennas to complement the one that was constantly being cut down by the base grounds-

keepers (he has restrung the abused antenna). "I've been able to receive and copy many more stations than before," he says, adding that "my distance in miles coverage has expanded greatly." Here's hoping the groundskeepers don't try to have three times as much fun by attacking all your antennas!

Thanks, Sarge, for the pix of you and your radio shack. Too bad the photographer didn't use flashbulbs. The photos were too dark for use here. Please try again and resubmit them to us. Also, we're always glad to use photos of this column's readers and their monitoring equipment.

Bob Roehrig, K9EUI, from Illinois: Yes, there are stations on shortwave radio that

Ship Directory

Call Sign	Name of Ship	Call Sign	Name of Ship
ELFD4	Akoe	ELCF3	Oak Sun
SWUM	Antipolis	3FZV	Oriental Hope
ONAG	Balder Antwerpen	KBCF	Overseas Chicago
SQDL	Cedynia	DDQS	Pharos
DVYW	Dagtab	5LGG	Prow 1
3EPI	Dagwood 101	PPNT	Rio Branca
DZBA	Extraco 2	LECK	Royal Viking Sea
WBVY	E Exxon Charleston	EGYZ	Saja
BZXJ	Frotachile	HZOP	Saudi Riyadh
7FKY	Global Highway	C6DN	Scandinavian Sun
ELAS3	Horncap	GBBA	Sea Princess
P3EB	Johanna Schulte	VXZF	Trinity Bay
LYIR	Kokand	WRGL	Valley Forge
GXEK	Lackenby	9VMU	Viva
KWJE	Lay Barge 29	WEHJ	Western Sun
LYFI	Marshal Novikov	BORI	Zhong Tiao Han
C6BB3	Mermoz	4XIL	Zim New York
TCFS	Mohac		



Loyal POP'COMM reader H.J. "Tink" Schaffer of Winston-Salem, NC says, "I do all the SWLing and Hamming right here in the same shack . . . I do quite a bit of RTTY work, both amateur and shortwave listening." Thanks for sending in the photos, "Tink."

use 75 wpm (57 baud) RTTY and ASCII RTTY. Tune to 12132 and you'll find several Mexican government stations sending Telexes at 75 wpm; and try 20876 at 850/110N in the ASCII mode to copy XQ8AFI, the Cerro Tololo Observatory, Chile, as it sends astronomy messages to KFK92, Kitts Peak Observatory, Tucson, Arizona.

The first of two supplements to Ulrich Krebs's *RTTY-Handbook* was issued recently. Consisting of 20 pages, it is devoted mainly to stations using ARQ, FEC, TDM, or encryption devices. These supplements, which update the frequency guide, cost 27 Swiss francs for both and are available from Poly-Verlag, Spranglenstrasse 30, CH-8303 Bassersdorf, Switzerland.

Frequently, I receive letters from readers asking about the use of computers such as the Commodore 64 and various RTTY software used with the computer. I'm sorry to say that I am unfamiliar with all computers except for the IBM PC, which I use only for word processing, and not at all for RTTY reception. My own RTTY monitoring layout consists solely of a radio receiver, RTTY demodulator and a video monitor. I am equally unfamiliar with the various software on the market for use with RTTY. So, please direct all questions about this topic to the dealer from whom you bought your computer (and that includes the IBM line) or software. They're trained to help you. I'm not.

Before we move on to the loggings section, I wish to extend my heartfelt thanks for your enthusiastic support of this column. May the coming holidays be your best Christmas and New Year's ever!

Now let's see what Santa Claus would be monitoring if he wasn't so busy getting ready for his annual gift-giving journey . . .

Ye Olde Holiday RTTY Log:

2360: Test tape says UBDB DE UBDBFE. Was 50 at 2350 UTC (Peter, England). Wonder if this is UBD in Tabynsk, USSR-- Ed.

2382: RYRY & foxes + TEST DE UBDA, 50 wpm at 2351; was // 2608 & 2750 kHz. Same type of xmsn as 2360 kHz (Peter, England). Probably same station, too-- Ed.

2515: Un-ID station w/test tape at 50 wpm (Peter, England). Four possibilities are Brest & Vitebsk in Belorussian SSR; Volgograd in Russian

Abbreviations Used In The RTTY Column

AA	Arabic
ARQ	SITOR mode
BC	Broadcast
EE	English
FEC	Forward Error Correction mode
FF	French
foxes	"Quick brown fox..." test tape
GG	German
ID	Identification/ied
MFA	Ministry of Foreign Affairs
nx	news
PP	Portuguese
RYRY	"RYRY..." test tape
SS	Spanish
tfc	traffic
w/	with
wx	weather

SFSR; & Sidon, Lebanon. All known to use RTTY on this freq-- Ed.

2667: Another un-ID station w/test tape at 50 wpm. Noted at 0400 (Peter, England). Could be either Aix-en-Provence or Strasbourg, France as they both use this freq-- Ed.

3199: RYRY + TEST DE UBDB at 50 wpm at 2345 (Peter, England). Same guess as 2360 kHz-- Ed.

4196.4: 54HDZ, one of those Spanish Navy units, w/RYRY & SGSG, 850/100R at 0100 (Ed.).

4215.2: Un-ID station runs RYRY around 2200 at 500/66R. "Has been on for months & I've never logged anything other than RYRY" sez Fred Hetherington, FL.

4232: HWN, Paris Naval R., France, noted at 1945 at 66 wpm (Ary Boender, Netherlands). Ary joins our close-knit group this month, thus further expanding our RTTY observations from Europe-- Ed.

4290: IAR, Rome R., Italy, w/navigation warnings at 66 wpm, 2000 UTC (Baender, Netherlands).

4532: Tokyo, Meteo, Japan, w/wx at 1126, 850/66N (Michael Walker, TX).

4607.3: 51DEL, Spanish Naval unit w/RYRY & SGSG, 850/100R at 0125 (Ed.).

4848.3: "Very quick brown fox" tape from un-ID USN station at 0T14, 850/100N (Ed.).

4852.7: Another "Very quick brown fox," this time in FDM mode (120/100N) from a USN station (un-ID) at 0117 (Ed.).

5203: FIT, Prefecture of Police, Paris, France w/police tfc in FF at 0005, ARQ mode (Hetherington, FL). Nice catch, Fred!-- Ed.

5217.4: FUM, French Naval R., Papeete, Tahiti, in TDM mode w/FF tfc to FUJ at Noumea, New Caledonia at 0935 (Hetherington, FL).

5335.2: RDM78, Tbilisi, USSR w/wx data at 0200, 520/66N (Hetherington, FL).

5841.2: AFP, Paris, France, w/FF nx at 0016, 425/66N (Tom Brailey, MI).

5907.5: Un-ID w/foxes + TESTE DE RPFN at 0315, 850/66R (Brailey, MI). RPFN is the ID used by Monsanto Naval R., Portugal-- Ed.

6252: 78EAL of Spanish Navy tests w/72JKL using RYRY & SGSG at 0736, 425/100N (Albin Magliano, Tahiti). 78EAL reputed to be Spanish Navy at Las Palmas, Canary Islands-- Ed.

6269: JRAE w/RYRY at 0310, 170/66N (Jim Navary, VA). This is the Soviet freighter OLGA ULYANOVA out of Leningrad-- Ed.

6340.5: NRPI, USCGC GENTIAN testing to NAMN at 2120, 170/100R (Daryll Symington, OH).

6787.6: Moscow Meteo, USSR w/wx data in TDM mode at 1000 UTC. Ends BC in EE announcing that next forecast to be issued 1 week later (Hetherington, FL).

6792: PDB, INTERPOL in Utrecht, Holland sending police message in ARQ to FSB of INTERPOL, HQ Paris (St. Cloud), France at 1300 (M/Sgt David Freed, US Army, West Germany). Kneitel's book *Guide To Embassy & Espionage Communications* lists this as PDB2 in Bilthoven, Holland-- Ed.

6943: VOA nx BC in SS from Tolya, Japan to S. America at 1120, 850/66R (Hetherington, FL).

7474: TJK, ASECNA, Douala, Cameroon, w/aero tfc in EE at 2201, 425/66N (Brailey, MI).

7945: Encrypted tfc in USN net at 0403, ID'd via USB voice comms involving 6 Romeo, 6 Bravo, 8 November, & 9 Golf (Ed.).

7960.3: IRNA nx in EE from Teheran, Iran, much about war with Iraq at 1958, 66 wpm (Freed, West Germany).

8085: Coded wx from Khabarovsk Meteo, USSR, 425/66N at 0130 (Guy Atkins, MA).

8165.2: 5YD, Nairobi Aero, Kenya w/RYRY at 2223, 425/66N (Ed.).

8346: HCLA, M/V SANTA ROSA, an Ecuadorian ship w/ETA message at 2244 in ARQ (Ed.); KEJD US SPRAY, w/tfc to WLO at 0015 in ARQ; HPTF the CHOGUAN also to WLO in ARQ at 0439 (Jim Hartung, MD). Hope these corrections help, Jim: KEJD is GULFSPRAY, a Gulf Oil Co. tanker; HPTF is CHOLGUAN, a Panamanian flag reefer-- Ed.

8350: C6CB, the Bahamian ship YORKTOWN, working Partishead R. at 2338 in ARQ (Hartung, MD). This one transports heavy cargoes-- Ed.

8452: Kalingrad R., USSR w/RYRY & navigational warnings at 66 wpm at 2120 (Boender, Netherlands).

8684.5: ARQ phasing signal noted at 1642 from Rogaland R., Norway. Was ID'd via its LGB TLX marker in CW (Ed.).

9340.8: MKK, the RAF station in London, w/RYRY & foxes at 0130, 170/66R (Hetherington, FL).

9469.3: OBC, Callao Naval R., Peru, to LOL Buenos Aires Naval R., Argentina at 0100, 850/100N (Hetherington, FL).

9846: TUH w/RYRY at 0212, 425/66N (Navary, VA). That's the ASECNA office in Abidjan, Ivory Coast-- Ed.

10122: Un-ID aero station w/tfc at 1844, 425/66N (Wolfgang Palmberger, West Germany).

10337.3: Mystery station of the month: un-ID w/foxes & 1 to 0 count at 850/66N from 1323-1700. Returns at 2025 on 10338.3 kHz w/same tape then shifted 200 Hz higher in freq to 10338.5 kHz at 2035 to send encrypted tfc at 200/100N. Off the air at 2039. Any ideas? (Ed.).

10358: Royal Norwegian Army tfc in Norwegian air at 2010, ARQ (Palmberger, W. Germany).

10796: KYODO nx in EE from Tokyo, Japan at 0228, 425/66N (Magliano, Tahiti).

11013.3: Argentina battles Czechoslovakia-- but but in the semifinals of a tennis match! Was reported in SS by DyN, Buenos Aires at 1541, 850/100R (Ed.).

11105.2: Un-ID Soviet wx station w/coded BC in Cyrillic at 0307, 500/66R (Ed.).

11150.1: "QRV QRV QRV DE VOA WASHDC CALLING" + RYRY at 1550, 425/100N (Ed.).

11419.7: Nx in Vietnamese from VNA, Hanoi at 1430, 500/66R (Ed.).

NEW!

WE MOVED

RADIO WEST**(619) 726-3910**

Suppliers of

- Shortwave Radios
- Antennas
- Books
- Expertise

NEW LOCATION

**850 ANNS WAY DR
VISTA, CA 92083**

Call or Write For A Catalog . . . \$1.00

CIRCLE 3 ON READER SERVICE CARD

Station Manager/Code Tutor The Fun Way To Learn Morse Code

A self teaching guide to learn code, proceed at your own pace. Taught by a time proven way. Adjustable speed and tone. Random practice to prevent memorization.

Designed for the IBM® PC®, XT® PCjr®. Menu driven, prompts for easy use; full color displays; or specify no color. \$15.95 + \$3.00 s/h (Ohio residents include sales tax.)

Also available: a General Purpose Logging Program. Write for information.

OMEGA CONCEPTS, INC.

Professional software for the Radio Amateur

P.O. Box 615
Troy, OH 45373T.L. Jones (KB80A)
Author

IBM is a registered trademark of International Business Machine Corp.

Please send all reader inquiries directly.

TRANSPORTABLE LONG RANGE COMMUNICATIONS

Our "HIGH TECH" TW100F Fly-Away Radio is a complete long range transportable communications system. The advanced microprocessor controlled SSB Transceiver covers the frequency range 1.6 to 30MHz in 100Hz increments and stores up to 100 channels in permanent memory. The Internal Antenna Tuner permits the use of random length wire antennas or poorly matched dipoles. The TW100F operates directly from 12 volts DC or 115/230V AC using the internal power supply. The TW100F is not just a transceiver packaged in a suitcase, it is specially designed integrated system installed on shock mounts in a rugged aluminum carrying case conforming to IATA standards for storage under the seat in commercial aircraft. The special design with on-demand forced air cooling has enabled us to combine high power with small size and exceptionally low weight. The TW100F contains a handset, antennas and power leads for battery and AC operation.

Available under GSA contract

- 1.6 - 30MHz (100Hz steps) • 125 Watts PEP output • 100 Memory channels
- 115/230V AC and 12V DC • Internal antenna tuner
- Case size 11 1/2" x 21" x 10" in (18 x 53 x 33 cm) • Weight 31 lbs (14kg) with access.
- Made in U.S.A.

TRANSWORLD
for communications

 TRANS WORLD COMMUNICATIONS
240 Pauma Place, Escondido, CA. 92025 USA, Phone (619) 747-1079, Telex 695-433
A subsidiary of Datron Systems, Inc.

CIRCLE 71 ON READER SERVICE CARD

11430: KCNA, Pyongyang, N. Korea w/RURY + nx w/EE nx at 1500, 275/66R (Ed.).

11494: Nx in Polish from PAP, Warsaw at 1228, 425/66R (Ed.).

11536: Non-stop text in FF discussing worldwide mil affairs from 1232-1317, 350/66N, un-ID station left the air at 1322 (Ed.).

12245: Jeddah Meteo, Saudi Arabia noted 1534-1600 w/coded wx, 350/66N (Ed.).

12251: ADN nx in EE from Berlin, East Germany at 1733, 400/66N (Dallas Williams, CO).

12263: N'Djomena, Chad, w/coded aviation wx & aviation related tfc in FF at 1604, 170/66R (Ed.).

12315: TASS nx in EE from Moscow, USSR at 1736, 425/66R (Williams, CO).

12494.4: FNXZ, French cargo ship PENGALL w/ARQ tfc at 2226 (Ed.).

12498.5: 9VDN, Singapore cargo ship ALDEBARAN w/position report, ARQ at 2311; XCTO, Pemex oiler TOLTEC w/crew list in ARQ at 1721; KRHL, the cargo ship GREEN WAVE w/"HOW COPY GA" in ARQ at 1712 (Ed.).

12500: DILZ, the West German ship SANDRA ESWESCH w/tfc to Berne R., Switzerland at 1917, ARQ (Hartung, MD). The actual name is SANDRA WESCH, a heavy cargo carrier out of Hamburg, West Germany-- Ed.

12515: ZENA, the Hong Kong flag bulk-carrier LANTAU PEAK w/tfc to KLC at 1513, ARQ (Ed.).

12787: NMO, USCG in Honolulu, HI to NODL at 0635, 170/100R (Magliano, Tahiti). NODL is the callsign of USCGC FIREBUSH, a CG seagoing buoy tender-- Ed.

13080: HEC13, Berne R., Switzerland w/DPA nx in GG via ARQ mode at 1930-1950 (Ed.).

13083: NMR, USCG San Juan, PR signing off w/un-ID vessel at 1725, ARQ mode (Ed.).

13400.9: "Save official material" noted in SS from Mintex (MFA), Havana Cuba to Embacuba, Panama, 500/66N at 1504 (Ed.).

13523: CCS, Santiago Naval R., Chile w/tfc in SS to CCYO at 1729, 850/66N (Williams, CO). CCYO is the Chilean Navy ship YELCHO, an oceanographic research vessel. It is the ex-USS TEKESTA, which served during WWII as a US Cherokee-class fleet tug. Many of Chile's naval ships are quite old and a number are USN WWII vintage. The YELCHO (with AGS-64) on her hull carries a survey launch on her fantail. The crew is 5 officers & 59 men-- Ed.

13647.5: OLI5, CTK Prague, Czechoslovakia w/RURY, 425/66N at 1155 (Tom Kneitel, NY).

13780: "HAV HAV DE SHAI SHAI HR NW ZNN SITN LK ZCA717 LR CZA085 PLS CFM AND QRX TKS" repeated via tape, ended at 1158 with "QRX TUNHO GBSK SK GBG." Was 425/50R. Probably Cuban diplo (Tom Kneitel, NY).

13925: Y3D5, Deutsche Post, Berlin, East Germany, w/RURY at 1725, 425/66N (Williams, CO).

13985.4: MFA, Havana, Cuba w/diplo tfc in SS to Embacuba, Guyana at 2245, 425/66N (Symington, OH).

14392.8: AGA7ZW, USAF MARS station in Zweibrucker Air Base, West Germany relaying telegrams via AIR. Many airmen noted they were participating in 70th international 4-day marches at Nijmegen, Holland. Was 850/100R at 1600 (Ed.).

15696.6: CLN484, PTT, Havana, Cuba in Moore Code at 1245. You need an M-6000 to decode this type of transmission (Ed.).

15776.3: ZRH, Cape Naval R., Fisantekraal, RSA calling NMN & sends RURY/foxes at 1344, 850/100R (Ed.).

15947.6: GXQ, British Army radio in London w/RURY & foxes at 1254, 425/66N (Ed.).

15965.8: Tfc in Dutch from an un-ID Dutch embassy sent in ARQ at 1327, also 5L groups (Ed.).

15984.4/15986.5: Duplex circuit involving Thai embassy at Ottawa, Canada on the higher freq. First noted on the higher freq at 1240 w/US-Thai trade nx & diplo msgs all in EE, 425/66N. QRU & off at 1255. Corrections to the nx copy came on at 1259 on the lower freq & then repeated on the higher freq. The Ottawa sta ID'd as HSF212NH "Thaiduta Ottawa." The embassy in Washington ID'd as HSF212WSN & also YANKKEE KNY24 (Ed.).

16000: Nx in FF from MAP, Rabat, Morocco which recently began using this freq for its nx bc. Look for it around 1500-1600 at 400/66R (Williams, CO).

16011: 5F groups at 1321, 500/66N. Ended abruptly at 1325 w/o msg being completed. Suspect this to be from a diplo mission in Cuba (Ed.).

16107: RURY & nx in FF from Diplo, Paris, France at 0455, 425/66N (Magliano, Tahiti).

16662.5: KGWT, the THOMAS G. THOMPSON, signed off w/WLO at 1903, ARQ. This is a Military Sealift Command vessel under control of the Oceanographer of the USN. It is used for oceanographic surveys & is assigned to the University of Washington (state) (Ed.).

16664: DASO, CCNI ANTARTICO, a West German cargo/container ship w/Telex in GG to Hamburg, ARQ at 1445 (Ed.).

16676: UZUR to UNM2 at 1400, 170/66N (Carol Kirk, CT). UZUR is the KOULIKOVO POLE, a Soviet ship contacting Klaipeda R., USSR-- Ed.

16702: UDXH sending RURY at 1356, 170/66N (Kirk, CT). UDXH is the GEORGIY LEONIDZE, a bulk ore carrier from Batumi, USSR-- Ed.

17095: 58JDQ of the Spanish Navy w/RURY & SSGS to 56UAZ at 1739 & 1934, 850/100R (Freed, West Germany; Williams, CO).

17141: Nx in Cyrillic about Communist Party in USSR sent at 1331 by UFN, Novorossisk R., USSR at 170/66N (Ed.).

17176: Msg in Cyrillic from Odessa R., USSR at 0536, 425/66R (Magliano, Tahiti).

17183: Nx in GG appears to be sent by Y5M, Rügen R., East Germany. Not listed on this freq. RTTY setting of 170/66R would suggest Y5M as source. Nx ran 1351-1359 & ended w/SK. One dispatch began "BT. CORR.: SECTE 2 ARTIKEL WASHINGTON: SIEHT VOG, 1986..." (Ed.).

17224.5: Telegrams & 4F tfc to LYHR sent at 1437 by UFN, Novorossisk R., USSR, 170/66N. LYHR is the Lithuanian SSR tanker SVERDLOVSK-- Ed.

17369.8: COY895, apparently Havana Naval R., Cuba w/RTTY phasing signal at approximately 500/100... 1342 UTC. Switched to CW & sent repeated B's. Then back to RTTY w/short 5F msg & into CW sending QRR, ZND2, ZNB, ZNN4 (Ed.).

18190: INTERPOL tfc in EE at 1753 (200/66R) from Paris. Dealt w/caut matters followed at 1800 w/weekly messages about drug trafficking. (Williams, CO). Kneitel lists the callsign as FSB59 on this frequency-- Ed.

18872: XINHUA, Beijing, PRC ends RURY at 0830, 425/66R (Palmerberg, West Germany).

19068.4: MAP nx in FF from Rabat, Morocco at 1615, 425/66R (Navary, VA).

20471.2: Foxes/RURY + PRUEBA DE CXR, Montevideo Naval R., Uruguay at 1310, 850/100R, (Ed.).

20879.9: CLP1, Mintex (MFA), Havana, Cuba w/5F groups & SS "circulars" to Embacuba, Algeria at 1834, 500/66N (Ed.).

PC

A World Time Clock

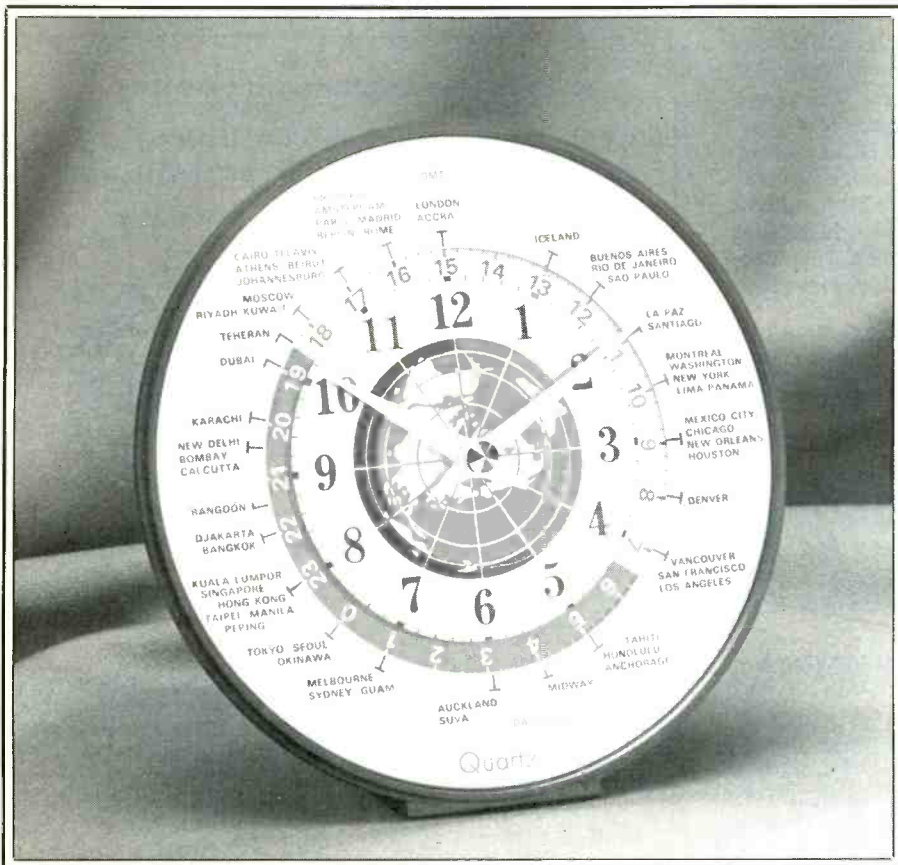

This is one of the most attractive analog clocks I've seen in years, and if you're like me, you're going to want one for yourself . . . and maybe another for a friend or relative.

The World Time Clock is marketed by World-Tech products, and is available in several different self-supporting styles—one of which is bound to be right for your needs. The WTC is a 12/24-hour timepiece operated by a "pencil"; that is, a 1.5-volt DC battery of the AA type. A quartz crystal oscillator operating at 32.768 MHz insures a mean daily accuracy of ± 0.5 seconds per day. A CMOS IC chip provides the required 'brains' at very low current drain, meaning that the battery you insert when you first acquire your clock will probably last for a year or so before it needs replacement. Your clock will operate over a voltage range of 1.25-1.7 volts, DC, and a temperature range of minus 10 to plus 50 degrees Celsius (+14 to +122 degrees Fahrenheit) and its temperature coefficient of change is only 0.05 seconds per day per degree Celsius in that range.

The World Time Clock is 6½" in diameter, displaying the time in the basic manner of all analog clocks: Arabic numerals from 1 to 12 on the gold-colored face, indicated by an hour and minute hand in gold; and a second-hand represented by a small red jet aircraft that circles a polar projection of the earth once each minute. Around the periphery of the number circle, there is a recessed black and silver 24-hour dial that moves with the time. The black portion represents nighttime hours, and the silver portion represents day time hours. Around the outside perimeter of the clock, in black letters on a gold background, are the names of the various cities of the worlds.

Your clock is set as follows to show local time and world times at a glance: By removing the back cover of the unit, you can insert a single "AA" battery in the recess marked for it. A UM-3 battery (or similar) is called for. The hour and minute hands are set to correct local time by means of turning a hand-setting knob at the rear of the movement. The world time is set by a knob which

rotates the black and silver disk until the correct hour appears at the time zone of your location. The hours from 0 to 23 then represent the hours of the full day, with those hours of silver on black representing nighttime locations, and the hours of black on silver representing daytime locations.

At the bottom of the clock face there is a dotted red line which denotes the International Date Line of our globe. If your home is located clockwise between the date line and the zero hour, cities in this region have the same date as yours, while other cities beyond this region have yesterday's date. Conversely, if your home is located counterclockwise between the date line and the zero hour, cities in this region have the same date as yours, but cities in locations beyond this region have tomorrow's date! It all sounds very complicated, but when you have the clock in front of you and set it to the correct local time . . . you can instantly see what time and what day (yesterday, today, or tomorrow) it is anywhere in the world. When the zero hour overlaps the dateline, the whole world has the same date, but only for an instant.

Frequently, I have the need to call Europe or Australia, and up until now have had a terrible time trying to figure out what time of day (or night) it is on the other side of the globe. Even worse, I have trouble trying to determine what DAY it is at the location I want to call. Now, the problem is over because I can tell at a glance what time of day or night it may be, and what day it is.

The entire clock face is covered by a protective dome of clear plastic which keeps dust and grease away from the dial and hands, yet permits you to clearly see the time. Your World Time Clock can stand up by itself on a 'foot' that projects from the bottom . . . or, you may opt to have your clock displayed in a smoky-grey acrylic plastic frame or stand, a clear Lucite frame, or even a frame with wood borders, at a small extra cost.

World Time Clocks are available also in silver or gold colors to satisfy your particular requirements. They are functional, accurate, attractive and very, very desirable. Prices begin at \$44.95 and go to \$89.95. Readers of *Popular Communications* may take advantage of a special introductory price discount of up to \$15.

World-Tech Products, Inc., 1233 Kapp Drive, Clearwater, FL 33575. (813) 442-5862, or 1-800-835-2246 (ext. 216) for orders only.

PC

Reviewed by Jim Gray, W1XU

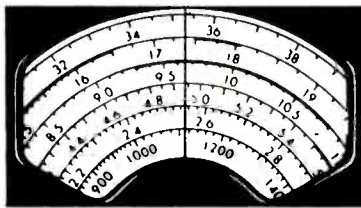

COMMUNICATIONS CONFIDENTIAL

BY DON SCHIMMEL

YOUR GUIDE TO SHORTWAVE "UTILITY" STATIONS

We were joined this month by several newcomers and to them goes a hearty welcome. One of the newcomers was Bjorn Otto Donnum who lives in Norway and is a member of the DAL Listeners Club in Oslo. His letter stated that he has been monitoring utilities for about one year and he has already received QSLs from approximately 70 stations in 42 countries from all over the world. Bjorn asked for a QSL address for a St. Louis station but it's just not possible to turn up information on a station when only the location is given. Many locations have multiple radio outlets and without the callsign of the station in question, I can not provide any identification comments.

I must offer a big thank-you to all readers who heeded my plea and are submitting their logs in the requested format. The separation of loggings by several lines is a big plus when I select items to be used.

Several questions must be taken care of before I receive some more to the same. A number of readers have asked for information regarding WKM. The data I hold shows the following: WKM West Haven Radio, Atlantic Marine Communications, 45 Victory Drive, New Haven, CT 06515. The station operates on 442, 500, 4244, 6418.5, 8502/8534, 12745/12948, 16978.4 and 22407 kHz. A traffic list is sent at 35 minutes after the hour and a WX broadcast is sent at 1300Z.

The next question to be answered is one that is frequently asked. What are the sources of QSL address information? One such source is the *Guide to Utility Stations* (4th Edition) by Klingenfuss. There are some 27 pages of world-wide QSL addresses. In addition, this book also contains a frequency listing of Utility Stations, callsign lists, callsign allocation, RTTY stations, Q & Z signals and other miscellaneous sections of useful information. This book can be obtained from many of the POP'COMM advertisers. Another publication that will provide you with QSL addresses is the *SPEEDX Reference Guide to the Utilities* and it likewise has other helpful information besides the QSL addresses. Ordering details should be requested from SPEEDX, 7738 East Hampton S., Tucson, AZ 85715. Also, from time to time, addresses supplied by readers are carried here in the column as is the case this month.

Both of the QSL replies received by Jerry Brumm, IL had many beautiful stamps affixed to the envelopes and the letter from Luanda, Angola was even forwarded to him via registered mail. Jerry pointed out that the address in the reply replaces the one shown in the Klingenfuss listing. Jerry also mentioned that he receives more responses from foreign utes when he includes a self-addressed, stamped envelope. He added that he has heard from a number of people that the International Coupon (IRC) system is breaking down and many overseas post offices will not accept the coupons either because the clerks do not understand them or because the particular government has decided, officially or unofficially, not to accept them. Jerry gets his foreign stamps from local stamp dealers as they generally have the most current stamps and know what the foreign mail rates are.

The POP'COMM RTTY Editor, Bob Margolis, left his TTY machines long enough to do some CW and voice monitoring and picked up two numbers transmissions with one on top of the other. The first one was on 9125 kHz at 0600 in AM with a YL/SS announcing "Atención 930-040" and then into 5F groups until 0613 at which time the broadcast terminated without the usual ending phrase. At 0610 the second YL/SS had come up on top of the 0600 message, announcing "Atención 954" and into 5F groups

UNITED STATES COAST GUARD COMMUNICATIONS STATION
PORTSMOUTH, VA. N-M-N

STATION: PATRICK O'CONNOR, SHORT WAVE LISTENER

TIME: 0016 Z

FREQ: 8765.4 KHZ

DATE: 22 FEB 86

MODE: A3J/USB

MAXIMUM OUTPUT POWER: 10 KW

MAXIMUM ERP: 400 KW

TX/RX ANTENNAS: VARIOUS

73'S

J. T. Doherty
J. T. DOHERTY
COMMANDER
U.S. COAST GUARD
COMMANDING OFFICER



Here is a USCG QSL sent in by Patrick O'Connor.

STATE OF IDAHO

JOHN V. EVANS
IDAHO TRANSPORTATION BOARD
JOHN W. OHMAN
LLOYD S. BARBER
MARION DAVIDSON
E. DEAN TISDALE



TRANSPORTATION DEPARTMENT

BUREAU OF AERONAUTICS AND PUBLIC TRANSPORTATION
3483 HICKENBACKER ST. BOISE, IDAHO 83705
PHONE (208)334-3183

May 6, 1986

Robert C. Homuth

Dear Mr. Homuth:

Your letter requesting information on the Mountain Home, Idaho, NDB has been referred to our organization.

The Mountain Home NDB was installed by the State of Idaho, Idaho Bureau of Aeronautics, in 1980. The facility was then turned over to the Federal Aviation Administration, who is currently responsible for its operation and maintenance.

The facility transmits on 333 KHZ with an identification of "STI" (Sturgeon Intersection) maximum transmitter output is 50 watts. The identification code is transmitted 12 times per minute.

The transmitter is a Wilcox Model 785E, 50 watt peak power.

The antenna system is of symmetrical "T" configuration. The height is 60', with the two poles set 450' apart. The antenna uses a double center downlead to the transmitter.

The counterpoise system consists of 16 radials, 500' in diameter. The radials are No. 8 AWG bare soft copper wire, with 8' ground rods at the radial ends.

The soil is basically a sandy silt, however, the facility was built on an old landfill site, so there is a mixture of miscellaneous material in the ground.

This facility has always given us good airborne range. (up to 150 miles). The NDB serves as a final approach fix for a nonprecision instrument approach to Mountain Home Municipal Airport.

I hope this information has been helpful.

Sincerely,

WORTHIE M. RAUSCHER, Chief
Bureau of Aeronautics and
Public Transportation

Larry A. Hippler
LARRY A. HIPPLER
Airport Development

Note this informative reply received by Robert Homuth.

CY CHEYENNE BEACON
353 KHz.
Robert Homuth, Phoenix, Az.
This Confirms Your Reception!
0500 UTC 12 APRIL 1986

POWER: 30 watts
ANTENNA: Vertical with flat-top
NOTES: Cheyenne non-directional beacon was on the air at this time and does have the Ident "CY" and operates on 353.0 KHz. FEDERAL AVIATION ADMINISTRATION AIRWAY FACILITIES SECTOR P. O. BOX 2027 CHEYENNE WYOMING 82001
SIGNATURE: Vernon Ray Homuth
AND STAMP: ET, Certification Official. 24 April 1986

A returned PFC sent to Robert Homuth, AZ.

until 0614 when it terminated with the ending of "Final Final." This is not the first time that errors have been noted for the numbers broadcasts. I recall that about 18 months ago I tuned into a 5F CW transmission and underneath the carrier was another 5F CW message and this was on top of a YL/SS in AM with yet a third 5F message. Then there was another incident about two years ago when I heard a YL/SS on 13428 kHz conclude a 5F groups transmission and a few minutes later the carrier came back on the air with the musical theme introduction of Radio Havana. A male announcer stated it was "Radio Havana Cuba" and a SW broadcast program commenced. Very quickly, however, the carrier was taken abruptly off the air.

Some very interesting material was received from Robert Homuth, AZ and he included some more addresses for QSLs from beacon stations. His letter stated in part "I am surprised that the stations I have logged seem so easy to QSL. I've noticed that the operators of the non-directional beacons do not have many long distance reception reports, so this would seem to be an excellent band for utility QSLers who need rare USA states or difficult-to-log DX countries not normally heard on the higher frequencies. So far, none of the stations I wrote had a ready made QSL card, so all of my replies are letters or returned prepared form cards. A SASE is vital for a USA reply, and one or more IRCs are needed for foreign replies."

Here are some beacon addresses: (* indicates 50/10 USCG station).

Call	Freq.	Address
AOP	290	DOT, FAA, RKS, AFSFO P.O. BOX 309 Rock Springs, WY 82902-0309
C	300*	Mobile Point Lighthouse c/o USCG Base Building 101, Brookley Complex Mobile, AL 36615
CO	407	Federal Aviation Agency Sector Field Office STOP 79 Petersen AFB Colorado Springs, CO 80914
CY	353	FAA Airway Facilities Sector P.O. Box 2027 Cheyenne, WY 82001
DDP	391	FAA Sector Field Office, 866J GPO Section San Juan, PR 00936

"DDP" runs 3000 watts, and is easily heard across the continental USA and Canada. Even though the station doesn't yet have a printed QSL card, their QSL letter indicates that they would greatly

appreciate detailed reception reports including reception quality, receiver used, fade-in/fade-out times, etc.

GUY 275 Aircraft Maintenance Service, Inc.
P.O. Box 1276
Guymon Airport
Guymon, OK 73942

This station runs 25 watts, but its central USA location may offer coast to coast reception.

H 310* Officer in Charge
Egmont Key Light Station
600 8th Avenue SE
St. Petersburg, FL 33701

"H" is located 30 miles south of St. Petersburg, Florida and has a navigational range of 170 miles. This lonely USCG outpost is out of range of FM broadcasts from Tampa, and the officer in charge of the light station was surprised I could log him in Phoenix, Arizona.

INE 521 Flight Services Station
Missoula County Airport
5225 Highway 10 West
Missoula, MT 59802

INE runs 250 watts into a tower antenna. With its high power, MCW mode, efficient radial system, and high frequency which borders on the bottom of the AM broadcast band, this beacon stands to be an easy non-directional beacon catch for those DXers without longwave capabilities!

M 316* South Pass Light Station
c/ USCG RADSTA New Orleans
4640 Urquhart Street
New Orleans, LA 70117

PB 317* Piedras Blancas, CA
S 322* Point Sur, CA
SC 294* Santa Cruz, CA
SL 288* San Luis Obispo, CA

All of the above Monterey Bay USCG light stations run less than 15 watts and are excellent band opening indications for southern California.

QSL: USCG Group
100 Lighthouse Avenue
Monterey, CA 93940

All of the above stations, except for the Monterey Bay stations either run high power, or are located in a favorable location, and might be heard across the USA! All have verified quickly with letters or prepared cards.

J. Hall, WA reports on two odd CW activities he has heard. One unidentified station at approximately 11190 kHz sends "KFSKFSKFS," followed by the letter "U" with accompanying whistling noises at times. The second mystery station he picked up was on 8002 kHz and he remarked that there seemed to be at least two stations involved, one very strong and one barely audible. "It always begins with someone sending 'OM OM OM' in CW along with 'VEE VEE VEE.' This type of transmission he also observed on 12269 kHz at 0250Z as follows: 'OM OM OM ER ER QSX BK 10438 10438 OM OM VEE VEE' and this appeared to be answered by '4SUU.' The first operator replied with 'OM QSX BK 10438 ER ER ZBR ZBR IEN IET EE.' This continued for about 20 minutes. The first calling party was so powerful it blew my S-needle over easily even with the RF gain at zero." Ed. Note: I have also observed this same activity and it was in the 14661-86 kHz region at 1909Z. The operator had a very sloppy, distinctive fist and would move a few kHz and call and then move a few more kHz, call again, repeating this procedure up and down the band. It was quite easy to follow him when he shifted because most often it seemed he left his carrier on at full strength and changed frequency. Possibly related to this strange operation was a station heard on 4654.4 kHz. This guy was sending V's followed by DE OP OP. He sent QSA4 so he must have heard the other end but it would appear the other end did not hear him because he continued to send V's and the DE OP

★ QUALITY PARTS ★ DISCOUNT PRICES ★ FAST SHIPPING!

SEND FOR FREE CATALOG... 48 PAGES!

ALL ELECTRONICS CORP.
 905 S. VERMONT • P.O. BOX 20406 • LOS ANGELES, CA 90008

10 AMP SOLID STATE RELAY
 CONTROL: 3-32 vdc
 LOAD: 140 vac 10 amp
 SIZE: 2 1/2" x 1 1/2" x 1 1/2"
\$9.50 EACH 10 FOR \$90.00

13.8 VDC REGULATED POWER SUPPLY
 These are solid state, fully regulated 13.8 vdc power supplies. Both feature 100% solid state construction, fuse protection, and L.E.D. power indicator. U.L. listed.

2 amp constant, 4 amp surge \$20.00 each
 3 amp constant, 5 amp surge \$27.50 each

RECHARGEABLE NI-CAD BATTERIES

AAA SIZE | 25V 500mAh \$1.85
 AA SIZE | 1.25V 500mAh \$1.85
 AA with slider tab \$2.00
 C SIZE | 1.2V 1200mAh \$3.50
 D SIZE | 1.2V 1200mAh \$3.50

PHOTO-FLASH CAPS
 170 mf 330v 75¢ ea. Three sizes
 CAT# PPC-170
 400 mf 330v 1.00 ea.
 CAT# PPC-400
 800 mf 330v 1.35 ea.
 CAT# PPC-800

48 KEY ASSEMBLY FOR COMPUTER OR HOBBYIST

NEW T.I. KEYBOARDS: Originally used on computers, these keyboards contain 48 S.P.S.T. mechanical switches. Terminates to 15 pin connector. Frame 4" x 9"
 CAT # KP-48 \$6.50 each
 2 for \$11.00

COMMODORE PRINTER/PLOTTER
 Commodore Model # 1520
 Four color X-Y plotter. Standard VIC serial interface allows easy connection to Commodore 64 computers. Up to 80 characters per line (upper and lower case) in four sizes.

\$49.95 each
 CAT # COM-1520
 EXTRA pen sets \$1.50 per set.

FLASHER LED
 5 volt operation red jumbo T 1 1/2 size \$1.00 each
 NEW GREEN FLASHER
 CAT# LED-4G \$1.00

MINIATURE TOGGLE SWITCHES

S.P.D.T. (on-on) Solder lug terminals \$1.00 each
 S.P.D.T. (on-off-on) Solder lug terminals \$1.00 each
 10 for \$9.00 100 for \$80.00

XENON FLASH TUBE
 3/4" long X 1 8" dia. Flash tube designed for use in compact camera flash units. Ideal for experimentors.
 CAT# FLT-1 2 for \$1.00

D.P.S.T. LIGHTED ROCKER SWITCH
 115 vac lighted rocker snap mounts in 3/4" x 1 1/8" hole
 Orange lens. 16 amp contact \$1.50

ULTRA-MINIATURE 5 VDC RELAY
 Fujitsu # FBR21NED005M20
 High sensitivity COIL: 120 ohms \$1.25 each
 CONTACTS: 1 amp 10 for \$10.00
 Mounts in 14 pin DIP socket

TOLL FREE ORDERS
 • 1-800-826-5432
 (IN CA: 1-800-258-6666)
 INFO • (213) 380-8000
 TWX • 5101010163 ALL ELECTRONIC

• QUANTITIES LIMITED
 • MINIMUM ORDER \$10.00
 • USA \$3.00 SHIPPING NO C.O.D.
 • FOREIGN ORDERS INCLUDE SUFFICIENT SHIPPING CALIF. RES. ADD 6 1/2%

MINI-PUSH BUTTON
 S.P.S.T. momentary normally open 1/4" bushing Red button. 35¢ each 10 for \$3.00

CIRCLE 77 ON READER SERVICE CARD

COPPER ELECTRONICS
 4200 PRODUCE ROAD - LOUISVILLE, KENTUCKY 40218
 Call us FREE **1-800-626-6343**
 or write for FREE Flyer.

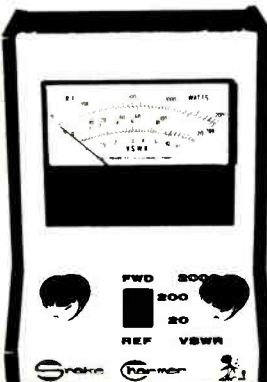

Snake Hammer
WATTMETER
59.95

6 LOT 54.95 12 LOT 49.95

SPECIFICATIONS:
 * Power Range: 20, 200, 2000 Watts
 * VSWR: Voltage Standing Wave Reading
 * Peak Reading During modulation
 * Accuracy +/- 5 percent on dead carrier

We have a national factory warranty service on many brands, and we service All CB, Amateur, and Commercial Equipment.

THE LOWEST PRICES IN THE COUNTRY!

CIRCLE 28 ON READER SERVICE CARD

BARBADOS EXTERNAL TELECOMMUNICATIONS LIMITED
 P.O. BOX 22 - BRIDGE TOWN - BARBADOS - TELEPHONE: 808-427-8000 - TELEFAX 302-2702
 Please refer to ITU Company Listing for name and date

To: Jerry Brumm



Dear Sir:

We acknowledge receipt of your QSL letter advising your reception of BARBADOS RADIO's 8p0 transmission on 1900.9 kHz on 11 May 1986. 6000 W.

Barbados radio is the local Coast Station operated by: BARBADOS EXTERNAL TELECOMMUNICATIONS LTD. The radiated power of our transmission is 1KW, and we use an omnidirectional antenna.

Yours faithfully

Kerry Agell, SVA

Manager Operations



ICW

MEMBER OF THE CABLE AND WIRELESS WORLDWIDE COMMUNICATIONS GROUP

EMPRESA PÚBLICA DE TELECOMUNICAÇÕES

Jerry Brumm

Luanda, 23 de Junho de 1986

U.S.A.

Dear Sir,

We are very glad to answer your report-letter of 19th January 1986. Thanks very much for your correct information.

This is our (QSL) confirmation of your report on 13023 kHz at 2133-2137 UTC.

Our correct address is:

ESTAÇÃO COSTEIRA LUANDARADIO
 EMPRESA PÚBLICA DE TELECOMUNICAÇÕES-EPTEL
 C.P. 625 - LUANDA
 REPUBLICA POPULAR DE ANGOLA.

Best regards

Yours/Trully



Jerry Brumm shares two QSLs with readers.

OP and back to V's again. He then commenced sending DE OP, a group of five figures, DE OP, another group of five figures, etc. Sometimes two groups would follow the DE OP but most of the time it was just one group. I really couldn't tell if he was sending valid traffic to someone or was just messing around on the key.

Dallas Williams, CO., sent in a most interesting report on a catch he made of telemetry from a Russian spacecraft. Here is what he had to say about it: "19954 kHz (variable) — Soviet spacecraft telemetry (MIR?) consisting of tone pulses intermixed with data bursts. Tune in at 0405 with LOS 0425. Must have been a near overhead pass as the signal got quite strong at 0408. Again the following day AOS 1841, LOS 1902; AOS 2021 with signal peak at 2030 and LOS 2039; AOS 2159, LOS 2212. Doppler very much in evi-



QSL

**Defense Civil Preparedness Agency
Radio Station / WGU 20 / 179 Kilohertz
1st 50 KW / All Solid State AM Transmitter
Chase, Maryland**

◀ This QSL ran in the November issue but somehow the elves decided to trim the border off of it, so we're running it again in the hope that it makes it all in one piece this time.

dence. Signal did not suddenly appear or disappear like VHF/UHF spacecraft signals do but slowly faded in and then out, possibly due to the frequency involved. Given a period of about 100 minutes then the altitude would be approximately 500 miles (statute) with a speed of about 6500 m/s, assuming a reasonably circular orbit." Ed. Note: Although I am not too knowledgeable of spacecraft terminology I believe MIR stands for Military-InfraRed. This would possibly be an Early Warning Satellite for the detection of the infrared signature of the exhaust plume from the boost phase of a missile launch. AOS is Acquisition of Signal and LOS is Loss of Signal.

Abbreviations Used For Intercepts

AM	Amplitude Modulation mode
BC	Broadcast
CW	Morse Code mode
EE	English
GG	German
ID	Identifier/ied/ication
LSB	Lower Sideband mode
OM	Male operator
PP	Portuguese
SS	Spanish
tfc	Traffic
USB	Upper Sideband mode
w/	with
wx	Weather report/forecast
YL	Female operator
4F	4-figure coded groups (i.e. 5739)
5F	5-figure coded groups
5L	5-letter coded groups (i.e. IGRXJ)

Intercepts

378: Beacon RJ, Roberval, PQ at 0322 (Pat O'Connor, NH).
 404: Beacon IUB, Baltimore, MD at 0351 (O'Connor, NH).
 419: Grosse Isle, MI beacon at 0400. Verified as 25 watts (O'Connor, NH).
 2096.5: KGW347, Philadelphia. PA wkg towboat PATRIOT in USB at 1128 (Bob Margolis, IL).
 2813: GYAI, London Navrad, England in CW at 0356 w/DE/QSX marker (Margolis, IL).
 2846: 9FF, 9BB, R81, 9RF tactical calls calling & working one another in CW at 0651 (Margolis, IL).
 4109.5: 3ELX3, Cruiseship HOMERIC in USB at 0410 in Ocean Gate NJ w/phone patch (D. Symington, OH).
 4131.2: WPKD, ship AMERICAN ALABAMA in USB at 0208 to WOM, Miami w/phone patch (Symington, OH).
 4134.3: CZGD, Canadian warship IROQUOIS in USB at 0220 to CommSta Portsmouth (on 4428.7 kHz) re distressed vessel (Symington, OH).
 4369.8: WLC, Rogers City, MI in USB at 2315 w/Great Lakes Marine WX BC (Margolis, IL).
 5547.2: Japan Air 66 in USB at 1350 to San Francisco w/selcall tone check (Lavalee, S. Korea).
 5562: NOAA 42 aircraft to KJY74 of NOAA in Miami (National Hurricane Center) at 0525 (Hall, WA).
 5696: "Honolulu Rescue" to Whiskey Tango 805 w/instructions re dye markers, smoke flares, SAR buoy & red flares (Hall, WA).
 5999.5: EE/OM in USB at 0650 reading "World Trends Message" about circular emanating from an-ID embassy recruiting all Arab airmen & mariners to apply to the "Libyan Arab Ararat Bureau to join "Libyan Armed Forces" & subsequent reactions (Hall, WA).
 5917.5: 5L groups in CW at 0404. Message repeated 3 times, no ID ("Mr. ?", MO).
 6200: NRPZ, USCGC PAWPAW working CommSta Portsmouth (6506.4 kHz) in USB at 2348 (Symington, OH).
 6506.4: USS KALAMAZOO to NMN (USCG Portsmouth, VA) re their copter removing passengers from vessel BRAUNSWAGGER (Goubeaud, TN).
 6515.7: WCM, Pittsburgh to vessels on Ohio River in USB at 2015 (Goubeaud, TN).

6655.2: Korean Air 016 in USB at 1405 to Honolulu w/position report (Lavallee, S. Korea).
 6693: Vancouver Navrad to ORIOLE in USB simplex at 0622 w/USN info re Lahina Maui harborage (Hall, WA).
 6730: Air Force 2 in LSB at 2137 to Andrews AFB w/patch to SAM Command Post re ETD message. Also ID'd as SAM 86970 before & after landing (Symington, OH).
 6840: Odd CW sta at 0333 repeating groups T64N TAUE 4BTD. Off at 0340 (Hall, VA). Appears to be cut #'s T=0, A=1, U=2, E=5, B=7, D=8, N=9-- Ed.
 8198.1: WJME, Factory Ship ROYAL SEA in USB at 2250 to WOM, Miami w/patch. Ship near Bermuda at 33N/60W (Symington, OH).
 8204: D5MX, Liberian M/V GLORIA in USB at 0516 to Portuello del Rey (another ship?). Op was OM/SS (Hall, WA).
 8207.4: WSD8090, Yacht NEW HORIZONS in USB at 0142 to WOM, Miami w/patch. Off Grenada coast (Symington, OH).
 8287.6: IABJ, Italian Navy sail training barkentine) AMERIGO VESPUCCI in USB at 0622 w/patch to Palermo via Roma Radio (Margolis, IL).
 8391: JRDR, ship KHALIJ FREEZER in CW at 1256. This is a Japanese freighter w/telex to Stockholm (Margolis, IL).
 8394: 3EGK3, Panamanian reefer AMERICA REX in CW at 0455 (Margolis, IL).
 8578: SUH3, Alexandria, Egypt in CW w/VVV (O'Connor, NH).
 8765.4: NNM, USCG Portsmouth, VA at 0239 in USB w/request for aid for a foundering vessel (O'Connor, NH).
 8787: VCS, Halifax Coast Guard Radio, NS, in USB at 0340 w/warning re vessel overturned & adrift at 47N/38-49W (Hall, WA).
 8903.2: New Zealand flight 24 in USB at 1437 to Honolulu w/position report (Lavallee, S. Korea).
 8984: USCG Rescue 2113 calling Portsmouth in USB at 1458 w/no response. Requested freq change to 5696 kHz. USCG CommSta Miami working CG helos 1430 & 1713 in USB at 1507. CG Rescue 2113 to Miami CommSta in USB at 1507. Both Miami & Portsmouth very active here (Wagy, WI).
 8993: TEAL 22, USAF observation to McDill in USB at 1703 asking for Miami WX (Wagy, WI).
 8994: RAIDER 12 to San Francisco Air in USB at 1609 (Wagy, WI).
 9138: Synchronized CW pips at 0530 atop some sort of digital ttc. Varying in length & abruptly off w/3 long tones & 1 big weird one at 0540. Back to 5 pulses (Hall, WA).
 9388: Un-ID CW station at 1835 w/"ATD ANURI NMDRR" then repeats. At 1840 changed to "GGW RMUUD WRRTR," then at 1845 sends "WND IIRIT UINWD" & repeats (Margolis, IL). This appears to be another case of cut #'s. Looks like 1 thru 0 system equals A U W M I R G D N T-- Ed.
 9520: Presumed Soviet jammer at 0646 targeting Radio Free Europe (Hall, WA).
 9958: EE/YL in AM at 2200 w/figure groups in 3/2 format. Repeated message at 2220, off 2234 (Margolis, IL).
 11107: YL/GG in LSB at 1834 repeating "Papa November" accompanied by odd musical tones, then into GG w/erratic pattern of 5L & 3L groups, off 1845 (LeVinus, NY).
 11110: Un-ID CW atation at 2020 w/11110 (zero cut as T). Sends "FIR TAR DE ALAD 1" followed by "TAR DE 4OYA" (Hall, WA).
 11180: Air Force 2 to Andrews AFB in USB

at 1818, then Andrews requested change to LSB mode for patch to SAM Command Post (Wagy, WI).
 11233: Trenton Military to aircraft Canadian Military 406 on USB at 1343 w/instructions to land at Winnipeg for VIP pickup (Wagy, WI).
 11243: CROWBAR to METHOD 99 in USB at 1820 asking to change to Quebec frequency (Gobeaud, TN).
 11268.5: 1 Oscar Lima in USB at 1840 w/drill message to 8 Alfa Mike (who was on 11267 kHz).
 11345: Eastern 939 working Bermuda in USB at 1752. Eastern 24 working Lima in USB at 1754. Air Panama 500 calling Panama in USB at 2146 (Margolis, IL).
 11352: YL/SS in AM at 1619 w/4F groups, repeated message at 1620 (Margolis, IL).
 11760: Jammer UI (presumed Soviet) doing a job on either or both VOA & R. Vaticana. The amount of jamming in 11 MHz SWBC band increases every month (Hall, WA).
 12435.4: WL2059, passenger ship CAROL BABY to WJT, Tampa Shrimp Co., Miami. In USB at 1439 (Margolis, IL).
 12552.8: YTOF, Yugoslav freighter KRANJ calling YUR, Rijeka in CW at 1822 (Margolis, IL).
 12700: 3DP4, Suva, Fiji calling CQ in CW at 0345 (O'Connor, NH).
 12880: SAG6, Gothenburg, Sweden in CW at 0411 w/VVV & ttc list. QRM from VAI in Vancouver (Hall, WA).
 12906.9: VHP, CommSta, Canberra, ACT, Australia in CW w/VVV at 0618 ("Mr. ?", MO).
 13033: UBA2, Petrapavlosk, USSR in CW at 0421 w/CQ sent at several different speeds (Hall, WA).
 13052: UJQ7, Kiev, Ukrainian SSR, in CW at 0427 calling "VLA" then "4LA" (Hall, WA).
 13201: SWAN 44 in USB at 0703 to Clark AFB, Philippines w/meteo ttc (Lavallee, S. Korea).
 13214: AJE, Croughgton AB, England in USB at 1901 (Symington, OH).
 13354: ASCOT 5512, British RAF transport aircraft at 2302 in USB calling San Francisco Aeradio (O'Connor, NH).
 13985: Odd CW station at 2220 w/long SS message followed by "DE ORT EEL EEL DE ORT EEL EEL CUBANO RESIDANTE EN 'MIAMI' (Miami?) J NEEL" (Hall, WA).
 14364: 91A, 8191 & RAYMOND 24 working in USB at 1925. Net control was in clear & scrambled. Code word "Green" used when sending scrambled ("Mr. ?", MO).
 14384.5: CIW802, Canadian MARS-type station in in USB at 1910 working CIW92 (Symington, OH).
 15000: BPM, Xian, PRC, time station in CW at 0659 w/very faint YL ID in AM under JJJ & WWV/WWVH (Hall, WA).
 15015: MAC 60161 asking for phone patch to Dover AFB via Scott AFB in USB at 1820. Advised Dover about problem w/fuel indicator light on #3 engine, ETA Dover 25 minutes (Wagy, WI).
 15034: WX for various Canadian localities in SSB at 2248. Off at 2250 (Gilson, MD).
 16715.9: UJBX, Soviet cargo ship CHOURA KOBER working UMW in Murmansk, CW at 1441 (Margolis, IL).
 16724: 9VLA, Cargo vessel POSEIDON BREEZE (flag of Singapore) to WCC, Chatham, in CW at 1608 (Margolis, IL).



ANTENNAS AND SIGNAL IMPROVING ACCESSORIES

Two Homemade Scanner Antennas

Not too many scanner antennas are homemade. However, a second inexpensive antenna may be helpful on occasion for use in some other location than your main listening center. Maybe it's experimentation or just the satisfaction of building your own that is attractive. Wire antennas are more uncommon than homemade in the scanner service although they perform well and cost very little. A ground plane antenna with wire radials, plus a wire sloper-type are covered. Both antennas are cut for the VHF LO band. Representative lengths are given in the dimension table. Both antennas also perform acceptably on the higher-frequency scanner bands, little different than many of the commercial all-band models.

The ground plane, Fig. 1, consists of the vertical radiator and three or four wire radials that extend out from the mast and drop to the ground level. In addition, these radials serve as guys for the mast. The main radiator is a length of 5/8" diameter aluminum tubing that is held to the mast by a U-bolt, see Fig. 2, and a bolt/nut pair that also serves as the terminal to which the inner conductor of the coaxial cable is connected. The length of the radiator was chosen at 69" which corresponds to a resonant length at approximately 40 MHz. This same length has an approximate 3/4 wavelength on the aviation radio band in the 125 MHz spectrum. Reasonable results are obtained on the UHF LO and HI bands as well. The mast is two 10' telescoped sections of PVC piping which, along with the aluminum tubing, elevates the top of the radiator to more than 20', Fig. 3. A single 10' PVC section can be held by a chimney strap as well as a wall bracket or roof mount as you prefer.

The ends of the three wire radials (gauge 16 hook-up wire) are soldered to a single eye-ring lug which, in turn, is held by a second bolt/nut terminal, Fig. 4. The braid of the coaxial cable also connects here. The opposite ends of the radials attach to individual insulators. A rope attached to the other end dropped down to one of the three 120° spaced ground stakes. The stakes are located approximately 12' from the mast.

A 20' length of cable was used in our installation and was taped to the mast in two positions in its run to near the base. An adapter, Fig. 5, was inserted at its end to change over to a second length of cable that uses F connectors. The latter cable completed the run to the scanner. The PL-259 plug to F connector is Radio Shack part 278-258. A PL-258 coupler is also needed

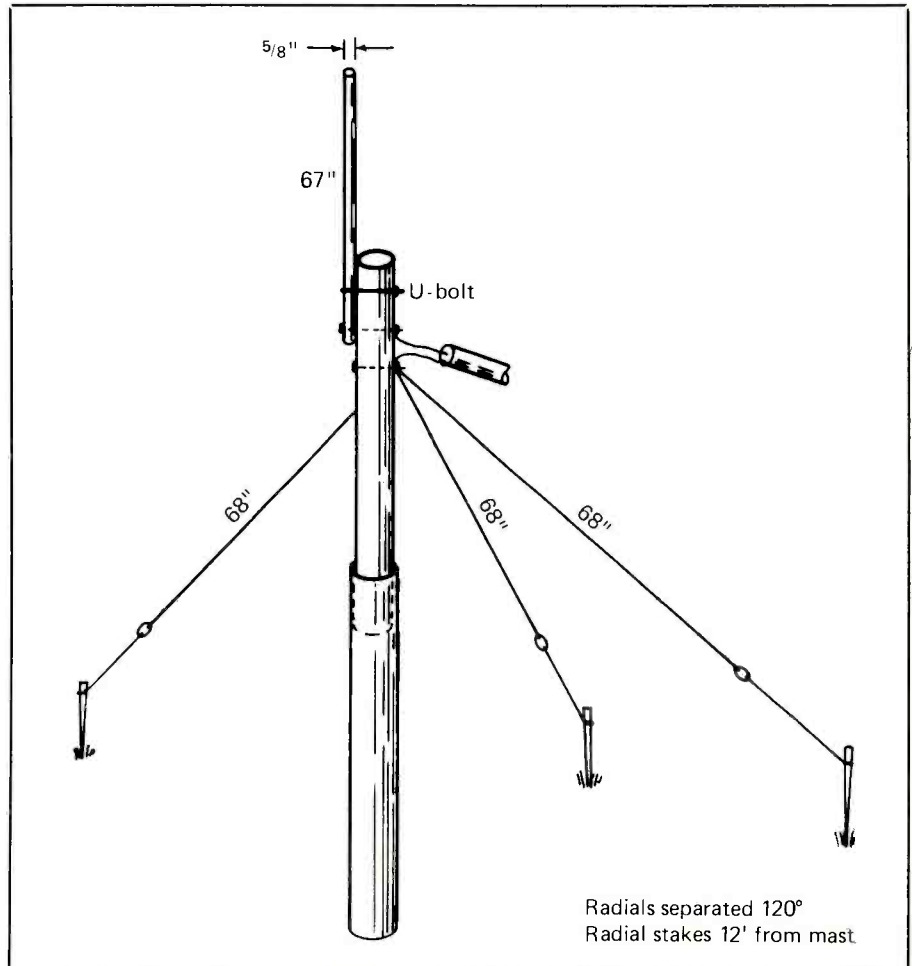

Figure 1: Homemade scanner antenna.

Typical Scanner Antenna Dimensions

FREQUENCY MHz	$\lambda/4$ Vertical or One Side of Dipole (Inches)	Resonant Radial (Inches)	$3/4\lambda$ Element (Inches)
30	92.3	93.3	289
40	69.25	70.25	276
45	61.56	62.5	192
125	22.16	23	69.41
153	18.1	18.6	56.71
159	17.42	17.9	54.57
167	16.59	17	51.95
460	6.02	6.1	18.66
470	5.894	5.9	18.46
490	5.653	5.71	17.71

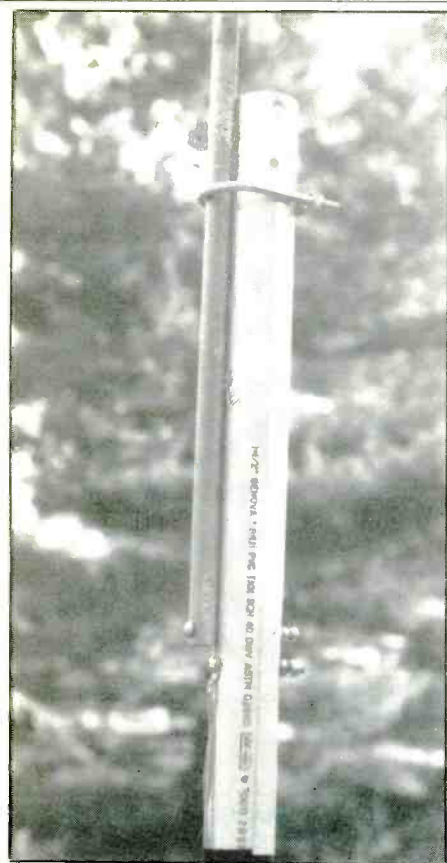

Figure 2: Radiators attached to mast top.

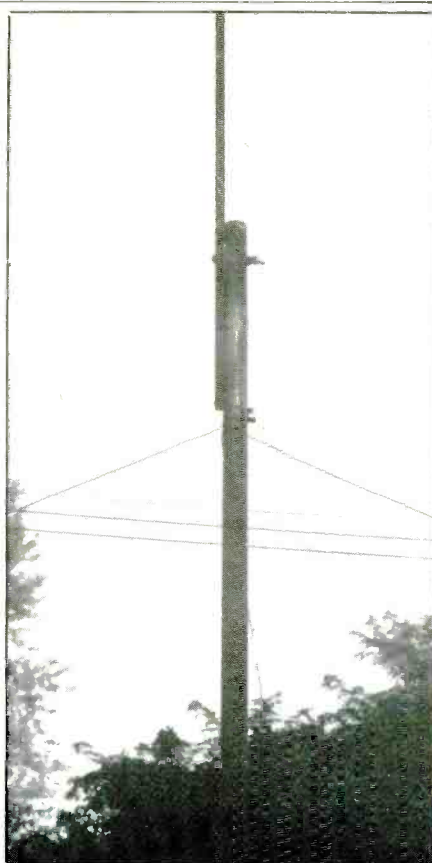

Figure 3: Vertical radiator and radials.



Figure 4: Radiator, radials and terminals.

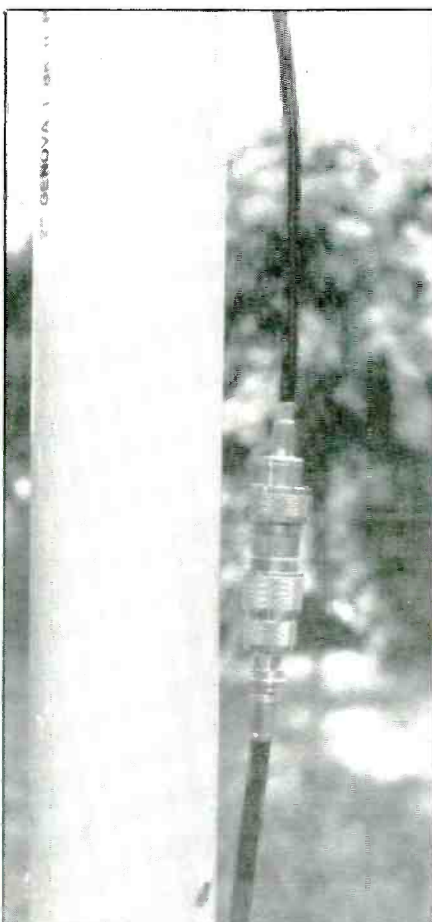
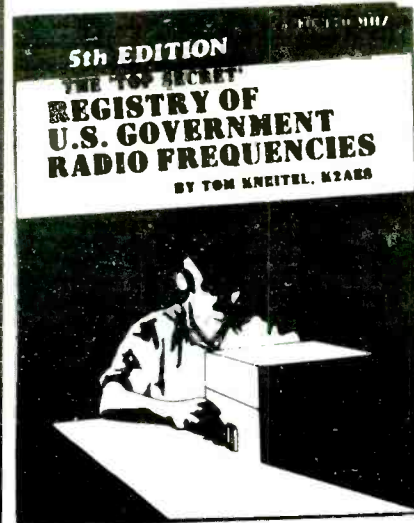

Figure 5: Adapter arrangement for PL-59 to F-connector changeover.

**YOU
AIN'T HEARD
NOTHIN...YET!**



Since 1967, CRB Research has been the world's leading publisher and supplier of unique hobby and professional books and information including:

- Scanner Frequency Guides
- Shortwave Frequency Guides
- Military/Federal Communications
- Broadcast Station Registries
- Undercover Communications
- Survival Communications
- Covert Operations
- Electronic Espionage
- Surveillance
- Monitoring
- Cryptography & Codes
- Bugging
- Wiretapping
- Communications Antennas
- Electronics & Projects
- Fox Scanner Directories
- Computer Technology
- & Other Related Topics!

New titles are constantly being added to our exciting catalog. If it's interesting and unusual, we've got it. You'll see! Ask for our latest FREE catalog.

CRB RESEARCH

P.O. Box 56 Commack, NY 11725

CIRCLE 29 ON READER SERVICE CARD

SAVE \$\$ ON SWL BOOKS WITH GILFER

Save \$6 with this combo. Only \$27.90

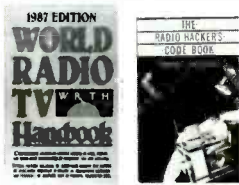

The Radio Hacker's Code Book explores the international world of codes and ciphers, shows how to program your home computer, (Basic and Z80 Assembler) discusses code-breaking and RSA public-key cipher system. Reg. \$13.95. Combined with 1987 World Radio TV Handbook, the "bible" of shortwave listening, with more info and guides than any other publications. Reg. \$19.95

Save \$8 with this combo. Only \$30.45



Lichte's Radio Receiver - Chance or Choice, the book the manufacturer's don't want you to read. Comprehensive, concise, honest in-depth reviews of dozens of famous-brand shortwave receivers including ICOM, SONY, YAESU, KENWOOD, DRAKE, JVC, DYMEK, SANYO, BEARCAT, and many more. Reg. \$18.50. Combined with '87 World Radio TV Handbook

GILFER SHORTWAVE

P.O. Box 239, 52 Park Ave., Park Ridge, NJ 07656 Ph. (201) 391-7887

CIRCLE 1 ON READER SERVICE CARD

QSL IT!

Gerry L. Dexter's **Secrets Of Successful QSLing**

—shows you how to verify more of the stations you log.

This complete guide to reception reporting and QSL collecting covers everything from the basics to specialized, little-known techniques. It's surely guaranteed to help increase your replies.

Illustrated, with foreword by Ian McFarland of Radio Canada International.

Just \$9.95 + \$1.00 shipping, \$2.00 foreign. U.S. funds only.

Order now from:

Tiare Publications
P.O. Box 493
Lake Geneva, WI 53147

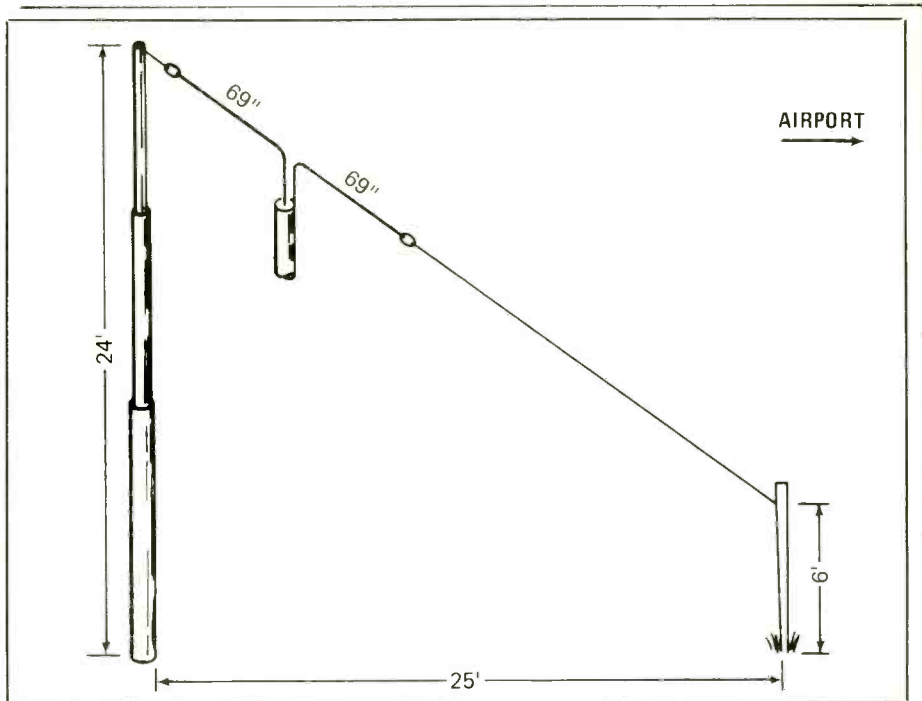

Figure 6: Wire antenna for scanner.

(Radio Shack 278-1369). In my own set-up this line terminates at a two-position coaxial switch with F input connectors (Radio Shack 15-1249). A scanner reference antenna connects to the second input. Otherwise the lead should be connected directly to the antenna input connector of your scanner.

Scanner Wire Antenna

A wire dipole, Fig. 6, operates well on the scanner bands and even on the 450 MHz band when standard UHF PL259 connectors are used. We checked such a dipole cut for about 40 MHz. This frequency was selected because the antenna length would then operate as a 3/2 wavelength on the aeroband (125 MHz). A sloper mount as shown provides limited directivity toward

the airport of a nearby metropolitan area. In comparison with the commercial all-band scanner antenna, its performance was the same on the VHF LO, a bit better on VHF HI (especially on the aeroband), and a bit poorer on UHF LO. Of course, it is possible to juggle performance among the various bands by shifting the cut frequency on the VHF LO band.

The high end of the antenna was atop a 24' PVC mast. Slope dimensions are shown in Fig. 6. It is interesting that this mast also supports a 13 meter SWB vertical and its associated radials. A rope lanyard is used to raise other antennas up and down the mast such as the above scanner wire antenna. On such a mast no stand-off insulators are needed and the possible influence of a metallic mast on antenna operation does not exist. **PC**

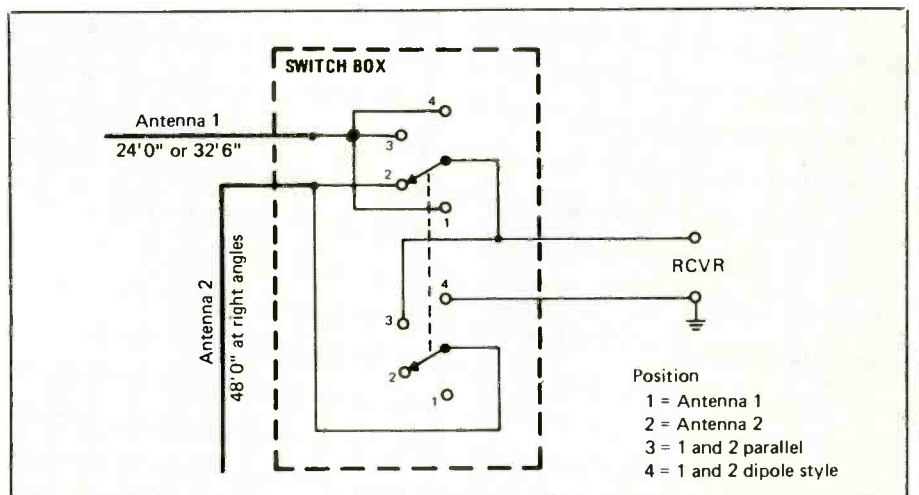

Corrected diagram of Flexo switch for indoor antenna application. (Original diagram in Oct. '86 POP'COMM, pg. 59.)

GILFER'S Apartment Dweller Shortwave

Live in an apartment? Short of antenna space? Noisy location? Call GILFER for equipment to improve your SWL listening.



DATONG ACTIVE SWL ANTENNAS FOR BIG PERFORMANCE ANYWHERE 3-meter (9 1/4') dipoles with low-noise amplifiers at the dipole and at the interface. Indoor model (AD-270) uses flexible wire elements; outdoor model (AD-370) uses stainless steel whips. Mount anywhere. 6 dB gain at the dipole, 12 dB at the interface. 100 kHz-70MHz. AD-270 \$114.50 (+ \$3); AD-370 \$134.50 (+ \$4.50); power converter \$10.95.

DRESSLER ACTIVE/SCANNER ANTENNAS For VHF/UHF/SCANNER use.

Covers 50-650 MHz. Vertical antenna system with superior dynamic range, low noise hybrid amplifier. Model ARA-500 ideal for use with ICOM R-7000 below; \$169.95 (+ \$4). For HF use. #ARA-30, 200 kHz-30MHz. Indoor/Outdoor fiberglass rods with long wire performance. Low noise FET amp with 10 dB gain. \$159.95 (+ \$4).



DATONG AUTOMATIC FILTERS/BLANKERS CLEAN UP RECEPTION FL-3 Audio Filter provides 12 poles of tunable filtering to dig out weak signals, remove interference automatically. Easy to connect. \$229.95 (+ \$4). Model SRB2 Woodpecker Blanker blanks out Russian radar interference automatically. \$169.95 (+ \$2.50).



ICOM IC-R7000 25-2000 MHz SCANNING RECEIVER Commercial grade performance; 99 memories; keyboard entry; multi-mode scanning; 6 tuning speeds; dual color display; tunes SSB, FM narrow and wide, AM. \$949 (+ \$9).



JRC NRD-525 PROFESSIONAL SWL RECEIVER Microprocessor controlled; tunes 150 kHz to 29.999 MHz; 200 memories; scanning; keyboard entry; blanker; passband tuning; many options including Computer Interface. \$1179 (+ \$9.50).

Write or call for information and catalog. Prices and specs. subject to change without notice. VISA/MC Phone orders: 8am-11pm. Showroom: 9am-5pm weekdays, Sat. 11am-1pm



**GILFER
SHORTWAVE**

P.O. Box 239, 52 Park Ave., Park Ridge, NJ 07656 Ph. (201) 391-7887

CIRCLE 38 ON FREE INFORMATION CARD

POPULAR COMMUNICATIONS BOOK SHOP

The Radio Publications Group—The "Bill Orr Series"

These easy reading classics belong in the library of any active ham. Loaded with practical how-to information, with tables, charts, and formulas arranged for handy reference.

Beam Antenna Handbook, 200 pages, paperback, \$7.95. Order #R143.

Wire Antennas, 192 pages, paperback, \$7.95. Order #R144.

Antenna Handbook, 192 pages, paperback, \$7.95. Order #R145.

Cubical Quad Antennas, 112 pages, paperback, \$6.95. Order #R146.

VHF Handbook, 336 pages, paperback, \$11.95. Order #R147.

Interference Handbook, by W.R. Nelson, 247 pages, paperback, \$9.95. Order #R172.

World Radio TV Handbook 1986

The world's only complete directory of international broadcasting and TV stations—the established, authoritative guide endorsed by the world's leading broadcasting organizations. A comprehensive country-by-country listing of short-, medium-, and long-wave stations, revised and updated to reflect actual conditions. Also includes special features on The Future Regulation of High-Frequency Broadcasting, Solar Activity in 1985, Technical Innovations at Radio Nederland's New Transmitting Station, and more. 600 pages, paperback, \$19.95. Order #B097.

World Press Services Frequencies by Thomas Harrington

A comprehensive manual covering the field of radiotele-type news monitoring—antennas, receivers, terminal units, monitors, and more. Contains 3 master lists of times of transmission, frequencies, plus ITU list of over 50 news services worldwide. 84 pages, paperback, \$8.95. Order #U173.

Broadcasting Law & Regulation

R. Terry Ellmore

A guide to the rules and regulations that govern commercial and non-commercial radio and TV broadcasting, including cable. 504 pages, hardcover, \$24.95. Order #T213.

Protecting Electronic Equipment from Electrostatic Discharge

Edward A. Lacy

Provides an in-depth look at both the causes of ESD and the procedures and equipment used to combat it. 176 pages, paperback, \$11.45. Order #T214.

Radio Handbook, 22nd ed.

by Bill Orr, W6SAI

A state-of-the-art, single-source reference on radio communications and theory for hams, professional ops, techs, and engineers. New coverage includes solid-state devices, Yagis and quads, and H.F. amplifier designs. A hands-on instruction manual, as well. 1168 pages, hardcover, \$39.95. Order #S197.

Confidential Frequency List Revised 6th ed.

by Perry Ferrell

Bigger than the 4th edition, this new book has 30% more stations listed, more than 7500 operating between 4-28 MHz. Listings by frequency and callsign. Complete list of Coastal CW stations plug Embassy, Aeronautical, Military, Time Sigs, Feeders, VOLMET, FAX, INTERPOL., etc. Details on schedules, emergency channels, alternates, and never-before-published IDs. Paperback, \$15.95. Order #G196.

The Shortwave Propagation Handbook, 2nd ed.

by George Jacobs, W3ASK, and Theodore J. Cohen, N4XX

A new, revised edition of the popular guide to all your propagation needs. Contains up-to-the-minute information and charts, and guides you through producing your own propagation data. 154 pages, paperback, \$8.95. Order #C137.

Beginner's Guide To Reading Schematics

Robert J. Traister

A hands-on guide to understanding and using schematic diagrams that should be required reading for every electronics student and hobbyist. Here's the key to mastering the fundamental concepts needed to design, build, troubleshoot, and repair electronic circuits of all types. Filled with step-by-step explanations and plenty of clear, to-the-point illustrations. 140 pages, paperback, \$8.95. Order #T215.

QTY.	ORDER #	TITLE	PRICE	TOTAL
Shipping charges \$2.00 per order. Shipping charges waived on orders of \$50.00 or more. Books shipped best way. All orders are processed the day they are received, but please allow 30 days for delivery within North America.			Book Total	
			Shipping Charge	
			Grand Total	

Name _____

Address _____

City _____

State _____ Zip _____

Check MasterCard VISA



Card No. _____ Expires _____

X _____

Signature required on all charge orders:

CLANDESTINE COMMUNIQUE

WHAT'S NEW WITH THE CLANDESTINES

BY GERRY L. DEXTER



Welcome to this new *POP'COMM* feature. We are going to flatten ourselves against walls and peek around corners for a regular glimpse into broadcasting's back alleys—the murky world of clandestine broadcasting.

Many listeners and even some publications tend to mix pirate stations and clandestine broadcasters together in the same pot, even though the two are really quite different. Pirate stations are operated by individuals who go on the air partly for the fun of broadcasting and partly to provide what they hope will be alternative programming. Clandestine stations are run by governments, intelligence organizations, revolutionary fronts and other political groups. Their purposes are serious, even *deadly* in nature: they seek nothing less than a change in the government they oppose, sometimes via a violent overthrow of that government.

There's no nicely framed operating license hanging on the studio wall at either kind of station, but that's about all the two types have in common.

Getting involved in DXing, identifying and tracing clandestine broadcasters, means getting involved in what is certainly one of the more fascinating forms of radio monitoring. Fascinating and equally frustrating. Many of the stations are not on the air at times and on frequencies suitable for reception in North America. Many do not verify reception reports and, indeed, do not even have a known address to which a report could be sent. The backers of some clandestines are totally unknown to us. So, if you are looking for a real monitoring challenge you have come to the right place!

If you are new to the hunt let's get you started with five fairly easy clandestine targets:

Radio Venceremos is the voice of the Farabundo Marti National Liberation Front (FMLN) seeking to overthrow the El Salvador government. Its strong signals are well heard in North America during the evening hours in the area around 6560. Careful, though, since there's a counterfeit Radio Venceremos in the area, although unlike the real one, its programming isn't as uptight as a Dalek. There's at least one music jammer in the area as well.

Radio Quince (15) de Septiembre is the main station of the Nicaraguan Contra guerrillas. It was revealed some months ago that the CIA had put funds into this FDN voice and the probable results can be observed in the stronger signals from this station during the evenings on 5950.

The Voice of Unity opposes Soviet occupation of Afghanistan and is heard in local languages from 1530-1625 on 11490. It formerly went under the name Voice of the United Muslim Fighters.

Voice of the Liberation of Iran, a station of the Iranian resistance (Front for the Liberation of Iran) operates from 0330-0530 on 9027 and 15555 and 1630-1830 on 7080 and 9027 and includes an English ID at sign on.

Radio Truth opposes the Zimbabwe government and operates from a base in South Africa, almost certainly with that government's approval if not actually South African-run. It's one of the few clandestines with English broadcasts. Check 5015 at 0430 for the bird call which signals sign on.

Those five clandestine broadcasters make a good start and we'll have more next time. In the meantime you can get a more extensive grounding on the subject in our book *Clandestine Confidential* (\$7.95 plus \$1 postage) from CRB Research, P.O. Box 56, Commack, NY 11725.

Readers who are interested in clandestine broadcasting are urged to submit information. More than loggings, we seek background data, addresses or leads to addresses of groups who are operating clandestine stations or who are probable future station operators. Frankly, we suspect that a number of *POP'COMM* readers are in a position to provide such material. To them we say that your identity and connections will be kept quiet if you so request. But, whether you are "well placed" or not, we look forward to hearing from you. If we work together perhaps we can solve one or more of the many mysteries with which this area of monitoring presents us. Our address is Clandestine Communique, Popular Communications, 76 North Broadway, Hicksville, NY 11801.

Good hunting!

PC

NEW! Lower Price Scanners

Communications Electronics™, the world's largest distributor of radio scanners, introduces new lower prices to celebrate our 15th anniversary.

Regency® MX7000-GP

List price \$699.95/CE price \$469.95
10-Band, 20 Channel • Crystalless • AC/DC
Frequency range: 25-550 MHz, continuous coverage and 800 MHz. to 1.3 GHz, continuous coverage. The Regency MX7000 scanner lets you monitor Military, Space Satellites, Government, Railroad, Justice Department, State Department, Fish & Game, Immigration, Marine, Police and Fire Departments, Broadcast Studio Transmitter Links, Aeronautical AM band, Aero Navigation, Paramedics, Amateur Radio, plus thousands of other radio frequencies most scanners can't pick up. The Regency MX7000 is the perfect scanner to receive the exciting 1.2 GHz. amateur radio band.

Regency® Z60-GP

List price \$299.95/CE price \$179.95/SPECIAL
8-Band, 60 Channel • No-crystal scanner
Bands: 30-50, 88-108, 118-136, 144-174, 440-512 MHz. The Regency Z60 covers all the public service bands plus aircraft and FM music for a total of eight bands. The Z60 also features an alarm clock and priority control as well as AC/DC operation. Order today.

Regency® Z45-GP

List price \$259.95/CE price \$159.95/SPECIAL
7-Band, 45 Channel • No-crystal scanner
Bands: 30-50, 118-136, 144-174, 440-512 MHz. The Regency Z45 is very similar to the Z60 model listed above however it does not have the commercial FM broadcast band. The Z45, now at a special price from Communications Electronics.

Regency® RH250B-GP

List price \$659.00/CE price \$329.95/SPECIAL
10 Channel • 25 Watt Transceiver • Priority
The Regency RH250B is a ten-channel VHF land mobile transceiver designed to cover any frequency between 150 to 162 MHz. Since this radio is synthesized, no expensive crystals are needed to store up to ten frequencies without battery backup. All radios come with CTCSS tone and scanning capabilities. A monitor and night/day switch is also standard. This transceiver even has a priority function. The RH250 makes an ideal radio for any police or fire department volunteer because of its low cost and high performance. A 60 Watt VHF 150-162 MHz. version called the RH600B is available for \$454.95. A UHF 15 watt version of this radio called the RU150B is also available and covers 450-482 MHz. but the cost is \$449.95.

NEW! Bearcat® 50XL-GP

List price \$199.95/CE price \$114.95/SPECIAL
10-Band, 10 Channel • Handheld scanner
Bands: 29-7-54, 136-174, 406-512 MHz. The Uniden Bearcat 50XL is an economical, hand-held scanner with 10 channels covering ten frequency bands. It features a keyboard lock switch to prevent accidental entry and more. Also order part # BP50 which is a rechargeable battery pack for \$14.95, a plug-in wall charger, part # AD100 for \$14.95, a carrying case part # VC001 for \$14.95 and also order optional cigarette lighter cable part # PS001 for \$14.95.



NEW! Scanner Frequency Listings

The new Fox scanner frequency directories will help you find all the action your scanner can listen to. These new listings include police, fire, ambulances & rescue squads, local government, private police agencies, hospitals, emergency medical channels, news media, forestry radio service, railroads, weather stations, radio common carriers, AT&T mobile telephone, utility companies, general mobile radio service, marine radio service, taxi cab companies, tow truck companies, trucking companies, business repeaters, business radio (simplex) federal government, funeral directors, veterinarians, buses, aircraft, space satellites, amateur radio, broadcasters and more. Fox frequency listings feature call letter cross reference as well as alphabetical listing by licensee name, police codes and signals. All Fox directories are \$14.95 each plus \$3.00 shipping. State of Alaska—RL019-1; State of Arizona—RL025-1; Baltimore, MD/Washington, DC—RL024-1; Buffalo, NY/Erie, PA—RL009-2; Chicago, IL—RL014-1; Cincinnati/Dayton, OH—RL006-2; Cleveland, OH—RL017-1; Columbus, OH—RL003-2; Dallas/Ft. Worth, TX—RL013-1; Denver/Colorado Springs, CO—RL027-1; Detroit, MI/Windsor, ON—RL008-3; Fort Wayne, IN/Lima, OH—RL001-1; Hawaii/Guam—RL015-1; Houston, TX—RL023-1; Indianapolis, IN—RL022-1; Kansas City MO/KS—RL011-2; Long Island, NY—RL026-1; Los Angeles, CA—RL016-1; Louisville/Lexington, KY—RL007-1; Milwaukee, WI/Waukegan, IL—RL021-1; Minneapolis/St. Paul, MN—RL010-2; Nevada/E. Central CA—RL028-1; Oklahoma City/Lawton, OK—RL005-2; Orlando/Daytona Beach, FL—RL012-1; Pittsburgh, PA/Wheeling, WV—RL029-1; Rochester/Syracuse, NY—RL020-1; San Diego, CA—RL018-1; Tampa/St. Petersburg, FL—RL004-2; Toledo, OH—RL002-3. New editions are being added monthly. For an area not shown above call Fox at 800-543-7892. In Ohio call 800-621-2513.

NEW! Regency® HX1500-GP

List price \$369.95/CE price \$239.95
11-Band, 55 Channel • Handheld/Portable
Search • Lockout • Priority • Bank Select
Sidelit liquid crystal display • EAROM Memory
Direct Channel Access Feature • Scan Delay
Bands: 29-54, 118-136, 144-174, 406-420, 440-512 MHz. The new handheld Regency HX1500 scanner is fully keyboard programmable for the ultimate in versatility. You can scan up to 55 channels at the same time including the AM aircraft band. The LCD display is even sidelit for night use. Includes belt clip, flexible antenna and earphone. Operates on 8 1.2 Volt rechargeable Ni-cad batteries (not included). Be sure to order batteries and battery charger from accessory list in this ad.

Bearcat® 100XL-GP

List price \$349.95/CE price \$203.95/SPECIAL
9-Band, 16 Channel • Priority • Scan Delay
Search • Limit • Hold • Lockout • AC/DC
Frequency range: 30-50, 118-174, 406-512 MHz. The world's first no-crystal handheld scanner now has a LCD channel display with backlight for low light use and aircraft band coverage at the same low price. Size is 1 3/4" x 7 1/2" x 2 1/2". The Bearcat 100XL has wide frequency coverage that includes all public service bands (Low, High, UHF and "T" bands), the AM aircraft band, the 2-meter and 70 cm. amateur bands, plus military and federal government frequencies. Wow... what a scanner! Included in our low CE price is a sturdy carrying case, earphone, battery charger/AC adapter, six AA Ni-cad batteries and flexible antenna. Order your scanner now.

Bearcat® 210XW-GP

List price \$339.95/CE price \$209.95/SPECIAL
8-Band, 20 Channel • No-crystal scanner
Automatic Weather • Search/Scan • AC/DC
Frequency range: 30-50, 136-174, 406-512 MHz. The new Bearcat 210XW is an advanced third generation scanner with great performance at a low CE price.

NEW! Bearcat® 145XL-GP

List price \$179.95/CE price \$102.95/SPECIAL
10 Band, 16 channel • AC/DC • Instant Weather
Frequency range: 29-54, 136-174, 420-512 MHz. The Bearcat 145XL makes a great first scanner. Its low cost and high performance lets you hear all the action with the touch of a key. Order your scanner from CE today.

TEST ANY SCANNER

Test any scanner purchased from Communications Electronics™ for 31 days before you decide to keep it. If for any reason you are not completely satisfied, return it in original condition with all parts in 31 days, for a prompt refund (less shipping/handling charges and rebate credits).

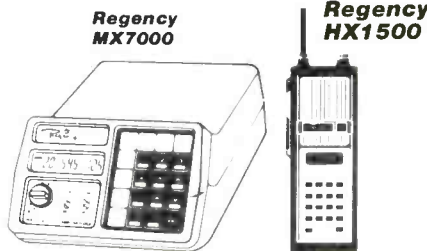

CIRCLE 82 ON FREE INFORMATION CARD

NEW! Bearcat® 800XL-GP

List price \$499.95/CE price \$317.95
12-Band, 40 Channel • No-crystal scanner
Priority control • Search/Scan • AC/DC
Bands: 29-54, 118-174, 406-512, 806-912 MHz. The Uniden 800XL receives 40 channels in two banks. Scans 15 channels per second. Size 9 1/4" x 4 1/2" x 1 1/2".

OTHER RADIOS AND ACCESSORIES

Panasonic RF-2600-GP Shortwave receiver.....\$179.95
RD95-GP Uniden Remote mount Radar Detector.....\$128.95
RD55-GP Uniden Visor mount Radar Detector.....\$98.95
RD9-GP Uniden "Passport" size Radar Detector.....\$199.95
BC-WA-GP Bearcat Weather Alert.....\$49.95
DX1000-GP Bearcat shortwave receiver SALE.....\$349.95
PC22-GP Uniden remote mount CB transceiver.....\$99.95
PC55-GP Uniden mobile mount CB transceiver.....\$59.95
R1060-GP Regency 10 channel scanner SALE.....\$92.95
MX3000-GP Regency 30 channel scanner.....\$229.95
XL156-GP Regency 10 channel scanner.....\$139.95
UC102-GP Regency VHF 2 ch. 1 Watt transceiver.....\$124.95
P1405-GP Regency 5 amp regulated power supply.....\$69.95
P1412-GP Regency 12 amp reg. power supply.....\$164.95
MA256-GP Drop-in charger for HX1200 & HX1500.....\$84.95
MA518-GP Wall charger for HX1500 scanner.....\$14.95
MA516-GP Carrying case for HX1500 scanner.....\$14.95
MA257-GP Cigarette lighter cord for HX12/1500.....\$19.95
MA917-GP Ni-Cad battery pack for HX1200.....\$34.95
SMMX7000-GP Svc. man. for MX7000 & MX5000.....\$19.95
SMMX3000-GP Service man. for Regency MX3000.....\$19.95
B-4-GP 1.2 V AAA Ni-Cad batteries (set of four).....\$9.95
B-8-GP 1.2 V AA Ni-Cad batteries (set of eight).....\$17.95
FB-E-GP Frequency Directory for Eastern U.S.A.....\$14.95
FB-W-GP Frequency Directory for Western U.S.A.....\$14.95
ASD-GP Air Scan Directory.....\$14.95
SRF-GP Survival Radio Frequency Directory.....\$14.95
TSG-GP "Top Secret" Registry of U.S. Govt. Freq.....\$14.95
TIC-GP Techniques for Intercepting Comm.....\$14.95
RRF-GP Railroad frequency directory.....\$14.95
CIE-GP Covert Intelligent, Elect. Eavesdropping.....\$14.95
A60-GP Magnet mount mobile scanner antenna.....\$35.95
A70-GP Base station scanner antenna.....\$35.95
USAMM-GP Mag mount VHF/UHF ant. w/12' cable.....\$39.95
USAK-GP 3/4" hole mount VHF/UHF ant. w/17' cable.....\$35.95
USATLM-GP Trunk lip mount VHF/UHF antenna.....\$35.95
Add \$3.00 shipping for all accessories ordered at the same time.
Add \$12.00 shipping per shortwave receiver.
Add \$7.00 shipping per scanner and \$3.00 per antenna.

BUY WITH CONFIDENCE

To get the fastest delivery from CE of any scanner, send or phone your order directly to our Scanner Distribution Center™. Michigan residents please add 4% sales tax or supply your tax I.D. number. Written purchase orders are accepted from approved government agencies and most well rated firms at a 10% surcharge for net 10 billing. All sales are subject to availability, acceptance and verification. All sales on accessories are final. Prices, terms and specifications are subject to change without notice. All prices are in U.S. dollars. Out of stock items will be placed on backorder automatically unless CE is instructed differently. A \$5.00 additional handling fee will be charged for all orders with a merchandise total under \$50.00. Shipments are F.O.B. Ann Arbor, Michigan. No COD's. Most products that we sell have a manufacturer's warranty. Free copies of warranties on these products are available prior to purchase by writing to CE. Non-certified checks require bank clearance. Not responsible for typographical errors.

Mail orders to: Communications Electronics™, Box 1045, Ann Arbor, Michigan 48106 U.S.A. Add \$7.00 per scanner for R.P.S./U.P.S. ground shipping and handling in the continental U.S.A. For Canada, Puerto Rico, Hawaii, Alaska, or APO/FPO delivery, shipping charges are three times continental U.S. rates. If you have a Discover, Visa or Master Card, you may call and place a credit card order. Order toll-free in the U.S. Dial 800-USA-SCAN. In Canada, order toll-free by calling 800-221-3475. WUI Telex anytime, dial 671-0155. If you are outside the U.S. or in Michigan dial 313-973-8888. Order today.

Scanner Distribution Center™ and CE logos are trademarks of Communications Electronics Inc.

‡ Bearcat is a registered trademark of Uniden Corporation.
† Regency is a registered trademark of Regency Electronics Inc. AD #070286-GP

Copyright © 1986 Communications Electronics Inc.

For credit card orders call
1-800-USA-SCAN

COMMUNICATIONS ELECTRONICS INC.

Consumer Products Division

P.O. Box 1045 □ Ann Arbor, Michigan 48106-1045 U.S.A.
Call 800-USA-SCAN or outside U.S.A. 313-973-8888

BRRRR – Some Boiler Rooms Are Air-Conditioned

Selling stuff via the phone, paying for it with a credit card and having it delivered via UPS is the mainstay of "Mail Order." It has been a long time since the post office was the main media of the mail order business. The hip word for selling things over the phone these days is "telemarketing." Marketing is a new word for the process that we used to call "saling".

The whole telephone sales business has many facets. One thing is certain, your phone company thinks it is a good thing. There are inbound sales calls, such as airline reservations and car rental. Then there are outwardbound sales calls, which tend to be the most disreputable, but need not be. A stockbroker calling a client with a hot tip is an outwardbound sales call.

A company that wants to accept orders over the phone, usually starts with an 800 number. These numbers are known as "IN-WATS" (INward Wide Area Telephone Service) in the phone business. Besides making the call toll-free for the buyer, they also enable a company to have one location to handle all sales calls. It is difficult to identify the location of an 800 number, but the phone company will tell you if you inquire. You can get the 800 numbers of corporations by dialing 1-800-555-1212. Yes, this is a free call also.

A small company may have their 800 number come up on the operators console and then be routed internally by the operator. It may be a direct line ringing on a sales desk. In larger companies there may be a large "telemarketing" department. This, at its most sophisticated level, is a room full of operators wearing headsets and sitting at computer terminals. Depending on the type of business, the terminals may show airline schedules, rental cars available at various sites or customer accounts and inventory at hand.

The operators in a large inbound telemarketing department have their calls handed to them automatically on a first-come, first-served basis. The incoming call distribution system is called ACD (Automatic Call Distribution). Anyone who has called an airline or credit card company has hit such a system. If the operators are busy the phone is answered automatically, an announcement is made and the terrible music is turned on.

If you don't get an operator within a set period of time, usually a minute or so, another announcement comes on to tell you that Whatsit Corp. really cares and please hang on.

Automatic Call Distribution means customers get the first operator available and that the calls are distributed fairly. Each operator gets calls in rotation. The problem with ACD is that if you call in and get an operator whom you must call back, it can be a bit tricky. Some systems have extension numbers that the caller can access. With other systems, the caller must first talk to the operator who gets the call and then ask to speak to the operator that the caller wanted. This can mean more time listening to music. But why worry? After all, you are not paying for the call!

By using sales and reservation centers, many companies have dramatically improved their service to the public and helped their bottom line in the bargain. Many of these "telemarketing centers" work round the clock.

Some companies, rather than set up their own center, employ a service that will answer calls and take orders for them. The companies that sell knives and golden oldie records on late night TV are some of the biggest users of this type of service. Most of these service centers are in Nebraska. Why Nebraska? Several reasons: The Nebraska accent is "neutral." The time zone is Central. Finally, as SAC is in Nebraska, they have excellent long distance phone service into Nebraska. A good giveaway for an 800 number order service is the request that you ask for "operator 76" or something like that. Some large companies that offer various services will also tell the caller to ask for a particular operator after getting connected.

The other end of "telemarketing" is where companies call customers and potential customers. Stock brokers are probably the biggest users of this end of things. Many companies have a sales staff sitting at phones calling customers and soliciting orders. Companies do this to give them better control of their income or to increase sales. Many of these companies call regular customers and build a relationship with them. Some organizations call customers that are late with payments in a regular fashion with a room of "collectors." Even magazine pub-



lishers sometimes use telemarketing services to remind subscribers that their subscription is due to expire and take a credit card order for a new subscription.

Many of these telemarketing operations have operators/sales staff sitting at terminals and wearing headsets for maximum efficiency. Since customers can be spread across the United States, these customers usually use WATS service. WATS (Wide Area Telephone Service) is a bulk long distance service available to business users. Some companies with customers at the other end of the country may rent a satellite transponder and go via their own transponder for the long distance and make a local call at the other end.

When you consider the size of the phone bill that a company may face with 25 operators on long distance lines all day, the figures can be staggering. Companies with such massive phone bills often employ a full-time telephone consultant. The consultant's job is to continually find ways to shave the phone bill. Routing the calls is obviously one way to do this. Satellites and private lines are a good way to accomplish this. Improvement of the working environment of the operators is another. If all the data they need is available on a computer terminal and they are not fatigued by their equipment, then productivity and time per call will go down. One thing that helps operators is automatic dialers. Some dialers are built into computers, so that when the customer's name is on the screen, hitting one key will dial the number.

AT&T has good experience on telephone productivity and has in the past given training seminars on the subject. Planning the traffic flow so that customers do not have to wait on the line to be handled keeps costs down and is an immeasurable help in improving the customer's attitude.

The back end of telephone sales is the

"Boiler Room." It is this activity that has given the term "telephone sales" a bad name. A boiler room is a small room usually furnished with a coffee machine, folding tables and single line telephones for each sales employee. The employees often share tables, sitting shoulder to shoulder. To keep down the background noise in such an environment, noise cancelling microphones are often used.

The employees of boiler rooms are often paid on a commission only basis. There is frequently not much commission forthcoming. Most of these operations are either illegal or nearly illegal. The working conditions are probably illegal. The nationwide center of boiler rooms is Southern California. There are two reasons for this: One, cheap long distance calls to the east coast early in the morning when the East Coast is hard at work. Two, there is a massive pool of unemployed actors who can practice their talents being someone else on the phone.

The folklore is that boiler rooms got their name because they were operated out of basements and boiler rooms. In fact, most of them work out of decaying office buildings and rundown store fronts. There may be fifteen operators and a supervisor in a small room. The owner will be seen rarely. He usually lives in the smarter part of town.

What do boiler rooms do? They sell overpriced office and photocopy supplies. Convince people to "invest" in strange "can't lose" high-yield financial instruments, gold and diamonds. Solar energy, air conditioning, and other "home improvements" are popular. They also sell tickets to the "police man's ball" and other quasi-charities. Oh yes, the charity gets some of the money, usually about 10%, the rest is commission to the operator and money in the pocket of the boiler room owner.

Where do boiler rooms get their telephone numbers? When calling businesses, they use trade directories, the yellow pages and other commercially available lists. When calling residences, they do not use the telephone book. Too many people have unlisted numbers. What they do is take a telephone prefix, which corresponds to a target area and sequentially dial every number. They would start with, say, 330-001 and keep dialing until they get to 330-9999. Many of these numbers would be business numbers or not in service. They just hang up and keep dialing. So next time they call you at your unlisted number, you know how they do it.

One device that has been used but has lower response than if real people were speaking is to get a computer to dial sequential numbers and play a pitch tape once the call is answered. The tape pauses to ask your name, address and telephone number. The computer owner then plays back the receive tape to pick off the "qualified leads." These machines annoy so many people that their yield is low. Hopefully, the yield will stay low and they will never catch on.

PC

NATIONAL TOWER COMPANY

P.O. BOX 12286 Shawnee Mission, KS 66212

Hours 8:30-5:00 M-F **913-888-8864**



MIDLAND® CB

7-114S.....\$59.90

40 Ch. ETR CB, 4 watt, scan, Ch 9 switch, PA/CB, ANL, S/RF LED meter, WITH: magnetic mt. center loaded antenna & all cables.

77-112S.....\$54.90

Same as above except does not have ANL, instant Ch 9 or PA.

77-250.....\$99.90

POWER MAX - Highest quality RF Amplifier available, ETR tuning, 40% more sensitivity, SWR, RF gain, mic gain, instant Ch 9 or 19, ANL, noise blanker.

76-300.....\$89.90

COMPACT 40 CH AM BASE - precision performance in small size, instant Ch 9, solid state S/RF meter, mic gain, ANL/NB switch.

77-915.....\$42.90

READY RESCUE IV - Portable emergency CB with case, emergency channel 9 & 19 only.

uniden®



WASHINGTON.....\$179.90

AM/SSB, NB/ANL, PA, clarifier, squelch, mic gain, RF gain, TX/RX, instant Ch 9.

PC244.....\$119.90

AM/SSB mobile, clarifier, RF gain, mic gain, noise blanker, instant Ch 9, SR/F meter.

PC55.....\$59.90

Digital, S/RF meter, RF gain, TX, instant Ch 9, squelch, noise limiter, PA.

★ CALL ★ COMPLETE LINE OF MIDLAND & UNIDEN CB's AVIALABLE



uniden®

Bearcat

BC210XL

\$159.00

18 Ch 6 band, dual scan speed, squelch, direct Ch access, limit, search, programmable, AC/DC.



BC50XL.....\$114.90

10 Channel 10 band, hand held.

BC100XL.....\$179.00

16 Channel 9 band, aircraft, hand held.

BC145XL.....\$99.90

16 Ch 10 band, weather, AC/DC.

BC175XL.....\$159.00

16 Ch, 11 band, aircraft, AC/DC.

BC210XW.....\$179.00

20 Ch, 8 band, weather, AC/DC.

Regency®



MX3000.....\$199.90

30 Ch 6 band, programmable, search, dual scan speed, squelch, Ch lockout, Ch 1 priority, with/mobile mounting bracket, AC adaptor charger, & DC cord.

C403.....\$59.90

4 Ch, 3 band, crystal, AC only.

R806.....\$69.90

6 Ch, 6 band, prog., mobile, AC/DC.

R1070.....\$99.90

10 Ch 6 band, programmable, AC only.

Z45.....\$149.90

45 Ch 7 band, aircraft, AC/DC.

Z60.....\$169.90

60 Ch 8 band, aircraft, clock, AC/DC.

XL156.....\$114.90

10 Ch 6 band, programmable, AC/DC.

HX1500.....\$219.00

55 Ch 10 band, hand held, aircraft.

MX7000.....\$419.90

20 Ch, 25-550MHz, 800-1.3GHz.



uniden®



880..QUANTUM..\$229.00

X & K band SUPERHET.

870.....VECTOR.....\$134.90

super small SUPERHET.

847.....\$159.00

Super small REMOTE

844.....EXPRESS.....\$149.00

Dash/Visor LED & audio.

860.....\$119.00

SUPERHET dash/visor.

861.....\$89.90

Audio & visual alert.



RD35.....\$69.90

SUPERHET, X & K band

audible & visual alert.

RD55.....\$99.95

Sequential LED alert,

SUPERHET, X & K band.

RD9.....\$189.90

Dual conversion, 2 power

cords, SUPERHET, X &

K Bands.

RD95.....\$129.95

RD55 REMOTE.



IMPULSE.....\$79.90

Compact SUPERHET,

audible & visual alarm.

VIXEN III.....\$159.90

LED SUPERHET

ROADSTAR.....\$104.90

Dash/Visor SUPERHET.

SUPERFOX REMOTES\$169.90

Miniature, City/HWY set-

ting, SUPERHET.

LISTENING POST

BY GERRY L. DEXTER

WHAT'S HAPPENING: INTERNATIONAL SHORTWAVE BROADCASTING BANDS

No sooner done than undone! The exchange of transmitter time between Radio France International's French Guiana relay and Radio Beijing ended just a few months after it began! The new French government didn't like the agreement and so cancelled it. RFI continues to look for a means of putting a better signal into its Asian target areas and Radio Beijing, which graced our radios with pretty good quality reception for a time, is back to square one.

For QSL chasers, Radio Botswana has been a study in frustration, a lesson in patience. Now, however, QSLs from Radio Botswana just may be right around the corner. The former chief engineer who was so adamant about not replying has left the station. His replacement is a Ham radio operator and the word we get is that he welcomes reception reports on Radio Botswana's broadcasts. Sooo . . .

Speaking of tough accomplishments on shortwave, will this be the season in which a few determined DXers manage to hear Bhutan? Radio NYAB (now the Bhutan Broadcasting Service) now has a 5-kilowatt transmitter in service, along with its old 300 watt. So, it just might be that some determined and careful listening will turn this one up, if one can find the right conditions and the proper reception "window." The 5-kilowatt transmitter is scheduled Monday through Saturday from 1100-1400 on 6035 and on Sundays from 0600-0900. The last half hour is in English.

It is still too early to expect any sounds out of the new Christian Science Monitor shortwave station, operated by Herald Broadcasting. But, just in case, here's an advance schedule, courtesy of the Australian Radio DX Club: 0200-0300 on 9575, 0300-0500 on 9745, 0500-0600 on 9635, 0600-0700 on 6140, 0700-0800 on 6195, 1400-1800 on 17775, 1800-2000 on 17835 and 2000-2200 on 9670.

The agreement for the Voice of America's relay station in Israel has been signed, but construction isn't scheduled to begin before the first of the year which means a sign-on date is still quite away off.

Also a long time coming are the new technical facilities of Radio Yugoslavia, now targeted for a start-up sometime early next year. The new Radio Yugoslavia will operate in ten languages using four 500-kilowatt transmitters.

That new Honduran station we mentioned last month is using the name "Family Radio" although there is no connection with WYFR that we know of. The location isn't completely traced yet but may be Puerto Lempira. The station is operating in Spanish



Wonder if J. Keul in California can hear stations of the past on this neat collection of old shortwave sets?

and Indian languages on 4755 but the sign-off appears to be very early—2300 or 0000—so that'll make this one a winter season target for most of us.

ANARCON-86 in Montreal saw around 350 attendees during its July 18-20 run. It appeared that, at any one time, about half of those were either in an elevator or waiting for one to arrive! There were numerous films, slide shows and seminars, on-site shortwave programs done both live and recorded. Many stations and dealers filled two large rooms with displays. It was a great pleasure to meet Jens Frost, editor-in-chief of the *World RadioTV Handbook* and famous New Zealand DXer, writer and broadcaster Arthur Cushen along with Jonathan Marks from Radio Netherlands and John Beck of HCJB and dozens of others including some old friends and some reporters to this column.



Here's the staff of "Brussels's Calling" on the BRT.

We were honored with the 1986 North American DXer of the Year award and sincerely thank all those who had a part in this. Other awards included those to Jens Frost (International DXer of the year), and Dr. Bruce Elving (Specialty Band DXer of the Year). ANARC Executive Secretary Terry Colgan and Robert Horvitz, ANARC's Government Affairs Liaison, were given special awards for their work in combatting the Electronic Communications Privacy Act bill.

In all, it was a very worthwhile, enjoyable and educational weekend and thanks to RCI's Ian McFarland for the superb job of organizing and running the affair.

Mark your calendar now and plan to attend the 1987 convention which will be held in July in the Toronto area. More details will be available from the convention's organizers, the Ontario DX Association, P.O. Box 161, Station A, Willowdale, Ontario, M2N 5P0, Canada.

The new edition of *Radio Database International* is out now and it's a book we can highly recommend to anyone who listens to shortwave broadcast stations from either a program or DX aspect. The current edition combines last year's tropical and international bands editions into one book, and includes a number of feature articles and receiver reviews as well. The book should be available from many of the SW dealers or you can get it direct from P.O. Box 300, Penns Park, PA 18943. It's priced at \$12.95 (add \$1.95 shipping).

The mail this month contains word from more people who've received QSLs from the Voice of Nicaragua. Garth Carman in Alberta, Stephen Gustafson and Michael Marshal of Indiana, Donald Witt in Illinois and Henry Mutterperl of Pennsylvania all received form letter replies and a variety of other goodies.

Michael Marshall (491 Applewood Ct., Apt. 2, Evansville, IN 47712) is looking for a club based in the southern Indiana/south-

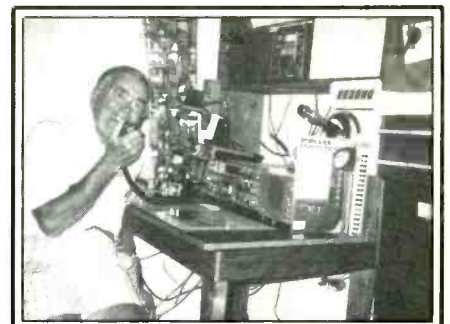

Frederick G. Bragg, VE2NDQ in his combination Ham shack and listening post.

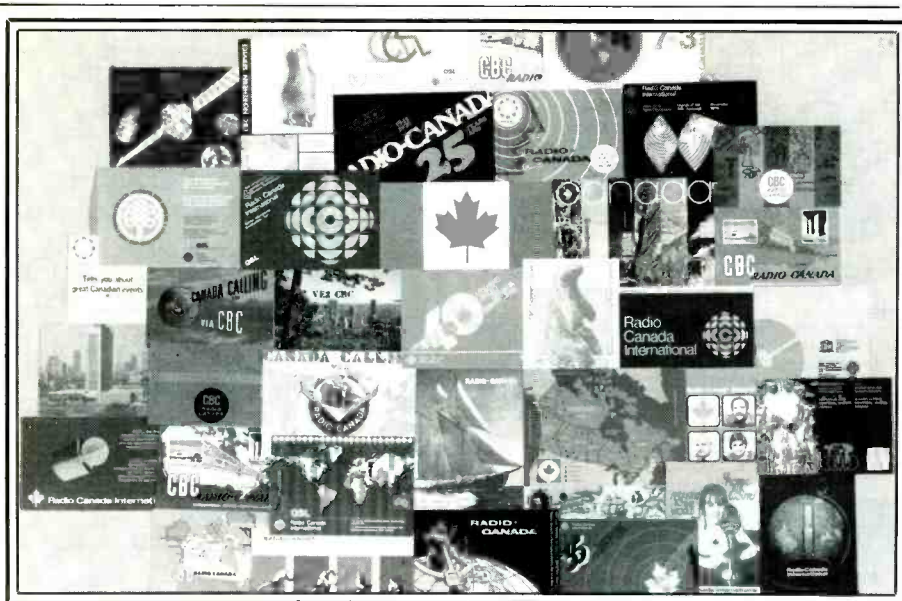

Put them all together and they spell "impressive," as this collection of RCI QSL cards over the year demonstrates.



Say mister, want to buy a certificate? Here's what Listening Post reporter Garth Carman received after a \$10 donation.

ern Illinois or northern Kentucky area. Finding that, he'd like to hear from people in those areas who'd be interested in forming a regional club in that area. We don't know of any clubs based there so let us know if you find one or decide to start one.

J.D. Stephens (3605—8 Chasewood, Huntsville, AL 35805) wants to exchange correspondence with other DXers in the southeast. J.D. says he's received a QSL from the BBC's Ascension Island Relay station, an event which, while not quite commonplace, does indeed happen. The reply came from S. Hurst, BBC Atlantic Relay Station, English Bay, Ascension Island, South Atlantic.

David Cole in Baton Rouge, LA notes that he was able to talk to Lord Carrington, Secretary General of NATO on the BBC's "It's Your World" international call-in program last April. David has also become a regular monitor for the Voice of Germany.

POP'COMM is responsible for Frederick G. Bragg, VE2DNQ not spending more time Hamming. Fred claims that the magazine offers so many listening opportunities that it takes time away from Ham operating.

We have Frederick's Ham shack and listening post as a feature photo this month.

Shawn Axelrod in Winnipeg, Manitoba, advises of a new regional club there. It's the Association of Manitoba DXers (AMANDX). The group plans to concentrate on self-help for its members and promotion of the hobby. If you want more info, write to AMANDX, 21 Knightsbridge Drive, Winnipeg, Manitoba R2M 4E7, Canada.

There's a new computer bulletin board in operation which devotes some space to shortwave. Paul Filiault of Taunton, MA says it's free of charge and can be reached at SFCHQ BBS, Middleboro, MA, phone (617) 947-9819.

Anyone know of a dealer for or the distributor of Nordmende radios in the U.S.? If so, drop the word to Terry L. Hodne, 1801 North Mable, Sioux Falls, SD 57103.

Will a letter from you show in the mailbox next month? Hope so, because we welcome your logging reports, clippings, schedules, QSLs (originals if you can spare them), shack photos, questions, comments and such. Remember that loggings should be by country with space between each item and your last name and state abbreviation after each.

We thank and QSL the following: Michael Loftus, Springfield, OR; Jim Kuel III, Anaheim, CA; John Miller, Thomasville, GA; Bruce R. Gilson, Silver Spring, MD; David Cole, Baton Rouge, LA; Timothy S. Williams, Parsippany, NJ; George R. Neff, Niles, OH; Michelle Shute, Pensacola, FL; Ryan Nunez, Athens, GA; J.D. Stephens, Huntsville, AL; K.J. Hobbs, Hamilton, ONT; Gene Rials, Baker, LA; Allen Willie, Beaverlodge, ALB; Sheryl Paszkiewicz, Manitowoc, WI; Bob Eichenholtz, Coraopolis, PA; Mark A. Northrup, Ann Arbor, MI; Garth Carman, Edmonton, ALB and H. Muterperl, North Wales, PA.

Until next month, good listening!



ACTIVE ANTENNA

•Short wave at its best!

New 3-30 MHz active antenna especially designed for SWL's. Remote probe mounts outside away from noise sources. Only 36" high but internal amplifier makes it perform like a 100' long wire.

30' of miniature coaxial cable connects the probe to its control box. This compact (only 4 x 4 x 2 in.) control features a high pass filter to eliminate overload from local broadcast stations. A post-amplifier follows the filter. The antenna operates from +12-v DC or from 115-v AC with optional adapter.



Model PA-351 \$129.95 + \$4 shipping/handling in U.S. & Canada. 115-v AC adapter \$9.95. California residents add sales tax.



Send for FREE catalog that shows our complete line of preamplifiers, loop antennas, VLF converters, audio filters and more.

PALOMAR ENGINEERS
BOX 455, ESCONDIDO, CA 92025
Phone: (619) 747-3343

MADISON Electronics Supply

3621 Fannin St.
Houston, TX 77004
Call for Quotes
1-800-231-3057
Texas Number:
1-713-520-7300

ICOM IC-R7000



Commercial quality scanning receiver 25-1300 MHz plus, keyboard entry. 99 memories. 5 tuning speeds. Call for \$\$\$

ANTENNAS

MADISON stocks antennas from most MAJOR ANTENNA MANUFACTURERS. Examples:
BARKER & WILLIAMSON TRAP DIPOLE \$7.50
AMECO New Tunable Preamplifier Antenna \$69.00

ROHN TOWERS CALL SPECIAL - BUTTERNUT ANTENNAS

SC-3000 30 to 512 MHz SCANNER ANT \$8.95
SWL DIPOLE stub tunned, low loss 2 to 30 MHz. 44.95
HF6V 80, 40, 30, 20, 15 & 10 meter vertical 124.95
HF2V 80 & 40 meter vertical 124.95
ACCESSORIES IN STOCK CALL

POLICIES: MASTERCARD - VISA - COD
All prices FOB Houston, TX except as noted. Prices subject to change without notice, subject to prior sale. Used gear sale price refunded if not satisfied. Texas residents subject to sales tax.

Here's What's On
All Times UTC

ALBANIA-R. Tirana, 0008 on 7065 w/"Review of the Albanian Press" (Cole, LA).
ANTIGUA- Deutsche Welle Relay, at 0305 on 9690 to NA (Neff, OH); 17810 at 2102 w/nx in GG (Loftus, OR).
ARGENTINA- RAE at 0102 in EE on 9690 w/nx, mx. Audio was muffled (Loftus, OR).
ASCENSION ISLAND- BBC Relay, 9515 at 2025 w/World Service, into PP at 2030. Also 6110 w/"Calling the Falklands" at 2130 (Cole, LA).
AUSTRALIA- R. Australia, 5995 at 1025 in Neo-Polynesia w/commentary (Muterperl, PA); 6060 at 1137 w/talk on anxiety (Eichenholtz, PA); 9580 at 1330 in EE (Hobbs, ONT); 9710 at 1130 w/"Australia Tonight" (Northrup, MI); 15160 w/nx at 0430 (Keul, CA); 15160/15240/17795 at 0430 (Cole, LA); 15320 from 2310-2330 w/nx (Gilson, MD).
 VLW, Perth on 9610 at 1226 w/Dixieland, comedy, C&W, ABC nx. Too weak to catch ID (Northrup, MI).

VNG (Time station) at 0710 on 12000 (Willie, Alberta).
AUSTRIA- R. Austria International, 9755 at 0430 w/"Report From Austria" (Loftus, OR); 0330 in EE on 9770, nx & commentary (Muterperl, PA); 15320 at 1234 w/nx in EE (Cole, LA).
BANGLADESH- R. Bangladesh, 15525 at 1228 to 1300 s/off in EE w/IS, ID, nx, commentary, history, vocals, politics (Paszkievicz, WI).
BELGIUM- BRT on 9830 at 1300 in EE w/"Brussels Calling" (Muterperl, PA); 15590 at 1300 in EE w/ "Around The Arts" & "P.O. Box 26" (Rials, LA).
BRAZIL- R. Guiba, Porto Alegre, 0318 in PP w/"futebol," time check, ID's, jingles (Paszkievicz, WI).
 R. Educacao Rural, Campo Grande, 4755 at 0806 in PP w/mx, announcements (Willie, Alberta).
 R. Anganguera, Goiania, 4915 at 0652 w/announcer, mx, jingles (Willie, Alberta).
 Radiobras, 11745 s/on at 0200 w/enormous signal (Carman, Alberta).
 R. Bandierantes, Sao Paulo, 11925 at 0218 in PP w/many references to Sao Paulo, ID's (Loftus, OR).

Abbreviations Used in Listening Post	
AA	Arabic
BC	Broadcast/ing
CC	Chinese
EE	English
FF	French
GG	German
ID	Identification
IS	Interval Signal
JJ	Japanese
mx	Music
NA	North America/n
nx	News
OM	Male
pgm	Program
PP	Portuguese
RR	Russian
rx	Religion/lous
SA	South America/n
SS	Spanish
UTC	Coordinated Universal Time (ex-GMT)
v	Frequency varies
w/	With
WX	Weather
YL	Female
//	Parallel frequencies

THE BEST GETS BETTER AT EEB

AMBASSADOR 2020

NEWEST
HIGH TECH
RECEIVER



\$299.95 VALUE
INTRODUCTORY
PRICED
\$199.95
FREE
AC Power Adapter—
Mention This Ad
(\$14.95 Value)

Here is the latest in the series of fine receivers from Taiwan (ROC). The last three years have seen big changes from Taiwan. There was the Radio Shack DX 400, the Uniden CR 2021, the Sangean ATS 803 and now the Ambassador 2020.

- State of the art PLL world band receiver.
- Easy to use with direct digital dialing of frequency.
- 5 tuning functions: direct frequency key-in, auto scanning, manual scanning, preset recall and manual rotary tuning.
- 9 programmable memories.
- Radio, clock and alarm turn on automatically, play preset stations at preset time.
- Wide/narrow bandwidth. You select for better listening in today's crowded band.
- RF gain control to prevent overloading when near strong stations and improve SSB reception.
- Signal strength indicator (5 LED).
- Shortwave button allows user to tune only international shortwave bands. No need to guess start and stop frequency.
- AM button allows full coverage of 150 KHz to 30 MHz.
- FM button allows full coverage of 88-108 MHz.
- Unique speed dialing—the faster the dial is turned the larger the frequency steps.
- Multimode AM-FM-CW-SSB allow full coverage of commercial traffic. Amateur, aircraft, ship at sea, and more.
- 24 hour clock—sleep/alarm selectable switch allows hour & minutes or minutes & seconds.
- Sensitivity and dynamic excellence for a portable radio.
- High stability for good CW-SSB-RTTY reception.
- Excellent audio with separate bass and treble controls, stereo balance.
- Din plug for standard stereo hook-up.
- External speaker jack.
- Built in whip antenna and terminals for external antenna.
- Battery powered 3D & 2AA (not included).
- Optional AC wall power pack switchable 120/240V 50/60 Hz.
- Same size and weight as Sony ICF 2010

DIPLOMAT 4950

HERE IS THE RECEIVER
EVERYONE NEEDS!



\$99.95 VALUE
INTRODUCTORY
PRICE
\$69.95

The perfect radio for the person on the go—The Student or a second shortwave for office or home. Slightly larger than the Sony ICF 4910; otherwise The Diplomat is identical and covers more!

- Medium wave AM 550-1670KHz
- FM 88 to 108 with stereo head set out.
- Shortwave 2.3 to 5 MHz continuous 120, 90, 75 and 60 meter bands (not covered by Sony ICF 4910) and 49, 41, 31, 25, 19, 16 and 13 meter band each expanded for easy tuning.
- LED tuning and stereo indicators.
- Battery portable (3 AA not included).
- AC adapter 120V-4.5V optional—\$9.95.
- Low battery drain for extended listening.
- Amazing sound for a small package.

Contact your favorite shortwave dealer. Call 800-368-3270 for dealer list or order direct. EEB is importer and service center for the Ambassador 2020 and Diplomat 4950.



ELECTRONIC EQUIPMENT BANK
516 Mill Street, N.E.
Vienna, VA 22180
Order Toll Free: 800-368-3270
Technical and VA Orders (703) 938-3350

R. Suriname International, via Radiobras, 17755 at 1731 in Dutch w/IS, choir, address, phone #, nx (Paszkievicz, WI).

BULGARIA- R. Sofia, 7115 at 0345 in EE w/DX program (Cole, LA); 11720 at 2203 w/feature & mx (Gilson, MD); 15330 at 2130-2200 in EE w/nx, talks, letter pgm (Neff, OH).

BURKINA FASO- R. Burkina at 0541 on 4815 w/soft pops (Shute, FL).

CANADA-R. Canada International, 5960 at 0000 in EE w/nx, ID, "Canada a la Carte," DX show (Neff, OH); 9755 at 2310 w/nxm 11955 w/CBC nx at 1400; 15325 at 1430 w/nx in FF (Gilson, MD).

CFRX, Toronto, 6070 at 0800 w/mx, commercials (Hobbs, ONT); at 1215 (Northrup, MI); 1328 w/sports (Gilson, MD).

CKZN, St. John's, Nfld., 6160 at 1013 in EE (Muterperl, PA).

CKZU, Vancouver, 6160 at 2000 w/"Almanac" in EE (Loftus, OR).

CKFX, Vancouver, 6080 at 0139 w/C&W, local ads. Relaying CKWX/1130 (Loftus, OR).

CHINA- R. Beijing, 9535 at 1215 w/"News About China" (Cole, LA); 9640 at 0507 w/world nx, commentary, mx (Williams, NJ).

CLANDESTINE- R. Venceremos, fair in SS around 0300 w/several freq changes—6545, 6556, 6560 (Carman, ALB). Be sure to read POP'COMM's special clandestine section in this issue—Ed.

La Voz del CID, 0730 in SS on 6305; 0330 on 9940 (Carman, Alberta); 0630 w/anti-Castro talks, ID (Loftus, OR).

R. Caimon, 7470 at 0155, good in SS (Carman, Alberta).

COLOMBIA- La Voz del Llano, 6115 at 0615 in SS, faded at 0630 (Stephens, AL).

COOK ISLANDS- R. Cook Is., 11760 at 0730 in EE w/mx, YL announcer (Willie, Alberta).

COSTA RICA- (New) Adventist World R., 15460 at 2230 in EE w/test xmsn (Rials, LA).

R. Reloj, 4832 at 0445 w/mx, many time checks in SS (Williams, NJ); 6006 at 0750 w/ID's, clock ticks (Loftus, OR). Nominal 6006 kHz—Ed.

TIFC, Faro del Caribe, 5055 at 0335 w/rx pgm in EE (Cole, LA).

CUBA- R. Havana, 6100 at 0527 w/talk on sports (Keul, CA); 9550 at 1130 w/nx in SS (Gilson, MD); 9730 at 1909 in SS (Eichenholtz, PA); 9740 at 0118 in EE w/nx, Cuban mx (Loftus, OR); 11760 at 2255 in SS w/mx, ID (Gilson, MD).

R. Rebelde, 5025 w/Top 40 at 0145 (Carman, Alberta).

R. Mayak relay, 4765 at 0410 in RR but badly QRM'd (Carman, Alberta).

CZECHOSLOVAKIA- R. Prague on 5930 at 0029 w/IS, s/on in Czech (Gilson, MD); 0114-0155 in EE (Neff, OH); 7345 at 0140 in EE (Carman, Alberta).

EAST GERMANY- R. Berlin International, on 6080 at 0022 w/talk, s/off at 0025 (Gilson, MD); 9560 at 0204 in EE, talks, ID's, mx (Neff, OH).

ECUADOR- HCJB on 6230/9870 at 0600 w/ID (Keul, CA); 9870 at 0240 in EE w/"Musical Mailbag" (Loftus, OR); 11910 at 0030 in EE (Hobbs, ONT); 11960 at 1211 in SS (Gilson, MD); 15115 at 1232 w/travelog (Eichenholtz, PA); 15150 at 0015 in FF (Carman, Alberta); 15150 at 0015 in FF (Carman, Alberta).

HD210A, Guayaquil (time station) on 7600 at 0335 in SS (Muterperl, PA).

CIRCLE 74 ON READER SERVICE CARD

ENGLAND-BBC on 5975 at 0540 w/"Book Talk" (Keul, CA); 6120 at 2307 w/nx; 6175 at 2307 w/nx, 9510 at 1155 (Northrup, MI); 9915 //12040 at 2130 w/"Calling The Falklands" & 0353 w/World Service on 7185 (Cole, LA). Some relayed by Antigua, etc.-- Ed.

FINLAND- R. Finland International, 15400 at 1530 in EE (Hobbs, ONT); 1405-1420 in EE (Gilson, MD).

FRANCE- R. France International, 7120 at 0350 w/EE nx //9800 & 11700 (Cole, LA); 9550 at 0031 in SS, 9715 in SS at 2300, nx in FF 0000; 9800 at 0030 in SS; 15365 in FF at 1401 (Gilson, MD) Some via French Guiana relay-- Ed.

GABON- Africa #1, 4810 at 0515 w/African mx pgm in FF (Williams, NJ).

R. Japan via Moyabi relay at 2329 on 9645 w/ID, Okinawa mx pgm (Eichenholtz, PA).

GHANA- Ghana BC Corp, 4915 at 0608 w/talks about road repairs, economy. Into un-ID language at 0615 (Keul, CA); World nx in EE at 0604, un-ID language at 0616 (Williams, NJ).

GREECE- V. of Greece, 7430 at 0130 w/nx in EE, QSL in 2 weeks! (Rials, LA).

GUATEMALA- TGNA, R. Cultural, 3300 at 0317 w/"Back To The Bible" & another EE rx pgm (Williams, NJ).

GUYANA- GBC-2 on 5950 from 0330 s/on w/"Earlybird" pgm & birthday announcements (Stephens, AL).

HAITI- 4VEH on 4930 at 0025 w/Bible pgm in 2 languages (EE & FF) & s/off at 0031 (Williams, NJ).

HONDURAS- HRVC, 4820 at 0418 w/"Back To God Hour" & rx mx in EE (Williams, NJ).

HUNGARY- R. Budapest w/YL in EE at 0200 on 12000 (Carman, Alberta).

ISRAEL- Kol Israel, 7410 at 2330 s/on w/Hebrew nx, mx 0010 (Gilson, MD); 9435 at 2310 w/nx, "Face To Face (Eichenholtz, PA); to 0125 s/off in EE (Carman, Alberta).

IRAQ- R. Baghdad, 7170 at 2100 in EE w/ID, sked, mx & talk (Neff, OH); 0300 on 9565 w/nx in EE, ID, Arabic mx (Miller, GA); 15120 at 2130 in EE (Muterperl, PA).

ITALY- RAI on 9710 at 0345 w/bird IS (Shute, FL).

JAPAN- R. Japan, 9645 (via Gabon, Ed.) at 2300 w/nx, "Tokyo Pop-in" & "Meet The People" (Miller, GA); 9675 at 1135 w/"Japan Panorama" (Cole, LA); 9735 at 0715 w/"Japan Music Scene" (Loftus, OR); 11815 in EE at 1700 (Carman, Alberta); 15195 at 0258 w/nx, EE s/off; 17810 at 0500 w/nx in EE (Cole, LA).

KAMPUCHEA- V. of The People of Kampuchea, 11938 at 1305 w/nx in Laotian & Vietnamese, ID 1300 (Willie, Alberta).

LIBERIA- VOA relay, 7280 at 0700 w/"Daybreak Africa" (Loftus, OR, 9540 at 0800 (Shute, FL).

LITHUANIAN SSR- R. Vilnius, 9665 at 2200 in EE (Muterperl, PA).

MALI- Radiodiff.-TV Malienne, strong at 0700 on 7285. Local programming, all FF (Stephens, AL).

MONACO- Trans World R. on 7025 at 0835 w/rx pgm. Freq change to 9500 at 0857 (Williams, NJ). Don't recall seeing these freqs reported anywhere before-- Ed.

MOROCCO- R. Monte Carlo via Nador on 9775 at 1917. Interview but garbled (Eichenholtz, PA).

NETHERLANDS ANTILLES- R. Netherlands Relay, 6020 in PP at 0105 (Gilson, MD); 6165 at 0553 in EE (Neff, OH); 9650 at 1045 (Gilson, MD); 15315 at 2230 s/on in SS (Gilson, MD).

Trans World R., Bonaire 9535 w/rx pgm in GG, off at 1030. Also on 11815 at 1133 w/nx, rx drama (Gilson, MD); 1140 w/"Good Time" pgm. (Eichenholtz, PA).

NIGER- ORTN, tentative on 5020 at 0550 w/partial ID "Radiodiffusion du Television..." choral music, time pips, short flute & guitar IS at 0600 (Shute, FL). Certainly ORTN-- Ed.

NIGERIA- V. of Nigeria, 7255 at 0515 w/mx pgm, world nx (Williams, NJ).

NICARAGUA- V. of Nicaragua, 6015 at 0436 w/Central American nx headlines, s/off 0443 (Williams, NJ); 0136-0159 in EE (Neff, OH). More recently on 6100-- Ed.

NORTH KOREA- R. Pyongyang, 11830 at 0809 in EE w/nx about Olympics in S. Korea (Loftus, OR).

NORTHERN MARIANAS- KYOI, Saipan, 11900 at 1145 w/rock mx (Gilson, MD).

NORWAY- R. Norway International, 9580 at 0000 w/"Norway Today" & "Trends & Traditions" (Miller, GA).

PAPUA NEW GUINEA- NBC, Port Moresby, 4890 at 0800 w/light mx, wx report (Willie, Alberta).

PERU- R. Union, Lima, 6115 at 0644 in SS w/Peruvian mx, ID 0645 (Loftus, OR).

POLAND- R. Polonia, 7270 at 2245-2249 w/nx. Heavy QRM from station playing Arabic mx (Gilson, MD).

PORTUGAL- R. Portugal, 9680 at 0043 w/"Listeners' Mailbag" in EE (Cole, LA).

ROMANIA- R. Bucharest at 0400 in EE w/NA service on 9510 (Cole, LA).

SOLOMON ISLANDS- SIBC, Honiara, 9545 at 0735 in EE w/nx, island mx (Shute, FL); 0730 in EE w/nx, wx, ads (Rials, LA); 0707 in EE & Pidgin (Loftus, OR).

SOUTH KOREA- R. Korea, 9750 at 1400 in EE to NA //15575 (Cole, LA).

SPAIN- Spanish Foreign R. on 6055 at 0017 w/press review, mx (Gilson, MD); 0106 on 9630 in EE (Loftus, OR); 0000-0059 w/nx, ID, mx, letters short story & DX pgm (Neff, OH); 15345 at 1830 (Carman, Albania).

SRI LANKA- SLBC on 9720 at 1450, US pops, nx at 1500. Announced All Asian Service (Stephens, AL).

SWEDEN- R. Sweden International w/"Sunday from Stockholm" at 2300 on 11745 (Nunez, GA); 2300 on 11705 w/talk in EE (Carman, Alberta); 15345 at 1420 w/discussion, multi-lingual ID, into Swedish at 1430 (Gilson, MD).

SWITZERLAND- Swiss R. International in Italian to 0357 on 6135//9725 (Cole, LA); 9885 at 0208 in EE w/nx, "Dateline" (Neff, OH); 1000 w/nx on 11745; 12035 at 0230 in EE (Keul, CA); 1336 on 15570//15585 w/"Dateline" (Cole, LA).

SYRIA- R. Damascus, 9950 in EE at 2114 w/mx, ID, nx (Neff, OH); 2200 w/brief nx & ID (Miller, GA); 2016 on 12085 w/world nx, mx, press review & "Portraits of our Country" (Williams, NJ); 2032 in EE (Neff, OH).

TAHITI- R. Tahiti, 15170 in FF w/island & pop mx at 2340 (Loftus, OR).

TAIWAN- V. of Free China, 5985 (via WYFR-- Ed.) at 0233 w/mx & talk about mx (Keul, CA); 9680 at 0245 in EE (Carman, Alberta); 15130 s/on 2301 (both also WYFR-- Ed.)

TANZANIA- R. Tanzania, 9684 in EE at 0415 w/talks on political & cultural developments there, possible switch to vernaculars at 0430, fade around 0436 (Stephens, AL).

TURKEY- V. of Turkey on 9345 at 0331 w/"The DX Corner" (Williams, NJ); 9560 at 2201 w/nx, press review, ID, "Last Week In Turkey" (Neff, OH); 2347-0000 in Turkish (Gilson, MD).

UKRAINIAN SSR- R. Kiev on 9640 at 2337 w/nx & mailbag (Gilson, MD).

UNITED ARAB EMIRATES- UAE Radio, Dubai 11940 at 0345 in EE w/"Wide World of Arabic Music" (Muterperl, PA); 11955 at 1603 w/mailbag pgm in EE (Shute, FL).

UNITED STATES- VOA, talks at 0605 on 9670 (Keul, CA); 9775 at 0300 w/nx; 0300 s/off at 9840; 0310 on 15375 (Carman, Alberta).

WINB, Red Lion, 0325 on 15155 (Carman, Alberta).

La Voz de la OEA (Organization of American States) via VOA on 11830 from 2345 s/on to 0030 s/off in SS. Also 15160 (Stephens, AL).

KCBI, Dallas, 11735 at 1804 in EE w/country mx review (Shute, FL).

WRNO, New Orleans, 6185 w/"Top 40 Satellite Survey" at 0657 (Loftus, OR); 7355 at 0230 w/Top 40, ads (Rials, LA); 11705 at 2155, 11965 at 1400 (Gilson, MD); 15420 at 1700 (Hobbs, CNT)

WHRI, Noblesville, 7355 at 0355 s/off in EE (Cole, LA); 9852.5 at 0300 s/off (Carman, Alberta); 15105 at 1801 w/EE s/on (Shute, FL).

R. Marti, 9570 at 1412 w/mx (Gilson, MD); 11930 at 1600 w/Central American nx in SS (Shute, FL).

WYFR, 11875 at 1605 w/rx pgm (Gilson, MD).

AFRTS on 6030 from 1230 w/"Perspective" & nx (Gilson, MD); 15430 at 1152 (Eichenholtz, PA).

USSR- R. Moscow, 7175 at 0557 w/mailbag (Keul, CA); 7400 from 2330 tune-in (Gilson, MD); 9600 (via Havana-- Ed.) at 1215 w/"Soviet Way of Life" (Northrup, MI); 11840 (via Havana-- Ed.) at 1830 w/nx & commentary (Hobbs, ONT); 11950//15225 at 1200 w/nx (Gilson, MD); 12030 at 0545 (Carman, Alberta).

VATICAN CITY- R. Vatican, 9605 at 0050 w/features in EE. Lotsa noise (Cole, LA).

VENEZUELA- R. Rumbos, Caracas, 4970 at 0406 w/mx & time announcements in SS (Williams, NJ).

R. San Cristobal, 9570 at 1400 in SS (Hobbs, ONT). Listed but unreported in quite some time. ID?-- Ed.

R. Tachira, San Cristobal, 4830 from 0121 w/mx, SS DJ (Gilson, MD).

Ecos del Torbes, San Cristobal, 4980 at 0956 w/SS mx/nx (Williams, NJ).

WEST GERMANY- V. of Germany, 6040//6085 at w/nx (Gilson, MD); 6120 at 0545 in EE (Keul, CA); 11705 at 1210 w/nx & nx magazine in GG (Northrup, MI); 15270 at 2305 in GG, 17715 at 1215 in GG (Gilson, MD).

ZAMBIA- R. Zambia, at 0500 in EE. Weak & barely readable (Stephens, LA). On 4910?-- Ed.



PICKS UP A WHISPER 50 FEET AWAY!

The model WAT-50 miniature FM transmitter uses a 4-stage circuit NOT to be confused with a simple wireless microphone. Simply snap the unit on top of a 9V battery and you can hear every sound in an entire house up to 1 mile away! Use with any FM radio. Tunes to any frequency from 70mhz - 130mhz. Easy to assemble kit includes all parts and instructions. Only 29.98 tax incl.



The **WIRELESS TELEPHONE TRANSMITTER** model WTT-20 is only about the size of a dime, yet transmits both sides of a telephone conversation to any FM radio with crystal clarity. Completely automatic. Uses power from the telephone line itself - never needs a battery! Up to 1/4 mile range. Tunes from 70mhz - 130mhz. Easy to assemble kit includes all parts and instructions. Only \$29.98 tax incl.

Call or send **MO, VISA, MC** for immediate delivery. Single kit orders include \$1.50 S&H. **FREE SHIPPING** on orders of 2 or more. All orders shipped by U.S. Mail. **COD add \$4.00.** Personal checks allow 21 days.

DECO INDUSTRIES
BOX 607, BEDFORD HILLS, NY 10507
914-232-3878

CIRCLE 21 ON READER SERVICE CARD

CB RADIO OWNERS!

We specialize in a wide variety of technical information, parts and services for CB radios. 10M-FM conversions, repairs, books, plans, kits, high-performance accessories. Our 11th year! Catalog \$2.

CBC INTERNATIONAL, P.O. BOX 31500PC,
PHOENIX, AZ 85046

SWL Receivers, Antennas, Books ICOM KENWOOD YAESU

Michigan Radio

Sun, Mon - Closed
 Tue, Wed - 10-6
 Thu, Fri - 10-9
 Sat - 10-4

313-469-4656

We accept Visa, Mastercard & COD's

28360 South River Rd. • Mt. Clemens, MI 48045



The magazine for Computerist & Amateur Radio
 Your #1 source of Packet info.

"received my moneys worth with just one issue"

-J. Trenbick

"always stop to read CTM, even though most other magazines I receive (and write for) only get cursory examination"

-Fred Blechman, K6UGT

U.S.A.	\$18.00 for 1 year
Mexico, Canada	\$32.00
Foreign	\$43.00 (land) \$68.00 (air)
(U.S. funds only)	
Permanent (U.S. Subscription)	\$150.00
Sample Copy	\$3.50

CHET LAMBERT, W4WDR
 1704 Sam Drive • Birmingham, AL 35235
 (205) 854-0271

CIRCLE 8 ON READER SERVICE CARD

BROADCAST TOPIK

BY MARK MANUCY, W3GMG

DX, NEWS AND VIEWS OF AM AND FM BROADCASTING

Last month my big item was talking about how the clear channels are being diminished by new allocations for daytime and full-time stations. A letter from Steve Anderson in California, received shortly after the column was in the mail, points out the problem all over again.

Steve's letter says in part, "There are also quite a few new stations that we can pick up at night around here. We must all wave good-bye to WLS 890 since KDXU signed on the air one night on the same channel. At 10,000 watts from St. George, Utah, it can be received very well by everyone from Mexico to Northern California, and who knows how far east! The music is just as good as WLS and we can get KDXU all night every night, not just during the winter and very poorly like WLS. Another good-bye to WWL in New Orleans ever since KIEV, Glendale, went to 24 hours. WWL will be very sadly missed and fondly remembered. Oh, the good ol' days (2 years ago)! KWNK from Simi Valley will be an interesting catch on 670, if you can get by KBOI in Boise. KRVN in Lexington, NE is harder and harder to get because of the smaller stations on the same frequency.

The biggest and best news though has to be about KTNN (The Navajo Nation) from Window Rock, AZ very close to Gallup, NM. With 50 kw on 660, it reaches everywhere in the west and at night the music, although Top 40, is just great—Lou Reed and John Cougar Mellencamp! The interesting part (that I discovered at 4 a.m. while studying for Calculus tests), was that when it signs on at 4 a.m., it is in the Navajo language. This is probably the only time that people will hear a Native American language. It comes in well this way for the first hour and then fades out. While they speak Navajo they play country and western music."

Steve says, although he enjoys hearing about the east coast DX to which this author is in tune, he thought we'd like to hear from his radio. Just great Steve! I think that type of report is much more interesting than a bunch of lists. We welcome such reporting!

Jerry Starr writes this month to discuss AM stereo with me. He's not as enthusiastic about it as I, but does agree with me about the silliness of the Motorola and Kahn fighting and the "great marketplace" situation. Jerry says, (and I've heard others mention the same thing), "A continuously tuning radio might break down the psychological barriers between AM and FM radio. The entire band would just become Radio. No new receiver technology would be required and the cost would likely be less than worrying about a chip that would switch between the

KQV RADIO PITTSBURGH abc COVERAGE AREA

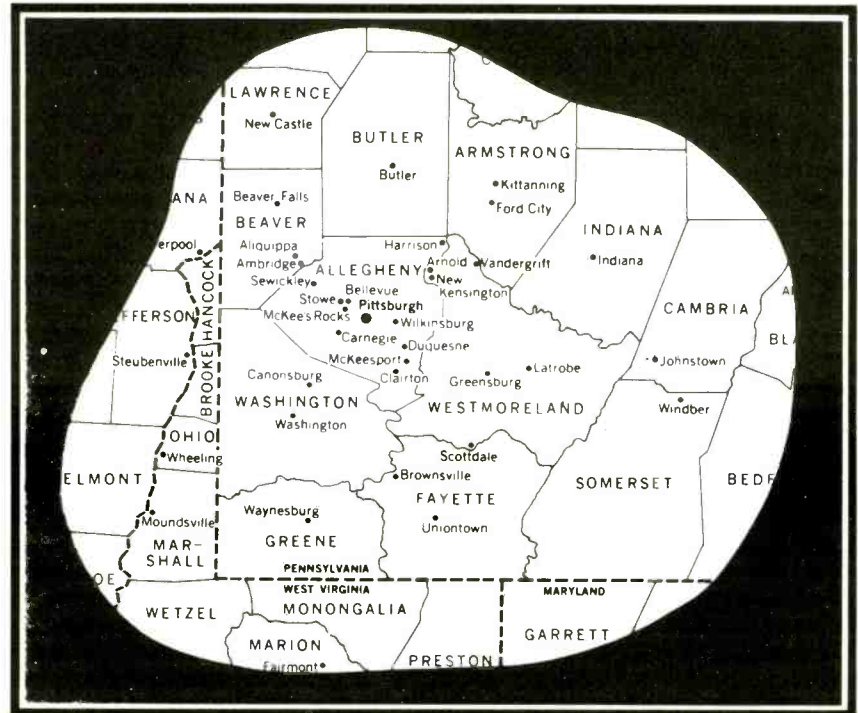

various AM stereo modes. A listener tuning up the FM dial would wander unknowingly into the AM band and discover, as you and I already acknowledge, that AM can sound every bit as good and be just as entertaining as FM. One more thought. Since most all new receivers are now made with digital displays, the continuous AM/FM band wouldn't require a slide-rule dial a mile long." All I can say is, it makes sense to me. Any readers have thoughts on this?

Several times we've mentioned the discontinuance of the Sony SRF-A100 but Dick Ipsen writes to tell of his experience with one of the new Sonys, the CFS-6000. He bought one over the Fourth of July weekend and, being a previous SRF-A100 owner, gives us the following comparison, "In one of your columns you mentioned that the A-100 had a poor FM section, not so the CFS-6000. The AM sounds really good until you switch it over to FM stereo, then it's no contest. Let's hope the AM stations clean up their act." This radio is quite a bit larger than the A-100 and has detachable speakers as well. A five-band graphic equalizer, a

tape deck with Dolby and a balance control round out the set. The tuning accuracy is just as bad as the A-100 and Dick takes his GE World Monitor along to find a specific station. That's a nice radio too, with a digital readout that one can turn on or off; it also has a tuning meter and a switchable wide/narrow filter on AM.

One reader who is very excited about AM stereo is Mike Pfof. He enjoys WEBY in Milton, FL. Says their stereo is the best he's heard—even better than WSB. Mace Twigg is an AM and FM DXer and has pulled in good DX from his home in Minnesota. On FM he's logged WQUE, WEBZ, WRNO and WNOE all from New Orleans. He also heard WNOE during a hurricane watch while they were operating with daytime parameters. Those are the fun ones for me too, Mace! The fun part of this particular WRNO (FM) catch was comparing it to the WRNO worldwide programming.

If it comes to the most AM stereo receivers I think Marvin Fricklas may be in first place. He has three Sonys and a Radio Shack. The XRA-33 in his car, the A-100 in

COVERAGE

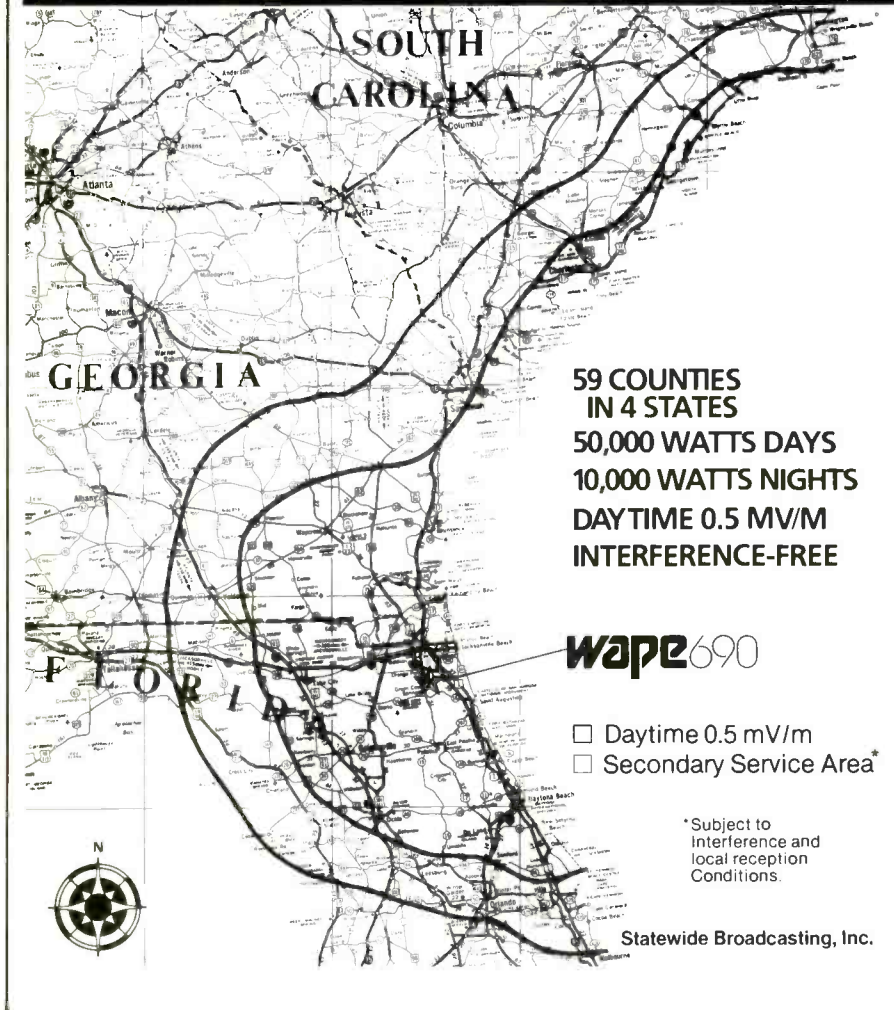

**59 COUNTIES
IN 4 STATES
50,000 WATTS DAYS
10,000 WATTS NIGHTS
DAYTIME 0.5 MV/M
INTERFERENCE-FREE**

wape 690

- Daytime 0.5 mV/m
- Secondary Service Area*

*Subject to
Interference and
local reception
Conditions.

Statewide Broadcasting, Inc.

the den the RS TM-152 in the living room and a walkman on his hip. Talk about dedication to AM stereo! As with others, Marv's comments on AM stereo are not all complimentary. For example, he says WHLI sounds so bad he needs the stereo indicator on the XRA-33 to tell him they're broadcasting in stereo! By contrast WPAT sounds so good he called their engineer one day when they had the stereo off to ask what the trouble was. The startled engineer explained that a necessary adjustment was being made and was surprised that anyone knew about stereo. Marv says the best sound comes from CHNL in Hamilton, Ontario, on 900.

An interesting side note about these stereo stations that we've mentioned. The letters say nothing of interference or "platform motion," which we know exists. WEBY, WSB, WPAT and CHNL mentioned above are C-Quam stations. It will be interesting to follow your letters on this subject. Please let me know what you are hearing. If you want a listing of all the AM stereo stations in the U.S. send me \$2.50 and I'll send you a 4 "

× 7½" pamphlet with all the stations broadcasting AM stereo.

One last note on AM stereo. Kahn's request to the FCC to check the operation of the C-Quam system for interference has come up dry. The FCC says they found no interference.

Kevin Taubenheim is thinking of getting the Sony ICF-2010 along with a loop antenna. He's heard that loop antennas can cause overload on portable radio and wanted advice. It's true, loop antennas can cause a radio to overload, but it is much less likely than with a long-wire-type antenna. To control the overload there are several things that can be done. If the receiver, such as the 2010, has a RF attenuator this may be reduced to prevent excessive signal. See the November column for more info. The overload is much less likely since the loop is tuned to a specific frequency, thereby reducing the response to others. Most commercial loops have a gain control which may be reduced if overload is present. Nonetheless, the loop for BC band DXing is hard to beat. One of the best features is the direc-

tionality of the loop and its ability to operate most anywhere. If you want more information on loops send me an SASE and mention that you would like more info about loops. Also available are plans for building box and ferrite loops. The box loop plans are \$5.50 and the ferrite plans are \$7.50 postpaid.

So, how many times have you moved your shack? I hate to count the times that my shack has been moved. I've moved it completely around in the basement four times in the last five years. Between now and next month there will be another move—from the basement to the third floor. That should be a big help as far as AM listening is concerned since any loop antenna will perform better when not surrounded by conduit, heating and water pipes. The only negatives of the move might be getting a good ground. My best ground is a radiator but that's on the opposite side of the room from where I want to locate the shack. The other item that I will have to adjust to is the bright light of the third floor. I don't know if my eyes can stand the strain of the light after living so long below ground! But my wife wants my company, so who am I to say no. Not only that, but I'll probably be able to see the keyboard of the computer a little better.

A ground in a radio shack is very important for a number of reasons. If any outside antennas are used, a good ground is extremely important for protecting equipment and the house from lightning. Whenever an outside antenna is not in use it should be disconnected from all equipment. The antenna should also be grounded when not in use. Even if only inside antennas are used, including loops, a shack should still be attached to a common ground.

Suppose there is an inside antenna strung around the outer edges of the attic. A lightning strike which might occur nearby, hitting a tree, the power lines near your home, the neighbors' TV antenna, or even (perish the thought) your home, might cause enough voltage to be induced into your attic antenna to destroy the receiver to which it is connected. It is not uncommon for lightning to strike rain gutters on a house and jump (arc) to other metallic items such as nails or cabling (AC or coax) setting a fire which could cause considerable damage. Antenna considerations are very important and not to be taken lightly.

If the shack consists only of built-in or desk-top operated loop antennas then the ground can still be very important. A receiver with a good ground may not "hear" as much noise from within the house or down the street. Here is a simple test to determine if it is safe to connect a ground to your radio or receivers. If you don't have a neon test lamp, pick one up at the hardware or dime store for about \$1.50. These have two test leads with a small neon lamp at the top. When each lead is plugged into a standard AC socket the two elements inside the lamp glow a bright orange color. In order to test your gear to see if it is safe to connect a ground, hold one of the two test leads in your hand and touch the chassis or the

Call Letter Changes

Location	Old	New	Location	Old	New
AM Stations			FM Stations		
Rainbow City, AL	WKFX	WJBY	Demopolis, AL	WNAN	WZNJ
Flagstaff, AZ	KZKZ	KVNA	Globe, AZ	KIKO-FM	KEYX
Phoenix, AZ	KFLR	KAMJ	Phoenix, AZ	KAMJ	KAMJ-FM
Tucson, AZ	KGLR	KFLT	Sun City, AZ	KLFF-FM	KONC-FM
Tucson, AZ	KFLT	KFXX	San Diego, CA	New	KIFM
Pomona, CA	KWOW	KMNY	Eureka, CA	KPDJ-FM	KRED-FM
Greenley, CO	KGRE	KATR	Fowler, CA	KTED	KEZL
Pensacola, FL	WCHZ	WFXP	Homestead, FL	New	WRFM
Blountstown, FL	WKMK	WYBT	Miami, FL	WCJX	WPOW
Nashville, GA	WNGA	WLYZ	Sarasota, FL	WAVE-FM	WHVE
Ottawa, KS	KOFO	KFRG	Blountsville, FL	WRTM	WPHK
Nicholasville, KY	WKYJ	WJMM	Nashville, GA	WLYZ	WJYF
Forest, MS	WJYV	WQST	Des Moines, IA	KMGK	KDWZ
Meridian, MS	New	WNBW	Blue Hill, ME	New	WERU-FM
Sardis, MS	WRDS	WKXT	Sanford, ME	WSME	WCDQ
Albuquerque, NM	KDXA	KZSS	Forest, MS	WQST	WQST-FM
Alamogordo, NM	KINN	KZZX	Glendive, MT	KGLE-FM	KDZN
Trumansburg, NY	WJCU	WPIE	Albuquerque, NM	KRKE-FM	KZRR
Buffalo, NY	WYSL	WPHD	Los Alamos, NM	New	KPZA
Mebane, NC	WMYT	WGLH	Buffalo, NY	WPHD	WPHD-FM
Charlotte, NC	WGKY	WNLF	Glen Falls, NY	WNIQ-FM	WRXI
Tulsa, OK	KVLT	KSKS	Whitney, PA	New	WLIH
Reading, PA	WHUM	WAGO	Mc Kenzie, TN	WKTA	WWYN
Jasper, TN	New	WAPO	Quanah, TX	KQTX	KIXC-FM
Brattleboro, VT	WMMJ	WTSA	Victoria, TX	New	KEPG
Dishman, WA	New	KSPD	Cape Charles, VA	WWGH	WIAV
Tumwater, WA	KCIF	WVSN	Cheney, WA	KEWC-FM	KEWU-FM

ground point of your gear with the other test lead. Turn the gear on and off while watching the neon lamp. Should it glow, even faintly, it indicates there is a voltage on the chassis of that gear. Turn the AC plug over and try the test again. Should the neon lamp still glow then do not attempt to ground the gear and get it checked by a technician because the test lamp is showing a voltage is present on the chassis of the radio which might not be a safe condition.

With three-prong AC plugs the chassis should be at ground potential through the large round prong on the AC plug. This is what the prong is for and that is the reason it should not be cut or defeated. If you are using an adapter, three pins to two, then the green wire from the adapter should be under the screw on the AC wall plug to accomplish the same thing. However, if your house is an older model like mine, it is likely that a number of plugs, if not all, in the house have only two prongs. There might not be a ground wire attached from the fuse box to the outlet either. Many old houses are wired with only two wires, some still separate individual wires strung from knobs and run through porcelain tubing (knob and tube).

This situation presents us with no ground at the AC plug. Do not defeat the three-prong plug, however, under any circumstances. If you do not have a three-prong wall socket, use the adapter. To repeat, do not cut the ground prong off. If you do not know whether the AC plus has a ground,

Station Updates

Call	Location	Freq	Pwr	Ant
AM				
WVVW	St. Marys, WV	630	.5/0	NDA
WCBX	Eden, NC	830	1/1	DA-N
KASY	Auburn, WA	1210	50/1	DA-D
KLIP	Fowler, CA	1210	10/1	NDA
KZUN	Priest River, ID	1600	5/0	NDA
FM				
KVCR	San Bernardino, CA	91.9	90	1620'
WJGA-FM	Jackson, GA	92.1	2.15	375'
WBTR-FM	Carrollton, GA	92.1	.58	635'
KBLQ-FM	Logan, UT	92.9	50	716'
KIXS-FM	Killeen, TX	93.3	100	1948'
KWKF-FM	Shreveport, LA	94.5	100	1107'
KVIC	Victoria, TX	95.1	100	500'
WXTC	Charleston, SC	96.9	100	1770'
KDEJ	Anchorage, AK	97.3	25	593'
WWGT	Portland, ME	97.9	16	889'
WVCX	Tomah, WI	98.9	100	990'
WPBB	Romney, WV	100.1	.205	1271'
KLTG	Lamesa, TX	100.3	100	1000'
KYXI	Yuma, AZ	100.9	100	1076'
WFAL	Falmouth, MA	101.1	2.5	253'
WPCM	Burlington, NC	101.1	100	1190'
WAYZ-FM	Waynesboro, PA	101.5	50	230'
WMXQ	Moncks Corner, SC	105.5	3.0	328'
WCIG	Mullins, SC	107.1	3.0	328'
KLVE	Los Angeles, CA	107.5	27.9	3000'
KAND-FM	Corsicana, TX	107.9	100	842'

KEY: D = Daytime, N = Nighttime, DA = Directional Antenna, DA1 = Same Pattern Day & Night, DA2 = Different Pattern/Power Day/Night, NDA = Omni Antenna Day and/or Night, * = Special Operation or Critical Hours, N/C = No Change.

WNOE-AM

Keep It Country Stereo 1060

WEBY

Stereo 1330

take your neon tester, touch one lead to the screw holding the plastic or metal cover on the wall socket. Should the test lamp glow brightly as you insert the other test lead into one side of the socket and then the other that indicates this particular wall socket is probably a grounded socket. Be sure that your fingers are not touching the metal tips of the test leads as you use it when testing a wall socket.

All we have determined so far is whether or not you have a grounded AC socket. This is also what I have to do when I move my shack to the third floor. This "AC ground" is not a valid ground for our radio shack, however. Go through the chassis test with each piece of shack gear noting the results on a piece of paper. Include all tape recorders, amplifiers, boosters, anything that plugs in the wall. Be sure to run this test with all gear disconnected from everything else. No wires attached at all. Get an individual reading on each piece of gear. Now let's check each piece of gear with every other piece of gear. Take the neon tester and touch one lead to the chassis of one item and the other lead to the chassis of the next item. Turn each one on and off separately and together noting the lamp each time. Should the lamp glow it means that there is voltage between those two pieces of gear. If it is a bright glow it means that should you touch those two items with your hands . . . zap!

What I am leading up to is a common connector between all of your gear that will prevent any shock from occurring should you touch two dissimilar items. If any labels on the gear read 110-120 volts AC/DC, don't use it with the rest of your station. We use AC only and/or battery powered equipment together. AC/DC is forbidden in our shacks! Now that everything is checked out let us connect a common wire to each piece of equipment and then to our ground. The common wire need not be large. One could separate the wires in common lamp cord

and use one side of the wire. The neatest way would be to use crimp-on spade lugs if you have them or otherwise twist the ends of the wires together tightly and find a convenient screw or other ground on each item. I know if you are using a tape recorder, the shielded wire provides a ground to the tape deck but this continues the ground should the audio connector be removed. It should not be necessary to ground battery-operated tape recorders.

A good ground is harder to find today than it used to be. A lot of plumbing is plastic and that doesn't conduct RF. The metal duct work in air-conditioning can be isolated and never reach a ground. It might make a better antenna! Same is true for hot-air heating. The good ol' radiator heat systems do pretty well even though the pipes may not be copper. Baseboard hot water heating generally uses copper piping. Don't use electric baseboard for a ground, we're trying to stay away from AC. Then there is the normal household plumbing, much of which today might be plastic. A quick check with the neon tester would answer that question if you are extremely careful. No glow means plastic plumbing. The shack should be located as close to a ground source as possible. That is why I liked my basement location. Plenty of grounds in the basement. If nothing else is available two- or three-, six- or eight-foot ground rods outside the nearest window can be used. The wire from a ground to the shack should be at least a number 14 wire. Connect the ground to the common wire from all the gear after putting the neon tester between them for one final check. No glow means okay to connect. If the tester glows then seek some competent help before doing anything else. Should any questions arise about this entire procedure please ask help of someone competent enough to give you the right answer. I'll answer by mail if you send a SASE.

The mailing address for all correspondence and to order pamphlets is P.O. Box 5624, Baltimore, MD 21210. **PC**

SUBSCRIBE NOW & SAVE! - Twelve Issues \$16



the HAM STATION

P.O. Box 4405
220 N. Fulton Avenue
Evansville, IN 47711

ORDERS: 800-523-7731
INDIANA: 812-422-0231

ICOM R71A



- Commercial Grade Receiver
- 100 kHz - 30 MHz
- 32 Memories
- See ICOM Ad For More Info.
- Call For Discount Price

R7000



- Commercial Receiver VHF-UHF
- 25-2000 MHz
- 99 Memories
- Special Price, Call

TEN-TEC RX325



- New Shortwave Receiver
- Keyboard Entry
- Call For Special Price

DIAMOND

D130

- 25-1300 MHz Super Discone Antenna.
- Transmit on 50, 144, 430, 1200 MHz
- Monitor 25-1300 MHz with one antenna



YAESU 9600



- 60-905 MHz
- Optional Video Output
- Now On Sale



8800

- All Mode SW Receiver
- 150 kHz to 30 MHz
- VHF Converter Optional
- Call For Price

SCANNER SCENE

BY CHUCK GYSI, N2DUP

MONITORING THE 30 TO 900 MHz "ACTION" BANDS

The relay press radio service has perhaps the least number of available frequencies of any radio service, but probably has some of the most exciting listening at times.

Relay press frequencies are used by newspapers and wire services such as the Associated Press and United Press International. Some of the relay press frequencies are shared by users in the motion picture radio service, so don't be surprised to hear on-location film crews chatting on your favorite newspaper's channel.

The six primary channels used by newspapers are: 173.225, 173.275, 173.325, 173.375, 452.975 and 453.000 MHz. On the UHF frequencies, 452.975 and 453.000 are repeater outputs while 457.975 and 458.000 are the respective mobile input channels to the repeater pairs. In addition, 452.9625, 452.9875, 457.9625 and 457.9875 can be used for low-power, 2-watt operations. Chances are, however, you'll never hear anything on the low-power, 2-watt channels except perhaps building security in a newspaper's offices. Newspapers generally don't have use for handheld-to-handheld communications.

The relay press channels can be used by newspapers for any of their operations. At a daily newspaper that I work for as an editor, we use our radio system to call staff and freelance photographers for assignments, to page a courthouse reporter making his daily checks of various county offices or the executive editor at a Cub Scouts dinner, to dispatch drivers to pick up advertising copy from advertisers and agencies, and to have newspapers delivered by circulation department employees to customers who were missed by their carriers. Our newspaper also has a few walkie-talkies that we give to reporters sent out on breaking news stories such as murders and fires so we can get information back and forth from the news scene and our newsroom.

Newspaper channels are favorite frequencies for many listening hobbyists. However, editors are more than aware that their competition in town may also be listening to their communications, thus they may warn reporters and photographers over the air to call the office from a pay phone for specific information or assignments that they don't want their competition to get wind of.

Newspapers also use business band channels in some cities either in lieu of or to supplement the relay press channels. Some larger newspapers may use more than one relay press channel in addition to business band frequencies. *The New York Times* can be found on two 173-MHz channels, while

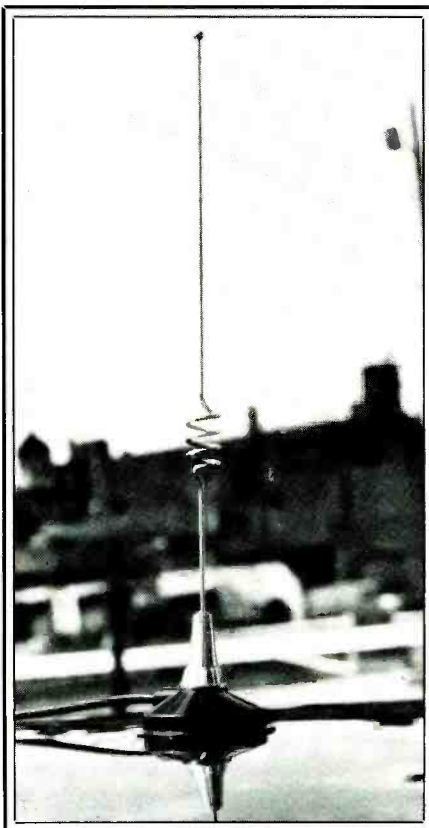

This quick magnetic-mount 800 MHz antenna makes it a snap for reporters or photographers to throw a cellular mobile telephone in their car while on assignment.

The Philadelphia Inquirer and its sister *Philadelphia Daily News* can be found on one 173-MHz channel, both of the UHF repeater relay press channels as well as UHF business band channels. At *The Inquirer* each channel has specific uses, such as for photographers, delivery trucks, company tow trucks for delivery trucks and building security.

If you hear what sounds like someone reading a news story over the air on a relay press channel, it's not an old story—chances are it's a breaking story. One time a story was breaking on deadline for the newspaper I work at. Our reporter at the scene wasn't near a pay phone, so he dictated his story over a walkie-talkie to a reporter sitting at the metro desk. The reporter on the desk typed the story as it was dictated onto a computer terminal for news editors to review.

Newspapers also have started using cellular mobile telephones lately. However, one of the biggest uses of cellular phones by newspapers is the transmission of news sto-

ries from portable computer terminals to newspaper computers.

Many daily newspapers use portable computer terminals for reporters in bureaus and on special assignments. These desktop and lapsed terminals (the Radio Shack TRS-80 Model 100 is the most popular) can be carried along by reporters and because they contain batteries, reporters can write their stories right at a news conference, a ball game or a special event.

When the reporter is ready to send the story to the editors, he/she can use either a pay phone or, as many now are doing, a cellular phone. The computer signals are carried either over the phone lines or over the cellular radio system to the newspaper's computers. Newspapers now can purchase combination units that include the portable computer terminal and a cellular phone. With these units, the reporter can call his or her editor for advice on a story and then send their story on the same cellular portable phone. Reporters now don't have to worry about finding that dreaded pay phone and keeping a pocketful of dimes—or quarters as it is these days.

Some other users you might find on relay press channels as well as wire services are traffic reporting services. For instance, Shadow Network Traffic, which reports traffic information for radio stations in New York, New Jersey and Philadelphia, uses 452.975 and 453.000 to collect traffic reports from mobile reporters during rush hours in the New York City area. They probably qualify for licensing in the relay press radio service because they provide a wire service on traffic conditions to some radio and TV stations. Regular wire services such as AP and UPI use the relay press channels primarily for news photographers. However, the wire services' associated broadcast audio services must use the 161, 450 and 455 MHz frequencies that TV and radio stations use for their crews and broadcast feeds.

Weather Watchers

If you monitor data from TIROS-N weather satellites in the 1700 to 1710 MHz band, the federal government wants to hear from you.

Motorola has proposed, through the Federal Communications Commission, to operate what in essence is a wireless computer network system for offices that will operate in the 1700 to 1710 MHz band, which is currently allocated to the meteorological satellite service.

However, the National Oceanic and Atmospheric Administration wants to register

those who have monitoring stations to collect data from the weather satellites in the 1700 to 1710 MHz band to protect them from potential interference from the computer radio systems that Motorola would be selling to businesses.

There is no charge to register your weather satellite receiving station and NOAA will advise those who register their stations as to what they can do to protect themselves from potential interference.

The FCC is expected to request those who use the computer radio systems to submit technical reports stating whether or not they might interfere with NOAA-registered satellite receiving stations and operating zones will be set up to protect the satellite receivers.

If you don't register with NOAA, you can't go screaming when computer gibberish wipes out your receiving station. For more information, write to: Richard Barth, National Oceanic and Atmospheric Administration, Office of Radio Frequency Management, Room 6006, Main Commerce Building, Washington, DC 20230.

You, too

Yes, we need your input. If you have any scanner listening tips, frequencies, code lists or photographs you'd like to share with our readers, please drop us a line at: Chuck Gysi, N2DUP, Scanner Scene, Popular Communications, 76 North Broadway, Hicksville, N.Y. 11801-2909. **PC**

USE

YOUR

F
R
E
E

I
N
F
O
R
M
A
T
I
O
N

C
A
R
D

RF Limited

Suggested
Retail Price
\$99.95



- New UV-800
- Converts your UHF scanner to Cellular Telephone Frequencies!
- 384 MHz offset
- 12-13.8 VDC operation
- patch cord included
- 1 year limited warranty
- Send for free brochure
- Dealer inquiries invited

Dimensions - Height: 1"; Width: 2 1/2"; Length: 4 1/4"

CIRCLE 20 ON READER SERVICE CARD

P.O. Box 1124 • Issaquah, Washington 98027
Telephone (206) 392-0399
Telex 329 473 BURGESS SEA
Facsimile (206) 392-0419



The Super Converter 8001 Features:

- Listening to 810-912 MHz Band on a UHF Scanner and /or Other Monitor Receivers
- Easy Connections to Your Receiver
- 9 Volts Battery Operation Power Source and Power On Indicator by LED Display
- External Power Jack

Warranty

- 180 Days From Date of Purchase

Unit Cost

- \$59.94 plus \$4.00 Shipping and Handling Charge

EASY LISTENING

- FOR 810 TO 912 MHz BAND SUPER CONVERTER 8001
- FOR YOUR UHF SCANNING RECEIVER AND OTHERS

A super-converter 8001 has been certified by FCC part 15 regulation.

HOW TO ORDER

Name: _____

Address: _____

City: _____ State: _____

Zip: _____ Phone () _____

Make Check or Money Order payable to
GRE AMERICA, INC.

Mail to: GRE AMERICA, INC.
425 Harbor Blvd., Belmont, CA 94002

Unit Cost @ \$59.94 x _____ = _____ Total

CA. Residents Add 6.5% Tax _____

Shipping & Handling @ \$4.00/ _____

Unit x Qty = _____

PAYMENT METHOD TOTAL ▶

Check Money Order

Mastercard Visa

Card No. _____

Expiration Date _____

Signature _____

**PHONE ORDER: 800-233-5973
or 415-591-1400**

COMMUNICATIONS SHOP

Advertising Rates: SCAN members and POP/COMM subscribers are entitled to one FREE 30-word, non-commercial classified ad per year. Enclose subscription name label with ad copy. For those people not in the previously mentioned groups, non-commercial ads are 30 cents per word, including abbreviations and addresses; minimum charge \$6.00 per issue. Ads from firms offering commercial products or services are \$1.00 per word; minimum charge \$20.00 per issue. Leading key words set in all caps at no additional charge. All ads must be prepaid in full at time of insertion; a 5% discount is offered for prepaid 6 time insertions. All ads must be typewritten double spaced.

Approval: All ad copy is subject to Publisher's approval and may be modified to eliminate references to equipment and practices which are either illegal or otherwise not within the spirit or coverage scope of the magazine.

Closing Date: The 10th day in the third month preceding date of publication. Because the advertisers and equipment contained in Communications Shop have not been investigated, the Publisher of Popular Communications cannot vouch for the merchandise listed therein. Direct all correspondence and ad copy to: PC Communications Shop, 76 N. Broadway, Hicksville, NY 11801.

COMPUTER PROGRAMS for Commodore 64. Menu driven providing logs for BCL/SWL. Update formats, QSL records, other. Disk or tape. Screen and/or printer. Send SASE for more info & sample printout. Manucy, P.O. Box 5624, Baltimore, MD 21210.

WANTED: CASH PAID FOR USED SPEED (TRAFFIC) RADAR EQUIPMENT. Write or call: Brian R. Esterman, P.O. Box 8141, Northfield, IL 60093, (312) 251-8901.

COMMUNICATIONS PLANS, BOOKS, KITS! AM/FM broadcasting (licensed/unlicensed), 1750 Meter transceivers, ham/CB amplifiers, surveillance bugs, more. FREE catalog. PAN-COM, Box 130-P*, Paradise, CA 95969.

ANOTHER DAY with an empty mailbox? Improve your QSL returns with *Secrets of Successful QSL'ing* by Gerry L. Dexter. This complete guide to reception reporting and QSLing SWBC, Utility, Ham and medium wave stations covers everything from basics to advanced techniques. Just \$9.95 plus \$1 s/h, \$2 s/h foreign orders, U.S. funds only. Order now from Tiare Publications, P.O. Box 493, Lake Geneva, WI 53147.

FCC COMMERCIAL GENERAL RADIOTELEPHONE LICENSE Correspondence Course. 60 individual lessons for \$89.50. Payment plan. Results guaranteed! Details free. American Technical Institute, Box 201, Cedar Mountain, NC 28718.

HAMS & CB'ERS. Send for free discount catalog. Amateur Communications, Etc., 2317 Vance Jackson Rd., San Antonio, TX 78213, 512/734-7793, CBBS 512/734-3521.

COMPLETE ANTENNA DIMENSION TABLES for shortwave broadcast bands. Band-by-band and multiband dimensions for dipoles, verticals, slopers, longwires and a simple beam. Simple drawings too so you can't go wrong. A recent addition is a set of tables for US HF Ham bands for SWL'ers and Hams. US and Canada \$3 plus 50¢ postage and handling. Ed Noll, P.O. Box 75, Chalfont, PA 18914.

LEARN MORSE CODE in 4 hours. My method works. \$5.25 to J.L. Steiger, 375 Hillside Rd., Seven Hills, Ohio 44131.

HISTORIC WIRELESS/RADIO ARCHIVES! Tom Kneitel's new book, "Radio Station Treasury (1900-1946)." Gigantic 176-page compendium listing stations that operated between the dawn of the spark era & the end of WWII. A profusion of frequencies, skeds, callsigns, slogans, licensee data, power, locations, etc. Covers the world's AM band & SW broadcasters, "utes," point/point, press, aviation, maritime, police, federal, military, experimental, longwave, early FM/TV, secret WWII propaganda stations, more! Comprehensive sourcebook directory packed with huge array of fascinating features & facts about tens of thousands of stations in every nation & category, of every size & type! Unique reference guide, nothing ever before like it! Research radio history in your own community & throughout the world. Personally autographed by the author (upon request when ordering). Only \$12.95 plus \$1 postage (USA/Canada/APO/FPO) from CRB Research, P.O. Box 56, Commack, NY 11725.

COMMUNICATE VIA PERSONAL COMPUTER on the airwaves for miles legally and without need for license. My book explains all. \$10 to Broadcast Technical Services, 11 Walnut Street, Marshfield, MA 02050.

CB RADIO OWNERS! We specialize in a wide variety of technical information, parts and services for CB radios. 10M-FM conversions, repairs, books, plans, kits, high-performance accessories. Our 11th year! Catalog \$2. CBCI, Box 31500PC, Phoenix, AZ 85046.

ELECTRONIC SPYING is the name of the game. It's also the title of a startling book which reveals the closely guarded methods & equipment used by professionals & amateurs who eavesdrop on homes & businesses with (sometimes) legal and (usually) illegal bugs & wiretaps. Written in non-technical language everyone can easily understand, *ELECTRONIC SPYING* has photos & illustrations clearly revealing exactly how they do it & where they get the equipment (much of it inexpensive & easily available). Leaves nothing to the imagination! Latest techniques covered & offers an in-depth wealth of information on the ever increasing electronic invasion unavailable from any other source. This book is used by law enforcement agencies as a reference manual. Only \$7.95 (plus \$1.00 postage) per copy from CRB Research, P.O. Box 56, Commack, N.Y. 11725.

NEW! AIR-SCAN 4th Edition by Tom Kneitel. At last, a complete directory of aero communications stations/frequencies! Now in gigantic 120 page large-size (8 1/2 x 11) format containing 40,000 listings (USA/Canada/Mexico/PR), including worldwide HF (2-30 MHz) freq. guide. In addition to 118-136 MHz VHF aero-band scanner listings, also covers 30-50, 138-174, & 400+ MHz aero freqs. never before published. AIR-SCAN covers civilian/military airports, also "unlisted" airports not open to public, FAA freqs, FSS, towers, Unicom, airport security and operations freqs, new airborne air/ground telephone freqs, "hidden" business-band aero stations, military, traffic choppers, aero weather, federal agency aero, flight schools, aircraft mfrs., crop dusters, air ambulances and much more throughout USA. Largest directory of all-band aero radio communications ever published. Includes how-to text on aero monitoring and equipment selection. Only \$10.95 + \$1 shipping to USA/Canada/APO/FPO. Order from CRB Research, P.O. Box 56, Commack, NY 11725.

CLANDESTINE CONFIDENTIAL keeps you up to date on the latest in clandestine broadcasting. 6 issues per year \$10 in the U.S., \$13 foreign. G.L. Dexter, RR4 Box 110, Lake Geneva, WI 53147.

JOIN A RADIO listening club. Complete information on major North American clubs for 25¢ and SASE. Association of North American Radio Clubs, 1500 Bunbury Drive, Whittier, CA 90601.

NORTH AMERICAN RADIO-TV STATION GUIDE by Vane Jones. Brand new 15th Edition! Thick 226-page book listing all US/Canadian/Mexican/West Indies AM/FM/TV broadcasters according to location/frequency/callsign, plus TV network affiliation, AM station day/night power, schedule data, etc. Painstakingly complete, accurate, up-to-date. The ultimate broadcast station directory. Only \$9.95 (plus \$1 postage) from CRB Research, P.O. Box 56, Commack, NY 11725.

SCANNER UNSCRABLERS, lets you hear the coded messages of police, fire and emergency channels. Complete satisfaction guaranteed. DNE, Inc., Rt 7, Box 257, Hot Springs, Arkansas 71901. 501-623-6027.

WORLD'S MOST UNUSUAL Communications Books! A large selection of outstanding titles covering scanners, "confidential" frequency registries, bugging, wiretap ping, electronic surveillance, covert communications, computers, espionage, monitoring, and more! New titles being added constantly! Ask for our large new FREE catalog. CRB Research, Box 56-PC, Commack, NY 11725.

NEW! TOP SECRET REGISTRY OF U.S. GOV'T FREQUENCIES by Tom Kneitel. Yes, it's finally here! The NEW 5th Edition is now 168 pages BIG in large 8 1/2" x 11" format (same page size as POP/COMM). Latest federal scanner frequency listings for FBI, FCC, Border Patrol, ATF, Immigration, Secret Service, CIA, Customs, Coast Guard, Armed Forces, and much more. Tens of thousands of callsigns, frequencies, locations. The ultimate scanner directory also reveals many HF listings plus complete historic roster of all federal land stations authorized in 1923 (60 years ago)! New 5th Edition is \$14.95 postpaid by Book Rate Mail, or add \$2 if First Class Mailing wanted. Order your copy now! CRB Research, P.O. Box 56, Commack, NY 11725.

SIDEBAND OPERATORS! Join the oldest/largest network of 27 MHz SSB operators. Now more than 100,000 strong! Send self-addressed stamped long (#10) envelope for FREE details and application (no obligation). SSB Network, P.O. Box 908, Smithtown, NY 11787.

MODIFICATION KITS (DX 400, R70/71A, ICF-2010, others), radios, filters, accessories. Prices - SASE, Catalog - \$1. RADIO PLUS ±, 3635 Chastain Way, Pensacola, FL 32504.

MILITARY ELECTRONICS: CPRC-26 Infantry Manpack Radio, compact, transmits-receives 46-54 MHz FM, with battery box, antenna, crystal: \$17.50 apiece, \$32.50/pair. PRC-510 Backpack Radio, transmits-receives 38-55 MHz FM continuous tuning, with battery box, antenna: \$34.50 apiece, \$67.50/pair. R-390A Communications Receiver, .5-30 MHz all modes: \$195 complete/checked, \$115 complete/repairable. R-748 Receiver, 130-150 MHz single channel AM: \$27.50. R-108 Receiver, 20-28 MHz FM: \$27.50 mint. ARC-27 Guard Receiver, 220-248 MHz single channel AM: \$12.50 mint. 45-day replacement guarantee. Add \$4.50/piece shipping except R-390A, shipping collect. Baytronics, Dept. PC, Box 591, Sandusky, OH 44870.

PROPAGANDA TAPES! Authentic, rare recordings of WWII German and Japanese shortwave broadcasts by "Tokyo Rose," "Axis Sally," and others. One hour cassette \$9.95. D-W Research, 4548 Auburn Blvd., #231-A, Sacramento, CA 95841.

SURVEILLANCE RECEIVER, LTV G-175, 30-260 MHz, AM-FM-CW, COR for recording adjustable bandwidth 10 KHz, 40/75 KHz, 300 KHz, sensitivity: AM-1 uv, FM-2 uv, 24 lb, good condition, \$275. Frank Moreland, 3748 Yosemite, San Diego, CA 92109.



Delaware Amateur Supply

Rob. WA3QLS Paul. WA3QPX

71 Meadow Road, New Castle, Del. 19720 **302-328-7728**

Factory Authorized Dealer! **9-5 Daily, 9-8 Friday, 9-3 Saturday**

KENWOOD YAESU ICOM TENTEC

MICROLOG KDK SANTEC KANTRONICS

AEA, AMERITRON, AND MUCH MORE!

Large Inventory, Daily UPS Service Katherine. KA3IYO

800-441-7008

New Equipment Order & Pricing

Prices are subject to change without notice or obligation. Products are not sold for evaluation.

NO Sales Tax in Delaware! one mile off I-95 SERVICE, USED GEAR INFO: 302-328-7728

TUNE IN HIDDEN SCA BROADCASTS. Commercial free background music, Talking books for the blind, Medical news, Radio paging, etc. Adapter plans \$4. Adapter kit \$39.95. Catalog \$1. OCTE(M), Box 840, Champlain, NY 12919.

TELEPHONE TRANSMITTER, FM room transmitter schematics with detailed construction procedures using Radio Shack's numbered parts. Both, \$6. Receivers available. Sheffield Electronics, 7223 Stony Island, Chicago, IL 60649.

Expert Repair on scanners, shortwave receivers, ham gear and stereo. FCC licensed. Timberline Electronics, P.O. Box 2064, Idyllwild, CA 92349. 714-659-4018.

ATTENTION WRITERS: Manuscripts wanted on a wide variety of communications and monitoring subjects. SASE brings want list or send your suggestions, resume, credits. Tiare Publications, P.O. Box 493, Lake Geneva, WI 53147.

PLL TONE DECODER. Remote control your station with push-button type tones over radio or wire. Will decode two telephone type tones and turn on or off. Kit, all parts and board included. \$39.95 plus \$1.00/s/h. US funds only. M. Bohnhoff Productions, P.O. Box 1243, Wheeling, IL 60090.

LANDMOBILE AND MARINE RADIO TECHNICAL HANDBOOK has been written for current and prospective two-way radio technicians, operators, and engineers. It can be used as a radio-communications textbook for home study or classroom. Two-way fundamentals, circuit details, maintenance and installation data, test equipment types and practical usage, two-way services and frequencies, transmission characteristics and classifications, solid-state fundamentals as related to transmission circuits, modulation systems, digital and microprocessor circuits, test equipment types and usage, antenna systems, landmobile systems and circuits, repeater, trunked, and cellular radio, marine radiotelephone and radiotelegraph equipment, direction finders and loran, marine radar and FCC licensing information. 575-page SAMS book \$24.95 + \$2 P&H. Ed Noll, Box 75, Chalfont, PA 18914.

JOIN a radio listening club. Complete information on major North American clubs and sample newsletter \$1. Association of North American Radio Clubs, P.O. Box 462, Northfield, MN 55057.

ESPIONAGE/EMBASSY Communications Guide, by Tom Kneitel. What's behind mystery "numbers" transmissions, coded embassy messages, and stations operated by foreign governments in the USA & Canada. How nations monitor each other's official codes and communications. Illustrated! Includes largest/latest registry of stations (frequencies/callsigns/locations/modes) operated embassies of the world's governments, intelligence agencies, U.N., Interpol, International Red Cross, U.S. State Department, HF/VHF/UHF. Now you can tune in on Embassy & Espionage Communications is \$10.95 + \$1 postage (USA/Canada/APO/FPO) from CRB Research, Box 56, Comack NY 11725.

WANTED: BEARCAT III extra scanner information. Schematics, operating instructions, etc. Will pay copy and mailing costs. Robert DeArmond, 16911 Newland Street, Apt. D, Huntington Beach, CA 92647.

WANTED: ANY INFORMATION on radio unit identifiers, etc., for DuPage County, Illinois (Sheriff, Forest Preserve, State's Attorney, Highways, Health Department, etc.) Am willing to provide other local or state info in trade. Kevin O'Rourke, Box 324, Elmhurst, IL 60126.

DRAKE UV-3 2-METER, 220/440 transceiver \$300. Heathkit SW-7800 receiver, built by licensed pro., mint \$175. Sony ICF-6500W mint \$65. All with manuals. Carl Stahnke, 451 Buckminster, Norwood, MA 02062. 617-769-6328.

FREE LIST and lowest prices on scanners, CB's, multi-band receivers, satellite dish systems, and more. Send large SASE—ARSS2, 4509 Lariat, Baytown, TX 77521.

MOTOROLA PORTABLE, Model MX-300S, VHF, 150-159 MHz, 12-ch, 2-batteries, 1-hour charger, speaker/mike, excellent shape. \$450 Postal M.O./Certified ck. John R. Miller, 2450 Colony Loop, Anchorage, AK 99507. 907-349-7817.

WORLDWIDE AIR TRAFFIC CONTROL FREQUENCY DIRECTORY for 2-22 MHz shortwave aeronautical bands. Hear commercial airlines on oceanic and many foreign domestic routes. Cross-referenced lists include over 200 cities plus weather and airline channels. Send \$4.75 (Massachusetts residents add 5%) + \$1.25 p&h. (U.S. \$2.25 Air Mail outside North America) to Cambridge Airadio, Dept. PCB, Suite 486, 89 Massachusetts Avenue, Boston, MA 02115.

SCANNER FREQUENCY SEARCH SERVICE. Frustrated by incomplete directories? Hear ALL there is to hear. Heald, 1905 Johnson Mill, North Branch, MI 48461.

PROTECT YOUR SCANNER! Quality leather case for RS PRO-30 \$45 (add \$4 p&h) others available on request, send check or M.O., ALEXANDER, P.O. Box 1556, Kitchener, Ontario, Canada N26-4P2.

FOR SALE BEARCAT 220 20-ch. base mobile scanner SO-239 connector in place of Motorola jack on rear apron. 30-50 118-136 144-174 420-512 mount bracket manual \$100. (916) 534-6991.

COURIER, FINANCIAL SERVICES, PROCURATION and much more. Professional services too detailed to enumerate. Travel anywhere, ready passport. All assignments considered! Dependable and trustworthy. Suite 626, 4040 West Kennedy Blvd., Tampa, Florida 33609. (813) 842-5246, Extension 70. All inquiries confidential.

SUPER SAVINGS: R-7000 \$999.95, MX-7000 \$459.95, ICR-71/A \$799.95, Sony 2010 \$299.95, HX-1500 \$249.95, BC-800XLT \$329.95, Yaesu, Kenwood, Panasonic, MFJ, CBs, Accessories, USED GEAR, MORE! 31-page 1986 Picture Catalog \$1.00 (refundable). Galaxy Electronics, Box 1202, 67 Eber Ave., Akron, OH 44309. (216-376-2402) 9-5pm EST.

SALE: NO HAM OR SWL would sell his shortwave receiver that was sensitive, stable and selective. But I'm 82 years old, a Ham for over 50 years. I want to get out of the fast lane and back to my rocking chair and hifi. The receiver is an ICOM R70, like new, with a manual and box it came in. I'll sell it for half what I paid for it. \$300 plus shipping is the price. Stan Tyler, K4ANN, 116 N. Airport Rd., Perry, Florida 32347, telephone 904-584-4344.

FOR SALE: BC 250 \$75. Doesn't work: (needs integrated circuit IC6). As is. Will send UPS. Send M/O or cert. ck. Harlan Riddle, 541 4th St., Lincoln, IL 62656. 217-735-1759.

NEED SCHEMATIC for Allied Knight Kit R-100-A receiver and operation manual for KLM 2700 Transceiver. Will reimburse. Marvin Hess, 204 Queensway Rd., Elma, NY 14059.

FOR SALE: Yaesu FT-77 with microphone and manual. Recently aligned by Yaesu. \$400 firm. Marvin Rosen, N3BQA, 20 W. Madison St., Baltimore, MD 21201. 1-301-685-6308.

FOR SALE: Hallicrafter SR-150 Transceiver, Hammarlund HQ-160 Receiver, C-64 Computer, Printer/Disk Drive Datasette Modem, Software. Fred Allen, Box 1771, Grand Forks, ND 58206. (701) 746-0073.

REGENCY MCL-64B 4-Channel Transceiver crystallized for 39.82, 98, 94, 92, changeable by technician. Has scan and noise blanker. \$310 M.O. Wayde Carlson, Box 1573, Miles City, MT 59301.

OPTIMUM ANTENNA AZIMUTH HEADINGS in degrees relative to North computed from your exact location to over 400 worldwide locations including 60 within Continental U.S.A. Nine pages. Orient your SWL or Ham antenna to maximize your chance of hearing or communicating with any place on Earth. Send \$4.50 to Engineering Systems Inc., P.O. Box 939, Vienna, VA 22180.

TRUE HIGH PERFORMANCE RECEPTION

The AR-33 is a fully synthesized FEATHERWEIGHT VHF/FM portable receiver covering 140-170MHz in 5 kHz steps.

It employs the latest microprocessor technology, along with a multitude of features and performances. The AR-33 has proven its performance in the world of professional communication including a great number of Federal/Local government agencies.

The AR-33 is the TRUE HIGH PERFORMANCE type monitor-receiver, from professional, to high-end users at a reasonable price.

DESIGN FEATURES:

- Employs 1 microprocessor, 6 integrated circuits, and 13 transistors in slim housing.
- 2 Memory channels for instant recall of pre-set frequencies.
- Receiver employs 4 varactor tuned stages which track with the frequency selected for optimum performance over the entire band.
- Super wide range (30Mhz minimum).
- Easy-to-use thumbwheel frequency selector dial.
- Super high sensitivity (0.2uV for 12 dB SINAD)
- Microwave grade OSM miniature coaxial antenna connector.
- Large diameter (50mm) and extra thin (9mm) speaker generates clear, crisp audio.
- Inexpensive AA battery operation (2 are required).
- Earphone jack for private listening.
- Concentric type squelch and volume control.
- Furnished with complete set of accessories.
- Quality crafted and assembled in Japan.
- High impact ABS case.
- Size—130mm (H) x 63mm (W) x 26mm (D).
- Weight—Approx. 200g with batteries.
- Full 1 year limited warranty.

The AR-33 is available factory direct or through selected dealers...



ACE communications, inc.

22511 Aspan Street • Lake Forest • California • 92630 • (714) 581-4900 Telex 29-7385 ACE UR

CIRCLE 41 ON READER SERVICE CARD

December 1986 / POPULAR COMMUNICATIONS / 73

HOLIDAY GREETINGS

Give a friend a gift that lasts all year



POPULAR COMMUNICATIONS



(and save \$2.00 per subscription)

Dear Readers,

It's holiday shopping time again. Time to remember all your friends with a gift they'll appreciate all year long.

By simply filling out and mailing the enclosed order form you'll bring hours of reading pleasure to your friends without the worry of picking the "wrong color" or the "wrong size" and best of all no long lines to wear you down.

For the ham on your list there's CQ, filled with great reading each month . . . widely acclaimed as the best reading ham magazine published today.

For the communications buff, especially the SWL or scanner fans there's Popular Communications, loaded with fascinating and factual stories which you'll find nowhere else.

New to our family is Modern Electronics for the all around electronics enthusiast, covering video, stereo, computers, circuits, communications, building projects and much more.

There's something for almost everyone on your list. So, beat the holiday rush! Send in your order form today.

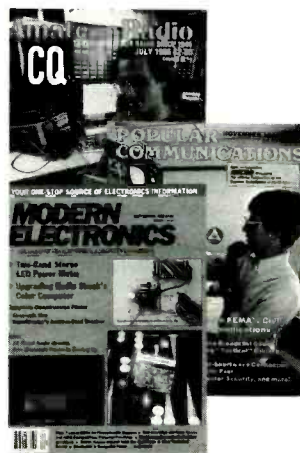

Please type or print clearly name, address & zip code of each recipient in the space provided

Check Title(s) Desired

Name _____ CQ
 Street _____ PC
 City _____ ME
 State _____ Zip _____

Check Title(s) Desired

Name _____ CQ
 Street _____ PC
 City _____ ME
 State _____ Zip _____

Check Title(s) Desired

Name _____ CQ
 Street _____ PC
 City _____ ME
 State _____ Zip _____

Quantity

_____ Sub to CQ Amateur Radio (Reg. 18.00) × 16.00 = _____
 _____ Sub to Popular Communications (Reg. 16.00) × 14.00 = _____
 _____ Sub to Modern Electronics (Reg. 16.97) × 14.97 = _____
Total Due _____

Make checks payable to CQ Publishing - (US funds only)

Please add 2.00 per Canadian subscription & 4.00 per foreign subscription

Mastercharge number _____
 VISA expires _____

Signature _____

Send To: CQ Publishing, Inc., 76 N. Broadway, Hicksville, New York 11801

Advertiser's Index

AMC Sales	41
ARRL	3
Ace Communications	73
Alden Electronics	7
All Electronics	52
BEE Electronics, Inc.	35
Barry Electronics	75
CBC International	65
CRB Research	55
Capri Electronics	76
Communications Electronics	59
Computer Trader	65
Copper Electronics	52
Deco Industries	65
Delaware Amateur Supply	72
Dick Smith Electronics	31
EGE, Inc.	39
ENCOMM	12
Elec. Equip. Bank	Cov. II, 1, 16, 64, 75
Fair Radio Sales	37
GRE America	71
Gilfer Shortwave	56, 57
Grove Enterprises	16
Ham Station	69
JoGunn Ent.	27
Kenwood	Cov. IV
MFJ Enterprises, Inc.	4
Madison Electronics	63
Michigan Radio	65
National Tower Co.	61
Omega Concepts	37
Pacific Cable Co.	48
Palomar Engineers	63
Pop/Comm Book Shop	57
RF Limited	71
Radio Shack	5
Radio West	48
Regency Electronic	23
Satman	15
Scanner World, USA	8
Signal Engineering	41
Spectronics	13
Transworld Communications	48
Universal SW Radio	16, 27
World-Tech Products, Inc.	75
Yaesu Electronics	Cov. III

REALISTIC DX-160, shortwave/longwave receiver \$55, and a Realistic 5-watt 40-channel walkie-talkie \$45. Both in excellent condition. Call (203) 621-5244.

WANTED: BC 455, unmodified and inexpensive tuner. Joseph Schwartz, 1JJ, 11 Windham Loop, Staten Island, NY 10314, (718) 698-8069.

FREQUENCIES WANTED—NJSP present and proposed (incl 800) RE: ACE, GSP (need Ch 3), TPK, AC Area also. Will trade. Reply Bob King, P.O. 73, Spring Lake, NJ 07762.

FOR SALE: HYGAIN PROSCAN 16 ch. 3 band. REGENCY TMR-8HL 8 ch. 2 band. Manuals. Working. \$17.50 each prepaid U.P.S. (402) 489-3970. E.J. Berlyman, 5919 Newton, Lincoln, NE 68506-2742.

MINT UNMODIFIED NRD-515 RECEIVER with NVA-515 speaker, NDH-518 memory unit and CW filter. All original cartons \$900 firm. ROBOT 400 SSTV w/camera mint \$280. Call Glenn Finerman (914)-357-5419.

BEARCAT 100 programmable 16 channel handheld scanner with case and charger. \$150. Also BEARCAT 210 programmable scanner. \$100. Both excellent condition. Bill Thompson, 25 Windhaven Lane, Oak Ridge, TN 37830.

REGENCY MX7000 warranty thru 11/89: \$400. Realistic PRO-30, re-charger & batteries: \$225. Jensen AM/FM/Cassette car stereo: \$225. Wanted/trade: Regency 16 Channel programmable VHF radio. Bruce Hayer, 277 Denver Dr., Des Plaines, IL 60018.

WANTED: Realistic DX-302 or Sony CRG-1. Must work good on all bands. Write Bob Pheysey, 1617 Woodsong Court, Grayson, GA 30221 with price.

BEARCAT 260 mobile AC/DC 16 channel programmable scanner EC complete with all acces. \$150. R.D. Duracka, 342 Rosalie Lane, Palatine, IL 60067.

SCANNER CRYSTALS: Regency, Realistic, Bearcat, \$2.00 ea. Large selection. Write for list. E. Damback, PO Box 1109, Elizabeth, NJ 07207.

FREQUENCIES WANTED: Unknown frequencies for Rockland County, NY. Not Police, Fire or Ambulance. Harrah Bus Co. wanted. Please send any information to: Ben Steinberg, 36 Dana Road, Monsey, NY 10952.

SCOTT MARINE RADIO, Model SLRM, Need Manual. Michael Roslowski, 3 Parnly St., Rumson, N.J. 07760.

ICOM IC-R71A BRAND NEW! Never used, received as a gift. \$625. Call Charlie. Days 617-235-1940; Eves 617-468-3937.

FOR SALE 16 Channel scanner radio \$250. Pro 30 Realistic programmable. Lee Johnson, 206 Vernon Ave., Glen Burnie, MD 21061.

REGENCY HX1000, Handheld (30 Channel prog.), excellent cond. w/Nicad battery, charge-cord, ear-phone, leather case and instruction manual. \$175. Call Jon (315) 732-2070.

Subscribe today and Save!
Save Up to 40% on
POPULAR COMMUNICATIONS

Shortwave Receivers, Antennas

ICOM - KENWOOD - YAESU Etc.

Call 212-925-7000

Open 7 days a week, Mon.-Fri. 9am-6pm,
Thurs. until 8pm, Sat. & Sun. 10am-5pm

Barry Electronics

512 Broadway • New York, NY 10012

Sales & Service Commercial Radio For 35 Years

Please send all reader inquiries directly.

WORLD-TECH PRODUCTS

NEW

SALE PRICE
\$32.95
Reg. \$44.95
M-8201 (G)
GOLD



KNOW THE TIME ANYWHERE, EVERYWHERE, INSTANTLY



SALE PRICE
\$34.95
Reg. \$49.95
M3111 (A)S

• Gold or silver time piece handsomely displayed in a smoked acrylic stand.

- 12/24 Hour Time Piece.
- Dual Dial World Time Clock.
- Easy to read local time in cities around the world.
- Daylight/Nighttime shown on 24-hr. dial.
- Accuracy assured to ± 15 seconds per month with quartz movement.
- Time piece diameter 6 1/2".
- Uses 1 "AA" battery not included.
- Guaranteed for one year.

A UNIQUE GIFT ITEM.

ORDERS ONLY CALL 24HRS/7 DAYS

1-800-835-2246

Ext. 216

Florida residents add 5% sales tax. Within the Continental U.S.A. please add \$2.50 shipping and handling.

WORLD-TECH PRODUCTS, INC.
1233 Kapp Dr., Clearwater, FL 33575
(813) 442-5862



C.O.D.'s Acceptable

NEW

SALE PRICE
\$64.95
Reg. \$79.95
M3202 WJG
WOOD/GOLD



NEW

SALE PRICE
\$74.95
Reg. \$89.95
M3104L
LUCITE



CIRCLE 31 ON FREE INFORMATION CARD

THE MONITORING MAGAZINE

NEW

Now In Stock

RADIO DATABASE INTERNATIONAL

Information that every shortwave listener needs.
NEW 1987



- More than 350 pages
- At a glance: Data on every Broadcast Station in the shortwave spectrum . . . Names, Locations, Frequencies, Operating time, Language, Target area and Transmitter power . . . All displayed in a convenient easy to read frequency graph form.
- Separate cross index of major stations alphabetically by country.
- Buyer's guide to more than 50 tabletop and portable receivers by Larry Magne of World Radio TV Handbook fame.
- Reviews on all new receivers introduced during the past year.
- Antenna recommendations.

If you thought that the 1986 Radio Database International was terrific, wait until you see this brand new expanded edition. IBS has gone all out to make it the best, most useful radio listening publication available anywhere.

1987 Radio Database International is *only* \$12.95 (plus \$1.95 for shipping and handling).

TO RECEIVE YOUR COPY, SIMPLY CALL US TOLL FREE AT 800-368-3270.



ELECTRONIC EQUIPMENT BANK

516 Mill Street, N.E.

Vienna, VA 22180

Order Toll Free: 800-368-3270

Technical and VA Orders (703) 938-3350

CIRCLE 17 ON READER SERVICE CARD

December 1986 / POPULAR COMMUNICATIONS / 75

BUGGED???

Find hidden radio transmitters (bugs) in your home, office or car. The TD-17 is designed to locate the most common type of electronic bug - the miniaturized radio transmitter - which can be planted by anyone, almost anywhere.

The TD-17 warns of the presence of nearby RF transmitters, within the frequency range of 1 MHz to 1,000 MHz, when the RF Alert LED turns on. The flashing Range LED and audio tone give an indication of the distance to the bug. The Sensitivity control, used in conjunction with the two LEDs, helps you quickly zero in on hidden bugs.

The hand-held TD-17 weighs less than 7 oz. and is housed in a high-impact plastic case. Furnished complete with battery, antenna, instruction manual and one year Limited Warranty. Save \$100 to \$200 and order at our factory direct price of only \$98. VISA and MASTER-CARD accepted. Satisfaction guaranteed or your money back. *FREE literature.*



CAPRI ELECTRONICS
Route 1G
Canon, GA 30520
(404) 376-3712

Of course, by that time I myself was sitting in a quickly darkening room. In my haste and anticipation, I hadn't thought about the long-term ramifications of my antenna project, nor was I prepared nor happy to relinquish my new S-40A receiver so that my family could use it in the dimly lit living room to listen to music of the season. Once in a while I could hear my grandfather making a subtle appeal upon my behalf, "It's really much nicer sitting here in the dark, don't you think? Let's do it this way every year."

"... I realized that I was involved in a hobby that would stick with me for many years to come."

The S-40A wasn't returned to me for a week. Seven days of mental anguish while I was forced to resurrect the discarded (and, by then, dented) S-38 receiver, using a coat hanger as an antenna.

It's been a long time and a lot of loggings past that memorable experience, but it seems as though I always manage to stop to think about the first inklings that I had when I realized that I was involved in a hobby that would stick with me for many years to come. That enthusiasm has never left me; I doubt if it ever will.

I hope that this Holiday Season gives you reason to look back upon your own early experiences, savor them, and then be inspired to introduce someone (young or old) to the hobby.

Maybe you'll get that dream receiver that you've been thinking about. Perhaps you know someone who would be bowled over if they received a beginner's receiver or scanner from you this year. **PC**

Beaming In (from page 4)

me towards these good people didn't fall upon deaf ears, they fell upon ears that were far more interested in hearing London, Rome, and Moscow than they were in hearing the 128th rendition of Uncle Leo's experiences in Paris during WWI, and how Aunt Ethel's daughter *still* hadn't called her.

My glory was short-lived; it lasted until approximately 4 in the afternoon at a time when family cheer was at a high point and cigar smoke and laughter permeated every corner of the apartment. At about 4 o'clock

a futile attempt was made to turn on the lights in response to the rapidly setting winter sun. At first it was thought to be an uncanny coincidence that so many light bulbs had simultaneously conked-out. It reminded Uncle Leo of how he celebrated every holiday in the dark while he was in the trenches during "the Big War."

When replacing the bulbs proved an ineffective remedy, an inspection was made and it was discerned that the lamps and radio had been cannibalized. Even though the Old Man had no professional training as a private eye, he announced that he had a hunch about the identity of the culprit.

SCANNING TODAY (from page 9)

above the legal limit with no slowdown in sight. The alternate route with a few stoplights takes 10 minutes longer than usual, but Bill arrives relaxed. Others, however, will spend a frustrating extra hour in traffic with stalled, overheated cars.

We should caution all right now that a few states do not allow scanners in vehicles, so be sure to check before installing one without a permit. (If in doubt, SCAN has a state-by-state guide available for \$1.00 postage/handling.) Most states, however, (wisely) have no restrictions whatsoever. It is amazing to me how few commuters make use of a scanner. I guess it is just a secret known only to us scanner buffs.

The Book On Disasters . . . On Computers

Since we wrote the editorial about keeping a "disaster book" of seldom listened to frequencies for reference in an emergency (see August 1986 *POP'COMM*) we have received many letters from members telling us that the notebook is obsolete. Not the function of the book, but the fact that it is a book at all! They describe their own personal computer systems that offer amazing capabilities. For instance, one SCAN member reported on his computerized book of types of emergency services and industries such as utilities,

refineries, chemical plants, transportation companies, and others. Each "page" in the book lists all of those within one category and the frequencies . . . just like our written notebook. But it goes much further. A file of 10-codes and other data for each frequency can be "windowed" on the screen individually on command as an inset picture on the display screen. Or all the information about an individual frequency can be displayed: Users and phone numbers, transmitter locations, 10-codes, special terms used . . . any useful information that can help in an understanding of what is being heard. "But that's not all," as those high-pressure ads on TV would say, "There's more!" Usually in a major emergency there will be several categories of users active. In the case of an industrial accident, the company communications system, fire, police, civil defense and other frequencies may all be active. This system allows a group of these frequencies to be listed with code letters next to each. The "window" display can then be changed between any of the active frequencies, with user names and 10-codes displayed. A long way from the notebook, indeed. But I have one challenging question, what happens if the power fails? My notebook and battery-operated portable will still be tuned in by candlelight. What will you computer-aided scanning folks do? Your comments are welcome, as always.



Yaesu has serious listeners for the serious listener.

Yaesu's serious about giving you better ways to tune in the world around you.

And whether it's for local action or worldwide DX, you'll find our VHF/UHF and HF receivers are the superior match for all your listening needs.

The FRG-9600. A premium VHF/UHF scanning communications receiver. The 9600 is no typical scanner. And it's easy to see why.

You won't miss any local action with continuous coverage from 60 to 905 MHz.

You have more operating modes to listen in on: upper or lower sideband, CW, AM wide or narrow, and FM wide or narrow.

You can even watch television programs by plugging in a video monitor into the optional video output.

Scan in steps of 5, 10, 12½, 25 and 100 KHz. Store any frequency and

CIRCLE 9 ON READER SERVICE CARD

related operating mode into any of the 99 memories. Scan the memories. Or in between them. Or simply "dial up" any frequency with the frequency entry pad.

Plus there's more, including a 24-hour clock, multiplexed output, fluorescent readout, signal strength graph, and an AC power adapter.

The FRG-8800 HF communications receiver. A better way to listen to the world. If you want a complete communications package, the FRG-8800 is just right for you.

You get continuous worldwide coverage from 150 KHz to 30 MHz. And local coverage from 118 to 174 MHz with an optional VHF converter.

Listen in on any mode: upper and lower sideband, CW, AM wide or narrow, and FM.

Store frequencies and operating modes into any of the twelve channels for instant recall.

Scan the airwaves with a number of programmable scanning functions.

Plus you get keyboard frequency entry. An LCD display for easy readout. A SINPO signal graph. Computer interface capability for advanced listening functions. Two 24 hour clocks. Recording functions. And much more to make your listening station complete.

Listen in. When you want more from your VHF/UHF or HF receivers, just look to Yaesu. We take your listening seriously.

YAESU

Yaesu USA

17210 Edwards Road, Cerritos, CA 90701
(213) 404-2700

Yaesu Cincinnati Service Center

9070 Gold Park Drive, Hamilton, OH 45011
(513) 874-3100



Dealer inquiries invited.

Prices and specifications subject to change without notice.
FRG-9600 SSB coverage: 60 to 460 MHz.

KENWOOD

...pacesetter in Amateur radio

NEW

Hear it All!



R-5000

High performance receiver

THE high performance receiver is here from the leader in communications technology—the Kenwood R-5000. This all-band, all mode receiver has superior interference reduction circuits, and has been designed with the highest performance standards in mind. Listen to foreign music, news, and commentary. Tune in local police, fire, aircraft, weather, and other public service channels with the VC-20 VHF converter. All this excitement and more is yours with a Kenwood R-5000 receiver!

- Covers 100 kHz-30 MHz in 30 bands, with additional coverage from 108-174 MHz (with VC-20 converter installed).
- Superior dynamic range. Exclusive Kenwood DynaMix™ system ensures an honest 102 dB dynamic range. (14 MHz, 500 Hz bandwidth, 50 kHz spacing.)

R-2000

- 150 kHz-30 MHz in 30 bands
- All modes • Digital VFOs tune in 50 Hz, 500 Hz, or 5-kHz steps • 10 memory channels
- Programmable scanning • Dual 24-hour digital clocks, with timer • 3 built-in IF filters (CW filter optional) • All mode squelch, noise blanker, RF attenuator, AGC switch, S meter • 100/120/220/240 VAC operation • Record, phone jacks
- Muting terminals • VC-10 optional VHF converter (108-174 MHz)



- 100 memory channels. Store mode, frequency, antenna selection.
- Voice synthesizer option.
- Computer control option.
- Extremely stable, dual digital VFOs. Accurate to ± 10 ppm over a wide temperature range.
- Kenwood's superb interference reduction. Optional filters further enhance selectivity. Dual noise blankers built-in.
- Direct keyboard frequency entry.

- Versatile programmable scanning, with center-stop tuning.
- Choice of either high or low impedance antenna connections.
- Kenwood non-volatile operating system. Lithium battery backs up memories; all functions remain intact even after lithium cell expires.
- Power supply built-in. Optional DCK-2 allows DC operation.
- Selectable AGC, RF attenuator, record and headphone jacks, dual 24-hour clocks with timer, muting terminals, 120/220/240 VAC operation.

Optional Accessories:

- VC-20 VHF converter for 108-174 MHz operation • YK-88A 1.6 kHz AM filter • YK-88S 2.4 kHz SSB filter • YK-88SN 1.8 kHz narrow SSB filter • YK-88C 500 Hz CW filter • YK-88CN 270 Hz narrow filter
- DCK-2 DC power cable • HS-5, HS-6, HS-7 headphones • MB-430 mobile bracket • SP-430 external speaker • VS-1 voice synthesizer • IF-232C/IC-10 computer interface.

More information on the R-5000 and R-2000 is available from Authorized Kenwood Dealers.



KENWOOD

TRIO-KENWOOD COMMUNICATIONS
1111 West Walnut Street
Compton, California 90220

CIRCLE 32 ON READER-SERVICE CARD

Specifications and prices are subject to change without notice or obligation.