

POPULAR COMMUNICATIONS

OCTOBER 1982 \$1.75

- **Locating Secret Radio Frequencies** • **6 New Telephone Add-Ons** • **Top 10 Toughest DX Targets** • **Instant Emergency Scanner Antenna** • **Emergency Power for Survival Communications** • **Scanning Brinks Armored Cars** • **New DX Countries on the Way!**



New Devices That Let Anyone Copy Morse Code and Radioteletype. See pages 28 and 38.



Let's get personal...

try out the in-stock selection of Heath/Zenith microcomputers, peripherals, accessories and software.

Now available at your nearby Heathkit Electronic Center, or through the Heathkit mail order catalog.

You get more with a Heath/Zenith personal microcomputer system! We offer:

1. Proven high-performance hardware: Thousands of our microcomputers prove themselves daily, in the field.

2. Vast software library: Three operating systems (including CP/M), languages, word processors, an electronic spreadsheet, versatile utilities and the 500-program Heath Users' Group software library.

3. Self-instruction courses: Evaluation and programming courses from Heathkit/Zenith Educational Systems.

4. Service support: Before and after the sale – consultation by phone, carry-in service by trained technicians.

Test run one of our microcomputers at any of the more than 60 convenient Heathkit Electronic Centers in the U.S.

Heathkit[®] ELECTRONIC CENTERS*

See the white pages of your telephone book for store locations and telephone numbers.

*Units of Veritechnology Electronics Corporation in the U.S.

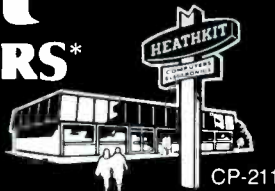

CP-211

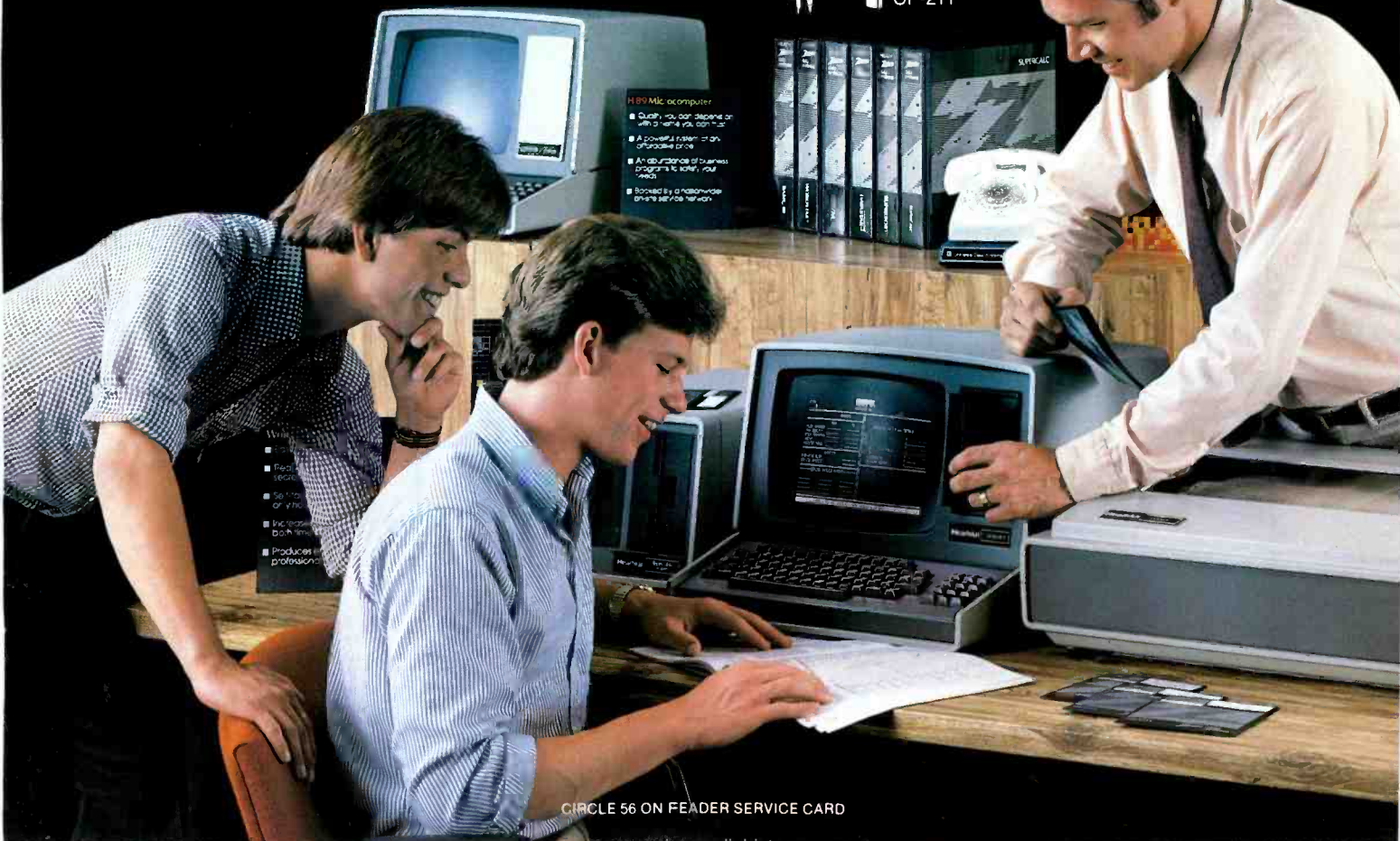

CIRCLE 56 ON FEADER SERVICE CARD

www.americanradiohistory.com

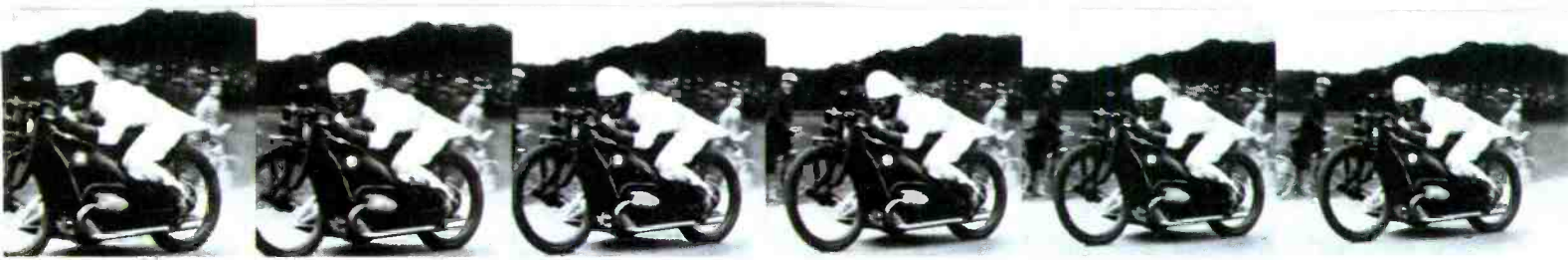

INTRODUCING THE LATEST HEIR TO 59 YEARS OF GERMAN ENGINEERING.

While the fine lines and sculpted features of most sport bikes spring from the drawing tables of stylists, those of the BMW R65LS had a different birthplace.

The drafting tables of German engineers.

As a result, they are the recipients of the same pragmatic consideration and evolutionary refinement as the legendary engine that powers this 650cc machine.

The shapely sport fairing, for example, provides much more than cosmetic appeal. It helps reduce front-wheel lift by over 30%.

The LS handlebars are low, compact, and help to provide a seating position that "is sporting in a way that Japanese bikes, even with red paint have not discovered" (Cycle World).

(High bars are also available.)

The bike's slender tail,

artful as it too appears, was created in one of the most aesthetically indifferent environments known to man: the massive BMW wind tunnel in Ismaning, Germany.

Even the wheels of the LS possess a beauty that goes far deeper than their gleaming enamel. Each rim section is made of a highly rigid aluminum alloy; each hub and spoke assembly is separately cast from a far more elastic aluminum alloy to provide added flexibility. And then everything—hubs, spokes and rims—is cast as a single unit.

Comminating in an exceedingly resilient "composite" wheel that not only helps

increase handling prowess but decreases unsprung weight.

In the end, the BMW R65LS is one sports bike whose graceful lines do not serve as camouflage for weak engineering. For it is a machine as adept at slicing through the wind and rounding corners as it is at turning heads.

Its price? A lofty \$3,790*.

But as a motorcycle columnist of AutoWeek observed, "a bad motorcycle is worthless; a good motorcycle is worth whatever it costs... By that standard, the R65LS is a bargain."

*Manufacturer's suggested retail price: \$3,790. Actual price will depend upon dealer. Price excludes state and local taxes, dealer prep, destination and handling charges. © 1982 BMW of North America, Inc. The BMW trademark and logo are registered trademarks of Bayerische Motoren Werke AG.

THE LEGENDARY MOTORCYCLES OF GERMANY.



ZX81



Introducing the Sinclair ZX81.

If you're ever going to buy a personal computer, now is the time to do it.

The Sinclair ZX81 is the most powerful, yet easy-to-use computer ever offered for anywhere near the price: only \$99.95* completely assembled.

Don't let the price fool you. The ZX81 has just about everything you could ask for in a personal computer.

A breakthrough in personal computers.

The ZX81 is a major advance over the original Sinclair ZX80 – the first personal computer to break the price barrier at \$200.

In fact, the ZX81's 8K extended BASIC offers features found only on computers costing two or three times as much.

Just look at what you get:

- Continuous display, including moving graphics

THE \$99.95 PERSONAL COMPUTER.

- Multi-dimensional string and numerical arrays
- Mathematical and scientific functions accurate to 8 decimal places
- Unique one-touch entry of key words like PRINT, RUN and LIST
- Automatic syntax error detection and easy editing
- Randomize function

useful for both games and serious applications

- 1K of memory expandable to 16K
- A comprehensive programming guide and operating manual

The ZX81 is also very convenient to use. It hooks up to any television set to produce a clear 32-column by 24-line display. It comes with a comprehensive programming guide and operating manual designed for both beginners and experienced computer users. And you can use a regular cassette recorder to store and recall programs by name.

Order at no risk.**

We'll give you 10 days to try out the ZX81. If you're not completely satisfied, just return it to Sinclair Research and we'll give you a full refund.

And if you have a problem with your ZX81, send it to Sinclair Research within 90 days and we'll repair or replace it at no charge.

Introducing the ZX81 kit.

If you really want to save money, and you enjoy building electronic kits, you can order the ZX81 in kit form for the incredible price of just \$79.95.* It's the same, full-featured computer, only you put it together yourself. We'll send complete, easy-to-follow instructions on how you can assemble your ZX81 in just a few hours. All you have to supply is the soldering iron.

A leader in microelectronics.

The ZX81 represents the latest technology in microelectronics. More than 10,000 are sold every week. In fact, the ZX81 is the fastest selling personal computer in the world.

We urge you to place your order for the ZX81 today.

To order.

To order, simply call toll free. Or use the coupon below. Remember, you can try it for 10 days at no risk.** The sooner you order, the sooner you can start enjoying your own computer.

Call toll free 800-543-3000.

Ask for operator #509.
In Ohio call: 800-582-1364;
in Canada call: 513-729-4300.
Ask for operator #509. Phones open 24 hours a day, 7 days a week. Have your MasterCard or VISA ready.

These numbers are for orders only. If you just want information, please write: Sinclair Research Ltd., 2 Sinclair Plaza, Nashua, NH 03061.

* Plus shipping and handling. Price includes connectors for TV and cassette, AC adaptor, and FREE manual

** Does not apply to ZX81 kits.

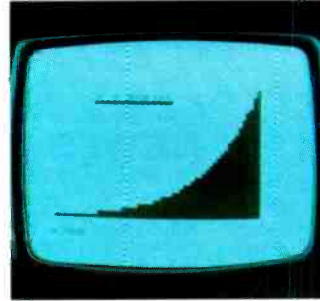

NEW SOFTWARE: Sinclair has published pre-recorded programs on cassettes for your ZX81. We're constantly coming out with new programs, so we'll send you our latest software catalog with your computer.

16K MEMORY MODULE: Like any powerful, full fledged computer, the ZX81 is expandable. Sinclair's 16K memory module plugs right onto the back of your ZX81. Cost is \$49.95, plus shipping and handling.

sinclair

To order call toll free: 800-543-3000

Ad Code 11PN	Price*	Qty.	Amount
ZX81	\$99.95		
ZX81 Kit	79.95		
16K Memory Module	49.95		
Shipping and Handling	4.95		\$4.95
		TOTAL	

MAIL TO: Sinclair Research Ltd.,
One Sinclair Plaza, Nashua, NH 03061.

Name _____

Address _____

City _____ State _____ Zip _____

*U.S. dollars

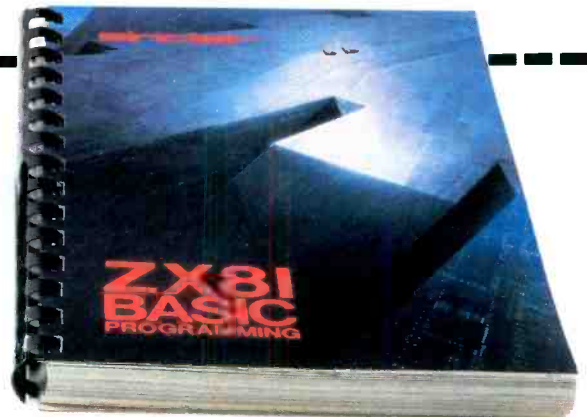

Synthesized Hand-Held Scanner!

Communications Electronics™, the world's largest distributor of radio scanners, now has even lower prices on our radio scanners. Chances are the police, fire and weather emergencies you'll read about in tomorrow's paper are coming through on a scanner right now.

With your scanner, you can monitor the exciting two-way radio conversations of police and fire departments, intelligence agencies, mobile telephones, energy/oil exploration crews, and more. Some scanners can even monitor aircraft transmissions! You can actually hear the news before it's news. If you do not own a scanner for yourself, now's the time to buy your new scanner from Communications Electronics. Choose the scanner that's right for you, then call our toll-free number to place your order with your Visa or Master Card.

We give you excellent service because CE distributes more scanners worldwide than anyone else. Our warehouse facilities are equipped to process thousands of scanner orders every week. We also export scanners to over 300 countries and military installations. Almost all items are in stock for quick shipment, so if you're a person who prefers fact to fantasy and who needs to know what's really happening around you, order your scanner today from CE!

NEW! Bearcat® 350

The Ultimate Synthesized Scanner!

List price \$599.95/CE price \$384.00

7-Band, 50 Channel • Alpha-Numeric • No-crystal scanner • AM Aircraft and Public Service bands • Priority Channel • AC/DC Bands: 30-50, 118-136 AM, 144-174, 421-512 MHz. The new Bearcat 350 introduces an incredible breakthrough in synthesized scanning: Alpha-Numeric Display. Push a button—and the Vacuum Fluorescent Display switches from "numeric" to word descriptions of what's being monitored. 50 channels in 5 banks. Plus, Auto & Manual Search, Search Direction, Limit & Count, Direct Channel Access, Selective Scan Delay, Dual Scan Speeds, Automatic Lockout, Automatic Squelch, Non-Volatile Memory. Order your Bearcat 350 today!

Bearcat® 300

List price \$549.95/CE price \$336.00

7-Band, 50 Channel • Service Search • No-crystal scanner • AM Aircraft and Public Service bands • Priority Channel • AC/DC Bands: 32-50, 118-136 AM, 144-174, 421-512 MHz. The Bearcat 300 is the most advanced automatic scanning radio that has ever been offered to the public. The Bearcat 300 uses a bright green fluorescent digital display, so it's ideal for mobile applications. The Bearcat 300 now has these added features: Service Search, Display Intensity Control, Hold Search and Resume Search keys, Separate Band keys to permit lock-in/lock-out of any band for more efficient service search.



NEW! Bearcat® 350

Bearcat® Rebate Offer

Get a coupon good for a \$30.00 rebate when you purchase a Bearcat 100. \$15.00 rebate on model 210XL. \$10.00 rebate on model 200. Offer valid only on purchases made between September 1, 1982 and October 15, 1982. Limit of one rebate per household. Offer good only in the U.S.A. Void where taxed or prohibited by law. Resellers, companies, clubs and organizations—both profit and non-profit, are not eligible for rebates. Employees of Electra Company, their agencies, distributors and retailers of Bearcat Scanners are also not eligible for rebates.

Bearcat® 210XL

List price \$349.95/CE price \$229.00

6-Band, 18 Channel • Crystallless • AC/DC Frequency range 32-50, 144-174, 421-512 MHz. The Bearcat 210XL scanning radio is the second generation scanner that replaces the popular Bearcat 210 and 211. It has almost twice the scanning capacity of the Bearcat 210 with 18 channels plus dual scanning speeds and a bright green fluorescent display. Automatic search finds new frequencies. Features scan delay, single antenna, patented track tuning and more. When you purchase the Bearcat 210XL between September 1, and October 15, 1982, you'll also get a factory rebate coupon good for \$15.00.

NEW! Bearcat® 20/20

List price \$449.95/CE price \$276.00

7-Band, 40 Channel • Crystallless • Searches AM Aircraft and Public Service bands • AC/DC Priority Channel • Direct Channel Access • Delay Frequency range 32-50, 118-136 AM, 144-174, 420-512 MHz. The Bearcat 20/20 automatic scanning radio replaces the Bearcat 220 and monitors 40 frequencies from 7 bands, including aircraft. A two-position switch, located on the front panel, allows monitoring of 20 channels at a time.

NEW! Bearcat® 200

List price \$269.95/CE price \$179.00

8-Band, 16 Channel • AC only • Priority Dual Scan Speeds • Direct Channel Access Frequency range: 32-50, 138-174, 406-512 MHz. The Bearcat 200 is a scanner with high performance. Sealed one-piece keyboard lets you program each channel for automatic scanning. There's automatic lockout to by-pass individual channels. Direct Channel Access to go instantly to any channel. Plus Automatic Squelch, Dual Scan Speed, Selective Scan Delay and Automatic Search to let you find hidden frequencies.

NEW! Bearcat® 100

The first no-crystal programmable handheld scanner.

List price \$449.95/CE price \$284.00

8-Band, 16 Channel • Liquid Crystal Display Search • Limit • Hold • Lockout • AC/DC Frequency range: 30-50, 138-174, 406-512 MHz. The world's first no-crystal handheld scanner has compressed into a 3" x 7" x 1 1/4" case more scanning power than is found in many base or mobile scanners. The Bearcat 100 has a full 16 channels with frequency coverage that includes all public service bands (Low, High, UHF and "T" bands), the 2-Meter and 70 cm. Amateur bands, plus Military and Federal Government frequencies. It has chrome-plated keys for functions that are user controlled, such as lockout, manual and automatic scan. Even search is provided, both manual and automatic. Wow...what a scanner!

The Bearcat 100 produces audio power output of 300 milliwatts, is track-tuned and has selectivity of better than 50 dB down and sensitivity of 0.6 microvolts on VHF and 1.0 microvolts on UHF. Power consumption is kept extremely low by using a liquid crystal display and exclusive low power integrated circuits.

Included in our low CE price is a sturdy carrying case, earphone, battery charger/AC adapter, six AA Ni-cad batteries and flexible antenna. The Bearcat 100 is in stock for quick shipment, so order your scanner today.

NEW! Fanon FCT-200 Cordless Telephone

CE price \$149.00

Looking for an excellent cordless telephone? We recommend the Fanon model FCT-200. This cordless phone is designed and engineered to provide many years of reliable service and put an extra measure of convenience into your home or office. It features extended range, automatic secure protection, two-way intercom between the Fanon-phone handset and a conventional phone plugged into the base. Manual secure lock override. Two-way call alert. Last number memory redial. High-low volume control and low battery indicator light. Full duplex, simultaneous conversation capability. Operates with most touch tone or rotary dial systems. FM quality - quiet operation. Rechargeable Nickel-cadmium batteries included. Under ideal conditions, the range is 700 feet. Order today!

TEST ANY SCANNER

Test any scanner purchased from Communications Electronics™ for 31 days before you decide to keep it. If for any reason you are not completely satisfied, return it in original condition with all parts in 31 days, for a prompt refund (less shipping/handling charges and rebate credits).

CIRCLE 73 ON READER SERVICE CARD

Bearcat® Four-Six ThinScan™

List price \$189.95/CE price \$118.00

Frequency range: 33-47, 152-164, 450-508 MHz

The incredible, Bearcat Four-Six Thin Scan™ is like having an information center in your pocket. This four band, 6 channel crystal controlled scanner has patented Track Tuning on UHF, Scan Delay and Channel Lockout. Measures 2 3/4 x 6 1/4 x 1 1/2". Includes rubber ducky antenna. Order crystal certificate for each channel. Made in Japan.

Fanon Slimline 6-HLU

List price \$169.95/CE price \$104.00

Low cost 6-channel, 4-band scanner!

The Fanon Slimline 6-HLU gives you six channels of crystal controlled excitement. Unique Automatic Peak Tuning Circuit adjusts the receiver front end for maximum sensitivity across the entire UHF band. Individual channel lockout switches. Frequency range 30-50, 146-175 and 450-512 MHz. Size 2 3/4 x 6 1/4 x 1 1/2". Includes rubber ducky antenna. If you don't need the UHF band, get the Fanon model 6-HL for \$94.00 each, and save money. Same high performance and features as the model HLU without the UHF band. Order crystal certificates for each channel. Made in Japan.

OTHER SCANNERS & ACCESSORIES

NEW! Regency † D810 Scanner	\$259.00
NEW! Regency † D300 Scanner	\$199.00
NEW! Regency † D100 Scanner	\$159.00
Regency † M400 Scanner	\$229.00
Regency † M100 Scanner	\$195.00
SCMA-6 Fanon Mobile Adapter/Battery Charger	\$49.00
CHB-6 Fanon AC Adapter/Battery Charger	\$15.00
CAT-6 Fanon carrying case with belt clip	\$15.00
AUC-3 Fanon auto lighter adapter/Battery Charger	\$15.00
PSK-6 Base Power Supply/Bracket for SCMA-6	\$20.00
SP50 Bearcat AC Adapter	\$9.00
SP51 Bearcat Battery Charger	\$9.00
SP58 Bearcat 4-6 ThinScan™ carrying case	\$12.00
FB-E Frequency Directory for Eastern U.S.A.	\$12.00
FB-W Frequency Directory for Western U.S.A.	\$12.00
FFD Federal Frequency Directory for U.S.A.	\$12.00
TSG "Top Secret" Registry of U.S. Government Freq.	\$10.00
ASD Frequency Directory for Aircraft Band	\$10.00
TIC Techniques for Intercepting Comm. Manual	\$12.00
CIE Covert Intelligence, Elect. Eavesdropping Man.	\$12.00
B-4 1.2 V AAA Ni-Cad batteries (set of four)	\$9.00
A-135cc Crystal certificate	\$3.00

Add \$3.00 shipping for all accessories ordered at the same time.

INCREASED PERFORMANCE ANTENNAS

If you want the utmost in performance from your scanner, it is essential that you use an external antenna. We have a base and a mobile antenna specifically designed for receiving all bands. Order #A60 is a magnet mount mobile antenna and order #A70 is an all band base station antenna. Price is \$35.00 each plus \$3.00 for UPS shipping in the continental United States.

BUY WITH CONFIDENCE

To get the fastest delivery from CE of any scanner, send or phone your order directly to our Scanner Distribution Center.™ Be sure to calculate your price using the CE prices in this ad. Michigan residents please add 4% sales tax. Written purchase orders are accepted from approved government agencies and most well rated firms at a 30% surcharge for net 30 billing. Minimum purchase order \$200.00. Minimum prepaid order \$35.00. All sales are subject to availability, acceptance and verification. All sales on accessories are final. Prices, terms and specifications are subject to change without notice. Out of stock items will be placed on backorder automatically unless CE is instructed differently. Most products that we sell have a manufacturer's warranty. Free copies of warranties on these products are available prior to purchase by writing to CE. International orders are invited with a \$20.00 surcharge for special handling in addition to shipping charges. All shipments are F.O.B. Ann Arbor, Michigan. No COD's please. Non-certified and foreign checks require bank clearance.

Mail orders to: Communications Electronics™, Box 1002, Ann Arbor, Michigan 48106 U.S.A. Add \$7.00 per scanner or phone product for U.P.S. ground shipping and handling, or \$14.00 for faster U.P.S. air shipping to some locations. If you have a Visa or Master Card, you may call and place a credit card order. To order dial 800-521-4414. If you are outside the U.S. or in Michigan, dial 313-994-4444. Order from CE, without obligation today!

Scanner Distribution Center™ and CE logos are trademarks of Communications Electronics™. † Bearcat is a federally registered trademark of Electra Company, a Division of Masco Corporation of Indiana. ‡ Regency is a federally registered trademark of Regency Electronics Inc. AD #072882

Copyright © 1982 Communications Electronics™



854 Phoenix □ Box 1002 □ Ann Arbor, Michigan 48106 U.S.A.
Call TOLL-FREE (800) 521-4414 or outside U.S.A. (313) 994-4444

EDITORIAL STAFF

Tom Kneitel, K2AES
Editor

Anita Hippius
Associate Editor

CONTRIBUTING EDITORS

Gerry L. Dexter
Shortwave Broadcast

Joseph E. Jesson
RTTY Monitoring

R.L. Slattery
Survivalist Communications

Harry L. Helms, KR2H
Utility Communications

Al Muick
Alternative Radio

Bill Cheek
Rick Maslau, KNY2GL
Special Assignments

Bill Sanders
Radar Detectors

Richard Barnett
Scanners

Mark Long, WA4LXC
Satellite TV

BUSINESS STAFF

Richard A. Ross, K2MGA
Publisher

James Reilly
Associate Publisher

Herb Pressman
Advertising Manager

Dorothy Kehrwieler
General Manager

Arlene Caggiano
Accounting

Cheryl Chomicki
Subscriber Services

PRODUCTION STAFF

Elizabeth Ryan
Art Director

Dorothy Kehrwieler
Production Manager

Gail M. Schieber
Production Assistant

Pat Le Blanc
Phototypographer

Hal Keith
Technical Illustrator

Offices: 76 North Broadway, Hicksville, NY 11801. Telephone 516 681-2922. Popular Communications (ISSN 0733-3315) is published monthly by Popular Communications, Inc. Corporate officers: Richard A. Ross, Pres.; Thomas S. Kneitel, Vice Pres.; Alan M. Dorhoffer, Secretary. Application to mail at controlled circulation rates pending at Hicksville, NY and Gordonsville, VA. Subscription prices: Domestic—one year \$12.00, two years \$22.00, three years \$32.00. Canada/Mexico—one year \$14.00, two years \$26.00, three years \$38.00. Foreign—one year \$16.00, two years \$30.00, three years \$44.00. Foreign Air Mail—one year \$69.00, two years \$136.00, three years \$203.00. Entire contents copyright ©1982 by Popular Communications, Inc. Popular Communications assumes no responsibility for unsolicited manuscripts, photographs, or drawings. Allow six weeks for change of address or delivery of first issue. Printed in the United States of America. Postmaster: Please send change of address to Popular Communications, 76 North Broadway, Hicksville, NY 11801.

POPULAR COMMUNICATIONS

OCTOBER 1982

VOL. 1, NO. 2



14



20



24

FEATURES

Make Way For Those New DX Countries! 14

Some countries exist for only a few months, or consist of a single room or building. Many countries are around but nobody knows about them. A few are getting ready to announce their existence. It could make a DXer crazy!

by Tom Kneitel, K2AES

Selecting "Underground Radio" Frequencies 20

Undercover & underground communications stations have their favorite hidden frequencies. Here's the inside story, and loads of info on those frequencies and how you can monitor them via communications receiver or scanner.

by Harry Caul

The Top Ten Toughest DX Targets 24

In every hobby there is the creme de la creme or the ultimate—the elusive goal everybody seeks to attain. In DXing it consists of 10 especially rare broadcasting stations. Here's info about them, with an expert's advice on how to snag them for yourself.

by Gerry L. Dexter

The (Almost) Instant VHF / UHF Antenna 34

With almost no effort at all you can whomp together a dandy and effective little scanner antenna covering 110-512 MHz. Great for Survivalist or emergency uses.

by Tony Earll, KNY2AE

A German Spy Receiver – 1943 Vintage! 47

Here's the schematic of a weird but clever little receiver scrounged up from 4 assorted odds & ends. It was found when they captured a spy during World War II. Darndest circuit you ever saw!

by Anson MacFarland, KVA4EX

POP' COMM Reviews 48

The Capri EA-14 Electronic Antenna

by Rick Maslau, KNY2GL

Scanning On The Brink(s) 60

Everybody knows about Brinks and their fleet of armored trucks which haul millions of dollars in cash and bullion. Here's a listing of the stations Brinks uses to communicate with their vehicles.

by Rick Maslau, KNY2GL

The Ohio Sheriff's Codes & Signals 75

Here's the code used by most of the Sheriffs in Ohio—it's different from the one used by the Ohio State Police. Hang on to it for reference.

DEPARTMENTS

Beaming In	6	Survival	56
Mailbag	12	POP' COMM Products	62
POP' COMM Product Spotlight	28	Satellite View	66
Radar Reflections	30	Free Radio Focus	69
Communications Confidential	32	Scanner Scene	74
RTTY Monitoring	38	Washington Pulse	76
Listening Post	50	Communications Shop	80
On The Line	54		

BEAMING IN

AN EDITORIAL

A Clever Idea!

There are two things which have always brought delight to my heart—being able to say, “I told you so,” and saying (with appropriate smugness), “I thought of it first.” Well, the fact is that I can’t really say either in connection with this idea, but I thought I’d pass it along to you because it’s so clever—even though I didn’t think of it first.

Those of you who are licensed Amateur Radio operators may be aware of the benefit of being on an *Auto Call List*. Without going into the complex intricacies of such an operation, the gist of it is that members all support the operation of a 2 Meter band repeater. Each member is, by means of that repeater, hooked into a gigantic local party line which is capable of providing instant DX tips to those members who are hunting down specific exotic countries. This is especially handy if a member is eagerly seeking a contact with some obscure point on the planet but can’t seem to snag it. All members of the *Auto Call List* have a record of which of these countries are desired by other members, so if they should chance upon a station operating there they can immediately get on the horn and pass along the word. In actual operation it’s more involved than this capsule outline description, but mainly that’s the point of the whole concept. It works and lots of DX hounds belong to such systems.

A logical extension of this terrific concept would be to utilize a similar network to establish a system whereby scanner monitors and shortwave listeners might establish a local hotline to clue one another in on various happenings while they are taking place—whether on local scanner frequencies or anywhere in the world on shortwave frequencies. Think about the possibilities! A member hears something of interest to one or more other members and can then instantly send out the alert.

If you’re saying that it’s not practical because every member would have to be a licensed Amateur Radio operator, consider that such a network would *not* necessarily have to be operational on Amateur Radio frequencies. It could be established in the General Mobile Radio Service which operates between 462.55 and 462.725 MHz on 8 channels. Repeaters are allowed there and it isn’t at all difficult (no test) to obtain a license. Several companies, such as Standard Communications, produce equipment for the GMRS.

Fact is that I’ve been informed of one such local group which is being formed for this purpose! The group is calling itself The

Emergency Notification Association of Metropolitan New York (ENANY). Their literature describes it as a *non-profit organization dedicated to the hobby of serious scanning*. While addressing itself only to communications taking place on scanner frequencies, ENANY says its mission is “to make certain that its members are aware of all significant law enforcement, fire fighting, and emergency medical service operations . . . as they occur.”

The plan has members (within a 50 mile radius of New York City) going about their regular monitoring activities, and “as significant emergency operations occur,” using their two-way capabilities (via the repeater) “to notify other members of these activities.” They state that it minimizes the need for individual members to have multiple scanners as informal agreements between members as to “who listens to what.” The repeater service is provided to the Association “at a nominal charge by a local two-way radio sales and service concern,” thus removing from the members the necessity of setting up and maintaining the repeater. However, they are responsible for the purchase, licensing, maintenance, and proper operation of their own stations feeding into the repeater. Many GMRS equipment dealers operate repeaters which they will permit to be used by their customers.

It’s really a clever idea, even if I didn’t think it up myself (drat!). I could see it expanded to cover monitoring tips on the DX shortwave bands with very little effort. I should point out that I could see that there might be some technical problems involved with isolating the output of the members’ individual transmitters from leaking into and disrupting (or even damaging) their own scanners because of the close proximity of the equipment. Such problems have been noted by Amateurs using the *Auto Call* idea, but they can be solved with a bit of expertise.

For those of you who are interested in pursuing the idea for possible use in your own localities, I suggest you discuss it with an electronics communications dealer who sells GMRS equipment. You might also wish to contact ENANY to get further specific details of what they’re up to. They’ve announced two addresses: P.O. Box 741, Ridgewood, NJ 07451-0741 and P.O. Box 368, New York, NY 10013-0368.

ENANY says that the idea “is absolutely

Continued on page 78

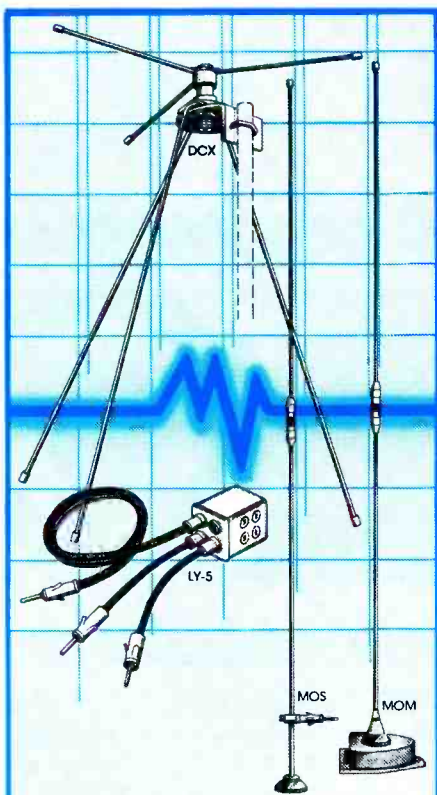

HUSTLER Monitor Antennas Bring In All Of The Action

If you aren't using a Hustler Monitor Antenna, you're missing the action!

With a Hustler Discone or Mobile Tri-Band monitor antenna, your scanner will bring in every band — clearly and quietly from greater distances. And every Hustler monitor antenna meets the highest standards of quality and engineering in the industry — our own.

Our vertically-polarized DCX Discone Model covers all public service frequencies from 40 - 700 mHz. And, its unique coilless design minimizes signal loss.

Hustler's popular Monitor Match™ utilizes your car's antenna for up to five different bands. And, Hustler Tri-Band mobile antennas offer you more mounting configurations, plus the reliability of top-grade components throughout every model.

Don't miss any of the excitement. Bring it all in with a Hustler — Still the standard of performance.

HUSTLER

3275 North "B" Avenue
Kissimmee, Florida 32741

An AMATEUR Company

CIRCLE 12 ON READER SERVICE CARD

PRINT THE WORLD



See What You've Been Missing!

Stay in touch with world events, monitor weather, ship traffic, and radio amateurs. Connect to your receiver and display shortwave radio teleprinter and Morse code transmissions with the new receive-only **HAL CWR-6700 Telereader**.

- Receive ASCII or Baudot RTTY
- Six standard RTTY speeds: 45, 50, 57, 74, 110 and 300 baud
- 3 RTTY shifts for low or high tones: 170, 425 and 850 Hz
1275 or 2125 Hz mark tone
- Adjustable space for fine tuning
- Receive Morse code — 4 to 50 wpm
- 36 or 72 characters per display line
- 20 lines of 36 characters or
- 16 lines of 72 characters on screen
- Two pages of video display
- Parallel ASCII printer output
- Requires +12 VDC and external TV monitor
- One year limited warranty
- Small size (8" x 3" x 12.75")

Write or call for more details. See the CWR-6700 at your favorite HAL dealer.



HAL COMMUNICATIONS CORP.

BOX 365

URBANA, ILLINOIS 61801

217-367-7373

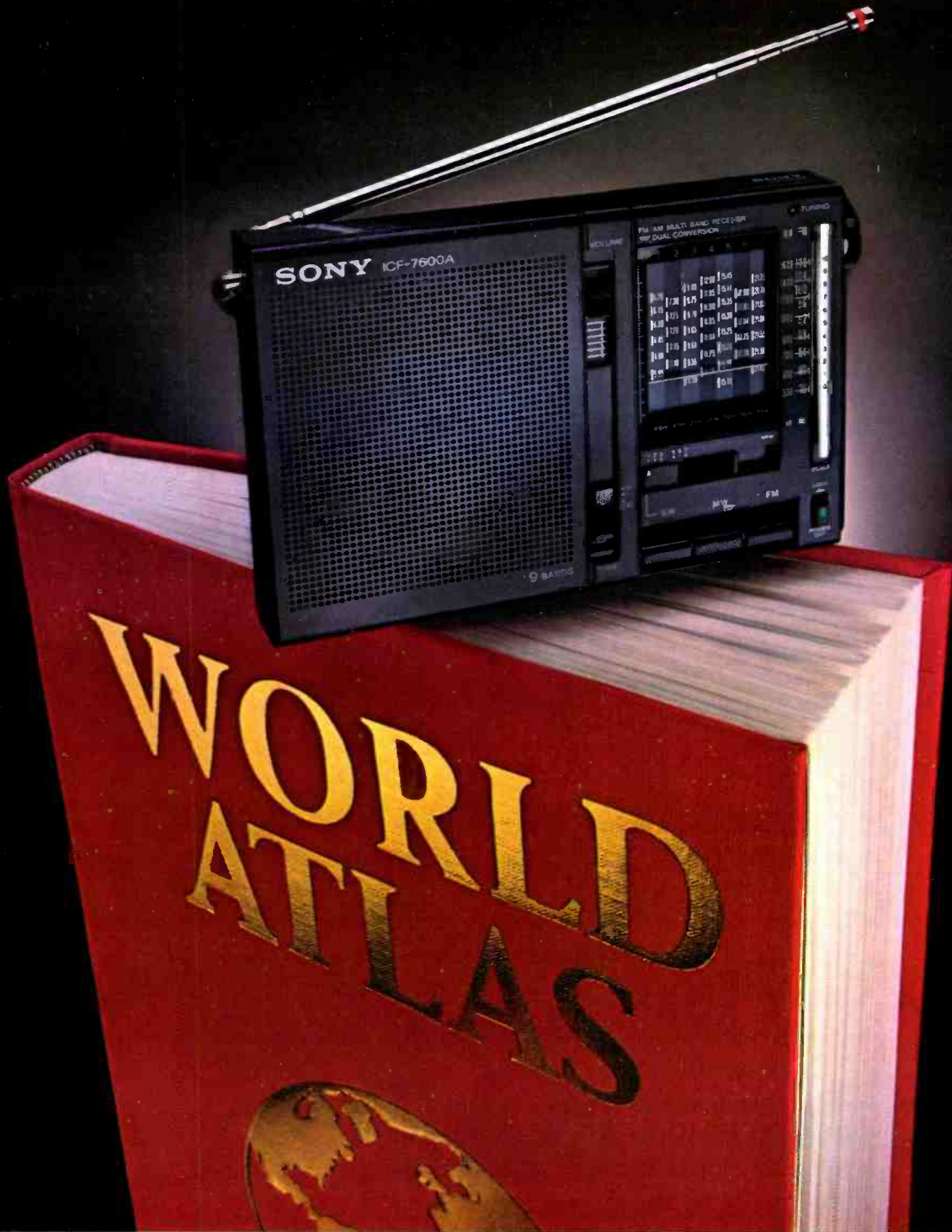

It's a small world.

Your eyes aren't deceiving you. You're looking at a Worldband radio that's very, very small.

Almost as small as a paperback book.

Gone are the days of a room filled with monstrous radio equipment and all its knobs and dials. The easy-to-use Sony ICF-7600A stands neatly on a desk if you're looking to bring the world into your home. And fits neatly into a briefcase should you travel and like to take the world with you.

It's a wonderful thing to own.

It has seven shortwave bands,



plus AM and the full 76 to 108 MHz FM band.

Its special circuitry (including dual conversion) pulls in the signal while filtering out the interference.

The RF amplifier brings in clear, interference-free reception. And separate crystal oscillators keep that reception stable.

So even though you're listening to a station thousands of miles away, this Sony will make it sound like it's coming from around the corner.



SONY
THE ONE AND ONLY

© 1982 Sony Corporation of America. Sony is a trademark of Sony Corporation. Model shown: ICF-7600A.

Buy a Sony Worldband radio and you're eligible to win a free trip for two to the faraway place of your dreams. See your participating Sony dealer for details.

CIRCLE 74 ON READER SERVICE CARD

www.americanradiohistory.com

If you like to make things work...and then find out why they work—

you could be getting paid for doing something you really enjoy!

Learn electronics...right on up to an Associate Degree...in your own home without giving up your present job or income.

People who really like their work get ahead faster. And, when your natural abilities match the job requirements, you have an extra advantage. When you use practical training to sharpen your skills, your odds are better for keeping your job even if others are losing theirs. So, if you find satisfaction and interest in making things work, a career in electronics may be for you.

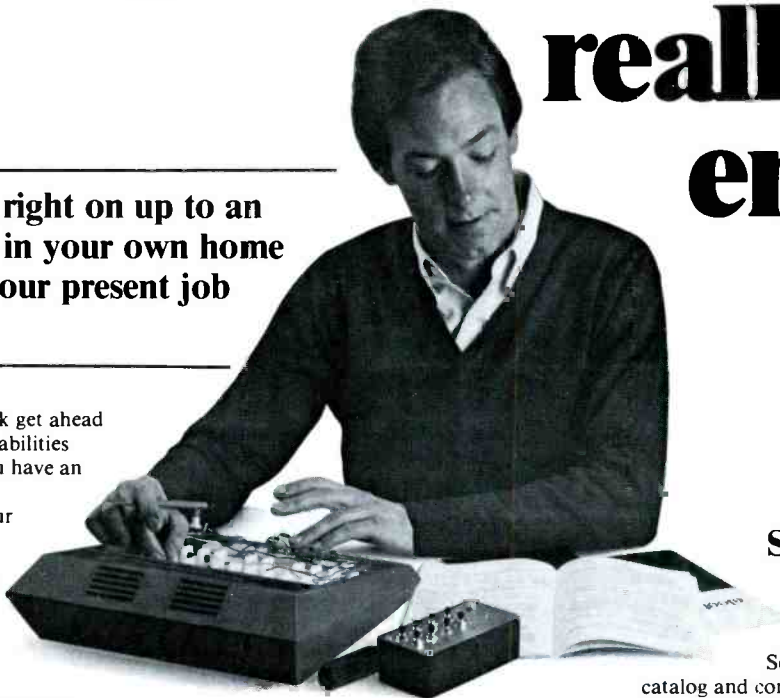

WHY ELECTRONICS IN THE 80's

Opportunity.

The field of electronics simply offers more career opportunities — and more job security — than most other fields today. Take digital technology, for example. Much of the new telecommunications, data processing, and production equipment depends upon sophisticated microprocessors to receive, sort, and send digital signals in microseconds. Two of CIE's newest home study courses combine digital electronics theory with actual experience on digital equipment. Successful completion of either one of those courses is creditable toward CIE's Associate Degree program. That's right...you can earn an Associate Degree without attending a single class session.

MAKING THINGS WORK

Many of CIE's Career Courses stress "hands-on" training. We believe textbook knowledge is important — but it's just as important to know to apply your book learning in practical situations. From basic circuitry in CIE's Personal Training Laboratory in several Career Courses, through the Microprocessor Training Laboratory, CIE helps channel your desire to "make things work" into skills you can sell.

IN A CLASS BY YOURSELF

One of the great benefits of home study is the independence it gives you. You study where and when you want to. You move as fast as you can handle it. There's no classroom to go to because with CIE, the classroom comes to you! But, you're never alone. When you request help, the CIE electronics expert best qualified will personally respond in writing.

SET YOUR OWN GOALS

CIE's wide selection of courses gives you many options. You start with a Career Course that suits your talents. Then, since more than half of CIE's courses include a series of optional lessons to prepare you to pass the government-administered FCC License exam, you can get an FCC License... a requirement for *some* electronics jobs and a credential for *all* electronics jobs. You may then go on and earn an Associate in Applied Science Degree in Electronics Engineering Technology. It's all up to you!

START MAKING THINGS WORK FOR YOU

Send today for the CIE school catalog and complete package of career information. It's all FREE, and it will help you decide where you want to start and how far you want to go. For your convenience, we'll try to have a school representative contact you to review the various educational programs and assist in course selection. Just mail the postage-paid card or write, mentioning the name and date of this magazine. We want to help you make things work, so send for your FREE school catalog today!

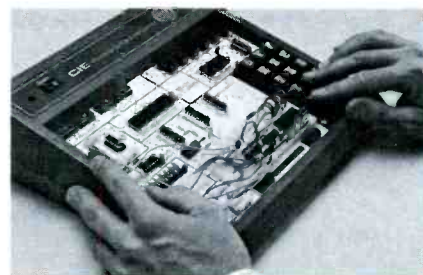

CIE's Microprocessor Training Laboratory, an integral part of the Associate Degree program, lets the advanced student apply digital technology in many of the same ways electronics professionals do.

CIE Cleveland Institute of Electronics, Inc.
1776 East 17th Street, Cleveland, Ohio 44114

Accredited School National Home Study Council

MAILBAG

LETTERS TO THE EDITOR

The most interesting questions we receive will be answered here in each issue. Address your questions to: Tom Kneitel, Editor, Popular Communications magazine, 76 North Broadway, Hicksville, NY 11801.

The Big Ear

You mentioned listening in on cordless phones in the September issue of Popular Communications. That made me wonder if this constitutes wiretapping. How about discussing listening in on cordless phone conversations?

Haig Manarian
Austin, TX

These are very handy units but, as with all telecommunications devices, they can be monitored by third parties. It doesn't require any direct wire connection to monitor them so it can't be considered wiretapping. However, since these units aren't FCC licensed (they operate under the FCC's low power Part 15 regulations), they may well not be covered under the secrecy of communications provisions (Section 605) of the Communications Act.

The units are rated as having ranges anywhere between 50 and 700 feet (even more if the antennas are modified). Fact is that if you have a good receiver, a preselector, and a decent antenna, you might be able to hear stations a mile or two off into the distance.

The majority of units are using FM with the "base" portion of the system transmitting on frequencies between about 1600 and 1800 kHz. Popular frequencies are 1666, 1695, 1725, and 1755 kHz (+3 kHz). Some units are designed so that you can hear both sides of the conversation by monitoring only the "base" channel, although with ones designed differently you may have to listen for the hand-held portion of the system via a scanner tuned to one of the following frequencies: 49.83, 49.845, 49.86, 49.875, or 49.89 MHz. At least one of the newer designs operates with both the "base" and hand-held units in the 49 MHz band.

As a bit of trivia relating to cordless telephones, several readers have written to say that the "base" units need only minor modifications to be turned into nifty little "Free Radio" type pirate broadcast transmitters operating in the 1610-1620 kHz band so popular with these stations. — Editor.

That Low Down DX

I've had many interesting RTTY encounters using my RTTY-reader, identifying stations in 20 different countries within the first week I had the unit. I've also tried looking for RTTY stations on the longwave frequencies below the standard AM broadcast band since my receiver will tune down to 150

kHz. There are several stations I copied but there's one that was really odd. It has been heard numerous times on 167.5 kHz in the evenings. The only way it can be read is with the RTTY reader set on "ASCII" mode, which is unusual since the only other station I've ever copied using that is the ARRL's station W1AW on the 80 Meter Ham band. The station calls CQ and identifies with the call-sign KAFB, giving the message "QSL BOX 5615 NM 87185." I wrote to the FCC to ask about the call-sign and they said that they haven't issued that call-sign! I also note that this station sometimes transmits its' message in regular CW. Any help in identifying it? Possibly it's a station run by a hobbyist in the 1750 Meter unlicensed "lower" band.

Mark Paulsen
Sacramento, CA

Your guess about the station being a "lower" project was pretty good, but thusfar I don't think that these stations have used RTTY. Based upon the address they gave it would place the station at Kirtland AFB, Albuquerque, NM, and the message indicates that they're looking for reception reports. Undoubtedly KAFB isn't a call-sign, per se, but simply the abbreviation for Kirtland Air Force Base. I don't know the purpose of the station but it's most likely an experimental transmission. Nice catch! If you could tune down to the VLF frequencies (to about 17 kHz) you'd be able to copy RTTY stations from many areas of the world since they are operating there 'round the clock. Check out several of the VLF converters now on the market which will work with any communications receiver. — Editor.

Clubbed?

About 6 months ago I got into monitoring and DXing. It didn't take me long to find out that there are literally hundreds of clubs and associations which claim to exist on a national basis. It reminded me of when I first got into philately (stamp collecting), only worse! My stamp collecting experiences let me learn that once you sort through the useless clubs and the ones top-heavy with wimps, there are maybe a dozen national groups worth bothering with. It cost me lots of time and money to learn that lesson, however. I was impressed with the first issue of POP' COMM and thought that if I wrote to you, you could select maybe a dozen or so national monitoring and DX groups which stand out above the crowd, and then I could head in the right direction with as little expense and annoyance as possible.

Michael Kennedy
Pasadena, CA

You may have come to the right place. I've been both disappointed and stung many times myself. Although you didn't mention if

you have any specific areas of interest, I'll pass along the names of those organizations which I feel are the best national groups currently around. Check with each of them and find out if they cover the specialties (scanners, utilities, shortwave broadcast, etc.) which interest you most; a self-addressed stamped envelope (SASE) sent to each should bring you the information you want. Check with:

American Shortwave Listeners' Club, 16182 Ballard La., Huntington Beach, CA 92649.

Assoc. of Clandestine Enthusiasts, P.O. Box 452, Moorhead, MN 56560.

Assoc. of DX Reporters, 7237 Fairbrook Rd., Baltimore, MD 21207.

Canadian Int'l. DX Club, 6815 12th Ave., Edmonton, Alta. Canada T6K 3J6.

Free Radio Campaign-USA, c/o Sp/4 Al Muick, 3rd Opns Bn. USAFSA, CMR Box 1912, APO New York 09458.

International Radio Club (IRCA), Box 21074, Seattle, WA 98111

Longwave Club of America, 45 Wildflower Rd., Levittown, PA 19057.

National Radio Club, P.O. Box 118, Poquonock, CT 06064.

North American Shortwave Assoc., 45 Wildflower Rd., Levittown, PA 19057.

Radio Communications Monitoring Assoc. (RCMA), P.O. Box 4563, Anaheim, CA 92803.

SPEEDX, P.O. Box E, Elsinore, CA 92330.

Worldwide TV-FM Assoc., P.O. Box 202, Whiting, IN 46394.

World Scanner Assoc., Box 1002, Ann Arbor, MI 48106.

If you can't find what you're looking for from these groups, then it probably doesn't exist. Remember that the club scene does seem to change from time to time with new groups rising and some established ones sometimes faltering. The great old Newark News Radio Club, after 55 years of operation, recently called it quits. As time goes on, perhaps we will have additional club listings. — Editor.

Big Rock Candy Mountain

Somewhere in the Rocky Mountains there's supposed to be a fabulous hollowed out mountain in which is stored many millions of dollars worth of bullion, art treasures, and other unimaginable delights. This is reputed to be a super security installation right out of a James Bond movie. My question is, if there is such a place, don't they have a communications system which operates within the frequency range of a scanner? How can I get more information?

Ron Mitchellson
Denver, CO

Continued on page 78

Introducing incredible tuning accuracy at an incredibly affordable price: The Command Series RF-3100 31-band AM/FM/SW receiver* No other shortwave receiver brings in PLL quartz synthesized tuning and all-band digital readout for as low a price.† The tuner tracks and “locks” onto your signal, and the 5-digit display shows exactly what frequency you’re on.

There are other ways the RF-3100 commands the airways: It can travel the full length of the shortwave band (that’s 1.6 to 30 MHz). It eliminates interference when stations overlap by narrowing the broadcast band. It improves reception in strong signal areas with RF Gain Control. And the RF-3100 catches Morse

communications accurately with BFO Pitch Control.

Want to bring in your favorite programs without lifting a finger? Then consider the Panasonic RF-6300 8-band AM/FM/SW receiver (1.6 to 30 MHz) has microcomputerized preset pushbutton tuning, for programming 12 different broadcasts, or the same broadcast 12 days in a row. Automatically. It even has a quartz alarm clock that turns the radio on and off to play your favorite broadcasts.

The Command Series RF-3100 and RF-6300. Two more ways to roam the globe at the speed of sound. Only from Panasonic.

*Shortwave reception will vary with antenna, weather conditions, operator’s geographic location and other factors. An outside antenna may be required for maximum shortwave reception.

†Especially a comparison of suggested retail prices.



This Panasonic Command Series™ shortwave receiver brings the state of the art closer to the state of your pocketbook.



With PLL Quartz Synthesized Tuning and Digital Frequency Readout.

Panasonic
just slightly ahead of our time.
CIRCLE 49 ON READER SERVICE CARD

Here Come The New DX Countries

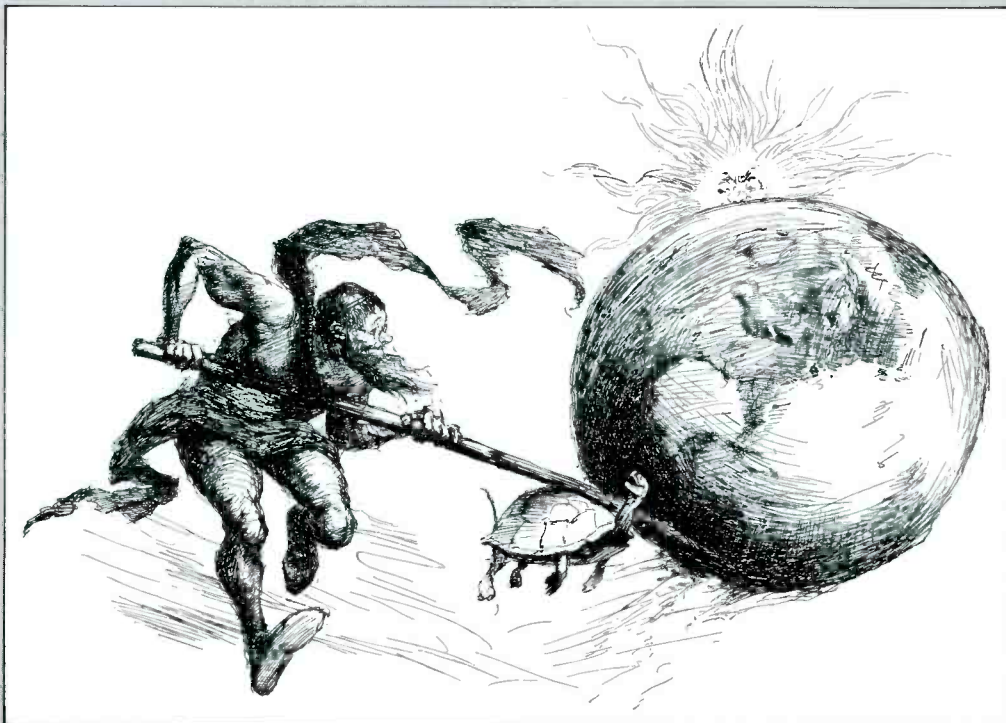

World Politics Is Generating Lots Of New Countries & Also Making Many Present Ones Extinct

BY TOM KNEITEL, K2AES, EDITOR

Right this minute, international intrigue, revolutions, guerrillas, terrorists, espionage, politics, and many other factors are at work creating scores of brand new nations. These same forces are poisoning many other countries on the brink of extinction.

If you're a DX hound you soon find out that you eventually round up most of the easy to monitor (or work) nations. Then, with a little extra effort, you can scratch through several layers of static and interference and root out a measure of "rare" nations—many times provided for you on the shortwave bands by intrepid Amateur Radio operators who have gone to all manner of hardships to reach little nooks and crannies around the world in order to set up temporary DXpedition radio operations. Such DXpeditions have produced various barren reefs and isolated unpopulated islands which would never have otherwise been the source of signals—Minerva Reef, Rockall, St. Peter and Paul Rocks, Blenheim Reef, Spratley Islands—and the rest. Maybe you needed credit for working stations there in order to qualify for a DX award, or possibly

you wanted to catch those stations just for the challenge alone.

Of course, DXpeditions will eventually run out of exotic reefs and islands to seek out. For the most part, there are a finite number of such spots, and sooner or later we will have searched for and located every possible rock, reef, and tiny patch of coral or soil which could be classified as a "country" by even the most liberal interpretation of the word. But don't fret; DXpeditions notwithstanding world politics have traditionally issued forth a large helping of new nations. And likewise, some of those nations which you easily conquered via radio could end up being rare after they've ceased to exist and can't be heard any longer.

The Way Of The World

Fortunately and unfortunately, our world isn't comprised only of geological features. It's an odd crazy-quilt of political and bioregional areas which have been in a state of constant change and evolution. While the land areas remain almost unchanged, na-

tions are arriving and departing at an ever increasing rate. This offers some interesting prospects for the DX enthusiast and some fascinating challenges for the future. Fact is there are countries out there which may have been overlooked by the DX community—exotic lands, exotic people.

Let's take a closer look at this. We're going to try to get a random sampling of those nations whose time came and went, whose time is yet to come, and even ones whose time is now but have not been recognized.

On The Map

If you take a world atlas published recently and compare it to one brought out only a few years back, you'll instantly see many new independent nations shown—Belau, Kiribati, Malawi, Bangladesh, Antigua, Lesotho, St. Lucia, Tuvalu, Vanuatu, Zaire, and countless others. Your older atlas will also reveal that many nations it lists don't show up in current editions. These nations are now extinct. There isn't any shortage at all of nations which have gone out of busi-

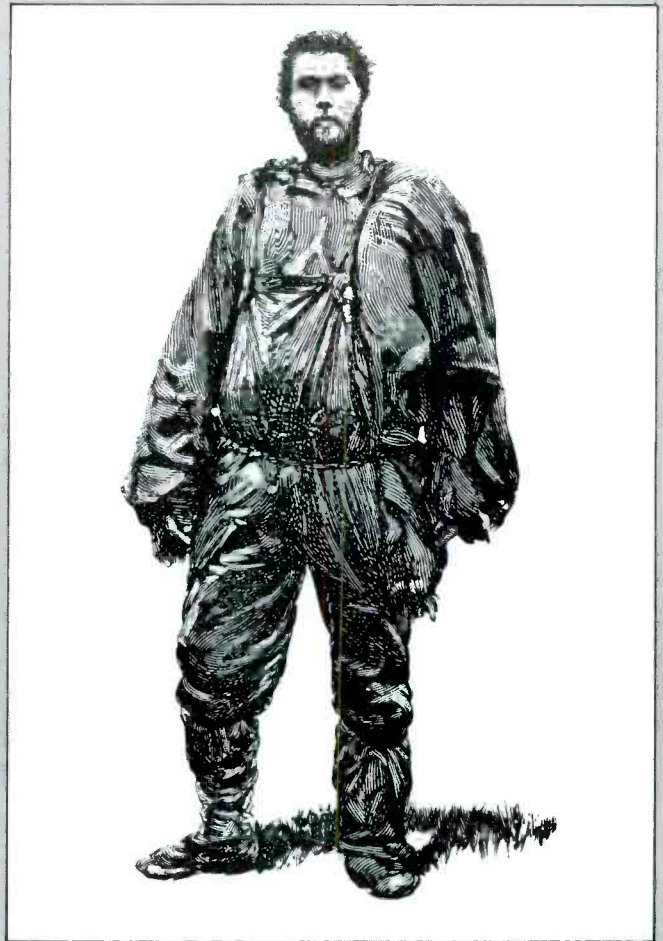
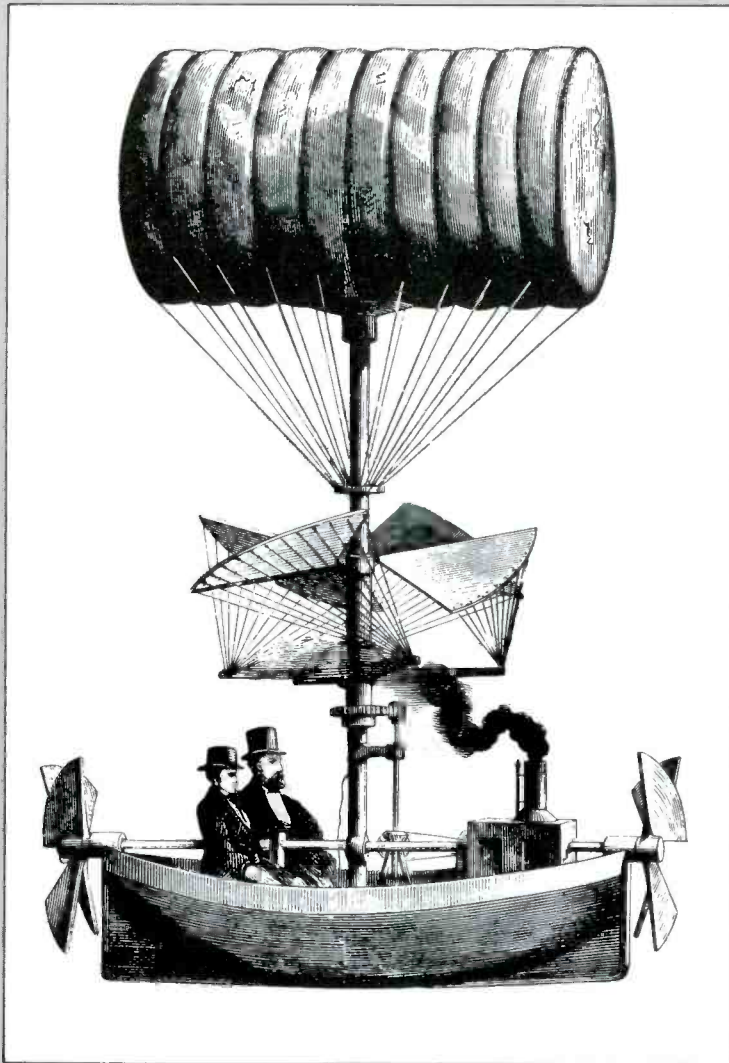

Rare nations . . . provided by intrepid operators who have gone to all manner of hardships to reach nooks and crannies around the world to set up DXpeditions.

ness in the history of civilization. Wars especially are prone to changing our maps, and because of wars, most any piece of real estate you could select in Europe or the Middle East has been a part of several different nations. Some areas have undoubtedly belonged to more than a dozen nations if you dig back far enough into history.

Honor Roll Of Extinct Nations

The nations of the ancient and medieval world kicked off the ball. I'm sure you can recall Illyria, Pisidia, Mysia, Assyria, Phrygia, Media, Lydia, Babylonia, Ararat, Bithynia, Phoenicia, the Byzantine Empire, and others; some collapsed from within while others were conquered by their neighbors or fell under the domination of distant kingdoms. Too bad radio hadn't been invented in those days! Think of all of the really rare DX countries you could have racked up by now! Of course, you'd have had to have been quick on the draw to snag some which came and went in jiffy time.

While China's been around for some 5,000 summers, Japan for 2,600 years, and ancient Rome was there for 1,000 years, consider that within the period of a single year (1918) a nation calling itself Western Ukraine both arrived and departed. In 1920, another nation known as The Far Eastern Republic repeated that stunt! Hatay existed for only a single year (1938-9), as well as Katanga and Kasai (1961).

Some relatively short-lived nations, which in recent times could have provided DX credit to the alert radio buff, include: Danzig (1920-1939), Manchukuo (1932-1945), Saar (1951-1957), Biafra (1967-1970), Trieste (1947-1954), Eastern Silesia (1918-1920), Epirus (1912-1913), South Russia (1918-1920), and Fiume (1922-1924). They're gone now, some the victims of treaties, others showed into oblivion by war, annexation, or re-annexation with nations from which they had split.

The memorial honor roll for so-called *deleted countries* is quite lengthy—Canal Zone, Zanzibar, Desroches, Aldabra, Ka-

rela-Finnish Republic, Manchuria, Ifni, and so on. QSLs from such countries counted for DX credit only if they were issued prior to a specific cutoff date when their status changed. The ARRL is currently carrying almost 50 recently departed countries on their *deleted list*.

The second cousins of deleted countries are those which tried hard but somehow never got past the point of being on the verge of existing, like the Jason Islands. The Jason Islands are an archipelago stretching northwest from West Falkland. They are a privately owned bird sanctuary whose sole permanent inhabitants, save a lone caretaker, are penguins and albatrosses. The late Leonard Hill, who purchased the islands in 1970, commenced issuing both postage stamps and currency which he claimed were "legal." Since penguins and albatrosses don't write letters or spend money there seems to have been little practical value to either of these benefits—although the tiny "nation" still claims every right to issue stamps and currency and, in fact, the son of the man who purchased the islands has

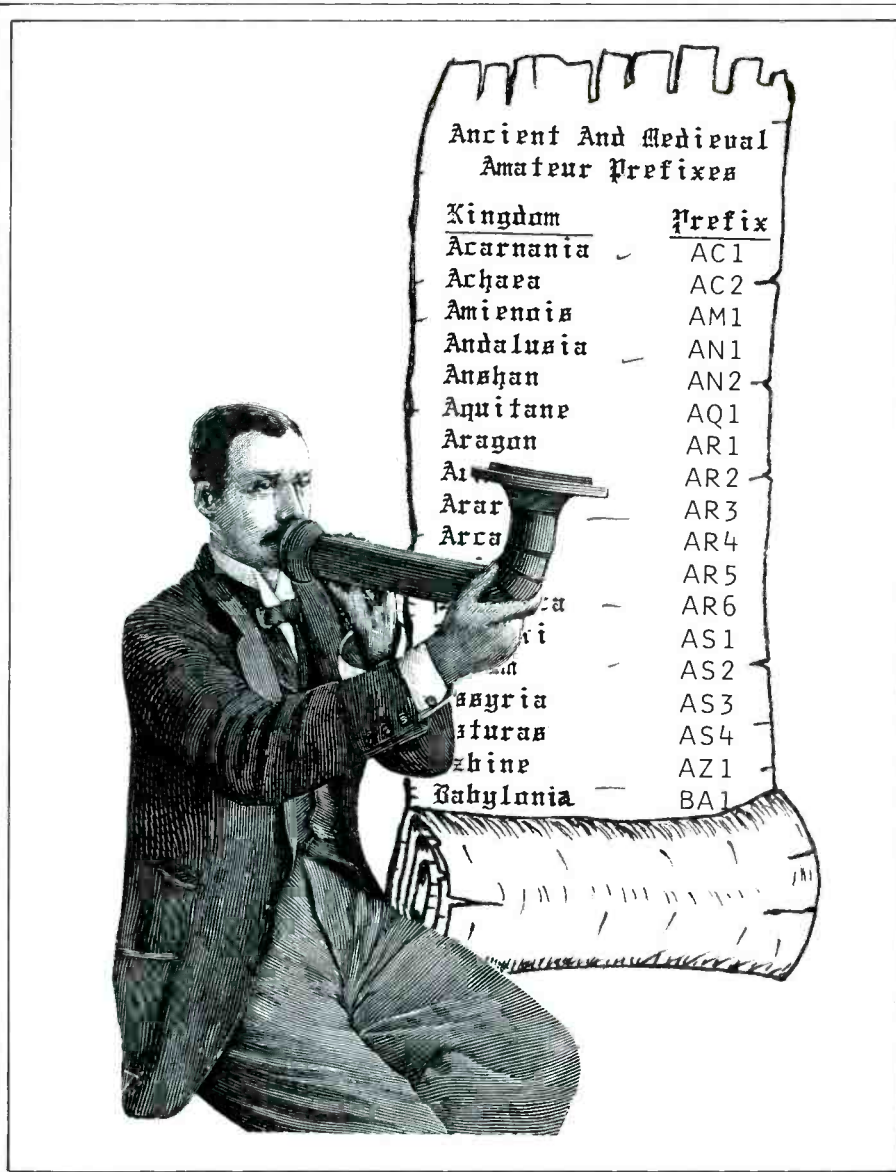

Too bad radio hadn't been invented in those days.

been reported to be considering bringing out additional currency!

Another area, the Republic of the South Moluccas, even issued postage stamps, but no other nation's postal authority would recognize the stamps as valid. Stamp collectors wouldn't even collect them!

In the late 1970s, three more of Africa's many new nations arrived on the scene—Venda, Transkei, and Bophuthatswana. Despite clever and massive efforts on their parts to capture world recognition and attention, they have remained obscure non-nations in the eyes of the international community. These three non-nations are "on the air," however!

Some devious unknown person even tried to make it look like there was a new country called Kibris (Kibris is a Turkish Federated State located on Cyprus). Recently, someone took it upon themselves to issue postage stamps bearing that nation's name. The Kibris Postal Administration quickly

and angrily snapped, "they have no legal or official status and cannot be used as postage stamps." So Kibris still counts as Cyprus!

Wishful Thinking

Did you realize that the International Telecommunications Union office at the United Nations Building in New York City is considered a separate country towards claiming a DX award? Same thing for the ITU office in Geneva, Switzerland! These are countries which consist of one room in an office building! On a slightly larger scale, another valid country for DX credit is SMOM (Sovereign Military Order of Malta), which consists of a single building in Rome.

Well then, let's seriously consider granting country status to Campione d'Italia, an Italian enclave located in the Ticino area of Switzerland. It's a little bit of old Italy which is entirely surrounded by Switzerland's borders! In 1944 they even issued their own postage stamps.

Also within the borders of Switzerland is a town called Biltgen, except that it's not Swiss. It belongs to West Germany!

And what about country status for Liviria? It is an enclave of Spain located near Andorra, but it lies fully within the borders of France.

What eager DX hound isn't tantalized by pondering the possibilities of someone setting up "new country" operations in an embassy of a foreign nation? Those structures are considered to be the sovereign territory of the nation occupying them.

A perfect example of how this affects radio is in the United States Embassy at Monrovia, Liberia. Our government operates an RTTY station there and it operates with the callsign KKN44 (on 11.474 MHz). That callsign is as American as ants at a Fourth of July picnic. Well, it conjures up some intriguing possibilities, to say the very least. There are dozens of foreign embassies in many major world cities. Each major city could open up a raft of DX countries with only a little creative planning and diplomatic cooperation.

Private And Artificial Nations

To my knowledge, there hasn't been any serious DX consideration directed toward the many curious mini-nations which are springing up all over the place of late. To the owners (or rulers) of such micro-paradises, these are considered to be sovereign and independent states.

For instance, the nation of Sealand was established in 1966 and is located entirely upon an abandoned 10 by 25 foot World War II gun platform located 6 miles off the coast of Essex, England. Its' sovereign, Prince Roy (Bates), his wife, and his son are the sole inhabitants. However, this independent republic has prepared its own money, passports, and postage stamps. There is also a two-way radio located in Sealand, thus making it one of the world's rarest populated DX countries!

A mini-nation of similar nature is the Republic of New Atlantis, but this one is larger than Sealand, being situated on a 30 by 100 foot artificial island 6½ miles southwest of Jamaica in the West Indies. This mouse that roared has a flag, postage stamps, a national anthem, and in the 1960s, claimed that it was granted *de-facto* recognition by the prestigious International Court of the United Nations. Its' founder is the brother of the late Ernest Hemingway.

The Hutt River Province is a self-proclaimed sovereign state located on a large sheep ranch in Australia. Under the leadership of Prince Leonard, it declared its independence and seceded from Australia in 1970. Eventually, he authorized the printing of postage stamps and the minting of various coins (including gold). The coins are acceptable in exchange at Hong Kong banks which certainly gives the HRP some international recognition and status. The Australian government has viewed the existence of the HRP with concern and annoyance.

Unnoticed by most people, yet another

private mini-state has sprung up. This one calls itself the United Kingdom of Arya (UKA) and claims to be located on a South Pacific Island, the specific location of which is said to be a secret (but their newsletter "Arya," is published in Los Angeles). A recent edition said, "We proudly announce that we have been operating as a government for one year now," mentioning a kick-off date of January 1, 1981, and claiming that its founder is "adventurer Arch Edwards." Arya offers many titles of nobility for sale, and you can become an instant baron for \$60, a duke for \$100, a warrior for \$25, or a mere private citizen for a paltry \$12. A questionnaire has to be completed and all applicants "have to be of pure Aryan blood" in order to reap the benefits of citizenship.

Political Boiling Pots

Right now there are potentials for new or reborn nations on the burners of the world's stove. Some are simmering, while others are boiling violently. The media brings these places before us regularly, including Croatia, Quebec, Greenland, Puerto Rico, Palestine, Faroes Islands, Kurdistan, Northern Ireland, and Basque Provinces, the Moluccas Islands, Latvia, Lithuania, Estonia, etc. Some of these places are already counted as separate countries by DXers, but others would create new DX challenges.

There is currently an increasing world interest in several so-called bioregions—localized areas within nations containing groups of residents who have language, cultural, and/or tradition diversities from those na-

tions within whose borders they exist at the present for one reason or another. Some have called such bioregions "stateless nations which exist only in the minds of those who reside there." The magazine, *CoEvolution Quarterly* (Issue #32), recently examined these bioregions in some detail. Author John Stewart pointed out that an organization called The Federal Union of European Nationalities (FEUN) has been formed to represent some 30 "national groups," such as Frisians, Scanians, Samis, and others.

Scania, for example, is located in the four southern provinces of Sweden and contains about 800,000 residents. It was an independent nation until the late 1600s when it was annexed into Sweden. Despite Sweden's long efforts to draw the Scanians into the mainstream of Swedish culture, the people there have resisted integration. They are now attempting to revive their language. However, the general Swedish population has thusfar not acknowledged the nationalist Scanian movement or regarded it with any seriousness.

Stewart also describes Samiland, a stateless nation now situated within the borders of Norway, Sweden, and the USSR. The lifestyle of the Samis is mainly pastoral in nature and not at all unlike that of the native Americans; and also like the native Americans, they feel that they have been taken unfair advantage of by governmental authorities. As a result, since 1978 the Samis have been organizing a political awareness structure which seeks to bring their culture into a new unity. Protests have been successful in getting the Norwegian government to grant some of their demands.

Frisia (a/k/a Freisland) was the first nation to grant recognition to the American government—that was in February of 1782. But after a long history of independence, Frisia somehow managed to get itself sliced up into three different regions located in two other nations, the Netherlands and West Germany. A recent survey showed that almost 85% of the Dutch Frisians could still speak their native language, Frysk. About 17 publications are issued in Frysk, and a few Frysk programs are broadcast on the radio. The German Frisians, however, haven't been as successful in retaining the old language, but they retain close cultural ties with the other Frisians and a strong nationalist movement seems to be getting a good start. Who knows where it could eventually lead?

Other cultural inconsistencies in Europe include the Danish community which exists in northern Schleswig and the German culture in Jutland (Denmark). The potentials are ripe for these areas to seek nation building as they bring their goals into focus.

On The Way In & Out

Of course, there are a few reminders that our planet is not fully settled down from a geological point of view. Earthquakes show that tectonic activity is still with us, with continental plates not finished in their migrations. Land areas are changing.

Despite massive efforts to capture world at attention, they have remained non-nations in the eyes of the world.





There's also a two-way radio in Sealand, thus making it one of the world's rarest populated DX countries.

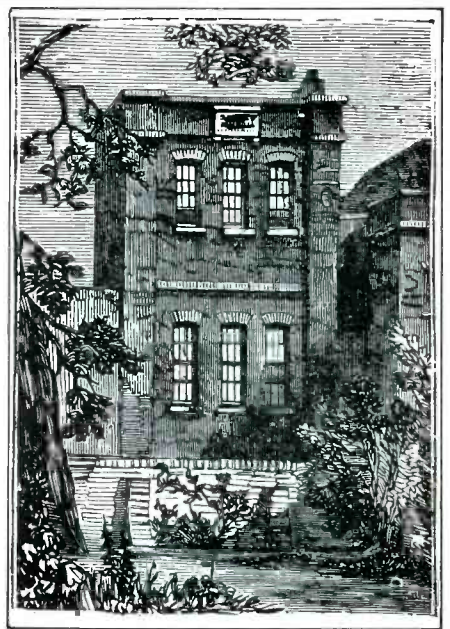

Another valid country for DX credit consists of a single building!

For instance, in December of 1967, an island now known as 7-Metis Shoal suddenly popped out of the Pacific Ocean near Tonga. Within 6 months it was a half-mile long and 150 feet high. Another new island, Sturtsey, arose from the ocean depths southwest of Iceland in 1963.

We haven't forgotten tales of the legendary Atlantis or so-called Lost Continent of Mu, but a more modern version is the elusive Dougherty Island. It was discovered 1,500 miles southwest of Cape Horn (at Latitude 59 S, Longitude 95 W) in 1800 by Capt. Swain, an experienced American whaler. Years later, two other whalers, Capt. Gardner and Capt. Macy, spotted it and confirmed its location, describing it as ice covered, 8 miles long, and rising 80 feet from the sea. In 1830 two American vessels set out to explore it, but despite a lengthy search, they were unable to locate Dougherty Island.

Then in 1841, Capt. Dougherty, commanding the good ship *James Stewart*, passed the island at less than 1,000 feet distance and kept it in sight for nearly a full day. He confirmed its position as charted by Capt. Swain and further described the island in considerable detail, even to the odd high bluff at the northeast corner. A few years later, Capt. Keates saw and described the island, later confirmed by Capt. Whitson (1885) and Capt. Stannard (1886). In 1893, Capt. White of New Zealand rounded Dougherty Island and described it exactly as seen by others. That was apparently the last time it was spotted.

Four subsequent separate intensive searches were made in 1894, 1900, 1907, and 1910 without spotting any trace of it.

Capt. Scott (of Antarctic fame) sailed directly over the spot and reported soundings of 3 miles. In 1915 the scientific yacht *Carnegie* sailed back and forth over the entire area in an attempt to locate the island without any success. Eventually, in 1932, it was removed from maritime charts.

The elusive Dougherty Island is by no means unique. The famed Admiral Peary discovered a place he proudly named Crocker Land (Latitude 100 W, Longitude 83 N) in 1906. By the time the expedition of

Donald MacMillan arrived on the spot in 1914, Crocker Land had—er—well, vanished! Sorry about that.

There was, of course, no doubt as to the existence of Krakatoa Island, located in the Sunda Strait between Sumatra and Java. On August 26th, 1883, it had a population of 36,000 residents. By August 28th the local 2,600 foot high volcano had not only eliminated all of the residents, it had done a reasonably good job of destroying itself and the remainder of the island. All that's left

Years later two other whalers spotted it and confirmed its location.





They established their own elections, army, schools, taxes, sheriff, and laws.

now is a small low islet with a crater in the center.

So, while the political fortunes of the nations of the world are one thing, potential DX countries are still subject to making sudden appearances and exits which can't be easily predicted. Maybe we ought to consider getting radio communications or broadcasting operations as soon as possible on newly discovered plots of world real estate, lest they cease to exist before they can be counted for credit for something.

On The Home Front

All of these activities have not been very close to home, but Americans will quickly recall several independent nations which once existed within our present borders (Confederate States of America, Republic of Texas, Hawaii). But there have been a couple of other almost forgotten independent nations which are far more intriguing.

Amelia Island is 4 miles wide and 15 miles long and is located off Florida's east coast north of Jacksonville. In the early 19th Century, it was the central operating location for smugglers during the American embargo on trade with Europe. In general, it was a wide open place and in 1817, a South American adventurer named Luis Aury arrived there with his forces and established an independent nation dedicated to convincing Florida to throw off Spanish rule. In what came to be called The Amelia Island Incident, the American government sent a naval expedition there to depose Aury and his government. In 1862, the island again had to be recaptured by federal forces when it became part of the Confederate States of America.

In 1832 there was a border dispute between the U.S. and Canada concerning a mountainous area along the New Hampshire border. At that time the 300 residents within the area seized the opportunity to proclaim themselves as the independent Indian Stream Republic. They established their own elections, army, schools, taxes, sheriff, and laws. The 500 square mile nation went about its business for a full six years without hassle, but in 1838, the U.S./Canadian dispute flared up again. This time the New Hampshire militia marched into the Indian Stream Republic and occupied it, convincing its citizens to "surrender." Today the area has 600 residents and is known as Pittsburg, NH.

In 1860, the handful of residents of tiny Muscongus Island located off the Maine coast near the village of Friendship, seceded from the United States after learning that they had been left off official maps and (as a result) couldn't vote in the Presidential election. They established their own independent government, and although Maine wouldn't recognize their independent status, they refused to pay any taxes, warning off tax collectors with pistols, rifles, and shotguns. It wasn't until 1934, 75 years later, that the grandchildren of the original secessionists forgave the United States government and requested that Muscongus Island be readmitted to the Union.

More recently (1967) Hurricane Beulah caused a shift in the course of the Rio Grande River near a point where it meets the Gulf of Mexico. That created a 400 acre island right in the middle of the river. Somehow, the island ended up off the U.S. tax

roles and was claimed by neither the U.S. nor Mexico. Along about the middle of 1979 the island was obtained from its American owners by a chap who announced that he intended to establish a new nation there to be known as The Cherokee Nation—a place "free of taxes and bureaucrats." Thus far, no further developments from this emerging nation have been reported, although it would have instant appeal as a spot for an inexpensive DXpedition.

Another potential close-to-home DXpedition spot to consider would be lonely and little Machias Seal Island about 12 miles off the coast of Cutler, ME. There is a vagueness about whether Machias Seal Island lies in American or Canadian waters; even authoritative Hammond maps show the island with the notation "sovereignty undetermined." This is one of the few known chunks of real estate in North America which might well be up for grabs!

New Nations? They're All Around Us!

Fact is, one way or another, new DX countries (and potential DX countries) are all around us. Just as old and worn out nations are slipping off into limbo, the parade of new countries is heading towards the reviewing stand. And your communications receiver puts you front and center!



The
HAM SHACK

808 N. Main • Evansville, IN 47711

DISCOUNT PRICES ON

- New & Used Shortwave Receivers
- Video Readers for Radioteletype (RTTY), Morse Code, and Computer Transmissions (ASCII)
- Antennas & Antenna Accessories
- Books & Publications

Large inventory of these major brands: AEA, B&W, Butternut, Cushcraft, Drake, HAL, Kantronics, MFJ & Yaesu. Call or send SASE for our new & used equipment list.



812-422-0231

MON-FRI 9AM-6PM • SAT 9AM-3PM

CIRCLE 13 ON READER SERVICE CARD

Operation:

Underground Radio—Part II

Selecting Secret Radio Frequencies

BY HARRY CAUL

Underground radio operations are springing up throughout the world! By underground I mean stations which aren't licensed and which generally function from temporary locations which are not known to either the public or the governments from whose territories they operate. Such stations operate for any of a variety of reasons including (but not limited to) secure communications relating to business or financial transactions; for paramilitary, mercenary, or guerrilla forces operations; and even for some survivalist communications systems. Then there are also one-way (or broadcast type) transmissions which take place with the intention of being heard by the general public. Usually, these are for propaganda, revolutionary, counter-revolutionary, or other political purposes.

Without even taking into account the vast number of hobby oriented underground stations—both two-way and broadcasters—this still fills the radio spectrum with a myriad of transmissions in all operating modes and on numerous frequencies lying between the AM broadcasting band and the UHF scanner bands! *Anybody* can hear them; in fact there are so many such stations operating throughout the world that it's difficult *not* to hear at least a few every time you flip on a communications receiver. Maybe you call some "spy numbers" stations—those stations with their Spanish or German language announcers transmitting coded 5-digit groups; these are the most obvious ones. Fact is that those stations are very easy to hear since they most often use AM mode and operate from high-profile portions of the international shortwave spectrum.

Chances are, however, that you've probably stumbled upon many other undercover radio communications systems without even realizing what you're hearing! The ma-

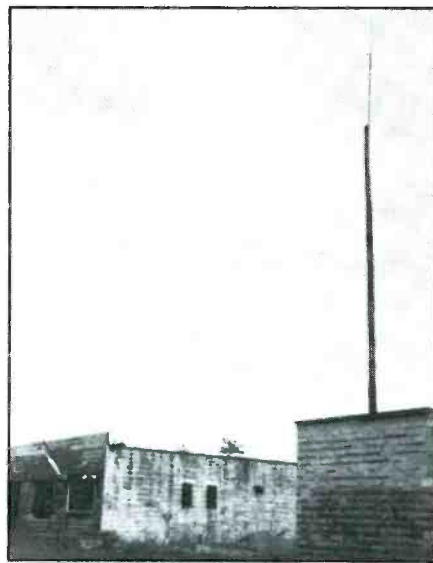

Rebels in El Salvador had been using this building as their regional communications headquarters. Note that the VHF communications antenna atop the pole at the rear of the building.

jority of them make a concerted effort to blend into the background and be known to those who are supposed to hear them—in other words, to remain undetected by outsiders (that's *you!*). However, if you know some of the hiding places of the underground stations, you can root them out. Let's take a look at some of the two-way communications frequencies used by underground stations so that you can search for them with your communications receiver and your scanner.

Before I get into specifics, let me remind you that the majority of underground communications operations are of relatively short duration, with stations changing loca-

tions, identifications, and rotating their operating frequencies periodically. This is done for several reasons, not the least of which is to avoid being tracked down by various authorities (military or civilian) who would cause immediate (and sometimes) violent termination of the operations—sometimes even similar termination of the operators themselves! The majority of the world's governments don't look kindly upon unauthorized radio communications within their borders, and some are more hostile about it than others.



The El Salvadorian rebels secret communications center in this view reveals that the government located the station and took a decidedly dim attitude toward its operation. Oddly enough, they left the antenna and its' mast still intact!

In the United States, the Federal Communications Commission has the authority to license and regulate all communications and broadcasting stations. When persons or organizations are located being in violation of FCC licensing regulations, the results could well include fines and/or even prison sentences, depending upon several variables including the nature of the operations. Certainly, of all places, the borders of the United States are definitely not high upon the list of preferable places from which to operate unauthorized communications facilities, even though it's regularly done by many adventurous souls for their own reasons. It isn't recommended. However, you are welcome to use your receiver or scanner to try and listen to it! No law against that at all!

The HF Bands

Selecting long range frequencies for underground operations is tricky because of several reasons. One of them is that there is a shortage of frequencies between 2 and 26 MHz and authorized services jealously fight over who can use which bands in preference to others. As a result, these frequencies are allocated for specific purposes such as broadcasting, amateur, maritime, aeronautical, fixed, and other uses. Some of those who are authorized to use specific bands guard their integrity and (to whatever extent is possible) seek to chase interlopers from the frequencies when they become known; more often than not this includes notifying appropriate governmental authorities.

Another factor relates to propagation characteristics of radio waves; besides finding frequencies which may be safe from instant detection, the frequencies must be suitable to propagate to other points of the world at the times desired for transmission. Also to be taken into account is whatever frequencies are selected should be viewed with an eye towards evaluating potential dangerous interference on the frequencies which could endanger life or property. Besides the obvious altruistic motives of such a policy, such interference only tends to speed up detection and its resultant unpleasant aftermath. As you can see, there are a number of things to be weighed when selecting frequencies and it isn't generally done without a certain amount of consideration, not only for the operators of the system but also for others whom the operations could affect.

Frequency 13.560 MHz has been employed from time to time for both voice and non-voice underground long-range communications. The frequency is easily accessible with most Amateur Radio equipment and has been used for worldwide communications without causing discernable interference to any vital services. It's a frequency allocated for "industrial, scientific, and medical" (non-communications) "ISM" apparatus. Mostly, it's used for radio wave arc welding purposes and it's not jealously guarded by anybody nor is it frequently monitored.

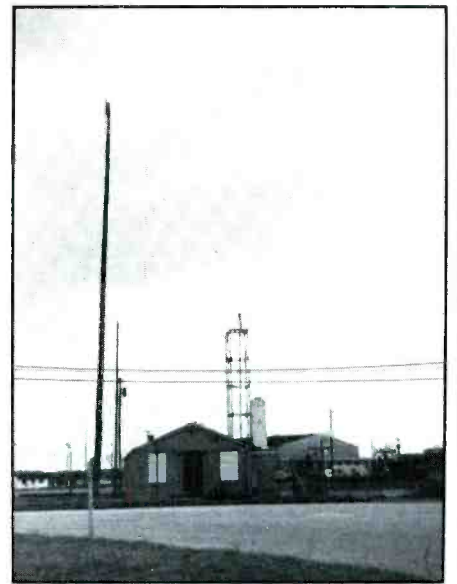

Not all so called "spy numbers" stations are operating without some sort of official authority. Using radio direction finding techniques, one such station was tracked down by a listener to this steel-shuttered and unmarked building at a military installation in Europe.

Other HF frequencies which have been successfully used by secret stations include those allocated for maritime simplex purposes—and there are 22 of them stretching out between 2 and 22 MHz. If you listen there (SSB mode), much of what you'll hear is idle chit-chat between the captains of sea going yachts, tankers, trawlers, and freighters—not at all unlike a gigantic CB channel. Most of the time no callsigns are used, and while there are maritime shore stations on these frequencies which exchange non-safety traffic with vessels—the majority of traffic is inter-ship and of a social nature.

Since there are so many of these frequencies spread out over the spectrum, and because of the nature of their use, they have been known to be used for voice communications by stations located on land. They are not in any way connected with maritime interests, although sounding very much like they might well be ships at sea! At least most of the time they get away with it, although two years ago one DX fan wrote to the "Utilities Stations" editor of the *American Short-wave Listeners Club* publication to question two stations he had picked up on 8.2942 MHz since their ID's didn't sound very much like they were ships—NATIVE ECHO and 12-OSCAR. Looks like he had stumbled across two covert non-maritime stations!

Mercenary troops (mercs), led by Col. "Mad" Mike Hoare, used these frequencies during their unsuccessful attempt in November (1981) to overthrow the government in the Seychelles Islands. The mercs had long distance communications with various parties in South Africa who had organized the operation; these communications were on 6.5219 and 16.5902 MHz.

The 22 maritime simplex frequencies are:

2.065 MHz	12.4292 MHz
2.079 MHz	12.4323 MHz
2.0965 MHz	12.4354 MHz
4.125 MHz	16.5871 MHz
4.1436 MHz	16.5902 MHz
4.4194 MHz	16.5933 MHz
6.2186 MHz	22.124 MHz
6.2216 MHz	22.1271 MHz
6.5219 MHz	22.1302 MHz
8.2911 MHz	22.1333 MHz
8.2942 MHz	22.1364 MHz

26 to 28 MHz

Standard CB frequencies (26.965–27.405 MHz) are sometimes disdained by underground operators because of crowding, interference, and the general clowning around which takes place thereupon. However, CB equipment is inexpensive and plentiful, as well as being locally available in most areas of the world. Also, it can be used for reasonably long distance communications when ionospheric conditions are right. Many persons have modified CB equipment to operate illegally above and below the authorized CB band. While the majority of those doing this are strictly hobbyists, there has been some use of these frequencies for paramilitary and mercenary communications. In particular, frequencies 27.6625 and 27.8625 MHz were noted in use by mercenary forces in Rhodesia (now Zimbabwe). Frequencies 26.865 and 26.875 MHz have been noted in use by rebels in El Salvador. SWAPO guerrillas in Namibia are operating on 27.580 MHz.

Those overseas users who can put up with hobbyist interference on these frequencies adjacent to the CB channels have the advantage of being able to get away with things for long periods of time. This is because they are buried in with countless thousands of worldwide bootleg hobby stations with whom they share the frequencies and it's not always easy to pick them out of the crowd. On the other hand, possible "hostile" uses for CB equipment is the prime reason why so many governments (especially unstable governments in underdeveloped and "third world" nations) have staunchly refused to legalize the use of CB. They simply don't want that type of equipment brought into their borders because of the possible uses in connection with espionage and insurgencies of the citizenry—now or in the future!

Above 30 MHz

Throughout the world, each nation has established different uses for specific frequencies above 30 MHz. It's difficult to try to summarize them on a worldwide basis, especially since most communications are used for short range purposes. If you do any listening between 30 and 50 MHz you may have heard all of the overseas skip—much of it of highly questionable authority.

Perhaps it's simpler to try to give some ex-

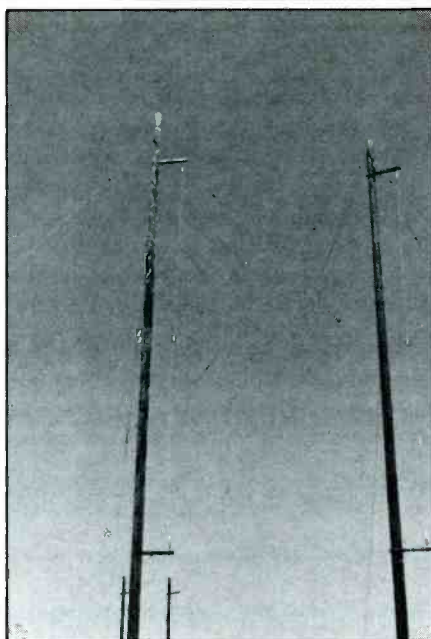

A closer look at some of the antennas used at the apparent "spy numbers" station located at the shuttered building in Europe.



The essence of so-called underground communications concerns frequency selection, non-interference, communications security, and operating with equipment which can be established, dismantled, and transported in short order. An antenna which can be erected or taken down in less than 15 minutes is a definite plus!

amples from within the various frequencies allocated to different purposes in the United States and show you how some have used them for their own purposes.

For instance, 40.68 MHz is another frequency akin to 13.560 MHz on the HF bands, used for "ISM" purposes. Other similar frequencies include 27.120 MHz (within the band limits of CB frequencies) and 433.92 MHz. These are not allocated for communications purposes and therefore not likely to be the site of monitoring or interference complaints from other users.

There are also a number of other frequencies which have been used by underground operators with a certain amount of discretion. Frequencies set aside for the exclusive use of low-powered short-range communi-

cations devices such as hand-held transceivers and wireless microphones include:

30.84 MHz	154.57 MHz
33.12 MHz	154.60 MHz
33.40 MHz	457.525 MHz
35.02 MHz	457.55 MHz
42.98 MHz	457.575 MHz
	457.60 MHz

There are frequencies set aside for the use of highway callboxes and other non-voice telemetry devices, as well as for voice and non-voice one-way paging. The assumption that if persons intend to operate more than 100 miles from stations authorized for operation on individual frequencies, there is little likelihood of causing interference or being detected. These include:

154.456 MHz	173.3962 MHz
154.464 MHz	462.75 MHz
154.471 MHz	462.775 MHz
154.479 MHz	462.80 MHz
154.625 MHz	462.825 MHz
157.74 MHz	462.85 MHz
158.46 MHz	462.875 MHz
173.20375 MHz	462.90 MHz
173.21 MHz	462.925 MHz
173.2375 MHz	465.00 MHz
173.2625 MHz	467.75 MHz
173.2875 MHz	467.775 MHz
173.3125 MHz	467.80 MHz
173.3375 MHz	467.825 MHz
173.3625 MHz	467.875 MHz
173.39 MHz	467.90 MHz

Frequencies established for (FCC Part 15) low power unlicensed operation are frequently used for all manner of odd transmissions. Who is to say if such are within the power limitations established by the FCC? These can be monitored on:

49.83 MHz	49.86 MHz
49.845 MHz	49.875 MHz
	49.89 MHz

Some questionable communications have been monitored on the following low powered mobile-only frequencies allocated to the General Mobile Radio Service (old Class A CB):

467.55 MHz	467.65 MHz
467.575 MHz	467.675 MHz
467.60 MHz	467.70 MHz
467.625 MHz	467.725 MHz

Short-range low-power (35 watt) business service mobile stations and portable base stations may be licensed on 464.50, 464.55, 469.50, and 469.55 MHz. I was informed that all four of these frequencies are popular for unlicensed communications at survivalist hideaways and at several paramilitary training centers scattered around the nation. I have not confirmed this; however, you might be able to do so.

I might add that there are 5 VHF frequencies set aside for inter-ship use by yachts. If you live within range of any coastal area or inland lake or waterway you will be able to quickly realize that, as with similar HF channels, all of these frequencies are used primarily for horsing around on a scale un-

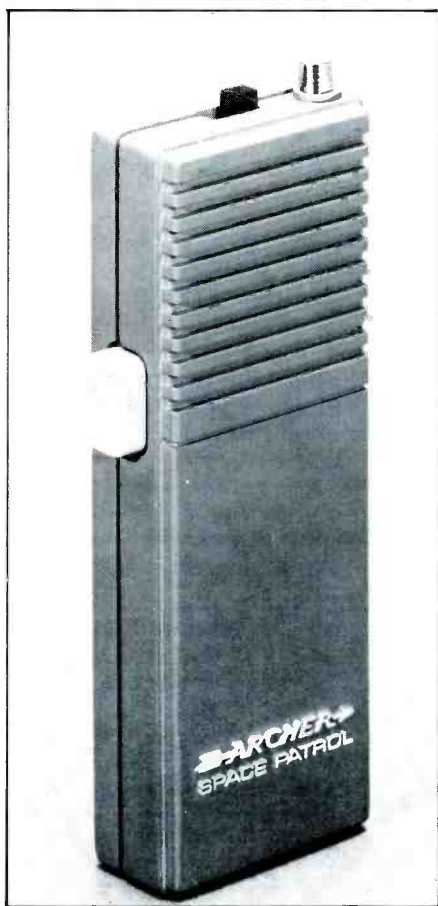

This little hand held unit (which operates on 49 MHz) has been used effectively by more than one group of persons seeking short-range underground communications without anybody wondering what's going on. Since such units don't require licenses in the U.S., the frequencies aren't monitored by anybody who might otherwise care!

matched this side of the CB channels. Seldom do the vessels use any callsigns—many times the vessel names aren't even announced. Such sloppy operation leaves these frequencies (which aren't often monitored by the FCC or the Coast Guard) ripe for unauthorized base and land mobile operations by underground tactical stations. Indeed, many boat owners are known to remove their VHF-FM radios from their vessels and illegally stick them in their homes and vehicles for operation on these frequencies in order to keep in contact with their friends. These are among the most ripped-off frequencies going. The frequencies in question are:

156.375 MHz	156.525 MHz
156.40 MHz	156.625 MHz
	157.425

Other assorted frequencies which have been noted in unauthorized use include hypothetical or non-existent channels which lie between authorized frequencies—a particularly dangerous game because you never know who your modulation products might be jamming on an adjacent frequency



UHF communications transceivers don't always operate with licenses on authorized frequencies. Their nominally short operating ranges make them appealing for local tactical communications without too much fear of causing interference or detection.

where stations are authorized. Also, there are VHF (and therefore limited range) frequencies assigned to forestry conservation agencies operated by various states. Some persons have figured out which of such frequencies are not in use within 75 or 100 miles of their own location and have then set up low power operations on them. They say that nobody seems to know the difference; my feeling is that it's a more dangerous game than many others I could think of.

Ham Bands?

I haven't mentioned anything about the misuse of Amateur Radio frequencies for unauthorized (non-hobby) communications, although there is evidence of it which goes back over a long period of time. In underdeveloped nations especially, it is no problem to operate on VHF bands for almost any purpose which can be dreamed up and do it with impunity for as long as one wants. Throughout Central and South America, as well as Africa, there are countless unauthorized two-way systems operating with 2 Meter band equipment. This isn't limited to those using it for what might be termed *underground* operations, for it is more often in use by taxi services, truck companies, mining operations, and other legitimate businesses electing to use the low cost gear without the bother of all the payoffs and red tape getting a license requires in some nations.

Indeed, even in the United States there was long a network of bootleg stations located in long-distance trucks riding on the Interstates. This was called the "National Truckers Intercom Channel" (147.57 MHz); it may still be in operation. It used the cheap 2 Meter band transceivers which Sears Roebuck used to sell from their catalog! This network was reported as far back as 1977 in various publications. More recently, illegal American trucker stations have been reported on 6.960 MHz (lower sideband).

The low band Amateur Radio frequencies (notably the 15, 20, and 40 Meter bands) have had some underground operations

noted, especially in overseas areas where licensed Amateurs provide part-time communications for various rebel and guerrilla forces—or where their equipment has been stolen by those same forces. Operating on these bands is generally a risky business since Amateurs are quick to pick such ringers out of the crowd and then raise hell with the governments involved to get them off the air. Nevertheless, I am aware of at least one such system which operated between South America and Europe on a schedule of several times per week for many months without any problems whatsoever. CW was used exclusively, and, as part of their "cover," the stations used legit sounding Amateur callsigns and would even respond to other Amateurs in the event they were called—although they kept such contacts as brief as possible. It wasn't until 3 months after the operation was voluntarily scrubbed that one of the stations was mentioned in an Amateur magazine with the suspicion that it was probably a clunker.

Drug smugglers have been noted using frequencies just outside the high frequency edges of the 20 and 40 Meter Amateur bands. Monitoring these networks indicates that they are international in scope with stations located on land as well as aboard vessels at sea. It would seem that the equipment used is Amateur Radio type gear.

As you can see, there may be far more going on over the various frequencies which can be tuned on a communications receiver and a scanner than you may be aware, even on frequencies not covered here. If you tune around the listen carefully, who knows what you might hear?

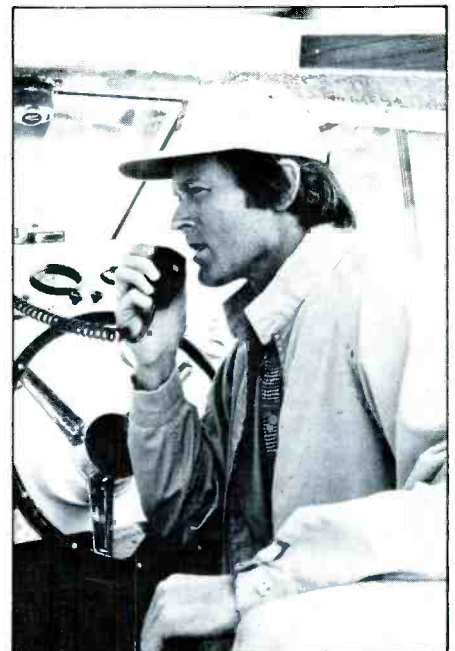

Not all transmissions you can monitor on HF and VHF maritime frequencies are really what they seem. Such frequencies are frequently ripped off for various and sundry purposes by persons having nothing whatsoever to do with maritime operations!



The Top Ten Toughest Targets

BY GERRY L. DEXTER

If you were to ask a hundred shortwave broadcast DXers to make up lists of the ten hardest-to-hear countries, it's pretty certain the stack of lists handed to you would contain no two alike! What's hard to hear in one part of the country may be much harder in another. Or perhaps the DXer "got lucky," so a country that is on one person's list isn't on another's.

And actually, some of the "countries" on our POP COMM list aren't really countries at all! However, many shortwave broadcast DX country lists divide up certain countries and create extra countries based on such things as geographical separation from the main political unit, history, and so on. That, however, is an entirely different story. And a very long one! Our POP COMM list uses the shortwave country list of the North American Shortwave Association.

If we were to take the title of this article literally, then countries would not be the main game because there are many shortwave stations in places like Bolivia, Peru, India, Burma, China, Zaire, and others which are far harder to log than many of the countries on our list. However, we are conceding to the DXers fixation on countries, in part because the situation with stations changes much more often.

Before we run down the list though, a few words of caution. If you're new to the exciting and challenging game of shortwave broadcast DXing, we recommend you take pains to what DXers call the "Magic Box" school of DXing. The Magic Box theory maintains that if there's but one chance in a million of hearing a station, and if we're dealing with natural forces (i.e. the ionosphere) where anything can happen—then why not me? No really knowledgeable DXer believes this. It just doesn't happen that way. You have to know what is and what isn't possible. You have to be familiar with the sounds of stations from various areas of the



NATIONAL

BROADCASTING

COMMISSION of Papua New Guinea

Phone 941337 Cables Natbroadcast Telex:

Our Ref: JG:IT.

Radio New Ireland, Date: 9/2/77
P.O. Box 140,
Kavieng,
New Ireland Province, P.N.G.

Gerry L. Dexter,
RR4, Box 80 - D,
Lake Geneva, WI 53147,
U.S.A.

Dear Sir,

Thank you very much indeed for your letter of the 25th. September, 1976 received at this office or Radio Station on the 4th/10/1976.

It was with great pleasure to having received from you as someone who is in such far out distance that can able to pick out the reception of this Radio Station.

However in verifying your report against the programme which was put out by this Station at the time of your listening, we have found that you had listened straight at the time the Station was on its opening of broadcast at the time and those talks we believe you have heard was made by a male announcer when presenting various classical or vocal musics. Your listening time was between 1730pm and 1742pm P.N.G. Times. And as you have correctly reported, this Station does operate at the frequency of 2.428 MHz in the 120 meter band with a transmitter powered only at 2,000 KW.

Our broadcast times has now been slightly changed, so we now operate for 3½ hours in the mornings and 6 hrs in the night. We serve a total population of about 65,000 people in this province.

We now hope that this letter has been of some benefit to your report.

With thanks and regards,

Yours sincerely,

I. TSIKA
for The Manager.

QSL from Radio New Ireland, part of the National Broadcasting Commission of Papua/
New Guinea. Note the head-scratching third paragraph.

ON MALDIVIAN GOVERNMENT SERVICE

Ref: L:14/1:54/73:FM



not left
Stops
with

MALE
R 2300

Mr. Gerry L. Dexter,
Rt. 1, Maple Road,
Lake Geneva, Wisconsin, 53147,
UNITED STATES OF AMERICA.

Department of Information and Broadcasting,
Male', Republic of Maldives.



It's a lucky DXer who finds an envelope like this in his mailbox.

world, know a little about propagation and a dozen other factors. In short, be very careful and very, very sure before claiming to have heard any station that's out of the ordinary.

Now, here comes a pretty lady with our first envelope of the evening . . .

Djibouti

Formerly Afars, Issa, and French Somaliland, Radio Djibouti is one of the easiest on our challenge list. But it's still plenty tough! It takes good conditions to Africa to bag this one on their frequency of 4.780 MHz around their listed 0300 GMT sign on. There are Latin American broadcasters on and near the frequency too. Although log-gable with effort and patience, Radio Djibouti is not reported often. Languages used include French, Arabic, and Somali. The *World Radio TV Handbook* indicates plans to go to 20 kilowatts of power. If and when that happens, Radio Djibouti's exclusive status will have to be reviewed.

New Ireland

Actually, New Ireland, to which we're assigning the number nine spot, is actually part of Papua/New Guinea. It's probably a toss-up whether the station, Radio New Ireland, is easier to hear now than it was a year ago. It was a tough task when the station operated in the 120 Meter band and depended on very good conditions. However, the station has recently moved to 3.905 MHz so propagation is not the paramount factor it was before. But, it's a questionable trade-off since the station must now break through continuous and heavy Amateur Radio interference to be heard. Listen for it around sunrise, especially in the spring and fall. Radio New Ireland is one of the National Broadcasting Commission stations of Papua/New Guinea. West Coast DXers will have a much easier shot at Radio New Ireland which runs to 1300 GMT.

Zanzibar

Although actually a part of Tanzania, many shortwave country lists have Zanzibar listed as a separate country as, indeed, it

once was. Experienced DXers well remember the long battle to get a verification from Radio Tanzania-Zanzibar and the infamous Omar M. Omar, who was always promising but never delivering! Reception of Radio Tanzania-Zanzibar requires very good African conditions. Your best bet is to try 3.339 MHz at 0330 and try to catch the station signing on. Signals probably will not hold up very long, usually fading after 20 minutes.

Comoro Islands

Ranking seventh is Radio Comoro, which can occasionally be heard during superior African conditions around their sign on time of 0300 GMT on 3.331 MHz. Unfortunately, the Canadian time station, CHU, occupies a spot just 1 kHz below the Comoro frequency, making for a great deal of interference. Some DXers have also heard the station on 7.260 where it operates from 0300-1500 but, again, this is an extremely rare occurrence.

Scotland

A newcomer to the shortwave DX hobby might be surprised to find a well-known Eur-

opean spot on a list such as this. Scotland lacks any government or other "normal" shortwave broadcast station. A pirate broadcaster, Weekend Music Radio, does provide a slim opportunity to log Scotland, at least as long as the Scottish authorities allow it to continue to operate. West Coast people have the advantage on Radio New Ireland but East Coast DXers are in a better position to hear Weekend Music Radio. Power is a mere 50 watts, but it has been heard in the United States. The station operates on 6.260 MHz but can also use 6.250 or 6.290. They have kindly scheduled some test broadcasts to North America during the past two DX seasons, a practice we hope will continue! The station is on the air Sunday mornings, so try around (yawn!) 0800 or 0900 GMT.

Hong Kong

Some years ago, Radio Hong Kong was a station one could try for every morning until it was heard. Not so today! The shortwave outlet was taken off the air for a few years. Then, two years ago, it miraculously reappeared—for about ten days! As it turns out, Radio Hong Kong now makes a practice of returning to shortwave to provide weather and other information for the South China Sea Races which occur in April—every other year! You guessed it. They were on in 1982 so you're out of luck until April, 1984. When that time arrives, try 3940 or a little higher around 1100 GMT. Don't forget now!

Falkland Islands/ Malvinas Islands

The Falkland Islands Broadcasting Service has long stirred things in every serious DXer's heart—far away, lonely, romantic. It's in English and it's possible. Disturbed geomagnetic conditions will sometimes enhance the possibilities, especially now while sunspot activity is still high. The station's traditional schedule ran until 0130 GMT on

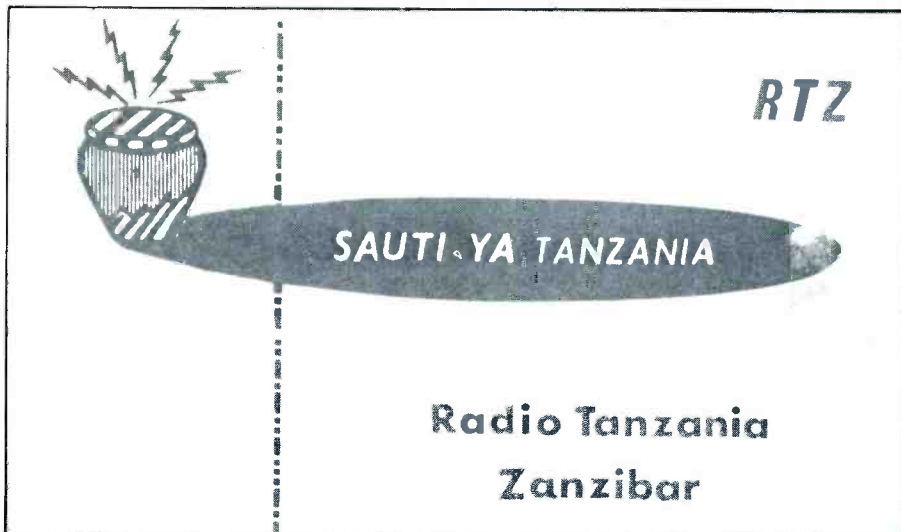

After many years of effort, Radio Tanzania at Zanzibar began replying with QSLs instead of promises.

THE
FALKLAND ISLANDS BROADCASTING
STATION

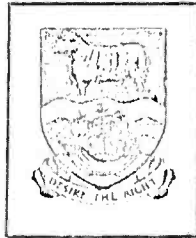

2370 kHz

QSL GERRY H. DEXTER

No. 5

Michael J. Kern
BROADCAST SECRETARY

The much-sought Falkland Islands QSL.

been a common spot for the Voice of Maldives in the past at their 1200 GMT sign on. Unusual propagation conditions have also resulted in a handful of loggings on this frequency at 0030 GMT in the dead of winter. Watch our shortwave column and, hopefully, we'll bring you news of the return of the Voice of Maldives.

Bhutan

This tiny Himalayan kingdom has been represented on the shortwave bands for a number of years but it remains just a tantalizing dream log for all but a few Asian DXers. Radio NYAB (operated by the National Youth Association of Bhutan) uses just 300 watts! Although listed for 4.690 MHz it is reported by Asian DXers as currently varying widely around 4.600. To make things even more interesting, the schedule is very limited—Wednesdays and Fridays from 1100-1400 GMT on 4 MHz and from 0600-0900 on Sundays on 7.040 MHz. Other than a "tentative" logging or two from California, U.S. listeners have drawn a blank on it!

Tristan da Cunha

Number One! The toughest! Remember the political thriller "Vanished"? Well, Tristan was where they all vanished to! Tristan da Cunha would probably get most everybody's vote as the most difficult catch of them all. In fact, aside from a DXpedition by

2.370 MHz. An FIBS QSL is a prized one in any collection!

Maldiv Islands

If you don't live in Asia or California you have to be very smart and very lucky to come up with this Indian Ocean broadcast. The Voice of Maldives runs the highest power on our list, but still ranks as an ex-

remely difficult catch. And currently the station isn't even on shortwave! Except for the local medium wave outlets, activity from this station ceased some months back. It is reported this is due to an upgrading project and that the Voice of Maldives will return with higher power and an "International Service." We don't know what the schedules and frequencies will be, but 4.754 has

Twelve times each year 64,128 active Amateurs get a taste of a different kind of Amateur Radio magazine . . . one that they read cover to cover . . . and they enjoy. It's more than just a magazine. It's an institution.



The Radio Amateur's Journal
76 North Broadway
Hicksville, NY 11801

SUBSCRIBE TODAY!

Please send me CQ for Life 3 Years 2 Years 1 Year
This is a Renewal New Subscription Starting With _____ Issue.

Name _____ Call _____
Street _____
City _____ State _____ Zip _____

Rates (check one)

	USA	VE/XE	Foreign
<input type="checkbox"/> Life Sub	\$280	—	—
<input type="checkbox"/> 3 Years	\$ 36	\$42	\$48
<input type="checkbox"/> 2 Years	\$ 25	\$29	\$33
<input type="checkbox"/> 1 Year	\$ 14	\$16	\$18

Paid by: Check Money Order

Master Charge

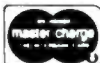

VISA



Account Number

--	--	--	--



MS/78

OFFICE DE RADIODIFFUSION-TELEVISION FRANÇAISE

Station des Comores

CNC 2/980/71

Moroni, le 8 Octobre 1971

Le chef d'Établissement
de l'ORTF aux ComoresMonsieur Gerry I. Dexter
Rt. 1, Maple Rd.
Lake Geneva,
Wisconsin 53147
U.S.A.

Cher Monsieur,

Comme suite à votre rapport d'écoute, j'ai le plaisir
de vous confirmer que vous avez bien reçu la Station de Moroni les
14, 15 et 16 Septembre 1971.Je vous prie de croire, Cher Monsieur,
à l'assurance de mes sentiments distingués.

M. Satti

Le Chef d'Établissement

A brief verification letter from RTF-Comoro Islands. The station is just called Radio Comoro now.

a couple of South African DXers who were operating from the African coast a number of years ago, we don't think this station has ever been heard outside the island itself except for perhaps an occasional passing ship! But, if you like to think big, try 3.290 around their listed sign off of 2205 Sundays, Wednesdays, and Fridays. The band will not be "open," though. For some years the World

Radio TV Handbook has indicated the station plans to add a 1 kilowatt transmitter, but it seems unlikely this will happen or make any difference if it did! Meantime, power is a miniscule 40 watts!

So, there you have the POP' COMM Top Ten Toughest. If you log half of them you're doing exceptionally well. If you log them all—pinch yourself! You've been dreaming!

POPCOMM's Top Ten Toughest Targets

Rank	Country	Station	Frequency	Best Time (GMT)
1	Tristan da Cunha	ZOE Tristan Radio	3.290	2200 Su/W/F
2	Bhutan	Radio NYAB	4.600v	1100-1400 W/F
3	Maldives Is.	Voice of Maldives	4.754	1200
4	Falkland Is.	FIBS	2.370	0100
5	Hong Kong	Radio Hong Kong	3.940v	1100 (April/84)
6	Scotland	Weekend Music Radio	6.260	0900 Sundays
7	Comoro Is.	Radio Comoro	3.331	0300
8	Zanzibar	RT-Zanzibar	3.339	0330
9	New Ireland	R. New Ireland	3.905	1100-1300
10	Djibouti	R. Djibouti	4.780	0300/0400

v = variable frequency
Su = SundaysW = Wednesdays
F = Fridays

MFJ SHORTWAVE ACCESSORIES

NEW Indoor Tuned Active Antenna. Rivals, can even exceed reception of outside long wire.

Rivals long wires

\$79⁹⁵



MFJ-1020 NEW INDOOR ACTIVE ANTENNA sits on your desk ready to listen to the world. Rivals, can often exceed, reception of outside long wire. Unique Tuned Active Antenna minimizes intermod, provides RF selectivity, reduces noise outside tuned band. Also use as preselector for external antenna. Covers 300 KHz to 30 MHz in five bands. Adjustable telescoping antenna. Controls: Tune, Band Selector, Gain, On-Off/Bypass, LED, FET, bipolar circuitry. Phono jack for external ant. 6x2x6 inches. 9-12 VDC or 9 V battery for portable use. 110 VAC with optional AC adapter, \$9.95.



\$99⁹⁵

MFJ-1040 RECEIVER PRESELECTOR. Improves weak signal reception, rejects out-of-band signals, reduces image response. 1.8 to 54 MHz. Up to 20 db gain. Low noise MOSFET. Gain control. Bandswitch. Can use 2 ant., 2 rcvrs. ON-OFF/Bypass. 20 db attenuator. LED. Coax, phono jacks. 8x2x6 in. Also for XCVRS to 350 watts input. Auto bypass. Delay control. PTT jack. **MFJ-1045, \$69.95.** Same as MFJ-1040, less attenuator, xcvr auto bypass, delay control. PTT. Use 1 ant., 1 rcvr. 5x2x6 in. 9V bat. Both requires 9-18 VDC or 110 VAC with optional AC adapter, \$9.95.

\$99⁹⁵



MOBILE SWL CONVERTERS to hear the shortwave world while you drive. **MFJ-304** (\$79.95) covers 19, 25, 31, 49 meter bands. **MFJ-308** (\$99.95) adds 13, 16, 41, 60 meters. Two dual-gate MOSFETS give excellent sensitivity, selectivity with car receiver. Push button band selector. Tune with car radio. Plugs between antenna and radio. 12 VDC. **304** is 5 1/4 x 1 1/4 x 4 1/4". **308** is 6 1/4 x 1 1/4 x 5 1/4". **Free catalog.**

MFJ-10, 3 foot coax with connectors, \$4.95.

Order from MFJ and try it. If not delighted, return within 30 days for refund (less shipping).

One year unconditional guarantee.

Order yours today. Call toll free 800-647-1800. Charge VISA, MC. Or mail check, money order. Add \$4.00 each for shipping and handling.

CALL TOLL FREE ... 800-647-1800

Call 601-323-5869 for technical information, order/repair status. Also call 601-323-5869 outside continental USA and in Mississippi.

MFJ ENTERPRISES, INCORPORATED
Box 494, Mississippi State, MS 39762

CIRCLE 15 ON READER SERVICE CARD



PRODUCT SPOTLIGHT

AEA MBA-RO Code Reader

The AEA MBA (Morse-Baudot-ASCII)-RO (Reader Only) is a complete multi-code decoder and display unit that is all you need (other than a 12VDC source) to copy Morse and RTTY signals directly from your communications receiver. With the MBA Reader™, it is possible to tune in amateur, weather, and news broadcasts that are sent in Morse Code, Baudot, or ASCII (American Standard Computer Information Interchange) radioteletype. The MBA-RO is ideal for SWLs, Hams, operators striving for higher code speeds, and for monitoring news or weather broadcasts—even while out at sea.

The MBA Reader contains a built-in 32 character vacuum fluorescent display that presents any copied message moving from right to left across the display window. Large blue characters allow for minimum eye fatigue after long periods of viewing. There are no noisy mechanical parts to wear out or break down. There is also no requirement for a roll of teletype paper that can eventually cause a mess in the operating room. Important messages can be recorded on a standard tape recorder for future reference.

Nothing (economically) can match the interpretive skills of the human brain that has been trained in the art of Morse code copying, and no electronic Morse code reader can match the ability of a skilled CW operator when copying at or near the noise level.

However, the MBA Reader's computer can make optimized dot, dash, and spacing decisions better than most other readers, and when copying at or near the noise level the MBA-RO excels when compared to other much more expensive machines. The MBA Reader will also copy Morse code at speeds higher than has ever been recorded by a human operator.

A tremendous advantage offered by the MBA-RO is the opportunity for post-copy editing, thanks to the 32 character display. This is particularly useful in reading long, complex sentences. This becomes evident during high speed CW copy or for RTTY (especially 110 Baud ASCII) monitoring. With a 32 character display, even 100 wpm RTTY is a snap to read.

The MBA-RO comes with a built-in inverter power supply that allows for portable operation from a 12VDC power source. An optional UL approved AC power adaptor, AEA model AC-1, is also available for operation from 117VAC. The MBA Reader power input circuit is protected against inadvertent reverse polarization of the input power leads. A rugged compact metal package is designed for minimum R.F. radiation or susceptibility problems.

The MBA-RO uses the receiver audio output with no special modifications necessary. Any standard output impedance will drive the MBA Reader, and a TTL level or

switch closure (hand key or keyer) will likewise do the job. The unit is simple to hook-up and simple to use, no bulky CRT or printer is required. The few (three) controls, which are all well marked and self-explanatory, are located on the front panel.

Morse code (CW) signals are enhanced by a built-in 100 Hz wide filter centered on 800 Hz. Tuning is made easy with an LED tuning indicator. The filter can be switched out for copying a signal that is drifting, or for operating at a different tone pitch when using the receiver's own filter.

Dual mark and space RTTY filters are provided in order to achieve the inherent noise rejection advantages of RTTY operation. The narrow shift filters are factory tuned for 170 Hz shift (used in most amateur transmissions) while the wide shift filters are factory tuned for 425 Hz shifts (used in most news broadcasts). They can be easily tuned in the field for any other shift desired.

In RTTY operation, the CW filter position can be used instead of the RTTY positions to tune only the space frequency for various frequency shift signals. This is the only mode offered by some competitors. It has the advantage of flexibility in tuning different frequency shift signals, but the disadvantage of much less noise immunity!

An adjustable CW and RTTY threshold control with a dual LED tuning indicator will drive the MBA Reader, and a TTL level or

tor's ability to copy signals close to the noise. An automatic speed indication can be switch selected. The speed appears in the four right most characters of the display and thus reduces the message display to 28 possible characters when it is selected.

There is no need to select a CW speed operation range. The MBA-RO has an exclusive automatic speed tracking feature that will follow the most drastic speed changes, as are encountered when normally tuning across the band. This feature makes receiver frequency tuning easier because you do not have to be concerned that the computer is still trying to "catch-up" to the new speed while tuning.

The MBA Reader will decode all standard Morse characters. This includes all punctuation, special (double letter) characters, and many European non-English letters.

All MBA Readers are subjected to a 48 hour burn-in at 120 degrees F to catch solid state infant mortality failures before they leave the factory.

All sales of AEA products are handled through a network of dealers throughout the U.S. and much of Europe. AEA does not sell direct with the exception of sub-unit parts. If you would like a free demonstration of the MBA-RO (or any other AEA product) see your local AEA dealer. AEA would be pleased to send you a list of dealers, upon request. Their address is: P.O. Box 2160, Lynnwood, WA 98036.

Specifications

Display: Blue 32 character vacuum fluorescent with 0.29 inch high 14 segment characters.

Modes: Morse Code, Baudot RTTY, ASCII RTTY.

Speed: Automatically tracks Morse code from 3 wpm to 99 wpm. Baudot RTTY speeds are: 60 wpm, 67 wpm, 75 wpm, and 100 wpm. ASCII RTTY SPEED: 110 Baud.

Filtering: 100 Hz CW filter centered at approximately 800 Hz. Narrow shift dual RTTY filter factory tuned to 970 Hz and 800 Hz (170 Hz shift). Wide shift dual RTTY filter factory tuned to 1225 Hz and 800 Hz (425 Hz shift). RTTY filters can be easily tuned for other desired shifts. Changing capacitors will allow for tuning higher frequency AFSK tones.

CW filter position can be used in RTTY mode for tuning space frequency only, to copy unusual frequency shift transmissions, but without the noise immunity advantage of the normal narrow and wide shift dual filter positions. All filters can be switched out, which can be particularly useful if a center frequency other than 800 Hz is desired.

Input Impedance: Will work with virtually any receiver or audio output amplifier impedance.

Integrated Circuits: 17 plus one micro-computer.

Power Requirement: 13 VDC \pm 2 VDC at 500 ma.

Dimensions: 8 $\frac{3}{4}$ " \times 5 $\frac{1}{8}$ " \times 2".

Net Weight: Approximately 2 lbs.

Your own satellite TV system for \$2,586.⁰⁰ 10 FT. PARABOLIC

What the system will do:

You can receive up to 60 channels of T.V. direct from satellites to your home receiver. Movies, sporting events, religious programs, other T.V. stations, and much more.

What the system includes:

1. 10 ft. fiberglass dish made of reflective metal bond with fiberglass. Weather-resistant and virtually maintenance-free. Dish comes in 4 sections.
2. Single pedestal heavy duty polar mount for extra strength and installation simplicity; easy satellite to satellite adjustment.
3. Four pole rotator mount for more stability, square tube legs and rotator included.
4. All aluminum LNA mount and horn holder for accurate aiming of LNA. All aluminum, weather-proof LNA cover.
5. Drake ESR-24 Receiver or Auto-Tech Receiver. Your choice. Down converter located at the dish.
6. Amplica or Avantek LNA 120°.
7. Chapparel Feed Horn for unsurpassed quality.
8. All accessories included.

Complete Systems, Receivers,
Antennas, LNA's & Accessories
CALL US TODAY! 901-795-4504

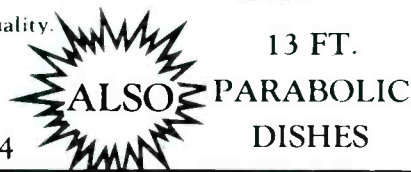

TENNESSEE ELECTRONICS
— P.O. BOX 181108 —
MEMPHIS, TENNESSEE 38118

CIRCLE 21 ON READER SERVICE CARD

Imagine What Moving Every Two Years Would Do to Your Family

Imagine moving for the second time in four years. To a city whose name you can't pronounce. In a country you never even heard of.

And you've got to tell your little boy, he can't bring his hamster. And your little girl, she can't bring her friends. While you tell yourself, "Be brave."

When you're the wife of someone in the service, that fantasy is a reality. And sometimes, it's hard to handle the loneliness alone.

At the USO we help the service family both stateside and overseas with learning their new community with informal classes and with assistance on any kind of problem. We try to make moving away from home a little bit more like moving home.

Support USO through the United Way, OCFC, or local USO campaign or send a tax-deductible contribution to USO, Box 1982, Washington, D.C. 20013.

RADAR REFLECTIONS

RADAR DETECTORS AND THEIR USE



Officer Is Sentenced For Falsified Radar Log

Vernon R. Nutting, a former Medford, WI police officer, was sentenced to 60 days in the Taylor County jail with Huber Law Privileges in connection with charges stemming from a falsified radar log. Nutting, 45, was originally charged with lying under oath, but a special prosecutor agreed to reduce the charge if Nutting agreed to a guilty plea.

The complaint against Nutting was filed after he testified in court that a radar log he presented in a speeding trial was the same log he had filled out the day of an offense. The complaint filed against the officer stated that he later told a Medford Detective and a Taylor County Chief Deputy that he had been unable to find the original radar log and made up a copy before going into court.

In imposing the sentence, Clark County Circuit Judge Michael Brennan said a jail sentence was necessary because of the tremendous amount of paranoia among the public concerning radar guns and logs. He said that traffic cases are based entirely on an officer's credibility and the public must have faith in the system. Nutting's attorney said Nutting created the second radar log because he thought he was doing his duty.

New Bill Would Eliminate Oklahoma Trooper Look-Alikes

The Oklahoma House passed a bill that would end a practice in some small towns in which local officials try to disguise themselves as Highway Patrol troopers to catch

speeding offenders. The bill by Rep. Don Mentzer was approved recently and sent to the Senate.

Mentzer said in certain small towns where an interstate highway is included in the city limits, the local officials "have bought a police car, painted it black and white, and put a state map on the door." When the local officers stop a traffic offender, they accept cash fines on the spot. "We don't allow troopers or anybody else to accept cash" for traffic tickets, said Mentzer, a former Highway Patrol trooper.

He also said that local officers have been known to threaten the speeders with jail if they don't pay their tickets immediately. The bill says that the Highway Patrol shall be the primary law enforcement authority on interstate highways, state highways, and U.S. highways.

Youth Beats Speeding Ticket

At 17, Jeffrey Kowalchuk may be the youngest defendant around to beat a traffic charge while acting as his own lawyer in a trial. Circuit Judge Neal Nettesheim (Waukesha, WI) agreed that enough doubt was created about the operation of a radar unit to dismiss a speeding charge against the youth. The judge said, "I told him he did a nice job defending himself. I also told him he ought to go to law school."

Kowalchuk and another driver were pulled over and issued speeding citations by Officer Gary Frea. Frea claimed he clocked both cars at 47 mph in a 25 mph zone. The other driver admitted guilt but Kowalchuk

contended he wasn't speeding. At his trial, the officer testified that both cars were in perfect alignment, but the judge doubted that. Dismissal of the case saved Kowalchuk a \$74.20 fine and court costs.

New York Engineer Estimates Loss Of \$3000 In Fighting Radar Ticket

Milton Zohn claims he may have spent \$3,000 in lost time, plane fares, hotel bills, and other expenses settling a recent speeding ticket in Dansville, New York. After about two hours of tussling in court, he could also add \$60 in court costs to that figure. That's how much Justice John Weidman fined him for going 70 in a 55 mph zone. Zohn, a 44-year-old electrical engineer employed at Kennedy Space Center, flew to Dansville twice on combined business/traffic ticket business.

Some interesting areas of the trial: Zohn: "I design radar for a living." Assistant District Attorney James Coniglio: "Objection, your honor. There has been no foundation for the competency of this witness." Justice Weidman: "I'll agree with that."

Zohn never was able to challenge the competency of the radar operator because of the constant objections raised by Coniglio. Zohn, having trouble picking his way through the objections, said that he was going only 52 and that Wright didn't operate the radar properly. State Trooper Wright said that he had checked his radar and found it accurate before going out on patrol. The case is currently on appeal to the Livingston County Court.

Wisconsin Legislation To Eliminate Radar Reading As Primary Evidence

Legislation which would eliminate a radar reading as primary evidence of speeding would have disastrous effects on Wisconsin's counties and school districts, according to a Wisconsin State Patrol representative. Mike Moschkau, director of the Bureau of Inspection, told the Assembly Highways Committee counties and school districts could lose as much as \$5.5 million in revenues if radar use is curtailed.

The legislation, introduced by Rep. Edward Jackamonis, would still allow a radar reading to be used in the prosecution of a motorist picked up for speeding, but the reading could not be used as primary proof of speeding. Currently, radar can be used as primary evidence to support a speeding conviction if the prosecution establishes five

facts relating to the radar device and its use. Included in that criteria, set forth in a 1978 Wisconsin Supreme Court case (Hanson), is proof that the radar device is accurate.

Moschkau said one of the problems involved in radar use is that readings may vary slightly. But he said many courts are reluctant to accept speeding cases in which drivers are clocked at less than 63 or 64 mph.

Virginia Enforces Sale Statute

Virginia state police recently charged two Norfolk men with the sale of radar detectors. John Willey Mack, president of J M Security and Sound, and Raymond E. Lassiter were recently arrested after they allegedly sold radar detectors to undercover investigators. Lassiter was released from Norfolk City Jail after posting a \$250 bond. Mack was issued a summons.

Police said they were alerted by newspaper advertisements offering the devices for sale. Of course, Electrolert, Inc. is still fighting this battle in Federal Court, but until a solid decision is handed down, the sale and use of the detectors are still considered illegal in the state.

FCC Questions Radar Guns Use

Hundreds of radar guns used by Missouri police and numerous other police units across the country may be illegal. This is due to changes made without government approval, a Federal Communications Commission official said.

The FCC is investigating a Colorado company which has sold 650 radar units to the Missouri Highway Patrol and more to police departments in the state, according to Charles M. Cobbs. Cobbs, division chief of the FCC's Equipment Authorization Bureau in Washington, said the company may have changed its radar without federal approval. The company received a certification from the FCC in 1974, but it has manufactured five additional models while using the same certification.

Ralph Biele, of the Missouri Highway Patrol, said the FCC had approved the units in 1978. The Highway Patrol issued almost 200,000 speeding tickets in 1981 using radar units. Fines for those tickets totaled almost \$8 million.

"As far as we know, we are okay," Biele said. "But if it turns out that the units are not accepted, then I guess we'll just have to go from there."

Biele said the MHP's purchase order required FCC approval for the radar units. Records uncovered by the Missouri Network commentator Kent Malinowski indicate the antenna size, operating current, and several operating features have been changed since the 1974 certification.

"The question is, have they changed the product from the time we examined it to the time it's now being marketed and sold,"

Cobbs said. "He is not allowed to make any changes in the product unless the change is approved prior to it being instituted in the production line. The company says it has made only minor changes in the radar unit which do not affect the FCC certification.

A spokesman said the company was not aware of an FCC investigation. Cobbs said the FCC sent a letter requesting a radar model for evaluation.

Cobbs said selling uncertified equipment was technically illegal. However, it is believed the FCC will probably allow the company to relabel or recall units that are not properly certified.

Unlicensed Radar Endangers Speeding Prosecutions

The expiration of the radar licenses means trouble for speeding convictions according to Ed Hummers, a Washington communications law specialist who has done extensive work in the police radar field. Mr. Hummers recently said that he has seen courts dismiss traffic violations when police have used either unlicensed equipment or uncertified equipment. "No jurisdiction, no government agency, no individual may use unlicensed equipment, no matter what the purpose of that equipment," Hummers said.

The following counties in the state of Missouri have bought radar guns but have not licensed them: Atchison, Barry, Callaway, Camden, Cape Girardeau, Christian, Dent, Howell, Madison, Marion, Montgomery, Ozark, Polk, Ray, St. Genevieve, Shelby, Stone, and Taney.

Counties which have licenses for only some of their equipment: Butler, Dade, Jasper, Macon, Modaway, Pike, Platt, and St. Charles.

Counties with expired licenses: Cole, Greene, and Putnam.

Cities which have bought radar guns but have not licensed them: Albany, Bella Villa, Burnham, Clinton, Crystal City, Eureka, Hawk Point, Hayti, Independence, Jennings, New Bloomfield, O'Fallon, Osage Beach, St. Peters, Stockton, Vinta Park, and Warrenton.

Cities which have licenses for only some of their equipment: Blue Springs, Cabool, Monett, Sugar Creek, Sunset Hills, Town, and Country.

Cities with expired licenses: Advance, Cartersville, Caruthersville, Elvins, Fenton, Festus, Flat River, Freeburg, Glenaire, Hannibal, Kahoka, Lakeland Twp., Lathrop, Licking, Malta Bend, Monroe City, Marshall, Missoula, Morehouse, Montrose, Mountain Grove, Mountain View, New Franklin, Normandy, Olympia Village, Pagedale, Parma, Richland, Riverside, Rock Hill, St. Martin's Sedalia, Slater, Stanberry, Sturgeon, Taos, Troy, University City, Velda Village, Walnut Grove, and Wellsville.

The above information is compliments of the Missouri Network. Congratulations on a great job!



ARE YOU SERIOUS ABOUT POWER INDEPENDENCE?

We offer a complete, easy-to-install wind system that gives you up to 2000 watts of 110 volt electricity whenever you need it, independent of centralized electric power companies, oil, or gas, yet designed to be compatible with a variety of alternate energy sources.

For more information about the Windpower system and our money back guarantee, call us at 616/823-2682 or write:

Windpower Corp.
16341 E. 8 Mile Rd., Stanwood, MI 49346
616/823-2682

CIRCLE 48 ON READER SERVICE CARD

AMATEUR RADIO-SHORTWAVE-SCANNERS
COMMERCIAL-CB-MARINE
BOOKS-MAGAZINES SALES & SERVICE
New & Used Equipment
Tower & Antenna Installation & Repair
(716) 668-8873



DX COMMUNICATIONS
3214 Transit Road
West Seneca, N.Y. 14224

CIRCLE 53 ON READER SERVICE CARD

CABLE TV CONVERTERS DESCRAMBLERS

BUY DIRECT & SAVE

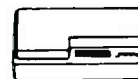

40 CHANNEL CONVERTER
\$38 Regular \$69

AMATEUR MICROWAVE ANTENNA

- Microwave Parabolic Antenna
- 26 DB Gain
- Advanced Down Converter
- Power Supply Included
- Low-Loss Coaxial Cables
- Complete-Ready to Install

\$119 Elsewhere \$289

Send \$2 for Complete Catalog
Quantity Discount • VISA • COD



VIDEO RESEARCH PO BOX 19462

LOUISVILLE, KY 40219
For Orders Only 800-626-5533
For Information 502-969-1810

CIRCLE 47 ON READER SERVICE CARD

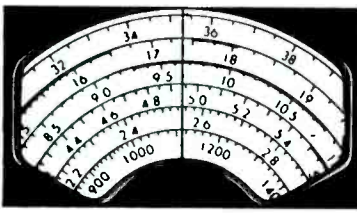

COMMUNICATIONS CONFIDENTIAL

YOUR GUIDE TO SHORTWAVE "UTILITY" STATIONS

Major Shift In International Aero Frequencies



A major switch will be taking place involving international airline frequencies.

Anybody owning a communications receiver has undoubtedly had occasion to tune across one of the many frequencies used for international aircraft enroute communications. On these frequencies can be heard an endless stream of contacts between airliners and ground stations located throughout the world. It's a DX festival *par excellence*, with planes from exotic and little-known foreign airline companies communicating with ground stations in virtually every nation. Of course the major well-known international airlines' aircraft can be monitored, too. Communications are in English, and by sitting on a frequency and monitoring it for a while, you can most likely tune in on stations in a number of countries you had previously monitored. Many people have actively sought QSLs from these stations and have been rewarded verifications from countries which are difficult to catch on broadcast or ham bands.

The problem is that every once in a while the frequencies used for these fascinating communications get jumbled around—new ones are added, old ones are discontinued. In a major shuffle which has been going on of late, a 2-stage changeover to many new frequencies is in progress, with the smoke fi-

nally planning to settle down (at least for the time being) on 1 February 1983.

Communications Confidential has compiled a directory of the existing frequencies used on the international aeronautical routes showing, for reference, the new replacement channels which will be used commencing 1 February 1983. Note that the lower frequencies (2-6 MHz bands) are primarily suited to nighttime DX (nighttime at your location, that is), while frequencies above 17 MHz are better during daylight hours at your location.

Throughout Alaska

Present use: 2861, 3411, 4383.8, 4668, 4693 kHz.

New frequencies: 2866, 3449, 4383.8, 5472, 5490, 5631 kHz.

(Note that 4383.8 kHz is only for ground station emergency use.)

Central and Southeast Alaska

Present: 2875, 2924, 3481, 5547, 6568, 6617, 10041 kHz.

New: 2875, 2911, 3470, 5484, 6580, 6604, 8876, 11357 kHz.

Alaska Aleutian chain

Present: 2924, 3446, 6568, 10057, 11295, 11319 kHz.

New: 2911, 2956, 5496, 6580, 8855, 10066, 11363 kHz.

Central East Pacific

Present: 3001, 3467, 5554, 5603, 8843, 11282, 13300, 13336, 17904 kHz.

New: 2869, 3413, 4657, 5547, 5574, 6673, 8843, 10057, 11282, 13300, 17904 kHz.

Central West Pacific

Present: 2896, 4675, 5505, 6631, 8854, 11303, 13300, 17904 kHz.

New: 2998, 3455, 4666, 5652, 5661, 6532, 6562, 8903, 10081, 11384, 13300, 17904 kHz.

North Pacific

Present: 2910, 5589, 6655, 8938, 13300, 17904 kHz.

New: 2932, 5628, 6655, 6661, 10048, 11330, 13300, 17904 kHz.

South Pacific

Present: 2945, 5559, 5643, 8847, 11327, 13300, 17904 kHz.

New: 3467, 5559, 5643, 8867, 10084, 11327, 13300, 17904 kHz.

North Atlantic

Present: 2868, 2931, 2962, 2987, 5610, 5624, 5638, 5673, 8879, 8889, 8891, 8945, 11303, 13291, 13306, 17946 kHz.

New: 2872, 2899, 2962, 2971, 3016, 3476, 4675, 5598, 5616, 5649, 6622, 6628, 8825, 8831, 8864, 8879, 8891, 8906, 11279, 11309, 11336, 13291, 13306, 17946 kHz.

Europe

Present: 3479, 4689, 6582, 10084, 17941 kHz.

New: 3479, 5661, 6598, 10084, 13288, 17961 kHz.

South America

Present: 2889, 2910, 4696, 5582, 6666, 8847, 8826, 10096, 11360, 13297, 17907 kHz.

New: 2944, 3479, 4669, 5526, 6649, 8855, 10024, 10096, 11360, 13297, 17907 kHz.

South Atlantic

Present: 2875, 3432, 5565, 6610, 8882, 10049, 13344, 13357, 17955 kHz.

New: 2854, 2935, 3452, 5565, 6535, 8861, 11291, 13315, 13357, 17955 kHz.

Southeast Asia

Present: 2868, 2987, 5624, 5645, 5673, 8840, 8882, 11396, 13309, 13288, 17907 kHz.

New: 3470, 3485, 5649, 5655, 6556, 8942, 10066, 11396, 13309, 13318, 17907 kHz.

East Asia

Present: 2987, 5670, 5673, 8931, 11396, 13279, 13303, 13309, 17907 kHz.

New: 3016, 3485, 3491, 5655, 5670, 6571, 8897, 10042, 11396, 13297, 13303, 13309, 17907 kHz.

Middle East

Present: 3404, 3446, 5603, 6624, 8847, 10009, 13336, 17961 kHz.

New: 2944, 2992, 3467, 3473, 4669, 5667, 5658, 6625, 6631, 8918, 8951, 10018, 11375, 13288, 13312, 17961 kHz.

Africa

Present: 2868, 2917, 2966, 3411, 4682, 5484, 5491, 5498, 5505, 5519, 5540, 5659, 6589, 6638, 8826, 8903, 8924, 11300, 13304, 13336, 17961 kHz.

New: 2851, 2878, 3419, 3425, 3467, 4657, 5493, 5652, 5658, 6559, 6574, 6673, 8894, 8903, 11300, 11330, 13273, 13288, 13294, 17961 kHz.

Indian Ocean

Present: 3481, 5634, 8875, 13306, 17961 kHz.

New: 3476, 5634, 8879, 13306, 17961 kHz.

North Central Asia

Present: 3425, 3495, 6533, 6589, 6603, 10096, 13303 kHz.

New: 3004, 3019, 4678, 5646, 5664, 6592, 10096, 13303, 13315, 17958 kHz.

Caribbean

Present: 2952, 2966, 5550, 5568, 6540, 6561, 8840, 8959, 11387, 11396, 13297, 17907 kHz.

New: 2887, 3455, 5520, 5550, 6577, 6586, 8846, 8918, 11396, 11387, 13297, 17907 kHz.

The following channels are used by aircraft operating in support of offshore drilling operations in open water areas beyond the range of VHF:

Present: 2973, 4654 kHz.

New: 2878, 3019, 3434, 4672, 5463, 5508 kHz.

The following channels are designated for long distance operational control communications, providing for "the exercise of authority over the initiation, continuation, diversion, or termination of a flight affecting the safety of the aircraft and the regularity and efficiency of a flight." Amongst other uses, these frequencies are used for communications during a *skyjacking*, especially while the aircraft is in international air space:

Present: 6526, 10093, 13348, 17925, 21996 kHz.

New: 3013, 3494, 5529, 5538, 6637, 6640, 8933, 10033, 10075, 11342, 11348, 13330, 13348, 17925, 21964 kHz.

The following frequencies are used by flight test purposes on the condition that they are utilized only for emergency and backup use while the aircraft is beyond the range of VHF communications:

Present: 2868, 2994, 3474, 4675, 4682, 5469, 5596, 6559, 8917, 10009, 11287, 11375, 13312, 17965 kHz.

New: 2851, 3004, 3443, 5451, 5469, 5571, 6550, 8822, 10045, 11288, 11306, 13312, 17964, 21931 kHz.

Intercepts

MHz	Callsign	Location	Mode	GMT	Remarks
2.889	"Shannon"	Shannon, Rep. Ireland	SSB	0420	Aviation weather
3.039	IDR8	Rome, Italy	CW	0407	V-marker
4.221	GYU	Gibraltar (Royal Navy)	CW	0430	Callsign marker
4.235	YHM	Sorong, Indonesia	CW	0434	V-marker
4.252	GKC	Portishead, England	CW	0438	Callsign marker
4.263	FFP4	Ft. de France, Martinique	CW	0439	CQ
4.277	HKB	Barranquilla, Colombia	CW	0442	CQ
4.291	TIM	Limon, Costa Rica	CW	0444	CQ
4.670	—	?	AM	0217	"Spy Numbers" in Spanish
5.813	—	?	AM	0225	"Spy numbers" in Spanish
6.447	OXZ3	Lyngby, Denmark	CW	0227	CQ
6.463	FUM	Papeete, Tahiti	CW	0514	V-marker
6.464	HKB	Barranquilla, Colombia	CW	0229	CQ
6.500	KPH	Bolinas CA	CW	0230	V-marker
6.514	BRAVO 3 DELTA	?	SSB	1522	Working ECHO 1 XRAY
6.541	"Boyerros"	Havana, Cuba	SSB	0240	Working an aircraft
6.662	—	?	SSB	0248	QSO in Spanish
6.705	"6675"	Canadian military act.	SSB	0245	QSO Halifax RCAF
6.750	PAPA CHARLIE 02	aircraft	SSB	0258	QSO MacDill USAF
6.873	MATS 80224	aircraft	SSB	0259	QSO MacDill USAF
7.529	—	Greenville NC	SSB	0254	VOA feeder
7.544	—	?	AM	0525	"Spy numbers" in Spanish
7.544	NAM	Norfolk VA	CW	0537	CQ
8.090	—	?	CW	0230	"Spy numbers" 5-digit gps.
8.148	OVG	Frederickshaven, Denmark	CW	0307	Marker (Navy)
8.416	—	?	AM	0226	"Spy numbers" in Spanish
8.453	HWN	Paris, France (Navy)	CW	0357	Marker
8.465	NMN	Norfolk VA (USCG)	CW	0351	CQ
8.493	GYA	Whitehall, England	CW	0443	Marker (Royal Navy)
8.498	SAG	Goteburg, Sweden	CW	0449	Marker
8.552	CTP	Oeiras, Portugal	CW	0451	Marker (Navy)
8.574	HKC	Buenaventura, Colombia	CW	0457	Marker
8.694	4XO	Haifa, Israel	CW	0240	CQ
8.756	NMC	San Diego CA (USCG)	SSB	2240	Weather
8.868	VFG	Gander, Nfld.	SSB	0320	Weather
8.918	J3R	Grenada	CW	0250	V-marker
8.925	—	?	SSB	0255	"Spy numbers" in English
8.945	CLIPPER 191	PAA aircraft	SSB	0331	QSO Santa Maria, Azores
9.123	—	?	CW	0320	"Spy numbers" 5-digit gps.
9.973	—	?	AM	0310	"Spy numbers" in German
10.235	—	Greenville NC	SSB	0310	VOA feeder
10.457	—	Greenville NC	SSB	0315	VOA feeder
11.176	"Albrook"	Canal Zone	SSB	0335	QSO MATS aircraft
11.182	WIND 13	aircraft	SSB	1605	QSO Scott AFB
11.200	MVU	W. Drayton RAF	CW	0422	Marker
11.329	OVG8/12	Frederickshaven, Denmark	CW	0437	V-marker (Navy)
11.474	KKN44	Monrovia, Liberia	CW	0406	Marker (U.S. Embassy)
12.545	SXBH	M/V POHITI	CW	2042	Calling FFL
	ELTW	M/V IMA	CW	2045	Calling WCC
	A8SS	M/V CYS EXCELLENCE	CW	2047	Calling VCS
12.700	NMR	San Juan PR (USCG)	CW	0321	CQ
12.830	XFM	Manzanillo, Mexico	CW	0325	CQ
12.835	GKB2	Portishead, England	CW	0327	Callsign marker
12.989	LPD88	Gen. Pacheco, Argentina	CW	0330	Callsign marker
13.116	WOM	Miami FL	SSB	2010	QSO M/V MIZAWA
14.556	RIW	Khiva, USSR	CW	1915	QSO'ing several stations
16.463	—	Russian vessels	SSB	2159	QSO (in Russian)
16.466	SVMC	M/V KATIA	SSB	2157	QSO (in Greek)
16.491	—	Russian vessels	SSB	2202	QSO (in Russian)
16.540	—	Russian vessels	SSB	0205	QSO (in Russian)
16.723	6ZNJ	M/V CHRYSSI GOULANDRIS	CW	2214	Calling WCC
16.725	SXWG	M/V CORAL	CW	2217	Calling WSL
16.727	OUKV	M/V TUNISIAN REEFER	CW	2206	Calling KOK
16.745	ELBD	M/V ALTAJ	CW	2228	Calling DAN
16.779	OVXC	M/V DANA SIRENA	CW	2222	Calling WCC
17.175	CLS	Havana, Cuba	CW	2146	CQ
20.628	—	?	CW	1832	Repeating "GMN QTC 2"

This month's loggings submitted by Stewart MacKenzie, Ben Harkins, Richard Parton, Jack Younger, Travis Bickel, Eric Olthwaite, Tom Kneitel, and your columnist.

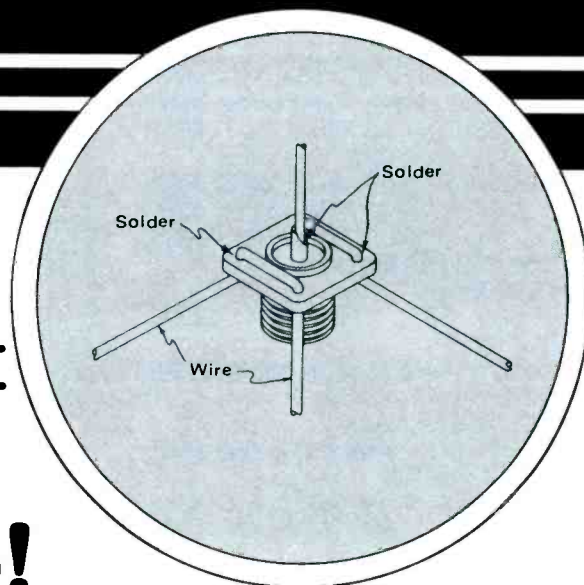
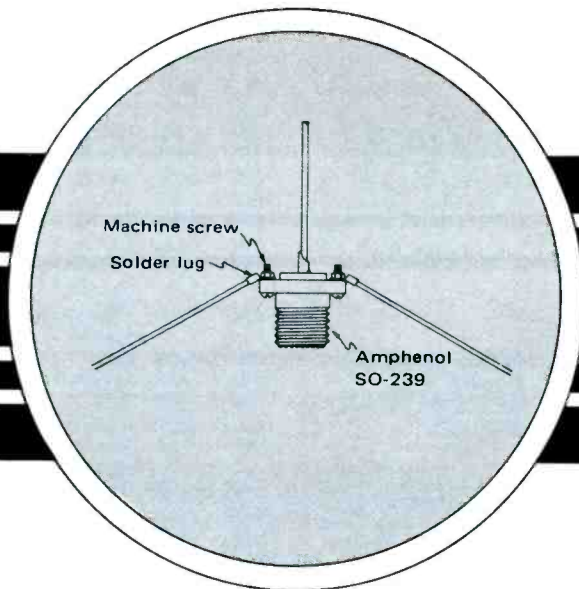

(Almost) Instant VHF/UHF Antenna – Cheap!

They All Laughed When I Sat Down To Listen To My Scanner

BY TONY EARLL, KNY2AE

I don't claim this to be the ultimate VHF antenna. It's not even close to that category. But it is one you could possibly put together from a couple of parts in your junk box. Even if you had to go out and buy everything new, the cost is next to nil. But the best part is that it's a quickie but efficient scanner antenna which can be pressed into service on little more than a moment's notice with very little bother. That makes it ideal for temporary or emergency applications—like your regular antenna coming down in a storm. It also features survivalist communications systems applications.

Although intended for scanner use, it could also be pressed into service for low power transmitting uses in a pinch. Sure it's funny looking, maybe even a tad scuzzy, but it does the job and will function reliably to suit your needs. Fact is, you really could use it as your basic main antenna if you didn't mind getting a couple of snide comments from friends and neighbors.

Essentially, it's a ground plane reduced to a rather primitive form and minus the polished appearance of commercial production methods. From an electrical standpoint, it's nevertheless a ground plane antenna.

Construction

It's as easy to assemble as a few solder connections or tightening four small nut and bolt combinations. That's really all there is to it. I wish I could impress you with my expertise in describing the complex design involved and the heroic efforts it took me to build one, but that's the whole story!

The secret ingredient is the SO-239 female coaxial cable socket which acts as the central point of the entire antenna. Decide what frequency you will primarily be monitoring and cut yourself some elements of the proper length. You'll need 1 "radiator" (vertical) element and 4 "ground" (drooping) elements. Experience has shown that while coat hangers may be used (no, Bunky, *not* wooden coat hangers) for these components, they are beasts to solder. I recommend that copperweld or any type of heavy wire be used for them. The antenna is versatile enough to be used throughout all communications frequencies from 110 MHz (low frequency end of the VHF aero band) right on through to 512 MHz (high frequency end of the UHF-T band). Using the measurements shown it should be quick work to

bring the antenna into tune with your frequency range of primary coverage, although for receiving purposes it's pretty broadbanded.

Element Cutting Measurements

Frequency	Radiator	Ground Radials
110 to 120 MHz	24"	26½"
120 to 130 MHz	22"	26½"
130 to 140 MHz	18¾"	26½"
146 MHz (2 Meter band)	17"	26½"
140 to 150 MHz	17¾"	26½"
150 to 160 MHz	15½"	26½"
160 to 174 MHz	14"	26½"
220 to 250 MHz	11½"	15"
250 to 300 MHz	9"	13"
300 to 340 MHz	7"	13"
340 to 360 MHz	6½"	12"
360 to 400 MHz	6"	11"
400 to 420 MHz	5½"	10"
420 to 450 MHz	5¼"	9"
450 to 470 MHz	5"	8½"
470 to 488 MHz	5"	7¾"
488 to 512 MHz	4¾"	7¾"

That's about as straightforward as you can

get; just match up your desired frequency and snip with a wire cutter! I should mention that if it's your intention to transmit with this antenna then it will require finer tuning (trimming) with the aid of a VSWR bridge designed for VHF operation (such as the MFJ-812 or similar).

The vertical radiator element is soldered into place as shown in the illustration. Attach a solder (terminal) lug to each of the four ground radials and solder the lugs to the radials. Using machine screws and nuts, place the ground radials at the four holes at the corners of the SO-239. Only a very slight droop (if any) is required on the radials, and they should be spaced so that each radial is at 90° to the adjacent ones. Recheck your measurements at this point to make sure that they still match the chart. If not, they may require a slight touch-up trim.

Another version of this antenna doesn't require solder lugs at the radial ends. This version is constructed by cutting only two radials, each being twice the required length plus 1 inch. The radials are then passed through the holes in the SO-239 and soldered. Re-measure and, if needed, trim to best length.

Either version can be connected to your coaxial cable (via PL-239 connector) and then taped to any vertical support. You might wish to consider weatherproofing the SO-239 and its attachments with silicone or epoxy, especially if the antenna is to be in use for an extended period of time. Silicone on the PL-259 is always a good idea no matter how brief a period of time the antenna may be in use. If rainwater gets into those things, it can really mess them up.

Another type of mounting is to pass the cable through a length of conduit pipe which will support the antenna. No connection is necessary to the pipe, although you can tape the sleeve of the PL-259 connector to the top of the pipe to hold it firm.

Naturally, any time you're working with placing an outside antenna, stay far clear of any electrical lines for safety's sake; they're a definite hazard!

I borrowed a friend's receiver for the UHF aero band just to see what all the fuss was about. This antenna, cut for the middle of the band (300-340 MHz), was a cheap, handy, and fast way for me to fire up this receiver on the band. It did an admirable job. Of course he eventually wanted his receiver back and now I'm sitting here with a nifty UHF aero band antenna which is going begging for a receiver into which it can feed signals! Oh well, it is sturdy and maybe I'll just leave it there in the hopes that Bearcat, Regency, Fox, Realistic, or somebody (anybody!) will eventually bring out a scanner for this band!

In the meantime, if you pass my house you may wonder about that sleazy looking ground plane—righto, the one which seems to be cut for some mysterious frequency. Now you know!

Keep these instructions conveniently located; you never know when you'll need one of these.

... from the publishers of 

LISTEN UP!

Here's what you've been looking for — an all new hard-hitting monthly magazine which gives a unique insider's view of what's really going on in the world of communications. POP' COMM is your primary source of information — bigger and better than any communications magazine, with exciting coverage of scanners, shortwave broadcast & utility stations, spy stations, pirate and clandestine broadcasters, RTTY monitoring, survivalist communications systems, FCC news, wiretapping and bugging, voice scrambling/unscrambling, surveillance/undercover communications, satellite & cable TV, sophisticated telephones, & more. What you've been looking for all along! Take advantage of substantial savings over the newsstand price by subscribing now. Don't miss out on even one single issue of POPULAR COMMUNICATIONS — order your subscription now.

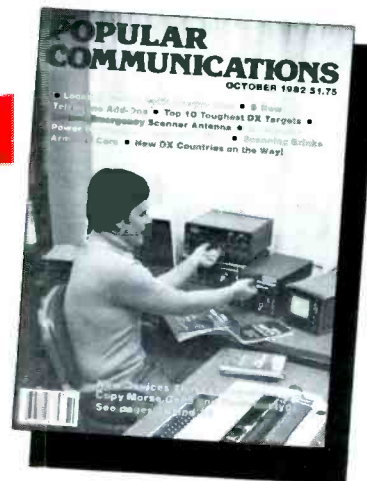

Twelve Issues

\$12

SUBSCRIBE NOW & SAVE!

POPULAR COMMUNICATIONS 76 N. Broadway, Hicksville, NY 11801

Yes! The **NEW POPULAR COMMUNICATIONS** is just the magazine I've been looking for. Start sending it to me now! I understand that I may cancel at any time for any reason, and receive a full refund on my unused subscription.

Paid by: Check Money Order MasterCard Visa
My account number is:

--	--	--	--

Name _____
Street _____
City _____ State _____ Zip _____

- 1 Year (12 Issues) \$12.00
Newsstand price \$21.00
- 2 Years (24 Issues) \$22.00
Newsstand price \$42.00
- 3 Years (36 Issues) \$32.00
Newsstand price \$63.00

Canada/Mexico — one year \$14.00, two years \$26.00, three years \$38.00; Foreign — one year \$16.00, two years \$30.00, three years \$44.00;
Foreign Air Mail — one year \$69.00, two years \$136.00, three years \$203.00.

THE EXCITING WORLD OF RADIOTELETYPE MONITORING

It is easy to be enthusiastic about a virtually unlimited worldwide data base, a digital form of news data available 24 hours-a-day! Imagine a constant flow of information available in many languages, just for a modest investment in equipment. What an ideal marriage—digital information available from the demodulator and a personal computer to process and search for key phrases or terms.

Our initial goal is to introduce the new horizons of exploring commercial RTTY SWLing and to review the basics of how and what is being transmitted from VLF through HF (10 kHz to 30 MHz). In subsequent columns we hope to gradually introduce the advanced modulation schemes used (such as FDM—Frequency Division Multiplexing, and TDM—Time Division Multiplexing) and review specific ways to improve reception by evaluating different antennas and equipment modifications, satisfying the most hardcore listeners. But more importantly, we need to pool together all of our monitoring skills and report changing transmission times and frequencies to the editor.

First of all, a few warnings. Please do not try to QSL these commercial news networks as many take a very dim view of non-intended public reception reports. Since most are commercial, point to point communications agencies, specific receiving parties are intended. Using the informational content for other than one's own personal use is strictly forbidden and in violation of the 1934 Communications Act—specifically Section 605.

Surprisingly, many RTTY FSK (frequency shift keying) signals that one would assume to be non-readable are readable with simple bit inversion correction schemes (other privacy and scrambling techniques will be covered in future writings). At least some level of privacy is insured by protecting the information from being read by the casual listener. But, more on this later and we'll quickly move to the excitement of opening a vast store of information.

What is information? This fundamental question is the key to understanding the importance of access to the world's news networks and commercial data transmitted by FSK. The dictionary equates information with knowledge—the result of information. Today the resolution from a changing economy, one which is based upon the change from a manufacturing/industrial society to one of information and information handling. Information makes the difference between a decision and a guess, and between success and failure!

The future, in fact, promises to create an environment in which the people who know how to acquire, store, and ultimately use information will have more power than ever

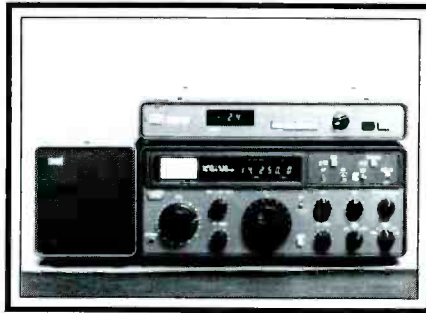

The Japan Radio Company NRD-515 is an example of a high-quality, professional grade, general coverage (100 kHz-30 MHz) receiver that can be used for copying RTTY signals, offering maximum results.



RTTY reception accessories easily connect to a receiver and are compact and easy to operate. This Kantronics Mini-Reader has only five push-button controls and the messages stream across the display in a continuous moving "ribbon" of information.

before. A recent poll taken to ascertain the truly believable sources shows the people rank U.S. TV news as number one in believability over any other source, in spite of its narrow perspective!

The cornerstone of democracy and independence is the free flow of information; indeed, to establish propaganda as truth, information has to be sorted and selected to promote a particular cause by giving only a portion of the total information.

This is beautifully illustrated as one monitors news from around the world. News is our most precious resource in the United States and this resource has to be protected. As unbiased news sources try to be, all certainly are contaminated by cultural biases. The only way to provide a clear understanding of current events is to compare and balance all available news. Now, in order to establish truth over a particular crisis—the Falkland crisis, for example—is to receive the news both from England and Argentina with commentaries from the United States and the Soviet Union.

As a DXer and RTTY enthusiast, I can read direct newsreports from Telam, Saportti (Argentina News Service), and LPS London and decide for myself the actual situation with INFOIND (NY) and TASS (Moscow) to balance this news!

The low cost, familiar home computer has accelerated the insatiable appetite for information since this tool makes data more manageable. With this tempting introduction, just what is FSK/RTTY? Well, frequency shift keying is a modulation scheme to transmit digital (on or off) data over an analog channel.

Data is transmitted by an agreed upon code. The most popular digital code used by the news agencies are low speed Baudot, consisting of a start bit, five data bits, and a stop bit. A bit is a shortened term for binary digit, a fundamental unit of information. In order to transmit each bit, the transmitter frequency is shifted slightly when a zero, or space, is sent. The carrier is shifted a certain amount, usually ranging between 170 Hz and 850 Hz with 425 Hz shift the most commonly used by news agencies. Now the receiver's BFO converts this received carrier shift into audio tones for the demodulator (or terminal unit) to regenerate one or zero as intended. This method of modulation, known as frequency shift keying, is one of the most efficient, with a 3 dB advantage over the on-off keyed system.

So, with the receiver's BFO on, a binary one (or mark) is adjusted for 2125 Hz by carefully watching the meter, LEDs, or scope for a maximum or peak signal. As a space is transmitted, this audio frequency gets shifted typically 425 Hz (to 2550 Hz) or 850 Hz (to 2975). The demodulator, at a minimum, converts the 2125 Hz tone and 2550 Hz tone to a one or zero, respectively. Many demodulators additionally (or optionally) provide a direct video output by inter-



If you have a video monitor and/or a hard copy printout, you can obtain an accessory, such as this Info-Tech M-200F, which will connect to your receiver and give you a large screen display or "hard copy" printout of the messages you're monitoring.

SELECT YOUR FAVORITE FEATURE



Yes, the CT2100 has the features you want – and built-in, too! The CT2100 has been designed by the RTTY people at HAL for optimum operator convenience. No “hidden” keyboard controls to remember – it’s all on the front panel, arranged for serious operators. Why settle for a compromise or imitation when you can have the CT2100? Compare feature for feature; you’ll find that the CT2100 offers the most performance and flexibility for your dollar.

- Send or receive ASCII, Baudot, or Morse code
- RTTY and Morse demodulators are built-in
- RTTY speeds of 45, 50, 74, 100, 110, 300, 600, and 1200 baud – ASCII or Baudot
- Four RTTY modems: “high tones”, “low tones”, “103 Modem tones”, and “202 Modem tones”
- Three shifts for high and low tones (170, 425, and 850 Hz)
- Crystal-synthesized transmit tones
- Send and receive Morse code at 1 to 100 wpm
- Characters displayed on 24 line screen
- Choose either 36 or 72 characters per line
- 2 pages of 72 character lines or 4 pages of 36 character lines
- Split-screen for pretyping transmit text
- Audio, current loop, or RS232 data I/O
- Printers available for hard-copy of all 3 codes
- On-screen RTTY tuning bar plus LED indicators
- ALL ASCII control characters; half or full duplex
- Brag-tape storage of 8-256 character messages in MSG2100 EPROM option
- Two programmable HERE IS messages

Write or call for more details. See the CT2100, KB2100, Printer, and Video Monitor at your favorite HAL dealer.



HAL COMMUNICATIONS CORP.

BOX 365

URBANA, ILLINOIS 61801

217-367-7373

Moto-trak



Your key to ALL the satellites, ALL the programming, right from the comfort of your easy chair.

Satellite television offers so much to explore. Why settle for the one-satellite limitation of fixed dishes, or endless cranking at the dish in all kinds of weather? Enjoy all the convenience KLM's Moto-trak system has to offer . . .

- 12 automatic satellite selections at the twist of a dial
- Fully independent Azimuth and Elevation control, to search or optimize
- Spot LED "travel" indicators
- Constant LED Azimuth/Elevation readout
- Polarity Control, for all channels, horizontal and vertical
- 12' solid aluminum dish or 16' screened dish for a perfect picture

And, enjoy the reliability of a motorized mount that's precision engineered from the ground up. Not an afterthought or a flimsy add-on, KLM's Moto-trak uses industrial quality reduction motors, gear, and screw drives, state-of-the-art motor control electronics.

Best of all, the Moto-trak system is a perfect match for KLM's reliable SKY EYE II and new SR-3 Satellite Receivers. Complete systems are available NOW. Once again, more of the performance, features, convenience, and reliability you've come to expect from KLM.

KLM
P.O. Box 816, Morgan Hill, CA 95037
(408)779-7363

CIRCLE 27 ON READER SERVICE CARD

Send for KLM's
SITE SURVEY KIT
AZ-EL Tester, Manual,
Sat-Coordinates \$29.95

SR-3

(The one you've been waiting for!)



The SR-3 Satellite Receiver . . . once again, more of the performance, features, and convenience you've come to expect from KLM. Handsomely styled cabinet outside, state-of-the-art single conversion circuitry inside. Install the SR-3 up to 1000 feet from the dish; a single 50 ohm feedline makes it clean and easy. Select KLM's separate remote downconverter or the revolutionary "Ampliverter" that combines LNA and downconverter in one very compact package. And, enjoy these easy-to-look-at/easy-to-use features:

- Rapid "SCAN" for easy satellite tracking
- LED signal strength readout
- Positive detent channel tuning plus fine tune
- Full audio tuning/stereo version available
- Video inversion

The SR-3 with remote downconverter or Ampliverter is available NOW, just like KLM's new motorized dish systems with remote "Moto-Trak" control. More of the best from KLM.

KLM

P.O. Box 816, Morgan Hill, CA 95037
(408) 779-7363

CIRCLE 35 ON READER SERVICE CARD

Entirely professional level!

You'll find the difference the more you use it.

ULTIMATE QUALITY, NRD-515



Receiver, NRD-515

SPECIFICATIONS

Receiving frequency range: 100kHz to 30MHz continuous (30 bands)
 Receiving modes: USB/LSB/CW/RTTY/AM
 Receiving system: Up conversion type
 Double superheterodyne
 First IF: 70 455MHz
 CW SSB AM
 0.5µV 2µV
 2µV 6µV
 6kHz/2 4kHz/0 6kHz/0.3kHz
 (*Option)
 Stability: Within 50Hz/one hour
 Power requirements: AC 100/117/220/240V, 50/60Hz, 50VA
 Dimensions and Weight: 340mm(W) x 140mm(H) x 300mm(D). Approx. 7.5kg
 Preset memory (Option): 24ch
 Frequency stability: Less than 50Hz per hour after warming up
 Image rejection ratio: 70dB or more
 IF rejection ratio: 70dB or more
 Input impedance: 50 to 75 ohms, unbalanced
 AF outputs:
 Speaker output: 1W or more (4 ohms)
 Record/line output: 1mW or more (600 ohms)

Highest grade all-wave receiver

NRD-515

Best for 59

Transmitter, NSD-515



SPECIFICATIONS

Rated output power: 100W NSD 515 (50W 28MHz band)
 Frequency range: 1.8MHz-2.0MHz/3.5MHz-4.0MHz/
 7.0MHz-7.3MHz/14.0MHz-14.35MHz/
 21.0MHz-21.45MHz/28.0MHz-29.0MHz/
 29.0MHz-29.7MHz/Optional new bands
 approved by WARC '79
 10.1MHz-10.15MHz/18.068MHz-
 18.168MHz/24.89MHz-24.99MHz/
 A3J (USB/LSB) A1 (CW) F1 (RTTY)

• For more information please contact to;



Since 1915

Japan Radio Co., Ltd.

AUSTRALIA: N S W.—EMONA ELECTRONICS PTY LTD. Phone: 398-6378
 Victoria—VICOM IMPORTS PTY LTD. Phone: (03) 62 6931
 FINLAND: Kotka—VISI RADIO OY Telex: 53260 VISI SF
 FRANCE: Paris—SOCIÉTÉ G.E.S. (GENERAL ELECTRONIC SERVICES) Phone: (1) 345 35 92
 CANADA: Vancouver—GLENWOOD TRADING CO. LTD. Phone: 604 984 4404
 GERMANY: Hannover—RICHTER & CO. Phone: (0511) 352 1111
 ITALY: Milanese—TECRNOVENT. ITALIA, SRL Phone: 02 32 83 089

MAIN OFFICE: Mori Building Fifth, 17-1, Toranomon 1-chome, Minato-ku, Tokyo 105, Japan Cable Address: "JAPANRADIO TOKYO"
 Phone: (03) 591-3451 Telex: 0222-3068

U.S.A. LIAISON OFFICE: T. Hayashi,
 120 East 56th Street, New York, New York 10022
 Phone: 212-355-1180 Telex: 230-645636 JAPANRADIO NYK

SWITZERLAND: SEICOM AG Phone: 064 515566
 U.K.: Derbyshire—LOWE ELECTRONICS, LTD. Phone: 0629-2430
 U.S.A.: Ohio—UNIVERSAL AMATEUR RADIO INC. Phone: (614) 866-4267
 NEW ZEALAND: Dunedin—RADIO ENGINEERING LTD. Phone: 51-075

CIRCLE 39 ON READER SERVICE CARD

Satellite TV...

the boom industry of the 80's.



Receive up to 50 TV channels 24 hours a day... un-cut movies, sports, religious programming, and much much more... direct to your home even if you live out of range of good TV reception.

It's a whole new world of entertainment.

Dealer Inquiries Invited
For more information Call
1-800-255-9013



**International
Satellite
Systems**

PO Box 901 • North Little Rock, Arkansas 72115
501 753-7153

CIRCLE 53 ON READER SERVICE CARD

SCANNER CRYSTALS!

America's leading mail-order supplier!

Let Z-Tech Enterprises be your prime source of precision scanner crystals. We are specialists in crystals for federal frequencies, public safety, aero band, business/industrial, maritime. Shipped to you factory fresh and ready to zero in on the stations you want to hear. Low prices, too! We'll be pleased to send you our special order form offering the best prices you've ever seen for precision custom-cut scanner crystals. Just ask us for it!

Z-TECH ENTERPRISES
P.O. Box 70 Hauppauge, NY 11788

CIRCLE 77 ON READER SERVICE CARD

Frequency	Location	Time	Language	Shift	Baud Rate	Normal/Reverse Phase
19.980 MHz	Tehran, Iran	15:23 UTC Scheduled at 17:30 UTC	English	425 Hz	50 Baud	Reverse
7.960 MHz	Tehran, Iran	20:23 UTC	English	425 Hz	50 Baud	Reverse
Argentina has two excellent (S9 signal in Midwest using a simple vertical) news agencies, Telam and Saporiti, both logged in Spanish.						
9.090 MHz	Buenos Aires, Argentina	01:30 UTC	Spanish	850 Hz	50 Baud	Reverse
13.515 MHz	Buenos Aires, Argentina	00:05 UTC	Spanish	850 Hz	50 Baud	Normal
Poland has English transmissions from Polska Agencja Prasowa or PAP as it is commonly known. PAP is Poland's official news agency.						
20.495 MHz	Warsaw, Poland	16:05 UTC	English	425 Hz	50 Baud	Reverse
9.391 MHz	Warsaw, Poland	06:35 UTC	English	425 Hz	50 Baud	Reverse

change frequencies and times to provide some privacy, and also transmission times vary on weekends and holidays.

We would like to keep track of monitored news agencies in this column, so any current schedule information will be gratefully accepted by the editor of this column. Names of the DXers will not be published unless specifically desired. This brings us to interesting and relevant news agencies recently monitored. Space requirements do not allow the numerous news agencies.

The current "hot spots" in the world today seem to be the Middle East, Latin America, and Poland. Therefore, let's start with the Islamic Republic News Agency transmitting to Eastern Europe.

Let me know if you prefer a balanced coverage of equipment and listings, or would you, the reader, like to concentrate on listings of news agencies with some FSK/RTTY utilities. Also, if a response is desired, please send an SASE. Send in your favorite FSK loggings so we can stay up to date in our publishing and information flow!

Send to: Joseph Jesson, 21414 Honey Lane, Lake Villa, IL 60046

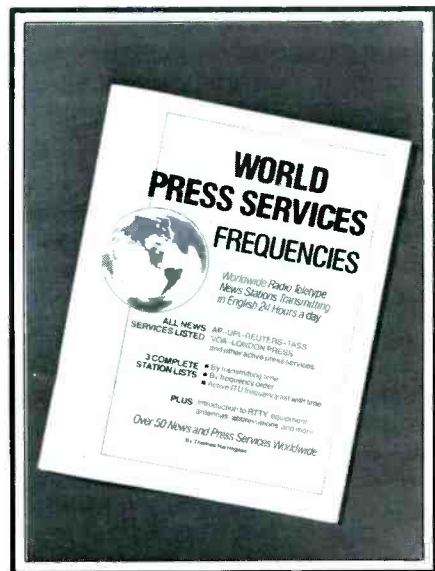

Several good reference books are now available as an aid to the RTTY DXer, listing frequencies, schedules, and even details of the transmitting techniques used by the RTTY stations.



This is the HAL Telereader and accessory keyboard.

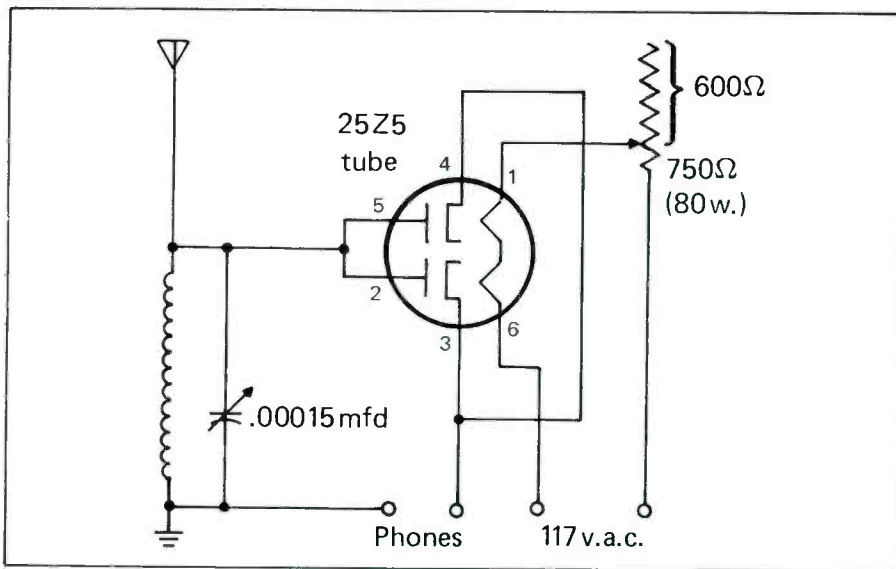

A German Spy Built This Clever Little Receiver From Odds & Ends!

Below is the photo of the little "spy" receiver as it appeared in the 1943 newspaper. There are only four main parts!

Spy Receiver – 1943 Vintage!

BY ANSON MacFARLAND, KVA4EX

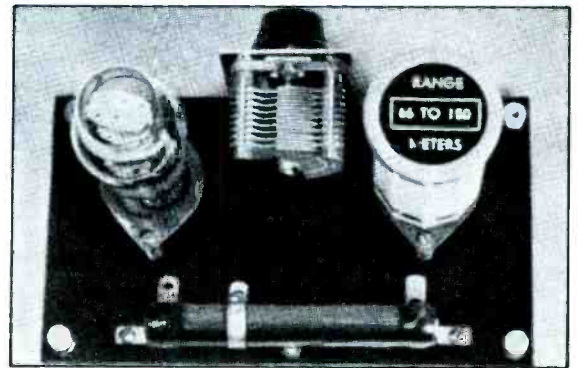

Here's one from the past! We're referring to an improvised little 1-tube receiver that a German spy was arrested with during World War II. Unsophisticated as it is, it's a really clever and novel circuit which shows that even with the shortage of radio components available to the public during the war years, someone resourceful could scrounge up a couple of oddball scrap parts and slap together a radio that could work!

The designer and original builder of this little gem was arrested in Virginia in 1943; they said he was a spy! Amongst his possessions were various incriminating documents and photos, plus some electronics equipment—most of which was inoperative. The only working piece of electronic hardware he had was a little homebrew receiver which he had built from parts cannibalized from the inoperative equipment. I guess he didn't wish to take his communications receiver down to the corner radio shop to get it fixed; people with foreign accents and shortwave receivers were prone to drawing undue attention to themselves in those days.

After he was arrested, there were local newspaper stories galore about him, complete with photos of the various artifacts found in his possession. I happened to come upon this a few months ago while I was looking in some old newspapers for an unrelated

research project for our county historical society. I was caught by the design of his little receiver project since it contained only a capacitor, a resistor, a coil, and a 25 volt rectifier tube! A photo was shown but it wasn't apparent to me how such an odd assortment of components could assemble together to produce a radio receiver; it didn't seem to have a detector! And all of this was operated from the 117 volt AC power lines, which was equally curious.

I pondered over this for a while, even dug back through later newspapers to see if any additional information was to be forthcoming. It wasn't. All I knew was that he was able to assemble some components which the newspaper described as a "small shortwave receiver containing a type 25Z5 vacuum tube." I pulled out my pencil and paper and tried to figure out how a circuit would work using this strange mix of components. With help from a friend whose radio knowledge dates back into the heyday of the vacuum tube, I was able to sketch out a schematic of something which is probably a very close copy of this fellow's interesting circuit. Moreover, when these parts were breadboarded together, we did get it working and doing a reasonably respectable job of things, displaying good selectivity and sensitivity with absolutely no hum.

How It Works

Using the type 25Z5 rectifier as a detector tube, no filtering system was needed (because no plate voltage is used). The AC voltage was needed only to heat the filaments of the 25Z5, with no connections between the AC line and the receiver proper. The 25Z5 acted as a diode and had its two plates and cathodes tied together. The plates were connected to the fixed plates of the .00015 mfd. tuning capacitor to the coil and to the antenna. The cathodes were connected to the moving plates of the capacitor and to the other end of the antenna side of the coil. Headphones were placed in the cathode circuit of the tube.

The rectifier heater voltage had to be adjusted critically from 5 to 6 volts, instead of the rated 25, for satisfactory operation. The 80 watt fixed resistor with an adjustable tap enabled a standard line cord to be used; the resistor is a biggie, for sure! The photo of the set shown in the newspaper revealed that a commercial plug-in type coil was used in the set, as well.

It made a nice addition to my collection of World War II espionage circuits. If readers are interested, I'll be happy to share some more of my collected miniature espionage transmitters and receivers from those years.

EQUIPMENT REVIEW:

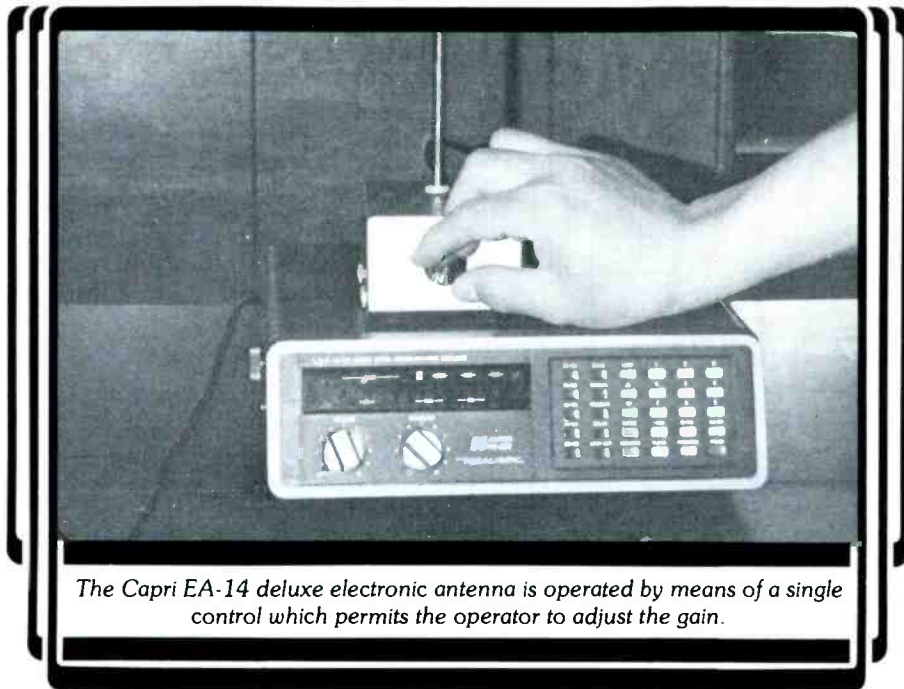

The Capri EA-14 deluxe electronic antenna is operated by means of a single control which permits the operator to adjust the gain.

The Capri EA-14 Electronic Antenna & Amplifier

Capri Electronics came up with what we feel is a darn clever device. We're talking about their Model EA-14 Deluxe Electronic Antenna for scanners. Actually, it's more than just an electronic antenna; it's really two units in one. The basic idea (and use) of the unit is to replace the detachable little whip that comes with your scanner, which plugs into the rear deck of the scanner.

On the other hand, most of us have attempted to improve scanner performance by bypassing the use of the factory-supplied indoor whip in favor of something more suitable for pulling in those ever lovin' VHF signals. We've discovered that an antenna mounted outside and as high-up as possible offers a definite improvement over the factory supplied indoor whip. Of course, those who do their monitoring from inside of apartment houses and certain office buildings are all too often stuck with the indoor whip because of landlord type restrictions.

So, if you're stuck without the ability to do your monitoring with an external antenna, you can use the Capri EA-14. And, happily, even if you've got an outside antenna, you can use the Capri EA-14 to beef up the signals which that antenna is pulling in—effec-

tively giving you the ability to reach out further into the hinterlands with your monitoring ability. It's a dilly of a unit alright, and neatly designed into a nifty and attractive package.

General Description

The Capri EA-14 is housed in a small metal box. A telescoping antenna is supplied and can be connected to the unit through a hole provided in the top of the cabinet. The front panel contains a single knob which is used to turn the EA-14 on/off and to adjust the amount of amplification gain it provides—a pilot lamp lets you know when the device is on.

The rear deck has a Motorola type plug extending from a short length of coaxial cable. This is what plugs into the antenna socket on the rear of your scanner. A female Motorola type jack is also provided in the event you are using the EA-14 as a signal booster for your outdoor antenna rather than as a complete indoor antenna. The lead-in from the outdoor antenna may be plugged into the EA-14, thus placing the device in series



This unit is small and unobtrusive; will fit atop any scanner with plenty of room to spare.

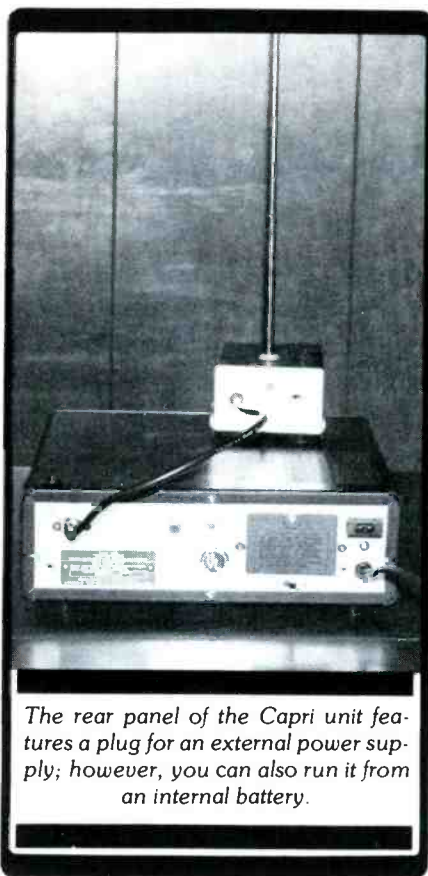

The rear panel of the Capri unit features a plug for an external power supply; however, you can also run it from an internal battery.

with the external antenna. Also extending from the rear deck is a power cord; the EA-14 requires 12 to 16 volts DC at 30 mA in order to operate. You can get power from an existing power source or obtain Capri's Model A-01 power adapter to do this job.

The Capri EA-14 is designed to work on all signals between 30 and 900 MHz, offering a maximum of 20 dB gain on the low and high bands, and 12 dB on the UHF band. That's giving you a 100 times gain on those low and high band signals and better than a ten boost on the UHF band! The noise factor is less than 2 dB.

The telescoping antenna can be removed if the EA-14 is being used in conjunction with an external antenna. When it is used, its length can be adjusted for precision matching to any specific band (including the VHF aero band) or simply left at 28" for general all-band monitoring.

Use

Since the EA-14 is a broadband amplifier, there isn't any RF peaking control required. That means the only control you may have occasion to adjust is the gain control. Strong local signals, when fed through this powerful amplifier, will obviously be more than most scanners are prepared to handle with much grace and aplomb. Such incoming signals will best be monitored with the

EA-14's gain reduced to some less enthusiastic point than full blast lest you produce intermodulation or overload in your scanner.

For trying to hear those mobile units off in the boonies, those base stations two counties away, or aircraft which would otherwise be out of range of your station—why just crank 'er open and it's like taking the cotton out of your scanner's ears! You should be able to pick up weak and distant signals with any decent outdoor antenna being fed into the EA-14. And, if you're using the EA-14 as a self-contained indoor antenna, you should be hearing many more stations than you're used to with the basic whip supplied with the scanner.

Consider that the Capri EA-14 is inexpensive (\$59.50), fully wired and tested (it is not a kit), hooks up in about 5 minutes without any special tools or technical expertise on the part of the scanner owner, is simple to operate, and brings the effective sensitivity of your scanner and its antenna system up by as much as 100 times! It might just be an accessory which you'd find a good use for in conjunction with your scanner.

The Capri EA-14 is made by Capri Electronics, Route 1 Box 91-1J, Canon, GA 30520.

Reviewed by Rick Maslau, KNY2GL

INFO-TECH M200-F TRI-MODE CONVERTER

The Best in Code Converters



Converts Morse & RTTY (Baudot & ASCII) to video, and serial Baudot or ASCII for hard copy

Morse reception: 6-55 wpm standard (simple user adjustment for higher speeds). Automatic speed tracking & word space adjustment. RTTY/ASCII Operation: Decodes RTTY (45, 50, 57, 74, 100 Baud) and ASCII (110 & 300 Baud). Auto CR/LF, automatic threshold control, selectable unshift on space, limiter is switch selectable, solid state tuning "meter." Demodulator has 3 fixed shifts and 1 tunable shift, user selectable printer outputs in ASCII or Baudot for all modes with crystal controlled baud rate generator. RS232, TTL & isolated loop outputs. User adjustable autostart.

- Video Display Formats: up to 25 lines of 72 characters
- Built-in 115/230v power supply

Contact Us for Further Information and Name of Your Nearest Dealer

INFO-TECH ELECTRONIC EQUIPMENT

Manufactured by:
DIGITAL ELECTRONIC SYSTEMS, INC.
1633 Wisteria Court • Englewood, Florida 33533
813-474-9518

MADE IN U.S.A.

CIRCLE 75 ON READER SERVICE CARD

CIRCLE 75 ON READER SERVICE CARD

SATURN V STATE-OF-THE-ART

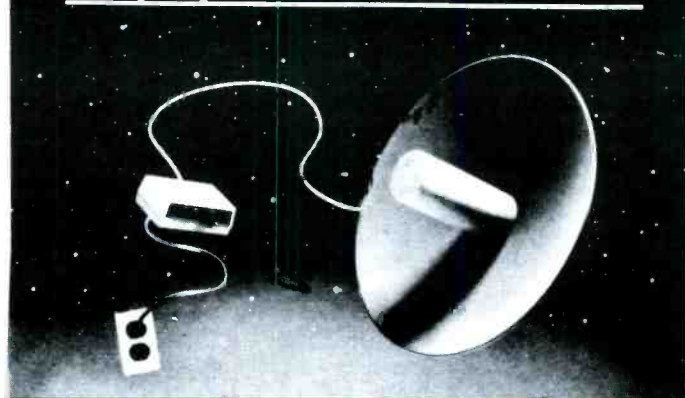

The Saturn V is a deep fringe microwave receiver for homeowners that are outside of the service area of local pay TV stations (i.e., HBO, Showtime). It is normally used within line of sight of a transmitting tower in a 50 mile range and is simply attached to your TV antenna mast. This unit is completely ready to install including all cable and mounting hardware. It is designed to be installed by the homeowner.

We accept MasterCharge & Visa.

Microwave and Satellite Systems

JDL Industries T.M.

4558 Auburn Blvd., Suite 208
Sacramento, California 95841 (916) 454-2190

1-3	\$165.00
4-11	\$120.00
12-49	\$105.00
50-99	\$ 95.00
100-149	\$ 85.00
150-up	\$ 80.00

CIRCLE 78 ON READER SERVICE CARD

LISTENING POST

BY GERRY L. DEXTER

WHAT'S HAPPENING: INTERNATIONAL SHORTWAVE BROADCASTING BANDS

Nice to have you stop by again. Come on out on the deck, have a cold one, we'll pop on the portable, and talk shortwave.

Although 1982 isn't over yet, it has certainly given us a prime example of how exciting and fascinating shortwave can be in the midst of a crisis. For instance, when Argentina landed troops on the Falkland Islands back in early April, all sorts of interesting things began to happen on the radio.

Radio stations are always among the first on the list of targets in a coup or military invasion, and the Falkland Islands Broadcasting Station was no exception. FIBS suddenly became LRA60—Radio Nacional Islas de Malvinas, and in a matter of a day or two, Argentine broadcasters had taken over the operation of the station. There were some unconfirmed reports of 24-hour-a-day operation in contrast to the limited schedule to which FIBS had held. English broadcasts were largely kept on the air in deference to the needs of the islands' population.

At about the same time, over on the Amateur bands, there were reports of a so-called "official" Argentine government channel or channels transmitting personnel news to the Malvinas. The station was LU4ERM operating on 7.075, 14.150, and 21.225 MHz at various times.

Meanwhile, back on the Falklands/Malvinas, the islands' cable and wireless point-to-point station was heard relaying LRA60 and occasionally noted still using the cable and wireless identification tape. The station was using 24.146 and 11.565 MHz; 15.890 had a single sideband feeder relaying a broadcast band station LU14 in Las Heras, Argentina.

On April 23, a radio event took place sufficiently interesting to capture even the attention of the general media. A "Tokyo Rose" type female broadcaster took to the air to entertain British troops advancing towards the islands. "Argentine Annie," as she was dubbed by the press, broadcast for about 45 minutes at various times of the day, including 2000, 2200, 0000, and 0200 GMT on 17.740 MHz. She called herself Liberty, and in between the playing of rock and pop music (including a good deal of Beatles records), she made appeals to the troops to turn back and go home to their loved ones. While the signal strength was good, the modulation was not, so the broadcasts were somewhat difficult to understand.

The British Forces Broadcasting Service, which used to have several shortwave outlets in various parts of the world, soon found themselves wishing they still did. BFBS decided they should be speaking directly to their troops. An arrangement was made with the BBC where two BBC frequencies

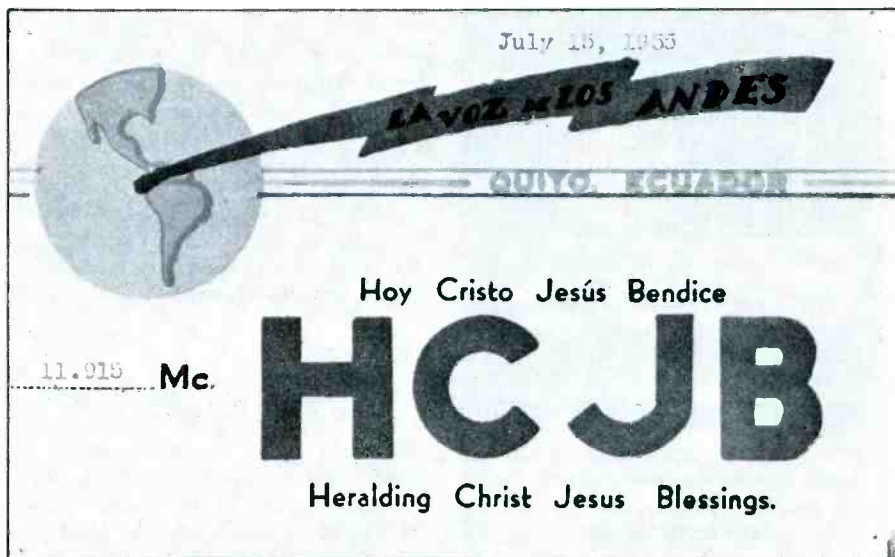

One of the first stations usually heard by shortwave listeners, HCJB in Quito, Ecuador, has been around a long time—even longer than this 1955 QSL.

were made available to BFBS and programs aimed at the fleet were aired Mondays, Wednesdays, and Saturdays from 1100-1130 GMT via the BBC Ascension Island transmitters on 21.490 and 17.830 MHz.

Meanwhile, the BBC hadn't forgotten the islanders. The regular BBC program "Calling the Falklands" was increased from a weekly to a daily program aired from 2120-2200 on 15.400 and 11.820. The BBC reported being inundated with telephone calls and people showing up at the studios with messages to be relayed to friends and relatives on the Falklands.

In early May, the BBC reported that its Spanish service to Latin America was being jammed and had identified the source of the jamming as coming from Argentina. Surprise, surprise. To combat the interference,

the BBC added several frequencies and increased their broadcast schedule to Latin America, an increase which included a new morning transmission.

There is a rather odd footnote to the jamming. A Chilean broadcaster, Radio Mineira in Santiago, was reported to be relaying the entire BBC Latin American service in order to help get the BBC signals through.

By this time, there were suspicions that Radio Nacional Islas de Malvinas' shortwave outlet on 2.370 had been closed down. This was in order to prevent its being heard on the mainland and thus presumably to prevent any news being gathered from such a potential source.

Then Argentina made a move to bring the sound of home to its troops, who were now fairly isolated on the Malvinas due to the



A mini-pennant from the rare Mexican station La Voz del Maestro on 6.185.



Radio Difusora "SAN MARTIN" S.A.

UNA VOZ Y UN SONIDO PARA UN PERU MAS UNIDO

ONDA MEDIA 1130 KHz	ONDA CORTA 4810 KHz	F. M. 97.5 MHz
---------------------------	---------------------------	-------------------

con tu preferencia y sintonía... seremos tu eterna compañía!!!

Many stations send stickers including these from Capital Radio in Transki, one of the South Africa "homelands" and Radiodifusora San Martin in Peru.



British blockade. Three Argentine local stations showed up on shortwave, using the transmitters of Radiodifusion Argentina el Exterior (RAE) (more recently called simply Radio Argentina). Radio Rividavia was on 9.690 from 0000-1000; Radio del Plata used 11.710 from 0300-1000, and Radio Continental's programming was 6060 from 1100-1500. The first two were widely heard but 6060 was dominated by Radio Havana. All three are medium wave stations located in Buenos Aires.

Back in Britain and down on the medium wave broadcast band, one of the local, independent radio stations in Portsmouth suddenly assumed a 24-hour-a-day schedule. It renamed itself "Radio Victory" in an attempt to provide some morale boosting to the local residents, many of whom had sons and husbands on the ships. Apparently the loss of the Sheffield spurred this action. The station planned to continue round the clock operations as long as the crisis lasted.

In mid-May, the British took a page from the Argentine book and came on the air with their own "clandestine" station, Radio Atlantica del Sur, operated by the Ministry of Defense. Using a BBC transmitter on Ascension Island, Atlantica del Sur operated from 2300-0200 GMT on 9.710 MHz, playing a nondescript selection of music and asking for letters to a London box number. The station had two disc jockeys, Francisco and Ernesto, and a lady announcer, Mariana Flores, who apparently was Britain's answer to Argentine Annie.

Thanks indeed go to Radio Netherland's Media Network program and Glenn Hauser's Listener's Notebook column in *Frendx*, the bulletin of the North American Shortwave Association where much of the background for this summary was obtained.

'Round The Bands

*All times are Greenwich Mean Time.

Brazil

If you're a fan of the bossa nova and other Brazilian rhythms, you'll enjoy the programs of Radiobras. English is carried on 15.290 and 17.830 between 0200 and 0300 and

interspersed with short features on the Brazilian scene. (Reinecker/SPEEDX)

Equatorial Guinea

The former Radio Equatorial, La Voz de Rio Muni, is now announcing as Estacion Continental de Radio Nacional. Normally it is on 4.926, although it will occasionally pop up on 5.004. Late afternoon or late evening checks will sometimes bring this one in. (QTH Africa/NASWA LN)

Guyana

The only shortwave activity from here is the Guyana Broadcasting Corporation on 5.950 from 0730-0305, weekends to 0505.

The shortwave transmitter carries the second program of the local medium wave service (M. Kent Sidel/NASWA LN)

Honduras

Currently active shortwave stations include the following: Radio Luz y Vida on 3.250, Radio Juticalpa on 4.780, La Voz de Evangelica (HRVC) on 4.820, Radio Lux on 4.890, and La Voz de Mosquitia on 4.910. (Don Moore in NASWA/LN)

Italy

A new Catholic pirate station is on the air, Radio Pace. It actually began operation about four years ago with a medium wave station, then TV, and most recently, shortwave. It is intended for Italian missionaries and emigrants. You can tune for this one on 15.475 slightly variable or 15.600. It can be heard with fair to good strength in the midwest in the local afternoons or evenings. The stations address is Via Oriani 2, 37122 Verona, Italy.

Kuwait

Three frequencies used by Radio Kuwait are 15.495, 11.675, and 9.840 around 0500 when heard with news in Arabic. (Noel Green/DSWCI)

Laos

Information on Laos and its stations is continually changing. But the most recent

data available shows the following stations active: Houa Phan, 4.657 from 2300-0015 and 1115-1300; Xieng Khouang, 5.613 and 7.182, 2300-0030, and 1100-1400; Udom Sai, 6.850 variable, 2300-0030 and 1100-1300; Pakse 6.600 variable, 2300-0030 and 1100-1400; Luang Prabang 6.995 and Savannakhet, 7.384 not heard recently although they could reappear at any time; Vientiane (Radio Nacional Lao) is on 6.130 with the foreign service. Local mornings are the best times to tune for these. (Ralph W. Perry/NASWA/LN)

Malagasy Republic

The new 100 kilowatt transmitter of Radio Malagasy is being widely reported to 2100 GMT sign-off and again at 0300 GMT sign on. Frequency is 5.010 but check 5.020 if you don't find it on the first spot.

Maldives

This rare outlet, always sought by DXers, is an impossibility at present since the shortwave transmitters have been taken off the air. There is hope that the silence is due to an upgrading of facilities and that a return to shortwave with higher power may be expected. (Sarath Weerakoon, NASWA/LN)

Marianas Islands

Look for this one to be added to the shortwave country rolls soon, if not already. The station will be KYOI from Saipan Island and is planned as a 24 hour music station operated by the California-based company, Marcom. No frequencies are available as yet.

Mongolia

Radio Ulan Bator's English programs are now aired from 1200-1235, 1400-1435, and 1445-1120 on 6.383, 7.230, and 12.070. (Nishimura/NASWA/LN)

New Zealand

The foreign service of Radio New Zealand is in trouble again and may well be off the air by now. As happened once before, the New Zealand government threatened to curtail the shortwave operations as an economy



New 1982 DX Countries Chart



Now available!

Large-size wall chart lists all the official DX Countries in the world with a host of valuable data about size, population, government, etc. No shack is complete without one! 23" x 35", two colors, on heavy poster stock. Mailed by First Class mail, folded in 9" x 12" envelope. Only \$2.95 each, post-paid. Quantity prices available.

Send DX wall charts.
Enclosed is \$2.95 for each chart.

Mail to:

CQ Magazine
76 N. Broadway
Hicksville, NY 11801

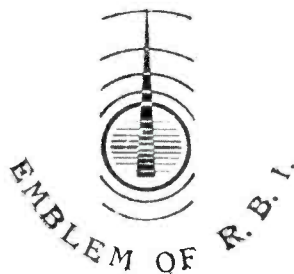

RADIO BAGHDAD
VOICE OF THE REPUBLIC
OF IRAQ

Q. S. L.

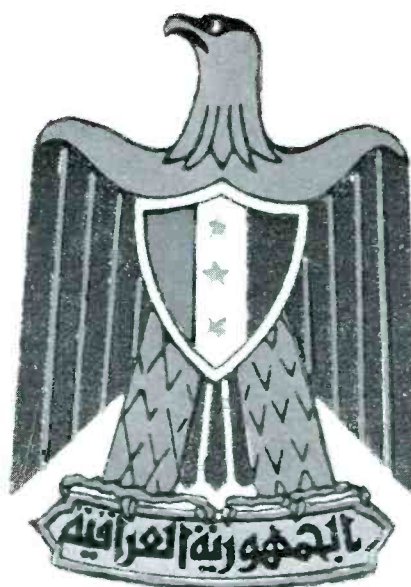

With a little effort, this Radio Baghdad QSL can grace your wall.

measure, although at press time several alternatives were being considered. Listeners wishing to do their part to keep Radio New Zealand on shortwave should write to the Prime Minister, the Honorable R. Muldoon, House of Representatives, Wellington, New Zealand. (Arthur Cushen/SCDX)

Qatar

Radio Qatar is scheduled from 0245-1700 on 9.570, 0245-0800 and 1000-1400 on 15.505, and 1400-2125 on 15.185. (Quaglieri/NASWA/LN)

Singapore

Radio Singapore has been heard from 0000-1605 on 15.440 variable. You might also try 11.940 for this one. (Victor Goonetilleke/DSWCI)

Somalia

Radio Mogadishu is now using a new 100 kilowatt transmitter which relays the station's home service. Try for it on 6.790 around 0300. It's also listed to use 11.860 from 1700-0000 and 15.295 from 0300-1700. (DSWCI)

South Korea

Radio Korea can be heard beaming English to North America at 0030-0100 on 11.810 and 15.575, at 0430 on 11.810, and at 0930 on 9.570 and 11.725. (Mario Occhinera/SCDX)

Spain

Radio Exterior de Espana has English to North America at 0000-0200 on 9.630 and 11.880 and again from 0530-0630 on the same frequencies. You could also try the transmissions to Europe from 1900-2100 on 9.765 and 11.840. (Harrell/SPEEDX)

Switzerland

Upcoming transmissions from the International Committee of the Red Cross are scheduled for October 25-27, November 22-24, and December 27-29 on 7.210 from 0600-0700, 1130-1230, and 1700-1800. (DSWCI)

Uganda

Radio Uganda is reported to be back in operation with its foreign service. It's sched-



Frequency 621 KHz
MW 483 Meters



Frequency 5980 KHz
SW 50 Meter Band

Voice of Asia
亞洲之聲

This is to verify that your reception report on English program on 5980 KHz from 1127 to 1200 GMT on Sept. 26 19 80 corresponded with our station log of the same day. Thank you for your interest. Further report are welcome.

P. O. Box 880, Kaohsiung,
Taiwan, Republic of China

QSL

For many months no one could get a reply from the Voice of Asia on Taiwan. Then the flood began with multiple QSLs, booklets, key chains, and so on appearing every month.

uled to North America on 15.325 in English from 0300-0400. (DSWC1)

Zimbabwe

Radio Two operates daily from 0325 sign on, on 3.306 and Radio One on 3.396 weekdays only from 0325, Sundays from 0400. (Richard Ginby/NASWA/LN)

Here's your chance! Radio Canada International is making preparations for the High Frequency Broadcasting Planning Meeting to be held in 1983 and 1985 and is seeking comments on shortwave broadcast usage to assist in the planning. RCI is seeking opinions on the following questions:

- 1) What corrective action would you consider useful in resolving the present chaotic conditions on the international shortwave broadcasting bands?
- 2) What action would you see as being necessary to make possible a world wide, equitable allocation procedure for the shortwave broadcasting bands?
- 3) What procedure would you foresee as being necessary in any changeover to SSB (single sideband) for international shortwave broadcasting stations? What sort of time frame should be involved?
- 4) What action do you anticipate might be necessary to achieve an agreement on power limits for international high frequency broadcasting? What should this transmitter power limit be?
- 5) Do you consider it necessary for any shortwave broadcasting station to transmit the same program on more than one frequency in a given band at any given time?
- 6) How do you view the national and international aspects of SW broadcasting?
- 7) What would you suggest as a solution to the problem of out-of-band broadcasting activities which are carried out by some 30 member administrations of the International Telecommunications Union?
- 8) As an active SW listener, what receiver improvements or voluntary standards on the part of manufacturers would you feel might be useful or necessary?
- 9) Do you think that the existing HF

broadcasting bands are being properly used at the present time? Do you think that a World Administrative Radio Conference on HF Broadcasting in 1984 would be useful?

10) What proportion of your radio listening activities is devoted to each of the following two categories:

SWLing - % 10 20 30 40 50 60 70 80 90 100
DXing - % 10 20 30 40 50 60 70 80 90 100

Radio Canada International requests that responses to questions be numbered the same as the question. Please send your response to the following address: RCI/HF WARC, P.O. Box 6000, Montreal, Quebec Canada H3C 3A8.

Once upon a time, the DX hobby club scene in this country was a jungle of jealousy, where inter-club wars raged with the fury of a berserk jammer. The inauguration and subsequent growth of ANARC—The

Association of North American Radio Clubs—has changed all of that. ANARC operates as an aid to the clubs and promotes the shortwave and general DXing hobby as a whole. ANARC publishes a monthly newsletter which is available for \$5 for one year's worth of issues from ANARC, 1500 Bunbury Drive, Whittier, CA 90601. The publication features information about clubs, new equipment, and the Handicapped Aid Program.

You're the one we're waiting to hear from. Let's have your loggings, shack photos, good quality QSL copies, questions, and comments.

With thanks to Listener's Notebook by Glen Hauser in *Frendx*, publication of the North American Shortwave Association; the *SPEEDX* bulletin; Danish Shortwave Club International; Sweden Calling Dxers; and their individual reporters. Thanks for stopping by. See you next month!

Dialta Amateur Radio Supply

212 - 48th Street
Rapid City, South Dakota 57701
605-343-6127

INTERNATIONAL FAVORITES



and

INFO-TECH

ELECTRONIC
EQUIPMENT

RTTY and Morse demodulators

Interested in RTTY?

Free brochure!

SEE US FOR THE BEST DEAL

Call Us

SHORTWAVE LISTENERS!
DECODE Morse, RTTY, and ASCII signals
SAVE \$

ON THE LINE

NEW AND EXCITING TELEPHONE TECHNOLOGY



Advanced, Multi-Function Telephone Communications

ANOVA Electronics' Model 7000 Telephone Center is an advanced, multi-function system offering automatic answering and dialing, a full duplex speaker phone, as well as a variety of unique features not previously available in a single operating unit.

The automatic answering system is equipped with dual minicassettes which can record up to sixty minutes of incoming messages. As an innovative and practical feature with special interest for the small business operator, the ANOVA Telephone Center electronically records all incoming call times and dates, then automatically displays them during message playback, to provide a complete and accurate call log.

An exclusive seven-channel message tape allows for two regular use announcements, as well as for Tape Full and Announce Only. In addition, three Emergency Auto-Dial messages can be programmed for automatic activation by the ANOVA Protection Center.

Up to 16, 15-digit numbers can be pre-set in the ANOVA Telephone Center for automatic one-button dialing. Special dialing instructions (i.e., credit card account numbers, etc.) also may be pre-set via the unit's ability to link multiple series of digits together, and calls may be automatically charged to MCI, Sprint, or other long distance reduced-rate services.

Providing for immediate access to recorded messages from an outside location, a remote control "beeper" activates tape playback, skip, repeat, or erase functions from virtually any telephone, anywhere. A Remote Message Indicator signals the user to hang up if there are no messages, in order to avoid toll charges. Other key features of the Telephone Center are an automatic or inter-

val redial, a digital message counter, dictation and conversation recording, call timing, call screening, and call holding.

Although it utilizes sophisticated electronic technology, the ANOVA Telephone Center has been human engineered for optimum operational simplicity. Reflecting the unit's contemporary styling, only the operating controls used most often are visible, while those for the less frequent programming functions are hidden behind a convenient lift-up panel.

For more information, contact ANOVA Electronics, 3 Waters Park Dr., San Mateo, CA 94403, or circle number 114 on the reader service card.

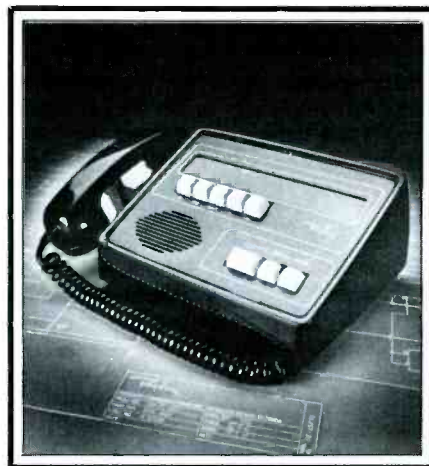

Regency Introduces Digital Tone Remote Control

Regency Communications' MA-312 is a digital tone remote control. The MA-312 may be used as extended local control, or remote control, from a base station. Optional adaptor boards are available to interface the MA-312 with desk top and rack mount

base stations. Other features include a 12 hour digital clock and a V.U. meter.

The MA-312 has its price set at \$525.00. For more information, contact Regency Communications, 1227 South Patrick Drive, Satellite Beach, FL 32937, or circle number 116 on the reader service card.

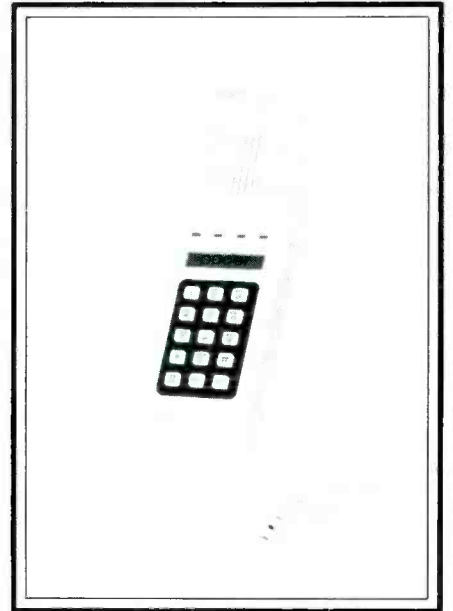

The New P1000S Speakerphone

Pathcom Inc., manufacturers of PACER Telephones, has introduced the PACER Speakerphone, model P1000S. Besides the full duplex speakerphone feature, the PACER can be used as a one-piece telephone for private conversations. Other features include pushbutton dialing, last number re-dial, four volume levels, locking mute button, ringer on/off, and switchable 10/20 pulse per second dialing.

The suggested retail price is \$99.95. For more information, contact Pathcom Inc., 24105 South Frampton Ave., Harbor City, CA 90710, or circle number 115 on the reader service card.

Advanced Cordless Telephone System

Mura Corporation has announced the introduction of an advanced cordless telephone system. This telephone system, the MURAPHONE MP-800/801, is two complete telephones in one system. The switchable universal rotary and DTMF (tone) based system provides the consumer with a 32-number memory dialer with automatic last number redial. Operating range of the



MP-800/801 is conservatively rated at 1,000 feet (depending on local conditions).

Features of the unit include full FM duplex, microprocessor circuitry for both versatility and RF stability, full duplex intercom between Base and Remote—enabling either unit to activate the intercom mode while putting an outside call on hold. The system automatically releases the hold so the telephone is never busy. The Base unit will accept up to five separate Remote units, and the Remotes can be paged from the Base unit either individually or all at once.

The system's 32-number memory dialer and last number redial can be accessed from both the Base unit and the Remote unit. The MP-800/801 also allows the user to automatically switch between DTMF touch tone and Rotary pulse dialing. It also allows for switching from pulse to DTMF for MCI and Sprint type calls.

In addition, over 1200 privacy/security codes per channel enable the owner to program his own personal code system. MURAPHONE MP-800/801 also incorporates the Mura SAGE™ PHONE's micro-computer voice synthesizer. The voice synthesizer aids in programming the unit and will read out all numbers stored in the memory—either individually or all of them sequentially. This voice synthesized read out is available at both the Base and Remote units.

"The MURAPHONE MP-800/801 incorporates the most sophisticated microprocessor technology yet developed for telephone applications," company president George Hardy said. "The system is compatible with PABX office systems and can access the entire range of information storage and retrieval through its DTMF touch tone dialing system. It is the ultimate cordless telephone for the home or the office."

The new MURAPHONE MP-800/801 is available now and carries a suggested list price of \$249.95. For more information, contact Mura Corp., 117 Cantiague Rock Rd., Westbury, NY 11590, or circle number 120 on the reader service card.

Remote Pushbutton Ease

Shown in the photo is the handset of Sony's first telephone, a cordless remote pushbutton unit called the SPP-11 Zone Phone™. Features include convenient remote operation, automatic redialing, paging from the base station, and rechargeability. The complete Zone Phone system is available at a suggested retail price of \$219.95. For more information, circle number 118 on the reader service card.

Midland's Cord Free

The Midland Cord-Free(R) telephone, Model 80-200, packs a lot of potential inside its slim, compact decorator styling. The telephone consists of two units: a base that is connected to an electrical outlet and a cordless portable handset that can receive and transmit calls within 60 feet of the base.

Compatible with all standard telephone systems (touch-tone and pulse), the telephone features a push-button dial and automatic redialing of the last number called by pressing a button on the handset. The handset features a telescopic antenna that communicates with a similar one on the base.

The power is supplied by nickel-cadmium batteries that are recharged automatically when the unit rests in its cradle.

Other features make cordless phoning convenient and virtually foolproof. The remote handset contains a talk/standby switch that is positioned to receive or transmit calls, an on/off switch on top of the unit, and a buzzer that sounds to indicate a call is coming in or someone at the base is paging the user. In addition, the handset has a slide control for volume adjustment and an indicator light signaling the need for recharging.

The base connects to an electrical outlet and a conventional telephone modular wall jack. The base also features an in-use light, a charge light, a power-on indicator, and a modular phone jack that will accept a standard extension phone. It comes with hardware for easy wall mounting if preferred to normal desk-top use.

The Midland Cord-Free(R) telephone, Model 80-200, has a suggested retail price of \$119.95. For more information, contact Midland International Corp., 1690 North Topping, Kansas City, MO 64120, or circle number 119 on the reader service card.

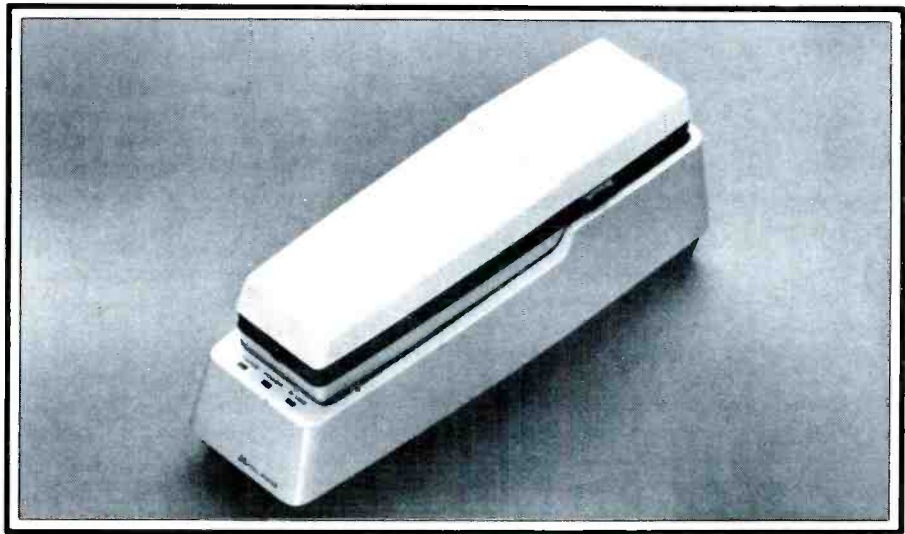

ESTABLISHING SURVIVALIST COMMUNICATIONS SYSTEMS

Powerful Stuff!

I recall reading in the newspapers a few years back that some well-meaning people in one of the Gulf states hastily organized a communications team in order to provide two-way messages with the "outside world" from their area—an area which was about to get blitzed by a rather nasty hurricane. They had everything they needed—a location which was high and dry, plenty of radio equipment, food, and a sturdy antenna which could withstand whatever nature was about to toss at them.

All went fine until the local power company's above ground lines were turned into a tangled mess of spaghetti shortly after the first healthy gusts of wind churned down the pike. It seems that they thought they had thought of everything, but no one had anticipated that trying to run the lights and communications gear from the power mains might not be entirely suitable as a long-term arrangement. They rode out the storm in darkness and radio silence!

Unfortunately, it's surprising how little thought is given to the fact that conventional public power sources may not be available just when you need them most. It's one thing to substitute candles for light bulbs when public power systems fail, but it's another story when you've got to run electronic equipment such as transmitters, scanners, or communications receivers.

So, living in an apartment building and hoping to be able to either communicate or receive anything when times get rough is going to mean preparing to have emergency power on tap. Living in a suburban home will call for the same resourcefulness. And if you are out in a rural area or hidden away in the boonies, all of this becomes more important since getting your equipment powered could easily be your problem most or all of the time!

There are various types of alternative power which could be considered for your communications needs. The following is a list of just a few of them.

Batteries

Batteries are fine, and if you've got a hand-held scanner or transceiver, the unit was designed to operate from small batteries. But remember that batteries need replacing or recharging. So you either need plenty of replacements or a way of recharging them independent of power mains. Batteries which are used in transceivers deplete their stored up power faster than ones used for receiving only (in scanners or other receivers). That is the basic reason transmitters use up more of the ol' juice than receivers.



A power inverter converts 6 or 12 volts DC, such as obtained from a battery, and changes it over to 117 volts AC. A quality power inverter will most likely be a vital part of a survivalist communications installation.

Alkaline batteries in hand-helds seem to give the longest and most reliable service of the non-rechargeable types. Whatever type of small batteries you may decide to stockpile, they'll have a longer shelf-life if you store them in a cold place; you should even remove the ones installed in the radios for such storage when they're not in use.

Larger batteries of the lead-acid type (such as used in vehicles) will probably deliver sufficient 12-volt power to run communications equipment. However, you'll have to check your equipment to make certain it has been designed for 12 VDC operation. Obviously, equipment designed exclusively for 117 VAC operation can't be operated from a battery without the use of a power inverter.

Remember that lead-acid batteries also need recharging and you'll have to figure out a way of accomplishing this independent of the power mains. One way might be to use the jumper cables attached to the (proper) terminals of the battery in a vehicle and then running the vehicle's engine for a period of time. It's not a good idea to use the vehicle battery itself to operate the electronics gear because if you drain it you won't be able to start the vehicle!

Keep in mind that whether you're talking about little AAA batteries or large lead-acid types, there are no bargains in batteries. A really good heavy duty lead-acid battery is usually priced at slightly more than \$200 (and weighs more than 140 lbs.). Power inverters come in all price ranges and power handling capabilities. Forget the chintzy \$25 ones unless you don't plan on doing anything more than operating a scanner or a transistorized broadcast portable. A good inverter which produces 550 watts of 117 VAC is going to run about \$170, while a 1000 watt unit which will hold a constant 60 cps output carries a \$400 price tag.

For several reasons (including system reli-

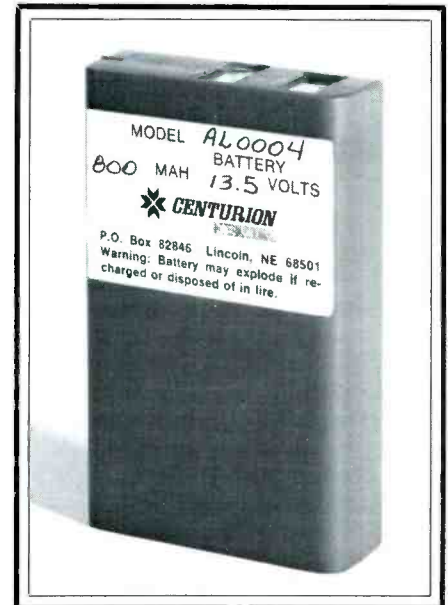

Batteries come in all sizes and working capacities for various installations from hand-held transceivers right on up to the main power source for a base station. However, they require replacement or recharging regularly. Recharging can be accomplished by any of several means.

ability at all times and quiet operation while your station is in use) the best bet is to plan your system to operate from batteries rather than directly from wind, solar, or other generating sources. Use those sources for the sole purpose of recharging the batteries you are using to power your equipment.

Wind Power

The wind is free—it doesn't have to be imported, isn't subject to the whims of OPEC, and you don't have to worry about power blackouts. Besides the obvious mental pleasures of getting energy without paying a fuel bill, you may be able to deduct up to half the cost of wind driven power generating equipment from your State and Federal income tax under the Energy Credit program. Nifty!

A reliable wind generator will deliver 200 watts (15 volts, 14 amps), cost less than \$600 (before tax credit), and comes complete with a tower. Some areas have zoning restrictions which don't permit wind-driven power generators. On the surface, these restrictions appear to be perpetuated by those who don't like the looks of the devices in the neighborhood or who complain that the slowly revolving propeller "causes snow" on their TV sets; mostly, it's the power utilities who don't like people to put these things up.

Your best bet is to check your local area zoning regulations if you're considering wind power.

If you install a wind power system, you don't have to sit and wait for a special emergency to use it. The system can be placed into regular daily use charging a battery used to supply your regular electric power needs. In some areas of the nation there are laws which require local public utilities to purchase electric power generated by wind driven systems in the event the owner has no use for the power at certain hours of the day or night. That would give you quite a leg up on shaving your electric bill!

For more information on homebrew wind generated electric systems you can contact: Windpower Co., 110 Sanborn, Big Rapids, MI 49307 for new equipment, or Roland Coulson, RFD 1 Box 225, Polk City, IA 50226 for reconditioned equipment, old but good. You might also wish to check with the publishers of a magazine entitled *Wind Power Digest*, 109 E. Lexington, Elkhart, IN 46514, as they publish a comprehensive directory of sources of wind energy hardware. It's titled the *Wind Energy Directory*—check with the publisher for the price of the latest edition.

Gasoline Generators

The most popular traditional emergency power system is the gasoline generating unit, including similar ones which operate from LP gas or on diesel fuel. While there are some shortcomings to gasoline generator use, they are nonetheless versatile and have earned themselves a fine reputation for supplying power in a pinch. Many companies now produce these generators in a wide variety of generating capacities, prices, and operating features. Among the better manufacturers are: Heath, Kawasaki, Kohler, Power Guard, Shibaura, Caterpillar, Cummins, Homelite, Empire, I.D.E., Onan, M.T.U., Allis Chalmers, Lister, Deutz, Waukesha, Westerbeke, Pincor, Detroit Diesel Allison, Suzuki, Honda, Dometic, and Generac.

Typical prices/specs: The Shibaura SG-500 kicks out 400 watts of 120 VAC and 100 watts of 12 VDC; it has a 1/2-gallon fuel tank which will keep it going for up to four hours. Weighing in at 44 lbs., it costs about \$350 (Sears sells them).

The Power Guard unit produces 2,500 watts of 120 VAC and 180 watts of 12 VDC. I've seen it selling in the \$560 price range.

The Dometic R-38 generator pumps out 3,800 watts of 120 VAC and 12 VDC. The gasoline version sells for about \$1,300, while the LP gas model is approximately \$1,500.

Generac (like most manufacturers) has several models in their line of generators. Their big monster unit, the Model 8227, comes up with a whopping 7,000 watts, which is enough to run your commo equipment and pretty much anything else you might have a need to power this side of a cyclotron. It weighs in at 282 lbs. and costs a bit

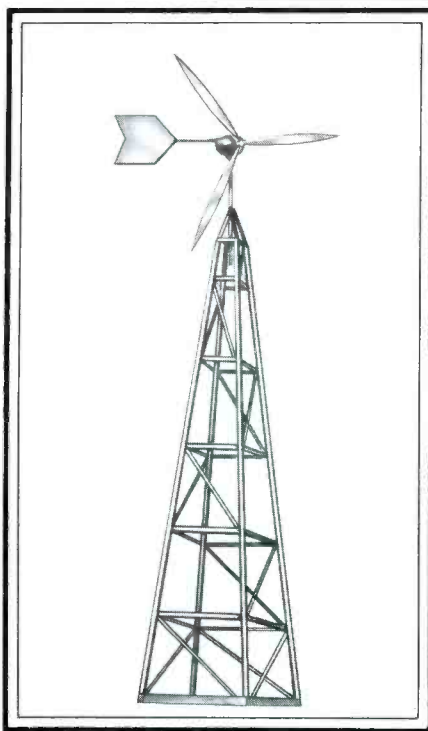

Wind generated power is rapidly becoming popular (again) because the systems are so reliable and versatile—and the breezes which keep them going aren't subject to the price whims of OPEC or the "shortages" of the oil companies!

on the far side of \$2,100. Their Model 8467 diesel unit puts out 3200 watts, weighs 280 lbs., and will run you about \$2,400.

There are certain things to look for in a generator. These special features include an automatic low oil shutdown to protect the engine, a spark arrest muffler (for instance, one approved by the U.S. Forest Service), an in-line fuel filter, electronic ignition system (no ignition points to maintain), recoil starter, constant engine speed, easy maintenance, vibration reducing mounts, automatic voltage regulation, portability, circuit breaker, and an enclosed alternator to protect it from rain, snow, and dirt.

There are also some things to keep in mind. You've got to have safe storage facilities for the fuel. Some units generate lots of ignition noise along with the electricity, and this can make radio reception a bit hairy. These units are intended for outdoor use only and should never be used indoors; and many units are not intended for use when it's raining. Anti-fire precautions must be taken when fueling the engines. Extra parts such as drive belts and spark plugs must be kept on hand.

Solar Power

Yes, solar power is something to consider, too. A company called Solarex makes a hand-held portable broadcast band receiver which is powered by nine solar cells producing 3.5 VDC in bright sunlight. The power is stored in two AA NiCad batteries. The solar cells can also be used to charge batteries for

Bearcat® 210XL Super Scanner

Look what you get with the Bearcat 210XL. Exciting, new spaceage styling. No-crystal, pushbutton tuning. New, 18 channel, 6-band coverage of over 6000 frequencies. And features like 2 scan speeds. Automatic Squelch, Search, and Lockout. Direct Channel Access. Selective Scan Delay. And much more. There's never been a Scanner like the Bearcat 210XL.



"TAKE IT FROM A SMART OPERATOR."

Don Adams

BEARCAT 210XL SCANNER \$229.

THE LOWEST PRICED, FULL-FEATURE, BEARCAT NO-CRYSTAL SCANNER EVER.

Bring home all the real excitement of scanning, and save! Bearcat 160 features a smooth, keyless keyboard for all controls including volume and squelch. Has 5-band, 16 channel coverage. Priority, Selective Scan Delay, Automatic Lockout and Search. And much more. Bearcat is number one in scanning.

"TAKE IT FROM A SMART OPERATOR."

Don Adams

\$189. BEARCAT 160 SCANNER

Electra Electra Company Division of Masco Corp. of Indiana

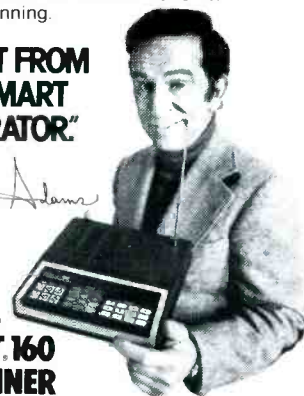

Add \$7.00 per scanner for U.P.S. ground shipping in the continental U.S. Send your cashier's check or money order to our address below or order by phone if you have a Visa or Master Charge card.

COMMUNICATIONS ELECTRONICS™

854 Phoenix □ Box 1002 □ Ann Arbor, Michigan 48106 U.S.A.
Call TOLL-FREE (800) 521-4414 or outside U.S.A. (313) 994-4444
CIRCLE 80 ON READER SERVICE CARD

other equipment—the 40 milliamps they produce will charge AA size batteries. They can also be used to power other equipment which uses 3.5 VDC.

Solar Electronics (156 Drakes Lane, Summertown, TN 38483) is now producing a line of solar powered communications equipment which has already proven itself quite efficient and effective, even under adverse weather conditions. Solar Electronics will send you some information on this equipment upon request. If you've got a communications receiver, you might be able to listen to some of the Solar Electronics folks on the air. They can often be found on the 15-Meter Ham band (21.331 MHz) on Tuesdays and Thursdays between 1500 and 1700 GMT, and also between 1800 and 2100 GMT; if you've got a Ham station you can even work 'em. Look for Mark, WA4LXC.

Fine attention is being given to the potential use of solar power for radio communications by Solar Innovations Corp. (18 Cloverdale Ave., Salem, MA 01970). Their *Star Trek* portable solar powered generators are available in many models and each model is modular and upgradable so that power can be added after the original system is deployed. Ask them for complete details.

Encon Corporation (27584 Schoolcraft, Livonia, MI 48150) produces a fine line of photovoltaic systems intended to power communications equipment. Write to them!

ARCO Solar, Inc., whose solar power products are being offered through 2,500 dealers across the United States and Canada, is a major force in this exciting field. Amongst their dealers are leading communications suppliers; you might check with your local electronics outlet to find out more about their products.

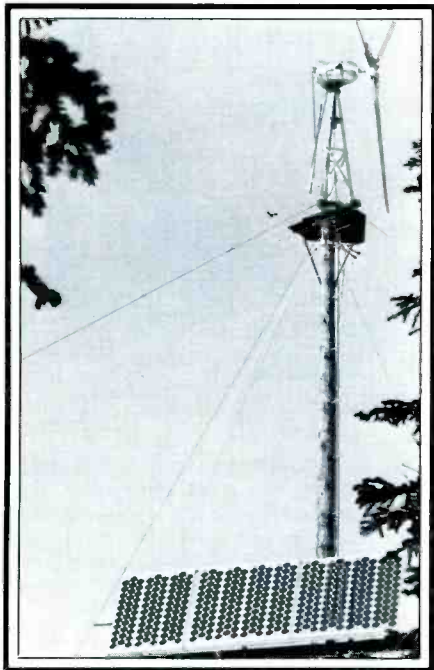

This installation in Alaska makes good use of wind and solar power combined. (Photo courtesy of ARCO Solar Inc.)



Photovoltaic cells develop electricity from the sun and are suited to many communications applications, including battery charging. Here's a complete portable solar-powered communications system (which includes a battery, collapsible antenna, and solar panel). It's produced by Solar Electronics in Tennessee.

Water Power

I bet you thought I wasn't going to mention water powered electric generating! Well, frankly, I wasn't, but I didn't want to cause any readers to write to ask why it wasn't included in our summary of alternative power sources.

Actually, water is a fine source of electric power and I recommend it highly. It is, however, not something easily suited to portable use or installation at temporary sites. It is best used at a rather permanent site or installation, and it goes without saying that you have to have access to a relatively nearby river or stream of suitable size and current flow. However, if that's your situation, then you may want to check out its possibilities. You can generate anywhere from 100 to 1-million watts, depending on the water source and equipment you use, and easily become completely power independent. A good source of information on water powered electric generating equipment is Ron Bierer, Water Power Machinery, 2505 Highway 93 North, Hamilton, MT 59840.

Human Power

Let's not forget that old last resort, human power. That means generating electricity for your needs by means of a foot or hand crank generator. It can be done and chances are you can design your own unit around a bicycle frame, pedals, and a generator hooked to a drive belt. You can also seek out a military surplus hand-crank generator. These were plentiful during the 1940s and 1950s but seem to have become less popular in recent years.

We have seen several companies offering the type G-8/GRC hand-crank generators which supply 6 outputs on 3 independent windings, 30 to 400 volts, 6 and 12 volts. The G-8/GRC is currently priced between \$85 and \$90. The unit can operate a low power transceiver directly or can be used to charge batteries. Two sources noted offering these recently are Core Resource, P.O. Box 4526, Mountain View, CA 94040 and B.W. Trading Co., P.O. Box 692-1052, Newark, OH 43055.

Insofar as buying a "ready to ride" bicycle-type pedal electric generator, I've never located any national manufacturer offering one—although there may be some local outfits making them for hometown consumption. You might wish to write to the following places to see if they can supply plans or information on building one for yourself:

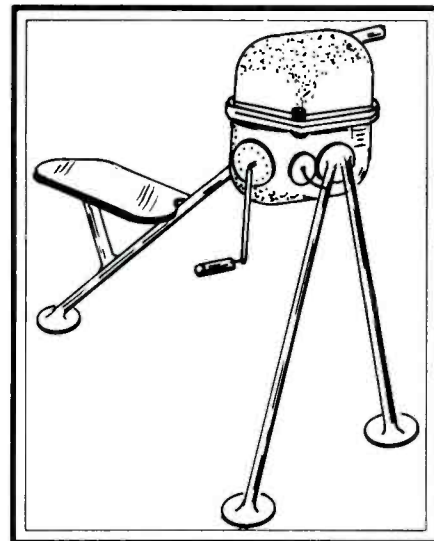

When everything else fails you can always generate your own electricity by the old tried and proven "armstrong" method. These 30-year-old hand-crank military surplus electric generators are still available and represent a backup system worthy of consideration for emergency power.

North Shore Ecology Center, 3070 Dato, Highland Park, IL 60035 and Ananda Village, Nevada City, CA 95959. A reader advises that these companies may be able to supply this information for a minimal fee.

Personally, I would consider a foot/hand crank generator as a system of last resort or secondary back-up system. I would use it only after the power mains go, and after you run out of fuel for the gasoline generator!

Don't Forget

Whether you plan on running your equipment directly from one of the various generators or from generator-charged batteries, you'll have to make a listing of all of the equipment you have which will require power. You must then obtain a system which will be able to provide sufficient power for your requirements with a buffer margin left over, just to be sure. While older tube

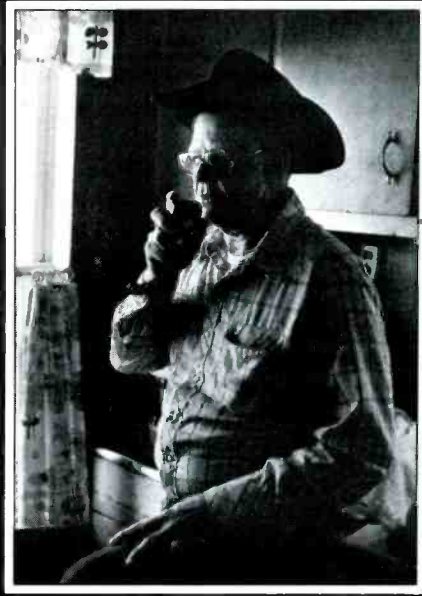

Ray Rudd has lived in the remote Beartooth Mountains, north of Billings, MT for 43 years. For the past two years, he has had electricity thanks to three solar modules and two batteries which power 15 lights, a radio receiver, and a transceiver. (Photo courtesy of ARCO Solar Inc.)

type communications equipment required more power than modern solid state gear, you may still find that a few pieces of modern equipment add up to more of a power requirement than you would have thought. You may also want to use your emergency power equipment to operate lighting, heating, refrigeration, and even Granny's heating pad. What with one thing here, another thing there, the old juice gets "spoken for" pretty fast!

Some examples of the power requirements of communications gear: a scanner uses 10 watts (120 VAC), a communications receiver about 40 watts, and a 10 watt transceiver will draw 40 watts while you are receiving but about 100 watts when you are transmitting. Contrast these with other electricity-using devices you may wish to run from your system: electric heating pad, 60 watts; electric hotplate, up to 1,100 watts; electric baseboard heater (8 ft. long providing 6,820 BTU), 2,000 watts!

So, if you run your communications equipment and appliances directly from a generator, that source will have to have sufficient capacity to handle the load. And if you are going to operate from generator-charged batteries, the batteries will have to be able to meet the load requirements, while the generator used to recharge the batteries will have to be sufficient to keep the batteries under constant full charge.

In our next issue we will put the spotlight on using windpowered generators for your station. I've rounded up an expert in this field who has long used it in conjunction with communications equipment and he's got some valuable (and eye-opening) revelations to boggle your minds!

May We Recommend

The Longwave Club of America, 45 Wildflower Rd., Levittown, PA 19057. Here's a club for those rugged enthusiasts interested in knowing what's happening below 540 kHz! Their monthly publication, *The Lowdown*, not only covers listings of stations operating between 10 and 540 kHz, but also has interesting coverage of the 1750 Meter (no license) low power communications band as conducted by Ken Cornell (W2IMB—well known "Lowfer" authority. Membership includes mailing of the publication by First Class Mail and costs \$10 per year (anywhere in the world).

When writing to the above, please mention that you saw it in POP' COMM!

SWL - DX - HEADQUARTERS

10 Miles West of Washington, D.C.

RECEIVER SALE

YAESU FRG7700

The shortwave listener's dream: to have the best is now a reality. YAESU, the leader in quality communications equipment, proudly introduces the FRG 7700 all mode communications receiver.

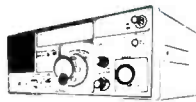

SAVE \$70

• General coverage 15-30 MHz		
• All mode AM, CW, SSBand, FM		
• Digital frequency/Time display		
• 12 channel memory	SALE \$149	
• FR77700 antenna tuner	SALE \$ 59	
FRG7700	\$549	SALE \$479
FRG-7	\$339	SALE \$289

KENWOOD R-1000	\$499	SALE \$449
KENWOOD R-600	\$399	SALE \$359
DRAKE R-7	\$1549	SALE 1467
SONY ICF-2001	\$349	SALE \$299
PANASONIC RF-3100	\$349	SALE \$289



McKay DYMEC Sets the Standard
ACTIVE ANTENNA
DA100D Reg. \$154.95 SALE \$139.00

PALOMAR LOOP ANTENNA

The answer for the serious BCB DXer. Rotates to null out that local station and open the airwave to those DX stations you didn't know were there.



One loop amp required \$77.50
Choose 1 or more loops for your favorite bands) \$59.95 ea.

Runs on 9V battery supplied FREE

RTTY-CW-ASCII

See What You've Been Missing!

Stay in touch with world events, monitor weather, ship traffic, and radio amateurs. Connect to your receiver and display shortwave radio teleprinter and Morse code transmissions.

INFO-TECH M 200F

Trimode Converter

The Ultimate in Morse, CW, and Teletype reception. Fill your TV screen* with never ending printed information from around the world. CW-RTTY-ASCII. News services converted to video.



Sale \$549
LIST \$610

*TV monitor required. YOUR FINAL COST \$489
From \$149 up with \$60 factory rebate

HAL COMMUNICATIONS CORP.

CWR-6700 TELEREADER

- Receive ASCII, Baudot RTTY, or CW
- Six standard RTTY speeds
- 16 lines by 36 or 72 character display
- Two page video display
- Parallel ASCII printer output
- Requires ±12 VDC and external TV monitor
- *TV monitor required. From \$149 up



AEA-MBA Top of the line self-contained CW-RTTY-ASCII Reader. Bright blue 32 character display. MBA is ideal for SWLs. Harms and for monitoring news or weather broadcasts even while at sea. MBA \$299.95 12VDC Supply \$14.95
BOTH ONLY \$289.95

KANTRONICS Mini-Reader CW-RTTY-ASCII Reader with clock all in one compact unit. Fits into palm of your hand. Readout on moving display 10 easy to read characters. Mini-Reader. Ext. 12V Pwr. Pk. Demo Display Tape. Retail at \$289.95

Sale Price \$259.95

THE EEB Book Store

Books Add More Enjoyment to Your SWLing

• Federal Frequency Directory 2,420 MHz	\$14.95	• 1982 WRTVH—The World's Most Authoritative Directory of International Broadcasting	\$16.50
• SWL's Manual of Non-Broadcast Stations	\$12.95	• World Press Services	\$5.95
• How to Tune the Secret Shortwave Spectrum	\$6.95	• Better Shortwave Reception 4th Edition	\$4.95
• Complete Handbook of Radio Receivers	\$9.95		

Prices subject to change without notice.
UPS charges not included.
No CODs.



Electronic Equipment Bank
516 Mill Street, N.E.
Vienna, Virginia 22180
800-368-3270 Order Desk
Except Va, Ak, Hi
703-938-3350 Va. Orders and
Technical Info

Scanning On The Brink(s)

BY RICK MASLAU, KNY2GL

There's no doubt about it. No security carrier or armored car service has been in the news media more than Brinks Incorporated. Brinks is a major national factor in this industry and is therefore probably the long established first choice of those wishing to transport large amounts of valuables, including cash, jewelry, bullion, and various other high profile items.

Unfortunately, this has given the crazy notion to a certain element of society that to attempt to separate Brinks from some of those items in their care could be a highly profitable (if not risky) adventure. Indeed, on January 17th, 1950, several masked and armed men entered the Prince Street office of Brinks in Boston and made off with \$2,750,000—and in 1950 that amount of money was far more awesome than it is even now; it would be the same as \$8 million today, maybe more. That was perhaps the most highly covered (in the media) ripoff in modern times, and they even made a 3 hour major motion picture about it in 1976! However, the criminal intentions towards Brinks have hardly slackened over the years, and a number of successful (and unsuccessful) attempts have been made to pull off another "Great Brinks Robbery."

A recent attempt which gained national attention took place in Nanuet, NY in October 1981. It was a bungled job which cost several people their lives. The \$1,600,000 taken was recovered quickly, and those suspected of planning and participating in the escapade were also rounded up within a relatively short period of time. They are awaiting trial as this is being written. Allegedly, the prime motivation for that particular ripoff was to finance an amalgamation of several radical political groups.

None of these events have probably been cause for *Messrs. Brinks* to achieve any piece of mind, and for good reason. Brinks therefore maintains a rather extensive private two-way communications system between their armored vehicles and the offices, and much use of it is made for dispatching and emergency purposes.

If you've got a scanner, you can monitor these stations. Here are their locations, call-signs, and operating frequencies.

Brinks Incorporated Station Roster

Location	Callsign	Frequency
CA Indio	WOI402	44.20
CA Montrose	KTV725	44.20
CA Oakland	KTV726	44.20
CA Running Springs	WOI402	44.20
FL Jacksonville	KKR478	159.495
FL North Miami	KWE610	159.495
FL Orlando	KJF284	159.495
FL (statewide)	KA68479	159.585
FL Sun City Center	KQG359	159.495
GA Atlanta	KIU567	159.495
IL Chicago	KTC828	159.495
	KE8127	474.3125
	KZZ778	159.495
IN Gary	KTK608	159.495
IN Indianapolis	KWI807	159.495
KS Kansas City	KLO426	159.495
ME Falmouth	KJK651	44.44
MD Bethesda	KVN930	159.495
MA Waltham	KLM584	159.495
MA Wilbraham	KTK605	159.495
MI Detroit	KIB721	159.495
MI Flint	KTK606	159.495
MN Minneapolis	WQJ974	159.495
NY Endicott	KRO318	159.495
NY New York City	KWV708	159.495
NY Syracuse	KWT699	159.495
NY Tonawanda	WBB402	159.495
NC Charlotte	KLW364	159.495
NC Raleigh	KYI907	159.495
OH Akron	KWT698	159.495
OH Beachwood	KWE356	44.44
OH Cincinnati	KYI923	44.44
OH Columbus	KYI924	44.44
OH Dayton	KRO339	159.495
PA Philadelphia	KYZ687	464.125
PR Cayey	KF9190	159.495
PR (all areas)	KWT697	44.20
TX Beaumont	KM5897	44.44
US (all areas)	KF9190	159.495
	KL5523	159.495
	KL8820	159.495
	KP5039	159.495
VA Chesterfield	KLW362	159.495
VA Culpeper	KQW481	44.44
VA Norfolk	KLW363	159.495
VA Richmond	WBB98	72.08
WI New Berlin	KTK609	159.495

“10” Code

Used by many
law enforcement agencies

- | | |
|--|---|
| 10-0—Caution | 10-48—Traffic standard needs repairs |
| 10-1—Unable copy—change location | 10-49—Traffic light out at . . . |
| 10-2—Signal good | 10-50—Accident (F, PI, PD) |
| 10-3—Stop transmitting | 10-51—Wrecker needed |
| 10-4—Acknowledgement (OK) | 10-52—Ambulance needed |
| 10-5—Relay | 10-53—Road blocked at . . . |
| 10-6—Busy—stand by unless urgent | 10-54—Livestock on highway |
| 10-7—Out of service | 10-55—Intoxicated driver |
| 10-8—In service | 10-56—Intoxicated pedestrian |
| 10-9—Repeat | 10-57—Hit and run (F, PI, PD) |
| 10-10—Fight in progress | 10-58—Direct traffic |
| 10-11—Dog case | 10-59—Convoy or escort |
| 10-12—Stand by (Stop) | 10-60—Squad in vicinity |
| 10-13—Weather—road report | 10-61—Personnel in area |
| 10-14—Prowler report | 10-62—Reply to message |
| 10-15—Civil disturbance | 10-63—Prepare make written copy |
| 10-16—Domestic problem | 10-64—Message for local delivery |
| 10-17—Meet complainant | 10-65—Net message assignment |
| 10-18—Complete assignment quickly | 10-66—Message cancellation |
| 10-19—Return to . . . | 10-67—Clear for net message |
| 10-20—Location | 10-68—Dispatch information |
| 10-21—Call . . . by telephone | 10-69—Message received |
| 10-22—Disregard | 10-70—Fire alarm |
| 10-23—Arrived at scene | 10-71—Advise nature of fire |
| 10-24—Assignment completed | 10-72—Report progress on fire |
| 10-25—Report in person (meet) . . . | 10-73—Smoke report |
| 10-26—Detaining subject, expedite | 10-74—Negative |
| 10-27—(Drivers) license information | 10-75—In contact with |
| 10-28—Vehicle registration information | 10-76—En route |
| 10-29—Check record for wanted | 10-77—ETA (Estimated Time Arrival) |
| 10-30—Illegal use of radio | 10-78—Need assistance |
| 10-31—Crime in progress | 10-79—Notify coroner |
| 10-32—Man with gun | 10-80—Chase in progress |
| 10-33—EMERGENCY | 10-81—Breathalyzer report |
| 10-34—Riot | 10-82—Reserve lodging |
| 10-35—Major crime alert | 10-83—Work school xing at . . . |
| 10-36—Correct time | 10-84—If meeting . . . advice T |
| 10-37—(Investigate) suspicious vehicle | 10-85—Delayed due to . . . |
| 10-38—Stopping suspicious vehicle | 10-86—Officer/operator on duty |
| 10-39—Urgent—use light, siren | 10-87—Pickup/distribute checks |
| 10-40—Silent run—no light, siren | 10-88—Advise present telephone # of . . . |
| 10-41—Beginning tour of duty | 10-89—Bomb threat |
| 10-42—Ending tour of duty | 10-90—Bank alarm at . . . |
| 10-43—Information | 10-91—Pick up prisoner/subject |
| 10-44—Request permission to leave patrol . . . for . . . | 10-92—Improperly parked vehicle |
| 10-45—Animal carcass in . . . lane at . . . | 10-93—Blockade |
| 10-46—Assist motorist | 10-94—Drag racing |
| 10-47—Emergency road repairs needed | 10-95—Prisoner/subject in custody |
| | 10-96—Mental subject |
| | 10-97—Check (test) signal |
| | 10-98—Prison/jail break |
| | 10-99—Records indicate wanted or stolen |

COMMUNICATIONS DIVISION

We treat amateurs professionally.

Fifty-four years of experience has taught Harvey a lot more about communications equipment than makes and model numbers. We have learned that the communications enthusiast needs special, highly professional treatment and that's why Harvey has an entire division devoted exclusively to this area.

Fifty-four years of experience has also taught us the value of the old-fashioned ways of doing business. We believe more in expertise than in salesmanship. We want to be of service both before and after the sale. If we don't have what you want, we'll either get it for you or tell you where you can get it yourself. But, we think your chances of finding exactly what you're looking for and receiving the help you need are better at Harvey than anywhere else in the country. Let us prove it to you today.

Yaesu
R.L. Drake
McKay Dymek
President
Cobra

Sony
Panasonic
Bearcat
Grundig

CALL TOLL FREE:
1-800-223-2642

Ask for Dou "Joe" Chin—KB2MU

HARVEY

25 W. 45th St., N.Y., N.Y. 10036 (212) 921-5920

CIRCLE 26 ON READER SERVICE CARD

PRODUCTS

REVIEW OF NEW AND INTERESTING PRODUCTS

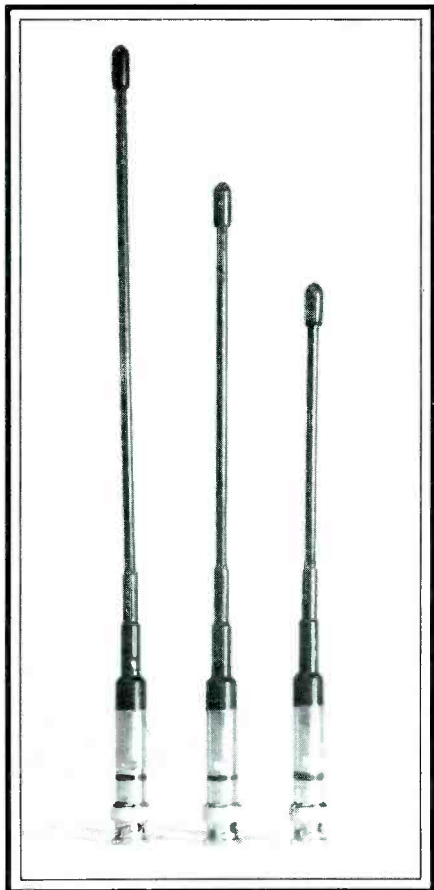

UHF Gain Antenna For Hand-Helds

Centurion has introduced a new flexible UHF gain antenna for use with hand-held radios. The new antenna features an ended design and represents a $\frac{1}{2}$ -wave radiator with approximately 2.5 dB gain over a $\frac{1}{4}$ -wave portable whip antenna.

The antenna is factory-tuned to discrete frequency from 406-512 MHz, and has a usable band of 20 MHz. The base is fitted with a BNC connector. Designated Style G, the antenna ranges in length from 7-13 inches.

For more information, contact Centurion International, P.O. Box 82846, Lincoln, NE 68501-2846, or circle number 112 on the reader service card.

Versatile Scanner

Fox Marketing, Inc. says their Fox BMP 10/60 Scanner is the world's first and smallest base unit with the flexibility of being a Base, Mobile, or Portable unit. It combines these unique features of Base, Mobile, and Portable systems in one sleek, compact, and

lightweight package with the use of two optional accessories.

Optional accessories include Porta-Pac, a portable battery pack with a separate antenna and an earphone for private listening. The Porta-Pac enables the consumer to keep the scanner with them for reports anytime . . . anywhere. Unlike hand-held scanners, the Fox has two full watts of audio, so listeners can hear everything clearly.

The Fox scanner becomes a Mobile unit when it slides easily into the other optional accessory, the Mobile Mounting Bracket. It includes a DC power cord adaptor to operate the scanner from any vehicle's cigarette lighter and an "antenna coupler" which uses the vehicle's existing antenna for the scanner operation, without having to install a separate antenna. As a Mobile unit, the scanner receives and transmits "true life happenings" in all forms of travel, including the listeners' car, boat, truck, or motorhome. The bracket also allows for quick removal of the scanner so it can be put into a glove compartment for security or carried along to the next location.



The Fox Scanner also offers 60 pre-programmed active frequencies. The pre-programmed frequencies include the Public Service Bands for weather, police, fire, marine, and mobile telephone. The scanner has complete 10-channel programmability and will monitor all other Public Service Band Communications of emergency, Ham, ship to shore, taxicabs, forestry, industrial, ambulance, etc. It's the smallest base unit on the market today, measuring $6\frac{1}{2}$ " \times $1\frac{5}{8}$ " \times 9" and weighing only $1\frac{1}{2}$ lbs.

The scanner also includes features of *skip*, *action*, *pause*, and *seek*.

The *skip* feature allows users to selectively "skip over" unwanted channels without erasing them from the scanner's memory. Listeners can "skip" channels they don't wish to constantly monitor, such as weather.

The *action* feature, when activated, samples channel 1 every 2 seconds and automatically switches to channel 1 when there is any action. This happens regardless of whether the scanner is listening to another channel or just scanning.

The *pause* feature selectively allows the user to delay the automatic scanning process on any or all channels for 2 seconds after the end of a transmission. This allows listeners to hear the reply to a transmission before the scanner continues scanning.

The *seek* feature allows the user to seek out unknown, exciting frequencies. By entering the frequency of their choice, the user then presses and holds down *seek*, causing the scanner to seek upwards looking for unknown active frequencies. A second depression and holding of the *seek* key will cause the scanner to seek downwards for unknown frequencies. The scanner seeks in 5.0 kHz steps in the low and VHF bands and 12.5 kHz steps in UHF.

The Fox BMP 10/60 combines a contemporary design with a smooth touch sensitive keyboard which responds with a "beep" to verify positive contact of a selected key.

Suggested retail price is \$349.95. The optional Porta-Pac and Mobile Mounting Bracket are suggested at \$39.95 and \$9.95 respectively.

For further information, contact Fox Marketing Inc., 4518 Taylorsville Rd., Dayton, OH 45424, or circle number 101 on the reader service card.

Earth Station Products Brochure Available

Blonder-Tongue Laboratories, Inc., Old Bridge, NJ, is offering a new brochure which describes and illustrates the B-T line of TVRO earth station products. Five basic systems, each applicable to a specific geographic area, are detailed, along with a reference map to assist a potential user in his product selection.

TVRO earth station products available from Blonder-Tongue include: 3, 3.65, 4.6, and 5 meter antennas, low noise converters, 24 channel receivers, ESM earth station modulators, and two and four way signal splitters. In addition, the company also has available a group of auxiliary earth station products: foundation pier kits, pres-

surization kits, 0.65 meter extender ring kits, and receiver mounting trays. This complete TVRO line provides Blonder-Tongue customers with a professional system having totally compatible components.

For a copy, write to T. Zdzienicki, Blonder-Tongue Laboratories, Inc., 1 Jake Brown Rd., Old Bridge, NJ 08857, or circle number 107 on the reader service card.



Synthesized Long Distance Communications With SSB Transceiver

Modar Electronics, Inc., a subsidiary of Motorola Inc., has announced the availability of the Triton 40-S SSB Transceiver for mobile/fixed radio communications.

The Triton 40-S radio features a microprocessor controlled, dual loop, frequency synthesizer. Two versions are available: a 2 to 18 MHz, 125 watt model, and a 2 to 13.2 MHz, 150 watt capability model. Up to 40 simplex or half-duplex channels can be stored in the radio's memory, and frequencies may be changed at any time.

Frequency changes are simplified with an easy-to-use plug-in programming card accessory that includes a keypad and LED display. Other features include constant SINAD squelch for effective noise elimination between messages, electronic channel switching for operator convenience and long-term reliability, plus a dimmer switch for easy nighttime viewing of the channel selector. Also available is a noise blanker which effectively suppresses ignition noise interference.

The Triton 40-S transceiver is enclosed in a rugged, plated steel housing and weighs 18.5 lbs. Compact in size, measuring 10 $\frac{3}{8}$ " x 15 $\frac{1}{4}$ " x 4", this radio can be mounted in a variety of locations, including overhead, for user convenience. It is compatible with Motorola's fully automatic, microprocessor-controlled antenna tuner.

Additional information about the Triton 40-S SSB Transceiver, its features and capabilities, is available from Motorola Inc., Modar Electronics, Public Relations Department, 1301 E. Algonquin Road, Schaumburg, IL 60196, or circle number 117 on the reader service card.

Low Cost Quarterwave Antenna Series

The Antenna Specialists Co., with the addition of two new quarterwave antenna

series, now provides the mobile radio industry with a variety of quick-install, economy antennas. They offer excellent performance in both VHF and UHF. The new quarterwave antennas require no field tuning and can be mounted in several configurations, especially important in today's down-sized vehicle market.

The ASP-1610 unity gain series covers UHF from 406-512 MHz. It will accept 150 watts of power and exhibits VSWR of 1.5 to 1 or better. The stainless steel radiator, approximately 6 inches long, ensures long-life and service-free operation.

The ASP-1410 series covers the 136-174 MHz VHF band. They are factory tuned to eliminate any field adjustment. Power rating is 150 watts maximum, with VSWR of 1.5:1 or better.

Both series are available in low-profile rooftop, magnetic, or trunk-lip mounting configurations. A low-profile conversion model, less cable, is available in each series.

For more information, contact Marketing Department, The Antenna Specialists Co., 12435 Euclid Avenue, Cleveland, OH 44106, or circle number 105 on the reader service card.

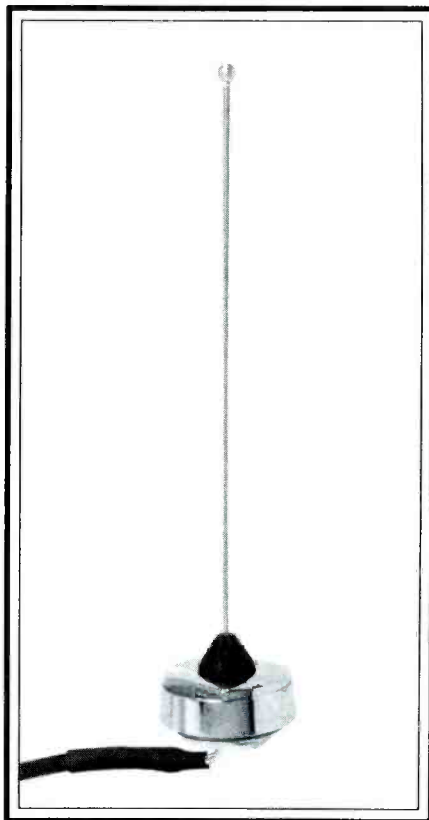

New Means Of Preventing Car Theft

Here's a low-cost answer to the auto theft problem. The GARD-A-CAR Auto Immobilizer is a new invention that stops car thieves "cold." It immobilizes the car while the thief is trying to escape in it.

Suppose a car thief breaks into your car, jumps the ignition, and gets it started. Without GARD-A-CAR that's all there is to it. With GARD-A-CAR, the engine stalls

"dead" in less than eight seconds. (When the unit is turned "on," a timed circuit breaker cuts off the electric current flowing to the distributor). There is just enough time to drive the car a few feet, if that far, and then the car stops. The thief cannot restart the engine. He is caught off guard, stranded at the scene of the crime where he's highly visible. He must flee by foot or be caught. Your car is left behind.

GARD-A-CAR is thwarting car thieves because stopping the engine catches them unaware. The car appears to have gone haywire—out of gas or carburetor flooded. Only the car owner knows that his car has the control box to do this. It can easily be hidden and the GARD-A-CAR people have a list of the best hiding places.



The control box is operated by flipping the switch "on" when leaving the car and "off" when returning. If an attempt is made to start the car, the element is reset by pressing the red button.

Car owners install GARD-A-CAR themselves in a few minutes (or they can take it to any auto service station). There are no holes to drill. Just connect two wires to the 12-volt hot wire that runs from the coil to the distributor. The unit is designed for any ignition system, conventional or electronic. There is no interference with normal car operation. Also, GARD-A-CAR can be used in conjunction with other anti-theft devices as a fail-safe. The GARD-A-CAR Auto Immobilizer comes complete with connectors and easy instructions. It's from GARD-A-CAR, Inc., 9505 Groh Road, Grosse Ile, MI 48138. For additional information, circle number 103 on the reader service card.

Headset For High Noise Environments

Controlonics Corporation announced a new Unex radio headset for use in high noise environments with applications in police, security, broadcast, and industrial communications. Designed for two-way radios, the new dual muff headset RHS-8A is an improved version of the Unex RHS-7. The 8A provides a larger ear dome design which affords a higher level of protection against ambient noise, and its modular design (mechanical configuration, cords, and connectors) and integrated electronics allow easy serviceability and adaptation for a variety of applications and requirements.



The noise cancelling electret microphone picks up intended voice transmissions, but rejects background noises, including industrial machinery and nearby conversation. Virtually no extraneous noise is returned to the ear by sidetone, thus allowing clearer communications and reducing listener fatigue. The broad flat frequency response provides excellent tone, increasing voice recognition.

All Unex headsets, lightweight, single muff and dual muff, feature the noise cancelling microphones and modular flexibility, and all are designed to deliver superior communications in maximum user comfort. For more information on the Unex RHS-8A dual muff radio headset, write to UNEX, Division of Controlonics Corporation, 5 Liberty Way, Westford, MA 01886, or circle number 108 on the reader service card.



Electrolert, Inc. Announces New Product Acquisition

Electrolert, Inc. of Tipp City, OH, announced the acquisition of the Weatheralert product line from Hinda Distributing, Inc. of Chicago, IL. The Weatheralert product line consists of seven different models of high quality, crystal-controlled VHF radio receivers designed to receive NOAA 24-hour weather broadcasts and the alarm transmissions which are broadcast during severe weather conditions.

The various models retail from \$25 and up, ranging in features from low-cost receiver to an attractive digital alarm clock/weather receiver combination, containing the severe weather alarm feature. Hinda Distributing, Inc. introduced the Weatheralert products during the early 1970s and since that time the name has become one of the best known in the industry for performance, features, and quality.

Speech Scrambler

Midian Electronics, Inc. has introduced a new speech scrambler, the VPU-1. The VPU-1 is a subminiature inversion-type scrambler employing 4 codes with two separate code groups. One code group is for government and one is for private use. The unit measures 1" x 1.85" x 5/16" and fits in most handheld and mobile radios.

The VPU-1 is capable of full duplex operation and is compatible with other fixed frequency inversion scramblers. It is priced under \$190.00. For more information, contact Midian Electronics, Inc., 5907 E. Pima Street, Tucson, AZ 85712, or circle number 102 on the reader service card.

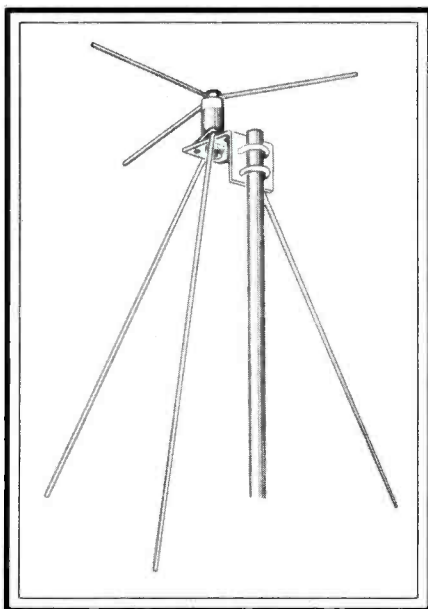
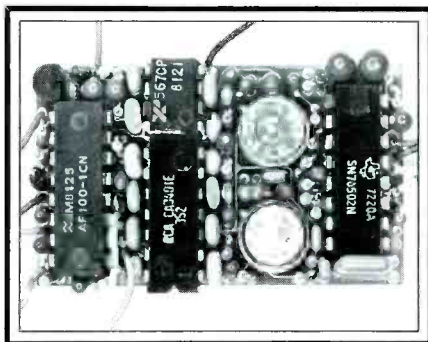

New Monitor Antenna

Recognizing the growing demand by owners of scanner monitor receivers for well performing, inexpensive external monitor antennas, The Antenna Specialists Co. has introduced the MON-64 DISCAN™. This is a new lightweight model that can increase base station reception by as much as 100 percent.

The MON-64 DISCAN provides excellent reception on the popular low band, VHF, UHF, and "T"-band frequencies from 25-512 MHz. Scanner listeners are discovering that the whip antenna that comes with the radio often is inadequate for monitoring distant stations, or for near increasing num-

ber of low powered portables in the public safety areas. The MON-64 significantly improves reception of such stations.

Weighing less than 2 lbs., the DISCAN antenna is easy to install, and comes complete with SO-239 connector and double U-clamp bracket; cable is not provided. The antenna mounts easily on any pipe or tubing up to 1/4" in diameter.

Suggested list price of the MON-64 is \$19.95. For complete specifications, write to: The Antenna Specialists Co., 12435 Euclid Avenue, Cleveland, OH 44106, or circle number 109 on the reader service card.

Fuzzbuster

The Fuzzbuster Informer radar detector utilizes an advanced integral detection system that picks up all types of radar, even the "off" frequency signals some other units might miss entirely. This new integral detection technology has created a radar detector so compact and lightweight it can be visor mounted and comes with its own bracket.

The new Fuzzbuster is low in cost yet high in performance. Best of all, the Fuzzbuster Informer is completely automatic, no knobs to turn or buttons to push. Simply plug it in and you're ready to drive.

The Fuzzbuster Informer carries a suggested retail price of \$129.95. For further information, contact Electrolert, Inc., 4949 S. 25-A, Troy, OH 45373, or circle number 106 on the reader service card.



Full Line Of VHF/UHF Monitor Antennas For Indoor And Mobile Scanners Or Receivers

A full line of indoor and mobile VHF/UHF monitor antennas has been introduced by Hustler Inc. These multi-band antennas round off Hustler's already complete line of CB, amateur, and professional communications products. Hustler monitors were designed for optimum reception on the most-listened-to bands—37-50 MHz (VHF), 150-174 MHz (VHF), and 450-512 MHz (UHF). Calls on these bands include police, fire, forestry service, utilities, business, railroad, marine, hospitals, paramedics, weather alert, ambulance, disaster relief, taxis, and mobile telephone.

Hustler monitor antennas are precision-built and engineered to never need trimming or adjusting. That feature eliminates the annoyance of resetting the antenna length

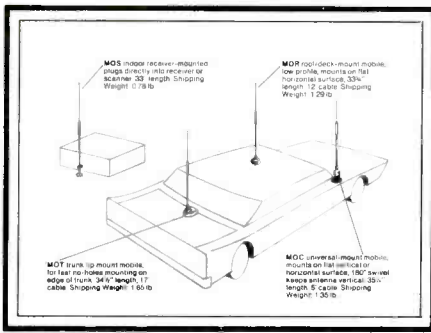

every time a different band is scanned, as with other monitor antennas. The line includes the 33-inch Model MOS indoor receiver-mounted antenna which plugs directly into a receiver or scanner.

Model MOR has a specially engineering low-profile mount that installs easily on a flat horizontal surface, like a roof or deck lid.

Model MOT is a trunk lip mount antenna designed for fast no-holes mounting on the edge of most trunks and hatchbacks.

Model MOC is a universal-mount mobile antenna easily mounted on a flat vertical or horizontal fender surface, with an adjustable 180° swivel to keep the antenna vertical.

Finally, the model MOM is a magnetic mount mobile antenna for temporary scanner installations.

Each new Hustler monitor antenna is made from the finest high-quality long-life materials, including tough corrosion-resistant stainless steel, high-impact plastics, and triple-plated chrome components. The above mobile models include 17' top quality coaxial cable and installed connectors.

For further information on these or other Hustler antenna products—including amateur, professional, or CB—write: Sales Department, Hustler, Inc., 3275 North B Avenue, Kissimmee, FL 32741, or circle number 111 on the reader service card.

Motorized Antenna Control Unit

A new motorized antenna control unit, SATSCAN Model 6197, from Channel Master, offers armchair ease of operation and maximum control in locating satellites. The unit's digital readout continuously displays a 3-digit satellite reference figure accurate to one-third of a degree for precise antenna orientation at all times. Simple up/down pushbuttons rotate the antenna through the entire satellite belt. A complete sweep of the belt takes about 30 seconds.

To save wear on the antenna motor, rotation is automatically stopped at the end of the satellite arc. Complete reliability and long operational life are ensured by the use of a heavy duty linear actuator motor with a low 12-volt DC power requirement that minimizes shock hazard. Full power is used only when the up or down buttons are pressed. Standby voltage is minimal. In the case of power interruption, the Analog Feedback Power Loss memory allows the unit to retain

and display its current satellite location when power is restored.

The antenna control unit can be installed up to 1000 feet away from the dish without adding extra line boosting equipment. This is accomplished by a special voltage selection panel located on the rear of the console.

Each unit comes with a dealer site-specialized Satellite Location Reference Card which gives the specific 3-digit reading for each satellite. Further information can be obtained by circling number 113 on the reader service card.



XK Radar Detectors

The Fox XK and Fox XK Remote are radar detectors that are impossible to see because of their unique designs. Tested under actual road conditions, the Fox XKs offer superior radar warning on both X and K bands.



Fox XK mounts on the sun visor and offers superior detection capability. Improved circuitry has reduced the "false" alarm levels and increased sensitivity to pulsed radar signals. Suggested retail price is \$149.95.

Fox XK Remote is impossible to see, eliminating the possibility of theft or harassment. For maximum concealment, the Fox XK Receiver is hidden behind the vehicle's grille, while the Control/Warning device is mounted under the dash, keeping the entire system hidden from view. Suggested retail price is \$199.95.

Fox Marketing has a full line of radar warning devices, including: SuperFox, remote super-heterodyne and SuperFox Vixen, one of the world's smallest super-heterodyne radar detectors.

For further information, please contact Fox Marketing, Inc., 4518 Taylorsville Rd., Dayton, OH 45424, or circle number 104 on the reader service card.

RTTY RADIOTELETYPE FREQUENCY LISTS

2000 WORLDWIDE RADIOTELETYPE STATIONS BY FREQUENCY... World Press Services Frequencies & Manual. All press services, frequencies and transmission times. BOOK with 3 LISTS... \$8 ppd.

UNIVERSAL ELECTRONICS
1280 AIDA DR. • REYNOLDSBURG, OH 43068
CIRCLE 68 ON READER SERVICE CARD

INSTALL YOUR OWN PRIVATE TVRO SYSTEM!

Here is a complete home TVRO satellite receiving system that you can install yourself. Call or write for more information and our FREE brochure detailing systems, components and accessories.

Complete 10' and 12' systems: CALL TODAY!

TVRO-10\$2995	TEK Microwave Corp 22518 - 97th Ave No. Corcoran, MN 55374 612-488-8814
TVRO-12\$3495	

Plus freight charges
24 channel receiver
Drake ESR-24\$969

CIRCLE 31 ON READER SERVICE CARD

SATELLITE TV SYSTEMS
"COMPARE OUR QUALITY, PRICES, AND SERVICE!"

WE MANUFACTURE:

Parabolic Dishes	Motorization Systems
Polar Mounts	LNA Holders
Demo Trailers	Aluminum Horns

WE STOCK:

Drake	Blonder Tongue
Washburn	KLM
Auto Tech	Modulators
Amplica	Switches & Hardware
Avantek	Cable & Connectors
Chaparral	Alliance U-100 & HD-73
Avcom	

Call Or Write For Our Latest Brochure And Prices.

AUSTIN C. LEWIS K4GGC 901-784-2191	LEWIS CONSTRUCTION CO. P.O. BOX 100 HUMBOLDT, TN 38343
--	--

"IN BUSINESS AT THIS LOCATION SINCE 1964"

CIRCLE 52 ON READER SERVICE CARD

★★★★★ **A STAR IS BORN** ★★★★★

- ★ Ideal for Novices, SWL's and seasoned amateurs
- ★ Built-in code practice oscillator & speaker
- ★ 12 VDC Operation or 120 VAC with adapter provided
- ★ Optional serial/parallel ASCII output port

- ★ Copies Morse, Baudot & ASCII codes
- ★ Two optimized Morse ranges
- ★ Digital & Analog filtering with 16 db AGC
- ★ Automatic speed tracking 3 - 70 WPM

A code reader so advanced it costs you less! Call or write for brochure or order direct.

CODE ★ START Kit CS-K \$169.95
CODE ★ STAR Wired CSF \$229.95
Optional ASCII Output Port Kit CS-1K \$ 59.95
Optional ASCII Output Port Kit Wired (Specify 110 or 300 Baud and 20mA or TTL level) CSIF \$ 79.95

Send check or money order. Use your VISA or MasterCard. Add \$5.00 shipping and handling for continental U.S. Wisconsin residents add 4% State Sales Tax.

Microcraft Corporation Telephone: (414) 241-8144
P. O. Box 513C, Thiensville, Wisconsin 53092

CIRCLE 67 ON READER SERVICE CARD

SATELLITE VIEW

INSIDE THE WORLD OF TVRO EARTH STATIONS

What's Up?

T rue to the sense of adventure which undoubtedly lives within the hearts of every owner of an earth station is the curiosity of wondering what else is "out there" zipping around the cosmos and transmitting TV pictures, SSTV, telemetry, facsimile (FAX), or whatever. Y'know, when they show the "satellite photos" of the weather maps on the 11 o'clock news, the question isn't where the high and low pressure areas are, but how they tuned in on those "satellite photos."

As we sometimes tend to forget, there are innumerable space trinkets out there wobbling around high above the surface of the planet. Not all are given slick commercial "handles" like *Westar*, *Satcom*, and *Comstar*, and not all transmit *Showtime* and *Wometco Home Theater*.

You might equate the ones transmitting entertainment programming with sports cars, while the others are rugged trucks not intended for recreational purposes. Most don't have actual names. Instead, they are given a serial number or a sort-of name which is little more than an abbreviation.

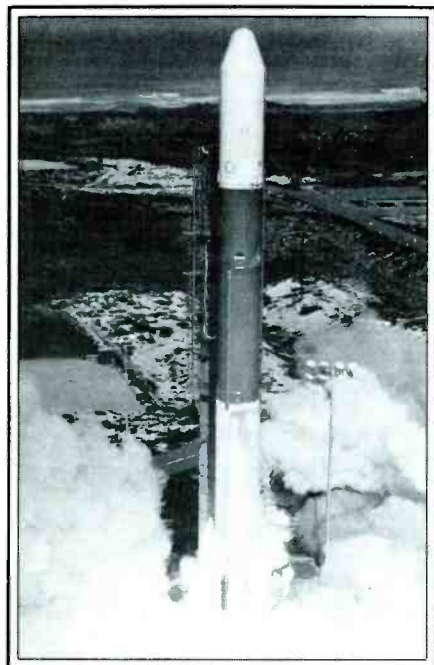

This Delta Rocket lifted off in March, 1978 from NASA's Western Test Range carrying the Landsat-Earth Resources Technology Satellite and the AMSAT/OSCAR-8 into polar orbits. (USAF/NASA photo)

Frequency	Name	Inclination	Period
1.6825 GHz	SMS-2	2.0	1436.9 Min
	GOES-2	0.2	1436.2
	GOES-3	0.9	1436.2
1.7025	NIMBUS-5	99.7	107.1
	NIMBUS-6	99.8	107.4
	NOAA-6	98.6	101.1
	NOAA-7	98.9	101.9
	NIMBUS-5	99.7	107.1
2.2085	NIMBUS-5	99.7	107.1
2.209086	GOES-4	0.0	1436.1
2.211	NIMBUS-7	99.3	104.1
2.214	DE-1	90.0	410.8
	GOES-4	0.0	1436.1
2.2155	ISEE-1	38.9	3441.5
2.218503	SAGE	54.9	95.8
2.2295	LANDSAT-2	99.2	103.2
	LANDSAT-3	99.1	103.2
2.248	SAGE	54.9	95.8
2.2498	IUE	28.4	1439.5
2.253	NIMBUS-6	99.8	107.4
2.2608	ISEE-1	38.9	3441.5
	ISEE-2	38.9	3443.9
2.2648	ISEE-1	38.9	3441.5
2.2655	LANDSAT-2	99.2	103.2
	LANDSAT-3	99.1	103.2
	NIMBUS-7	99.3	104.1
2.2735	NIMBUS-7	99.3	104.1
2.275	DE-2	90.0	95.7
2.2875	LANDSAT-2	99.2	103.2
	LANDSAT-3	99.1	103.2
	SMM	28.5	94.3

While some operate continually, others will transmit stored up data only upon instructions from a command signal from an earth station. These birds may be handling long distance telephone calls or telegrams, or they could be beaming down weather maps, geological, or other scientific data relating to earth or space. They could even be transmitting intelligence information.

And while sports cars cruise merrily along on the lovely parkways, in ready view of all, all too often the trucks lumber, unseen, along the back roads. They are out of sight, but nonetheless doing a job. Likewise, while the *Westars* and that crowd operate between 3.7 and 4.2 GHz, the workaday satellites do their work off the beaten path on an adjacent frequency band. Nevertheless, there are those here on *terra firma* who, from equipment installed in their homes, have received direct signals of various kinds from these odd birds. It takes some tinkering and maybe some modified or homebrewed gear to do it, but it's not as uncommon as you might think. As a matter of fact, no sooner had POP' COMM gone on sale when we started to receive letters from readers asking for frequency information on various "work horse"

satellites sending out weather maps and other similar data. Never let it be said that we aren't responsive to our readers!

Above is a listing of some of the non-entertainment satellites, together with frequency and location information, which are currently operating. You can use it to get an idea of what's up there and where it is.

Other satellite related bands for the experimenter include the 11/12 GHz band (INTELSAT), and the 5.925-6.425 GHz band used for uplinks to the TV broadcast birds.

New Home Earth Stations

A new generation of satellite earth stations from Channel Master offers high performance combined with simplified and convenient operation. Redesigned from feed to mount, and featuring a more sophisticated and advanced electronics package, the new earth stations are available in eight different models that can tailor satellite reception to the specific needs of the individual private viewer.

Each satellite system includes a 10 or 12 foot parabolic dish, motorized or manual polar mount, 100° or 120° LNA (low noise

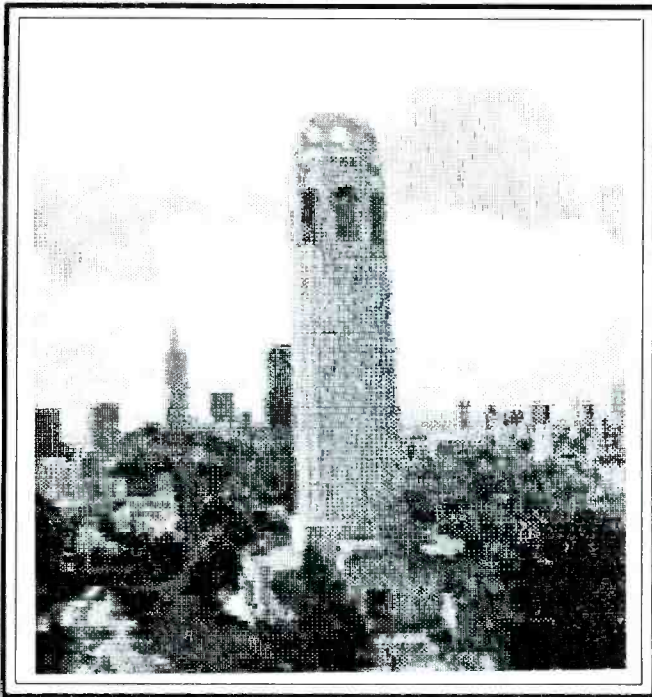

Slow scan TV (SSTV) is a handy technique which was invented by a ham operator named Cop MacDonald. These days it has many uses within the scientific community in addition to its use on the ham bands. Here's what an SSTV picture looks like — as printed out by an Epson MX-80 computer printer.

amplifier), scaler feed with automatic polarizer, full-feature 24-channel receiver/downconverter, built-in modulator, and all necessary cables and connectors. The antennas, made up of four interchangeable lightweight sections for 10 foot models (six sections for 12 foot models), use a reflective metal layer that is encased in a rugged, weather-resistant fiberglass shell.

The prime focus feed assembly (LNA, scaler feed, and polarizer) and the downconverter are supported above the dish by lightweight, high strength aluminum struts providing added stability during operation and easy alignment during assembly. The correct polarity is automatically chosen by a special integral polarizer according to the channel selected by the receiver.

The new polar mount is designed for maximum accuracy. Once installed and aligned, full domestic satellite coverage is provided by a single manual or remote control motorized adjustment. Channel Master's antennas and basic mounting system have successfully withstood hurricane force winds in excess of 100 mph without deviating from a set position in tests conducted at the Lockheed-Georgia wind tunnel facility. These earth stations can be installed in about four hours in a wide variety of locations with a minimum of site preparation.

The new electronics package features an easy to operate 24-channel receiver that offers a wide range of features. Push-button tuning with automatic polarity switching and LED digital channel display are combined with a center/fine tuning meter and signal strength meter for precise reception. Additional features include channel scan for rap-

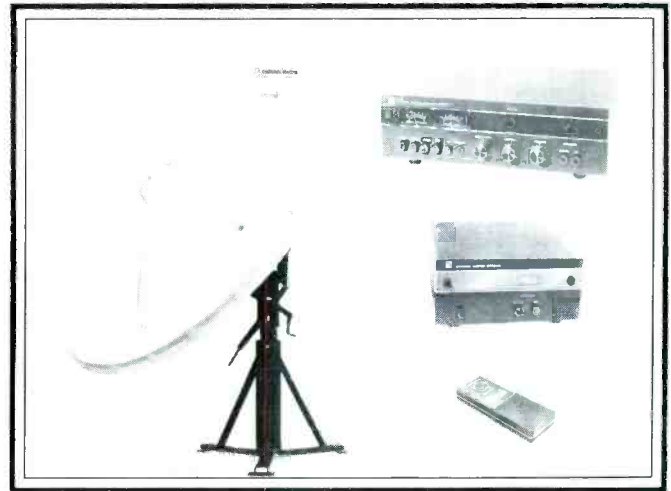

TVRO earth station with polar mount. Receiver (6128), SATSCAN (6197), and Remote Control (6192).

The series 3941 diplexer is designed and tuned to specific frequency requirements.

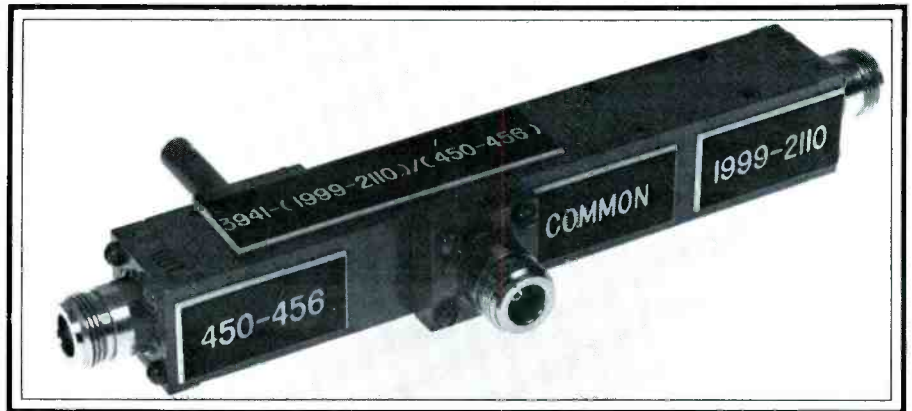

id location of active transponders and a built-in modulator. An optional remote control unit makes channel selection and fine tuning even more convenient.

Motorized earth station models use a remote control system called SATSCAN that features simple up/down push buttons to aim the antenna. A continuous 3-digit LED readout indicates antenna orientation with accuracy to one-third of a degree. The system comes with a dealer site-specialized satellite reference card and features low shock hazard 12-volt operation with heavy duty actuator motor.

These new earth station systems range in price from a suggested list of \$4,495 for model 6172 consisting of a 10 foot dish, 120° LNA manual system, to \$5,955 for model 6278 which features a 12 foot dish, 100° LNA motorized system. The most popular system is expected to be model 6272—a 10 foot dish, 120° LNA motorized

system that retails for \$4,995. For more information, check with Channel Master, Ellersville, NY 12428.

Video Cassette Recorder Features Wireless Remote Control, Omniseach, And Access To 105 Channels

The new Panasonic PV-1480 recorder is extremely versatile, even allowing operation via a full function infrared wireless remote controller from anywhere in the room. The new recorder is programmable to record automatically up to eight separate programs over a 14-day period.

The new Panasonic recorder is well suited to use at TVRO installations and features Omniseach, a visual cue and review function displaying recorded material at 9 times the speed of play, both in forward and reverse. Its cable-ready electronic tuner re-

**YOU AIN'T HEARD
NOTHIN' YET!**

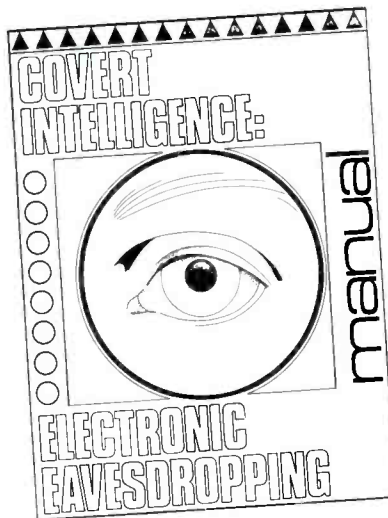

CRB Research, the pioneer communications data publisher, offers the serious scanner monitor and communications receiver owner many unique and exciting frequency reference publications covering federal agencies (military and civilian), aero frequencies, energy industry frequencies, and most other things you want to monitor.

We also offer a wide range of professional publications on bugging, wiretapping, electronics surveillance, covert operations, espionage, and other tactical topics. Fact is, we're adding new titles all the time, so even if you saw our last exciting catalog, chances are you may not yet be aware of some of our newest available publications.

Our catalog is available at no cost—we know that you'll find it fascinating. We've been in the communications data business since 1967, and we know just what you like. You'll see!

CRB RESEARCH

P.O. Box 56 Commack, NY 11725

CIRCLE 66 ON READER SERVICE CARD



The new Panasonic PV-1480 Video Cassette Recorder has several innovative features including Omnisearch and a cable-ready electronic tuner. VCR's are especially well suited for use in conjunction with TVRO installations; you just tape 'em straight off the birds for viewing at your leisure. Make those wee-small-hours programs part of your viewing!

ceives up to 105 TV channels with an extended range 14-position tuner that can receive 12 VHF channels, low or high, all UHF channels, and 23 unscrambled mid-band and superband CATV channels. The new unit is also compatible with Panasonic's

PV-CT2 cable adaptor that allows viewing one cable program while recording another.

Model PV-1480 records up to 8 hours with the NV-T160 tape and records in standard play (SP), long play (LP), and super long play (SLP) speeds. It offers automatic TV/VTR switching, automatic AFT, and automatic rewind at the end of the tape during play. Audio and video in and out jacks and tracking control are concealed behind a front panel sliding door, and a 4-digit tape counter, digital clock/timer, dew detector, and channel lock are all standard features.

The new Panasonic recorder Model PV-1480 utilizes a damped eject mechanism to provide smooth tape unloading and soft-touch controls for easy activation. (Check applicable regulations relating to recording copyrighted TV programs.)

Microwave/VHF-UHF Diplexer

Series 3941 Diplexers are used to combine or separate two narrow band RF signals (in the 115-2500 MHz band). This allows a single run of coax to handle both without affecting the individual transmitter or receiver.

The 3941 diplexer can be used to operate a microwave transmitter or receiver and a VHF-UHF paging system transmitter or two-way communications system on a common feed line. It is designed and tuned to specific frequency requirements. The model shown combines (or separates) the 450-456 MHz and 1999-2110 MHz bands. Typical mutual isolation is 35 db and insertion loss is less than 0.8 db (0.4 db typical).

Price and delivery are \$840 and two weeks, respectively. For more information, contact Microwave Filter Co., Inc., 6743 Kinne Street, East Syracuse, NY 13057.

Coming In The November Issue Of

POPULAR COMMUNICATIONS:

- The Insider's Guide To The Secret Lingo of Spies
- The Satellite TV Revolution
- Equipment Grounding For Performance
- Weather Bureau's Emergency HF Network
- New York City FD Codes
- The Purolator Armored Car Network
- Windpower Your Station
- Emergency Receiving Antennas
- Getting The Most From Your Scanner
- DXing The Soviets

And lots more! Watch for it!

FREE RADIO FOCUS

BY AL MUICK

ACTIVITIES OF UNDERGROUND BROADCASTERS

Welcome to this second column on Free Radio. If you're a newcomer to Popular Communications magazine, this column is dedicated to unofficial and unlicensed broadcasting. I'm your editor, Al Muick (SP/4 USA).

Radio Pace from Verona, Italy is active on 15475 kHz and has already been heard in the U.S. with good signal quality. They are scheduled from 2200-0500 GMT and strangely enough, are beamed to South America. They usually run an ID tape in Italian with a phone number and filler music. No address as of yet.

Radio Indiana is making sporadic joint transmissions with its sister station, WOOF. Times to check are 0300, 0400, 0500, and 0600 on a weekend around 7425 kHz. They often ID as "The Voice of Truth" and can be reached through the FRC-USA.

Radio Free San Francisco was heard on 6214 kHz signing on at 0015 GMT with pop music and some outrageous editorials. Radio Northstar International still operates on 13787 kHz between 0000-0600 GMT on the weekends. Operation is sporadic.

WOIS is currently active on 7425 kHz around 0500 on the weekends. Due to discrepancies with Ma Bell, they are no longer using phone loop numbers. Instead, they are now using a forwarding address: P.O. Box 982, Battle Creek, MI 49016.

KCFR from California is operating with about 250 watts and super audio on 6857 kHz which is parallel with 7357 kHz. The latter frequency suffers from QRM. Check around 0600 GMT on the weekends and enjoy their new wave/hard rock style which is hard to beat. Their address is Box 4948, Arcata, CA 95521.

WCRS, Community Radio Service, is currently active on 7400 kHz (a poor frequency choice), around 0100 GMT on the weekends. Their style is mainly oldies.

The "Voice of SYNCOM" has returned to the airwaves on such frequencies as 14745, 14600, 7425, 7375, 6280, 6250, and 6225 kHz at all times of the weekend, playing oldies and Top 40 music. Although the station is on the East Coast, they were heard in the midwest with a 20 dB over S9 signal! PRN, Pirate Radio New England, has returned to 1620 kHz and can be heard with long broadcasts on the weekends that start 0100 GMT and last until daylight.

Radio Free Radio (odd name, huh?) pops up occasionally on 7425 kHz but they don't appear to take their programming seriously enough and, as a result, it is usually very poor. Check for KQSB, a new station, on Sundays GMT at 0400, 0500, and 0600 on 7425 kHz, and 1800, 2000, and 2200 on

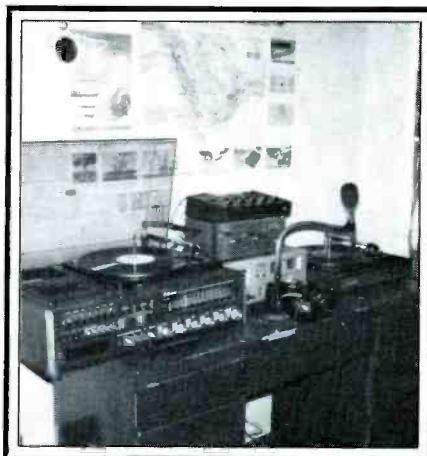

WPOT's neat and tidy looking studio and control room. Everything seems to be on hand except a license.

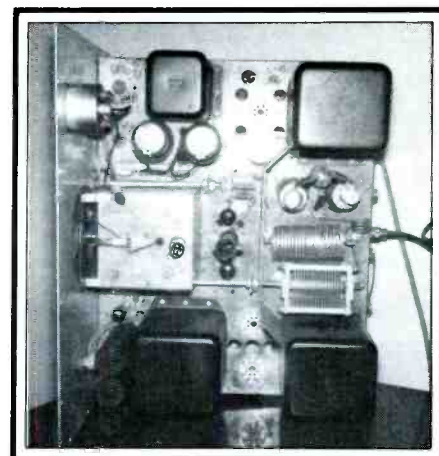

WPOT's transmitter—a butterfly's eye-view looking into its innards while the rig is standing on its side under test.

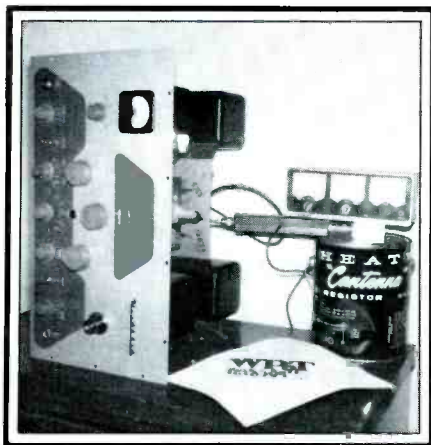

The WPOT kit-built transmitter undergoing periodic testing and checking. Actually, it's a transmitter designed for Amateur Radio use which tunes up adequately on frequencies at the high frequency edge of the standard AM broadcasting band. Note the QSL on the desk top!

14570 or 14450 kHz. Their address is Box 4948, Arcata, CA 95521.

A technical hint for pirates comes from the "Voice of The Pyramids." Mike Johnson, chief engineer for VOP, says, "You can improve the audio quality of a DX-100B transmitter by changing capacitors C-11 and C-13 to .05 μ f at 600 WVDC to restore low frequency response. You can also change C-56 to .005 μ f at 600 WVDC to increase the high frequency response. You might eliminate C-56 altogether and bypass C-11 and C-13, but watch out for feedback and hum, respectively." Thanks a lot Mike. I'm sure that will help out numerous readers.

This month's technical corner is a schematic for an audio compressor. This type of unit seems to be a must for stations seeking to attain a really professional sound. What this little gizmo does is keep a constant, unwavering volume level going to the transmitter, thus virtually eliminating distortion and lessening the chance of overmodulation.

As you know, music and speech have varying volume levels. Well, this little beauty brings up the small background noises and keeps the loud noises down. It's also used for talkover, like a professional radio station. The music control on the mixer is kept at a set level, and when there's no talking, the compressor brings the music up to a good constant level; when talking commences, it reduces the level of music and allows the voice to come over it. When talking stops, the music comes back!

A technical explanation for this—volume compression or a form of automatic gain control may be used to maintain constant voice intensity over a large range of audio input to the speech/audio system of a transmitter. This is accomplished by making the system gain a function of the average variations in speech amplitude. Practical systems rectify and filter the speech signal as it passes through the speech amplifier and applies the DC current of the signal to a gain-control element in the amplifier.

The compression system usually has a time constant such that control voltage is held at a steady value between syllables and words. Simple compressors usually exhibit an attack time of 300 milliseconds or longer. Compression range on the order of 20-35 dB is realizable in practical circuits corresponding roughly to the dynamic range of the human speaking voice. Reverberation

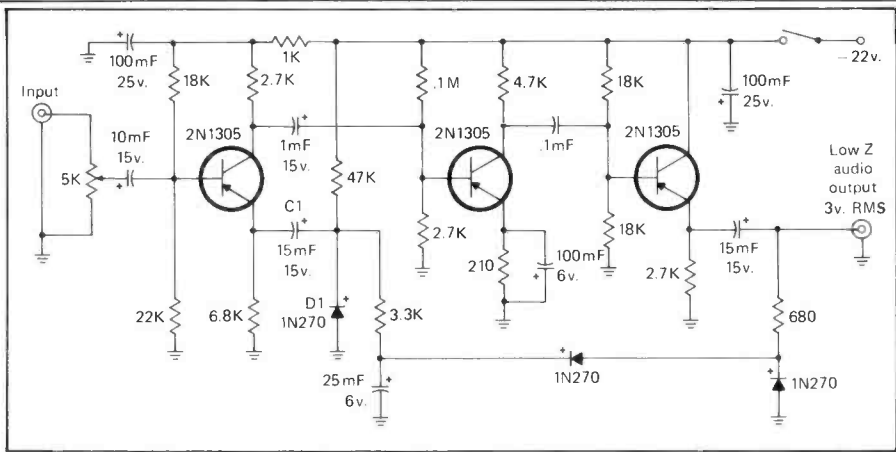
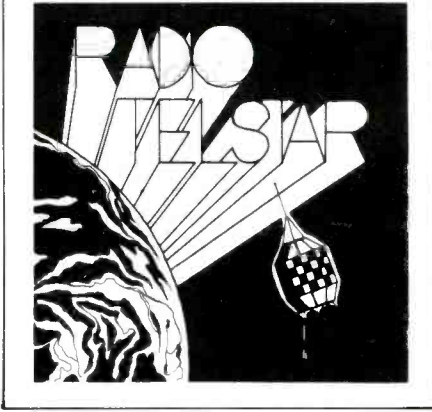

Fig. 1 - Schematic of a Solid-State Compressor.



To _____
 Date _____
 Time GMT _____
 Frequency _____ KHz
 QRP _____
 Aerial _____



FROM STATION

qs

FM 3M.

OPERATOR MARLJN
THANKS FOR QSO

LIBANON-WILLEBRORD

**ATTENTION:
SATELLITE TV
DEALERS &
CABLE OPERATORS**

We are your complete in-stock distributor for complete TVRO systems and accessories. Custom cable with crimp "N" connectors.

**BLONDER-TONGUE &
JERROLD DISTRIBUTORS**

SALES • SERVICE
RESIDENTIAL • COMMERCIAL
DESIGN • INSTALLATION

ENERGY SYSTEMS LTD.

**2306 CHARLES AVE.
DUNBAR, WV 25064
PHONE: 1-800-624-9046**



and background noise usually limit the practical compression range to 15 dB or so.

A solid-state compressor/amplifier is shown in schematic A. It is designed to be used with an audio source with an impedance of 500-2000 ohms, and provides a compression range of approximately 20 dB.

Compression is achieved by change of gain brought about by variation of the emitter bypass capacitance in the first-stage transistor. With the emitter load impedance about twice that of the collector load, and with the unbypassed emitter, the first stage is about 0.5.

In series with the emitter bypass capacitor (C-1) is a variable resistance composed of a diode network. Control voltage derived from the output of the amplifier is applied to the diode, which isolates bypass capacitor C-1 from signal voltages, effectively lowering the stage gain. Maximum stage gain is approximately the ratio of the collector load resistance (2.7 K ohm) to the forward resistance of the cathode control diode (D-1) and minimum stage gain is about 0.5.

Small coupling capacitors are used between amplifier stages to limit the low-frequency response of the system. In order to increase the low-frequency response of the compressor, you must lower or eliminate the values of the coupling capacitors.

A sample copy of the Free Radio Campaign-USA's newsletter, *The Wavelength*, is available for \$1. The address is: SP/4 Al Muick, 3rd Opns Bn USAFSA, CMR Box 1912, APO NY 09458.

Well, I hope you've enjoyed this column and that it has been of some help to you. Don't forget . . . if you have information or a technical tip to share with our readers, please feel free to send it in! If you have any questions that require a personal answer, please enclose an SASE. I answer all letters as long as an SASE is enclosed.

MADISON

Electronics Supply

AN AUTHORIZED KANTRONICS DEALER

MINI READERtm \$289.95



The code reader that puts the world in the palm of your hand. The MINI-READER copies MORSE/RTTY/ASCII and includes power adapter. Who says great things don't come in small packages.

MINI-TERMINALtm \$299.95

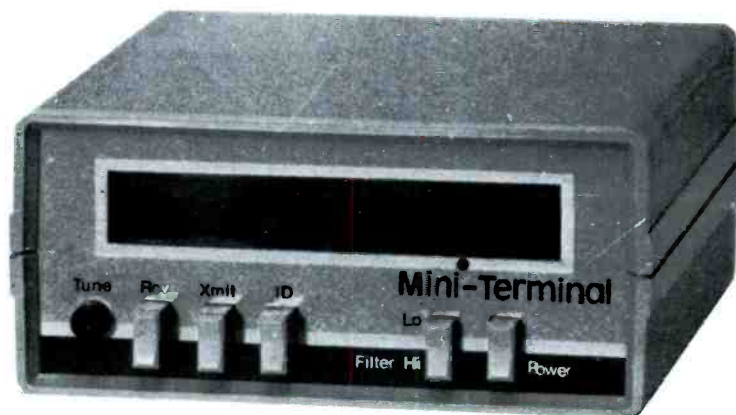

You send CW with your key or keyboard, and the **Mini-Terminaltm** converts to RTTY or ASCII. **Mini-Terminaltm** also reads all incoming CW, RTTY, and ASCII messages and reads out on a bright green 10-digit display. For hard copy simply attach any Centronix compatible printer, such as the Epson MX-80 or the Paper Tiger, and watch the **Mini-Terminaltm** do the rest.

THE INTERFACEtm \$189.95

Kantronics, the innovator in code readers and RTTY terminals, leads the pack again with **The Interfacetm**.

Your personal computer becomes a complete CW and RTTY terminal with **The Interfacetm** linking it to your transceiver.

The Interfacetm receives any shift of RTTY, ASCII or CW and transmits all the necessary AF-SK tones for RTTY, ASCII, and RTTY CW-ID. The manual includes a complete software example



for the Apple II Plus, featuring split screen display, buffered keyboard, status display, and much more. Software is also available on diskette for Apple and cartridge for Atari.

CALL FOR QUOTES 713-658-0268

1-800-231-3057 MON, WED, FRI. 6PM-10PM CT

MADISON ELECTRONICS SUPPLY
MASTER CHARGE & VISA WELCOME

1508 MCKINNEY
 HOUSTON, TEXAS 77010

CIRCLE 112 ON READER SERVICE CARD

MONITORING THE 30 TO 512 MHz "ACTION" BANDS

Here's How To Monitor Those Oddball Frequencies Your Scanner Doesn't Cover

It doesn't take long to realize that when you look at the basic scanner receiver there are frequencies "missing." It doesn't go straight through from 30 MHz to 512 MHz. That may have given you the uneasy feeling that maybe you are being cheated out of some good listening because of the gaps in your coverage.

You can rest easy. Most of these gaps are easily accounted for and aren't of any interest to communications listeners.

Some frequencies, however, which aren't covered by the majority of scanners, do contain various communications services which you may want to monitor. There are ways of doing this.

First, let's see what's between 30 and 512 MHz in the way of frequencies not included in many scanners.

50-54 MHz: The 6 Meter Amateur band; mostly SSB; some CW and FM.

54-72 MHz: TV Channels 2-4.

72-76 MHz: Operational and fixed stations. There are voice and non-voice (control circuit) communications here. Some services use this band for relay stations and low power communications. It is of definite interest to scanner users.

76-88 MHz: TV Channels 5 and 6.

88-108 MHz: FM broadcasting band.

136-138 MHz: Space (artificial satellites use this band in addition to microwave frequencies). With the proper antenna you can pick up these signals, although they may not be of interest to you because they are non-voice.

138-144 MHz: Government communications. These frequencies are used by military services and have a definite interest to scanner monitors.

174-216 MHz: TV Channels 7-13.

216-220 MHz: Telemetry; little interest to scanner users.

220-225 MHz: Amateur 1 1/4 Meter band; mostly FM via repeaters.

225-400 MHz: Primarily used by military aircraft and military/civil ground stations communicating with those aircraft. The sub-band 240-270 MHz is used by military satellites. The sub-band 329-336.4 is used for (non-voice) aero-navigational transmitters. Aero-voice communications on this band are AM mode and are of increasing interest to communications monitors.

400-406 MHz: Telemetry and other non-voice operations, including artificial satellites. Minimal scanner user interest.



Hamtronics makes a series of nifty converters which tune your scanner in on some interesting offbeat frequencies.

406-420 MHz: Government communications. High scanner user interest.

806-894 MHz: Most scanners don't cover this new so-called "metropolitan land mobile band" which has been carved from the UHF-TV channels. However, monitors in larger metropolitan areas may find that its use is growing rapidly.

Based upon this information, you can decide if there's anything which suits your interest. You may well have a scanner which is designed to cover parts of one or more of these frequency bands. For instance, the Radio Shack Realistic PRO-2002 scanner very thoughtfully includes the 138-144 MHz and 410-420 MHz bands, while it tantalizingly omits the interesting 406-410 MHz band segment of Federal Communications frequencies!

Regency scanners are capable of covering some of these frequencies if they are modified to do so; the so-called "Canadian" export models intended for use in that nation cover a somewhat offset array of frequencies compared to the ones designed for use in the United States. These Canadian export units cover 30-46.4 MHz, 138-167.8 MHz, and 406-482 MHz. Some readers report being able to obtain these units on special order from Regency's dealers in the United States. Others advise that they have been able to make arrangements with the Regency factory in Indianapolis to have existing Regency scanners modified or converted into so-called "Canadian" frequency coverage versions.

There is, of course, the option to try to make this modification yourself—providing you have the information on how to do it,

the expertise and experience in working with scanner innards, and the bench equipment to keep track of how you're doing. The instructions for making these alignments on both the Regency ACT-T-16K and ACT-K-100 scanners (as worked out by Regency) are available at no cost by requesting them from CRB Research, P.O. Box 56, Com-mack, NY 11725. Please send a self-addressed stamped (37¢ in uncanceled U.S. stamps), #10 (office size) return envelope with your request. Your best bet, however, is to take the scanner and these instructions to your friendly neighborhood communications shop and ask the technician about getting him to do the job.

Of course, some Regency scanners can be nudged out of the band a little by using the simple trick of pressing the decimal point button before programming in your out-of-band frequency, as reported by Tom Kneitel in his book *The Top Secret Registry of U.S. Government Radio Frequencies*. You might try it! Also, a company called Digi-com, Box 1175, New York, NY 10009 sells a report on how to expand the capabilities of a Bearcat 250 to pick up out-of-band frequencies; check with Dicom on current availability and price. Dicom's report is concerned with programming tricks and not with digging into the scanner's innards by means of soldering iron and Excedrin bottle.

Another approach is to elbow yourself into the offbeat frequency spectrum by means of converters. These are scanner accessories which receive the desired bands and convert them into frequencies which can be tuned in by your regular scanner. The converters simply get inserted in line with the antenna

lead-in with no groping around inside of the scanner required.

Converters for some of the oddball frequencies are being made by Hamtronics Inc., 65 Moul Road, Hilton, NY 14468. Among the units they offer are ones which will permit a regular scanner to receive 72-76 MHz, 135-144 MHz, 240-270 MHz, 400-420 MHz, and 806-894 MHz. Of course, you'll want to have a suitable antenna for each band connected to the converter which covers that band. The converters are designed to cover one single band each and are reasonably priced; Hamtronics will send their catalog with full information upon request.

Hamtronics can also make up (on special order) converters to cover an 18 MHz-wide segment of the 225-400 MHz UHF aero band. This will permit reception of that band segment on a standard VHF aero band scanner covering 118-136 MHz. Hamtronics points out that covering the entire (175 MHz-wide) band in a single converter isn't feasible because of the limitations of VHF aero band scanners which are only capable of covering a band of frequencies 18 MHz-wide. So, when ordering such a scanner, you'd have to advise Hamtronics which 18 MHz-wide portion of the band you want to monitor.

The ultimate approach to receiving the 225-400 MHz UHF band would be to buy a scanner made for that band. Unfortunately, *there ain't no such animule!* At least not yet, and no scanner manufacturer has made any noises about bringing one out. Some hardy monitors have tracked down military surplus receivers capable of tuning that band—but that's a long topic for a future story.

MFJ Enterprises produces a satellite converter which takes the 130-150 MHz band and lets you monitor it between 30 and 50 MHz on any scanner.

Yaesu manufactures a converter (Model FRV-7700) designed to convert the 118-150 MHz band to frequencies covered by their Model FRG-7700 communications receiver. You'll note that the frequencies covered by this converter include the 138-144 MHz military communications band. Although I haven't worked with one of these units, it may well be that it can be functional with any communications receiver. However, not all communications can receive FM mode (the FRG-7700 can) and it would be well to be certain that if you intend to get this converter you will feed it into a communications receiver which can receive FM.

About the only offbeat band you can tune without any additional effort might be the 608-614 MHz radio astronomy research band! That would be achieved by tuning it in on your nearest standard TV set. TV Channel 37 has been set aside for radio astronomy research and the FCC won't license any TV broadcasters there. Who knows? If the little green men are transmitting on that frequency, and you've got a giant antenna pointed in the right direction, you might just score big. What—you're on the cable? Forget it!

THE OHIO SHERIFF'S CODES AND SIGNALS



The following Ohio Sheriff's Code was submitted by Seville Two-way Radio in Seville, OH. They pointed out that the Ohio State Patrol uses a different set of codes.

Readers wishing to submit communications codes from various areas are invited to do so and we will pass them along in these pages.

CODE 2	Accident (property damage)	CODE 60A	Suspicious car
CODE 4	Accident (injury)	CODE 62	Traffic detail
CODE 6	Aircraft crash	CODE 64	Vandalism
CODE 8	Assault	CODE 66	Escape or jail break
CODE 10	Assist other unit	SIGNAL 1	Contact Sheriff
CODE 12	Burglary	SIGNAL 3	Contact Chief Deputy
CODE 12A	Burglary in progress	SIGNAL 5	Contact headquarters
CODE 12B	Alarm drop	SIGNAL 7	License registration request
CODE 14	Bad checks/forgery	SIGNAL 7A	Stolen file check request
CODE 16	Dead on arrival	SIGNAL 9	Investigate complaint
CODE 18	Dog bite	SIGNAL 11	Arrest record check request
CODE 20	Domestic trouble	SIGNAL 13	Special detail
CODE 22	Drowning	SIGNAL 15	Warrant
CODE 24	Drunk	SIGNAL 17	Contact party in person
CODE 26	Fight	SIGNAL 19	Contact party by phone
CODE 28	Fire	SIGNAL 21	Prisoner
CODE 28A	Bomb activated	SIGNAL 23	Off the air to eat
CODE 28B	Bomb threat	SIGNAL 25	Return to headquarters
CODE 28C	Bomb located, not detonated	SIGNAL 27	Emergency run
CODE 30	Gambling	SIGNAL 29	Squad or ambulance request
CODE 32	Homicide	SIGNAL 31	Wrecker required
CODE 34	Juveniles	SIGNAL 33	Car in service
CODE 36	Larceny	SIGNAL 35	On patrol
CODE 38	Missing person	SIGNAL 35A	Everything okay but check out
CODE 40	Man with gun	SIGNAL 37	Car out of service, off air
CODE 40A	Man with knife	SIGNAL 39	Give location
CODE 42	Nature unknown	SIGNAL 41	One unit in radio contact
CODE 44	Officer in trouble	SIGNAL 43	Home
CODE 46	Prowlers	SIGNAL 45	Contact news media
CODE 48	Rape	SIGNAL 47	Get report
CODE 48A	Sex offense	SIGNAL 49	Radio repair
CODE 50	Robbery	SIGNAL 51	Cannot answer
CODE 50A	Robbery in progress	SIGNAL 53	Mental
CODE 52	Shooting	SIGNAL 55	Civil Defense alert
CODE 54	Stabbing or cutting	SIGNAL 67A	Leaving county
CODE 56	Stolen car	SIGNAL 67B	Returning to county
CODE 58	Suicide	SIGNAL 99	Emergency traffic, all stand by
CODE 60	Suspicious person		

WASHINGTON PULSE

FCC ACTIONS AFFECTING COMMUNICATIONS

Anti-Scanner Law In Philadelphia Is Declared Unconstitutional

The traditional American right of persons to listen to the airwaves has been successfully defended in Philadelphia, PA. The city of Philadelphia recently began enforcing a 1967 ordinance which was actually enacted before the scanner radio was invented in 1968. By interpreting the law to apply to scanners, the city tried to make it illegal to sell, possess, or use a scanner radio—even in a private home—within city limits.

Although the law has been in effect for 15 years, it was not enforced in Philadelphia until last fall, when several owners and employees of retail stores were arrested for selling scanners. It was the only area in the entire U.S. that had such a restriction.

In dismissing charges against the defendants, Municipal Court Judge J. Earl Simmons, Jr. determined that Section 10-817 of the Code of Philadelphia ordinances (anti-police radio receiver case) is unconstitutional as being beyond the permissible scope of the police power of the city council and as being unduly oppressive upon individuals. The judge ruled that the citations charging summary offenses should be dismissed and the defendants discharged.

Judge Simmons went on to say, "The market . . . is made up of individual owners who use it (the scanner radio) for personal entertainment or security purposes. Group use (of scanner radios) is endorsed, and in fact encouraged, by local law enforcement agencies which conduct programs to teach the use of such scanner radios as a crime combatant. The reception of police and fire calls has many beneficial social by-products reflected in the activities and publications of these citizen organizations. . . . There is no evidence to support the contention that access to the police or fire channels increases crime, or the risk thereof, or interferes in any way with the unhampered conduct of the police and fire activities; on the contrary, it demonstrates a markedly decreased risk of criminality when such scanners are employed by the citizenry. Thus, the conclusion is compelled that the ordinance is unconstitutional."

The scanner industry was launched in 1968 when Electra introduced the first scanner. Since that time, the market for scanners has grown steadily. To date, the industry has sold over 6 million units, penetrating about 7 percent of U.S. households!

Operators Of Unlicensed Station Pay Fines

Dennis D. Skelton of Seattle, WA, paid a \$500 fine for operation of an unlicensed sta-

tion on 27.595 MHz. An engineer of the Field Operations Bureau's Seattle District Office monitored and located Mr. Skelton's station on October 21, 1981. At the station inspection on October 23, Skelton admitted to knowing operation on 27.595 MHz was not legal.

Ferguson Electric Company, Houston, TX, paid a \$750 fine for operation of an unlicensed station. Acting to resolve a complaint of interference on the Business Radio frequency of 151.925 MHz, an Engineer of the Field Operations Bureau's Houston District Office located and identified, by close in radio direction finding, the interference source at the Ferguson Electric Company. The unlicensed status of the station was ascertained; a Notice of Apparent Liability in the amount of \$750 was subsequently issued on December 11, 1981 for violation of Section 301 of the Communications Act of 1934, as amended.

John A. Conley of Pueblo, CO, paid a \$600 reduced fine for operation of an unlicensed station on 27.615 MHz. Communications were traced to "Conley's TV Sales," by close in radio direction finding on January 20, 1982 by an Engineer of the Field Operations Bureau's Denver District Office, and the station was inspected the same day. The unlicensed station included a 390 watt amplifier. The unlicensed status was confirmed and a Notice of Apparent Liability in the amount of \$750 was subsequently issued on January 27, 1982 for violation of Section 301 of the Communications Act of 1934, as amended.

John T. Camp of Portland, OR, paid a \$150 reduced fine for operation of an unlicensed station on 27.605 MHz. Communications were traced to Mr. Camp's home on November 19, 1981 by an Engineer of the Field Operations Bureau's Portland District Office. The station was located by close in radio direction finding techniques, and Camp was identified through voice correlation from past interviews. The unlicensed status was ascertained and a Notice of Apparent Liability in the amount of \$750 was issued on December 14, 1981 for violation of Section 301 of the Communications Act of 1934, as amended.

NBS Publication Describes Ways of Suppressing Electromagnetic Interference Affecting Mobile Radio Equipment

Owners and operators of vehicles with mobile communication equipment will be interested in a publication from the Commerce Department's National Bureau of Standards (NBS). It describes methods of

suppressing electromagnetic interference (EMI) affecting this radio equipment.

EMI caused by various components of the vehicle's own electrical system can seriously degrade the performance of mobile radios. This degradation is particularly noticeable in remote areas where the vehicle is at a considerable distance from its base station and the signal is weak.

Although NBS performed its study primarily for the nation's law-enforcement community, the findings are applicable to most users of mobile radios. The report, *Methods of Suppressing Automotive Interference (SP 480-44)*, concentrates on radio systems using narrow-band FM communications in the 25-900 MHz frequency bands; these bands were selected as those most commonly used by public safety agencies.

The report discusses the sources of EMI within a vehicle, including the ignition system and electric motors used to operate a variety of equipment, from windshield wipers to rotating warning lights. There is a discussion of customary practice and new methods of suppressing ignition EMI.

In addition to known techniques such as the use of resistor spark plugs, resistive spark-plug cable, and grounding straps, the report describes more recent developments such as the use of silicone grease in the distributor and means to reduce conductive fan-belt discharge. The report concludes that EMI can be reduced significantly by employing these techniques; it outlines a simple procedure for measuring the amount of degradation to a typical narrow-band FM receiver, as well.

Prepared by NBS for the National Institute of Justice, U.S. Department of Justice, the report is available for \$6.00 prepaid from the National Technical Information Service, Springfield, VA 22161. Order by title and PB #82-165259.

Two 450-470 MHz Frequency Pairs Redesignated For Detroit Area General Business Use

The FCC redesignated two pairs of Business Radio Service frequencies in the 450-470 MHz band, now assigned on an itinerant basis, for general use in that service in the Detroit area. This is to help relieve congestion on the business frequencies there.

With that action, the FCC terminated a proposed rulemaking begun in January, 1981 in which it had proposed to make four other frequency pairs in the band available to the Business Radio Service on a shared basis with other private land mobile radio services. In view of current and prospective use of the frequencies in the other services

and potential interference with Canadian users, the FCC said the frequencies are not actually available for additional use.

The redesignated channels are 464.500/469.500 and 464.550/469.550 MHz. They will continue to be assigned nationally on an itinerant basis for temporary base stations such as those used at major construction sites for a period of months. The change will make them available for regular permanent base station use in the business service within 35 miles of Detroit.

The 1981 proposed rulemaking was in response to a request by the National Association of Business and Educational Radio, Inc., to reallocate to the Business Radio Service all channels in the 150-174 and 450-470 MHz bands in the Detroit area which were unused and had no licensees. NABER based its request on congestion in the Detroit area and on a 1977 FCC Detroit monitoring study which showed little if any use there of 76 frequencies in the two bands.

Later review indicated that only two pairs of frequencies allocated to the Industrial Radio Services for sharing as industrial pool frequencies and two pairs shared by the Petroleum and Forest Products Radio Services had no base station assignments within 75 miles of Detroit. The rulemaking proposed to make those available on a shared basis and to reassign two unused, itinerant pairs of business frequencies to permanent use.

Comments indicated that most of those frequencies were in use and would have greater future use in their assigned activities. Communication with the Canadian government brought the response that greater use of all but one of the frequencies probably would result in harmful interference to Canadian stations. Coordination with Canada is required before actual use of the frequencies in border areas.

How To Request Special Temporary Authority In Private Radio Services

The FCC grants special temporary authority (STA) to permit immediate or temporary operation of certain private radio facilities during emergencies or other urgent conditions. The Licensing Division responds favorably, whenever possible, to STA requests, but it must review and evaluate each one carefully. Therefore, all requests should contain at least the following 13 items:

- (1) name and address of applicant;
- (2) description of emergency or need;
- (3) type of operation to be conducted (field tests, dispatching, etc.);
- (4) explanation of how facilities will be used;
- (5) times and dates of operation;
- (6) class of station and radio service;
- (7) location of transmitter and/or mobile area, including geographical coordinates, if known;
- (8) number of fixed transmitters and mobile units;
- (9) operating frequency or frequencies;
- (10) output power of transmitters;

- (11) proposed type of emission;
- (12) description of antenna, including height above ground and power gain; and
- (13) statement explaining the business or activity of applicant.

All STA requests must be complete within themselves and cannot rely on pending applications. Lack of information may result in the application being returned.

Requests must be submitted in writing, preferably on company or business letterhead, and delivered to the FCC, Gettysburg, PA 17325, at least ten days before the proposed operating date. In an extreme emergency, the FCC will accept a request made by telephone or telegraph, but it must be followed by a signed letter within 10 working days, or the STA will be rescinded.

The FCC will not grant STAs for operations in areas that require Canadian coordination, unless the need is extremely urgent and for a short time. (The FCC coordinates with Canada most frequencies allocated to land mobile services for use above line A and east of line C, as defined in Section 1.955 of FCC rules.)

Applicants may call the Licensing Division in Gettysburg at (717) 337-1212 for more information or assistance. Equipment suppliers also might provide help with preparing STA requests.

Exemption From Marine Radiotelegraph Requirement Granted Large Ships

The Commission granted a general exemption from CW requirements to large cargo ships operating in coastal waters which carry a package of alternative communications equipment and meet specified operational requirements. The Commission exempted cargo ships of 1,600 gross tons and more, operating entirely within 150 nautical miles of the coasts of the 48 contiguous states, from the requirement of the Communications Act that they be equipped for radiotelegraph operation.

To qualify for the exemption, a ship must be equipped with:

- Satellite terminal providing both voice and telex communication.
- Single sideband radiotelephone with voice channels capable of operating on any designated distress and safety channel in the marine bands.
- Narrow band direct-printing radiotelegraph with error correction capacity.
- Radiotelephone distress frequency watch receiver on 2182 kHz with radiotelephone alarm signal generator.
- At least two VHF transceivers.
- Emergency and reserve power sources for all the above equipment.
- 500 kHz auto alarm receiver and capability to relay any received distress signal to shore via one of the above systems.

In addition, to qualify, a ship must be able to operate and maintain all of its distress and

safety communications systems to the standards set by FCC rules and must participate in the AMVER (Automated Mutual-assistance Vessel Rescue) system. An international system operated by the U.S. Coast Guard, AMVER assists search and rescue efforts by maintaining characteristics and positions of participating ships by computer.

The Communications Act authorizes the FCC to exempt individual ships and classes of ships from the radiotelegraph requirement if they do not travel more than 150 nautical miles from land. The Commission has exempted certain ships with special configuration and some navigating the Great Lakes 90 percent of the time but making occasional coastwise voyages.

In considering a general exemption, the Commission said, it was obliged to consider the potential effect on the efficiency of distress services for all ships. It concluded that alternative means of communication must be at least the equivalent of radiotelegraph for distress and safety purposes.

All U.S. ships of 1,600 tons or more are required to have VHF equipment to comply with federal law. They also are required to have radiotelephone capable of transmitting and receiving on 2182 kHz and, in compliance with SOLAS provisions, to have a watch receiver reserved for that frequency. This equipment establishes a link between radiotelephone and radiotelegraph.

The continuing number of ship disasters has demonstrated the need to develop a better distress system with improved communications technology. The planned Future Global Maritime Distress and Safety System will be essentially a ship-to-shore system to alert rescue coordination centers and a shore-to-ship system to alert ships best able to render assistance. The system will use satellites and other improved communications techniques. All the maritime mobile frequency bands will be used to ensure transmission and reception of emergency calls at all distances. The general exemption will serve as a bridge in the transition to the global system.

Noting that English is used universally on VHF in port areas, the Commission said it does not believe a language barrier exists to a degree that would inhibit distress and safety communication by radiotelephone.

Contact SANDRO'S The Communication Specialists

- for ● Scanners
● Short Wave Receivers
● Accessories
● All Your Electronic Needs

Factory distributor center for these major brands:

Cobra	Panasonic	Amphenol
Gold Line	Antenna Specialists	Clarion
Telex	Courier	Swan
Turner	Audiovox	Bearcat
RMS	Shakespeare	Shure
Wilson	Astatic	Valor
Midland	Mura	Nye-Viking
Regency	Hustler	

SANDRO'S ELECTRONICS, INC.

1559 Brentwood Road
Bayshore, NY 11706 (516) 666-4434

Beaming In (from page 6)

vital to the truly *die hard* scanner owner." Time will tell if it is.

And, yes, I'm well aware of the fact that if one intends to live with the letter of Section 605 of the Communications Act (secrecy of communications), that a certain amount of thought and planning would have to be put into the way the relevant traffic would be passed in such a system. However, the idea has lots of potential for listeners and it's worthy of further exploration.

Did It With His Little Computer

A "foolproof and unbreakable code" has been cracked wide open in a stunning accomplishment which underscores the difficulty in maintaining the secrecy and security for electronic communications and even computer networks. The feat was accomplished recently by Adi Shamir, a computer scientist in Israel, who presented his results to code experts in the United States, including the developer of the code he had broken. When the code was created in 1976, its inventor offered a \$100 prize to anyone who could decipher it. In 1982, he sent Shamir a check, thus confirming that his foolproof code had indeed been fooled.

Y'see, that's the thing of it all. The present state of technology in weaponry, communications, and electronic security makes it vir-

tually impossible to keep barely a half-a-hop ahead of the technology which can decode, foil, jam, confuse, defeat, reveal, or even better the very latest "ultimate" developments. Every code can be broken by somebody somewhere. Except in the case of an egg, everything which can be scrambled can be de-scrambled. And it seems that someone always can figure out a weapons system more awesome than the one we all thought couldn't be beaten. Once any of these things exist they are self-defeating because they establish themselves as a goal to be conquered—they become no more than links in the chain known as progress.

Some have claimed that code breakers, those who de-scramble the scrambled, and those who can root out secrets are somehow counterproductive, even dangerous. Our own Central Security Service (a branch of the super-secret National Security Agency) has sought to restrict the activities of those who do private research into cryptology (code breaking). On the other hand, you might view efforts to crack codes, de-scramble deliberately garbled messages, and root out hidden frequencies and communications stations as a test of the validity of the claims that such "secrets" are truly secrets, or that whatever it is which is alleged to be unbeatable or unbreakable is as claimed. If such things are not as represented, then maybe it's just as well we find out about it.

It may well be that the very first Paleolithic

gent who figured out that standing behind a tree could protect him from getting konked on the noggin' with a thrown rock kicked off a chain reaction which has lasted to the present day. How long did it take his opponent to realize that a larger rock would have to be tossed—so as to knock down the tree in order to reach its target; which led to standing in back of a pile of stones for protection; which led to—well it led to a never ending series of one-upmanship steps which you could say have either: A) advanced our civilization into the era of interplanetary exploration, lasers, and computers, or B) placed us on the brink of nuclear holocaust.

Obviously the progression of events hasn't ended; we are still on the quest for that truly unbreakable code, learning the location of that definitely secret radio station or frequency, that fully secure communications system, that ultimate weapon. The challenge to discover or create such things also triggers within our species the desire or need to penetrate or surpass them once they are presented. That's why Hillary conquered Mt. Everest, why Bannister beat the 4 minute mile, why Marconi sent messages through the "ether," and why Adi Shamir broke the unbreakable code. It's the nature of the species *Homo sapiens*.

The cycle would seem to have no end, unless our civilization ends. Of course, that's not at all beyond the realm of possibility either. Let someone top that!

Mailbag (from page 12)

There really is such a place! In the early 1970s, a company named Perpetual Storage, Inc., spent almost a half million dollars blasting a three story storage bunker out of the solid granite 200 feet beneath Wasatch Mountain, which is in Little Cottonwood Canyon, southeast of Salt Lake City, Utah. The steel and concrete reinforced walls are said to be impregnable, secure against theft, fire, flood, earthquake, and nuclear holocaust. The door leading into the bunker weighs 6 tons.

The inventory includes bullion and art treasures (as you mentioned) and also the videotape, computer tape, and microfilm records of large corporations, in addition to records and other materials assembled by academic institutions. Credit card and financial companies want to make certain that they can always recall who owes them money even if "the worst" happens.

All of this is watched over by a security force you wouldn't believe. Touch and motion sensors line the mountain slopes while cameras with zoom lenses and windshield wipers scan the rugged terrain. Guards are trained in special weapons and tactics. A visitor to the vault had better have an appointment since nobody can approach the place without being noticed and they'll shoot at anybody who gets inside the vault without authorization.

The only information I can offer on the communications system is that they were assigned the callsign KVT958 for operation on 462.025 MHz for a base station and 11 mo-

bile units. The original license expired in 1978 and no longer appears in the FCC's records. Therefore its status is unknown. If you try to get close enough to be within radio range, at least stay out of the firing range of their security force! — Editor.

Viewer Is Hottest Thing On TV!

Recent media coverage about possible health hazards from color TV set and microwave oven radiation has me thinking that maybe the units I have could be operating in excess of federal limitations. Would the FCC test these equipments to certify that they are safe to use?

Mike Salerno
Reno, NV

The U.S. Food and Drug Administration is the agency concerned with radiation leaking from TV sets and microwave ovens, although the possibility of defects in either is remote. If your TV set was manufactured since 1970 (when the strict regulations were first passed as to allowable radiation), it is highly unlikely that there is anything wrong with your set. However, you can contact the FDA's consumer complaint division and, if it's necessary, they may send an inspector to your home to inspect your set. One reader claims that a good quick check of whether a microwave oven is leaking is to pass a radar detector near the oven while it's operating! I don't vouch for that method, but ya gotta give him a gold star for trying! — Editor

SUBSCRIBER SERVICE
CHANGE OF ADDRESS

Planning to move? Please let us know six weeks in advance so you won't miss a single issue of POPULAR COMMUNICATIONS.

Attach old label and print new address in space provided. Also include your mailing label whenever you write concerning your subscription to insure prompt service on your inquiry.

POPULAR COMMUNICATIONS
76 N. Broadway,
Hicksville, NY 11801

NEW ADDRESS HERE

NAME _____
ADDRESS _____
CITY _____ STATE _____
DATE _____ ZIP _____

ATTACH LABEL HERE

PLEASE PRINT

COMMUNICATIONS SHOP

Advertising Rates: Non-commercial ads are 30 cents per word including abbreviations and addresses; minimum charge \$6.00 per issue. Ads from firms offering commercial products or services are \$1.00 per word; minimum charge \$20.00 per issue. Leading key words set in all caps at no additional charge. All classified ads must be prepaid in full at time of insertion; a 5% discount is offered for prepaid 6 time insertions. All ads must be typewritten double spaced.

Approval: All ad copy is subject to Publisher's approval and may be modified to eliminate references to equipment and practices which are either illegal or otherwise not within the spirit or coverage scope of the magazine.

Closing Date: The 10th day in the third month preceding date of publication. Because the advertisers and equipment contained in Communications Shop have not been investigated, the Publisher of Popular Communications cannot vouch for the merchandise listed therein. Direct all correspondence and ad copy to: PC Communications Shop, 76 N. Broadway, Hicksville, NY 11801.

PHONE BUGGED? Uncle listening? Fight back! Don't be Watergated! Latest countermeasures information \$1.00-ppd. Negeye Engineering, Box 547-PC, Pennsboro, WV 26415.

HOMESAT TELEVISION HANDBOOK & BUYERS GUIDE tells everything, including programming information, advice on choosing the right system for your needs, & budget. \$10.00. H&G Homesat Services, Dept. P, Box 422, Seaford, NY 11783.

MICROWAVE TV ANTENNAS 2 GHz Best in the West! Complete with cable, accessories, warranty, \$125.00. Dealers wanted! Galaxy Electronics, 6007 N. 61 Ave., Glendale, AZ 85301 (602) 247-1151; MC/VISA.

SCANNER CRYSTALS! America's leading mail order specialist, sent to you postpaid and factory fresh! Lowest prices anywhere, so low we can't even print them here! Send for free catalog and special order form! Z-Tech, P.O. Box 70, Hauppauge, NY 11788.

DIRECT, AUTOMATIC RECORDING from scanner, telephone, 2-way receivers, etc., for days without attention. We have 24 hour cassette recorders, voice-activator controls, miniature wireless transmitters (FM), miniature microphones, pocket amplifiers, etc. Our catalog is \$2.00 (refundable). Garrison Electronics, Box 128, Kew Gardens, NY 11415.

MILITARY COMMUNICATIONS EQUIPMENT for sale—SASE and \$1 for list with specifications to: Michael P. Murphy, 738 Laguna St., El Cajon, CA 92020.

POLICE ★ FIRE SCANNERS. Write for unbelievable low discount price list. Crystals \$2.94. State Police patches \$3.50. Dever Communications Discount Mail-order Service, Rt. 2, Box 277, Hot Springs, AR 71901.

"ELECTRONIC BANANZA": Bearcat-100 \$289.95, BC-350 \$384.95. Regency-D810 \$269.95, M-400 \$239.95. Frequency Directories. Shortwave Receivers. Sony-2001 \$298.99, ICF-6500 \$189.95. Kenwood-R-600 \$344.95, R-1000 \$419.95. Also Panasonic, Yaesu, Freedom Phones, CB Radios & More! Free UPS Shipping In The Continental USA: Galaxy Electronics, Box-1202, 67 Eber Ave., Akron, Ohio 44309.

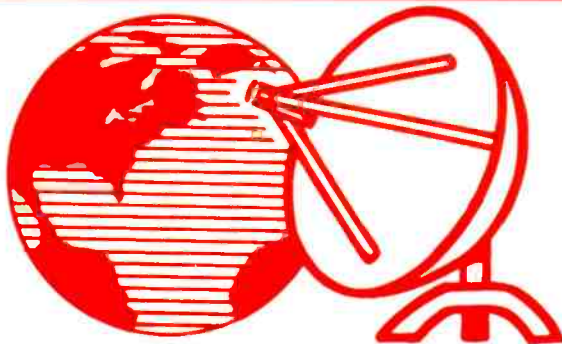

SATELLITE TELEVISION SYSTEMS

WE WILL NOT BE UNDERSOLD!!

Complete Systems, Antennas, Receivers, LNA's & Accessories

CALL US TODAY!

812-238-1456

hoosier electronics

"Nation's Largest Total Communications Distributor"

P.O. BOX 3300 • TERRE HAUTE, INDIANA 47803

AD INDEX

BMW	1
Birdview Satellite Comm.	Cov. III
CRB Research	68
Cleveland Institute of Electronics	11
Communications Electronics	4, 57
DX Communications	31
Dialta Amateur Radio Supply	53
Digital Electronic Systems	49
Electronic Equipment Bank	49
Hal Communications	7, 39
Ham Shack	19
Harvey Radio	61
Heath Co.	Cov. II
Hoosier Electronics	80
Hustler Communications	6
International Satellite Systems	44
JDL Industries	49
Japan Radio Co., Ltd.	43
KLM Electronics, Inc.	40, 41
Lewis Construction Co.	65
Long's Electronics	Cov. IV
Madison Electronic Supply	73
MFJ Enterprises, Inc.	27
Microcraft Corp.	65
Panasonic	13
Pop Comm Book Shop	79
Sandro's Electronics	77
Sinclair Research Ltd.	2, 3
Sony Corporation	8
Tem Microwave	65
Tennessee Electronics	29
Universal Electronics	65
Universal Radio	42
Video Research	31
Windpower	31
Z-Tech	44

**NOW
AVAILABLE**



BirdviewTM

**Home Satellite
Television
Only \$2,995**
Suggested Retail
Complete System

If your viewing is limited to a few TV channels — see what you're missing. Tune in sporting events, international news, movies, entertainment channels and a wide variety of children's, cultural and educational programs.

- Simple Operation
- "Live" Picture Quality
- Professional Installation

MODEL 20/20



YOU GET THE PICTURE 20/20

Turn ordinary television into extraordinary entertainment.
Call or write for the dealer nearest you.

CALL TOLL FREE: 1-800-835-0662 Kansas: 1-800-362-0088

Birdview Satellite Communications, Inc. POST OFFICE BOX 963, CHANUTE, KANSAS 66720 316-431-0400

CIRCLE 76 ON READER SERVICE CARD

Long's... your communications headquarters

A. "World Radio TV Handbook"- A directory of international radio and television. Covers short-wave and includes an annual survey of receiving equipment **16.50**

B. YAESU QTR-24 24 hour quartz world clock- Lets you determine the time anywhere in the world at a glance. Operates up to a year with the included batteries. **49.00**

C. BEARCAT FF-1550 Freedom Phone 1550 cordless telephone- Lets you make or receive calls anywhere up to 600 feet from its base station. Also can be used as an intercom when connected to your phone. Features pushbutton dialing, automatic redial and remote battery charger. List 279.95. **199.95**

D. BEARCAT 210XL 18 channel crystalless scanner- Covers the most popular bands, Low 32-50, High 148-174, 2m Ham 144-148, 75 cm Ham 420-450, UHF 450-470 and T 570-512 MHz. Scans 5 to 15 channels per second. AC/DC operation. List 349.95. **229.95**

E. KENWOOD R-600 general communications receiver- 150 kHz to 30 MHz continuous coverage of the AM, SSB and CW bands. Features 30 band coverage, PLL tuning, tone control and selectable AC power, 100/120/220/240 V. List 399.95 . **359.95**

F. KENWOOD HS-6 lightweight headphones- Frequency response 100 Hz-10,000 Hz 12.5 ohms. Miniature conversion plug included **29.95**

G. PANASONIC RF-1405 PSB High/Air/FM/AM 4-band portable radio- Listen to police, fire, marine, air and 2m ham bands. Battery operation. Earphone and AC cord included. List 79.95 . . **64.95**

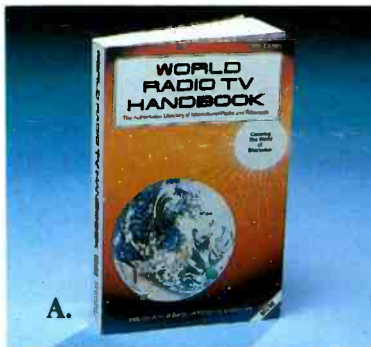

A.

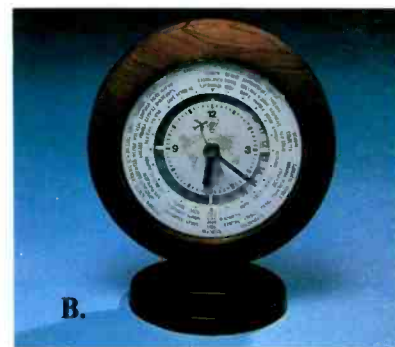

B.



C.



D.



E.

F.

KENWOOD



G.

Panasonic

CALL TOLL FREE 1-800-633-3410

IN ALA. 1-800-292-8668 9 AM TIL 5:30 PM CST MONDAY THRU FRIDAY

Long's Electronics

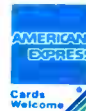

MAIL ORDERS: P.O. BOX 11347 BIRMINGHAM, AL 35202 • STREET ADDRESS: 3131 4TH AVENUE SOUTH BIRMINGHAM, ALABAMA 35233

CALL OR WRITE FOR OUR FREE CATALOG

CIRCLE 32 ON READER SERVICE CARD