

# POPULAR COMMUNICATIONS

DECEMBER 2012

Shortwave Listening • Scanning • AM & FM • Radio History

## Listen!

*Who's That With Radio Goodies for the Holidays? pp. 11 & 16*

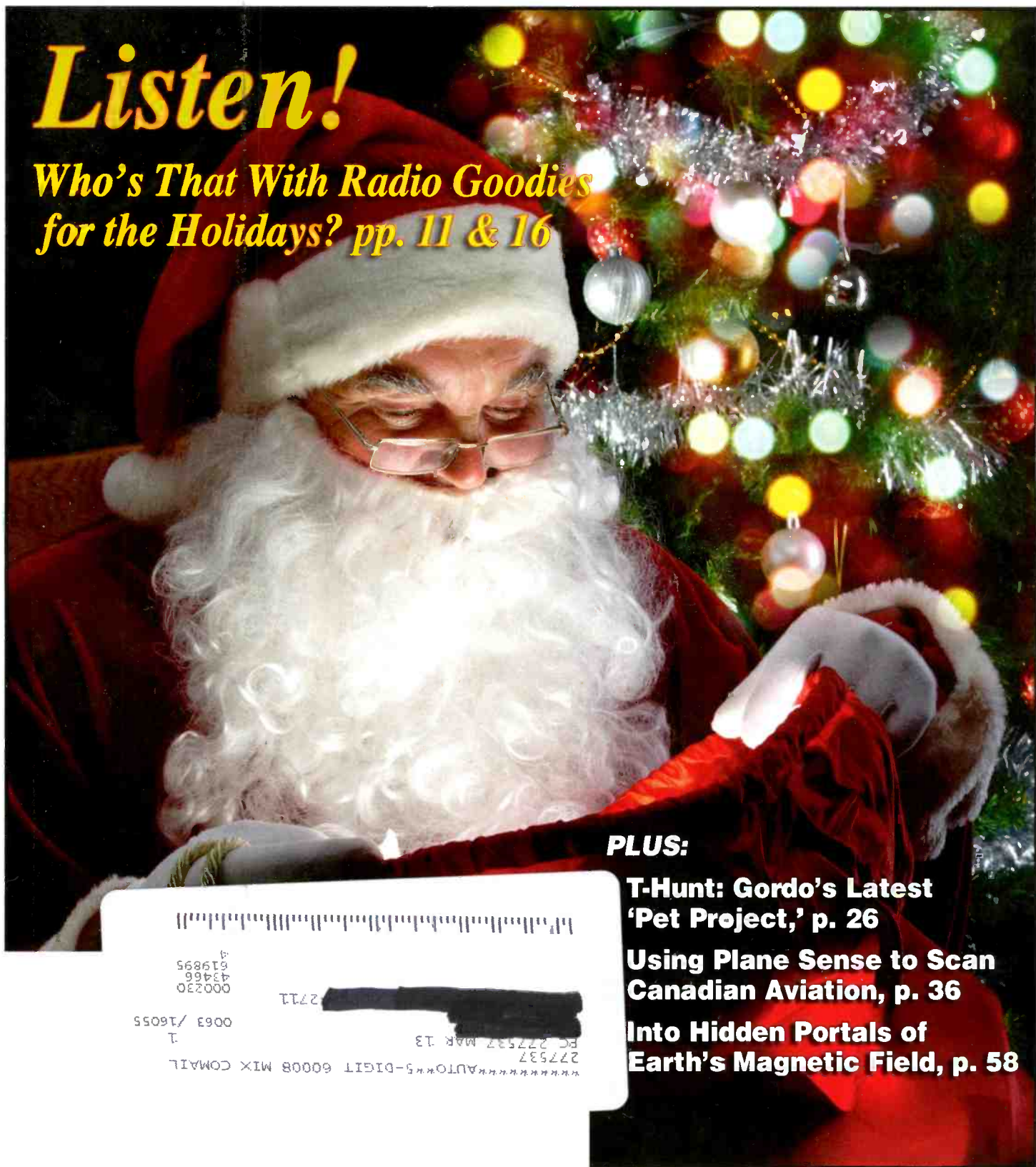

**PLUS:**

**T-Hunt: Gordo's Latest 'Pet Project,' p. 26**

**Using Plane Sense to Scan Canadian Aviation, p. 36**

**Into Hidden Portals of Earth's Magnetic Field, p. 58**

\*\*\*\*\*AUTO\*\*5-DIGIT 60008 MIX COMAIL  
 227537  
 PG 277537 MAR 13  
 1  
 0063 /16055  
 000230  
 43466  
 619895  
 4



**GRECOM**

# Scanning Just Got Easier!



◀ **NEW!** PSR-120  
800MHz Analog Scanner



PSR-310



PSR-410

◀ Analog Trunking  
Scanners



PSR-800  
Digital P25 Scanner

Simply Enter Zip Code, load  
precise local Public Safety  
systems and start Scanning.

Digital Trunking  
Scanners



PSR-600



PSR-500



PSR-200U ▶

Conventional Scanners



PSR-100 ▶

PSR-700 the first  
Scanner with a  
built-in SD card  
and nationwide  
database included!



PSR-700

## The #1 Scanner Manufacturer for over 40 Years!

Our customers say our scanners are the easiest to use and the easiest to program. We have the best quality digital audio decoding and the best AGC action in the business. And we're your best value, too! It's no wonder that we're the #1 scanner manufacturer 40 years running. Call or visit your favorite GRE dealer today to find out more!



**GRE AMERICA INC.**  
425 Harbor Blvd., Belmont, CA 94002

[www.greamerica.com](http://www.greamerica.com)

Mobile use of this device maybe unlawful, or require a permit, in some areas. Check with local authorities for regulations in your area. Product may vary from depiction.



# Universal Radio — Quality equipment since 1942.



1102S



The **Bonito 1102S RadioJet** shortwave receiver combines innovative design with the advantages of modern computer technology. It has a frequency range of 40 kHz to 30 MHz with an excellent sensitivity of .03  $\mu$ Volts on a noise level of -137 dBm with an extreme resolution of 144 dB at a sampling of 24kHz. The Noise floor is extremely low, because there are no active parts between the antenna and the ADC. Strictly speaking, this radio is not an SDR, although it is exclusively controlled by computer. So far, no SDR has defined, controlled, read or computed anything like the RadioJet. Bonito *RadioJet* is a short wave receiver with a built-in USB audio device and a 24kHz multichannel IMjack or to put it simply: The most obvious application of modern radio technology. The software has been designed in such a way that its size and its coloring can be custom-tailored to any screen. This can be achieved with the presets or user-defined. The center piece of this IF-receiver is the supplied software. It makes all the different applications possible. An IF-Input-Device is built into the *RadioJet* so that the radio is like an external USB-Audio recorder and an easy installation without a complicated driver is assured: simply plug and play. The supplied standard software features: Reception and recording of transmissions in USB, LSB, CW, AM, FM and DRM. All filters are completely variable and can have their waviness and notches drawn by hand with the equalizer. S-meter and spectroscopy have an extremely accurate dBm-scale and can be calibrated. This device derives its power from the USB connection. BNC antenna input. Made in Germany. 4.5 x 1.25 x 4 inches. This device requires a USB cable (not supplied).

Order #5789

\$699.95



PERSEUS



The **Microtelecom Perseus** is a cutting-edge, multi-mode, software defined receiver covering 10 kHz to 40 MHz. Enjoy world class performance: 3rd order IP: +31 dBm, Sensitivity: -131 dBm, Dynamic Range: 104 dB (BW 500 Hz CW). Nine six-pole front end bandpass filters prevent overload of the A/D converter. There is a 3 step attenuator plus switchable low noise preamplifier. An impressive full span lab-grade spectrum display function is featured. An almost magical spectrum record feature allows you to record up to an 1600 kHz portion of radio spectrum for later tuning and decoding. A Wide/Narrow noise blander has recently been added. The audio source is via your PC soundcard. The Perseus operates from 5 VDC and comes with an international AC power supply, AC plug converter, SO239 to BNC RF adapter, USB cable and CD with software and detailed manual. Made in Italy.

Order #0122

\$999.95

The **Shuttle Pro V2** hand controller adds great ergonomic versatility to your Perseus receiver. It allows one-handed access to nine fully programmable push buttons as well as a shuttle/jog knob for analog type tuning.

Order #5319

\$99.95



SDR-IQ



The **RFspace SDR-IQ™** with **RF DSP™** offers unprecedented performance with a frequency coverage of 500 Hz to 30 MHz in 1 Hz steps. (Please note the low end tuning range is 500 Hz, not 500 kHz). It features the fastest and highest resolution plug and play spectrum display available. The SDR-IQ™ comes with the latest version of **SpectraVue™** software. It supports AM, WFM, USB, LSB, N-FM, DSB and CW with fully adjustable DSP Filter bandwidths and FFT sizes of 2048 to 262144 points. The resolution bandwidth is as low as 0.031 Hz. The SDR-IQ™ is the smallest SDR with **RF DSP™** that samples the whole HF band at once and performs the initial filtering at a 67 MHz sample rate with 23 bit accuracy. It has a high performance Analog Devices 14 bit analog to digital converter and sends 16 bits of I/Q Data to the PC via USB (no messy soundcard cables required). The SDR-IQ is USB powered so no power supply is required. Works great with laptops running on batteries. It offers incredible receive performance and high resolution spectrum display capability. The rear panel has a USB port, serial port and BNC antenna input jack. The SDR-IQ software CD works with Windows 2000, XP and Vista. Made in the United States.

Order #0106

\$509.95

NetSDR



The **RFspace NetSDR** is a high performance networked software designed receiver with 1.6 MHz bandwidth. The NetSDR uses a high performance 80 MHz, 16 bit ADC with both dithering and randomization for best performance. The output I/Q bandwidth is configurable via software. PC communications are handled over a 100 base-T port using 24 or 16 bit I/Q words. The NetSDR is a complete plug and play solution. As opposed to other SDRs in the market, there is no need for additional preamplifiers, preselectors or code development. The unit is compatible with the Moetronix SpectraVue and SDR-Radio software that will have you up and running in minutes. The software includes analog and digital mode demodulation and I/Q capture of spectrum at up to a 1.6 MHz bandwidth. The SDR-Radio software allows the use of the NetSDR over the Internet. The full 1.6 MHz waterfall and demodulation audio can be transported via a 5 KB/s link. For those interested in writing their own applications, RFspace supplies a fully documented protocol for communicating with the hardware. There is no need to calculate the down converter DSP parameters. The NetSDR just needs the center frequency, attenuator and preselector filter settings, output sample rate and mode to begin streaming data. Other solutions require complicated USB interfacing that is platform specific. The NetSDR utilizes straight TCP/IP and Ethernet for all communications. This offers the highest possible performance due to the highly optimized Ethernet drivers on PC, Mac and Linux systems. The NetSDR packets are fully routable so that the receiver may be placed at remote locations. Multiple receivers can also be combined and their data transported over a higher data rate Ethernet pipe using simple switches and routers. In this application, each NetSDR can be set to a different IP address or port.

Order #0383

\$1449.95

universal  
radio inc.

**Universal Radio, Inc.**  
6830 Americana Pkwy.  
Reynoldsburg, Ohio  
43068-4113 U.S.A.

☎ 800 431-3939 Orders & Prices  
☎ 614 866-4267 Information  
☎ 614 866-2339 FAX Line  
✉ dx@universal-radio.com

[www.universal-radio.com](http://www.universal-radio.com)

● Visit our website for more exciting  
new and used hobby radios.

- Visa
- MasterCard
- Discover
- JCB
- Prices and specs. are subject to change.
- Special offers are subject to change.
- Returns subject to a 15% restocking fee.
- Prices shown do not include shipping.



# POPULAR COMMUNICATIONS CONTENTS

DECEMBER 2012  
VOLUME 31, NUMBER 4



## FEATURES

- 16 Presents of Mind: Gordo's Picks for the Holidays**  
*by Gordon West, WB6NOA/WPC6NOA*
- 20 WLS Listeners, Please 'Stand By!'**  
Part II: The Broadcast Giant's Longstanding Place in AM DXing and Live Entertainment  
*by Andrew Ooms*
- 26 Hey, It's Transmitter Hunting Gone Wild!**  
*by Gordon West, WB6NOA/WPC6NOA*

## FEATURED COLUMNS

- 11 Broadcast Technology**  
Eight Great Gift Ideas for Radio Enthusiasts  
*by Bruce A. Conti, WPC1CAT*
- 36 Plane Sense**  
Northern Exposure: Canada's Rich Aviation Scanning Environment  
*by Bill Hoefler, KPC4KGC/KG4KGC*
- 58 The Propagation Corner**  
Exploring Hidden Portals in Earth's Magnetic Field  
*by Tomas Hood, WPC7USA/NW7US*
- 70 Shannon's Broadcast Classics**  
A Picture of Radio. Gray  
*by Shannon Huniwell, WPC2HUN*

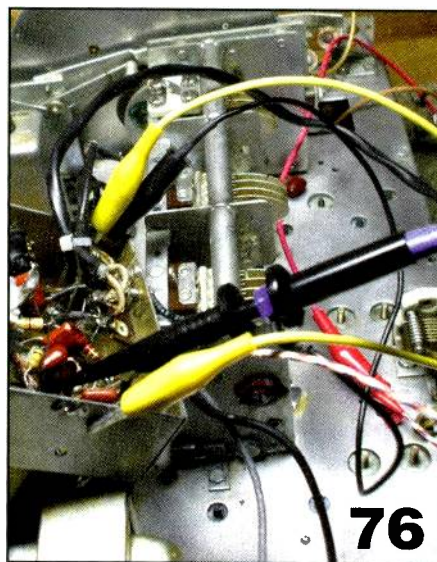
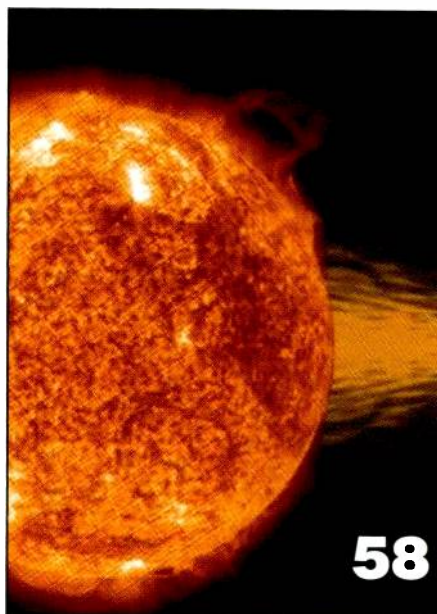

## ON THE COVER

Jolly ol' Kris Kringle, your friends and relatives are puzzled about what to give you this holiday season. You're stumped, as well, about what to wrap for your communications hobbyist buddies. Whether you're buying for others or dropping hints for yourself, Bruce A. Conti, WPC1CAT; and Gordon West, WPC6NOA, have a dozen radio-related gift ideas that might be just what you're looking for. See pages 11 and 16. Season's greetings! (Cover design by Liz Ryan, Pop'Comm Art Director. Cover image courtesy of Shutterstock)

## COLUMNS

- 10 Horizons**  
Just Who Pays for What We're Hearing?  
*by Rob de Santos*
- 30 Ham Discoveries**  
Considered Mobile HF Yet? Take it to the Streets  
*by Kirk Kleinschmidt, KPC0ZZZ/NT0Z*
- 41 Power Up**  
New, Interesting and Useful Communications Products  
*by Jason Feldman, WPC2COD*
- 42 World Band Tuning Tips**  
World News, Commentary, Music, Sports, And Drama At Your Fingertips
- 44 Monitoring**  
'Frequency' Opens the Door to Shortwave  
*by Richard Fisher, KPC6PC*
- 64 Global Information Guide**  
Sometimes It Seems the SWL World Is Upside Down  
*by Gerry L. Dexter, WPC9GLD*
- 54 Monitor of the Month**  
WPC7USA, Omaha, Nebraska  
*by Richard Fisher, KPC6PC*
- 76 The Wireless Connection**  
Arithmetic Selectivity and the SX-101A Receiver  
*by Peter Bertini, K1ZJH*
- 84 The Loose Connection**  
Holiday Wishes: Good Things, Small Packages  
*by Bill Price, N3AVY*

## DEPARTMENTS

- 4 Tuning In**  
An Editorial
- 6 Newsworthy**  
Unwired, InfoCentral, And Washington Beat
- 35 Reader Survey**
- 69 Spurious Signals**
- 82 Across the Spectrum**

web: [www.popular-communications.com](http://www.popular-communications.com)



# Tap into secret Shortwave Signals

Turn mysterious signals into exciting text messages with the MFJ MultiReader™!



MFJ-462B  
\$199<sup>95</sup>

Plug this self-contained MFJ Multi-Reader™ into your shortwave receiver's earphone jack.

Then watch mysterious chirps, whistles and buzzing sounds of RTTY, ASCII, CW and AMTOR (FEC) turn into exciting text messages as they scroll across an easy-to-read LCD display.

You'll read interesting commercial, military, diplomatic, weather, aeronautical, maritime and amateur traffic . . .

## Eavesdrop on the World

**Eavesdrop** on the world's press agencies transmitting *unedited* late breaking news in English -- China News in Taiwan, Tanjug Press in Serbia, Iraqi News in Iraq -- all on RTTY.

**Copy** RTTY weather stations from Antarctica, Mali, Congo and many others. Listen to military RTTY passing traffic from Panama, Cyprus, Peru, Capetown, London and others. Listen to hams, diplomatic, research, commercial and maritime RTTY.

## Super Active Antenna

"World Radio TV Handbook" says MFJ-1024 is a

"first-rate easy-to-operate active antenna...quiet... excellent dynamic range... good gain... low noise... broad frequency coverage." Mount it outdoors away from electrical noise for maximum signal, minimum noise. Covers 50 KHz-30 MHz. Receives strong, clear signals from all over the world. 20 dB attenuator, gain control, ON LED. Switch two receivers and auxiliary or active antenna. 6x3x5 in. Remote has 54" whip, 50 feet coax. 3x2x4 inches. 12 VDC or 110 VAC with MFJ-1312, \$15.95.



MFJ-1024  
\$159<sup>95</sup>

## Indoor Active Antenna

Rival outside long wires with this tuned indoor active antenna. "World Radio TV Handbook" says MFJ-1020C is a "fine value... fair price... best offering to date... performs very well indeed."

**Tuned** circuitry minimizes intermod, improves selectivity, reduces noise outside tuned band. Use as a preselector with external antenna. Covers 0.3-30 MHz. Tune, Band, Gain, On/Off/Bypass Controls. Detachable telescoping whip. 5x2x6 in. Use 9 volt battery, 9-18 VDC or 110 VAC with MFJ-1312, \$15.95.



MFJ-1020C  
\$99<sup>95</sup>

## Compact Active Antenna

Plug this compact MFJ all band active antenna into your receiver and you'll hear strong, clear signals from all over the world, 300 KHz to 200 MHz including low, medium, shortwave and VHF bands. Detachable 20" telescoping antenna. 9V battery or 110 VAC MFJ-1312B, \$15.95. 3/4x1 1/4x4 in.



MFJ-1022  
\$69<sup>95</sup>

## Eliminate power line noise!

**Completely** eliminate power line noise, lightning crashes and interference before they get into your receiver! Works on all modes -- SSB, AM, CW, FM, data -- and on all shortwave bands. Plugs between main external antenna and receiver. Built-in active antenna picks up power line noise and cancels undesirable noise from main antenna. Also makes excellent active antenna.

## MFJ Antenna Matcher

Matches your antenna to your receiver so you get maximum signal and minimum loss. **MFJ-959C** Preamp with gain control boosts weak stations 10 times. 20 dB attenuator prevents overload. Select 2 antennas and 2 receivers. 1.6-30 MHz. 9x2x6 in. Use 9-18 VDC or 110 VAC with MFJ-1312, \$15.95.

## High-Gain Preselector

**High-gain,** high-Q receiver preselector covers 1.8-54 MHz. Boost weak signals 10 times with low noise dual gate MOSFET. Reject out-of-band signals and images with high-Q tuned circuits. Push buttons let you select 2 antennas and 2 receivers. Dual coax and phono connectors. Use 9-18 VDC or 110 VAC with MFJ-1312, \$15.95.

## Dual Tunable Audio Filter

Two separately tunable filters let you peak desired signals and notch out interference at the same time. You can peak, notch, low or high pass signals to eliminate heterodynes and interference. Plugs between radio and speaker or phones. 10x2x6 inches.



MFJ-1026  
\$199<sup>95</sup>



MFJ-959C  
\$119<sup>95</sup>



MFJ-1045C  
\$89<sup>95</sup>



MFJ-752D  
\$119<sup>95</sup>

Listen to maritime users, diplomats and amateurs send and receive *error-free* messages using various forms of TOR (Telex-Over-Radio).

**Monitor** Morse code from hams, military, commercial, aeronautical, diplomatic, maritime -- all over the world -- Australia, Russia, Japan, etc.

**Monitor** any station 24 hours a day by printing transmissions. Printer cable, MFJ-5412, \$11.95.

**Save** several pages of text in memory for later reading or review.

## High Performance Modem

MFJ's high performance *PhaseLockLoop™* modem consistently gives you solid copy -- even with weak signals buried in noise. New threshold control minimizes noise interference -- greatly improves copy on CW and other modes.

## Easy to use, tune and read

It's easy to use -- just push a button to select modes and features from a menu.

It's easy to tune -- a precision tuning indicator makes tuning your receiver easy for best copy.

It's easy to read -- front-mounted 2 line 16 character LCD display has contrast adjustment.

**Copies** most standard shifts and speeds. Has

MFJ *AutoTrak™* Morse code speed tracking.

Use 12 VDC or use 110 VAC with MFJ-1312D AC adapter, \$15.95. 5/8x2 1/4x5 1/4 inches.

## WiFi Yagi Antenna -- 15 dBi 16-elements extends range



**16-element,** 15 dBi WiFi Yagi antenna greatly extends range of 802.11b/g, 2.4 GHz WiFi signals. 32 times stronger than isotropic radiator. Turns slow/no connection WiFi into fast, solid connection. Highly directional -- minimizes interference.

**N-female** connector. Tripod screw-mount Wall and desk/shelf mounts. Use vertically/horizontally. 18Wx2 1/4 Hx1 1/4 D inches. 2.9 ounces.

**MFJ-5606SR, \$24.95.** Cable connects MFJ-1800/WiFi antennas to computer.

**Reverse-SMA male to N-male, 6 ft. RG-174. MFJ-5606TR, \$24.95.** Same as MFJ-5606SR but Reverse-TNC male to N-male.



MFJ-1800  
\$29<sup>95</sup>

## MFJ Shortwave Headphones

**Perfect** for shortwave radio listening for all modes -- SSB, FM, AM, data and CW. Superb padded headband and ear cushioned design makes listening extremely comfortable as you listen to stations all over the world! High-performance driver unit reproduces enhanced communication sound. Weighs 8 ounces. 9 ft. cord. Handles 450 mW. Frequency response is 100-24,000 Hz.



MFJ-392B  
\$24<sup>95</sup>

## MFJ All Band Doublet

102 ft. all band doublet covers .5 to 60 MHz. Super strong custom fiberglass center insulator provides stress relief for ladder line (100 ft.). Authentic *glazed ceramic* end insulators and heavy duty 14 gauge 7-strand copper wire.



MFJ-1777  
\$59<sup>95</sup>

## MFJ Antenna Switches

MFJ-1704 \$79<sup>95</sup> MFJ-1702C \$39<sup>95</sup>



MFJ-1704 heavy duty antenna switch lets you select 4 antennas or ground them for static and lightning protection. Unused antennas automatically grounded. Replaceable lightning surge protection. Good to 500 MHz. 60 dB isolation at 30 MHz. MFJ-1702C for 2 antennas.

## Morse Code Reader

Place this pocket-sized MFJ Morse Code Reader near your receiver's speaker. Then watch CW turn into solid text messages on LCD. Eavesdrop on Morse Code QSOs from hams all over the world!



MFJ-461  
\$89<sup>95</sup>

## MFJ 24/12 Hour Station Clock

MFJ-108B, \$21.95. Dual 24/12 hour clock. Read UTC/local time at-a-glance. High-contrast 5/8" LCD, brushed aluminum frame. Batteries included. 4 1/2x1Dx2H inches.



## MFJ Shortwave Speaker

This MFJ *ClearTone™* restores the broadcast quality sound of shortwave listening. Makes copying easier, enhances speech, improves intelligibility, reduces noise, static, hum. 3 in. speaker handles 8 Watts, 8 Ohm impedance. 6 foot cord.



MFJ-281  
\$12<sup>95</sup>

## Dealer/Catalog/Manuals

Visit: <http://www.mfjenterprises.com> or call toll-free 800-647-1800

• 1 Year *No Matter What™* warranty • 30 day money back guarantee (less s/h) on orders direct from MFJ

**MFJ** MFJ ENTERPRISES, INC.  
300 Industrial Pk Rd, Starkville, MS 39759 PH: (662) 323-5869  
Tech Help: (662) 323-0549

FAX: (662) 323-6551 8-4:30 CST, Mon-Fri. Add shipping. Prices and specifications subject to change © 2012 MFJ Enterprises, Inc.



# POPULAR COMMUNICATIONS

## EDITORIAL STAFF

**Richard Fisher, K16SN**, Editor

(E-mail: [editor@popular-communications.com](mailto:editor@popular-communications.com))

**Jason Feldman, WPC2COD**, Associate Editor

(E-mail: [jason@popular-communications.com](mailto:jason@popular-communications.com))

**Richard S. Moseson, W2VU**, Editorial Director

(E-mail: [w2vu@popular-communications.com](mailto:w2vu@popular-communications.com))

## CONTRIBUTING EDITORS

**Peter J. Bertini, K1ZJH**, Restoration/Electronics

**Bruce A. Conti**, AM/FM Broadcasts

**Rob de Santos**, Trends in Technology

**Gerry L. Dexter**, Shortwave Broadcast

**Mitch Gill, NA7US**, Homeland Security

**Bill Hoefer, KPC4KGC**, Aviation

**Tomas Hood, NW7US**, Propagation

**Shannon Huniwell**, Classic Radio

**Kirk Kleinschmidt, NT0Z**, Amateur Radio

**Bill Price, N3AVY**, Humor/Communications

**Ken Reiss**, Technical/Scanning

**Dan Srebnick, K2DLS**, Computers And Radio

**Bob Sturtevant, AD7IL**, Puzzles And Trivia

**Jason Togyer, KB3CNM**, Cartoons

**Gordon West, WB6NOA**, General Radio Comm.

## BUSINESS STAFF

**Richard A. Ross, K2MGA**, Publisher

**Chip Margelli, K7JA**, Advertising Manager

**Emily Leary**, Sales Coordinator

**Sal Del Grosso**, Accounting Manager

**Doris Watts**, Accounting Department

## CIRCULATION STAFF

**Melissa Gilligan**, Operations Manager

**Cheryl DiLorenzo**, Customer Service Manager

**Ann Marie Auer**, Customer Service

## PRODUCTION STAFF

**Elizabeth Ryan**, Art Director

**Barbara McGowan**, Associate Art Director

**Dorothy Kehrrieder**, Production Director

**Emily Leary**, Production Manager/Webmaster

**Hal Keith**, Technical Illustrator

**Larry Mulvehill, WB2ZPI**, Photographer

**Rod Somera**, Webmaster

A publication of



CQ Communications, Inc.  
25 Newbridge Road  
Hicksville, NY 11801-2953 USA

Popular Communications (ISSN-0733-3315), Vol. 31, No. 4 published monthly by CQ Communications, Inc., 25 Newbridge Road, Hicksville, NY 11801. Telephone (516) 681-2922. FAX (516) 681-2926. Web Site: <<http://www.popular-communications.com/>> Periodicals Postage Paid at Hicksville, NY and at additional mailing offices. Subscription prices (payable in U.S. dollars): Domestic—one year \$34.95, two years \$62.95, three years \$91.95. Canada/Mexico—one year \$44.95, two years \$82.95, three years \$121.95. Foreign Air Post—one year \$54.95, two years \$102.95, three years \$151.95.

U.S. Government Agencies: Subscriptions to Popular Communications are available to agencies of the United States government, including military services, only on a cash with order basis. Requests for quotations, bids, contracts, etc. will be refused and will not be returned or processed.

Entire contents copyright © 2012 by CQ Communications, Inc. Popular Communications assumes no responsibility for unsolicited manuscripts, photographs, or drawings. Allow six weeks for change of address or delivery of first issue.

Printed in U.S.A.

Postmaster, Please send change of address to: Popular Communications, 25 Newbridge Rd., Hicksville, NY 11801

## EDITORIAL

### Tuning In

by Richard Fisher, KPC6PC/K16SN  
<[editor@popular-communications.com](mailto:editor@popular-communications.com)>

# Pop'Comm @ 30: Tuning in the New Year, Circa 1982-'83



"What are you doing New Year's Eve?" *Pop'Comm* shortwave listening impresario Gerry Dexter asked readers in December 1982 — just a few months after the magazine's launch. "Why not try something really different during the changeover from 1982 to 1983? Celebrate with your shortwave receiver."

In the following pages, Gerry gave readers an hour-by-hour guide to monitoring stations going around the world, starting in the South Pacific. It's a cleverly-written guide to round-the-world listening as New Year's is celebrated time zone to time zone. Although likely out of sync with today's stations, times and frequencies, here's an abbreviated look through Gerry's window on the shortwaves at New Year's 30 years ago.

## Auld Lang Syne: Time Zone-By-Time Zone

1200 GMT: It's New Year's in the South Pacific. Tune in **Radio New Zealand**, and "if you draw a blank, another possibility is **FR4**, Noumea, New Caledonia on 7170 kHz in French," Gerry wrote.

1300 GMT: Gerry suggests "a **Russian transmitter site** at Petropavlovsk" on 4485.

1400 GMT: "This brings the New Year to Eastern Australia, so tune to one of **Radio Australia's Overseas Service** frequencies.

1500 GMT: Be ready for **Radio Japan-NHK** — Gerry said, on 9505, 9645, or 11815 kHz.

1600 GMT: Tune in **VLW9** in western Australia, or try the **Voice of the Philippines** on 9580. Celebrate with **Radio Malaysia** at 1630 GMT.

1700 GMT: U.S. West Coast monitors should tune for **Radio Peking**, Gerry directed.

1800 GMT: "This is a *virtual impossibility*," he wrote. "They are raising glasses of yak's milk in Lhasa. But take a stab at **Tibet** on 9490." **India** will come up at the bottom of the hour.

1900 GMT: "They should be carousing in **Karachi (Pakistan)** . . . This one will be difficult to catch." Gerry suggests aiming for **Afghanistan** at 1930 GMT.

2000 GMT: No targets at the top of the hour, but, at 2030, "it's 1983 in Iran and the **Voice of the Islamic Republic** should be an easy catch on 15084 kHz."

2100 GMT: Midnight in Moscow. "The North American Service isn't on the air yet, but the World Service of **Radio Moscow** is going strong."

2200 GMT: **Cairo, Egypt** or **South Africa's RSA** are ringing in 1983 now.

2300 GMT: "It's off to Europe," Gerry wrote: **Vienna, Rome, Swiss Radio International** . . . "There are lots of countries to choose from at this hour."

0000 GMT: "Where else but London?" Gerry asks, and the **BBC**, of course.

0100 GMT: **Cape Verde Islands** is your only choice. *A tough one.*

0200 GMT: In 1983, you had a break. "Make a fresh pot of coffee or do some sit-ups," Gerry recommended.

0300 GMT: Catch the celebration at **Radiobras** in Brazil, where they "should be *samba-ing*," he said. At 0330 there's **Radio Apinte** from Paramaribo, Suriname.

0400 GMT: It's back to Brazil for **Radio Bare** on 4895 kHz "from Manaus on the Amazon River."

0500 GMT: It's New Year's on the U.S. East Coast, "but no fair cheating" with domestic stations. "Try **HCJB** in Quito, Ecuador, or **Radio Havana, Cuba**."

0600 GMT: Gerry suggests **XEWW, La Voz de l'America Latina** from Mexico City.

0700 GMT: "Yawn!"

0800 GMT: It's **KGEI** from California on 9615 kHz.

0900 GMT: Another breather hour. "But take heart," Gerry encourages. "You've almost made it!"

1000 GMT: Here's something different: National Bureau of Standards time station **WWVH** in Hawaii. *Tick, tick, tick.*

1100 GMT: "The day ends with something of a whimper," Gerry writes. "In fact, total silence, since there are no possibilities this hour . . . But whether you spend 24 hours at the receiver, or just do some casual listening, it's very likely you'll find at least one station that'll catch your ear . . . *Happy New Year!*"

## Season's Greetings

*From all of us at Pop'Comm, may you and yours have the best of holidays. We hope this season is as bright as the tubes in your vintage receiver. Even brighter!*

— Richard Fisher, KPC6PC/K16SN



## New! - PK-232SC with Sound Card, Rig Control, USB - All built-in!



**PK-232SC Multimode Data Controller\***  
Sound Card, Rig Control, USB, Pactor, RTTY, CW Packet & more!

100,000 sold - All-time top selling data controller!

*New PK-232SC Now shipping!*

- Single USB connection to computer
- USB Sound Card built-in
- 3-Way Rig Control built-in - logic level, RS-232 & USB!
- Computer isolated from radio

*New Lower SC + DSP Upgrade Combo Pricing!*

**As Always-  
Upgrade any PK-232 ever made  
to the PK-232SC!**

Customize your PK-232 with our complete line of upgrades and accessories.

*Need Software? Check the new Ham Radio Deluxe & Radio Operating Center bundle!*

*Optimized for the PK-232SC and other Timewave/AEA TNCs [www.ham-radio-deluxe.com](http://www.ham-radio-deluxe.com)*

The incredible PK-232SC again expands its role in your radio station. Now it connects to your computer with a single USB cable - no audio cables, no RS-232 cables! It has a built-in USB sound card with isolated audio I/O to your radio to prevent ground loops. The new logic level and RS-232 rig control is optically isolated for your Icom CI-V, Yaesu CAT, Kenwood and other radios. You never have enough downstream USB ports so we even added a pair for that new radio with USB rig control and other accessories.

## Signal Processing, Antenna Analysis, Data & Remote Control



- **DSP-599zx Audio Signal Processor\***

Noise Reduction, precision highpass, lowpass, bandpass & notch filtering for audio, CW & data.

*Now shipping with new bigger & brighter display!*



- **TZ-900 Antenna Analyzer**

Sweep and analyze antennas in seconds. Zoom, Compare & Store Data. Sunlight-visible color graphics, handheld, rechargeable batteries, no computer required.

*Once you use the TZ-900 - you'll never want to use any other!*



- **ANC-4 Antenna Noise Canceller**

Kill Noise before it reaches your receiver!  
Great for suppressing power line noise, plasma TV noise & many other local electrical noises.

*See & hear a demo on YouTube!*

- **DSP-232 + Multimode Data Controller\***  
Sound card interface, USB, Pactor, 1200/9600 Packet

- **PK-96/100 TNC - 1200/9600 Packet\***  
Available with USB or RS-232

## HamLink™ Wireless and USB Remote Control & Audio

- **HamLinkUSB™ Rig Control Plus**  
C-IV, CAT, RTS (PTT, FSK or CW) for sound card software
- **PK-232 RS-232-to-USB Adapter\***  
Use the PK-232 with your new computer!

- **HamLinkBT-BTH+™ Bluetooth® Adaptor**  
Use a standard cellphone Bluetooth® headset to keep your hands free for driving and operating. Includes USB rig control for your station. Audio, VOX & PTT - Fixed & Mobile.



*\*From the Timewave Fountain of Youth - Upgrades for many of our DSP & PK products. Call Us Now!*



# The Weirder Side of Wireless, and Beyond

Compiled by  
Richard Fisher,  
KPC6PC



**Photo A.** Yuri Suzuki, designer-in-residence at the London Design Museum, developed a printed circuit board that traces the form of the London Underground subway system — *the tube*. As you can see, the radio is, nonetheless, tubeless. Visit <<http://bit.ly/QWK6jt>>. (Internet screen grab)

## A Tube Radio . . . Without Tubes

We knew it was going to happen eventually. (Not really, but it sounds good.)

A smart designer has produced a radio with its printed circuit board tracings in the shape of the London Underground subway system, which Brits also refer to as *the tube*.

Credit Japanese artist Yuri Suzuki with this triumph. **Photo A.** He is designer-in-residence at the London Design Museum.

Who would have thought that in this new millennium we'd have a tube radio — without tubes. For more information on Suzuki's project, visit <<http://bit.ly/QWK6jt>>. (Source: Southgate ARC News)

## CQ-DX Funkamateure

Hey, Americans aren't the only ones who can make fancy amateur radio promotional films.

*CQ-DX Funkamateure*, **Photo B**, a vintage German product, is funky, grainy, black-and-white, almost 15 minutes long, and quite charming. Is there an Oscar for "Retro Ham Radio Schtick?"

On YouTube, the film is described as Ein film von 1955 über den Amateurfunk. Heute ist die Technik zwar eine andere aber das Grundsätzliche im Film gezeigt ist auch heute noch so.

If you weren't there that day in German class, it translates to: A film from 1955 about amateur radio. Although the technology today is different, the basic communication shown in the film is still the case today.

Say it loud and proud: Ich bin ein Ham! (**WATCH:** CQ-DX Funkamateure at <<http://bit.ly/QyPhc2>>. — KPC6PC)

## #askjulius: Your Tweets, Please?

Federal Communications Commission Chairman Julius Genachowski's inaugural dive into a Twitter chat got off to



**Photo B.** *CQ-DX Funkamateure* a vintage film that introduces viewers to amateur radio in Germany, circa 1955. Visit: <<http://bit.ly/QyPhc2>>. (Internet screen grab)

a rough start when a legion of Tweeters sent questions, but The G Man gave no answers.

**PROBLEM:** Apparently Genachowski wasn't hash-tagging his responses with #askjulius — the one participants were using to send him questions. They waited. Five, 10, 15, 20 minutes. Instead of a frank and open discussion, snark ensued. (**TRANSLATION:** See No. 1 at <<http://bit.ly/SDRSmZ>>. — KPC6PC)

"As one tweeter noted," an *Adweek* story reported, "it was a rookie mistake. Genachowski can be forgiven, but it's hard to believe there aren't any social media geniuses at the FCC who could have made sure the chairman of the agency in charge of the nation's airwaves and telecommunications didn't blow it."

*Adweek* sources said Genachowski "was actually at Twitter headquarters during his Twitter fail" — #oop-sicjulius. (Source: *Adweek* <<http://bit.ly/QeLxg6>>)

## Offered a Punch On Valentine's Day

Experts chalk it up to frustration and a bad season. An enraged Boston Red Sox Manager Bobby Valentine, appearing on WEEI-Boston's *The Big Show*, threatened to punch air personality Glenn Ordway in the face after he asked if the baseball manager had "checked out?"

Read that:

- A short-timer?
- Phoning it in?
- His head out of the game?
- No longer into it?

Valentine's response: "What an embarrassing thing to say. Ya know, if I was there I would punch you right in the mouth." Fortunately for Ordway, Valentine was not there. The manager was, indeed, *phoning it in* — just not during a ballgame.

Valentine would later say it was all a joke: "Didn't I go, 'Ha, ha? I don't think physical violence is necessary for 60-year-old people.'" A jovial Valentine wore boxing gloves to a subsequent in-person interview with Ordway. The manager thinks he'll be back in 2013. Stay tuned. (Source: *Published reports*)

## Communications News, Trends and Short Takes

By Richard Fisher,  
KPC6PC

### SWL Broadcaster Vacates 40-Meter Amateur Band

Having finished “experimental transmissions,” Radio Bangladesh has left 7105 kHz in the 40-meter amateur radio band and has moved to 7250.

According to published reports, the move is due in part to SWLers and radio amateurs who reported the inappropriate operation. German regulator BNetzA <<http://bit.ly/SnAMlX>> filed the official complaint to Radio Bangladesh. (Source: Published reports)

### Arbitron Report: Radio Is Nearly Saturating U.S. Audience

Arbitron has found in a recent Radar report that radio has boosted its share of listeners 12 and older, and now reaches almost 93 percent of the U.S. audience weekly.

About 94 percent of adults 18-49 with a household income of \$75,000 or higher listen to radio. “The report also showed positive growth among Hispanic and black listeners,” according to the National Association of Broadcasters. (Source: NAB SmartBrief)

### Global Service Offers Options for Online Radio

Radionomy, a free global service founded in 2008, allows people from around the world to “discover, listen to and create online radio stations,” the organization says.

“Featuring a wide variety of music and themed stations produced and run by real people such as music fans, artists, DJs, opinion leaders, comedians and story tellers, and so on, Radionomy stations are more than just playlists,” officials said.

Radionomy, backed by MusicMatic, is one of the largest online radio networks in the world with more than 6,000 Internet radio stations and more than 42 million listening hours each month. To learn more about Radionomy, visit <<http://www.Radionomy.com>>. (Source: Radionomy)

### U.S. Local TV Stations Trend to More News

Some TV stations around the United States have expanded their news operations, “now fielding more than 60 hours a week and nearly one-third planning more such content for 2012,” according to an NAB SmartBrief citing *TVNewsCheck* as its source.

“I think there is something to be said for a TV station providing local news,” Alice Jacobs, vice president of news at Sunbeam’s WSVN in Miami. “I know people say you can go to the Internet and other places. But when there is live breaking news in South Florida, they turn to us and they watch.” (Source: NAB SmartBrief)

### Dick Clark Productions Sold to Dodgers Owner

A report in the *Los Angeles Times* says Guggenheim Partners, the new owner of the Los Angeles Dodgers, is buying Dick Clark Productions for \$370 million.

The financial services firm, which paid more than \$2 billion for the baseball team, “wants to further expand its Hollywood footprint, especially in live content,” published reports said.

Dick Clark Productions has rights to the Golden Globes, the Academy of Country Music Awards and the American Music Awards. “We would characterize this as the beginning of the beginning,” Todd Boehly, president of Guggenheim Partners, said. “We really believe this type of content is going up in value.” (Source: *LA Times*, other published reports)

### Notable Passings . . .

**Sean Smith, KG4WSS**, was one of four Americans — including Ambassador Chris Stevens — killed September 11 in an attack on the U.S. Consulate in Benghazi, Libya. According to the *ARRL Letter*, Smith had worked for the State Department for the past 10 years, following a six-year enlistment in the U.S. Air Force. He was on temporary assignment in Libya at the time of the attack.

. . . Chairman of Region III of the International Amateur Radio Union **Michael Owen, VK3KI**, who was also President of the Wireless Institute of Australia, died September 22 at age 75. He was also IARU Vice President from 1989 to 1999. Mr. Owen is survived by his wife and two daughters.

. . . State-run Radio Mogadishu identified **Liban Ali Nur**, news director and anchor for Somalia’s national television network, and **Abdisatar Dahir Sabriye**, an anchor and producer, as casualties of a suicide bombing in a packed tea house. The head of another radio station, the *Voice of Democracy*, also died in the blast, and four other journalists were wounded, three critically, the network reported. The United Nations condemned the suicide bombing in Somalia’s capital as a “cowardly attack.”

. . . **Everett Gracey, WA6CBA**, who co-founded both Mirage Communications (now a part of MFJ) and RF Concepts, died in late August at age 90. A World War II veteran awarded the Silver Star, Bronze Star, and Purple Heart, Mr. Gracey was also responsible for bringing Alinco products into the U.S. ham marketplace and most recently was the dealer representative for LDG Electronics. He was also involved with AMSAT and the SAREX/ARISS amateur radio in space programs, and was the author of several books. He is survived by his daughter and son-in-law, five grandchildren, eight great-grandchildren and three great-great-grandchildren.

. . . According to the BBC, **Saad Al-Hilli**, a mechanical design engineer at Surrey Satellite Technology, has been identified as one of the murder victims found in the French Alps. (*IN DEPTH: Read the full BBC story at* <<http://bbc.in/PshqyT>>. — KPC6PC.) A British bicyclist discovered the crime scene.

“I am deeply shocked and saddened,” SST’s Matt Perkins said. “Saad’s colleagues will remember him as an experienced and committed engineer who worked as part of a tightly knit team” Mr. Al-Hilli joined SST in November 2010. (Sources: *ARRL, BBC, CNN, CQ Newsroom* <<http://www.CQNewsroom.blogspot.com>>.)





## Capitol Hill And FCC Actions Affecting Communications

by Richard Fisher,  
KPC6PC/KI6SN

### FCC: No Foul Against NBC for Airing 'Manure Chant'

TMZ has reported the FCC will not punish NBC for failing to cut audio of a "manure chant" by the stadium crowd during a highly-charged National Football League game Sunday night, September 23.

Baltimore fans broke into the chant after Ravens Coach John Harbaugh's call for a timeout was not recognized by a replacement referee. The home team was pitted against the visiting New England Patriots.

The several-minute chant was described by NBC commentator Al Michaels as "the loudest manure chant" he'd ever heard.

*(WATCH: Video of "manure chant" at <<http://bit.ly/OV1gCc>>. CAUTION: Listener discretion advised. — KPC6PC)*

TMZ reported an FCC official said the Commission will not penalize NBC for the audio. "There's never been any penalties imposed for obscenities inadvertently heard over air," the FCC said. *(Source: TMZ, <<http://tmz.me/SIM1pS>>)*

### 'Internet Radio Fairness Act' Comes Before Congress

The U.S. House of Representatives' Jason Chaffetz (R-Utah) and Jared Polis (D-Colorado) have introduced the "Internet Radio Fairness Act," which could change the way streaming audio royalties are calculated.

Chaffetz said Internet radio is "barely hanging on" because it pays "such a larger proportion of revenue in royalties," adding the legislation will "level the playing field for Internet radio services by putting them under the same market-based standard used to establish rates for other digital services."

"Congress enacted the royalty rate standard for Internet radio 14 years ago, when Internet radio was barely a concept," Chaffetz said in a statement reported on the Web by *Nextgov*. "This bipartisan legislation levels the playing field for Internet radio services by putting them under the same market-based standard used to establish rates for other digital services, including cable and satellite radio. It's well past time to stop discriminating against Internet radio."

Sen. Ron Wyden (D-OR) was to introduce companion legislation in the U.S. Senate. *(Source: Nextgov <<http://bit.ly/S111MU>>)*

### Whopping Fine Levied Against Florida Cable Operator

A cable operator serving a resort area in Florida has been fined \$236,000 by the FCC "for violations, including its repeated failure to respond to the commission, to install or maintain Emergency Alert System (EAS) equipment, and to operate within signal leakage limits that prevent possible interference with navigation," according to a *Broadcast Engineering* story.

St. George Cable of St. George Island, Florida, must pay the fine and confirm, "under penalty of perjury, that it is in compliance with EAS and signal-leakage rules," the Commission said.

FCC agents from the Tampa office found dozens of leakages into aeronautical frequencies during a facility inspection in 2011. "and ordered the operator to shut down until the problem was fixed," the report noted.

"After the FCC hand-delivered the order and explained it to cable executives, the operator told the commission it would comply, but it never contacted the FCC to obtain authority for conducting testing on its repairs. A re-inspection found more leaks — many of which exceeded 100  $\mu$ V/m at 3m. The FCC told the St. George Cable to cease operations. The cable company ignored the order." *(Source: Broadcast Engineering, <<http://bit.ly/SA7XKm>>)*

### Lawmakers: FCC Must Protect Over-the-Air TV

In a letter to the FCC, a group of Tennessee lawmakers called on the Commission to "take steps to ensure Americans will still be able to receive broadcast (over the air, OTA) TV signals from stations after the incentive auction of spectrum." The members of Congress say *all Americans* should know if their OTA signals will be disrupted by the auctions. *(Source: NAB SmartBrief, <<http://bit.ly/UVyt06>>)*

### Commissioner: Don't Count Out Broadcast Television

FCC Commissioner Ajit Pai told a broadcast conference in Dallas that it would be "counterproductive" to move all broadcasting to broadband services because broadcast television is far from being a relic of the past.

Pai, a Republican appointed to the Commission in May, spoke at the National Association of Broadcasters radio conference in September.

According to a Web report from *Broadcast Engineering*, Pai said, "the most popular programming enjoyed by Americans continues to be offered by broadcasters. Last year, in fact, 96 of the 100 most watched television shows in our country were aired on broadcast television. As we head into the future, I believe that broadcasting should, and will continue to play an important role in America's media landscape." *(Source: Broadcast Engineering, <<http://bit.ly/Ri4wG0>>)*

### Genachowski Pushes for Broadband Quality and Speed

*The Washington Post* reports FCC Chairman Julius Genachowski in an op-ed piece has outlined "several things the country could do to improve the quality of its broadband networks and give U.S. consumers the high-speed data they demand."

Genachowski said, "that there needs to be a push for next-generation bandwidth and that the public sector has a 'vital, but limited' role to play in making sure that happens."

In the op-ed, the *Post* said, "Genachowski called for ensuring Internet openness, releasing more wireless spectrum, and promoting universal access." *(Source: The Washington Post, <<http://wapo.st/UVOOlq>>)*

# Icom has the receivers for the experts...

Official Amateur Radio Transceiver Supplier



BOY SCOUTS OF AMERICA®

## IC-R9500 The Ultimate Wide Band Receiver

- 0.005–3335.000MHz\*
- USB, LSB, CW, FSK, FM, WFM, AM
- 1020 Alphanumeric Memory Channels
- P25 (Option UT-122)
- Five Roofing Filters and so much more!



For those just getting started...



## IC-R75 Wide Band Receiver

- 0.03–60.0 MHz\*
- Triple Conversion
- Twin Passband Tuning
- Digital Signal Processing (DSP)

## AND for those on the go!

### IC-R20 Advanced Ops

- RX: 0.150–3304.999MHz\*
- AM, FM, WFM, SSB, CW
- 1250 Alphanumeric Memory Channels
- Dualwatch Receive
- 4-hour Digital Recorder



### IC-RX7 Track Ready

- RX: 0.150–1300.0MHz\*
- AM, FM, WFM
- 1825 Alphanumeric Memory Channels
- 100 Ch/Second High Speed Scan
- Computer Programmable<sup>2</sup>
- Water Resistance Equivalent to IPX4



### IC-R6 Pocket Compact

- RX: .100–1309.995MHz\*
- AM, FM, WFM
- 1300 Alphanumeric Memory Channels
- 100 Ch/Second High Speed Scan
- Computer Controllable<sup>1</sup>



### IC-R2500 2 Wide Band RX in 1 Black Box

- RX: 0.01–3299.99MHz\*
- AM, FM, WFM, SSB, CW (Main)
- AM, FM and WFM (Sub)
- 1000 Memory Channels
- Optional D-STAR (UT-118)
- Optional P25 (UT-122)
- Optional DSP (UT-106)
- PC Controllable



### IC-PCR1500 PC Control Wide Band RX

- RX: 0.01–3299.99MHz\*
- AM, FM, WFM, SSB, CW
- Record and Save Audio as .WAV File
- USB Cable Connection
- Optional DSP

**Limited Time Only!**  
See your dealer for details.

### Information & Downloads

RECEIVERS | AMATEUR TOOL KIT | COMIC BOOKS | VIDEOS | [WWW.ICOMAMERICA.COM](http://WWW.ICOMAMERICA.COM)

Electronic advertisements feature active links for each radio.

\*Frequency coverage as specified in the owner's manual for each frequency span. †Option UT-118 required. ‡Optional DS-10X† required.  
© 2012 Icom America, Inc. Icom is a registered trademark of Icom, Inc. All specifications are subject to change without notice or obligation. 40779





# Just Who Pays for What We're Hearing?

By Rob de Santos  
 <commhorizons@gmail.com>  
 Twitter: <@shuttleman58>

*“The answers will be critical to determining the future of ‘radio.’”*

If you want to get a group of radio and Internet executives going, ask them who should pay for content and how much should they pay.

I don't mean just what you, the listener, pays, but what should broadcasters, satellite providers, and Internet radio stations pay for content? Particularly music. How those questions are answered isn't just a matter of economics to the businesses involved. The answers will be critical to determining the future of *radio*.

To understand where we are today, it is important to understand the economic model radio has operated under for decades. The general idea went like this: Radio was *broadcast radio* and in order to use music, compensation was paid to the copyright owners. This was done via a copyright royalty scheme.

Since music received “free promotion” via radio, radio has been exempt from “performance” royalties. This resulted in much lower total royalties than it might have otherwise. This means when you hear a song on broadcast radio, the composer and lyricist are paid, but the performer is not.

For most commercial entities, this ranges from five to 20 percent of revenue. Non-commercial broadcasters paid even lower rates than did commercial entities. Broadcasters covered this cost and had means to profit via advertising. In non-commercial radio, it profits from listener contributions and government subsidies.

Times have changed, though, and new distribution methods have appeared. First, there was cable. Music services distributed via cable pay about double what broadcast radio pays, but generally average only 15 percent of revenue.

Then satellite radio and Internet radio arrived on the scene. Satellite radio fees are in line with cable services and Sirius XM says that about 10 to 12 percent of the monthly subscription fee covers royalties. Satellite radio has subscriber fees and some advertising to pay those costs.

Internet radio, though, has always been a problem. From its first appearance in the mid-1990s, the question of royalties has been controversial. Under current law, royalties are not set the same way as other radio distribution methods.

Most royalties are set by statute, or by negotiation between the parties. For Internet radio, it is *willing buyer, willing seller*. The leverage is all on the part of the rights holders, and rights holders largely set the standard. The result has been royalty rates that average 40 to 60 percent of revenue.

During the last fiscal year, Pandora paid out 55 percent of its revenue in royalties. It doesn't take an

MBA to realize that is probably not a sustainable business model. Revenue is mostly advertising with some subscription fees for premium service. Other Internet radio companies are in a similar situation. Even broadcast radio relayed over the Internet is subject to these royalties. With limited digital revenue, broadcasters who provide Internet feeds are unhappy, too.

The explosion of Internet radio delivered by mobile devices such as smartphones and tablets has brought the issue to the attention of Congress and the public. Two solutions are on the table right now.

One solution would level the playing field by raising all royalties to the level of Internet radio. It seems unlikely this will prevail. The other solution would be to apply the same royalty standards to all forms of radio that would, in effect, lower Internet radio to match satellite and broadcast radio. It would also add performance royalties to broadcast radio where they have not previously applied.

Predictably, broadcasters aren't thrilled. A decision by Congress is unlikely until sometime in 2013 and you can be sure every interested party of the entertainment industry is going to weigh in.

As a listener and a hobbyist, I value every means I have to listen to programming and music where and when I want. I also know that creative people and performers need compensation so they continue to create more great music.

Radio stations — whatever their distribution method — must be able to make a reasonable profit so they stay on the air. If our future in communications is to be everything we desire, then the communications hobby needs to help shape that future, too. Without a resolution to the royalty issue that is equitable, we will lose some of these choices in the future.

Before wrapping up the column this month, a few notes:

- Almost as soon as I finished writing last month's column on the future of AM radio, stories appeared in the press indicating both industry and the FCC are beginning to study the issue. *Stay tuned!*
- I want to express my thanks to the many readers who sent comments and compliments to my daughter Amanda for her thoughts when she filled in for me in October's *Horizons*.
- Finally, this is my 50<sup>th</sup> column. I've thoroughly enjoyed writing this column and appreciate your constant feedback. Let me know your thoughts on the radio royalty issue and I'll be back next month. — K8RKD



# Eight Great Gift Ideas for Radio Enthusiasts

By **Bruce A. Conti, WPC1CAT**

*Can't figure out what would bring good cheer to a DXer this year? Have no fear, the annual wish list is here. A radio, a log, maybe software, or an antenna hung on a windsock pole with care. Eight product reviews for you to compare from the comfort of home in your favorite armchair.*

*"Here's wishing you many enjoyable hours at the radio dials in the New Year."*

## Tecsun Ultralight

Digital signal processing innovation, once reserved for communications gear, has reached the level of consumer grade handheld pocket radios, and Tecsun has mastered the technology in its line of portable radios.

The Tecsun PL-380, **Photo A**, tops the short list of ultralight DXer favorites. As featured in last month's *Broadcast Technology*, seasoned DXers like Gary DeBock have successfully received challenging trans-Pacific signals on the PL-380 from coastal Oregon locations.

The AM performance is indeed outstanding for such a compact radio. Selectable IF bandwidths of 6, 4, 3, 2, and 1 kHz help to reduce adjacent channel interference, an unusual feature for a radio of its size. Being coupled to an external antenna further enhances the performance.

The PL-380 is also a great FM DX receiver. In an FM band-

scan over the summer, I was able to log at least one station on every frequency with the PL-380 and its telescoping whip antenna. In fact the PL-380 was capable of receiving every signal that could be found on a high-end Sangean HDT-1X receiver and outdoor antenna. (SEE: *The FM logbook* at <http://bit.ly/RQ1MSM>). – WPC1CAT)

Lots of frequencies can be stored in the PL-380 memory — 100 AM, 100 FM, 100 LW, and 250 SW — for quick tuning. In addition an "Easy Tuning Mode" (ETM) will automatically scan for signals and temporarily store frequencies into memory. The PL-380 has all the conveniences of a modern consumer radio too, including a snooze alarm, sleep function, and lighted digital display.

The PL-380 is powered by three AA batteries or by an external 5-VDC USB connection. The Tecsun PL-380 can be found

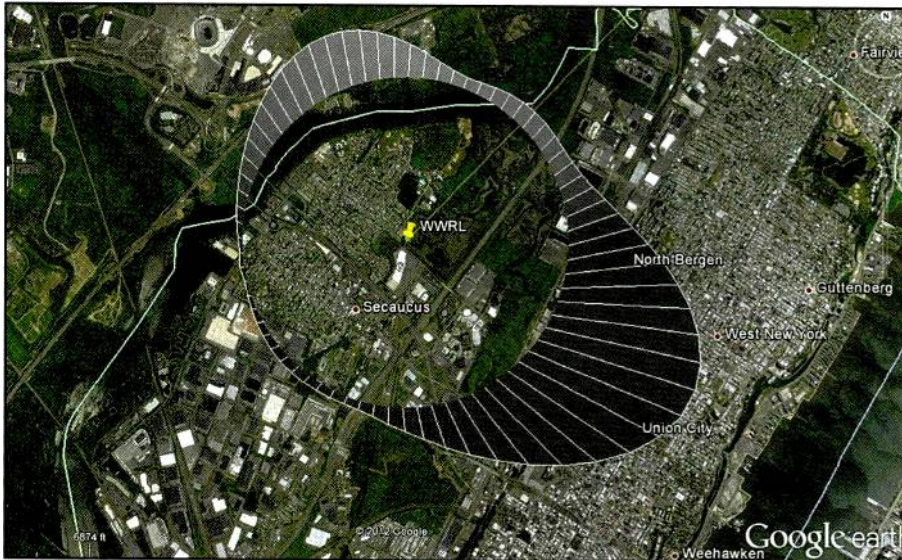

**Photo A.** The Tecsun PL-380 "hot-rodded" with an external 7-inch ferrite loop antenna by Gary DeBock for optimal performance. (Courtesy of WPC1CAT)



**Photo B.** The 32-foot, heavy-duty telescopic windsock pole when fully collapsed measures only 46 inches long, receiving the approval of *Aurora*, the DX Cat. (Courtesy of WPC1CAT)





**Photo C.** This 3-D representation of the 1600 WWRL antenna pattern mapped on Google Earth by WorldStation shows most of the power aimed east toward New York City from the New Jersey transmitter site. (Courtesy of WPC1CAT)

online for under \$50 from online retailers or eBay.

### Telescoping Antenna Mast

Innovative amateur radio operators have found an alternative use for telescoping windsock poles. I first discovered them demonstrated at the New England Amateur Radio Festival.

These poles have typically been used to support windsocks at temporary aviation or para-glider landing sites, and to fly kites and flags in whimsical garden displays.

Now they've become popular for antenna masts at field day events and DXpedition setups. Henry Pollock, K4TMC, of The Mast Company has made several types of these telescoping poles available to the amateur radio community for antenna deployment. Of particular interest to both AM and FM broadcast DXers is The Mast Company's 32-foot, heavy-duty fiberglass telescoping pole, **Photo B.**

It has a 1/16-inch wall per section, and the tip section is a sturdy 5/16-inch diameter. The top section includes a 1-inch-long, metal tip sleeve to protect the end and a wire loop to attach items. The pole is painted dark green with a slick shiny finish for stealth use in those *picky* neighborhoods. For temporary use, you can lash one to a deck railing with some bungee cords.

For a more permanent setup, K4TMC suggests one of those RadioShack® 3-foot tripod roof mounts staked to the ground, <<http://bit.ly/Vx0smg>>. Patio/

deck umbrella stands have also been used. Of course, the pole can be guyed with rope for additional support at an open field site.

The 32-foot, heavy-duty pole is sturdy enough to safely support the center of a Delta broadband loop, a lightweight FM dipole, or a small yagi and accompanying feedline. Use two poles to raise the ends of a larger dipole or broadband loop. It collapses to a length of 46 inches and slips into a provided protective sleeve for easy transport and storage. The telescoping sections use a friction-fit joint in which you extend and secure each section with a slight twist.

The mast is \$115.00, which includes shipping in the U.S. by FedEx ground. Visit The Mast Company <<http://bit.ly/OVV33c>> for more information.

### WorldStation Radio Database Software

New broadcast DX applications for WorldStation radio database software with the addition of FCC data was introduced in the October edition of *Broadcast Technology*.

WorldStation provides one-click access to the FCC Media Bureau's AM Query database, plus Aoki, EiBi, and HFCC shortwave databases. FCC data is integrated with Google Earth to map transmitter sites. Software developer Robert Griffin, KC2JJM, has since added new features. **Photo C.**

"If you are an AMDXer, you may have wondered why some stations are not audible in your location while others boom

in," writes KC2JJM about the latest release. "To make a long story short, it's due [in part] to the antenna pattern. Not all stations have omni-directional antenna systems. The FCC publishes the antenna pattern data online.

"I've taken this data and added a new feature to the AM tables that visualizes this antenna pattern in 3-D in Google Earth. Writing this code was involved because I had to develop a robust screen scraper to parse the data on-the-fly from the FCC website. The plots will work with any station in the FCC database (including foreign ones). I'm simply taking the

## This Month in Broadcast History

*75 Years Ago (1937):* Montreal radio station CBF signed on 910 kHz with 50 kilowatts, coinciding with the launch of the French-language network of the Canadian Broadcasting Corporation. In 1941, as part of the North American Radio Broadcasting Agreement, CBF moved to 690 kHz which was designated a Canadian clear channel, where it remained until moving to FM followed by terminating the AM signal in 1999. CKGM now occupies 690 in Montreal, moving from 990 just last September.



*50 Years Ago (1962):* "Return to Sender" by Elvis Presley <<http://bit.ly/PQNYmS>> topped the Million Dollar Music Swing-Along Survey on 1300 WMAK Nashville.

*25 Years Ago (1987):* Construction of experimental anti-skywave AM broadcast antennas was delayed by snags in the approval process for two separate design proposals. The "Biby" antenna awaited completion of a land lease agreement in Virginia, and Howard University was concerned that the tower warning lights would interfere with astronomy classes at their observatory near the "Prestholdt" antenna test site in Maryland.

— WPC1CAT

microvolt data for each 5 degrees of the compass (FCC data) and plotting it in feet as the virtual height of the antenna field strength at a 1-mile radius from the antenna site."

The latest version includes menu-level entry of receiver coordinates, as well, which will automatically update distance calculations to transmitter sites in the FCC database. The basic WorldStation "virtual receiver" database-only software sells for \$29.95, which includes one year of upgrades. The WorldStation customized for remote control of Ten-Tec RX-340/331 and RX-350, Ten-Tec Jupiter, Ten-Tec Orion, and Orion II, or the Drake R8A/B/E, ICOM R-75, or Racal 6790/GM, and TCI 8174 receivers

is \$49.95. Visit <<http://bit.ly/RQ574n>> to learn more about this versatile software.

## Euro-African Medium Wave Guide

Herman Boel provides an overview of literally all long- and medium-wave stations in Europe, Africa, and the Middle East in *The Euro-African Medium Wave Guide* (EMWG), **Photo D**.

It gives extensive information on each station including location, broadcast times, languages, parallel shortwave frequencies, format, address, telephone, fax, website, DRM, and QSL information. EMWG is compiled from observations of Boel and other DXers, information obtained directly from radio

stations, and other publications such as radio club bulletins.

"In the mid-1990s I was becoming more and more interested in medium wave, in particular the European medium wave," writes Boel in the preface to EMWG. "I noticed that the sources I used to consult, the *WRTH* and *Sender & Frequenzen*, mostly contained concise frequency lists with nothing more than frequency, station name, and power output.

"This led to a continuous browsing between pages to get as much information as possible and make DXing easier. Just like many other DXers, I started to make my own list with the information I could find. That information came especially from various club bulletins, but also from messages in the DX Antwerp bulletin board system. This was the Internet's predecessor and meant a true revolution for DXers who could now exchange information through their computers.

"At the time, the EMWG was still called the *Long and Medium Wave Guide for Europe, North Africa, and the Middle East*, and was initially drawn up in the Flemish language. As non-Flemish speaking DXers also became interested, I switched to English and uploaded the list at regular intervals onto the DX Antwerp bulletin board.

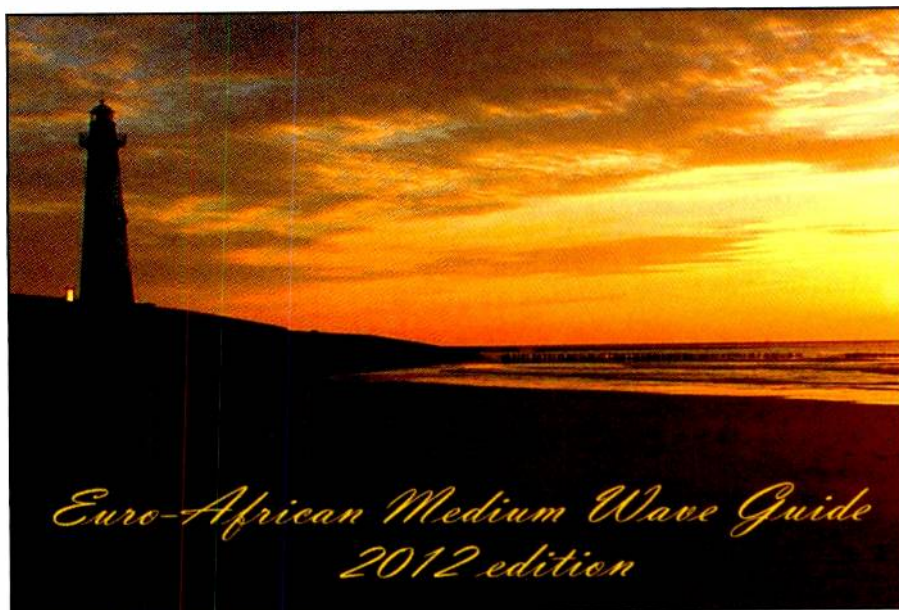

**Photo D.** The EMWG is an excellent resource for DXers interested in the reception of AM broadcast signals from Europe, the Middle East, and Africa. (Courtesy of WPC1CAT)

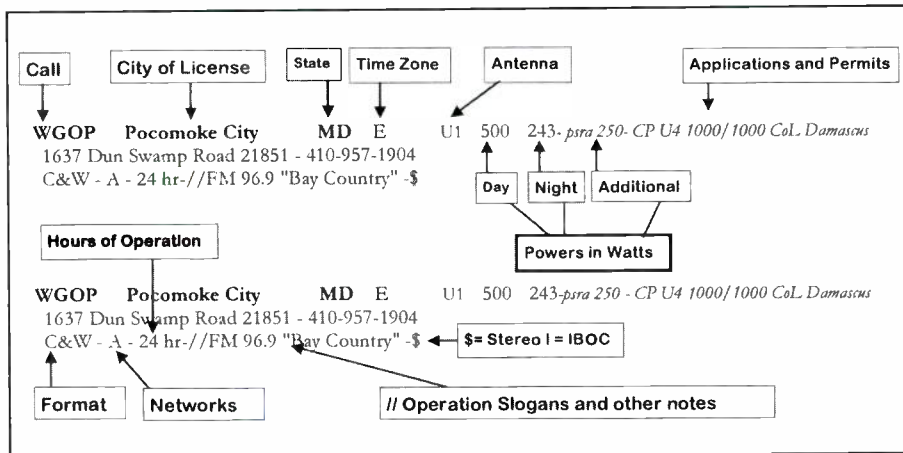

**Photo E.** Each entry of the NRC AM Radio Log contains a wealth of radio station information. (Courtesy of National Radio Club)

## WorldRadio ONLINE

- DX World
- Rules & Regs
- DX Predictions
- Propagation
- Aerials and more!

A general interest online only ham magazine with a special focus on the human side of amateur radio and on projects and activities accessible to the average ham. Regular topics include DXing, emergency communications and "trail friendly" radio!

### HOLIDAY SPECIAL PRICES!

**1 year Subscription only \$18.95**  
**2 years \$28.95**  
**3 years \$37.95**

View on your PC, Mac, iPad, iPhone or Android (2.0+)

## WorldRadio Online

25 Newbridge Rd., Hicksville, NY 11801  
 1-800-853-9797  
[www.worldradiomagazine.com](http://www.worldradiomagazine.com)



“The later renamed *European Medium Wave Guide* caught on well, and thanks to some renowned DXers and DX clubs, the publication became more and more professional. At the end of 2002, the EMWG could be consulted online and was now even more being kept up to date. In December 2004, the EMWG was merged with James Niven’s *African Medium Wave Guide* and subsequently covered not only the whole of Europe and the Middle East, but the whole of Africa as well.”

Today the EMWG is an invaluable resource for North American trans-Atlantic AM broadcast DXers. While the basic EMWG is available for free anytime online, for 5 Euros (approximately \$6.50 U.S.) an enhanced PDF edition can be customized to include azimuth and distance from your receiver coordinates to every radio station listed. Visit <<http://www.emwg.info>> for your copy of the latest EMWG.

## National Radio Club AM Log

The *NRC AM Radio Log* is the indispensable resource for information about AM radio stations in the United States and Canada. **Photo E.** The 33<sup>rd</sup> edition contains 274 pages of data and cross references in 8.5- by 11-inch size, three-hole punched, loose-leaf format.

More than 6,000 updates since last year’s edition include call letters of FM simulcasts with the AM station listings, listings of regional groups of stations, stations licensed to use HD digital, and a comprehensive list of low-power FM translators simulcasting AM broadcasts. The FM translator cross-reference in the log is especially useful with so many AM stations now identifying themselves by their FM relay frequency.

“Formerly called the *National Radio Club Domestic Log*, the first edition was published by mimeograph and hand-typed stencil in Boston in 1968,” writes Editor Wayne Heinen, NØPOH, in the forward. “The roots of the Log, though, date back to the 1930s when *Radex Magazine* published a log, and the ’40s and ’50s when the Newark News Radio Club Editor Carroll Weyrich produced an annual medium-wave log.”

Like the EMWG, today the Log is a must for AM broadcast DXers, containing more information than can be found in any other single source. The *NRC AM Radio Log* sells for \$28.95, which includes U.S. delivery from <<http://www.nrcdxas.org>>, or get a member discount by joining the National Radio Club. Founded in 1933, the club is celebrating its 80<sup>th</sup> year of service to the AM broadcast DX community.

## Tower Site Calendar

Photographing broadcast transmitter sites has become a fascinating and specialized interest of many radio enthusiasts. Case in point: Paul Walker, of WDDH, recently started a Facebook group called “I Take Pictures of Transmitter Sites” and within a couple weeks it grew to 640 active members sharing photos and stories. However some of the credit for the growing popularity of transmitter site paparazzi must go to Scott Fybush, of WXXI, who has chronicled his radio road trips for more than a decade now with the Tower Site of the Week on <<http://www.fybush.com>> and in the annual *Tower Site Calendar*.

The 2013 12<sup>th</sup> edition of the *Tower Site Calendar*, **Photo F**, features more photos of broadcast towers taken by Scott Fybush on his travels. The 12-month wall calendar boasts a full-color photo each month of a well-known broadcast transmitter site.

The 2013 edition includes sites in Florida, Wisconsin, Kentucky, California, Iowa, Idaho, Las Vegas, Colorado,



**Photo F.** On the cover of the 2013 *Tower Site Calendar* is the Sandia Crest antenna farm serving Albuquerque, New Mexico — home to 14 FM and 11 DTV stations including KOB-TV, the state’s first TV station. (Courtesy of Scott Fybush)

Boston, Cleveland, Albuquerque, upstate New York, and western Massachusetts.

The 2013 *Tower Site Calendar* is available online for \$18.95 exclusively from <<http://www.fybush.com>>, where the *NRC AM Radio Log* is also available. Is there a tower site coffee table book in the works? Stay tuned!

## Total Recorder

So far we’ve got an ultralight radio, antenna mast, databases, logbooks, and calendar. Now we need something to capture audio of all the great DX catches. Total Recorder software from High Criteria Inc. is a DXer favorite for recording and editing DX audio on a computer.

High Criteria offers two versions of Total Recorder — Standard and Professional.

The standard edition provides all the basic functionality for audio recording, converting file formats, and editing needed for DX purposes. Total Recorder will record any sound passing through any line of your sound card. For example, you can record sound being played back by an external program, or sound from a microphone, an external LP, cassette, CD/DVD player, or AM/FM/Satellite radio.

You can also record Internet broadcasts, streaming audio, or local audio files reproduced by other programs, such as RealPlayer, Windows Media Player, iTunes, Musicmatch Jukebox, and WinAmp, without the need for special lines for your sound board and without a loss of quality due to redundant conversions from digital to analog to digital. Total Recorder includes powerful scheduling tools for unattended recording too.

A key difference between the standard and professional versions is the post-editing options. The Standard edition allows for selecting and saving a fragment of a file, while the Professional edition allows for cut, copy, paste, and delete of selected fragments, as well as insertion of a file/fragment into an existing file. Pro will also extract track information from an Internet stream.

High Criteria recommends downloading and installing a no-cost evaluation copy of Total Recorder Standard Edition to make

# Learn More, Hear More, Build More With Great New Books from W5YI!

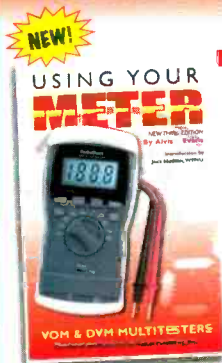

## USING YOUR METER

Teach yourself the correct use of your multimeter. Book explains fundamental concepts of electricity including conventional and elector. current and series and parallel circuits. It teaches how analog and digital meters work and tells you what the voltage, current and, resistance measurements mean. Then it provides fully-illustrated, step-by-step instruction on using your meter in practical applications in the home, workshop, automotive and other settings. An excellent learning tool and reference for the hobbyist and ham.

METR \$24.95



## WORLDWIDE LISTENING GUIDE

John Figliozzi's brand new, expanded 5th Edition *Worldwide Listening Guide* explains radio listening in all of today's formats – "live," on-demand, WiFi, podcast, terrestrial, satellite, internet, digital and, of course, AM, FM and SW. Includes a comprehensive program guide to what can be heard how, when and where. Link to WWLG website keeps you up-to-date on program schedule changes. Spiral bound to open in a flat, easy-to-use format.

WWLG \$24.95

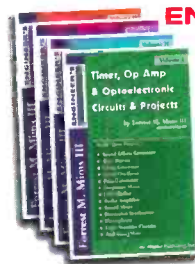

## ENGINEER'S MINI NOTEBOOKS

These Mims classics teach you hands-on electronics! Study and build 100s of practical circuits and fun projects. Each volume contains several of his famous Mini Notebooks. Terrific ideas for science fair projects and a great way to learn about electronics! Useful reference guides for your workbench!

- Vol. 1: Timer, Op Amp, & Optoelectronic Circuits & Projects** MINI-1 \$12.95
- Vol. 2: Science & Communications Circuits & Projects** MINI-2 \$12.95
- Vol. 3: Electronic Sensor Circuits & Projects** MINI-3 \$12.95
- Vol. 4: Electronic Formulas, Symbols & Circuits** MINI-4 \$12.95

**Order today from W5YI: 800-669-9594 or on-line: [www.w5yi.org](http://www.w5yi.org)**

The W5YI Group P.O. Box 200065 Arlington, TX 76006-0065

Mention this ad for a free gift.

CQ

sure it addresses your requirements and runs properly on your PC. An online FAQ-page and tutorials will help you achieve your goals faster.

Free and fast technical support is provided even with the no-cost evaluation



**Photo G.** The C.Crane CC Witness Plus MP3 player/recorder includes a built-in AM/FM radio. (Courtesy of C.Crane)

version. The evaluation copy is a fully functional version of the program with the exception that an audible noise will be inserted about every 60 seconds throughout each original recording you make, but you can playback and edit previously recorded files without the 'watermark' noise being inserted.

The standard edition costs \$17.95 and the professional version \$35.95 from <<http://www.totalrecorder.com>>.

## C.Crane CC Witness Plus Recorder

Recording directly to a computer with Total Recorder may not be an option for many AM DXers. If proximity to a computer causes too much interference to your radio, then the CC Witness Plus MP3 player/recorder is the solution. The Pogo "Radio Your Way" MP3 player/recorder is the predecessor to the Witness, and I've been using it for years to make interference-free MP3 recordings of DX audio.

The Witness features a stereo line input for recording from an analog audio source such as the headphone output of a radio. Additionally, according to C.Crane, the Witness is the only MP3 player/recorder with its own AM/FM radio onboard, providing the option of

recording directly from the internal radio or an external source. Furthermore, the Witness has a timer that can be programmed for unattended recording of up to 20 events — great for overnight DX and program recording.

The Witness includes 2 GB of internal memory, expandable to 8 GB with an optional external SD card. Those 2 GB can hold as much as 140 hours of audio at a 32-kb-per-second sampling rate. The Witness is powered by an internal rechargeable lithium polymer battery pack, an included external charger/power supply, or USB connection to a computer with the provided cable. Audio files are easily uploaded to a computer from the Witness via the USB connection for editing and saving.

The CC Witness Plus is available for \$149.95 from C.Crane, <<http://www.ccrane.com>>. While there, take a look at the entire C.Crane catalog of radio goodies for more gift ideas.

## That's It!

Next month, it's back to the radio dial and your log reports. Wishing you many enjoyable hours at the dials in the New Year. 73 and Good DX! – WPCICAT



# Presents of Mind: Gordo's Picks for the Holidays



By Gordon West, WB6NOA/WPC6NOA

It's holiday gift-giving time again. Here are a few items you may want Santa to leave under your tree . . . or tower!

## Ham Source EZ-Gate 80 Power Transfer Unit

Ham Source's John Kalotai, N1OLO, now has a second, *new* power supply/battery, solid-state transfer unit to handle up to 80 amperes of current — the EZ Gate 80.

According to Ham Source, the EZ-Gate 80. **Photo A**, is "the ultimate in backup (power) for your shack or repeater site. (It provides) serious power handling for a serious station (with) instantaneous, low-loss power switchover from the DC supply to the backup battery."

Similar to the company's lower-current-capable, 40-ampere EZ Gate, the



**Photo A.** The EZ-Gate 80 power transfer unit from Ham Source can help take the worry out of power interruptions at your listening post or amateur radio station. (Courtesy of Ham Source)



**Photo B.** "Seminars about ham radio technical and semi-technical topics are our strong draw," Quartzfest leader, Steve Weed, KO4QT, says. (Courtesy of WB6NOA)



**Photo C.** An aerial view of Quartzfest, near Quartzsite, Arizona, shows the radio noise-free environment its annual radio-enthusiast visitors enjoy. (Courtesy of WB6NOA)

output of your power supply attaches to POWER SUPPLY, and the big backup battery goes to the BATTERY terminal. The OUTPUT goes to the gear you plan to run.

When you have AC going in the shack, and your power supply turned on, your gear is happy, plus the big battery also gets a hefty charge of 10 or 20 amps, if it is well down. The red, green, and yellow LEDs indicate the mode of the charge controller. It also shows charge current to your battery.

If AC should fail, *instantly* the power for your gear starts pulling off the 12-volt battery. No relays — it's instant diode switching. And, when power is restored, your power supply now recharges the battery, and your rig runs off the power supply. The EZ-Gate 80 is \$189. Visit: <<http://www.hamsource.com>>.

### Free Education @ Quartzfest 2013

*Here's a freebie:* Spend up to 10 days as part of Quartzfest 2013 — the annual encampment of shortwave listeners, scanner enthusiasts, and amateur radio operators on Bureau of Land Management (BLM) land, just south of Quartzsite, Arizona.

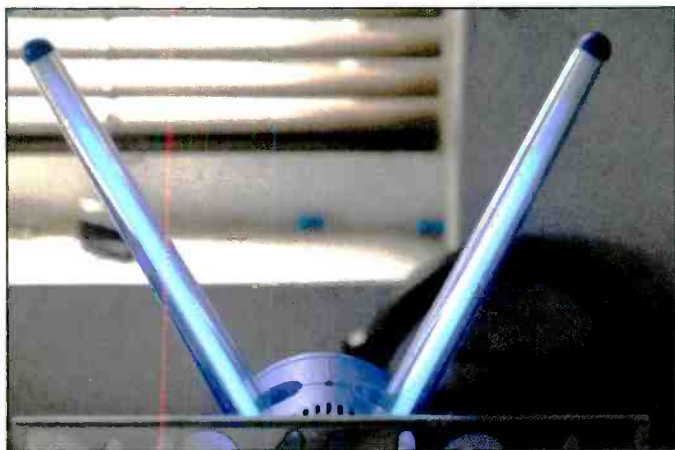

**Photo D.** Voice-activated blue rods from Edmund Scientifics can add a bit of flash to your amateur radio station. (Courtesy of WB6NOA)

This desert event is held simultaneously with a giant RV show at Quartzsite.

“Seminars about ham radio, technical, and semi-technical topics are our strong draw,” Quartzfest leader, Steve Weed, KO4QT, said, **Photos B and C**.

“This is a hands-on event. We play radio and wireless from sun up to well after dark. *Popular Communications* shortwave listeners will enjoy static-free evening DXing seminars around the campfire. Bring your shortwave sets, and, for scanner listeners, there is plenty to hear — and learn — on VHF and UHF bands”

Quartzfest 2013 is being held January 15-25, followed by a caravan to the Palm Springs Desert RAT hamfest on January 26. Since you will be in the area, you might want to check out the Yuma, Arizona hamfest a couple of weeks later. These are



**Photo E.** Gordon West lights up his amateur callsign — WB6NOA — with the modulation of his voice during a webcast of Ham Nation. Watch the YouTube video at <<http://bit.ly/PfJN3b>>. (Internet screen grab)



all in the U.S. southwest where the weather is usually great at this time of year.

To learn more about the upcoming seminars/campout, visit <http://www.Quartzfest.org> and see the great time awaiting you.

## Voice-Activated Blue Rods

If you watch the weekly Internet show *Ham Nation*, (Wednesdays at 9 p.m. Eastern on TWIT.TV/hn) you will see the twin blue neon wands flashing above my call sign with every syllable I speak.

It's a great little gadget to illustrate modulation, and is available from Edmund Scientifics at <http://www.Scientificsonline.com>. You'll find it as Product No. 3151207.

The antenna light-up wands can be positioned and adjusted independently. **Photo D.** You can also set the neon to constant ON, to fill the tubes without any sound activation, or adjust the sound control sensitivity to the amount of action you want to see. It plugs into 12 volts, and comes with an adapter — and is priced below \$20.

*(WATCH: The Voice-Activated Blue Rods in their "flash dance" at WB6NOA in this YouTube video: <http://bit.ly/PfJN3b>, Photo E. — WB6NOA)*

For our regular radio classes, we bring in a lot of equipment from Edmund Scientific, a company that really knows how to take care of its customers. I give Edmund Scientific the highest *Gordo Award* for working with all who need lots of demo gadgets. *Check them out.*

## New HF Mobile Whip

Most of us are familiar with the concept of a mobile antenna in which the operator plugs a lead into an inductor tapped for various amateur radio bands. They have been great performers across multiple ham bands — one band at a time.

Here's a new concept that is worth exploring: "The Great Lakes 392HF All-Bander" mobile antenna, with a common 3/8- by 24-inch mobile stud. It's from Daniel Christopher Althouse, NØRBN, and we came across it on eBay.

The mobile antenna is tuned by manipulating twin leads and a tap with more than 390 possible combinations to cover 80 through 10 meters.

- You want the marine band at 6 MHz? *No problem!*
- You want a MARS band at 14.5 MHz? *No problem!*
- You want CB at 27 MHz? *No problem!*

There are 14 fine-tune taps, seven coarse-tune taps, and one larger coarse tap to bring the total coverage down to 80 meters. It is reported to handle 600 watts.

The tap connections are solid brass. The coil is 12.5 inches by 1.5 inches, and the whip comes in two sections. The lower section is 4 feet in length, while the upper is 4 feet of stainless steel and can slide into the lower section for storage. Total height of this exceptionally, well-made mobile antenna is just over 9 feet.

Of course, it needs a good automobile ground to play, and my friend Pastor Jason Gant, W6AUX, is running some tests of this antenna on NTIA U.S. Coast Guard Auxiliary HF channels. It is priced at about \$199, and it will be interesting to see how well it compares to the much more expensive mobile whips that use center and top-loading for band changes.

"The Great Lakes 392HF All-Bander" features band changing at the base coil. I will keep you posted, but this new antenna design sounds interesting for the radio operator needing unlimited HF operation on ham channels and authorized "other" high frequencies for NTIA, MARS, CAP, and Coast Guard Auxiliary/SHARES.

For more information, visit NØRBN's website at <http://www.greatlakesantennas.com>. Telephone: (989) 305-7345.



**Photo F.** More than 390 inductance tap combinations are possible with "The Great Lakes 392HF All-Bander" mobile antenna. (Courtesy of WB6NOA)

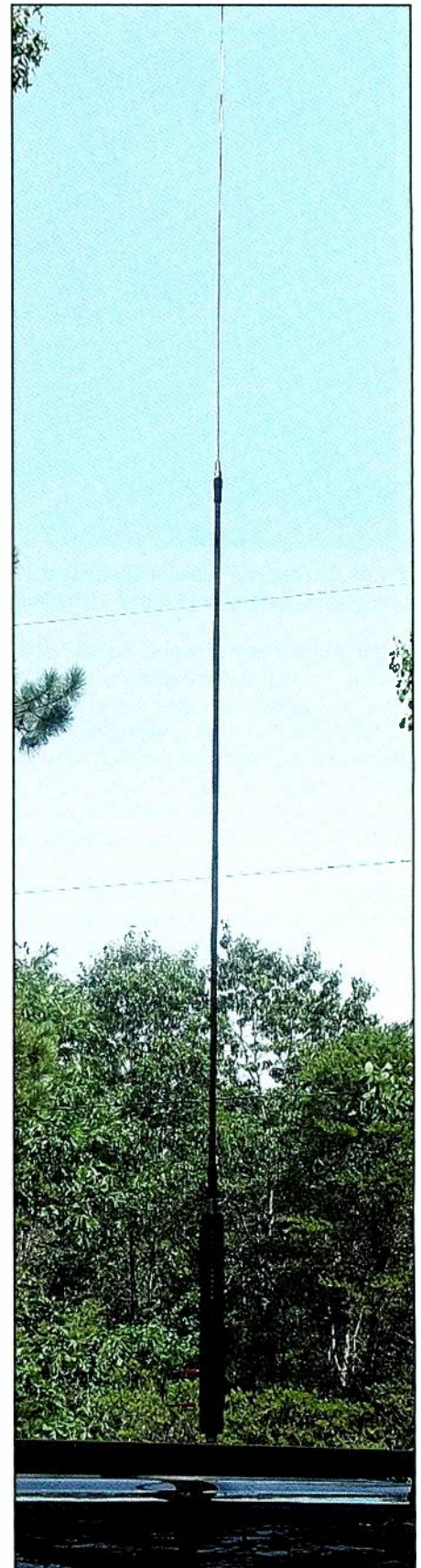

**Photo G.** The 392HF is a tidy and efficient mobile whip. At full extension, it is just over 9 feet in height. (Courtesy of WB6NOA)



**SCANNER MASTER**

**CALL 1-800-SCANNER**

**Pre-Programmed Scanners from Uniden and GRE!**

**November ONLY!**  
\$5 off any purchase of \$50 or more!  
Coupon Code Nov2012PC



**Uniden HomePatrol**  
Trunking Digital



**GRE PSR-700**  
Trunking-Non Digital



**SCANNER MASTER is the nation's oldest and largest scanner-only dealer. For over 30 years we've specialized in nothing but scanners, frequency guides, scanner software and scanner accessories.**

 <p><b>Uniden-Bearcat® Scanners</b></p> <p><b>Uniden Remote Heads In Stock!</b></p>	 <p><b>GRE GRECOM Scanners</b></p>	 <p><b>RadioShack Scanners</b></p>	 <p><b>AOR &amp; ICOM Receivers</b></p>
<p>◆ Mobile and Portable Scanner Antennas ◆ The Best in Scanner Software ◆ Scanner Accessories</p>			

**Our Services**  
 Programming  
 New Product Guide  
 Boston Area Store  
 Worldwide Shipping  
 One Page Checkout  
 Gift Wrapping  
 Gift Certificates  
 Newsletter

**Buy Your Next Scanner from Scanner Master and Receive**

- 10% OFF Car Chargers
- 10% OFF Cases
- 10% OFF Computer Cables
- And Much More!

**Our Guarantees**  
 30 Day Money Back  
 Same Day Shipping

See Our Website Or Call For Details

MEMBER OF 

**North American Master Distributors for some of the world's most unique and exciting scanner accessories, including:**

- BuTel ARC Scanner Programming and Control Software** for Uniden, Radio Shack, AOR and ICOM Scanners
- RadioReference.com Subscriptions** - The ultimate nationwide frequency and trunking database
- EXCLUSIVE Waters & Stanton Products** including the Watson line of products from the U.K. - A variety of antennas, speakers, filters, amplifiers, aircraft tracking software and much more!
- DD Amtek** - Affordable high-performance indoor and outdoor scanner filters and pre-amplifiers!

**Your One Source for Everything You Need**

**We Have All the Basics:** Scanners, antennas and accessories for base, mobile or portable operation.

**The Latest Technology:** Scanner software, pre-amplifiers, filters, a GPS enabled antenna and much more! Tools that will make your operation the best it can be.

**Professional Programming:** Just plug in your scanner and start listening right out of the box!

**Professional Services**

Low cost **Lead Generation Systems** to expand your business

**News Gathering Systems** for media outlets

**Remote Control, Audio Recording, and Custom Mobile Solutions** for media and public safety

**Consultation, Installation, and Complete System Engineering** -

Turnkey solutions ensuring your system works the first time

**Local News and Information** how and when you need it!

**Come and Visit our Store and Police Scanner Museum:  
260 Hopping Brook Road, Holliston, MA 01746**

**1-800-SCANNER    www.scannermaster.com    info@scannermaster.com**

Scanner Master is a proud partner of RadioReference.com



# WLS Listeners, Please 'Stand By!'

## Part II: The Broadcast Giant's Longstanding Place in AM DXing and Live Entertainment

By Andrew Ooms

Some of the interest in station news on the part of WLS-Chicago listeners and subscribers to *Stand By* is that DXing was a big part of the early years of radio broadcasting.

The frequencies were much less crowded in the early decades of broadcasting than they were later, so distant stations were easier to catch.

Quite a few stations were on frequencies occupied by no other station anywhere in the United States or Canada. Also many of today's sources of interference and static were absent — or less intrusive — back then. Few stations, including those of the power and scope of WLS, were broadcasting after midnight, so those who did broadcast during the night throughout the country could be heard at tremendous distances.

### DXing On Silent Nights

Some Chicago stations in the 1920s voluntarily ceased broadcasting Monday evenings so that Chicago listeners could catch signals from other cities. This was reciprocated by other cities that had different nights of silence.

WLS was heard to some degree throughout the entire United States. It was not always possible to tell if listeners writing in had heard WLS or had heard its *Saturday Night Barn Dance* — carried, in part, by NBC and its increasing number of affiliates.

Many listeners in Alaska or Montana didn't really care about the details. They

*"Last month we were introduced to WLS's 'Stand By,' reaching out from Chicago in print to a vast and diverse audience . . . This month we take to the air."*



heard WLS one way or another. But responses to non-network programming came from people in the Atlantic seaboard states, the far west, and from several Canadian provinces. New Zealand and Australian listeners were also heard from. Listeners wrote from Hudson Bay and Churchill, Manitoba. We can only imagine how appreciated radio was in those cold, isolated places, which were likely pretty good locations

for catching North American and European signals.

There were many drop-in visitors to the station. For example, consider a group of Wyoming sheep men who had accompanied several rail car loads of lambs to the Chicago Stockyards — then the largest in the country, handling 11 percent of the nation's meat. They made a point to come to the station to say hello to one of their sources of farm news and music. They



**Photo A.** A publicity photograph for the *National Barn Dance* on WLS shows four couples dancing to the music and square dance caller Guy Colby in March 1940. (Courtesy of Wikimedia Commons)





**Photo B.** Yodelers Mary Jane and Carolyn Dezurik were the first women to become stars on both the *National Barn Dance* and the *Grand Ole Opry*. Their voices were heard by legions of loyal WLS listeners. (**LISTEN:** To the sisters perform "Arizona Yodeler," circa 1938, <<http://bit.ly/Tssli7>>. – AO)  
(Courtesy of Wikimedia Commons)

were on the way to Detroit to buy about a dozen new vehicles for citizens of their town, using the lamb sales proceeds.

*Stand By* reported this as a wonderful example of capitalism in action. During those dismal Depression years, good economic news was highly regarded when it could be found.

Groups visiting the station included schools, Scout and Brownie troops, the Chicago Cubs, and the Blackhawks hockey team.

## On the Air . . . Everybody Dance!

Now that we know what could be read in WLS's *Stand By* magazine, let's get on to what could be heard on the station.

Music is the most famous aspect of the WLS Prairie Farmer years — specifically country music. Then it was more often referred to as *hillbilly*, *western*, or *barn dance* music.

(NOTE: Interestingly, in its next format under different ownership, WLS also became famous for its popular rock n' roll and Top-40 programming in the 1950s, '60s and '70s. – AO)

Saturday nights on WLS were huge. Taking over from WENR at 6:30 p.m., programming segments typically includ-

ALPHA DELTA

COMMUNICATIONS, INC. AA

30

YEARS

Superior Customer Service

Continuous Product Innovation

## Alpha Delta Model DX Series Antenna

The ULTIMATE antenna for shortwave DXing! Model DX-ULTRA dipole

The Model DX-ULTRA HF SWL half wave multi-frequency dipole antenna has been given 5 STARS by a major shortwave book as the BEST overall broadband dipole for signal reception and low noise pick up! It is in use by commercial and military HF monitoring stations worldwide.



The Model DX-ULTRA covers AM broadcast through 30MHz. Provides efficient, low noise, broadband performance for Medium Wave, Tropical, International SW, Military, Government, Embassy, Maritime, Aircraft and Utility monitoring throughout the HF spectrum.

Overall length is 82 ft. and it is made with severe weather rated components: 12 ga. insulated high tensile strength solid copper wire and stainless steel hardware, ISO-RES inductors, parallel wire "tapered wing" elements and the Model SEP ARC-PLUG (tm) gas tube static voltage protector built in to the Model DELTA-C center insulator. Connectors will accept 50 Ohm coax or balanced line. Can be installed as flat top or inverted-V. Made in our U.S. ISO-9001 production facility.

The Model DX-ULTRA is optimized for the HF shortwave spectrum and the design is derived from the World Acclaimed Model DX-CC multi-band transmitting dipole.



**Limited Space Requirements?** Check out the Model DX-SWL quarter wave SWL sloper. It has been rated as the best, most efficient SWL sloper with great low angle DX performance. Only 60 ft. long overall, it is made with the same severe rated high tensile strength wire and stainless steel hardware as the DX series dipoles. Check our WEB for installation details for all models.

The WEB site link is

**"Limited Space High Performance Antennas"**  
on our home page.

All prices plus shipping/handling. 888-302-8777.

Also available from Alpha Delta dealers

[www.alphadelta.com](http://www.alphadelta.com)

for product technical details, installation requirements,  
pricing, dealers and contact information



Listening is only half the fun...

**POPULAR COMMUNICATIONS**  
is the other half!

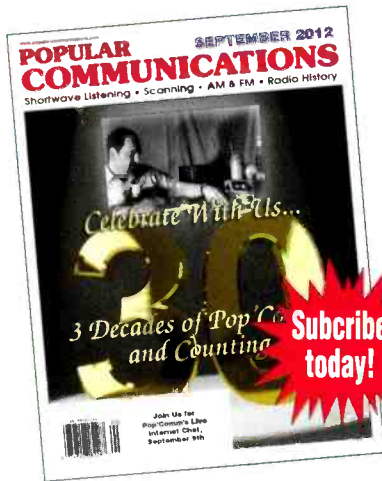

Subscribe today!

The World's most authoritative monthly magazine for Shortwave Listening and Scanner Monitoring.

You'll find features on scanner monitoring of police, fire, utility, and aircraft communications; international shortwave listening; CB radio; amateur radio; FRS; GMRS; monitoring radio digital communications; AM/FM commercial broadcasting; weather and communications satellites; telephone equipment radio nostalgia; clandestine and military radio.

Choose the **PRINT Edition** or **New DIGITAL Edition!**

Buy both at a **SPECIAL price!**  
**Holiday Special!**

1 year	Print	Digital	Both!
USA	\$32.95	\$23.00	\$46.95
CN/MX	\$42.95	\$23.00	\$56.95
Foreign	\$52.95	\$23.00	\$66.95

**Popular Communications**  
25 Newbridge Road, Hicksville, NY11801  
Phone: 516-681-2922; Fax 516-681-2926  
Visit our web site:  
[www.popular-communications.com](http://www.popular-communications.com)

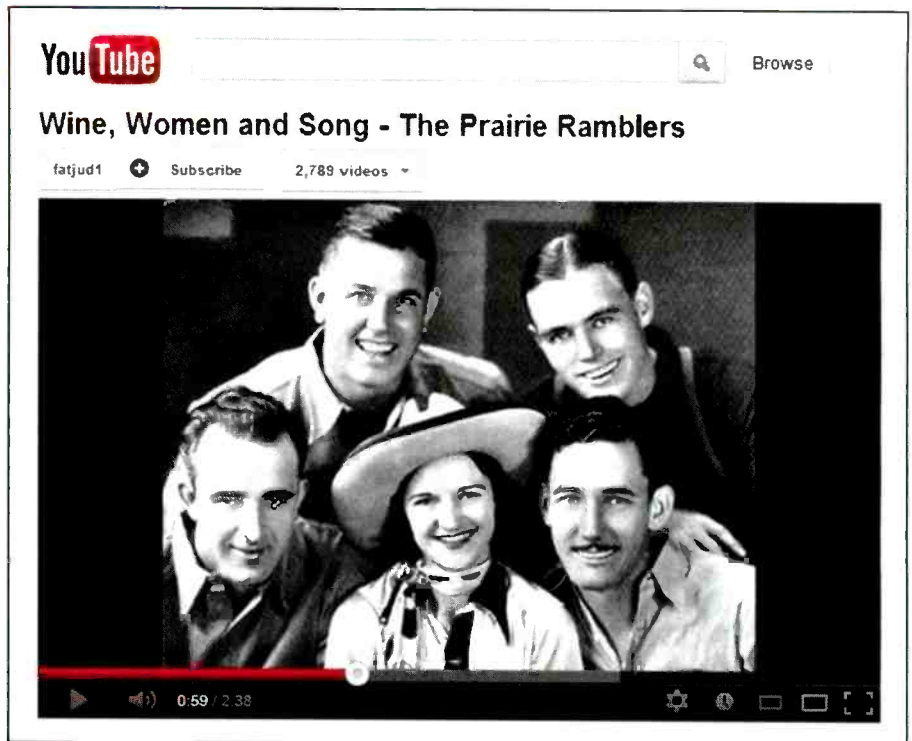

**Photo C.** Special events broadcasts such as New Year's Eve would bring popular acts to the WLS microphones. (**LISTEN:** To the Prairie Ramblers performing the Texas swing classic "Wine, Women and Song," <<http://bit.ly/NNsUzm>>. (Internet screen grab)

ed the *Keystone Barn Dance Party*, followed by the *National Barn Dance* at 7:30, **Photos A** and **B**, carried by NBC Blue nationwide.

Winding down the evening with local programming again, the *Prairie Farmer* program came on at 8:30 with many of the same performers and the same music as the earlier segment. Special nights, like New Year's Eve, had additional programming segments featuring, for example, the *Prairie Ramblers* with Patsy Montana, **Photo C**; and Red Foley and the *Hoosier Sod Busters*, or the *Hoosier Hot Shots*. The segments were called the *Barn Dance Jamboree*, *Barn Dance Varieties*, the *Aladdin Hayloft Theatre*, and so on.

The *Barn Dance* was held in the Eighth Street Theatre, and usually sold out at about 2,000 tickets weekly. Admission was 50 or 75 cents.

**Toe-Tapping Spreads to Other Stations**

Broadcasting a Saturday night barn dance was not limited to WLS — although it was one of the first to do it.

WSM-Nashville, for example, **Photo D**, had the now-renowned *Grand Ole Opry* with emcee George D. Hay. At age

30 he was already calling himself the "Solemn Ol' Judge." Hay got his start at WLS.

Other Saturday night programs heard for decades beginning in the '20s and '30s include the *Louisiana Hayride* on KWKH, Shreveport; the *Midwestern Hayride* on WLW, Cincinnati; the *Saturday Night Jamboree* on WWVA, Wheeling, West Virginia; and the one I grew up with: *The Missouri Valley Barn Dance* on WNAX, Yankton, South Dakota.

Groups of *WLS Barn Dance* performers were booked for various venues almost every night of the year at high school auditoriums and other venues across a dozen states and as far away as the Oklahoma State Fair in Tulsa. Typically 20 performances of WLS talent were scheduled away from Chicago weekly.

Famous — or moderately famous — WLS performers or guests appearing on the *Barn Dance* included frequent visitor Gene Autry, and Pat Buttram, who was a regular.

Red Foley was the first of a three-generation set of music chartists:

- Son-in-law Pat Boone
- Granddaughter Debbie Boone

That's good for a trifecta of No. 1 hits



**Photo D.** WSM-Nashville would eventually follow WLS's *National Barn Dance* lead with its own weekly broadcast: *The Grand Ole Opry*. Many up-and-coming stars appeared on the Nashville stage. Can you identify the singer-guitarist who appeared there in 1965? (**HINT:** He's often "On the Road Again," <<http://bit.ly/VztNwd>>. Courtesy of Wikimedia Commons)

on three charts: Country, Pop and Christian.

There was Arky the Arkansas Woodchopper, the Novelodeons, and Jimmy Dean, in his pre-sausage days. (**LISTEN:** To Arky the Arkansas Woodchopper singing "Mrs. Murphy's Chowder," <<http://bit.ly/RQX9I6>>. – AO)

Listeners also heard the Maple City Four, the Hometowners, a teenage George Gobel, the beloved Lulu Belle & Scotty, Uncle Ezra, and Smiley Burnette. (**LISTEN:** To Lulu Belle & Scotty sing "What You Don't Know Won't Hurt You," <<http://bit.ly/RcuURA>>, **Photo E.** – AO)

One listener wrote to *Stand By* that she had written down the date and time of more than 700 songs Patsy Montana sang over WLS over the years.

## Defending Their 'Country' Taste

Most, if not all, of the music on WLS was country. The NBC Symphony was on WENR, and popular music was left to other Chicago stations. Listeners' letters were almost unanimously in favor of old time music — country — and no other.

Occasionally, someone would write *Stand By* asking for a greater variety of

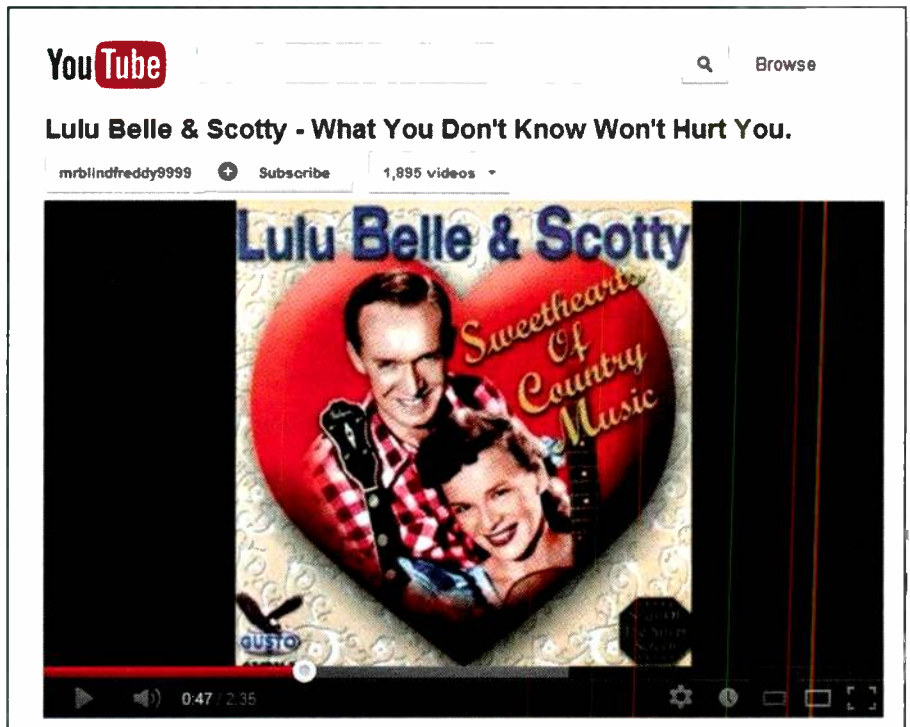

**Photo E.** Lulu Belle & Scotty were audience favorites on the WLS *National Barn Dance*. (**LISTEN:** To one of the duo's big hits: "What You Don't Know Won't Hurt You," <<http://bit.ly/RcuURA>>. Internet screen grab)

music, and would promptly get shouted down in subsequent letters. Many carried a familiar theme: *Don't you have a way to change stations on your radio if you don't like WLS music?*

One listener requested much less yodeling. Popular music and jazz was referred to as *new music*. A columnist described some jazz as reminding him of "the noise that would be made if a truckload of empty milk cans ran into a freight car of hogs on the way to market."

## Radio as Their Friend

Farm families far and near were not the only deeply appreciative listeners. Many letters came from aged or disabled shut-ins whose radios made a huge contribution to their quality of life.

Each year *Stand By* listed hundreds of orphanages, hospitals, senior citizen homes, veterans' homes, and schools that had been recipients of radios WLS had donated.

A picture was occasionally published showing groups of grateful orphans or others — some as far away as Nome, Alaska.

## WLS's Variety of Programming

In addition to Saturday nights, WLS broadcasted live country music for sev-

eral hours every morning — interspersed with farm market news, local and world news, weather, and chit chat.

A studio organist and storyteller named Ralph Waldo Emerson — after his ancestor essayist and philosopher — was a popular daily performer. Weather for the ships on the Great Lakes was presented daily for a time, and its cancellation brought howls of complaint.

Farm news was huge. Livestock and grain prices were as interesting to many people as the Dow Jones stock average is to many of us today. Crop predictions, agricultural advice, and down home events in various areas were essential for the business of farming and a lot of fun for some, as well.

Gardening tips for farm and city dwellers were popular. Listeners sent in seeds and plants for identification, and sometimes samples of crops for the staff to identify or enjoy. A plant grown from seeds dropped by migratory birds was one enigma to be solved and identified by the highly-regarded WLS agricultural experts.

## Seizing on Rural Roots

A major block of farm-related programming beside the early morning hours was the wildly popular noontime *Dinner Bell Roundup*, with more live country



music and much more farm news, including the stockyards and grain exchange prices of that morning.

One annual highlight of the WLS agricultural emphasis for several years was the *National Corn Husking Contest*. The contest held in Fountain County, Indiana in November 1935 had 110,000 attendees. Apparently, it was great entertainment with no admission charge. The 18 best huskers from nine states husked for 80 minutes without a break, up to 50 ears a minute. Due to a lot of practicing at his farm for many weeks, the 1935 winner set a world record of 36.9 bushels in his 80 minutes. The proceedings were broadcast on WLS, of course.

### Amen: Local Devotional Broadcasts

Matters of faith were an important aspect of broadcasting in those days when most country music programming on any station included a hymn toward the end of each hour.

WLS had daily morning devotions, a Sunday school review program on Saturday morning, and several hours of Christian programming on Sunday morning. All of the devotional programming, including the Sunday morning block, was live and in studio.

Remote broadcasts from local churches and national religious programming was not a part of WLS in those days. In addition to the religious music provided by the station organist and other staff musicians, Dr. John W. Holland spoke daily, and was deeply appreciated by many listeners as a source of comfort and encouragement.

### And Now, the News . . .

WLS carried several newscasts daily — five to 15 minutes in duration. At that time, news *on the hour* or *on the half-hour* had not been initiated on any stations, and definitely *all news, all the time* stations were still to be formatted.

Stations had three or four shorter newscasts daily, but it was the network stations that carried high profile commentators on the news nightly. WLS, being replaced by WENR most evenings, does not appear to have had a national commentator during the mid-1930s. Of course, its farm news was extended during the breakfast and lunchtime shows, likely not limited to 15 minutes when the markets or weather or farm-related events were newsworthy.

WLS newsman Herbert Morrison is still remembered for his recorded broadcast made while he watched the Hindenburg burn and crash on May 6, 1937, **Photo F**. His comments, which can still be heard on records and the Internet, start with a description of the awesome sight of the beautiful slow-moving airship

approaching its Lakehurst, New Jersey mooring. When it suddenly burst into flames and crashed to the ground, he uttered his famous phrase, “*Oh, the humanity . . .*”

Morrison would turn away to compose himself and soon return to finish the report. (**WATCH and LISTEN:** To WLS’s Herbert



**Photo F.** WLS newsman Herbert Morrison will forever be remembered for his recorded broadcast made while he watched the Hindenburg crash on May 6, 1937. (**WATCH and LISTEN:** To WLS reporter Herbert Morrison’s broadcast the tragedy from Lakehurst, New Jersey, <<http://bit.ly/Om1HoU>>. Internet screen grab)



**Photo G.** When the Ohio River Valley was struck by a devastating flood in 1937, WLS listeners contributed more than \$100,000 for disaster relief. That’s about \$1.5 million in today’s dollars. (Courtesy of Wikimedia Commons)

Morrison broadcast the Hindenburg tragedy from Lakehurst, New Jersey in 1937, <<http://bit.ly/Om1HoU>>. – AO)

Morrison had flown to New Jersey from Chicago to report the landing, and his recording was sent to WLS for broadcast the next day — the only eyewitness radio report, I believe, and certainly the first broadcast.

## Covering the 'Soaps' and Special Events

Although WLS did not carry a virtual wall-to-wall of soap operas that Chicago's WBBM and WMAQ broadcast Monday through Friday — more than 15 per day per station — it had the popular *Ma Perkins* and *Pepper Young's Family* in the mornings.

*Stand By* reported Proctor and Gamble sponsored 73 programs weekly on the NBC Red and Blue networks alone.

As did most stations in those days, WLS carried a variety of special events and speakers on a large number of subjects, including health, gardening, government, education conventions, child raising issues, and business. College debate teams covered current political and economic issues.

WLS broadcast the opening ceremonies for the 1936 Olympics, frog-jumping contests, the Queen Mary's first voyage, and a solar eclipse tracked from several locations.

Due to an epidemic of infantile paralysis in 1937, the beginning of school in September was delayed for several weeks. During those weeks, WLS and five other Chicago stations broadcast class sessions. Chicago newspapers printed the class schedules.

The 1937 flood of much of the Ohio River Valley was described as the largest natural disaster of the time to hit the United States. **Photo G.** WLS listeners contributed more than \$100,000 for relief of citizens of Indiana and Ohio. During those years, 25 cents was a significant amount of money, and probably was about the average size of a WLS listener's flood relief contribution.

## In the WLS Mailbag

In 1934, WLS received 1,051,041 letters. One week it received more than 67,000, partly due to a contest or premium offer. It did schedule occasional contests with prizes that at the time were much sought, but seem paltry by today's standards.

Occasionally, a doctor or hospital would call the station about a need for donations of blood for specific patients. One such call for the needs of a boy resulted in about 200 volunteers calling the hospital or station within an hour or two.

The station regretfully announced that it could not broadcast missing person reports. Several hundred people were disappearing monthly in the metropolis of Chicago.

## Time for Sports

Although WLS did not have many live play-by-play sports broadcasts, *Stand By* listed the events carried by other stations. Baseball wasn't mentioned. But less-frequently occurring events were carried: Rowing (Yale-Harvard, the Poughkeepsie Regatta, Oxford-Cambridge), horse racing, amateur boxing from Yankee Stadium, the Bears versus the College All-Americans, tennis (the Forest Hills National Championships, now the U. S. Open, and the International Wrightman Cup), the National Air Races,

the National Softball Tournament, and the Indianapolis 500.

Sportscasts were mainly on WGN, WMAQ, and WBBM — the same stations, if not the same call letters, as today. WGN carried the Chicago Bears and all Chicago Blackhawks home games.

College football was prominent. Northwestern, Illinois, and Notre Dame were well-covered, especially home games. The Rose Bowl, Sugar Bowl, and Army-Navy games were carried by the networks.

## ... And So Much More

As you might guess, my collection of 160-plus *Stand By* magazines of 16 to 20 pages each contain enough information to write a book. In these two parts, we've only scratched the surface of an extremely popular melding of print and electronic media a long time before "interactive media" found its place in popular vernacular.

(NOTE: Dan Lux was a source of data for this story. – AO)

**radiosport**  
headsets  
[www.arlancommunications.com](http://www.arlancommunications.com)

At last...  
Professional Quality  
Listen-Only & Boom-Mic  
headsets for Ham Radio

reviews at  
**eHam.net**  
ham radio on the net

hear the difference  
feel the difference

ARLAN Communications  
805 504-3944 9AM-6PM Pacific Time

**Discount Prices - Great Service**

**\$99 Dual Band**  
**Wouxun**

**QJE Supplies**  
From \$39.95

**ALINCO**

**Heil**

**Your source for Amateur, CB,  
Marine, Scanners and Parts.  
Brands shown and more!**

**www.CheapHam.com**

Hometek LLC, 1575 Rte 37W, Unit 4, Toms River, NJ 732-716-1600



# Hey, It's Transmitter Hunting Gone Wild!

## ***Tiny Ticker-Tags Can Be Your Latest Radio 'Pet Project'***

By Gordon West, WB6NOA

Here's P-hunting — *err*, T-hunting at its best! What we have here are 1-milliwatt, 222-MHz *ticker-tags* — tiny transmitters — that will play for a month before the battery needs to be replaced. Clip one to *Fluffy* and *Pooch* and your pets won't even know they are being tracked.

Consider this: No ammo box needed for this transmitter. It's about the size of a quarter, pulses every second on the 222-MHz band, faithfully gives your callsign in CW every 10 minutes and runs for about a month on drugstore variety CR-2032 cell battery.

This equipment design was developed more than 20 years ago by Spence Porter, WA6TPR, an enterprising radio amateur and owner and president of Communications Specialists, Inc., in Orange, California, <<http://www.com-spec.com>>.

Seasoned hams remember CommSpec for its TE-64 CTCSS signaling gear, long before manufacturers built in sub-audible tones for handheld and mobile transceivers.

### **Easy Does It**

The Locator receiver does not require juggling a hand-held radio or Yagi antenna. It is PLL synthesized on the 222-MHz amateur radio band; has a built-in, fold-out Moxon directional



**Photo A.** The *P-Hunting* ticker-tag transmitter is barely visible in this little kitty's fur. (Photography courtesy of WB6NOA)

*“Clip one to Fluffy and Pooch and they won't even know they're being tracked. There are lots of uses for these itty-bitsy wonders.”*

antenna; battery; S-meter; attenuator; and push wheel switch for frequency selection to other transmitter frequencies.

This T-hunt *ticker-tag* transmitter and receiver system can be used for all sorts of interesting projects. *Let your imagination go wild.*

The system is particularly useful for those who love pets, grannies and kids, and even for that new HF transceiver loaned to the club for use at the local county fair.

### **For Demonstration: A Pet Project**

Let's start with *Pooch* and *Fluffy* and work up to more exotic *ticker-tag* applications.

The transmitter “ticks” are scant 20-millisecond pulses, with a repetition rate of about 1 tick-per-second. Power output is about a milliwatt and the ticks, along with your callsign in CW every 10 minutes, will faithfully be transmitted for about a month.

For smaller pets — say, a cat or a ferret — a conductive thread is sewn into the break-away collar with a minimum residential transmitting range of about a block.

For *Pooch*, this same transmitter may also be configured for a much larger collar with a short, flexible, dangling antenna, increasing the range to about two or three blocks in a residential area.

Doing some testing at the beach, the unobstructed range to a small cat collar is nearly a mile. Double that for *Pooch's* longer antenna system.

The 20-millisecond pulse on the 222-MHz band cannot be detected easily by a common FM receiver. If you were fortunate enough to score a multi-mode VHF receiver from AOR, the narrow CW mode will pull in the signal quite nicely.

### **Receiver Specifications**

The ultimate Locator receiver comes from CommSpec. This one is precisely tuned for these 222-MHz *ticker-tags* with an impressive specification rating:

- Sensitivity: 0.01 microvolts
- Selectivity: 70 dB down @ 4 kHz, 80 dB @ 10 kHz
- IF filtering: 10.7-MHz, 8-pole crystal filter; 455-kHz, 8-pole ceramic filter

# www.**ALINCO**.com

**Quality. Style. Performance!**

Now you can "Tune in the world with SDR" without breaking your budget. Thanks to Alinco's new 150kHz to 30MHz desktop receiver, the DX-R8T featuring an I/Q output, you can monitor AM/FM/SSB/CW signals either in a superheterodyne or by using a PC with free SDR software. Enjoy DRM hi-fi broadcasts without a converter. PC-decode of HFDL, FAX, NAVTEX, RTTY, PSK and more. Alinco makes SWL fun and affordable!

SSB/AM/FM/CW and I/Q  
LW/MW/SW 150kHz to 30MHz  
Desktop Receiver  
**DX-R8T**



\* An external 12Vdc/1A power supply and antenna required.

Distributed in North America by GRE America, Inc., 425 Harbor Blvd. Belmont, CA. 94002 USA.

Ph: (650) 591-1400 Fax: (650) 591-2001 em: alinco-sales@greamerica.com Website: http://www.greamerica.com

Not subject to FCC part 15/IC approval. No license is required to operate this product. Specification subject to change without notice or obligation. ALL warranty claims and requests for repair/technical assistance for Alinco products should be sent to GRE America regardless of contact information found on the warranty certificate packed with the product.

- Front end: Dual MosFet with six helical resonators, Hi side to eliminate desense from digital TV signals
- Antenna jack: BNC
- Frequency Coverage: 222.0 MHz to 224.990 MHz, 10-kHz steps
- Fine Tuning: +/- 500 Hz from channel center
- MDS sensitivity: -150 dBm
- Attenuator: 3-step, 0 dB, 30 dB, 60 dB
- Headphone jack: 3.5-mm mono
- Size: 6.2 inches x 3.5 inches x 1.4 inches
- Weight: 19 oz. including 9-volt battery
- Included antenna: Fold-up Moxon directional 5-dB gain
- PLL Channel Selection: three-position push wheel switch
- Battery test switch: ON / OFF
- Channels: 60 - 09: 222.250 MHz to 223.290 MHz

The receiver itself is also a good tracker of EMI (electromagnetic interference) noise, and it's so sensitive with the



**Photo B.** The hand-held receiver, from Communications Specialists, Inc. <<http://www.com-spec.com>>, features a built-in Moxon antenna.



**Photo C.** A close-up of a ticker-tag shows it's about the size of a quarter. It is seen here with the battery removed.



Moxon antenna, you can pick up gas-powered lawn mowers half a block away!

Once you have the gear, you don't need to sign up for "service." No GPS signal is needed, nor is there any monthly service fee tied into a cell phone data account.

Commercial pet trackers, using GPS and a smart phone, would play for only a day of battery life. If *Pooch* hides in a metal shed, GPS tracking is off the air.

### 'Stop That Thief!'

The little 222-MHz, milliwatt *ticker-*

*tags* are the same technology that gets slipped into a stack of \$100 bills at the bank. The array of four vertical antennas on police department units is tuned just below our 222-MHz band, with a multi-thousand dollar receiver showing a bearing to the stolen loot.

"What started out as a short-range, Part 15 asset tracking system, has allowed us to design these tiny transmitters up to the 222-MHz ham band, without restrictions to power output or antenna length," WA6TPR says.

The individual pet transmitters may be ordered in various configurations, with

the embedded thread collar for cats and dogs as a favorite.

### Output Frequency Selection

The transmitter frequencies were carefully chosen to avoid 222-MHz FM repeater inputs or outputs — each frequency for the pet *ticker-tags* is interstitial to — *between* — FM channels.

Weak signal operators will not find any of these transmitters down in the weak signal portion of the 222-MHz band. Even if the tiny pet ticker is placed right at an FM repeater site, it would likely go undetected due to its 20 millisecond duration, and ultra-narrow bandwidth.

### For the Classic T-Hunter

For traditional ham T-hunting, the receiver with the built-in Moxon antenna eliminates the danger of swinging a Yagi with sharp ends.

The transmitting tag can be hung on a tree limb, and the reception is easy up to half a mile away. As the T-hunter gets closer and closer to the hidden transmitter, he or she can click in 30 dB and 60 dB of attenuation, allowing them to get within a few feet of the *ticker-tag* when the S-meter reads full tilt.

### Back to Fluffy and Pooch

If you take your furry friend along in the RV, the pinger system becomes invaluable. You stop near the lake, open the RV door, and maybe *Fluffy* disappears, in or out? *No problem.*

Turn on the receiver, and if the signal is pegged at 60-dB attenuation, start looking inside the coach. But, if you barely hear a signal with no attenuation, best head outside and start calling!

For those with inside/outside pets, there is always the worry that they jumped into the moving van or delivery truck across the street. The truck is about to pull out and you panic. Put on an optional omni-directional rubber duck antenna, turn on the receiver, and start walking around the closed up truck. If the pet accidentally got inside, the full-signal strength at 60-dB attenuation will say you are within a few feet of your little friend.

If your pet goes for a ride in the back of the gardener's van — as ours did — you know he's nowhere near when you've checked the house and property and the block with no response on the receiver.

With a 222-MHz beam on a rotator on your roof, you might pick up the signal

For 45 years  
our volunteers have  
endured long hours  
and tough  
working conditions  
for no pay.



And 9 out of 10  
would do it again.

TO FIND OUT WHY  
contact

**REACT International, Inc.**

(301) 316-2900 • (866) REACT-9-9

12114 Boydton Plank Road, Dinwiddie, VA 23841

REACT.HQ@REACTintl.org

www.REACTintl.org

from a mile away. *Still no luck?* Next week ask the gardener where he next stops after your house. Drive there, with your receiver tuned to your pet's channel, with an outside magnetic 222-MHz antenna. If the faint sound of the ticker begins, the best procedure is to walk the walk.

The Moxon antenna in a residential area can certainly tell you when you are getting close to the transmitter. Switch to an omni-directional rubber duck antenna when the sound gets louder and add attenuation as signal strength increases. Do some shielding with your body to help determine the direction to the sound. Ultimately, with 60-dB atten-

uation, using the rubber antenna, your fuzzy friend will see you or hear you calling and come running.

### More Uses . . .

Scout leaders could tag their Cubs on the next outing with each one getting a separate frequency. Multiple tags can be ordered on different channels. The tags work nicely on a lanyard or even in a pocket. Use the same technique to find the missing scout!

At our county fair, we hide one of these 222-MHz tickers inside that \$5,000 amateur radio transceiver borrowed from the ham radio store. If that radio happens to

depart from its demonstration position, we should be able to tell its general location, starting with the Moxon antenna for homing.

### About the System

Each transmitter can be ordered on a specific frequency. Your callsign can be embedded as a 15-wpm CW identification every 10 minutes. Each transmitter is under \$99.

The Locator SSB/CW receiver sells for about \$250 and will be tuned to pick up all of the channels, including the channels you have ordered for your transmitters.

The CR 2032 lithium coin cell is a common battery sold at RadioShack® or drug stores. They are also available from CommSpec when you order the tracking system.

Again, the ticker will perform 24/7 for just under a month. When the battery begins to get weak, you'll hear the difference in the tone as a distinct warble.

If you really want to have some fun with multiple pets and tags, look at the signals on one of those new compact spectrum analyzers or the Yaesu VR-5000 multimode communications receiver. A quick glance at five beeping blips tells you the gang is in the backyard!



**Photo D.** A handful of *ticker-tags*, the specialized receiver and a map of the search area can provide lots of T-hunting fun — or make that *S-Hunting*. Attach one to each member of your den or troop and no Scout gets lost!

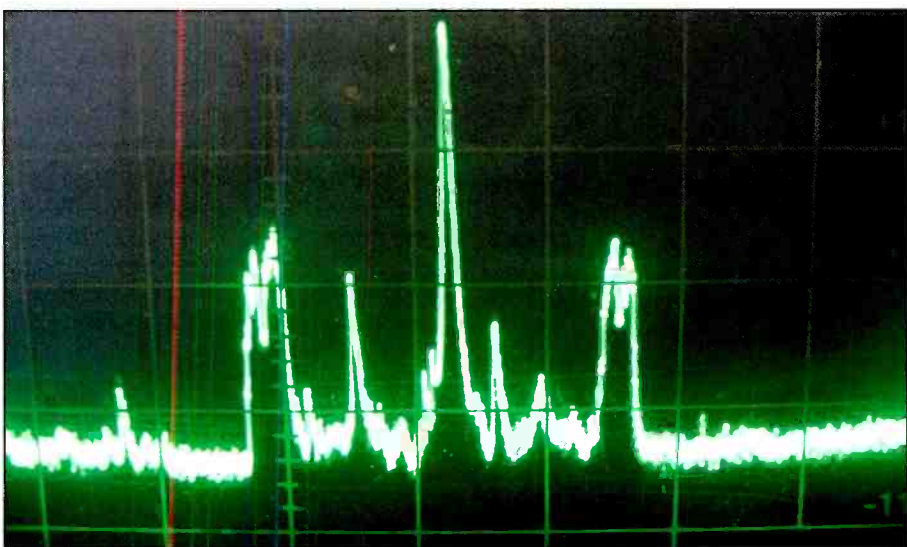

**Photo E.** Zero in on several *ticker-tags* using a spectrum scope and you'll see radio activity of multiple channels.

## CCRadio2



### Designed for Even Better Long Range AM & Now Emergencies

- AM, FM, 2-Meter Ham, Weather Band and NOAA Weather Alert
- 2-Meter Scans Five Memories for Active Frequencies, Squelch
- Built-in Twin Coil Ferrite® AM Antenna for Max. Reception
- Signal & Battery Strength Meters

\$159<sup>95</sup> Black Mica or Titanium

## C.C. CRANE

**Free Catalog**

**800-522-8863 · ccrane.com**



## Considered Mobile HF Yet? Take it to the Streets!

by Kirk Kleinschmidt,  
NTØZ, KPCØZZZ  
<kirk@cloudnet.com>

*“Mobile hamming is a gateway drug that can lead to all kinds of additional fun including portable operating, hill topping, grid-square activation . . .”*

From a marketing perspective, say the gurus; the Internet will soon be the modern equivalent of the postcard, the telex teleprinter network, and the carrier pigeon. We still have all of these things, but compared to the present day Internet, the writing's definitely on the wall.

What's replacing the Internet as we know it? *Mobile stuff.* That is as in *cell phones* and *tablets*. Most of the technological innovation in the computer space is already taking place in the mobile arena, and it looks as though the social and commercial arenas are scrambling to follow suit.

The physical network that makes up the Internet is in place and growing rapidly, but that infrastructure is being increasingly used to support various other methods of *connectivity*, most of them wireless.

As the adage says: “If you can't beat 'em, join 'em!”

The same technological advances that are driving cell phones and tablets forward are also making mobile amateur radio equipment better, smaller, and less expensive than ever before. So, why not take advantage of the trend and take your ham radio hobby to the streets in your car, truck, or RV?

Although we've “broken” the old laws of physics when it comes to equipment size, performance, and cost, we haven't made as much progress in working similar magic for mobile antennas. But even if you won't work lots of DX on 80 and 160 meters, mobile hamming is still a blast.

It's also an important option for those of us who suffer under deed restrictions and over-the-top property association bylaws, and the like. Until remote station operation is completely casual, mobile HFing can keep you on the air and having fun.

Just like cell phones and computers, what used to take a collection of fridge-size gear and a rat's nest of unsightly cables can now be accomplished with an all-band transceiver the size of a house brick.

### Modern Mini Rigs

The mobile and portable rigs of today from Yaesu, ICOM, Kenwood and other manufacturers are popular in shacks and out. Most cover HF, VHF, and even an UHF band or two with digital readouts and lots of bells and whistles.

Smaller than most car radios, these rigs are easy

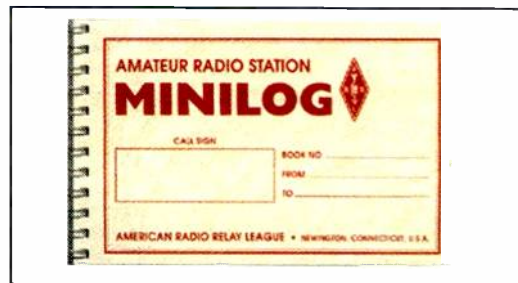

Keeping a station log while operating mobile can be somewhat daunting. Some ops use a portable digital recorder and transcribe their entries after returning home, while others use a *mini log*. One available from the ARRL is about 6 inches by 4 inches, is spiral bound, has fields for all of the usual log data, and its 96 pages can record 720 contacts.

to install in — or under — a crowded dashboard. Designed for mobile and portable use, these rigs have conventional mobile mounts or detachable control heads that allow the bulk of the radio to be mounted under the seat or in the trunk.

Some models to check out include:

- Kenwood's remote-headed TS-480HX — a 200-watter).
- ICOM's IC-7000 (bells and whistles included) and IC-703/IC-706 series (not currently produced but still available).
- Yaesu's FT-897, FT-857, and FT-817ND — a tiny, full-featured QRP radio prized by outdoor enthusiasts.

There are many other non-current models that are still available used. These include Kenwood's HF-only TS-50S, Alinco's DX-70, and SGC's SG-2020. You can also do as your forebearers did and use a smallish DC-powered desktop radio in your vehicle. This is especially handy if you're driving a big rig, a van, or an RV.

If properly setting up a mobile ham shack is outside your comfort zone, seek the help of an experienced mobile operator — perhaps from your local club — and consider reading up on the process.

Joe Reinhardt, AA6JR, regularly writes about mobile operating in *Pop'Comm's* sister publication, *CQ* magazine, <<http://www.CQ-Amateur-Radio.com>>.

Good book titles include *Amateur Radio on the Move* by Roger Burch, WF4N, and others,

**bhi****Upgrade your station this Christmas...****bhi****...With a bhi or GAP HEAR IT DSP Noise canceling product!****Our technology is designed to recognize speech and remove noise and interference!****HEAR IT Speaker**

- "Quick Adjust" DSP control
- 8 DSP filter levels 9 to 35dB
- 2.7W Amplified DSP speaker
- 3.5mm mono headphone socket
- On/off audio bypass switch
- 12 to 24V DC (500mA)

**HEAR IT In-Line**

- 3W Amplified DSP In-line module
- Use with a speaker or phones
- 8 filter levels
- Separate input level & volume controls
- Line in/out controls

**Available as bhi from:**

fax: 256 880 3866  
www.w4rt.com  
info@w4rt.com

E &amp; O.E.

**Enjoy your hobby again!****DSPKR****Superb 10W rms audio!**

- 7 filter levels - Simple one touch control - Filter store function
- 10Watts rms audio - Volume control
- Input overload LED - Sleep mode - 3.5mm Mono headphone socket
- 10 to 16VDC supply (2A)

Products designed in the UK by bhi Ltd

www.bhi-ltd.com

**Available as "HEAR IT" from:**

GAP Antenna Products Inc.  
99 N. Willow St. Fellsmere, FL 32948  
Tel: (772) 571 9922 Fax: (772) 571 9988  
www.gapantenna.com

**ANEM MKII**

- Compact DSP module
- 8 filter levels 9 to 35dB
- Audio bypass mode
- Use with a speaker or headphones.
- Supplied with audio and power leads

**DSP modules to retrofit in your radio or speaker....****NEDSP1061-KBD**

Low level audio for Yaesu FT-817 etc....

**NEDSP1062-KBD**

- 3W audio output (4ohm)  
- 4 or 8 filter levels - Audio bypass - 12 to 18VDC

Fitting instructions available for both modules



and *The Amateur Radio Mobile Handbook*, by Peter Dodd, G3LDO.

My favorite book on the subject — which has to unfortunately be procured on the used market — is *Everything You Forgot to Ask About HF Mobileering*, by Don Johnson, W6AAQ. If you can manage to find a copy, *don't let it go*. Don has forgotten more about the subject than most of us will ever know.

Also, be sure to check out KØBG's informative website for mobile ops, <<http://www.k0bg.com>>. Compiled by Alan R. Applegate of Roswell, New Mexico, it's a valuable resource for mobile beginners.

Whatever your rig, whatever your vehicle, your first tasks are to:

- Mount the radio securely (so it won't fly around, becoming a deadly projectile in a crash) and position it to allow easy operation while underway.
- Run a pair of *heavy-gauge* power supply wires from the cockpit-mounted rig *directly to the vehicle battery*.
- Find a sturdy, low-resistance chassis ground point *as close to the rig as possible*.
- Run a coaxial cable from the rig to the antenna mount.

**Size Does Matter**

Even for physically small 100-watt transceivers, your rig's DC power cables should be *massive*. Use well-insulated, flexible power leads that are 8-gauge *or larger*. Big cables will minimize voltage drop and minimize RFI and noise pickup under the hood. Use a few inches of smaller-gauge wire to make the

connections at the back of your rig — to avoid the "tail that wagged the dog" effect!

The positive and negative supply cables should *each* be fused *at the vehicle battery*. And use clean new properly-sized battery terminals when making your power supply connections. Don't *jury rig* connections that might be required to handle more than 100 amps of DC.

Don't rely on the negative power supply lead or the shield braid of the coaxial antenna feed to provide a good transceiver ground. Connect a low-inductance braid or strap from the transceiver chassis directly to the nearest piece of frame metal.

**Mobile Antennas**

Aesthetics aside, mounting your mobile antenna in the center of your vehicle's roof achieves the best RF performance. If that's not an option, trunk and hood decks come in second, with front and rear bumpers tying for last place.

As hinted at earlier, the physics of mobile antenna performance aren't spectacular, even on a good day, and placing your antennas in non-optimal locations will just make things worse. To help ensure mobile HF success, bite the bullet and mount your antenna where it has a fighting chance.

Antenna mounts come in all shapes and sizes. Some bolt directly to your car body, some attach to the lip of your car's trunk and some use powerful magnets to hold your antenna in place. Whatever the mechanism, most mounts simply provide a place to mount a whip-type antenna. As with any backyard vertical antenna, the whip must be insulated from the car body and the coax shield feeding it must be connected directly to the car body/frame.



# Hobby Books and Cds!



## Reflections III

by Walt Maxwell, W2DU

All the info in Reflections I and II and more! This completely revised and updated, 424-page 3rd edition is a must-have!



8.5 X 11 Paperback \$39.95

New! CD Version \$29.95

Buy both for only \$59.95

## The Quad Antenna

by Bob Haviland, W4MB

Comprehensive guide to the construction, design and performance of Quad Antennas. General Concepts, Circular-Loop & Arrays, Rectangular & Square Loops, Multi-Element Quads and more!



8.5 X 11 Paperback \$19.95

New! CD Version \$14.95

Buy both for only \$29.95

## The NEW Shortwave Propagation Handbook

by W3ASK, N4XX & K6GKU

This authoritative book on shortwave propagation is your source for easy-to-understand information on sunspot activity, propagation predictions, unusual propagation effects and do-it-yourself forecasting tips.



8.5 X 11 Paperback \$19.95

New! CD Version \$14.95

Buy both for only \$29.95

Shipping & Handling: USA - \$7 for 1st book, \$3.50 for 2nd, \$2 for each additional. CN/MX - \$15 for 1st, \$7 for 2nd, \$3.50 for each additional. All Other Countries - \$25 for 1st, \$10 for 2nd, \$5 for each additional.

**CQ Communications Inc.**  
25 Newbridge Rd., Hicksville, NY 11801  
516-681-2922; Fax 516-681-2926  
<http://store.cq-amateur-radio.com>

There are plenty of exotic multiband mobile antennas, but the best antenna for HF mobile beginners is a monoband whip for 20-10 meters. They're simple, inexpensive and reasonably efficient.

With Lakeview's definitive line of Ham Sticks no longer available, the next best thing is probably MFJ's line of HF Stick monoband whips for 80-6 meters. These helically-loaded antennas are easy to use, easy to tune and cost less than \$20. Performance on the low bands isn't spectacular for any mobile antenna, but from 20 through 6 meters, monoband whips work fine and are an outstanding value.

Save the screwdriver-type antennas and the Texas Bugcatchers for when

you're more experienced and want to increase performance and operating convenience.

## All-Important Ground Connections

Good ground connections are *critical* for mobile HF performance, and *every* mobile antenna mount must have a good, low-impedance connection to your vehicle's frame and chassis panels — including magnetic mounts. Without a high-

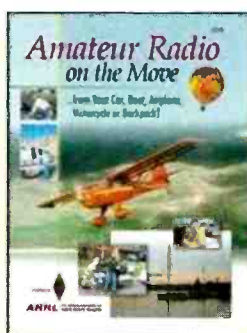

Want to get on the air from your car or RV, boat, airplane, motorcycle or backpack? The expert advice in *Amateur Radio on the Move* will help you through the joys and challenges of modern mobile radio. Topics include installation tips, safety issues, antennas, grounds, noise and more.

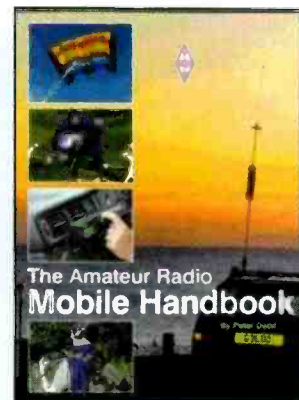

From across the RF Pond comes the RSGB's *Amateur Radio Mobile Handbook*, a must-have for hams who regularly "go mobile" or are interested in doing so. The book's 128 pages cover all aspects of mobile operation including the basics, installing equipment and antennas in a vehicle, maritime mobile, bicycles mobile and even pedestrian mobile.



David Palmer, KB5WIA, of Fairfield, California, operates mobile from various California desert locations, often while participating in VHF and satellite contests and other on-air activities. As shown here, he's working HF via the Yaesu FT-857D transceiver inside his Toyota pickup. The antenna, visible above the bed box, is a Yaesu ATAS-120A screwdriver-type mobile whip that covers 40-6 meters. For more information and many additional photos, visit <http://www.kb5wia.blogspot.com>. (Courtesy of KB5WIA)

quality chassis connection, your RF performance will suffer tremendously — as if it's not suffering enough already by merely being in a mobile environment.

Bumper mounts and other direct-to-the-frame mounts usually provide an *OK* connection to ground — but even direct frame/body connections can usually be improved with the addition of ground straps made from copper braid. Improving your ground connection by even a small amount can dramatically improve antenna performance and help reduce or eliminate unwanted noise. You can never have a ground connection that's too good.

## Unfamiliar Surroundings

Mobile conditions are somewhat challenging for antennas and electronics. Your rig may encounter temperature extremes, voltage swings, mechanical shock, excessive humidity, and a host of other factors that aren't relevant at home.

You may also have to deal with electrical noise from the ignition system, on-board computers, blowers, fans, defrosters and so on. You may even *cause* interference to your car's electrical system. *The ARRL RFI Book* is probably the best single reference for solving these problems.

As a beginner, consider operating at 20 meters or higher until you gain experience with operating and antenna installation issues. Successfully installing and adjusting antennas for 80 through 30 meters, where mobile antenna efficiencies can be devastatingly low, isn't beginner-friendly. With today's somewhat depressed upper-HF propagation, 20 and 17 meters are prime mobile bands for beginners and experienced ops alike.

## Safety, Noise, Antenna Tuning . . .

Get familiar with mobile operating from a safe, parked position. Even otherwise responsible hams can cause accidents while tuning antennas, tweaking knobs, reading SWR meters, jotting logbook entries, and so on. *Drive first, operate second!*

Radios with effective noise blankers are worth their weight in gold among mobile ops; it's too bad they're so hard to find. When shopping for a mobile rig, test noise blankers carefully and check out ham magazine product reviews to see how well the noise blankers work. Mobile environments are *noisy*.

Forget about using cabin-mounted antenna tuners to *match* your *back of the car* mobile whips. Mobile antennas are physically small and offer compromised performance at best. Don't waste precious decibels by using an in-car tuner. If you require extreme frequency agility, get a motorized screwdriver antenna or place an autocoil at the *antenna feed point*. It's a good idea at home and a better idea when mobile.

With antennas on the roof, the rear deck or the rear bumper, running 50 to 100 watts on HF shouldn't pose any RF-exposure problems, but don't purposefully tempt fate with crazy installations, and so on.

## Be Safe, Have Fun, and Obey the Law

Some jurisdictions are wrangling with mobile scanner laws, some of which affect licensed ham operators. Always keep a copy of your amateur radio license on hand and, should an inquiring peace officer ask about your mobile radio gear, *stay calm and be polite*. Seek outside help if necessary, but don't argue with the officer by the side of the road.

Mobile hamming is a gateway drug that can lead to all kinds of additional fun such as portable operating, hill topping, RVing, county hunting, grid-square activation, and more. I heartily endorse it. *See you on the highways and byways!*

— KPCØZZ/NTØZ

# Pop'Comm December 2012 Reader Survey

Your feedback is important to us at *Pop'Comm*. It helps guide us to make the magazine even more valuable to you each month.

Please take a few minutes to fill out this month's Reader Survey Card and circle the appropriate numbers corresponding to the questions below. We'll pick a respondent at random for a year's free subscription or an extension of an existing subscription as thanks for your participation — so don't forget to fill in your mailing address and other contact information.

We encourage your comments and suggestions in the space provided, as well. Thank you.

*Last, but not least:* You can now take this survey online. See details below.

### With *Pop'Comm* being offered in both print and digital formats, I:

- Stuck with the print edition. . . . . 1
- Changed to the digital edition. . . . . 2
- Take both editions. . . . . 3
- Am still considering what to do. . . . . 4

### *Pop'Comm* is giving readers lots of links to supplemental information on the Web.

- I like that a lot. It's like having an even bigger magazine. . . . . 5
- I find the basic information enough. Links don't interest me. . . 6
- I use some links, but not others. I'm ambivalent . . . . . 7

### What supplemental content in *Pop'Comm* is most interesting? Choose all that apply:

- Audio . . . . . 8
- Video. . . . . 9
- In-depth background information. . . . . 10
- All of the above . . . . . 11
- None of the above. . . . . 12

### To which digital editions of CQ Communications magazines do you subscribe? Choose all that apply:

- Popular Communications* . . . . . 13
- CQ Amateur Radio* (*CQ* magazine) . . . . . 14
- CQ VHF* . . . . . 15
- WorldRadio Online* . . . . . 16
- I don't subscribe to any digital edition. . . . . 17

### Are you happy that all CQ Communications magazines are available digitally? Tell us why, or why not. (Use the comment line.)

## Take This Reader Survey Online

You can now participate in this reader survey via the Internet. Simply go to *Pop'Comm On the Web* : <<http://www.popcommmagazine.blogspot.com/>> and click the link to the *Pop'Comm December 2012 Reader Survey*. It's quick and easy.

## The Envelope, Please . . .

For participating in the *Pop'Comm Readership Survey*, the winner of a free subscription or extension is **Ronald Fenton, WPC9EZK**, of **Kankakee, Illinois**. *Congratulations, Ronald!* Regarding our question regarding the overlap of SWLing, scanning, CB, amateur radio, and hobby communications in general, we couldn't agree more with Ronald. "The future of over-the-air radio depends on cooperation — not fractionalization," he said.



## Northern Exposure: Canada's Rich Aviation Scanning Environment

By Bill Hoefer,  
KPC4KGC/WPE4JZZ/  
KG4KGC  
<flacap388@gmail.com>

*“Similar to the U.S. Airport/Facility Directory, the Canada Flight Supplement, published by Nav Canada, is 1,500+ pages, covering every airport in every province in the Commonwealth.”*

Last month we got into the meat of what *Plane Sense* is all about — aviation frequencies — and the U.S. Airport/Facility Directory.

This month we'll look at the directory from a perspective north of the U.S. border: Canada. As pointed out in November's column, the A/FDs are published in seven volumes covering the lower 48 states as well as volumes for Alaska and Hawaii. For Canadian aviation frequencies, we find them published in just one book — the Canada Flight Supplement, published by Nav Canada, **Photo A**.

The supplement, like its U.S. counterparts, is issued every 56 days. It is available by subscription for \$129 CDN in Canada and \$134 CDN elsewhere, which includes shipping.

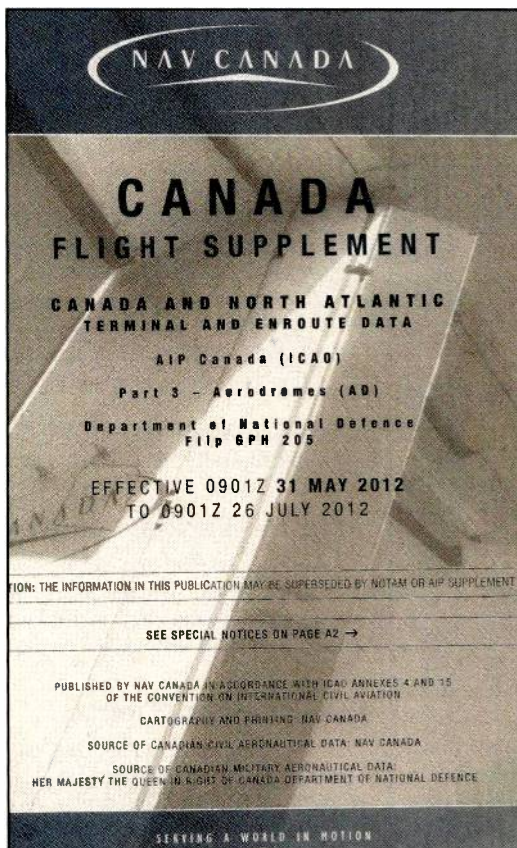

Photo A.

Individual copies are available from various Canadian fixed base operators and flight schools. The copy I'm basing December's *Plane Sense* on is from May 31 through July 26 of 2012 and is more than 1,500 pages. The Canadian Supplement is in six sections covering every airport in every province in the Commonwealth. Unlike the American A/FD, the Canadian version expands on each airport and is, in my *not so humble* opinion, easier to read and understand.

### Section A

Section A, Special Notices, and General Information consists of roughly 90 pages. After the Special Notices, which appear to be updated in each issue, and the Table of Contents comes the General Information, which tells how to “interpret” the airport listings.

Near the end of Section A is where we find the Communications (or COMM) section, **Photo B**. This covers Flight Service (RADIO, RCO, and DRCO) as well as Tower, UNICOM, and AWOS frequencies, among others.

Since Canada is a bilingual country, you may find the symbol (bil) which means that particular frequency is bilingual. Obviously civilian and/or military frequencies are shown.

Notice DRCO? You won't find that designation in the U.S. A/FD. This is called *Dial-up Remote Communications Outlet* which is activated by keying the pilot's microphone multiple times which will allow the pilot to communicate with flight service. It is explained in detail in Section A.

Other information includes ATIS, Clearance Delivery (CLNC DEL), Apron and Ground frequencies, and Tower (TWR) frequencies. Also included are military, VHF, and UHF DF (direction finding) frequencies with AWOS. These are similar to those from the U.S. However, one thing is unique to the Canadian supplement — MF or Mandatory Frequency. Mandatory Frequency is just that — mandatory. Much like most UNICOM frequencies, these are found at uncontrolled airfields. Among the military UHF frequencies some Wing Operations frequencies may be found.

Also, Section A provides examples of Air Route Traffic Control Center (or Centre) frequencies with Flight Service examples.

## Section B

At roughly 1,150 pages, Section B is the heart of the supplement — the listing of all the airports in the Canadian commonwealth. Each airport's listing has all known frequencies in each appropriate section. In the U.S., A/FD a large airport, such as Atlanta Hartsfield (KATL) may take only two pages, but the layout in the Canadian guide may take as many as five pages — an example of which is Abbotsford, British Columbia (CYXX), **Photos C and D**.

(NOTE: The contiguous U.S. states' airport identifiers start with K, with Alaska starting with PA, Fairbanks being PAFK. Hawaii with PH, and Honolulu being PHNL. — KPC4KGC)

Not only are the airports found here, but center (centre) and flight service frequencies.

## Section C

Look through the nearly 200 pages of Section C and you won't find any frequency listings. It focuses on flight planning. This is

a great explanation of flight plans, emergency security control, Canadian airspace boundaries, explanation of airspace, updates of aviation charts, flight restrictions, and preferred routes.

## Section D

Here we find something not found in the American A/FD: Listings of radio navigation aid frequencies. Section D includes the names of facilities, the type of NAVAID, the callsign, the frequency, and the location — as in latitude and longitude, **Photo E**.

One thing included here but not in the American A/FD is a listing of AM radio stations throughout Canada, **Photo F**. Why would this be included?

On most aircraft, one of the radio receivers covers low and medium frequencies. Low frequencies (or LF) found below the standard AM bands are used for non-directional radio beacons. However, these receivers can be used to locate and *home in* on the MF AM band.

Of course the AM radio receiver can't be used for navigation. Legally, it can be used to locate specific cities, and of course to get the latest news and weather. A little top-40 music does help pass the time, too. This listing includes the city and

**A86 GENERAL**

**COMMUNICATIONS (COMM)**

The term "(bil)" when placed after the term "COMM" indicates that all services listed below are offered bilingually. When bilingual services are limited, the term "(bil)" will precede the appropriate service.

**FREQUENCIES:**

A frequency followed by an "X" means the frequency can be requested through the control agency under which it is listed. If there are other limitations placed upon availability of frequencies, these will be indicated. Frequencies published followed by the letter "T" or "R" indicate that the facility will only transmit or receive respectively on that frequency; when followed by the letter "P" the frequency is a back-up for precision approach radar (see "NAVIGATION" section for this legend). When VHF frequencies are quoted to three places of decimals it indicates 25KHZ separation. HF frequencies used by the Canadian Flight Service Stations are capable of SSB J3E emission only. Frequencies printed in bold type indicate a high altitude frequency (starting at FL180 and above, unless otherwise indicated).

**EMERGENCY FREQUENCIES:**

Within this Supplement emergency frequencies are listed within this directory as (V) indicating 121.5 (U) indicating 243.0 and (E) indicating 121.5 and 243.0.

*All services bilingual*      *Bilingual services at these facilities*

COMM	(bil)
RADIO	(bil) 122.2 236.1 (E) (emerg only 867-979-5685)
RCO	Goose rdo 126.9 (RAAS) 126.7 (FISE)
DRCO	Goose rdo 126.9 (RAAS) 126.7 (FISE) 236.1 (FISE)
ATIS	114.8 124.6 1-877-517-ATIS (2847)
CLNC DEL	121.4
APRON	122.4 "call sign"
GND	121.9
TWR	118.7 124.0 (inbound) 226.5
MF	radio 118.7 04-12Z‡ 5NM 3100 ASL (CAR 602.98)
ATF	unicom ltd hrs O/T † 122.8 5NM 4000 ASL
TML	(bil) 124.65 134.475
ARR	(bil) 120.8 352.7
DEP	(bil) 120.5 363.8
VFR ADV	terminal 125.2
PAL	Sumspot Ctr 125.9 308.3
UNICOM	122.8
APRT RDO	122.1 (V) 14-06Z‡
A/G	4895
MIL	Wing Ops 264.6
VDF	118.7
UDF	227.6 (U)
INTL AIR	6350 (Selcal)
AWDS	124.7 <i>International Air Carrier</i>
LWIS	128.7
PMSV	344.6

**SUMSPOT CENTRE**

127.0 133.675 132.175 132.475 132.475  
Sault Ste. Marie 132.65 134.425 227.3 344.5

*Peripheral station*      *Bold indicates High Altitude frequency (starting at FL180 and above, unless otherwise indicated).*  
*Light type indicates Low Altitude frequency*

**SUMSPOT FSS - RCO**

Moosonee 122.5 (RAAS) 12-02Z‡ (N51 17 W80 38)  
Muskoka 122.3 (RAAS) (N44 58 W79 18)

Photo B.

**B4 AERODROME/FACILITY DIRECTORY**

**ABBOTSFORD BC** CYXX

ELEV 194

TORA FOR INTERSECTION DEPARTURES			LDA FOR LAND AND HOLD SHORT OPERATIONS (LAHSO CHART)		
RWY	INTXN	TORA in ft	FROM	TO	LDA in ft
01	C	4204	Thrd Rwy 19	Short of Rwy 07-25	4600
			Thrd Rwy 25	Short of Rwy 01-19	8400

REF	N49 01 31 W122 21 36 2.2SW 19°E UTC-8(7) Elev 194' VTA A5004 LO2 H13 T1 CAP RCAP
OPR	City 604-855-1001 Cert
PF	A-1,2,3,6 C-4,5
CUST	AOE/15 888-226-7277 16-08Z‡
FLT PLN	Pilots are to open/close VFR Flt Pln with Kamloops FIC via phone or Pacific rdo 122.5 when practicable. NOTAM FILE CYXX FIC Kamloops 866-WXBRIEF (Toll free within Canada) or 866-541-4101 (Toll free within Canada & USA) ACC Vancouver IFR 604-586-4590/4591 or 800-668-1333; IFR tng flts PPR ctc 604-586-4592 or 800-668-1333 WX METAR H24. TAF H24, Issue times: 00, 06, 12, 18Z. PIK TWR Main Floor foyer. For door access use MF plus *
SERVICES	FUEL MG-1, 100LL, JA (CON S IP JA-1, FSI) 604-854-1964 by truck, 604-854-0887 self-serve VISA & Mastercard only. OIL All S 1,2,3,4,5 ARFF 6 14-07Z‡ O/T 2 hrs PPR call out chg JASU AC/DC 28V 400 amp min PVT ADV Abbotsford Shell Aerocentre 122.95 604-854-1964; 800-765-7779 MIL CON Abbotsford Shell Aerocentre 604-854-1964

Photo C.



province, callsign, frequency, wattage, and location of the tower. For those of us old enough to remember, this is very reminiscent of the old *White's Radio Log*. Can you envision an A/FD including a White's? *Very interesting.*

The final part of section D is probably most useful to those on the Atlantic coast.

For those flying to Europe, long-distance communications is necessary. Stations on the East Coast in Gander, Newfoundland, and New York City are listed here — as well as Shannon, Ireland and Keflavik, Iceland. **Photos G and H.** Talk about an *all-purpose book*.

## Sections E and F

**Section E** is for military use exclusively with few frequencies but plenty of information not normally seen by the general public. One surprising part of this section deals with procedures regarding Russian military aircraft. *That was an eye opener.*

The almost 20 pages of **Section F** deal with emergency procedures. With the exception of the 121.5-MHz (International Air Distress) and 243.0-MHz (Military Air Distress) frequencies, there's not much information here.

## A True Story

In closing let me tell you of an incident that occurred to me in the late 1980s.

AERODROME/FACILITY DIRECTORY B5	
<b>ABBOTSFORD BC (Cont'd) CYXX</b>	
<b>RWY DATA</b>	Rwy 07(067°/25(247°) 9597x200 asphalt/concrete Thld 25 disp 295'. Rwy 01(007°/19(187°) 5328x200 asphalt
<b>RWY CERT</b>	Rwy 07 RVR 1200(1/4sm)/Rwy 25 RVR 1200(1/4sm)
<b>TWY</b>	Twy D uncontrolled E of blast fence. Twy B rstd to acct with wingspans 78' or less. Reverse turns to exit Rwy 07 onto Twy C4 rstd to acct with wingspans 50' or less. Turns onto Twy A from Twy C rstd to acct with wingspans 171' or less. Turns from Twy A onto Twy C rstd to C-130 & smaller (blast issue). Turns west onto Twy C4 and east onto Twy C1 from Twy C rstd to acct with wingspans 133' or less.
<b>APRON</b>	Ltd parking and de-icing dur win ops, all wide body acct 2hr PPR ctc ops 604-864-5544. Tran prkg rstd to Apron 1 Ext. All other prkg and Run-up Pad PPR ctc ops. Apron 1 north of Twy B. Including Twy A ltd to acct with wingspans of 118' or less.
<b>RCR</b>	Opr Ltd win maint 1400-0730Zt, O/T 2 hrs PN call out chg. PPR dur win maint exc sked ops, ain or emerg. CRFL, PLR/PCN.
<b>LIGHTING</b>	01-AS(TE ME) P2, 19-AD(TE ME) P2, 07-AN(TE HI), 25-AO(TE HI) P3
<b>COMM</b>	
<b>RCO</b>	Cranbrook rdo 119.4 (RAAS) 07-15Zt Pacific rdo 122.5 (FISE) 126.7 (bcst)
<b>ATIS</b>	119.8 1-877-517-2647 15-07Zt
<b>GND</b>	121.8 15-07Zt
<b>TWR</b>	119.4 (inner) 121.0 (outer) 295.0 (V) 15-07Zt (emerg only 604-855-1199)
<b>MF</b>	MF and advsy svcs only provided over Canadian territory. Cranbrook rdo 119.4 295.0 07-15Zt CZ shape Irregular 4500 ASL (CAR 602.98) (emerg only 250-426-6312)
<b>PAL</b>	Victoria Tml 132.7 (avail on gnd) 290.8
<b>NAV</b>	
<b>NDB</b>	XX 344 (M) N49 00 56 W122 29 16 068° 4.3NM to A/D CULTUS LU 214 (M) N49 01 16 W122 02 59 252° 12.3NM to A/D WHITE ROCK WC 332 (L) N49 00 12 W122 45 01 067° 14.7NM to A/D
<b>ILS</b>	IXX 109.7 (Rwy 07) RVR
<b>PRO</b>	Rgt hand circuit Rwy 07 & 01 (CAR 602.96). Rwy 01/19 and Twy B not avbl for acct taxiing when RVR below 2600 (CAR 602.96) NIGHT RESTRICTIONS: Turbo-jet, turbo-fan and turbo-prop lng not permitted fr 06-15Zt. All other night lng as authorized by the APM. Procedures for crossing the southern Strait of Georgia within Tml Class C airspace refer to Vancouver Intl, VTPC for Crossing the Southern Strait of Georgia. ATS REQUIREMENTS: All VFR acct arriving, departing or transiting the Vancouver or Victoria Tower Class C or D airspace require a transponder code. - All acct departing Vancouver or Victoria Intl (including Water Aerodrome) call Kamloops FIC at 888-987-2633 (888-YVR-CODE) or 604-586-4595 for code assignment at least 30 min prior to flight or file a VFR Flight Plan/Flight Itinerary. - All acct arriving Vancouver Intl (including Water Aerodrome) or transiting Vancouver or Victoria Control Zones obtain a code from one of the following ATS units: Vancouver Harbour, Nanaimo, Victoria Harbour, Boundary Bay, Langley, Abbotsford or Pitt Meadows, or call Kamloops FIC at 888-987-2633 (888-YVR-CODE) or 604-586-4595. - All acct arriving Victoria Intl from a non NAV CANADA site call Kamloops FIC at 888-987-2633 (888-YVR-CODE) or 604-586-4595 for code assignment at least 30 minutes prior to flight or file a VFR Flight Plan/ Flight Itinerary.

Photo D.

As covered in my introductory column, (*"Inside the World of Aviation Scanning," August 2012, page 46 - KPC+KGC*), I've worked in every aspect of air traffic.

From 1982 to 1993 I was a controller in Albany, Georgia (KABY) — long before civilian use of GPS. The local control frequency of 118.8 MHz was interfering with the radar approach control in Tampa, Florida (KTPA). The FAA and FCC were petitioned to have our frequency changed. We moved to 120.25 MHz. However, even though the frequency change showed up in the A/FD, not everyone had the information. As a result, we had a backup radio set up on 118.8 MHz.

One summer day — cloudless with unlimited visibility — a pilot flying a Cessna 172, **Photo I**, called on 118.8 MHz. I picked up the microphone to reply, but he didn't receive my transmission.

Since I knew he was coming in, and from which direction, I kept a lookout to the south. There he was. I aimed the facility light gun at the Cessna, gave him a steady green, watched for the rocking of wings, and observed him landing on Runway 4.

He wasn't fully off the runway when I heard another aircraft. I looked up to see a light twin engine Cessna 310, **Photo J**, crossing the landing threshold of Runway 4.

D6 RADIO NAVIGATION AND COMMUNICATIONS						
RADIO NAVIGATION AIDS BY LOCATION (Cont'd)						
Name	Type	Freq/Ch Indicator(Aux Code)	(N)Lat	(W)Long	Elev	Var/Dec
Hombjarg, Iceland	NDB	HO 298.8(M)	66 24 44	22 23 02		
Husavik, Iceland	NDB	HS 329(M)	65 55 37	17 26 20		
Ilulissat, Gnid.	NDB	JV 367(L)	69 14 34	51 04 40		
Ilulissat, Gnid.	DME	JA 111.95/56Y	69 14 29	51 03 58		
Ingo, Iceland	VOR/DME	ING 112.4/71	63 48 11	16 38 17		
Jan Mayen, Norway	NDB	JAN 362	70 56 41	08 40 12		
Julianehaab, Gnid.	NDB	JH 265(L)	60 43 30	46 02 00		
Kangerlussuaq, Gnid.	DME	ISF 109.55/32Y	67 01 07	50 40 56		
Killaloe, ON	VOR/DME	YXI 115.6/103	45 39 47	77 36 10		12W
Kook Islands, Gnid.	NDB	KU 298(M)	64 04 17	52 01 03		
Kopasker, Iceland	NDB	KP 400(L)	66 18 08	16 27 00		
Laberge (Whitehorse), YT	NDB	JB 236(L)	60 56 56	135 08 16		25E
Lakeshore (Watson Lake), YT	NDB	XG 338(L)	60 06 45	128 47 53		25E
Langholt, Iceland	NDB	LA 344(L)	65 34 38	19 29 20		
Langruth, MB	VOR/DME	VLR 112.2/59	50 25 20	98 43 25	935	9E
Malarmf, Iceland	NDB	MA 303.4(M)	64 43 41	23 48 29		
Mans, ON	VOR/DME	YMS 114.5/92	44 08 35	80 08 47		9W
Marmorlik, Gnid.	NDB	MAR 322(L)	71 07 41	51 13 21		
Miqueion, France	NDB	MQ 402 (L)	47 05 51	56 23 09		21W
Nanortalik, Gnid.	NDB	NN 270(L)	60 08 45	45 15 20		
Naramala (Pentiction), BC	NDB	UNT 312(M)	49 35 50	119 36 10		18E
Narsaq, Gnid.	NDB	NS 404(L)	60 53 54	46 00 46		
Nes (Reykjavik), Iceland	NDB	NS 370(L)	64 08 03	21 57 49		
Nordfjordur, Iceland	NDB	NF 325(M)	65 08 00	13 44 39		
Ogur, Iceland	NDB	OG 400(L)	66 02 36	22 41 18		
Okanagan (Pentiction), BC	NDB	ON 356(L)	49 20 33	119 34 08		18E
Pabok (Du Rocher-Parcé), QC	NDB	W7 219(M)	48 22 54	64 33 50		21W
Paine (Shothomish Co (Paine Fid)), WA	VOR/DME	PAE 110.6/43	47 55 11	122 16 40	670	20E
Patreksfjordur, Iceland	NDB	PA 348(M)	65 33 30	23 58 20		
Prins Christian Sund, Gnid.	NDB	OZN 372(H)	60 03 32	43 09 49		
Raufarhofn, Iceland	NDB	RG 301.1(M)	66 27 12	15 57 12		
Reykhol, Iceland	NDB	RH 325(L)	64 39 52	21 17 35		
Reykjanes, Iceland	NDB	RN 291.9(M)	63 48 53	22 42 53		
Reykjaneskoll, Iceland	NDB	RE 316(M)	65 55 37	22 25 55		
Rif, Iceland	NDB	RF 330	64 54 42	23 49 24		
Robinson (Whitehorse), YT	NDB	PJ 329(L)	60 26 22	134 51 41		25E
Sable Island, NS	NDB	1B 277(M)	43 55 50	60 01 22		20W
Saguenay, QC	VOR/DME	VBS 114.2/69	48 01 02	71 18 09	2918	19W
St-Felix-de-Valois, QC	NDB	UFEX 260(L)	46 11 32	73 25 08		16W
Sao Miguel, Azores	NDB	MGL 371(M)	37 44 00	25 35 00		
Sault Ste. Marie, MI	VOR/DME	SSM 112.2/59	46 24 44	84 18 54		4W
Scaresbyund, Gnid.	NDB	SC 343(M)	70 29 12	21 57 36		
Simcoe, ON	VOR/DME	YSO 117.35/120Y	44 14 18	79 16 18	932	10W
Simutag, Gnid.	NDB	SI 279(M)	60 41 00	46 36 00		
Skageta, Iceland	NDB	SM 312.6	56 07 12	20 06 12		
Skagi, Iceland	NDB	SA 379(L)	64 18 21	21 58 18		
Skookum (Cranbrook), BC	NDB	SX 368(M)	49 57 18	115 47 32	2830	17E
Stettuhlid, Iceland	NDB	SD 370(L)	66 04 00	19 20 06		
Stykkisholmur, Iceland	NDB	SU 382(M)	65 03 36	22 45 20		
Tatoosh, WA	VORTAC	TOU 112.2/59	48 17 59	124 37 1652		22E
Telkwa (Smithers), BC	NDB	TK 391(L)	54 40 11	126 59 33		22E
Thorshofn, Iceland	NDB	TH 339(M)	66 15 03	15 16 04		
Torbay, NL	VOR/DME	YYT 113.5/82	47 29 07	52 51 08		20W
Turner Valley, AB	NDB	TV 299(L)	50 45 00	114 22 06		17E
Upemavik, Gnid.	NDB	UP 399(M)	72 47 35	56 09 14		
Vopnafjordur, Iceland	NDB	VP 393(M)	65 42 59	14 51 14		

Photo E.



I had *no idea* who this pilot was — landing without a clearance. I observed him turning off the runway at the same taxiway the Cessna 172 had taken. When I saw which fixed base operator he was taxiing to, I called to request the Cessna 310 pilot give me a call.

A few minutes later I received a phone call. The pilot asked if there was a problem. I asked him if he knew he had landed without a clearance. *Here is where the fun begins.* He said, "Well, I was on the right frequency: 120.8."

I advised him we didn't have 120.8 MHz here. He insisted we did. I told him the closest 120.8 was in Americus, Georgia (KACJ), some 35 miles northeast. He continued to argue I was wrong. (NOTE: *I'd only been there since 1982. So, I guess I could be wrong. KPC4KGC*)

I pressed the point that we didn't have 120.8 MHz. He was getting vehement. "It says right here in my guide — Cook County, 120.8!" *I just smiled.*

ME: "Cook County?"

PILOT: "Yes!"

D28 RADIO NAVIGATION AND COMMUNICATIONS					
COMMERCIAL BROADCASTING STATIONS					
The following listing is provided by the Department of Industry Canada and is updated every six months; it covers all Canadian AM stations 40W and higher. Commercial broadcasting stations that are within the coverage of a VTA are not shown on the VNC.					
NOTE:					
(a) Some stations operate H24 but most operate 0700-2359 local time.					
(b) Power is listed in watts. Where there is separate power for day and night power is in parenthesis.					
CAUTION:					
(a) A station may switch to a back-up transmitter without warning and the back-up facility may be at a different location.					
(b) Commercial Broadcasting Stations are subject to outage or change without NOTAM.					
(c) Some Commercial Broadcasting Stations will not identify themselves by their designated identifier.					
COMMERCIAL BROADCASTING STATIONS					
BROADCAST STATION	CALL SIGN	FREQ	POWER	TOWER LOCATION (N)LAT (W) LONG	
<b>YUKON TERRITORY</b>					
Beaver Creek	CBDM	690	40	62 22 51	140 53 07
Carmacks	CBOF	990	40	62 06 01	136 15 58
Dawson	CBDN	560	400	64 03 21	139 24 49
Eisa	CBUD	560	40	63 55 34	135 30 53
Mayo	CBDG	1230	40	63 37 45	135 53 34
Ross River	CBOJ	990	40	61 56 30	132 26 53
Swift River	CBDY	970	40	60 00 08	131 11 43
Teslin	CBDK	940	40	60 10 01	132 43 40
Watson Lake	CBDH	990	400(165)	60 03 58	128 43 22
Whitehorse	CBPY	810	50	60 41 32	134 58 17
	CFWH	570	5000(1000)	60 47 00	135 06 51
	CKRW	610	1000	60 41 32	134 58 17
<b>NORTHWEST TERRITORIES</b>					
Aklavik	CBAX	1210	40	68 13 20	135 01 41
Fort McPherson	CBOM	690	40	67 25 42	134 51 55
Fort Norman	CBOI	920	99	64 54 30	125 32 28
Fort Providence	CBQC	1230	99	61 40 20	117 38 21
Fort Simpson	CBDO	690	40	61 52 18	121 22 51
Fort Smith	CBDI	860	99	60 00 13	111 52 32
Inuvik	CHAK	860	1000	68 20 41	133 41 09
Norman Wells	CBDW	990	40	65 16 52	126 48 43
Tuktoyaktuk	CBAC	1150	40	69 26 36	133 00 01
Wrigley	CBQG	1280	40	63 13 02	123 26 24
Yellowknife	CFYK	1340	2500	62 25 55	114 25 10
<b>NUNAVUT</b>					
Gjoa Haven	CBIA	640	40	68 37 36	95 52 21
Iqaluit	CFFB	1230	1000	63 43 56	68 32 43
<b>BRITISH COLUMBIA</b>					
100 Mile House	CKBX	840	1000(500)	51 40 11	121 17 27
Abbotsford	ABBOTSFORD-1	850	10000	49 01 07	122 13 51
Alice Arm	CBKL	1150	40	55 27 29	129 27 21
Ashcroft	CBWA	860	40	50 43 26	121 16 13
	CINL	1340	1000	50 45 30	121 17 52
Blue River	CBKM	860	40	52 06 20	119 18 30
Bralome	CBRZ	1350	40	50 46 35	122 49 04
Burnaby	CJML	940	20	49 15 04	123 00 05
Burns Lake	CFLD	760	1000	54 15 19	125 45 30
Cache Creek	CBKS	1450	40	50 48 42	121 19 40

Photo F.

B342 AERODROME/FACILITY DIRECTORY	
<b>GANDER CENTRE</b> (emerg only 709-651-5207)	
(132.1 extended range) 124.175 125.9 128.5 132.6 133.9 289.4	
Brevoort 124.825 & 128.075 (FL290 & above)	
Churchill Falls 126.025 (128.7 Cinc Del 2330-0730Z)	
Deer Lake 134.6	
Goose Bay 120.4 (127.675 132.4 133.425 FL290 & above) 294.5	
Hibernia 118.25	
Hopedale 128.325 & 132.65 (FL290 & above) 135.4	
Kuujuaq 134.2 (FL290 & above) 2330-0730Z O/T Montreal Centre	
Natashquan 135.45 (FL180 to FL280) (135.45 Cinc Del 2330-0730Z)	
Saglek 123.75 & 135.325 (FL290 & above)	
St. Anthony 124.725 128.6 133.0 134.3 371.9 371.9 (FL280 and below)	
St. John's (NL) 125.075 128.175 132.05 133.15 227.3 230.3 (134.7 245.0 (FL290 & above))	
St. Pierre (Allen's Is) (128.45 Cinc Del 2330-0730Z) 134.9	
Stephenville 132.3 132.3 (FL280 & below) (135.05 Cinc Del 2330-0730Z)	
Sydney (119.42 Cinc Del 2330-0730Z)	
Wabush 134.0 (FL290 & above)	
<b>GANDER RADIO-RCO</b>	
Cambridge Bay Intl Air 2971 4675 8891 11279 Nat'D (SELCAL)	
Iqaluit Intl Air -2971 4675 8891 11279 Nat'D (SELCAL)	
Gander Intl Air 126.9 127.1	
Hopedale Intl Air 120.55 128.6 133.0 134.3 371.9 371.9 (FL280 and below)	
Iqaluit Intl Air 126.9	
Prins Christian Sund, Greenland Intl Air 127.9	
Frederiksdal, Greenland Intl Air 127.9	
St. Anthony Intl Air 127.1 122.37	
St. John's Intl Air 126.9 122.37	
Gander Radio Intl Air HF	
Nat 'A' 3016 5598 8906 13306 (SELCAL)	
Nat 'B' 2899 5616 8864 13291 (SELCAL)	
Nat 'C' 2872 5649 8879 11336 13306 (SELCAL)	
Nat 'D' 2971 4675 8891 11279 (SELCAL)	
Nat 'F' 3476 6622 8831 13291 (SELCAL)	
VOLMET 3485 6604 10051 13270	
<b>GANDER RADIO / INTERNATIONAL (NAT and Anchorage Arctic FIR)</b>	
For hours of operation and a description of HF Radiotelephony Network Operations for the North Atlantic and Anchorage Arctic Flight FIR refer to TC AIM COMM Section 6. SATCOM voice may be used to contact Gander Radio for non-routine flight safety calls or during periods of poor HF propagation. INMARSAT Code 431613 Public Phone 709-651-5328.	
<b>GANDER RADIO / DOMESTIC (CANADIAN NORTHERN AIRSPACE)</b>	
Gander Radio is responsible for (ICAO) HF communication in Canadian Northern Airspace. Aircraft operating within Canadian Northern Airspace may use SATCOM voice as an alternative to HF for routine communications. During periods of HF unreliability, the use of SATCOM voice for all communications is strongly encouraged. INMARSAT Code 431613, Public Phone 709-651-5328.	

Photo G.

RADIO NAVIGATION AND COMMUNICATIONS D35			
NORTH ATLANTIC METEOROLOGICAL INFORMATION (HF) (VOLMET)			
<b>GANDER</b>			
3485	H+20-25	TAF	Montreal/Pierre Elliott Trudeau, Toronto, Ottawa
6604		METAR	Gander, Montreal/Pierre Elliott Trudeau, Toronto, Ottawa, Goose.
10051			
13270	H+25-30	TAF	SIGMET (1), Winnipeg, Edmonton, Calgary, Churchill
		METAR	Kuujuaq, Winnipeg, Churchill.
	H+50-55	TAF	Gander, St. John's, Halifax
		METAR	Gander, St. John's, Halifax, Stephenville, Montreal (Mirabel).
	H+55-60	TAF	SIGMET (1), Goose, Iqaluit, Sondrestrom.
		METAR	Goose, Iqaluit, Sondrestrom, Kuujuaq.
NOTE (1) Includes SIGMET or notification of SIGMET affecting flights operating above FL 100 in the Gander Oceanic and the Gander Domestic, Moncton, Montreal and Toronto FIR.			
<b>NEW YORK</b>			
3485	H+00	FORECASTS	Detroit, Chicago, Cleveland.
6604		ACTUALS	Detroit, Chicago, Cleveland, Niagara Falls, Milwaukee, Indianapolis.
10051			
13270			
	H+05	FORECASTS	Bangor, Charlotte, Pittsburgh.
		ACTUALS	Bangor, Pittsburgh, Windsor Locks, St. Louis, Charlotte, Minneapolis.
	H+10	FORECASTS	New York, Newark, Boston.
		ACTUALS	New York, Newark, Boston, Baltimore, Philadelphia, Washington.
	H+15	FORECASTS	Bermuda NAS, Miami, Atlanta.
		ACTUALS	Bermuda NAS, Miami, Nassau, Freeport, Tampa, West Palm Beach, Atlanta.
	H+30	FORECASTS	Niagara Falls, Milwaukee, Indianapolis.
		ACTUALS	Detroit, Chicago, Cleveland, Niagara Falls, Milwaukee, Indianapolis.
	H+35	FORECASTS	Windsor Locks, St. Louis.
		ACTUALS	Bangor, Pittsburgh, Windsor Locks, St. Louis, Charlotte, Minneapolis.

Photo H.



ME: "Adel, Cook County?"

PILOT: "That's right!"

ME: "I hate to break this to you, but you're *not* at Adel Cook County."

PILOT: "What do you mean, I'm not?"

ME: "Adel Cook County is 42 miles southeast of here on Interstate 75. You're at Albany Dougherty County."

After about 10 seconds of deafening silence I hear, "Ohhhh." He apologized. Five minutes later he taxied out to Runway 4 — on the right frequency. When he took off, he pulled up the gear, turned right to the southeast toward Adel, and I never saw him again.

You'd think a pilot with a twin engine rating should know where in the world he is. But this was not to be my first — or last — lesson in pilot or controller mix-ups.

(WATCH: Get a pilot's view of a Cessna 310 landing in Cody, Wyoming <<http://bit.ly/Qa4zUG>>, Photo K. — KPC4KGC)

### Season's Greetings

Here's wishing you the best during this Christmas and Hanukkah season. Meantime, listen up and make sure your wheels are down and locked. — KPC4KGC.

### Good News for the VHF/UHF Enthusiast

The all-time favorite magazine for the VHF/UHF enthusiast, CQ VHF is better than ever and here to serve you!



Take advantage of our subscription specials you'll save money and have CQ VHF delivered right to your mailbox. Only \$28 for four information-packed quarterly issues. Or better yet, enter a two or three year subscription at these special prices. As always, every subscription comes with our money back guarantee.

#### Holiday Special Prices!

	USA	VE/XE	Foreign Air Post
1 Year	26.00	36.00	39.00
2 Years	52.00	72.00	78.00
3 Years	78.00	108.00	117.00

Add a 1-year digital subscription for only \$10

Mail your order to:

CQ VHF

25 Newbridge Road • Hicksville, NY 11801

Subscribe on line at [www.cq-vhf.com](http://www.cq-vhf.com)

FAX your order to us at 516 681-2926

Call Toll-Free  
800-853-9797



Photo I. This Cessna 172 is similar to the model flown by the pilot landing — with assistance from KPC4KGC — at Albany Dougherty County airport on a crystal-clear summer day. (Courtesy of AlfvanBeem via Wikimedia Commons)



Photo J. The pilot of a Cessna 310 — similar to the aircraft shown here — was surprised to hear from KPC4KGC that he'd accidentally landed 42 miles northwest of his intended destination. (Courtesy of FlugKerl via Wikimedia Commons)



Photo K. You're in the pilot's seat as a Cessna 310 makes a landing in Cody, Wyoming — undoubtedly the exact destination he was aiming for <<http://bit.ly/Qa4zUG>>, unlike the pilot KPC4KGC had to mentor years ago. (Internet screen grab)

**IN GEAR**  
Power Up

By Jason Feldman, WPC2COD

**DX Engineering's New UNUN**

DX Engineering has introduced the DXE-UN-43, a multi-band vertical UNUN specifically designed for use with any non-resonant, 43-foot-tall, vertical multi-band antennas, such as DXE's MBVE-1 and MBVE-5. DX Engineering said the UNUN assures the best efficiency from your vertical multi-band antenna and transmission line/tuner installation.

DX Engineering's UN-43 minimizes the additional transmission lines losses caused by SWR and allows your antenna to perform to its full potential. By allowing your wide-range tuner to easily match the antenna's complex impedance, low-frequency performance is improved.

Features include full-band tunable coverage on 160-10 meters when used with customer supplied wide-band tuner, SWR under 1.5:1, and 2-kilowatt CW/5-kilowatt SSB power handling capability. Components are enclosed in a high-impact weather sealed NEMA spec case. Rugged hardware is used throughout, including a silver-Teflon SO-239 input, stainless steel washers and wing nuts at the feedpoint connection.

DX Engineering said the MSRP is \$104.95. The complete kit with mounting hardware and tinned braid connections, DXE-UN-43-R is \$129.95. Customer supplied wide band tuner required. (VISIT: DX Engineering website: <<http://www.dxengineering.com>>)



**Photo A.** The DXE-UN-43 is a multi-band vertical UNUN specifically designed for use with any non-resonant, 43-foot-tall, vertical multi-band antennas. (Courtesy of DX Engineering)

**Uniden Adds New Submersible Marine Radio**

Uniden has added the MHS135DSC to its lineup of submersible handheld marine radios. The 6-inch by 9-inch by 4-inch radio weighs 4 pounds and features a large backlit LCD screen with a dot matrix display and a backlit keypad that features a one-touch channel 16/9 key.

If the radio were to fall overboard, Uniden says not too worry because the radio is fully JIS8 submersible, meaning that the radio is sealed for continuous submersion under pressure specified by Uniden. The radio can also float and features an emergency strobe light.

All marine channels are included along with weather channels and NOAA weather alerts. The radio includes a SM81 speaker/microphone and transmits at 1, 2.5, and 6 watts.

The included battery can provide up to eight hours of talk time and the radio comes with a rapid AC/DC charging cord and cradle.

Other accessories include a belt clip, an antenna, and a three-year warranty. The MSRP is \$249.00. (INDEPTH: For more information on the MHS135DSC, visit: <<http://bit.ly/OB4cnF>>)

**Features:**

- Built-in GPS with DSC Features
- GPS Compass
- Temperature Display
- Add Favorite Locations (up to 100 locations)
- Auto Plot to DSC Distress Call
- JIS8 Submersible
- Power Boost PTT Key
- Emergency Strobe Light
- Glow in the Dark Power & PTT Keys/Seal
- 1040-mAh, High-Capacity Li-Ion Battery Pack
- 8 Hours Talk Time
- Variable TX Power (1, 2.5, 6 Watt)
- Supplied with Rapid AC/DC Charging Cords and Charging Cradle
- WX/Emergency Alert



**Photo B.** Uniden has added the MHS135DSC to its lineup of submersible handheld marine radios. (Courtesy of Uniden)

WWW.SCANCAT.COM

TOLL FREE 888-722-6228

ScanCat-Lite-PLUS  
Reg. \$39.95 - Limited Time Special \$29.95

Now It's Easier Than Ever  
To Program Your Scanner.

FREE walk-you-through set up videos.

[www.scancat.com/youtube](http://www.scancat.com/youtube)  
Click on "Learn as you view."

ScanCat-Lite-PLUS

- Supports over 50 Scanners in one Program
- Import One Scanner's frequencies, Program any other radio scanner with the same frequencies

SCANCAT-FREQUENCY SPECIAL

ScanCat-Lite-Plus.....	\$39.95
RSD Frequency CD.....	9.95
Total Retail Value <del>\$49.95</del>	

HOLIDAY SPECIAL \$29.95 + \$6 s&h

COMBO ALL-IN-ONE CD

ScanCat-Lite-Plus.....	\$39.95
RSD Frequency CD.....	9.95
Mr. Scanner Frequency CD.....	29.95
If Purchased Separately <del>\$79.85</del>	

SPECIAL \$49.95 + \$6 s&h

NOW AVAILABLE \$CALL HOKA Code 3-32

**COMPUTER AIDED TECHNOLOGIES**

ORDERS: (318) 687-4444 FAX: (318) 686-0449  
Info/Tech Support: (318) 686-1999  
(9 a.m. - 3 p.m. Central M-F)

WWW.SCANCAT.COM

---

POWERPORT **Worldpouch**

Designed for the Yaesu FT-817, but also for Alienco VHF/UHF mobiles

831-427-8197 • KC6QLB  
[www.powerportstore.com](http://www.powerportstore.com)

---

Why just listen?  
Morse Code requirement dropped!

HamTestOnline™

Online courses for the ham radio written exams

- ▶ Fastest way to learn — most students pass the ham radio exam after only 10 hours study.
- ▶ Study material, practice exams, and a virtual private tutor, all rolled into one. An intensely effective learning system. Just ask our students!
- ▶ 100% guaranteed — you pass the exam or get your money back.
- ▶ Online system — study when you want, at your own pace.
- ▶ Free trial — try before you buy!

[www.hamtestonline.com](http://www.hamtestonline.com)

Any day you don't learn something new is a wasted day!

POP'COMM DECEMBER 2012 41



## BROADCASTING

### World Band Tuning Tips

# World News, Commentary, Music, Sports, And Drama At Your Fingertips



This listing is designed to help you hear more shortwave broadcasting stations. The list covers a variety of stations, including international broadcasters beaming programs to North America, others to different parts of the world, as well as local and regional shortwave stations. Many of the transmissions listed here are not in English. Your ability to receive these stations will depend on time of day, time of year, your geographic location, highly variable propagation conditions, and the receiving equipment used.

AA, FF, SS, GG, etc. are abbreviations for languages (Arabic, French, Spanish, German). Times given are in UTC, which is five hours ahead of EST, i.e. 0000 UTC equals 7 p.m. EST, 6 p.m. CST, 4 p.m. PST.

UTC	Freq.	Station/Country	Notes	UTC	Freq.	Station/Country	Notes
0000	5860	Radio Farda, USA, via Sri Lanka	Farsi	0300	9965	Radio Cairo, Egypt	
0000	5319u	Arrmed Forces Network, Diego Garcia		0300	9675	Radio Cancao Nova, Brazil	PP
0000	15755	BBC, Thailand Relay		0300	5040	Radio Havana Cuba	SS
0000	15170	Christian Voice, Australia		0300	5025	Radio Rebelde, Cuba	SS
0000	3310	Radio Mosoj Chaski, Bolivia	QQ	0300	9705	Radio Ethiopia	Amharic
0000	9685	International Radio of Serbia, via Bosnia		0300	7215	TWR, via South Africa	Amharic/EE
0000	4824	La Voz de la Selva, Peru	SS	0300	4930	VOA, Botswana Relay	
0000	8989u	Pescador Preacher, Nicaragua	SS	0300	7170	Voice of the Broad Masses, Eritrea	AA
0000	11780	Radio Nacional Amzonias, Brazil	PP	0300	4778	Radio Difusora Roraima, Brazil	PP
0000	5580	Radio San Jose, Bolivia	SS	0300	4895	Radio Novo Tempo, Brazil	PP
0000	6125	Radio Santa Cruz, Bolivia		0300	7505	WRNO, USA	
0000	15275	Radio Thailand		0400	3925	HCJB, Ecuador, via Germany	GG
0000	5954v	Radio Republica, (to Cuba)	SS	0400	7310	BBC, via South Africa	
0100	11620	All India Radio		0400	6160	CKZU, Canada	
0100	11775	Caribbean Beacon, Anguilla		0400	12045	Deutsche Welle, Germany, Rwanda Relay	
0100	6070	CFRX, Canada		0400	11925	Radio Bandeirantes, Brazil	PP
0100	6165	Radio Nederland, Bonaire Relay	SS	0400	4935	Radio Capixaba, Brazil	PP
0100	1190	Sri Lanka Broadcasting Corporation	Hindi	0400	9630	Radio Exterior Espana, via Costa Rica	SS
0100	5110	WBCQ, USA		0400	5960	Radio Japan, via Canada	
0100	6155	Radio Fides, Bolivia	SS	0400	9575	Radio Mediterranee Intl, Morocco	aa
0200	6090	Caribbean Beacon, Anguilla		0400	4774	Radio Tarma, Peru	SS AA
0200	6050	HCJB, Ecuador	SS	0400	6185	Radio Educacion, Mexico	SS
0200	6020	China Radio International, via Albania	CC	0400	12005	RT Tunisienne, Tunisia	AA
0200	11710	Radio Argentina al Exterior		0400	4960	VOA Relay, Sao Tome	
0200	9305	Radio Cairo, Egypt		0400	9925	Voice of Croatia, via Germany	Croatian
0200	6055	Radio Exterior Espana, Spain	SS	0400	15180	Voice of Korea, North Korea	
0200	5950	Radio Taiwan International, via Florida		0400	9665	Voz Missionaria, Brazil	PP
0200	9610	Vatican Radio	FF	0400	11820	BBC, Oman Relay	
0200	3220	Radio Sonder Grense, South Africa	Afrikaans	0400	4950	Radio Nacional, Angola	PP
0200	3350	Radio Exterior Espana, Costa Rica Relay	SS	0400	6165	Zambia National Radio	
0200	4955	Radio Cultural Amuata, Peru	SS	0400+	11690	Radio Okapi, to Congo via South Africa	vernacular
0200	6030	Radio Marti, USA, to Cuba	SS	0500	5910	Alcaravan Radio, Colombia	SS
0300	9425	BBC, Cyprus Relay	AA	0500	11775	China Radio International, via Albania	AA
0300	9500	BBC, England	Farsi	0500	11530	Denge Mezopotamia, to Iran	Kurdish
0300	9750	BBC, Seychelles Relay		0500	15610	Radio Cairo, Egypt	Swahili
0300	6973u	Galei Zahal, Israel	HH	0500	4055	Radio Verdad, Guatemala	SS
0300	5045	Radio Cultura do Para, Brazil	PP	0500	5915	Radio Zambia	
0300	5010	Radio Madagasikara, Madagascar	Malagasy	0500	4885	Radio Clube do Para, Brazil	PP
0300	15240	Radio Australia		0500	11970	Radio Japan	
0300	9315	Radio Cairo, Egypt	SS				

UTC	Freq.	Station/Country	Notes	UTC	Freq.	Station/Country	Notes
0500	11765	Super Radio Deus e Amor, Brazil	PP	1600	11740	Adventist World Radio, Guam	
0500	13765	Vatican Radio		1600	11825	Adventist World Radio, Guam	
0500	15120	Voice of Nigeria		1600	15360	Adventist World Radio, Guam	
0500	9330	WBCQ, USA		1600	11685	Sarawak FM, Malaysia	Bhasa Malay
0500	3185	WWRB, USA		1700	15235	Channel Africa, South Africa	
0500	7245	Radio Mauritanie, Mauritania	AA	1700	11600	Radio Libye, Libya	FF
0500	15170	Broad. Svc. of Kingdom, Saudi Arabia	AA	1700	17735	RT Tunisienne, Tunisia	AA
0600	5995	Radiodifusion Malienne, Mali	FF	1800	9690	China Radio International	CC
0800	7260	Radio Vanuatu	FF	1800	17605	Radio Nederland, via Vatican	
0800	6010	La Voz de su Concencia, Colombia	SS	1800	15630	Voice of Greece	GG
0900	4747	Radio Huanta 2000, Peru	SS	1800+	9785	Voice of Turkey	
0900	4810	Radio Logos, Peru	SS	1900	15400	BBC, Ascension Island Relay	
1000	2485	Northern Territory SW Service, Australia		1900	13590	CVC-One Africa, Zambia	
1000	4827	Radio Sicuani, Peru	SS	1900	15310	Radio Romania International	Romanian
1000	4717	Radio Yura, Bolivia	SS	1900	15300	Radio France International	FF
1000	4755	The Cross Radio, Microneisa		1900	15465	Voice of Russia	FF
1100	3345	Radio Northern, Papua New Guinea	Tok Pisin	1900	9925	Family Radio, USA, via Madagascar	
1100	9595	All India Radio	Urdu	2000	15190	Radio Africa, Equatorial Guinea	
1100	9870	All India Radio	Hinsi	2000	15540	Radio Kuwait	EE/AA
1100	15500	Islamic Republic of Iran Broadcasting	Dari	2000	11735	RadioTanzania, Zanzibar	Swahili
1100	9720	Radio Nederland, via Northern Marianas	II	2000	13820	Radio Havana Cuba	SS
1100	15265	Radio Japan, via Bonaire	JJ	2000	1800	Radio Belarus	Belarussian
1100	3260	Radio Madang, Papua New Guinea	Tok Pisin	2100	11800	Deutsche Welle, Germany, Rwanda Relay	
1100	3925	Radio Nikkei, Japan	JJ	2100	12025	HCJB, Ecuador via Germany	AA
1100	4781	Radio Oriental, Ecuador	SS	2100	21690	Radio France International	FF
1100	5020	Solomon Islands Broadcasting Coporation		2100	17550	Radio Kuwait	AA
1100	11945	Radio Veritas Asia, Philippnes	Mandarin	2200	15350	China Radio Internaional	CC
1100	155420	Radio Free Sarawak, via Palau		2200	15525	HCJB, Australia	
1200	12105	Adventist World Radio, Guam	Mandarin	2200	15110	Radio Exterior Espana, Spain	SS
1200	9655	Radio New Zealand International		2200	17750	Radio Havana Cuba	SS
1200	4750	RRI-Makassar, Indonesia	II	2200	15345	Radio Nacional, Argentina	SS
1200	15240	Trans World Radio, Guam	Kok Borok	2200	9540	Radio Romania International	
1200	11710	Voice of Korea, North Korea	KK	2200	15720	Radio New Zealand Internatonal	
1200	15450	Voice of Turkey		2200	7255	Voice of Nigeria	
1200	7325	Wontok Radio Light, Papua New Guinea		2200	9580	Africa Number One, Gabon	FF
1200	4750	Bangladesh Betar	EE/other	2200	9705	La Voix du Sahel, Niger	FF
1200	7200	Myanmar Radio	Burmese	2200	9915	BBC, Ascension Island Relay	
1300	9580	Radio Australia		2200+	9760	Cyprus Brloacasting Corp.	Greek: wknds
1300	11715	KJES, USA		2300	11680	Radio Havana Cuba	SS
1300	7295	Traxx FM, Malaysia	Bhasa Malaya	2300	15585	Radio Free Asia, Northern Marianas Relay	CC
1300	15250	VOA, Philippines Relay	CC	2300	11605	Radio Free Asia, via Taiwan	VV
1300	7540	VOA, Philippines Relay		2300	11840	Radio Havana Cuba	SS
1300	15290	Radio Pakistan	Tamil	2300	11680	Radio Havana Cuba	SS
1300	3915	Radio Fly, Papua New Guinea		2300	15230	Radio Havana Cuba	SS
1300	3325	Radio Bougainville, Papua New Guinea	Tok Pisin	2300	13650	Radio Japan	Thai
1300	6130	Lao National Radio	Lao	2300	11930	Radio Marti, USA	SS
1300	9920	Far East Broadcasting Co., Philippines		2300	12105	Voice of Greece	GG
1300	11605	Radio France International, via South Africa	FF	2300	12050	WEWN, USA	SS
1300	440	Voice of the Strait, China	CC	2300	13620	World Harvest Radio, USA	
1300+	11965	Deutsche Welle, Germany, via Singapore	CC	2300	9480	WTWN, USA	
1400	9640	KBS World Radio, South Korea		2300	14950	Salem Stereo, Colombia	SS
1400	11705	Radio Japan, via Palau		2300	7405	Islamic Republic of Iran Broadcasting	Tajik
1400	11685	Trans World Radio, India	Urdu	2300	11815	Radio Brazil Central	PP
1400	9560	Voice of Russia		2300	11595	Democratic Voice of Burma, via Armenia	Burmese
1400	7110	Thazin Radio, Myanmar	Burmese				
1500	9655	KNLS, Alaska					
1600	13670	China Radio International					



# 'Frequency' Opens the Door to Shortwave

## WPC4MDN Was So Impressed by the Movie, He Just Had to Jump In

Compiled by  
Richard Fisher, KPC6PC

*"Seeing 'Frequency' got me into the communications hobby, and propelled me into getting my amateur radio license in 2008."* –  
WPC4MDN

If the *Pop'Comm Monitoring Station* community was a gift for the holidays — which, indeed, it is — we'd have to find a bigger and bigger box in which to put it.

We'll soon be counting a membership numbering 1,500 at a pace that sometimes challenges us. No matter. Jason Feldman, WPC2COD, Director of Registration has done a great job in meeting your requests and is a firm believer in *the more, the merrier*. Not a bad thought around holiday time.

Here are more of your communications monitoring snapshots as we head toward the close of 2012.

### Jeremy Neese, WPC4MDN, Mobile, Alabama

I have been a SWL since watching the movie *Frequency* back in 2000. It got me into the hobby, and propelled me into getting my amateur radio license in 2008. I requested WPC4MDN because they have my late mother's initials, from who I first learned to love the radio in general.



**Photo A.** The 2000 hit movie *Frequency* was the inspiration Jeremy Neese, WPC4MDN, of Mobile, Alabama, needed to get into the shortwave listening and amateur radio game. Watch the movie's original trailer at <<http://bit.ly/NS3jFI>>. (Internet screen grab)

(WATCH: The "Frequency" movie trailer; Photo A, at <<http://bit.ly/NS3jFI>>. – KPC6PC)

### Nick Baga, KPC7VWS, Albany, Oregon

I started SWLing in 1959 upon building a Knight-Kit R100-A receiver. **Photo B.** Many days and nights were spent enjoying listening to broadcast stations both domestic and international.

My first choice for a *Pop'Comm Monitoring Station* ID sign was KPC7VWS, and I am glad I got it. I've recently become a ham radio operator, as well, and the choice matches my radio amateur call letters, KF7VWS.



**Photo B.** Nick Baga, KPC7VWS, of Albany, Oregon, "started SWLing in 1959 upon building a Knight-Kit R100-A receiver," he writes. "Many days and nights were spent enjoying listening to broadcast stations both domestic and international."

## Alan Dixon, WPC4WB, Melbourne, Florida

It is high time now that I order a *Pop'Comm* Monitoring Certificate for myself. Being a *Pop'Comm* alumnus, I had particularly wanted to be among the first to do so. But health problems and other distractions have delayed my request until now.

I requested the *WB* suffix because I am the originator of the *Washington Beat* column in *Popular Communications* magazine.

The certificates are a palpable link to the past, even as they bring us right into the future of radio monitoring. This is especially important since all such previous programs — to my knowledge — have become extinct. It was our own readers who had alerted me to the demise of the SSB Station Registration (11-meters) circa 2004. I would learn later that *Pop'Comm* founding Editor, Tommy Kneitel, ex-K2AES (SK), had closed his CRB Research operation in preparation for his move to Florida. (*NOTE: At the time of his death, Mr. Kneitel's amateur callsign was W4XAA – KPC6PC*)

While not the same as a monitoring station registration program, the SSB Station certificates were one way that *Pop'Comm*, albeit indirectly, offered documented recognition to its readers. And in a not-too-distant concept, this all reminds me a bit of my *Pop'Comm* GMRS Station Certification and Recognition offer in connection with my *On-The-Go Radio* column starting in 2003. Our GMRS-licensed readers obviously valued the special copyrighted certificate and laminated wallet card included in the deal.

So, simply based on that obviously limited (by radio service) audience response, I predict a truly thunderous stampede to the new *Pop'Comm* Monitoring certificate!

## Dan Cameron, KPC7NE, Whithall, Michigan

My dad bought me a crystal radio set when I was seven years old, and now I'm an avid shortwave listener, medium-wave DXer, and QSL collector.

My first receiver for shortwave was a Grundig pocket radio. Then I went through three G5s in one year — continuous playing. Now I'm back to a Grundig Satellit 750 receiver, **Photo C**, connected to an equalizer and tape deck.

I send lots of requests for QSLs, but my Internet provider kicks 'em back to

me most the time. Otherwise I'd have more. I also monitor amateur radio activity from time to time.

## Bob Fauble, WPCØXCT, Lino Lakes, Minnesota

I first started as an SWL in 1965 with a Hallicrafters S-41G Skyrider Jr. receiver, **Photo D**. My favorite listening was to radio amateurs on 75-meter AM. I have since become involved with CB and currently hold an Amateur Extra Class ticket, NØXCT.

I am very happy to have been issued *Pop'Comm* Monitoring Station identification sign WPCØXCT!

## Charles Zimmer, KPC5EN, Eloy, Arizona

I have been a radio amateur and avid

SWLer for more than 35 years and thought it would be neat to have an ID sign for both. My present amateur callsign is KG5EN and was issued shortly after moving to Texas in 1985. That's why I'm so glad to have been issued the *EN* suffix.

I currently listen on a Kenwood TS590S, ICOM IC-751A, and an old National NC183D, with updated tubes and a product detector — added in 1978.

## Brian Smith, WPC9IND, Greenwood, Indiana

My amateur radio callsign is W9IND — a vanity call I obtained in 1997 after first admiring it as a Novice in 1971.

As a lifelong resident of Indiana, the *Pop'Comm* Monitoring Station identification sign suffix *IND* fits.



**Photo C.** Dan Cameron, KPC7NE, of Whithall, Michigan, started with a crystal set at age 7, but over the years has graduated to the Grundig Satellit 750 receiver, considered a real gem by many SWLers. (Courtesy of Universal Radio, <<http://www.universal-radio.com>>)



**Photo D.** Bob Fauble, WPCØXCT, Lino Lakes, Minnesota, "first started as an SWL in 1965 with a Hallicrafters S-41G. My favorite listening was to radio amateurs on 75-meter AM." For a comprehensive look at this receiver, visit the Hallicrafters S-41G Skyrider Jr. page on the Boatanchor Pix website, <<http://bit.ly/UKEUo8>>. (Internet screen grab)



# Holiday Gift Ideas



## **DX World Guide** by Franz Langner, DJ9ZB

This 384-page DXer's guide-book is the first edition using color throughout and the first to be entirely in English.

Includes info on well over 300 DX entities. Geographical info, WAZ and ITU zones, ITU callsign allocations, amateur prefixes and more!

**6 X 9 Paperback \$42.95**  
**New! CD Version \$22.95**  
**Buy both for only \$60.95**



## **W6SAI HF Antenna Handbook** by Bill Orr, W6SAI

W6SAI was known for his easy-to-understand writing style. In keeping with this tradition, this book is a thoroughly readable text for any antenna enthusiast, jam-packed with dozens of inexpensive, practical antenna projects that work!

**8.5 X 11 Paperback \$19.95**  
**New! CD Version \$14.95**  
**Buy both for only \$29.95**



## **2013 World Radio TV Handbook**

The most up-to-date info on mediumwave, shortwave, FM broadcasts and broadcasters. Articles, reviews of the latest equipment, maps, and more. Due in mid-Dec. You will not be charged until it ships!



Order No. WRTH **\$35.00**

## **Understanding, Building & Using Baluns & Ununs**

by Jerry Sevick, W2FMI

The successor to the popular and authoritative Baluns and Ununs. Great deal of new tutorial material, and designs not in previous book, with crystal clear explanations of how and why they work.

**8.5 X 11 Paperback \$19.95**  
**New! CD Version \$14.95**  
**Buy both for only \$29.95**



## **Sloper Antennas**

By Juergen A. Weigl, OE5CWL

**Single- and Multi-Element Directive Antennas for the Low Bands**

With calculations and practical experience, this book shows which basic concepts have to be considered for sloper antennas for the low bands.

**6 X 9 Paperback \$24.95**  
**New! CD Version \$18.95**  
**Buy both for only \$36.95**



## **Lew McCoy on Antennas**

by Lew McCoy, W1ICP

Unlike many technical publications, Lew presents his invaluable antenna info in a casual, non-intimidating way for anyone!

**8.5 X 11 Paperback \$19.95**  
**New! CD Version \$14.95**  
**Buy both for only \$29.95**



## **Reflections III**

by Walt Maxwell, W2DU

All the info in Reflections I and II and more! This completely revised and updated, 424-page 3rd edition is a must-have!

**8.5 X 11 Paperback \$39.95**  
**New! CD Version \$29.95**  
**Buy both for only \$59.95**



## **The Quad Antenna**

by Bob Haviland, W4MB

Comprehensive guide to the construction, design and performance of Quad Antennas. General Concepts, Circular-Loop & Arrays, Rectangular & Square Loops, Multi-Element Quads and more!

**8.5 X 11 Paperback \$19.95**  
**New! CD Version \$14.95**  
**Buy both for only \$29.95**



## **The NEW Shortwave Propagation Handbook**

by W3ASK, N4XX & K6GKU

This authoritative book on shortwave propagation is your source for easy-to-understand information on sunspot activity, propagation predictions, unusual propagation effects and do-it-yourself forecasting tips.

**8.5 X 11 Paperback \$19.95**  
**New! CD Version \$14.95**  
**Buy both for only \$29.95**



Call 1-800-853-9797 or FAX your order to 516-681-2926  
You can also order on our website: <http://store.cq-amateur-radio.com>



# RSGB Books



## Guide to VHF/UHF Amateur Radio

By Ian Poole, G3YWX  
112 pgs.

Everything you will need to help you enjoy VHF/UHF to the fullest. Choosing the right transmitter, receiver, antenna, utilizing the correct part if each band and more!

Order No. RSGVUAR **\$16.00**

## Microwave Projects 2

By Andy Barter, G8ATD

If you're interested in building equipment for the amateur radio microwave bands, the designs in this book are sure to please!



Order: RSPM2 **\$28.50**



## Practical Wire Antennas 2

By Ian Poole, G3YWX  
176 pages

Significantly expanded and fully revised. Includes designs for a wide range of practical wire antennas. Just about every type of wire antenna you could imagine with complete designs.

Order: RSPA2 **\$23.50**

## QRP Basics

By Rev. George Dobbs, G3RJV  
208 pages

How to get the best results from a QRP station whether from home or outdoors. How to construct your own station, complete transmitters, receivers and some accessories. Includes toroidal coils, construction techniques and equipping a work station.



Order: RSQRPB **\$28.50**

## VHF/UHF Handbook

Edited by Andy Barter, G8ATD  
320 pages.

Guides you through the theory and practice of VHF/UHF operating and transmission lines. Includes information on getting started, antennas, constructing your own equipment, satellite ops, local nets and specialized modes.



Order: RXVUH **\$29.50**



## HF Antenna Collection

252 pages.

A collection of outstanding articles and short pieces which were published in *Radio Communication* magazine. Includes single- and multi-element, horizontal and vertical antennas, extremely small transceiving and receiving antennas, feeders, tuners and more!

Order: RSHFAC **\$33.00**

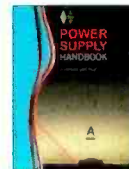

## Power Supply Handbook

By John Fielding, ZS5JF  
288 pages

How power supplies work, selecting components, building and modifying supplies, measuring the finished supply, batteries, chargers, test equipment - it's all right here!

Order: RSPSH **\$28.50**

## World at Their Fingertips

By John Clarricoats, G6CL



The story of amateur radio in the U.K. and a history of the Radio Society of Great Britain. Its pages and illustrations give an account of the development of a hobby that has provided technical knowledge and service to the community.

Order: RSWATF **\$16.00**

## Microwave Know How for the Radio Amateur

Edited by Andy Barter, G8ATD

This 192-page compilation of articles aimed at those interested in building equipment for the microwave bands



Order: RSKH **\$25.00**



## Stealth Antennas

By Steve Nichols G0KYA

Offers a wide range of antenna solutions for getting your signal out despite limited location, intolerant neighbors or HOAs.

From using house rain gutters and drain pipes, or a magnetic loop in the loft, to a tuned loop around the window frame you'll find a wide range of ingenious solutions.

Order: RSSA **\$23.95**

## HF Amateur Radio

Second Ed.

This full revised and expanded second edition guides you through setting up an efficient amateur radio station, equipment to choose, installation, the best antenna for your location and MUCH more.



Order: RSHFAR **\$23.00**

## HF Antennas for Everyone

Edited by Giles Rad, G1MFG



No matter the size of your available space - you'll find antenna designs that will help you get your signals in and out!

Order: RSHFAE **\$27.95**

## Morse Code for Radio Amateurs

by Roger Cooke, G3LDI

Fully revised and updated tenth edition shows how to learn Morse code and get the maximum enjoyment from using it. Includes a dual purpose CD (computer/audio) with nearly an hour of audio recordings of Morse code at 5, 10, 15, 20 and 25 words per minute



Order: RSMCRA **\$16.00**

## Digital Modes for All Occasions

By Murray Greenman, ZL1PBPU  
208 pages



Simply the most "complete" book on digital modes available. Over 100 illustrations!

Order: RSDMFAC **\$28.50**

## Backyard Antennas

208 pages

Antenna guru Peter Dodd explains how using a variety of simple techniques make it possible to achieve very high performance from a compact antenna.



Order: RSBYA **\$33.00**



## Virtual Radar Explained

By Mick Richards, G4WNC

The reception and plotting of ADS-B transmissions for aircraft. Great for aviation enthusiasts.

Order: RSVRE **\$16.95**

Call 1-800-853-9797 or FAX your order to 516-681-2926  
You can also order on our web site: <http://store.cq-amateur-radio.com>



# More great CQ gifts!

## HEATHKIT

A Guide to the Amateur Radio Products

by Chuck Penson, WA7ZZE



**Back by popular demand!**

This 328-page Second Edition is a must-have for collectors and Ham history buffs alike.

Order No. HEATH **\$32.95**

## The Vertical Antenna Handbook

by Paul Lee, N6PL

Learn basic theory and practice of the vertical antenna. Discover easy-to-build construction projects.



Order No. VAH **\$17.95**

## MIL SPEC Radio Gear

Korean to Present Day  
by Mark Francis, KIØPF



Detailed write-ups for many familiar sets: PRC-25/-77, RT-68, PRC-1099, GRC-106, GRR-5, R-392 and more. Over 230 pages of ops, mods, and maintenance tips 200+ illustrations.

**Sale!**

Order No. MILSPEC ~~\$27.95~~ **\$15**

## 33 Simple Weekend Projects

by Dave Ingram, K4TWW



Do-it-yourself electronics projects from the most basic to the fairly sophisticated. Also, practical tips and techniques on creating your own projects.

Order No. 33PROJ **\$17.95**

## cds

Ham Radio Magazine on CD

Enjoy quick and easy access to every issue of this popular magazine, broken down by years!

1968-1976

Order No. HRCD1 ~~\$59.95~~

1977-1983

Order No. HRCD2 ~~\$59.95~~

1984-1990

Order No. HRCD3 ~~\$59.95~~

**ON SALE - only \$54.95 ea.**

**Buy All 3 Sets and Save \$49.90!**

Order No. HRCD Set

**\$129.95** (Reg. \$149.95)



# CQ 2013-14 calendar

CQ Amateur Radio Operators Calendar



**15 months of value**  
January 2013 through March 2014

Fifteen spectacular color images of some of the biggest, most photogenic shacks, antennas, scenics and personalities from across the country! This year's calendar is better than ever!

Includes dates of important Ham Radio events, major contests and other operating events, meteor showers, phases of the moon, and other astronomical information, plus

important and popular holidays. CQ's 15-month calendar (January 2013 through March 2014) is a must have!

Shipping & handling: USA \$3, CN/MX \$5, All other countries \$10

**A great holiday gift!**

Order No. HRCAL **\$10.95**



**\$10.95**  
+ S/H

Shipping & Handling: U.S - .add \$7 for the first item, \$3.50 for the second and \$2 for each additional. FREE shipping on orders over \$100 to one U.S. address.  
CN/MX - \$15 for 1st item, \$7 for 2nd and \$3 for each add'l. All Other Countries-\$25 for 1st item, \$10 for 2nd and \$5 for each add'l.  
Single Calendar: USA \$3, CN/MX \$5, All other countries \$10



# RSGB Books

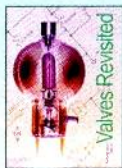

## Valves Revisited A Guide to Thermionics

By Bengt Grahn, SMØYZI  
272 pages

Provides the basics of how valves work to how to build your own. Details their use in amplifiers, receivers, power supplies signal generator and much more!

Order No. RSVR **\$32.50**

## Homebrew Cookbook

By Eamon Skelton, EI9GQ

Starts with the very basics of homebrew and progresses to advanced topics. It will have you itching to dust off your soldering iron!

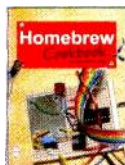

Order: RSHC **\$23.95**

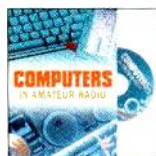

## Computers in Amateur Radio

By Steve White, G3ZVW  
208 pages

A practical guide to a wide range of amateur radio topics. Software defined radio (SDR), Datamodes, modelling for antennas, propagation and even terrain for HF, D-Star and APRS. CD packed with logging, contests, mapping, morse code training, APRS, RTTY, SSTV and more.

Order: RSCAR **\$32.50**

## Amateur Radio Astronomy

Second Edition  
By John Fielding, ZS5JF  
384 pages

Covers in depth the subject of receiving radio signals from outer space. A practical reference for the application of radio technology in this fascinating topic.

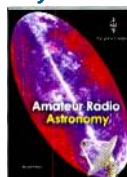

Order: RSARA **\$32.50**



## The Amateur Radio Operators Manual

Edited by Giles Rad, G1MFG

With more than twenty-five new contributors, this 7th Edition has lots of new material. Whether you're new to the hobby, or an established amateur this book is a goldmine of useful and practical info.

Order: RSRAOM **\$28.95**



## RSGB Prefix Guide 10th Edition

By Fred Handscombe, G4BWP  
80 pages

Fully updated- it provides the latest and most comprehensive list of the world's amateur radio prefixes and addition information covering references for continent, CQ Zone, DXCC, OIOTA, ITU Zone, Latitude & Longitude and much more. The very latest DXCC information is included with an unprecedented five new DXCC entities being added and two deleted.

Order: RSPXG **\$19.50**



## Technical Topics Scrapbook- All 50 yrs

By Pat Hawker, G3VA  
176 pages plus CD

All the words, pictures and line drawings from columns as they appeared. CD contains PDFs of pages arranged in annual collections from 1958 to 2008. Book reproduces pages from 2005 - 2008.

Order: RSTT50 **\$29.50**

## International QRP Collection



Edited by Dobbs, G3RJV  
& Telenius-Lowe, 9M6DXX

The authors scoured the world for the best and have compiled them into this great scrapbook. Largest section of this 176-page collection is devoted to construction.

Order: RSIQC **\$23.95**

## Antenna Topics

By Pat Hawker, G3VA  
2002 Edition, 384 pages

This book is a goldmine of info and ideas on antennas. Pat Hawker has been writing his "Technical Topics" column in Radcom since 1958 and in this time has produced much excellent work. Carefully indexed this book is not only a great reference work but also a history of over forty years of antenna design.

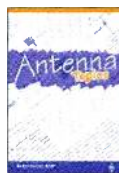

Order: RSAT **\$33.00**

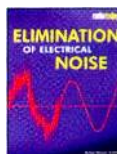

## Elimination of Electrical Noise

From 30kHz to 30MHz  
By Don Pinnock, G3HVA  
64 pages

If you suffer from electrical noise problem Don's experiences and advice may provide solutions. Details various types of noise, how it's generated and how best to deal with it.

Order: RSEEN **\$16.50**



## HF Antennas for All Locations

By Les Moxon, G6XNRSGB,  
2nd Edition, 322 pages

Details the design and construction of hundreds of amateur antennas. No matter what your location you'll find at least one antenna in this collection that will work for you!

Order: RSHFAAL **\$33.50**



## Amateur Radio Essentials

Edited by George Brown, M5ACN  
288 pages

Everything from Rho to Radiation Resistance, Filtering to Fractal Aerials, Solar Indices to Spurious Signals. Divided into six broad sections covering a huge range of material. Beginners will find basic info about most of the things that matter and old hands will find data that other textbooks often do not include.

Order: RSARE **\$30.50**

## Weekend Projects for the Radio Amateur

By George Brown, MW5ACN  
224 pages

Packed with over sixty articles covering a wide variety of projects. Two main parts - Build It Yourself (aerials, general and station accessories) and Reference (packed with articles to maximize the hobby).



Order: RSWP **\$27.50**

## RF Design Basics

By John Fielding, ZS5JF  
192 pages

Aimed at those who wish to design and build their own RF equipment. Written for the average radio amateur, an accessible and useful reference work for everyone interested in RF design.



Order: RSDB **\$33.50**



## Radio Nature

By Renato Romeno, IK1QFK  
256 pages

Nature has spoken through radio signals since the origins of the Universe. A fascinating look at these signals, a guide to receiving and analyzing them.

Order: RSRN **\$32.50**

Call 1-800-853-9797 or FAX your order to 516-681-2926  
You can also order on our web site: <http://store.cq-amateur-radio.com>



**\*Spend \$100  
and get FREE  
shipping!**

# ... more great gifts!

## A Year of DX

by Bob Locher, W9KNI

Look over the shoulder as the author works country after country, in pursuit of the Holy Grail – winning the CQ DX Marathon.



Order No. YDX **\$19.95**

## The Complete DXer

Third Edition

The joy of the chase, the agony of defeat, the thrill of victory are the stuff of The Complete DXer, a book that is almost as seductive as the DX chase it describes. It excites, it entertains, it teaches!

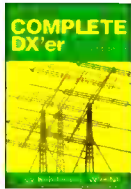

Order No. COMPDXer **\$19.95**

## VHF Propagation

Practical Guide for Radio Amateurs

by WB2AMU & WB6NOA

Tropo Ducting, Sporadic-E, Auror, Meteor Scatter, F2 Propagation, TE, Combo Modes - it's all right here!

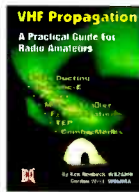

Order No. VHFProp **\$15.95**

## Mouse Code

by Joel Thurtell, K8PSV

A great book for the kids in your life! When humans start plowing up North Field and cutting down trees, two field mice (re-)invent radio to warn the animals of danger, using a form of Morse code that can only be called... Mouse Code!



Order No. Mouse **\$12.95**

## Nifty E-Z Guide to D-STAR Operation

2nd Edition

A comprehensive guide to D-STAR operating! Ideal for those getting into D-STAR. Written for both the beginning and experienced D-STAR users. Straight forward and simple explanations.



Order No. NIFDS **\$13.95**

## "Getting Started" DVD Paks

Our renowned "Getting Started" videos grouped together on DVDs!

**On SALE!**

### CQ Ham Radio Welcome Pak

1 DVD contains 3 programs:  
Ham Radio Horizons  
Getting Started in Ham Radio  
Getting Started in VHF



Order # HAMDVD ~~\$24.95~~ \$16.00

### CQ HF Specialty Pak

1 DVD contains 2 programs:  
Getting Started in DXing  
Getting Started in Contesting



Order # HFDVD ~~\$24.95~~ \$16.00

### CQ VHF Specialty Pak

1 DVD contains 3 programs:  
Getting Started in Satellites  
Getting Started in VHF  
Getting Started in Packet



Order # VHFDVD ~~\$24.95~~ \$16.00

Buy any combination of DVDs and SAVE!

1 Pak for ~~\$24.95~~ - \$16.00

2 Paks for ~~\$45.95~~ - \$30.00

3 Paks for ~~\$65.95~~ - \$42.00

## The Short Vertical Antenna and Ground Radial

by Sevick, W2FMI

This small but solid guide walks you through the design and installation of inexpensive, yet effective short HF vertical antennas. With antenna restrictions becoming a problem, it could keep you on the air!



Order No. SVERT **\$10.00**



## HR Anthologies

~~\$19.95~~

Sale **\$16 ea.**

Buy all 4 for only \$60

Enjoy collections of the best material published in Ham Radio magazine, conveniently arranged by subject and original publication date. Choose your interest, your time period and choose your anthology!

- Homebrewing Techniques ..... Order # AHOME
- Test Eqpt & Repair Techniques ..... Order # ATEST
- Antennas - 1968 - 1972 ..... Order # ANTS1
- Antennas - 1973 - 1975 ..... Order # ANTS2
- All 4 for \$60 ..... Order # ASET

## Collins Radio Repair & Tune-Up DVD Guides

From Hi-Res Communications, Inc., these well-produced, authoritative DVDs cover all the most common repair and tune-up subjects on these classic radios. It's like having an experienced professional right next to you!



**Collins 75A**  
4 hours  
Order C-75A  
**\$89.95**



**Collins KWS-1**  
2 hours  
Order C-KWS-1  
2 hours **\$39.95**



**Collins KWM-2**  
4 hours  
Order No. C-KWM  
**\$89.95**



**Collins 75S-3/32S-3**  
4 hours  
Order No. C-75S  
**\$89.95**

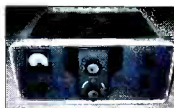

**Collins 30L-1**  
61 minutes  
Order No. C-30L  
**\$39.95**



**R-390A**  
7 hours  
Order C-390A  
**Only \$109.95!**

**R-390A Addendum\***  
4 hours  
Order C-R390AAdd  
**Only \$49.95!**

\*The addendum disc is an another four full hours of detailed info. This video is meant to supplement, not replace, the original video above.

Shipping & Handling: U.S - .add \$7 for the first item, \$3.50 for the second and \$2 for each additional. FREE shipping on orders over \$100 to one U.S. address.

CN/MX - \$15 for 1st item, \$7 for 2nd and \$3 for each add'l. All Other Countries-\$25 for 1st item, \$10 for 2nd and \$5 for each add'l.

Single Calendar: USA \$3, CN/MX \$5, All other countries \$10

# Magazines at holiday prices!



## CQ Amateur Radio

CQ's editorial content is aimed squarely at the active ham. Within each issue, CQ's features and columns cover the broad and varied landscape of the amateur radio hobby from contesting and DXing to satellites and the latest digital modes. CQ includes equipment reviews, projects, articles on the science as well as the art of radio communication and much, much more.

**Holiday Special!** Domestic Rates: 1 year ~~\$38.95~~ **\$36.95** - 2 yrs ~~\$70.95~~ **\$66.95** - 3 yrs ~~\$102.95~~ **\$96.95**  
 Print Edition Canada/Mexico: 1 year ~~\$54.95~~ **\$49.95** - 2 yrs ~~\$96.95~~ **\$92.95** - 3 yrs ~~\$141.95~~ **\$135.95**  
 Foreign: 1 year ~~\$68.95~~ **\$61.95** - 2 yrs ~~\$120.95~~ **\$116.95** - 3 yrs ~~\$177.95~~ **\$171.95**

Add a CQ DIGITAL Edition sub to your Print sub at a special rate: 1 yr \$16; 2 yrs \$30; 3 yrs \$43

Purchase a CQ DIGITAL Edition Subscription ONLY - 1 yr \$26; 2 yrs \$50; 3 yrs \$69



## Popular Communications

The world's most authoritative monthly magazine for shortwave listening and scanner monitoring. Features scanner monitoring of police; fire, utility and aircraft communications; international shortwave listening; CB radio; amateur radio; FRS and more.

**Holiday Special!** Domestic Rates: 1 year ~~\$34.95~~ **\$32.95** - 2 yrs ~~\$62.95~~ **\$58.95** - 3 yrs ~~\$94.95~~ **\$85.95**  
 Canada/Mexico: 1 year ~~\$44.95~~ **\$42.95** - 2 yrs ~~\$82.95~~ **\$78.95** - 3 yrs ~~\$121.95~~ **\$115.95**  
 Foreign: 1 year ~~\$54.95~~ **\$52.95** - 2 yrs ~~\$102.95~~ **\$98.95** - 3 yrs ~~\$151.95~~ **\$145.95**

Add a Pop'Comm DIGITAL sub to your Print sub at a special rate: 1 yr \$14; 2 yrs \$26; 3 yrs \$37

Purchase a Pop'Comm DIGITAL Edition Subscription ONLY - 1 yr \$23; 2 yrs \$44; 3 yrs \$64



## CQ VHF

The all-time favorite magazine for the VHF/UHF enthusiast is better than ever. This quarterly magazine focuses on Ham radio above 50 MHz. Regular columns include: Antennas, OpEd, Satellites, VHF Propagation, & FM.

**Holiday Special!** Domestic Rates: 1 year ~~\$28.00~~ **\$26.00** - 2 yrs ~~\$56.00~~ **\$52.00** - 3 yrs ~~\$84.00~~ **\$78.00**  
 Canada/Mexico: 1 year ~~\$38.00~~ **\$36.00** - 2 yrs ~~\$76.00~~ **\$72.00** - 3 yrs ~~\$114.00~~ **\$108.00**  
 Foreign: 1 year ~~\$44.00~~ **\$39.00** - 2 yrs ~~\$88.00~~ **\$78.00** - 3 yrs ~~\$128.00~~ **\$117.00**

Add a CQ VHF DIGITAL sub to your Print sub at a special rate: 1 yr \$10; 2 yrs \$18; 3 yrs \$25

Purchase a CQ VHF DIGITAL Edition Subscription ONLY - 1 yr \$17; 2 yrs \$32; 3 yrs \$46



## WorldRadio Online

A general interest online only ham magazine with a special focus on the human side of amateur radio and on projects and activities accessible to the average ham. Regular topics include DXing, emergency communications, and "trail-friendly radio."

**Holiday Special!** 1 year ~~\$19.95~~ **\$18.00** - 2 years ~~\$29.95~~ **\$28.00** - 3 years ~~\$39.95~~ **\$37.00**

Call 1-800-853-9797 or FAX your order to 516-681-2926  
 You can also order on our web site: <http://store.cq-amateur-radio.com>



## MONITOR OF THE MONTH

Listening, Around the World

# WPC7USA, Omaha, Nebraska

Please send us a photograph of your listening post and tell us about your monitoring experience. We'd be happy to feature you as a Pop'Comm Monitor of the Month. Write to Pop'Comm Monitor of the Month at: <PopCommMonitor@gmail.com>.

– Richard Fisher, KPC6PC

By Richard Fisher,  
KPC6PC

*“Listening to Northwest Orient pilots talking with the control tower, or hearing South Africa on that Sony portable radio catapulted me into a world of ideas and possibilities”*

“So it’s just about 9 p.m. and I’m listening to *The Voice of Greece*,” Tomas Hood, WPC7USA, of Omaha, Nebraska says in a YouTube video shot in May. “We’re listening to this via a downspout rain gutter pipe three-stories high — that’s the antenna. And that’s an ICOM IC-7000 receiver. We’re listening to shortwave. This is . . . coming all the way from the country of Greece to Omaha.” (WATCH: WPC7USA’s “Voice of Greece video” at <<http://bit.ly/SzAjEJ>>, Photo A. – KPC6PC)

It is remarkable how 2 minutes at a shortwave listening post can capture the excitement — indeed, the amazement — of hearing sounds from faraway places. It’s the fuel that fires our monitoring passions. And Tomas’ goes back to when he was nine years old.

“I have been enjoying the hobby of shortwave radio since about 1973,” he writes. “I discovered my parents’ Sony portable four-band radio — which had AM, FM, LW, and SW, Photo B.

“I loved the shortwave band. I heard all sorts of exotic sounds. And, best of all, I heard radio stations from all over the world. It was like traveling the world, without leaving home. I was like an explorer. I caught the bug of shortwave radio, and AM radio DXing.



Photo A. A two-minute, four-second video by Tomas Hood, WPC7USA, captures the excitement of shortwave listening as he monitors *The Voice of Greece* in May from his listening post in Omaha, Nebraska, <<http://bit.ly/SzAjEJ>>. (Internet screen grab)

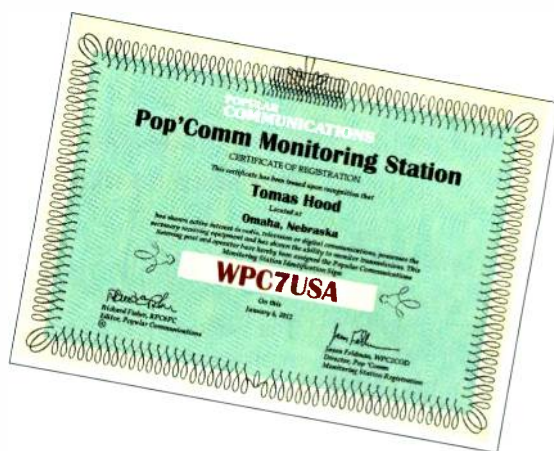

“Many years later, I am now not only enjoying shortwave listening, but I talk with amateur radio operators around the world.”

(NOTE: You may recognize NW7US/WPC7USA as monthly writer of Pop'Comm's Propagation Corner. He writes, as well, propagation columns for CQ and CQ VHF magazines. – KPC6PC)



Photo B. “Here is a picture of the Sony 7F-74DL portable that was my very first radio,” Tomas writes. “Well, my parents’ radio!” (Courtesy of WPC7USA)

"I've recently obtained a used replacement for that long-lost Sony portable SW radio from my childhood! I found it at a hamfest," Tomas writes. "What a joy!"

WPC7USA's 2012 equipment is a long

way from that Sony portable, **Photos C, D, E, and F.**

Recalling his early days at the radio dial, WPC7USA writes about the "amazing sounds" and "exotic stations that

struck my fancy as I tuned around. Soon, I found myself listening to the time signals on WWV, news broadcasts from the BBC, and cultural shows from Radio South Africa, Radio Canada International, HCJB, and Radio Australia. These were just a few of the international shortwave broadcast stations that captured my imagination. I felt that I was traveling the world, without leaving my backyard.

"I was particularly fascinated back then by the hourly WWV propagation bulletin. I sat listening with rapt attention and great imagination, while thinking of Skylab and space, and radio waves. This was my first exposure to the concept of sunspots, space weather, and the variability of radio-wave propagation on shortwave radio." (NOTE: WPC7USA is recognized worldwide as a leading authority on space weather and is administrator of numerous websites, including <<http://www.sunspotwatch.com>>. — KPC6PC)

"I began to look for books on electronics and radio — tubes, electricity, and that sort of thing," Tomas recalls. "My folks bought electronic kits for me to build. Remember back when RadioShack® still sold electronic kits



**Photo C.** Tuned to 9.420 MHz, WPC7USA's ICOM IC-7000 is shown atop an MFJ 940B Versa Tuner II at his listening post. (Internet screen grab)

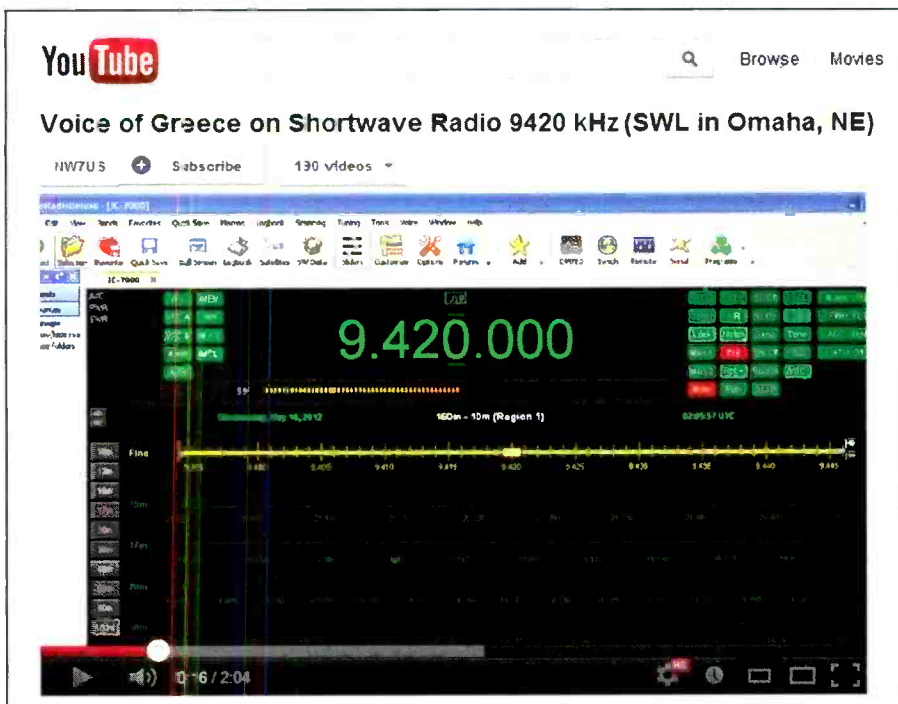

**Photo D.** Receiver-computer integration at WPC7USA adds a whole new dimension to shortwave listening. (Internet screen grab)

Since 1942  
[www.RFfun.com](http://www.RFfun.com)  
 universal radio inc.

**ADVANCED SPECIALTIES INC.**  
 Orders/Quotes 1-800-926-9HAM  
[www.advancedspecialties.net](http://www.advancedspecialties.net)  
**BIG ONLINE CATALOG**  
 BCD996KT 25,000 Channel Digital Trunking Scanner  
**UNIDEN BEARCAT & GRE DIGITAL SCANNERS**  
 • CB • AMATEUR • RADIOS & ACCESSORIES  
 ALINCO • YAESU • GALAXY  
 • GRECOM • COBRA  
 (201)-VHF-2067  
 114 Essex Street, Lodi, NJ 07644  
 Closed Sunday & Monday



# New Members: *Pop'Comm Monitoring Station Program*

Here are the newest station monitors granted a station identification sign, authorized to receive a Certificate of Registration and welcomed to the *Pop'Comm Monitoring Station* program.

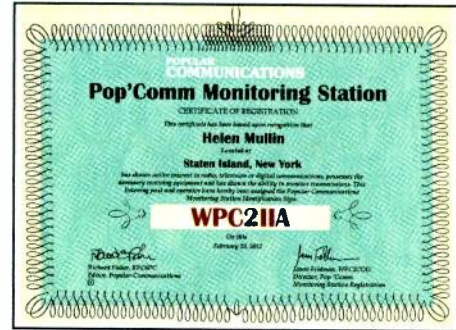

Petal, MS; Jeff Murray, **WPC2GEP**, Accord, NY; William Hoefer, **WPC4KGC**, Front Royal, VA; Luis Gaud, **WPC1LG**, South Ozone Park, NY; Robert Vacarro, **WPC2RPV**, Holtsville, NY; Darin Roberts, **WPC7LA**, Nampa, ID; Robert Berry, **WPC4RFB**, Martinsville, VA; Douglas Cummins, **WPCØFZE**, Independence, MO; James Ferry, **WPC8CEC**, Thornville, OH; Michael Trakinat, **WPC3DCA**, Ellicott City, MD; Richard Pickard, **WPC8EES**, Battle Creek, MI; Gene Stevens, **WPC9ZWC**, McHenry, IL; Thomas Rawlins, **WPC8TLR**, Bay City, MI; Harry Darr, III, **WPC3CDY**, Newark, DE; William Pratt, **WPC4WGP**, Bradenton, FL; Carroll Janisch, II, **WPC9VFD**, East Troy, WI; Helen Mullin, **WPC2IIA**, Staten Island, NY; Keith Fulton, **WPC6GHU**, Anaheim, CA; Dennis Webber, **WPC4DNW**, Jacksonville, NC; Nick Rumpel, **WPC4NIC**, Kannapolis, NC; Glenn Daniels, **WPC2NY**, Marlboro, NY; Richard Kinison, **WPC3RJK**, Waldorf, MD; Bruce Cech, **WPC9PKM**, Collierville, TN; Mark Titterington, **WPC2EGB**, Altamonte Springs, FL; Tina Muldrow, **WPC4TME**, Virginia Beach, VA; Major Armstrong Memorial Radio Club, **WPC2XMN**, Royal Palm Beach, FL; Bill Coury, **WPC8UUP**, Ypsilanti, MI; Mark Heller, **WPC9RF**, Two Rivers, WI; Howard Burns, **WPCØATB**, Bismarck, ND; Paul Martin, **WPC3PM**, Downingtown, PA; Ernest Rendwick, Jr., **WPC2PHW**, Bemus Point, NY; Craig Scott, **WPC2DRD**, Watervliet, NY; Frank Sanko, **WPC8SJS**, Xenia, OH; J. Nick Adams, **WPC4GKE**, Havana, FL; Bart Lee, **WPC6DLT**, San Francisco, CA; Stephen Perez, **WPC4MBH**, Lakeland, FL; Michael Conway, **WPC8ANG**, Emmitsburg, MD; John Rendace, **WPC9IAX**, Crystal Lake, IL; Doris Haskell, **WPC4VDT**, Valrico, FL; Robert Wilson, **WPC1KB**, West Brookfield, MA; Ernesto Marquez, **WPC4PSL**, Port Saint Lucie, FL; Petal Amateur Wireless Society, **WPC4PHS**, Petal, MS; Henry Schuett, **WPC5LOW**, Springtown, TX; William Caruthers, **WPC4WLC**, Fort Lauderdale, FL; Bill Ellis, **WPC5MMC**, Ovilla, TX.

## KPC and DX Prefixes

They are listed by name, station identification sign, and monitoring station location.

Ralph Stallsworth, **KPC4IHS**, Fort Myers, FL; Gary Washington, **KPC3TJA**, Kansas City, KS; Vincent Henley, **KPC7GV**, Anacortes, WA; Darin Roberts, **KPC7ID**, Nampa, ID; Gene Patterson, **KPC3SWL**, Gibsonia, PA; Chris Storey, **KPC6WNK**, Torrance, CA; Clifford Bronson, III, **WPC6AXS**, San Jacinto, CA; Don Ferguson, **KPCØZWC**, St. Charles, MO; Landon Hendrix, **KPC4DF**, Cedartown, GA; Leon Sagaloff, **KPC7IWB**, Dillon, MT; Jherdi Bronson, **KPC6JAB**, San Jacinto, CA; Hank Kobler, **KPC4HEK**, Deland, FL; Robert Klinger, Jr., **KPC3HH**, Ellsworth, WI; David Cleveland, **KPC3XT**, San Diego, CA; Joseph Totello, **KPC4TN**, Knoxville, TN; Patrick Frazier, **KPC7PHX**, Phoenix, AZ; John Shinkowsky, **KPC3JFS**, Harrisburg, PA; Doug Brown, **VEPC3LO**, London, Ontario, Canada; Larry Fravel, **KPC8YYY**, Shinnston, WV; Larry Lucas, **KPC8JHW**, Huntington, WV; Jeffrey Hodgis, **KPC1BCH**, Virginia Beach, VA; Mack Rhea, **KPC4MR**, Hendersonville, TN; Patrick Goodrich, **KPC3NFN**, Hagerstown, MD; Bob Cole, **KPC8IZK**, Cincinnati, OH; George Hedges, **KPC4HOY**, Versailles, KY; Daniel Quintiliani, **KPC3DRQ**, Milford, PA; Silas Luttrell, **KPC4DUT**, Taswell, IN; Terry Stivers, **KPCØZMN**, Greenville, MO; Jeffrey Racey, **KPC3XV**, Knoxville, TN; Verna Racey, **KPC3PKS**, Knoxville, TN; Richard Patterson, Jr., **KPC4RGP**, Blackstone, VA; Dennis Mason, **KPC4HK**, Raleigh, NC; Luis Amaral, **CTPC2LAM**, Porto, Portugal.

## WPC Prefixes

Also: Oscar Leverette, Jr., **WPC4OCL**, Macon, GA; Randy Wesson, **WPC4FLA**, Orlando, FL; Jonathan Province, **WPC1JCP**, Antelope, CA; David Bennette, **WPC5DVO**,

For complete information on the *Pop'Comm Monitoring Station Program* and to join, visit *Pop'Comm Monitors On the Web*: <<http://popcommmonitors.blogspot.com>>.

— Jason Feldman, **WPC2COD**  
Director, PCMS Registration  
<[PopCommMonitor@gmail.com](mailto:PopCommMonitor@gmail.com)>

and was supportive to the home-builder of electronics? I built a simple AM transmitter kit, and a VHF receiver kit that enabled me to hear Air Traffic from the local airport.

"Listening to Northwest Orient pilots talking with the control tower, or hearing

South Africa on that Sony portable radio catapulted me into a world of ideas and possibilities."

As he entered junior high, Tomas "acquired a military surplus shortwave receiver. Late at night when I was supposed to be sleeping, my bedroom would

be lit with the glow of warm orange light from the tubes in the heart of the radio.

"I heard signals from all over the world. Some of them seemed to flow into my room with ease from the dipole antenna that I hid around the eaves of the house. Even AM broadcast-band DXing was exciting. I remember hearing stations from South America, such as a station from Peru," WPC7USA writes.

"While I served in the United States Army, stationed in Europe, I would stay tuned to the world by using any receiver I could find. An example of my obsession would be from times when I was deployed to tactical communications sites *in the field*.

"When I was not on duty and not asleep, I would sneak into backup communications shelters (tactical units sitting on a truck, kind of like those campers on the back of a pickup truck), and fire up military communications gear so I could listen to my news from the BBC, or a show from Trans World Radio in Monte Carlo."

Tomas writes that reception of *The Voice of Greece* in the video, **Photo F**, was in the 31-meter band. "The transmitter in Greece was using 170,000 watts of power."

It was all Greek to Tomas. *Another one in the log!*

(**VISIT:** WPC7USA's Shortwave Listening site on the Web at <<http://swl.hfradio.org>>. – KPC6PC)

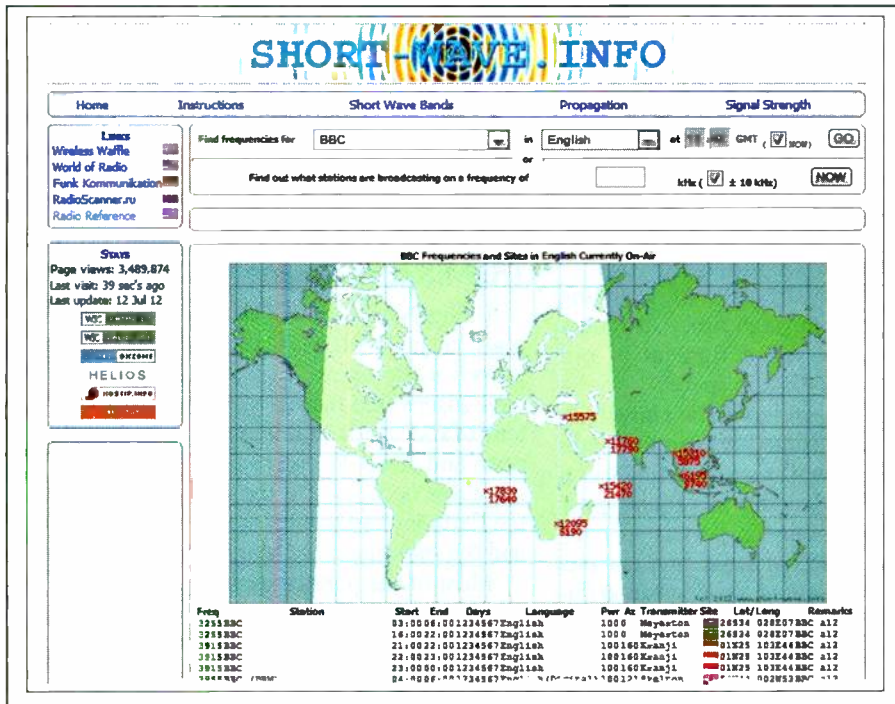

**Photo E.** In this camera pan across the monitoring post, WP7USA shows an extremely useful Web resource: Short-Wave Info, <<http://www.Short-Wave.info>>, where SWLers can quickly find information about stations that are currently on the air. (Internet screen grab)



**Photo F.** SWLers can visit the Voice of Greece website at <<http://www.ert.gr/voiceofgreece>>. (Internet screen grab)



# Exploring Hidden Portals in Earth's Magnetic Field

by Tomas Hood, NW7US,  
WPC7USA  
<nw7us@arrl.net>

*“Armed with new Earth-Sun portal models, we can better predict the impact of space weather on our world, including communications.”*

**H**ave you seen television programs, or a movie in which tunnels, or portals, open up between Earth and some far-off place in space? The mere thought is fascinating.

We imagine the possibilities of traveling through space, or even through time. Are these extraordinary openings just a figment of our imagination? Do portals exist in space?

A NASA-funded researcher at the University of Iowa has discovered some between the Earth and the Sun, and has shown us a way to find them. Plasma physicist Jack Scudder has found clear markers of incredible magnetic portals — even though they are invisible, unstable, and elusive. Physicists call them X-points, or electron diffusion regions. These are where the Earth's magnetic field connects to the magnetic field of the Sun. *The result?* An uninterrupted portal leading

from Earth to the Sun. It's a link of 93 million miles long.

## THEMIS and Cluster in Research

Using NASA's THEMIS spacecraft <<http://g.nw7us.us/RPHHfs>> and Europe's Cluster probes <<http://g.nw7us.us/RPHUit>>, scientists have discovered that these portals, located a few tens of thousands of kilometers from Earth, may open and close dozens of times each day. These openings occur where the geomagnetic field of the Earth intersects with the incoming solar wind and the Interplanetary Magnetic Field (IMF).

Most of the portals are small and short-lived, while others are large enough, and last long enough to allow the inflow of energetic solar particles that heat the Earth's upper atmosphere, and to also affect the Earth's geomagnetic field. When tons of these particles are allowed in through a portal, a geomagnetic disturbance or even a storm develops, along with the magical aurora. Thus, these portals are in part responsible for changes in the propagation of shortwave radio signals by way of the Ionosphere. The more active the geomagnetic field, the more degraded shortwave radio propagation becomes.

“It's called a flux transfer event or ‘FTE,’” space physicist David Sibeck of the Goddard Space Flight Center, said. “Years ago, I was pretty sure they didn't exist, but now the evidence is incontrovertible.”

## Connecting the Dots

Researchers have known for many years that the Earth and Sun are connected in some way — what we call the “Sun-Earth Connection.” They developed models to explain the complexity of the interaction between the Sun and the Earth's Magnetosphere, the giant magnetic *bubble* that surrounds the Earth; the Ionosphere, and Earth's atmosphere. These models suggest that some sort of portal must exist.

Observations near Earth provided scientists with the evidence of solar particles filling our Magnetosphere, as the solar particles come rushing in on the solar wind. The data clearly reveals that these energetic particles then ride the magnetic field lines down to each of the Earth's mag-



**Figure 1.** The existence of portals between Earth and a far-distant place in space is a favorite theme in science fiction, capturing our imagination. Some have theorized that portals of time and distance may well exist. Modern science has discovered at least one type of portal that opens between the Earth and Sun — as often as every eight minutes! (Courtesy of NASA)

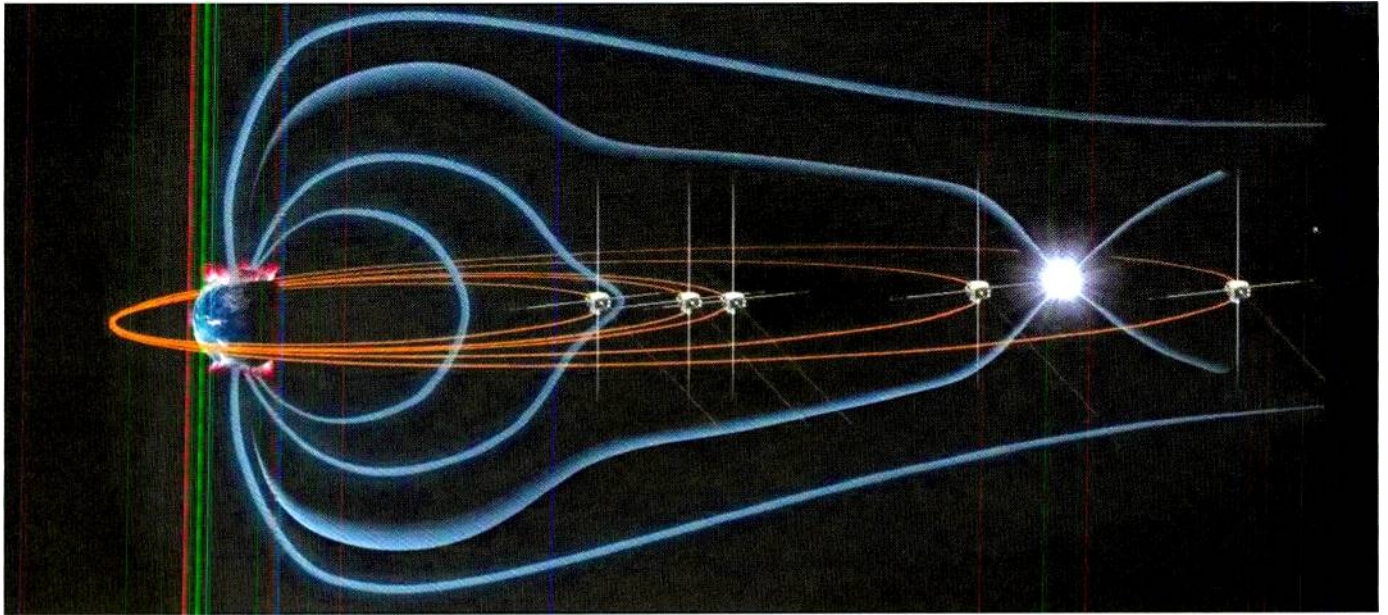

**Figure 2.** This is an artist's rendering of the X-point, or electron diffusion region. These are places where the Earth's magnetic field — the Magnetosphere — connects with the magnetic field of the Sun (the Interplanetary Magnetic Field, or IMF, which is stretched out away from the Sun on the solar wind). Note the placement of research probes (not to scale), ready to monitor the region where portals occur. (Courtesy of NASA)

netic poles. This means there is a path directly from *terra firma* all the way to the Sun.

"We used to think the connection was permanent and that solar wind could trickle into the near-Earth environment anytime the wind was active," Sibeck said. "We were wrong. The connections are not steady at all. They are often brief, bursty, and very dynamic."

We now know that FTEs form where the Magnetosphere and the IMF interface. The Magnetosphere, where it directly faces the Sun, is always being compressed toward the Earth by the solar wind.

The data collected by researchers revealed that at least every eight minutes, these two magnetic fields briefly merge, or "reconnect," forming a portal through which energetic solar particles can flow. The portal takes the form of a magnetic cylinder about as wide as the Earth. *Huge!*

## Scoping the Scene

The four Cluster spacecraft, as well as NASA's five THEMIS probes, have flown through and surrounded these cylinders, measuring their dimensions and sensing the particles that flow through.

This new data allows the scientists to re-work their models of the Earth-Sun Connection. They believe there are two varieties of FTEs: Active and passive.

- Active FTEs are magnetic cylinders that allow solar particles to flow through rather easily. They are key gateways of energy for Earth's Magnetosphere.
- Passive FTEs are magnetic cylinders that are much more resistive to the passing of solar particles. Somehow, the internal structure of these cylinders strongly resists the passing of solar particles.

As it stands, Active FTEs form at equatorial latitudes when the IMF becomes southwardly oriented, while passive FTEs

form at higher latitudes when the solar wind's magnetic orientation is northward. (**NOTE:** *The Propagation Corner has explained how we measure this solar wind orientation and how it is reported as the "B sub-Z" index, or  $B_z$ .* – WPC7USA)

Armed with the new models, we can better predict the impact of space weather on our world, including communications, weather, power grids, and the environment in which satellites work.

Now that scientists know some of the characteristics and what to look for, they are hunting for these portals and hope to reveal much more about the Sun-Earth Connection. These regions where the portals appear are called, "X-points," or electron diffusion regions. To explore these regions more directly, NASA is planning a new mission called, "MMS," short for Magnetospheric Multiscale mission.

It plans to launch the MMS mission by 2014 to study the interplay in this region. The spacecraft is to be fitted with energetic particle detectors and magnetic sensors. Four of these spacecraft will spread out in Earth's magnetosphere and surround the portals to give researchers a perfect way to observe and learn.

## Signposts: Finding the Portals

Of course, they have to find the portals as they appear. These portals are invisible, and may not last very long. Thankfully, there are some clear indicators that act as signposts.

Portals form via the process of magnetic reconnection. Complex lines of magnetic force interact with Earth's magnetic fields, and when the alignment is right, they join and somewhat combine. Think of taking two magnetic bars and aligning them so that their north poles face one another. Using metal filings, we can see the two magnetic fields of the bar magnetic pushing against one another. That is because *like repulses*, so if we re-orient each magnet such that the north pole of one faces the south pole of the other, the two magnets act as if they are one. The metal filings clearly reveal this.





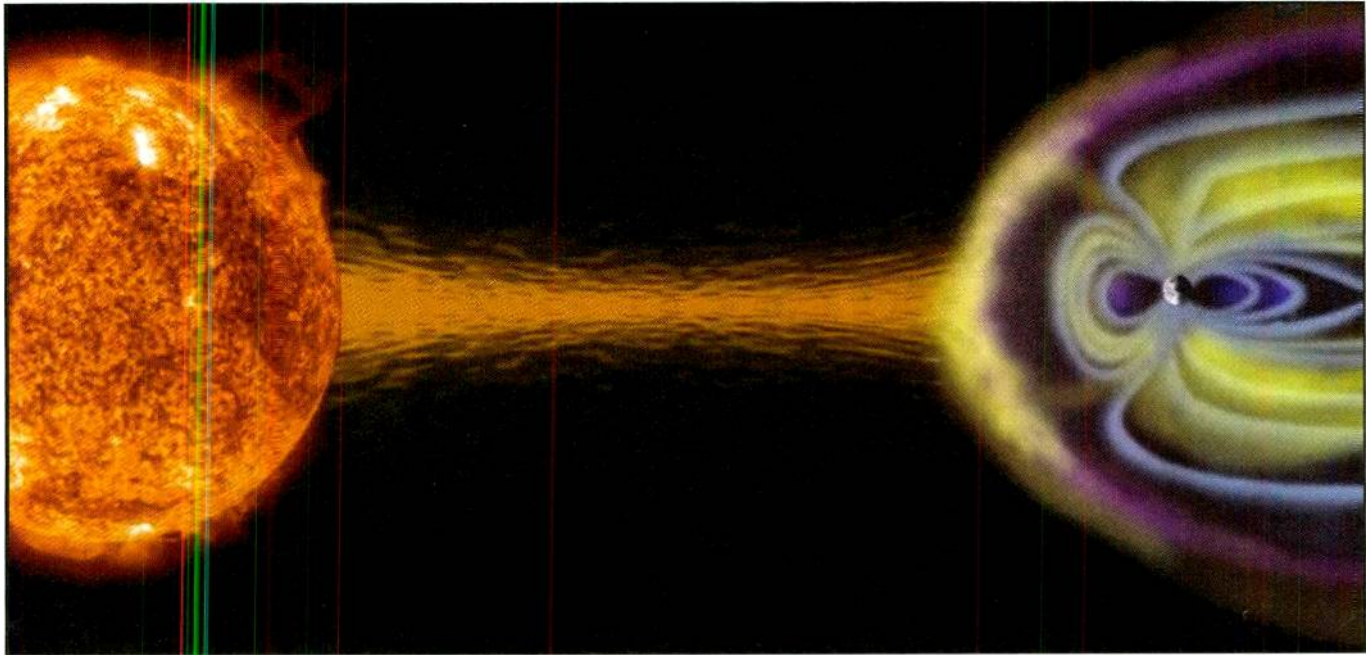

**Figure 3.** Through portals in Earth's Magnetosphere, tons of energized solar particles freely flow from the Sun to the Earth, penetrating our atmosphere. This is known as the Sun-Earth Connection. (Courtesy of NASA)

The same thing happens at times in these portal connections between Earth and Sun. The sudden joining of magnetic fields can propel jets of charged solar particles from the X-point, creating an electron diffusion region.

## What We Know

Physicist Scudder found there are five simple combinations of magnetic field and energetic particle measurements that tell us when a probe comes across an X-point or an electron diffusion region.

This means that a single member of the up-coming MMS constellation using these diagnostics can find a portal and alert the rest of the probes, allowing scientists to research this phenomenon with much greater detail.

Radio enthusiasts know there are times when propagation fluctuates and changes rapidly, and dramatically, for no apparent reason. And, we know there are more gradual changes occurring over the span of a few days.

At times, typical data points that we watch don't seem to reveal why propagation conditions become unstable or even worse. But, now we know there can be fast and significant changes due to these portals.

Armed with the new data from the MMS mission, we may be better equipped to understand what is going on, as well as to forecast — or at least know — when conditions may change. That allows us to better plan radio communication.

*Each month, this column explores radio propagation and the Sun-Earth Connection. Stay tuned as this story unfolds — WPC7USA.*

## The LW and MW DX Season

We are in the heart of DX season! With winter officially starting December 21, medium-wave (MW) DX-chasers in northern latitudes stretch their beverage antenna or deploy loop antennas. They hope to catch faint signals from exotic AM broadcast

station located across the North Atlantic and Pacific Oceans, and from all locations of the Americas and even from Africa.

Usually, they have great success during this time of year because it is easier to catch these weak signals during the long hours of darkness when the lowest ionospheric layer, the D-region, is least ionized. These conditions allow broadcast band DX signals (signals in the frequency range between 530 kHz and 1750 kHz) to propagate great distances with very little loss.

One of the reasons for this improvement in conditions is that the seasonal decrease in weather-related noise makes it easier to hear the weaker DX signals on the lower frequencies. With thunderstorms few and far between, storm-related static and noise is greatly reduced.

Seasonally, the geomagnetic activity tends to quiet down during the winter months, adding another reason for better MW propagation conditions. The most active geomagnetic seasons are centered on the two equinoxes, in the spring and autumn. The solstice periods result in lower geomagnetic activity, providing more stable and reliable propagation on the shortwave spectrum, especially on the lower frequencies. Even trans-polar propagation is improved because of the lower geomagnetic disturbances at the polar regions.

Be sure to try your ear at BCB DXing several hours before local sunset, and continue through the night into the early daylight hours. In some cases, you might even hear an opening quite late in the morning.

The shortest day of the year is not the day when the sunrise is latest and the sunset earliest. The latest sunrise times at mid-latitudes are right around December 30, while the earliest sunset times are usually between December 5 and 10. This means that December can be viewed as an *autumn* month in terms of sunrise DX, but should be considered more like January for sunset DX.

This time of year is also the season when we experience an improvement of radio-wave propagation below 500 kHz, precisely because of the combined improvement of long hours of



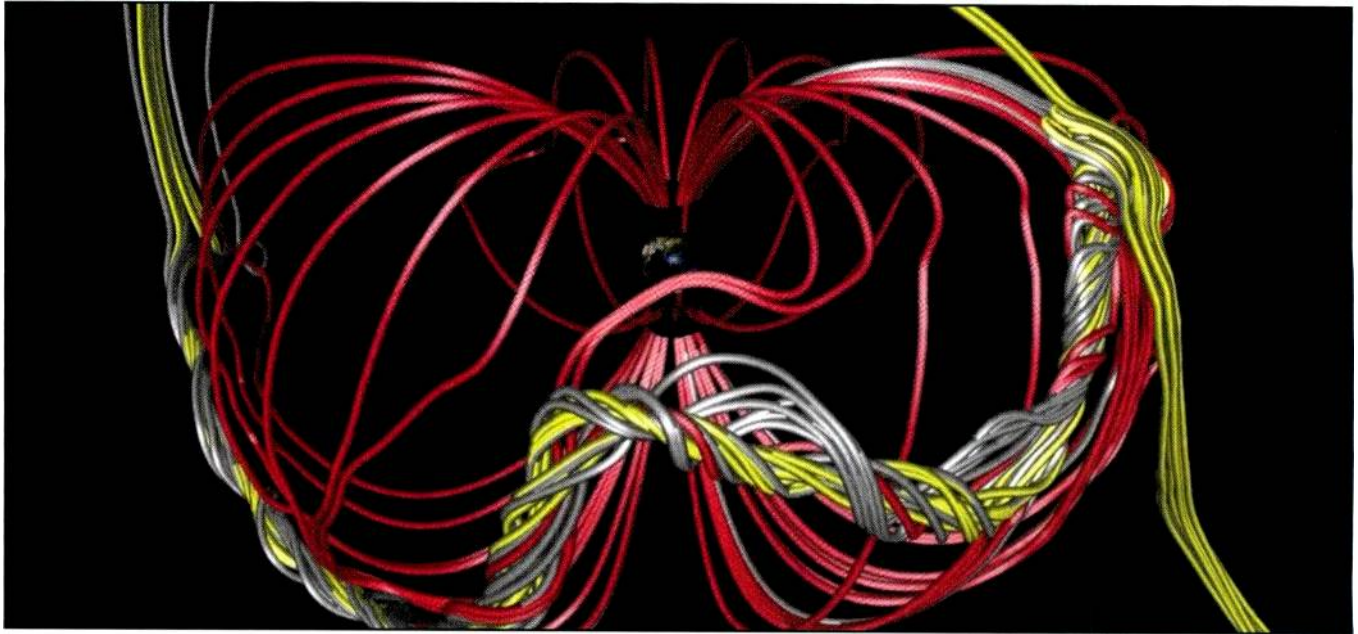

**Figure 4.** Signposts of portals which may occur every eight minutes, some lasting mere moments, others lasting much longer, have been identified by research probes by both NASA and the European Space Agency. Mingling lines of magnetic field lines from the Sun tangle up with Earth's magnetic field lines, in a process known as "reconnection." It is at the points of reconnection what the X-points, or electron diffusion regions, occur. (Courtesy of Community Coordinated Modeling Center, Space Weather Laboratory at NASA Space Flight Center)

darkness and the seasonal quiet provided by the reduction in northern-hemispheric electrical storms.

### Shortwave DXing Season

On the mid- to low-HF bands from early evening until late at night, and then again from early morning through high noon, expect great DX. Sunspot Cycle 24 activity is gradually increasing, causing a more energetic F<sub>2</sub>-region Ionospheric and resulting in more worldwide DX on the higher HF spectrum.

Propagation on 19 and 16 meters is becoming excellent, with both opening up at dawn toward the east, and remaining open toward the west during the early evening. As typical, every year at this time, 19 meters will be the most exciting daytime band, while 22 and 25 meters will become close seconds.

Propagation picks up with early morning openings in all directions until about an hour or two after sunrise, and then scattered openings remain through the day until early evening.

When geomagnetic conditions are good and when the solar flux is significant, 22 through 16 meters are likely to remain open toward the south and west from early evening until about midnight.

This time of year, the HF spectrum useful for around-the-clock DX will be 31 and 25 meters. Twenty-five meters continues to be an excellent band for medium distance (500 to 1,500 miles) reception during the daylight hours, with longer distance reception (up to 2,000 to 3,000 miles) possible for an hour or two after local sunrise, and again during the late afternoon and early evening.

From midnight to sunrise, 41 and 31 meters promise some of the hottest nighttime DX during December. The first DX openings should be toward Europe and the east during the late afternoon, then move across the south through the hours of darkness, while remaining open into most parts of the world. Just after sunrise, openings will be more in a westerly direction. Low seasonal noise will make DXing a pleasurable endeavor.

For regional shortwave DXing, rely on short-skip propagation (distances between 250 and 1,300 miles). During December try 90 through 41 meters during the day for paths less than 250 miles, and 90 down to 120 meters at night for these distances. For openings between 250 and 750 miles, try 41 meters during the day, and both 90 and 120 at night. For distances between 750 and 1,300 miles, 22 through 31 should provide daytime openings, while 41 down to 90 will be open for these distances from sunset to midnight. After midnight, 90 meters will remain open out to 1,300 miles until sunrise. Try 31 and 41 meters again for about an hour or so after sunrise.

For openings between 1,300 and 2,300 miles, openings will occur on 22 through 16 meters, with fewer on higher bands, during the daylight hours.

During sundown to midnight, check 22 through 41 meters for these long-distance openings, and then check 41 down to 90 meters after midnight until sunrise. Try 41 and 31 meters again for an hour or so after sunrise.

DX openings on 120 and 90 meters during the hours of darkness and into the sunrise period, with considerably decreased static levels, are a sure bet during the longer hours of darkness in the northern latitudes.

Look for openings toward Europe and the south from the eastern half of the United States and towards the south, the Far East, Australasia, and the South Pacific from the western half of the country. Ninety meters should peak toward Europe and in a generally easterly direction around midnight, and then open in a generally western direction with a peak just after sunrise. The band should remain open toward the south throughout most of the night.

### Propagation on VHF and Above

Quite a bit of meteor shower activity is expected this month, and this should result in great conditions for meteor-scatter openings on the VHF bands for distances up to about 1,000

miles. When a meteor burns up in the atmosphere, its intense heat creates an ionized trail, making it possible for radio signals to propagate off of the ionized trail much like they would off of the ionosphere.

The annual Geminids meteor shower, which this year is a great candidate for visual enjoyment due to lunar full moon, provides opportunity for meteor-scatter propagation from December 4 to December 17. The shower's peak is on December 13 with a maximum hourly rate possibly reaching 120, this year.

The Geminids meteor shower is a great opportunity for those trying the meteor-scatter mode of propagation, since one doesn't have to wait until after midnight to have results. The radiant rises early, but the best operating time will be after midnight local time.

This shower also boasts a broad maximum, lasting nearly one whole day, so no matter where you live, you stand a decent chance of working some VHF/UHF signals off of a meteor's plasma trail. For a complete list of meteor showers in December, visit <http://www.imo.net/calendar/2012>.

A secondary seasonal small peak in sporadic-E ionization may also result in some short-skip openings on low VHF between distances of about 800 and 1,300 miles. A rare occurrence of aurora during days of stormy geomagnetic activity is possible, providing some unusual short-skip openings on low VHF.

There is considerably less likelihood for trans-equatorial (TE) VHF openings during December, but look for a possible opening between the southern states and locations deep in South America. The best time to look for these is between about 8 and 11 p.m. local time.

## Current Solar Cycle 24 Progress

The Royal Observatory of Belgium reports that the mean monthly-observed sunspot number for August 2012 is 63.1. The lowest daily sunspot value during August 2012 was 20 on August 15. The highest daily sunspot count for August was 116 on August 3. The 12-month running smoothed sunspot number centered on February 2012 is 66.9, one point higher than January. A smoothed sunspot count of 84 is expected for December 2012, give or take about 8 points.

The Dominion Radio Astrophysical Observatory at Penticton, BC, Canada,

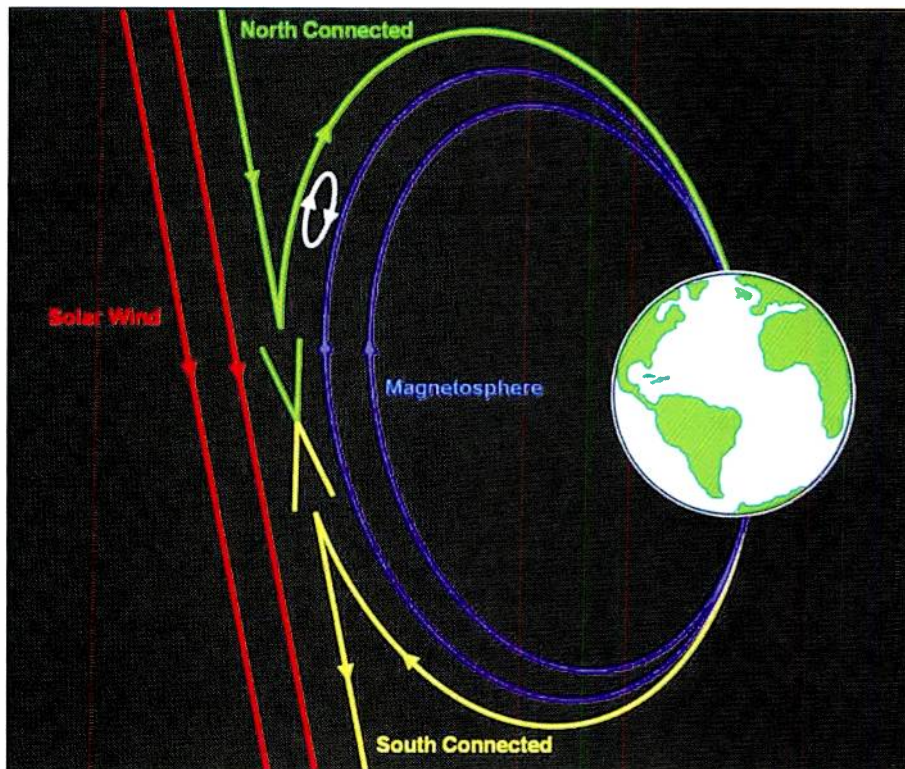

**Figure 5.** This diagram illustrates an X-point, where a Sun-Earth portal occurs. A NASA-sponsored researcher at the University of Iowa has developed a way for spacecraft to hunt down hidden magnetic portals in the vicinity of Earth (see text). These portals link the magnetic field of our planet to that of the sun. See a movie detailing this process at <http://g.nw7us.us/P2Mcw7>. (Courtesy of NASA)

reports a 10.7-cm observed monthly mean solar flux of 115.7 for August 2012. The 12-month smoothed 10.7-cm flux centered on February 2011 is 126.7, up two points from January. The predicted smoothed 10.7-cm solar flux for December 2012 is about 140, give or take about 7 points.

The observed monthly mean planetary A-Index ( $A_p$ ) for August 2012 was 7, showing a steady level in geomagnetic activity. The 12-month smoothed  $A_p$  index centered on February 2012 is 8.4, about the same as January. Expect the overall geomagnetic activity to be quiet to stormy during December. Refer to the *Last Minute Forecast* published in *CQ* magazine or on the NW7US website <http://sunspotwatch.com> for the outlook on what days that this might occur.

## I'd Like To Hear From You

I welcome your thoughts, questions, and experiences regarding this fascinating science of propagation. You may email me, write me a letter, or catch me on the HF amateur bands. On Twitter, please follow [@NW7US](https://twitter.com/NW7US) and if you wish to have an hourly automated update

on space weather conditions and other radio propagation-related updates, follow [@hfradiospacewx](https://twitter.com/hfradiospacewx).

I invite you to visit my online propagation resource at <http://sunspotwatch.com/>, where you can get the latest space data, forecasts, and more, all in an organized manner. If you are on Facebook, check out <http://www.facebook.com/spacewx.hfradio> and <http://www.facebook.com/NW7US>.

Speaking of Facebook: check out the *Popular Communications* fan page at <http://www.facebook.com/PopComm>. This is a great place for the magazine's community to participate and share information, tips, DX spots, and photos of your antennas, radios, or your excursions into the field with your radio gear for that DX hunting trip.

*Until next month,*

73, Tomas, NW7US  
P.O. Box 27654  
Omaha, NE 68127  
[nw7us@nw7us.us](mailto:nw7us@nw7us.us)  
[@NW7US](https://twitter.com/NW7US)  
[@hfradiospacewx](https://twitter.com/hfradiospacewx)



## Sometimes It Seems the SWL World Is Upside Down

by Gerry L. Dexter,  
WPC9GLD  
<gdex@wi.rr.com>

*“With economies around the world in constant flux, and changing technologies, it’s perhaps a good habit to expect the unexpected on the shortwaves”*

**I**t approaches — perhaps even surpasses — the level of irony to realize that, at a time when economic “issues” are killing shortwave services in countries including Canada, Germany, and the Netherlands, Third World broadcasters such as Bangladesh, Pakistan — even Somalia — are very much on the upswing.

### Around the Dial

The Bangladesh government-operated station **Bangladesh Betar**, <<http://www.betar.org.bd>> has been noted lately using a newly acquired 100-kilowatt transmitter. It opened in mid-August using 15520. A few days later the station was on 15105 and was fairly well heard by several DXers in the mornings up until about 1500.

Previously, Bangladesh used only 4750 from 0600-1500, most likely heard around 1230-1300 with its General Overseas Service.

Meanwhile, **CVC-Christian Vision** has pulled the plug on its broadcasts from Chile due to declining listenership to shortwave (*or, so officials say!*) and a growing collection of AM/FM local affiliates. So don’t look for it on 17680 or any of its other listed frequencies. Christian Vision does continue its operations from Zambia.

**HCJB** is now using Wertachtal, Germany as a relay site, having discontinued the use of Calera de Tango, Santiago, which is being knocked down after CVC stopped using the facility.

**Radio Nederland** will continue to operate its

relay at Talata Volonondry, Madagascar, beyond the end of this year. Technically that might not be for very much longer, although it has recently installed transmitters formerly used at the Horby, Sweden site — so perhaps this one will continue for at least a few years.

A new Peruvian is in the works from Chazuta, Peru, operated by Iglelesia Evanagelica Central de Chazuta. **OAW9A** will use 4810. This 1-kilowatt station may well be the newly-reported Radio Logos which is also using 4810.

### Recently Heard, or Newly Active

Be on the lookout for **Radio Republik Indonesia**, Wamanea, Irian Jaya, has recently been discovered back on 4870 carrying Jakarta news at 1200 . . . **Adventist World Radio** continues the expansion of its antenna installation on Guam. Once installed, we should get better reception.

### Counting On You . . .

Remember, your shortwave broadcast station logs are always welcome. But *please* be sure to double or triple space between the items, list each logging according to its home country and include your last name and state abbreviation after each. Also needed are spare QSLs or good copies you don’t need returned, station schedules, brochures, pennants, station photos, and anything else you think would be of interest.

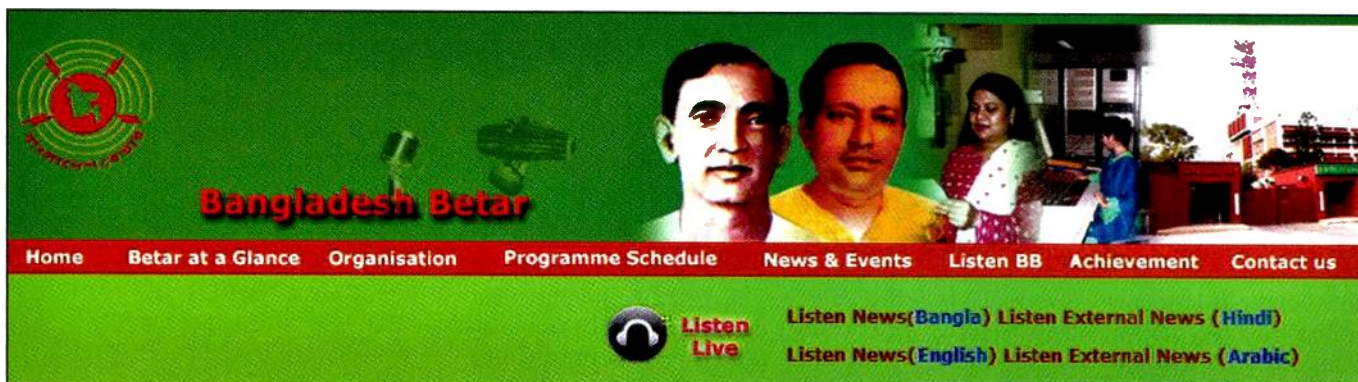

Bangladesh Betar, <<http://www.betar.org.bd>> has been heard using a newly acquired 100-kilowatt transmitter. The station has been on 15105 and “fairly well heard by several DXers in the mornings up until about 1500,” WPC9GLD writes. (*Internet screen grab*)

And how about sending a photo of you at your listening post? It's your turn to grace these pages!

## For Your Listening Pleasure

Here are this month's logs. All times are in UTC. Double capital letters are language abbreviations (SS = Spanish, RR = Russian, AA = Arabic, etc.). If no language is mentioned then English (EE) is assumed.

**ALASKA**—KNLS, 9655 at 1648 with oldie pops and M with sked, address and website. (Sellers, BC)

**ANGUILLA**—Caribbean Beacon, 6090 at 0443 with Bible comments and 11775 at 2135 with a similar pgm. (MacKenzie, CA)

**ASCENSION**—BBC South Atlantic Relay, 9915 with world news, discussion at 2230. (Brossell, WI) 15105 at 1358 with weak IS while looking for Bangladesh. (Sellers, BC) 15400, //9310 at 1920 with *Sportsworld*. (Coady, ON) 17795 at 1800 opening and into world news. (Fraser, ME)

**ARGENTINA**—Radio Nacional/Radio Argentina al Exterior, 11710 at 0200 with IS and ID loop before the hour, then time pips and rotating multilingual ID loop, then M and W with headlines and small talk. (Coady, ON) 0237 with tangos. M/W with laughter and EE talks, f/by a DX supplement feature and closedown anmts at 0255, usual IS, ID in various languages until into SS at 0300. (D'Angelo, PA) 15345 in SS at 2306. (MacKenzie, CA)

**AUSTRALIA**—Radio Australia, 5940 at 1345 with *Feature Album of the Week* and 6140 via Singapore at 1216 with *Asia Pacific*. (Sellers, BC) 11945 at 1251 with a pgm on child care. (Brossell, WI) 9710 at 1020 in Tok Pisin with news and current affairs pgm. (Barton, AZ) 15240 at 0238 with rugby coverage. (Coady, ON) 9580 at 1802 on oil production, //9690, 15240 at 0002, 15515 at 2054 with Olympic comments, and 21740 at 2226. (MacKenzie, CA)

Northern Territory Service: VL8K-Katherine 2485 at 1050, //4835. (Wilkner, FL) VL8T-Tennant Creek 4910 at 0820. (Wilkner, FL) 2485-Katherine at 1140 playing 60s music, //4835. (Sellers, BC)

CVC, 15170, Darwin in CC at 0016. (MacKenzie, CA)

HCJB Australia, 15525 at 2256 with choir and M with religious comments. (MacKenzie, CA)

**BONAIRE**—Radio Nederland Relay, 6165 in SS at 0140. (Parker, PA) Radio Nederland Relay, 15540 in DD at 2043. (MacKenzie, CA)

**BOLIVIA**—Radio Mosoj Chaski, Cochabamba, 3310 at 0950 in Quechua. Also noted at 0000. (Wilkner, FL)

Radio Santa Ana, Santa Ana de Yacuma, 4451.1 at 0020 with SS talk. (Wilkner, FL)

Radio San Miguel, Riberalta, 4699.4 in SS from 0930-1000. (Wilkner, FL)

Radio Yura, Yura, 4717.6 at 0950 and 0400 with traditional OA music. (Wilkner, FL)

Radio Pio Doce, Siglo XX, 5952 at 0000 with non-stop Latin pops and anmts by W. (Rippel, VA) 0010 with M/W and SS talk. (Coady, ON) 0025. (Wilkner, FL) 0052 with excited SS talk, formal ID at 0056, M hosting vocals from 0102. (D'Angelo, PA)

Radio San Jose, San Jose de Chiquitos, 5580.2 at 0030 with music under t-storm. (Wilkner, FL)

Radio Santa Cruz, Santa Cruz, 6134.8 with a Latin ballad at 0024 and SS talks. (Coady, ON)

**BOTSWANA**—Voice of America Botswana Relay, 9855 at 0342 with a report on Syria with comments by Hilary Clinton. (Coady, ON)

**BRAZIL**—(all in PP – gld)

Radio Municipal, Sao Gabriel da Cachoeira, 3375.1 at 0950. (Wilkner, FL)

Radio Difusora Roraima, Boa Vista, 4878.1 to 0400\* with anthem. (Wilkner, FL)

Radio Club do Para, Belem, 4885 with hilife music at 0500. (Parker, PA)

Radio Novo Tempo, Campo Grande, 4895 at 0402 with slow music, M anc. (Parker, PA)

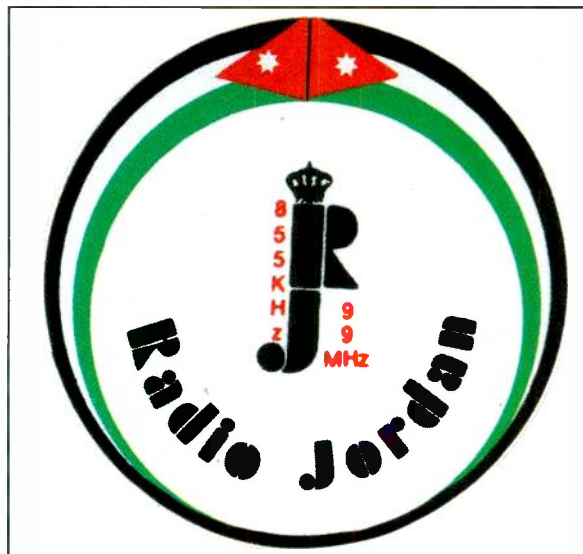

Radio Jordan, listed for 11960, seems to be inactive much of the time. (Courtesy of John Miller)

Radio Difusora Macapa, Macapa, 4915 at 0256-0406 with anmts and group vocals. (D'Angelo, PA) 0457. (Parker, PA)

Radio Educacao Rural, Tefe, 4925.2 at 1000 with M/W and rapid ID also 0400-0410. (Wilkner, FL)

Radio Capixaba, Vitoria, 4935.1 at 0400. (Wilkner, FL)

Voz Missionaria, Camboriu, 5940 at 0052 with slow ballad and 9665 at 0451. (Parker, PA)

Super Radio Deus e Amor, Curitiba, 6060 with impassioned preacher at 0753 and 9565, //6060 at 0812. (Coady, ON) 11765 at 0509. (Parker, PA)

Radio Nacional Amazonas, Brasilia, 6180 at 0215 with Latin music. (Parker, PA) 11780 at 1218 with vocal groups and M with comments. (MacKenzie, CA)

Radio Cancao Nova, Cachoeira Paulista, 9675 at 0324 with DJ hosting a mix of Brazilian ballads and pops. (Coady, ON)

Radio Bandeirantes, Sao Paulo, 15190 at 0440 with M and phone caller. (Parker, PA)

**CANADA**—CBC Northern Service, 9615 at 0441 on recent shootings. (Parker, PA)

CFRX, Toronto, 6070 at 0119 with *Startalk* pgm. (Parker, PA) 0315 with a late night call-in pgm. (Ogrizovich, FL)

CKZN, St. John's (Newfoundland), 6160 at 0040 with rock numbers. (Coady, ON) 0159 with network ID, f/by promos. (D'Angelo, PA)

CKZU, Vancouver, 6160 at 0411 with *Ideas* pgm and a book review. (Sellers, BC)

**CHILE**—CVC-La Voz, 17680 at 2153 on 8/17 the final broadcast with two M discussing in SS, several IDs and audience applause. (D'Angelo, PA) (*NOTE: Another sad loss – gld*)

## Help Wanted

We believe the Global Information Guide — month after month — offers more logs than any other monthly SW publication! (Nearly 550 shortwave broadcast station logs were processed this month!) Why not join the fun and add your name to the list of GIG reporters? Send your logs to Gerry Dexter, Global Information Guide, and 213 Forest St., Lake Geneva, WI 53147 or email them to <gdex@wi.rr.com>. See the column text for formatting suggestions.

*\*Not all logs get used. There are usually a few which are obviously inaccurate, unclear or lack a time or frequency. Also dis-counted are unidentified, duplicate items (same broadcaster, same frequency, same site) and questionable logs.*



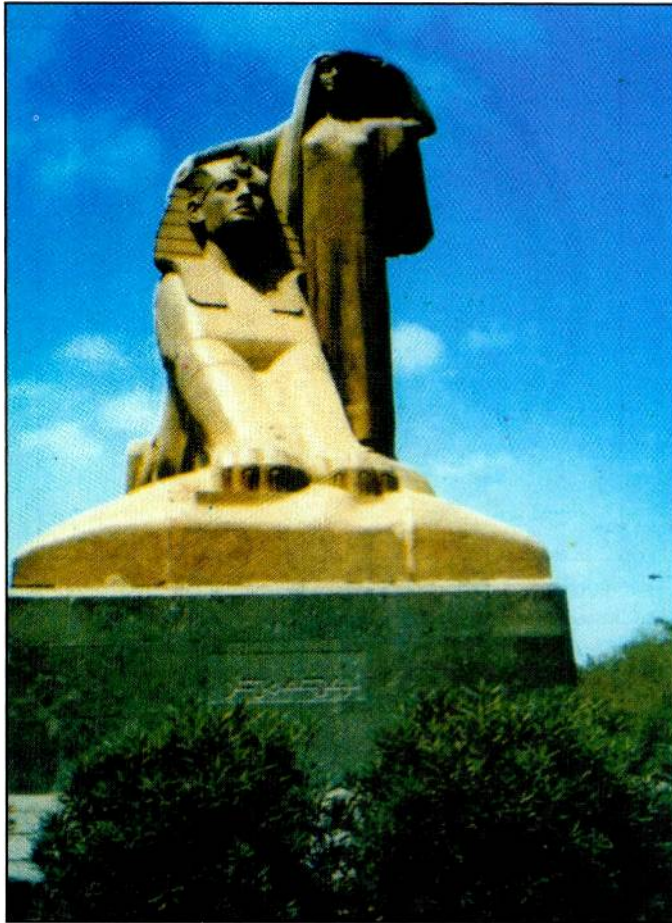

Radio Cairo is in the news due to the anti-American demonstrations. the station still has modulation problems.

**CHINA**—China Radio International, 6020 via Albania in CC at 0252, 6140 via Canada at 0440, 9690 in CC at 1806, and 15350 in CC at 2243. (MacKenzie, CA) 11650-Urumqi in EE at 1215. (Sellers, BC) 9800 at 1555 and 13670 at 1655 but began mixing with Voice of Korea after their 1700 sign on. (Barton, AZ) 11775 via Albania in AA at 0507. (Parker, PA) 15180 via Wertachtal in AA at 1911 and 15440-Kunming in CC at 1145. (Brossell, WI)

CPBS/China National Radio: Voice of Pujiang, 3280 in Mandarin at 1157. Also CNR2 7245 & 7265 at 1443 with CC pops. (Sellers, BC) 7410-Beijing in CC at 1122, also Xinjiang PBS-Urumqi, 9835 in CC at 1139. (Brossell, WI)

**COLOMBIA**—Alcaravan Radio, Puerto Lleras, 5910 in SS with upbeat music. (Parker, PA)

**CROATIA**—Voice of Croatia, 9925 via Germany in Croatian at 0415. (MacKenzie, CA)

**CUBA**—Radio Havana Cuba, 5040 in SS at 0335, 6010 in EE at 0600, 6060 in SS at 0455, 11680 in EE at 2323, 11780 in SS at 2317, 11840 in SS at 2312, 13820 in SS at 2058, 15140 in SS at 2325, 15370 in SS at 0020, 15230 in SS at 0013, 17705 in SS at 2238, and 17750 in SS at 2239. (MacKenzie, CA)

Radio Rebelde, 5025 in SS at 0333. (MacKenzie, CA)

**DIEGO GARCIA**—AFN/AFRTS, 4319u at 0000 with pops under major UTE QRM. (Wilkner, FL)

**ECUADOR**—HCJB, Pichincha, 6050 in QQ at 1010, ID at 1015 and into Andean flute music. (Coady, ON) 0233 in SS, 12000 in SS at 0054. (MacKenzie, CA) 12025 via Wertachtal in AA at 2137. (Brossell, WI)

Radio Oriental, Napo, 4781 in SS at \*1100 sign on, also noted at 0020. (Wilkner, FL)

**EGYPT**—Radio Cairo, 9305-Abis in presumed AA at 0253 with perhaps the worst audio I've ever heard from them, also 9315-Abu

Zaabal in SS at 0300 with rap. Signal was weak, but with clear audio. (Parker, PA) 9965 in AA at 0347. (Coady, ON) 15610 in Swahili at 0457. (Sellers, BC)

**ENGLAND**—BBC, 5875-Middle East Relay, Cyprus, at 0045 in Dari; 6175-Cyprus at 0225; 9410-Wooferton at 0307; 9425-Cyprus in AA at 0310; 9500-Wooferton in Farsi at 0315; 11680-Wooferton in AA at 0521; and 12015-Cyprus in Somali at 0525. (Parker, PA) 7310 via South Africa with news at 0503. (Coady, ON) 15755-Cyprus with *Outlook* ending with sign off at 1359. (Sellers, BC). At 0022 on a noisy frequency. (MacKenzie, CA)

**EQUATORIAL GUINEA**—Radio Africa, 15190 at 0555 with choir and preacher. Sign on anmts including website mention at 0606. (Sellers, BC) 1757-past 1900 with US-produced EE religious pmg. Gone by 1858 recheck. (Alexander, PA) 2005 with a sermon. (Brossell, WI)

**ERITREA**—Voice of the Broad Masses, 7165, 7170, 7180, 7190 – noted at various opening times just prior to 0300. Opening in AA with HOA vocals and a loop of M/W alternating IDs, each frequency carrying the second program. (Coady, ON)

**ETHIOPIA**—Radio Ethiopia, 9705 at 0347 with M in Amharic, f/by HOA vocals and flutes. Fanfare at 0400 and another M with ID, more music. (D'Angelo, PA) 0402 in Amharic with excited M talk and brief light instls. (Coady, ON)

**FRANCE**—Radio France International, 11605 via Meyererton in FF at 0533 and 11700-Issoudun in FF at 0519. (Parker, PA) 11705 in FF and partial EE at 1924. (Coady, ON) 15300 in FF at 1904. (Brossell, WI)

**FRENCH GUIANA**—Radio France Intl., 21690 in FF at 2155, suddenly went off at 2157. (MacKenzie, CA)

**GERMANY**—Deutsche Welle, 11800-Rwanda Relay at 0500 with EE news on Syria. (Parker, PA) \*2059-2117 with music, f/by time pips, ID and W with EE news. (D'Angelo, PA) 11800 and //11835 at 2125 with a news roundup. (Brossell, WI) 11865-Rwanda with Africa news at 2110. (Fraser, ME) 11865 at 2125 with *Inside Europe*. (Ogrizovich, FL) 12045-Rwanda at \*0400-0437, time pips, ID and M with news. (D'Angelo, PA)

**GREECE**—Voice of Greece, 12105 in GG at 2306 and 15630 in GG at 2216. (MacKenzie, CA) 15630 in Greek at 1823. (Brossell, WI)

**GUAM**—Adventist World Radio, 9980 at 2340. (MacKenzie, CA) 11740-Agat in EE at 1646 and 11825 at 1620 with Gospel songs and a modern prodigal son story. (Sellers, BC) 12105 in (I) Mandarin at 1244, 15240 at 1258 with talks in (I) Kok Borok. (Brossell, WI) 15630 at 1602 with hymns and preacher. (Coady, ON)

Trans World Radio/KTWR, 9910 in CC at 1143. (Brossell, WI)

**GUATEMALA**—Radio Verdad, Chiquimula (p), 4055 in SS at 0100. Static wiped out TOH ID. (Rippel, VA) 0530 with M preaching in EE. (Wilkner, FL) 1119 with EE preacher concluding with hymn and W in SS at 1120. (Sellers, BC)

**INDIA**—All India Radio, 9595 at 1128 in (I) Urdu, 9870-Bangaluru at 1141 in (I) Hindi, 11840 in (I) Mandarin at 1241, and 15410-Panaji (Goa), in (I) Thai at 1142. (Brossell, WI) 11620-Bangaluru at 0115 with sub-continental music and anmts by M. (Rippel, VA) 15175-Goa, at 1550 in Gujarati, with control room problems. Closing anmts at 1559 and carrier off at 1600. (Sellers, BC)

TWR India, 11685 via Samara at 1457 opening in Urdu at 1457. (Sellers, BC)

**INDONESIA**—Radio Republik Indonesia, Palangkaraya (Kalimantan), 3325 in II at 1203 with W doing news. (Sellers, BC)

RRI Makassar (Sulawesi), 4750 at 1218 with a speech in Bhasa Indonesia. (Sellers, BC)

**IRAN**—IRIB, 11940-Kalamabad in Dari at 0437. (Parker, PA) 15500 in (I) Dari at 1155 and 17650 at 1830 with Koran recitations and news in FF. (Brossell, WI)

**ISRAEL**—Galei Zahal, 6973u at 0130 with back to back U.S. and other pops. (Rippel, VA) 0301 with news in HH and pops pmg from 0304. (D'Angelo, PA)

**JAPAN**—Radio Japan, 5960 via Canada in JJ at 0450, 9695 via Singapore in EE at 1227 and off by 1230, 9835 in JJ at 1810, 13640 in JJ at 2252, 15265 in JJ at 2308, 15445 in JJ at 1853, and 15720 in



RCI is one of a troubling list of silent broadcasters these days.

JJ at 1803. (MacKenzie, CA) 11705 via Palau at 1401 with M/W doing news, //15735 via Uzbekistan. (Sellers, ON)

Radio Nikkei, 3925 in JJ ending pgm at 1140 with "Let's read the Nikkei Weekly" and continued in JJ. //6055. (Sellers, BC)

**KUWAIT**—Radio Kuwait, 15540 at 1951 with rhythm and blues songs and talk on Ramadan. (Ogrizovich, FL) 2051-2101 close with M in EE, ID and closedown f/by orchestral anthem, 5 + 1 time pips and into AA. Into AA at 2024. (D'Angelo, PA) 17550 in AA at 2207. (MacKenzie, CA)

**MADAGASCAR**—Radio Madagasikara, 5010 at 0350-0415 with music to 0359 and anmts in Malagasy, 0400 news with instl music bits between items. A music pgm began again at 0404. (D'Angelo, PA)

**MALAYSIA**—Traxx FM, 7195 with W and domestic news at 1300, Traxx FM ID and mention of carrying the BBC World Service and into pops. (Sellers, BC)

Sarawak FM, 11665 at 1609 in Bhasa Malay with several Malay pop songs and a jingle ID, //9835.

**MEXICO**—Radio Educacion, Mexico City, 6185 in SS at 0020 with slow W vocal and slow piano accompaniment. (Parker, PA)

**MICRONESIA**—The Cross Radio, Pohnpei, 4755 at 1050-1100. (Wilkner, FL)

**MOROCCO**—Radio Medi UN, 9575, Nador at 0440 with AA music. (Parker, PA)

**NETHERLANDS**—Radio Nederland, 9720 via Northern Marianas in II at 1134, 17605 via Vatican with talk on women's rights at 1826. (Brossell, WI)

**NEW ZEALAND**—Radio New Zealand International, 6170 on mortgages there at 1025, 9655 with world news at 1230. (Brossell, WI) 11725 excellent at 0512 with news. (Parker, PA) 15720 at 2250. (MacKenzie, CA)

**NICARAGUA**—The Pescador Preacher, 8989u at 0000 with an SS sermon. (Wilkner, FL) 2345 with M in SS f/by contact with others seemed not to be the usual maritime mobile

traffic. (Parker, PA) (p) 2355 in USB with M with an impassioned speech. (Coady, ON)

**NIGERIA**—Voice of Nigeria, 15120 at \*0458 with abrupt sign on with preview of upcoming pgms, ID, email address and news at 0500. (Alexander, PA)

**NORTH KOREA**—Voice of Korea, 4404.8 in JJ at 1226, //3250. Listed for JJ at 1200-1250. (Sellers, BC) 9345 in (I) Mandarin at 1100. (Brossell, WI) 11535 in KK at 1825 and 15100 in CC at 0044. (MacKenzie, CA) 11710 in KK at 1201, 15180 with patriotic choruses at 0404. (Coady, ON) 13650 with chorals at 0505. (Barton, AZ) 15245 at 1130 with non-stop martial music and anmts by W. (Rippel, VA)

Pyongyang Broadcasting Station, 2850 with choir and W in KK at 1127, 3320 at 1206 with impassioned speech in KK. (Sellers, BC)

**OPPOSITION**—Democratic Voice of Burma, 11595 in (p) Burmese at 0012-0039\*. (D'Angelo, PA)

Radio Republica (to Cuba), 5954, 0025 in SS, but mostly jammed. (Wilkner, FL)

Voice of Peace and Democracy of Eritrea, 9558.4 at \*0358 in presumed Tigrinya opening with news. Off at 0431. \*Closed with flute music. (D'Angelo, PA)

Radio Biafra London (to Nigeria), 11870 at \*2000-2100\* on with African music and anmts in EE and vernacular, vernacular talk with occasional EE. This is Thursday and Saturday only. (Alexander, PA) 2054-2059\* in possible Igbo language, as well as EE. (D'Angelo, PA)

Denge Mezopotamia (to Iran via Ukraine), (p) 11530 in (p) Kurdish at 0534 with phone interviews. (Parker, PA)

Echo of Hope (to North Korea), 3985 at 1145 in KK with talks and KK music, //6003 and 6348, both poor with jamming. (Sellers, BC)

Shiokaze/Sea Breeze (to North Korea from Japan), 5985-Tokyo at 1340 on a North Korean escapee. (Sellers, BC)

Voice of the People (to North Korea), 3480 in KK at 1134, //3912 and 4450, both of which suffered jamming. (Sellers, BC)

Radio Damal (to Somalia), 11990 via Wooferton, at 1856-1929\* with HOA vocals, long talk in (p) Somali with long breaks in the transmission. (D'Angelo, PA)

Voice of the Somali People, 11990 via Wertachtal in (I) Somali at 1855. (Brossell, WI)

Radio Dabanga (to Sudan), 11650 via Vatican at 0529 in Sudanese with lengthy broadcast schedule and the catchy Radio Dabanga jingle. (Parker, PA)

Voice of the South Sudan Revolutionary Radio, 15725 at \*0500 sign on with African tribal music, IDs, vocals and talk in AA. (Alexander, PA)

**PAPUA NEW GUINEA**—NBC Sanduan (New Guinea), 3205 at 1154 with election results in Tok Pisin. (Sellers, BC)

NBC Madang (New Guinea), 3260 with election coverage in EE at 1148. (Sellers, BC)

NBC Northern (New Guinea), 3345 with an interview in Tok Pisin at 1149. (Sellers, BC)

**PERU**—Ondas del Huallaga, Huanuco, 3329.5 at 1025. Stronger in the 0930-1030 period than in the 2330-0100 time slot. (Wilkner, FL)

Radio Huanta 2000, Huanta, 4747 in SS strong around 0930. (Wilkner, FL)

Radio Tarma, Tarma, 4774.9 at 0400 with Andean flutes. (Wilkner, FL)

Radio Logos, 4810 around at 0905-1110 with lots of Andean flutes, generally better at this hour than in the evenings. (Wilkner, FL)

La Voz de la Selva, Iquitos, 4824.4 in SS at 0945 and 0030. (Wilkner, FL)

**PIRATES**—Captain Morgan Shortwave, 6915 at 0150 with pops. (Alexander, PA) 0214-0116\* with segments of oldies rock, email as <captainmorganshortwave@gmail.com>. (D'Angelo, PA) 0224 with rock and pop. Abruptly off at 0301\*. (Parker, PA)

Blue Ocean Radio, 9625u at 0427 with rock, "On shortwave you are listening to ... Blue Ocean Radio" (Sellers, BC) 0551 with various selections and singing ID "BOR shortwave" and "We play the best music for you." Mentioned something about being in an "undisclosable location in the Pacific Northwest." (Spain, WY) 0600 with blues and swing, Mexican-style polkas, C&W and folk. (Hassig, IL)

Renegade Radio, 6925 at 0210 with mix of selections and talk by M, apparent ID f/by CW at 0211. Off or lost in noise at 0228. (D'Angelo, PA) 0317 with "Move over Wolverine, Renegade Radio here", then a shoutout to Blue Ocean Radio. (Coady, ON)

## This Month's Winner

To show our appreciation for your loggings and support of this column, each month we select one "GIG" contributor to receive a free book or other prize. Readers are also invited to send in loggings, photos, copies of QSL cards and monitoring room photos to me at *Popular Communications*, "Global Information Guide," 25 Newbridge Rd., Hicksville, NY 11801, or by email to <gdex@wi.rr.com>. The email's subject line should indicate that it's for the "GIG" column. So, come on, send your contribution in today!

This month's prize winner is **Mark Taylor**, Madison, Wisconsin, who receives a copy of Steven Handler's *Utility DX'ers QSL Address Handbook*. (Available from Steven. Contact him at his email address: <shortwaverepoet@yahoo.com>)





... And so is Belgium's Radio Vlaanderen International.



Radio Argentina al Exterior still occupies 11710 during our evening hours.

Wolverine Radio, 6925u at 0252 with several rock selections and ID before into blues. (D'Angelo, PA) 0306 with rock and blues, slow scan TV tones and off at 0315. (Coady, ON) 6950 at 0155 with blues. (Alexander, PA)

Radio True North, 6935 at 0451 with rock, ID and email address for reports. (Sellers, BC)

WPON, 6925u at \*0000 with pop/techno/rap, ID, editorials on world economies. (Alexander, PA)

Red Mercury Labs, 6925u at 0205 with heavy metal and punk rock, <redmercurylabs@yahoo.com>. (Hassig, IL) 0402 with hard rock, fast scan TV, Captain Ron calling in. More fast scan at 0418 close. (Spain, WY)

Northwoods Radio, 6925 at 0110 with rock. (Alexander, PA)

Radio GaGa, 6925u at 0118-0231, pop, ID at sign off. (Alexander, PA)

Turtlehead Radio, 6930u at 0456 with shoutouts to listeners. (Patterson, PA)

Voice of KAOS, 6925u with rock and roll at 0005. (Patterson, PA)

Ann Hofer Live, 6925u at 2345 with Ann performing Buffet and Beatles songs. (Patterson, PA)

Radio Whatever, 6900 at 0051 with pop, CW and rap. Also 6925 at 0027. (Patterson, PA)

**ROMANIA**—Radio Romania International, 9540-Tiganesti, at 2200 with M reading world news. (Fraser, ME) 2234 with world news and 15310 in Romanian at 1818. (Brossell, WI) 11795 at \*0258 with IS, W doing opening ID and sign on anmts, then M with news in EE. //s 9645 was good and 11895 to Asia was fair. (D'Angelo, PA) 15220 at 2057 sign on with *The Week in Romania* pgm. (Ogrizovich, FL)

**RUSSIA**—Voice of Russia, 9560-Vladivostok (Asiatic Russia), at 1419 on housing in England, 1422 with ID, 12065-Chita (Asiatic Russia), at 1347 with *Outlook* pgm. (Sellers, BC) 15465-Moscow in FF at 1913. (Brossell, WI) 9800 at 2234 on the Olympics. (Ogrizovich, FL)

## In Times Past

Here's your "blast from the past" for this month:

Radio Pax, Beira, Mozambique, 7205 with a domestic service in Portuguese at 0356 on November 12, 1966.

**SAO TOME**—Voice of America Relay-Pinheira, 4960 at 0403 with news, f/by ID and *Science World* and 11900 at 2112-2132\* in FF with news features, EE ID and sign off. (D'Angelo, PA) 15730 at 2030 with Yankee Doodle theme and off. (MacKenzie, CA) 17895 at 1750 on music of Steven Foster. (Fraser, ME)

**SAUDI ARABIA**—Broadcasting Service of the Kingdom, 21510 in AA at 2146 with comments and music. (MacKenzie, CA)

**SERBIA**—International Radio of Serbia, 9685 at 0029 with IS and opening music, M with ID, frequencies and news to 0036 and W with ID repeat. (Coady, ON)

**SEYCHELLES**—BBC-Indian Ocean Relay, 9730 at 2238 on what's required of a UN soldier. (Brossell, WI) 9750 at 0339 on the death of a prominent Somali. (Coady, ON)

**SINGAPORE**—BBC-Far East Relay, 9740 at 1032 with a W hosting *The Strand* arts pgm. (Coady, ON) 15285 at 1150 with W and two M in a discussion. Off at 1200. (Sellers, BC)

**SOLOMON ISLANDS**—Solomon Islands Broadcasting Corp., 5020 at 1040 with just some audio getting past Radio Rebelde. (Wilkner, FL) 1150 in Tok Pisin with pops, anc with phone calls, devotional msg at 1201 prior to sign off. (Sellers, BC)

**SPAIN**—Radio Exterior de Espana, 6055 in SS at 0447, 9630-Costa Rica Relay in SS at 0426, 9710 in SS at 2250, 11680 in SS at 2356, 11815-Costa Rica in SS at 2145, 15110 in SS at 2050 with live sports coverage, 15160 in SS at 0035, and 17850-Costa Rica in SS at 2235. (MacKenzie, CA) 9535-Nobeljas in SS at 0320. (Parker, PA) 15110-Nobeljas with live sports coverage in SS at 1900. (Brossell, WI)

**SOUTH AFRICA**—Channel Africa, 15235 at 1700 with time pips, W anng "This is Africa Digest" then M with ID, frequencies and news. (Coady, ON)

**SOUTH KOREA**—KBS World Radio, 9640 at 1414 with EE and pops, M/W and, possible mention of listeners letters. (Sellers, BC) 15360 via Wertachtal in RR at 1850. (Brossell, WI)

**SRI LANKA**—Sri Lanka Broadcasting Corp., 11905-Ekala at 0126 with M and Hindi talk, f/by Hindi vocals and flutes. (D'Angelo, PA) 15745 at 0128 with children's chorus, time pips at 0120 and ID as "This is the All Asia Service of the SLBC." (Coady, ON)

**SWAZILAND**—TWR, 3200 at 0430 with M preaching in GG, //4775 was poor. (Sellers, BC)

**TAIWAN**—Radio Taiwan International, 5950 (via Florida), at 0220 with *Here In Taiwan* pgm. (Ogrizovich, FL) 6085 in CC at 1118 and 9735 in JJ at 1108. (Brossell, WI) 5950-Florida, at 0555, 15430 via France in CC at 2307, 17725 via Florida in SS at 2247. (MacKenzie, CA)

**THAILAND**—Radio Thailand, 15275 at 0021 with M/W and news, several local tourism ads, ID at 0029 and suddenly off. (Coady, ON)

**TANZANIA**—Radio Tanzania-Zanzibar, 11735 at 1957 with hילה type music and mentions of Zanzibar by W. Off at 2101. (Rippel, VA) 2011 in Swahili with ME vocals and talk by M at 2017, more talk and vocals to closing. (Coady, ON) 2052 with HOA music, off at 2100. (Brossell, WI) 2055-2059\* local music, tribal singing, ID and close-down anmt in Swahili. (D'Angelo, PA)

**TUNISIA**—RT Tunisienne, 12005-Sfax at 0427 with jazzed up tribal music. (Parker, PA) 17735 at 1836 with AA talks. (Brossell, WI)

**TURKEY**—Voice of Turkey, 6165 at 0301 with opening anmts in EE f/by news in EE. (D'Angelo, PA) 9515-Emirler at 0318 in EE on water management and 11980-Emirler in EE at 0432 with Turkish pops. (Parker, PA) 15450 with ID within newscast at 1236. (Coady, ON) 1310 in EE/TT with Turkish classical music. (Fraser, ME)

**UNITED STATES**—Voice of America, 7540-Philippine Relay with political discussion at 1422 and 9380-Philippines opening in EE at 1430. (Brossell, WI) 11830-Philippines in CC at 0040, 15385-

Philippines in CC at 0037. (MacKenzie, CA) 15115-Northern Marianas Relay in CC at 1255 and 15250-Philippines in CC at 1255. (Brossell, WI)

Radio Free Asia, 11605-Northern Marianas Relay in (I) Tibetan at 1237, 11785-Northern Marianas in CC at 1905, 11870-Northern Marianas in (I) Mandarin at 1507, and 12140-Northern Marianas in (I) Khmer at 1253. (Brossell, WI) 11605 via Taiwan in VV at 2350 and 15585-Northern Marianas in CC at 2308. (MacKenzie, CA)

Radio Free Europe/Radio Liberty, 9480-Lampertheim Relay in Afar at 0312 and 9550-Lampertheim, in Turkmen at 0323. (Parker, PA)

Radio Farda, 5860-Sri Lanka Relay in Farsi at 0036. (Parker, PA)

Radio Marti, Greenville, 11930 in SS at 2310. (MacKenzie, CA)

Family Radio/WYFR, 9280 via Taiwan in CC at 1432 and 15520 via UAE at 1420 in (I) Marathi. (Sellers, BC) 9465 via Taiwan at 1000. (Coady, ON) 11925 via Taiwan in (I) II at 1152. (Brossell, WI) 11530 in SS at 2345 and 15440 in SS at 2300. (MacKenzie, CA)

World Harvest Radio, 13620 at 2358, off at 2330. (MacKenzie, CA)

WWCR, Tennessee, 3215 at 0520, 5890 at 0236, 5935 at 0350, 9350 at 2240, 9980 at 1817, and 13845 at 2318. (MacKenzie, CA)

WBCQ, Maine, 9350 at 0522. (Parker, PA)

WTWB, Tennessee, 9480 at 2245. (MacKenzie, CA)

WTWW, Tennessee, 5755 at 0338. (MacKenzie, CA)



Yet another dead one is UAE Radio in Dubai.

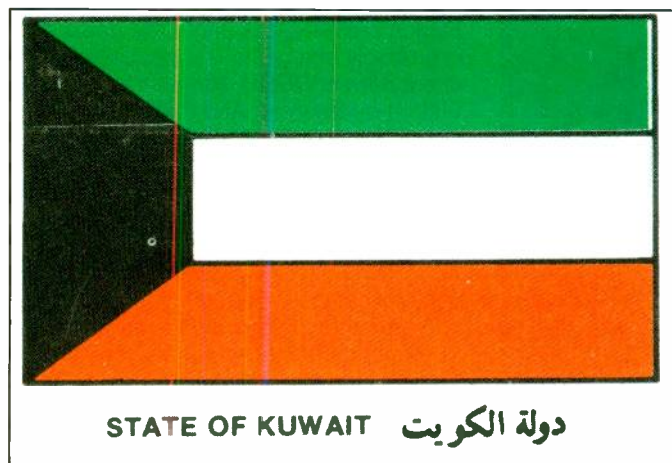

Radio Kuwait has been active again on 15540 and 17550.

Trans World Radio, via South Africa, 7215 at 0322 in (I) Amharic to IS and sign off at 0345. (Coady, ON)

WWRB, Tennessee, 3185 at 0320. (MacKenzie, CA) 5050 at 0130. (Ogrizovich, FL)

WEWN, Alabama, 5810 in SS at 0340, 12050 in SS at 2305, 13850 in SS at 2247, 15610 at 2100. (MacKenzie, CA) 11520 at 0005. (Ogrizovich, FL)

KJES, New Mexico, (p) 11715 at 1338. (Sellers, BC)

VATICAN—Vatican Radio, 9610 via Canada in FF at 0242. (D'Angelo, PA) 11885 in listed Swedish at 1850. (Brossell, WI) 13765 via Madagascar in EE at 0507. (Sellers, BC)

VENEZUELA—Radio Nacional, 13680 via Cuba in SS at 2256. (MacKenzie, CA)

VIETNAM—Voice of Vietnam, 6175 via Canada in VV at 0143 and 9555 via Canada in VV at 0432. (Parker, PA)

ZAMBIA—Radio Zambia, 5915 in vernacular at 0506, but poor in QRN. (Parker, PA) 6165 at 0243 with Fish Eagle IS, ID and opening anmts. Killed by The Voice of Turkey's sign on at 0255. (Coady, ON)

And that's a wrap! High fives, shoutouts and other forms of thanks and congrats go out to the following good folks who thought to contribute this month: Rich D'Angelo, Wyomissing, PA; William Hassig, Mt. Pleasant, IL; Stewart MacKenzie, Huntington Beach, CA; Robert Wilkner, Pompano Beach, FL; Robbie Spain, Rock Springs, WY; Harold Sellers, Vernon, BC; Mark Coady, Peterborough, ON; Robert Brossell, Pewaukee, WI; Gene Patterson, Gibsonia, PA; Allen Ogrizovich, Jacksonville, FL; Robert Fraser, Belfast, ME; Chuck Rippel, Chesapeake, VA; Brian Alexander, Mechanicsburg, PA; Rich Parker, Pennsburg, PA; and Rick Barton, El Mirage, AZ.

Thanks to all of you. And until next month, good listening!

## SPURIOUS SIGNALS

By Jason Togyer KB3CNM

popcommcomic.blogspot.com



© 2012 Jason Togyer / jtogyer@gmail.com / Popular Communications magazine

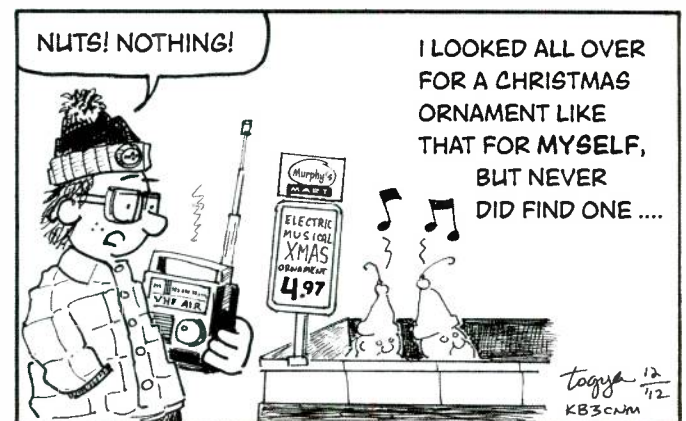



## A Picture of Radio, Gray

by Shannon Huniwell,  
WPC2HUN  
<melodyfm@yahoo.com>

*“The Oregon Pop’Comm subscriber and communications engineer quipped that she would gladly swap a year of her future if she’d be able to somehow get transported back into the decades-old pictures’ present for just one day.”*

**W**hen an old grayscale photograph containing a Southern California radio mystery arrived in my mailbox, it made me recall a novel I reluctantly read in high school: *The Picture of Dorian Gray*.

In the Victorian-era book, which I also remember *not* appreciating at the time, Oscar Wilde tells of a youthfully dashing, but unscrupulous Dorian Gray who hated the thought of ever getting old. After having his portrait beautifully painted, the young man made a dangerous wish that the picture, instead of himself, would show all of the outward signs of aging. It did . . . and got exponentially horrible each time he committed another evil deed. Meantime, passersby would see a perennially handsome Dorian Gray walking down some stately street and completely miss the reality of the increasingly corrupt character’s miserable soul. (**IN DEPTH:** For more about the Oscar Wilde novel, visit <<http://bit.ly/PDgLeP>>. —Ed)

I couldn’t help but caution Melissa Merrick with this sad tale after reading a letter she’d written regarding that radio-related photo and another much earlier broadcast image that had slipped from her possession.

The Oregon *Pop’Comm* subscriber and communications engineer quipped that she would gladly swap a year of her future if she’d be able to somehow get transported back into the decades-old pictures’ present for just one day.

“By going back in time and place,” Melissa imagines, “I could finally discover why my great-grandmother — then looking to be around 10 — posed smiling so broadly in front of a radio tower. And why she looked to be deliberately pointing at it.”

Since childhood, when first finding the picture while playfully exploring an elderly aunt’s attic, Melissa has wondered exactly where and at what pioneering radio station the snapshot was taken. This enigma was amplified by her Aunt’s pronouncement that Melissa — who was then approximately the same age as her great grandmother had been in the photograph — bore an uncannily strong family resemblance to the contagiously cute little girl. Melissa is equally curious as to whether or not the long-forgotten photographer’s selection of a tower background signaled that radio meant something significant to her great grandmother . . . and was genetically transmitted into her own otherwise unlikely female fascination with electrons, invisible radio waves, and communication busily pulsing through the air.

### No Picture At All

As Melissa’s saga unfolded, it turned out that not only had her great grandmother’s picture been misplaced sometime during the mid-1990s, but



**Photo A.** Courtesy of preservationists with the City of North Miami Beach, Florida archives, this photo still exists and is probably one of the last visual vestiges of short-lived WGBU, licensed to Fulford-by-the-Sea. And there’s only the slightest hint of the long-defunct AM in what I estimate to be a candid shot of potential residential boom-town Florida lot buyers circa August/September 1925. Look to the extreme right of the Administration Building/Sales Office and you can catch a snippet of one of the two, 150-foot antenna support towers designed to suspend the 500-watt outlet’s wire “aerial.” Had we — a year later — been able to stand in the same spot as this happy image’s photographer, the only thing evident would be despair and destruction.

Melissa's clearest memories of the image were jammed with static. Rendering me additionally clueless was her disclosure that she'd only seen a torn version of the faded gray-tone KODAK print, which ripped away any chance at deciphering its annotation; "*he-Sea, Florida*" was all the script that remained. And Melissa's great grandmother couldn't offer any clarification either, as she had died in 1940, shortly after giving birth to Melissa's grandmother, who passed away unexpectedly last year — further submerging the family's history.

Melissa's Mom apologized for "never being too interested in [her] people's genealogy," though vaguely recalled hearing that her Grandma Taylor had one of the first radios in the neighborhood; a crystal set she amazed her folks with by building it herself from a cylindrical oatmeal box and some gizmos from a boy who was sweet on the blue-eyed lass. This scintilla of family lore stuck only because it was connected to the legend of a young Greta Taylor climbing into the upper reaches of a Red Maple until one critical branch gave way. Reportedly, the second she regained consciousness, her first point of concern was the status of the wire antenna she'd been stringing, rather than with any discomfort sustained from two broken wrists.

From Melissa's hazy description of her great grandmother's four-legged tower picture, I figured that wiring probably ran horizontally from the structure's top. With that confirmed, any broadcast historian worth a watt could safely assume the presence of a second stick somewhere on the other end of that copper array. This fact, coupled with Greta Taylor's 1915 year of birth and Melissa's belief that her great grandmother had probably just hit double digits when the photo was taken, sent me searching through my pre-WWII radio directories for Florida facilities licensed to someplace with a "*he-Sea*" in its name.

The average *Wheel-Of-Fortune* enthusiast wouldn't have much trouble hazarding a guess at that missing letters puzzle and wagering that Lauderdale-by-the-Sea, Florida served as the mystery station's hometown. Thus enabling a quick solution to the early AM's calls and other vitals. A thorough search of my typically trusty old databases, however, sounded the dreaded double beeps, and sent me back to Rand McNally and *Google maps*. Neither the Sunshine State's Gables-by-the-Sea nor Holly-

wood-by-the-Sea moved the meter in my station search either.

## Of All The Histories Of All The Defunct AMs In All Of Florida . . .

Months after I conceded defeat in the first battle of Melissa's war on weak memories, Jan Lowry sent me a grab bag of station profiles ranging from a handful of pages to one sheet bearing only several paragraphs. That singleton wore the identity, WGBU-Fulford-by-the-Sea, Florida. It immediately focused my attention on remembering just *why* such an obscure community-of-license would ring a bell. No luck at first, but several hours after going to bed, I suddenly awoke with the answer, and sleepily went to my study in search of Melissa's correspondence. After comparing her details — though pretty skimpy — with Jan's WGBU profile, I am pretty sure that Melissa's radio-loving, great grandmother was indeed photographed near one of Florida's rarest radio stations.

One would need to look pretty quick at the Sunshine State timeline in order to catch WGBU — as well as its home base — coming and going. In fact, it was the station's rare venue that camouflaged the call letters from me at first. That's because Fulford-by-the-Sea was almost as short-lived as its "wireless" medium. Essentially little more than a residential housing development some nine miles north of Miami, the community came about through the finagling of the Miami-based Florida Cities Finance Company. This real estate sales outfit had just decided on the name — honoring deceased Spanish-American War-era Navy Captain William Fulford — for its subdivision of lots, when, in early 1925, the firm sought a U.S. Commerce Department broadcasting license for the town-to-be.

An authorization to share time with Miami Beach's WMBF on 780 kilocycles was granted in late June, and Florida Cities debuted the resulting WGBU about a month later. For some reason, radio regulators allowed WGBU to be born on its own frequency, 1080 kilocycles, rather than in the previously dictated WMBF 780 time share slot.

Jan confirms that the station's Western Electric 500-watt model 101-B got fed into wiring spanning a pair of "steel antenna towers located at Central Park in [the heart of] Fulford-by-the-Sea." The

North Miami Beach municipal website offers an indication how WGBU was electrically enlivened: "A powerplant generating 125 kilowatts was built opposite Central Park." When I asked Melissa to take a wild guesstimate as to the height of the one evident structure in her great-grandmother's picture, she hit the nail on the head with the answer, 150 feet.

Her question wondering what kind of shows WGBU featured was solved by Jan's research indicating that "from the start, many of [the fledgling station's] programs were arranged by the Chamber of Commerce of Fulford-by-the-Sea and promoted the interests of Florida Living

they go together  
not only do they GO together...  
they go ANYWHERE together.  
the 2001 is a completely portable AM, FM stereo and 8-track stereo sound system that goes with you... ANYWHERE  
2001 by Weltron  
THE NEW SHAPE OF SOUND  
WELTRON COMPANY DURHAM, N.C. 27702

**Photo B.** Whether trying to reach sun-seekers by the sea somewhere on either side of Florida or at beaches like Malibu on America's left coast, radio programmers with the best odds to do so were typically running Top-40 hits into their stations' towers. Just for fun, imagine the rest of the young lady in this 1972 ad for Weltron electronics company's model 2001 "go anywhere portable." My guess is that unless she had thought to bring a stack of eight-track tapes, the bikini-donned lass heading for surf, sand, and beach blanket would probably use her circular audio media center to catch AM waves while she caught some rays in those pre-sunscreen days.



and the advantages of [purchasing a charming and affordable little home] in the residential developments of the Florida Cities Finance Company.” Sounds like a litany of infomercials.

Apparently listeners of the more diverse programming on Miami’s WQAM 1140 kilocycles were also and inadvertently treated to Florida Cities Finance’s steady stream of veiled sales pitches due to WGBU’s signal interfering with its electronic neighbor. Jan says negotiations led to “a time sharing agreement in which WGBU 1080 would operate for two daily periods: 6:30 to 7:30 p.m. and 10:30 to 11:30 p.m. WQAM 1140 would operate from 7:30 to 10 p.m., and 11:30 p.m. to 1 a.m.” Interestingly, “during some portions of the evening both stations operated simultaneously.” If nothing else, the interference caused by two, low-power AMs transmitting with 50 kilohertz between their two carrier frequencies shows just how primitive the mid-1920s RF gear tended to perform.

Then again, in her June 1997 column, my *Pop’ Comm* predecessor, Alice Brannigan, offered a clue that makes WQAM the interloper in the band space spat with WGBU. She reported, “In November of 1925, WQAM reportedly *jumped* to the unauthorized frequency of 1050 kilocycles, using 1 kilowatt, though still authorized for 1140 kilocycles with 100 watts.” That too-smooth move down to 1050 — leaving just 20 kilocycles of protection before invading WGBU’s 1080 turf — gave the Fulford-by-the-Sea station officials legitimate reasons for contacting Washington and blowing the whistle on WQAM instead of simply doing a *handshake* solution.

## Trouble in Paradise and in the South Florida Skies

After reviewing what remains of Florida Cities Finance Company’s fiscal history, I got the gist of why the firm’s bigwigs probably thought it wise to avoid approaching the Feds throughout late 1925 and into the following year.

By early April 1926, the firm went bankrupt after fraud charges were hurled at several FCF officials. A court-appointed receiver took control of the housing development operation and WGBU, which had gone dark amidst the fiscal/legal turmoil. Wendell McMahill, who apparently leased WGBU from the bankruptcy receiver, set out to revitalize the facility. He blasted Florida Cities Finance as having been a lousy licensee

and promised to “get the station regularly licensed and operating in order to dispose of it along with the other property of the [FCF] company.” But the law and Mother Nature saw to it that such redemption didn’t happen.

Jan discovered that even the U.S. Post Office was investigating FCF’s past practices of mailing sales brochures detailing what turned out to be potentially bogus offers. Their findings resulted in the August 1926 indictment of FCF president, Merle Tebbets, “for the crime of using the mails to defraud.” As if that weren’t enough, one of the worst hurricanes to hit the U.S. came ashore in WGBU’s coverage area during mid-September 1926. News of the resulting loss of life served to drastically deflate any of what remained in that early Florida land/housing development bubble. And in addition to devastating whole communities, the storm sheared off the likelihood of WGBU’s continued existence, including its towers near which Melissa Merrick’s great grandmother had posed as a cute little girl.

Within a few weeks of the big blow, Washington radio regulators were told that the community’s radio station was beyond salvation. The Feds summarily cancelled WGBU’s license. Even Fulford-by-the-Sea’s identity went the way of the wind when it was morphed into the City of North Miami Beach sometime during 1931.

After exhausting the available details regarding WGBU’s short heyday, I still couldn’t help but wonder what in the world Melissa’s great grandmother was doing there and why she was shown pointing at one of its towers. Shortly before this copy went to press, a plausible answer surfaced when Melissa overheard a chance remark at her extended family’s summer 2012 reunion after a young relative pilfered a piece of pie from another’s plate. The mother chastised the child by saying, “If you keep on stealing pie, you’ll end up in a Florida prison like shady Uncle Max!”

Sporadic agreeing nods and laughter in the vicinity caused Melissa to seek clarification of an Uncle Max whom she’d never before heard. “Oh, he was kind of a black sheep in the clan,” an old lady from the eastern branch of the family tree replied. Let’s just say that Uncle Max was quite a colorful character who loved get-rich-quick schemes. He got into hot water in some questionable Florida real estate deal and ended up in the pokey for a year or so.”

Might he also have been involved in radio? Melissa wondered.

After he finished chewing his helping of that pie, a spry octogenarian near the end of the picnic table chimed in with the recollection, “You know . . . I think I once heard my folks say that Uncle Max had gone down to Florida in order to help build a radio station near Miami somewhere.”

The fellow looked to be recollecting other memories and said, “Seems to me that sometime in the mid-1920s, my mother, her folks, and her younger cousin Greta took the train to Miami or somewhere around there because Uncle Max



**Photo C.** Anybody recognize the cheerful lady in this late 1940s-1950s snap? Neither Southern California radio historian Jan Lowry nor I had even a ghost of an idea as to her ID. The neon KXLA sign definitely lit the Eureka! light bulb, however, in that it clearly identifies the Pasadena country and western station’s main studio’s entrance in a fancy outbuilding on the Huntington Hotel campus. The expression on the woman’s face offers no clue that the station would later dump its C&W music, become KRLA, make more history as a Top-50 hit station, then lose its license, and into 15 years of regulatory limbo. Among the scores of arcane facts surrounding the big AM’s woes is the 1974 callsign that its conditionally-named owners, Western Broadcasting Company were granted for the Pasadena frequency, but never used — KIGI.

and Aunt Jenny invited them to see their new town and the station where he worked. Say!" he exclaimed, while checking Melissa's nametag more closely. "Wouldn't cousin Greta Taylor be your great-grandmother?"

## Florida, Schmorida . . . Wasn't There Supposed To Be A California Radio Girl?

This column's introduction did mention a vintage picture showing someone at a Golden State station much easier to identify than Melissa's Florida puzzler. Here's why . . . Several years prior to Melissa contacting me about her great-grandmother's tower photo, she mentioned the enigma to a well-meaning co-worker who spent a lot of spare time perusing *eBay*. Weeks later while noticing a listing for an old snapshot titled; *Girl in front of radio station*, he impulsively placed a \$1 starting bid and won the auction without competition. The guy hoped that the subject might be Melissa's relative, but then remembered Melissa estimating that the girl in her picture was just a kid, not an adult female like the woman in the *eBay* photo.

Still, Melissa appreciated her colleague's thoughtfulness and found herself becoming curious about the person on the stairs outside of an entrance marked K-X-L-A in neon signage. That's the picture she mailed my way in order to test my broadcast detective skills.

Even without hitting the *Broadcasting Yearbooks*, I figured out that the "L-A" in the sign's message belonged to a station operating in the Los Angeles market; *Bingo! KXLA was an earlier incarnation of the infamous KRLA Top-50 powerhouse in Pasadena*. I also had confidence in the fact that Jan Lowry's uber-expertise lies within Southern California AM, FM, and TV, so I scanned the grayscale picture and emailed it off to his Golden State study. It was my hope that he'd recognize the lady on the stairs as some KXLA notable. "Hello Shannon," he replied and then cut to the chase. "The KXLA photo has no significance, except it shows the advertising sign above the station's second floor studios in the Huntington Hotel complex in Pasadena during the late '40s. That girl must have been the wife of the photographer."

My sense of story had me desperately wishing that she was a pioneering Truman-era feminine radio personality caught on film after her shift by an adoring fan, or maybe she was the technical-

**50,000 WATT KRLA**  
Serving 6,000,000 People

**MORE MUSIC FIRST ON KRLA 1110**

**DIAL KRLA 1110**  
**TOP FIFTY SURVEY**  
The Most Accurate in California

<b>WINK MARTINDALE</b> 8 - 9 A.M.	<b>ROY ELWELL</b> 9-12 NOON	<b>ROGER CHRISTIAN</b> NOON - 2 P.M.
<b>JIM O'NEIL</b> 3-6 P.M.	<b>SAM RIDDLE</b> 6-9 P.M.	<b>FROSTY HARRIS</b> 9-MIDNIGHT
<b>BOB EUBANKS</b> MIDNIGHT-6 A.M.		

**HEAR ALL THE 1110 MEN ON RADIO 1110**

**Photo D.** Evidence of just how much fantastic DJ talent KRLA packed in its heyday can be deciphered by the fact that its program director scheduled Bob Eubanks to do the overnight shift! Another daytime TV personality, Wink Martindale, held the morning slot. Over the years the Los Angeles area flame-thrower's air staff even included Casey Kasem. (*SEE: A brief aircheck with Casey Kasem: <<http://bit.ly/PDwcnA>>*) For much of KRLA's most influential (1959-67) years, its lineup of air-personalities were known collectively as the Eleven-Ten Men. Female DJs were a rarity on hit music radio.

ly-savvy fiancée of the crack engineer in charge of maintaining KXLA's fancy directional antenna pattern. Then again, the young woman was probably just a KXLA listener who visited the country and western outlet in order to pick up a Hank Williams record she's won in some music trivia contest.

According to details amassed by Jan for his private tome chronicling Los Angeles radio, KXLA was essentially born in July 1941 when the Pacific Coast Broadcasting Company won an FCC construction permit for a new Pasadena-based AM outlet with 10,000 directional watts on 1110 kilocycles. The station debuted in mid-February 1942 under the calls, KPAS, and ran just 5 kilowatts for a year before being technically able — from a 20-acre transmitter site in El Monte, California — to double its power and realize the CP's full authorization. This was implemented via a water-cooled, 10-kilowatt Western Electric "box" into a trio of 360-foot towers. Pacific Coast Broadcasting Company majority stockholder, J. Frank Burke Sr., already owned a Los Angeles AM, but his

KFVD 1020 kilocycles signed off at local sunset — Pittsburgh, PA time — in order not to interfere with legendary KDKA 1020's skywave signal. Incidentally, actor Melvyn Douglas held a minority ownership position in the new 1110-kilocycle outlet. Burke wanted the Pasadena facility so that he could finally control a truly full-time signal in California's Southland, but even this added AM property didn't remain his for long. The Commission's new duopoly/cross-ownership rules caused Burke to sell KPAS, albeit primarily to a son-in-law, in 1944.

As was often the case with so-called "second-city" stations, KPAS got treated to several auxiliary studios or offices. Both offices — located in a popular Hollywood music shop and the other in a downtown Los Angeles office building — were designed to give it an authentic L.A. provenance. KPAS' new licensee switched the callsign to KXLA in late 1945, concurrent with a then unprecedented format flip (from variety) to country and western programming and improved secondary studio space in a new Hollywood venue. Air-personalities



on this pioneering C&W operation included Tennessee Ernie Ford as morning DJ. His radio experience and 1955 hit, *Sixteen Tons*, helped propel him to even greater successes in the fledgling TV musical variety show scene. (SEE: *Tennessee Ernie Ford as he performs his big hit, "Sixteen Tons"* <<http://bit.ly/Xff1G>> -WPC2HUN)

Technical modifications at KXLA occurred throughout the summer of 1955 when its transmitter facility was relocated some 200 feet and officially change from a single directional pattern to one for day and a second phasing array at night. Additional tweaking and finagling resulted in another incremental transmitter locale change and a 1959 daytime open-throttle use of its new Continental Electronics 50,000-watt RF generator. Post-sunset power remained at 10 kilowatts with a dedicated directional footprint. These changes were part of the plan to make KXLA more attractive to those shopping for a big L.A. radio station. And in 1959, a group dubbed The Eleven Ten Broadcasting Corporation, happily paid \$900,000 for the facility.

## You're A Winner With . . . K-R-L-A — Eleven-Ten L.A.

Officials in the new company had been trying to decipher the secret as to how Los Angeles radio market leader, KFWB, was such a money machine. They became convinced that the erstwhile Warner Brothers station's embracing of contemporary hits, talented Top-40 music-oriented DJs, brief but exciting — if not somewhat exaggerated — spot newscasts, and heavy doses of quirky on-air contests caused the success.

Because KFWB 980 was only 5 kilowatts, they must have reasoned, a 50 kilowatt doing the same thing would certainly prove profitable in multiples of 10.

With that brand of confidence, Eleven Ten Broadcasting planned on dumping KXLA's twangy tunes, instituting call letters KRLA (King of all Radio in Los Angeles), and prepared listeners for the station's entry into "modern radio" a.k.a. Top-50 tunes, hit music/news/time/temperature, and lots of fun contests. Jan explains, "As a warm-up to the stormy career of KRLA in the upcoming years, a promotional gimmick employed by its new owners encompassed a change-over period with continual streams of announcements only, without [much] reference to call letters or without featuring any music or programs of any type.

"Its beginning was announced with three days of slogans and a contest to 'Find The Golden Key,' which would activate the station's new 50-kilowatt transmitter. Quietly, on Thursday, September 3, 1959, country music was dropped and the call letters were changed to KRLA, and it began airing a 'Top 50' popular music format, with 'Rocket News' — one minute capsule news headlines. KRLA, with its new 'Modern Radio' format, was soon to take on market leader KFWB and compete head-to-head in this type of programming."

It's unclear how the wife of a new KRLA advertiser rather than any one of the understandably disgruntled former KXLA listeners or confused Angelenos happening upon the promo loop were able to locate the golden transmitter key. What is embarrassingly recalled, however, is a second contest fired-off immediately after KRLA's new call letters and format were clarified.

It challenged the audience to find a disc jockey named Perry Alan, who had reportedly accepted an announcing post with the station, but was allegedly incognito somewhere in Southern California. Mr. Alan's 10-20, however, was nowhere near the

West Coast. Jan outlines the crummy contest: "Broadcasting clues as to Mr. Alan's appearance, KRLA offered \$10,000 to anyone who approached him with the message 'KRLA, 1110, L.A.' That was the first day. The reward was to be reduced a thousand dollars each day until he was found. Unfortunately for KRLA, Mr. Alan was found early in the contest period, and he was found not in Los Angeles but in Buffalo, New York, where he was completing his work at WKBW before leaving to join KRLA. Moreover, he was found by representatives of rival Los Angeles station, KFWB, which itself had been negotiating with Mr. Alan [to join the KFWB 'Channel 98' air-staff] and knew exactly where he was."

As can be imagined, KRLA officials probably had tears in their eyes when they were forced to issue a \$10,000 check to an employee of rival KFWB! The irony was not lost on regulators at the FCC who kept hearing rumors of KRLA's strangely-executed contests with odd outcomes. In 1962, they hauled KRLA brass into a license renewal hearing that resulted in funny business evidence about KRLA's inaugural "Find the golden transmitter key promotion."



**Photo E.** On the flip-side of this 1971 KRLA music survey sheet, the station's top tunes were charted by popularity. That reserved the back and front covers for print ads and for billboarding one of its DJs; although he was quite possibly either on tape or trying to make the best of being employed by interim "owners" who were simply aiming to squeeze every last nickel out of the shabby studios before FCC regulators could award the otherwise lucrative license to one of many clamoring applicants for 1110 kHz in Pasadena. The ad for Ambush perfume suggests that the wearer can seductively "leave a little something behind." Ironically, such a phrase could have been used in 1959 during KRLA's inaugural promotion designed to generate buzz when it first announced its call letters. For several days after dropping C&W music and KXLA moniker, it simply ran a taped loop of about a dozen contagiously composed limericks containing clues as to where a *golden key* to the new 50,000-watt KRLA transmitter might be found. The ingenious promotional messages were only interrupted by the stunting station's new "legal" station identification, *This is KRLA, Pasadena*. Several years later, that key contest was cited as evidence that KRLA licensee had not operated the station "in the public interest." In retrospect, he should have directed KRLA promotional staff to make sure it had left the so-called *golden key* behind in its secret locale *prior* to placing it *there after* the competition had already been running for a while. (IN DEPTH: For more information on KRLA, visit <<http://krlabeat.sakionline.net/airchecks.html>> to see a complete archive of early 1960s jingles and DJ air-checks)

Jan reports, "the key to the 50,000-watt transmitter was allegedly planted on the day it was found on a hillside overlooking Marineland of the Pacific, at Palos Verdes Peninsula." This new information gave FCC investigators the distinct impression the whole thing was rigged to remain unsolved until maximum promotion value had been achieved. Such incrimination, as well as damaging testimony regarding other shady gimmicks designed to generate listener buzz made the Commission's hearing examiner recommend yanking the big Pasadena AM's ticket.

However, even the meanest FCC bureaucrat knew it'd be painfully problematic to summarily silence a top-rated pop outlet in Los Angeles. In 1964, Commission officials allowed a non-profit organization, Oak Knoll Broadcasting Corporation, to lease KRLA's gear (for a paltry \$90,000 annually) and to direct KRLA personalities to stay "mum" about the tenuous license situation and give the impression on the air that nothing had changed. In fact, Oak Knoll (the victor in a five applicant interim operator race) siphoned off all of KRLA's then enviable profits and handed over the lion's share of those moneybags to the cabal building Los Angeles public television station, KCET(TV) and developing educational programs.

## Hey Nineteen!

Once Oak Knolls became established "temporarily" controlling KRLA, the FCC re-opened the frequency to regular commercial applicants and took its time deciding which of the 19 entities would eventually be granted a license to operate over Los Angeles air on 1110 kHz. Meanwhile, throughout the 15-plus years before a final decision was made to award the Pasadena prize to KRLA, Inc. (an amalgamation of several applicants), Oak Knoll, along with a gradual audience shift to stronger competitors on FM, drained KRLA nearly dry. The tenant cut costs wherever it could, as the educational TV people made sure no profits were plowed back into the radio station's programming. It brings to mind the old adage about killing the goose that lays the golden eggs. Format shifts didn't improve the ratings, nor did a January 1969 Oak Knoll decision to fire much of KRLA's air talent and run automated music segments.

When KRLA, Inc., could finally start fixing-up the big station shortly after Thanksgiving 1979, these new owners —

which included Hollywood notables Bob Hope and Art Linkletter, as well as representatives of the Goodson-Todman TV game show outfit — concentrated on an oldies format for which KRLA had been known largely through the do-it-yourself efforts of disc jockey Art Laboe.

Laboe had brokered time on KRLA for his automated "Oldies but Goodies" music format and produced his many hours of KRLA programming from his own studio at Sunset and La Brea in Hollywood.

Over the next few years, the stronger KRLA principals bought out the lesser shareholders for some \$4.75 million, before selling the entire operation for a respectable \$10 million to Greater Media, Inc., around Christmas 1984. This allowed KRLA to move to the Wilshire Boulevard Los Angeles office building venue of its new Greater Media sister, KHTZ (FM). Ownership gave attention to KRLA's technical side by building a new six-stick array and getting permission to run 20 kilowatts at

night by 1988. Greater Media traded its L.A. outlets to CBS for some Boston and Philadelphia facilities during summer 1997. Several other sales followed in the head-spinning radio station trafficking frenzy of the early 2000s. Along the way, KRLA got renamed KSPN and switched to all-sports programming. (This allowed a nearby Glendale AM on 870 to co-opt the famous call.)

By early 2003, KSPN was recast as youth-targeted KDIS under ABC/Disney ownership. Still, when Los Angeles radio buffs picture the best days of Southern California Top-50/40/30, many envision sunny 1960s skies with KRLA radio waves in the air. And some still smile about a particular kooky KRLA promotion when station staff managed to send shirt-pocket transistor sets — loudly playing on 1110 kilohertz — to random L.A.-area folks with unsuspecting mailboxes. Just maybe, one of those little radios found its way to the KXLA girl in Melissa's mystery picture — whomever she was.

**If you enjoy Amateur Radio  
...you'll enjoy**



**It's a different kind  
of ham magazine.**

Fun to read, interesting from cover to cover, written so you can understand it. That's CQ. Read and enjoyed by thousands of people each month in 116 countries around the world.

**It's more than just a magazine. It's an institution.**

CQ also sponsors these world-famous award programs and contests: The CQ World-Wide DX Phone and CW Contests, the CQ WAZ Award, the CQ World-Wide WPX Phone and CW Contests, the CQ World-Wide VHF Contest, the CQ USA-CA Award, the CQ WPX Award, the CQ World-Wide 160 Meter Phone and CW Contests, the CQ World-Wide RTTY Contest, the CQ 5 Band WAZ Award, the CQ DX Award, CQ iDX Award, CQ DX Field Award, CQ DX Marathon and the highly acclaimed CQ DX Hall of Fame. Accept the challenge. Join the fun. Read CQ.

**Print Edition & New Digital Edition Combo Sale!**

**Buy both at a SPECIAL Combo price and save!**

**HOLIDAY SPECIAL PRICES!!!!**

1 Year	Print	Digital	Both
USA	\$36.95	\$26.00	<b>\$52.95</b>
CN/MX	\$49.95	\$26.00	<b>\$65.95</b>
Foreign	\$61.95	\$26.00	<b>\$77.95</b>

**CQ The Radio Amateur's Journal**

25 Newbridge Road • Hicksville, New York 11801  
Phone 516-681-2922 • FAX 516-681-2926

[www.cq-amateur-radio.com](http://www.cq-amateur-radio.com)



# Arithmetic Selectivity and the SX-101A Receiver

## Last Touches On a Challenging Restoration of Hallicrafters' Classic Radio

By Peter Bertini, K1ZJH

*“Arithmetic selectivity is the reason dual-conversion receivers, with a higher first IF frequency, are able to deliver better image rejection across all of the amateur bands.”*

Early receivers walked a fine line between performance and cost, while being constrained by what was then state-of-the-art. We'll kick off this column by taking a look at some of the theory behind the SX-101A design — before delving further into the hardware and electronic aspects of the SX-101A restoration.

Let's discuss the concept of *arithmetic selectivity*. In simple terms, arithmetic selectivity means that the percentage bandwidth of a tuned circuit remains constant, regardless of frequency. Consider a 500-kHz tuned circuit that has a 10-kHz bandwidth at the -6 dB points on its selectivity curve.

Let's proportionally increase the inductor and capacitor value to tune the circuit to 50 kHz. For 2 percent of bandwidth, the new tuned circuit will have a 1-kHz at -6 dB bandwidth. This makes single-signal SSB and CW reception practical, using simple and inexpensive LC filtering in a low second IF stage.

Arithmetic selectivity explains why RF-tuned stages provide poorer image rejection at high frequencies, and why earlier receivers used very low IF frequencies to achieve adequate selectivity.

### Dual Conversion Receiver

Inexpensive, introductory-level communications receivers generally were single conversion and used a 465-kHz IF. The SX-101A is a double-conversion superheterodyne design.

Multiple conversion schemes, while adding complexity and expense, solved many of the image problems found in lower-cost sets. For a single-conversion set, using a higher IF would help to solve the image problems, but at the expense of reduced IF selectivity.

Crystal or mechanical IF filters, which can provide excellent selectivity at high IF frequencies were still experimental and uncommon in 1950s vintage ham gear. Instead, receiver designers were limited by the selectivity that could be obtained with tuned LC circuits.

By the time the SX-101A was introduced, many hams were experimenting and becoming active with the popular, new SSB (single-side-

band mode.) SSB required half the spectrum used by AM stations, but few ham receivers had narrow enough IF bandwidths to fully utilize the SSB mode to full advantage.

### First IF Determines Image Rejection

The SX-101A has a first IF operating at 1650 kHz, thus the image frequency is 3.3 MHz away from the desired frequency. A 455-kHz IF would



**Photo A.** The *doghouse* is the small sub-chassis that houses the second conversion oscillator (12AT7 tube) and the second converter stage (6BA6 tube). Transformer T5, marked on the photo, has two adjustments to set the 1600- and 1700-kHz crystal oscillator injection levels. The upper slug was damaged on this unit. The second slug is accessed through a hole in the main SX-101A chassis. The other two smaller transformers are the 50.75-kHz first IF transformer. (Photography by K1ZJH)

have an image frequency 910 kHz away from the desired signal. A tuned RF stage might have enough selectivity at 8 MHz to reject an image 910 kHz away, but for that same RF stage to achieve the same image rejection at 29 MHz the image frequency needs to be about 3.3 MHz away.

Arithmetic selectivity is the reason dual-conversion receivers, with a higher first IF frequency, are able to deliver better image rejection across all of the ham bands.



**Photo B.** Earlier versions of the *doghouse* used sockets to hold the 1600- and 1700-kHz crystals. Note the tuning slug lead screw for T5 is present on this unit.

As an interesting side note: The first Hallicrafters S-53 communications receivers used a 2-MHz IF. Hallicrafters devised 2-MHz IF transformers with narrow passbands in an attempt to reach a balance between image rejection and adequate selectivity, while keeping costs down. Apparently it didn't work as well as intended, since the later S-53A model reverted to the more standard 455-kHz IF.

## Arithmetic Selectivity Provides Single-Signal Reception

There is a small sub-chassis assembly on the main chassis of the SX-101A. Popular slang refers to this as the *doghouse* — home to the second conversion fixed crystal oscillators that operate at 1600 and 1700 kHz, as well as the second mixer stage, **Photo B**.

Whether the 1600 or 1700 kHz is active depends on whether the mode switch is set for either upper or lower sideband reception. An SSB signal is inverted when the crystal oscillator frequency is changed between high- and low-side injection. The IF is tuned for 50.75 kHz — the carrier frequency for a USB signal at the second IF.

For either LSB or USB the SX-101A BFO is set to 50 kHz, the carrier frequency for both USB and LSB modes. I used a frequency counter to measure the exact 1600- and 1700-kHz crystal frequencies. Lifting the 12AT7 tube shield until it is no longer grounded, and attaching the frequency counter input to the metal shield can do this.

There will be enough capacitive coupling to give reliable readings, without loading the circuit. For example: Let's assume the two crystals have aged and changed frequency. The 1600-kHz crystal is at 1602 kHz, and the 1700-kHz crystal reads 1701 kHz. Subtract the two frequencies, and divide by two. This shows the BFO frequency should be set to 49.5 kHz at midrange. For this example, the IF should be aligned — 750 Hz high — at 50.250 kHz instead of 50.750 kHz.

The SX-101 designers could have used a single fixed-conversion oscillator to convert the 1650-kHz IF down to 50 kHz. This would have saved a few dollars. While using two crystal oscillators to either up- or down-convert to the last IF frequen-

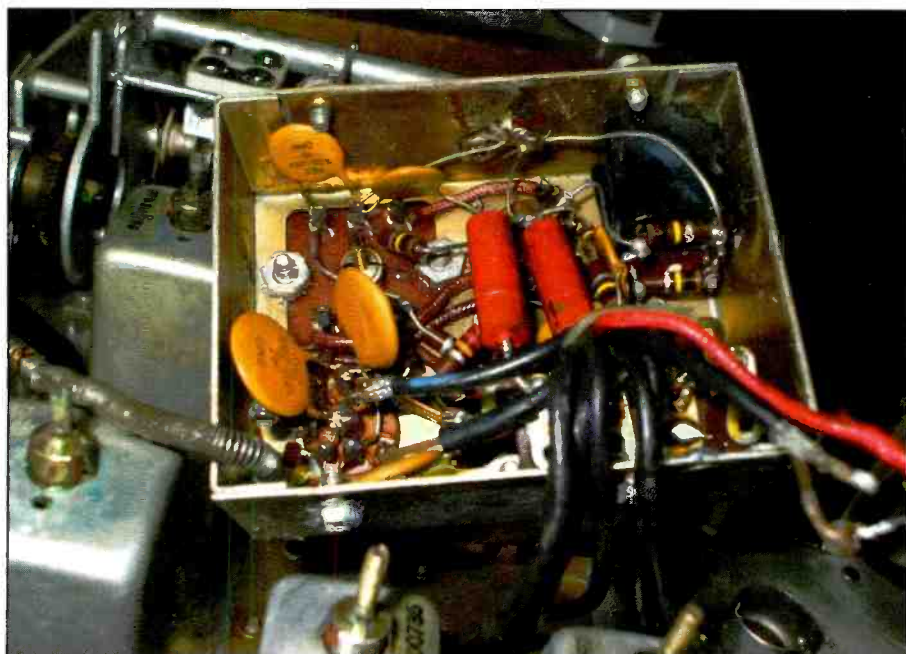

**Photo C.** Here's a component-side view of the later version of the *doghouse* sub-assembly. The local oscillator crystals are soldered in below the chassis. Very little restoration was needed, since the ceramic capacitors are usually very reliable. A few of the carbon composition resistors had shifted out of tolerance and were replaced as needed. The large bundle of RG-174 miniature coaxial cables go to the selectivity switch. These cables interconnect the selectivity switch to the first 50.75-kHz IF transformer which is mounted on the *doghouse*.



## Licensed Before 1988?

QCWA invites you to join with those distinguished amateurs licensed 25 or more years ago. Request an application from:

QCWA, Inc., Dept. PC  
PO Box 2088  
Malakoff, TX 75148-2088  
USA  
www.qcwa.com



## BACK ISSUES

Complete your collection today.



Only \$8.99  
Per Issue

Check, Money Order,  
Mastercard, VISA, Discover  
and AMEX accepted

25 Newbridge Rd., Hicksville, NY 11801  
Phone 516-681-2922 FAX 516-681-2926

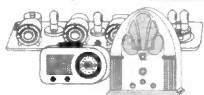

## ANTIQUE RADIO CLASSIFIED

Antique Radio's Largest Monthly Magazine - 4,000 Subscribers!

Classifieds - Ads for Parts & Services  
Articles - Auction Prices  
Meet & Flea Market Info.  
Radios, Ham Equip, Telegraph, Hi-Fi  
TV, Books, Art Deco, 40s & 50s Radios

U.S. Rates: 1 year  
\$36 (\$48 by 1st Class)

A.R.C., PO Box 1558  
Port Washington, NY 11050  
Web: www.antiquradio.com  
Email: arc@antiquradio.com

Toll Free: (866) 371-0512 Fax: (516) 883-1077



cy adds to the SX-101A receiver's complexity and cost, it does provide a substantial benefit.

A single conversion oscillator with the second IF centered at 50 kHz would require shifting the BFO frequency about

plus or minus 2 kHz either side of a 50-kHz center frequency to select either USB or LSB reception. This would require a correction in the dial scale readout to compensate for the 4-kHz carrier shift when changing SSB modes. The SX-

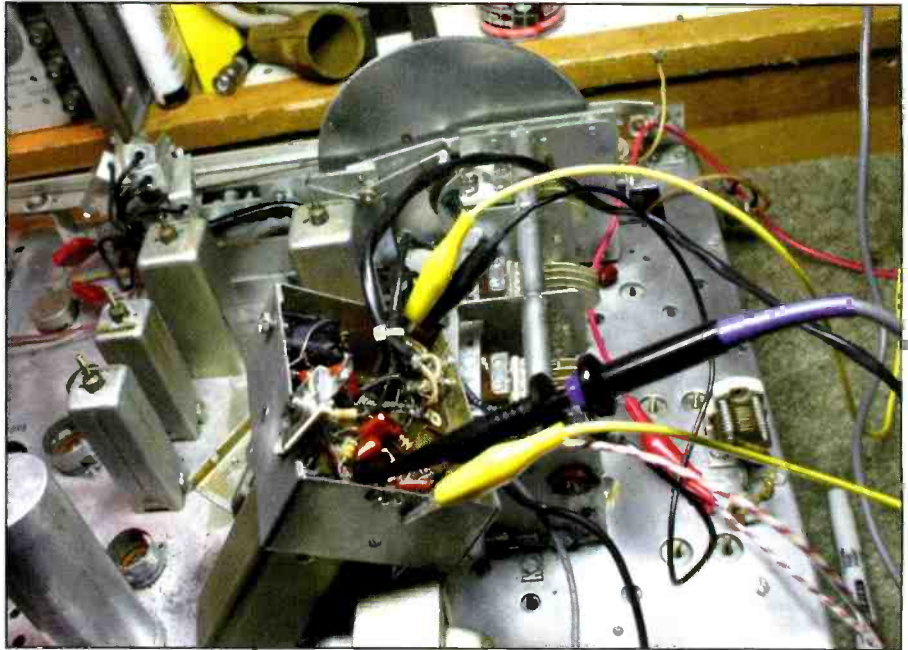

**Photo D.** After damaging the tuning core for transformer T5, I decided to replace both tuning slugs with compression trimmer capacitors. In this picture, the *doghouse* is being powered from an external DC and filament supply while I was working on a means to fix the damaged core. This was intended to be a temporary fix, but since it is working so well, I am reluctant to replace the doghouse with one salvaged from a donor SX-101 receiver.



**Photo E.** Once the correct value for the compression mica was determined; I installed two compression mica capacitors under the chassis. These are used to set the injection level for the 1700- and 1600-kHz oscillators. As previously mentioned, this was supposed to be a temporary fix, but it works well and I may leave it alone.

101A's up/down second IF conversion scheme preserves the dial scale calibration — the IF carrier frequency (BFO) never changes from exactly 50 kHz when switching SSB modes.

## Restoring the Doghouse

There are at least two different style doghouses of which I'm aware.

The 1700- and 1600-kHz crystals are in sockets in the earlier version, **Photo B**, while later versions had the crystal leads

directly soldered below the chassis, **Photo C**. I was curious if there were any paper capacitors hiding in the doghouse chassis. So far the only caps I've found hidden in the chassis have been reliable ceramic capacitors. However, some of the resistor values had shifted enough to warrant their replacement.

Removing the doghouse assembly is not a trivial task, and it is desirable to do a thorough job the first time around. Accessing the doghouse entails removing several wire leads, and numerous RG-174

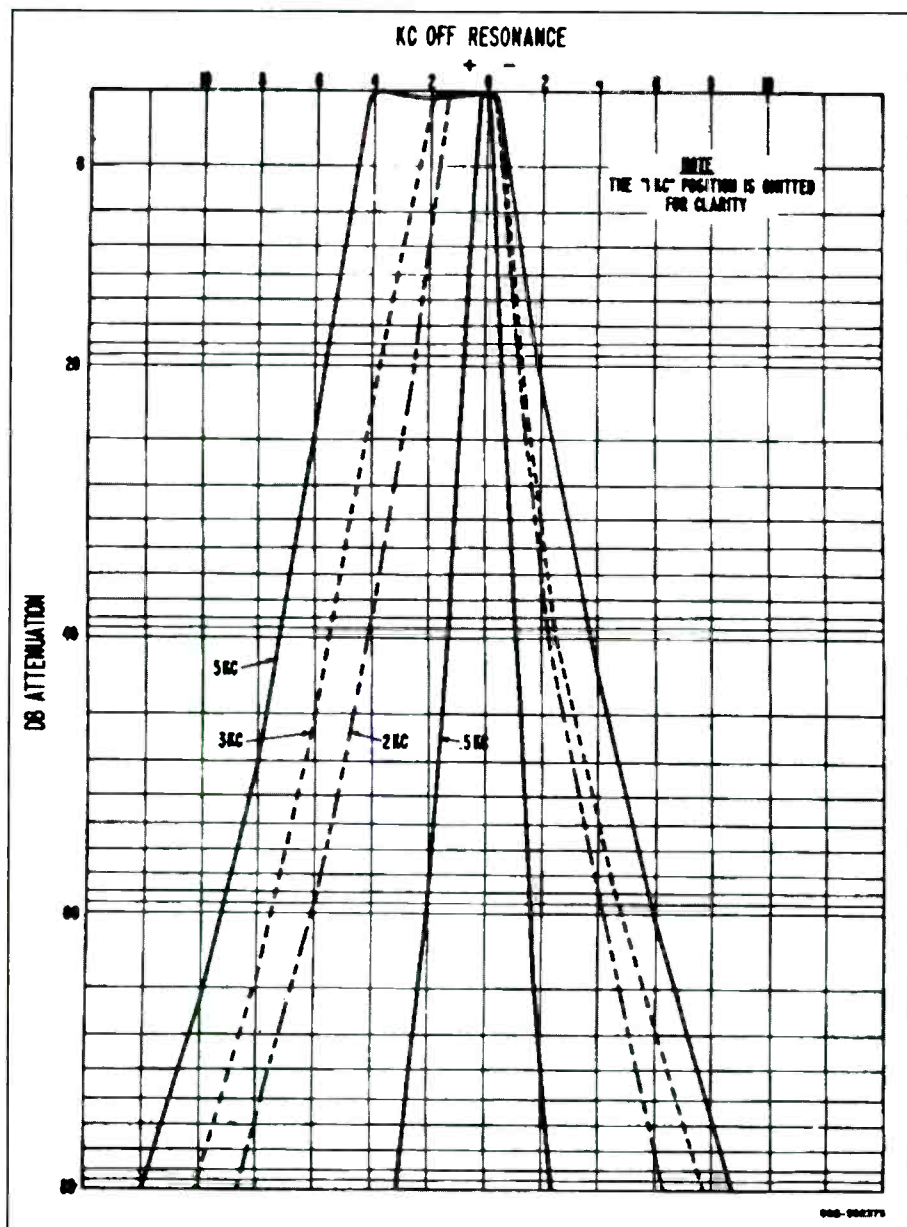

**Figure 1.** This scan was taken from the SX-101A and shows the IF selectivity curves for IF bandwidths between 5 kHz and 500 Hz. Note that the IF center moves with the selectivity positions to ensure that the BFO — carrier frequency — is always optimized for a 50-kHz BFO injection frequency. Modern filters provide a much flatter bandpass characteristic, with much steeper skirts. The ratio of the slope at -6 and -60 dB points determines the shape factor of a filter.

**TERRORISM FORCES  
US TO MAKE A  
CHOICE. WE CAN BE  
AFRAID. OR  
WE CAN BE READY.**

**READY**

**WWW.READY.GOV**

**1-800-BE-READY**

Ad  
Council

**Mil Spec Radio Gear**  
*Korean to Present Day*

by Mark Francis, KI0PF



You'll find detailed write-ups for many familiar sets: PRC-25/-77, RT-68, PRC-1099, GRC-106, GRR-5, R-392 and many more.

Includes over 230 pages of operating, modification and maintenance tips and information. Also includes over 200 illustrations!

**Super Sale!**

Originally selling for ~~\$27.95~~

Order today for only **\$15**

Shipping & Handling: U.S. & Possessions - add \$7 for first item, \$3.50 for second and \$2 for each additional. CN/MX- \$15 for 1st item, \$7 for 2nd and \$3 for each add'l. All Other Countries - \$25 for 1st, \$10 for 2nd and \$5 for each add'l.

**CQ Communications, Inc.**  
25 Newbridge Rd., Hicksville, NY 11801  
1-800-853-9797  
<http://stare.cq-amateur-radio.com>



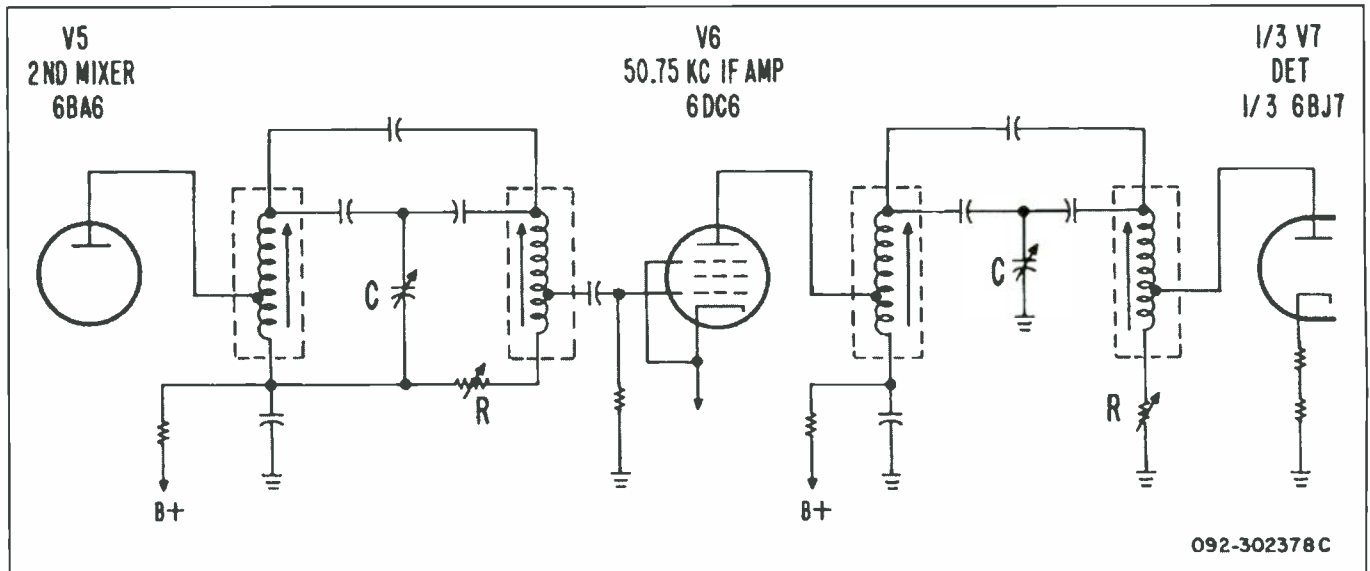

**Figure 2.** The 50.75-kHz IF filters are capable of very good single signal selectivity, down to 500 Hz for CW operation. This is *much too sharp* for SSB and AM modes. Wider IF bandwidths are achieved by spoiling the Q of the IF stages' tuned circuits by introducing R (resistance). The IF transformers are capacitive top-coupled, and the value of C determines the amount of coupling and the bandwidth.

shielded coax jumpers. Many of these coax leads are attached to the selectivity switch. Removing the selectivity switch from the front panel will provide enough slack on some of the leads to allow lifting the assembly for repair. Be very careful not to damage the switch assembly!

As mentioned previously in this series, my carelessness resulted in damaging the

upper tuning shaft on the T5 transformer, whose location is annotated in **Photo B**. This is used to set the 1600-kHz crystal oscillator injection level for the second mixer. I needed a temporary fix to get the radio up and running. I removed the tuning slugs and added two compression mica caps to tune the 1600- and 1700-kHz oscillator injection levels, **Photos D** and

**E**. I've since located a replacement *dog-house* from a donor SX-101, but I've been reluctant to tear into a working radio.

### SX-101A Selectivity Control

The SX-101A selectivity control offers bandwidths of 5, 3, 2, 1, and 0.5 kHz. The selectivity curves can be seen in **Figure 1**.

The various selectivity positions control the coupling and Q of the two 50.75-IF transformers. Q refers to the *Quality* of a capacitor or inductor. Less loss means higher Q, and also a sharper response. This in turn determines the IF stage bandwidth.

Note that the selectivity curves are a bit crude in comparison to the nearly ideal rectangular shape factors offered by modern mechanical or crystal filters. But the selectivity is adequate for casual CW or SSB operation. The equivalent schematic shown in **Figure 2** illustrates how the various selectivity steps are archived.

R and C are, respectively, fixed-value resistors and capacitors selected by the mode switch. The resistors set the Q of the IF transformer, while the capacitors control the degree of coupling between the plate and grid windings on both IF transformers.

The lower the Q, and the tighter the coupling and the wider the frequency response. The original components associated with the selectivity switch are shown in **Photo F**.



**Photo F.** The Selectivity switch determines the amount of coupling and the Q of the two 50.75-kHz IF transformers. Switching in different resistors and capacitors for each selectivity position does this. The original *bumblebee* capacitors should be replaced due to their high failure rates. The original carbon composition resistors were replaced with stable carbon film resistors.

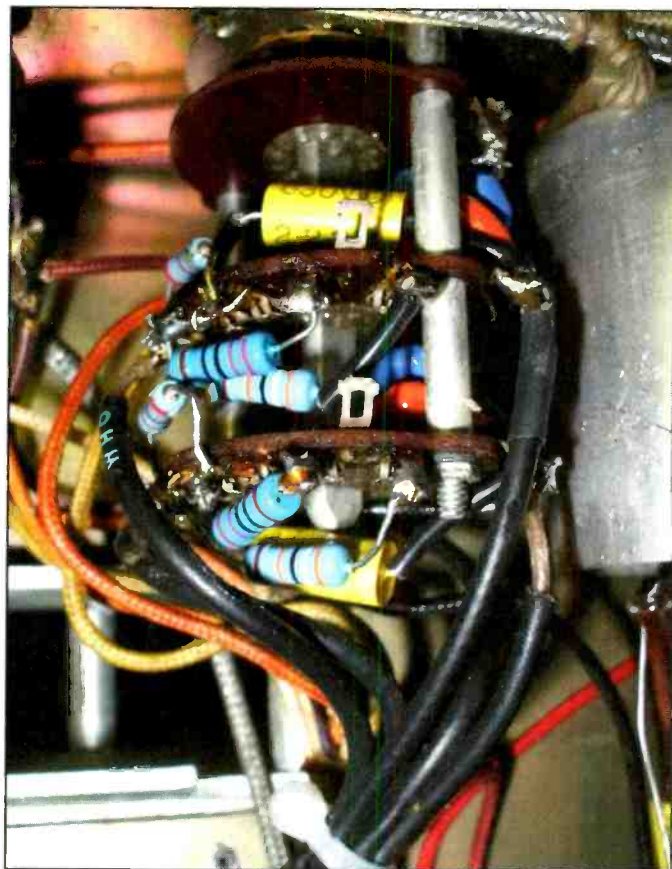

**Photos G and H.** These pictures show the replacement parts installed on the selectivity switch. Be very careful when de-soldering and removing the old components. The Phenolic wafer sections are easily damaged!

**Photos G and H** were taken after restoration. Use good quality, low-loss replacement capacitors for the filter elements! This means high-quality polypropylene, Mylar or silver mica caps — and do not substitute values. Higher-value ceramic disc capacitors in these ranges are probably Z5V or other dielectrics that are not suitable for this application due to high dissipation factors and poor stability characteristics.

## Alignment

The alignment information in the manual is pretty complete and concise. I can't offer much advice, except to take note that the manual strongly advises against disturbing the oscillator trimmer capacitors in the RF section. These are concentric ring trimmers, and the shafts were fixed by soldering during the factory alignment. Only the tuning slugs should need to be adjusted unless those trimmers were disturbed from the factory settings.

## Modifications

Quite a few hams have noted that the SX-101A has distortion on AM signals that are fully modulated. A 0.047- $\mu$ Fd capacitor (C80) in the ANL circuit loads the AM detector and causes this problem.

At the expense of losing the ANL, remove C80 to improve AM reception. The 12BY7A filament for the SX-101A is powered when the radio is plugged in. This was done to improve the receiver's stability, but it results in a short operating life for the 12BY7A tube.

I use a master switch to kill power to all of the equipment in

my ham station when it is not in use. Otherwise, I'd put the dedicated 12BY7A filament transformer on the SX-101A power switch, and let the receiver warm up for an hour or so before using it.

## In Conclusion

The SX-101A is a bit of a restoration challenge! Its size and weight make the servicing work cumbersome. But what else should be expected of a real, vintage *boat-anchor class* ham receiver?

It is a great radio, and makes a fine companion for my HT-32 Hallicrafters transmitter. To be honest, I'd suspect that a National NC-303 from the same era would offer better performance. I use the SX-101A for casual CW and SSB listening while I'm working in the shop.

Many earlier receiver designs used a first IF that falls into the expanded AM BCB between 1600 and 1700 kHz. This means these receivers are susceptible to interference from strong AM stations operating near the receiver IF frequency, especially at night when AM BCB opens up.

A simple LC trap, tuned to 1650 kHz, can be placed between the antenna connector and chassis to reduce the level of interfering stations operating on the 1650-kHz first IF.

## Looking Ahead

I'll be doing a future column showing how to integrate the SX-101A and HT-32 into a working ham station.

*Until next time, keep those soldering irons warm, and those old tubes glowing! — K1ZJH*



## This Month's Feedback from Pop'Comm Readers

### *The Iranian International Radio Festival, Cutting the Cable TV Cord*

*Pop'Comm appreciates and encourages comment and feedback from our readers. Via email, please write: <editor@popular-communications.com>. Our postal service address is: Editor, Popular Communications, CQ Communications, Inc., 25 Newbridge Rd., Hicksville, NY 11801-2953 USA. – Richard Fisher, KPC6PC/KI6SN*

#### **A Radio Festival in Iran? Are You Nuts?**

Editor, *Pop'Comm*,

Regarding the *InfoCentral* item headlined "International Radio Festival Hosted By Iran" in August's *Pop'Comm*:

*Really?* You have to be kidding. I am surprised you would even mention this from a country under international sanctions, supporters of terrorism worldwide, and a government that controls its people.

I would find it hard to believe that these radio people are not controlled or watched by their government. "Hope and Awareness" — I don't think so.

– Martin Cohen

*(Martin: Thanks for taking the time to write. We appreciate your feedback. – Richard Fisher, KPC6PC)*

#### **Life Is So Much Better After 'Cutting the Cord'**

Editor, *Pop'Comm*,

In regard to Rob de Santos, K8RKD's, August *Horizons* column headlined "The Internet, Cutting the Cord and the S Curve" on Page 10:

We dropped TV coming into our home about four years ago and our lives have never been better! We now watch nothing except shows we specifically have an interest in. They are mostly dramas or documentaries. We get them legally through iTunes or the purchase of DVDs. This has limited our TV watching to about an hour or so every two or three days. We no longer receive print newspapers or magazines either, and have digital subscriptions through publishers directly or through Zinio.

Our lives have really opened up because of this: More reading, less distraction, more social contact and less media influence. We feel like we're more alive every day now. I am 65, and not particularly computer savvy. But I know enough that 100 channels of TV crap was not good for my mental and spiritual health.

– Richard Austin

*(Richard: Thanks for the note. It's interesting to hear stories like yours. I follow a number of broad-casting media outlets and the TV industry remains convinced that the number of people like yourself is*

*miniscule. In fact, just today I read one major L.A. media publication claim that there were only 40,000 true "cord-cutters" out there. My guess is they are grossly underestimating the numbers. – Rob de Santos, Horizons columnist)*

#### **Cable TV? Who Needs It? Not Me!**

Editor, *Pop'Comm*,

I read Rob de Santos, K8RKD's, August *Horizons* regarding the cord-cutting phenomenon — a.k.a. *getting rid of cable TV*.

I find it amusing, as I have never had a cable TV subscription to begin with. Ever since I moved out from my parents' place, I have relied on OTA (over the air) TV. I never had the desire to watch MTV (when it had videos), or CNN 24 hours a day at my residence. For whatever reason, the channels never appealed to me. The monthly cost was always a factor whenever I had the bug to get the service.

Several years ago, I put up an outside antenna for improved FM reception and decided to connect the TV, as well. I had 25 TV channels to choose from, including the major networks.

When the analog-to-digital TV switch took place, I ended up with 80 channels to watch. Many are Asian in nature, but most have English so you can understand what is being said.

As long as I have all the major networks (ABC, NBC, CBS, PBS, Fox) and some Spanish networks (Azteca, Telemundo, Univision), I feel satisfied with the current TV reception I have. The antenna cost \$45. It worked with the old analog system and still works with the new digital system. There is no monthly fee for it, and I get HD on top of that.

– Dan Ramos,

*Huntington Beach, California*

*(Dan: Thanks for your message. I've been very interested to hear from readers like you who haven't been or no longer are cable subscribers. Most studies I've read suggest there is a group of people like you who have chosen not to be part of the 90 percent of Americans who get cable or satellite and never will subscribe. Fortunately for you, you are in a major media market where digital TV makes it unnecessary. It's not so clear that this would work as readily in most places outside of areas such as New York and Los Angeles. – Rob de Santos, K8RKD)*

## readers' market

**Advertising Rates for Readers' Mart:** Non-commercial ads are 30 cents per word, including abbreviations and addresses; minimum charge \$6.00 per issue. Ads from firms offering commercial products or services are \$1.00 per word; minimum charge \$20.00 per issue. Boldface words are \$1.20 each (specify which words). Leading key words set in all caps at no additional charge. All ads must be prepaid in full at time of insertion; a 5% discount is offered for prepaid 6 time insertions. All ads must be typewritten double spaced.

**Approval:** All ad copy is subject to Publisher's approval and may be modified to eliminate references to equipment and practices which are either illegal or otherwise not within the spirit or coverage scope of the magazine.

**Closing Date:** The 10<sup>th</sup> day in the third month preceding date of publication. Because the advertisers and equipment contained in Readers' Market have not been investigated, the Publisher of *Popular Communications* cannot vouch for the merchandise listed therein. Direct all correspondence and ad copy to: Attention: Classified Dept., PC Readers' Market, 25 Newbridge Rd., Hicksville, NY 11801.

**TWO NOVELS** involving ham radio: Full Circle and Frozen in Time, by N4XX. Visit <<http://www.theodore-cohen-novels.com/>>

**SuperBertha.com** ULTIMATE LONG BOOM OWA YAGIS: Designed by WA3FET and K3LR. Scott W3TX, 814-881-9258.

**OLD TIME RADIO SHOWS** on CDs. The Lone Ranger; Have Gun Will Travel; Sam Spade; Johnny Dollar and more! All legal public domain programs. [www.cdvdmarkt.com](http://www.cdvdmarkt.com)

**FOR SALE - DRAKE TR-7/TR-7A/R-7/R-7A Service kit.** Includes 13 Extender Boards and Digital Jumper Card. \$64.95 includes postage. See <http://wb4hfn.com/Services/W7AVK/tr7ext2.htm> Bob W7AVK, 5581 Panorama Drive, Moses Lake, WA 98837, w7avk@arrl.net, 509-750-7589.

**SuperBertha.com** CUSTOM ROTATING POLES: No guy wires, entire pole rotates, stack all your antennas, rotor at ground level, 50ft to 300ft high, EIA-T1A-222-G. Starting at \$37,799.00. Scott W3TX, 814-881-9258.

## MK484 IN STOCK !!!



This tuned radio frequency IC comes in a TO-92 package. Combined with a handful of Rs, Cs, a ferrite rod, and our air-variable cap, you can wire a simple TRF receiver from



150 kHz to 3 MHz! We also stock 365 single and dual-gang variables! Schematic included. The fun starts now.

The Xtal Set Society  
[www.midnightscience.com](http://www.midnightscience.com)  
405-517-7347

## ADVERTISERS' INDEX

Advertiser	Page #	Website Address
AOR USA, Inc.	Cov 3	<a href="http://www.aorusa.com">www.aorusa.com</a>
Advanced Specialties	55	<a href="http://www.advancedspecialties.net">www.advancedspecialties.net</a>
Alinco	27	<a href="http://www.greamerica.com">www.greamerica.com</a>
Alpha Delta Communications, Inc.	21	<a href="http://www.alphadeltacom.com">www.alphadeltacom.com</a>
Antique Radio Classified	78	<a href="http://www.antiqueradio.com">www.antiqueradio.com</a>
Arlan Communications	25	<a href="http://www.arlancommunications.com">www.arlancommunications.com</a>
bhi Ltd.	31	<a href="http://www.bhi-ltd.com">www.bhi-ltd.com</a>
C. Crane Company	29	<a href="http://www.ccrane.com">www.ccrane.com</a>
CQ Holiday Gift Ideas	46-50,53	<a href="http://www.cq-amateur-radio.com">www.cq-amateur-radio.com</a>
CheapHam.com	25	<a href="http://www.CheapHam.com">www.CheapHam.com</a>
Computer Aided Technologies	41	<a href="http://www.scancat.com">www.scancat.com</a>
Cutting Edge	41	<a href="http://www.powerportstore.com">www.powerportstore.com</a>
GRE America	Cover 2	<a href="http://www.greamerica.com">www.greamerica.com</a>
HamTestOnline	41	<a href="http://www.hamtestonline.com">www.hamtestonline.com</a>
Homeland Security	79	<a href="http://www.ready.gov">www.ready.gov</a>
ICOM America, Inc.	9	<a href="http://www.icomamerica.com">www.icomamerica.com</a>
Kenwood USA	Cov IV	<a href="http://www.kenwoodusa.com">www.kenwoodusa.com</a>
MFJ Enterprises, Inc.	3	<a href="http://www.mfjenterprises.com">www.mfjenterprises.com</a>
PowerPort	41	<a href="http://www.powerportstore.com">www.powerportstore.com</a>
QCWA	78	<a href="http://www.qcwa.com">www.qcwa.com</a>
REACT International, Inc.	28	<a href="http://www.reactintl.org">www.reactintl.org</a>
Scanner Master	19	<a href="http://www.scannermaster.com">www.scannermaster.com</a>
The Xtal Society	83	<a href="http://www.midnightscience.com">www.midnightscience.com</a>
Timewave Technology, Inc.	5	<a href="http://www.timewave.com">www.timewave.com</a>
Universal Radio	1	<a href="http://www.universal-radio.com">www.universal-radio.com</a>
W5YI	15	<a href="http://www.w5yi.org">www.w5yi.org</a>
www.RFfun.com	55	<a href="http://www.RFfun.com">www.RFfun.com</a>

Reach this dynamic audience with your advertising message, contact Chip Margelli at 405-ADS-CQCQ (405-237-2727), FAX 714-895-3714, or e-mail: [advertising@popular-communications.com](mailto:advertising@popular-communications.com).

## SLOPER ANTENNAS

By Juergen A. Weigl, OE5CWL

Single- and Multi-Element Directive Antennas for the Low Bands

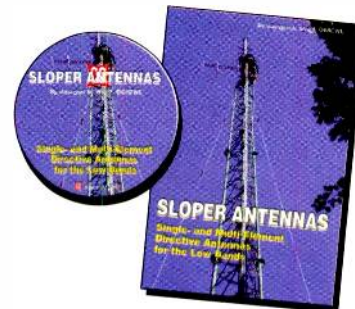

With calculations and practical experience, this book shows which basic concepts have to be considered for sloper antennas for the low bands. These fundamentals are supplemented by construction guidelines for directive antennas using a single element or several elements.

Also available on CD!

6 X 9 Paperback \$24.95

CD Version \$18.95

Buy both for only \$36.95

**Shipping & Handling:** US: \$7 for first item, \$3.50 for 2nd, \$2 for each additional, CN/MX \$15 for first item, \$7 for 2nd, \$3.50 each add'l. Other Countries: \$25 for first item, \$10 for 2nd, \$5 each add'l.

**CD Only** - USA \$5 for one \$3 each add'l;

CN/MX \$10 for one \$7 each add'l;

Other Countries: \$15 for one \$10 each add'l.

Book & CD to a single address = ONE item!

CQ Communications, Inc.

25 Newbridge Rd, Hicksville, NY 11801

[www.cq-amateur-radio.com](http://www.cq-amateur-radio.com)

Order today! 800-853-9797



## Holiday Wishes: Good Things, Small Packages

by Bill Price, N3AVY  
<chrodoc@gmail.com>

*“It’s truly amazing that I have both a general coverage receiver and now a complete telephone and computer that fits in my shirt pocket at the same time!”*

*Ho, ho, ho.* Time to drag the conductive aluminum tree from the attic, lift off the giant trash bag only to see it completely decorated and ready to plug in. *Simplicity.* If it were completely up to me, it would remain in the corner of the living room with its trash bag keeping it dust free, to be uncovered annually and illuminated.

Then there remains the issue of presents. The long-suffering Mrs. N3AVY is pretty easy to please. (In the copy I send to her, that sentence will end with “pretty,” and my flattery might earn me a hug or an extra piece of pie). She is unmoved by gadgetry, radios, even the electronic readers, and she is happy with fuzzy and snuggly things. That explains my beard, I guess.

From the earliest days that I can remember the joyous holidays of people buying me stuff, I had to write some very specific lists, often with the stock numbers from an Allied™ catalog, or perhaps the second best wish book that all the other kids used.

It’s hard to imagine that I have just about everything I want. There are a few extravagant things, which I wouldn’t even buy if I had the money, but beyond that, the wish books remain covered in dust. It would be nice if Norm and Beezer came and strung an antenna or two for me — nothing fancy — a dipole or two and maybe the longest long wire they could fit on the grounds. I’ve got a rig with most of the *old-fashioned* bands. I’ve got a bug. I’ve even got an antenna tuner.

If I say that I’ve already got a *mill*, I wonder how many readers will know that it’s an old manual typewriter — which takes away the difficulty of trying to copy code with a *stick*. That’s a pencil, for the uninitiated.

Truth be told (I say that a lot nowadays) all the radio gear seems so bulky and unnecessary. The company I work for just got me a smart phone. Up until now I’ve had a simple cell phone. When the cell stopped working, I asked if I might have one that sent and received email. I had no idea what these things can do.

I still don’t know where my voice finds its

way into the thing. The smart phone doesn’t extend much below my ear, and there seems to be only one pinhole in the bottom, near my mouth. A person couldn’t fit the end of a paperclip in there.

Those of you familiar with touching the glass and having things happen wouldn’t be impressed, but I certainly am. I’ve learned to tap, press-and-hold, slide and make all sorts of things happen, however if I don’t pick it up carefully, bad things seem to happen and it’s hard for me to get it back to doing something that I understand.

I’m worrying that I’ll be sitting there in front of my boss and all of a sudden, Melissa, the mistress of pain, will pop up on the screen and I won’t be able to make her go away.

It’s truly amazing that I have both a general coverage receiver and now a complete telephone and computer that fits in my shirt pocket at the same time! I believe the day has come (though someone will have to test me on this) that if someone were to come to my front door and offer me a nice Collins R-390, I’d probably turn it down because I could no longer lift it.

For all the years that I wanted a piano (and for a while, I had a pretty rough upright), I now have an electronic keyboard which I can tune in a second with my fingernail; that weighs about five pounds and stores on end in a closet.

Even my electric guitar and electric bass are solid-body versions, and take up virtually no room in the corner of an office. If it weren’t for the necessity of a 12-inch speaker, the amplifier too could be stored under the sofa.

The car is smaller (and lasts longer than the big old ones), and a nice compact microwave oven does a lot of the chores that the big old hot oven used to do. Maybe it’s a coincidence, but it seems that only one thing around the house has gotten larger over the years. Maybe because I don’t have to lift all those big, heavy things that have gotten smaller.

Whatever you enjoy this season, have a happy one. Hope you get some neat toys. *Small ones.*

# AR5001D Wide Coverage Professional Grade Communications Receiver

## The Legend Lives On!

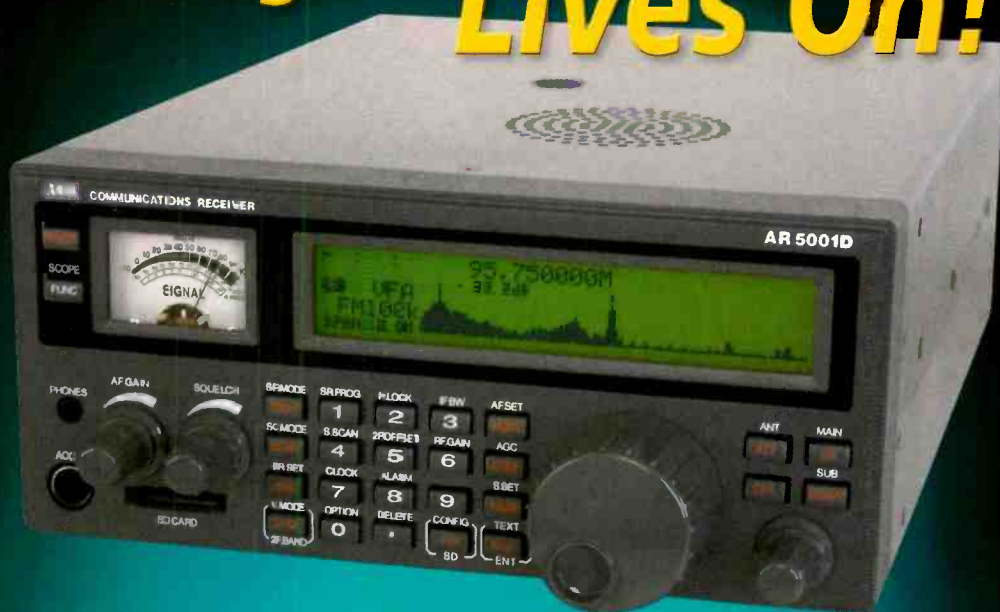

**The AR5001D delivers amazing performance in terms of accuracy, sensitivity and speed.**

Available in both professional and consumer versions, the AR5001D features wide frequency coverage from 40 KHz to 3.15 GHz\*, with no interruptions.

Developed to meet the monitoring needs of security professionals and government agencies, the AR5001D can be controlled through a PC running Windows XP or higher. Up to three channels can be monitored simultaneously. Fast Fourier Transform algorithms provide a very fast and high level of signal processing, allowing the receiver to scan through large frequency segments quickly and accurately. AR5001D standard features include storage of up to 2000 frequencies, 45 MHz IF digital signal processing, direct digital sampling, a high performance analog RF front-end, a DDS local oscillator and advanced signal detection capabilities which can detect hidden transmitters. With its popular analog signal meter and large easy-to-read digital spectrum display, the AR5001D is destined to become the choice of federal, state and local law enforcement agencies, the military, emergency managers, diplomatic service, news-gathering operations, and home monitoring enthusiasts.

Discover the next generation in AOR's legendary line of professional grade desktop communications receivers.

- Multimode receives AM, wide and narrow FM, upper and lower sideband and CW
- Up to 2000 alphanumeric memories (50 channels X 40 banks) can be stored
- Analog S-meter
- Fast Fourier Transform algorithms
- Operated by a Windows XP or higher computer through a USB interface using a provided software package that controls all of the receiver's functions
- An SD memory card port can be used to store recorded audio
- Analog composite video output connector
- CTCSS and DCS squelch operation
- Two selectable Type N antenna input ports
- Adjustable analog 45 MHz IF output with 15 MHz bandwidth
- Triple-conversion receiver exhibits excellent sensitivity
- Powered by 12 volts DC (AC Adapter included), it can be operated as a base or mobile unit
- Professional (government) version is equipped with a standard voice-inversion monitoring feature

**Add to the capabilities of the AR5001D with options:**

- Optional APCO-25 decoder
- Optional LAN interface unit enables control via the internet
- Optional I/Q output port allows capture of up to 1 MHz onto a computer hard drive or external storage device
- Optional AR-I/Q Windows software facilitates the easy storage and playback of transmissions captured within the selected spectrum in conventional modes, or, signals can be subjected to further analysis
- Optional GPS board can be used for an accurate time base and for time stamping digital I/Q data

**AOR**  
Authority On Radio  
Communications

® The Serious Choice in Advanced Technology Receivers

AOR U.S.A., Inc.  
20655 S. Western Ave., Suite 112  
Torrance, CA 90501, USA  
Tel: 310-787-8615 Fax: 310-787-8619  
info@aor.usa.com • www.aorusa.com

\*Cellular blocked for US consumer version. Unblocked version available to qualified purchasers with documentation. Specifications subject to change without notice or obligation



# EchoLink® Ready



## TM-V71A

With the Kenwood TM-V71A you have a choice of where you want your speaker on the top or on the bottom of the radio. Simply remove the faceplate and flip the main body, then reattach the face it's that simple! Yet another Kenwood 1st, this dual band transceiver has ten dedicated EchoLink® memory channels as well as EchoLink sysop-mode operation. EchoLink connection to your PC via the optional PG-5H cable kit is easy with no expensive interface needed.

EchoLink® is a registered trademark of Sinegenics, LLC. For more information please see: [www.echolink.org](http://www.echolink.org).



Large dual color amber or green thirteen segment LCD.

# KENWOOD

Customer Support (310) 639-4200  
Fax: (310) 537-8235



Scan with your phone to  
download TM-V71A Brochure.

  
[www.kenwoodusa.com](http://www.kenwoodusa.com)



ISO9001 Registered  
Professional Systems Business Group  
JICA-1205 D91  
A KENWOOD CORPORATION

ADS#46712