

POPULAR COMMUNICATIONS

JUNE 2011

Shortwave Listening • Scanning • AM & FM • Radio History

Spanning the Centuries

Where Radio History Comes Alive, p. 24

Scanning Our National Parks, p. 12

Sunspot Cycle 24 is for Real, p. 32

Plus: Mystery and Intrigue On a Ford Falcon's Radio Dial, p. 62



*****AUTO**5-DIGIT 60008
 0282
 P709
 5473
 PC 227537 MAR 12

NEW COMPACT HF TRANSCEIVER WITH IF DSP

A superb, compact HF/50 MHz radio with state-of-the-art IF DSP technology, configured to provide YAESU World-Class Performance in an easy to operate package. New licensees, casual operators, DX chasers, contesters, portable/field enthusiasts, and emergency service providers- YAESU FT-450D...This Radio is for YOU!



Compact size: 9" X 3.3" X 8.8" and Light weight: 7.9 lb

HF/50 MHz 100 W All Mode Transceiver

FT-450D

With Built-in Automatic Antenna Tuner

- NEW** Illuminated Key buttons
- NEW** 300 Hz/500 Hz/2.4 kHz CW IF Filters

- NEW** Foot stand
- NEW** Classically Designed Main Dial and Knobs
- NEW** Dynamic Microphone MH-31A8J Included

Large informative Front Panel Display, convenient Control knobs and Switches
The IF DSP guarantees quiet and enjoyable high performance HF/50 MHz operation



Handy Front Panel Control of Important Features including:

- **CONTOUR Control Operation**
The Contour filtering system provides a gentle shaping of the filter passband.
- **Manual NOTCH**
Highly-effective system that can remove an interfering beat tone/signal.

- **Digital Noise Reduction (DNR)**
Dramatically reduces random noise found on the HF and 50 MHz bands.
- **IF WIDTH**
The DSP IF WIDTH tuning system provides selectable IF passband width to fight QRM.
SSB - 1.8/2.4/3.0 kHz, CW - 300 Hz/500 Hz/2.4 kHz
- **Digital Microphone Equalizer**
Custom set your rig to match your voice characteristics for maximum power and punch on the band.
- **Fast IF SHIFT Control**
Vary the IF SHIFT higher or lower for effective interference reduction / elimination.

More features to support your HF operation

- 10 kHz Roofing filter
- 20 dB ATT/IPO
- Built-in TCXO for incredible ± 1 ppm/hour (@+77°F, after warm-up) stability
- CAT System (D-sub9 pin): Computer programming and Cloning capability
- Large, Easy-to-See digital S-meter with peak hold function
- Speech Processor
- QUICK SPLIT to automatically Offset transmit frequency (+5 kHz default)
- TXW to monitor the transmit frequency when split frequency operation is engaged
- Clarifier
- Built-In Electronic Keyer
- CW Beacon (Up to 118 characters using the CW message keyer's 3 memory banks)
- CW Pitch Adjustment (from 400 to 800 Hz, in 100 Hz steps)
- CW Spotting (Zero-Beating)
- CW Training Feature
- CW Keying using the Up/Down keys on the microphone
- Two Voice Memories (SSB/AM/FM), store up to 10

The rugged FT-450D aluminum die-cast chassis, with its quiet, thermostatically controlled cooling fan provides a solid foundation for the power amplifier during long hours of field or home contesting use.



MOS FET R3100HHF1



seconds each

- 20 second Digital Voice Recorder
- Dedicated Data Jack for FSK- RTTY operation
- Versatile Memory System, up to 500 memory channels that may be separated into as many as 13 Memory Groups
- CTCES Operation (FM)
- My Band / My Mode functions, to recall your favorite operating set-ups
- Lock Function
- C.S. Switch to recall a favorite Menu Selection directly
- Dynamic Microphone included

IMPORTANT FEATURES FOR THE VISUALLY IMPAIRED OPERATOR - Digital Voice Announcement of the Frequency, Mode or S-meter reading



Vertex Standard
US Headquarters
10900 Walker Street
Cypress, CA 90630 (714) 827-7600

For the latest Yaesu news, visit us on the Internet:
<http://www.vertexstandard.com>

Specifications subject to change without notice. Some accessories and/or options may be standard in certain areas. Frequency coverage may differ in some countries. Check with your local Yaesu Dealer for specific details.

Universal Radio — Quality equipment since 1942.

ICOM
IC-R75
 ✓ **FREE Icom**
Ball Cap



Enjoy exciting international radio reception with the Icom IC-R75-22 communications receiver. With full coverage from 30 kHz to 60 MHz; all longwave, medium wave and shortwave frequencies are supported plus extended coverage to include the 6 meter amateur band. Some innovative features of the R75 include: FM Mode Detection (but not the FM broadcast band), Twin Passband Tuning, Two Level Preamp, 99 Alphanumeric Memories, four Scan Modes, Noise Blanking, Selectable AGC (FAST/SLOW/OFF), Clock-Timer, Squelch, Attenuator and backlit LCD display. Tuning may be selected at 1 Hz or 10 Hz steps plus there is a 1 MHz quick tuning step and tuning Lock. The front-firing speaker provides solid, clear audio. The back panel has a Record Output jack and Tape Recorder Activation jack. The supplied 2.1 kHz SSB filter is suitable for utility, amateur, or broadcast SSB. However, two optional CW/SSB filter positions are available (one per I.F.). The formerly optional **UT-106 DSP board** is now included and factory installed! Free Icom ball cap. Order #0012 **\$619.95**



R6 The Icom IC-R6 covers 100 kHz to 1309.995 MHz (less cellular gaps) in: AM, FM Narrow and FM wide. Enjoy local VHF-UHF coverage plus international shortwave broadcast.

1300 memories store: frequency, mode, step size, duplex, CTCSS, tone squelch and skip settings. Other features include: attenuator, LCD lamp, AM ferrite bar antenna, auto power off, CTCSS decode, weather function and battery save. You can put the world in your pocket for under \$200.00. **Call or visit website for price.**



R20 The Icom IC-R20 covers an incredible 150 kHz to 3304.999 MHz (less cellular) with 1250 alphanumeric memories, bandscope and SSB/CW. It has: two VFOs, dual watch, voice scan control, NB, large two line LCD and CTCSS/DTCS/DTMF. A built-in IC audio recorder can record up to 4 hours of reception! With charger, Li-ion battery, belt clip and strap. **Call for price.**

Call for price.

IC-R9500



The Icom IC-R9500 raises the bar for professional receivers. Enjoy unmatched performance from 5 kHz to 3335 MHz (less cellular, in consumer version). Visit the Universal website for full details on this state-of-the-art instrument.

YAESU FT-450D



The Yaesu FT-450D amateur transceiver operates 160 to 6 meters with 100 watts on all bands. The superb receiver covers 30 kHz to 54 MHz. Operating modes include USB, LSB, CW, AM and FM. A built-in TCXO provides outstanding stability. The Yaesu FT-450D expands on the success of the previous FT-450, providing features such as: built-in antenna tuning system, classically designed knobs, dedicated data jack for FSK-RTTY, CTCSS, user configurable functions, digital voice announcement of frequency, mode and S-meter, 500 regular memories and two voice memories, CW beacon function, 10 kHz roofing filter, key illumination, foot stand plus 500 and 300 Hz CW filters. If you are in the market for a good shortwave receiver, with the idea of going into amateur radio in the future, this may be your ticket. The FT-450D comes with: MH-31A8J hand mic, mic clip and DC power cord. This radio requires 13.8 VDC at 22 amps.

YAESU

FT-857D



FREE Yaesu orange mug with FT-857D/897D.



The Yaesu FT-857D is the world's smallest HF/VHF/UHF multimode amateur transceiver covering 160 m to 70 cm with 100 watts on HF. Now with 60 meters and DSP2 built-in.

FT-897D



The Yaesu FT-897D is a multi-mode high-power base/mobile transceiver covering 160 m to 70 cm including 60 meters. Now with TCXO.

FT-817ND



FREE Yaesu canvas urban case with FT-817ND.

The Yaesu FT-817ND is an improved, deluxe version of the hugely popular FT-817. It includes 60 meter coverage plus the new high capacity FNB-85 battery. This radio has an excellent shortwave receiver built-in and is a fully self-contained, battery-powered, low power amateur MF/HF/VHF/UHF QRP transceiver.

**universal
radio inc.**

Universal Radio, Inc.
 6830 Americana Pkwy.
 Reynoldsburg, Ohio
 43068-4113 U.S.A.

☎ 800 431-3939 Orders & Prices
 ☎ 614 866-4267 Information
 ☎ 614 866-2339 FAX Line
 ✉ dx@universal-radio.com

www.universal-radio.com

★ Visit our website for more exciting new and used hobby radios.

- Visa
- MasterCard
- Discover
- JCB
- Prices and specs. are subject to change.
- Special offers are subject to change.
- Returns subject to a 15% restocking fee.
- Prices shown do not include shipping.

Tap into secret Shortwave Signals

Turn mysterious signals into exciting text messages with the MFJ MultiReader™!



MFJ-462B
\$199⁹⁵

Plug this self-contained MFJ MultiReader™ into your shortwave receiver's earphone jack.

Then watch mysterious chirps, whistles and buzzing sounds of RTTY, ASCII, CW and AMTOR (FEC) turn into exciting text messages as they scroll across an easy-to-read LCD display.

You'll read interesting commercial, military, diplomatic, weather, aeronautical, maritime and amateur traffic...

Eavesdrop on the World

Eavesdrop on the world's press agencies transmitting unedited late breaking news in English -- China News in Taiwan, Tanjung Press in Serbia, Iraqi News in Iraq -- all on RTTY.

Copy RTTY weather stations from Antarctica, Mali, Congo and many others. Listen to military RTTY passing traffic from Panama, Cyprus, Peru, Capetown, London and others. Listen to hams, diplomatic, research, commercial and maritime RTTY.

Super Active Antenna

"World Radio TV Handbook" says MFJ-1024 is a

"first-rate easy-to-operate active antenna... quiet... excellent dynamic range... good gain... low noise... broad frequency coverage." Mount it outdoors away from electrical noise for maximum signal, minimum noise. Covers 50 KHz-30 MHz. Receives strong, clear signals from all over the world. 20 dB attenuator, gain control, ON LED. Switch two receivers and auxiliary or active antenna. 6x3x5 in. Remote has 54" whip, 50 feet coax. 3x2x4 inches. 12 VDC or 110 VAC with MFJ-1312, \$15.95.



MFJ-1024
\$159⁹⁵

Indoor Active Antenna

Rival outside long wires with this tuned indoor active antenna. "World Radio TV Handbook" says MFJ-1020C is a "fine value... fair price... best offering to date... performs very well indeed."

Tuned circuitry minimizes intermod, improves selectivity, reduces noise outside tuned band. Use as a preselector with external antenna. Covers 0.3-30 MHz. Tune, Band, Gain, On/Off/Bypass Controls. Detachable telescoping whip. 5x2x6 in. Use 9 volt battery, 9-18 VDC or 110 VAC with MFJ-1312, \$15.95.



MFJ-1020C
\$99⁹⁵

Compact Active Antenna

Plug this MFJ-1022 MFJ all band active antenna into your receiver and you'll hear strong, clear signals from all over the world, 300 KHz to 200 MHz including low, medium, shortwave and VHF bands. Detachable 20" telescoping antenna. 9V battery or 110 VAC MFJ-1312B, \$15.95. 3 1/2"x1 1/4"x4 in.



MFJ-1022
\$69⁹⁵

Listen to maritime users, diplomats and amateurs send and receive error-free messages using various forms of TOR (Telex-Over-Radio).

Monitor Morse code from hams, military, commercial, aeronautical, diplomatic, maritime -- all over the world -- Australia, Russia, Japan, etc.

Monitor any station 24 hours a day by printing transmissions. Printer cable, MFJ-5412, \$11.95.

Save several pages of text in memory for later reading or review.

High Performance Modem

MFJ's high performance PhaseLockLoop™ modem consistently gives you solid copy -- even with weak signals buried in noise. New threshold control minimizes noise interference -- greatly improves copy on CW and other modes.

Easy to use, tune and read

It's easy to use -- just push a button to select modes and features from a menu.

It's easy to tune -- a precision tuning indicator makes tuning your receiver easy for best copy.

It's easy to read -- front-mounted 2 line 16 character LCD display has contrast adjustment.

Copies most standard shifts and speeds. Has

MFJ AutoTrak™ Morse code speed tracking.

Use 12 VDC or use 110 VAC with MFJ-1312D AC adapter, \$15.95. 5 1/2"Wx2 1/2"Hx5 1/4"D inches.

WiFi Yagi Antenna -- 15 dBi 16-elements extends range



16-element, 15 dBi WiFi Yagi antenna greatly extends range of 802.11b/g, 2.4 GHz WiFi signals. 32 times stronger than isotropic radiator. Turns slow/no connection WiFi into fast, solid connection. Highly directional -- minimizes interference.

N-female connector. Tripod screw-mount. Wall and desk/shelf mounts. Use vertically/horizontally. 18Wx2 3/4"Hx1 1/4"D inches. 2.9 ounces.

MFJ-5606SR, \$24.95. Cable connects MFJ-1800/WiFi antennas to computer.

Reverse-SMA male to N-male, 6 ft. RG-174.

MFJ-5606TR, \$24.95. Same as MFJ-5606SR but Reverse-TNC male to N-male.



Eliminate power line noise!

Completely eliminate power line noise, lightning crashes and interference before they get into your receiver! Works on all modes -- SSB, AM, CW, FM, data -- and on all shortwave bands. Plugs between main external antenna and receiver. Built-in active antenna picks up power line noise and cancels undesirable noise from main antenna. Also makes excellent active antenna.

MFJ Antenna Matcher

Matches your antenna to your receiver so you get maximum signal and minimum loss. MFJ-959C Preamp with gain control boosts weak stations 10 times. 20 dB attenuator prevents overload. Select 2 antennas and 2 receivers. 1.6-30 MHz. 9x2x6 in. Use 9-18 VDC or 110 VAC with MFJ-1312, \$15.95.

High-Gain Preselector

High-gain, high-Q receiver preselector covers 1.8-54 MHz. Boost weak signals 10 times with low noise dual gate MOSFET. Reject out-of-band signals and images with high-Q tuned circuits. Push buttons let you select 2 antennas and 2 receivers. Dual coax and phono connectors. Use 9-18 VDC or 110 VAC with MFJ-1312, \$15.95.

Dual Tunable Audio Filter

Two separately tunable filters let you peak desired signals and notch out interference at the same time. You can peak, notch, low or high pass signals to eliminate heterodynes and interference. Plugs between radio and speaker or phones. 10x2x6 inches.



MFJ-1026
\$199⁹⁵



MFJ-959C
\$119⁹⁵



MFJ-1045C
\$89⁹⁵



MFJ-752C
\$119⁹⁵

MFJ Shortwave Headphones



Perfect for shortwave radio listening for all modes -- SSB, FM, AM, data and CW. Superb padded headband and ear cushioned design makes listening extremely comfortable as you listen to stations all over the world! High-performance driver unit reproduces enhanced communication sound. Weighs 8 ounces, 9 ft. cord. Handles 450 mW. Frequency response is 100-24,000 Hz.

MFJ-392B
\$24⁹⁵

High-Q Passive Preselector

High-Q passive LC preselector boosts your favorite stations while rejecting images, intermod and phantom signals. 1.5-30 MHz. Preselector bypass and receiver grounded positions. Tiny 2x3x4 in.

Super Passive Preselector

Improves any receiver! Suppresses strong out-of-band signals that cause intermod, blocking, cross modulation and phantom signals. Unique Hi-Q series tuned circuit adds super sharp front-end selectivity with excellent stopband attenuation and very low passband loss. Air variable capacitor with vernier. 1.6-33 MHz.



MFJ-956
\$69⁹⁵



MFJ-1046
\$119⁹⁵

MFJ Shortwave Speaker

This MFJ ClearTone™ restores the broadcast quality sound of shortwave listening. Makes copying easier, enhances speech, improves intelligibility, reduces noise, static, hum. 3 in. speaker handles 8 Watts. 8 Ohm impedance. 6 foot cord.



MFJ-281
\$12⁹⁵

MFJ All Band Doublet

102 ft. all band doublet covers .5 to 60 MHz. Super strong custom fiberglass center insulator provides stress relief for ladder line (100 ft.). Authentic glazed ceramic end insulators and heavy duty 14 gauge 7-strand copper wire.



MFJ-1777
\$59⁹⁵

MFJ Antenna Switches

MFJ-1704 \$79⁹⁵ MFJ-1702C \$39⁹⁵



MFJ-1704 heavy duty antenna switch lets you select 4 antennas or ground them for static and lightning protection. Unused antennas automatically grounded. Replaceable lightning surge protection. Good to 500 MHz. 60 dB isolation at 30 MHz. MFJ-1702C for 2 antennas.

Morse Code Reader

Place this MFJ-461 pocket-sized MFJ Morse Code Reader near your receiver's speaker. Then watch CW turn into solid text messages on LCD. Eavesdrop on Morse Code QSOs from hams all over the world!



MFJ-461
\$89⁹⁵

MFJ 24/12 Hour Station Clock

MFJ-108B, \$21.95. Dual 24/12 hour clock. Read UTC/local time at-a-glance. High-contrast 5/8" LCD, brushed aluminum frame. Batteries included. 4 1/2"Wx1Dx2H inches.



MFJ-108B
\$21.95

Dealer/Catalog/Manuals

Visit: <http://www.mfjenterprises.com> or call toll-free 800-647-1800

• 1 Year No Matter What™ warranty • 30 day money back guarantee (less s/h) on orders direct from MFJ

MFJ MFJ ENTERPRISES, INC.
300 Industrial Pk Rd, Starkville, MS 39759 PH: (662) 323-5869
Tech Help: (662) 323-0549

FAX: (662) 323-6551 8-4:30 CST, Mon.-Fri. Add shipping. Prices and specifications subject to change. (c) 2010 MFJ Enterprises, Inc.

POPULAR COMMUNICATIONS

EDITORIAL STAFF

Richard Fisher, KI6SN, Editor

(E-mail: editor@popular-communications.com)

Jason Feldman, Editorial Assistant

(E-mail: jason@popular-communications.com)

Richard S. Moseson, W2VU, Editorial Director

(E-mail: w2vu@popular-communications.com)

CONTRIBUTING EDITORS

Peter J. Bertini, K1ZJH, Restoration/Electronics

Kent Britain, WA5VJB, Antennas And Accessories

Bruce A. Conti, AM/FM Broadcasts

Rob de Santos, Trends In Technology

Gerry L. Dexter, Shortwave Broadcast

Mitch Gill, NA7US, Homeland Security

Tomas Hood, NW7US, Propagation

Shannon Huniwell, Classic Radio

Kirk Kleinschmidt, NTØZ, Amateur Radio

Mark Meece, N8ICW, Military Monitoring

D. Prabakaran, News

Bill Price, N3AVY, Humor/Communications

Ken Reiss, Technical/Scanning

Dan Srebnick, K2DLS, Computers And Radio

Bob Sturtevant, AD7IL, Puzzles And Trivia

Tom Swisher, WA8PYR, Civil Aviation

Jason Togyer, KB3CNM, Cartoons

Gordon West, WB6NOA, General Radio Comm.

BUSINESS STAFF

Richard A. Ross, K2MGA, Publisher

Chip Margelli, K7JA, Advertising Manager

Emily Leary, Sales Coordinator

Sal Del Grosso, Accounting Manager

Doris Watts, Accounting Department

CIRCULATION STAFF

Melissa Gilligan, Operations Manager

Cheryl DiLorenzo, Customer Service Manager

Ann Marie Auer, Customer Service

PRODUCTION STAFF

Elizabeth Ryan, Art Director

Barbara McGowan, Associate Art Director

Dorothy Kehrwieler, Production Director

Emily Leary, Production Manager/Webmaster

Hal Keith, Technical Illustrator

Larry Mulvehill, WB2ZPI, Photographer

A publication of



CQ Communications, Inc.
25 Newbridge Road
Hicksville, NY 11801-2953 USA

Popular Communications (ISSN-0733-3315), Vol. 29, No. 10 published monthly by CQ Communications, Inc., 25 Newbridge Road, Hicksville, NY 11801. Telephone (516) 681-2922. FAX (516) 681-2926. Web Site: <http://www.popular-communications.com/> Periodicals Postage Paid at Hicksville, NY and at additional mailing offices. Subscription prices (payable in U.S. dollars): Domestic—one year \$32.95, two years \$58.95, three years \$85.95. Canada/Mexico—one year \$42.95, two years \$78.95, three years \$115.95. Foreign Air Post—one year \$52.95, two years \$98.95, three years \$145.95.

U.S. Government Agencies: Subscriptions to Popular Communications are available to agencies of the United States government, including military services, only on a cash with order basis. Requests for quotations, bids, contracts, etc. will be refused and will not be returned or processed.

Entire contents copyright © 2011 by CQ Communications, Inc. Popular Communications assumes no responsibility for unsolicited manuscripts, photographs, or drawings. Allow six weeks for change of address or delivery of first issue.

Printed in the United States of America.

POSTMASTER: Send address changes to Popular Communications, 25 Newbridge Road, Hicksville, NY 11801.

EDITORIAL

Tuning In

Confessions of a Pop'Comm Newbie

For more than 50 years, communications has been a central part of my life: SWLer at age seven. TV DXer at 9. Crystal set and regenerative receiver builder at 10. AM radio pirate at 12 (*shhhhhhhhh*). Licensed radio amateur at 14. FM board op and announcer in college. Communications writer and editor in a journalistic life.

True, it's not exactly the kind of autobiography you blurt out to pick up chicks in a bar. But here I find myself at the editor's desk of *Popular Communications*—a huge fan for years. *Somebody pinch me*. What an honor and privilege.

To all who have sent messages of congratulations, many thanks. To *Pop'Comm's* outstanding writing, editing, sales and production staffs, for rolling with my first-issue jitters: Sincere appreciation.

To my predecessor, Edith Lennon, N8ZRW, for setting this beautiful table: *I owe you — big time*.

And to you, the reader, I'm *so glad* you're along for this *Pop'Comm* ride.

On a moonless night about 15 years ago, Ralph Irons, N7RI, and I were taking a break from the rigors of ARRL Field Day, stretched out on a couple of picnic benches in the mountains above Los Angeles. Talking about how much we love this stuff.

"Ya'know," he said, as we gazed into the Milky Way, "sometimes I tune the AM radio to a spot between the local stations and listen. Not for signals. I listen to *the band*. The *atmospherics*. They're a thing of beauty."

After confessing — *not too loudly* — I do the same thing, I raised on an elbow: "So I'm not so nuts after all?"

"Yes, you are," Ralph replied. "But ain't it *great* being crazy?"

NEW: Pop'Comm On the Web Blog

With *Popular Communications* coming out once a month, it's nice to have a place to quickly update stories, carry breaking communications news, post clarifications or amplifications to pieces that have previously appeared, provide links to additional content and so on.

We've created that place with *Pop'Comm On the Web*, a blog *sidekick* to the printed magazine, giving readers great coverage in both the pulp and digital worlds.

by Richard Fisher, KI6SN

editor@popular-communications.com

Access couldn't be easier. Online, simply go to: < <http://www.PopCommMagazine.blogspot.com> >. No sign-up. No registration. No third degree. *It's free*.

We suggest you add *Pop'Comm On the Web* to your Bookmarks or Favorites list, putting you just one click away from a happy landing there every time.

NEW: Pop'Comm Now Tweeting On Twitter

Facebook has been a vacation home for *Popular Communications* readers for quite a while. *Gosh*, there are more than 1,000 of you following us there already: < <https://www.facebook.com/PopComm> >. If you haven't gotten on board, we'd love to have you join us.

In the effort to further expand our Web presence even more, we've now added Twitter to *Pop'Comm's* digital portfolio. Visit: < <http://www.twitter.com/PopCommMagazine> >. You're welcome to follow us there, as well. *We don't want you to miss a thing*.

NEW: Monthly Pop'Comm Live Internet Online Chat

As you might imagine, feedback from readers is extremely important to us. We want to make a good magazine even better by regularly hearing what you have to say about *Popular Communications*. So, each month I'll be hosting the *Pop'Comm Live Internet Online Chat* — bringing readers, columnists and the editor together in the chat-o-sphere. I promise it will be casual and friendly.

Taking part couldn't be easier. Go to the *Pop'Comm On the Web* blog: < <http://www.PopCommMagazine.blogspot.com> >. At chat time, click the *Cover It Live* box appearing on the page. Sign-in and you'll be transported to the chat area.

Our inaugural chat will be **Sunday, June 5**, beginning at **4 p.m. Eastern time (2000 UTC)**. Radio fans from around the world are encouraged to join in.

For now, please save the date and sign up for an email reminder on the *Pop'Comm* blog, compliments of *Cover It Live*. Hope to see you June 5.

— Richard Fisher, KI6SN

Icom has the receivers for the experts...

IC-R9500 The Ultimate Wide Band Receiver

- 0.005–3335.000MHz*
- USB, LSB, CW, FSK, FM, WFM, AM
- 1020 Alphanumeric Memory Channels
- P25 (Option UT-122)
- Five Roofing Filters and so much more!



For those just getting started...



IC-R75 Wide Band Receiver

- 0.03–60.0 MHz*
- Triple Conversion
- Twin Passband Tuning
- Digital Signal Processing (DSP)

AND for those on the go!

IC-R20 Advanced Ops

- RX: 0.150–3304.999MHz*
- AM, FM, WFM, SSB, CW
- 1250 Alphanumeric Memory Channels
- Dualwatch Receive
- 4-hour Digital Recorder



IC-RX7 Track Ready

- RX: 0.150–1300.0MHz*
- AM, FM, WFM
- 1825 Alphanumeric Memory Channels
- 100 Ch/Second High Speed Scan
- Computer Programmable²
- Water Resistance Equivalent to IPX4



IC-R6 Pocket Compact

- RX: .100–1309.995MHz*
- AM, FM, WFM
- 1300 Alphanumeric Memory Channels
- 100 Ch/Second High Speed Scan
- Computer Controllable¹



IC-R2500 2 Wide Band RX in 1 Black Box

- 0.01–3299.99 MHz*
- AM, FM, WFM, SSB, CW (Main)
- AM, FM and WFM (Sub)
- 1000 Memory Channels
- Optional D-STAR (UT-118)
- Optional P25 (UT-122)
- Optional DSP (UT-106)
- PC Controllable



*Frequency specs may vary. Refer to owner's manual for exact frequency specs. ¹Optional CT-17 required. ²Optional CS-RX7 required.
©2011 Icom America Inc. The Icom logo is a registered trademark of Icom Inc. All specifications are subject to change without notice or obligation. 30568

The Weirder Side of Wireless

by Staff

Mystery: Man Found Dead Atop WWJ-TV Tower

The discovery of a man's lifeless body on top of the 1,000-foot-tall WWJ-TV antenna tower has authorities in the Detroit suburb of Oak Park baffled as to how he got there and why he was wearing only a T-shirt and underpants — “despite the strong winds and freezing temperatures at such a height.”

According to a report by the *Daily Mail* (United Kingdom) and posted on MailOnline, “an autopsy is due to take place that detectives hope will determine how the man died and who he was. They did say, however, that his corpse bore no obvious signs of violence.”

The story reported that Oak Park Public Safety Sgt. Jason Ginoplis told Fox News his office had received a call from workers saying they had found a deceased male at “the very top of the tower.”

“Because of the precarious position of the cadaver,” the MailOnline story explained, “its recovery was a complicated process, involving three teams from the Oakland County Technical Rescue Team, the Independence Township, Pontiac Fire Department and Southfield Fire Department.”

According to Southfield Fire Chief Peter Healy, it was a high-angle recovery, “so technicians (went) up the elevator and climbed up the final approximately 45 feet to the level that the deceased (was) at,” the story said. For the full MailOnline report, visit: < <http://bit.ly/gCKoFw> >.

'Dumb, Dumber, Dumberest'

A 25-year-old Pittsburgh-area man qualified as a candidate for WDXD's morning show's “Dumb, Dumber and Dumberest” weekly highlight segment recently after he told hosts during an on-air call he was high.

Among the broadcast's listeners: The police.

Citations ensued after Michael Hegland, Irwin, Pennsylvania, called “The X” morning show and told host Bob McLaughlin, “he was pulled over for a brake light violation and was cited for not changing the address on his driver's license,” according to the *Pittsburgh Tribune-Review*. “Hegland said the officer who pulled him over told him if (Hegland) updated his license within two days, the citation would be dropped,” the story reported.

“I had to get my change of address on my license within two days, which I did and now, it's like, well how do I get a hold of (the officer) because he's not on duty?” Hegland asked McLaughlin, who went on to give him some simple advice: “Go to the police station with your paperwork and just turn it in,” the *Tribune-Review* reported. “Do me a favor, though,” McLaughlin reportedly said. “When you go . . . don't be as high as you are right now.” Hegland allegedly

responded: “Hey, they're going to have to deal with it.”

Long story short: The police heard the show and were eager to talk with Hegland — “who reeked of marijuana” — when he arrived at the police station, they said.

Hegland was ultimately cited for possession of a small amount of marijuana and possession of drug paraphernalia, “but was released after (the police chief) determined (Hegland) was not really under the influence.”

The station's website posted a podcast of Hegland's call and named it “Dumberest of ALL time — Irwin,” the *Tribune-Review* said.

To see the full story on the *Pittsburgh Tribune-Review* website, visit: < <http://bit.ly/ehY66K> >.

Led Zeppelin, Not: 'Wireless to Heaven'

OK, we've been long accustomed to hearing songs *on* the radio. It's not all that often, though, we hear songs *about* the radio.

Well, 90 years ago Irving Kaufman recorded *I Wish There Was a Wireless to Heaven* singing lyrics by Joseph Manuel and Harry White. Willy White wrote the music. (*No, it's not even close to Zeppelin's "Stairway to Heaven."* — Ed.)

Back in 1921, listeners were treated to this little ditty, whose chorus went like this:

*I wish there was a "Wireless" to Heaven
And I could speak to Mama ev'ry day,
I would let her know, by the Radio,
I'm so lonesome since she went away.
I wish that I could only send a message,
And hear my Mama answer me and say,
"Hush a bye my darling, dry your tears,
don't cry,
Mama dear is watching baby from the sky."
I wish there was a "Wireless" to Heaven,
Then Mama would not seem so far away.*

(For a link to hear the song in its entirety, visit Popular Communications' new online blog: *Pop'Comm On the Web*: < <http://www.PopCommMagazine.blogspot.com> > — Ed.)

Wanted: Your 'Unwired Tip of the Month'

Have you had a close encounter of the “Unwired” kind? Or heard about one? If so, drop us an email with details and we'll consider including your item in an upcoming column.

Of course, we'll credit you with the *Unwired Tip of the Month*. Think of it: Your name in print to show all your friends. Write: < editor@popular-communications.com >.

News, Trends, And Short Takes

by D. Prabakaran

Ford Plans DAB for All Its British Vehicles By The End of 2012

The Ford Motor Co./United Kingdom has pledged to make DAB digital radios standard across its range of vehicles by the end of 2012 — one year earlier than the industry-wide agreement. The new Ford Focus has been launched with DAB radio as standard, because Ford believes it will tempt buyers who are wary of the theoretical 2015 date for all FM broadcasts to be ended. It now plans to extend that policy.

(Source: *whatcar.com*)

Real Media Format No Longer Available from BBC World Service

Since the end of March, users of the BBC World Service can no longer watch videos or listen to its audio in Real Media format. All BBC broadcasts continue to be available in Windows Media and Flash.

BBCworldservice.com had been providing audio broadcasts in Real Media format since 1998. However, the use of this format has been in steady decline since the launch of Windows Media streams in 2003. With the introduction of Flash audio and video in 2008, Real Media has become the least used format. The BBC says that at its current level of use, it is becoming increasingly difficult and expensive to continue to support it.

This decision follows the BBC's announcement in October 2009 of the phase out of the use of Real Media in the UK — completed on March 31, 2010. The BBC is now ending its Real Media broadcasts internationally. There will be a phased approach to this process, starting with the live and on-demand streams that began March 14.

(Source: *BBC World Service*)

Radio Nepal to Reduce Height of Khumaltar Tower

Radio Nepal is lowering the height of its Khumaltar-based transmitter tower to ensure aircraft safety. The tower stands in the way of planes' take-off route. It will reduce its tower's height to 45 meters (148 feet) from its existing 97 meters (318 feet). The height has been creating trouble as it is on the secondary air route of Tribhuvan International Airport (TIA).

Radio Nepal and Qatar Airways recently reached a height-reduction agreement. Air crews are compelled to fly carrying less weight than capacity since they have to gain altitude within a couple of minutes of take-off due to be clear of the radio tower.

The Radio Nepal Khumaltar transmitting station has three, 100-kilowatt shortwave transmitters.

(Source: *Himalayan News Service*)

BBC World Service to Retain Hindi Evening Broadcast

On January 26, the BBC announced closure of its news and current affairs radio programming in Hindi following its Spending Review 2010 settlement. Since the announcement, there has been much public discussion of the potential for retaining some of this service and the BBC has been approached by a number of commercial parties with alternative funding proposals.

In order to explore these proposals further, BBC World Service has decided to retain an interim, one-hour evening news and current affairs broadcast in Hindi for Indian audiences. This broadcast will be available on all platforms — via shortwave, online and mobile. If sustainable commercial funding for this service cannot be found during the 2011/12 financial year, it will then have to close by March 2012, authorities said.

(Source: *BBC World Service Publicity*)

Ethiopia Steps Up Selective Jamming of VOA

Ethiopia has detained dozens of political activists as part of what opposition groups say is a crackdown aimed at preventing a North African or Middle Eastern-style popular uprising. Bekele Gerba, deputy leader of the Oromo Federalist Democratic Movement, says recent Voice of America (VOA) broadcasts have been audible, except for loud noises that disrupt the signal when political issues are discussed. There are experts standing by to jam the airwaves every time there is a political issue. Immediately the jamming starts. It has become virtually impossible to listen to the VOA on the radio. It is only possible on the Arabsat satellite.

VOA last year began broadcasts to Ethiopia by the Arabsat satellite after Prime Minister Meles authorized jamming its shortwave radio signals. The VOAnews.com web site is also blocked to Ethiopian Internet users. VOA is the only international radio service broadcasting in three main Ethiopian languages: Amharic, Afan Oromo and Tigrigna.

Commando Solo in Use on 6877 kHz to Libya

USAF EC-130J STEEL 74 has been transmitting on 6877.0 kHz to Libya. A recorded message

(Continued on page 68)

Capitol Hill And FCC Actions Affecting Communications

Alleged New Jersey FM 'Pirate' Slapped With \$10,000 FCC Fine

by Richard Fisher, KI6SN

The Federal Communications Commission has issued a Notice of Apparent Liability to an alleged New Jersey pirate radio operator, leveling a \$10,000 fine for illegal transmissions on 102.3 MHz FM.

Acting on an interference complaint in April 2010, Enforcement Bureau agents from the New York office visited the station of Bernabe Moreno in Passaic, finding broadcasting in progress. Moreno told agents he owned and operated the station, subsequently shutting it down at the direction of the authorities.

In its conclusion, the FCC determined that "because Mr. Moreno operated the station knowingly, we find that the apparent violation was willful. Because the operation occurred on more than one day (April 3 and 7), we find the apparent violation was repeated," therefore willfully and repeatedly violating Commission rules "by operating radio transmission equipment without required authorization."

Moreno was given 30 days to appeal the FCC decision.

(For a link to the text of the FCC's NAL against Bernabe Moreno, visit Popular Communication's new online blog, Pop'Comm On the Web: <<http://www.PopCommMagazine.blogspot.com>>. - Ed)

Some NPR Stations Report Spike in Donations

With Congress' threat to eliminate federal funding to support National Public Radio, some station managers are reporting increases in donations from listeners, according to a report on RadioInk.com.

"We spoke to Tim Eby who is the General Manager of St. Louis Public Radio KWMU," the Web site reported. "He tells us his recently completed campaign did very well, including a high number of first-time contributors . . . 'One of the objectives of our on-air campaigns is to hear from first-time contributors and 38 percent of our donors were giving to the station for the first time making this a very successful campaign,'" Eby said. "We were hoping to receive \$500,000 in pledges and ended up with a little more than \$520,000 from more than 4,200 contributors."

RadioInk reported, as well, that WTEB Public Radio in North Carolina "recently completed nine-days-worth of fundraising. Assistant General Manager Jill McGuire told the Jacksonville Daily news the station "got a lot of new members — people who were stepping up to the plate," in response to its message: "We had lost money already. And, we were saying that, also, the future of it is in question." The station raised \$180,000.

At WGCU in southwestern Florida, General Manager Rick Johnson told RadioInk that its October and February membership drives "were very successful. We had budgeted pledge goals of \$150,000 for each and both of them came in at \$200,000."

Eby told RadioInk it is difficult to know if listeners were responding to Congress' attempt to strip funding to NPR. The RadioInk report speculated, "it could be another sign that the economy is moving into positive territory. It could also mean that voters are not in favor of elected officials meddling with National Public Radio and they are speaking with their wallets." *(To visit RadioInk on the Web: <<http://www.RadioInk.com>>. - Ed.)*

NAB Blasts White House Over 'Performance Fees'

A recommendation in a 17-page document titled the *Administrations' White Paper on Intellectual Property Enforcement Legislative Recommendations* has the National Association of Broadcasters up in arms: "The Administration recommends that Congress create a right of public performance for sound recordings transmitted by over-the-air broadcast stations."

Specific language from the White Paper stipulates: "Historically, in the U.S., there has been no right of public performance for sound recordings transmitted by over-the-air broadcast stations.

"The absence of such a right puts U.S. copyright owners at a disadvantage internationally. They are not permitted to collect overseas royalties because they are not granted rights in the U.S. The U.S. stands alone among industrialized nations in not recognizing a public performance right in sound recordings. The Administration recommends legislation giving sound recording owners that right."

"This is hardly a new policy position from the White House," the NAB quickly responded, underscoring the organization "remains unalterably opposed to legislation creating an onerous, job-killing fee on America's hometown radio stations without offsetting provisions and benefits that recognize the unparalleled promotional value of radio airplay," according to a Web posting on RadioInk.com.

The NAB offered a legislative package addressing the issue in 2010, "which was summarily rejected by the musicFirst Coalition," the organization said. "Our offer still stands."

(For links to the full text of the White House White Paper and to the NAB's 2010 legislative package, visit Pop'Comm On the Web: <<http://www.PopCommMagazine.blogspot.com>>. - Ed.)



GRECOM

PSR-800 EZ Scan **Digital P25 Scanning Receiver** **Scanning just got easier!**

2011
Dayton Hamvention
Please visit GRE at
booth #451-454
May 20-22nd

*The first scanner that lets you hear what you want to hear
without knowledge of local communication systems!*

- ▶ Select only the local systems you want to monitor!
- ▶ Special requests? No problem – you can add favorite frequencies with the included PC software.
- ▶ The PSR-800 combines simple controls like those used in an MP3 player with the power and sophistication of a state-of-the-art scanning receiver!
- ▶ Designed to provide unprecedented ease of use, for beginners and experts!
- ▶ Includes a 2GB micro SD Card equipped with a special onboard library containing the entire USA and Canada database for all known digital & analog trunking systems and many conventional frequencies.
- ▶ Record up to 50hrs of Incoming Transmissions on to the 2GB MicroSD Memory card with expanding capacity of up to 32GB.
- ▶ The media player type menu allows you to instantly access trunking systems and conventional frequencies used by Public Safety, Government, and Businesses throughout the United States (and Canada) without training, without a manual - even if you have never operated a scanner before.
- ▶ Select your state, your county and view a list of objects you can monitor. Select the boxes of the items you want to hear. It is very much like using a MP3 player - that is, if you could buy an MP3 player with all music already installed!

NEW!

**Visit your favorite GRE dealer today
to find out more about the PSR-800!**

GRE

GRE AMERICA INC.
425 Harbor Blvd, Belmont, CA 94002

www.greamerica.com

Digital Radio: Where We Are and Where We're Headed

by Rob de Santos, K8RKD
commhorizons@gmail.com
Twitter: @shuttleman58

Digital radio is no longer new — but where is it going? First, it's probably worth taking stock of where we are. In the broadcast world, we have an alphabet soup of standards: DAB, DAB+, DRM, DRM+, HD Radio (IBOC) and other modes in satellite and Internet-delivered radio.

In the ham world, there is D-STAR, P25 and so on.

Here, I'll be concentrating on digital voice over the air but I acknowledge there are modes such as PACKET, RTTY, etc.

So, here's the question: *What's next and will digital radio ever be the default mode?*

On the Commercial Scene

Broadcast radio has struggled to face the digital revolution. It would be fair to say that nowhere on the planet has digital radio achieved critical mass or overtaken analog forms of broadcasting.

In part, the sheer size of the analog broadcast world and the number of transmitters and receivers, which are analog-only, has all but guaranteed the transition would be slow. However, even in North America, Europe, Australia and Japan the transition has been plagued with missteps, customer resistance and rapid obsolescence.

If we take a look at the state of HD-Radio in the U.S. and Digital Audio Broadcasting (DAB) in the United Kingdom — arguably the most successful implementations — you would probably conclude that we are still a long way from a digital-only world.

It's quite likely that the analog and digital systems will coexist for at least another eight to 10 years in one form or another. There is an argument that HD on the mediumwave bands has mostly failed in the U.S. as the number of stations adopting it has reached a plateau and perhaps has started to decline.

In the UK, there is an active *anti-digital* movement opposed to the end of analog broadcasting. The failure of DAB in Canada, for example, means that it will be many years before that country can consider the end of analog broadcasting.

In Australia, the use of digital is just now beginning to advance far enough to have a discussion on the future of analog radio. In shortwave, Digital Radio Mondiale (DRM) has struggled with minimal to nonexistent support by radio manufacturers and few hours broadcast outside of Europe.

As we have already seen with DAB and DAB+ in the UK, there is little room for upward compatibility with improved technology should modes that are more advanced be devised. This is partly because of cost, but also because most implementations include chip-based codecs and that the radios sold to date are not upgradable, for the most part.

The lack of foresight in this regard is a major failure on the part of the radio industry and regulatory

agencies. Regulatory agencies do not seem inclined, as has happened in television, to set *sunset* dates for analog broadcasting. Whether this will change with increased spectrum pressure isn't clear.

The biggest driver for digital radio may turn out to be the digital transition driven by Internet-delivered radio. As non-broadcast modes of delivery become more important, the pressures to maintain analog delivery of the signal will decline. That may give both broadcasters and regulators more ability to manage a transition away from analog.

What About the Ham Bands?

On the amateur radio side, where the experimenters often were leaders in radio technology in the past, digital voice modes have been slow to appear and take hold. In part, this is because of the need for specific modes to be developed free of patent issues and manufacturers to implement them once invented.

Manufacturers want a stable standard and reasonable hardware costs. D-STAR has struggled to gain a foothold partly because the only chip implementations are proprietary at this point. The significant price premium of the radios over those without D-STAR support has hampered adoption by amateur radio operators.

Outside of Japan, only one major manufacturer has adopted D-STAR. Repeaters are more expensive to setup than analog repeaters. As long as prices remain high, it is unlikely D-STAR will move forward.

Will digital voice modes become common in ham radio? I think they will, but we probably haven't seen the digital modes that will make it happen. Given the long history of invention by hams, why has this been the case? There are several possible explanations.

One that's obvious is the difficulty of devising an open standard and implementing it on a chip. Hams with more experience in the computer world are probably most likely to be able to do this.

Moreover, whatever is invented has to be economical and probably open source in order to get manufacturers to implement it on the chips inside most modern radios. The chicken and egg argument comes to mind here: *Demand for digital modes first or radios with digital modes first?*

The growth of Software Defined Radios or SDRs should help with this — at least in the shack but not as quickly with handhelds.

We're in a digital world and that isn't going to change. It is probably inevitable that this will invade your listening.

Do you listen to digital radio now? Do you plan to invest more in digital listening or transmitting?

Let me know the digital or analog method of your choice.

Until next month . . .

Uniden®

The **HOMEPATROL** is unlike any scanner you've ever had.

Talk about easy...how about simply entering your zip code or city on the touchscreen and you're there.

Connect an optional GPS receiver and the **HOMEPATROL** automatically selects channels for your precise area even as you move area to area.

Call or go online to get all the details.



HOMEPATROL
SIMPLY INFORMED



Revolutionary Not Evolutionary

To Order Call 1-800-USA-SCAN
www.usascan.com

**COMMUNICATIONS
ELECTRONICS INC.**
Emergency Operations Center

PO Box 1045, Ann Arbor, MI 48106-1045, USA

For Information Call 734-996-8888
Fax 734-663-8888

Tune In Our National Parks This Summer

Take Your Scanner With You and Hear Rangers, Lodges, Fire Crews and So Much More . . .

by Chuck Gysi, N2DUP



Grand Canyon National Park is one of the most scenic parks in the United States.
(Courtesy of National Park Service)

The natural beauty and history in our National Park System comes in all shapes and sizes. From the tiny 0.02-acre — yes, *two hundredths of an acre* — Thaddeus Kosciuszko National Memorial in Philadelphia, to the expansive 13.2 million-acre Wrangell-St. Elias National Park and Preserve in Alaska, there are nearly 400 national parks, preserves, recreation areas, monuments and more.

Every National Park Service site uses radio frequencies for a variety of purposes, depending on the nature of the facility. Smaller national parks may share one channel for rangers and various operations, while the largest of the parks may have many frequencies, including those used by fire teams, concessions, aircraft and so on.

Frequencies, Modes 'All Over the Map'

Because the National Park Service is a federal agency, there is no central depository of the frequencies used in our parks. At one time, the database of non-sensitive federal frequencies was open to the public. But, when the database was made secret by executive order in the 1980s, listeners had to learn how to find federal frequencies on their own and share the information with each other.

Today, our National Park Service is doing much like many other agencies and businesses, switching to narrowband frequencies and employing digital technology in a lot of the cases. Right now, national parks are on a hodgepodge of analog and digital frequencies. You'll need a digital scanner in order to monitor the newer digital frequencies. In some situations, the parks have switched from analog to digital on the very same frequencies, especially smaller parks, while other, larger parks, are using new digital frequencies as they migrate away from the analog channels.

Radio Is Everywhere

My wife and I have had the opportunity to tour many of our national parks in recent years, especially those in the western part of the country. Some visits were very short, like our sunset stop at Painted Desert National Park in Arizona — beautiful, but tough to photograph! Others, such as Zion National Park in Utah and the Grand Canyon in Arizona, allowed us to take in the scenery from tour buses.

On our excursions, I learned one thing. There are radio communications to be monitored no matter where you are.

The most interesting was at Death Valley National Park in California, which dips to 282 feet below sea level while you look up at snow-capped mountains rising in the distance to almost 11,000 feet above sea level. When you are in the lower regions of Death Valley, your radio recep-

tion is more or less limited to what you can hear line-of-sight and the mountaintop repeaters for the park as well as county emergency services.

You won't receive communications from the other side of the mountains while you are in the bottom of Death Valley.

quency is a remote receive site relaying signals to a repeater.

What's That I'm Hearing?

While we haven't covered their frequencies within the confines of this article, you may also encounter federal forest fire crews on their frequencies within national parks, as well as the Bureau of Land Management, which may administer public lands near national parks.

Where else should you search for frequencies used in our national park system? The larger, more remote parks may have aircraft frequencies in use. Many helicopters give sightseeing tours of Grand Canyon National Park, and some aircraft frequencies also are used for rescue efforts. By monitoring local airport frequencies, you can keep in the know too.

Another good place to search for communications within our national parks are business frequencies used by concession operators — shops, lodges, tour buses, guided tours, wilderness operations, restaurants, bookstores and more.

Search from 151.505-151.955, 154.515-154.600, 451-453, 461-465, 467.750-467.925 and 466-470 MHz. I'd pay close attention to the itinerant business frequencies of 151.505, 151.625, 158.400, 464.500 and 464.550 MHz because concession operators in many parks use them.

You also may hear biologists or contractors using itinerant channels, and don't be surprised to find individuals and families using FRS/GMRS handheld

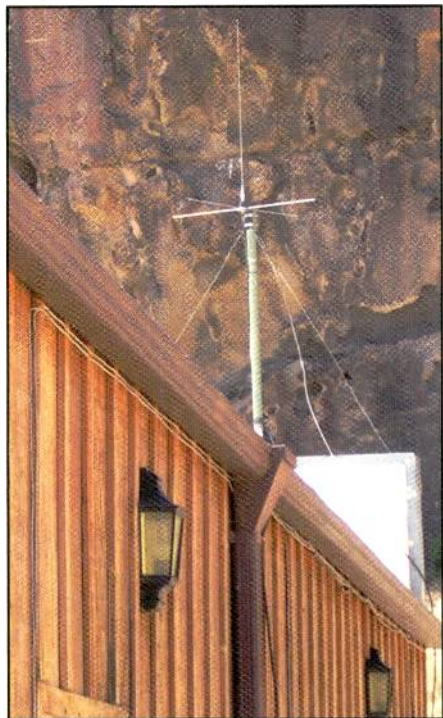

An antenna mounted on the ranger station in the Mohave National Preserve in California allows park rangers to communicate with one another throughout the preserve. (Photographs courtesy of Chuck Gysi, N2DUP/scancomm.net)

Tuning In

Where do you search for frequencies used in national parks? There are many places to search depending on what you want to hear.

Check the accompanying chart that lists frequencies in some of our more popular national parks and facilities.

At one time, most national parks communications had a tendency to show up in clustered areas, such as 166 MHz, but nowadays with narrowbanding and digital radio use, frequencies are all over the map.

Sure bets are the following VHF bands: 166-167, 168-169 and 170-174 MHz. If you want to make sure you cover all of the bases, search from 162-174 MHz exclusively for official parks communications.

There is very limited use of the 406-420 MHz federal band for national parks, and most frequencies used there only are links between repeaters or remote receivers. You won't miss anything as long as you monitor their counterpart VHF frequencies. The only real advantage to monitoring link frequencies is that you might have better reception than the main VHF channels depending where you are, especially if the UHF link fre-

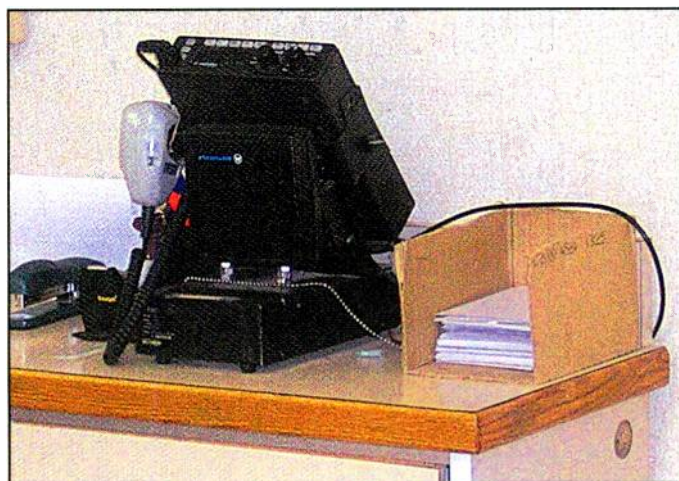

A Motorola two-way radio used by rangers as a base station is seen inside the Arches National Park visitor center in Utah. At the time this picture was taken, the radio operated analog on 172.600 MHz. The frequency's use has since been converted to digital.



A National Park Service ranger's Jeep is seen parked at Arches National Park in Utah. A long VHF whip antenna offers extended coverage while rangers are out in the park.



ANTENNA LOOP AN200

Accessory Antenna Loop for use with Other External Antenna Capable Radios

SATELLIT 750

AM/FM/Shortwave Radio with Aircraft Band, SSB (Single-Side Band) and a Rotating AM Antenna

GLOBE TRAVELER G3

AM/FM/Shortwave Digital Radio with Aircraft Band, SSB (Single-Side Band), RDS (Radio Data System) and Synchronous Detector

GRUNDIG

© Copyright 2011 Etón Corporation.
All Rights Reserved. To Order: 1.800.793.6542 | www.etoncorp.com

Start your travels

MINI 400

Super Compact AM/FM
Shortwave Radio with
Digital Display



TRAVELER II DIGITAL G8

AM/FM/Shortwave Radio with World
Time, Great for The Global Traveler



FIELD RADIO S450DLX

AM/FM/Shortwave Field Radio with
Liquid Crystal Display

Available at:

 amazon.com

 RadioShack

 THE SOURCE

 universal
radio inc.

 J&R

 eton
EMPOWERED BY NATURE

radios from 462.550-462.725 and 467.550-467.725 MHz.

Listening for Outlying Agencies

If you tune around, you may also hear surrounding public safety frequencies. County sheriff's deputies, fire departments, EMS units and highway crews all



This sign notes that motorists are 200 feet below sea level in Death Valley National Park in California. The lowest point is at 282 feet below sea level. Scanner reception at such low levels is limited to line-of-sight communications or those repeated off nearby mountains.



This sign in the middle of Death Valley National Park advertises the part-time FM broadcast station run by a local Indian tribe. Surrounded by mountains, it's difficult to hear even broadcast stations in Death Valley.

can be heard outside the national parks. In fact, in some national parks, such as Death Valley, county public safety agencies respond within the confines of the park for assistance. If you want to have your fingers on the pulse of what's going on in a national park, be sure to program in surrounding county and state police or patrol frequencies to keep in the know. Directories such as < <http://www.radioreference.com> > provide the information you need to program your scanner.

A Whole World Beyond . . .

There are many other types of frequencies we're not even touching on.

For example, discreet frequencies used to track wildlife with radio collars are possible to monitor if you are close enough to the animals. Many telemetry links relay information within national parks but don't prove to be exciting listening for most.

You also may find Travelers Information Stations broadcasting on AM or FM with essential information to park visitors. Listen around 1610 kHz on the AM band. I found an FM station that broadcasts on a part-time basis from Death Valley for an Indian tribe.

There Are Plenty of Choices

It doesn't matter what national park you are visiting. With almost 22,000 employees in the National Park Service, that means a lot of two-way radios are in use. And with 392 sites being administered by NPS, 58 of which are national

parks, you're bound to find something to monitor while you are visiting.

Program your scanner in advance or just let your scanner do the searching for you. During the summer months, national parks can become busy places and that means one thing, for sure — busy radio channels.

Busy On the Beat

A division of the National Park Service is the U.S. Park Police, which operates as a full service law enforcement agency with responsibilities and jurisdiction in those National Park Service facilities located primarily in the Washington, D.C., San Francisco (Golden Gate) and New York City areas.

The U.S. Park Police is the oldest uniformed federal law enforcement agency in the United States. Officers patrol many of the famous monuments and share law

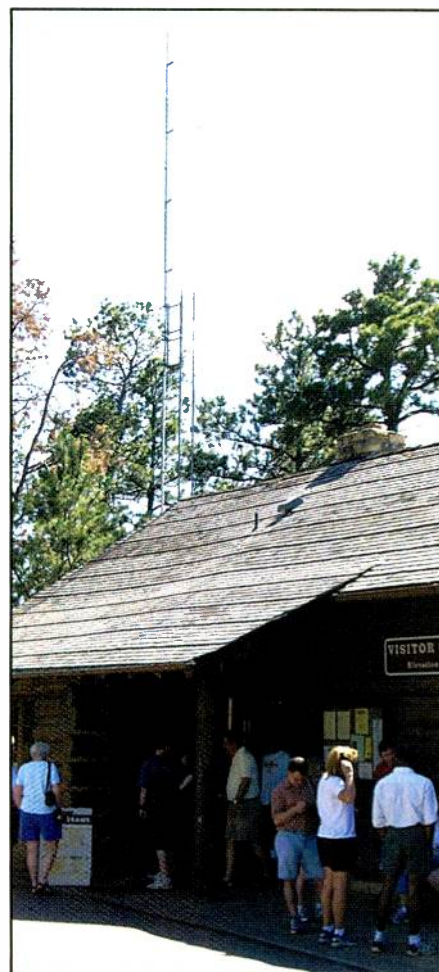

A radio tower can be seen behind the visitor center at Devils Tower National Monument in Wyoming. Devils Tower was the nation's first national monument back in 1906.

Some National Park Service Frequencies to Get You Started

Here is a list of select frequencies for *Popular Communications* readers that have been monitored at many, but not all, national parks in the United States.

This is not a complete list, nor does it include national forests. The most popular national parks have been presented here with not only frequencies used in the parks by the federal government, but also some business operations that occur within the confines of these large parks.

A "P25" indicates the frequency is being used in APCO P25 digital mode and reception requires the use of a digital scanner.

CTCSS and digital NAC codes shown can be used in conjunction with scanners that allow programming of quiet codes.

Carrier squelch indicates the absence of any quiet channel codes used on the frequency.

AM indicates AM mode used by aircraft stations.

Yellowstone National Park—Wyoming, Idaho, Montana

166.325	P25	NAC 167	North District-Washburn
165.5875		CTCSS 110.9	South District-Sheridan
164.800		Carrier squelch	Input to south repeater
165.5875		CTCSS 118.8	South District-Top Notch
166.375		CTCSS 192.8	Lamar District-Henderson
166.375		Carrier squelch	Ranger base
166.375		CTCSS 167.9	Ranger mobile
166.875		CTCSS 136.5	West
172.500		CTCSS 103.5	Fire Cache
167.150	P25	NAC 207	On-Scene
150.935		CTCSS 103.5	Wilderness Connection, Gardiner MT
151.835		Carrier squelch	Backcountry Adventures, West Yellowstone MT
464.500		CTCSS 131.8	Xanterra crew

Grand Teton National Park—Wyoming

171.675		CTCSS 146.2	Signal Mountain repeater
171.675		CTCSS 107.2	Flagg Ranch repeater
171.675		CTCSS 167.9	Gros Ventre repeater
172.425		CTCSS 123.0	Input to repeaters
172.425		Carrier squelch	Input to repeaters

Devils Tower National Monument—Wyoming

170.025	P25		Park Rangers
164.750		Carrier squelch	Rangers
168.6125		CTCSS 136.5	Rangers work

Glacier National Park—Montana

166.2375	P25	NAC 144	Rangers
166.375	P25	NAC 293	Operations
167.025	P25	NAC 293	Operations
170.100	P25	NAC 293	Operations
162.1625	P25	NAC 293	Operations 2
166.375		CTCSS 210.7	Talkaround
170.025	P25	NAC 293	Logan Pass
163.075		CTCSS 114.8	Logan Pass

Arches National Park—Utah

172.600	P25		Rangers patrol
171.700	P25		Rangers patrol input to 172.600
171.8125		CTCSS 67.0	Work teams north
171.8125		CTCSS 203.5	Work teams south
168.350		CTCSS 100.0	Bureau of Land Management

CC WiFi Internet Radio



Receive Your Favorite Stations*
Over 18,000 Available Worldwide

- Excellent, Clear Audio
- Works on Any Broadband Signal
- Now with Pandora
- Real, MP3, WMA Formats • 99 Presets
- Wireless or Direct Connection via Ethernet Jack, Line-Out, Headphone, Signal Strength Indicator
- No Subscription Fee

* Your favorite station must stream audio.
You must have broadband internet service.

\$139⁹⁵

C.CRANE

Free Catalog

800-522-8863 • ccrane.com

POWERPORT

PowerPort-312

12 volt, 12 amp hour rechargeable battery. 3-port DC outlets, battery status display. Padded bag with detachable accessory pockets.



831-427-8197 • KC6QLB
www.powerportstore.com

Licensed 1986 Or Before?

QCWA invites you to join with those distinguished amateurs licensed 25 years or longer. Request an application from:

QCWA, Inc., Dept. PC
PO Box 3247
Framingham, MA 01705-3247
www.qcwa.org

Stop by our booth at Dayton
May 20-22, 2011



Canyonlands National Park—Utah

166.325 P25 Operations

Capitol Reef National Park—Utah

168.575 Carrier squelch Car to car
 168.575 CTCSS 123.0 Henry Mountain repeater
 168.575 CTCSS 141.3 Rim repeater
 168.575 CTCSS 156.7 Miner's Mountain repeater

Bryce Canyon National Park—Utah

172.550 P25 NAC 532 Rangers
 172.500 CTCSS 123.0 Operations

Zion National Park—Utah

166.325 Carrier squelch Operations car to car
 166.325 CTCSS 107.2 Operations northeast
 166.325 CTCSS 123.0 Operations northwest
 166.325 CTCSS 114.8 Operations south
 172.6125 CTCSS 156.7 New channel
 168.350 Carrier squelch Tunnel operations

Mount Rushmore National Memorial—South Dakota

169.400 Carrier squelch Primary operations
 170.050 CTCSS 88.5 Secondary operations – Rangers

Badlands National Park—South Dakota

169.400 P25 NAC 293 Rangers

Mohave National Preserve—California

417.575 Rangers
 169.750 CTCSS 110.9 Providence Mountain repeater
 169.750 CTCSS 123.0 Clark repeater
 169.750 CTCSS 131.8 Christmas Tree repeater

enforcement duties with National Park Service rangers.

A Vast Landscape of Choices

From the Lincoln Memorial in Washington, D.C., to Independence Hall in Philadelphia, there are many sites to visit and monitor in the United States. In addition to urban facilities, if you are adventurous and head to the massive



A park ranger's Chevrolet Tahoe patrol vehicle is parked at the ranger station at Mohave National Preserve in California.



Park rangers assist with the loading of an ambulance near the visitor center of Devils Tower National Monument in Wyoming. Rangers there use digital radios on 170.050 MHz.

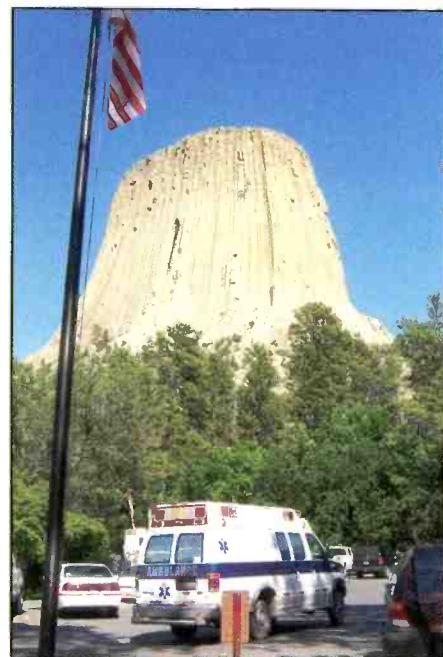

An ambulance leaves the visitor center of Devils Tower National Monument in Wyoming. The 1977 movie *Close Encounters of the Third Kind* used the formation as a plot element and as a location for its alien contact scene.



A two-way radio is mounted beneath the fan in the front of the shuttle bus at Grand Canyon National Park in Arizona.

Yosemite National Park—California

172.775		Fire
172.650	CTCSS 131.8	Mount Hoffman repeater
166.300		Valley repeater
168.6125		Tactical
168.5625		Air to ground

Petrified Forest National Park—Arizona

170.050	CTCSS 127.3	Rangers
172.050	P25 NAC 293	New rangers channel

Grand Canyon National Park—Arizona

166.350	CTCSS 123.0	Operations
166.350	Carrier squelch	Operations
170.050	CTCSS 94.8	Developmental, roads
172.575	CTCSS 127.3	Channel 5 rescue operations
164.725	CTCSS 123.0	South Rim rangers/EMS
172.450	CTCSS 123.0	Fire dispatch
169.1625	P25 NAC 293	North Rim HQ Tac
172.1125	P25 NAC 293	North Rim HQ/South Rim East Fire
171.5375	P25 NAC 293	North Rim HQ Rangers
171.650	P25 NAC 293	North Rim HQ EMS
169.650	P25 NAC 293	North Rim HQ Administrative
169.7875	P25 NAC 293	South Rim East Tac
171.650	P25 NAC 293	South Rim East Rangers
172.1375	P25 NAC 293	South Rim East EMS
169.725	P25 NAC 293	South Rim East Administrative
169.775	P25 NAC 293	South Rim West Tac
172.525	P25 NAC 293	South Rim West Fire
170.3875	P25 NAC 293	South Rim West Rangers
171.775	P25 NAC 293	South Rim West EMS
169.625	P25 NAC 293	South Rim West Administrative
123.000	AM	Grand Canyon Helicopters at airport
151.925	Carrier squelch	Lodges buses
152.945	CTCSS 179.9	Ranier Helicopter Lift
153.890	CTCSS 77.0	Lodges fire/EMS

ADVANCED SPECIALTIES INC.

Orders/Quotes 1-800-926-9HAM

www.advancedspecialties.net

**BIG
ONLINE
CATALOG**



BCD996XT
25,000 Channel Digital
Trunking Scanner



Uniden
HomePatrol
Digital
Easy To Use,
On-Screen Controls

**UNIDEN BEARCAT &
GRE DIGITAL SCANNERS
• CB • AMATEUR • RADIOS
& ACCESSORIES**

**ALINCO • YAESU • GALAXY
• GRECOM • COBRA**

(201)-VHF-2067

114 Essex Street, Lodi, NJ 07644



Closed Sunday & Monday



Since 1942

www.RFfun.com

universal
radio inc.

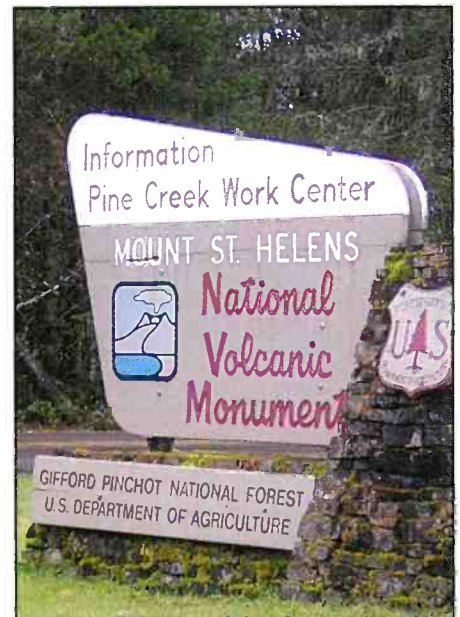

A sign for an information station is near the Mount St. Helens volcano that erupted in 1980. The area became a national volcanic monument in 1982 for research, education and recreation. The National Park Service oversees the volcano.

For ALL your monitoring needs,



AR2300 "Black Box" Professional Grade Communications Receiver

First in a new generation of software-controlled black box receivers, the AR2300 covers 40kHz to 3.15 GHz* and monitors up to 3 channels simultaneously. Remote control functions. Internal SD audio recorder allows for unattended long term monitoring. Spectrum recording with optional AR-Q software can be used for laboratory signal analysis. Using FFT, the unit scans large frequency segments quickly and accurately. Optional IP control port.

AR5001D Professional Grade Wide Coverage Communications Receiver

With amazing performance in terms of accuracy, sensitivity and speed, the AR5001D features ultra-wide frequency coverage from 40kHz to 3.15GHz* in 1 Hz steps with 1ppm accuracy and no interruptions. Large easy-to-read digital spectrum display and popular analog signal meter. The AR5001D makes it easy to monitor up to 3 channels simultaneously. Can also be controlled through a PC running Windows XP or higher. Great as a mobile or desktop receiver.



AR-Alpha with I/Q Control Software

Welcome to a new class of professional monitoring receivers. The AR-Alpha can perform unattended cataloging for extended periods and covers 10kHz to 3.3GHz* continuous, with no interruptions. It boasts a 5-inch color TFT monitor that displays spectrum bandwidth, a switchable time-lapse "waterfall" display or live video in NTSC or PAL. Five VFCs, 2000 alphanumeric memories that can be computer programmed as 40 banks of 50 channels, 40 search banks, a "select memory" bank of 100 frequencies and a priority channel. Also includes APCO-25 digital capability and can record up to 52 minutes of audio.

AR-One Communications Receiver

Enjoy total command of frequencies, modes and tuning steps with this versatile performer that allows you to control up to 99 units with a single PC. Covers 10 kHz to 3.3 GHz and delivers excellent sensitivity, ultra-stable reference frequency oscillator, high intercept, adjustable BFO and multi-IF signal output (10.7 MHz or 455kHz) plus 1000 memory channels and 10 VFOs.



AOR U.S.A., Inc.
20655 S. Western Ave., Suite 112
Torrance, CA 90501 USA
Tel: 310-787-8615 Fax: 310-787-8619
info@aorusa.com • www.aorusa.com

Specifications subject to change without notice or obligation.
*Government version, cellular blocked for US consumer version.

AOR is the Authority on Radio!



AR8200 Mark III World Class Portable Receiver

With 1,000 alphanumeric memories and a TCXC that delivers solid frequency stability and performance not found in most desktop units, the AR8200 Mark III covers 500 kHz to 3GHz* and can be used with optional internal slot cards that expand its capabilities. It features true carrier reinsertion in USB and LSB modes and includes a 3kHz SSB filter. The data port can be used for computer control, memory configuration and transfer, cloning or tape recording output. A special government version, AR8200Mark III IR, features user-selectable infra-red illumination of the display and operating keys.

AR8600 Mark II Wide-Range Desktop Receiver

With an optional P25 (APCO25) decoder module, improved front end and receive audio response, display illumination control, ultra-stable TCXO and up to four optional cards that can enhance certain functions, the AR8600Mark II covers 100kHz to 3GHz* with 1000 alphanumeric memories and free downloadable control software. Receives WFM, NFM, Super-narrow FM, Wide and Narrow AM, USB, LSB and CW.



AR-STV Handheld Video Receiver

See who is watching you or wireless video surveillance cameras. The AR-STV handheld receiver detects hidden NTSC or PAL analog video signals in real time. A valuable addition to any security operation, the AR-STV features a large 2.5 inch color LCD display and a USB connector that makes it easy to download stored images into a computer. With optional 4GB SD memory card, up to nearly 2000 images can be stored for later analysis.

SR2000A Spectrum Display Monitor

Ultra sensitive, incredibly fast, yet easy to use, the SR2000A lets you SEE received signals in FULL color. Using the power of FFT, it covers 25 MHz to 3GHz* and features a color monitor that displays spectrum bandwidth, a switchable time-lapse "waterfall" display or live video in NTSC or PAL. High quality internal speaker delivers crisp, clean audio signals. Scans 10 MHz in as little as 0.2 seconds. Instantly detects, captures and displays transmitted signals. PC control through RS232C serial port or USB interface. With 12 VDC input, it's perfect for base, mobile or field use.



Whatever the monitoring need, AOR products deliver exceptional performance for use by federal, state and local law enforcement agencies, the military, emergency managers, diplomatic service, news-gathering operations, and home monitoring enthusiasts.

157.620	CTCSS 118.8	Grand Canyon Helicopter Service
160.350	Carrier squelch	Grand Canyon Railway
467.800	Carrier squelch	Lodge paging
461.050	CTCSS 71.9	Shuttle buses

Rocky Mountain National Park—Colorado

166.350	CTCSS 110.9	East Net Channel 2
171.5375	CTCSS 110.9	Tundra
170.3875	CTCSS 110.9	Meadow Mountain
164.475	CTCSS 110.9	East Work Net Channel 7
166.300	CTCSS 123.0	West Net Channel 6
172.400	CTCSS 110.9	West Net
166.300	CTCSS 110.9	West Fire Channel 5
171.3625	Carrier squelch	West Work Net
171.3375	Carrier squelch	Work Net
168.6125	P25 NAC 389	Rangers car to car Channel 12
166.350	CTCSS 110.9	Direct Channel 1
168.350	Carrier squelch	Parking Channel 11
158.550	Carrier squelch	Direct Channel 13
168.5625	CTCSS 103.5	Maintenance Net
164.425	CTCSS 110.9	Fire Channel 8
173.9875	CTCSS 103.5	Direct - Fire

Mount St. Helens National Volcanic Monument—Washington

172.225	CTCSS 123.0	Operations
---------	-------------	------------

Great Smoky Mountains National Park—North Carolina

167.150	CTCSS 173.8	Channels 1, 2
167.150	P25	New operations
168.200	CTCSS 127.3	Channel 3 mobile
168.750		Channel 4 mobile
170.100		Channel 5 rangers
171.1625	CTCSS 173.8	Channel 6
171.1625	P25	New operations
167.050		Rangers mobile
169.0875		Rangers mobile
169.550	P25 NAC 4C5	Operations
169.950		Rangers mobile
169.0875	P25 NAC 4C5	New operations
170.5125	P25 NAC 4C5	New operations
170.3875	P25 NAC 4C5	New operations
172.5875	P25 NAC 4C5	New operations
166.350	P25 NAC 4C5	New parks liaison
169.725	P25 NAC 4C5	New operations
171.750	P25 NAC 293	New operations
172.525	P25 NAC 4C5	New operations

Everglades National Park—Florida

171.775	P25	East Everglades fire
172.425	P25	Operations
172.450	P25	Operations
172.525	P25 NAC 555	Operations
172.675	P25	Operations

Shenandoah National Park—Virginia

166.900	P25 NAC 4F9	Loft Mountain
171.700	P25 NAC 4F9	Hogback Mountain
172.650	P25 NAC 4F9	Bucks Elbow Mountain
172.675	P25 NAC 4F9	Fork Mountain

national parks in the western United States, such as Yellowstone or the Grand Canyon, you'll be treated to a lot of interesting listening outside the scope of what you monitor on a daily basis in your community.

Think of it: There are 84 million acres of National Park System properties out there to explore. With 4.5 million acres of bodies of water, 68,561 archeological sites, 27,000 historic structures, 12,250 miles of trails and 8,500 miles of roads, all you can do is get out there and turn on the scanner.

(Let us know what you find on the air this summer while visiting our national parks, monuments, memorials, recreation areas and other properties (the White House and National Mall are included in the National Park Service's catalog!). You can e-mail the author with your summer frequency finds at N2DUP@scanning1.com. - Ed.)



This sign in Yellowstone National Park, which sprawls across Wyoming, Montana and Idaho, shows the 45th parallel, or the half-way point between the North Pole and the Equator. Many radio frequencies can be heard at and around Yellowstone.

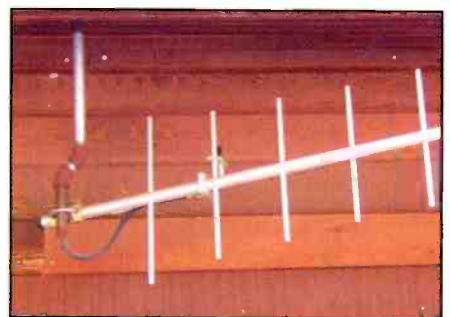

A UHF yagi antenna is seen mounted on the back of the visitor center at Zion National Park. The antenna, most likely, is for a link.

173.675	P25	NAC 4F9	Piney Hill
173.7625	P25	NAC 4F9	Big Mountain

National Park Service—Washington, D.C.

172.475	P25	NAC 4C5	Central Park Police Channel 5
168.425	P25	NAC 293	East
169.775	P25	NAC 4C5	George Washington Parkway patrols
172.750	P25	NAC 4C5	Central

Valley Forge National Park—Pennsylvania

169.550	P25	NAC 4CE	Rangers car to car
---------	-----	---------	--------------------

NOTE: Rangers dispatched on Montgomery County trunked 800 MHz system

Independence National Historic Park—Pennsylvania

164.125	P25		Operations
164.725	P25	NAC 293	Operations
164.750	P25		Maintenance crews
171.650	P25	NAC 293	Rangers and park operations

Gettysburg National Military Park—Pennsylvania

164.725	P25	NAC 585	Rangers and park operations
---------	-----	---------	-----------------------------

Statue of Liberty/Ellis Island—New York, New Jersey

166.6375	P25	NAC 4F9	Operations Channel 4
168.6125	P25	NAC 293	Tactical Channel 5
166.6375	P25	NAC 4F9	Park Police-Statue of Liberty/Ellis
166.325		CTCSS 136.5	Park Police Field Office Channel 1
167.075		CTCSS 136.5	Park Police Field Office Channel 2

Boston National Historic Park—Massachusetts

166.950	P25	NAC 109	Rangers
---------	-----	---------	---------

Hawaii Volcanoes National Park—Hawaii

168.550		Carrier squelch	Rangers/operations
---------	--	-----------------	--------------------

Denali National Park—Alaska

166.300		CTCSS 100.0	Rangers/operations
---------	--	-------------	--------------------

Kenai Fjords National Park—Alaska

166.750	P25	NAC 526	Rangers/operations
---------	-----	---------	--------------------



A National Park Service ranger boat is docked at the headquarters of the Virgin Islands National Park in Cruz Bay on the island of St. John. VHF communications are used throughout the island's national park.

CQ Books

Understanding, Building & Using Baluns & Ununs

by Jerry Sevick, W2FMI

The successor to the popular and authoritative Baluns and Ununs. Great deal of new tutorial material, and designs not in previous book, with crystal clear explanations of how and why they work.

8.5 X 11 Paperback \$19.95

New! CD Version \$14.95

Buy both for only \$29.95



The Short Vertical Antenna and Ground Radial

by Sevick, W2FMI

Small but solid guide walks you through the design and installation of inexpensive, yet effective short HF vertical antennas.

6 X 9 Paperback \$10.00



Sloper Antennas

By Juergen A. Weigl, OE5CWL

Single- and Multi-Element Directive Antennas for the Low Bands

With calculations and practical experience, this book shows which basic concepts have to be considered for sloper antennas for the low bands.

6 X 9 Paperback \$24.95

New! CD Version \$18.95

Buy both for only \$36.95



Reflections III

by Walter Maxwell, W2DU

Includes all the information in Reflections I & II and much, much more! This fully revised and updated, this 424-page, third edition is truly a must have!

8.5 X 11 Paperback \$39.95

New! CD Version \$29.95

Buy both for only \$59.95



Shipping & Handling: U.S. add \$7 for the first item, \$3.50 for the second and \$2 for each add'l item. FREE shipping on orders over \$100 to one U.S. address. CN/MX-\$15 for 1st item, \$7 for 2nd and \$3 for each add'l. All Other Countries-\$25 for 1st item, \$10 for 2nd and \$5 for each additional. Buy Both=single item!

CQ Communications, Inc.

25 Newbridge Road, Hicksville, NY 11801
Call: 1-800-853-9797 | Fax: 516-681-2926 |
website: www.cq-amateur-radio.com

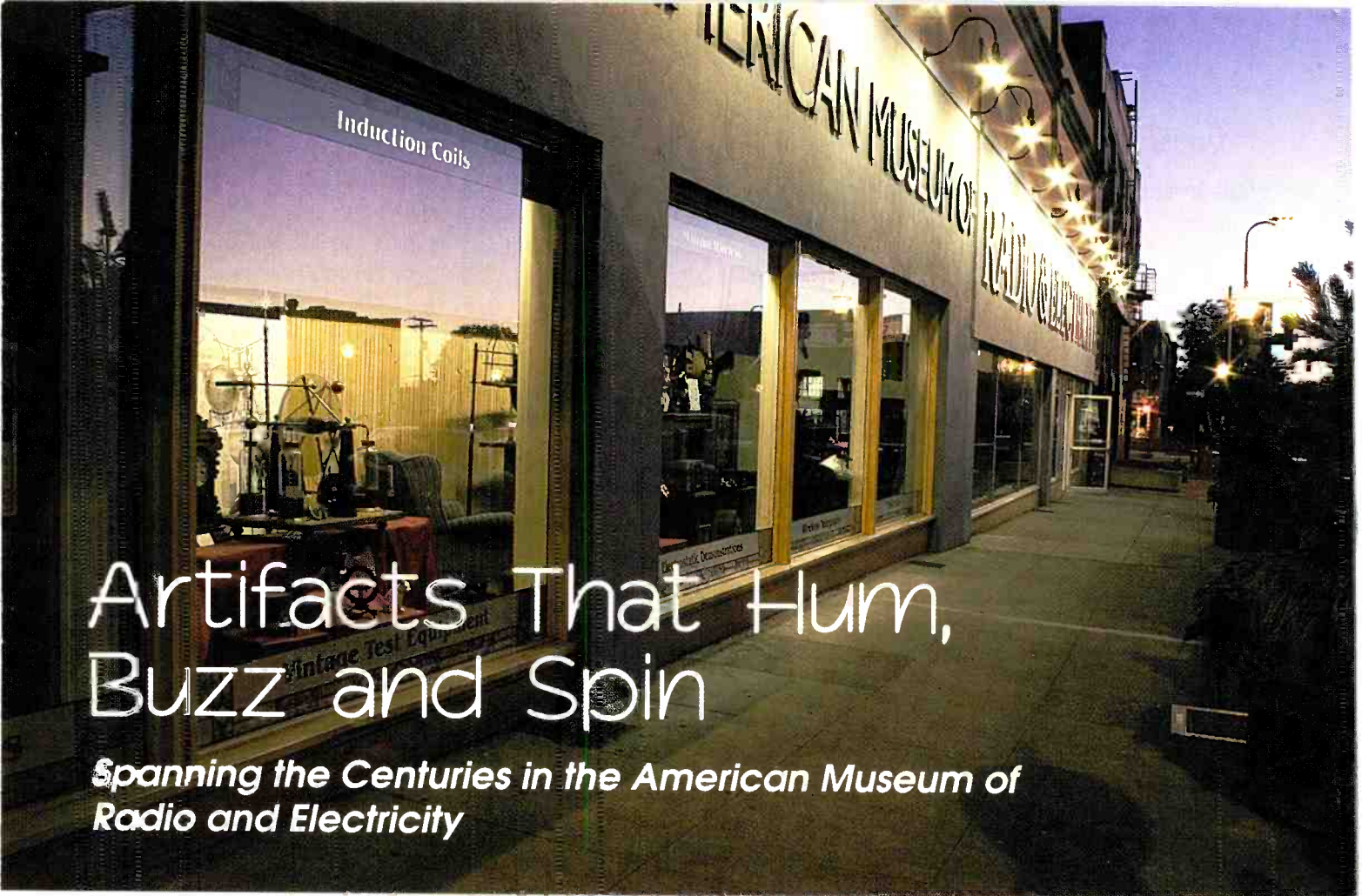

Artifacts That Hum, Buzz and Spin

*Spanning the Centuries in the American Museum of
Radio and Electricity*

by Roy Stevenson

Every year, thousands of amateur radio and communications aficionados visit the American Museum of Radio and Electricity in the small town of Bellingham, Washington, to see buzzing, humming and spinning artifacts that span four centuries.

Located just south of the Canadian border in the middle of Bellingham's bustling downtown area, the museum is a radio enthusiast's nirvana with a collection featuring many rare and historic objects that even the Smithsonian Museum has shown interest in obtaining.

The museum's 12,000 artifacts include unusual items such as 18th century Leyden jars (the first objects used to store electrical charges), Tesla coils, early 20th century Fleming valves (the grandfather of the modern triode vacuum tube), De Forest Audion amplifying vacuum tubes (that made radio and long distance telephone possible), electric lamps by Thomas Edison from the 1880s, the 1920 Westinghouse Model RADA (the first commercial radio receiver ever designed) and the RCA Radiola Model 30 (the first AC-powered radio).

Other rarities include original documents from Gilbert, Newton, Galileo, Benjamin Franklin, and Marconi, and a full-size replica of the wireless room on the *Titanic*. It's like walking through a pantheon of the history and evolution of radio and electricity, with all sorts of rare and bizarre artifacts that capture your attention and imagination.

Gallery One: In the Beginning . . .

The first gallery introduces *The Dawn of the Electrical Age*, with devices showing how electricity was produced in the early

The American Museum of Radio and Electricity brings a wealth of history to its facility at 1312 Bay Street in downtown Bellingham, Washington. (Unless otherwise noted, all photographs courtesy of Linda Popovich)

days – experiments you probably did in high school using materials such as resin, wax and glass tubes to generate static electricity. Influence machines produced electricity by using glass plates spinning in opposite directions.

You'll get a charge from the *Static Electricity Learning Center* as you attract large currents of energy from the Van de Graaff generator. The small metal electrical sportsmen are particularly fascinating. These French ornamental novelties, dating from the late 1700s, worked by discharging the electrical build-up from Leyden jars. The base of these 6-inch-tall hunting sportsmen is held in your hand and the barrel of the rifle is moved near the electrode of the charged jar. The jar discharges into the sportsman with a loud crack, while a flash appears at the rifle barrel. *Great stuff!*

You'll see an early Volta Cannon, invented by Alessandro Volta (1745-1827) who used methane swamp gas as the explosive agent in this experimental gun. When ignited with a rudimentary spark plug, a lead ball was ejected 20 feet across the room. Although never used as a weapon, Volta's invention led to the creation of the internal combustion engine, and Volta was honored by hav-

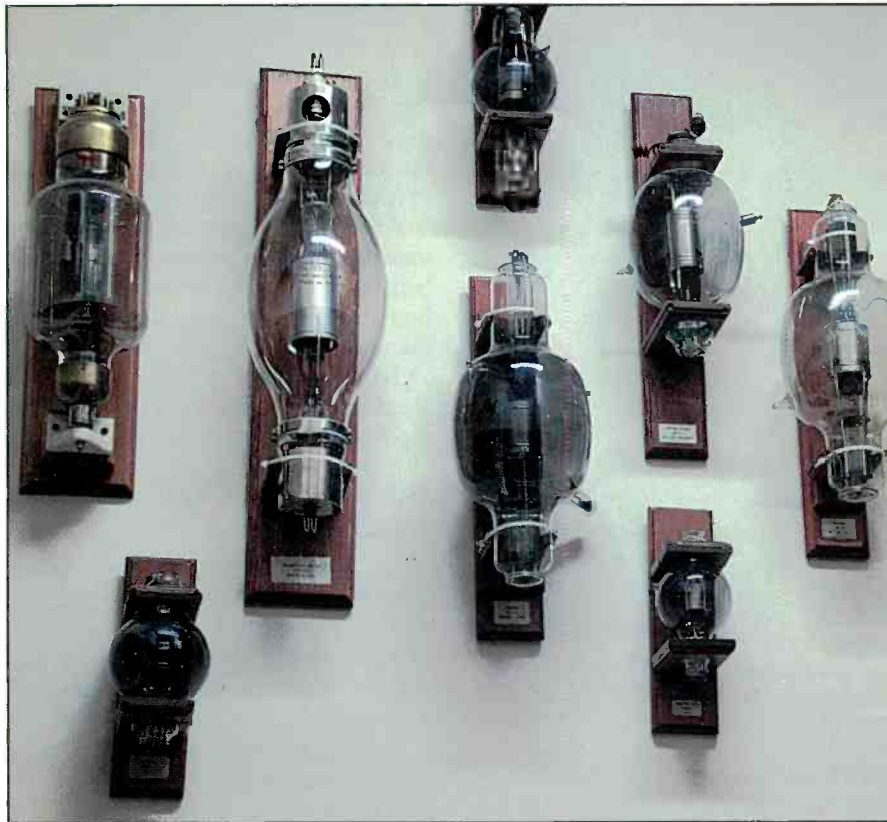

Historic radio tubes adorn one of the walls at the museum.

ing the measure of electric potential, the volt, named after him.

Gallery Two: Let the Sparks Fly

The second gallery, *Electricity Sparks Invention*, is even more intriguing. You'll see early electromagnets, electric motors, dynamos and an excellent series of displays that show how electric lighting was developed. Early Edison lamps and Nernst lamps show the evolution and experimentation with different lighting filaments.

German scientist Walther Nernst (1864-1941) experimented with ceramic rods, and Edison (1847-1931) tried bamboo and wire filaments. Here, you learn how Edison invented the screw-in socket base for light bulbs.

Early light sockets were held in place on the ceiling by a small thumbscrew, but the screws had a tendency to come loose and the lamp would fall from the light socket. Edison fiddled with the threaded lid on a nearby can of kerosene and declared, "This most certainly can make a bang-up socket for the lamp," and thus was born the screw-in lamp base!

The enigmatic genius Nikola Tesla (1856-1943) is also featured in this gallery.

Tesla, an immigrant from Croatia, worked first for Edison, but did not get along with him. Tesla subsequently went to work for George Westinghouse (1846-1914).

Tesla invented a system of motors and generators that operated by alternating

current and Westinghouse, a savvy businessman, quickly realized the value and uses of the alternating current (AC) motor. He built AC generating plants that could send power over a much greater distance than Edison's generators, thus putting a wrench in Edison's corporate works.

The museum presents dozens of interesting examples of early corporate competition, development, and subterfuge from these exciting times, and museum President and CEO, John Jenkins, is only too happy to tell you these stories.

How the Museum Came to Be

The museum's roots go back to 1985, with the antique radio and vintage magazine and service manual collection of Jonathan Winter, under the name The Bellingham Antique Radio Museum.

Its floor-to-ceiling display of antique radios soon attracted like-minded radio buffs. Then, in 1995, John Jenkins, general manager of worldwide sales and marketing for Microsoft Corporation, also an avid collector of electrical and communications artifacts, discovered the museum, teamed up with Winter, and funded its expansion into its current, larger location.

The museum became a non-profit 501(c) organization in 1998. With its new mission of turning the museum into a world-class display of all things electric, it was renamed the American Museum of Radio and Electricity.



"Before you is a full-size replica," a placard says, of Samuel F.B. Morse's demonstration telegraph, circa 1837. "This is an exact copy of the apparatus built from a series of measurements taken at the British Science Museum in London."



With a Mutual Broadcasting System banner as its backdrop, this RCA Radiovox Cathedral radio from 1928 sits on display at the AMRE.

Jenkins started his extensive personal collection when he was 13 years old, inspired by an old radio he discovered in his grandparents' basement. He pored through the pages of Morgan McMahon's book *Vintage Radio*, dreaming that someday he might own some of these radios.

During the next 40 years he brought together thousands of artifacts and books – beginning in the 16th century – about electromagnetism, the telegraph and telephone, electric light and wireless technology.

In his book, *Where Discovery Sparks Imagination*, Jenkins says he founded the museum because, "I wanted to recreate for people that sense of magic and discovery that I felt as a child when I sat down with McMahon's *Vintage Radio: A sense of appreciation for the amazing minds and hands of the scientists, inventors and craftsmen whose dedication, persistence and plain hard work have made our modern world possible.*"

The Telegraph: Key to the Future

A large number of exhibits in the *Electricity Sparks Invention* gallery show the development of the telegraph, the progenitor of wireless communications.

We learn that the first electric telegraphs were made in the early 18th century using static electricity, but when the battery was invented in 1800, telegraph inventors knew that a continuous

electric current would be ideal for telegraph transmission.

Then in 1821 Hans Oersted (1777-1851) discovered electromagnetism, and over the next 10 years William Sturgeon (1783-1850) and Joseph Henry (1797-1878) developed the electromagnet, which sparked a flurry of experimentation and further development of the telegraph.

As a result, many varieties of telegraphs were invented: Needle telegraphs, ABC and dial telegraphs and printing telegraphs. And then, of course, along came Samuel Morse's telegraph system and the telegraphic transmitting key. The museum contains one of the largest collections of early telegraph apparatus in the world.

Can You Hear Me Now?

The logical innovation to follow the telegraph was the telephone. The development of the telephone is a fascinating story and the museum's array of early instruments is superb.

Most people credit Alexander Graham Bell (1847-1922) with inventing the telephone – he did, after all, report the electrical transmission of speech in 1875 for the first time.

But, another inventor, Elisha Gray (1835-1901) had independently invented the telephone around the same time as Bell. Both lodged their patents on February 14, 1876, but it is believed that Gray lodged his patent first, by a few hours.

Bell prevailed in a court case, however, and went on to hit *the big time* while Gray doggedly continued his work, lodging 70 patents for his inventions including the "teletypograph," a precursor to the fax machine, and the "telephote," a primitive close-circuit television.

What is not commonly known is that industrial espionage may have played a hand in Bell's triumph. His lawyer somehow heard about the liquid mercury microphone transmitter devised by Gray, and cunningly inserted a description of it into Bell's patent, without Bell even having a liquid transmitter at the time!

The Fascinating Tale of the Hush-A-Phone

The Hush-A-Phone – a small rectangular baffle that fits over the mouthpiece of a telephone, with an opening just big enough to place your lips into – is a classic piece of telephone paraphernalia with a great story.

The party at the other end of the line can hear the speaker clearly, but no one else in the room can hear a sound. This invention precipitated a court case that changed the way we do business today.

In the late 1940s, AT&T sued the Hush-A-Phone Co., claiming it had added something on to AT&T's phone, which Hush-A-Phone clearly had done. However, the case was ruled in favor of the Hush-A-Phone, which had now set a legal precedent for inventors to add other things to someone else's invention.

Think of all of the inventions that have been approved as a result of this "add-on" ruling: the computer mouse and computer software are great examples. Eventually this ruling would lead to the break-up of AT&T and the development of the Internet.

Gallery Three: Hello, Radio

Radio enthusiasts will no doubt be fascinated by these stories, gadgets and inventions, but the real radio action starts in Gallery Three: *The Wireless Age*.

Covering the era from 1863 to 1920, these exhibits show the evolution of electromagnetic waves. James Maxwell (1831-1879) described the theoretical propagation of electromagnetic waves, and a first edition of his paper titled *On a Dynamical Theory of the Electromagnetic Field* is stored in the museum's library.

His mathematical formulae predicted that radio waves existed and that varying the amplitude of the electrical current in a wire could create them.



CALL 1-800-SCANNER



NEW Pre-Programmed Scanners from Uniden and GRE!



Uniden HomePatrol
Trunking Digital



GRE PSR-700
Trunking-Non Digital



SCANNER MASTER is the nation's oldest and largest scanner-only dealer. For over 30 years we've specialized in nothing but scanners, frequency guides, scanner software and scanner accessories.



Uniden-Bearcat®
Scanners

Uniden Remote Heads In Stock!



GRE
GRECOM
Scanners



RadioShack
Scanners



AOR & ICOM
Receivers

- ◆ Mobile and Portable Scanner Antennas
- ◆ The Best in Scanner Software
- ◆ Scanner Accessories

Buy Your Next Scanner from Scanner Master and Receive

Our Services

- Programming
- New Product Guide
- Boston Area Store
- Worldwide Shipping
- One Page Checkout
- Gift Wrapping
- Gift Certificates
- Newsletter

22% OFF Professional Hometown Programming

10% OFF Car Chargers

10% OFF Cases

10% OFF Computer Cables

And Much More!

Our Guarantees

- 30 Day Money Back
- Same Day Shipping
- New Products Only

See Our Website Or Call For Details



North American Master Distributors for some of the world's most unique and exciting scanner accessories, including:

BuTel ARC Scanner Programming and Control Software for Uniden, Radio Shack, AOR and ICOM Scanners

RadioReference.com Subscriptions - The ultimate nationwide frequency and trunking database

EXCLUSIVE Waters & Stanton Products including the Watson line of products from the U.K. -

A variety of antennas, speakers, filters, amplifiers, aircraft tracking software and much more!

DD Amtek - Affordable high-performance indoor and outdoor scanner filters and pre-amplifiers!

Your One Source for Everything You Need

We Have All the Basics: Scanners, antennas and accessories for base, mobile or portable operation.

The Latest Technology: Scanner software, pre-amplifiers, filters, a GPS enabled antenna and much more! Tools that will make your operation the best it can be.

Professional Programming: Just plug in your scanner and start listening right out of the box!

Professional Services

Low cost Lead Generation Systems to expand your business

News Gathering Systems for media outlets

Remote Control, Audio Recording, and Custom Mobile

Solutions for media and public safety

Consultation, Installation, and Complete System Engineering -

Turnkey solutions ensuring your system works the first time

Local News and Information how and when you need it!

Store Open 9-5, M-F

Come and Visit our Store and Police Scanner Museum:

260 Hopping Brook Road, Holliston, MA 01746

Check out our web site or call or e-mail us for our free product flyer!

1-800-SCANNER

www.scannermaster.com

info@scannermaster.com



The museum's 12,000 artifacts include unusual items such as 18th century Leyden jars – the first objects used to store electrical charges. (From "Where Discovery Sparks Imagination," by John D. Jenkins)



The label on the front panel of this piece of radio gear reads: 1/2 K.W. Quenched Multiple Spark Radio Transmitter – Manufactured by Marconi Wireless Telegraph Co., of America. (From "Where Discovery Sparks Imagination," by John D. Jenkins)

At this stage of your visit, you start to get an appreciation of how far ahead of their time these inventors really were – and it's a humbling experience.

On now to Heinrich Hertz (1857-1894), who was the first to send and receive radio waves. He's the granddaddy of modern radio, and radio wave frequencies are rightly named after him, although they were quaintly called "Hertzian waves" back in the day.

You'll see a parabolic Hertzian set from the early 20th century, an 1885 Hertzian-Wave Test Bench, and an unusual coherer that detects a radio pulse, causing a magnet to fire an attached pistol.

Next up in the museum's *radio hall of fame* is Guglielmo Marconi (1874-1937) who was the first to develop wireless transmission for practical use. Marconi's dream was to bypass landlines by using radio waves. After being rejected by the Italian and British governments, Marconi worked with William Preece, the Chief Engineer of the British Post Office.

Marconi patented his invention in 1896, and formed the Marconi Wireless Telegraph Co. Amazingly, Marconi's device was designed primarily for ship-to-shore communications, and completely overlooked the device's potential for popular entertainment broadcasting!

The displays show a plethora of Marconi's inventions, from a 1922

Marconi MC1 1.5-kilowatt Ship Set, a 1915 Marconi Type 16 Balanced Crystal Receiver, a 1920 Marconi Type 11 Direction Finder and a 1920 Marconi Half-kilowatt Quenched Multiple Spark Transmitter.

The full-scale diorama of the *Titanic's* radio room is painstakingly reproduced from a photograph and displays the exact model of Marconi wireless set that was used while the ocean liner was sinking.

You can listen to the spark transmitter's final message sent from the *Titanic*, on that night of April 14, 1912: *SOS SOS CQD CQD Titanic. We are sinking fast. Passengers are being put into boats. Titanic.*

Other pieces of wireless equipment displayed include a 1907 apparatus for receiving space signals made by Stone Tel & Tel Co., Boston; a 1908 two-coil syn-tonizer from De Forest Radio Telephone



The museum's Marconi Room captures the flavor of the period when radio was new and very exciting.

& Telegraph Co; a 1917 shipboard receiver; and a 1910 Model D Tuner from United Wireless Telegraph Co.

The sad story of A. Frederick Collins (1869-1952) is told here. Collins developed a *wireless telephone* in 1898, and based on his invention, Wall Street promoter Cameron Spear guided the 1909 merger of Collins Wireless Telephone Co. with the Continental Wireless Telegraph & Telephone Co.



Cofounders Jonathan Winter and John Jenkins stand among the thousands of display items in the American Museum of Radio and Electricity.

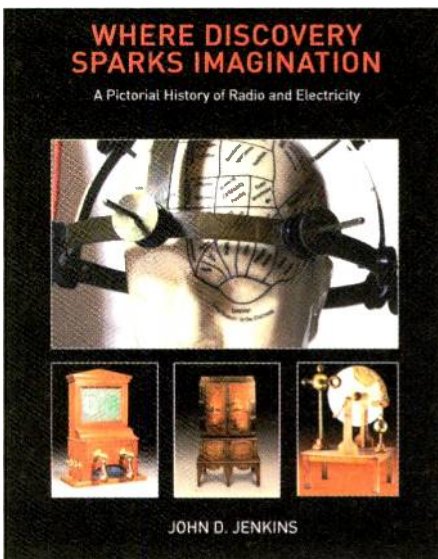

AMRE cofounder John D. Jenkins' book *Where Discovery Sparks Imagination: A Pictorial History of Radio and Electricity*.

In 1911 Collins, Spear and other company officials were indicted for using the mail to defraud in selling worthless stock. Collins was also charged with giving a fraudulent demonstration of his wireless telephone at Madison Square Garden two years previously.

Despite demonstrations that his apparatus worked, Collins served a year in jail. By the time he resumed his work, rapidly improving technology such as Lee De Forest's (1873-1961) vacuum tube left Collins behind. In the years that followed he wrote nearly 100 books, including *The Radio Amateurs Handbook* in 1922, which is still a staple of every radio hobbyist, now in its 85th edition.

The military was quick to use radio – its previous signals methods had been runners, flags, carrier pigeons, smoke signals and wired telegraphy. The *Radio Goes to War* section display features a number of military artifacts including a 1917 CW-938A Short Range Transmitter/Receiver, and a British 1914 Field Radio Set signed *Marconi's Wireless Telegraph Co., Ltd.*

Gallery Four: Homeward Bound

Gallery Four, *Radio Enters the Home*, illustrates implements of early broadcasting: the famous Zenith Radio

Why just listen?
Morse Code requirement dropped!

HamTestOnline™
Online courses for the ham radio written exams

- ▶ Fastest way to learn — most students pass the ham radio exam after only 10 hours study.
- ▶ Study material, practice exams, and a virtual private tutor, all rolled into one. An intensely effective learning system. Just ask our students!
- ▶ 100% guaranteed — you pass the exam or get your money back.
- ▶ Online system — study when you want, at your own pace.
- ▶ Free trial — try before you buy!

www.hamtestonline.com

Any day you don't learn something new is a wasted day!

Ultrasound Parabolic Dish
for hunting noise sources
Xtal Set Society, Inc
www.midnightscience.com
405-517-7347

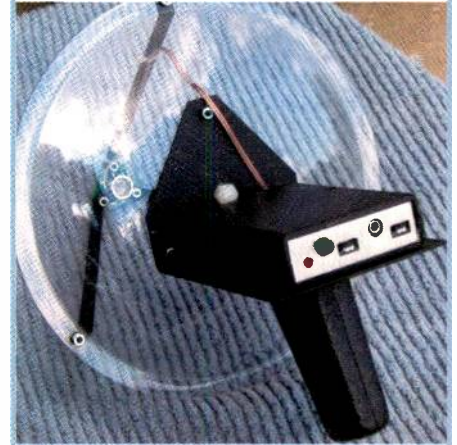

New Shielded Broadband Magnetic Moebius Receive Loop Kills Local QRN



Model RF PRO-1A

- Outperforms much larger antennas
- Covers 50 kHz to 30 MHz
- No tuning required
- Works great at ground level
- Includes high performance low-noise preamp with super-low intermod distortion
- Perfect antenna for SDR receivers
- Includes T/R switch

Proudly Made in the USA

Check Out Our Rave Reviews!

"The results are simply amazing. This little antenna at ten feet off the ground out-receives my dipole on 40 and 75 meters at 34 feet and is much quieter to listen to..... I recommend it whole-heartedly." *Ron Gould, KD7RJ*

"This might well be the best \$400 you've put out on a compact shortwave antenna. Highly recommended. Especially for small lots, apartments, or ornamentally territorial wives."

"I was impressed by its performance I've been able to work more stations on 30, 40, 80 and 160 ... it consistently hears better than my Bazooka." *Tad Williamson, WF4W*

"My friends and I are flat-out blown away with its performance. It's super quiet. Period."

Phone: 303-526-1965

www.PixelSatRadio.com



A peek inside AMRE's Titanic display gives visitors a view of how its communications center looked in 1912 – an exact reproduction of the ship's radio room.

Corporation, portable radios, RCA music makers and the Atwater Kent Open Receiving Sets.

Charles Herrold (1875-1948) began broadcasting music in San Jose in 1906. He made the distinction between “narrowcasting,” a transmission aimed at a single receiver, and “broadcasting,” aimed at a general audience.

Early radios were ugly and inefficient – small black boxes with wires sticking out – with poor selectivity. With broadcasts presenting the news, comedy and

drama, the radio moved into the living room, which meant radios needed to take on a new look.

Gallery Five: Going for the Gold

Radios became decorative furniture and thus was spawned *The Golden Age of Radio* described in Gallery Five.

There were only 5,000 radio sets in the United States in 1920, and by 1924 there were three million! There were literally hundreds of radio manufacturers.

The museum's collection of furniture radios from the 1930s through the 1960s is superb, and many are rare collectors' items worth tens-of-thousands of dollars.

A few of the museum's radio showpieces include the 1936 Crosley Cathedral Tabletop Receiver, the 1937 Emerson Duo-Vox AC-DC Receiver Model 107, the art deco 1940's De Forest-Crosley Console Radio Model SD 992 – looking like a miniature Empire State Building – and the 1937 Scott Pointer-Dial Philharmonic Console Radio Model 20A.

The American Museum of Radio and Electricity

1312 Bay Street
Bellingham, WA 98225
Phone: 360.738.3886

Hours:

Wednesday through Saturdays from 11 a.m. to 4 p.m.
Sundays noon to 4 p.m., and by appointment.

Admission:

Admission is \$5 for adults and \$2 for children 11 and under.

Treasures Galore

There are far more surprises that await you at the American Museum of Radio and Electricity. We've covered just a few of the highlights of the fascinating and captivating artifacts and stories living there.

Radio techies, radio historians, and those just looking for high drama, intrigue and espionage won't be disappointed. Above all else, the exhibits remind us that historically speaking, these discoveries took place *only yesterday*.

Study with the best!

Gordon West, WB6NOA and W5YI HamStudy® Software

NEW LOW PRICING!!

We're making ham study more affordable!

You want software with that?

How about 1-on-1 with Gordo, too!

You get more than a simple software CD when you study with Gordon West and W5YI HamStudy Software. Each of our Technician, General, and Extra Class book + software packages includes a host of feature-packed benefits that makes study for your first ham license or upgrade a true learning experience!

All of Gordon's books reorganize the Q&A into logical study groups that help you better learn the ins-and-outs of rules, repeaters, propagation, operating procedures, antennas, safety – all in one place. Each question is followed by Gordo's simple, educational explanation of the correct answer. No going back-and-forth from the engineering text to the question pool searching for the correct answer.

In our book, you get it all on one page in easy to understand terms and explanations! W5YI HamStudy Software reinforces your learning, providing an interactive experience that focuses your study and understanding of amateur practices and procedures and what you need to know to pass your FCC exam!

- No subscription or Internet connection required
- No PC installation required – software runs directly from the CD
- Answer a question wrong and Gordo's answer explanation from the book appears on screen to reinforce learning with highlighted key words in the question and correct answer
- The software scores your practice exam and tells you which questions you've mastered and those that need more study
- Study by sub-element to focus on areas where you need more study – stop answering questions you already know
- Color bar graph shows your progress and lets you know when you're ready to pass the real exam
- Print out practice tests and score yourself or a friend
- When you start passing multiple practice exams using our HamStudy Software you'll go to the VE session with confidence knowing you're going to pass and get your first ham license or upgrade!
- Package includes a **FREE FCC Part 97 Rules Book** (\$3.95 value) – a helpful reference for your study and ham shack

MOST IMPORTANT you get Gordo, TOO!

Stumped on questions? Need some encouragement? **Just give Gordo a call** from 10 a.m. to 4 p.m. Monday thru Friday, California time. 714-549-5000

Don't want or need software? **SAVE!** Just buy Gordo's book. **You still get to talk with Gordo, FREE!**



Get your Gordo book+software package from your local ham radio dealer or W5YI.org ORDER YOURS TODAY! Mention this ad and get discounted shipping and a FREE GIFT! order on-line at w5yi.org or call 800-669-9594

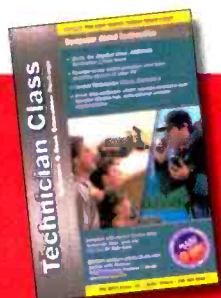

Technician Class Book + Software– (NCS) \$29.95
Book only– \$20.95

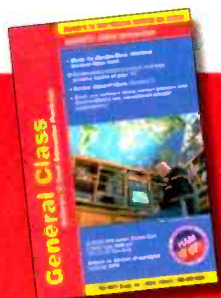

General Class Book + Software– (GUS) \$34.95
Book only– \$24.95



Extra Class Book + Software– (ECS) \$39.95
Book only– \$24.95

It's Official: Sunspot Cycle 24 is for Real!

by Tomas Hood, NW7US
nw7us@nw7us.us
Twitter: @NW7US
@hfradiospacewx

In the span of time between the February and March editions of *Popular Communications*, Sunspot Cycle 24 history was been made. Radio communicators and heliophiles throughout the world cheered the highly noticeable results of a rise in sunspot activity not seen since 2004.

While February 2011 saw the end of a year-long period of low sunspot activity (*yes, we had spots, but the overall energy stayed very low*), March marked the noticeable end of the sunspot cycle doldrums. The rise of sunspot activity starting in February was not an anomaly; the long season of low solar activity is finally over.

During several amateur radio contests in March, operators from around the world report-

ed conditions on the higher end of the shortwave radio spectrum were coming alive with activity unparalleled in seven years.

DX Clusters, Contests, SWL Reports Tell the Story

A view of the DX clusters throughout the month revealed a consistent offering of worldwide path openings on most of the higher amateur radio bands, with the openings on 20, 17 and 15 meters staying open much longer than expected. What amazed contest participants in the CQ WPX SSB contest < <http://www.cqwpvx.com/> > during the weekend of March 26, were the 10-meter openings into many areas of the world.

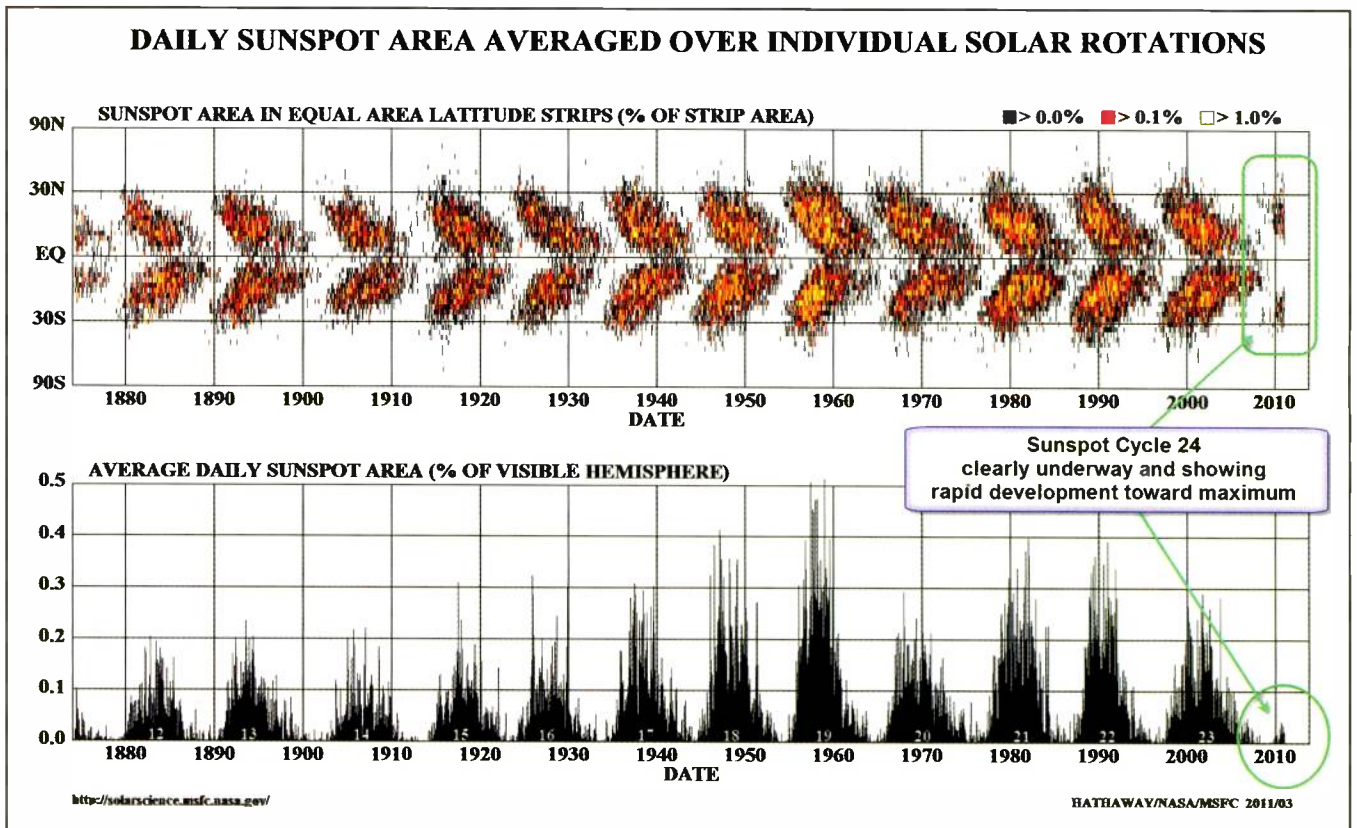

Detailed observations of sunspots have been obtained by the Royal Greenwich Observatory since 1874. These observations include information on the sizes and positions of sunspots as well as their numbers. These data show that sunspots do not appear at random over the surface of the sun but are concentrated in two latitude bands on either side of the equator. This butterfly diagram (updated monthly) reveals the positions of the spots for each rotation of the sun since May 1874. The plot shows that these bands first form at mid-latitudes, widen and then move toward the equator as each cycle progresses. Sunspot Cycle 24 (right-most in the plot) is following this expected trend and the plot reveals that we are moving into the more active phase of the current cycle. (Courtesy of David Hathaway, NASA)

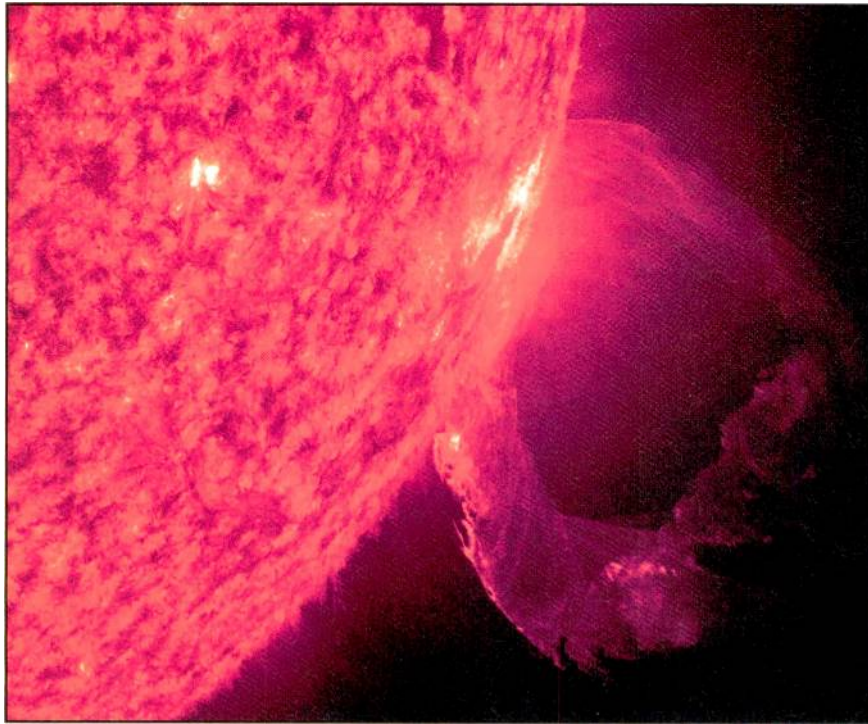

Prominence Eruption Up-Close: The Solar Dynamics Observatory (SDO) Atmospheric Imaging Assembly (AIA) captured this nicely rounded prominence eruption from March 19, 2011 as a prominence became unstable and erupted into space with a distinct twisting motion, lasting five hours. The image shows a tight close-up of the action in extreme ultraviolet light. Prominences are elongated clouds of plasma that hover above the Sun's surface, tethered by magnetic forces. (Courtesy of Solar Dynamics Observatory (SDO) / Atmospheric Imaging Assembly [AIA])

Contest results confirm the anecdotal evidence: *Sunspot Cycle 24 really exists and is on the rise!*

Shortwave radio listening was exhilarating, as well. Exotic radio signals from international broadcast stations from around the world — and not just from the highest-powered transmitters with the biggest antenna systems — were finally heard by listeners even in the higher latitudes equipped only with moderate antennas and simple radios.

This writer, for instance, finally heard Radio Cairo 'El-Bernameg Al-Aam' on 9.305 MHz shortwave on March 6 and on following evenings, as well as the Voice of Greece on 9.420 MHz with nearly an S-9 signal strength on the radio's meter.

These stations have not been so easy to catch for the past six to seven years! Conditions during March were on par with late 2004 and early 2005.

Sol's Numbers Don't Lie

March 2011 began with the 10.7-cm flux already at a record high for Sunspot Cycle 24, with the daily radio flux report-

ed as 111. By March 8, the daily 10.7-cm radio flux reading reached a record for the new cycle (as of press-time): a very welcomed 155 — the highest level of solar energy since July 23, 2004, when the daily radio flux reached 165.

That is a *very long* seven years since we've witnessed this level of solar energy ionizing the F-region, enabling worldwide DX!

Other records were broken during the same week: On March 8, as well, the total smoothed observed sunspot count was 137. The highest previous count was six years earlier, on July 7, 2005 when the daily number was 149.

Interestingly, the total combined sunspot area reached a remarkably large size of 1,650 *solar hemisphere* units (the units of sunspot area is millionths of the Sun's visible hemisphere). The last time the sun was *that covered* by sunspots was January 18, 2005, when the combined size of that day's sunspots (109) also equaled 1,650.

It is safe to say that Sunspot Cycle 24 is finally showing a steady and more rapid rise in overall level of activity and ener-

Pop'Comm June 2011 Reader Survey

Learning more about our readers — who they are; their likes and dislikes — is an ongoing initiative for *Pop'Comm*. Your feedback is important to us. It helps guide us to make the magazine even more relevant, useful and enjoyable to you each month.

Please take a few minutes to fill out this month's Reader Survey Card and circle the appropriate numbers corresponding to the questions below. We'll pick a respondent at random for a year's free subscription or an extension of an existing subscription as thanks for your participation — so don't forget to fill in your mailing address and other contact information.

We encourage your comments and suggestions in the space provided, as well. Thank you.

Last, but not least: You can now take this survey online. See details below.

How long have you been a Pop'Comm reader?

- Less than 1 year 1
- 1 to 3 years 2
- 3 to 10 years 3
- More than 10 years 4

What is the one thing you'd like to see more of in Pop'Comm?

- Features on interesting people and things 5
- Shortwave listening 6
- Scanning / Monitoring 7
- Digital technology 8
- Radio and TV history 9
- Amateur radio / antennas 10
- Propagation / technology 11
- Humor 12
- New Products 13

Which best describes you?

- Shortwave listener 14
- Scanner monitor 15
- Broadcast band DXer 16
- Amateur radio operator / techie 17
- Gadget / new technology lover1 8
- Radio-TV history buff 19
- Equipment restoration aficionado 20

What is an area of communications not now covered in Pop'Comm you'd like to see featured monthly? (Use the comment line.)

Take This Reader Survey Online

You can now participate in this reader survey via the Internet. Simply go to *Pop'Comm On the Web* : < <http://www.popcommmagazine.blogspot.com/> > and click the link to the *Pop'Comm June 2011 Reader Survey*. It's quick and easy.

And the Winner Is . . .

For participating in the *Pop'Comm Readership Survey*, the winner of a free subscription or extension is **Keith Mehl, ABØVK**, of **Des Moines, Iowa**. *Way to go, Keith!*

Optimum Working Frequencies (MHz) - For June 2011 - Flux = 111, Created by NW7US

UTC	00	01	02	03	04	05	06	07	08	09	10	11	12	13	14	15	16	17	18	19	20	21	22	23
TO/FROM US WEST COAST																								
CARIBBEAN	25	24	24	24	22	20	19	17	16	15	14	13	14	16	18	19	20	21	22	23	24	24	24	24
NORTHERN SOUTH AMERICA	32	32	32	29	27	24	22	21	19	18	17	16	16	19	22	24	26	28	29	30	31	32	32	33
CENTRAL SOUTH AMERICA	30	27	25	23	21	20	18	17	16	16	15	19	19	21	23	26	27	29	30	31	32	33	33	32
SOUTHERN SOUTH AMERICA	25	18	17	16	15	15	14	14	14	14	13	13	13	18	20	23	25	27	28	30	31	32	31	29
WESTERN EUROPE	15	14	13	12	11	11	16	15	14	13	12	14	17	19	20	21	22	23	23	22	22	21	19	18
EASTERN EUROPE	11	10	10	10	14	17	15	14	13	12	12	11	15	18	20	21	22	21	21	20	18	16	12	11
EASTERN NORTH AMERICA	29	29	28	28	27	26	24	22	20	19	17	17	18	20	22	24	25	26	27	27	28	28	29	29
CENTRAL NORTH AMERICA	16	16	16	16	15	15	14	13	12	11	10	10	10	11	12	13	13	14	15	15	15	16	16	16
WESTERN NORTH AMERICA	8	8	8	8	8	8	8	8	7	6	6	5	5	5	6	6	7	7	7	8	8	8	8	8
SOUTHERN NORTH AMERICA	26	26	26	25	25	25	23	21	19	17	16	15	15	15	17	19	21	22	23	24	24	25	25	26
HAWAII	21	21	22	22	22	22	21	21	19	18	16	15	14	13	12	12	13	15	16	18	19	19	20	21
NORTHERN AFRICA	19	18	16	15	14	14	16	15	14	13	13	15	17	19	20	21	22	23	23	23	23	23	22	21
CENTRAL AFRICA	20	18	17	16	16	17	16	15	14	13	12	14	17	19	20	21	22	23	23	24	24	24	24	22
SOUTH AFRICA	17	16	15	15	14	14	16	22	20	19	19	19	21	22	23	24	25	26	27	23	21	20	19	17
MIDDLE EAST	16	16	16	16	17	18	15	14	13	12	12	11	16	18	20	21	22	23	23	22	22	21	20	18
JAPAN	22	22	23	23	23	23	22	22	21	19	18	16	15	15	15	17	15	15	16	18	19	20	21	21
CENTRAL ASIA	23	24	24	23	23	23	22	21	20	19	17	16	15	14	14	17	18	19	17	16	16	17	19	21
INDIA	20	21	21	21	21	19	18	15	14	13	12	11	11	11	11	10	10	9	13	16	18	19	20	21
THAILAND	19	21	23	23	23	22	22	21	19	18	16	15	14	13	14	17	19	20	18	17	16	15	15	17
AUSTRALIA	33	33	34	34	34	33	33	31	29	25	23	21	20	18	17	16	16	15	15	14	18	25	29	31
CHINA	21	21	22	22	23	22	21	20	19	17	15	14	13	13	14	17	19	17	17	17	17	18	19	20
SOUTH PACIFIC	33	33	33	32	31	29	26	18	17	16	15	15	14	14	14	14	13	13	23	27	30	31	32	32
TO/FROM US MIDWEST																								
CARIBBEAN	28	28	27	27	25	23	21	19	18	16	15	15	16	19	21	22	23	25	26	26	27	27	28	28
NORTHERN SOUTH AMERICA	30	29	29	27	24	22	20	19	17	16	15	15	16	19	21	23	24	26	27	28	28	29	29	30
CENTRAL SOUTH AMERICA	30	27	25	23	21	20	18	17	16	16	15	18	19	22	24	26	28	29	30	31	32	32	33	32
SOUTHERN SOUTH AMERICA	24	18	17	16	15	15	14	14	14	14	13	13	15	20	23	25	27	28	29	30	31	32	31	28
WESTERN EUROPE	17	16	14	13	12	12	14	15	14	13	16	18	19	20	21	22	22	23	23	23	22	21	20	19
EASTERN EUROPE	12	11	11	10	10	15	15	14	13	12	14	17	19	20	21	22	23	22	22	21	20	18	16	12
EASTERN NORTH AMERICA	21	20	20	20	19	18	16	15	14	13	12	12	13	15	16	17	18	19	19	20	20	20	21	21
CENTRAL NORTH AMERICA	10	9	9	9	9	9	8	7	7	6	6	6	6	7	7	8	8	9	9	9	9	9	9	10
WESTERN NORTH AMERICA	16	16	16	16	16	15	15	13	12	11	10	10	10	10	12	13	13	14	15	15	15	16	16	16
SOUTHERN NORTH AMERICA	18	18	18	17	16	15	14	13	12	11	10	10	11	13	14	15	16	16	17	17	18	18	18	18
HAWAII	25	25	26	26	26	25	25	23	21	19	18	16	15	15	14	14	16	18	19	21	22	23	24	24
NORTHERN AFRICA	23	22	20	18	17	17	17	17	17	17	17	18	19	20	21	22	22	23	23	23	23	23	23	23
CENTRAL AFRICA	20	19	17	16	15	15	17	16	16	16	17	18	19	20	21	22	22	23	23	23	23	23	23	22
SOUTH AFRICA	16	15	15	14	14	14	14	23	21	19	19	21	24	26	28	29	30	31	28	23	20	19	18	17
MIDDLE EAST	17	15	15	15	16	17	16	15	14	13	16	18	19	21	22	22	23	23	23	23	22	21	20	18
JAPAN	22	22	23	23	22	22	21	19	18	16	15	14	14	16	18	17	16	16	17	18	20	20	21	21
CENTRAL ASIA	23	23	23	23	22	21	20	18	17	16	14	13	14	16	18	20	21	19	18	16	16	17	19	21
INDIA	14	17	18	19	19	17	15	14	13	12	12	14	17	19	19	18	16	14	11	11	10	10	10	9
THAILAND	19	21	22	22	21	20	19	17	15	14	13	12	14	17	19	20	21	21	19	18	16	15	15	17
AUSTRALIA	33	34	34	34	33	33	32	30	27	23	22	20	19	18	17	16	15	15	14	14	20	26	29	32
CHINA	21	22	22	22	21	20	18	16	15	14	13	12	15	17	19	19	18	16	15	15	15	17	19	20
SOUTH PACIFIC	33	33	32	31	30	28	24	17	17	16	15	15	14	14	14	13	13	13	13	24	28	30	31	32
TO/FROM US EAST COAST																								
CARIBBEAN	22	22	22	20	19	17	16	14	13	13	12	12	14	16	17	18	19	20	21	21	22	22	22	22
NORTHERN SOUTH AMERICA	26	26	25	23	21	19	17	16	15	14	13	13	15	18	20	21	22	23	24	25	25	26	26	26
CENTRAL SOUTH AMERICA	30	27	25	23	21	19	18	17	16	16	15	18	21	23	25	27	28	30	31	31	32	32	32	32
SOUTHERN SOUTH AMERICA	22	18	17	16	15	15	14	14	14	14	13	13	20	22	25	26	28	29	30	31	32	32	30	27
WESTERN EUROPE	19	18	16	15	14	13	14	15	15	16	17	18	19	20	20	21	21	22	22	22	22	21	21	20
EASTERN EUROPE	14	13	12	11	11	15	15	15	15	15	17	18	19	20	21	22	22	23	23	22	21	19	18	15
EASTERN NORTH AMERICA	10	10	10	9	9	8	7	7	6	6	5	6	7	7	8	8	9	9	9	10	10	10	10	10
CENTRAL NORTH AMERICA	22	22	21	21	20	19	17	16	14	13	13	13	14	16	17	18	19	20	20	21	21	22	22	22
WESTERN NORTH AMERICA	29	29	28	28	27	26	24	22	20	19	17	17	18	20	22	24	25	26	27	28	28	28	29	29
SOUTHERN NORTH AMERICA	22	22	22	22	21	19	17	16	14	13	13	12	13	15	17	18	19	20	21	21	22	22	22	22
HAWAII	27	28	28	28	27	26	24	22	20	18	17	16	16	16	15	15	17	19	21	23	24	25	26	27
NORTHERN AFRICA	24	22	20	18	17	16	16	17	17	18	20	22	23	25	26	27	27	28	28	28	28	28	27	26
CENTRAL AFRICA	20	19	17	16	15	15	17	17	17	18	20	22	23	25	26	27	27	28	28	28	27	27	24	22
SOUTH AFRICA	16	15	15	14	14	14	14	19	18	18	19	22	24	26	28	29	30	30	28	22	20	19	18	17
MIDDLE EAST	21	19	18	17	17	17	16	15	15	16	18	19	20	21	22	22	23	23	23	24	24	24	23	23
JAPAN	22	22	22	22	21	20	18	17	15	15	15	15	17	18	20	19	17	16	16	16	17	18	20	21
CENTRAL ASIA	23	23	22	21	20	19	17	16	14	14	15	17	19	20	21	22	22	20	18	17	17	17	19	21
INDIA	10	10	10	9	16	17	15	14	14	15	17	19	20	21	22	21	21	20	19	18	16	12	11	11
THAILAND	18	20	21	20	19	17	16	14	13	14	16	18	20	21	22	22	23	22	20	18	17	16	15	16
AUSTRALIA	33	34	33	33	32	30	27	25	23	21	20	19	18	17	16	15	15	14	14	14	21	27	30	32
CHINA	21	21	21	20	19	17	16	15	14	14	16	18	19	21	21	20	18	16	15	14				

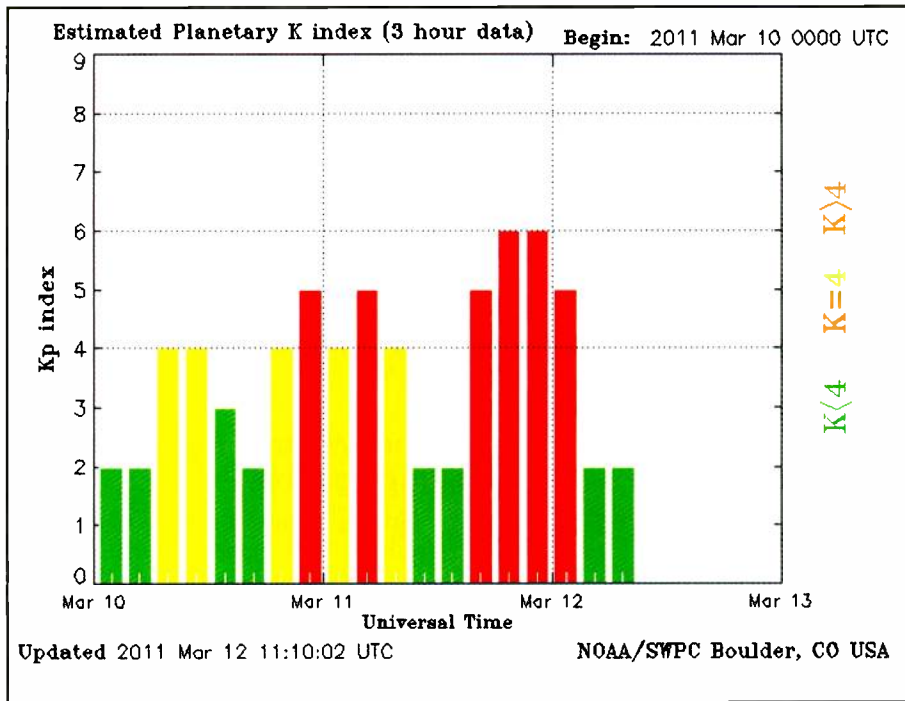

The passage of several back-to-back coronal mass ejections between the end of March 10 and March 12 triggered geomagnetic disturbances as strong as minor storm levels. This plot records the three-hour interval planetary K-index readings, showing how the passage of each CME caused the Kp to rise significantly. The result? The maximum usable frequencies are lowered by 10 to 20 percent from normal. If we expect an opening on 20 meters at 2300 UTC between Japan and California, we may see this path close during these geomagnetic disturbances. (Courtesy of NOAA/SWPC)

gy. The trend numbers of this cycle do show this: The good news is that the Provisional International monthly mean Sunspot Number for February 2011 is 29.4 — the highest so far in Cycle 24, starting with August 2009 when the monthly count was zero.

Along With the Good . . .

We must accept additional solar phenomenon such as X-ray flares and coronal mass ejections along with this increased sunspot activity. March had quite a few X-ray flares, including an X-class eruption. Most of the flares, however, were in the B- and C-class, with a handful of M-class flares associated with coronal mass ejections that were directed toward Earth.

Within three days of some of those eruptions, minor geomagnetic storm conditions developed, causing minor degradation of ionospheric radio propagation. During one passage of a coronal mass ejection, a proton storm ensued, making trans-polar radio DXing impossible.

Of course, on the sunlit side of the Earth, each flare caused a short-term sudden ionospheric disturbance — also

known as a radio black out. These chaotic conditions come with the increased and welcomed sunspot activity. We have to accept *the occasional bad* with the overall great conditions when the Sun's energy is on the rise.

As we go to press, sunspots reign on the Earth-side of the solar disc. Eight different sunspot regions, ranging from tiny to somewhat large and complex areas marched their way across the solar disc during the last days of March (they were numbered by NASA as Active Regions 11176, 11177, 11178, 11179, 11180, 11181, 11182 and 11183).

Video: Seeing is Believing

You can watch a video of one of these sunspots as it rotates into view around the Sun's eastern limb (the eastern limb is on our left, as we look up at the Sun). It's at: <http://nw7us.us/v0001.html> and spans March 19 through March 21. Toward the end of the period, there is a *moderate X-ray flare*. (A direct link to the video can be accessed, as well, via the new Pop'Comm On the Web blog: <http://www.PopCommMagazine.blogspot.com> >. — Ed.)

This active region is the first in a "train" of active regions that came into view the week of March 21. The video is a combined view at the 171- and 304-Angstrom wavelengths as seen by the *Solar Dynamics Observatory (SDO) Atmospheric Imaging Assembly (AIA)*.

The EVE of Instruction: Going to Extremes

Speaking of SDO: One of the arrays of instruments included on the spacecraft is the *Extreme Ultraviolet Variability Experiment (EVE)* — designed to measure the solar extreme ultraviolet (EUV) irradiance. The EUV radiation includes the 0.1-105 nm range, which provides the majority of the energy for heating Earth's thermosphere and creating its ionosphere (ionized plasma).

Extreme ultraviolet is a high-energy form of ultraviolet radiation with wavelengths between 1 and 120 nanometers. EUV photons are much more energetic and dangerous than the ordinary UV rays that cause sunburns. Fortunately for humans, Earth's atmosphere blocks solar EUV. Otherwise a day at the beach could be fatal.

When the sun is active, solar EUV emissions can rise and fall by factors of hundreds to thousands in just a matter of minutes. These surges heat Earth's upper atmosphere, puffing it up and increasing the air friction, or *drag*, on satellites. EUV photons also break apart atoms and molecules, creating a layer of ions in the upper atmosphere that reflect radio waves in the shortwave radio spectrum.

Included as part of the EVE instruments is a pinhole camera for use as a solar aspect monitor (*known as the 'MEGS-SAM'*) to provide a pointing reference for the EVE instruments.

However, MEGS-SAM also makes a spectral measurement of the solar irradiance in the 0.1- to 5-nm wavelength range at an approximately 1-nm resolution. This is useful in many ways. For the radio communicator, it provides a visual of the activity at these wavelengths. The energy in this slice of spectrum directly energizes the ionosphere, which in turn provides the "reflector" of our shortwave radio signals.

When we view the Sun through the SAM instrument and we see vast regions bright with X-ray energy, we know that the ionosphere is being energized at levels sufficient for world-wide propagation on a wider-range of the high frequency spectrum.

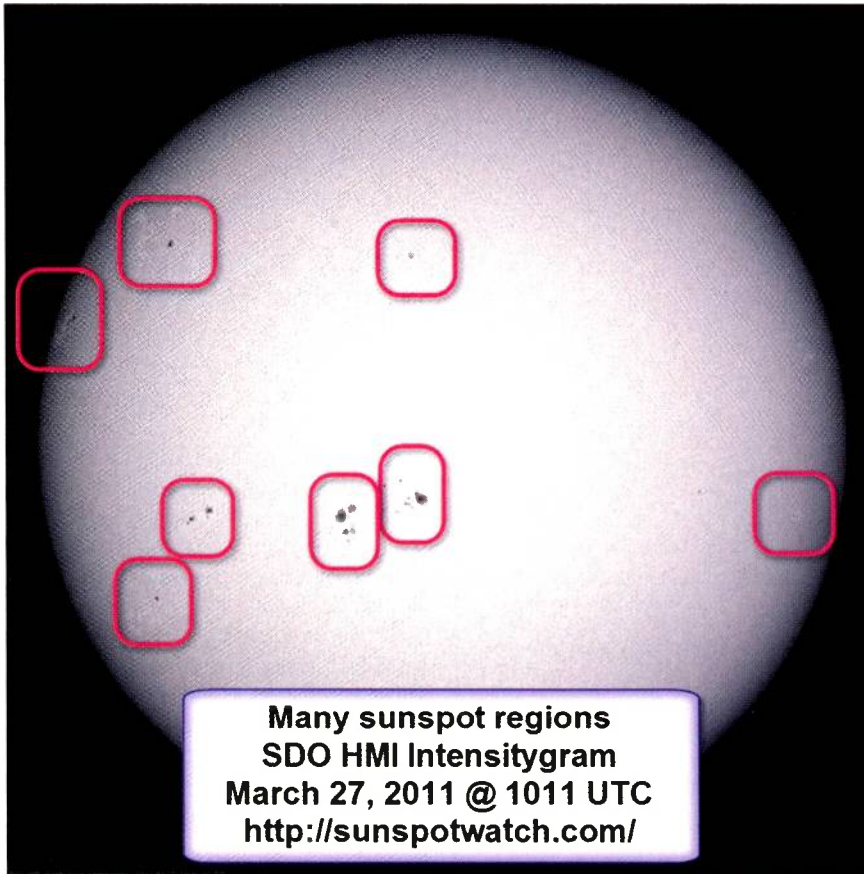

Sunspots reigned on the Sun in March 2011. We have not seen this level of sunspot activity since 2005. With such a rise in activity, the shortwave spectrum has come alive with world-wide DX. (Courtesy of SDO/Helioseismic and Magnetic Imager [HMI])

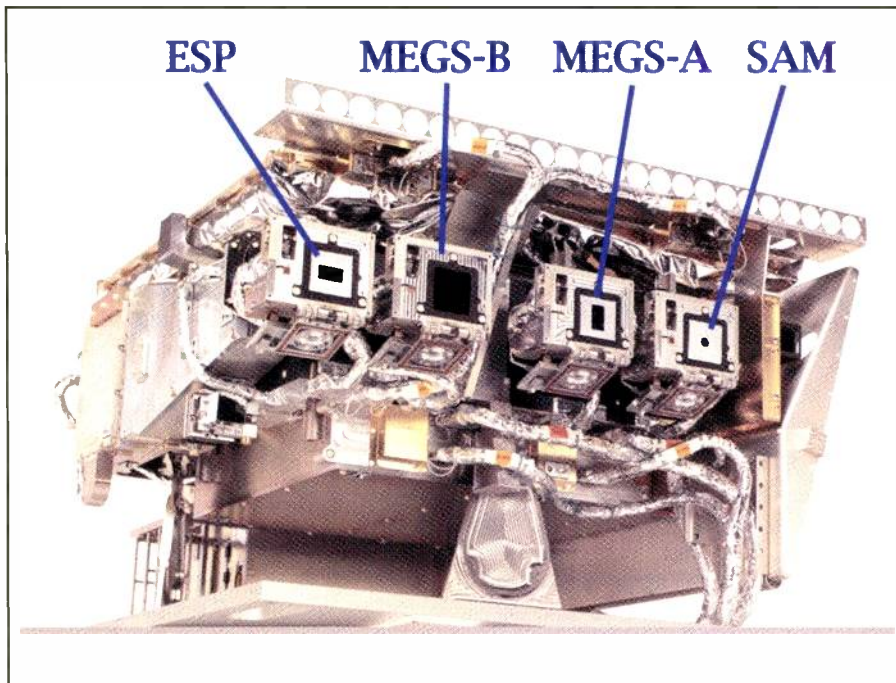

The Extreme Ultraviolet Variability Experiment (EVE) has four primary sensors. MEGS-A and -B are the Multiple UV Grating Spectrographs; ESP is the EUV Spectrophotometer; SAM is the Solar Aspect Monitor. (Courtesy of NASA)

“EVE gives us the highest time resolution and the highest spectral resolution that we’ve ever had for measuring the sun, and we’ll have it 24/7,” said Tom Woods, a solar physicist at the University of Colorado in Boulder, and the lead scientist for EVE. “This is a huge improvement over past missions.”

You may view the latest EVE SAM image, as well as the images from the other SDO instruments (SDO and HMI), at this author’s website, < <http://sunspotwatch.com> >.

June: What to Expect in HF Propagation

Spring is known for the changes in weather. The temperatures rise and the plants begin to wake up. As we move closer to summer, changes in the propagation of radio signals become obvious: DX signals on the higher bands become weaker and openings are sparse.

Each year, we notice that long-distance, east-west F-layer propagation on 10 through 15 meters suffers due to the lower Maximum Usable Frequencies (MUF) caused by the temperature changes in the upper atmosphere.

Now that June has arrived with typical summer-season conditions, there is improvement on north-south path propagation on these higher bands. Optimum frequencies for DX propagation are lower during most of the daylight hours, but higher during the late afternoon, early evening and nighttime hours, than were observed during the winter months.

Nighttime usable frequencies to most parts of the world are higher than at any other time of the year, while the daytime usable frequencies are generally lower than those during winter.

Smorgasbord for SWLers

Shortwave radio listeners will find 19 and 16 meters to be the most reliable daytime DX bands, while 19 and 22 may offer some nighttime openings on periods with higher flux levels. At the same time, the 25 and 31 meter bands are hot during the early evenings through late nights, as well as early to late mornings. The most reliable band for both daytime and nighttime should be a toss-up between these two bands.

Both 41 and 49 meters should offer good DX conditions during the night despite higher static. Look for Europe and Africa as early as sunset. After midnight, start looking south and west for Pacific,

powerwerx.com

The most Powerpole related products anywhere!

Wouxun Radios

NEW!

Wouxun KG-UV3D

Full featured, compact, 2M/440Mhz Dual-Band Handheld for under \$120

- Full 5 Watt Output on VHF, 4 Watts UHF
- High capacity (1700 mAh) Li-ion battery pack included
- Dual-band monitor (VHF/UHF, VHF/VHF, UHF/UHF)
- 3-4 hour desktop rapid charger included
- Dual Alpha-Numeric Backlit Display w/ Channel Name
- Built-in Ultra Bright LED Flashlight function

2M/220Mhz model also available.

Visit www.powerwerx.com/wouxun



FCC Certified

Windows PC programmable
Free software available

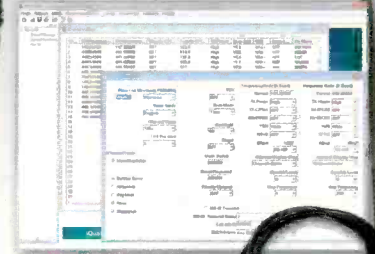

Optional low cost USB or serial programming cable required.

Anderson Powerpoles & Accessories



All Amps, Gauges & Colors in Stock!

Wouxun Radio Optional Accessories



USB Prog. Cable

Speaker Microphone

BNC RF Adapter

Car Charger

AA Battery Pack

UHF RF Adapter

Dual Slot Rapid Charger

Battery Eliminator

Adapter & Extension Cables



OEM Connectors & Filters



Fuse Holders & Fuses



Cooper Bussmann
Circuit Breakers
50, 70, 150 Amp

powerwerx.com



Follow us on Facebook
facebook.com/powerwerx



Follow us on Twitter
twitter.com/powerwerx

Order online at www.powerwerx.com
Order toll free 888-321-0073

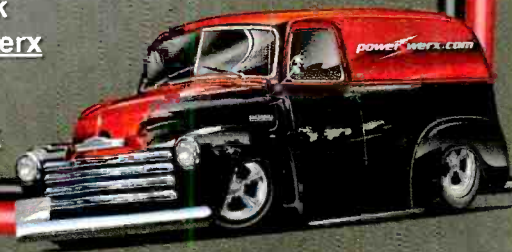

SDO/EVE SAM 0.1–7.0nm image
10-minute integration

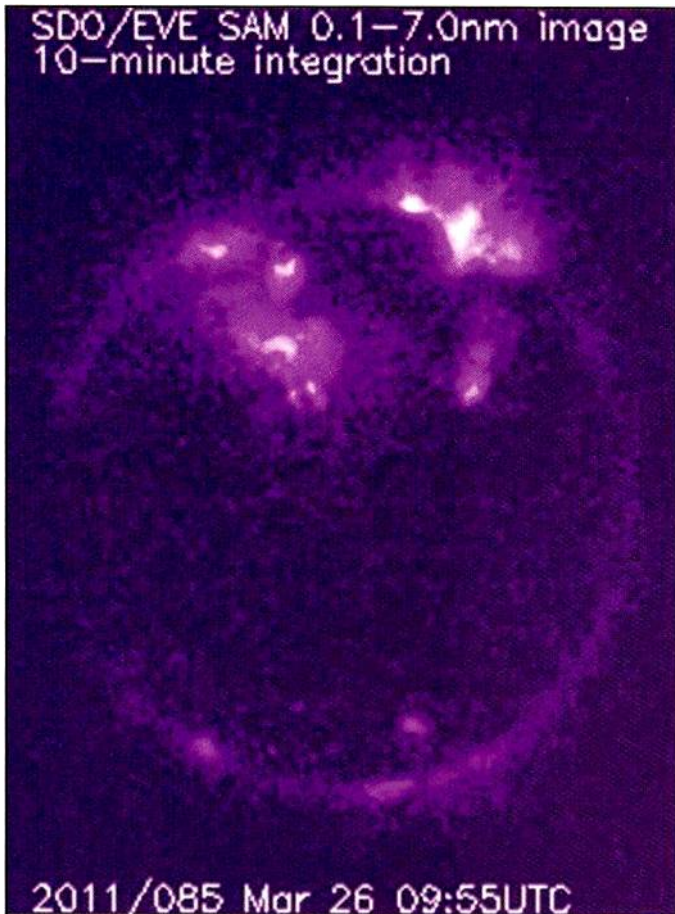

This is the pinhole view of the Sun (March 26, 2011), capturing the individual X-ray photons in the 0.1 nm to 7 nm range. The energy in this spectrum that reaches Earth's upper atmosphere is a major factor in the formation of our ionosphere, the "reflector" that provides the mechanism for world-wide shortwave radio propagation. When we see the bright areas in these images, they reveal very active X-ray events, which contribute to a strongly-energized ionosphere. (Courtesy of SDO/EVE)

South America and Asia. Short-skip should be possible out to about 750 miles during the daytime.

Expect some openings on 75 and 90, similar to how 40 meters will be acting. Fairly frequent short-skip openings up to 1,000 miles are possible during darkness, but expect very few daytime openings with all the static and absorption. MW (medium wave) and 120-meter propagation is rough in the summer due to the high static and higher overall absorption caused by the short nights and higher D-Layer ionization.

Don't Be Surprised

Because we are now seeing a more active Sun, expect X-ray flares to cause sudden ionospheric disturbances (radio black-outs) on the sunlit side of the Earth, lasting between 15 minutes to several hours at most. Also watch for solar coronal holes to cause degradation of HF propagation. These coronal holes spew out huge clouds of solar plasma toward Earth. This causes geomagnetic disturbances that cause the ionosphere to lose its ability to refract HF radio waves. At least one week of poor propagation is expected during June, because of coronal hole activity.

Thunderstorm noise and other natural static noise increases considerably during June and the summer months, masking exotic DX signals. This can make catching weak DX signals a true challenge.

Current Sunspot Cycle 24 Progress

The **Dominion Radio Astrophysical Observatory** at Penticton, British Columbia, Canada, reports a 10.7-cm observed monthly mean solar flux of 94.5 for February 2011 — up significantly from January's 83.7 and the highest yet in this new cycle.

The 12-month, smoothed, 10.7-cm flux centered on August 2010 is 80.7. The predicted smoothed, 10.7-cm, solar flux for June 2011 is 111, give or take about nine points. If we do see this high of a flux in June, expect openings on 10 and 12 meters primarily on paths between the northern and southern hemispheres; expect even more activity on 15 and 17 meters.

The **Royal Observatory of Belgium** reports that the monthly mean observed sunspot number for February 2011 is 29.4, over a 10-point jump up from January's 19.0, and the highest yet in new Sunspot Cycle 24. The lowest daily sunspot value of nine was recorded on February 6 and 7. The highest daily sunspot count was 53 on February 14. The 12-month running smoothed sunspot number centered on August 2010 is 17.4, up from July's 16.8. A smoothed sunspot count of 55, give or take about nine points, is expected for June 2011.

The observed monthly mean planetary A-Index (A_p) for February 2011 is five (January's adjusted figure is now six). These figures still indicate very quiet geomagnetic conditions overall. However, this is slowly changing now that we are seeing a rise in solar energy and sunspot activity.

The 12-month smoothed A_p index centered on August 2010 is 6.2, about the same as for July. Expect the overall geomagnetic activity to be varying greatly between quiet to minor storm level during June. Expect more geomagnetic activity as we continue into the new sunspot cycle. Refer to the *Last Minute Forecast* for the outlook on conditions during this month. You can find the online version of this outlook at < <http://sunspotwatch.com> >.

Connections . . .

Do you have a question that you'd like me to tackle in this column? Drop me an email or send me a letter, or catch me on the HF bands and I'll be sure to cover it. I'd love to hear any feedback you might have on what I have written.

If you are on Facebook, check out < <http://www.facebook.com/spacewx.hfradio> > and < <http://www.facebook.com/NW7US> >.

Speaking of Facebook, visit the *Popular Communications* magazine fan page at < <http://www.facebook.com/PopComm> >.

I invite you to visit my online propagation resource at: < <http://sunspotwatch.com/> >, where you can get the latest space data, forecasts and more, all in an organized manner. Please come and participate in my online propagation discussion forum at < <http://forums.hfradio.org/> >.

Until next month, 73, de NW7US, Tomas Hood
PO Box 1980, Hamilton, Montana 59840
nw7us@nw7us.us
Twitter: @NW7US
@hfradiospacewx

Trivia

Q: Where do radio stations get all their news pictures for their websites?

A: Some are sent in by listeners, of course, but that brings up an interesting story. Back in the '50s and '60s when a copy boy (newsroom clerk) did something outstanding, he was always promised the next opening in the station's Photo Department. It was a hollow promise back in the days when radio was really radio. Now, radio reporters can't leave the station to cover a news story without their digital cameras. Got to get those pictures for the station's website! That is progress for you.

Q: Were radio broadcasts from the north effective propaganda for the Viet Cong fighters in the south? Did the average VC have a radio of his own?

A: The average VC fighter did not have his own radio. They were far too expensive for farmers-turned-soldiers to own. Platoon radios, when not in military use, would be rotated among the various squads on a routine basis. Communist Cadre men would, of course, monitor the listening groups. These Cadre would see that only Radio Hanoi and Radio Liberation (both from the north) would be heard and that the right kind of comments were made by the listeners. The high number of defectors, however, shows that the propaganda was not always effective.

Q: Who was the first person to use a ventriloquist's dummy on the radio?

A: The first dummy (made of wood) to be heard on the air was Charlie McCarthy with his friend Edgar Bergen. Several years earlier another ventriloquist named Phil Cook did a similar act but didn't use an actual dummy. I suppose it didn't really matter since nobody could see either one's mouth move.

Q: Who is Doctor Demento and how did he get started?

A: The host of the Doctor Demento Show, the weekly syndicated program of humor and weird music, is Barret Hansen who started DJing for high school *sock hops* until he graduated and enrolled in Reed College in Portland, Oregon. It was there he got into broadcasting and became the student manager of the college's FM station. His degree is in classical music.

After college he began working for Specialty Records in Los Angeles and had a program on legendary rock station KPPC-FM, known for its *free-form rock*. In 1970, he started doing the Doctor Demento character and the world has not been the same since.

Q: I've heard that there is a special radio station for federal employees. Is that something for emergencies to give out special information?

A: I think you are talking about WFED, which is a special, but commercial radio station available only on the Internet. Most federal workers find their workplaces are hard to reach, as far as radio signals are concerned, with safeguards to keep their computers safe.

These safeguards make it so the workers can't listen to the radio. An Internet streaming station has been set up by a commercial firm to give those workers something like radio service. Because it is on the Web, it can be heard around the world by workers in other countries, even Coast Guard cutters off Antarctica and military bombers in flight.

Q: Here's one that all us Morse code operators want to hear about. Why is there an American and an International version of the code? And why do we all use the International one on the radio?

A: Morse code was actually invented by Alfred Vail who worked for Samuel Morse. He was an American working on a code for the English language. When the code started being used across international borders it proved inadequate for French, Spanish, German and other languages common in Europe. Extra letters and accent marks were simply not available.

In some languages some letters have two forms and, for example, CH is a separate letter all by itself. In time, another code was developed to cover those problems and the International code was the result. The most common use for radiotelegraphy in the early days was ship board wireless so International became the standard for early radio operators.

WWW.SCANCAT.COM

TOLL FREE 888-722-6228

COMBO ALL-IN-ONE CD

ScanCat-Lite-Plus.....\$29.95
Mr. Scanner FCC Public Safety.....29.95
Nat-Com's FCC Scancat Files.....9.95
Bonus Disk Of Frequencies.....15.00
If Purchased Separately \$84.85

NOW \$49.95

PLUS FREE Scanning Magazine(s)
(With Any Order Over \$40.00)

NOW! Open Up Uniden HomePatrol's True Potential

Program ANY Frequency Into The HomePatrol Without Limitations (CB-Ham-Marine-GMRS-FRS)

ScanCat-Lite-PLUS

Reg. \$39.95 - Limited Time Special \$29.95

Now It's Easier Than Ever To Use Your ScanCat Software.

FREE walk-you-through set up video. **NEW!** Home Patrol Video Tutorials!

www.scan-cat.com Click on "Learn as you view." You Tube

NOW AVAILABLE SSCALL HOKA Code 3-32



COMPUTER AIDED TECHNOLOGIES

ORDERS: (318) 687-4444 FAX: (318) 686-0449
Info/Tech Support: (318) 687-2555
(9 a.m. - 3 p.m. Central M-F)

WWW.SCANCAT.COM

Don't miss the next issue of WorldRadio Online

Here's what you'll find in WRO's June issue:

- Rules & Reg
- Aerials
- VE Exams
- Propagation
- DX World
- Contest Corner
- Trail-Friendly Radio
- DX Predictions... and more!



View this issue in its entirety < www.cq-amateur-radio.com >

WorldRadio Online

25 Newbridge Rd., Hicksville, NY 11801

1-800-853-9797

www.worldradiomagazine.com

World News, Commentary, Music, Sports, And Drama At Your Fingertips

This listing is designed to help you hear more shortwave broadcasting stations. The list covers a variety of stations, including international broadcasters beaming programs to North America, others to different parts of the world, as well as local and regional shortwave stations. Many of the transmissions listed here are not in English. Your ability to receive these stations will depend on time of day, time of year, your geographic location, highly variable propagation conditions, and the receiving equipment used.

AA, FF, SS, GG, etc. are abbreviations for languages (Arabic, French, Spanish, German). Times given are in UTC, which is five hours ahead of EST, i.e. 0000 UTC equals 7 p.m. EST, 6 p.m. CST, 4 p.m. PST.

UTC	Freq.	Station/Country	Notes	UTC	Freq.	Station/Country	Notes
0000	15370	China National Radio	CC	0400	5905	Deutsche Welle, Germany, via Portugal	
0000	4700	"Radio San Miguel, Bolivia	SS	0400	4900	Radio Familia, Guinea	FF
0000	4451	Radio Santa Ana, Bolivia	SS	0400	15275	Deutsche Welle, Germany, Rwanda Relay	GG
0000	4985	Radio Brazil Central	PP	0400	6075	Deutsche Welle, Germany, via England	GG
0000	6020	China Radio International		0400	9780	Radio Nikkei, Japan	JJ
0000	5915	IRIB, Iran	Bangla	0400	5915	Radio Zambia	
0000	6155	All India Radio	Urdu	0400	9655	Voice of Turkey	
0000	11590	Radio Cairo, Egypt	AA	0400	6130	Radio Romania International	
0000	15720	Radio New Zealand International		0400	7230	Channel Africa, South Africa	
0000	7290	Voice of Russia		0400	4775	TWR, Swaziland	GG
0100	6025	Radio Amanecer, Dominican Republic	SS	0500	11925	Radio Banderantes, Brazil	PP
0100	9755	Radio Canada International		0500	6155	Radio Austria International	GG
0100	7245	IRIB, Iran		0500	6185	Radio Educacion, Mexico	SS
0100	3340	La Voz Misionaria, Honduras	SS	0500	4960	VOA, Sao Tome Relay	
0100	3250	Radio Luzy Vida, Honduras	SS	0500	9675	Radio Cancao Nova, Brazil	PP
0100	4975	Pacifico Radio, Peru	SS	0600	6200	Radio Bulgaria	TT
0100	4747	Radio Huata 2000, Peru	SS	0600	9565	Super Radio Deus e Amor, Brazil	PP
0100	15180	Voice of Korea, North Korea		0600	9710	Radio Australia	
0100	4965	CVC-One Africa, Zambia		0600	9305	Radio Cairo, Egypt	AA
0100	11925	VOA, Philippines Relay	CC	0600	5875	BBC	
0100	7270	Voice of Russia	RR	0600	5010	Radio Nacional, Equatorial Guinea	SS
0100	6190	International Radio of Serbia		0600	5995	Radio Malienne, Mali	FF
0200	11710	RAE, Argentina		0600	9660	Vatican Radio	
0200	7250	IRIB, Iran		0600	6185	Vatican Radio	various
0200	4815	Radio El Buen Pastor, Ecuador	SS	0800	11840	TWR, Guam	
0200	4790	Radio Vision, Peru	SS	0800	9635	Radio Malienne, Mali	FF
0200	7445	BBC, Seychelles Relay		0800	3925	Radio Nikkei, Japan	JJ
0200	9525	TWR, Swaziland		0800	5020	SIBC, Solomon Islands	
0200	7250	Voice of Russia		0800	9690	Voice of Nigeria	Hausa/EE
0300	6000	Radio Havana Cuba	SS	0900	4885	Radio Clube do Para, Brazil	PP
0300	4780	Radio Djibouti	FF	0900	2485	VL8K, Australia	
0300	7375	Voice of Croatia, via Germany		0900	5954	Radio Republica, via Costa Rica	SS
0300	4052.5	Radio Verdad, Guatemala	SS	0900	4755	The Cross, Micronesia	
0300	7215	Radio Fana, Ethiopia	Amharic	0900	5990	Radio Senado, Brazil	PP
0300	5010	RTV Malagassy, Madagascar	Malagassy	1000	6135	Radio Santa Cruz, Bolivia	SS
0300	3320	Radio Sonder Grense, South Africa	Afrikaans	1000	6060	Radio Nacional, Argentina	SS
0300	6055	Radio Exterior Espana, Spain	SS	1000	9615	KNLS, Alaska	
0300	3345	Channel Africa, South Africa		1000	3280	La Voz del Napo, Ecuador	SS
0300	7200	Republic of Sudan Radio	AA	1000	6010	Radio Mil, Mexico	SS
0300	5910	Alcaravan Radio, Colombia	SS	1000	6070	CFRX, Canada	
0400	11690	Radio Okapi, Congo, via South Africa		1000	6270	Radio Cairo, Egypt	
0400	5865	Radio Algerienne, Algeria, via France	AA	1000	3310	Radio Mosoj Chaski, Bolivia	SS

UTC	Freq.	Station/Country	Notes	UTC	Freq.	Station/Country	Notes
1100	4955	Radio Cultural Amauta, Peru	SS	1700	15530	Radio France International	PP
1100	13790	China Radio International	CC	1700	9755	Vatican Radio	
1100	6035	La Voz del Guaviare, Colombia	SS	1700	13590	CVC-One Africa	
1100	7345	China National Radio	CC	1700	11735	Radio Romania International	
1100	6140	Radio Havana Cuba	SS	1800	7400	Radio Bulgaria	
1100	15340	HCJB, Australia	Indonesian	1800	11965	Deutsche Welle, Germany, Rwanda Relay	Hausa
1100	9500	CVC, via Uzbekistan	Hindi	1800	21690	Radio France International, Fr. Guiana Relay	FF
1100	3290	Radio Central, Papua, PNG	Pidgin	1800	9515	Adventist World Radio, via Austria	
1100	7105	Sound of Hope, Taiwan	CC	1800	15120	Voice of Nigeria	various
1100	5039	Radio Libertad de Junin, Peru	SS	1800	9650	Polish Radio, via UAE	
1100	5985	Myanmar Radio	BB	1800	11845	Radio Canada International	
1100	7360	Radio Nederland, via Philippines	DD	1800	9495	Voice of Turkey	SS
1100	3905	Radio New Ireland, New Ireland, PNG	Pidgin	1800	11835	Voice of Turkey	GG
1100	6020	Radio Victoria, Peru	SS	1800	9500	TWR, Swaziland	
1100	9695	Radio Japan	VV	1800	15360	KBS EWorld Radio, South Korea	
1100	6185	Radio Japan	RR			KBS World Radio, South Korea	RR
1100	9865	Vatican Radio, via Canada	SS	1800	9880	Voice of Russia	RR
1100	9380	Family Radio, USA, via Taiwan	CC	1900	17790	Radio Canada International	FF
1100	9355	Radio Free Asia, Sri Lanka Relay	Laotian	1900	15580	VOA, Sao Tome Relay	
1100	15150	Radio Romaina International	FF	1900	11655	Radio Nederland, Madagascar Relay	
1100	9835	Sarawak FM, Malaysia	Malay	1900	11600	Radio Jamahiriya/V of Africa, Libya	AA
1200	13610	China National Radio	CC	1900	9455	Radio Free Asia, Northern Marianas	Mandarin
1200	6160	CKZU, Canada		1900	17850	Radio Exterior Espana, Costa Rica Relay	SS
1200	6020	Radio Australia		2000	6225	RTE Worldwide, Ireland, via South Africa	
1200	11860	BBC, via French Guiana		2000	11795	Deutsche Welle, Germany, Sri Lanka Relay	
1200	4750	Radio Republik Indonesia, Sulawesi	II	2000	9580	Africa Number One, Gabon	FF
1200	11750	BBC, Thailand Relay		2000	9705	Radio Ethiopia	Amharic
1200	9750	Voice of Malaysia		2000	11655	Radio Nederland, via Madagascar	
1200	3255	Radio Buka, New Guinea, PNG	Pidgin	2000	13670	WINB, Pennsylvania	
1200	13650	KCBS, North Korea	KK	2000	15550u	WJHR, Florida	
1200	5446.5	AFN/AFRTS, Florida	usb	2100	11845	Radio Canada International	FF
1200	9740	BBC, Singapore Relay		2100	11730	Radio Havana Cuba	SS
1200	9720	Radio Thailand		2100	6155	Radio Belarus	
1200	9580	Radio Australia		2100	12095	BBC, Ascension Island Relay	
1300	9870	All India Radio	Hindi	2100	5970	Radio Tirana, Albania	ALB
1300	11935	Adventist World Radio, Guam	Malay	2100	12070	Deutsche Welle, Germany, Rwanda Relay	
1300	9470	All India Radio	Hindi	2100	15190	Radio Africa, Equatorial Guinea	
1300	9525v	Voice of Indonesia	various	2100	9705	La Voix du Sahel, Nger	FF
1300	9460	Polish Radio, via Austria		2100	9370	WTJC, North Carolina	
1300	9935	RS Makedonias, Greece	Greek	2200	11750	China National Radio	CC
1400	9355	Democratic Voice of Burma, via Armenia	BB	2200	12040	HCJB, Ecuador, via Chile	GG
1400	21695	Radio Jamahiriya/V of Africa, Libya		2200	12095	BBC, via South Africa	
1400	17660	BSKSA, Saudi Arabia	AA	2200	7245	Radio Mauritanie, Mauritania	AA
1500	9625	CBC Northern Service, Canada		2200	9435	Far East Broadcasting, Philippines	II
1500	15420	BBC, Cyprus Relay		2200	11535	Voice of Korea, North Korea	CC
1500	9485	BBC, Cyprus Relay		2200	7290	Radio PMR, Moldova	
1500	11905	Polish Radio, via England	Ukrainian	2200	11910	Radio Japan	JJ
1500	11710	Voice of Korea, North Korea		2200	11670	Radio Nacional Venezuela, via Cuba	SS
1500	9430	Far East Broadcasting, Philippines	Mandarin	2200	9480	WTWW, Tennessee	
1500	17725	Radio Jamahiriya/V of Africa, Libya		2200	9385	WWRB, Tennessee	
1500	9840	Voice of Vietnam		2200	9575	Radio Medi Un, Morocco	FF/AA
1500	17745	Sudan Radio Service, USA, via Portugal		2300	9685	Deutsche Welle, Germany, via Singapore	CC
1500	17540	Radio Romainia International	AA	2300	6297	Radio Nacional de la RASD	AA/SS
1600	7440	Radio New Zealand International		2300	17810	Radio Japan	CC
1600	7240	Radio Australia		2300	15250	Rdio Nacional Venezuela, via Cuba	SS
1600	9750	Radio Nederland, via France	DD	2300	9780	KBS World Radio, South Korea	Mandarin
1600	15345	BSKSA, Saudi Arabia	AA	2300	15190	Radio Inconfidencia, Brazil	PP
1600	11905	SLBC/Radio Ceylon, Sri Lanka	EE/Hindi				

Extraterrestrial QSOs: Meteor-Scatter!

by Kirk Kleinschmidt, NTØZ
kirk@cloudnet.com

As a Morse code-slinging HFer from Day One, it's somehow ironic that most of my local ham buddies are VHFers, voice-mode-only ops or even — gasp — TV DXers! But even though my definition of “2 meters” is the minimum length of flexible coax required to accommodate a tower-mounted antenna rotator, it's nice to know that I can contribute to the conversations at our weekly “geeks night out” dinner.

TV DXers, it turns out, are a sneaky bunch of enthusiasts who are eager to explore the mysteries and propagation modes that affect VHF and UHF signals — as are most beginning hams. Consequently, a recent dinner discussion centered

around these topics and ranged from garden variety to esoteric.

From this outing I learned that most beginning hams still think of VHF signals as traveling in line-of-sight paths and fading out after about 30 to 50 miles. After all, most TV signals do this (especially analog TV signals), as do most VHF repeater signals. If you live in a TV reception fringe area, a big directional antenna on a 50- to 75-foot tower will extend your range to 100 miles or so, just as with amateur radio VHF signals.

We talked about the many ways to propagate VHF signals over hundreds or even thousands of miles, including E- and F-layer skip, tropo-



This Perseids meteor was photographed at the European Southern Observatory in Chile on August 16, 2010, by ESO Photo Ambassador Stéphane Guisard, and was one of 8,000 exposures captured over several days. (Photo courtesy of ESO's S. Guisard via Wikimedia Commons.)

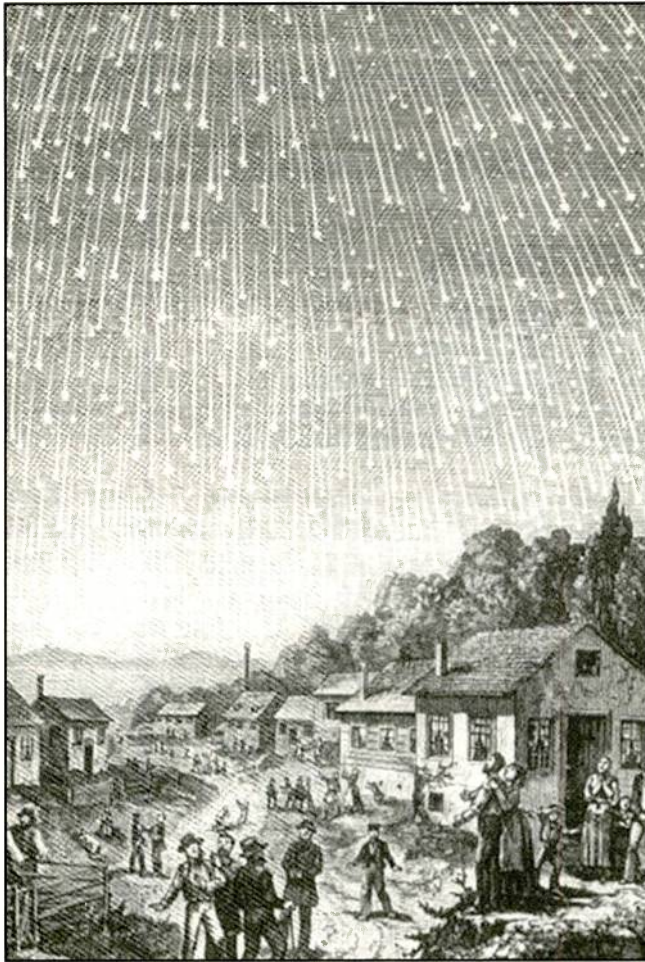

Major Annual Meteor Showers

Shower	Peak Dates	Zenith Hourly Meteor Rates
Quadrantids	Jan 4	120
Aquarids	May 6	70
Arietids	Jun 7	54
Perseids	Aug 13	90
Orionids	Oct 21	20
Geminids	Dec 14	120

Note: These are major showers only. The 2011 dates for many other showers can be found at < <http://www.imo.net/calendar> > hosted by the International Meteor Organization.

are seen streaking across the sky by nighttime observers. Radio signals see the trails left by meteors, too, as long, reflective tunnels of ionized particles. Earth stations that can mutually see the ionized trails can communicate with each other by bouncing — *scattering* — radio signals off of them. The ionized particles reflect radio waves only temporarily, but they can be put to good use!

Meteor-scatter contacts, because of the physics and the geometry involved, take place mostly on 10, 6 and 2 meters between stations 300 to 1,500 miles apart.

Faster, larger meteors produce more intense, longer-lasting trails and better propagation paths. For two stations to communicate via meteor-scatter, one or more meteors must pass through the ionosphere in a useful direction and at mutually visible elevations — 45 degrees or less is best.

Most meteor trails reflect radio waves from a few seconds to a few minutes, depending on the frequency, the size and speed of the meteor, and several other factors. At 10 and 6 meters, meteor trails can reflect signals for 30 seconds to several minutes. At 2 meters, the same meteor trail reflects signals for only a fraction of a second to a minute.

Signals propagated via meteor-scatter suddenly appear out of a completely dead band, last for a short time, and then disappear. The effect is *eerie!* During meteor showers, when several overlapping ionized trails may be scattering radio waves simultaneously, communications may be possible for several minutes to several hours.

Ops who specialize in working meteor trails get very excited about working the big showers. A November shower, officially called the Leonids (meteor showers are named for the constellations in which they appear — Leo, in this case), has produced once-in-a-lifetime radio propagation in years past. Every 33 years or so, when the shower's parent comet, Tempel-Tuttle, sweeps near the sun, the Leonid meteor shower can become a raging meteor storm.

Under good meteor shower conditions, 60 to 80 meteors streak across the sky each hour. During the Leonid storm in 1966, scientists saw peak rates of 150,000 meteors per hour — it was *pile-up central*, and almost certainly the most intense meteor-scatter session experienced to this day. Observers witnessed apocalyptic light shows in the sky. In some locations, people were awakened in the middle of the night by “bright daylight” streaming through their bedroom curtains!

In past centuries, more than one Leonid meteor storm prompted frenzied “end of the world” behavior. Unfortunately, the expected 1998-1999 Leonid storm didn't materialize. Some

Too bad hams weren't on the air during the 1833 Leonids meteor storm, depicted here in an engraving by Adolf Vollmy of a scene observed by minister Joseph Harvey Waggoner on his way from Florida to New Orleans.

pheric and transequatorial ducting, moonbounce and auroral propagation, among others. When someone brought up the phenomenon of bouncing signals off of large airplanes (mostly undesirable for digital TV reception), I countered with a more practical — and desirable — “bouncy mode” called meteor-scatter.

Instead of bouncing signals off airplanes, meteor-scatter communications is about bouncing radio signals off the ionized trails produced by extraterrestrial meteors burning through the atmosphere. It takes a little patience and a bit of study, but an ordinary station — and, perhaps, a personal computer — gets the job done nicely.

Extraterrestrial Radio Reflectors

Meteor showers are produced when the earth moves through orbiting debris streams left by passing comets. Mostly dust and other small particles, the space junk burns up as it speeds through the atmosphere. Although the earth constantly plows through random debris as it orbits the sun, meteor showers are recurring events. The earth encounters certain debris streams at about the same time each year. (See *Major Annual Meteor Showers* accompanying this column.)

Falling stars, whether produced by random meteors or the more predictable meteors that are part of a recurring shower,

If You Want to Learn More . . .

In addition to the operating procedures outlined in *The ARRL Operating Manual for Radio Amateurs*, see the list of web links below for meteor-scatter and WSJT information:

ARRL MS Links	< http://www.arrl.org/weak-signal-vhf-dx-meteor-scatter-eme-moonbounce >
AB7IY MS Links	< http://www.qsl.net/dk3xt/ms.htm >
NZ3M MS Primer	< http://www.nz3m.com/wsjt.html >
MS Primer	< http://www.astrosurf.com/luxorion/qsl-meteor-scatter.htm >
W6AMT MS Links	< http://www.amt.org/Meteor_Scatter/ >
W8WN MS Resources	< http://www.qsl.net/w8wn/hscw/hscw.html?B1=W8WN >
WSJT Home Page	< http://www.physics.princeton.edu/pulsar/K1JT/index.html >
WSJT Primer	< http://www.ykc.com/wa5ufh/Help/WSJTPrimer.htm#MS%20Modes >
WSJT6 User Manual	< http://www.physics.princeton.edu/pulsar/K1JT/WSJT_User_600.pdf >
WSJT 9 Supplement	< http://www.physics.princeton.edu/pulsar/K1JT/WSJT_9.0_Supplement.pdf >

scientists speculate that Tempel-Tuttle has run out of debris and is on its last legs. I guess we'll know for sure in 2030, the comet's next expected pass near the sun!

Voice-Mode QSOs

Two meters is the meteor-scatter workhorse band. The best bands for beginners are 10 and 6 meters. Station requirements are modest and openings last longer and are more consistent.

Traditional meteor-scatter contacts — mostly SSB, and mostly during major

showers — are made with dipole, vertical and even mobile antennas, especially on 10 and 6 meters. Directional antennas work best, though. On 10 and 6 meters, 50 to 100 watts and a 3-element Yagi produce solid results. On 2 meters, where the action is a bit more frantic, 150 watts and a 10-element beam should do nicely.

There are no special procedures for 10-meter meteor-scatter QSOs, as meteor trails usually last long enough to allow normal, brief contacts. Limit your transmissions to a few seconds. During meteor showers, try calling *CQ scatter* just

above (and, or below) 28.5 MHz. Aim your antenna in the direction you hope to make contacts.

SSB activity on 6 meters usually starts at 50.130 MHz and moves up. Contacts are fast, so stay alert! On 2 meters and above, most meteor-scatter work is accomplished via schedules, where each station transmits and receives in coordinated time intervals. Most activity centers around the 144.2-MHz national calling frequency.

On 6 and 2 meters during peak shower periods, call CQ for a few seconds, then

Collins Radio Repair & Tune-Up DVD Guides

Restoring or repairing classic Collins S-Line equipment? These DVDs are like having an experienced professional right next to you!

From Hi-Res Communications, Inc., these well-produced, authoritative DVDs cover all the most common repair and tune-up subjects on these classic radios.



Collins KWM-2

Two disc set, 236 minutes total
Order No. C-KWM \$89.95



Collins 75S-3/32S-3

Two disc set, 226 minutes total
Order No. C-75S \$89.95



Collins 30L-1

Single Disc 61 minutes total
Order No. C-30L \$39.95

Shipping & Handling: US & Possessions-add \$7 for the first item, \$3.50 for the second and \$2 for each additional item. Foreign-calculated by order weight and destination and added to your credit card charge.

CQ Communications, Inc.

25 Newbridge Rd, Hicksville, NY 11801

www.cq-amateur-radio.com

800-853-9797 - FAX us at 516 681-2926

The screenshot shows the WSJT 6 software interface. At the top, it displays 'WSJT 6 by K1JT' and a menu bar with 'File', 'Setup', 'View', 'Mode', 'Decode', 'Save', 'Band', and 'Help'. Below the menu is a spectrum display showing a signal peak. To the right of the spectrum, a 'Moon' box displays: Az: 263.24, El: -12.46, Dop: -114, Dgrd: -1.7. Below the spectrum is a QSO log table with columns: FileID, Sync, dB, DT, DF, W, and a text field. The log shows several entries, including '005600 5 -15 2.9 215 0 * CQ RU1AA KO4B 1 0' and '010200 7 -8 2.7 213 3 * TNX JOE -14 1 0'. Below the log is a control panel with buttons for 'Log QSO', 'Stop', 'Monitor', 'Save', 'Decode', 'Erase', 'Clear Avg', 'Include', 'Exclude', and 'TxStop'. The control panel also includes fields for 'To radio: RU1AA', 'Grid: KP40xd', 'Az: 33', '4311 mi', and a digital display showing '2006 Aug 10 12:22:16'. At the bottom, it shows '1.0003 0.9998 JT65B Freeze DF: 0 Rx noise: -1 dB TR Period: 60 s' and a 'Receiving' indicator.

This screen capture of WSJT version 6 shows WSJT creator Joe Taylor, K1JT, working RU1AA via moonbounce on August 10, 2006, on mode JT65B. WSJT includes protocols that are optimized for moonbounce, meteor-scatter and more. (Courtesy of WSJT)

listen for a few seconds. Contacts are complete when callsigns and one other piece of information (grid locator or state) is exchanged and acknowledged by "rogers." Repeats are often required. Keep your transmissions short and stay with a station until a full exchange of information is made.

Digital Modes

Once a mainstay, SSB meteor-scatter contacts are mostly made during major showers. Everyday contacts are now made primarily through a pair of digital modes tailored for meteor-scatter and moonbounce work called FSK441 and JT6M.

Much like the more common HF digital modes, FSK441 and JT6M are digital sound card modes that are part of a comprehensive weak-signal data communication suite called *WSJT*, written by Nobel prize winner Joe Taylor, K1JT. FSK 441 and JT6M send and receive data in super-fast bursts that take advantage of the frequent sub-second *pings* produced by the many common, but tiny (weak) meteors entering earth's atmosphere.

Operators using this mode need to synchronize their station clocks accurately because the process involves one station transmitting while the other receives, etc. So, using FSK441 and JT6M isn't as easy as using PSK31 on HF, for example, but its vastly superior performance compared to SSB has made it the technique of choice for VHF *ping jockeys* everywhere.

With its low power requirements and amazing signal-to-noise performance, FSK441 and JT6M (and their cousins) have ushered in a new era of long-distance VHF communications. Remember, regardless of weather, sunspot or ionospheric conditions, there is a steady stream of tiny meteors bombarding the atmosphere each day that are too small to sustain voice contacts, but are more than usable via FSK441 and JT6M.

Miscellany . . .

You have to be an early riser to work the daily meteors. Sunrise to about 9 a.m. is prime time, so late-sleepers will miss out on the best action. There are plenty of contacts to be made year-round — especially via FSK441 and JT6M — although June, July and August have the most meteor activity.

Although they're really "out there," meteor-scatter QSOs qualify for most of

the usual VHF/UHF awards and certificates, including WAS and VUCC. I haven't heard of any MS-only awards because it's often impossible to discern meteor-scatter propagation from tropo or E-skip openings.

The Arietids meteor shower, which unfortunately, is often a poor performer, overlaps the June VHF QSO Party weekend. Meteor-scatter propagation usually gives the best boost to the annual ARRL 10-Meter Contest, which intersects the December Geminids shower. Even when 10 meters seems totally dead, morning

scatter contacts put at least a few stations in just about everyone's log.

Making your first MS QSOs might seem daunting, but with a little study and perseverance, it's really only moments away — assuming you can be at your radio during the early morning hours! Unlike other propagation modes that rely on sunspots, weather and other "fickle factors," meteor-scatter propagation is, in its own way, a steady phenomenon. And the gear required to participate is useful for any other type of VHF/UHF operating. It's a real win-win situation.

2011-2012 CQ calendar **SALE!**

15 months of value- January 2011 through March 2012



Better than ever! This year's calendar will bring you 15 spectacular color images of some of the biggest, most photogenic shacks, antennas, scenics and personalities from across the country for only \$8.95 (+S&H)!

Calendar includes dates of important Ham Radio events such as major contests and other operating events, meteor showers, phases of the moon, and other astronomical information, plus important and popular holidays. The CQ Amateur Radio Operators Calendar is not only great to look at, it's truly useful, too!

Shipping \$2 US, \$4 CN/MX, \$9 FN

CQ Communications, Inc.

25 Newbridge Road, Hicksville, NY 11801
Call 1-800-853-9797 • FAX 516-681-2926
www.cq-amateur-radio.com



The DX Store

No BS. Just good old fashioned customer service



ICOM factory reconditioned (repacked) receivers and accessories. Repacked receivers have been completely reconditioned, tested, and calibrated by ICOM factory service technicians, and are covered by a full factory warranty for 90-Days.

www.dxstore.com
sales@dxstore.com

Don't Cry for Me, Argentina: A New Transmitter Pumps Life Into RAE – and Logs, Logs, Logs from Readers

by Gerry L. Dexter
gdex@wi.rr.com

Radio Argentina al Exterior (RAE), about which there have been some worrisome days, now seems to be out of the woods. There were rumors of financial worries and the concern that the broadcaster might join the way-too-many others in dropping shortwave. Now, to quote old time radio newscaster Gabriel Heater, "Ah, there's good news tonight!"

The Argentine government has announced it will supply a new transmitter for RAE, so we can continue to hear their broadcasts on 11710 kHz on a regular basis. Yea!

Cross Radio, mentioned last month as operating on a 24-hour basis, has cut back its schedule. The 24-hour thing was more or less a test to see how local listenership reacted. The all-hours routine has been cut back to 2130 until 0930. That still leaves enough opportune hours for most of us to hear the station.

Reception reports are accepted by email to < pohnpei@pmapacific.org >. The station's mailing address is: Pacific Missionary Aviation, The Cross Radio, P.O. Box 517, Pohnpei 96941, Federated States of Micronesia.

Here is a new DX target for you: the Maoming Marine Meteorological Broadcasting Station in Maoming City, Guandong Province, China. The station operates on 3360 USB with one kilowatt and is on the air at four brief (unspecified) times per day.

Radio Slovakia — thought earlier to be kaput — has managed to work out a deal in which it will be relayed by WRMI-9955 on Tuesdays through Friday at 0130-0200 and, in Spanish, at 0330-0400.

Deutsche Welle has been ordered by the German government to scale back its shortwave transmissions. This will probably take some time, but you can count on hearing less and less from DW as the months roll on.

The Colombian on 5910 is no longer Marfil Estereo. Instead, another co-owned broadcaster — Alcaravan Radio, from Puerto Lleras, has taken its place.

Wanted: Your Logs, QSLs, Photos, and More

Remember, your shortwave broadcast station logs are always welcome. But please be sure to double or triple space between the items, list each logging according to its home country and include your last name and state abbreviation after each.

Also needed are spare QSLs or good copies you don't need returned, station schedules, brochures, pennants, station photos and anything

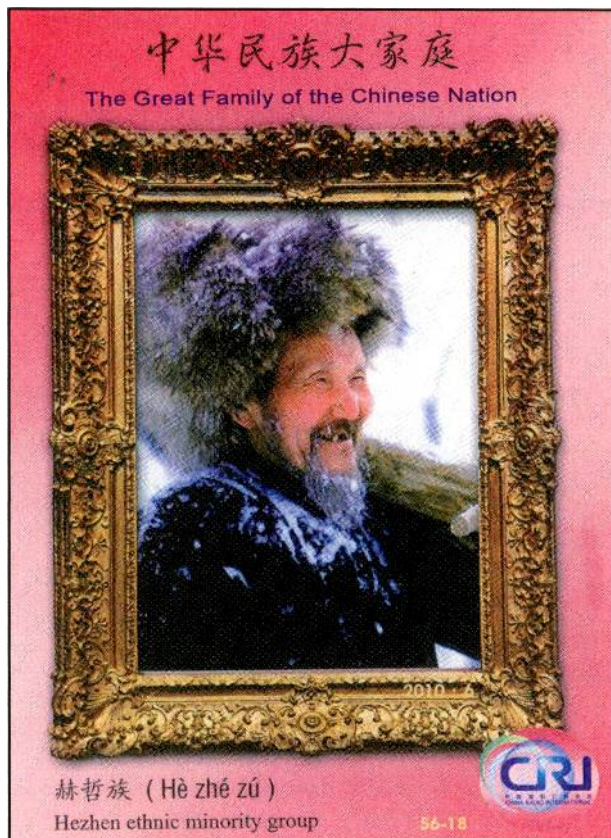

Rich D'Angelo received this card verifying the Qinhai (China) PBS station on 4220.

else you think would be of interest. And where, oh where, is that photo of you at your listening post? It's your turn to grace these pages!

Here are this month's logs. All times are in UTC. Double capital letters are language abbreviations (SS = Spanish, RR = Russian, AA = Arabic, etc.). If no language is mentioned English (EE) is assumed.

ALASKA—KNLS, Anchor Point, 9615 at 0959 with ID, sked and IS to *1001. (Sellers, BC)

ALBANIA—Radio Tirana, 5970 at 2152 in Albanian. (D'Angelo, PA)

ALGERIA—Radio Algerienne, 5865 via Issoudun at *0359 opening with M vocals, 5 + 1 time pips, possible NA and M in AA. (D'Angelo, PA) 0409 with Koran. (Parker, PA) 0443. (Yohnicki, ON)

ARGENTINA—Radio Nacional, 6060 with domestic SS pgming at 0945, W with time check. At 0953 this changes over to RAE for several minutes, then back to R. Nacional. (Perry, IL) 11710.6 at 0200 with rotating multi-lingual IDs and into brief news. (Coady, ON) 0210 with EE pgm. (Montgomery, PA) 15345 Radio Nacional at 0027 with 2 M and a sports event in SS. (MacKenzie, CA) 2344 with M in SS and pops, listener phone calls. (D'Angelo, PA)

ASCENSION ISLAND—BBC South Atlantic Relay, 6135 in Hausa at 0626, 12095 at 2143 with an interview. (Parker, PA) 2224 with news items. (MacKenzie, CA) 15400 at 2011. (Parker, PA)

AUSTRALIA—Radio Australia, 6020 at 1224 with ID and URL. (Yohnicki, ON) 7240-Shepparton at 1617 with call-in pgm. (Sellers, ON) 9580 with World Football Weekly at 1953 to sign off at 1958. (Coady, ON) 9710 with Pacific Beat regional news at 0715//9660. (Sellers, BC) 13630 at 0745 with sports results and play-by-play clips. (Barton, AZ) 17795 at 0000 with news items, //17715. (MacKenzie, CA)

ABC Northern Territories Service: 2310 Alice Springs at 1221 with pops and some fades. (Montgomery, PA) 2325 Tennant Creek at 1002 with sports commentary and music. (Sellers, BC) 1230 with IS and ID by

W. (Montgomery, PA) 2485 Katherine at 0950 with P-b-P sports. (Sellers, BC) 0950 with rock. (Wilkner, FL) 1224 with a music pgm. (Montgomery, PA)

HCBJ Global.15340 with EE ID at 1145 and into Indonesian. (Ng, Malaysia)

AUSTRIA—Radio Austria International, 6155 at 0521 with GG talks. (Parker, PA) 0709 switching from GG to EE for a brief newscast. (Sellers, BC)

BANGLADESH—Bangladesh Betar, 4750 at 1219 in vernacular with W vocal, talk by W and tentative ID at 1200. (Montgomery, PA) 1144 with local vocals, M anc in Bengali, ID and news. QRM from (p) Makassar started at 1159. (D'Angelo, PA)

BELARUS—Radio Belarus, 6155 at 2128 with M and ID, talk on the economy and many IDs. (Montgomery, PA)

BOLIVIA—Radio Eco, Reyes, 4409.8 heard at 2330 in SS. (Wilkner, FL)

Radio Santa Ana, Santa Ana del Yacuma, 4451.1 heard at 2330 with choral music, ID, string of vocals and M with SS comments. (Wilkner, FL)

Radio San Miguel, Riberalta, 4699.9 at 1034 with M in SS, ID and TC. (D'Angelo, PA) 0015 with just a threshold signal. (Strawman, IA)

Radio Santa Cruz, Santa Cruz de la Sierra, 6134.8 heard at 1015 with local ballads and clear ID at 1035. My favorite morning visitor. (Perry, IL)

BONAIRE—VOA via Bonaire, 15580 at 1930 mentioning "VOA news in two minutes." (Montgomery, PA)

BOTSWANA—VOA Relay, 7340 in (l) Kinyarwanda/Kirundi at 0416 with W talk and hifi music. (Coady, ON) 9885 at 0427 asking listeners to write VOA about reception in their area. (MacKenzie, CA) 12080 in PP at 1758. (Brossell, WI)

BRAZIL—(all in PP - gld)

Radio Municipal, Sao Gabriel de Cachoeira, 3375.3 at 0920 with domestic music at 0930. (Wilkner, FL)

Radio Imaculada Conceicao, Campo Grande, 4754.8 with M talk and orch music and a live audience at 0950. (Perry, IL)

Radio Difusora, Londrina, 4815 at 0034 with W and short talks, inspirational vocals. (D'Angelo, PA)

Radio Clube do Para, Belem, 4885 at 0552

with reggae, M anc with reverb. (Parker, PA) 0935 with the best signal on the band. ID as "Radio Clube do Para, muito bom dia...na faxia de 60 metros..." (Perry, IL)

Radio Educacao Rural, Tefe, 4925.2 at 0103 with M singing and guitar. (Parker, PA) 1022 with M talk, music bridge, apparent taped soccer highlights. (Perry, IL)

Radio Capixaba, Vitoria, 4935.2 at 0056 with W and guitar, M with ID. (Parker, PA) 0219 with intense preacher. (Montgomery, PA)

Radio Mundial/Iguatemi/Nossa Voz, 4975 at 2337 with talk by M and W, Brazilpops. (D'Angelo, PA)

Radio Brazil Central, Goiania, 4985 at 0035 with excited M talk. (Parker, PA) 0226 with M in long talk, station jingle and (t) ID at 0230. (Montgomery, PA)

Radio Cultura Ondas Tropicais, (p) 5045 at 2206 with music. (Montgomery, PA)

Radio Voz Missionaria, Florinapolis, 5939.8 at 0440 with religious talk, ballads and comls, //9665.1 (Alexander, PA) 9665 (p) at 0220 with M/W in long conversation. (Taylor, WI)

0338 with M in (p) sermon. (Strawman, IA)

Radio Cancao Nova, Cachoeira Paulista, 9675 (p) at 2230 with impassioned religious preacher. (Coady, ON) 2242. (Taylor, WI) 0606 with W singer being interviewed. (Parker, PA)

Super Radio Deus e Amor, Curitiba, 9565 at 0632 with M introducing a ballad. (Parker, PA) 9592.5 at 2327 with M and sermon, //11805. (D'Angelo, PA)

Radio Rio Mar, Manaus, 9695.8 at 1041 with M, ID, several ads and Amazonas area news. (D'Angelo, PA)

Radio Bandeirantes, Sao Paulo, 9645.3 at 0224 with M, ID and frequency anmt at 0228, several ads, 3+1 time check and more ads. (D'Angelo, PA) 0510 with songs and an interview. (Parker, PA)

Radio 9 de Julho, Sao Paulo, 9820 at 0558 with slow music, multiple time pips at TOH, ID, talk. (Parker, PA)

Radio Boa Vontade, Puerto Alegre, 11895 at 2303 with soft singing and M in religious talk, //9550 was better. (D'Angelo, PA)

Radio Inconfidencia, Belo Horizonte, 15190 at 2215 with talk, jingles, ID at 2234. Poor to fair on //6010. (Alexander, PA)

BULGARIA—Radio Bulgaria, 6200-Plovdiv at 0612 in Turkish with W anc and TT music. (Parker, PA) 7400-Plovdiv in EE at 1840 on new nuclear power plant. (Fraser, ME)

CANADA—Radio Canada International, 9755 at 0114 with The Link. (Barton, AZ) 11845 in FF at 2138 and 17790 in FF at 1918, //13650 and 17735. (MacKenzie, /CA) 11845 via Vatican at 1809 on new quotas on immigrant visas, //17790. (Sellers, BC)

CBC Northern Quebec Service, 9625 at 1524. (Sellers, BC)

CFRX, Toronto, 6070 at 0945 with Health Profile. (Sellers, BC)

Help Wanted

We believe the Global Information Guide — month after month — offers more SWBC logs than any other monthly SW publication! (Just short of 590 shortwave broadcast station logs were processed this month!) Why not join the fun and add your name to the list of GIG reporters? Send your logs to Gerry Dexter, Global Information Guide, 213 Forest St., Lake Geneva, WI 53147 or email them to <gdex@wi.rr.com>. See the column text for formatting suggestions.

**Not all logs get used. There are usually a few which are obviously inaccurate, unclear, or lack a time or frequency. Also discounted are unidentifieds, duplicate items (same broadcaster, same frequency, same site), and questionable logs.*

CFVP, Calgary, 6030 at 2203 with country and "Classic Country AM-10-60." (Sellers, BC)

Bible Voice Network, 6225 via Kazakhstan inviting letters at 1405 then into CC. (Sellers, BC)

CHAD—Radif. Tchadienne, N'djamena, 6165 at *0427 sign on with blafon IS, NA and FF anmts at 0430 and into Afropops. Also noted at 2200. (Alexander, PA) 0438 with continuous lively vocals, FF anc. No sign of Zambia. (D'Angelo, PA) 2150 with African rhythms, FF news at 2200. (Perry, IL) 2202 after Zambia closes with 2 M and FF news. (D'Angelo, PA)

CHINA—China Radio International: 6020 via Sackville with Voices from Other Lands at 0030. (Fraser, ME) 7325 at 1512 with news, //7405; 9415 with an interview at 0812, 9435 with news at 1501 and 9600 on Chinese foods and restaurants at 1634. (Sellers, BC) Xinjian PBS, 7260-Urumqi in (I) Mandarin at 1120, 7390-Hohhot in (I) Mongolian at 1130, 11875-Kunming in (I) Chaochow at 1155, 11620-Xi'an in JJ at 1212 and 13790 with CC language lessons at 1158. (Brossell, WI) 9460 ending People in the Know at 1229. (Coady, ON) 9460 at 0416, 9790 in Cantonese at 0425, 11990 in CC at 2143 and 17495 in Cantonese at 0010. (MacKenzie, CA) 9730-Kashi (p) at 1230 with In the Spotlight. (Ng, Malaysia) 11860-Kunming in Nepali at 0141. (Parker, PA) 13680 in CC at 1510. (Barton, AZ)

China National Radio/CPBS: CNR-1-Galmud, 4800 poor in CC at 2350. (Strawman, IA) Xizang PBS-Lhasa (Tibet) 4820 in Mandarin at 1552. PBS Xizang (Tibet), 4905 in EE at 1541, CNR-1 9170 in Mandarin at 1449. (Sellers, BC) Xizang PBS, (p) 5240 weak at 2130. (Montgomery, PA) 6030 at 1305 with what sounded like a Lion dance

performance. (Perry, IL) 11960-Beijing in CC at 0127. (Parker, PA) CPBS, 11750 in CC at 2233, 15370 in CC at 0022. (MacKenzie, CA) 6125-Shijiazhuang in CC at 1136, 7345-Beijing in CC at 1131 and 13610-Nanning in CC at 1205. (Brossell, WI)

Firedrake music jammer, 9380 against Sound of Hope at 1210. (Brossell, WI)

COLOMBIA—Marfil Estereo, Puerto Lleras, 5910 at 0039 in SS with flutes, anmts, fanfare and music. (Sellers, BC) 0430 with SS hilife. (Parker, PA) (5910 now carries the local Al Caravan outlet. – gld)

CROATIA—Voice of Croatia, 7375 via Germany at 0307 with music and Croatian. (Montgomery, PA) 2330 in Croat. (Fraser, ME)

CUBA—Radio Havana Cuba, 6000 at 0343 with news and sports in SS. (Padazopulos, Greece) 6010/6050/606/6150 all in use for the 0500-0700 EE broadcast. (Sellers, BC) 6140 in SS at 1159, NA at 1200. (Yohnicki, ON) 9820 in SS at 2229, 11730 in SS at 2130 and 11770 in SS at 2238. (MacKenzie, CA)

DJIBOUTI—Radio Djibouti, 4780 at *0258 with O/C, orch. anthem at 0259, M with ID and opening anmts and vocals. (D'Angelo, PA) *0300 with anthem, AA talk, Koran. (Alexander, PA) 0302 in AA with Koran. (Coady, ON)

DOMINICAN REPUBLIC—Radio Amanecer, Santo Domingo, 6025 at 1125 with a segued mix of schlocky religious vocals and Christian pops, with an occasional bona fide hymn. W with ID at 1010. (Perry, IL) 0220 with soft instls, M in SS and ID at 0245. (D'Angelo, PA)

ECUADOR—HCJB, 6050-Pichincha relaying their local 690AM at 1040 with local folk music. Clear HCJB IS at 1110. (Perry, IL) 9835 via Chile in GG at 2344. (Sellers, BC) 12040 via Chile in GG at 2228. (MacKenzie, CA)

Radio El Buen Pastor, Saraguro, 4815 at 1050 with upbeat non-descript music, ID at 1052 and seeming brief religious talk. (Perry, IL) 1104. (Montgomery, PA) 1109 in Quechua, ID and TC at 1118. (D'Angelo, PA) 1130. (Wilkner, FL)

La Voz del Napo, 3280, Tena in SS at 1020. (Wilkner, FL)

HD2IOA, 3810 at 0424 with time pips and M with time checks in SS. (D'Angelo, PA)

EGYPT—Radio Cairo, 6270 at 2151 with W and news and music interludes, M with history lesson. Weak audio with deep fades. Ended with ID at 2158. (Montgomery, PA) 9305 at 2354 with AA music and anmts, radio drama at 0001. Also, 11590 at 2357 seemingly back after the crisis but modulation very low, improving only when they switched to music. (Sellers, BC)

ENGLAND—BBC, 5790-Skelton in AA at 0404, 5875-Rampisham with On Assignment at 0618. (Parker, PA) 5875 Thailand Relay in EE at 1419, 5910 Seychelles Relay relay in EE at 2157, shown as switching to South Africa at 2200-2300, 9485 Cyprus Relay in EE at 1506. (Sellers, BC) 6005 with news at 0404. (Padazopulos, Greece) 9915 Cyprus in AA at 0452. (Parker, PA) 11750 Thailand Relay on Romanian dissidents at 1248 and 11860 via French Guiana at 1253. (Brossell, WI) 15420 Cyprus with time pips to 1500, in step with an atomic clock. (Strawman, IA) 15360 Thailand at 0024 on worldwide upswing on shoe sales. (MacKenzie, CA)

CVC/Christian Voice, 9500 via Tashkent in Hindi at 1109. (Montgomery, PA)

EQUATORIAL GUINEA—Radio Nacional, Bata, 5005 at 0626 with M/W talking in vernacular. (Parker, PA)

Radio Africa, Bata, 15190 with EE religious programming at 1751. (Taylor, WI) 2126. (Coady, ON)

ERITREA—Voice of the Broad Masses, 4770 (p) at 0415 with talk in local lang, HOA music occasionally above the noise floor. Very poor. (Coady, ON) 7175 at *0359 with IS, M with ID, opening anmts and news (in local lang), also 7205. (D'Angelo, PA)

ETHIOPIA—Radio Ethiopia, 9705 at 2000-2100* after Family Radio signs off, building to a good level after 2030 with local music pgm and occasional anmts in (p) Amharic. Off with unfamiliar orchestral anthem. (Perry, IL) 2010 with HOA music. (Alexander, PA) 2032 with HOA music hosted by M. Amharic talks, closing anmts at 2058 and NA. (D'Angelo, PA)

Radio Fana, 7215 in (p) Amharic at 0334 with folk music, M/W mentioning Addis Ababa. (Coady, ON)



democracy4know
<democracy4know@gmail.com>
12/23/2010 01:06 PM

Transmission details

- 1st Transmission:
0630-0730 local time on 7590 kHz
- 2nd Transmission:
1800-1900 local time on 15420 kHz

To: rdangelo@firstenergycorp.com
cc:

Subject: Re: 08 - Reception Report: Radio Free Sarawak on 21 November 2010 from 2234 to 2330 UTC or on 22 November 2010 from 0634 to 0730 your local time on a frequency of 7,590 kHz

Halo Mr Richard A. D'Angelo,

Many thanks for your reception report!

Your report confirm our other reception reports that the reception need improving. I hope that the technical folks will fix any problem there might be as soon as possible. Hope this reply will confirm for you the reception of your very nice letter. Our heartfelt appreciation!

Warmest regards to you and all of your family!

Ong BK
Fan Club of Radio Free Sarawak
Penang,
Malaysia



Radio Free Sarawak has been in the DX news lately. (Thanks: D'Angelo)

In Times Past...

Here's your "blast from the past" for this month:
Radiodifusion Television Congolaise, Brazzaville, Congo, on 4843 in FF at 0530 on June 11, 1964.

FRANCE—Radio France International, 15530 in PP at 1742. (Brossell, WI) 21690 in FF at 1750. (Barton, AZ) 1816 in FF. (Sellers, BC) 1845. (MacKenzie, CA)

GABON—Africa Number One, 9580 in FF at 0620 with M in FF over long hillife number. (Parker, PA) 2002 in FF with news and correspondent reports. (Coady, ON)

GERMANY—Deutsche Welle, 3995-Skelton in GG at 0638 and 11665 via Ascension in GG over Japan at *0000 and 11690 in Hausa with comments and brief excerpts from a speech. (Sellers, BC) 5905 with Newslink at 0412 and 9755 Rwanda Relay at 0507. (Coady, ON) 5905 Portugal Relay in EE at 0425 and 11605 Rwanda Relay in GG at 2151-2155.* (Parker, PA) 6075 in GG at 0403. (Padazopoulos, Greece) 7425 Sri Lanka Relay in RR at 2050 and 9865 via Singapore in CC at 2300. (Ng, Malaysia) 11965 Rwanda Relay in (f) Hausa at 1805 and 15275 in GG at 1804. (Brossell, WI) 11865 Portugal Relay in FF at 2245 and 12070 in EE at 2155. Off at 2200. (MacKenzie, CA)

GREECE—Voice of Greece, 7475 with Greek music at 0015. (Barton, AZ)

GUINEA—Radio Guinee, 7125 at 0722 with FF talk and local tribal music. (Alexander, PA)

Radio Familia, 4900 at 2330 with Afropops, FF anmts. (Wilkner, FL) 2345-0001* with Afropop and FF anmts. Fair level, but poor overall due to CODAR QRM. (Alexander, PA)

GUAM—Adventist World Radio/KSDA, 9790 with pgm on health at 1637. (Sellers, BC) 11935 at 1300 in Malay. (Ng, Malaysia)

Trans World Radio, 11840 heard at 0905 with Christian music. (Sellers, BC)

GUYANA—Voice of Guyana, 3290 heard at 0140, sounded like a M addressing small congregation. Extremely weak audio. (Parker, PA) 0605 with a sermon, news items, messages and music. (Wilkner, FL) 0920 with deep fades, M ancr and instls. (Perry, IL) 0926 on a cricket match. (Sellers, BC) 0949 with preaching, ID and news at 1001. (D'Angelo, PA) 2354 with M ancr and religious music. (Montgomery, PA)

GUATEMALA—Radio Verdad, Chiquimula, 4052.5 at 0240 with pgm of continuous music, M in SS at 0255. (D'Angelo, PA) 0245 with continuous music. Talk, but no ID, at 0300. (Montgomery, PA) 0604 with children's choir. (Parker, PA)

HONDURAS—Radio Luz y Vida, San Luis, 3250 at 0107 with nice music. ID at 0108. (Montgomery, PA) 1135 with chorus and hymn, M with ID at 1158. (Perry, IL)

Radio Misiones Intl/HRMI, 3340 at 0147 in SS. Signal level kept the noise down but low audio. (Parker, PA)

INDIA—All India Radio, 4840-Mumbai at 1548 with Indian music and talk, 4910-Jaipur (t) with EE news at 1540, 4920-Chennai with EE news at 1538, //5040, 5040-Jeypore poor in Hindi at 1521, 9445 with EE news at 2205 and 9870-Bangaluru with the Vividh Bharati entertainment channel at 0141 with Hindi vocals and M in Hindi. (Sellers, BC) 6155-Bangaluru opening at 0012-0015 with W talk, 0015 with call to prayer. I believe this is the domestic Urdu service. (Perry, IL) 6280-Bangaluru in EE at 2145 and 9870-Bangaluru with news items in Hindi at 1330, possible ID at 1330. (Montgomery, PA) 9470-Aligarh in Hindi at 1318 and apparent news in Hindi at 1330. (Coady, ON) 9470-Aligarh with Hindi service at 1510 and 9595-Khampur in Urdu at 0150. (Strawman, IA)

INDONESIA—Radio Republik Indonesia, Makassar (Sulawesi), 4750 at 1158 poking through Bangladesh with SCI and Jakarta news. (D'Angelo, PA)

Voice of Indonesia, 9525 at 1215 with slow music and talks in II. (Brossell, WI) 1315 ending commentary and EE ID. (Coady, ON) 1322 with EE woman hosting pgm of II music. (D'Angelo, PA) 1411 with an extended talk in II. (Strawman, IA)

IRAN—IRIB, 5890 in Urdu at 1533. (Sellers, BC) 5915 in Bangla at 0030. (Ng, Malaysia) 6120, //7250 with choral anthem, M with ID and into Koran. (Coady, ON) 7245 with Koran at 0133. (Brossell, WI) 7250 in EE at 0208. (Sellers, BC)

IRELAND—RTE Radio Worldwide, 6225 via South Africa at 2021-2031* close of a features pgm, f/by classical music, World Radio Network ID at 2028, news headlines. (D'Angelo, PA)



Logging AFN/AFRTS in Diego Garcia on 4319 is a neat trick! (Thanks: D'Angelo)

NHKWorld Radio Japan, 6185-Yamata with piano IS at 0655, sign on in JJ at 0700 and 9840 in EE at 1010 with news, JJ music. (Sellers, BC) 6185 in to Russian at 1130. (Barton, AZ) 1149 in RR. (Brossell, WI) 9685-Yamata in VV at 1110. (Ng, Malaysia) 9720 via Tashkent at *1259 with IS, opening by M in Bengali. (D'Angelo, PA) 11910 in JJ at 2250 and 17810 in CC at 2355, off at 0000. (MacKenzie, CA)

Radio Nikkei, 3925 in JJ at 0835 on replenishing forests in a mix of JJ and EE and 6055 in JJ at 1045, (Barton, AZ) 1135. (Brossell, WI) 0934 with JJ pops. (Sellers, BC) 1134 with JJ talk and traditional music. (D'Angelo, PA) 6055 at 2155. (Ng, Malaysia) 9760 in JJ at 0423. (MacKenzie, CA)

LAOS—Lao National Radio, 6130 with W hosting pgm of traditional music, familiar seven gongs at 1200, f/by news. (D'Angelo, PA)

LIBYA—Radio Jamahiriya/Voice of Africa, 11600 via Issoudun in AA at 1913. (Brossell, WI) 15215-Issoudun in FF at 1746. (Brossell, WI) 17725 via Issoudun at 1552 with M/W profiling several African cities. (Sellers, BC) 21695 via Issoudun in EE at 1455. (Parker, PA)

MADAGASCAR—Radio Madagasikara, 5010, already in progress at 0300 with African choral and pops, heavy on rhythm, then a seeming newscast at BOH. (Perry IL; Alexander, PA)

MALI—Radio Malienne, 5995 at *0555 with on with guitar IS, anthem, flute IS, FF ID and local music. Also 9635 at *0759 with flute IS and opening FF anmts, vernacular talk at 0800. (Alexander, PA)

MAURITANIA—Radio Mauritanie, 4845 in AA heard at 2358. (Parker, PA)

MALAYSIA—Sarawak FM, 5030 with Malay pops at 1519 in Bhasa Malay. (Montgomery, PA) 9835 at 1141 with W in Malay hosting pgm of traditional music. (D'Angelo, PA)

Voice of Islam, 6050 at 1550 with call to prayer, M ancr and vocals. (Barton, AZ)

Voice of Malaysia, 9750 heard at 1240 with M hosting II pgm. (D'Angelo, PA)

MEXICO—Radio Mil, Mexico City, 6009.9 at 1030 with romantic vocals and techno dance. ID at 1110. (Perry, IL)

Radio Educacion, Mexico City, 6185 coming on at 1057, symphonic NA, ID. (Perry, IL)

MICRONESIA—Cross Radio, Phonpei, 4755.4 heard at 0851 with contemporary Christian music, ID heard at 0900 as "This is 88.5 FM - The Cross." (Sellers, BC) 0955 poor-fair, not there at 1010 recheck. (Wilkner, FL) 1320 fair, but declining to poor by 1325. (Strawman, IA)

MOLDOVA—Radio PMR, 6240 at 2030 and M with EE news. (Ng, Malaysia) 7290 at 2230 with time pips and ID. (Coady, ON) 2300 in FF, changing to GG at 2330. (Montgomery, PA)

MOROCCO—Radio Medi One, Nador, 9575 at 2237 in FF with 70s disco, into AA news at 2300. (Coady, ON)

MYANMAR—Myanmar Radio, 5985 at 1135 with phone-in pgm and domestic songs. (Ng, Malaysia)

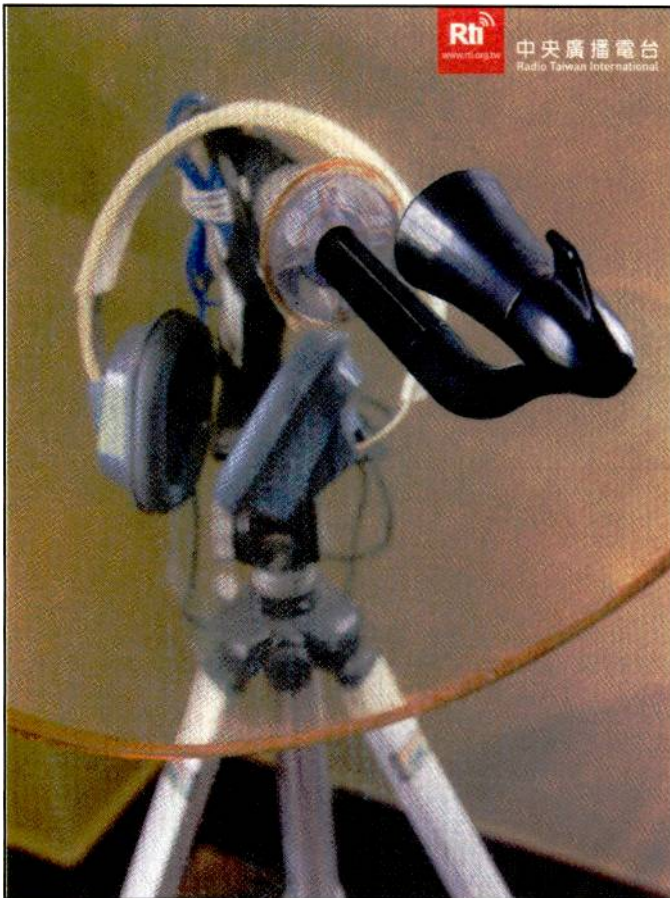

Rick Barton got this stylish card from Radio Taiwan International.

NETHERLANDS—Radio Nederland, 5860 via Philippines with news in II at 1100. (Ng, Malaysia) 7360 in DD at 1113. Closed at 1130 with NA. (Barton, AZ) 9750 via France in DD at 1625, and 11655 with an interview in EE. (Sellers, BC) 11655 at 2000 with Africa Worldwide. (Montgomery, PA)

NEW ZEALAND—Radio New Zealand International, 7440 at 1613 with a news report. (Sellers, BC) 15720 at 0013. (MacKenzie, CA)

NIGER—La Voix du Sahel, Niamey, 9705, 2100-2300 audible after Ethiopia signs off. FF talk, Afro and Europops. Off at 2300 with short flute IS and NA. (Alexander, PA) (p) at 2100 in similar format. (Perry, IL) 2106 after Ethiopia with FF talk, tribal vocals and phone calls. (D'Angelo, PA) 2108. (Montgomery, PA)

NIGERIA—Voice of Nigeria, 9690 at 0840 in (I) Hausa, local drums. Into EE pgm at 0900. (Alexander, PA) 15120 in EE at 1538. (Sellers, BC) 1806 with world news. (Brossell, WI) 1820. (Fraser, ME)

NORTH KOREA—Voice of Korea, 3250 in JJ at 1111, 9730 in EE to Asia at 0137, //11735, 13760, 15180. Also 9990 in EE to Middle East and Africa at 1620, 11710 in EE at 1550. (Sellers, BC) 9335 at *1300 with M with ID and orchestral anthem. (D'Angelo, PA) 11535 in CC at 2225. (MacKenzie, CA) 11735 at 0100 with IS, ID and talk. (Coady, ON)

Korean Central Broadcasting Station, 2850 with KK opera at 1118, 3480-Wonsan in KK at 1122. (Sellers, BC) 13650-Pyongyang in KK at 1205. (Brossell, WI)

OPPOSITION—Voice of Eritrea, 7235 via Ethiopia, *0359 to 0431* with HOA music at sign on, talk in (I) Tigrinya, better on //9560. Tu-Th-Sa only. (Alexander, PA)

Radio Y'Abaganda, (to Uganda), 15410 at 1753 in (I) Lubanga. (Brossell, WI) 17725 at *1700-1715 sign off. Crowd noise and yelling, EE anmt and local vocals. Sat only. (Alexander, PA; D'Angelo, PA)

Shikaze (to North Korea), 5910 with W in EE at 1428 and purpose. Off at 1430. (Sellers, BC)

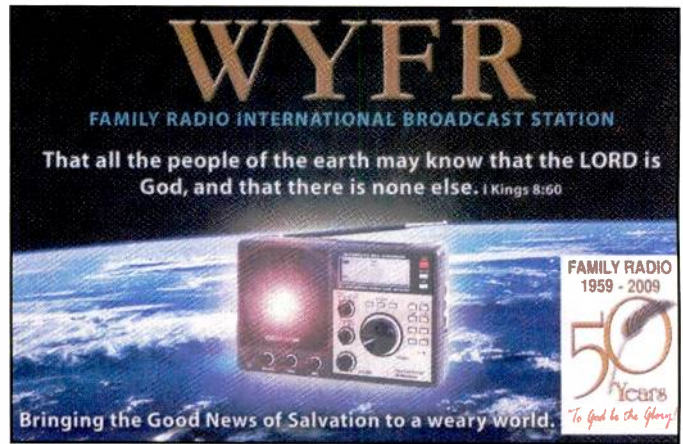

Family Radio wants you to believe the world ended last month. If they were right, you didn't even see this card. (Thanks: Doug Brown)

Radio Free Sarawak, 6025 at 1210 with talk by M in local Iban language. (Ng, Malaysia)

Radio Damal (to Somalia), 11740 via Wooferton at 1908-1930 with Somali talk with HOA music. Off abruptly. Also, 11970 via UAE at 1930-1940 with Somali talk and HOA music (Alexander, PA) 11740 via Wooferton at *1900-1930* in Somali with frequent IDs. (D'Angelo, PA)

Radio Dabanga (to Sudan), 7315 via Issoudun at *0430 in AA. (Parker, PA) 11515 via (p) Madagascar in AA at 1544 in local AA dialect. (Coady, ON) 1714. (Taylor, WI)

Radio Republica (to Cuba), 5954.2 in SS at 0010. (Perry, IL)

Sound of Hope (to China), 7105 via Taiwan at 2210 in Mandarin, M/W talks, anmts and music. (Coady, ON) 7280 in CC at 1200. (Brossell, WI)

Radio Nacional de la R.A.S.D. (to Morocco), 6927 at 2230 in AA with long talks, lively local vocals. (Coady, ON) 2340 in AA/SS. (Montgomery, PA)

Denge Mezopotamia (to Iraq), 11530 via Ukraine at 1425-1430 with local Kurdish music, Kurdish talk, off abruptly. (Alexander, PA)

Democratic Voice of Burma, 9355 via Armenia (p) the weak one under Firedrake at 1453. (Sellers, BC)

Radio Okapi (to DR Congo), 11690 via South Africa at 0423 with news and features in FF, "Okapi" jingles. (D'Angelo, PA)

PAPUA NEW GUINEA—NBC Central, Port Moresby (Papua), 3290 with pops at 1135. (Brossell, WI)

Radio Buka (New Guinea), 3325 at 1455 with long talk in Pidgin and lively vocals. (Barton, AZ)

Radio New Ireland (New Ireland), 3905 at 1105 with talks in Pidgin. (Brossell, WI)

PERU—Ondas del Huallago, Huanuco, 3330 at 1030 in SS. (Wilkner, FL)

Radio Huanta 2000, Huanta, 4747 several mornings around 1050 with OA music, M in SS. (Perry, IL) 1104 in SS with IDs, OA vocals. (D'Angelo, PA) 1109. (Montgomery, PA) Barely in at 0020. (Strawman, IA)

Radio Tarma, Tarma, 4775 at 1102, sometimes IDing as "Radio Tarma International", M in SS, OA music. Held to 1125. (Perry, IL) 2314 with W hosting mostly EE songs. (D'Angelo, PA)

Radio Vision, Chiclayo, 4790 at 1100 but distorted and fading. (Wilkner, FL) (t) at 1106 fair with SS news, but in horrendous noise. (Perry, IL) 0440 with SS sermon. (Strawman, IA) 0557 with loud-speaker preacher. (Parker, PA)

La Voz de la Selva, 4824.4 at 1108 with M in long SS talk. (Montgomery, PA)

Radio Cultural Amauta, Huanta, 4955 at 0051 with W in SS at a Poor level. (Parker, PA) 1116 with children singing after long SS talk by M. (Montgomery, PA) 2324 with M vocals and W SS anc. (D'Angelo, PA)

Pacifico Radio, 4974.8 at 0039 in SS with M/W talks. (Parker, PA)
 Radio Manatíal, Huancayo, 4986 in SS at 1120. (Wilkner, FL) 1125 with SS M in long talk. (Montgomery, PA)
 Radio Libertad, Junin, 5039.2 in SS at 1050. (Wilkner, FL) 1108 with OA vocals. (D'Angelo, PA)
 La Voz de las Huarinjas, Huancabamba, 5059.9 (t) in SS at 1140. (Wilkner, FL)
 Ondas del Suroriente, Quillabamba, 5120 in SS heard at 1030. (Wilkner, FL)
 Radio Bethel, Arequipa, 5921 in SS at 1100. (Wilkner, FL)
 Radio Santa Rosa, Lima, 6047 in SS at 1100. (Wilkner, FL)
 Radio Tawantinsuyo, Cusco, 1020 in SS but buried under co-channel QRM. (Wilkner, FL)

PHILIPPINES—FEBC, 9430 in CC at 1215. (Brossell, WI) In Mandarin at 1512. (Strawman, IA) 9435 in II at 2225. (Coady, ON)

PIRATES—Captain Morgan Shortwave, 6925, *2117-2203* with selections of M blues, frequent IDs, email as captainmorganshortwave@gmail.com. (Zeller, OH) 2153-2223* with rock, some blues. (D'Angelo, PA)

The Crystal Ship, 6876 at 2233 with pop/rock and new wave. tcsshortwave@gmail.com. (Hassig, IL) 2304 with a mix of pops. W with ID and lost by 2311. (Coady, ON)

WHYP, 6875 at 2140 with rock and talk about their equipment. (Gay, KY) 6925.1 with a collage of various pirate pgms and rock. (Zeller, OH)

Radio Jamba International, 6925 at *0401-0435* and *0454-0530+ with classical music and a Pastor Brown segment. (Zeller, OH) 2317 with rock. (Gay, KY)

Pirates Week Relay/WBNY Relay Service, 6989.9 heard at 0011-0043 with various pirate news and some off-air recordings. Also, 6913.5//6379.9 at 2218-2240+ on the pirate radio hall of fame. (Zeller, OH)

WEAK, 6940u (t) heard at 2340 with rock, pop and TV themes. (Sellers, BC)

Wolverine Radio, 6940u heard at 0213 alcohol-themed songs. (Hassig, IL)

Radio Ronin, 6923.9 at 1353-1414* with classic rock, email as radiatoroninshortwave@gmail.com. (Zeller, OH) 2324-2327. (D'Angelo, PA)

Voice of Next Thursday, 6989 at 2040-0010* and as WBNY Relay Service. Email as voiceofnextthursdat@gmail.com. (Zeller, OH)

Random Radio, 6925u at 0309-0318* with novelty tunes and a fast sign off anmt. (Zeller, OH)

KBLK "The shortwave voice of black oppression," 6925 at 1850 with rap and M in coarse language. (Gay, KY)

Radio Gaga, 6930u at 2356-0022 fade with rock/pop. No address heard. (Hassig, IL)

WBOG, 6925.2 at *1543-1652* with an "Hour of Slack" best. Identical format to the old Voice of Bob pirate. (Zeller, OH)

Voice of the Runaway Mahaarishi, 6930u at 2315 with theme, techno-pop, various spoofs. (Hassig, IL)

Radio 2010 International, 6955.2 at 2215-2348, strong, but no address heard. (Hassig, IL)

WPUP, 6930u heard at 2255-2315 with DJ "Dr. Puppeto" and various songs, talks and sounds of dogs. P.O. Box 1, Belfast NY 14711. (Hassig, IL)

Punxsutawney Pothead Radio, 6925 at 0020 with Captain Ganja prattling on. (Parker, PA)

Voice of Kaos, 6925u at 2002-2026* on widespread chaos in the Middle East and more caused by snow. Email as voiceofkaos@gmail.com. (Zeller, OH)

Northern Relay Service, 6930 heard at 0135 on cooking a rabbit and a bit on Elmer Fudd. Address as northernrelayservice@gmail.com. (Sellers, BC)

POLAND—Polish Radio, 9650 via UAE at *1800-1859* with EE pgm. Closedown anmts at 1856, soft instl music until carrier cut. (D'Angelo, PA) 1800. (Coady, ON) 1815. (Fraser, ME) 11905 via Wooferton at 1530 in Ukrainian. (Sellers, PA)

ROMANIA—Radio Romania International, 6130 at 0410 with an



It doesn't really require the proverbial cast of thousands to operate KBS World Radio in South Korea. This QSL shows actors from a Korean historical drama. (Thanks: David Weronka)

update on events in Romania, closing anmts, IS and off just before TOH. (Barton, AZ) 6145, //7355 with Radio Newsreel at 0105. (Coady, ON) 11735 at 1755 with soft instls. (Brossell, WI) 15150 in FF at 1100. (Ng, Malaysia) 17540-Tiganesti in AA at 1518. (Parker, PA)

RUSSIA—Voice of Russia, 7220 via Moldova at 0225 in RR and 7250-Krasnodar at 0230 with a radio drama. (Parker, PA) 7260-Vladivostok with Outlook pgm at 1515, 7290 via (p) Moldova with In Focus pgm at 0050, 9840 at 0643 in RR and 9855 in EE. Also, 11830-unlisted with Jazz Show at 2340. (Sellers, BC) 7270-Armavir in RR at 0138. (Brossell, WI) 9880 in FF with a features pgm at 1820. (Barton, AZ)

Radio Rossii, 4050-Biskek (Kyrgyzstan), (p) at 0011 with M in RR and comments. (Strawman, IA) 6195-Ulan Ude in RR at 1153. (Brossell, WI)

Radio Kyzyl, 6100 in RR at 1207. (Brossell, WI)

RWANDA—Radio Rwanda, 6055 at 2044-2101* with M in long FF talk, interspersed with short music segments. Music ended suddenly and then O/C for another minute. (D'Angelo, PA)

SAO TOME—VOA Relay, Pinheira, 4960 in FF at 0547 and 15620 in EE with IS and sign off anmt to 2033. (Parker, PA) 12015 with world news at 1800. (Brossell, WI) 15580 at 1855 with an editorial on Zimbabwe. (Fraser, ME)

SAUDI ARABIA—Broadcasting Service of the Kingdom, 15435

This Month's Winner

To show our appreciation for your loggings and support of this column, each month we select one "GIG" contributor to receive a free book or other prize. Readers are also invited to send in loggings, photos, copies of QSL cards, and monitoring room photos to me at *Popular Communications*, "Global Information Guide," 25 Newbridge Rd., Hicksville, NY 11801, or by email to gdex@wi.rr.com. The email's subject line should indicate that it's for the "GIG" column. So, come on, send your contribution in today!

This month's prize winner is **Charles Maxant** of Hinton, WV who now has the benefit of a 2011 edition of the *World Radio TV Handbook*, to aid him in his DX'ing search. Best wishes! If you don't have your 2011 edition yet this essential volume is available at your favorite radio hobbyist dealer, through online book sources, or your local book seller can certainly order one for you. Don't turn on your radio without it!

with AA talk at 1605. (Brossell, WI) 17660-Riyadh in FF at 1416. (D'Angelo, PA)

SEYCHELLES—BBC Indian Ocean Relay, 7450 with news in progress at 0235. (Montgomery, PA) 9410 with EE current events pgm ending at 1659. (Sellers, BC) 1922 with Focus on Africa and BBC news. (Coady, ON)

SINGAPORE—BBC Far Eastern Relay, 9740 with report on Muslims at 1225. (Brossell, WI) 15335 with Outlook pgm at 0223, //15360. (Sellers, BC)

SOUTH AFRICA—Channel Africa, 3345 with talks on the economy at 0340. (Montgomery, PA)

Radio Sonder Grense, 3320 with talk in Afrikaans at 0338. (Yohnicki, ON) 0345 with pop/rock. (Montgomery, PA)

SOUTH KOREA—KBS World Radio, 3955 via Skelton at 2206 with news, several IDs and financial report. (D'Angelo, PA) 9780-Kimje, in Mandarin at 2341. (Taylor, WI) 15360 via England with news in RR at 1803. (Brossell, WI)

SOLOMON ISLANDS—SIBC, 5020 at 1139 relaying BBC programming. (Brossell, WI)

SPAIN—Radio Exterior de Espana, 11940 in SS at 2148 and 17850 Costa Rica Relay in SS at 1912. (MacKenzie, CA)

SRI LANKA—Sri Lanka Broadcasting/Radio Ceylon, 11905 at 0018 with drums, NA and indigenous music. Also on suddenly just before 1530 and M/W alternating in EE and Hindi. (Sellers, BC) *1530 opening in EE with ID "This is Radio Ceylon calling out to India." Then news at 1531. (Alexander, PA)

SUDAN—Republic of Sudan Radio, 7200 in AA at 0241 with AA chants, M with long monotone talk. (Montgomery, PA) 0329. (Brossell, WI)

Miraya FM, 11570 via Slovakia at *1400 with "African music, AA talk and some HOA music. Also, 15710 via Slovakia at *1400. (Alexander, PA)

SWAZILAND—TWR, 4775 in GG at 0411. (Barton, AZ) 0343 in vernacular with group songs, then off briefly and into GG at 0400. Also, 9525 at 1943 with M and long FF talk. Off at 1950. (D'Angelo, PA; Montgomery, PA) 9500 at 1800 sign on. (Sellers, BC)

TAIWAN—Voice of Kuanguha, 9745-Kuanyin (p) at 2322 with alternating M/W ancrs in Mandarin. (Taylor, WI)

Voice of Han, Chingshui, 9745 at 1222 in CC. (Brossell, WI)

THAILAND—Radio Thailand, 9720 at 1229 with O/C, gong and M with ID and W with news. (Coady, ON) 1232 with M/W ancrs and news in EE. (D'Angelo, PA)

TURKEY—Voice of Turkey, 9495 in (I) SS at 1822; off at 1823. SS is listed from 1730-1820. (Sellers, BC) 9655 at 0409 ending news, then a press review and website URL. (Coady, ON) 11835 in (I) GG at 1807. (Brossell, WI)

UGANDA—UBC Radio, 4976 at 2037 with group vocals hosted by M, off in mid-sentence at 0209. (D'Angelo, PA)

UNITED STATES—Voice of America, 7225 Northern Marianas Relay in KK at 1215. (Brossell, WI) 7235 Timian in KK at 1302 and 9945 Sri Lanka Relay at 1506 with an EE lesson. (Coady, ON) 7325 Sri Lanka at 0105 news items and talk of Pakistan in Daybreak Asia pgm. (Montgomery, PA) 7430 Philippines Relay in Burmese at 2310 (Ng, Malaysia) 7520 Philippines with EE lesson at 1519, 9340 Philippines at 1700 ending (I) Bengali service, 9930 Sri Lanka Relay at 1520 with Border Crossings pgm. (Sellers, BC) 9415 Philippines in Uzbek at 1515. (Strawman, IA) 9545 Philippines in CC at 2215 and 17645 Philippines in CC at 0006. (MacKenzie, CA) 9885 via Meyerton with Daybreak Africa at 0505 and 11925 Philippines in CC at 0135. (Parker, PA)

Radio Free Asia, 5855 Northern Marianas in (I) VV at 1418 and 5780 via Tajikistan in (I) Tibetan at 1529. (Sellers, BC) 7495 Northern Marianas in CC at 2130. (Ng, Malaysia) 9355 Sri Lanka Relay in (I) Laotian at 1145, 11605 Northern Marianas in (I) Tibetan at 1244, 13830 via Tajikistan in (I) Tibetan at 1211. (Brossell, WI) 9455 Northern Marianas in Mandarin at 1934. (Coady, ON) 9835 Lampertheim (and IDing as such!) at *2229 going into Tibetan. (D'Angelo, PA)

Radio Free Europe/Radio Liberty, 5885 Sulaibiyah (Kuwait) with M/W in (I) Avar at 0411 and 5925 Biblis Relay in RR at 0445. (Parker,

PA) Radio Liberty (p), 9570 in Byelorussian at 1950. (Taylor, WI) AFN/AFRTS, 5446.5u-Key West at 1139 with NPR programming. (Montgomery, PA)

Family Radio/WYFR, 5825 at 1415 with preaching in (I) Nepali, 5835 via Kazakhstan at 1402 with Open Forum, and 7730-Okeechobee in Polish at 0722. (Sellers, BC) 7240 via Armenia at 2042-2058*. (D'Angelo, PA) 9280 via Taiwan in CC at 1145 and 11640 via Tajikistan in CC at 1241. (Brossell, WI) 9540 via Novosibirsk in (I) Thai at 1235. (Coady, ON) 2340 via Taiwan in CC. (Ng, Malaysia)

WINB, Pennsylvania, 13570 with W preacher at 2043. (Parker, PA) WJHR, Florida, 15550u at 2025 with M preaching. (Parker, PA)

WWRB, Tennessee, 9385 with preaching heard at 2205. (MacKenzie, CA)

Trans World Radio, 9800 via Monaco at 0844 with EE preaching. (Sellers, BC)

Adventist World Radio, 9515 via Austria at 1825 with African-accented EE preacher. (Sellers, BC)

WTTW, Tennessee, 9480 at 2210 with a sermon. (MacKenzie, CA) Overcomer Ministry, 9460 via Austria with Brother Stair at 1406. (Taylor, WI) 13810 via Nauen at 1521. (Coady, ON)

WTJC, North Carolina, 9370 at 2158. (MacKenzie, CA)

Southern Sudan Radio Service, 17745 at 1501-1530 with local string music and into AA at 1530. (Alexander, PA)

VATICAN—Vatican Radio, 4005 at 2214 in Italian with news, talks, Gregorian chants. (D'Angelo, PA) 7240 in FF at 2030. (Ng, Malaysia) 7585 via Tashkent in Hindi at 1442, 9660 in African Service from 0630 sign on. (Sellers, BC) 9755 at 1738 with African news. Signal dropped out at 1739 and not heard on several later checks. (Sellers, BC) 6185 at 0616 in Norwegian. (Parker, PA) 9865 via Canada at 1130 and open in FF. (Barton, AZ)

VENEZUELA—Radio Nacional, 11670 via Cuba in SS at 2230 and 15290 via Cuba in SS at 1936. (MacKenzie, CA) 15250 via Cuba with EE translations of SS commentary at 2316. (Sellers, BC)

VIETNAM—Voice of Vietnam, 9840-Son Tay on business practices there. (Sellers, BC) 12020 at 1500 with EE interview. (Ng, Malaysia)

ZAMBIA—ZBC Radio One, 5915 at 0435 in (I) Luvale with fast-talking W and aboriginal music. (Parker, PA)

CVC One Africa, 4965 at 0445 in EE. (Parker, PA) 4965 at 0402 with W hosting pgm of Christian music, TCs in Central African Time. (D'Angelo, PA) 2323 and M with ID. (Montgomery, PA) 9505 at 2015 with Christian rock. (Barton, AZ) 2020 with M offering website info (www.lafrica.tv) and into Christian rap. (Coady, ON) 2132 with Christian rock and messages in Kick Start pgm. (Sellers, BC) 13590 at 1736 with countdown of popular contemporary Christian songs and M ancr. (Taylor, WI) 1938 in FF with anmts, religious talk. (Barton, AZ)

Thanks to All

And, once again, order has been restored. Thanks to the following who answered the call this time. And a special welcome and thanks to my old buddy Ralph W. Perry, Wheaton, Illinois, who reenters DX'ing having retired after 25 years in the oil business in Asia.

The rest of the friends this month: Robert Wilkner, Pompano Beach, FL; Mark Coady, Peterborough, Ontario; Harold Sellers, Vernon, BC; George Zeller, Cleveland, OH; Rich D'Angelo, Wyomissing, PA; William Hassig, Mt. Pleasant, IL; Stewart MacKenzie, Huntington Beach, CA; Jerry Strawman, Des Moines, IA; Brian Alexander, Mechanicsburg, PA; Robert Montgomery, Levittown, PA; Rich Parker, Pennsburg, PA; Fotios Padazopoulos, Zaharo, Greece; Robert Brossell, Pewaukee, WI; Rick Barton, El Mirage, AZ; Michael Yohnicki, London, ON; Peter Ng, Johor Bharu, Malaysia; Mark Taylor, Madison, WI; David Weronka, Benson, NC; Robert Fraser, Belfast, ME and Chris Gay, Lexington, KY.

It's Bases Loaded in the Bay State (With Signals, That Is)

by Mark Meece, N8ICW
ohioscan@gmail.com

We start this month with a flashback to pre-colonial times and a visit to the *Who Knew?* Department.

When the Pilgrims landed at Plymouth they had no idea what to expect, or how their community would develop in the New World. As we learned in elementary school, the "Bay State," the Commonwealth of Massachusetts, would play a predominate role in U.S. history. *Military history* plays a big part, as well.



Westover AFB control tower makes a notable presence at the facility near Chicopee, Massachusetts. (Photographs courtesy of *Military Monitoring*)

Massachusetts became the sixth state on February 6, 1788. Plymouth was the second permanent English settlement in the New World, having been established more than 150 years earlier.

Fast-forward to today and we find Massachusetts has the highest population of the six New England states, with a population of 6.4 million — most of it concentrated in the greater Boston metropolitan area. Couple that with the relatively small land area of the state itself and Massachusetts rates third overall in population density.

Despite the small size of the state, it is rich in military activity with six major military bases. Here are snapshots of four facilities, and check *Listening In* to learn how to hear them all.

Barnes Air National Guard Base

In the southwestern part of the state we find Barnes Air National Guard (ANG) Base, located just north of Westfield off Interstate 90 in an area known to locals as Hampden Plains.

The base is a tenant of Barnes Municipal Airport (KBAF). Barnes' only military unit is the 104th Fighter Wing of the Massachusetts Air National Guard. Its subordinate unit, the 131st Fighter Squadron, now flies a fleet of 15 F-15C



Military jets line the ramp at Westover AFB.

LISTENING IN

BARNES MUNICIPAL AIRPORT (KBAF)

AERONAUTICAL OPERATIONS

46.7500	NATIONAL GUARD OPERATIONS (NFM)
118.900	WESTFIELD TOWER
121.700	WESTFIELD GROUND/CLEARANCE
123.050	NATIONAL GUARD OPERATIONS
125.350	BRADLEY APPROACH/DEPARTURE
127.100	ATIS
251.100	WESTFIELD TOWER
255.500	104TH FW AIR TO AIR
261.150	ATIS
283.300	MAINTENANCE CONTROL
286.200	WARREN GROVE RANGE
289.400	WESTFIELD GROUND
291.600	BOSTON CENTER
303.000	104TH FW OPS VIPER CONTROL
307.200	ALBANY CENTER
325.800	BRADLEY APPROACH
338.200	BOSTON CENTER
347.200	FORT DRUM FLIGHT COMM (RANGE 35)
356.300	NATIONAL GUARD OPERATIONS
359.000	BRADLEY APPROACH
377.100	BOSTON CENTER
379.100	BOSTON CENTER

SUPPORT FREQUENCIES

148.2000	FIRE/CRASH
148.4550	SECURITY (WESTFIELD CH. 7)
148.5250	BASE OPS
148.5500	TRANSPORTATION
149.5500	ANG COMMAND NET
150.1750	FUEL TRUCKS
150.3250	SECURITY

WESTOVER ARB (KCEF)

AERONAUTICAL OPERATIONS

114.000	ATIS
118.350	WESTOVER GROUND
123.000	UNICOM
125.350	BRADLEY APPROACH/DEPARTURE
134.850	WESTOVER TOWER
138.100	ATIS
252.100	439th AW COMMAND POST "CASINO ROYALE"
274.750	METRO WX
275.800	WESTOVER GROUND
348.750	WESTOVER TOWER
372.200	PTD

SUPPORT FREQUENCIES

138.075	OSI
138.125	NATIONAL GUARD OPERATIONS
138.2375/	CIVIL ENGINEERS
138.3250/	439TH AW AC MAINTENANCE
138.9625/	FIRE/CRASH
139.2375/	
150.2125	CIVIL ENGINEERS
140.7875	AC MAINTENANCE
142.1750	AERIAL PORT OPERATIONS
142.4500	439TH COMMUNICATIONS SQUADRON

143.6500	AC MAINTENANCE
149.0375	BASE OPERATIONS

MASSACHUSETTES MILITARY RESERVATION (MMR) OTIS ANGB (KFMH) CAMP EDWARDS AIR STATION CAPE COD PAVE PAWS

AERONAUTICAL FREQUENCIES

51.150	NATIONAL GUARD OPERATIONS
118.200	CAPE APPROACH/DEPARTURE
118.750	BOSTON CENTER DEPARTURE
120.475	ATIS
121.000	OTIS TOWER
121.600	OTIS GROUND
122.850	ARMY OPERATIONS
132.900	BOSTON CENTER
236.600	OTIS TOWER
236.825	ATIS
275.800	OTIS GROUND
284.600	CAPE APPROACH/DEPARTURE NORTH
291.100	BOSTON CENTER DEPARTURE
294.700	OTIS TOWER
326.150	COAST GUARD GROUND/SEA PRIMARY
345.000	COAST GUARD CAPE COD PRIMARY
372.200	PTD
379.050	COAST GUARD GROUND/ SEA SECONDARY
381.800	COAST GUARD OPERATIONS

SUPPORT FREQUENCIES

49.9300	ARMY NG REPEATER
139.300	CAMP EDWARDS RANGE CONTROL
140.0375	PAVE PAWS SECURITY
141.8875	PAVE PAWS TRAINING/EXERCISES
142.0750	PAVE PAWS MAINTENANCE
142.9750	NG MILITARY POLICE
143.4000	NG MILITARY POLICE
148.2625	P-25 UNKNOWN USE
149.5875	P-25 RAMP CONTROL



A Coast Guard HU-25C takes off from Cape Cod.

149.7375	P-25 UNKNOWN USE
150.7000	USCG AUXILIARY DISTRICT 1
150.7875	P-25 REFUELING OPS
163.4125	US ARMY CORPS OF ENGINEERS CAPE COD CANAL
163.5125	P-25 AC MAINTENANCE "BRAVO NET"
163.5375	P-25 OTIS ANGB SECURITY CH. 2
164.5500	CG AIR STATION CAPE COD OPS
165.1125	P-25 OTIS MOTOR POOL
165.1375	P-25 OTIS ANGB SECURITY CH. 1
166.2250	CG AIR STATION CAPE COD MAINTENANCE
171.2375	CG AIR STATION P-25 (Some Encryption)
171.3375	CG AIR CAPE COD AMBULANCES
173.5875	OTIS ANGB FIRE/CRASH
419.1250	COAST GUARD OFFICER OF THE DAY NET

HANSCOM AIR FORCE BASE (KBED)

AERONAUTICAL FREQUENCIES

118.500	HANSCOM TOWER
121.700	HANSCOM GROUND
121.850	CLEARANCE DELIVERY
122.950	UNICOM
124.400	BOSTON APPROACH/DEPARTURE
124.600	ATIS
236.600	HANSCOM TOWER

SUPPORT FREQUENCIES

149.225	BASE OPERATIONS
149.575	LASER LAB SECURITY
164.700	COMMAND NET
165.1625	TRANSPORTATION
166.225	FIRE/CRASH
168.200	CIVIL ENGINEERING
173.5625	SECURITY
173.9125	LASER LAB



Surrounded by lush vegetation, the PAVE PAWS radar dome stands out on Cape Cod.

Eagles. In 2007, it made the transition from the A-10A "Thunderbolt II" which had been flown since 1979.

Militarily, this area of even terrain was utilized as far back as 1905. It became particularly important in 1917 when it was used as a staging area for various Massachusetts, Vermont and Maine Militia Units. These units were reformed into combat regiments before being assigned to France for action in World War I.

Shortly after World War II the Massachusetts Air National Guard began its operations at Barnes Airport in 1946. Barnes Municipal Airport has two runways 2/20 and 15/33, the ANG currently occupies 186 acres.

Westover Air Reserve Base

A bit to the northeast in Chicopee, roughly 10 miles as the crow flies and 10 miles northeast of Springfield, is Westover Air Reserve Base (ARB). At 2,500 acres, it is the largest Air Reserve Base in the United States. It resides within the Silvio O. Conte National Fish and Wildlife Refuge and the Chicopee Memorial State Park borders the base to the south and east.



The environment is cool and clean in the PAVE PAWS computer room.



A radar technician works his post at the PAVE PAWS facility on Cape Cod.

CQ Books



VHF Propagation

by Neubeck, WB2AMU & West WB6NOA

A comprehensive source-book on VHF propagation by two great authors. Includes: Tropo ducting, Aurora, Meteor Scatter, TEP, Sporadic-E, Combo Modes and more!

6 X 9 Paperback \$15.95

The NEW Shortwave Propagation Handbook

by W3ASK, N4XX & K6GKU

This authoritative book on shortwave propagation is your source for easy-to-understand information on sunspot activity, propagation predictions, unusual propagation effects and do-it-yourself forecasting tips.



8.5 X 11 Paperback \$19.95

New! CD Version \$14.95

Buy both for only \$29.95

W6SAI HF Antenna Handbook

by Bill Orr, W6SAI

W6SAI was known for his easy-to-understand writing style. In keeping with this tradition, this book is a thoroughly readable text for any antenna enthusiast, jam-packed with dozens of inexpensive, practical antenna projects that work!



8.5 X 11 Paperback \$19.95

New! CD Version \$14.95

Buy both for only \$29.95



33 Simple Weekend Projects

by Dave Ingram, K4TWJ

Do-it-yourself electronics projects from the most basic to the fairly sophisticated.

Practical tips and techniques on creating your own projects.

6 X 9 Paperback \$17.95

Shipping & Handling: U.S. add \$7 for the first item, \$3.50 for the second and \$2 for each add'l item. FREE shipping on orders over \$100 to one U.S. address. CN/MX-\$15 for 1st item, \$7 for 2nd and \$3 for each add'l. All Other Countries-\$25 for 1st item, \$10 for 2nd and \$5 for each additional. Buy Both=single item!

CQ Communications, Inc.

25 Newbridge Road, Hicksville, NY 11801
Call: 1-800-853-9797 | Fax: 516-681-2926 | web-site: www.cq-amateur-radio.com

Originally, Westover Field was to be the premiere U.S. Army Air Base for the northeastern United States as the country prepared for World War II. Until then the country had only 17 poorly maintained air bases. Within two weeks of Germany's invasion of Poland, Chicopee was chosen for the base site.

The base's construction was included with President Roosevelt's sweeping Works Progress Administration (WPA) and the bill for \$750,000 was signed in November 1939. That allowed for 1,400 WPA and Civilian Conservation Commission (CCC) workers to begin construction of the base.

Westover opened on April 6, 1940 — also known nationwide as "Army Day." It is named in honor of Major General Oscar Westover, Chief of the Air Corps who died in September 1938. It was partially through his efforts that the period of Air Corps expansion began and led to the eventual formation of the United States Air Force as a separate service.

Westover has served as a bomber training base, a port of embarkation and debarkation for World War II and served as a staging point for the Berlin Airlift. It operated as a major Strategic Air Command Base (SAC) until 1974.

It has been an Air Force Reserve Base

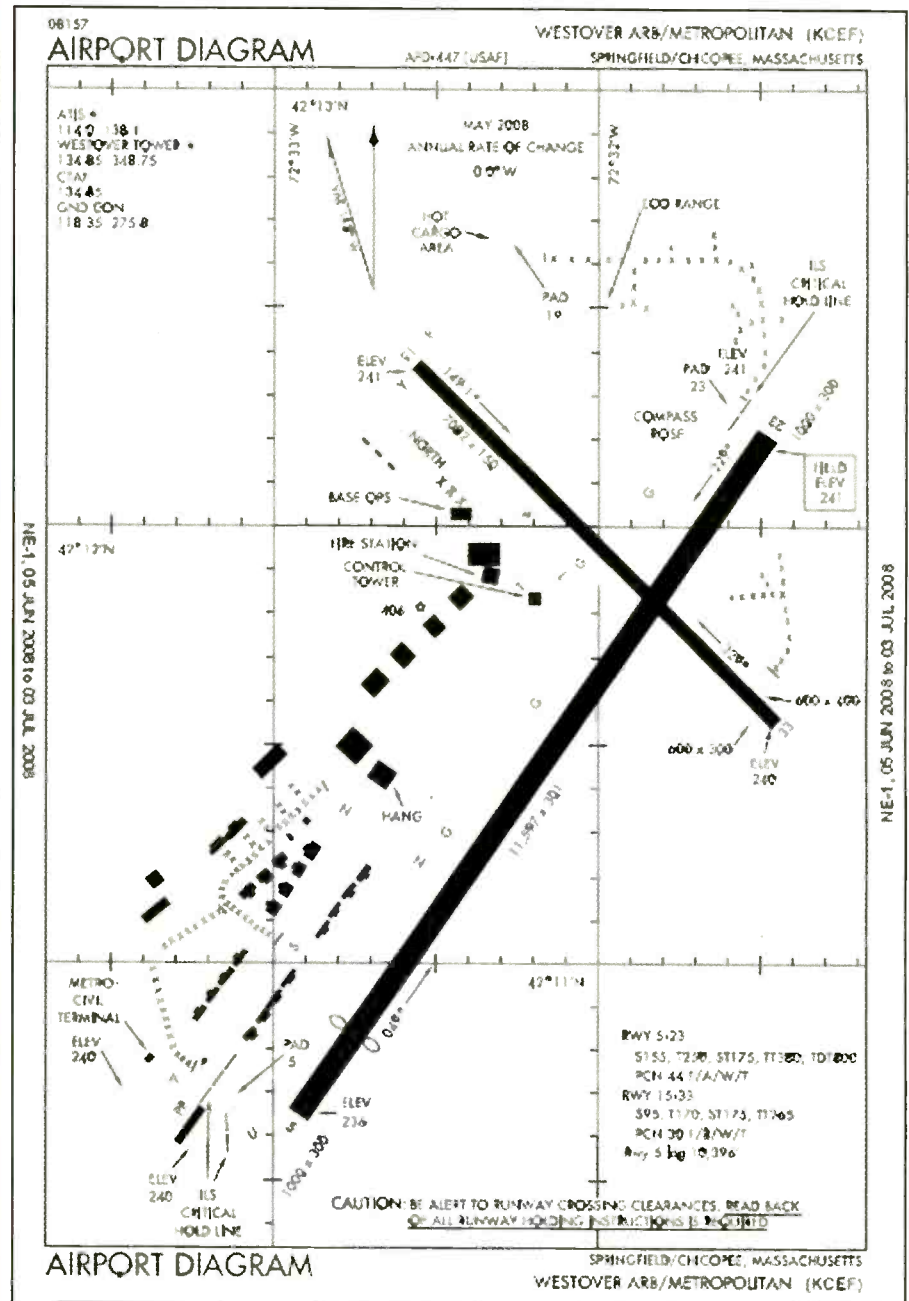

The Federal Aviation Administration made this diagram Westover AFB.

since May 19, 1974. In 2003, Westover was redesignated as a Joint Air Reserve Base to better reflect its expanding role from bases being closed as a part of the Base Re-Alignment and Closure Act (BRAC) of 2005.

Today Westover operates two runways: 5/23 and 15/33. Runway 5/33 is 11,597-foot long allowing for some of the largest cargo aircraft in the world to make use of Westover. It is also a Space Shuttle Emergency Landing Facility.

Headquartered at Westover is the 22nd Air Force with the U.S. Air Force Reserve Command's (AFRC) 439th Airlift Wing as the main tenant.

Its subordinate unit — the 337th Airlift Squadron — operates a fleet of 16 C-5A "Galaxy" aircraft.

Massachusetts Military Reservation

Moving further east to the western portion of Cape Cod is the site of the Massachusetts Military Reservation (MMR) which includes Otis Air National Guard Base, Camp Edwards (Army National Guard), Coast Guard Air Station Cape Cod and the U.S. Air Force Space Command PAVE PAWS radar site.

The area is a military training facility located south of the Cape Cod Canal in Barnstable County, two miles south of Bourne and some 50 miles southeast of Boston.

In 1938 the landing field at then-Camp Edwards was named Otis Field in honor of a famed Boston City Hospital surgeon Lieutenant Frank Otis who was a member of the 101st Observation Squadron. He died when the Douglas O-46A he was aboard crashed while on a cross-country training mission on January 11, 1937. With the formation of the Air Force in 1948, it was renamed to Otis Air Force Base.

Otis was closed in 2005 upon recommendation by the BRAC Act. It is now a base for the Massachusetts Air National Guard. The host unit is the 102nd Intelligence Wing, a non-flying unit left over from the 102nd Fighter Wing whose fleet of 15 F-15C Eagles were distributed among other U.S. Air Force facilities. Otis ANGB operates two runways: 14/32 and 5/23.

Hanscom Air Force Base

Located about 20 miles northwest of Boston near Bedford, Hanscom Air Force

Base has no active flying units. Its role is to serve as a support and research facility as headquarters of the Electronic Systems Center (ESC).

The host unit at Hanscom is the 66th Air Base Wing.

We list all known frequencies for the various facilities in our Listening In section.

Frequencies, Ahoy

As a side note, if you are in the area do not forget to search the marine band for lots of activity. Given the rich and

storied history of the area, there is much to see and do. Load up your scanner with the provided frequencies and let us know what you hear.

Wanted: Your Military Loggings

We have no military loggings for this issue, but we love receiving your input for the column. If you would like to report — be it on HF, VHF or UHF — please send it to: < ohioscan@gmail.com >. We'll include your report in an upcoming column.

For 45 years
our volunteers have
endured long hours
and tough
working conditions
for no pay.



And 9 out of 10
would do it again.

TO FIND OUT WHY
contact

REACT International, Inc.

(301) 316-2900 • (866) REACT-9-9

12114 Boydton Plank Road, Dinwiddie, VA 23841

REACT.HQ@REACTintl.org

www.REACTintl.org

Dashboard Detectives: Intrigue From a Minnesotan's Ford Falcon Radio

by Shannon Huniwell
melodyfm@yahoo.com

Two push button positions on the old car's radio are the only pieces I've got to this puzzle," a self-described "low-budget, classic car nut" admitted to me in an email. He also noted that he'd just saved the sad little Ford *Falcon* from some disreputable auto recycler's crusher and, perhaps like an obsessed adopted teen searches for a birth parent, really needed to find out where the 1960 car came from.

His dilapidated vehicle barely escaped with its rust-ridden life, let alone the requisite paperwork needed to start the painstaking process of registration sans any previous registrations or title.

"All of the buttons, except the last one, tune the dial to the same left-hand station near that old Civil Defense triangle symbol," the fellow described.

"The one furthest right, moves the pointer approximately to the middle. Can you hazard a guess where those buttons might have been set?" He then apologized for his radio ignorance and the fact that, rather than being a regular *Pop'Comm*

subscriber, he had thumbed-through our publication at a supermarket magazine rack and noticed one of my articles focusing on broadcast mystery. I hit my computer's reply button and emailed him a single-question homework assignment, "What do you hear when you push those buttons during the middle of the day?"

I don't think the guy had told me where he lived. When he got back to me with the following report, however, deducing suburban Richmond, Virginia represented a no-brainer for even the rustiest of AM DX'ers: "The right hand button brings in WRVA, but it sounds loud, sort of splashy, and distorted," he wrote. "The rest of the buttons go to a station called WMAL. It's not real strong, there's some static and a little interference in the background, but it's much clearer - toned and more tuned-in than WRVA."

After he completed my second assignment, the fellow indicated that fine-tuning did nothing to improve WMAL's signal, though twisting the dial just a tiny bit to the right, "sharpened-up WRVA like *Gangbusters!*" This told me that he was well within the city-grade footprint of Richmond's 50-kilowatt legacy facility on 1140 kHz (though the radio's presets were some 10 kHz south of 1140), revealed a steady fringe reception of a Washington, DC regional station at 630 kHz, and suggested that a previous owner of his late Eisenhower-era Ford was a top-40 music fan who called somewhere in the Minneapolis-St. Paul area home.

Long before GPS satellites pinpointed locales from space, radio-savvy individuals could identify specific broadcast marketplaces by simply hearing a teenager state two of his or her favorite AM "channels." From the fall of 1959 until about 1977, many young-at-heart in Minnesota's Twin Cities gave away their 10-20 by cheering for the frequencies 630 and 1130 kHz — RF domains of personality-driven music radio powerhouses, KDWB and WDGY respectively.

Does W-COW Ring A Bell?

Few Minneapolis-area kids catching the latest Beatles tune on a transistor radio locked on



Except for being white rather than red, this first year Falcon is just like the one that starts off our car radio button mystery. Then again, a close look at the 1960 catalog cover shot reveals another important, but inconspicuous dissimilarity. Perhaps for aesthetic reasons, the artist who rendered this picture omitted the compact car's antenna. Or, maybe the happy couple considering the thrifty vehicle didn't want to increase the price of their desired four-door by ordering any options.

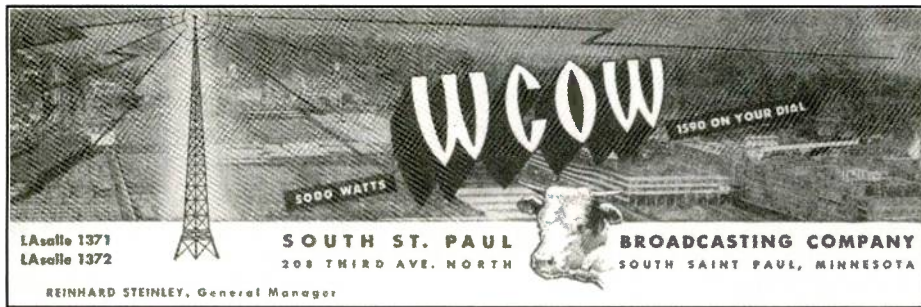

The bovine motif on WCOW's early 1950s letterhead gives it more of a stockyard feel than the young, hip image the station's successor, KDWB, would relentlessly begin promoting during the final year in that decade.

KDWB would have ever guessed that their favorite hit music station debuted with the discordant notes of a cow bell clang. That's exactly how it happened, however, on August 12, 1951, when the 5,000-watt daytimer on 1590 kHz took to the air and announced its city-of-license as *South Saint Paul*.

AM/FM historian Jan Lowry says WCOW had bovine call letters to hitch it to the "western and old-time music and rural-oriented programming" offered between hourly local news and sportscasts. The bucolic AM in the Twin Cities market was founded by the three Tedesco brothers from a family that served that region's ether as the radio version of Johnny Appleseed.

According to the Museum of Broadcasting's site < <http://www.pavekmuseum.org> > the siblings, who were recently inducted into the museum's Hall of Fame, "have been three of the most colorful figures in the history of Minnesota broadcasting. Jointly or separately, they have owned (started or purchased) 14 radio stations."

No doubt this brand of initiative played a role in their ongoing consideration of possible facility upgrades. In 1955, the Tedescos convinced the FCC to shift WCOW's official ID to Saint Paul. Also in the works was engineering that sought FCC permission to take their Twin Cities station from 1590 to an enviably low 630 kHz dial position. Regulators gave their OK for a kilowatt of directional daytime-only power on 630 kHz in 1956.

With this coup scored, the Tedescos set about to give their station a more sophisticated image, so they put W-COW back in the FCC's call letter barn and began revamping their property (still on 1590) with a new name, WISK, and an easy listening flavor aimed at the female audience.

Before actualizing WISK's eventual ride down the band in early May 1959, its ownership secured another FCC grant modifying its 630 kHz, 1 kilowatt-daytime construction permit to a 5,000-watt day and 500-watts at night CP with different antenna patterns.

Also new was authorization to build this new dual directional array at "Hudson Road — U.S. Highway 12 — and Tower Road in St. Paul." Barely four months after this expensive change took place, the Tedescos sold WISK to a division of Crowell-Collier Publishing Co. for \$625,000. The buyers also owned Los Angeles' KFVB and KEWB in Oakland, California.

Formula 63 Is Coming!

Throughout the late summer of 1959, Twin Cities newspaper editors and radio announcers found themselves conveying messages about a new "product" called *Formula 63*. According to this stuff's sponsor, this secret 63 held promise of being a delightful cure. On September 19, 1959, stations carrying *Formula 63* commercials became sick with regret when they realized they'd been unwittingly plugging an impending com-

petitor, KDWB Channel 63, the new identity of the erstwhile genteel WISK.

Following the Top-40 music/dynamic air-personality and contest-driven successes of Crowell-Collier's California stations, pioneer contemporary radio programmer Chuck Blore, and right-hand man Don French, saw to it that their employer's Minneapolis area rollout hit the air running. KDWB's ratings soared, fueling a famous rivalry between Channel 63 and crosstown Top-40 veteran WDGY 1130. Battles in this 1959-1977 music radio war kept Twin Cities listeners entertained and rooting for their favorite station.

Crowell-Collier decided to exit the radio business. To that end, KDWB was sold in early 1968 for an even million bucks to Valjon Inc., an investment group led by a New York advertising man. The following November the station's transmitter went up in flames, causing about \$100,000 damage and a 36-



Colorful billboards such as this one appeared throughout the Twin Cities, including northeast Minneapolis where Bob Caligiuri grew up dialing between KDWB and competitor WDGY. Which Top-40 outlet did he listen to more? Bob says he usually started with KDWB, but hit the button for WDGY whenever KDWB began playing a song he didn't like. He also remembers the stations representing a Beatles vs. Rolling Stones type of rivalry, with KDWB airing more Motown than WDGY. Though not sure where he read it, Bob recalls seeing a newspaper editorial complaining that KDWB represented itself as almost a religion. "It was something about their often long, self-reverent jingles," he mused. After decades, they still come to mind clearly, especially the slow ones meant to lead into a ballad: "*Kay Dee Double You Bee...*," he sings, "*Chan-nel Six-tee Threeeee.*" By the way, that *Color Radio* theme was a direct reference to the fact that the audio medium's theatre of the mind characteristics could be just as vivid as color TV. How about that stylized civil defense triangle in the "0" of the 630? In the days of slide-rule radio dials, the lower CD frequency of 640 kHz was close enough to KDWB's 630 kHz spot for anybody to find it.

KDWB

"MORE FUN THAN
POUNING NAILS!"
THE HAL MURRAY PROGRAM



3 to 6 P.M. ON KDWB



Just one of the dozens of affable, gimmick-loving air-personalities associated with KDWB, Hal Murray, did afternoon drive there during the early 1960s. Ask a Twin Cities Baby-Boomer to name a DJ, however, and most will smile, True Don Bleu, the high-energy jock who enjoyed a decade-long tenure on KDWB starting in 1968. Bleu, who's real name is Rick Kelleher, is now a top-rated radio personality in San Francisco. See the two girls in the KDWB logo, they're smiling one of the station's initial mantras: *My mommy listens to KDWB 630*. To add a feminine touch to the "0," it has a diamond setting on its top.

hour period of silence until a new RF generating unit could be delivered, installed and quickly "fired-up." The transmitter building — which also housed the studios, but much to the satisfaction of air staff, hadn't included the KDWB business and sales offices — was revitalized for accommodating the "suits" when they made the move from quarters in downtown Minneapolis during 1971.

Such a consolidation is often seen by keen insiders as the brand of economy measure preceding a station sale. Those sages likely told someone, *I told you so*, when Valjon flipped KDWB just four years into its ownership for \$3,250,000. The buyer, Doubleday Broadcasting, operated AMs in several western states.

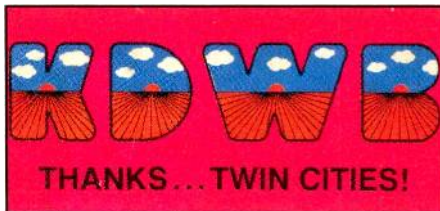

Here's a bumper sticker celebrating a good ratings book indicating KDWB as No. 1, probably in some youthful demographic otherwise considered to be "just a bunch of kids" by old-line adult radio market leader, WCCO.

Its improvement plan for the Midwest acquisition included "FCC authorization to identify KDWB as (hailing from) Minneapolis-St. Paul," instead of simply from the less-tony latter.

"In late 1976," Jan Lowry notes, "Doubleday bought an FM station (KYOU-FM) in the Minneapolis market to supplement the poor (500-watt directional) nighttime signal provided by KDWB." This acquisition got recast as simulcaster KDWB-FM and eventually became the tail that wagged the dog.

During the rest of the 1970s, the duo's format was continually tweaked to capture 18-49 and then 25-54 year old audiences coveted by most advertisers. The old Channel 63's Top-40 offering morphed into a "Hot 100-hit contemporary music" playlist.

When radio's largest listener base had really heated up the FM band during the 1980s, Doubleday made a killing on its Minneapolis market properties by selling KDWB-FM (licensed to Richfield, Minnesota) and — by this time — its tag-along, AM KDWB, for \$27 million. This May 1986 acquisition by Legacy Broadcasting Inc. returned the AM side to separate programming, albeit the budget-minded *The Oldies Channel* format from syndicator *Transtar*, pulled directly off satellite and piped into KDWB's autopilot control board.

A couple of years later this unit was among the gear relocated to new offices/studios in downtown Minneapolis. And as the '80s ended, Legacy sold KDWB and its more profitable FM sister to Midcontinent Radio Inc., for \$17,950,000 — a steal when one considers Legacy's original Minnesota investment.

Unspeakable Broadcast Blasphemy!

Jan Lowry reports that during the fall of 1991 Midcontinent instituted a change

in its Minneapolis AM property that struck a discordant note among the market's radio industry enthusiasts.

After getting FCC approval for a call-sign modification, Midcontinent dropped oldies (on KDWB) and adopted a 24-hour country music format.

If such a shift wasn't shock enough for folks who'd grown up hearing their favorite Top-40 tunes on KDWB and fondly remembered how Channel 63 fought the good fight against similarly-programmed enemy WDGY 1130, imagine their disbelief when the following station identification emanated from Twin Cities radios tuned to 630 kHz: "*This is AM 630, W-D-G-Y.*" Metaphorically, this was as sacrilegious as if Ford had replaced its classic "F" script logo with a Chevy bow-tie emblem.

Admittedly, the WDGY calls were grabbed for Midcontinent's new country-and-western venture because the former WDGY had made a significant run with country fare after exiting the Top-40 game in 1977. WDGY 1130 ditched its historic name in 1991 when becoming sports-oriented KFAN. Still, the irony of the ID, say some radio diehards, was enough to jinx whatever was subsequently tried on the Minneapolis 630.

The country experiment hardly lasted a year. The "little" WDGY became a conduit to simulcast KDWB-FM in 1992 and then, by May 1993, flipped to a non-rock/adult standards simulcast of Hudson, Wisconsin's WMIN. From these also-ran scenarios, WDGY 630 was dry-docked and taken dark by Midcontinent, as the company was in the process of selling off KDWB-FM for \$22 million.

With this 1995 sale complete, Midcontinent accepted an offer on the 630 AM transmitter site and then received FCC permission to reactivate WDGY 630 with 900-watts during the day and 130 watts at night via two towers in the vicinity of the WMIN site.

When WDGY 630 went back on the air (with another satellite-delivered oldies format) in January 1997, the reduced coverage barred it from being a Minneapolis or St. Paul-licensed facility, so was given a Hudson, Wisconsin identity. This reduced revamp of the once-mighty Channel 63 continued spawning these changes:

Midcontinent sold WDGY 630 to WMIN in 1997. The new owner moved it to Lakeland, Minnesota and installed a satellite talk format on it. This quickly evolved to talk and sports, and then sole-



Here's the KDWB transmitter/studio facility on Radio Road in Woodbury, Minnesota circa 1976. This image, courtesy of Dave Senechal and a wonderful Top-40-era aircheck site < <http://www.radiotapes.com> >, is about the only way one can now picture the legendary station's physical presence, as the building and towers are long gone.

ly sports (One-On-One Sports a.k.a. Sporting News Radio) during 2000.

A third tower was added to allow for a tweak in night power (from 130-watts) to 200-watts. Sports gave way to "Regional Mexican" music by the summer of 2001 when WDGY came under a local marketing agreement with operator, Radio Rey Inc.

Studios were moved to Minneapolis and a new transmitter site (shared with WCTS Maplewood, Minnesota) became FCC approved so that WDGY 630 could use a full kilowatt for day-times and a jump to 2.5-kilowatts at night.

This 2006 boost allowed for 10 times the night power afforded the classic KDWB 630! And further erasing the facility from its rock 'n roll roots, WDGY 630's callsign was dumped in favor of the more regally Spanish-relevant WREY (Rey in Spanish means "king.")

A Little Bit About The Big WDGY . . . Wee-Gee

WDGY was named by and for its founder Doctor George Young, who raised the funds to start the then 5-watt broadcast outlet via dual vocations of optometry and jewelry store proprietor. Actually, WDGY was the fourth set of calls Young used for his Minneapolis station, previously known as KFMT, WHAT and WGWY.

According to his fascinating 1970 college thesis about WDGY's history, author Jerry Verne Haines offers the following account of how Young happened to get into radio:

"One Sunday while (flamboyantly) riding in his (Rolls Royce), Dr. Young noticed the antenna tower of Gordon Volkenant, a high school student and holder of an amateur radio license. Volkenant operated his station at the home of his parents . . . Young (inquired) as to the name of the (85-foot) tower's owner . . . and telephoned him.

"How much do you want for it?" asked Dr. Young.

"Oh, about \$30, muttered Volkenant, anxious to get rid of the old antenna (that he was about to replace with a taller one)"

"Did you say \$90? I'll take it!" declared Dr. Young, and soon the tower was standing behind (Young's) house in Minneapolis."

To enliven the stick, Young scrounged a surplus Navy transmitter — with a penchant for drifting all over the band — meant to be mounted in a submarine chaser.

Shortly after securing a broadcast license, Dr. Young got the high school kid who'd sold him the tower to serve as engineer for his modest station's (government sequentially call-lettered KFMT) January 13, 1924 debut.

By late 1926, the facility became WDGY and sported 500-watts. When George Young died of cancer in 1945, WDGY had enjoyed several power increases, frequency shifts (finally to 1130 kHz in 1941), an experimental mechanically-scanned television



A page from WDGY's early 1950s promotional booklet prominently featured its new transmitter facility.



My guess is that this shot of the WDGY sign, towers and speck of a transmitter building was snapped when the Bloomington, Minnesota-based facility had just been completed in 1948. After Todd Storz bought the station eight years later, he found the area's dirt roads so unfriendly to station personnel's cars that he moved the studios to Minneapolis until the thoroughfares were improved in 1961. This and the other vintage WDGY photos are hosted on radio aircheck archivist, Tom Gavaras' neat Web site: < <http://www.radiotapes.com> >.



One of the houses in the Bloomington development adjacent to those nine WDGY self-supporting towers was home to the teenage owner of the Ford Falcon in our story. Those beautiful sticks (originally directing 50-kW days/25-kW nights, before the FCC granted WDGY a 50,000 unlimited time status) were dismantled circa 1986 when the transmitter site relocated so that developers could move in. After WDGY's most notable "formula radio" owners, Storz Broadcasting, sold it in 1984, the station went through several other companies, as well as format changes to country music, and then sports under new call KFAN.

dalliance (W9XAT) and a colorful history of program offerings.

Young's electronic legacy was then sold to the Stuart family, which owned a pair of Nebraska stations. Unfortunately for this clan, the 1946 transaction served more to drain their bank account than to produce profits. Chief among the hemorrhages was a staff resistant to any format changes that the Stuart's anticipated, and the cost of a complex, nine-tower directional antenna system that the family commissioned in then-rural Bloomington, Minnesota, in order to activate a 50-kilowatt days/25-kilowatt nights construction permit.

Even the least RF-savvy of WDGY's staff could predict that the huge power increase via the Bloomington CP looked a whole lot better on paper than it would in actual population coverage vis-a-vis construction/maintenance costs.

To attract *sophisticated* listeners who would give WDGY a high-profile/advertiser-friendly audience, the Stuarts dumped the station's long profitable religious "sold airtime" programs and introduced secular "good music" shows, man-on-the-street news and lots of sports. No matter making these pricey wattage and format "improvements," the Stuarts continually lost money with WDGY.

During the late 1940s, Minneapolis' WLOL (1330 kHz) featured an early version of the Top-40 format, albeit pre-rock 'n roll. WLOL owner Ralph Atlass had seen the ratings successes of the personality disc jockey-driven music, news and weather programmed WNEW in New York, so adapted the then-novel, non-network/non-long-form format on his Twin Cities AM. When WDGY was sold (for \$425,000) by the Stuarts in April 1952, buyer Twin Cities Broadcasting Corp. decided to give Top-40 — or so called "formula radio" — a try. Unfortunately for this venture, however, the program style was completely embraced. Consequently, the flow of music/DJ patter was interrupted by blocks of religious shows or a farm hour that came on the air each day at noon.

The only time WDGY enjoyed any notable audience during the Twin Cities Broadcasting tenure was in the evenings when "symphonic music" was offered. But by the mid-1950s, radio advertisers were becoming most interested in daytime listeners, as that's when the lion's share of adults were tuned to radio — as opposed to TV — stations, and the youth radio audience wasn't yet a real factor.

With WDGY dead last in the seven-station Minneapolis market radio ratings, its ownership was happy to accept a purchase offer from “formula radio” wunderkind, Todd Storz. The fact that Twin Cities Broadcasting took \$212,000 for WDGY — less than half of what it paid for it — speaks to the desire to wash their hands of the highly directional/costly to operate 50,000-watt also ran.

No matter its “basement” audience status at the time of Storz’ January 1956 acquisition of WDGY, he considered it a great buy and immediately reformatted the facility with best practices from his other three Top-40 outlets (such as Kansas City’s WHB).

Besides giving his station a cute callsign-mnemonic name (*Wee-Gee*) and a relatively short musical playlist, these tactics included frequent contests with cash prizes. Under this banner, WDGY’s ratings jumped to the point where the station was nipping at the RF heels of perennial market leader WCCO.

When pop music began taking on a rock ‘n roll and rockabilly tone, WDGY started growing up with the Minneapolis market’s burgeoning baby-boomer listenership, a lucrative niche it held almost all by itself until Crowell-Collier hit the Twin Cities ether with KDWB.

From 1959 through the remainder of AM Top-40/DJ personality radio’s approximately 20-year heyday, the competitive pair blasted out hundreds of thousands of hours of hit music-oriented companionship through about a dozen collective towers.

First Rate Stations – Second Rate Signals

Those nine self-supporting towers that highly directionalized the “real” WDGY’s 50-kilowatts represented a vision of beauty for radio lovers, but squeezed that impressive power level into an almond-shaped footprint with minimal coverage south, east or west of the Bloomington transmitter site. In fact, three 50,000-watt facilities, WDGY Minneapolis, one in Milwaukee and another in Detroit, had all been authorized to occupy 1130 kHz. In order to accomplish this sandwiching *and* protect what was arguably the original music/news/weather station WNEW-New York also at 1130 kHz, the Midwest 1130 trio were nominal “flame-throwers” with significant nighttime coverage (though these stations throttled back their RF after sunset) over at least one of the Great Lakes or in Canada.

Even so, WDGY rival, KDWB, would have killed for a moonlight signal with anything resembling a mere 10 percent of WDGY’s (then 25-kilowatt night) power. When the moon rose over Channel 63-land, KDWB was only authorized to transmit with 500-watts, primarily directed to the west of its St. Paul site.

Though nobody was murdered in the process, someone at KDWB apparently gave the order *not* to hit the switches that facilitated such power reduction and antenna change. Apparently, this accidentally-on-purpose practice was judged to be sufficiently long-running and flagrant that the FCC fined KDWB \$10,000 for repeated violations of observing licensed night power level.

In its 1961 admonishment, the FCC noted that the *round-the-clock at full power* situation had been taking place for about three years. The reason why broadcasters embroiled in a Top-40 war rued a thinly focused and/or sub-kilowatt nighttime signal is clear as day — kids listened to their AM transistor radios most vociferously while doing their homework or cruising with friends in \$600 cars.

In most media markets, big AMs with the best and least-directionally restrictive coverage were the so-called “legacy” or grown-up stations that usually wouldn’t muddy their good

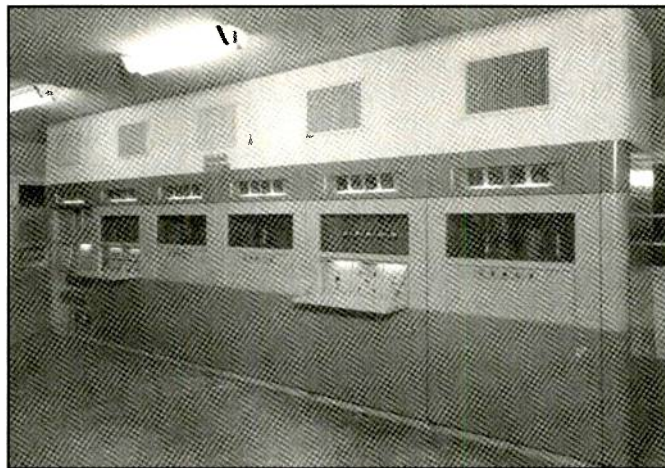

New for 1948, here’s the 50-kilowatt Westinghouse transmitter with top-mounted, contractor-fabricated ductwork that could double as heating vents in winter. It was just one piece of the expensive RF generating plant that drained the famous station’s second owners’ bank account and aimed big amounts of the electronically-compressed, 1130-kHz signal northward towards Minnesota’s smallest towns.

names with rock and roll music and related shenanigans. Consequently, such youthful fare often became the province of the second string outlets. That’s why many a baby-boomer with a bit of radio savvy fondly recalls having to turn his or her pocket portable this way and that in order to catch whatever remaining RF was available after pattern/power change time. In some cases, stations several states distant tuned in more reliably after sunset than did the local purveyors of hit music.

So Close, Yet Almost Overlooked

Remember the Ford Falcon owner who provided the initial drive for our Twin Cities story? He recently contacted me with words of serendipitous closure for this edition of *Shannon’s Broadcast Classics* and for his registration quest at the local Department of Motor Vehicles office.

During the process of restoring his compact car, the fellow removed its rear seat and discovered a long-forgotten spiral-bound notebook cover jammed between the seat back and bottom sections. As he started to chuck this bent piece of cardboard and assorted stash of *Teaberry* chewing gum wrappers also snatched from over four decades of under-seat seclusion, the guy noticed some doodling that successfully linked to my Minneapolis radio market assumption.

“Go B’ton BEARS!” was artfully scribed on the notebook cover. Right below it were the boasts, “B’ton High Seniors Rule! ’64’s Are #1!” And more carefully scripted on the inside of the cover was a girl’s name.

All of these clues, several hours on the Internet, and the kind assistance from a school librarian who admitted to enjoying detective work more than shelving books, led to putting together a puzzle about one of the Falcon’s early owners. To make a long story short, it was ascertained that “B’ton,” was kid code for Bloomington, the Minneapolis suburb that used to host WDGY’s RF plant and once home to Bloomington High School (which, in 1965 was renamed Lincoln High and years later torn down) with sports teams called the Bears.

The notebook had been the property of a teenager who was looking forward to graduating from “B’ton” in June of 1964, a

InfoCentral (from page 7)

in English, French and Arabic on SSB said, "Libyan ships or vessels remain anchored. Do not leave port. The Gaddafi regime forces are violating a United Nations resolution ordering the end of hostilities in your country. If you attempt to leave port you will be attacked and destroyed immediately. For your own safety, do not leave port."

The Commando Solo is operated exclusively by the USAF 193rd Special Operations Wing, which is based at the Harrisburg International Airport in Middletown, Pennsylvania. According to the *Milcom Monitoring Post*, the transmission is "slightly jammed."

Japan's New TV Tower Becomes World's Tallest

Japan can boast it has the world's tallest, free-standing television tower when the under-construction Tokyo Sky Tree rose to a height of 601 meters (1,971 feet). The steel structure eclipsed China's 600-meter Canton Tower, which opened in Guangzhou in September — although both are shorter than the world's tallest building, Dubai's 828-meter (2,716-foot) Burj Khalifa skyscraper.

Already a popular landmark in eastern Tokyo, the broadcast tower is scheduled to reach its top height of 634 meters (2,080 feet) and be completed by the end of the year. To keep the structure safe during Japan's frequent earthquakes, the tower has a cutting-edge, anti-seismic design including pilings that fan out underground like the branches of a tree. The tower consists of two parts, an outer steel frame and an inner shaft of reinforced concrete, which can move separately to cancel out their seismic energies — a design idea borrowed from ancient Japanese pagodas.

A year ago, the tower surpassed the current television and radio transmission tower — the 333-meter (1,093-foot) red-and-white Tokyo Tower, a symbol of Japan's post-war "economic miracle" — as the country's tallest structure. In early 2012, after Japanese television networks switch entirely to digital transmission, Tokyo Sky Tree will take over television broadcasts to beam signals across the city's ever-rising skyline.

With two observation decks, the tower is expected to attract an average 2.7 million visitors annually. Some 25 million people a year are expected to use commercial facilities inside the tower compound, including 300 shops and restaurants as well as an aquarium, a planetarium and a dome theater.

(Source: AFP)

Radio Australia Reinforces Broadcasts to Japan

The Australian Broadcasting Co., (ABC) has reinforced Radio Australia's capacity to assist the Australian government in the broadcast of urgent information to Australian citizens in Japan following the devastating earthquake and tsunami March 11. Broadcasts normally directed to Papua New Guinea have been extended to cover Japan. In addition, two broadcasts normally directed to Southeast Asia have been redirected to Japan.

Radio Australia's English service from Shepparton, Victoria will broadcast to Japan as follows until further notice (all times UTC):

2300-0700 on 13690 kHz
2330-00700 on 17750 kHz
0000-0500 on 21725 kHz
0700-1300 on 11945 kHz
0700-0900 on 9710 kHz
1100-1400 on 9560 kHz
1400-1800 on 5995/6080 kHz

(Source: Radio Australia)



The circled triangular Civil Defense logo was a common sight during the Cold War era, appearing in many places, including in design variations on car radio dials.

date used by the helpful librarian to find the girl's information in an old yearbook and then match it with an alumni database.

Now in her mid 60s, the Bloomington grad happily consented to be contacted by the Ford restorer. She reported that the little car was purchased used by her old high school boyfriend, "a guy," she laughed, "who is now senior enough to be considered (her) *old* husband." Reportedly, she then put him on the line and he gave the Falcon buff more than enough detail to satisfy the DMV.

I wondered why only one of the Ford radio's push buttons was set to WDGY, while the rest went to rival KDWB.

Perhaps as sort of a finder's fee, the car restorer emailed me a digital image of a Kodak snapshot he had received from the Minnesota couple. Appearing full screen on my computer, a good explanation was instantly evident.

The photo showed a pretty girl with a pageboy haircut, smiling next to the red Falcon. Hers had been the notebook discovered some 45 years later in that same vehicle. By the way, the car was proudly parked in the driveway of a modest tract home with three rows of towers evident about a couple football field lengths behind it.

"Back then, we lived next door to each other in a development that bordered on the WDGY transmitter property," the Minnesotan woman noted. "The darn station could literally be received on my kitchen toaster, so whenever we drove far enough out of the neighborhood to get a clear sound from KDWB, it was no puzzle why we enthusiastically pushed those KDWB buttons!"

SPURIOUS SIGNALS

By Jason Togyer KB3CNM

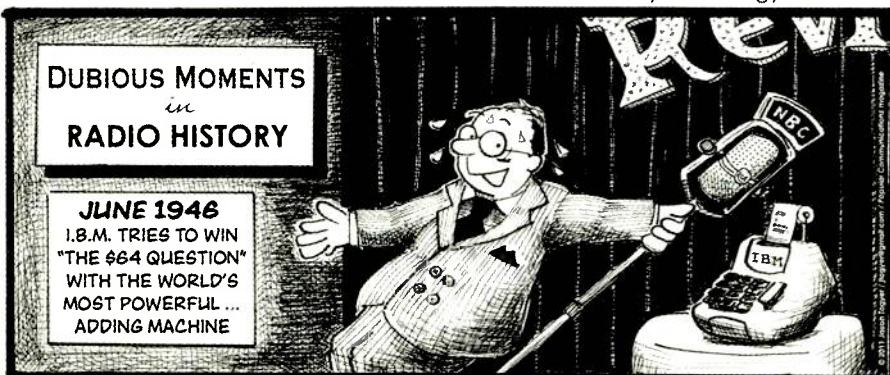

What in the World is Going On? Listen to Your Radio and Find Out!

by Mitch Gill, NA7US,
NA7US@yahoo.com

Now more than any other time since September 11, 2001 we should be monitoring stations around the world. We need to stay informed about what is happening around us. As of today there are several countries in the Middle East that are either close to being changed from a dictatorship to something else or the dictator is attempting to wipe out the opposition.

At the time I am writing this, Japan is still reeling from the earthquake and tsunami. It is also in a pitched battle to tame several nuclear reactors.

North Korea has not been in the news lately, but it is still hurling insults at South Korea. Iran launched a satellite which many believe is its way of testing future ballistic missiles and Israel is now stating it has the right to attack nuclear reactors in Iran.

Coalition forces are enforcing a no-fly zone over Libya, and it's reported that some key military and communications sites have been destroyed.

Shown in **Table 1** are frequencies you can monitor in various countries to get a wide perspective on current events. LSB means lower side band and USB means upper sideband.

Biological Warfare: Radios On the Front Line

Here in the United States, the U.S. Army is purchasing \$9 million worth of high-frequency (HF) radios from the Harris Corp. for application in the detection of biological threats.

Now, at first I thought that this was strange. *I got curious.*

Here is what this radio does: It's deployed with

another piece of equipment that detects and identifies biological warfare agents in the air. The instant an agent is detected, the radio sends the information from the field to headquarters.

From what I have read so far, this seems to be a system that will be deployed down range but it would not surprise me if some were deployed at very sensitive military installations here in the United States.

The Loop Receiving Antenna: If You Build It, the Signals Will Come!

A great receiving antenna is a loop. It receives in all directions and it does not have to have a specific design. In other words, it can look like a square, triangle or circle. One side can be lower than the other. It really doesn't matter.

What *does matter* is that you make it as large as possible. Hang it off trees or poles. It can even go between trees. You can also hang it off gutters around your house.

The secret is that you buy insulated wire and you use coax for feed line to complete the loop — RG-58 is the least expensive and works well.

One end of the loop is connected to the braid (ground) and the other to the center of the coax. You can then put any connector on the feed line you want to connect to your radio. Just remember the braided copper wire is for the ground and the center with the white foam or plastic around the wire is positive.

You also need a ground as close to the radio as possible. Mine is outside the radio room window. Here's one idea: Get an eight-foot copper rod and pound it into the ground. Run a heavy wire from the rod to the metal chassis of your receiver. In fact, there may be a ground lug on the radio that you can attach it to.

Having a ground serves two functions. One, of course, is for safety. The other is lesser known to shortwave listeners. *Keep it a secret as we don't want everyone to know: A good ground actually improves reception.*

How It's Done

Now, let's go step-by-step and build the loop-receiving antenna. First, scout the area where you

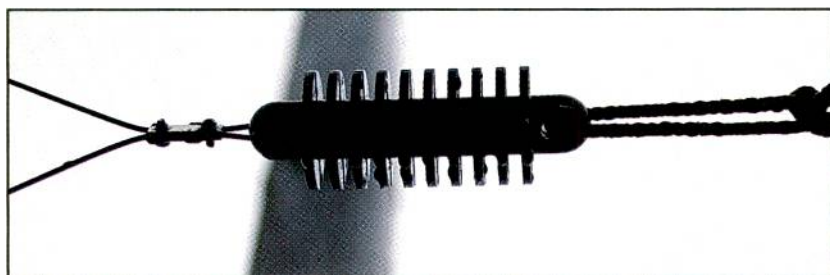

Insulators are used as a means for hoisting the loop antenna into the air.
(Photographs courtesy of Mitch Gill, NA7US)

COUNTRY	FREQUENCIES	COUNTRY	FREQUENCIES
ALBANIA	6115, 7425, 7450, 7465	NETHERLANDS	6020, 6040, 6165, 7120, 9345, 9795, 9895, 11655, 11675, 12065, 12080, 15315, 15525, 15595, 17725, 17810
ARGENTINA	9690, 11710, 15345	NEW ZEALAND	3935, 5950, 9765, 9870, 11725, 13840, 15720, 17675
AUSTRALIA	2310, 2325, 2485, 4835, 4910, 5025, 5995, 6020, 6080, 7240, 9475, 9560, 9580, 9590, 9660, 9710, 11650, 11880, 12080, 13630, 13670, 15160, 15230, 15240, 15515, 17715, 17750, 17775, 17785, 17795, 21725	NIGERIA	7255, 7275, 7380, 15120
AUSTRIA	5945, 6155, 7325, 9870, 13675, 13730	OMAN	15140
BAHRAIN	6010	PAKISTAN	6215, 7530, 11570, 15100, 17835
BANGLADESH	7185	PAPUA NEW GUINEA	3385, 4960, 7120
BELARUS	7360, 7390, 7420 BULGARIA 7400, 9400, 9500, 9700, 11700, 11900, 15700	PHILIPPINES	11720, 11885, 15190, 15270, 17665, 17720
CANADA RC	19610, 9755, 9770, 13650, 15365, 17740	POLAND	7130, 9525
CANADA CBC	6160, 9625	ROMANIA	6055, 6115, 6150, 7105, 7145, 7180, 9515, 9610, 9640, 9690, 9755, 11895, 15105, 15135, 17745
CHINA	5960, 5990, 6005, 6020, 6040, 6080, 6115, 6190, 7285, 9570, 9580, 9690, 9730, 9785, 9790, 9870, 11885, 11900, 11970, 13675, 13740, 15230, 15240	RUSSIA	6240, 7150, 7250, 7350, 9840, 12010, 12030, 13665, 15425
CROATIA	7285, 9470, 11690	SENEGAL	12000
CUBA	6000, 6060, 6180, 6300, 9505, 9550, 11760	SERBIA	6100
CZECH REP	5930, 6200, 7345, 7385, 9400, 9430, 9435, 9890, 9955, 11600, 13580, 15710	SINGAPORE	6080, 6150
ECUADOR	6050, 7385, 9745, 11700	SLOVAKIA	7230, 9440 SOLOMON IS. 5020v, 9545
EGYPT	4680, 7270, 9990, 11885, 15375, 17835	S AFRICA	3345, 7240, 7390, 9685, 15235, 15255, 17770
ETHIOPIA	7165, 9560v FRANCE 5920, 7315, 9720, 9765, 9805, 9865, 11615, 11725, 13680, 11995, 15160, 15275, 15605, 21620	SPAIN	6055, 6125, 9680, 11625, 11680
GERMANY	5905, 6140, 6180, 7225, 7240, 7280, 7285, 9565, 9735, 9755, 11690, 12045, 15275	SRI LANKA	6005, 9770, 11905, 15745v
GHANA	4915	SUDAN	4750, 7280, 9525, 9660, 9840, 13720
GREECE	7475, 9420, 9935, 12105, 15630, 17525	SURINAME	4990
GUYANA	3291, 5950	SWEDEN	6010, 7420, 11550, 15240
HUNGARY	5980, 6025, 6035, 9525	SYRIA	9330, 12085, 13610
INDIA	7410, 9425, 9445, 9690, 9705, 9910, 9950, 11620, 11645, 11715, 11935, 13605, 13710, 15020, 15075, 15155, 15235, 17510, 17670, 17800, 17895	TAIWAN	5950, 7130, 7445, 9355, 9680, 9785, 11550, 11850, 1995, 15215, 15465
INDONESIA	9525v, 11785, 15150v	TAJIKISTAN	7245
IRAN	6010, 6120, 6250, 7160, 7320, 7330, 9855, 11695, 15460, 17660	THAILAND	5890, 9535, 9680, 9725, 9805, 9810, 13770
ISRAEL	6280, 6985, 7545, 9345, 15640, 15760, 17535, 17600	TIBET	4820, 4905, 5935, 6050, 7170, 7240, 9490
ITALY	5965, 6010, 6035, 6090, 6120, 7170, 9760, 11800	TURKEY	5960, 6020, 6055, 7240, 9525, 11735, 12035
JAPAN	5975, 6110, 6120, 6145, 7230, 9505, 9535, 9875, 11690, 11695, 11715, 11730, 11740, 11935, 11970, 13650, 15195, 15355, 17685, 17810, 17825, 17845, 17870, 21610, 21670	TURKMENISTAN	4930, 5015
JORDAN	11690	UGANDA	4976, 5026
KOREA, N	3560, 4405, 6185, 6285, 7570, 9325, 9335, 9345, 9730, 9850, 9975, 9990, 11535, 11545, 11710, 11735, 12015, 13650, 13760, 15100, 15180	UKRAINE	5820, 5830, 9925
KOREA, S	7275, 9560, 9570, 9640, 9650, 9770, 15575	U K	5875, 5975, 6005, 6040, 6130, 6195, 7130, 7160, 7320, 9410, 9480, 9660, 9740, 9750, 11675, 11750, 11765, 11920, 12095, 15105, 15285, 15360, 15400, 15575, 17640, 17830, 17885, 21470
LAOS	7145	UNITED NATIONS	9565, 17810
LIBERIA	4760, 5470, 9525	USA AFRTS	4319-USB, 5446.5-USB, 5765-USB, 6350-USB, 7811.5-USB, 10320-USB, 12133.5-USB, 12759-USB, 13362-USB
LIBYA	7320, 17725, 21695	USA VOA	4930, 4960, 5960, 6080, 6105, 6110, 7125, 7175, 7205, 7405, 9645, 9760, 9785, 9885, 11655, 11885, 11890, 11975, 12015, 12150, 13600, 13640, 13710, 13735, 13755, 15150, 15185, 15205, 15290, 15445, 15580, 17640, 17715, 17730, 17895
LITHUANIA	7325, 9710, 9875	USA KAIJ	5755, 9480
MALAYSIA	7295, 9750, 15295	USA	WBCQ 5110-LSB, 7415, 9330-LSB, 18910-LSB
MEXICO	6185	USA WEWN	5810, 5850, 7560, 7570, 9450, 9955, 9975, 15785, 17595
MOLDOVA	6235	USA WRMI 7	385, 9955
MONGOLIA	12085	USA WWCR	3215, 5070, 7465, 9985, 12160, 15825
MYANMAR	5986	VANUATU	3945v, 7260v
NEPAL	5005	VATICAN	4005, 5885, 6185, 7250, 7305, 7360, 7365, 9310, 9610, 9635, 9645, 9660, 9755, 11625, 11740, 11850, 13765, 15595
		VIETNAM	6175, 7285, 9840, 12020
		YEMEN	9780v
		ZAMBIA	4910, 5915, 6165
		ZANZIBAR	11735



Concrete blocks are used to keep the loop antenna high in the air, while at the same time providing stress relief during high winds — when the trees are swaying.

want the antenna. Designate which trees you want to use. You don't need expensive or special wire. You just need one length of insulated wire. About 275 feet is ideal, but if your house is only 50-feet long and you want to use the gutters, you will still have a very good antenna.

I am going to use the trees in this example. Stick with me. You'll see why.

Lay the wire on the ground beneath where you are going to put up the antenna. Slide one end of an insulator onto the wire. Position it in front of each of the trees you are going to use as supports. Next solder the braid and center conductor of your coax to each end of the antenna.

The insulator is being used to provide a means for lifting the antenna into the trees so the wire won't be crimped.

Now you need five pieces of rope. I use parachord because it is light and strong.

Four will be used to lift the antenna into the tree and the fifth is an extra that you may need if your antenna is up higher. *The fun part starts here.*

I use a special fishing reel-slingshot combination. All you need, though, is a weight and a fishing pole. It takes a little practice but that's how I put up most of my antennas.

Once you *cast*, and the line goes over the limb you want, take the weight off and tie on the parachord. Then slowly retrieve it from the other side. Remember, though, it's not a fish so don't reel as though you're pulling in a 12-pound bass.

Once you have drawn the parachord low enough, tie it to the other hole on the insulator. Do this for all four insulators — or whatever number of insulators-trees you're using.

You are almost ready to lift the antenna wire. But you'll now need four concrete blocks. I know this may sound crazy, but it could save your antenna one day. Lift the antenna up — one tree at a time — and tie the end of the rope to the concrete block.

If you have any high winds, the tree will sway and the concrete will lift off the ground and go back down — taking stress off the antenna wire and keeping it safe.

Let me know if you make one of these, and how it works. My loop is 272-feet long and with it I can hear the world. *(I've also used it to talk to radio amateurs around the world, but that's another story.)*

Until next time, remember that you play an important role in keeping us all safe. You never know what you will hear but you know what you should do.

**TERRORISM FORCES
US TO MAKE A
CHOICE. WE CAN BE
AFRAID. OR
WE CAN BE READY.**

READY

**WWW.READY.GOV
1-800-BE-READY**



Good News for the VHF/UHF Enthusiast

The all-time favorite magazine for the VHF/UHF enthusiast, CQ VHF is better than ever and here to serve you!



By taking advantage of our subscription specials you'll save money and have CQ VHF delivered right to your mailbox. Only \$26 for four information-packed quarterly issues. Or better yet, enter a two or three year subscription at these special prices. As always, every subscription comes with our money back guarantee.

DON'T MISS OUT CALL TODAY

	USA	VE/XE	Foreign Air Post
1 Year	26.00	36.00	39.00
2 Years	52.00	72.00	78.00
3 Years	78.00	108.00	117.00

Please allow 6-8 weeks for delivery of first issue

Mail your order to:

CQ VHF

25 Newbridge Rd • Hicksville, NY 11801

Subscribe on line at www.cq-vhf.com

FAX your order to us at 516 681-2926

Call Toll-Free 800-853-9797

Pffreethhhhhhhhhhhhhhhhhhh . . . What's All the Noise About?

A Look At the FCC Rules vs. Rising Interference Levels

by Bruce A. Conti
contiba@gmail.com

It was in 1979 when the Federal Communications Commission first introduced new rules regulating emissions from digital devices, yet noise levels have been on the rise in our increasingly digital world.

FCC Office of Engineering and Technology (OET) Bulletin 62, titled *Understanding the FCC Regulations for Computers and Other Digital Devices* explains the application of Part 15 of Title 47 of the Code of Federal Regulations (47 CFR) which addresses digital devices as unintentional radiators causing harmful interference to radio communications and broadcasting. Broadcast Technology investigates key points from the bulletin and the limits of FCC testing.

So, What's a Digital Device?

The FCC defines a digital device as a device

or system that generates and uses digital timing signals operating at greater than 9,000 cycles per second (9 kHz). Under the Part 15 rules, there are two types of digital devices: Class A and Class B.

OET Bulletin 62 states, "If a digital device is sold or offered for sale to any residential users, then it is a Class B device regardless of its price or application."

Class A devices are restricted to a commercial, industrial or business environment, and therefore allow higher emissions than Class B. "The Class B technical standards are designed to protect against interference being caused to a receiver located about 10 meters away, such as might be found in a neighbor's house or apartment. The standards are not intended to prevent interference at closer distances or within the digital device user's residence. Such interference problems can usually be resolved by the user."



An anechoic chamber — or shielded room — can be used to prescreen a product for emissions that might otherwise be overwhelmed by ambient signals in the air.
(Photographs courtesy of Bruce A. Conti)

In other words, if a digital device located within your home is causing interference — then turn it off.

Trust, But Verify

According to Section 15.5 of FCC Part 15 rules, “digital devices that comply with the FCC technical standards and have been certified and marketed in accordance with the FCC rules may not cause interference and must accept any interference that they receive.

“This means that the user of a personal computer may be required to shut the computer off if it is found to be causing interference to any authorized radio communications, such as police, fire, TV or radio, even if the computer has been certified and has an FCC ID tag on it to prove it. In the event that this happens, the user will be allowed to resume use of the computer only after the cause of the interference problem has been eliminated.”

Note that this applies only to certified equipment, primarily computers, which are required to be assigned and labeled with an FCC ID number. Digital devices that are not personal computers or associated peripherals are *verified* rather than certified.

“The verification procedure requires that tests be performed on the device to be authorized. These tests measure the levels of radio frequency energy that are radiated by the device into the open air or conducted by the device into the power lines.

“After these tests are performed, a report must be produced showing the test procedure, the test results and some additional information about the device including design drawings.”

A manufacturer may self-verify or submit a product to an independent test lab. In either case, the verification report must be kept on file by the manufacturer. No filing with the FCC is required.

Cease and Desist — Until Things Are Fixed

Regardless of whether a digital device is certified or verified, Section 2 stipulates, “If someone purchases a non-compliant digital device, uses it, causes interference to authorized radio communications, and is the subject of an FCC interference investigation, the user will be told to stop operating the device until the interference problem is corrected.

However, the person or company that sold this non-compliant digital device to the user has violated the FCC marketing

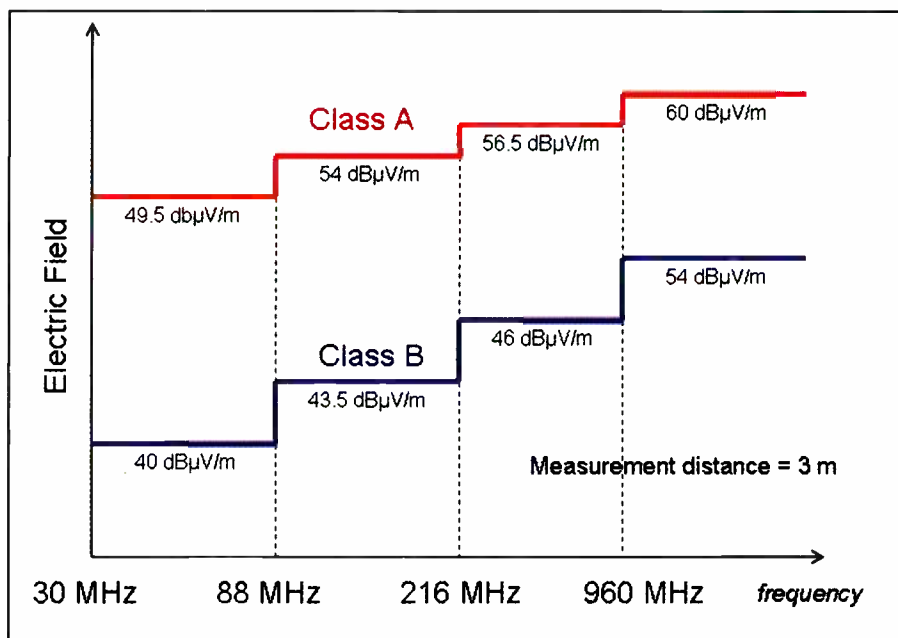

Under FCC Part 15 rules, there are two types of digital devices: Class A and Class B. This graphic shows acceptable emissions levels for each.

rules in Part 2 as well as federal law and may be subject to an enforcement action by the Commission’s Field Operations Bureau . . . It is the act of selling or leasing, offering to sell or lease, or importing a digital device that has not gone through the appropriate FCC equipment authorization procedure that is a violation of the Commission’s rules and federal law.”

But, On the Other Hand . . .

There are specific exemptions to Part 15 rules, however. Appliances are exempt, many of which are familiar sources of interference. The FCC defines appliances as devices that are designed to heat, cool or move something by converting electrical energy into heat or motion.

Examples include vacuum cleaners, toasters, air conditioners and clothes dryers. Devices that use radio frequency energy to do the actual heating, cooling or moving, such as microwave ovens and radio frequency lighting, are subject to technical standards in Part 18 of the FCC rules.

Digital devices used exclusively as electronic control systems by public utilities or in industrial plants are also exempt. Perhaps this explains the noise radiating from light-emitting-diode (LED) traffic lights.

Despite the exemptions, OET Bulletin 62 states, “Digital devices that are exempt from the technical standards in Part 15 are still not permitted to cause harmful inter-

ference to any authorized radio communications. Accordingly, it is strongly recommended that the manufacturer of an exempt digital device endeavor to have the device meet the technical standards anyhow.”

Conducted vs. Radiated Emissions

There are two types of emissions covered under Part 15: conducted and radiated. Conducted emissions testing measures noise currents from 450 kHz to 30 MHz on the power cord of a digital device. A Line Impedance Stabilization Network (LISN) is inserted in series between the unit under test and the AC mains to perform the measurements. The primary concern is that AC wiring could become an efficient radiator of conducted emissions from a digital device. The AC wiring might be of sufficient length to act as an antenna. Often a common-mode choke is implemented in the design of a digital device to reduce conducted emissions.

Radiated emissions are a measurement of the radiated electric field over the air from a digital device. Measurements are taken from an open-field antenna at a distance of three or 10 meters away from the unit under test.

In addition, measurements are peaked with antenna height adjusted between one and four meters, using vertical and horizontal polarization. Broadband-biconic

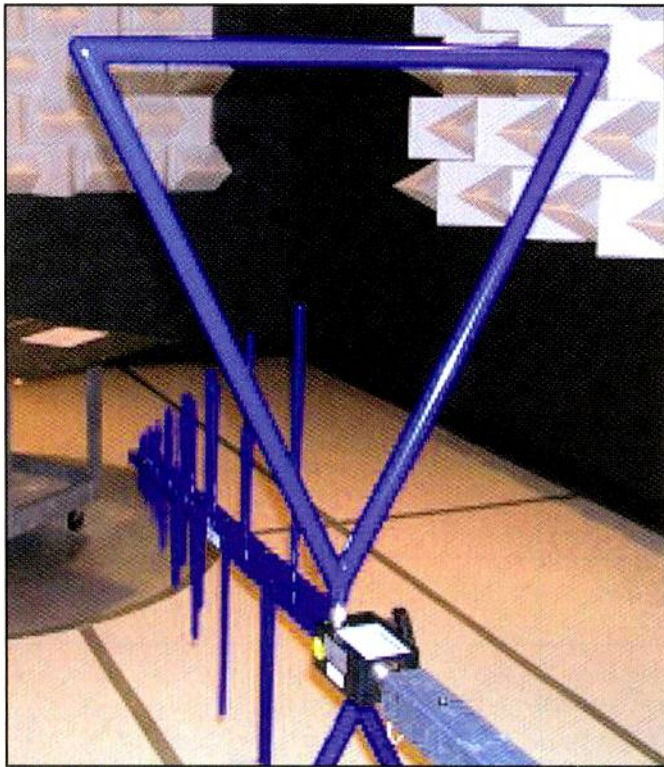

A piece of equipment undergoes testing in the anechoic chamber.

and log-periodic antennas are typically used for sweeps over a wide frequency range, or a dipole antenna with telescopic radials can be tuned to measure a specific frequency.

An anechoic chamber or shielded room can be used to pre-screen a product for signals that might otherwise be buried by ambient signals in the air. Some test labs have large-scale, anechoic chambers to accommodate 10-meter, open-field testing.

According to the standards of Part 15, unintentional radiated emissions are measured beginning at 30 MHz and above. Radiated emissions below 30 MHz are not of concern, the simple logic being that digital devices are typically not large enough to become efficient radiators at longer wavelengths. This explains what seems like ever-increasing levels of interference on shortwave and AM broadcast frequencies.

Manufacturers of verified digital devices are essentially allowed to sell products that cause harmful interference below 30 MHz, regardless of the intent of Part 15 rules!

Declaration of Nonconformity?

A digital device that has been certified or verified to meet FCC Part 15 rules must include a declaration of conformity. The declaration is a statement that identifies the product as tested to comply with FCC Part 15 and/or comparable European Community standards. The declaration can be included in the instruction manual or provided as a separate certificate of compliance.

Following is a typical generic declaration of conformity:

"This equipment has been tested and found to comply with the limits for a Class B digital device, pursuant to Part 15 of the FCC rules. These limits are designed to provide reasonable protection against harmful interference in a residential instal-

This Month in Broadcast History

75 Years Ago (1936)—The FCC began hearings regarding the allocation of frequencies above 30 MHz, which resulted in the designation of 19 television channels, each with a bandwidth of six MHz. Channel 1 was assigned 40-50 MHz, channel 19 288-294 MHz. RCA began regular experimental TV broadcasts on channel 1 from atop the Empire State Building in New York City. India State Broadcasting became what is still known today as All India Radio (AIR).

50 Years Ago (1961)—A young Perry Como, host of the *Kraft Music Hall*, was featured on the cover of *TV Radio Mirror* magazine. *Travelin' Man* by Ricky Nelson topped the *Budweiser Hit Singles* on 990 KTKT Tucson and 1360 KRUX Phoenix, Arizona.

25 Years Ago (1986)—RCA and its NBC network were acquired by General Electric for over \$6 billion, but FCC approval required RCA divestiture of radio stations in Chicago, New York and Washington.



lation. This equipment generates, uses, and can radiate radio frequency energy, and if not installed and used in accordance with the instructions, it may cause harmful interference to radio communications. However, there is no guarantee that interference will not occur in a particular installation. If this equipment does cause harmful interference to radio or television reception, which can be determined by turning the equipment off and on, the user is encouraged to try to correct the interference by one or more of the following measures: Reorient or relocate the receiving antenna. Increase the separation between the equipment and receiver. Connect the equipment to an outlet on a circuit different from that to which the receiver is connected. Consult the dealer or an experienced radio/TV technician for help."

In addition, digital devices are labeled:

"This device complies with Part 15 of the FCC rules. Operation is subject to the following two conditions: (1) This device may not cause harmful interference, and (2) this device must accept any interference received, including interference that may cause undesired operation."

To some radio communications hobbyists these statements may appear more like declarations of non-conformity, especially to those who have experienced harmful interference from digital devices such as personal computers, wireless network routers and especially plasma televisions.

Readers React

In response to the March 2011 edition of *Pop'Comm's Broadcast Technology* column — titled *HDTV Spec Mysteries Unraveled* — a few readers were surprised that there was no mention of the high levels of Radio Frequency Interference (RFI) caused by plasma televisions.

Milton Withers, AD5XD, of Richardson, Texas writes: "I was amazed and shocked you made absolutely no mention that plasma TVs are *The Mother of All RFI Producers* < <http://bit.ly/hFXLQZ> >. Plasma TV RFI from over 100 yards away

is so bad on 80 meters that I have to use a K9AY loop antenna to null out the direction of the offending signal. So ham or SWL, beware. Buying a plasma TV may put a damper on your radio hobby."

Pop'Comm reader **Joe Cacciatore** also warned: "My 50-inch Panasonic plasma TV is a huge generator of RFI all over my radio — from the AM broadcast band right up to about 20 MHz. It destroys most signals in different bands. The TV is located in a different part of the house (than the radio) but when it is on, I give up trying to DX on BCB or SWL. If I had known what a major problem the TV would cause on my radio, I never would have purchased it."

Plasma TV and RFI

An Internet search for *plasma TV RFI* indeed found plenty of information regarding radiated interference from plasma televisions. Panasonic, consistently ranked number one in plasma, also seems to be one of the worst RFI offenders.

Though there are reports that the newer, more energy-efficient plasmas are less noisy, it looks like it's best to stay clear of plasma. Based on various reports from those who've tried to cure the problem, the interference is radiated from the plasma screen, not conducted. It can't be eliminated by adding ferrite chokes to cables or the AC power cord.

The radiated emissions of plasma TVs can be received as far as a quarter-mile away. LED televisions on the other hand have been found to be noise-free.

Note to FCC: Is Anybody There?

The FCC Office of Engineering and Technology is online < <http://www.fcc.gov/oet> > where bulletins, technical documents, authorization procedures and FCC rules can be found.

Because the office deals with authorizations, it would seem logical that this would be the place to register a complaint. However no contact information regarding complaints is provided.

The FCC Media Bureau < <http://www.fcc.gov/mb> > has a complaint form available online, but it only covers such things as illegal broadcasting and do-not-call-list violations.

There's nothing specifically for complaints about interference to radio communications from unintentional radiation of digital devices. When it comes to accepting any interference received, I guess we're on our own.

Broadcast Loggings

AM broadcast band DXers are managing to catch interesting signals despite the increasing noise. Solar activity is on the rise too, resulting in some hot tropical DX for this month's selected logs. All times are UTC.

612 SNRT Sebaa-Aioun, Morocco, at 0215 poor reception with program in Arabic. Man with phone call followed by local music, into woman and man with additional talks in Arabic. Poor, but better than it's been recently. (Wood-MA)

730 HJCU Melodia, Bogotá, Colombia, at 0158 fanfare then man with "En la cadena melodia de Colombia, esta es la hora..." and mellow vocal. Recorded; good mixing with CKAC. (Black-MA)

810 KGO San Francisco, California, at 1445 still audible, but fadey and being overtaken by KUTR Utah. (Barton-AZ)

810 ZNS3 Freeport, Bahamas, at 0958 Bahamian national anthem then jingle, "Covering the islands like the sun, reaching far and wide to everyone, 810 AM," and announcement, "From Bimini to Abacor,

Berry Islands to South Florida, Bahamians everywhere tune to 810 AM." Recorded; excellent. (Black-MA)

880 WCBS New York, New York, I hear this station wall to wall and treetop tall! I get some fading, but not much. (Hallenbeck-ME)

900 CBW Winnipeg, Manitoba, at 1220 with weather into sports results. CBC news at the bottom of the hour. Had only begun hearing them recently. (Barton-AZ)

1000 Radio Granma, Manzanillo, Cuba, at 0059 "Transmite Radio Granma, Manzanillo, Cuba." This is the 5 kW transmitter at Media Luna, Granma province, a triplexed site with 1140 CMNL Radio Bayamo (1 kW) and 1260 Radio Progreso (2.5 kW). Recorded; poor-fair under IBOC interference from 1010 WINS New York. With thanks to Mauricia Molano from RealDX. (Black-MA)

1010 WINS New York, New York; I try to listen to them, but it's hard some nights as "News/Talk 1010" CFRB Toronto walks the dog over them with the same all news/traffic format, my go-to station when WCBS is doing Yankee games. (Hallenbeck-ME)

1120 KMOX St. Louis, Missouri, at 0730 forecast, heard on null of KANN Roy, Utah. (Barton-AZ)

1134 Hrvatski Radio, Zadar, Croatia, at 2315 good; beginning of English program, "...the Voice of Croatia. You're listening to Croatia Today." (Conti-NH)

1170 KCBQ San Diego, California, at 1659 break from Hugh Hewitt talk show to local promos, good IF on the hour as "Intelligent Talk." Usually 1170 is KFAQ Oklahoma. (Barton-AZ)

1215 VOR Bolshakovo, Kaliningrad, at 2215 panel discussion about natural gas use in Europe, production in the Ukraine; over Absolute Radio UK. At 2300 light classical music, "This is the Voice of Russia World Service," to good peak over UK and Spain. (Connelly-MA)

Thanks to Rick Barton; Chris Black, N1CP; Mark Connelly, WA1ION; Don Hallenbeck; and Steve Wood. 73 and Good DX!

If you enjoy Amateur Radio, you'll enjoy CQ

Fun to read, interesting from cover to cover, written so you can understand it. That's CQ. Read by thousands of people each month in 116 countries around the world.

It's more than just a magazine.

CQ also sponsors these world-famous award programs and contests: The CQ World-Wide DX Phone and CW Contests, the CQ WAZ Award, the CQ World-Wide WPX Phone and CW Contests, the CQ World-Wide VHF Contest, the CQ USA-CA Award, the CQ WPX Award, the CQ World-Wide 160 Meter Phone and CW Contests, the CQ World-Wide RTTY Contest, the CQ 5 Band WAZ Award, the CQ DX Award, CQ iDX Award, CQ DX Field Award, CQ DX Marathon and the highly acclaimed CQ DX Hall of Fame.

	USA	VE/XE	Foreign Air Post
1 Year	36.95	49.95	61.95
2 Years	66.95	92.95	116.95
3 Years	96.95	135.95	171.95

Please allow 6-8 weeks for delivery of first issue

CQ Magazine,
25 Newbridge Road, Hicksville, NY 11801
Phone 516-681-2922
FAX 516-681-2926

Allied Radio's Space Spanner Receiver: Reliving a Kit-Building Adventure

by Peter J. Bertini
radiconnection@juno.com

... But nostalgia is a strong force, and many of us yearn for the radios that started us off on a lifetime of radio adventures.

Let's go back, say 55 years or so... it's now 1957. The Cold War rages while the race to space seems lost to the USSR — winner of Round 1 by launching Sputnik I into orbit in October.

Thousands of ears tuned to 20.005 MHz, straining to hear the satellite's faint radio signal as it circled the earth every 96 seconds.

SWL was a booming hobby and the airwaves were filled with foreign stations and propaganda of all types. Many a beginning SWL or ham cut their teeth with modest gear — such as the Space Spanner receiver kits debuted in the Allied Radio 1957 catalog under its Knight-kit line up.

Reader Todd F. contacted us a few months back and shared the following tale:

I have a Knight-kit Space Spanner that I am trying to get going... it works, barely, but not well. It is identical to the one I built with proceeds from my paper route money when I was 14 or 15 years old in 1959. My kit didn't work! I laid awake wondering why, until I discovered I had run one wire through a solder lug rather than the two as shown in the instructions. Voila! The radio then worked.

It was a very big deal to me as a child. I used to get Radio Moscow on it, the BBC and Radio Havana... we lived in Florida during the Cold War era. It was all a great adventure — a turning point in my young life, which I only realized decades later — leading me to buy an example of that kit and the manual so I could relive that epochal moment.

The Space Spanner was the slightly bigger brother to the Ocean Hopper. Both were simple AC-powered regenerative receivers. Ed Engelken was kind enough to provide a scan of the catalog page for Space Spanner from his library of old catalogs (see **Figure 1**).

Alas, while the 17-MHz upper tuning limit precluded receiving the historic 20.005 MHz Sputnik I broadcasts, these little receivers rewarded their owners with countless hours of listening of what was perhaps shortwave broadcasting's golden era.



knight-kit "Space Spanner" Receiver Kit
THRILLING SHORTWAVE AND BROADCAST RECEPTION

ONLY **\$15⁹⁵**

- Built-in PM Speaker
- Sensitive Regenerative Circuit
- Standard and Short Wave Bands
- Convenient Bandswitching

Sensitive 2-band receiver in easy-to-build kit form. Short wave band covers 6 to 18 megacycles—pulls in exciting foreign broadcasts from many parts of the world, plus Amateur, aircraft, police and marine radio. Specially designed regenerative circuit also provides highly sensitive reception on broadcast band. Broadcast band or short wave is selected simply with the built-in bandswitch.

Built-in 4" PM speaker and beam-power output tube for plenty of volume. Headphone connectors on rear panel allow private, quiet listening; slide switch cuts out speaker. Sensitive circuit employs 12AT7 regenerative detector and audio amplifier; 50C5 power output; 35W4 rectifier. 6 controls allow precise, accurate tuning; Bandsread, Main Tuning, Antenna Trimmer, Band-switch, Regeneration, and Volume. Panel is finished in attractive gray; has black knobs. Detailed, step-by-step instructions include pictorial and schematic diagrams. With all parts, punched chassis and tubes. Less cabinet (below). Size, 7x10½x6". For 110-120 v., 50-60 cycle AC or DC. Shpg. wt., 4½ lbs.

83 Y 243. NET 15.95

CABINET FOR ABOVE. Smart, wood cabinet with durable, gray pyroxylin covering. Gives receiver handsome, professional appearance. Shpg. wt., 2 lbs.

83 Y 247. NET 2.90



Figure 1: Allied Radio's 1957 catalog page for the Knight-kit Space Spanner receiver kit.



Photo A: Todd's tired, old Space Spanner, an eBay auction site purchase. It had seen better days. (Photographs courtesy of K1ZJH)



Photo B: The top chassis view shows that the receiver is a rather spartan, three-tube regenerative design.

Todd continued: *I recall it was \$14.95 for the kit without the case. It was another \$5 for the case, which I did not order with the original kit. I built the kit and had it standing naked on my little desk because \$5 was another whole week's paper route income for me! I see in the manual that the antenna kit was \$1.03. I bought that with the kit, and stretched the wire between insulators, with the rubber-insulated downlead fed under a steel casement window.*

I have in my hands now a discontinued Radio Shack long wire antenna kit that is very similar to the original. I'm about to string it up and tune in some shortwave on the newly rebuilt radio as I did so many years ago.

Today I'm building solar electricity, solar hot water and solar hot air systems onto my remote, off-grid mountain cabin. These skills all started with this radio, which will now have its little shrine on my shelves — in working condition.

So, for this column we'll be showing what went into restoring Todd's Space Spanner. And by now hopefully he's reliving those childhood memories.

Todd's tale is similar to those of many of us old timers. My kit nemesis was the Lafayette KT-200, a more advanced super-het kit that I intended to use in my KN1ZJH Novice ham station back in the early '60s. Unfortunately, the receiver wasn't quite up to the task of dealing with the crowded Novice CW bands, and the career of a budding ham was almost cut short by that misstep!

But nostalgia is a strong force, and many of us yearn for the radios that started us off on a lifetime of radio adventures. I confess to now owning both a KT-200 and the later model KT-320.

Finding Manuals

One thing you'll need to properly service or reconstruct any electronic kit is a copy of the original factory manual. Fortunately, there are several good manual suppliers who have excellent inventories at very fair prices.

Manuals — both originals and copies — are offered on Internet auction sites, as well. Contact information for a few vendors I've used are listed with this article.

If you're Internet savvy, this URL <<http://bama.edebris.com/manuals/>> will bring you to the boat anchor archives, where users share downloaded manuals for vintage communications radios and vintage test equipment. Note that many of the Heathkit manuals are claimed to be under copyright protection, and are available only from authorized dealers.

It can be difficult to find the exact manual for a piece of gear that has undergone numerous factory revisions over the life of the production cycle. There are also many other Internet user groups that support specific manufacturers where information and restoration tips are freely shared among participants. For example, I belong to the Heathkit, Hewlett Packard and Hallicrafters user forums on *Yahoo!*

Kit designs spanned from the worst imaginable to some of the finest and most innovative equipment available. Yet any kit was only as good as the workmanship of the builder.

The gamut runs from *expert* — kits that look factory made — to kits that were assembled by youngsters with no prior soldering experience. Alas, so it was with Todd's Space Spanner.

Photo A shows the Knight Space Spanner as it was found. A rear chassis view can be seen in **Photo B**. So far, everything looked good! But, the underside of the chassis in **Photo C** revealed that this restoration would be a bit more involved than I had planned.

I had expected I'd be replacing a few out-of-tolerance resistors, improve the AC safety features of the hot AC/DC chassis and replace any vintage filter or wax capacitors with modern, new components to get Todd's set into reliable working order.

Photos D and **E** give a better idea of the reality of what I was getting into. The Space Spanner instructions advised the builder to use short leads, but the youngster who assembled this radio carried the advice to extremes.

Resistor bodies were pulled tight against the socket terminals, placing undue mechanical stress on the components. Note the messy wiring and poor parts placement seen in **Photo D**.

The plastic wire insulation was burned and overheated, leaving areas of exposed or bare wires. It was impossible to correct these problems without causing more problems.

Photo E shows another area where the workmanship was less than desirable.

Grainy and cold solder joints, poor mechanical connections on the solder lugs and more damaged wire insulation.

So, Where to Go From Here?

I had a few options. First, I could carefully remove all of the components and old wiring, leaving the original sockets, terminal strips, coils and controls in place.

The receiver is a simple, three-tube design, and only needs a reasonable quantity of commonly available and inexpensive parts.

Unfortunately, attempting to remove the old components ended up damaging the socket terminals, which were a brittle metal that easily snapped. Luckily my parts bins had exact replacements for the two, seven-pin- and one, nine-pin-wafer tube sockets. Rather than try working in tight confines of the chassis, I found it was safer to temporarily remove the two control potentiometers and band switch to facilitate cleaning their terminals.

Be *very careful*, as it is very easy to damage parts when trying to remove old leads that are wrapped around terminals. What I ended up with is shown in **Photo F**. The old, removed parts are shown in **Photo G**.

Tearing Down Old Kits

If you're willing to spend the time, money and effort, rebuilding old kits can be a rewarding experience. I've seen examples of many major rebuilds of early kits, including many of the larger ham transmitters and receivers.

It's not unusual to see these stripped down to a bare chassis and even replated to look like new. The restorer is rewarded with the experience of reliving those early kit days.

I decided to follow the original instruction manual to guide me through the kit. With more than 45 years of electronics experience behind me, I would feel confident working from the schematic alone, but I decided it might be more fun to follow the manual step-by-step, just as if I was building this radio for the first time.

I should add that attempting to build a kit from the schematic could lead to many problems. It is not uncommon to find errors in schematics, especially if the kit has undergone revisions. And, there are many critical steps regarding lead orientation and other concerns that cannot be conveyed by the schematic alone. A scan of the schematic from the manual is shown in **Figure 2**.

Space Spanner Design and Manual

The schematic reveals that the Space Spanner is a simple, AC/DC regenerative receiver. A dual section triode tube (type 12AT7) serves as the regenerative detector and first audio amplifier, followed by a 50C5 as the second audio power stage.

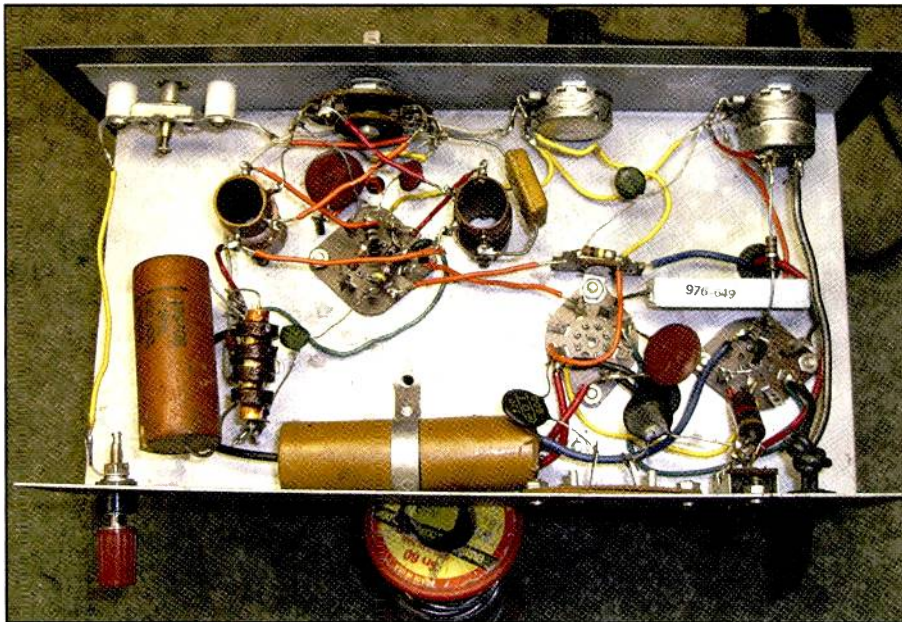

Photo C: The soldering and workmanship left much to be desired. It was probably the first time an anxious youngster had ever attempted such a ponderous challenge.

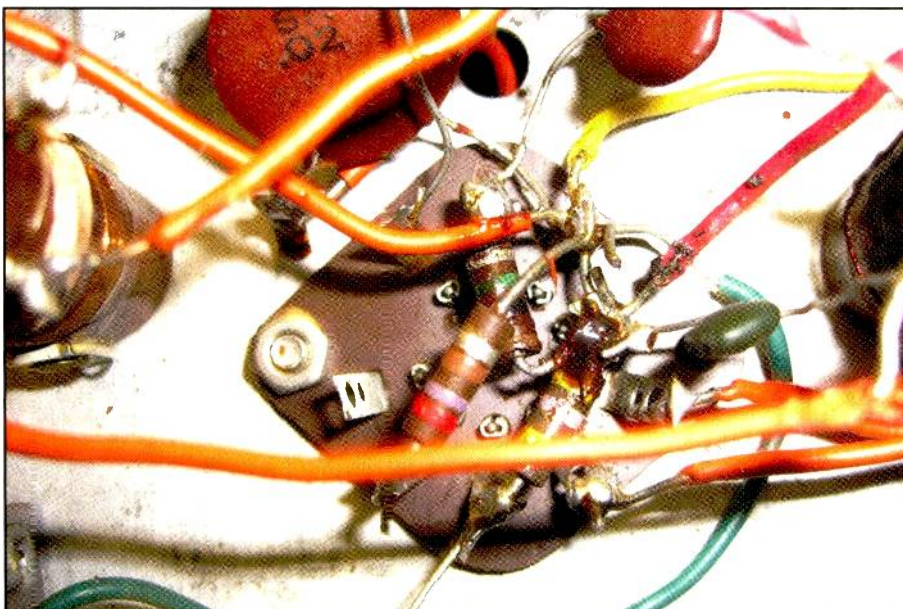

Photo D: This is the area around the 12AT7 dual triode. Unfortunately, components and leads are very crowded in this area — and vying for a dearth of solder terminal real estate. The engineers who laid out this kit could have done better.

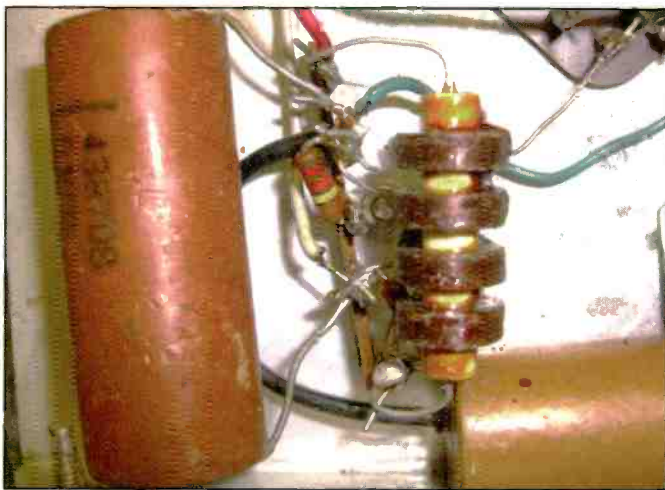

Photo E: Things aren't so crowded here, but again the workmanship could have been much nicer.



Photo F: Most of the original components couldn't be salvaged and except for a few major pieces, the chassis was stripped bare.

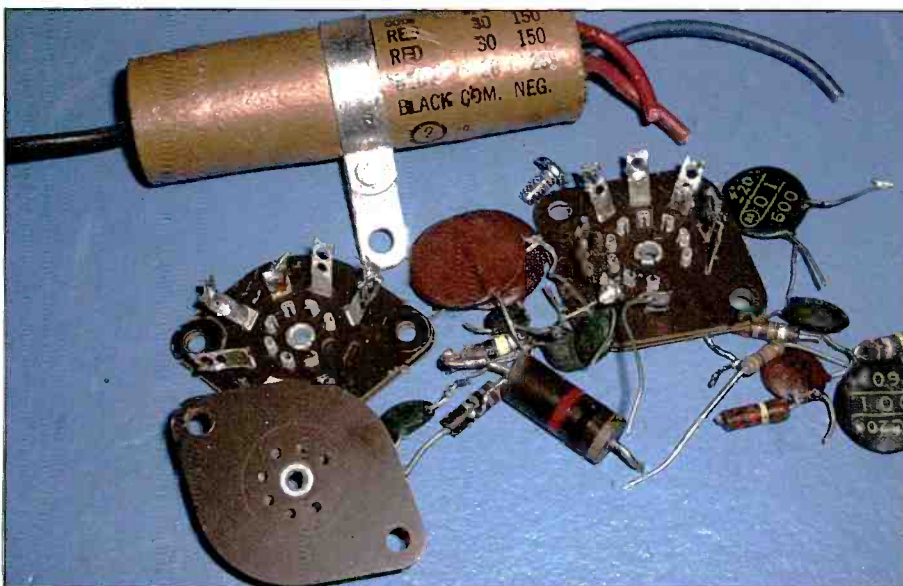

Photo G: Here are some of the removed components that will be replaced when the kit is rebuilt.

CQ Books

Lew McCoy on Antennas

by Lew McCoy, W1ICP

Unlike many technical publications, Lew presents his invaluable antenna info in a casual, non-intimidating way for anyone!

8.5 X 11 Paperback \$19.95

New! CD Version \$14.95

Buy both for only \$29.95

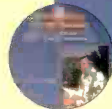

Reflections III

by Walter Maxwell, W2DU

Includes all the information in Reflections I & II and much, much more! This fully revised and updated, this 424-page, third edition is truly a must have!

424-page, 8.5 X 11 Paperback \$39.95

New! CD Version \$29.95

Buy both for only \$59.95



The Quad Antenna

by Bob Haviland, W4MB

Comprehensive guide to the construction, design and performance of Quad Antennas. General Concepts, Circular-Loop & Arrays, Rectangular & Square Loops, Multi-Element Quads and more!

8.5 X 11 Paperback \$19.95

New! CD Version \$14.95

Buy both for only \$29.95



"Getting Started" DVD Paks

CQ Ham Radio Welcome Pak

1 DVD contains 3 programs:

- Ham Radio Horizons
- Getting Started in Ham Radio
- Getting Started in VHF

Order HAMDVD ~~\$24.95~~ \$18.00



CQ HF Specialty Pak

1 DVD contains 2 programs:

- Getting Started in DXing
- Getting Started in Contesting

Order HFDVD ~~\$24.95~~ \$18.00



CQ VHF Specialty Pak

1 DVD contains 3 programs:

- Getting Started in Satellites
- Getting Started in VHF
- Getting Started in Packet

Order VHFVD ~~\$24.95~~ \$18.00

Any 2 Paks only \$35.00 3 Paks only \$52.00



Shipping & Handling: U.S. add \$7 for the first item, \$3.50 for the second and \$2 for each add'l item. FREE shipping on orders over \$100 to one U.S. address. CN/MX-\$15 for 1st item, \$7 for 2nd and \$3 for each add'l. All Other Countries-\$25 for 1st item, \$10 for 2nd and \$5 for each additional. Buy Both=Single Item!

CQ Communications, Inc.

25 Newbridge Road, Hicksville, NY 11801

Call: 1-800-853-9797 Fax: 516-681-2926 I

website: www.cq-amateur-radio.com

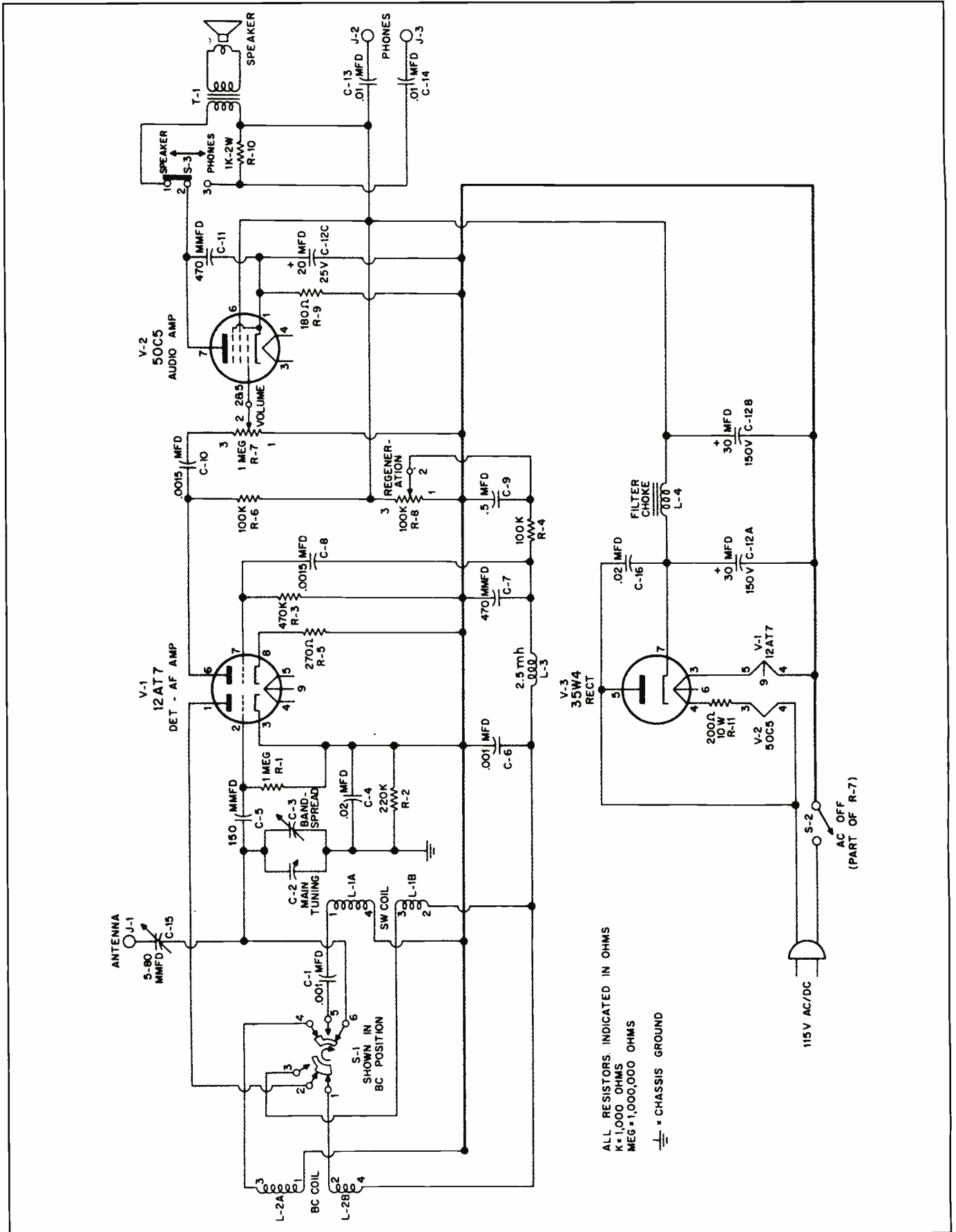

Figure 2: The Knight-kit Space Spanner schematic.

A 35W5 is the half-wave rectifier for the DC supply voltage. Since the three 150-mA tube filaments are wired in series, a 200-ohm power resistor is used to drop AC voltage by another 30 volts. If you replace this part, use a power resistor with a 10-watt rating.

The Knight-kit assembly manuals were well written and clearly illustrated.

Photo H shows the chassis at the stage identified in the manual as “first chassis wiring view.” Both the manual and schematic were placed on the bench so they could be easily seen and referenced while the chassis wiring progressed.

Many of the early components used in the original Space Spanner kit are now

obsolete and the modern equivalents are physically much smaller. For example, the humungous, .5-mFd, 400VDC wax paper capacitor (part C-9) seen in **Photo E** was replaced with a tiny modern Mylar film, .47-mFd, 630VDC capacitor — barely visible in **Photo H**.

This capacitor, and the multisection filter capacitor C-12, should both be replaced. I used a .47-mFd, 630VDC Mylar capacitor for C-9, and two discrete 33-mFd, 160VDC electrolytic capacitors to replace the two, 30- μ F sections of C-12 and a single 22-mFd, 60VDC electrolytic to replace the 20-mFd section used for the cathode bypass for the 50C5 audio stage.

A terminal strip was added to provide a tie point for the negative lead returns for these capacitors, since the individual leads were not long enough to reach the original tie points shown in the manual. This terminal strip is visible on the rear chassis apron wall in **Photo I**.

The kit used a ground lug under one of the mounting ears for the 12AT7 socket. This is a poor practice, since the metal-to-metal contact area is reduced, and it is likely that the mechanical connection will eventually develop a high resistance. I suggest soldering the lug to the chassis to ensure a good electrical connection.

Next: Capacitor Choices

Many of the capacitors were disc ceramic. These were generally considered to be reliable components. Unfortunately, I am finding more and more defective disc capacitors, so I’ve been adding them to my *must change* list.

As time passes, those parts we once thought would last indefinitely in reality aren’t. Almost all of the capacitors used in this receiver, except for C5, the 100-pF grid leak capacitor, and C4, the .02-mFd line bypass capacitor, may be replaced with modern Mylar capacitors, new disc ceramics or dipped silver micas. C5 will need to be either disc ceramic or silver mica due to its small pF value.

The AC line-bypass capacitor will be discussed in the next section. The capacitance value and its application will often dictate the most practical choice for a replacement capacitor. For example, you wouldn’t want to use an expensive dipped silver mica capacitor for RF bypassing or audio coupling. It would be a waste, and the large values are extremely expensive.

SAFETY CONCERNS: Potentially Deadly AC Line Voltages

The Space Spanner is an AC/DC radio, and thus there is always the risk of contact with deadly AC line voltages.

The radio uses a metal chassis, but it is isolated from either side of the AC line. The common return ground bus is not directly connected to the chassis, but for RF bypass purposes it is bypassed to the chassis using capacitor C4, a .02-mFd ceramic disc.

This part should be replaced with a UL-approved, AC line-bypass rated capacitor of no more than .015-mFd value. This limits the AC leakage current to up-to-date, UL approved levels for U.S. line voltages. Note this capacitor is not

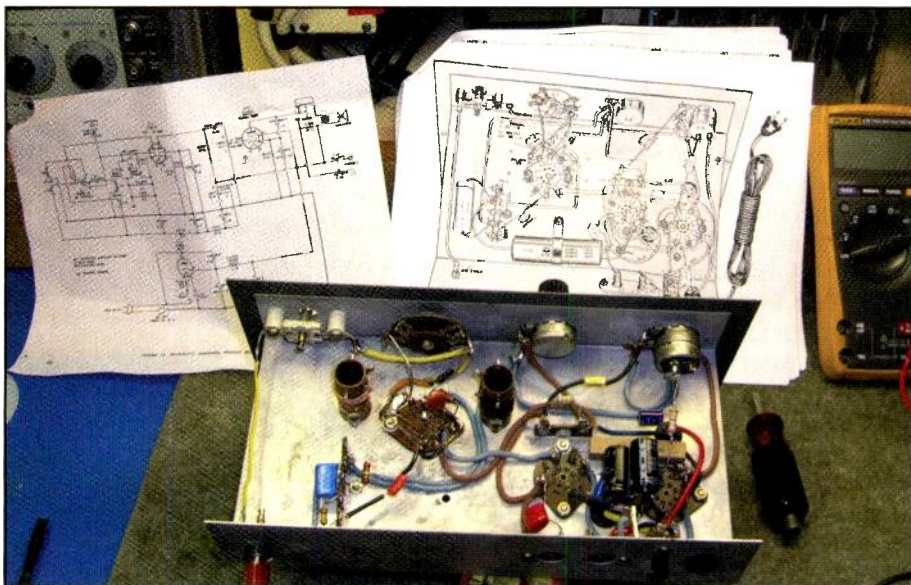

Photo H: Work progresses. New wafer tube sockets were installed and the wiring is nearing the first major *check point* in the manual.



Photo I: The restored chassis, ready for burn-in and testing.



Photo J: The Space Spanner is back in the cabinet, ready to be shipped back to Todd.

have its little shrine on my shelves — in working condition.

The Next Generation

By 1970 the little budget-minded Space Spanner had evolved into a newer four-band Spanmaster II receiver kit with coverage to 30MHz, selling for \$29.95 in kit form, cabinet included, for the next generation of aspiring hams and SWLs.

That will wrap up this column, and until next time, keep those soldering irons hot and those old tubes glowing!

References

Heathkit parts and original manuals:

Data Professionals
1807 Santa Rita Road
Suite D PMB 277
Pleasanton, CA 94566
(925) 548-6404

Web: < <http://www.d8apro.com/> >
Email: < Sales@D8aPro.com >

Manuals for all manufacturers:

Peter A. Markavage
27 Walling Street
Sayreville, NJ 08872

Web: < <http://www.manualman.com> >

Vintage Manuals Inc.
119 E George St.

Batesville, IN 47006
General: (812) 932-3417

Orders: (800) 807-6146

Fax: (812) 932-1022 (orders only)

Email: < mailto:sales@w7fg.com >

shown on the schematic. Also, I strongly suggest replacing the original AC line cord with one with a polarized plug. The neutral side of the line cord should be routed directly to the common return bus (where the negative leads for the three electrolytic capacitors connect.)

The AC *hot* side of the cord should be wired so it connects to the AC power switch on the volume control, and the other side of the switch should be moved to junction of pin 5 of the 35W4 and pin 4 of the 50C5.

Figure 3 shows these changes. This revision has the switch controlling the *hot* side of the line instead of the neutral. The polarized plug assures that the *hot* is the switched side.

There is always the chance of finding miswired AC outlets — *nothing is fool-proof*. Take great care when wiring the fil-

aments and the switch contacts to ensure that the common bus connections are not inadvertently shorting to the chassis.

The Legacy Continues . . .

Photo I shows the restored Space Spanner chassis. It looks far better than when we started, but in retrospect I might have done a few things differently. Wire dress and some other aspects could have been done a bit neater. The first time is always a learning experience.

Photo J shows the Space Spanner back in the cabinet and ready to go back to Todd for many more years of faithful service.

Todd's parting comments: *I'm building solar electricity, solar hot water and solar hot air systems onto my remote, off grid mountain cabin. These skills all started with this radio, which will now*

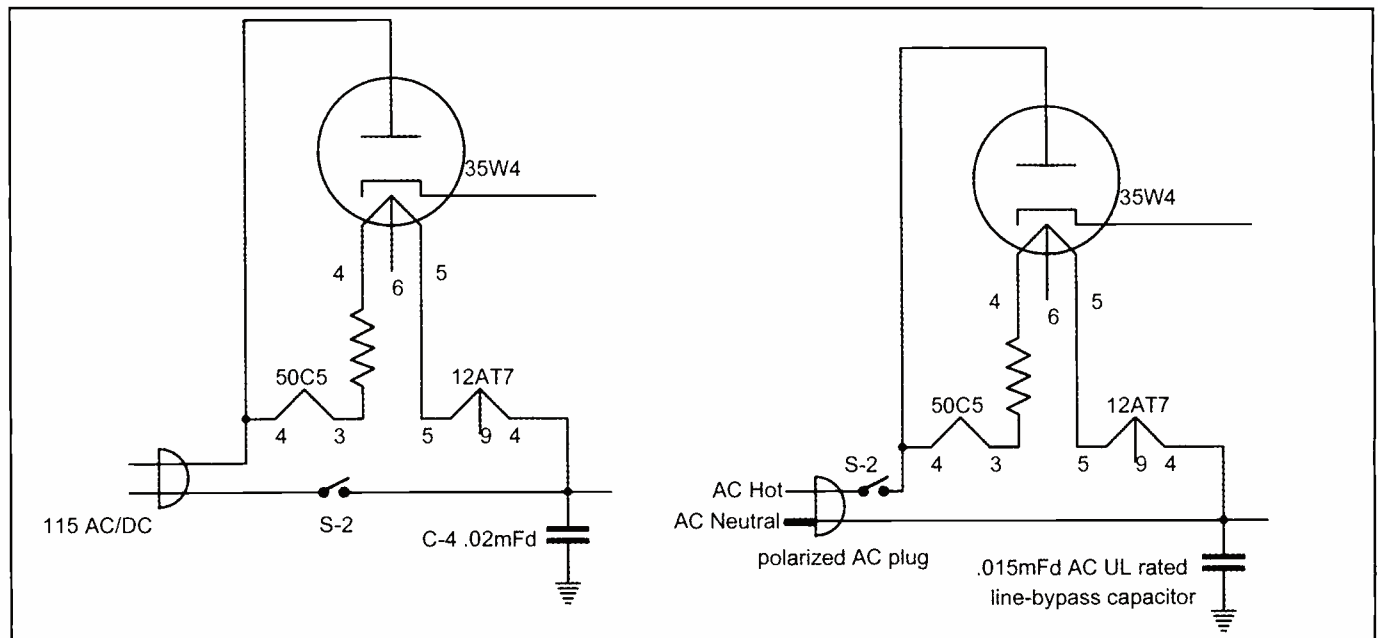

Figure 3: Here are the AC wiring changes.

readers' market

Advertising Rates for Readers' Mart: Non-commercial ads are 30 cents per word, including abbreviations and addresses; minimum charge \$6.00 per issue. Ads from firms offering commercial products or services are \$1.00 per word; minimum charge \$20.00 per issue. Boldface words are \$1.20 each (specify which words). Leading key words set in all caps at no additional charge. All ads *must be prepaid in full* at time of insertion; a 5% discount is offered for prepaid 6 time insertions. All ads must be typewritten double spaced.

Approval: All ad copy is subject to Publisher's approval and may be modified to eliminate references to equipment and practices which are either illegal or otherwise not within the spirit or coverage scope of the magazine.

Closing Date: The 10th day in the third month preceding date of publication. Because the advertisers and equipment contained in Readers' Market have not been investigated, the Publisher of *Popular Communications* cannot vouch for the merchandise listed therein. Direct all correspondence and ad copy to: Attention: Classified Dept., PC Readers' Market, 25 Newbridge Rd., Hicksville, NY 11801.

SuperBertha.com ULTIMATE LONG BOOM OWA YAGIS: Designed by WA3FET and K3LR. Scott W3TX. 814-881-9258.

COMMUNICATIONS MONITORING ANTENNAS, HF/VHF/UHF Super Discone \$49.75, AntennaCraft Scantenna \$47.70, 30-1200 MHz. 4-12 dB Log Periodic \$69.50, 806-900 MHz. 13 dB 9 element Yagi \$74.00, MURS/GMRS Dual Band Base \$48.95. All prices **INCLUDE** Priority S&H&I. See these antennas plus many many more for Amateur, Business, CB, and Monitoring radio, plus cellular phone antennas on the web at: www.antennawarehouse.com MC/Visa Order line 877-680-7818. To help maintain our low pricing, we do not print catalogs.

FOR SALE - DRAKE TR-7/TR-7A/R-7/R-7A Service kit. Includes 13 Extender Boards and Digital Jumper Card. \$64.95 includes postage. See <http://wb4hfn.com/Services/W7AVK/tr7text2.htm> Bob W7AVK, 5581 Panorama Drive, Moses Lake, WA 98837, w7avk@arrl.net, 509-750-7589.

SuperBertha.com CUSTOM ROTATING POLES: No guy wires, entire pole rotates, stack all your antennas, rotor at ground level, 50ft to 300ft high, EIA-TIA-222-G. Starting at \$37,799.00. Scott W3TX. 814-881-9258.

ADVERTISERS' INDEX

Advertiser	Page #	Website Address
AOR USA, Inc.	20,21, Cov III	www.aorusa.com
Advanced Specialties	19	www.advancedspecialties.net
C. Crane Company	17	www.ccrane.com
CQ Bookstore	23,79	www.cq-amateur-radio.com
Communications Electronics	11	www.usascan.com
Computer Aided Technologies	41	www.scancat.com
DX Store	47	www.dxstore.com
Eton Corporation	14,15	www.etoncorp.com
GRE America	9	www.greamerica.com
Grundig	14,15	www.etoncorp.com
HamTestOnline	29	www.hamtestonline.com
Homeland Security	71	www.ready.gov
ICOM America, Inc.	5	www.icomamerica.com
Kenwood USA	Cov IV	www.kenwoodusa.com
MFJ Enterprises, Inc.	3	www.mfjenterprises.com
Pixel Satellite Radio	29	www.PixelSatradio.com
PowerPort	17	www.powerportstore.com
Powerwerx	39	www.powerwerx.com
QCWA	17	www.qcwa.org
REACT International, Inc.	61	www.reactintl.org
Scanner Master	27	www.scannermaster.com
The Xtal Society	29	www.midnightscience.com
Universal Radio	1	www.universal-radio.com
W5YI Group	31	www.w5yi.org
www.RFfun.com	19	www.RFfun.com
Yaesu	Cov II	www.vxstdusa.com

Reach this dynamic audience with your advertising message, contact Chip Margelli at 405-ADS-CQCQ (405-237-2727), FAX 714-895-3714, or e-mail: advertising@popular-communications.com.

Listening is only half the fun...

POPULAR COMMUNICATIONS is the other half!



The World's most authoritative monthly magazine for Shortwave Listening and Scanner Monitoring. Read by more active listeners world-wide.

You'll find features on scanner monitoring of police, fire, utility, and aircraft communications; international shortwave listening; CB radio; amateur radio; FRS; GMRS; monitoring radio digital communications including CW, RTTY, SITOP, etc; AM/FM commercial broadcasting; weather and communications satellites; telephone equipment and accessories; radio nostalgia; alternative radio; clandestine radio; and military radio.

USA	Canada/Mexico	Foreign
1 Yr <input type="checkbox"/> 32.95	1 Yr <input type="checkbox"/> 42.95	1 Yr <input type="checkbox"/> 52.95
2 Yrs <input type="checkbox"/> 58.95	2 Yrs <input type="checkbox"/> 78.95	2 Yrs <input type="checkbox"/> 98.95
3 Yrs <input type="checkbox"/> 85.95	3 Yrs <input type="checkbox"/> 115.95	3 Yrs <input type="checkbox"/> 145.95

Popular Communications

25 Newbridge Road, Hicksville, NY11801
Phone: 516-681-2922; Fax 516-681-2926

Visit our web site:
www.popular-communications.com

A Parallel Universe: What are the Chances?

by Bill Price, N3AVY
chrodoc@gmail.com

I've always griped about the odds of finding someone on the ham bands who shares some of my interests. At one time, I worked countless QSOs and never found anyone with a common interest beyond radio.

One day, the Internet came along and made it possible for me to find — in a couple of clicks — hams who enjoy chromatic harmonicas, shoot air-guns, have pet rats and drive a 14-year-old van with 218,000 miles on it.

Such is (almost) the case with reader/friend David G., of “somewhere northeast of here.”

We began by exchanging comments about a column, and gradually discovered more and more common interests, including ham radio, SWL, an affinity for air guns and pet rats. I learned that he once, at least, attempted the chromatic harmonica, though we have not actually compared the color and age of our vans.

What's more, we both have a HPJIE* and discovered more recently that we are both moderately proficient at lock-picking — *now you see why I don't mention his full name here.*

We've confirmed that neither of us is a burglar, and although I still maintain a small rodent population, David's rodent history involved a previous pet belonging to his daughter. He is currently left with only a cat — and yes, there are cats at the N3AVY household too.

Friends Norm and Beezer have nagged me for countless years to get on the air, but since I've moved to Cowfield County, I've lacked the motivation, despite both of their best efforts to have an antenna raising party in my yard.

It seems that I'm on the road to becoming active once again. Now, don't all crowd the bands at once — I still haven't found a suitable spool of antenna wire, nor my old feedline, and I haven't yet scouted out the appropriate tree branches, etc.

Those of you who have read earlier columns may know that I live on a working farm, complete with some nice tall silos, but the fact remains that there are power lines between them and my house, so they're off limits. Trees will have to suffice.

David got me carrying a portable shortwave radio around the house and I began to listen to WIAW's code practice broadcasts, and found them relaxing. I still can't copy with a pencil and

I'm going to have to look for one of my old manual typewriters to get back into the groove, but I'm making progress.

I recently bought an antique green keyer from a nice ham named Perry, who's somewhere out in 9-land. It's the first keyer I've ever owned, and it has taken me a bit of practice, but I can now send almost twice as fast as I can comfortably receive — a ham milestone if ever there was one.

Norm, Beezer and David are now egging me toward actually stringing an antenna through the trees and getting on the air.

Norm asked me if I still had the old Yaesu rig that he'd left here some years back, and I assured him that I did. Climbing around in my vast inventory of misplaced things, I not only found it, but found that it had become a Kenwood during the time that it sat here waiting to be rediscovered. During that hunt, I also uncovered a missing pair of binoculars I'd been looking for and a yet-unused chronograph that's been missing for over a year.

It should be interesting to see if I can still communicate using CW. I've never uttered so much as a “peep” on SSB, and — as if it's an omen — the microphone that Norm gave me with the rig has quietly disappeared — though I found the matching outboard VFO.

So perhaps I'll soon be on the air with some old friends. Aside from Norm, Beezer and David, there's *Chief Bob*, my former Coast Guard chief radioman, and another friend in Pennsylvania — just like it says on the license plates — who has an unlisted name and call sign which I'll respect here.

Somehow after all these years of inactivity, it seems I've found enough ham friends with whom I share other common interests besides radio. I'll have to get a dozen or so QSL cards printed, drill a hole beneath the windowsill, and practice my slingshot skills so I can launch an antenna soon.

I've even begun to play with the practice exams so I can upgrade to Extra Class. My biggest barrier, though, is those @!#! Jones Charts and their impedance matching questions. Time will tell. If not — check *Newsweek*.

* High-Paying Job in Electronics

AR2300 "Black Box" Professional Grade Communications Receiver

Introducing a new generation of software controlled "black box" receivers!



Available in professional and consumer versions, the AR2300 covers 40 KHz to 3.15 GHz*

With the new AR2300 "black box" receiver from AOR, up to three channels can be monitored simultaneously. Fast Fourier Transform algorithms provide a very fast and high level of signal processing, allowing the receiver to scan through large frequency segments quickly and accurately. All functions can be controlled through a PC running Windows XP or higher. The AR2300 features advanced signal detection capabilities which can detect hidden transmitters. An optional external IP control unit enables the AR2300 to be fully controlled from a remote location and send received signals to the control point via the internet. It can also be used for unattended long-term monitoring by an internal SD audio recorder or spectrum recording with optional AR-IQ software for laboratory signal analysis. The AR2300 appeals to federal, state and local law enforcement agencies, the military, emergency managers, diplomatic service, news-gathering operations, and home monitoring enthusiasts.

Discover exceptional performance, state of the art specifications and a receiver with a menu of optional extras that can be configured to your own needs and specifications.

- Receives AM, wide and narrow FM, upper and lower sideband, CW modes, and optional APCO-25
- Up to 2000 memory channels (50 channels X 40 banks) can be stored in the receiver
- Alphanumeric channel labels
- Fast Fourier Transform algorithms
- Operated by a Windows XP or higher computer through a USB interface using a provided software package that controls all receiver functions
- An I/Q output port that allows the user to capture up to 1 MHz of bandwidth onto a computer hard drive or external storage device
- An SD memory card port that can be used to store recorded audio
- Analog composite video output connector
- CTCSS and DCS squelch operation
- Two selectable Type N antenna input ports
- Adjustable analog 45 MHz IF output with 15 MHz bandwidth
- Optional AR-I/Q Windows software facilitates the easy storage and playback of transmissions captured within up to 1 MHz bandwidth or, signals can be subjected to further analysis.
- An optional GPS board can be used for an accurate time base and for time stamping digital I/Q data.
- The triple-conversion receiver exhibits excellent sensitivity across its tuning range.
- Powered by 12 volts DC (AC Adapter included), it may be operated as a base or mobile unit.
- Software-driven operating selections include IF bandwidth, frequency, mode, filters, a screen-displayed graphical "S-meter," memory inputs, volume and squelch settings and more
- Professional (government) version is equipped with a standard voice-inversion monitoring feature



® The Serious Choice in Advanced Technology Receivers

AOR U.S.A., Inc.
20655 S. Western Ave., Suite 112
Torrance, CA 90501, USA
Tel: 310-787-8615 Fax: 310-787-8619
info@aurusa.com • www.aurusa.com

**Cellular blocked for US consumer version. Unblocked version available to qualified purchasers with documentation. Specifications subject to change without notice or obligation.*

KENWOOD

Listen to the Future

AIRWAVE SUPERIORITY

Never before has a compact HT offered as many features, and such high powered performance as the TH-F6A. Arm yourself with one today and gain your own airwave superiority.

- Triband (144/220/440 MHz)
- Receives 2 frequencies simultaneously even on the same band
- 0.1-1300MHz high-frequency range RX (B band)¹
- FM/FM-W/FM-N/AM plus SSB/CW receive
- Bar antenna for receiving AM broadcasts
- Special weather channel RX mode
- 435 memory channels, multiple scan functions
- 7.4V 1550mAh lithium-ion battery (std.) for high output² and extended operation
- 16-key pad plus multi-scroll key for easy operation
- Built-in charging circuitry for battery recharge while the unit operates from a DC supply
- Tough construction: meets MIL-STD 810 C/D/E standards for resistance to vibration, shock, humidity and light rain
- Large frequency display for single-band use
- Automatic simplex checker
- Wireless remote control function
- Battery indicator • Internal VOX • MCP software

¹Note that certain frequencies are unavailable. ²5W output

TH-F6A TRIBANDER



www.kenwoodusa.com



KENWOOD U.S.A. CORPORATION
Communications Sector Headquarters
3970 Johns Creek Court, Suite 100, Suwanee, GA 30024
Customer Support/Distribution

P.O. Box 22745, 2201 East Dominguez St., Long Beach, CA 90801-5745
Customer Support: (310) 639-4200 Fax: (310) 537-8235

ADS#39008