

# POPULAR COMMUNICATIONS

JUNE 2010

Shortwave Listening • Scanning • AM & FM • Radio History

## Radio Takes To The Field

### Hams Hone Skills And Have Fun At Field Day



**Tech Showcase:  
The UniWave Di-Wave  
100 DRM Receiver, p. 21**

**Reaching A Younger  
Generation Through  
FRS And Ham Radio, p. 79**

063502  
P291  
PCMI  
80008 \*\*\*\*\*AUTO\*\*5-DIGIT  
PC 277537 MAR 11  
\*\*\*\*\*  
205E90  
1172

**PLUS: Preparing For  
Emergency Monitoring  
• Easy 5/8-Wavelength  
Vertical Antennas •  
Safe, Reliable Power  
Generators**

# THE PROFESSIONAL STANDARD



- Continuous Frequency Coverage: 100 kHz ~ 2.6 GHz / LSB, USB, CW, AM-Narrow, AM, Wide AM, FM-Narrow, and Wide FM (cellular frequencies are blocked)
- 2000 Memory Channels / 100 Memory Groups
- Dual Receive
- Digital Signal Processing / Bandpass Filter, Noise Reduction, Notch Filter, Narrow CW Peak Filter (Optional DSP-1 requires)
- Real-Time Spectrum Scope
- World Clock with UTC/Local Settings
- Preset Shortwave Broadcast Station Memory Bank
- Extensive Scanning Capability/Smart Search™



## COMMUNICATIONS RECEIVER VR-5000

0.1~2599.99998MHz\*  
LSB/USB/CW/AM-N/AM/  
WAM/FM-N/WFM  
\*Cellular blocked

### CARRY THE WORLD WITH YOU!

- Frequency coverage : 0.1-1299.99995 MHz
- Modes : NFM, WFM, AM, USB, LSB, CW
- Huge Memory Capacity: 1091 Channels
- Multiple Power Source Capability~Polycarbonate Case
- Real-Time 60-ch Band Scope Range  
6 MHz / Step 100 kHz
- Full Illumination For Display And Keypad
- Convenient "Preset" Operating Mode
- Front-end 20 dB Attenuator

## ALL-MODE WIDEBAND RECEIVER VR-500



For the latest Yaesu news, visit us on the Internet:  
<http://www.vertexstandard.com>

Specifications subject to change without notice. Some accessories and/or options may be standard in certain areas. Frequency coverage may differ in some countries. Check with your local Yaesu Dealer for specific details.

**YAESU**  
Choice of the World's top DXers™  
Vertex Standard  
US Headquarters  
10900 Walker Street  
Cypress, CA 90630 (714)827-7600

# Universal Radio — Quality equipment since 1942.

## ICOM<sup>®</sup> IC-R75

✓ **FREE**  
Icom Ball Cap



Enjoy exciting international radio reception with the Icom R75-22 communications receiver. With full coverage from 30 kHz to 60 MHz; all longwave, medium wave and shortwave frequencies are supported plus extended coverage to include the 6 meter amateur band. Some innovative features of the R75 include: FM Mode Detection (but not the FM broadcast band), Twin Passband Tuning, Two Level Preamp, 99 Alphanumeric Memories, four Scan Modes, Noise Blanker, Selectable AGC (FAST/SLOW/OFF), Clock-Timer, Squelch, Attenuator and backlit LCD display. Tuning may be selected at 1 Hz or 10 Hz steps plus there is a 1 MHz quick tuning step and tuning Lock. The front-firing speaker provides solid, clear audio. The back panel has a Record Output jack and Tape Recorder Activation jack. The supplied 2.1 kHz SSB filter is suitable for utility, amateur, or broadcast SSB. However, two optional CW/SSB filter positions are available (one per I.F.). The formerly optional **UT-106 DSP board** is now included and factory installed! Free Icom ball cap. Order #0012 **\$619.95**

## ICOM<sup>®</sup>

## ICOM IC-RX7 SUPER SPECIAL

### IC-RX7



This is the best deal you will find on a wideband portable receiver!

Buy the Icom IC-RX7 at our special sale price of **\$199.95** and we will also include:

- ✓ **FREE Race Scanning book**  
This book will help you be properly equipped and informed to enjoy the race from a new perspective.
- ✓ **FREE Go Bag**  
Plenty of room for your IC-RX7, batteries, accessories, directories and more. With carry strap and open front pocket.



### R6

The Icom R6 covers 100kHz to 1309.995 MHz (less cellular gaps) in: AM, FM Narrow and FM wide. Enjoy local VHF-UHF coverage plus international shortwave broadcast. 1300 memories store: frequency, mode, step size, duplex, CTCSS, tone squelch and skip settings. Other features include: attenuator, LCD lamp, AM ferrite bar antenna, auto power off, CTCSS decode, weather function and battery save. You can put the world in your pocket for under \$200.00.

Call or visit website for price.



### R20

The Icom R20 covers an incredible 150 kHz to 3304.999 MHz (less cellular) with 1250 alphanumeric memories, bandscope and SSB/CW. It has: two VFOs, dual watch, voice scan control, NB, large two line LCD and CTCSS/DTCS/DTMF. A built-in IC audio recorder can record up to 4 hours of reception! With charger, Li-ion battery, belt clip and strap. Call for price.



The Icom R9500 raises the bar for professional receivers. Visit the Universal website for full details on this state-of-the-art instrument.

The Icom IC-RX7-05 is a slim and smart wideband receiver that tunes from 750 kHz to 1300 MHz (less cellular and gaps) in these modes: AM, FM Narrow and FM wide. This allows you to hear regular AM and FM radio, longwave, international shortwave transmissions from around the world as well as local VHF/UHF communications. It features a large, backlit LCD plus a nice keypad. It is splash resistant to equivalent IPX4 standard. CTCSS and DTSC decode is built in. Other features include: keypad, RF Gain, Attenuator, Auto Power save and voice squelch control. A built-in ferrite rod antenna provides good medium wave reception. A total of 1650 scannable alphanumeric memories are available. Many sophisticated forms of scanning and searching are supported. Comes with: BP-244 Li-Ion battery, MB-122G belt clip and BC-149A charger. Regular price \$299.95.

Icom IC-RX7, Go Bag & Race Scanning Order #5007 **\$199.95**

[www.universal-radio.com](http://www.universal-radio.com)

◆ Visit our website or request our free 128 page catalog for other exciting Icom products.

Universal Radio, Inc.  
6830 Americana Pkwy.  
Reynoldsburg, Ohio  
43068-4113 U.S.A.

☎ 800 431-3939 Orders & Prices  
☎ 614 866-4267 Information  
☎ 614 866-2339 FAX Line  
✉ dx@universal-radio.com



Universal Radio is also pleased to carry the complete Icom amateur radio equipment line. The IC-7700 shown.

- Visa
- MasterCard
- Discover
- JCB
- Prices and specs. are subject to change.
- Special offers are subject to change.
- Returns subject to a 15% restocking fee.
- Prices shown are after mfg. coupons.

universal  
radio inc.

# POPULAR COMMUNICATIONS CONTENTS

JUNE 2010  
VOLUME 28, NUMBER 10

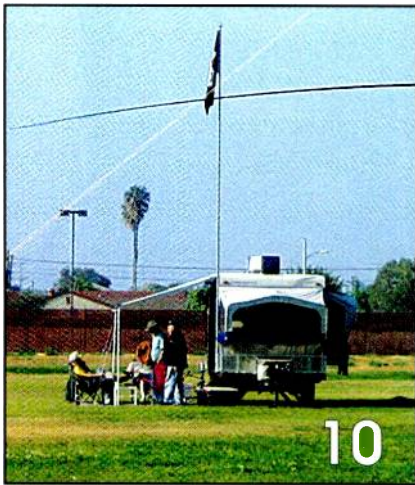

## FEATURES

- 10 Getting Ready For Amateur Radio Field Day**  
Follow K7JA's Valuable Tips For Your Most Successful Field Day Ever!  
*by Chip Margelli, K7JA*
- 18 Calling For Backup: Ham Radio Enhances A Police Department's Preparedness**  
To Help Him Serve And Protect, A Police Chief Set Up Shack In His Station  
*by Chief Mike Burg, N8QQN*
- 21 Tech Showcase: The UniWave Di-Wave 100—Finally, DRM Radio For The Average Listener...Almost**  
*by Rob de Santos, K8RKD*

## FEATURED COLUMNS

- 24 ScanTech**  
Preparing For Emergency Monitoring  
*by Ken Reiss*
- 57 The Antenna Room**  
Easy 5/8-Wavelength Vertical Antennas For Three Bands  
*by Kent Britain, WA5VJB*
- 68 Ham Discoveries**  
Generate Some Fun On Field Day—Safely!  
*by Kirk Kleinschmidt, NTØZ*
- 79 Gordon West's Radio Ways**  
Amateur Radio: The Next Generation—Growing The Hobby Through The FRS Connection  
*by Gordon West, WB6NOA*

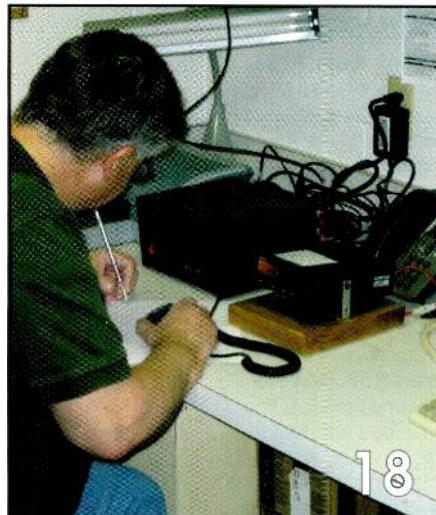

## ON THE COVER

As author Chip Margelli, K7JA, says in his cover feature "Getting Ready For Amateur Radio Field Day," this annual operating event represents many things. It's a chance to prepare, publicize, and to "propagate," and by that we mean to spread the hobby, to cultivate the next generation. For more ideas on this, see also "Gordon West's Radio Ways," starting on page 79. (Pictured on cover are Jason Wilborn, KG4BMH, and his daughter Kaylee at Field Day 2009 in Allons, Tennessee; photo by Larry Mulvehill, WB2ZPI)

## COLUMNS

- 9 Horizons**  
TV Everywhere  
*by Rob de Santos*
- 32 Global Information Guide**  
Somalis Everywhere And Other Shortwave Stirrings  
*by Gerry L. Dexter*
- 42 World Band Tuning Tips**  
World News, Commentary, Music, Sports, And Drama At Your Fingertips
- 46 Broadcast Technology**  
A Cloudy Picture For Free TV  
*by Bruce A. Conti*
- 50 Military Radio Monitoring**  
Fort Campbell, Kentucky—The Aerie Of "The Screaming Eagles"  
*by Mark Meece, N8ICW*
- 60 Shannon's Broadcast Classics**  
Radio Phonies And Real Top-40  
*by Shannon Huniwell*
- 66 Homeland Security**  
Is Communications Technology Helping Or Hurting?  
*by Mitch Gill, NA7US*
- 71 The Propagation Corner**  
The Sun In Sonic And Visual Art—A Creative Aid To Solar Scientists  
*by Tomas Hood, NW7US*
- 76 The Wireless Connection**  
The Night Hawk Receiver: Revisiting A "Radio Connection" Classic  
*by Peter J. Bertini*
- 84 The Loose Connection**  
The Joys Of Modern Communication (Or Why Bill Should Get A 2-Meter Rig)  
*by Bill Price, N3AVY*

## DEPARTMENTS

- 4 Tuning In**  
An Editorial
- 6 Newsworthy**  
Unwired, InfoCentral, And Washington Beat
- 44 Radio Fun**  
Trivia And Toons
- 45 Power Up**  
Radios & High-Tech Gear

web: [www.popular-communications.com](http://www.popular-communications.com)

# Tap into secret Shortwave Signals

Turn mysterious signals into exciting text messages with the MFJ MultiReader™!



MFJ-462B  
**\$199<sup>95</sup>**

Plug this self-contained MFJ MultiReader™ into

your shortwave receiver's earphone jack.

Then watch mysterious chirps, whistles and buzzing sounds of RTTY, ASCII, CW and AMTOR (FEC) turn into exciting text messages as they scroll across an easy-to-read LCD display.

You'll read interesting commercial, military, diplomatic, weather, aeronautical, maritime and amateur traffic . . .

## Eavesdrop on the World

Eavesdrop on the world's press agencies transmitting *unedited* late breaking news in English -- China News in Taiwan, Tanjug Press in Serbia, Iraqi News in Iraq -- all on RTTY.

Copy RTTY weather stations from Antarctica, Mali, Congo and many others. Listen to military RTTY passing traffic from Panama, Cyprus, Peru, Capetown, London and others. Listen to hams, diplomatic, research, commercial and maritime RTTY.

## Super Active Antenna

"World Radio TV Handbook" says MFJ-1024 is a

MFJ-1024  
**\$159<sup>95</sup>**

"first-rate easy-to-operate active antenna...quiet... excellent dynamic range... good gain... low noise... broad frequency coverage."

Mount it outdoors away from electrical noise for maximum signal, minimum noise. Covers 50 KHz-30 MHz. Receives strong, clear signals from all over the world. 20 dB attenuator, gain control, ON LED. Switch two receivers and auxiliary or active antenna. 6x3x5 in. Remote has 54" whip, 50 feet coax. 3x2x4 inches. 12 VDC or 110 VAC with MFJ-1312, \$15.95.

## Indoor Active Antenna

Rival outside long wires with this tuned indoor active antenna. "World Radio TV Handbook" says MFJ-1020C is a "fine value... fair price... best offering to date... performs very well indeed."



MFJ-1020C  
**\$99<sup>95</sup>**

Tuned circuitry minimizes intermod, improves selectivity, reduces noise outside tuned band. Use as a preselector with external antenna. Covers 0.3-30 MHz. Tune, Band, Gain, On/Off/Bypass Controls. Detachable telescoping whip. 5x2x6 in. Use 9 volt battery, 9-18 VDC or 110 VAC with MFJ-1312, \$15.95.

## Compact Active Antenna

Plug this compact MFJ all band active antenna into your receiver and you'll hear strong, clear signals from all over the world, 300 KHz to 200 MHz including low, medium, shortwave and VHF bands. Detachable 20" telescoping antenna. 9V battery or 110 VAC MFJ-1312B, \$15.95. 3 1/8x1 1/4x4 in.

MFJ-1022  
**\$69<sup>95</sup>**



## Eliminate power line noise!

Completely eliminate power line noise, lightning crashes and interference before they get into your receiver! Works on all modes -- SSB, AM, CW, FM, data -- and on all shortwave bands. Plugs between main external antenna and receiver. Built-in active antenna picks up power line noise and cancels undesirable noise from main antenna. Also makes excellent active antenna.

Matches your antenna to your receiver so you get maximum signal and minimum loss. MFJ-959C Preamp with gain control boosts weak stations 10 times. 20 dB attenuator prevents overload. Select 2 antennas and 2 receivers. 1.6-30 MHz. 9x2x6 in. Use 9-18 VDC or 110 VAC with MFJ-1312, \$15.95.

## High-Gain Preselector

High-gain, high-Q receiver preselector covers 1.8-54 MHz. Boost weak signals 10 times with low noise dual gate MOSFET. Reject out-of-band signals and images with high-Q tuned circuits. Push buttons let you select 2 antennas and 2 receivers. Dual coax and phono connectors. Use 9-18 VDC or 110 VAC with MFJ-1312, \$15.95.

## Dual Tunable Audio Filter

Two separately tunable filters let you peak desired signals and notch out interference at the same time. You can peak, notch, low or high pass signals to eliminate heterodynes and interference. Plugs between radio and speaker or phones. 10x2x6 inches.

MFJ-1026  
**\$199<sup>95</sup>**



MFJ-959C  
**\$119<sup>95</sup>**



MFJ-1045C  
**\$89<sup>95</sup>**



MFJ-752C  
**\$119<sup>95</sup>**



Listen to maritime users, diplomats and amateurs send and receive *error-free* messages using various forms of TOR (Telex-Over-Radio).

Monitor Morse code from hams, military, commercial, aeronautical, diplomatic, maritime -- all over the world -- Australia, Russia, Japan, etc.

Monitor any station 24 hours a day by printing transmissions. Printer cable. MFJ-5412, \$11.95.

Save several pages of text in memory for later reading or review.

## High Performance Modem

MFJ's high performance PhaseLockLoop™ modem consistently gives you solid copy -- even with weak signals buried in noise. New threshold control minimizes noise interference -- greatly improves copy on CW and other modes.

## Easy to use, tune and read

It's easy to use -- just push a button to select modes and features from a menu.

It's easy to tune -- a precision tuning indicator makes tuning your receiver easy for best copy.

It's easy to read -- front-mounted 2 line 16 character LCD display has contrast adjustment.

Copies most standard shifts and speeds. Has

## MFJ Shortwave Headphones



MFJ-392B  
**\$24<sup>95</sup>**

Perfect for shortwave radio listening for all modes -- SSB, FM, AM, data and CW. Superb padded headband and ear cushioned design makes listening extremely comfortable as you listen to stations all over the world! High-performance driver unit reproduces enhanced communication sound. Weighs 8 ounces, 9 ft. cord. Handles 450 mW. Frequency response is 100-24,000 Hz.

## High-Q Passive Preselector

High-Q passive LC preselector boosts your favorite stations while rejecting images, intermod and phantom signals. 1.5-30 MHz. Preselector bypass and receiver grounded positions. Tiny 2x3x4 in.

## Super Passive Preselector

Improves any receiver! Suppresses strong out-of-band signals that cause intermod, blocking, cross modulation and phantom signals. Unique Hi-Q series tuned circuit adds super sharp front-end selectivity with excellent stopband attenuation and very low passband loss. Air variable capacitor with vernier. 1.6-33 MHz.

## MFJ Shortwave Speaker

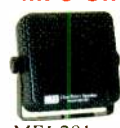

MFJ-281  
**\$12<sup>95</sup>**

This MFJ ClearTone™ restores the broadcast quality sound of shortwave listening. Makes copying easier, enhances speech, improves intelligibility, reduces noise, static, hum. 3 in. speaker handles 8 Watts. 8 Ohm impedance. 6 foot cord.

MFJ AutoTrak™ Morse code speed tracking.

Use 12 VDC or use 110 VAC with MFJ-1312D AC adapter, \$15.95. 5 1/4"Wx2 1/2"Hx5 1/4"D inches.

## WiFi Yagi Antenna -- 15 dBi 16-elements extends range



MFJ-1800  
**\$29<sup>95</sup>**

16-element, 15 dBi WiFi Yagi antenna greatly extends range of 802.11b/g, 2.4 GHz WiFi signals. 32 times stronger than isotropic radiator. Turns slow/no connection WiFi into fast, solid connection. Highly directional -- minimizes interference.

N-female connector. Tripod screw-mount. Wall and desk/shelf mounts. Use vertically/horizontally. 18Wx2 1/4"Hx1 1/4"D inches. 2.9 ounces.

MFJ-5606SR, \$24.95. Cable connects MFJ-1800/WiFi antennas to computer.

Reverse-SMA male to N-male, 6 ft. RG-174.

MFJ-5606TR, \$24.95. Same as MFJ-5606SR but Reverse-TNC male to N-male.

## MFJ All Band Doublet

102 ft. all band doublet covers .5 to 60 MHz. Super strong custom fiberglass center insulator provides stress relief for ladder line (100 ft.).

Authentic glazed ceramic end insulators and heavy duty 14 gauge 7-strand copper wire.



MFJ-1777  
**\$59<sup>95</sup>**

## MFJ Antenna Switches

MFJ-1704  
**\$79<sup>95</sup>**

MFJ-1704 heavy duty antenna switch lets you select 4 antennas or ground them for static and lightning protection. Unused antennas automatically grounded. Replaceable lightning surge protection. Good to 500 MHz. 60 dB isolation at 30 MHz. MFJ-1702C for 2 antennas.

## Morse Code Reader

Place this MFJ-461 pocket-sized MFJ Morse Code Reader near your receiver's speaker. Then watch CW turn into solid text messages on LCD. Eavesdrop on Morse Code QSOs from hams all over the world!

MFJ-461  
**\$89<sup>95</sup>**

## MFJ 24/12 Hour Station Clock

MFJ-108B, \$21.95. Dual 24/12 hour clock. Read UTC/local time at-a-glance. High-contrast 5/8" LCD, brushed aluminum frame. Batteries included. 4 1/2"Wx1Dx2H inches.



## Dealer/Catalog/Manuals

Visit: <http://www.mfjenterprises.com> or call toll-free 800-647-1800

• 1 Year No Matter What™ warranty • 30 day money back guarantee (less s/h) on orders direct from MFJ

**MFJ** MFJ ENTERPRISES, INC.  
300 Industrial Pk Rd, Starkville, MS 39759 PH: (662) 323-5869  
Tech Help: (662) 323-0549

FAX: (662) 323-6551 8-4:30 CST, Mon-Fri. Add shipping. Prices and specifications subject to change. © 2010 MFJ Enterprises, Inc.

# POPULAR COMMUNICATIONS

## EDITORIAL STAFF

**Edith Lennon, N2ZRW**, Editor

(E-mail: editor@popular-communications.com)

**Richard S. Moseson, W2VU**, Editorial Director

(E-mail: w2vu@popular-communications.com)

## CONTRIBUTING EDITORS

**Peter J. Bertini, K1ZJH**, Restoration/Electronics

**Kent Britain, WA5VJB**, Antennas And Accessories

**Bruce A. Conti**, AM/FM Broadcasts

**Rob de Santos**, Trends In Technology

**Gerry L. Dexter**, Shortwave Broadcast

**Richard Fisher K16SN**, Capitol Hill News

**Mitch Gill, NA7US**, Homeland Security

**Tomas Hood, NW7US**, Propagation

**Shannon Huniwell**, Classic Radio

**John Kasupski, W2PIO**, UtilityComm/EmComm

**Kirk Kleinschmidt, NTØZ**, Amateur Radio

**Mark Meece, N8ICW**, Military Monitoring

**D. Prabakaran**, News

**Bill Price, N3AVY**, Humor/Communications

**Ken Reiss**, Technical/Scanning

**Dan Srebnick, K2DLS**, Computers And Radio

**Bob Sturtevant, AD7IL**, Puzzles And Trivia

**Tom Swisher, WA8PYR**, Civil Aviation

**Jason Togyer, KB3CNM**, Cartoons

**Gordon West, WB6NOA**, General Radio Comm.

## BUSINESS STAFF

**Richard A. Ross, K2MGA**, Publisher

**Arnold Sposato, N2IQO**, Advertising Manager

**Don Parrish, KA5OXN**, Marketing/New Business

**Emily Leary**, Sales Coordinator

**Sal Del Grosso**, Accounting Manager

**Doris Watts**, Accounting Department

## CIRCULATION STAFF

**Melissa Gilligan**, Operations Manager

**Cheryl DiLorenzo**, Customer Service Manager

**Ann Marie Auer**, Customer Service

## PRODUCTION STAFF

**Elizabeth Ryan**, Art Director

**Barbara McGowan**, Associate Art Director

**Dorothy Kehrwieler**, Production Director

**Emily Leary**, Production Manager/Webmaster

**Hal Keith**, Technical Illustrator

**Larry Mulvehill, WB2ZPI**, Photographer

A publication of



CQ Communications, Inc.  
25 Newbridge Road  
Hicksville, NY 11801-2953 USA

Popular Communications (ISSN-0733-3315), Vol. 28, No. 9, published monthly by CQ Communications, Inc., 25 Newbridge Road, Hicksville, NY 11801. Telephone (516) 681-2922. FAX (516) 681-2926. Web Site: <http://www.popular-communications.com/> Periodicals Postage Paid at Hicksville, NY and at additional mailing offices. Subscription prices (payable in U.S. dollars): Domestic—one year \$32.95, two years \$58.95, three years \$85.95. Canada/Mexico—one year \$42.95, two years \$78.95, three years \$115.95. Foreign Air Post—one year \$52.95, two years \$98.95, three years \$145.95.

U.S. Government Agencies: Subscriptions to Popular Communications are available to agencies of the United States government, including military services, only on a cash with order basis. Requests for quotations, bids, contracts, etc. will be refused and will not be returned or processed.

Entire contents copyright © 2010 by CQ Communications, Inc. Popular Communications assumes no responsibility for unsolicited manuscripts, photographs, or drawings. Allow six weeks for change of address or delivery of first issue.

Printed in the United States of America.

POSTMASTER: Send address changes to Popular Communications, 25 Newbridge Road, Hicksville, NY 11801.

## EDITORIAL

### Tuning In

# Semper Paratus

by Edith Lennon, N2ZRW

editor@popular-communications.com

Earthquakes, tsunamis, blizzards, floods—we haven't enjoyed a slow news cycle in months. It seems like the entire Western Hemisphere has been walloped by more than its share of natural calamities, ranging from mainly inconvenient power outages caused by winter storms to the horrific devastation suffered in Haiti.

I receive a slew of newsletters, net announcements, and updates on a broad swath of radio and technology topics, as well as general news alerts, and my email inbox is jammed to its cyber rafters with items concerning emergencies great and small. These past weeks it struck me going through them how often I read phrases like "Amateur radio provided the only means of communication..." or "Hams assist local first responders..." These stories aren't just about responses to large-scale emergencies like Haiti—in such instances we know amateur radio is the only viable means of communication—but also about grassroots efforts in communities all across the country to ensure that reliable communications are in place for when they're needed.

For instance, the *Bothell Reporter* (Washington) tells us about "volunteers working...to set up what is now a network of about 60 amateur, or ham, radio operators ready to aid city emergency workers in the case of a major disaster such as an earthquake or similar happening." From the *Daily News* (Bowling Green, Kentucky), we learn that "...hams will remove [residential TV] towers for free, recondition them and install them at numerous locations in the 10-county Barren River Area Development District to support emergency communications among ham radio operators, hospitals, county emergency management directors, American Red Cross chapters and other emergency workers." *Ukiah Daily Journal* (California) informs its readers that, "Amateur radio operators help with tsunami warning test." "Amateur radio operators across Seneca County and Ohio participated in a statewide tornado drill Wednesday morning," trumpeted *Advertiser-tribune.com*. There were many, many more instances of hams contributing to their communities' emergency response preparedness.

Why do they do it? The reasons were also plentiful in the news, in pieces with titles like "Local sirens fail to go off during statewide tornado drill" (Coshocton Tribune Ohio) and "Lincoln, Surrounding County 911 Services

Disabled" (the *Lincoln Journal Star* Nebraska). Again, there were many more, but you get my drift. In these instances, hams were instrumental in detecting the problems, in responding to them, or in developing a plan for preparedness in the future.

So in this issue it's especially timely that *Pop'Comm* gratefully tips its hat to amateur radio with our cover story and columns focusing on ARRL Field Day, coming up at the end of this month. We also highlight one individual's effort to incorporate ham radio in a backup communications system in "Calling For Backup: Ham Radio Enhances A Police Department's Preparedness." It's a great example of the spirit and dedication we see in hams worldwide as they strive to be of service to their communities.

And while we're at it, we give an approving nod to the FCC for revisiting its recent pronouncements on amateur radio communications on behalf of employers, lately the subject of two guest editorials on this page. With a Notice of Proposed Rule Making taking up the issue, the FCC is seeking "comment on whether to amend the rules to permit amateur radio operators to participate in government-sponsored emergency and disaster preparedness drills and tests, regardless of whether the operators are employees of the entities participating in the drill or test" (see "Washington Beat" for more). Perhaps we can soon wave goodbye to waivers where they're obviously unnecessary. Let's hope so.

## Magazine Publisher K2MGA Receives Dayton Honor

Dick Ross, K2MGA, publisher of *Popular Communications* and *CQ* magazines, is being honored with the Special Achievement award at the 2010 Dayton Hamvention. The award is in recognition of his leadership in the amateur radio industry as he marks his 50th anniversary with *CQ* magazine. Also being honored this year are Jim Stafford, W4QO, Simon Brown, HB9DRV, and the North Fulton (GA) Amateur Radio League. Honorees will receive their awards during the 2010 Dayton Hamvention on May 14-16.

I have to keep this short and sweet because I know he'd prefer no mention at all, but I have to offer my kudos. So congratulations, boss. And thank you (you know why).

# Big Savings on Radio Scanners

# Uniden®

# SCANNERS



## Bearcat® 796DGV Trunk Tracker IV with free scanner headset

Manufacturers suggested list price \$799.95  
**CEI Special Price \$519.95**

**1,000 Channels • 10 banks • CTCSS/DCS • S Meter**  
**Size: 6 15/16" Wide x 6 9/16" Deep x 2 9/8" High**

**Frequency Coverage:** 25,000-512,000 MHz., 806,000-956,000 MHz. (excluding the cellular & UHF TV band), 1,240,000-1,300,000 MHz.

When you buy your Bearcat 796DGV TrunkTracker package deal from Communications Electronics, you get more. The GV means "Great Value." With your BC796DGV scanner purchase, you also get a **free deluxe scanner headphone** designed for home or race track use. Headset features independent volume controls and 3.5 mm gold right angle plug. The 1,000 channel Bearcat 796DGV is packed with features to track Motorola Type I/II/III Hybrid, EDACS, LTR Analog Trunk Systems and Motorola APCO 25 Phase I digital scanner including 9,600 Baud C4FM and CQPSK. Also features control channel only mode to allow you to automatically trunk many systems by simply programming the control channel, S.A.M.E. weather alert, full-frequency display and backlit controls, built-in CTCSS/DCS to assign analog and digital subaudible tone codes to a specific frequency in memory, PC Control and programming with RS232C 9 pin port (cable not supplied), Beep Alert, Record function, VFO control, menu-driven design, total channel control and much more. Our CEI package deal includes telescopic antenna, AC adapter, cigarette lighter cord, DC cord, mobile mounting bracket with screws, owner's manual, trunking frequency guide and one-year limited Uniden factory warranty. For maximum scanning enjoyment, order magnetic mount antenna part number ANTMMBNC for \$29.95. For complete details, download the owners manual from the [www.usascan.com](http://www.usascan.com) web site. For fastest delivery, order on-line at [www.usascan.com](http://www.usascan.com).

## Bearcat® BCT8 Trunk Tracker III

Manufacturer suggested list price \$299.95  
**CEI Special Price \$169.95**

**250 Channels • 5 banks • PC Programmable**  
**Size: 7.06" Wide x 6.10" Deep x 2.44" High**

**Frequency Coverage:** 25,000-54,000 MHz., 108,000-174,000 MHz., 400,000-512,000 MHz., 806,000-823,995 MHz., 849,0125-868,995 MHz., 894,0125-956,000 MHz.

The Bearcat BCT8 scanner, licensed by NASCAR, is a superb preprogrammed 800 MHz trunked highway patrol system scanner. Featuring TrunkTracker III, PC Programming, 250 Channels with unique BearTracker warning system to alert you to activity on highway patrol link frequencies. Preprogrammed service searches makes finding interesting active frequencies even easier and include preprogrammed police, fire and emergency medical, news agency, weather, CB band, air band, railroad, marine band and department of transportation service searches. The BCT8 also has preprogrammed highway patrol alert frequencies by state to help you quickly find frequencies likely to be active when you are driving. The BCT8 includes AC adapter, DC power cable, cigarette lighter adapter plug, telescopic antenna, window mount antenna, owner's manual, one year limited Uniden warranty, frequency guide and free mobile mounting bracket. For maximum scanning enjoyment, also order the following optional accessories: External speaker **ESP20** with mounting bracket & 10 feet of cable with plug attached \$19.95. Magnetic Mount mobile antenna **ANTMMBNC** for \$29.95.



## Bearcat® BCD396T Trunk Tracker IV

Suggested list price \$799.95/CEI price \$519.95  
**APCO 25 9,600 baud compact digital ready handheld TrunkTracker IV scanner featuring Fire Tone Out Paging, Close Call and Dynamically Allocated Channel Memory (up to 6,000 channels), SAME Weather Alert, CTCSS/DCS, Alpha Tagging.**  
**Size: 2.40" Wide x 1.22" Deep x 5.35" High**

### Frequency Coverage:

25,000-512,000 MHz., 764,000-775,9875 MHz., 794,000-823,9875 MHz., 849,0125-868,8765 MHz., 894,0125-956,000 MHz., 1,240,000 MHz.-1,300,000 MHz.

The handheld BCD396T scanner was designed for National Security/Emergency Preparedness (NS/EP) and homeland security use with new features such as **Fire Tone Out Decoder**. This feature lets you set the BCD396T to alert if your selected two-tone sequential paging tones are received. Ideal for on-call firefighters, emergency response staff and for activating individual scanners used for incident management and population attack warning.

**Close Call Radio Frequency Capture** - Bearcat exclusive technology locks onto nearby radio transmissions, even if you haven't programmed anything into your scanner. Useful for intelligence agencies for use at events where you don't have advance notice or knowledge of the radio communications systems and assets you need to intercept. The BCD396T scanner is designed to track Motorola Type I, Type II, Hybrid, SMARTNET, PRIVACY PLUS, LTR and EDACS\* analog trunking systems on any band. Now, follow UHF High Band, UHF 800/900 MHz trunked public safety and public service systems just as if conventional two-way communications were used. **Dynamically Allocated Channel Memory** - The BCD396T scanner's memory is organized so that it more closely matches how radio systems actually work. Organize channels any way you want, using Uniden's exclusive dynamic memory management system. 3,000 channels are typical but **over 6,000 channels are possible** depending on the scanner features used. You can also easily determine how much memory you have used and how much memory you have left. **Preprogrammed Systems** - The BCD396T is preprogrammed with over 400 channels covering police, fire and ambulance operations in the 25 most populated counties in the United States, plus the most popular digital systems. **3 AA NiMH or Alkaline battery operation and Charger** - 3 AA battery operation - The BCD396T includes 3 premium 2,300 mAh Nickel Metal Hydride AA batteries to give you the most economical power option available. You may also operate the BCD396T using 3 AA alkaline batteries. **Unique Data Skip** - Allows your scanner to skip unwanted data transmissions and reduces unwanted birdies. **Memory Backup** - If the battery completely discharges or if power is disconnected, the frequencies programmed in the BCD396T scanner are retained in memory. **Manual Channel Access** - Go directly to any channel. **LCD Back Light** - A blue LCD light remains on when the back light key is pressed. **Autolight** - Automatically turns the blue LCD backlight on when your scanner stops on a transmission. **Battery Save** - In manual mode, the BCD396T automatically reduces its power requirements to extend the battery's charge. **Attenuator** - Reduces the signal strength to help prevent signal overload. The BCD396T also works as a conventional scanner to continuously monitor many radio conversations even though the message is switching frequencies. The BCD396T comes with AC adapter, 3 AA nickel metal hydride batteries, belt clip, flexible rubber antenna, wrist strap, SMA/BNC adapter, RS232C cable, Trunk Tracker frequency guide, owner's manual and one year limited Uniden warranty. Not compatible with AGEIS, ASTRO or ESAS systems. Order on-line at [www.usascan.com](http://www.usascan.com) or call 1-800-USA-SCAN.

**Close Call Radio Frequency Capture** - Bearcat exclusive technology locks onto nearby radio transmissions, even if you haven't programmed anything into your scanner. Useful for intelligence agencies for use at events where you don't have advance notice or knowledge of the radio communications systems and assets you need to intercept. The BCD396T scanner is designed to track Motorola Type I, Type II, Hybrid, SMARTNET, PRIVACY PLUS, LTR and EDACS\* analog trunking systems on any band. Now, follow UHF High Band, UHF 800/900 MHz trunked public safety and public service systems just as if conventional two-way communications were used. **Dynamically Allocated Channel Memory** - The BCD396T scanner's memory is organized so that it more closely matches how radio systems actually work. Organize channels any way you want, using Uniden's exclusive dynamic memory management system. 3,000 channels are typical but **over 6,000 channels are possible** depending on the scanner features used. You can also easily determine how much memory you have used and how much memory you have left. **Preprogrammed Systems** - The BCD396T is preprogrammed with over 400 channels covering police, fire and ambulance operations in the 25 most populated counties in the United States, plus the most popular digital systems. **3 AA NiMH or Alkaline battery operation and Charger** - 3 AA battery operation - The BCD396T includes 3 premium 2,300 mAh Nickel Metal Hydride AA batteries to give you the most economical power option available. You may also operate the BCD396T using 3 AA alkaline batteries. **Unique Data Skip** - Allows your scanner to skip unwanted data transmissions and reduces unwanted birdies. **Memory Backup** - If the battery completely discharges or if power is disconnected, the frequencies programmed in the BCD396T scanner are retained in memory. **Manual Channel Access** - Go directly to any channel. **LCD Back Light** - A blue LCD light remains on when the back light key is pressed. **Autolight** - Automatically turns the blue LCD backlight on when your scanner stops on a transmission. **Battery Save** - In manual mode, the BCD396T automatically reduces its power requirements to extend the battery's charge. **Attenuator** - Reduces the signal strength to help prevent signal overload. The BCD396T also works as a conventional scanner to continuously monitor many radio conversations even though the message is switching frequencies. The BCD396T comes with AC adapter, 3 AA nickel metal hydride batteries, belt clip, flexible rubber antenna, wrist strap, SMA/BNC adapter, RS232C cable, Trunk Tracker frequency guide, owner's manual and one year limited Uniden warranty. Not compatible with AGEIS, ASTRO or ESAS systems. Order on-line at [www.usascan.com](http://www.usascan.com) or call 1-800-USA-SCAN.

## More Radio Products

Save even more on radio scanners when purchased directly from CEI. Price includes delivery in the continental USA excluding Alaska.

Bearcat 898T 500 channel TrunkTracker III base/mobile.....	\$209.95
Bearcat 796DGV Digital 1,000 ch. TrunkTracker IV base/mobile.....	\$519.95
Bearcat BCD396T APCO 25 Digital scanner with Fire Tone Out.....	\$519.95
Bearcat 246T up to 2,500 ch. TrunkTracker III handheld scanner.....	\$214.95
Bearcat Sportcat 230 alpha display handheld sports scanner.....	\$184.95
Bearcat 278CLT 100 channel AM/FM/SAME WX alert scanner.....	\$129.95
Bearcat 248CLT 50 channel base AM/FM/weather alert scanner.....	\$104.95
Bearcat 244CLT 30 channel base AM/FM/weather alert scanner.....	\$94.95
Bearcat 92XLT 200 channel handheld scanner.....	\$105.95
Bearcat 72XLT 100 channel handheld scanner.....	\$89.95
Bearcat BR330T handheld shortwave/scanner with Fire Tone out.....	\$274.95
Bearcat BCT8 250 channel information mobile scanner.....	\$169.95
Bearcat 350C 50 channel desktop/mobile scanner.....	\$96.95
AOR AR160Q Wide Band scanner with quick charger.....	\$199.95
AOR AR3000AB Wide Band base/mobile receiver.....	\$1,079.95
AOR AR8200 Mark IIIB Wide Band handheld scanner.....	\$594.95
AOR AR8600 Mark II Wide Band receiver.....	\$899.95
Deluxe Independent Dual Volume Control Racing Headphone.....	\$29.95
Scancat Gold For Windows Software.....	\$99.95
Scancat Gold for Windows Surveillance Edition.....	\$159.95

## Bearcat® BC246T Trunk Tracker III

Suggested list price \$399.95/CEI price \$214.95  
**Compact professional handheld TrunkTracker III scanner featuring Close Call and Dynamically Allocated Channel Memory (up to 2,500 channels), SAME Weather Alert, CTCSS/DCS, Alpha Tagging.**  
**Size: 2.72" Wide x 1.26" Deep x 4.6" High**

### Frequency Coverage:

25,000-54,000 MHz., 108,000-174,000 MHz., 216,000-224,980 MHz., 400,000-512,000 MHz., 806,000-823,9875 MHz., 849,0125-868,9875 MHz., 894,0125-956,000 MHz., 1,240,000 MHz.-1,300,000 MHz.

The handheld BC246T TrunkTracker scanner has so many features, we recommend you visit our web site at [www.usascan.com](http://www.usascan.com) and download the free owner's manual. Popular features include **Close Call Radio Frequency Capture** - Bearcat exclusive technology locks onto nearby radio transmissions, even if you haven't programmed anything into your scanner. **Dynamically Allocated Channel Memory** - Organize channels any way you want, using Uniden's exclusive dynamic memory management system. 1,600 channels are typical but **over 2,500 channels are possible** depending on the scanner features used. You can also easily determine how much memory is used. **Preprogrammed Service Search (10)** - Makes it easy to find interesting frequencies used by public safety, news media TV broadcast audio, Amateur (ham) radio, CB radio, Family Radio Service, special low power, railroad, aircraft, marine, racing and weather frequencies. **Quick Keys** - allow you to select systems and groups by pressing a single key. **Text Tagging** - Name each system, group, channel, talk group ID, custom search range, and S.A.M.E. group using 16 characters per name. **Memory Backup** - When power is lost or disconnected, your BC246T retains the frequencies that were programmed in memory. **Unique Data Skip** - Allows the BC246T to skip over unwanted data transmissions and birdies. **Attenuator** - You can set the BC246T attenuator to reduce the input strength of strong signals by about 18 dB. **Duplicate Frequency Alert** - Alerts you if you try to enter a duplicate name or frequency already stored in the scanner. **22 Bands** - with aircraft and 800 MHz. The BC246T comes with AC adapter, 2 AA 1,800 mAh nickel metal hydride batteries, belt clip, flexible rubber antenna, wrist strap, RS232C cable, Trunk Tracker frequency guide, owner's manual and one year limited Uniden warranty. For more fun, order our optional deluxe racing headset part #HF24RS for \$29.95. Order now at [www.usascan.com](http://www.usascan.com) or call 1-800-USA-SCAN.

**Close Call Radio Frequency Capture** - Bearcat exclusive technology locks onto nearby radio transmissions, even if you haven't programmed anything into your scanner. **Dynamically Allocated Channel Memory** - Organize channels any way you want, using Uniden's exclusive dynamic memory management system. 1,600 channels are typical but **over 2,500 channels are possible** depending on the scanner features used. You can also easily determine how much memory is used. **Preprogrammed Service Search (10)** - Makes it easy to find interesting frequencies used by public safety, news media TV broadcast audio, Amateur (ham) radio, CB radio, Family Radio Service, special low power, railroad, aircraft, marine, racing and weather frequencies. **Quick Keys** - allow you to select systems and groups by pressing a single key. **Text Tagging** - Name each system, group, channel, talk group ID, custom search range, and S.A.M.E. group using 16 characters per name. **Memory Backup** - When power is lost or disconnected, your BC246T retains the frequencies that were programmed in memory. **Unique Data Skip** - Allows the BC246T to skip over unwanted data transmissions and birdies. **Attenuator** - You can set the BC246T attenuator to reduce the input strength of strong signals by about 18 dB. **Duplicate Frequency Alert** - Alerts you if you try to enter a duplicate name or frequency already stored in the scanner. **22 Bands** - with aircraft and 800 MHz. The BC246T comes with AC adapter, 2 AA 1,800 mAh nickel metal hydride batteries, belt clip, flexible rubber antenna, wrist strap, RS232C cable, Trunk Tracker frequency guide, owner's manual and one year limited Uniden warranty. For more fun, order our optional deluxe racing headset part #HF24RS for \$29.95. Order now at [www.usascan.com](http://www.usascan.com) or call 1-800-USA-SCAN.

## Buy with Confidence

### Order on-line and get big savings

For over 37 years, millions of communications specialists and enthusiasts worldwide have trusted Communications Electronics for their mission critical communications needs. It's easy to order. For fastest delivery, order on-line at [www.usascan.com](http://www.usascan.com). Mail orders to: Communications Electronics Inc., P.O. Box 1045, Ann Arbor, Michigan 48106 USA. Price includes \$30.00 UPS Ground shipping/handling/insurance per scanner to a street address in the continental USA excluding Alaska. Add \$20.00 shipping for all accessories. For shipments to Canada, Puerto Rico, Hawaii, Alaska, Guam, P.O. Box, APO/FPO, USPS Priority Mail or UPS 2 business day delivery, add \$30.00. Michigan residents add sales tax. No COD's. For Bearcat scanners your satisfaction is guaranteed or return item in unused condition in original packaging within 61 days for refund, less shipping charges. 10% surcharge for net 10 billing to qualified accounts. All sales are subject to availability, acceptance and verification. Prices, terms and specifications are subject to change without notice. We welcome your Discover, Visa, American Express, MasterCard, IMPAC or Eurocard. Order toll free, call 1-800-USA-SCAN or 1-734-996-8888 if outside Canada or the USA. FAX anytime, dial 1-734-663-8888. Dealer and international inquiries invited. Order your radio scanners from Communications Electronics today.

## For credit card orders call 1-800-USA-SCAN

e-mail: [cei@usascan.com](mailto:cei@usascan.com)

**www.usascan.com**  
 PO Box 1045, Ann Arbor, Michigan 48106-1045 USA  
 For information call 734-996-8888 or FAX 734-663-8888  
Price schedule effective January 2, 2006 AD #010206 © 2006 Communications Electronics Inc.



# Visit WWW.USASCAN.COM • 1-800-USA-SCAN

# The Weirder Side Of Wireless

by Staff

## A Little Child Shall Lead Them

An air traffic controller at New York's Kennedy Airport allowed his 9-year-old son to radio instructions to several pilots. The incident occurred on February 16, apparently in the early evening when the airport buzzes with international flights. According to a report by the Associated Press, the few quick exchanges between the boy and jets waiting to take off from JFK, one of the nation's busiest airports, appeared to delight pilots, with one responding, "I wish I could bring my kid to work." The Federal Aviation Administration, which was far less delighted, suspended the controller and a supervisor after a recording of the calls was posted on the Internet, then reported on by a Boston television station. On the recording, which lasts about a minute, the boy appears to repeat instructions fed to him by his father. "JetBlue 171 cleared for takeoff," the boy is heard to say, followed by his father offering more detailed instruction. In another exchange, the boy instructs the same flight to contact departure controllers, to which the pilot responds: "Over to departure JetBlue 171, awesome job!" There are some similar exchanges on the recording, and a pilot can be heard to laugh, the boy to giggle, according to the report. No doubt in an effort to be fair, the controller allowed the boy's twin sister to take a turn at the mic the next day. No word on what the pilots thought of her job performance. The FAA said it has barred unofficial visits by friends or relatives to FAA air traffic operational areas while it "reviews its policies." An awesome idea!

## Flash Mobbing—What A Feeling!

According to an article in *Computerworld*, the City of Brotherly Love is cracking down on mobs of teenagers that have turned violent during gatherings police believe were orchestrated in part through "flash mob" wireless communications, including SMS texting and Twitter. During one incident, witnesses estimated that as many as 2,000 teenagers thronged narrow sidewalks, blocked traffic, jumped on cars and roughed up bystanders in a 10-block strip near South Street. While the Philadelphia police and mayor didn't blame the technology for the violence directly, they acknowledged that texting and other wireless communications can bring large groups together quickly. Youthful "stupidity" instead took the rap. However, two members of the Philadelphia City Council were considering taking legal action against Facebook, Twitter, and MySpace—a response that was likened to suing the phone company over calls placed in preparation for a bank robbery—and there were demands for the police or FBI

to monitor social networks (the FBI is apparently providing unspecified assistance). Stupidity is not the sole provenance of youth, it would seem.

## Shut Up And Talk

Researchers in Germany have come up with a way for people to communicate via cell phone without speaking or texting—they simply move their lips. This soundless communication system, which is being developed by a team at the Karlsruhe Institute of Technology (KIT), uses electromyography to measure and record the electrical activity produced by skeletal muscles. It analyzes muscle movements recorded by electromyographic sensors on the face and converts that data into sound that can be heard at the other end of the phone. While not yet at the commercially viable stage, the implications are obvious for the hearing impaired as well as for those concerned with privacy. But the collective cheer that will be raised by the millions of long-suffering public transportation users will be deafening.

## The FBI-Made-Me-Do-It Defense

Internet radio host and provocateur Harold C. Turner, currently on trial for making death threats against several federal judges, claims his incendiary speech was encouraged by the FBI, for which he became a paid informant in 2005 and from which he received more than \$100,000 for his efforts. Federal prosecutors sought to portray Turner as a white supremacist whose racist and sometimes violent rhetoric predated his recruitment as an informant and continued after the government dropped him because of "serious control problems," according to recent reporting in the *New York Times*. The charges stem from a blog posting on his Web site that featured photos of the judges and declared them "worthy of death." An earlier trial ended in a hung jury. The government cited email messages, postings, and radio comments in which Mr. Turner made thinly veiled threats, boasted of his influence with his listeners, and said that he would be "honored" to take credit for the murder of the family of a federal judge. "I intend to incite revenge, vicious, brutal, savage revenge with malice aforethought," he wrote in one message. In his defense, Turner claims his racist rhetoric was a tool to help the FBI flush out domestic terrorists from within the white supremacist movement and declared his repulsion to racist views, even as he became one of the country's most prominent proponents of them, referring to it as "part of my shtick" and maintaining that he never believed the message he promulgated, according to the *Times*.



## News, Trends, And Short Takes

by D. Prabakaran

### **Ethiopia To Jam VOA Broadcasts**

Ethiopia is preparing to jam the Amharic-language broadcasts of the Voice of America, Prime Minister Meles Zenawi declared in a press briefing with international media correspondents based in the capital, Addis Ababa. The prime minister accused VOA's Amharic service of "engaging in destabilizing propaganda," comparing it to Radio Télévision Libre des Mille Collines, the Rwandan station whose inflammatory broadcasts helped stoke the 1994 genocide. In a statement, VOA rejected the comparison as "incorrect and unfortunate." The issue arose when a reporter asked Mr. Zenawi about interference VOA listeners had experienced since late February. Mr. Zenawi said the government has been testing equipment that would allow it to block VOA broadcasts, according to news reports. He said a final decision on the jamming had not been made. Mr. Zenawi's statements were the first acknowledgment of government interference with VOA broadcasts, which are beamed by satellite from Washington and received in Ethiopia via shortwave radio.

(Source: Committee to Protect Journalists)

### **Radio Sweden To Become Internet-only Station**

Radio Sweden will terminate its mediumwave and shortwave broadcasts on October 31, 2010, in favor of Web services. Swedish Radio management stated that is the best use of resources and is in line with international trends. The English-language service is to continue on the Web and on national broadcasts. The Russian output will be available on the Web, as is the German now. Among the immigrant languages, Albanian, Assyrian-Syriac and Bosnian-Serbian-Croatian are to be terminated on the same date. Meanwhile, Arabic and Somali, presently the largest immigrant language groups in Sweden, are to be boosted. The same applies to Romani, one of Sweden's five official minority languages. The Persian service will include Dari spoken by the rapidly increasing number of Afghan refugees coming to Sweden. Kurdish broadcasts remain unchanged. Swedish Radio's output in immigrant languages will be available on the Web and broadcast nationally.

(Source: Radio Sweden)

### **BBC Confirms Plans To Cut Back Website, Close Radio Stations**

The BBC confirmed its plan to slash spending on its online services and close two radio stations in a shake-up designed to boost program funding. Digital radio stations BBC Asian Network and BBC 6 Music will close next year as part of a review of the BBC's budget and services, said Director General Mark Thompson. Spending on its online services, which commercial competitors complain stifle competition,

will be cut by 25 percent by 2013. The shake-up will free an extra 600 million pounds (\$890 million dollars) to be spent on program-making, Thompson told staff at the BBC's headquarters in London.

(Source: AFP)

### **DRM Minimum Receiver Requirements Published**

The DRM Consortium's Technical Committee has completed the technical requirements for receivers designed for the DRM system below 30 MHz. This Minimum Receiver Requirement (MRR) document describes the minimum performance required for the technical parameters that provide a fully functioning DRM receiver. A second phase of work will extend the document to detail the figures for DRM+ receivers, too. The DRM Technical Committee has also completed work revising the Multiplex Distribution Interface (MDI) and Receiver Status and Control Interface (RSCI) standards to include DRM+.

(Source: DRM press release)

### **Consumers Want HD Radio In Mobile Devices**

iBiquity has released the findings of a new comScore study, which indicate that there is consumer demand for HD Radio technology in handheld devices. According to the study, 68 percent of consumers surveyed are "interested" or "extremely interested" in mobile phones that include HD Radio Technology. Also, 75 percent of those who own a mobile phone would listen to HD Radio broadcasts via their mobile phone. The study found that \$42 "is the value premium consumers attribute to HD Radio Technology in mobile phones."

(Source: www.fmqb.com)

### **First In-car Web Radio Announced By MINI**

RadioTime, Inc., a developer of technology for finding and listening to radio online, announced that MINI has integrated the RadioTime Web radio service into its MINI Connected option, which offers a USB interface for integration of the Apple iPhone in the car's audio and infotainment system. The MINI Connected option makes MINI the first car manufacturer to offer this function in a regular production car. The MINI Connected option features a Web radio function based on the RadioTime directory enabling the iPhone to tune thousands of AM/FM and Internet-only radio stations worldwide. Using MINI Connected, the driver can tune to Web radio stations airing anywhere in the world and regardless of his current location, depending on Internet connection and network coverage.

(Source: The RadioTime Blog)

# Capitol Hill And FCC Actions Affecting Communications

## FCC Issues NPRM Regarding Amateur Radio Communications On Behalf Of Employers

A Notice of Proposed Rule Making (NPRM) taking up the issue of whether radio amateurs should be authorized to communicate on behalf of their employers in certain circumstances has been issued by the Federal Communications Commission. The NPRM, released March 24, proposes, "adding a narrow exception to the general prohibition on communications on behalf of an employer for amateurs involved in government-sponsored emergency drills," according to a story from the *CQ Amateur Radio* newsroom. "It also seeks comments on whether certain other drills that are not sponsored by government agencies—such as those conducted by hospitals—should be included in the proposed exemption as well."

The new language for Section 97.113(a) of the FCC rules as proposed in the NPRM would read:

A control station operator may participate on behalf of an employer in a government-sponsored emergency preparedness or disaster readiness test or drill, limited to the duration and scope of such test or drill, and operational testing immediately prior to such test or drill.

The FCC document said,

...experience has shown that amateur operations can and have played an essential role in protecting the safety of life and property during emergency situations and disasters. And as evidenced by recent waiver requests, state and local government public safety agencies and other entities often conduct disaster and emergency preparedness drills to be best-prepared for such eventualities. The proposed rule would obviate the need for a waiver in such instances by allowing employees of public safety agencies and other entities to operate amateur stations for testing and drilling of emergency communications preparedness.

## National Broadband Plan Sent To Congress

Deeming it a 21st Century roadmap "to spur economic growth and investment, create jobs, educate our children, protect our citizens and engage in our democracy," FCC Chairman Julius Genachowski in March unveiled details of the Commission's *Connecting America: The National Broadband Plan*. "It's an action plan," said Genachowski, "and action is necessary to meet the challenges of global competitiveness, and harness the power of broadband to help address so many vital national issues." The FCC found nearly 100 million Americans do not have broadband in their homes and 14 million Americans do not have access to broadband. ARRL Chief Executive Officer David Sumner, KI7ZZ, was pleased the plan did not cite broadband over power lines (BPL) as a viable delivery system. "The Plan's goals call for speeds that BPL cannot deliver," according to a report in the League's *ARRL Letter*. Sumner said it is "good news for all radio communication services—including the amateur radio service—that have experienced [BPL] interference from the spectrum pollution that inevitably results

from deliberately introducing radio frequency energy on unshielded, unbalanced conductors."

## House, Senate Consider Adding Engineers, Scientists To FCC Commissioners' Staffs

A proposal calling for assigning a technical engineer or scientist to the staff of each FCC Commissioner has been introduced in the U.S. House of Representatives. "The FCC Commissioners' Technical Resource Enhancement Act" (HR 4809) was brought forward by U.S. Rep. Jerry McNerny (D-CA) in March and mirrors a U.S. Senate version (S 2881) introduced by Sen. Olympia Snowe (R-ME) in December 2009. Each of the new advisors would provide "technical consultation when appropriate and...interface with the Office of Engineering and Technology, Commission Bureaus and other technical staff of the Commission for additional technical input and resources." The bill stipulates that each appointee hold at least an undergraduate degree from an "institution of higher education in their respective field of expertise."

## APCO Presses FCC On Satellite Communications Issues

Pointing out that "satellite services are critical for redundancy of public safety communications networks and for providing gap coverage in severe emergencies or in scenarios where terrestrial coverage is not available or possible," the Association of Public-Safety Communications Officials (APCO) International has called upon the FCC "to investigate requiring that equipment designed to operate on the 700 MHz public safety broadband network be capable of communicating directly and seamlessly with communications satellites."

According to APCO International President Richard Mirgon, the organization "believes that access to satellite services may greatly improve public safety's capability, interoperability and redundancy at a comparable cost to terrestrial-only devices, and will be a great step in our nation's efforts to improve public safety communications in rural areas."

## Report: 700-MHz D Block May Be Re-Auctioned Next Summer

D Block spectrum that failed to sell in an FCC auction in 2008 may go back on the block next year, according to published reports. The FCC told Reuters news service in March that a new auction could be held in the first or second quarter of 2011. "Two years ago, the agency parceled out pieces of the 700 MHz band," an online story from *Phone+* magazine reported, "all except for the D Block, set aside for public safety use. Too many operators opposed the conditions attached to the band, so it languished unsold."

"Companies including T-Mobile are said to be interested in the 10 MHz of spectrum, to better compete with large rivals," the story said. "The only trouble is, consumer broadband use could be interrupted when first responders need an interoperable communications system during disasters such as Hurricane Katrina and the Sept. 11, 2001, terrorist attacks."

## TV Everywhere

by Rob de Santos  
commhorizons@gmail.com  
Twitter: @shuttleman58

*“The basic model of TV Everywhere is that you can access it over your laptop, or pipe the video with a suitable device such as a laptop to your television from anywhere.”*

The TV industry has been more than a little concerned about the impact of Internet-delivered video on their business model. The concern is particularly acute when it comes to popular TV shows available directly to consumers without the “middleman”: your cable or satellite provider. Hulu.com is an example of this free to the viewer television (rumors suggest Hulu may become a partially paid service soon). The introduction of set-top boxes, such as those sold by Roku and Sezmi, provide additional concern. Occasional news reports of viewers who pay for Internet service and not cable TV, and even get their only TV via the Internet, are adding to TV executive anxiety. These companies don’t want to find themselves where the music industry is now.

While the number of viewers who have “cut the cable” remains small and projections for a continued trend vary widely, the industry is being proactive in looking for solutions. Recently, I’ve had a chance to be a beta tester for one approach that Time Warner Cable and Comcast Cable are examining for stopping audience erosion. The product is called TV Everywhere and is now available in some Comcast service areas and is under beta testing with some Time Warner customers. At the press time, only about 10,000 customers of these companies have had a taste of this product.

The basic model of TV Everywhere is that you can access it over your laptop, or pipe the video with a suitable device such as a laptop to your television from anywhere. However, you must have an account established, and that account process will verify that you are a paying subscriber to Comcast or Time Warner. In other words, if you get your TV over the air or from another company, you will not be able to use the service until your provider joins the service. Each time you want to use the service it will verify that you are logged in and a current subscriber.

During the recent test, programs from the TNT and TBS cable channels were the only ones available, and the number of series from which you could choose was very limited (I’m sure this would not be the case once the service is fully deployed). For each of the four to six TV series available from each network, you could general-

ly view previous episodes that had already aired. Live or current week programs were not always available. The number of episodes varied considerably with each series, though in some cases included entire previous seasons. It was my unfortunate luck that none of the programming included series I had an interest in or had ever watched before, so I enlisted a friend to evaluate the programming also and we compared notes.

I found the registration process cumbersome but once it was complete, log in and access worked well enough. As is typical of a beta service, there were some glitches. Despite my high-speed connection at home (I have the fastest service available to residential users in my geographic area), the video would often freeze or become jittery. This happened under several different computers and operating systems. The image size was good (larger than what is typical of YouTube, for example, though not HD), but of insufficient quality for full screen. Venturing forth to a coffee shop, the performance was about the same. In terms of quality, my friend felt that Hulu was superior. Unfortunately, there wasn’t an obvious way to capture and record the video generated by the Flash- and JavaScript-driven player, but the creative user may be able to find a way to do that.

My conclusion after three weeks of testing is that TV Everywhere has potential as a value-added service for the cable TV subscriber. In addition to offering mobility, it’s another way to catch up on episodes or even entire seasons missed. It doesn’t, at this early stage, represent the future of television in my opinion. With the increasingly diverse sources of television available, will it prevent the move of viewers away from traditional methods of distribution? I doubt it. It might help the cable companies keep those subscribers who want more than they get now, but aren’t as anxious to expend the additional effort required to watch TV without the subscription fees.

Would you use a service such as TV Everywhere if it were offered to you? Let me know if you’ve tried TV over the Internet and plan to join the “cable cutters.”

# Getting Ready For Amateur Radio Field Day

***Field Day Is The Most Popular Operating Event Of The Year For Hams. Follow K7JA's Valuable Tips For Your Most Successful Field Day Ever!***

by Chip Margelli, K7JA



A bidirectional beam like the Lazy-H can be very effective if you live in the Midwest and want to work both coasts.

ARRL's ever-popular Field Day, held in the fourth full weekend of June every year, is different things to different hams. It's an emergency exercise. It's a contest. It's a chance to teach operating skills to newer hams who may not have a station of their own. It's a chance to try out that new antenna design, or even a chance to try out that new chili recipe. It's all these things, and more.

Because of its uniquely multi-faceted appeal, Field Day has been bringing clubs and individuals together for many decades. For many of us, Field Day is a fun-filled weekend of comradeship, as we join forces to battle mosquitoes, lousy propagation, balky generators, and Murphy's Law in a time-honored demonstration to the general public of our first-response emergency communications capability.

Many of you hear about Field Day plans at your local radio club meeting, but you may be uneasy about volunteering to "captain" a station if you've never done it before. So let's explore a few areas of responsibility, planning, and preparation,

Chip Margelli, K7JA, has been licensed since 1963, and holds the Extra class license. Chip is the Vice President for Amateur Products Sales at Heil Sound, Ltd. of Fairview Heights, Illinois, and has been operating Field Day for over four decades. He may be reached via email at [k7ja@dxer.com](mailto:k7ja@dxer.com).

and you'll see that it's nothing that you can't put together yourself! Yes, you'll make mistakes, but Field Day is all about learning what works and what doesn't, and in amateur radio we learn by doing.

So let's start our exploration of what we need to put together a station as part of a larger Field Day effort (typically associated with a radio club). For the purposes of this article, I'll concentrate on the assembly of a station for the 28 MHz (10-meter) band as well as the VHF/UHF bands. For several years, I've volunteered to captain this station for the Orange County Amateur Radio Club (W6ZE), and we've enjoyed great success (to the tune of around 1,000 QSOs on these combined bands!).

Even you are an old hand at Field Day, or have your plans already in place for your first foray, you still may find some new ideas here for a little useful tweaking.

So, without further ado, here are my best tips for success on that glorious June weekend. Let's break it down.

## **Assemble A Team**

No matter how ambitious or modest your station plans are, you need to have help. You can't do it alone, and Field Day is all about teamwork. So get together with two or three like-minded club members, and make up a planning and preparation team



Teresa Dall, KAØCDO, and John Cavanaugh raise a 60-foot tower at a roadside rest area south of Duluth, Minnesota, for Field Day 2007. But what's wrong with this scene? You got it! No hard hats! (Photo by Paul M. Walsh via Wiki Commons)

for your station. You can worry about adding operators, as needed, later on, but initially you need to pull together some additional troops who can assist with radios, coaxial cable, antennas and masts, and other items you'll need for your successful Field Day station.

Once you've assembled your team, it's helpful to jot down everyone's responsibilities, to ensure that all the bases are covered. There's nothing guaranteed to cause a panic quite as quickly as the words, "I thought you were bringing that" on Friday afternoon during Field Day setup!

In generating this checklist, you'll be performing one of the most important

tasks in Field Day planning: writing stuff down! As you think of things you might need during Field Day, write them down somewhere and keep these notes all in one place. Then check them off as you're packing for the event, and you won't be caught short of something important when you need it most!

### Consider Your Radio And Antenna Requirements

Field Day is, ultimately, an operating event, and that requires radios and antennas in order to make the QSOs. It's important, though, to think critically about *all*

### Find Out More

Field Day is held on the fourth full weekend of June, and it's open to participation by individuals and groups throughout IARU Region 2 (the Western Hemisphere). It begins at 1800 UTC (2:00 PM, Eastern Daylight Time), and the operating period goes on for 24 hours. Setup begins at 1800 UTC on Friday, although you can start setup at 1800 UTC on Saturday and then operate an additional three hours Sunday afternoon (most participants set up on Friday).

It's a good idea to familiarize yourself with the rules, including the many opportunities for "bonus points," and complete information may be found at the web site for ARRL, The National Association for Amateur Radio, at <http://www.arrl.org/contests/forms/fd-2010-packet.pdf>.

Of course the best way to find out about Field Day is by stopping by in person. Contact a local club and ask where they'll be operating—you're sure to receive a warm welcome. Club contact info is also available on the ARRL website.

your needs when planning your Field Day station.

In the case of our 10-meter and VHF/UHF station, we have several aspects to consider. For the 10- and 6-meter bands, we need to cover both SSB and CW. On the 144-, 222-, and 430-MHz bands, the majority of the QSOs will be made on FM, but (depending on your location) it may make sense to have SSB/CW capability as well. Here in the Los Angeles area, there is considerable "weak signal" (i.e., SSB/CW) interest, particularly on 2 meters, and this makes it worthwhile to operate there; the same might not be the case in Davenport, Iowa, or Pocatello, Idaho. Geography and ham population density do come into play.

Remember, though, that VHF/UHF antennas for FM are vertically polarized, while SSB/CW operators use horizontal polarization, so covering multiple modes means you'll need multiple antennas and additional coaxial cables to feed them. Fortunately, it's quite possible to mount a small horizontal beam on the same mast as you use for an omni-directional FM vertical antenna. Still, every band or mode you add to your station lineup has consequences, in terms of radio/antenna/cable

requirements, so don't waste a lot of time thinking about setting up operating capability for 1296-MHz RTTY or other such unproductive bands and modes.

For Field Day radios, flexibility and redundancy are both important, and physical size can also be a factor (see below). Radios that can work both SSB/CW and FM, on both HF and VHF/UHF, are definitely preferred; these include popular rigs like the ICOM IC-706, IC-7000, and IC-746Pro, the Kenwood TS-2000, and the Yaesu FT-847/857/897 series.

Your club's choice of Field Day location can play a big part in your choice of radios. If your club operates from a city park five miles from your home, you can actually think about dragging your 65-pound base station radio out to your site. But if you have to pack your gear in over a mountain trail, or take it with you on an airplane (yes, you read correctly), small/compact rigs are the way to go.

For example, in 2003 I was part of a small group that accepted an invitation to operate Field Day from Cuba with a group of Field Day fanatics from the *Federacion de Radioaficionados de Cuba* (yes, there are Field Day junkies everywhere), and we had to bring all our radios and antennas and coax with us in checked baggage! So we kept the radios small, which saved us hundreds of dollars in excess baggage charges. And we had a memorable weekend operating with the very neat callsign COØUS in the first joint Cuban-USA Field Day operation in history!

Finally, be sure to use power supplies, for your DC-powered radios, that are low-noise switching regulator types. A typical switching-regulator supply will tolerate AC voltage swings of about 85 to 130 volts or so; this tolerance of AC voltage swing can be very important in the Field Day environment. There are many AC supplies available today that are designed for ham radio use, and they do an excellent job on Field Day.

## Antenna Planning And Materials

It's awfully tempting to use Field Day as an excuse to try out that spiffy eight-element 10-meter beam you've always dreamed of. I've certainly been known to indulge myself in that from time to time. But two lessons that I've learned are that A) a *small* antenna can almost always be put up *higher* than can a *big* antenna, and B) when it comes to the heights typically used on Field Day, you want to get as

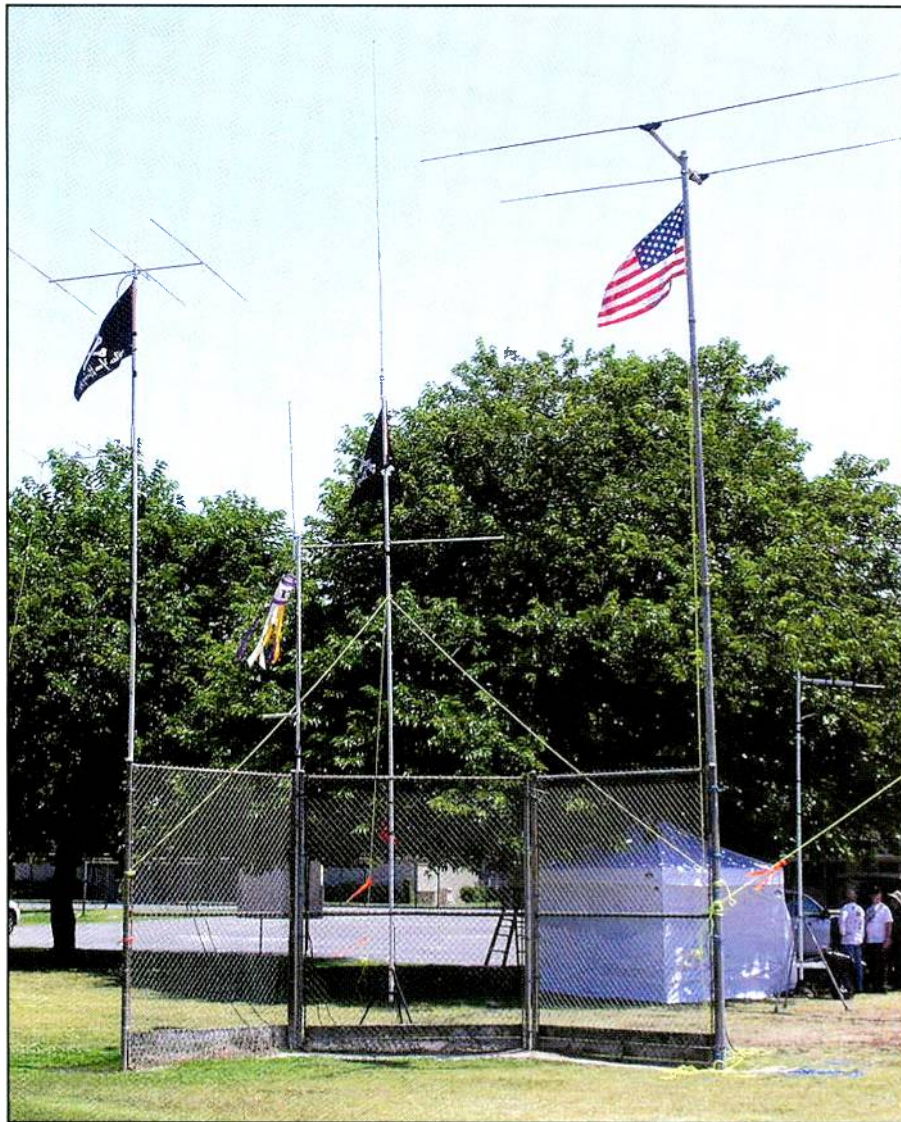

A baseball backstop in a school yard can make an excellent support structure for VHF antennas.

much height as you can *tilt* into the sky. Yes, you can sometimes commandeer a 110-foot crank-up tower from a local rental company for the weekend, but usually your Field Day antenna will be tilted up using strong backs and lots of folks pulling on ropes.

For 10 meters, a two-element Yagi is an excellent Field Day antenna. It provides several dB of gain over a very wide azimuth pattern, allowing you to "spray" your signal over a wide geographical area. If you're in a "corner" of the U.S. or Canada, a unidirectional antenna like this is ideal; point the back of the antenna at the ocean! But keep the beam to three elements or less, not just for size and weight reasons, but also to keep your signal from being too "pointy," lest you illuminate fewer stations with a tight pattern.

If you're in the Midwest, you don't

want to make contacts on just *one* coast, so think in terms of a bi-directional antenna. Suitable designs include the W8JK beam, the Lazy-H (practicable for 10 and 6 meters), and the Bisquare. A bi-directional antenna may be three dB down from a Yagi in the beam's favored direction, but it will be several S-units *better* than the Yagi of the beam's *back*!

Yagis are often built out of aluminum tubing, and for 10 meters and higher bands they can be very lightweight. But you can also build antennas out of wire, perhaps using fiberglass fishing poles as supports. For our Field Day operations from St. Croix, U.S. Virgin Islands (as KP2AA), our group used a three-element Yagi for 20 meters built in this manner. This beam weighed less than 10 pounds, which is remarkable for a full-sized three-element Yagi for this band, and it

worked beautifully, with excellent pattern and gain.

For VHF and UHF, once again do not succumb to the temptation to get too long and "pointy" with your choices of horizontal beams for SSB/CW. You're interested in spraying your signal to the widest possible ground-wave area, unless you're in a remote area and there is significant population only in one direction. Generally it's better to go for a smaller, lighter beam (say, four or five elements on 2 meters) at 35 feet than a heavier, longer beam (perhaps 15 elements) at only 20 feet, which may be as high as you can get it. You can use longer-boom antennas, but you may end up having to have a secondary antenna for another direction; from California, it's common to put a high-gain antenna pointed east, with a somewhat smaller antenna facing north for stations in the Pacific Northwest, an area of considerable activity.

For FM, use a good high-gain vertical mounted on the highest mast you can, and, with all VHF/UHF antennas, use the best low-loss coax you can lay your hands on. It seems silly to use an antenna with 6 dB of gain fed with coax that has 6 dB of loss, doesn't it? Remember to test *all* coax in advance of Field Day to be sure its connectors and insertion loss are OK.

All your antennas must be mounted on masts of some sort, and your club likely has some aluminum or steel towers, perhaps mounted on trailers, which are ideal for Field Day use. But there is another ideal, low-cost, and widely available antenna support material that is excellent for Field Day portable antennas: stackable surplus military aluminum mast.

These mast sections are four feet long, with an outside diameter of about 1.8 inches. The wall thickness is 0.11 inches and the aluminum is very strong. Seven or eight sections are pretty easy to stack, and this mast will support any reasonable antenna for 10 meters or VHF/UHF. The mast sections simply stack one above another, and the structure is capable of tolerating a significant bend without being damaged. This mast is seen at just about any hamfest you go to, or you may order it from The Mast Company ([www.tmastco.com](http://www.tmastco.com)).

These mast sections are typically found in a dark green color. The first thing you do with them is mask off the inner telescoping section (about 3 1/2 inches long, at the top of each section), and then paint the green areas *white*! In the hot summer sun, you will not be able

to touch the green sections with bare hands, but sections painted white will be cool to the touch.

Another excellent mast material is boom material from surplus or discarded large tri-band HF Yagis, like the KT34/36XA beams. These are often in a ham's aluminum pile after an estate-sale

take-down, and with a diameter of three inches, they combine excellent rigidity and light weight. One of these booms, tilted up, will hold Field Day antennas for 20 meters and higher bands with ease.

I have not supplied specific design information for the antennas I have suggested in this section, but I will be glad to



You can't beat the fun of Field Day. Here's Janet, KL7MF, operating 20 Phone from COOUS, Field Day 2003 (Cuba).



Author Chip Margelli, K7JA, and Gordon West, WB6NDA, set up for Field Day practice down at the beach. No extension cords, either!

# RADIOS FOR EVERYDAY ADVENTURES



SATELLIT 750

**GRUNDIG**

Available at:







FIELD RADIO GS350DL



IM400



GLOBE TRAVELER G3



TRAVELER II DIGITAL G8



BUZZ ALDWIN EDITION AVIATOR G6

etón CORPORATION

tune in: to life

send design ideas and information via email. Part of the fun of planning for Field Day, though, is spending some time with antenna-modeling software, building up an antenna from scraps lying around the junk heap or parts from your local home-improvement store, and then putting it up on Field Day to see if it actually works!

## Your Operating Shelter And Station Layout

You may be fortunate enough to have a trailer or recreational vehicle that can be used as an operating shelter. These are great for keeping the rain and sun off the operators, but be sure there is ample space for your radios and for operators to be comfortable sitting in their chairs.

Tents and “easy-up” canopies can afford you much more room, if you have multiple operating tables in your plans (as may be required for the 28/50/144/222/430-MHz bands!). You must, however, plan on adding supplemental sunshades and/or rain bonnets, depending on your location, and remember that it will get cold at night (unless you’re in the Caribbean!), so consider both nighttime and daytime temperatures as you plan your shelter.

The available space in your shelter, and the number of people expected to be operating at any given time, will have a critical effect on how you lay out your station. You’ll need to find out, from your club’s Field Day committee, how many signals they want to have on the air (this determines your “Transmitter Class” for your Field Day exchange, and when you submit your entry), and in a 10-

meter/VHF station you will find yourself with at least two stations in simultaneous operation at any given time.

A strategy I use is to have the 2-meter SSB station actually manned, with an operator calling CQ, but with a 2-meter FM rig sitting nearby, on 146.49 or 146.55 MHz (you can’t use 146.52 during Field Day) to pick off new stations that show up on FM. By concentrating on SSB stations, you have a better chance of getting contacts further out than on FM, thereby adding to your *net* score for all “voice” contacts, which are lumped together for scoring purposes. If you have a dual-band FM rig, have one VFO on 146 MHz and the other VFO on 446 MHz; just be sure to log the contact on the right band!

When laying out an individual operating table, be sure to pay attention to basic ergonomics— sufficient separation of radio and operator to ensure comfortable tuning, CW key (if applicable) on the correct side of the radio, radio offset to side to make room for laptop computer (if used for logging), and other such factors. Lay out each station in advance of Field Day to be sure you have all the accessories and cables that you need together and in one place. Double-check your checklist to be sure you haven’t forgotten anything, and then pack it away and don’t touch it before you leave for the Field Day site!

About computer logging: it’s great for CW stations, particularly because “CQ” and Field Day report messages can be generated automatically. But if your station will have a number of short-term operators stopping by to get on the air for an hour or two, you’ll probably need to think in terms of paper logging for your

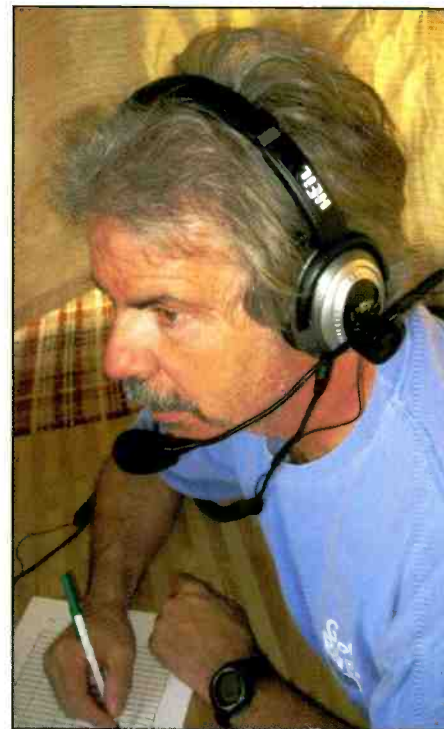

Noise-quieting headphones can significantly enhance your ability to hear weak Field Day callers.

station. It’s not a huge burden for the experienced operators, and paper logging removes a huge “intimidation factor” when it comes to breaking in new operators, some of whom may be participating in their first “contest” experience (and this is an important aspect of Field Day: operator training). Removing duplicate contacts after Field Day is a matter of taking a few hours to enter the contacts into a logging program in a “post contest” mode, and you’ll be set. Be sure



Table space inside a vacation trailer can support three or more bands’ worth of today’s compact transceivers.



Take Field Day with you to some place exotic. Here's your author at Miami airport en route to Havana for the 2003 COØUS Field Day operation with Cuban hams.

to school all operators, though, on the importance of printing *clearly*; it's amazing how the modern-age use of computer keyboards has led to the deterioration of penmanship!

Finally, be sure that your planning check-list includes a bag of snap-on ferrite cores, used for RF interference suppression, as well as bandpass filters, particularly for the HF bands, if that's your assignment. On Field Day, grounding is generally not what you have at your home station, and you may need to make some in-the-field provisions for minimizing odd peeps and squawks in your headphones, or on your signal. Some rigs, without a "cold" ground on their DC power cable, may actually take off scanning, or do other odd things, and snap-on ferrites can fix that in an instant. Bandpass filters help keep harmonics and broadband noise from your station from bothering other stations at your site, and if all station captains see to the proper filtering on their transmitters, you're likely to avoid difficulties once the Field Day operating period begins at 1800 UTC on Saturday.

## Power Distribution

A complete description of the portable power sources available for Field Day is beyond the scope of this article, and that subject is being treated elsewhere in this magazine (see this month's "Ham Discoveries" column, "Generate Some Fun On Field Day—Safely!"). Your club undoubtedly has a "Power Chairman" appointed to deal with this matter, so let's concentrate on power distribution,

assuming your club will be using a generator that provides AC.

Interfacing to your club's "power grid" consists of two issues: A) getting power into your station from the generator, and B) distributing power throughout your station.

A typical extension cord may have 16-gauge conductors, and this type of cord is entirely too light for effective power transfer over a run of 100 feet; voltage drop will be excessive, and such a cord will only handle about 1600 watts of total power in any case. Your station's power budget may be higher than that, especially with multiple transmitters going, along with a refrigerator, coffee pot, and lamps during the night. Rather, a heavy "10-3" extension cord, with three 10-gauge conductors, is an excellent investment that will deliver power to your station with minimal voltage drop and with current-carrying capability to spare.

Once the extension cord reaches your station, connect a three-way 10-gauge power splitter cord to the extension cord, and *then* you can connect individual power strips for each station. If you have more than one station at your site, a single power strip will probably have its circuit breaker trip at some point, so you need to distribute the current draw among several power strips. This three-way AC power split is *very* important in multi-transmitter station engineering.

Remember to tape over all AC power connection points (where you connect your extension cords, etc.), because the inevitable rain encountered on Field Day should be kept out of all electrical connections, for obvious reasons. Bring sev-

eral rolls of black electrical tape to Field Day, and use it on all electrical and antenna connection points.

## Safety

Wherever you operate, however big or small your antennas may be, there is no excuse for participating in an unsafe Field Day! And while very few Field Day antenna projects will meet national building and safety codes, you can still be safe in the construction, use, and take-down of antennas and masts.

Hard hats must be worn by all who work in areas where antennas and masts are being handled. All workers should be supervised by a safety manager on site, and nobody should ever stand in a position where a mast or other antenna support could possibly fall on them. It should be abundantly clear that no antenna support should be anywhere near an overhead power line, and *any* overhead wire should be treated as though it is carrying high voltage.

Once an antenna structure is safely installed, the area surrounding it should be cordoned off with yellow security tape. It's also a good idea to tie small pieces of yellow security tape to all guy ropes securing your masts, so that nobody walks into the guy rope should the main security tape blow away during the night.

Safety precautions are an important part of every emergency-preparedness exercise, so don't take short-cuts when it comes to having a safe and fun Field Day!

## Enjoy Your Field Day!

Once 1800 UTC arrives on Saturday, and the first "CQ Field Day" calls hit the airwaves at your station, 90 percent of the work is done. It's now time to enjoy the event. Be sure that all your operators have the cold or hot drinks they need, keep an eye on them for signs of lethargy (time to switch ops!), and be mindful of the contacts being made so as to coach the operators on not missing important openings to various geographical areas. But most of all have fun with all these cool antennas you're trying out, enjoy the comradeship that comes from a team effort, and take lots of pictures for your club's newsletter.

Sunday night, when you're home and everything is unloaded and put away, you'll probably be exhausted—that's a sure sign of a successful Field Day weekend! You'll lean back in your chair and think "*Never again...until next year!*"

# Calling For Backup: Ham Radio Enhances A Police Department's Preparedness

*To Help Him Serve And Protect, A Police Chief Set Up Shack  
In His Station*

by Chief Mike Burg, N8QQN

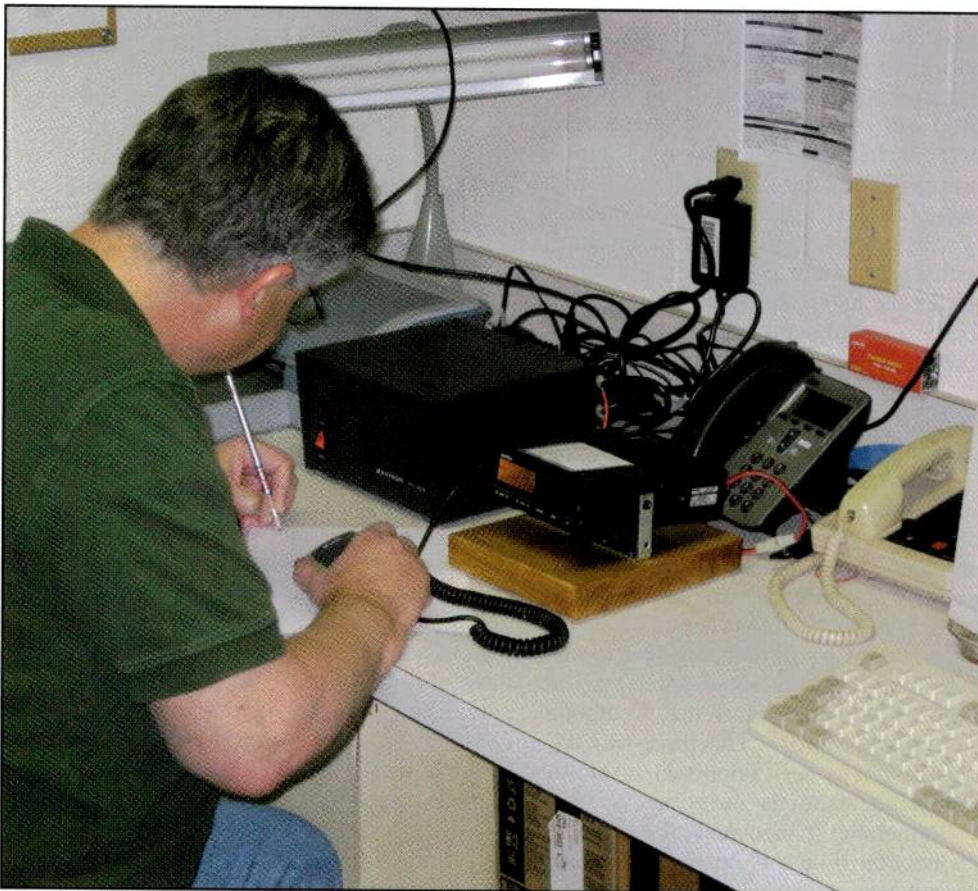

Local amateur radio operator Del La Bo, N8OFP, working the 2-meter amateur radio station at the Rittman Ohio Police Department.

As a police officer with a ham radio background, I had much more than a passing interest in public safety communications. In fact, I promised myself that if I ever got into a position where I could do something positive to improve the communications within our police department, I would. Then about two years ago I made Chief and found myself in just that position.

## **A Little Background**

My department, the Rittman Police Department, located in Wayne and Medina Counties, Ohio, is one of the three 9-1-1 PSAPs (Public Safety Answering Points) within our county. Our dispatchers serve six different public safety agencies: two police departments, three fire departments, and an EMS department). Our communications center is in the police department, which is on the east end of town, and our repeater/antenna site is at the west end of town. They're linked via phone lines.

Chief Mike Burg, N8QQN, is the Chief of Police for the Rittman Ohio Police Department and a 32-year veteran of the force. He is a graduate of the 168th Session of the FBI National Academy and holds a Technician class ham license.

*“...I wanted to set up an amateur radio station in our police department...while many amateurs are prepared for emergency communications, how many could stay on the air if an emergency situation meant no electricity for an extended period?”*

Rittman is in northeast Ohio, so we see our share of snow, ice, and the occasional tornado. Luckily, the police department has a massive emergency power generator with an auto-on switch, as does the repeater site. This is all well and good, but if the “right” snow or ice storm hits, or even if a bad traffic accident brings down the “right” set of phone lines, emergency power isn’t going to help our communications center at all—it’s going to be out of commission. So as Chief, one of the first things I had on my to-do list was establish some type of auxiliary communications at the police department, bypassing the repeater.

I went about setting up a back-up system that would serve the department in an emergency. Budget and other constraints dictated that it would have to be inexpensive, but being based on radio technology, it would be absolutely dependable. Would it offer the coverage that we get with the repeater? Obviously not, but it would sure beat the alternative of having no communications at all!

## The Birth Of A Station

I had an obvious source for the backup transceiver: I got one of our mobile radios—a Motorola CDM-1250 with 36 programmed frequencies—and had it programmed exactly like the ones installed in the patrol cars. It’s attached to a hefty Astron RS-35A power supply (with spare fuses in close proximity!) and a 100-watt amp.

My second requirement was a suitable antenna. Because we’re a 9-1-1 PSAP, it’s kind of important that our dispatchers hear what’s going on around us, yet the scanner antenna we had in dispatch was all but useless since our dispatch center is, for the most part, located in a bunker, complete with concrete floor, walls, and ceiling with a heavy steel door! We needed something better. To take care of that problem, we placed a small 2-meter mag-mount antenna (commercial grade) on the roof of the building. It’s connected via coax that we ran through some existing conduit.

A major consideration I had for this backup system was interoperability. I kept thinking about the post-9/11 response evaluation and how it found that one of the biggest problems public safety responders faced was the inability to communicate with one another. Since our neighboring municipality, with which we work rather closely, had recently moved to UHF while we operate on VHF, I wanted to make sure we didn’t have that problem.

After some searching, I was able to locate a decent UHF two-channel mobile, a Motorola Radius, to put in dispatch. It was programmed with the neighboring police and fire department frequencies and we ran a small UHF antenna to it from the roof of the police department. The radio is usually not even turned on, but should we need immediate public safety communications with our neighbors, we now have the capability. In the event we have to send a car over to their city to assist them, as an additional backup, we obtained a two-channel UHF handheld, also programmed with their police and fire frequencies.



The 2-meter Ringo Ranger antenna mounted on the peak of the building gives great coverage.

Again, I expect these two radios will get little use, but they give us the capability of communicating with our neighboring municipality should the need arise, and that’s important.

## The Heart Of The System

Finally, I wanted to set up an amateur radio station in our police department. It was important to me to have a station on the premises because, I reasoned, while many amateurs are prepared for emergency communications, how many could stay on the air if an emergency situation meant no electricity for an extended period? We would be able to thanks to our generator power and size of our fuel tank, as well as our plan to keep the fuel tank full.

Our generator powers the entire department, so I would be able to put the amateur station just about anywhere. Location was important. I wanted it in close proximity to, but not in, our dispatch center. In the event of an extended “situation,” our dispatchers would be busy enough trying to hear each other with-

out having to worry about the audio coming from another radio.

Naturally, I also wanted it in a location that would be good for the operators of the amateur station should they have to operate during an extended situation. Luckily in the back of the police department is a large meeting room that was an ideal spot for the station. It has a full kitchen and is equipped with a phone and cable TV (though neither of these might work during an emergency!). This room is also conveniently adjacent to the rest rooms, yet is separated from dispatch by a hallway and two doors.

Initially, we used a RadioShack HTX-212 as the ham transceiver, while I looked around for a suitable mobile radio. I found what I needed through a local radio club, the Silvercreek Amateur Radio Association, and purchased a 99-channel, 40-watt Vertex/Yaesu FTL-2011 mobile with hand mic from one of the members, donating it to the department's station. I built a wood base for it, and programmed in 12 area repeaters as well as two simplex frequencies (leaving plenty of channels to fill!), and put it into service from its convenient location.

Because it's a 40-watt rig we don't

need an amplifier, so we're saved that additional expense. With just the radio's output power, we easily hit repeaters that are as far as 23 miles away, as well as the majority of repeaters in between. Having the antenna on the highest peak of the building has also been an asset to the station's overall operation and functionality. So far, I'm pleased to say, it appears that it will be a great setup for emergency communications.

## Other Considerations

Obviously, because of the sensitive nature of police department interiors, not just anyone will be able to have free access to our ham station, and some criteria will have to be established that the operators will have to meet. I'm also still in the process of determining what that will be, as well as what training level these operators should have. SKYWARN and some level of National Incident Management System/Incident Command System experience would be extremely beneficial. Much of the NIMS/ICS training is available free online through the FEMA website. Also desirable would be the ARRL Amateur Radio Emergency Communications Courses (ARECC Level I-II-III).



To prevent damage when the radio's not in use, we disconnect the coax connection. We have about 15 feet of slack in the coax in the drop ceiling, with only the PL-259 connector sticking out, and simply pull it down to reconnect.

er or other emergency situation, whether natural or man made.

Having this station up and running and open to some operators who might likely use it in an actual emergency situation, means that the equipment and surroundings will be familiar to those operators, greatly enhancing their comfort level. I hope it will also encourage amateur radio operators who are new to public safety communications to seek out training and get involved.

I'm sure there will be many other benefits that we'll discover over time. Perhaps as a secondary public service during non-emergency times this amateur radio station can be used as a community outreach tool, say assisting local Boy Scouts in obtaining their Emergency Preparedness or Radio merit badges. I'd like to think it may have a role in inspiring young people to become tomorrow's hams.

## On The Air

The initial test of our radio station, which we just completed, proved even more successful than we expected. The coverage was great and everything worked just as planned. The first actual public service operation of the radio was on March 24, when it was used by the Silvercreek Amateur Radio Association to run the local tornado safety drill net in conjunction with the national Weather Service/SKYWARN out of Cleveland.

I'm happy to say that the system is ready should a need arise, and I know that our community is safer because of it.

## Good News for the VHF/UHF Enthusiast

The all-time favorite magazine for the VHF/UHF enthusiast. CQ VHF is better than ever and here to serve you!



By taking advantage of our subscription specials you'll save money and have CQ VHF delivered right to your mailbox. Only \$26 for four information-packed quarterly issues. Or better yet, enter a two or three year subscription at these special prices. As always, every subscription comes with our money back guarantee.

	USA	VE/XE	Foreign Air Post
1 Year	26.00	36.00	39.00
2 Years	52.00	72.00	78.00
3 Years	78.00	108.00	117.00

Please allow 6-8 weeks for delivery of first issue



**FREE** 2010/11 CQ Amateur Radio Ops Calendar  
with every 3-year subscription!  
a \$8.95 value - FREE!

CQ VHF • 25 Newbridge Road •  
Hicksville, NY 11801

Subscribe on line at [www.cq-vhf.com](http://www.cq-vhf.com)  
FAX your order to us at 516 681-2926  
Call Toll-Free 800-853-9797

## Other Benefits

The greater community will also benefit in many ways from our having this amateur radio station. For instance, there is a consortium of 35 hospitals in our area that jointly obtained a grant, known as the North East Central Ohio Hospital Ham Radio Implementation Plan, for amateur radio equipment. Our station now gives us communication capabilities with our local hospital, through its station, should normal means of communication go down. This could be of critical importance if we have a large-scale disaster.

The police department amateur radio station can also be used to run the annual tornado safety drill net in conjunction with the State of Ohio Department of Public Safety and the National Weather Service. This would assist with public relations as well, as it would open the police station to the local news media to see the net in operation, educating our citizens about the preparations their public service agency is taking to better provide for their safety.

An amateur radio station located within the public safety complex (police/fire/EMS) is a plus for the community. It's just another form of communication that can be used in the event of severe weather.

# The UniWave Di-Wave 100

## Finally, DRM Radio For The Average Listener...Almost

by Rob de Santos, K8RKD  
commhorizons@gmail.com  
Twitter: @shuttleman58

Since the first announcement of the Digital Radio Mondiale (DRM) effort to bring digital radio to the shortwaves, the biggest question from every listener has been, “when will we see a consumer grade digital radio?” Well, finally, a working radio is available with the release of the UniWave Di-Wave 100 radio (Photo A). Recently, I was able to give the radio a hands-on test, courtesy of its U.S. distributor, Universal Radio of Reynoldsburg, Ohio.

### Major Features

The radio provides reception of longwave, mediumwave, and shortwave frequencies in DRM mode, FM radio with RDS support for the North American band, and support for MP3 music, MP4 video, and JPEG graphics using a MMC/SD card reader built into the side panel. While this is much more than a simple radio,

Rob de Santos is *Pop’Comm’s* “Horizons” columnist and has been an SWL for over 30 years.

*“...this is the first radio to make DRM listening accessible to anyone other than the technically inclined.”*

whether the added media support is useful depends on the user’s situation. The frequency ranges are a little odd, with the LW ranging from 150 to 228 kHz, the MW as given by the specs ending at 1620 kHz, and the SW range starting there and going through 30 MHz (DRM is continuous from 150 kHz to 30 MHz).

The radio’s 3-inch speaker offers 1-watt output. The sound is adequate for a bedside or desktop radio, but an external speaker helps. Its 3.5-inch LCD display has a nice, crisp appearance and is easy to read, even from moderate angles, and its clock and memory are backed up by a 3-volt (CR2025) battery. There’s a telescopic whip antenna, with a rear external antenna jack, and a mini-USB port and headphone jack located on the side panel (Photo B). The radio has an unusual backside shape, but the “bulge” (Photo C) makes it convenient to grab onto and carry, as well as to stand it up on a table. Its dimensions are 5 x 9.3 x 2.6 inches (HWD).

One of the features that I particularly liked is that the Di-Wave 100 allows what UniWave calls “listening time shift” of up to 10 minutes. This permits you to pause a program and resume it a few minutes later, DVR style, without missing anything. This is long overdue in most receivers.

The DRM mode also features “Alternative Frequency Switching,” which identifies if a second or third frequency is available at the time you’re listening. In theory, this should be beneficial to shortwave listeners, but since there isn’t an alternate frequency for any DRM broadcast aimed at North America right now, I was unable to test this. The radio also features support for the “Journaline” teletext service, but since I didn’t observe any text associated with the DRM broadcasts I monitored. I can’t make any assessment of this feature, either.

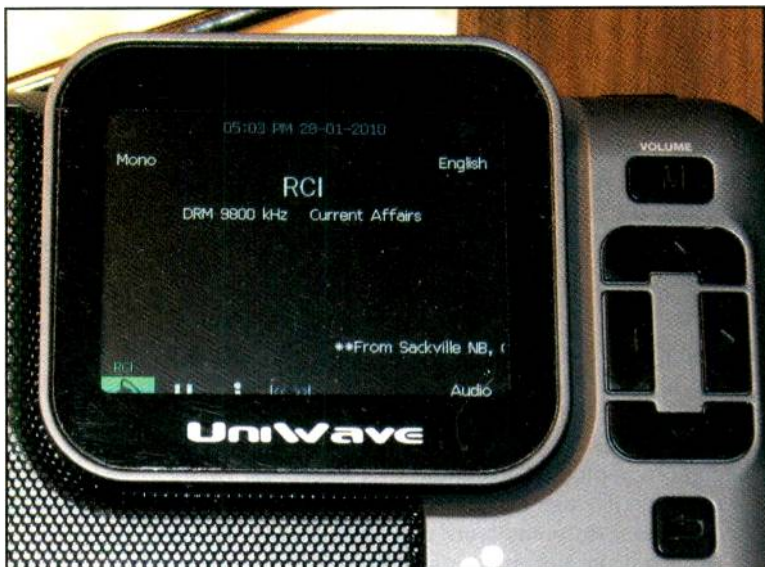

Photo A. Close-up of UniWave’s Di-Wave 100 Radio front panel

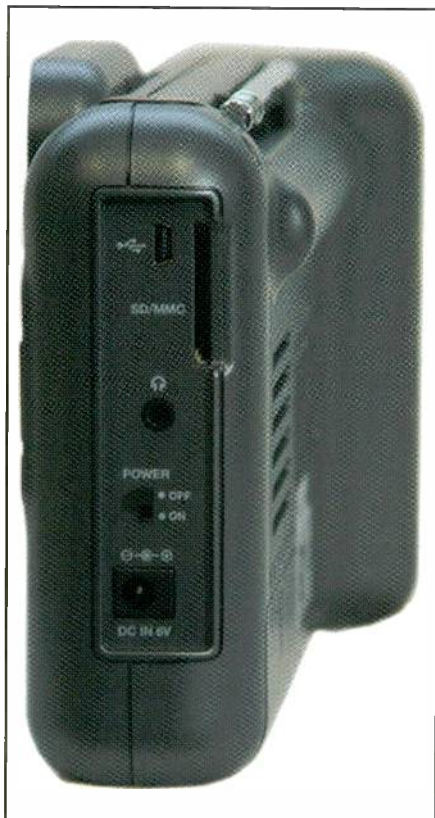

Photo B. Side panel connections

The radio has extensive configuration choices in the settings screens, yet was easy to set up. A “wall-wart” is provided with the radio, or you can use battery power (four “C” cells). I tried the radio both ways and, though I didn’t do precise measurements of battery life, found that the radio drains the batteries fairly quickly, so rechargeable batteries might be a good idea. Fortunately, running it with the AC adapter did not seem to introduce much noise and so didn’t adversely affect reception.

A significant issue I had with the radio was the rather arcane user interface. Take another look at the front panel in Photo A and you’ll notice its four directional navigation buttons (up, down, left, right), a back button, and a volume control. Unfortunately, the “OK” or “select” button is on the top of the radio, and using it proved awkward at best. This almost always required extra hand movement in order to navigate menus.

## Tuning The Radio

After turning the radio on, you get a menu display that lets you choose which feature you wish to use. Selecting “Radio” with the top side button takes you to a sub menu where you can go directly



Photo C. Back panel of Di-Wave 100.

to the last frequency and mode used, to a view of the built-in radio guide to select a frequency, or to an on-screen frequency pad and manually enter a frequency. All three methods work acceptably well, though I found the on-screen pad slow and cumbersome. It would be better if the radio offered touch entry for this pad, but since you must navigate from number to number with the directional buttons and then finally select enter with the on screen enter choice, it is simply too slow. Far better is the navigation via the radio guide or using the memory recall modes.

Once you enter a frequency, the radio will spend several seconds checking for the presence of a DRM signal. If it fails to find one, automatic tuning takes over and begins to scan the stored frequencies from the radio guide, from longwave through the high end of the shortwave bands. If a signal is detected, the radio will stop and attempt to lock on the signal and decode it. From my observation, it requires a signal 11db or more above the noise floor to lock on to a signal successfully.

The sound quality of the DRM broadcasts on the radio was very good provided the AM filter was left in the wide position. My partner couldn’t tell whether the radio was on a local station or a shortwave signal from the sound quality. Nevertheless, dropouts were a problem if propagation suffered or if there was more noise than the DRM sys-

tem could handle. When tuned to a DRM signal, the radio provides an “expert mode” information screen with data about the DRM signal, which is useful to the technically inclined but probably not of much interest if you don’t know the details of DRM transmissions.

Listening off the whip from my location in Ohio was inadequate, however. With the low strength of DRM signals aimed at North American listeners, the whip is simply not good enough. I found that the radio worked much better if I clipped a long wire to the whip or connected an external antenna. (Admittedly, it’s speculative, but I would imagine that if the power levels used by the broadcasters increased, reception would improve.) All the signals I was able to hear were directed at North America and in the shortwave bands, as no longwave or mediumwave DRM is available here as yet; I’ve had reports from other users, however, that adding a dipole trap antenna allowed occasional reception of broadcasts aimed at other geographic regions. Once more, I was unable to assess the slide show (“Multimedia Object Transfer”) feature as none of the DRM broadcasts appeared to transmit any images.

Reception of local FM signals was excellent with RDS information picked up where it was available. The sound wasn’t CD quality, but pretty good for a portable radio of this size. The radio



doesn't decode the HD broadcasts now available in most areas of the U.S.

## Radio Guide Software

The radio guide is stored in memory and users can add to that by manually entering a frequency to store into it. The preferred way to do this is via the downloadable radio guide software. I downloaded and installed the radio software on a Windows XP SP3 laptop and the installation went without a hitch. I connected the provided USB cable to my laptop and to the radio and both appeared to recognize they were connected.

The software gave me an option to download an update from the UniWave website, which I succeeded in doing after one failed attempt. However, numerous attempts to upload the stored frequencies from the radio or to download updated ones to the radio failed. Several re-installations and further attempts also failed. Furthermore, the software only works on Windows and is not yet available in a Mac or Linux version.

## Auxiliary Features

The radio offers the ability to display JPEG photos stored on an SD card (not provided), either one at a time or in a slideshow, and the navigation through directories and subdirectories works well. This feature appeared to function as described in the manual and did a good job of scaling the images to fit the screen. Although the radio allows you to rotate pictures that may be improperly oriented, it's preferable to do that before saving the pictures to the memory card.

The MP3 playback also works as described. I was able to load a variety of MP3 files to a memory card and the radio played them perfectly. The radio lets you skip forward or backward, repeat, and fast forward through the musical selections. You can also display photos and play music simultaneously, though I did not attempt this.

I was unsuccessful at getting the MP4 video playback to work. I saved several different MP4 files to my memory card, but the radio refused to play any of them. It did not appear to recognize the files at all, and whether this was a firmware problem or a problem with the files I used, I could not determine.

## The Verdict Is...

The UniWave Di-Wave 100 is a first-generation DRM radio and, as such, I was very satisfied with its performance. Broadcasters, particularly in Europe, have made DRM broadcasts available and now listeners have a radio to go with them. The radio has a list price of \$360, but at press time, Universal Radio was selling it for US\$299.95. In my opinion that's a fair price, provided that UniWave fixes the features that don't work properly.

At this point, of course, there still isn't much to listen to for North Americans, and the radio is probably of greatest value to Europeans. According to the latest listings I was able to find, there are only six regularly scheduled broadcasts per day totaling less than seven hours to the Americas. Of those, I successfully heard Vatican City, Radio Canada International, and China Radio International; I did not hear TDP Radio from Belgium.

Whether DRM will ever be a "market success" for shortwave broadcasting is doubtful given the on-going decline in countries broadcasting via shortwave. After years of attending the Winter SWL Festival in Kulpville, Pennsylvania ([www.swlfest.com](http://www.swlfest.com)), and attending the DRM demonstrations organized there by Dr.

## At A Glance The UniWave Di-Wave 100

### Major Features And Specifications

#### DRM Functions

- Station name, program information
- Journaline
- Slideshow
- Listening time-shift: 10min
- Alternative Frequency Switching

#### Radio Reception

- DRM on shortwave, longwave and mediumwave
- FM with RDS; stereo on headphones
- SW/MW/LW
- 768 Station memories: 256 DRM/256 FM/256 AM

#### Multimedia

- MMC/SD card reader
- USB connection
- MP3 playback
- MPEG4 playback
- JPEG Photo Album Viewer

#### Other Features:

- 3.5" TFT LCD display
- Multi-language graphical user Interface (English, Chinese, German, French, Spanish)
- Time/date
- Headphone jack
- External antenna socket
- Adjustable telescopic antenna
- Speaker: 3" 1 W output

#### Power:

- AC adapter included (120W input) or DC 6V by 4x1.5V C cell
- Battery back-up 3V (CR2025) for time setting

#### Dimensions

- 5 in. (H) x 2.6 in. (W) x 9.3 in. (L)

*Information courtesy of UniWave.*

#### Price:

- US\$360 (List)
- US\$299.95 (Street)

#### Contact:

UniWave Development (Manufacturer)  
[www.uniwave.fr](http://www.uniwave.fr)

Universal Radio, Inc. (U.S. Distributor)

6830 Americana Parkway

Reynoldsburg, OH 43068-4113

Phone: 800 431-3939 Orders & Prices; 614 866-4267 Information

Email: [dx@universal-radio.com](mailto:dx@universal-radio.com)

Web: [www.universal-radio.com](http://www.universal-radio.com)

Kim Andrew Elliott, it's my belief that this is the first radio to make DRM listening accessible to anyone other than the technically inclined. Even so, without more programming and a halt in the decline of shortwave, generally, the Di-Wave 100 may prove too little, too late.

*The author and Popular Communications wish to thank Fred Osterman and Universal Radio for their assistance with this review.*

# Preparing For Emergency Monitoring

by Ken Reiss  
radioken@earthlink.net

Recent world events have reminded us just how fast major emergencies can happen. Earthquakes all over the world, tidal waves following those earthquakes, and even a few large snowstorms have all pointed out just how fragile both life and our infrastructure can be. The season for severe storms is just around the corner in many parts of the country. A train accident nearby, or a factory mishap can strike anywhere, without warning. Should one of these events happen within scanning range will you be ready? If not, how can you be?

A lot of what becomes interesting in an emergency situation is as boring as it can be during the rest of the year. Here's where a scanner with lots of banks, or even multiple scanners, comes in handy. A computer-controlled, or computer-programmable radio would also be convenient so you

can have those seldom-used but highly interesting frequencies ready at a moment's notice.

If you've been scanning for any length of time, you know the old saying about needing the scanner on before you hear the sirens. With an emergency of any size, that's especially true, although you can follow unfolding events, like storm response, as the operations continue over days or even months.

For monitoring a smaller event, the trick is to be ready *before* it happens. Once the event occurs, you won't have time to look up and research frequencies that might be in use. A little advanced planning goes a long way. Maintaining a word processor file on your computer, or a hardcopy notebook, dedicated to several types of emergencies is handy. When something happens, you can pull out the list and start programming. Even bet-



While floods usually come with some warning, they can be devastating. This view of Grand Forks, North Dakota, was taken during the 1997 Red River flood; the river's normal banks are marked by the span of the bridge. (Photo courtesy FEMA/Michael Rieger)



FEMA personnel work inside a Mobile Emergency Response Support (MERS) vehicle. These vehicles are equipped with satellite communications systems to enable communications wherever they are needed. (Photo courtesy FEMA/Mark Wolfe)

ter is to have a computer program that's pre-loaded with banks; then you can have your scanner reprogrammed at the drop of a hat by computer.

In addition to simply providing interesting communications fare, being ready to tune an unfolding emergency can also give you the information you need to make some important decisions of your own about what actions you may want to take. Nobody likes to force people out of their homes, and the officials who have to make those decisions don't make them lightly—or rapidly. Once an official decision is made, it may take a while for the notification to reach you. You can make your own decisions sooner if you have more information.

Of course, if something happens right in your backyard, scanning will be the least of your concerns, so we'll focus on how to tune emergencies that may occur close—but not too close—to you.

## A Little What-If Planning

Your first step is to take a look around your neighborhood to determine what's there—I mean what's *really* there for you as a scanner listener? For instance, there

are two sets of railroad tracks within one mile of my house, and yet I didn't really notice either of them for a long time. One set is covered by a bridge, so I don't see them when I drive that way, and the other set runs behind the subdivision in back of me, so I didn't pay much attention to them either—until I started looking.

Get a map and draw one-mile, two-mile, and five-mile circles around your house. Draw one more circle to represent the area that you typically scan (where the departments and agencies you regularly listen to are located). It may not be a per-

fect circle, but be realistic about what you really keep up with.

You'll be surprised at how much a mile circle really encompasses. It doesn't take long to drive a mile on the roads, but looking at the radius you'll see that it covers a lot of ground. Imagine if a railroad spill or factory accident created a vapor cloud in your area; it could easily be toxic a mile or two away. Now imagine what communications would be entailed in a response to that situation.

Have a good look at that map. What type of businesses do you know of with-

## Frequency Of The Month

Each month we ask our readers to let us know what they're hearing on our "Frequency Of The Month." Give it a listen and report your findings to me here at "ScanTech." We'll pick a name at random from the entries we receive and give that lucky winner a free one-year subscription, or extension, to *Pop'Comm*. Remember to include your address in case it's your name that's drawn! Good luck!

This month, our frequency is **460.400**. Let me know what you hear (or don't hear!), either via email at [radioken@earthlink.net](mailto:radioken@earthlink.net), or by traditional method at Ken Reiss, 9051 Watson Rd. #309, St. Louis, MO 63126. Be sure to put the actual frequency on the envelope or in the email subject line so it gets entered correctly for our one-year subscription drawing. And don't forget that address!

Our most recent FOTM winner is **Jason Andrew Fowler**, KB7PZZ, of Las Vegas, Nevada. Congratulations, Jason!

# AR-ALPHA

## Professional Grade Communications Receiver



- Multi-mode unit capable of receiving AM (synchronous), ISB, RZ-SSB, USB, LSB, CW, WFM including FM stereo, NFM, APCO-25 digital, and TV in both NTSC and PAL formats
- Up to 1MHz of bandwidth can be recorded for later playback and review
- 6-inch TFT color panel can display received video signals or depict spectrum activity over a wide choice of bandwidths including a

### With New I/Q Control Software!

AOR proudly presents the AR-ALPHA, the first in a new class of professional monitoring receivers! Designed to cover 10KHz to 3.3GHz continuous, with no interruptions\*, this receiver features sophisticated I/Q control software that enables it to perform unattended datalogging for extended periods. It boasts a 6-inch color TFT display, five VFOs, 2000 alphanumeric memories that can be computer programmed as 40 banks of 50 channels, 40 search banks, a "select memory" bank of 100 frequencies, and a user designated priority channel. It also includes APCO-25 digital capability and a DVR with six channels that can record up to a total of 52 minutes of audio. Monitoring professionals will appreciate the world class engineering and attention to detail that makes the AR-ALPHA such an amazing instrument.

"waterfall" function to show signal activity over a specified time period

- Composite video output on the rear panel of the unit
- Selectable IF bandwidths: 200 Hz, 500 Hz, 1 KHz, 3 KHz, 6 KHz, 15 KHz, 30 KHz, 100 KHz, 200 KHz and 300 KHz along with the ability to shift the IF
- CTCSS and DCS selectable squelch functions; DTMF tone decode
- Built-in voice-inversion descrambling\*\*
- CW pitch control, AGC, AFC
- Auto-notch feature
- User selectable spectrum display function from 250 KHz through 10 MHz in 1 KHz increments. Above 10 MHz bandwidth, it can display 20 MHz, 50 MHz, 100 MHz or 1 GHz, but above 20 MHz bandwidth, no audio will be available
- Resolution bandwidth is also user-selectable in increments of 1 KHz, 4 KHz, 32 KHz, 64 KHz, and 128 KHz
- Fast Fourier Transform (FFT)
- Rear panel connections include 12 VDC power, RS-232C, USB 2.0, I/Q output with 1 MHz bandwidth, two antenna ports (one SO-239 and one Type N) and up to four antennas may be selected through the receiver's controls with the optional AS5000 antenna relay selector
- Use desktop or with 19" rack mount

*The AR-ALPHA redefines excellence in professional monitoring receivers. No wonder so many monitoring professionals including government, newsrooms, laboratories, military users and more, rely on AOR.*



AOR U.S.A., Inc.  
20655 S. Western Ave., Suite 112  
Torrance, CA 90501, USA  
Tel: 310-787-8615 Fax: 310-787-8619  
info@aorusa.com • www.aorusa.com

Specifications subject to change without notice or obligation.  
\*Documentation required for qualified purchasers in the USA.  
\*\*Not available on US consumer version.

# Advanced AR-IQ Software Allows High Speed I/Q Recording Up to 1MHz Bandwidth!



Signal searching is easy with playback capabilities through a PC



PC screen displays waterfall function to capture signal bursts

- Up to 1MHz bandwidth can be recorded for later evaluation
- High recovered audio quality with no deterioration of recorded data
- Can be used to perform unattended datalogging
- Spectrum display, full color waterfall and averaging functions support signal evaluation and analysis
- Easy to use. No training required.

can even listen repeatedly to a loop in time to decode a transmission received in difficult conditions.

AR-IQ software can be uploaded to multiple PCs so that you can transfer data from a PC connected to the AR-ALPHA over to another PC for playback and review.

**The AR-ALPHA with AR-IQ software sets a new standard for professional grade multimode monitoring receivers!**  
**To order, contact your AOR dealer today.**

AOR has brought a new level of receiver control to the AR-ALPHA with the addition of AR-IQ software. This free software enables the AR-ALPHA to store and playback a full 1MHz of bandwidth activity without any loss of quality. Raw data can be easily transferred from the AR-ALPHA to the hard drive of almost any computer\*\*\* for later analysis and review. It is even possible to listen to a frequency off-line by recording

data and storing it on a PC. Operators can also create loops to cover a particular time frame so that no signal is missed. Signal bursts are easily seen with the full color waterfall display function.

Using the control panel of the AR-ALPHA through a PC monitor, operators are able to enjoy added capabilities. You can perform unattended datalogging for extended periods of time depending on storage capacity. So, for hours, days or even weeks, you can capture up to 1MHz bandwidth between 10kHz and 3.3 GHz for later playback and analysis. You

\*\*\*AR-IQ software can be used with any dual core class PC operating Windows® XP or Vista with 2GHz CPU and 1GB RAM.



FEMA workers setting up a Mobile Disaster Recovery Center. These campers are self contained and include satellite uplinks and other forms of mobile communications. (Photo courtesy FEMA/Marvin Nauman)

in one mile? Drive around or walk the dog (and give both of you some exercise) and now look around in detail. If you're driving, take a friend or a portable audio recorder along to make notes so you can concentrate on the road.

Once you get this information, go back home and think a bit about the kinds of activities that go on in those places. An

industrial park might have any number of businesses that deal with some form of hazardous materials. What would happen if some chemical spilled? Or an explosion occurred? Or a major fire broke out? Analyzing your neighborhood in this way makes for a great rainy day project.

Now ask yourself some more questions. While we all hope it never hap-

pens, if a serious situation should arise, what agencies would be likely to respond immediately? Does your fire department have a hazardous materials unit that operates separately from the main companies? Or does that unit have frequencies of its own? What frequencies would be used by the first responders? Would they switch to another set once they were on the scene? What frequencies are used for on-the-scene coordination of big events? What inter-agency frequencies might be involved?

Once you get started thinking this way, a huge range of possibilities opens up to you. For instance, let's just look at medical services. Which ones might be involved? What frequencies do the on-scene units use? How about dispatch, ambulances, or coordination with the hospital en route? If you're in a large metropolitan area, would multiple hospitals get involved? Which hospitals in your area handle trauma patients? How about hazardous materials incidents? How about a large traffic accident? If you only have one local hospital, might it transfer non-critical patients somewhere else? How about very critical patients? Is there a medivac service in your area? What frequencies does that use? Where's the closest trauma center? Burn unit? It's certainly a lot to think about. Listening to

### Dropping In On Field Day

If you're interested in learning more about emergency preparedness and how your radio hobby fits in with that, you owe it to yourself to check out an amateur radio Field Day event. What's that?, you ask...

The American Radio Relay League's website has this to say: "ARRL Field Day is the most popular on-the-air operating event in amateur radio. It's held annually on the fourth full weekend in June, and is a time when "tens of thousands of amateur radio operators gather for a public demonstration of our service. Field Day is part educational event, part operating event, part public relations event—and ALL about FUN!"

In a nutshell, these are planned events at which ham radio operators hone their skills and demonstrate their capabilities "in the field," all in the name of the Amateur Radio Service. This community enjoys large amounts of spectrum because of its ability and willingness to help out in disasters and emergency situations, providing both local and worldwide communications when necessary.

If you're not a ham yourself but would like to see what it's all about, it may be as easy as finding a local club and asking who's operating and where. Most hams are quite happy to have visitors, and you might even get to help out a bit if you want to. See "Getting Ready for Amateur Radio Field Day," by Chip Margelli, K7JA, elsewhere in this issue to find out how.



Cal Fire operates DC 10 aircraft as part of a military support effort of U.S. Northern Command to provide assistance to the U.S. Forest Service, the California Department of Forestry and Fire Protection, and the National Inter-agency Fire Center. These planes are used primarily for fighting wildfires in the west. (Photo courtesy FEMA/Adam DuBrowa)

your medical services now when only routine traffic is happening will answer a lot of those questions. Now make a target monitoring list for each type of event that you can foresee.

Don't forget that the larger the event, the more likely it is that there might be involvement by some entities you don't normally listen to. Utility companies are the first thing that come to my mind. I don't listen to them under normal circumstances, but in an emergency both the gas and electric companies are likely to be called to shut off services to an affected area—even for say a relatively small fire. In a big event, they're going to be very busy. Do you have their frequencies on your list?

Sometimes you can get more background information from these so-called "back channel" communications than you will from the fire department or hazmat team that's on the scene. The fire responders are right there, so they're probably yelling things to each other rather than talking on the radio. The utility guys, however, need to know exactly what they're getting into before they get there, so there may be some explanations given on the radio.

Don't count out commercial and residential areas, either. What would happen if a large fire or electrical problem

occurred near you? How about a lightning strike? A tornado, hurricane, or earthquake? Just because you don't have industry or railroads nearby doesn't mean you can't come up with interesting targets if you use your imagination.

### The Time Of The Season—Weather Emergencies

Unfortunately for many of us, there's one type of monitoring that all too often pays off: severe weather-related communications. Severe weather affects pretty much everyone, at one time or another. And when it happens, it *is* in your backyard! At a minimum, you should have a written list of what's normally in your scanner (that's a good idea anyway, just in case) and a frequency plan for severe weather emergencies. It may take more than one list if your area is subject to different kinds of weather emergencies.

Begin by determining what types of severe weather could affect your area and who would be likely to respond to that condition. If you're in a state where severe snow storms are likely, you'll need one set frequencies for agencies that would respond to those. If your area is also subject to tornadoes or hurricanes, you'll need other lists for agencies that would respond to those.

We're just getting ready to enter the hurricane and tornado season, and in a good part of the country, most severe storms occur from the early spring through late fall. Of course, Mother Nature being as unpredictable as she is, they can occur almost anytime, anywhere. So even though you may have just put the snow blower away, you could still be in for more activity.

### SKYWARN

It's not nearly as much fun to listen to this stuff if it's coming your way, but being well prepared is your best defense. One thing you should do, if you haven't already, is to join your local SKYWARN program and get trained on the types of emergencies that are likely to strike your area. One of the things that you'll learn in that training is how to keep yourself safe.

Moreover, if you're in an area that's prone to tornadoes, you can be of great assistance as there's a tremendous need for volunteer spotters. Radar has come a long way in identifying likely areas for tornadoes to occur, but only a trained spotter can tell for sure if there's an actual tornado, and if so, if it's in the air putting on a fascinating but mostly harmless display, or if it's in contact

## CC WiFi Internet Radio



**Receive Your Favorite Stations\*  
Over 16,500 Available Worldwide**

- Excellent, Clear Audio
- Works on Any Broadband Signal
- Now with Pandora
- Real, MP3, WMA Formats • 99 Presets
- Wireless or Direct Connection via Ethernet Jack, Line-Out, Headphone, Signal Strength Indicator
- No Subscription Fee

\* Your favorite station must stream audio. You must have broadband internet service.

\$139<sup>95</sup>

**C. CRANE**

**Free Catalog**

**800-522-8863 • ccrane.com**



Brownsville Texas fire and rescue teams respond to a warehouse fire. Multiple agencies may be involved in getting such fires under control and evacuating an area due to hazardous conditions or materials in the warehouse. (Photo courtesy FEMA/Jacinta Quesada)

with the ground destroying almost everything in its path.

But no matter where you live, you can still be of great service. By joining your local SKYWARN or emergency services volunteers, you'll be more likely to know where you can volunteer to help in a meaningful way if you're lucky enough to be unaffected by an emergency.

Ham radio is the primary communications method for a lot of SKYWARN activities, although not in all areas. Find out what modes and frequencies are used in your vicinity. Put those in your scanner and lock them out until you need them, or at least put them on your weather emergency list to be programmed in when it happens. Unless you're interested in ham radio, you may not appreciate the day-to-day activity of the repeaters tying up your scanner and making you miss public safety traffic. On the other hand, many people enjoy listening to ham radio and dedicate a scanner to it for that reason—many of them are also inspired to get a license, which is easier now than it's ever been! (If you are interested in checking out ham radio from

the transmitting side of the signals, see "Dropping In On Field Day.")

In the St. Louis area, where I live, as well as in some other locations I'm familiar with, the SKYWARN program kicks into action once a severe storm watch or warning is issued. Policies on how and when the network is activated and what activities go with what level of watch or warning varies, but you can bet that someone will be monitoring the situation. As conditions worsen, these volunteer networks spring into action. They are often the best source of accurate and up-to-date weather and storm information.

## Related Comms

You'll also want to listen to police and fire channels in these situations. The police are likely to be primary weather observers and are positioned all over town. Anything out of the ordinary will be reported quickly.

Once a serious storm or other emergency strikes—or even before—police and fire services are pressed into action.

Medical emergencies will be their first priority, followed closely by fire control and rescue operations. There may also be a need to set up trauma centers or patrol areas to keep gawkers or looters from a severely damaged area. In severe events, outside assistance may be brought in; if damage is widespread, other communities may not even be able to assist. In very serious situations, federal disaster teams and National Guard units may be called in to an afflicted area. These can take some time to mobilize and you'll have days of intense communications to monitor. Activity of local agencies attempting to cope with the situation and assess the need for outside assistance can be nothing short of pandemonium.

Again, the utility companies will be busy in these areas as well, and downed wires and power problems will be their priority. You may yet need those batteries you stockpiled for that snowstorm that didn't materialize! (To make sure you're really prepared for an extended outage, see "Generate Some Fun On Field Day—Safely!" in this month's "Ham Discoveries" for helpful info on power generators.)

## The Fine-Tuning

Once you've got all your lists put together, you may find there are some holes in your knowledge. That's really the whole point (no pun intended), because it will give you some direction about what to listen to in order to fill in the gaps.

And when you've exhausted everything you can think of, perhaps you can discover something new and interesting by monitoring one of our Frequencies of the Month for awhile. You may be quite pleasantly surprised with what shows up.

Frankly, I'll take dull and boring traffic stops any day over the havoc that can result during an emergency, and hopefully you'll never need any of these lists. But it's still fun to put them together and work on filling in the gaps. There's no way you'll be able to compile lists that are completely accurate, or that take into account every type of disaster that you could possibly encounter, but that's OK. Remember, in most instances, this is just a hobby and meant to be enjoyable. And if an emergency does strike, you'll be better prepared—and maybe safer—for having taken the time to do this *before* "the big event" occurs. So make some lists and have fun. Find out what you don't know.

Until next month, Good Listening!



SCANNER MASTER

CALL 1-800-SCANNER



www.scannermaster.com

info@scannermaster.com



SCANNER MASTER is the nation's oldest and largest scanner-only dealer. For over 30 years we've specialized in nothing but scanners, frequency guides, scanner software and scanner accessories.

Uniden-Bearcat® Scanners **Uniden Remote Heads In Stock!** GRE GRECOM Scanners RadioShack Scanners AOR & ICOM Receivers

◆ Mobile and Portable Scanner Antennas ◆ The Best in Scanner Software ◆ Scanner Accessories

- Our Services**
- Programming
  - New Product Guide
  - Boston Area Store
  - Worldwide Shipping
  - One Page Checkout
  - Gift Wrapping
  - Gift Certificates
  - Newsletter

We help you choose the right scanner for your area and we also offer scanner programming services! Having trouble programming a scanner you already own? Call or e-mail us. We can do it for you!

- Our Guarantees**
- 30 Day Money Back
  - Same Day Shipping
  - New Products Only
- See Our Website Or Call For Details
- MEMBER OF

North American Master Distributors for some of the world's most unique and exciting scanner accessories, including:

- Butel ARC Scanner Programming and Control Software for Uniden, Radio Shack, GRE, AOR and ICOM scanners
- RadioReference.com CD-ROM - The ultimate nationwide frequency and trunking database on CD
- Solid State Electronics (SSE) - The famous "Jim" line of scanner Pre-amplifiers, filters and accessories
- Waters & Stanton and the Watson line of products from the U.K. - A variety of antennas, speakers, filters, amplifiers, Aircraft tracking software and much more
- DD Amtek - Inexpensive high-performance indoor and outdoor scanner filters and pre-amplifiers

Our Product and Services Categories

- Scanners (Uniden-Bearcat, GRE, AOR, RadioShack)
- Scanner Packages (discounts when you buy a scanner with accessories)
- Scanner Programming
- Scanner Software
- Frequency Guides and RadioReference.com CD-ROM
- Scanner Antennas and Cable (base, mobile, portable)
- GPS Receivers for Uniden Scanners
- Scanner Carrying Cases
- Aviation Scanning (Air-Nav box, antennas, amplifiers, filters)
- Race Scanning (Scanners, headsets, splitters, antennas)
- Scanner Accessories
- Base/Portable/Mobile Brackets & Mounts
- Scanner Speakers & Earphones
- AC Adapters and Scanner Batteries
- PC Cables & Connectors for Scanners
- Notch and Band-pass Filters
- Scanner pre-amplifiers
- Mobile Antenna Mounts & Power Cords
- ScannerStation Multi-Scanner Monitoring Software
- Commercial Monitoring Systems Design & Installation

Store Open 9-5, M-F

We've Moved! Our new address and showroom: 260 Hopping Brook Road, Holliston, MA 01746

Check out our web site or call or e-mail us for our free product flyer!

1-800-SCANNER www.scannermaster.com info@scannermaster.com

Scanner Master is a proud partner of RadioReference.com

# Somalis Everywhere And Other Shortwave Stirrings

by Gerry L. Dexter  
gdex@wi.rr.com

Another African opposition station has taken to the air. Bar-Kulan is intended for Somalis “Everywhere,” which is what the station’s name means in English. It’s run by a group of Somali journalists who claim the program content will be open to just about every aspect of political thought, Somali culture, ideas, entertainment, and business (hopefully that won’t include the Somali pirate industry!). That should prove a lot to cram into their one-hour programs, which will (initial-

*“[African opposition station Bar-Kulan is] run by a group of Somali journalists who claim the program content will be open to just about every aspect of political thought, Somali culture, ideas, entertainment, and business...”*



TRAXXfm is one of the Malaysian stations heard on shortwave via Radio Television Malaysia. (Thanks Rich D'Angelo)

ly) run from 0500–0600 on 15750 and 1600–1700 on both 9930 and 9960; the sites are as yet unspecified. Later on, the group intends to initiate broadcasts on FM, via satellite, and also do live audio streaming. Big plans. Let’s hope that the shortwave, at least, is for real.

Also donning a target on its back is Djibouti. It will be the focus of La Voix de Djibouti, which is said to use 15165 from 1530–1630 on Thursdays, mostly in FF with some AA and Koran recitations. Again, there’s no indication of what transmitter site is being used, but you can be sure it’s outside of Djibouti.

Radio Vanuatu now has three active frequencies, having added 5055 to 3945 and 7260. 5055 is hosting a new 10-kW transmitter, which runs in parallel with 3945 from 0700–2000. 7260 does a solo gig for the remaining hours.

La Voz del Guaviare, from San Jose del Guaviare, Colombia, has reactivated on 6035 having been off the air for almost a year (see logs).

Radio Bana, Eritrea, has repositioned itself on 5060, having left 5100. It’s a tough one and, as log reporter Sheryl Paszkiewicz notes, it requires “a good African night.”

## Reader Logs

Before we go into the logs, I need to mention again that some of you need to take a little more care with your submissions. Common mistakes are leaving out the time or frequency, using non-standard abbreviations for station names, or omitting a location, or transmitter site. As an extreme example, Germany, Poland, and the Netherlands do not even transmit from within their own coun-



A view inside the new WJHR, which is actually the home of owner George S. Mock in Milton, Florida. (Thanks Rich D'Angelo)



Towers at one of the Voice of America's Asian relay stations. (Thanks Rich D'Angelo)

tries any longer, so it's very important to "cite the site." Otherwise, you may leave a new SWL counting the wrong country. The *World Radio TV Handbook* and the main online references (EiBi, Aoki, and HFCC) all include transmitter sites in their listings.

Now...remember, your shortwave broadcast station logs are always welcome. But *please* be sure to double or triple space between the items, list each logging according to the broadcaster's home country, and include your last name and state abbreviation after each. *Please check your material before submitting!*

Also needed are spare QSLs or good copies you don't need returned, station schedules, brochures, pennants, station pho-

tos, and anything else you think would be of interest. And how about sending a photo of you at your listening post? It's your turn at bat!

Here are this month's logs. All times are in UTC. Double capital letters are language abbreviations (SS = Spanish, RR = Russian, AA = Arabic, etc.). If no language is mentioned English (EE) is assumed.

**ALASKA**—KNLS, 6915 on radic propagation at 1230. (Ng, Malaysia)

**ALBANIA**—Radio Tirana, 6135 at 0335 acknowledging reception reports. (Maxant, WV)

**ALGERIA**—RT Algerienne, 5865 via Issoudun at 0407 with

*Listening is only half the fun...*

## POPULAR COMMUNICATIONS *is the other half!*

The World's most authoritative monthly magazine for Shortwave Listening and Scanner Monitoring.  
Read by more active listeners world-wide.

You'll find features on scanner monitoring of police, fire, utility, and aircraft communications; international shortwave listening; CB radio; amateur radio; FRS; GMRS; monitoring radio digital communications including CW, RTTY, SITOR, etc; AM/FM commercial broadcasting; weather and communications satellites; telephone equipment and accessories; radio nostalgia; alternative radio; clandestine radio; and military radio.



**\*FREE**  
2010/11 CQ Amateur  
Radio Ops Calendar  
with every 3-year subscription!  
Purchase a 3-year subscription  
and receive a 15 month calendar  
(Jan. 2010 through Mar. 2011)  
a \$8.95 value

\*While supplies last.

	USA	CN/MX	Foreign
1 Yr	32.95	42.95	52.95
2 Yrs	58.95	78.95	98.95
3 Yrs	85.95	115.95	145.95

**Popular Communications**

25 Newbridge Road, Hicksville, NY11801

Phone: 516-681-2922; Fax 516-681-2926

Visit our web site: [www.popular-communications.com](http://www.popular-communications.com)

## Pop'Comm June 2010 Reader Survey Questions

This month, we like to ask about your hobby and emergency preparedness. Please use the Reader Survey Card and circle all appropriate numbers. We'll pick one respondent at random for a free one-year subscription, or extension, to *Pop'Comm*, so don't forget your address. Thanks for participating.

### How prepared do you feel you'd be if an emergency struck?

- Very, I've got the bunker stocked . . . . . 1
- I could ride out a situation for many days . . . . . 2
- I'm set with the basics . . . . . 3
- I'd be up a creek . . . . . 4

### How has your radio hobby made you better prepared?

- I'm set with the scanners I need . . . . . 5
- I'm set with broadcast receivers . . . . . 6
- I'm set with ham radio equipment . . . . . 7
- I'm set with other two-way radios . . . . . 8
- I have reliable backup power . . . . . 9
- I've received specialized training . . . . . 10

### Have you experienced an emergency situation in which you used your radio skills/equipment?

- Yes . . . . . 11
- No . . . . . 12
- Not yet . . . . . 13

We're out of room for February survey highlights, but the winner of a free subscription or extension to *Pop'Comm* for sending in his response that month is **Adam Shirley of Meridian, Mississippi**. Congratulations, Adam!

Koran. (Spies, WV) 0454 in AA with Koran. (Parker, PA)

**ANGUILLA**—University Network, 6090 heard at 0715 with Melissa Scott preaching. (Maxant, WV)

**ARGENTINA**—Radio Nacional/RAE, 6060 in PP at 1010 with local music and slightly distorted audio. 11710 at 0015 in PP, ID at 0056 and into SS ID and anmts at 0100 then into JJ. Also, 15345 in SS heard at 2230. (Alexander PA) 11710 at 0318 with tangos, W ancr in FF. (D'Angelo, PA) 15345 in SS at 2200. (Paszkievicz, WI) 2350 in SS. (MacKenzie, CA)

**ASCENSION IS.**—BBC Atlantic Relay, 7255 at 0408 and 12095 at 2232. (MacKenzie, CA) 15400 at 1932. (Brossell, WI) 15400 at 1640, 17640 at 1556 and 17830 at 1525. (Parker, PA)

**AUSTRALIA**—Radio Australia, 6020 at 1330, 9745 at 0715, 11945 with call-ins at 0925, 12080 at 2115 and 13630 at 2115. (Maxant, WV) 9580 at 1900. (Patterson, Philippines) 11660-Shepparton in CC at 1345. (Parker, PA) 12040 via Palau at 2223. (Ronda, OK) 11880-Shepparton at 1815, 13630-Shepparton at 2252, 15515-Shepparton at 2230, 15560-Shepparton at 2323 and 17795-Shepparton at 2325. (MacKenzie, CA) 12040 via Palau at 2345 and 15290 via Taiwan at 0620. (Ng, Malaysia)

ABC Northern Territories Service: Alice Springs, 2310 barely above the noise level at 1149. (Brossell, WI) Heard very late at 1425. (Barton, AZ) 4835 at 2130. (Ng, Malaysia) Tennant Creek, 4910 at 2205. (Patterson, Philippines) 0204. (Parker, PA)

HCBJ Global, Kununnura, 11750 with gospel reading at 0920 and 15400 with call-ins at 2345. (Maxant, WV) 0215 in Hindi. (Ng, Malaysia) 1525 in Mandarin at 2310. (Patterson, Philippines)

**AUSTRIA**—Radio Austria Intl, 6155 in GG at 2103. (Brossell, WI) 7325 in GG at 0005. (Fraser, ME) 13675 via Canada in GG at 1605. (Maxant, WV)

**BELARUS**—Radio Belarus, 6155 at 2120 with talk, then times and frequencies. (Maxant, WV)

**BOLIVIA**—Radio Mosoj Chaski, Cochabamba in SS at 2355. (Wilkner, FL)

Radio Yura, Yura in SS heard at 2340. (Wilkner, FL)

Radio San Miguel, Riberalta, 4700 in SS at 0000. (Wilkner, FL)

Radio San Jose, SJ de Chiquitos in SS at 0000. (Wilkner, FL)

Radio Santa Cruz, Santa Cruz in SS at 1040. (Wilkner, FL)

Radio Fides, La Paz, 6155 in SS at 1010. (Wilkner, FL)

**BONAIRE**—Radio Nederland Relay, 6165 in DD at 0438 and 15315 in SS at 2352. (MacKenzie, CA)

**BOTSWANA**—VOA Relay, Mopeng Hill, 4930 at 2115 with *African Beat*. (Ng, Malaysia) 0250, also 17715 at 1645 and 17895 at \*1500. (Parker, PA) 9885 at 0338. (Brossell, WI) 11710 at 0502 to 0530 sign off.

## Help Wanted

We believe the "Global Information Guide" offers more logs than any other monthly SW publication (nearly 670\* shortwave broadcast station logs were processed this month!). Why not join the fun and add your name to the list of "GIG" reporters? Send your logs to "Global Information Guide," 213 Forest St., Lake Geneva, WI 53147. Or you can email them to [gdex@wi.rr.com](mailto:gdex@wi.rr.com). Please note that attachment files do not always go through. See the column text for formatting tips.

*\*Not all logs get used. There are usually a few which are obviously inaccurate, unclear, or lack a time or frequency. Also discounted are unidentifieds, duplicate items (same broadcaster, same frequency, same site), and questionable logs*

(D'Angelo, PA) 12080 in FF from \*2000 and 15580 at 1807. (Ronda, OK) 17895 heard at 1835. (MacKenzie, CA)

**BRAZIL**—(All in PP—gld) Radio Cultura, Araraquara, 3365 heard at 0950. (Wilkner, FL)

Radio Difusora do Amazonas, Manaus, 4805 with vocal at 2352. (Wilkner, FL)

Radio Alvorada, Londrina, at 0024 with W in religious talks. (Parker, PA)

Radio Clube do Para, Belem, 4885 with a discussion at 0225. (Parker, PA) 0411. (Yohnicki, ON) 0604 with ballads and echo effects. (Wood, TN)

Radio Novo Tempo, Campo Grande at 0140 with M ancr and inspirational music. (Parker, PA)

Radio Difusora, Macapa, 4915 at 0201 with fast-talking M and many IDs. (Parker, PA) 0427. (Wood TN)

Radio Educacao Rural, Tefe, 4925 at 0149 with religious talk. (Parker, PA)

Radio Capixaba, Vitoria, 4935 monitored at 0143 with high-speed M/W chatter. (Parker, PA)

Radio Brazil Central, Goiania, 4985 with fast talking ancr, jingles and assorted merriment. (Parker, PA) 2300 with futbol. (Wilkner, FL)

Radio Cultura do Para, Belem, 5045 heard at 0353 with rock, ID and frequency anmt. (Parker, PA) 0402 with music similar to U.S. pops from the '60s and '70s. (Wood, TN)

Voz Missionaria, Florinapolis, 5940 at 0130 with jingle, talks, ID. (Paszkievicz, WI) 0500 with anmts, promos, jingles, contemporary Christian music, very weak on //9665. (Alexander, PA)

Radio Senado, Brasilia, 5990 at \*0922 abruptly on with Brazil-pops. ID at 0930 and more ballads. (Alexander, PA)

Radio Inconfidencia, Belo Horizonte, 6010 at 0730. (Maxant, WV)

Radio Nacional Amazonia, Brasilia, 6185 at 0705 with several IDs, music with listener call-ins. (Wood, TN) 11780 with Brazilian music at 0039. (Yohnicki, ON) 0341 with talks. (Brossell, WI) 2245. (Patterson, Philippines)

Super Radio Deus e Amor, Curitiba, 9565 at 0120 with preaching, //6060 was weak under Cuba. Also, 11765 at 0055 with local religious music and a sermon. (Alexander, PA)

Radio Bandeirantes, Sao Paulo, 9645 at 0200 with talk, promos and vocals during *Sunday Program*. (Paszkievicz, WI)

Observatorio Nacional, Brasilia, 10000 at 0015 with ID and time every 10 seconds. No trace of WWV. (Parker, PA)

**BULGARIA**—Radio Bulgaria, 5900-Plovdiv with Cuban music at 0323. (Parker PA) 0332 with Bulgarian hip-hop. Also 7400 with SWL news at 0330. (Wood, TN) 7300 in SS at 0321. (Brossell, WI) 7400 heard at 2240. (Fraser, ME) 7400 with folk songs at 0725. (Maxant, WV) 9400 in BB at 0105. (MacKenzie, CA)

**CANADA**—Radio Canada Intl, 5840 via Sweden in AA at 0312, 12025 in FF/EE at 2144 and 15305 in PP at 2245. (MacKenzie, CA) 9610 in FF at 1820 and 9755 at 0105. (Maxant, WV)

CBC Northern Service, 9625 with pgm *Vinyl Tap* at 0426. (Wood, TN)

CFRX, Toronto, 6070 with news/talk at 1810 (Maxant, WV)

CKZN, St. John's (Newfoundland), 6160 at 0725. (Maxant, WV)

**CHAD**—RN Tchadienne, N'Djamena, 4905 heard at 0319 with W playing pops. (Parker, PA)

**CHILE**—CVC, Santiago, 17680 with Christian pops at 1553. (Parker, PA) 2328 with vocals. (MacKenzie, CA)

**CHINA**—China Radio Intl, 7285 via Albania with *China Horizons* at 2030. (Fraser, ME) 7300 in CC at 0144, 9570 via Albania at 0044, 9590 in SS at 0133, 9765 in Khmer at 0040, 9820 in Hakka at 0034, 9860 also in Hakka at 0010, 11885 at 0112, 13580 in CC at 0004 and 13700 in SS at 2235. (MacKenzie, CA) 7360-Kunming with CC/Thai lesson at 1215. (Ng, Malaysia) 9435-Kashi at 1647 and 9685-Xi'an in VV at 1332. (Brossell, WI) 15125-Kashi at 0725. (Patterson, Philippines)

China National Radio/CPBS: 6175 at 1700 in CC. (Barton, AZ) 9675 in CC at 0045, 11835 in CC at 0018 and 12045 in CC at 0010. (MacKenzie, CA) CNR-1, 11720-Shijiazhuang, in Mandarin at 0112. (Ronda, OK) Xizang PBS, Lhasa (Tibet), 4820 in CC at 1220. (Paszkievicz, WI) CNR-2, 9820-Xi'an in Mandarin at 2228. (Ronda, OK) 4920 in (p) TT at 0015. Xinjiang PBS, Urumqi, 3950 in CC at 0150 and 4980, Urumqi, in (I) Uighur at 0026. (Parker, PA)



The Voice of Malaysia highlights local views and activities. (Thanks Peter Ng, Malaysia)

Firedrake music jammer: 11945 against Radio Free Asia Northern Marianas Relay and 15430 vs. RFA at 2343. (MacKenzie, CA)

**COLOMBIA**—Marfil Stereo, Puerto Lleras, 5910 at 0518 with SS Mancr and song. (Parker, PA) 0538 in SS with some IDs and MOR Latin music. (Wood, TN)

La Vox de tu Concencia, Puerto Lleras, 6010 in SS with religious talk at 1035. (Alexander, PA)

La Voz del Guaviare, SJ de Guaviare, 6035 heard at 0045 with SS anmts. early sign off this night at 0056 with national anthem. (Alexander, PA)

**CROATIA**—Hrvatski Radio/Voice of Croatia, Deanovic, 3985 in CC at 0240. (Parker, PA) 0320 in SS. (Maxant, WV) 7375 via Germany monitored at 0310 in SS/EE and into SS. (Wood, TN) 0705 with news on Croatia. (Maxant, WV) 7285 in Croatian. (Brossell, WI)

**CUBA**—Radio Havana Cuba, 6120 with *Havana Hit Parade* at 0653. (Wood, TN) 9600 in SS talk at 0010. (Ng, Malaysia) 11730 in SS at 2240 and 13770 with peppy salsas at 1922. (Patterson, Philippines) 11760 in SS at 1825, 11800 in SS at 1819, 13770 in SS at 2215 and 13790 in SS at 2223. (MacKenzie, CA)

Radio Rebelde, 5025 in SS at 0045. (Maxant, WV) 0549 with domestic music. (Yohnicki, ON)

**CZECH REPUBLIC**—Radio Prague, 5930-Litomyšl at 2235. (Fraser, ME)

6200 in SS at 0150. (MacKenzie, CA) 9430 at 2110. (Maxant, WV) 11660 with *One on One* at 1420. (Ng, Malaysia)

**DIEGO GARCIA**—AFRTS, 4319u at 2152. (Patterson, Philippines)

**DJIBOUTI**—Radio Djibouti, Arta, 4780 at 0303 with Koran, AA talk, some local tribal music. (Alexander, PA) 0340 in AA. (Brossell, WI) 0414 with “neo-tribal” music. (Parker, PA)

**DOMINICAN REPUBLIC**—Radio Amanecer, Santo Domingo, 6025 at 0030 with SS talk. (Alexander, PA) 0135 with religious pgm. (Paszkiwicz, WI)

**ECUADOR**—HCJB Global, 11920 via Chile in PP at 2330. (Patterson, Philippines) 12025 (Site?) in GG monitored at 2317. (MacKenzie, CA)

**EGYPT**—Radio Cairo, 6270 with vocals at 0315. (Maxant, WV) 7540 in SS at 0155. (Brossell, WI) 9915-Abis in SS at 0145. The signal was horribly distorted. (Parker, PA)

**ENGLAND**—BBC, 3255 South Africa Relay at 0307. (Paszkiwicz, WI) 5790-Rampisham to Europe in RR at 0553, 5875-Rampisham to Russia at 0620, 5905 Cyprus Relay in AA at 0510 and 6105 Cyprus at 0355. (Parker, PA) 6145 South Africa at 0350. (Ronda, OK) 7255 South Africa at 0405. (Maxant, WV) 9740 Singapore Relay at 1500. (Linonis, PA) 15105 South Africa in Swahili at 1538. (Parker, PA) 15790 Cyprus in Pashto at 0907. (Patterson, Philippines) 17710 via Russia in Hindi at 0205. (Ng, Malaysia)

**EQUATORIAL GUINEA**—Radio Nacional, Bata, 5005 at 0544 with vocals, M with SS talk, ID at 0608 and remote news reports. (D’Angelo, PA)

Radio Nacional, Malabo, 6250 at \*0535 sign on with SS talk, Radio Nacional and Radio Malabo IDs. (Alexander, PA) 0550 with W in SS talk, vocals, ID at 0601. (D’Angelo, PA)

**ERITREA**—Voice of the Broad Masses, Asmara, 7175 at 0357 with IS, (p) ID and into talk at 0358. (Ronda, OK)

Radio Bana, 5060 (t) at 0415 with vocals on a good African night. (Paszkiwicz, WI)

**ETHIOPIA**—Radio Ethiopia, 7110 at 0316 with HOA music. (Brossell, WI) 2035 to 2101 close with local and Western/Europops. Amharic talk. (Alexander, PA)

Radio Fana, 6110 in (p) Tigrinya at 0313. (Brossell, WI) 6890 at 2040 with HOA music, some US pops, Amharic talk. (Alexander, PA)

Amhara State Radio, 6090 under Caribbean Beacon at 0420 with talk and vocals. (Ronda, OK)

Voice of Peace and Democracy, via Radio Ethiopia transmitter, 7165 at \*0357 with local HOA music and echo ID. Talk in (l) Tigrinya

**Why just listen?**  
Morse Code requirement dropped!

**HamTestOnline™**  
Online courses for the ham radio written exams

- ▶ Fastest way to learn — most students pass the ham radio exam after only 10 hours study.
  - ▶ Study material, practice exams, and a virtual private tutor, all rolled into one. An intensely effective learning system. Just ask our students!
  - ▶ 100% guaranteed — you pass the exam or get your money back.
  - ▶ Online system — study when you want, at your own pace.
  - ▶ Free trial — try before you buy!
- [www.hamtestonline.com](http://www.hamtestonline.com)

*Any day you don't learn something new is a wasted day!*

**Licensed 1985 or Earlier?**

QCWA invites you to join with those distinguished amateurs licensed 25 or more years ago. Request an application from:

**QCWA, Inc., Dept. PC**  
PO Box 3247  
Framingham, MA 01705-3247  
USA



**POWERPORT**

**WaterSafe**

12V, 8 amp hour battery built into a completely watertight, padded Pelicar case w/waterproof outlet. Extra space for securing your cell phone, GPS, or radio



**PowerPort-312**

12 volt, 12 amp hour rechargeable battery. 3-port DC outlets, battery status display. Padded bag with detachable accessory pockets.

**PowerPort73**

Lightweight DC Power; 12 volt, 8 amp hour rechargeable battery w/3-port DC outlets. Padded carrying bag & auto 2-stage AC wall charger.



**Folding Solar Cells**

5 and 26 Watt Folding Solar charger.

**831-427-8197 • KC6QLB**  
[www.powerportstore.com](http://www.powerportstore.com)



The mostly female staff of the Voice of Malaysia. (Thanks Peter Ng)

at 0400. Listed for Mon-Wed-Fri only. (Alexander, PA)

Voice of the Tigray Revolution, 5980 heard at \*0256 sign on with IS, vernacular talk, HOA music. Weak under Okeechobee. (Alexander, PA)

**FRANCE**—Radio France Intl, 5925 in their North African service at 0627. (Wood, TN) 7315 with news at 0405. (Paszkiwicz, WI) 9805 in FF at 0405 and 11725 in FF at 0710. (Maxant, WV) 15300-Issoudun in FF at 1648. (Parker, PA) 15605 at 1600. (Linonis, PA) 1622. (Brossell, WI)

**GERMANY**—Deutsche Welle, 5915 via England in RR at 0535, 6130 Portugal Relay at 0500, 6180 Rwanda Relay at 0432, 9655 Rwanda in GG at 0048, 9775 via Ascension in GG at 0125, 11725 Rwanda in GG at 1947, 11830 in CC at 2328, 12025 Rwanda in GG at 0033, 15275 Rwanda in Hausa at 1855, 15440 Portugal in GG at 1832 and 15640 via Cypress Creek in GG at 2226. (MacKenzie, CA) 5915 via Rampisham in RR at 0525, 15275 via Rampisham in FF at 1751, 15315 via Issoudun in Hausa at 1645 and 15640 Portugal in GG at 1555-1558 close. (Parker, PA) 5945 at 0410, 9560 at 1605, 11690 at 2150 and 15605 at 1625. (Maxant, WV) 5905 via England at 0430. (Spies, WV) 9785 via Bonaire in GG at 0810 and 15640 via Cypress Creek in GG at 2320. (Patterson, Philippines) 7380 via Madagascar in II at 2241 and 9650 Sri Lanka Relay in Hindi at 1519. (Ronda, OK) 11690 Sri Lanka Relay with sports news at 0312. (Ng, Malaysia) 11725 Rwanda in GG at 1927. (Brossell, WI) 1945. (Fraser, ME) 15275 Rwanda in GG at 1800. (Linonis, PA)

**GREECE**—Voice of Greece, 9420 in Greek at 0336. (MacKenzie, CA) 12105 at 0720. (Maxant, WV)

RS Makedonias, 7450 in Greek at 1900. (Linonis, PA)

**GUAM**—Adventist World Radio, 9810 in CC at 1408. (Strawman, IA) 15320 in EE at 2238. (MacKenzie, CA)

Trans World Radio/KTWR, 12105 in CC at 0930. (Ng, Malaysia)

**GUINEA**—Radio Guinee, 7125 heard at 2352 to 0001\* with local Afropops and FF talk. Abruptly off at 0001. (Alexander, PA)

**HONDURAS**—Radio Luz y Vida, San Luis, 3250 in SS heard at 1100. (Wilkner, FL) 1216 with slow religious music, SS ancr. (Parker, PA)

**INDIA**—All India Radio, 4820-Kolkata, 0104 in (p) Hindi, 5040-Jeypore in vernacular at 1226, 9870-Bangaluru at 0206 and 11620-Khampur in EE at 1337. (Parker, PA) 6055 with Indian instls at 2320 and 6180 with Indian classical music at 2120. (Ng, Malaysia) 6115-Bangaluru at 0110 in Urdu to Pakistan.

(D'Angelo, PA) 9425-Bangaluru in Hindi at 2250 and 9835-Delhi in Hindi at 1310. (Ronda, OK) 9870-Bangaluru in Hindi at 1730. (Maxant, WV) 11585-Delhi in Hindi at 1249. (Brossell, WI) 11645-Delhi at 2310. (Patterson, Philippines)

**INDONESIA**—Radio Republik Indonesia, 3325-Palangkarya (Kalimantan) in II at 2145 and 3995-Kendari (Sulawesi) in II at 2155. (Patterson, Philippines)

Voice of Indonesia, 9525 monitored at 1115 in II. (Linonis, PA) 1315 with EE news. (Alexander, PA) 1339, switched to Malay at 1400. (D'Angelo, PA) 1345. (Maxant, WV)

**IRAN**—Islamic Republic of Iran Broadcasting/Voice of Justice, 7325 at 0146. (Brossell, WI) 15545 in AA heard at 1230. (Fraser, ME)

**JAPAN**—5960 via Canada in JJ at 0447, 6195 via Bonaire in SS at 0423, 9835 in JJ at 1853, 11910 in JJ at 2336, 13640 at 2215, 13650 in JJ at 2308, 15195 in CC at 2348, 17605 in JJ at 2332 and 17810 in II at 2315. (MacKenzie, CA) 6035 in (I) Korean at 1628 and 9835 going into JJ at 1700. (Barton, AZ) 11705 in JJ at 1415. (Maxant, WV) 11740 via Singapore in JJ at 0850 and 17810-Yamata with JJ/CC lesson at 2350. (Ng, Malaysia) 11910-Yamata in JJ at 2325. (Patterson, Philippines) 17735 via Issoudun in JJ at 1535. (Parker, PA)

Radio Nikkei, 3925 at 0830 mixing JJ and EE. (Barton, AZ) 1200. (Parker, PA) 9595 in JJ at 0528. (Ronda, OK)

**KUWAIT**—Radio Kuwait, 11990 with US vocals at 1920. (Maxant, WV) 15110 in AA at 1545. (Parker, PA)

**LAOS**—Lao National Radio, 7145 in EE at 1330. (Ng, Malaysia)

**LIBYA**—Radio Jamahiriya/Voice of Africa, 15215 in FF at 1710. (Parker, PA) 1800. (Linonis, PA) 17725 with EE features at 1422. (D'Angelo, PA) 1540, also 21695 at 1448. (Parker, PA)

**MADAGASCAR**—Radio Madagaskara, 5010 at 0247 with local pops, IS at 0254.

## This Month's Winner

To show our appreciation for your loggings and support of this column, each month we select one "GIG" contributor to receive a free book or other prize. Readers are also invited to send in loggings, photos, copies of QSL cards, and monitoring room photos to me at *Popular Communications*, "Global Information Guide," 25 Newbridge Rd., Hicksville, NY 11801, or by email to [gdex@wi.rr.com](mailto:gdex@wi.rr.com). The email's subject line should indicate that it's for the "GIG" column. So, come on, send your contribution in today!

This month's prizewinner is **William Hassig of Mt. Prospect, Illinois**, who receives a T-shirt, courtesy of those fine folks at Universal Radio, who are standing by to send you a copy of their giant free catalog containing everything you need to enjoy your radio hobby to the max. It's easy to get one: just send a request to them at [DX@universal-radio.com](mailto:DX@universal-radio.com) or call them at 614-866-4267 or drop a p-mail request to 6830 Americana Parkway, Reynoldsburg, OH 43068 and your wish book will be on its way!

Please mention *Pop'Comm* and the "Global Information Guide" when contacting them.



This attractive building houses the offices of WRMI, Miami. (Thanks Charles Maxant, WV)

choral anthem, opening ID anmts, local music and Malagasy talk. (Alexander, PA) 0315 Malagasy news by W. (Paszkievicz, WI)

Radio Mada Intl, 15670 via Moldova at \*1530 with test tones, sign on and talk in (p) Malagasy. Sat.–Sun. only. (Alexander, PA)

**MALAYSIA**—Voice of Malaysia, 6175 with music at 0930. (Maxant, WV)

Traxx FM on RTM, 7275-Kajang with EE news at 0700. (Ng, Malaysia)

**MALI**—RT Malienne, 9635 in FF at 0830 with AA-type music. (Linonis, PA)

**MAURITANIA**—Radio Mauritanie, 4845 at 0048 with Koran. (Parker, PA) 0603 in AA. (Wood, TN)

**MEXICO**—Radio Transcontinental, Mexico City, 4800 in SS at 0508. (Ronda, OK) 0655. (Maxant, WV) 0837. (D'Angelo, PA) 1215. (Paszkievicz, WI) 2350. (Wilkner, FL)

Radio Mil, Mexico City, 0424 in SS with slow ballads and news. (Parker, PA)

Candela FM, Merida, 6105 at 0635 with SS talk and ballads. (Alexander, PA)

Radio Educacion, Mexico City, 6185 heard at 0610 with variety of segued music. Almost completely covered by the Brazilian at 0626. (Wood, TN) 0730 with SS vocals. (Maxant, WV)

Radio UNAM, 9599 in SS monitored at 0135. (Maxant, WV)

**MOROCCO**—RTV Marocaine, 15345 in AA at 1624. (Brossell, WI)

**NETHERLANDS**—Radio Nederland, 5955 Portugal Relay in DD at 0601. (Parker, PA) 9895 Portugal in SS at 0025 and 17655 via Madagascar at 1945. (MacKenzie, CA) 12080 via Meyerton at 1919. (Ronda, OK)

11655 via Greenville in SS at 2315. (Patterson, Philippines) 15280 via Northern Marianas in II at 2213. (Paszkievicz, WI)

**NEW ZEALAND**—Radio New Zealand Intl, 6170 at 1345, 9765 at 0935, 11725 at 0455 and 17675 at 2125. (Maxant, WV) 15720 at 2346 and 17675 at 2213. (MacKenzie, CA)

**NIGERIA**—Voice of Nigeria, 15120 at 1708 with W and EE news. (D'Angelo, PA) 1835 in EE. (Maxant, WV)

**NORTH KOREA**—Voice of Korea, 9335 on Japan's ambitions concerning Korea. Later, in FF at 1618. (Brossell, WI) 11535-Kujang in KK at 2305. (Patterson, Philippines) 11710 at 1130 sign on with usual anti U.S. rants. (Linonis, PA) 15100 with *Listeners Mailbag* at 0245. (Ng, Malaysia) 15180 in EE at 0110, //13670. (Paszkievicz, WI)

KCBS, 9665 with martial music and songs in KK at 1608. (Brossell, WI)

Pyongyang Broadcasting Station, 9325 in KK at 1317. (Brossell, WI)

**NORTHERN MARIANAS**—Far East Broadcasting/KFBS, 12090 in VV at 2238. (MacKenzie, CA)

**OPPOSITION**—Radio Dabanga (to Sudan), 11655 via Madagascar at 1700 with AA talk, ID jingles, //13800. (Alexander, PA)

## ADVANCED SPECIALTIES INC.

Orders/Quotes 1-800-926-9HAM

[www.advancedspecialties.net](http://www.advancedspecialties.net)



GRE PSR-500 Digital Triple Trunking Handheld



BCD996XT 25,000 Channel Digital Trunking Scanner

**BIG ONLINE CATALOG**

**UNIDEN BEARCAT & GRE DIGITAL SCANNERS**  
• CB • AMATEUR • RADIOS & ACCESSORIES

ALINCO • YAESU • GALAXY  
• GRECOM • COBRA

(201)-VHF-2067

114 Essex Street, Lodi, NJ 07644



Closed Sunday & Monday



Since 1942  
[www.RFfun.com](http://www.RFfun.com)  
universal radio inc.

Radio Voice of the People (to Zimbabwe), 11610 via Madagascar at \*0400 in EE/vernacular with ID anmts, short mx breaks. (Alexander, PA)

Ethiopian Adera Dimtse Radio (to Ethiopia), 11830 at \*1700 in (I) Amharic. Some HGA music. Saturdays only. (Alexander, PA)

Voice of Peace and Democracy (to Eritrea), 7165 via Ethiopia at \*0537 with HOA music, echo ID and talk in (I) Tigrinya. Off at 0432. (Alexander, PA)

Radio Free Chosun (to North Korea), 12085 with KK talk at 1240. (Ng, Malaysia)

Radio Republica (to Cuba), 9810 via Sackville in SS at 0236. (Parker, PA)

**PAKISTAN**—Radio Pakistan, 17700 with news in EE at 1100. (Ng, Malaysia)

**PAPUA NEW GUINEA**—Radio Central, Port Moresby (Papua), 3290 with vocals at 1250. (Paszkievicz, WI)

**PERU**—Ondas del Huallaga, Huanuco, 3330 at 10-5 with M/W in SS, ID at 1010. (Wilkner, FL)

### In Times Past...

Here's your "blast from the past" for this month:

**IRAQ**—Radio Baghdad, 13620 at 1307 on October 30, 1990, with its General AA service from former Radio Kuwait transmitters in Iraqi-occupied Kuwait. (Dexter, WI)



WRMI's general Manager Jeff White in the engineering room. (Thanks Charles Maxant)

Radio Tarma, Tarma, 4775 monitored at 2335 with ID, M in SS. (Wilkner, FL)

Radio Vision, Chiclayo, 4790 at 0403 with M in SS and campos. (Parker, PA) 0442 preaching in SS before an audience, choral vocals to 0500, several IDs and more preaching. (D'Angelo, PA)

Radio Maranon, Jaen, 4835 at 0233 with W in SS, M with ID. (Parker, PA)

Radio La Hora, Cusco, 4857 with SS DJ. (Wilkner, FL)

Radio San Antonio, Atalaya, 4940 at 0050 with religious talk, occasional W talk. (Parker, PA)

Radio Cultural Amuata, Huanta, 4955 with long SS talk, boisterous music. (Parker, PA)

Radio Libertad, Junin, 5040 at 1040 with SS talk. (Wilkner, FL)

Ondas del Suroriente, Quillabamba, 5120 in SS monitored at 1050. (Wilkner, FL)

Radio Bolivar, Cd. Bolivar, 5460 with music monitored at 0010. (Wilkner, FL)

Radio Reina de la Selva, Chachapoyas, 5485 with M in SS, OA music. Gone at 0215 recheck. (D'Angelo, PA)

Radio Tawantinsuyo, Cusco, 6174 at 1040 in SS. (Wilkner, FL)

**PHILIPPINES**—Radio Veritas Asia, 11705 in Hindi closing down at 0055. Also 15530 in Telegu at 0105. (Ng, Malaysia) 11935 in Karen at 0012 and 15280 in Mandarin monitored at 2235. (MacKenzie, CA)

FEBC Intl, 9400 in Mandarin at 1240. (Brossell, WI) 9430-Bocue in Mandarin at 1528. (Ronda, OK)

Radio Pilipinas, 11880 with *Philippines Today* at 0300. (Ng, Malaysia) 15190 in Tagalog at 1750. (MacKenzie, CA)

**PIRATES**—Outhouse Radio, 6925v variously at 0043, \*0102, 0227, 0238, 1632, 1722 and 1909 with blues mixed with space sounds, techno rock, Radioactivity by Kraftwerk, various rock groups. (Zeller, OH) 0043, 0815 and 1905 with rock, country, pop. (Alexander, PA) 0110, 0505 and 2328 with various rock things. (Hassig, IL) 0505 with an ID at 0534. (D'Angelo, PA)

MAC, 6850.7 at 1632 with the old Radio Prague IS and rock. (Alexander, PA) 6925 at 1600, 1632 and 2215 with Ultraman Show, old TV themes, young boy ancr. macshortwave@yahoo.com and macshortwaveeradio@gmail.com. (Zeller, OH)

WBNY, 6900 at 2225 with "Pirate Week" pgm, mentioning T-shirt giveaway. (Alexander, PA) 2253 mentioning T-shirts, SWL Fest, pirates being busted. Also 6955 at 2345 with country things, Commandeer Bunny. Mentioned WBNY relay service. (Hassig, IL)

WMPR, 6925 at 2210 with typical techno rock with several "This is WMPR" IDs. (Zeller, OH, Balant, OH) 2235 with rock, electronic dance things, computer voice IDs. (Alexander, PA) 2245 usual dance things, cat meows. (Hassig, IL)

The Crystal Ship, 5385 at 0029 and 2345 with rock, an email from

John Poet. (Hassig, IL) 6876 at 1523 with rock oldies, numerous ID, said the broadcast was in "glorious AM." (Zeller, OH) 1640 with rock. (Alexander, PA)

WTCR, 6930u with pop/rock. (Hassig, IL) 6950u at 0135 with lite pops. (Alexander, PA)

Wolverine Radio, 6925u monitored at 0228 with X-rated comedy songs and parodies. (Hassig, IL) 6950u with 5 sec. music mix segments. (Wood, TN)

WEAK Radio, 6925u at \*2229 with rock and blues, IDs at 2311 and at close. (Zeller, OH)

Radio USA, 6925u at 2155 with angry heavy metal, parody ads, punk rock. Obviously an old pgm as it gave out of date address info. (Zeller, OH, Hassig, IL, Alexander, PA)

We Monkey Radio 6925 at 0037 with pop/rock group The Monkeys and said "all monkeys all the time." (Hassig, IL) 2210 various monkey-related tunes. (Alexander, PA)

Radio Gaga, 6925u at 1555. (Parker, PA) 2335 in what they said was a test. (Zeller, OH)

I Pod Radio, 6925u with pop music from the '40s. No ID but another pirate in a QSO dug it out of them; apparently a new station. (Zeller, OH)

Captain Morgan, 6925 at 2300 with various rock/pop things, TV themes. Gave captainmorganshortwave@gmail.com. (Hassig, IL)

Pirate Radio Boston, 6925 at 0055 with DJ "Charlie Loudenboomer," heavy metal, and X-rated song. Email as pirateradioboston@gmail.com. (Hassig, IL)

The Voice of Next Thursday, 6955 at 2207 with ID, talk about Google. Lost or closed around 2214. (D'Angelo, PA)

Radio Amica (Euro), 7610 at 0040 with pops and II ID anmts. Also noted at 2310. (Alexander, PA)

Cupid Radio (Euro), 15070 at 1312 acknowledging listener reports, lite music. (Alexander, PA)

**POLAND**—Polish Radio, 9650 at 1845 with Western vocals. (Maxant, WV) 0755 with 70s pop. (Alexander, PA) (*Site??—gld*)

**PORTUGAL**—9455 in PP at 0050. (MacKenzie, CA) 15560 at 1617 with MOR cover versions of U.S. pops, some in PP. (Wood, TN) 21655 in PP at 1444. (Parker, PA)

**ROMANIA**—Radio Romania Intl, 5915 at 2300 with *Radio Newsreel*. (Ng, Malaysia) 6130 at 0445 in EE. Off at 0457. (MacKenzie, CA) 6150 with EE news at 0310. (Brossell, WI)

**RUSSIA**—Voice of Russia, 5900-Armavir with world news at 0205, 12010-Samara in GG at 1750. (Brossell, WI) 6135-Orzu in SS at 0202. (Parker, PA) 6240 via Moldova with *Monthly Musical Calendar* at 0050. (Fraser, ME) 0420, 7230 in AA at 1820 and 7335-Chita in SS at 0400. (MacKenzie, CA)

Radio Rossii, 5920-Petropavlovsk-Kamchatka, at 1206 in RR. (Brossell, WI) 5930-Murmansk in RR at 1342. (Ronda, OK) 5940 in RR at 0525. (MacKenzie, CA)

**SAO TOME**—VOA Relay, Pinheria, 4960 at 0402 and 15580 at 1610. (Parker, PA) 0426 with EE program promos, news at the half hour. (Wood, TN) 6080 at 0335 with an interview. (Ronda, OK)

**SAUDI ARABIA**—Broadcasting Service of the Kingdom, 9657 in (I) Turkish at 1941. (Brossell, WI) 9875 in AA heard at 1940. (Fraser, ME) 15225 in AA at 1705 and 17895 with Koran at 1455-1457\*. (Parker, PA)

**SEYCHELLES**—BBC Indian Ocean Relay, 9410 at 2031 with news features and several IDs. (Wood, TN)

**SINGAPORE**—BBC Far Eastern Relay, 9605 in CC at 1329. (Brossell, WI)

**SLOVAKIA**—Radio Slovakia Intl, 5915 in Slovak at 1730. (Maxant, WV)

**SOUTH AFRICA**—7230 at 0415 discussing Obama and 12080 at 1915 on South African Red Cross. (Maxant, WV) 7230 at 0417. (MacKenzie, CA) 15235 with news at 1701 and 17860 in Swahili at 1515. (Parker, PA) 15240 at 1929. (Ronda, OK)

Radio Sondergrense, 3320 in Afrikaans at 0337. (Brossell, WI) 0400 with ID. (Yohnicki, ON) 2140. (Patterson, Philippines)

**SOUTH KOREA**—KBS World Radio, 6045 via Canada in SS at 0631. (Parker, PA) 9770 in VV at 1235 and 9805 in CC at 2315. (Ng,



Malaysia) 11810-Kimje at 0050. (Patterson, Philippines)

**SPAIN**—Radio Exterior de Espana, 3350 Costa Rica Relay in SS at 0245. (Barton, AZ) 5965 Costa Rica in SS at 0638 and 21570 in SS at 1624. (Wood, TN) 6055 in SS at 0510, 9640 in SS at 1925, 9675 in SS at 0035, 9765 in SS at 2350, 11810 Costa Rica in SS at 1817, 11815 in SS at 2332, 15125 Costa Rica in SS at 2233, and 17850 Costa Rica at 1818. (MacKenzie, CA) 6055 in SS at 0005. (Maxant, WV) 7270 in AA at 2044. (Brossell, WI) 11815 Costa Rica in SS at 2250. (Patterson, Philippines) 17850 Costa Rica in SS at 1521 and 21570 in SS at 1440. (Parker, PA)

**SUDAN**—Rep. of Sudan Radio, 7200 heard at 0350 with AA bits about Sudan, bird calls, HOA-type music. (Paszkiwicz, WI) 0537 in AA with many mentions of Darfur, Koran and ME music. (Wood, TN)

Miraya FM, 7385 via Slovakia, \*0300 heard at a new, additional time. *Good Morning Sudan* pgm with mix of AA and EE, local Afro-pops, promos. Off at 0600. 9825 via Slovakia from 1500 with IDs, news in EE, IDs as "Miraya FM," "Miraya 101" and "101 Miraya FM." EE to 1545 then into AA. Also, 15670 via IRRS/Slovakia from \*1400 with variety of Western and Afro-pops and EE news at 1500. (Alexander, PA)

**SURINAM**—Radio Apinte, 4990 at 0422 with M in unid Lang, soul music. (Wood, TN) 0436 with soft pop vocals, promo anmts by M/W, several Radio Apinte mentions, EE anmt at 0500. (D'Angelo, PA) 0450 with pop vocals. (Paszkiwicz, WI) 0506 with pops and slow jazz. (Parker, PA)

**SWAZILAND**—TWR, 3240 with sermon in Shona, mentions of South Africa. (Paszkiwicz, WI) 4775 in GG but poor under WWCR. (Ronda, OK) 0417 in German, choral singing, ID address and closing anmts. (D'Angelo, PA) 0430 in EE with M/W ancrs, music bridges. (Parker, PA)

**SWEDEN**—Radio Sweden Intl, 7425 to Africa at 2125. (Maxant, WV)

**SYRIA**—Radio Damascus, 9330 heard at 2132 with EE news, local pops, talk about plans to save Old Damascus. Also 12085 at 2122 with EE news and local music. Better modulation than usual. (Alexander, PA)

**TAIWAN**—Radio Taiwan, 3965 via Issoudun in GG at 2145. (Patterson, Philippines) 5950 via Florida at 0353 in EE about a kangaroo trying to drown Lassie. (Parker, PA)

**TANZANIA**—Radio Tanzania-Zanzibar, 11735 in 1910 in Swahili with AA music. (Linonis, PA) 1927 in Swahili. (Brossell, WI)

**THAILAND**—Radio Thailand, 7365 in JJ at 1312. (Brossell, WI) 7570-Udon Thani to Europe in EE at 1926. (Parker, PA) 9680 at 0025. (Maxant, WV) 12095 at \*0030 abrupt sign on in EE and news at 0034. (Alexander, PA) 0035 in EE. (Patterson, Philippines)

**TUNISIA**—RT Tunisienne, 7225 in AA at 2046. (Brossell, WI) 7335 at 0748 with M hosting ME music recorded with crowd noises. (Wood, TN)

**TURKEY**—Voice of Turkey, 5960 with piano IS at 2350, 9610 signing on at 2128 with IS and 12035 with multi-lingual ID at 1415. (Maxant, WV) 11835 in GG at 1744. (Brossell, WI)

**UGANDA**—UBC/Radio Uganda, 4976 at 0340 with some EE, promos, dance music. (Paszkiwicz, WI)

**UKRAINE**—Radio Ukraine Intl, 5970-Kharkov in UU heard at 0608. (Parker, PA) 7440 in EE at 0117. (MacKenzie, CA) 0200. (Brossell, WI) 0344. (Wood, TN)

**UNITED STATES**—VOA, 5890 Northern Marianas Relay in Korean at 1213, 7225 Northern Marianas in Korean at 1210, 7295 via Novosibirsk in Mandarin at 1310, 9310 Sri Lanka Relay in (I) Pashto at 1316 and 15225 Philippines Relay in Mandarin at 1237. (Brossell, WI) 9680 in FF at 2120, 11925 in CC at 0014, 11975-Greenville at 1812, 13725 in Creole at 2217, 15390-Greenville in Creole at 2244 and 21495-Greenville in PP at 1805. (MacKenzie, CA) 9530 Philippines in KK at 1414. (Strawman, IA) 12080 heard at 2735. (Maxant, WV)

Radio Free Asia, 5855 Sri Lanka Relay in VV at 0010, 11605 via Taiwan in VV at 1400 and 15150 Northern Marianas Relay in Mandarin at 0610. (Ng, Malaysia) 9355 Northern Marianas in CC at 1915, 9905 via Palau in Mandarin at 1844, 12075 Northern Marianas in Korean at 2140 and 15550 Northern Marianas with M in CC at 2320. (MacKenzie, CA) 11540 via Dushambe in TT at 1326. (Parker, PA) 11590 Kuwait Relay in TT at 1250. (Brossell, WI)

Radio Farda, 5860 Kuwait Relay in Farsi at 0450 and 5925 Lampertheim Relay in Farsi at 0330. (Parker, PA) 9925 Thailand Relay in Farsi heard at 2216. (Ronda, OK)

Radio Liberty, 5840 Biblis Relay in Tartar at 0441 and 5940 Lampertheim Relay in RR at 0335. (Parker, PA) 9760 Sri Lanka Relay in (I) Uzbek at 1606. (Brossell, WI)

Radio Marti, 7405-Greenville in SS at 0348 and 15330-Greenville in SS at 1850. (MacKenzie, CA)

AFN/AFRTS, 7811u-Key West at 0343. (MacKenzie, CA) 12133.5u-Key West at 2330. (Parker, PA)

Sudan Radio Service, 17745 via Portugal at 1500 opening EE with contact info, local elections and music. Sat/Sun only. (Alexander, PA) 1528. (Parker, PA)

Adventist World Radio, 7425 via Wertachtal in AA at 0427. (Paszkiwicz, WI) 11750 via South Africa at 1930 with ID. (Brossell, WI)

WINB, Pennsylvania, 9265 at 0110 and 13570 at 1833. (MacKenzie, CA)

WBCQ, Maine, 7415 with "Amos 'n' Andy" recreation at 2030. (Fraser, ME)

WTJC, 9370 at 0342. (MacKenzie, CA)

WJHR, Florida, 15550u at 1758. (D'Angelo, PA) 1804 with a fire and brimstone preacher. (Alexander, PA)

Family Radio/WYFR, 5960 via Nauen in AA at 2225. (Paszkiwicz, WI) 6240 via Moldova at 2044. (D'Angelo, PA) 7730 in SS

at 0350 and 9355 in SS at 0340. (MacKenzie, CA) 9465 via Taiwan at 1005. (Ng, Malaysia) 9280 via Taiwan in CC at 1313, 9615 via Irkutsk in II at 1245. (Brossell, WI) 11580 in SS at 2230. (Patterson, Philippines)

WTWW, Tennessee, 9480 testing at 1826-1900. Reports to tedrandall@tedrandall.com. (D'Angelo, PA) 2208 with low fidelity and compressed audio. (Spies, WV)

WWCR, Tennessee, 3215 at 0715, **4775** at 0607. (Wood, TN) 0456. (D'Angelo, PA) (*Get off this frequency and out of this band!*—gld) 5935 at 0700. (Maxant, WV) 12160 at 1808. (MacKenzie, CA)

KVOH, California, 17775 in SS at 2325. (Patterson, Philippines)

WRNO, Louisiana, 7505 monitored at 0355 with vocals, ID. (MacKenzie, CA) 0403. (Wood, TN)

WEWN, Alabama, 9390 at 0000 and 15610 at 1720. (Maxant, WV) 12050 in SS at 2223. (MacKenzie, CA) 15610 at 2315. (Patterson, Philippines)

WWRB, Tennessee, 5745 at 0045. (MacKenzie, CA)

**VATICAN**—Vatican Radio, 5885 at 2105, 7360 at 0650 and 9660 in FF at 0405. (Maxant, WV) 5900 in CC at 2205. (Ng, Malaysia) 9660 via Madagascar at 0513. (Ronda, OK)

**VENEZUELA**—Radio Nacional, 6060 via Cuba at 1105. (Maxant, WV) 9855 via Cuba in SS at 0020 and 15250 in SS/EE at 2310. (MacKenzie, CA) 11670 via Cuba in SS heard at 2235. (Patterson, Philippines)

**VIETNAM**—Voice of Vietnam, 6175 via Canada at 0350. (Maxant, WV) 7220-Sontoy in Mandarin at 1208. (Brossell, WI) 11720-Sontoy in VV at 2320. (Patterson, Philippines)

**ZAMBIA**—CVC-The Voice-Africa, 4965 at 0031 with EE talk. (Parker, PA) 9430 at 0519 with Christian pop in *Continental Breakfast* pgm. (Ronda, OK) 9505 at 2143 with pop vocals and W ancr, several "One Africa" IDs. Off at 2205. (D'Angelo, PA) 13590 at 1943. (Yohnicki, ON)

And, once again, order is restored! Numerous and extensive thanks to the following fine folks who sent logs for this month, namely: Brian Alexander, Mechanicsburg, PA; T.C. Patterson, Cebu, Philippines; William Hassig, Mt. Pleasant, IL; Stewart MacKenzie, Huntington Beach, CA; Peter Ng, Johore Bahru, Malaysia; Robert Brossell, Pewaukee, WI; Robert Wilkner, Pompano Beach, FL; Sheryl Paszkiwicz, Manitowoc, WI; Rich D'Angelo, Wyomissing, PA; Jerry Strawman, Des Moines, IA; George Zeller, Cleveland, OH; Jim Ronda, Tulsa OK; Joe Wood, Greenback, TN; Charles Maxant, Hinton, WV; Robert Fraser, Belfast, ME; Michael Yohnicki, London, ON; Dave Balint, Wooster, OH; Jack Linonis, Hermitage, PA; and Alan Spies, WV. Thanks to you all.

Until next month, good listening!

# BROADCASTING

## World Band Tuning Tips

# World News, Commentary, Music, Sports, And Drama At Your Fingertips



This listing is designed to help you hear more shortwave broadcasting stations. The list covers a variety of stations, including international broadcasters beaming programs to North America, others to different parts of the world, as well as local and regional shortwave stations. Many of the transmissions listed here are not in English. Your ability to receive these stations will depend on time of day, time of year, your geographic location, highly variable propagation conditions, and the receiving equipment used.

AA, FF, SS, GG, etc. are abbreviations for languages (Arabic, French, Spanish, German). Times given are in UTC, which is five hours ahead of EST, i.e. 0000 UTC equals 7 p.m. EST, 6 p.m. CST, 4 p.m. PST.

UTC	Freq.	Station/Country	Notes	UTC	Freq.	Station/Country	Notes
0000	7325	Radio Austrla International	GG	0300	3255	BBC Relay, South Africa	
0000	4717	Radio Yura, Bolivia	SS	0300	6110	Radio Fana, Ethiopia	Tigrinya
0000	11780	Radio Nacional Amazonas, Brazil	PP	0300	6270	Radio Cairo, Egypt	
0000	9570	China Radio International, via Albania		0300	7110	Radio Ethiopia	Amharic
0000	6025	Radio Amanecer, Dominican Republic	SS	0300	4780	Radio Djibouti	AA
0000	9865	Radio Nederland, Bonaire Relay	SS	0300	5010	Radio Madagasikara, Madagascar	Malagasy
0000	9895	Radio Nederland, via Portugal	SS	0300	6150	Radio Romania International	
0000	4955	Radio Cultural Amuata, Peru	SS	0300	3240	Trans World Radio, Swaziland	Shona
0000	9455	RDP Intl, Portugal	PP	0300	7200	Republic of Sudan Radio	AA
0000	11935	Radio Veritas Asia, Philippines	Karen	0300	5950	Radio Taiwan International, via Florida	
0000	6240	Voice of Russia, via Moldova		0300	5925	Radio Farda, USA, Germany Relay	Farsi
0000	9680	Radio Thailand		0300	7811u	AFRTS, Florida	
0000	9855	Radio Nacional Venezuela, via Cuba	SS	0300	4976	UBC/Radio Uganda	
0000	4965	CVC-One Africa, Zambia		0300	6175	Voice of Vietnam, via Canada	
0030	12095	Radio Thailand		0330	6150	Radio Tirana, Albania	
0100	9400	Radio Bulgaria	BB	0330	7400	Radio Bulgaria	
0100	3310	Radio Mosoj Chaski, Bolivia	SS	0400	5865	RT Algerienne, Algeria	AA
0100	6165	Radio Nederland, Bonaire Relay	SS	0400	9625	CBC Northern Service, Canada	
0100	4985	Radio Brazil Central	PP	0400	5960	Radio Japan, via Canada	
0100	11765	Super Radio e Amor, Brazil	PP	0400	6195	Radio Japan, via Bonaire	SS
0100	4925	Radio Educacao Rural, Brazil	PP	0400	11610	Radio Voice of the People, via Madagascar	
0100	9755	Radio Canada International		0400	11725	Radio New Zealand International	
0100	7540	Radio Cairo, Egypt	SS	0400	4790	Radio Vision, Peru	SS
0100	9915	Radio Cairo, Egypt		0400	7335	Voice of Russia	SS
0100	7235	Islamic Republic of Iran Broadcasting		0400	4960	VOA, Sao Tome Relay	
0100	9599v	Radio UNAM, Mexico	SS	0400	3320	Radio Sondergrense, South Africa	Afrikaans
0100	15180	Voice of Korea, North Korea		0400	6055	Radio Exterior de Espana, Spain	SS
0100	7415	WBCQ, Maine		0400	7230	Channel Africa, South Africa	
0100	7440	Radio Ukraine International		0400	4775	Trans World Radio, Swaziland	GG
0100	9265	WINB, Pennsylvania		0400	4990	Radio Apinte, Suriname	DD
0200	11710	RAE, Argentina		0400	5840	Radio Liberty, USA, Germany Relay	Tartar
0200	15400	HCJB Global Voice, Australia	Hindi	0400	7405	Radio Marti, USA	SS
0200	9645	Radio Bandeirantes, Brazil	PP	0400	7505	WRNO, Louisiana	
0200	4915	Radio Difusora Macapa, Brazil	PP	0400	9660	Vatican Radio	
0200	3985	Hravtski Radio/Voice of Croatia	Croatian	0500	11710	VOA, Botswana Relay	
0200	9810	Radio Republica, via Canada		0500	5910	Marfil Estereo, Colombia	SS
0200	4835	Radio Maranon, Peru	SS	0500	5905	BBC Relay, Cyprus	AA
0200	5900	Voice of Russia		0500	5005	Radio Nacional, Equatorial Guinea	SS
0300	4930	VOA Botswana Relay		0500	5940	Radio Rossii, Russia	RR
0300	5900	Radio Bulgaria		0500	7225	RT Tunisienne, Tunisia	AA
0300	4905	Radiodifusion Nationale Tchadienne, Chad	FF	0600	5045	Radio Cultura do Para, Brazil	PP
0300	7375	Voice of Croatia, via Germany	EE/SS	0600	6120	Radio Havana Cuba	
0300	5025	Radio Rebelde, Cuba	SS	0600	5925	Radio France International	

UTC	Freq.	Station/Country	Notes	UTC	Freq.	Station/Country	Notes
0600	6185	Radio Educacion, Mexico	SS	1700	15225	Broadcasting Service of the Kingdom, Saudi Arabia	AA
0600	4845	Radio Mauritanie, Mauritania	AA	1700	11835	Voice of Turkey	GG
0600	7360	Vatican Radio		1800	15580	VOA Botswana Relay	
0700	6090	University Network, Anguilla		1800	15275	Deutsche Welle, Germany, Rwanda Relay	
0700	6010	Radio Inconfidencia, Brazil	PP	1800	15215	Radio Jamahiriya/Voice of Africa, Libya	AA
0700	6070	CFRX, Canada		1800	7230	Voice of Russia	AA
0700	6160	CKZN, (Newfoundland) Canada		1800	11810	Radio Exterior Espana, Spain, Costa Rica Relay	SS
0700	7335	RT Tunisienne, Tunisia	AA	1800	17850	Radio Exterior Espana, Spain, Costa Rica Relay	SS
0800	4800	Radio Transcontinental, Mexico	SS	1800	11975	Voice of America	
0830	9635	RTV Malienne, Mali	FF	1800	9905	Radio Free Asia, via Palau	Mandarin
0900	9765	Radio New Zealand International		1800	15550	WJHR, Florida	
1000	6250	Radio Luz y Vida, Honduras	SS	1830	9650	Polish Radio, via UAE	
1100	2310	ABC Northern Territory Service, Australia		1900	15400	BBC South Atlantic Relay, Ascension Is.	
1100	6010	La Voz de tu Concencia, Colombia	SS	1900	13770	Radio Havana Cuba	
1100	4980	Xinjiang PBS, China	Uighur	1900	11725	Deutsche Welle, Germany, Rwanda Relay	GG
1100	9525	Voice of Indonesia	II	1900	7450	RS Makedonias, Greece	Greek
1100	3925	Radio Nikkei, Japan	JJ	1900	11990	Radio Kuwait	
1100	6060	Radio Nacional Venezuela, via Cuba	SS	1900	12080	Radio Nederland, via South Africa	
1200	6915	KNLS, Alaska		1900	15240	Adventist World Radio, via South Africa	
1200	15545	Islamic Republic of Iran Broadcasting	AA	1900	7570	Radio Thailand	
1200	11710	Voice of Korea, North Korea		1900	11735	Radio Tanzania, Zanzibar	Swahili
1200	3290	Radio Central, Papua New Guinea	Tok Pisin	1900	11750	Adventist World Radio, via South Africa	
1200	9400	Far East Broadcasting, Philippines	Mandarin	1900	13590	CVC-One Africa, Zambia	
1200	5920	Radio Rossii, Russia	RR	2000	7285	China Radio International, via Albania	
1200	7225	VOA Northern Marianas Relay	Korean	2000	12080	VOA Botswana Relay	FF
1200	7220	Voice of Vietnam	mandarin	2000	9410	BBC Relay, Seychelles	
1200	5050	Beibu Bay Radio, China	EE/VV	2100	12095	BBC South Atlantic Relay, Ascension Is.	
1300	6020	Radio Australia		2100	6155	Radio Austria International	GG
1300	11645	Radio Australia		2100	6155	Radio Belarus	
1300	9685	China Radio International	VV	2100	9420	Voice of Greece	Greek
1300	6175	Radio New Zealand International		2100	7425	Radio Sweden International	
1300	9335	Voice of Korea, North Korea		2100	12085	Radio Damascus, Syria	
1300	9325	Pyongyang Broadcasting Station, North Korea	KK	2100	5885	Vatican Radio	
1300	7365	Radio Thailand	JJ	2100	9505	CVC-One Africa, Zambia	
1300	9310	Voice of America Relay, Sri Lanka	Pashto	2200	12090	Far East Broadcasting, Northern Marianas	VV
1400	11600	Radio Prague, Czech Republic		2200	15345	RAE, Argentina	SS
1400	9810	Adventist World Radio, Guam	CC	2200	13630	Radio Australia	
1400	11705	Radio Japan		2200	13700	China Radio International, via Canada	SS
1400	17725	Radio Jamahiriya/Voice of Africa, Libya		2200	13790	Radio Havana Cuba	SS
1400	21655	RDP Intl, Portugal	PP	2200	5930	Radio Prague, Czech Republic	
1400	15670	Miraya 101 FM, Sudan, via Slovakia		2200	7380	Deutsche Welle, Germany, Madagascar Relay	Indonesian
1400	21570	Radio Exterior Espana, Spain, Costa Rica Relay	SS	2200	17675	Radio New Zealand International	
1400	12035	Voice of Turkey		2200	12090	Far East Broadcasting, Northern Marianas	VV
1500	17680	CVC, Chile	SS	2200	15280	Radio Nederland, via Northern Marianas	Indonesian
1500	9740	BBC Relay, Singapore		2200	15280	Radio Veritas Asia, Philippines	Mandarin
1500	15110	Radio Kuwait	AA	2200	15125	Radio Exterior Espana, Spain, Costa Rica Relay	SS
1500	9430	Far East Broadcasting, Philippines	Mandarin	2200	9480	WTWW, Tennessee	
1500	17860	Channel Africa, South Africa	Swahili	2300	15560	Radio Australia	
1500	17745	Sudan Radio Service, USA, via Portugal	AA	2300	12040	Radio Australia, via Palau	
1530	15670	Radio Mada, Madagascar, via Moldova	Malagasy	2300	7125	Radio Guinee, Guinea	FF
1600	9435	China Radio International		2300	17810	Radio Japan	Indonesian
1600	15605	Radio France International		2300	5915	Radio Romania International	
1600	15345	RT Marocaine, Morocco	AA	2300	5960	Voice of Turkey	
1600	15560	RDP Intl, Portugal	PP	2300	17775	KVOH, California	SS
1700	9610	Radio Canada International	FF	2300	15250	Radio Nacional Venezuela, via Cuba	SS
1700	9870	All India Radio	Hindi				
1700	11655	Radio Dabanga, via Germany	AA				
1700	15120	Voice of Nigeria	EE,others				

# Trivia And Toons

by R.B. Sturtevant, AD7IL

**Q.** Who first broadcast the Cold War slogan “Better Dead than Red!” and what radio station carried the program?

**A.** It actually goes back to before the Cold War. The slogan (Besser tot als rot) was coined by Nazi Minister of Propaganda Joseph Goebbels and it was broadcast via Radio Werwolf, the station that encouraged diehard Nazis in their last-ditch resistance to the Allied forces in Germany. The date of the first broadcast is apropos for this mouthpiece of propaganda: April 1, 1945.

**Q.** Did Nazi propaganda broadcasts have any real effect toward the end of World War II?

**A.** Not on the Germans, who had quite enough of Goebbels & Company and weren’t buying it anymore. They did, however, have an effect on the Allies. The Ministry of Propaganda at this time was using the Deutschland Transmitter Radio Station to promulgate its messages of glory still to come to anyone who would listen, and the word Werwolf figures prominently again here.

The Ministry was exalting the strength of the Werwolf (German for Werewolf) Organization. This “commando force” was proclaimed to be a dedicated group of 30,000 Nazi Freedom Fighters who would allow the Allies to overrun them, then conduct assassinations and sabotage behind the lines. The organization actually did exist, but numbered only about 6,000 or less. When the deaths of several prominent figures—including Major John Poston, one of Field Marshall Montgomery’s Staff Officers, and General Maurice Rose, the Commander of the 3rd Armor Division—were initially attributed to assassinations by Werwolf attack squads, the Americans gave this piece of propaganda more credit than it deserved. They slowed down and broadened their front and reinforced their supply lines. The British didn’t buy the propaganda and so didn’t take

any special precautions, continuing their advance at the same rate.

Goebbels also bruted about an “Alpine Redoubt” where the Nazis were moving their government and major factories to “continue the fight indefinitely.” In response, Eisenhower changed his plans, moving his axis of advance south toward Bavaria to meet the Nazis head on, leaving the taking of Berlin to the Russians and the industrial north of Germany to the British (who didn’t believe German radio on this either).

When the Americans reached Bavaria, they found there was no Alpine Redoubt and very few Werwolves—it had all been myth. Where the various armies wound up, however, determined where the different Zones of Occupation were established. These zones and their geographic relationships to each other established the basis of how the developing Cold War would be fought.

**Q.** Radio broadcasting to civilians was very important during World War II. Did any resistance groups set up clandestine broadcast stations?

**A.** We’ll keep going with our concentration on radio in the European Theater with this question. The answer is, yes, with two operating in German-occupied Warsaw.

During the Warsaw uprising from August 1 to October 2, 1944, the Polish Home Army established Radio Lightning. Radio Lightning was on the air at 32.8 and 52.1 meters four times a day from August 8 until October 4, two days after the uprising was crushed. The station broadcast in Polish, German, and English with a signal that was heard in New York City. Polish Radio, a civilian station, came on the air August 12 at 43.4 meters and also went dark on October 4.

The Germans tried to jam both stations by broadcasting their own “Polish” radio station on the same frequency. They also tried to bomb Radio Lightning off the air. A 1500-kilogram bomb hit the bank building that housed the station, but it failed to go off.

While Radio Lightning was transmitting military instructions, appeals for outside help, and morale-boosting music and speeches to the population, Radio Moscow was telling the underground fighters in Poland that the Russian Army was coming to their aid. Unfortunately that was a cruel hoax. Stalin had ordered the Red Army to wait until the uprising was over before entering Warsaw and eliminating the underground, which would have stood in the way of his post-war plans for Poland.

In August 2004 Radio Lightning went on the air again with a transmitter built by survivors and radio amateurs to commemorate the 60th anniversary of the uprising.

Spurious Signals



By Jason Togyer KB3CNM



**IN GEAR**  
Power Up

by Staff

**WWW.SCANCAT.COM**

## New, Interesting, And Useful Communications Products

### AOR's AR2300 "Black Box" Professional-Grade Communications Receiver

AOR USA has announced the availability of the AR2300, a new "Black Box" professional-grade receiver that offers high performance, state-of-the-art specifications, and a menu of optional additions that allow the operator to configure the receiver for specific custom applications or control it via the Internet.

The AR2300 is operated by a Windows XP or higher computer through a USB interface using a provided software package that controls all the receiver's functions. The tuning range is from 40 kHz to 3.15 GHz, and a U.S. consumer version is available that has the required "blocked" cellular frequencies rendered unavailable. The triple-conversion receiver exhibits excellent sensitivity across its tuning range. The AR2300 receives AM, wide and narrow FM, upper and lower sideband and CW modes; an optional adapter can be added that allows reception of conventional, unencrypted APCO-P25 digital transmissions. Up to 2,000 memory channels (50 channels x 40 banks) can be stored in the receiver, with data for each channel that includes frequency, alphanumeric channel labels, mode, selected antenna, and a "hit counter."

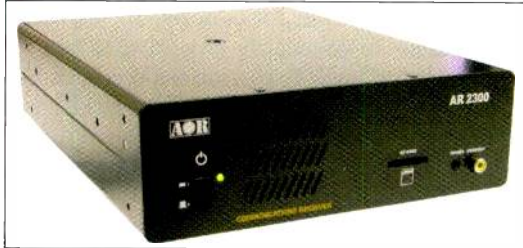

Fast Fourier Transform algorithms provide a very fast and high level of signal processing. Depending upon operator-selected configuration, up to three frequencies can be received simultaneously. Additional standard features include an adjustable analog 45 MHz IF output with 15 MHz bandwidth, an SD memory card port that can be used to store recorded audio, analog com-

posite video output connector, CTCSS and DCS squelch operation, two selectable Type N antenna input ports, an internal speaker along with a headset and external speaker port. The professional (government) version is equipped with a standard voice-inversion monitoring feature.

An optional external IP control unit enables the AR2300 to be fully controlled from a remote location and send received signals to the control point via the Internet. Other optional equipment choices include an I/Q output port that allows the user to capture up to 1 MHz of bandwidth onto a computer hard drive or external storage device. Optional AR-I/Q Windows software facilitates the easy storage and playback of transmissions captured within the selected spectrum in conventional modes.

The AR2300 is available through dealers across the U.S. and Canada and has an MSRP of \$3,795 (USD), but dealers may set their own prices. The government/professional version of the AR2300 is currently available; the U.S. consumer version will be available by late spring. For more information, visit [www.aorusa.com](http://www.aorusa.com).

### Heavy Duty Cable Protectors From CableOrganizer.com

If you've ever used duct tape to hold down cables, cords, or wires, you know that it's ugly, inefficient, damages flooring, and can pose a danger to people. It's safer and more effective to protect cables and wiring along the ground from passersby with cord covers. CableOrganizer.com offers a wide selection of high-, medium- and low-capacity cord covers, cable ramps, and cable protectors that are highly abrasion and heavy traffic resistant and offer a durable, safe and affordable way minimize hazards.

The company's Yellow Jacket Cable Protector (from \$109.99) is designed for continuous heavy traffic use and works well in outdoor environments, such as construction sites, industrial facilities and special events. The Medium Drop Over (\$62.99) is designed for indoor/outdoor applications and allows the smooth transit of pedestrians and small carts. Rubber Ducts (on sale for \$19.99 at press time) is an easy to install and flat-laying cord cover that protects cables and cords against foot traffic, and in some cases even vehicles. The flexible Floor Cord Cover Kit (\$9.03) lets you conceal and affix cables to just about any floor. Many other choices are available.

For more information, visit <http://CableOrganizer.com> or call toll-free at 866-222-0030.



Rubber Ducts cable protector from CableOrganizer.com.

**ORDER TOLL FREE  
888-722-6228**

**COMBO ALL-IN-ONE CD  
NOW \$49.95**

Reg. \$29.95  
ScanCat-Lite-Plus ..... \$29.95  
Mr. Scanner FCC Public Safety ..... \$29.95  
Nat-Com's FCC Scancat Files ..... \$9.95  
Bonus Disk Of Frequencies ..... \$15.00  
If Purchased Separately \$84.85

**PLUS FREE** Scanning Magazine(s)  
(With Any Order Over \$40.00)

**SUPPORT JUST ADDED FOR**

MFJ-8310 & 8322  
RADIO Shack PRO-106/197/404/405  
UNIDEN 3CD-346XT/396XT/996XT

**ScanCat-Lite-PLUS**

Reg. \$39.95 - Limited Time Special \$29.95

**Now It's Easier Than Ever To  
Use Your ScanCat Software.**

**FREE walk-you-through set up  
video to get you going fast.**

[www.scancat.com](http://www.scancat.com) **You Tube**  
Click on learn as you view.

**Scancat-Gold for Windows  
Version 8.50 \$99.95 to \$159.95**

**COMING SOON!! HOKA Code 3-32**



**COMPUTER AIDED  
TECHNOLOGIES**

ORDERS: (318) 687-4444 FAX: (318) 686-0449  
Info/Tech Support: (318) 687-2555  
(9 a.m. - 3 p.m. Central M-F)

**WWW.SCANCAT.COM**

**TERRORISM FORCES**

**US TO MAKE A**

**CHOICE. WE CAN BE**

**AFRAID. OR**

**WE CAN BE READY.**

**READY**

**WWW.READY.GOV**

**1-800-BE-READY**



## The Future Is Fuzzy For Free TV

by Bruce A. Conti  
contiba@gmail.com

*“With national broadband, subscription services, and ongoing DTV reception problems, it’s a cloudy picture for the future of free TV.”*

**I**t was 1941 when the FCC adopted the National Television Systems Committee (NTSC) 525-line black & white standard for analog television transmission and issued the first commercial licenses. Since then Americans have been enjoying free over-the-air TV broadcasts. Now just a year after the switch from analog to digital television (DTV) was completed—the most significant change since the FCC authorized color technology in 1950—the next big switch could signify the end of free TV. With national broadband, subscription services, and ongoing DTV reception problems, it’s a cloudy picture for the future of free TV.

### Intrusion Of National Broadband

The National Association of Broadcasters (NAB) was so concerned about the future of free TV, it produced a 30-second spot that aired on television stations earlier this year and offered this dire warning:

It’s our connection to our community, it’s our lifeline to the emergency information we need, it’s a free service that provides free entertainment, but one day soon it could be taken away. There’s a movement among special interest groups to limit free antenna TV, and millions of Americans who depend on it would lose out. Let’s tell Congress to keep free antenna TV as part of our communications future, always free, and always local.

Why the concern? In urging television stations to run the spot in heavy rotation, NAB President Gordon Smith and the NAB Spectrum Committee explained, “The broadcast industry could see the

greatest assault on the public airwaves since the 1980s, with the release of the FCC’s National Broadband Plan.”

As part of the American Recovery and Reinvestment Act of 2009, Congress directed the FCC to develop a National Broadband Plan to ensure that all people have access to broadband. Part of the plan calls for over-the-air television broadcasters to voluntarily give up spectrum for national broadband. Television stations not using their full allocation of bandwidth for HDTV and multicasting could otherwise be required to surrender the unused space for broadband, and unassigned broadcast channels could be auctioned by the FCC for use by the telecommunications industry for broadband. The auctions would help to fund implementation of national broadband. As a result, stations still broadcasting in standard definition (SD) rather than upgrading to high definition (HD) could end up locked in SD for life, and stations broadcasting only one channel could lose the ability to add multicast channels in the future. The same valuable extra bandwidth has also been targeted by television stations toward development of various mobile DTV applications to compete with the telecommunications industry.

The NAB went as far as to present a forum entitled “Broadcast Spectrum: Use It or Lose It” during its April trade show. More than 100 MHz of spectrum was given up in the transition to DTV, with the upper UHF band sold in auctions, and the NAB doesn’t want broadcasters to lose even more spectrum. Lobbying by broadcast and telecommunications interests is sure to continue as the FCC and Congress work to transform the plan into policy.

### Must-Carry And Retransmission Rules

The Cable Act of 1992 gave broadcasters the choice to forgo the old “must-carry” rule in favor of charging cable providers a retransmission fee for carrying their broadcasts. The must-carry rule requires that cable set aside a percentage of bandwidth for carrying local over-the-air signals. If a



Scenes from the NAB free antenna TV campaign.



Part of an ad Time Warner Cable ran during a retransmission dispute with Fox.

broadcaster chooses retransmission, then it has the right to charge cable providers a fee or deny consent to carry its signal. The law provides that once every three years broadcast stations elect between must-carry and retransmission consent.

Well-publicized rifts have already developed between cable companies, broadcast networks, and affiliates as a result of the retransmission rule. Most recently a retransmission dispute between WABC-TV New York City and Cablevision made headlines, resulting in the temporary loss of the ABC network for millions of viewers. Thankfully it was restored just in time for the live broadcast of the Oscars. Many will also remember when Fox was ready to pull the plug on Time Warner Cable subscribers during the college football bowl games last season as a retransmission contract was due to expire.

Retransmission disputes actually have left some cable subscribers in the dark. In 2007 the Sinclair Broadcast Group of over-the-air CBS and Fox affiliate stations denied Mediacom Communications retransmission consent for nearly a month while engaged in contract negotiations. And last year, Green Bay Packer fans were frustrated with NFL games being unavailable on cable and satellite from their local Fox affiliate.

An open letter from Jay Zollar, vice president & general manager, WLUK-TV Fox 11, highlighted the issue:

I appreciate your frustration in not picking up Fox 11 in high definition on either cable or satellite. We are eager to get an arrangement done with all of them, however we are not going to provide our digital content to third party distributors for absolutely nothing. It costs us hundreds of thousands of dollars each year to provide the quality digital and HD programming that consumers want and we will not let the cable and satellite providers have our content and package it and resell it to you. We are asking for less than 2 cents a day from each digital household and they refuse to discuss it.

Now cable and satellite operators are lobbying the FCC to arbitrate these disputes and prevent broadcasters from pulling their signals during contract negotiations. A consortium led by Time Warner Cable has asked for dispute resolution mechanisms that cable and satellite operators could turn to when negotiations hit an impasse as well as permission to keep carrying broadcast signals during the dispute resolution process. According to the FCC Cable Carriage Fact Sheet at [www.fcc.gov](http://www.fcc.gov), the retransmission rule as it currently stands states that until the cable operator and the television station reach an agreement, the cable operator is in fact prohibited from carrying that station's signal.

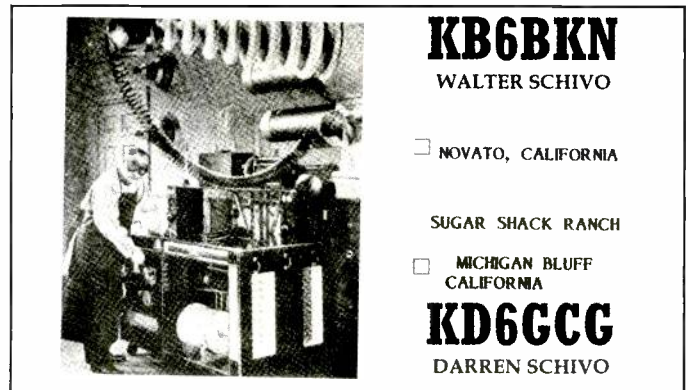

QSL card from KB6BKN and KD6GCG in California.

In the meantime, the big four networks—ABC, CBS, Fox, and NBC—might sooner rather than later decide to operate solely as cable channels, thereby eliminating the middleman: the broadcast affiliate. The networks have been demanding a bigger percentage of retransmission revenues from local affiliates, which are potentially faced with loss of affiliation if they don't comply.

The merger between cable provider Comcast and NBC might be another indication of the future of television. Jeff Zucker, NBC Universal president/CEO, has often commented that broadcast television is inferior to the cable model, which boasts the dual revenue streams of advertisers and subscribers.

## DTV Reception Woes Continue

Of course reception of free TV over-the-airwaves with an antenna and digital tuner is one alternative to avoid retransmission blackouts and rising cable bills. Or is it? For many, free antenna TV is not an option, or at least may not be for long. Opinions run strong in the blogosphere. "Free TV will be gone by 2020," predicts Gregory Dudek on the RoboSci blog. "Technical flaws with HD over the air, combined with new laws, assure this."

"The system was defective by design from the start," concurs Daniel Rouse, Jr. on the High TV Forum. He continues:

It was designed assuming everyone had 30-foot-high outdoor antennas. Many areas having reception issues with one or more channels still haven't seen increased power levels or installation of repeaters to restore the ability to receive channels at all or with stable reception...The 8VSB modulation-based standard for over the air DTV, while successful for some, is also a failure for a non-trivial number of viewers. The audio dropouts aren't tolerable, the video jitter and breakup whenever the airwave conditions are not vacuum-like is pathetic, and having to spend money on expensive upgrades and possibly playing the antenna purchase then return/exchange game is a worse investment of time and money than just giving up and going to a subscription digital cable or satellite service.

Dudek weighs in:

If you want to receive a full selection of digital TV broadcasts over the air, then you need a complicated set of one or more outdoor antennas, which may have to be directed using a rotor! Among other things, that precludes rapidly switching channels (channel surfing). Ugh! Antennas on the roof! More wires, cables! How many people are really going to mount an outdoor antenna, or a set of antennas. With rotors! What about those whose home or apartment faces the wrong way?

My DTV reception in southern New Hampshire varies with the weather. Only a handful of stations provide reliable service: the local PBS affiliate, two ABC affiliates, and two Spanish-

## RSGB Books from



### HF Antenna Collection

RSGB, 2nd Ed., 2002. 252 pages.

A collection of outstanding articles and short pieces which were published in *Radio*

*Communication* magazine. Includes single- and multi-element, horizontal and vertical antennas, extremely small transceiving and receiving antennas, feeders, tuners and much much more!

Order: RSHFAC **\$33.00**

### Practical Wire Antennas 2

By Ian Poole, G3YWX



This significantly expanded and fully revised edition includes designs for a wide range of practical wire antennas. Just about every type of wire antenna you could possibly imagine with complete and easy to understand designs

Order: RSPWA2 **\$23.50**

### Power Supply Handbook

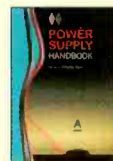

By John Fielding, ZS5JF

2006 Ed., 288 pages.

How power supplies work, selecting components, building and modifying supplies, measuring the finished supply, batteries, chargers, and equipment - it's all here!

Order: RSPSH **\$28.50**

### VHF/UHF Handbook

Edited by Andy Barter, G8ATD

RSGB, 2nd Ed., 320 pages.

This second edition guides you through the theory and practice of VHF/UHF operating and transmission lines. Includes info on getting started, antennas, constructing your own equipment, satellite ops, local nets and specialized modes.



Order: RXVUH **\$29.50**

### Technical Topics Scrapbook 1995-1999



By Pat Hawker, G3VA

RSGB, 2000 Ed., 314 pages.

This third compilation of 'Tech Topic' articles is a fascinating collection of circuit ideas, antenna lore, component news and scientific discussion, all at the most practical level.

Order: RSTTC99 **\$27.50**

Shipping & Handling: U.S. & Possessions- \$7 for the first item, \$3.50 for the second and \$2 for each additional. **FREE** shipping on orders over \$100.

Foreign-calculated by order weight and destination and added to your credit card charge.

**CQ Communications, Inc.**

25 Newbridge Rd., Hicksville, NY 11801

Call 800-853-9797 - Fax 516-681-2926

www.cq-amateur-radio.com



DTV E-skip reception of WRGB-DT Schenectady, New York, at 900 miles from Eric Bueneman, NØUIH in Hazelwood, Missouri.

language affiliates of Univision and Telemundo. CBS, CW, Daystar, Fox, Ion, NBC, and MyTV are all subject to interruption during "not vacuum-like" foul weather. On the other side of the country, *Pop'Comm* readers Walter Schivo, KB6BKN, and Darren Schivo, KD6GCG (Michigan Bluff, California), report similar interruptions of DTV reception under various weather conditions. Only nine out of 23 DTV stations received provide reliable service, the remainder affected primarily by varying degrees of multipath heat inversions. And these guys are equipped with Finco PS UHF dish and 12-element UHF Yagi-amplified antennas on a 35-foot mast.

The DTV Cliff Effect Assistance Act of 2009, sponsored by Senator Olympia Snowe and Representative Michael Michaud, both from Maine, proposed monetary support to promote installation

of relay transmitters in poor signal areas. According to the Congressional Research Service of the Library of Congress, the DTV Act directs the Assistant Secretary for Communications and Information of the Department of Commerce to make payments (not to exceed \$125 million in the aggregate) during FY2009-FY2012 from the Digital Television Transition and Public Safety Fund. Through this program, a local civil government body may receive funding for the construction and equipment of digital TV translators to fill gaps in the digital coverage for full-power stations where the gaps were created from the conversion of the signal from analog to digital. (The "cliff effect" refers to the sudden and complete loss of reception that occurs with even the slightest degradation of a DTV signal, because it's as though the signal falls off a cliff.)

### This Month In Broadcast History

*75 Years Ago (1935)*—Inventor Edwin Armstrong presented his first public demonstration of crystal-clear FM radio. NHK Japan began its international radio service with an English program beamed toward North America.

*50 Years Ago (1960)*—The American Football League signed a five-year television contract with the ABC network in preparation for its first season. BBC Television Centre

opened in London, proclaimed the world's first purpose-built center for television production. The "Because They're Young" theme by Duane Eddy topped the 1110 KRLA Los Angeles music survey.

*25 Years Ago (1985)*—CBS petitioned the FCC to deny an attempted hostile takeover of the network by Turner Broadcasting.

**KRLA** Hit **Radio 11**





DTV DX reception of WHIO-DT Dayton, Ohio, at 340 miles from Eric Bueneman, NØUIH.

Arabia, this has been the strongest of transatlantic signals. DXers in the Midwest might at least be able to pick out the distinctive interval signal through interference. (Conti-NH)

**1070 Cadena CMKS, Guantánamo, Cuba,** at 0500 presumed with national anthem through noise and unidentified domestics. (Conti-NH)

**1140 KZMQ Greybull, Wyoming,** at 1400 news and current events morning program, almost local quality, later fading to CHRB High River, Alberta, religious program. (Barton-AZ)

**1170 KLOK San Jose, California,** at 1425 music of India and announcer in (presumed) Hindi, mixing with KCBQ San Diego, which was running the *Mike Gallagher Show*. Heard ID and mentions of San Jose and Bay Area. Music sounded much like that heard on shortwave from All India Radio. (Barton-AZ)

**1350 KSRO Santa Rosa, California,** at 1255 *Coast to Coast* syndicated talk show, ID during break into local spots and promos. (Barton-AZ)

**1530 VOA Pinheira, São Tome,** at 0258, "This is the Voice of America, Washington, D.C." and Yankee Doodle, "This is the Voice of America signing on," and more Yankee Doodle. Then into English program. Good under WCKY. (Black-MA)

Although AM radio is plagued with lightning noise this time of year, June is typically a good month for FM and TV DXing. Whether it's AM, FM, or DTV, let us know what you're hearing! Check in with *Popular Communications* on Facebook. Thanks to Rick Barton; Chris Black, N1CP Eric Bueneman, NØUIH; and Marc DeLorenzo.

Until next time, 73 and Good DX!

The DTV Act, filed under S.899 and H.R.2903, has not yet made it out of committee, having been referred to the House Committee on Energy and Commerce, and to the Committee on Commerce, Science, and Transportation.

## Broadcast Loggings

DTV signals can be received over long distances under the right conditions. Eric Bueneman, NØUIH, of Hazelwood, Missouri, reports DTV reception over hundreds of miles by E-skip propagation. Check out the accompanying images showing DTV DX he captured with the Hauppauge Win-TV-Go video capture card and the Zenith DTT-901 DTV tuner, along with a RadioShack VU-210XR antenna at 30 feet.

Meanwhile, as the sun appears to be finally awakening from an extended period of solar inactivity, AM broadcast DXers are rediscovering tropical signals enhanced by auroral conditions in this month's selected logs. All times are UTC.

**540 HICM Radio ABC, Santo Domingo, Dominican Republic,** at 0259 HICM sign off with national anthem; fair with off-frequency growl noted from YNOW. Thanks to Sylvain Naud via RealDX for anthem verification. (Black-MA)

**540.18 YNOW Radio Corporación, Managua, Nicaragua,** at 0259 talk in Spanish mixing with Dominican Republic national anthem on 540 kHz. Fair after Dominican sign-off at 0300. (Black-MA)

**670 KLTT Commerce City, Colorado,** at 0700 ID into Billy Graham show, *sans* Billy. Very strong post sunrise DX. Still hanging in there at 0730, began fading at 0745. (Barton-AZ)

**690 KTSM El Paso, Texas,** at 2250, "You're listening to Bill Cunningham on AM 690 KTSM." (Barton-AZ)

**690 HJ CZ Radio Recuerdos, Bogotá,**

**Colombia,** at 2331 good over Radio Progreso Cuba; ID followed by a Spanish ballad. (DeLorenzo-MA)

**820 KUTR Taylorsville, Utah,** at 1500 local spots after ID on the hour, one promo for local program using the theme from *The Good, Bad & Ugly*. (Barton-AZ)

**840 4VEH Cap Haitien, Haiti,** at 0100 fair through WHAS and WRYM; speaker in Creole through the hour. 0114 same speaker, parallel streaming audio. (Conti-NH) At 0100 fanfare, then man in French with "This is Cap Haitien, you are listening to 4VEH, it is 8 o'clock," into religious program. (Black-MA)

**1060 Cadena CMKS, Baracoa, Cuba,** heard at 0500 under KYW; presumed with choral national anthem parallel 1070 kHz. (Conti-NH)

**1062 Danmarks Radio, Kalundborg, Denmark,** at 0440 an excellent, s9+10 signal; sign-on, alternating between two cycles of interval signal and ID. Other than 1521 Saudi

# STAY AHEAD OF THE STORM



## WEATHER DEFENDER®

NEW!

Weather Defender is a new GIS-enabled weather software program that gives you real-time weather conditions with street-level accuracy.

- Street-level Weather Tracking
- Real-time Weather Graphics
- Customizable "Safe Zones"
- Receive Alerts to E-mail, PDA, Cell phone

**PLUS:** Track Lightning Strikes, Severe Thunderstorms, Tornadoes, Hail, Earthquakes and more!

"...this one is the best!"

Verna Young, California

DOWNLOAD YOUR FREE DEMO TODAY!

## WWW.WEATHERDEFENDER.COM



## Fort Campbell, Kentucky— The Aerie Of “The Screaming Eagles”

by Mark Meece, N8ICW  
ohioscan@gmail.com

When we think of monitoring military aviation communications, the first things that spring to mind are usually fighter jets, tankers, and other large Air Force aircraft. Smaller aircraft, such as helicopters, may be a rarer catch, depending on where you live. But on occasion, if you're lucky and in the right place at the right time, your ears may pick up the whup whup whup of a UH-1 Huey Helicopter off in the distance. You may or may not catch a glimpse of it, but it will set your imagination going—where is it from and where is it going?

The United States Army, Marines, National Guard, and other assets all have many units fly-

*“The Air Assault training at Fort Campbell features a lot of helicopter activity, and aircraft commonly seen and heard in the area are the OH-58D ‘Kiowa Warrior’ Helicopter, the UC-35C (Army version of the Cessna Citation), the AH-6 ‘Little Bird’ Helicopter, the MH-60L Helicopter, and the UH-60L ‘Blackhawk’ Helicopter.”*



A new CH-47F Chinook flies over a training area at Fort Campbell, Kentucky, during the August 15 rollout of the upgraded aircraft. (Public domain photo)

ing various types of these birds. Let's look now at one of their nests.

## Fort Campbell, Altered States

For this issue we travel to the not-so-deep south to visit, Fort Campbell, Kentucky. Actually Fort Campbell spans the state line of Kentucky and Tennessee, over the area between Hopkinsville, Kentucky, and Clarksville, Tennessee. Most of the military reservation is inside Montgomery County, Tennessee.

The War Department originally considered the new base to be in Tennessee since that's where the base headquarters were located. The base Post Office was situated on the Kentucky side of the reservation, but that caused mail delivery problems. Colonel Guy W. Chipman put in a request that the address be changed to Kentucky and it was granted. The War Department made the change official on September 23, 1942.

## Base Beginnings

Although planning for a military training site was started in the late 1930s, it



The 101st Airborne Headquarters Air Assault. (Public domain photo)

was the attack on Pearl Harbor Naval Base that set in motion immediate funding to build the site. Congress approved \$4 million for the purchase of 105,000 acres and building started soon after. Within four months the base was ready for occupation. It opened in 1942 as Camp

Campbell, named after William Bowen Campbell, a former Governor of Tennessee and a Mexican War Hero during which he served as a colonel of the 1st Tennessee.

From the time it opened until the end of World War II it was the training facil-

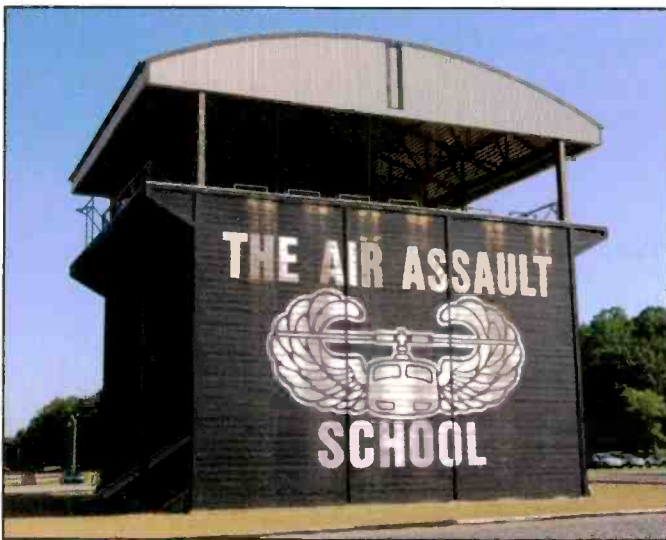

Air Assault School platform at Fort Campbell. (Public domain photo)



Air Assault School drop training. (Public domain photo)

ity for the 12th, 14th, and 20th Armored divisions, the IV Armored Corp and the 26th Infantry Division. The name was changed to Fort Campbell in 1950 when the base changed from wartime to permanent.

The famous 101st Airborne Division—"The Screaming Eagles"—became a major tenant of the base when the unit was

reactivated, after a post-war deactivation, on September 21, 1956, and the 101st Airborne's colors were presented.

## Sabalauski Air Assault School

The current active duty population at the post is around 28,000 troops stationed among a number of facilities at the base.

## Listening In

### Campbell Army Airfield (KHOP)

118.100	Approach/Departure
120.900	Tower
121.800	Ground
125.1750	ATIS
130.650	Pilot to Dispatcher
138.800	Clearance Delivery
141.350	Range Operations
142.900	Pilot to Dispatcher
230.100	Pilot to Dispatcher
251.200	AMC Command Post
266.800	Ground
269.525	Approach/Departure
278.800	Tower
303.000	National Guard Ops
308.400	ATIS
343.300	Metro WX
365.050	Range Operations
33.200	Metro WX
36.900	Medical EVAC Ops
65.200	EAGLE CONTROL

### Sabre AHP (KEOD)

124.675	Tower/CTAF
128.750	EAGLE CONTROL
134.350	Approach/Departure
138.700	Army Operations
142.975	Ground
237.600	Clearance Delivery
265.500	EAGLE RADIO
267.300	Ground
290.450	Tower

### Support Frequencies

30.200	Ground Tactical
32.500	Range Control
36.710	Convoy Net
36.890	Convoy Net
49.700	Explosive Ordnance Disposal Teams
49.950	Campbell Range F1
75.250	Campbell Range F2
139.325	Movement Control
141.225	Movement Control
148.590	Range Maintenance
164.200	Fort Campbell EMS
169.990	Range Maintenance

### Memphis ARTCC (ZME)

118.875	Nashville RCAG High
124.125	Nashville RCAG Ultra High
133.850	Nashville RCAG Low
257.750	Nashville RCAG High
317.600	Nashville RCAG Low
363.000	Clarksville RCAG

### Digital Communications

SYSTEM:	Fort Campbell
TYPE:	P-25 Standard
SYSID:	1FE

### Frequencies

SITE 101:	386.0750 *
SITE 102:	388.0000 *
SITE 103:	386.0375 *

### Common Voice Channels

385.8875	386.5250	388.6500
386.2250	386.6750	388.8000
386.3375	386.9750	388.9625
386.3750	388.3000	

### Talkgroups

102	101st RAP Team
108	EAGLE CONTROL 1 (MP Dispatch)
133	Fort Campbell Fire Dispatch I
134	Fort Campbell Fire TAC
410	Engineers - Electrical Maintenance
414	Engineers - Plumbing Maintenance
617	Welcome Center / 101st Airborne Museum

### Active Units

5th Special Forces Group
1-58th Aviation C Company
160th Special Operations Aviation Regiment (SOAR)
2-44th Air Defense Artillery
326th Engineer Battalion
716th Military Police Battalion
163rd MP Detachment
194th MP Company
551st MP Company
561st MP Company
716th Headquarters Detachment
86th Combat Support Hospital

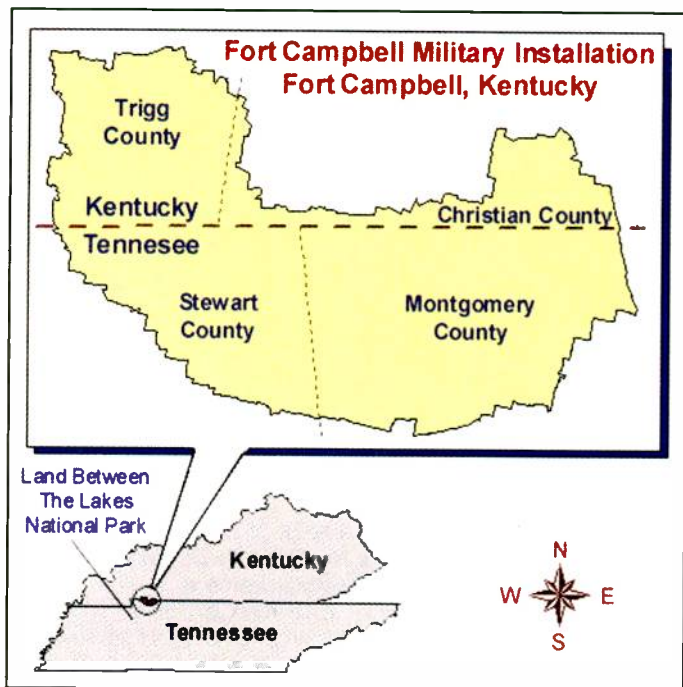

Area map of Fort Campbell.

including the storied Sabalauski Air Assault School. This took its name in 1994 from Command Sergeant Major Walter James Sabalauski who served three tours of duty in Vietnam and was awarded numerous citations for his heroic efforts. He retired at the age of 61 in 1971 and passed away in 1993.

The Sabalauski Air Assault School trains leaders and soldiers of the 101st Airborne and other army units in courses on Air Assault, Pathfinder, Pre-Ranger, and various other insertions-extraction-type operations. The 101st Airborne was a parachute infantry unit during World War II, but converted to an Air Assault unit during the Vietnam War. The school conducts over 60 classes a year, training over 8,000 soldiers annually.

The Air Assault training at Fort Campbell features a lot of helicopter activity, and aircraft commonly seen and heard in the area are the OH-58D "Kiowa Warrior" Helicopter, the UC-35C (Army version of the Cessna Citation), the AH-6 "Little Bird" Helicopter, the MH-60L Helicopter, and the UH-60L "Blackhawk" Helicopter.

### If You Visit...

Located on the Kentucky side is Campbell Army Airfield (KHOP) with two runways 5/23 and 18/36. Six nautical miles south across the state line is Sabre Army Heliport with one runway, 4/22. All of the frequencies used at the two airfields fall under Memphis Center for Air Route Traffic Control.

Fort Campbell was one of the first military installations to install a trunked radio system back in 1998 and has just recently upgraded to an APCO-25 (digital) system. There are three sites, with each sharing the same voice channels. A digital scanner is in order to listen in. Frequencies and other useful monitoring information are listed in the "Listening In" sidebar.

If you find yourself in the area, consider checking out the 101st Airborne Division's Don F. Pratt Memorial Museum just inside the base at Gate 4. The museum tells the rich history of the 101st and Fort Campbell. It features a large collection of military equipment from World War II to present day.

*A word of caution: If you are portable or mobile with your scanner, you need to know that Kentucky does have a scanner prohibition law. There are a few exemptions to the law, one being for a valid amateur radio license. Be wise and cautious while you enjoy your listening.*

### Military Intercepts

Doug Bell of Ontario, Canada, once again sets us up with this issue's military intercepts. Doug is using a Sony ICF-2010 and 50-foot longwire. If you'd like to add your reports, whether on HF, VHF, or UHF, send them to the email address listed in the column header. Please follow the format you see here and we'll include them in a future column.

**3455:** USB 0129 NATO 25 (CT-49A #LX-N19997/NAEW and CF) wkg New York Radio with a full position report and A EM-FK SELCAL check.

**3476:** USB 0258 ASCOT 5573 (C-130J/38th WG, RAF Lyneham, UK) wkg Gander Radio with position report.

0403 RAZZ 33 (E-6B #164409/VQ-4, Tinker AFB, OK) wkg Shanwick Radio with a full position report. Flight instructed to call Shannon on 134.260.

**5550:** USB 0150 REACH 878 (C-5A #70-0457/445th AW, 89th AS, Wright-Patterson AFB, OH) wkg New York Radio with a request for fl 280. Flight reported that it was too "hot and heavy" for anything higher than 280. RCH 878 conducted a BS-AD SELCAL check.

0236 REAPER 13 (B-1B/7th BW, 9th BS, Dyess AFB, TX) wkg New York Radio with a full position report and instructions to contact New York center on VHF. 2115 COAST GUARD 101 (C-37A #101/CGAS Washington, D.C.) wkg New York Radio with a KS-GP SELCAL check.

2210 SHUCK 98 (E-#B/552nd ACW, Tinker, AFB, OK) wkg New

## CQ BOOKS



### Sloper Antennas

By Juergen A. Weigl, OE5CWL

Single- and Multi-Element Directive Antennas for the Low Bands

With calculations and practical experience, this book shows which basic concepts have to be considered for sloper antennas for the low bands.

These fundamentals are supplemented by construction guidelines for directive antennas using a single element or several elements. You'll find all the information needed for successful home building of the antennas.

Order No. Sloper ~~\$24.95~~



### MIL SPEC Radio Gear

Korean to Present Day  
by Mark Francis, KI0PF

Detailed write-ups for many familiar sets:

PRC-25/-77, RT-68, PRC-1099, GRC-106, GRR-5, R-392 and more. Over 230 pages of operation, modification, and maintenance tips and info, including 200+ illustrations. Useful hints and mods, and more!

Order No. MILSPEC ~~\$27.95~~ \$25

Shipping & Handling: U.S. & Possessions - add \$7 for the first item, \$3.50 for the second and \$2 for each additional item. \* FREE shipping on orders over \$100.00 (merchandise only). Foreign-Calculated by order weight and destination and added to your credit card charge.

CQ Communications Inc.

25 Newbridge Rd., Hicksville, NY 11801

516-681-2922; Fax 516-681-2926

Order Toll-Free 800-853-9797



York Radio with a position report Flight instructed to call New York Center on 135.050.

2217 CANFORCE 3749 (CC-144 #144617/8 wkg 412TH SQN, CFB/Trenton, Ontario, CN) wkg New York Radio with routing data.

**5616:** USB 0256 RANGER 75 (KC-130T/VMGR-234, NAS Fort Worth, TX) wkg Gander Radio with a 030W position report.

2335 REACH 395 (C-17A #01-0187, 62nd AW, McChord AFB, WA) wkg Gsnder Radio with a position report of 51N 040W with fl 300.

**5696:** USB 1556 SWORDFISH 28 (HU-25, CGAS Miami, FL) wkg CAMSLANT Chesapeake with a message passed from

Cuban Border Guard in regards to a missing vessel with 2 POB.

2249 SWORDFISH 14 (HU-25, CGAS Miami, FL) wkg CAMSLANT Chesapeake reporting that is bound for HOMEPLATE.

**6586:** USB 0208 CANFORCE 3982 (CC-150 #15002 8th WG, 437th SQN, CFB Trenton, Ontario, CN) wkg New York Radio with a position report.

**8864:** USB 1212 BOXER 42 (C-40C #02-0202, 452nd AMW, 729th AS, DC-ANG, Andrews AFB, MD) wkg Gander Radio with a confirmation of its 040W position report.

1223 BOXER 43 (C-40C #02-0203, 452nd AMW, 729th AS, DC-ANG, Andrews AFB, MD) wkg Gander Radio with a position report of 54N 040W with a fl 360.

1315 COBRA 70 (OC-135B #61-2670.

55th WG, 45th RS, Offutt AFB, NE) wkg Gander Radio with unreadable flight data passed.

1421 RAZZ 33 (E-6B #164409, VQ-4, Tinker AFB, OK) wkg Gander Radio with a position of 54N 040W with fl 340.

1535 BLUE 71 (KC-135R #59-1444, 121st ARW, OH-ANG, Rickenbacker ANGB, OH) wkg Gander Radio with amended routing clearance passed.

1625 SPAR 25 (C-37A #01-0030, 6th AMW, 310th AS, Macdill AFB, FL) wkg Gander radio with a position report of 56N 040W with fl of 400.

1749 REACH 386 (C-130H #78-0811, 911th AW, 758th AS, AFRC Pittsburgh IAP, PA) wkg Gander Radio with 040w position report and fl 230.

**8918:** USB 1938 OTIS 81 (KC-130J #166381, VMGR-252, MCAS Cherry Point, NC) wkg New York Radio and receiving an amended routing clearance.

2035 CANFORCE 3645 (CC-177 #177702, 8th WG, 429th SQN CFB Trenton, Ontario, CN) wkg New York Radio with HQ-BD SELCAL check.

2038 CANFORCE 3990 (CC-144 #144515, 8th WG, 412th SQN CFB Trenton, Ontario, CN) wkg New York Radio with a full position report.

2040 REACH 411 (C-130J #05-8152, 403rd WG, 815th AS, Keesler AFB, MS) wkg New York Radio with a position report.

2045 DOTE 58 (E-6B #164407, VQ-4, NAS Patuxent River, MD) being repeatedly called by New York Radio with no response.

2052 RWEACH 677 (C-130J, #05-8158, 403rd WG, 815th AS, Keesler AFB, MS) wkg New York Radio with a position report.

**8983:** USB 1905 RESCUE 2003 (HC-130J, CGAS Elizabeth City, NJ) wkg CAMSLANT Chesapeake with a phone patch and message passed in regards to a medical situation. Flight reported a position of 23N 067W.

**9007:** USB 0325 CANFORCE 3982 (CC-150 #15002 8th WG, 437th SQN, CFB Trenton, Ontario, CN) wkg TRENTON MILITARY with flight data passed as well as weather for Trenton, Ottawa and Montreal.

**11175:** USB 1653 OSCAR 15 (C-130H, 314th AW, Little Rock AFB, AR) wkg a HF-GCS Station with unreadable data passed.

1940 REACH 7188 (C-17A, #07-7188, 437th AW, Charleston AFB, SC) wkg HF-GCS Station OFFUTT with a HF radio check.

**11232:** USB 1430 CANFORCE 3297 (CC-150 #15002 8th WG, 437th SQN, CFB Trenton, Ontario, CN) wkg TRENTON MILITARY with flight data passed.

**13927:** USB 1754 REACH 205 (C-17A, #06-6162, 60th AMW, Travis AFB, CA) wkg MARS Operator AFA9PF (Los Angeles, CA) with a phone patch.

**15010:** USB 1610 CANFORCE 3979 (CC-177 #177704, 8th WG, 429th SQN CFB Trenton, Ontario, CN) wkg HF-GCS Station PUERTO RICO with a phone patch and weather passed for Charleston, SC and Port-au-Price, Haiti.

For 45 years  
our volunteers have  
endured long hours  
and tough  
working conditions  
for no pay.



And 9 out of 10  
would do it again.

TO FIND OUT WHY  
contact

**REACT International, Inc.**

(301) 316-2900 • (866) REACT-9-9

5210 Auth Rd., Ste. 403, Suitland, MD 20746

REACT.HQ@REACTintl.org

www.REACTintl.org

## Easy 5/8-Wavelength Vertical Antennas For Three Bands

by Kent Britain, WA5VJB  
wa5vjb@cq-amateur-  
radio.com

This month I've got a trifecta in store for you as we broaden our range, as it were, and offer up a selection of some easy-to-build 5/8-wavelength antennas for the 2.4-GHz, 3.4-GHz, and 5.8-GHz bands. These handy devices can be used with WiFi, 802.11, Zigbee, amateur TV, Bluetooth, and any other services on these bands.

As a point of caution before we dive in, I want to point out that there are online calculators you may come across for these and similar antennas. One particular website actually calculated the dimensions down to the nearest .000000001 inch. Yep, there are *eight* zeros in there. If you ask me, someone needs to slap that lad upside of the head with a slide rule and take away his scientific cal-

culator—and the worst part is that his dimensions in this instance were *wrong!*

As Dr. Tom Clark, K3IO, likes to put it, "Why be approximately correct when you can be precisely wrong?" Several factors that affect the length of the elements, such as the diameter of the wire, were not even allowed for.

I'm happy to say all *these* designs were actually constructed and adjusted on an 8719 Network Analyzer. I much prefer to publish tested dimensions and actual, rather than theoretical, dimensions.

### Now, On To Our Antennas

Let's start out with a little overview of the 5/8-wave antenna.

You can match to a good SWR virtually any length of wire, that's why we often use antenna tuners on the shortwave bands. You can build a 5.8-GHz antenna tuner, but you had better find a *big* magnifying glass for that weekend project. Fortunately, 1/4 and 3/4-wavelengths are pretty easy to tune in a 50-ohm system. But while a 3/4-wavelength has a good impedance match, or SWR, it has a poor pattern. Much of the signal ends up going into upward lobes, not towards the horizon where you usually want the signal.

If you bend up a 3/4-wave length of wire until it is 5/8-wave long, however, you get a very nice pattern back at the horizon (more on this later). The loop, or partial loop, in the center element is not a loading coil like you might see on many HF antennas. In this case it's a delay line; that is a way of delaying the wave so that it's "seeing" 3/4 of a wavelength in a 5/8-wavelength space. This delay line can be a loop, part of a loop, a stub, or a zig-zag.

### Construction

Start with a piece of coax and some 18-gauge wire. Almost any coax, braided or semi-rigid, can be used as long as you can solder to it. The wire can be 16 or 20 gauge, but I wouldn't go beyond those sizes; stay with 18 gauge if you can.

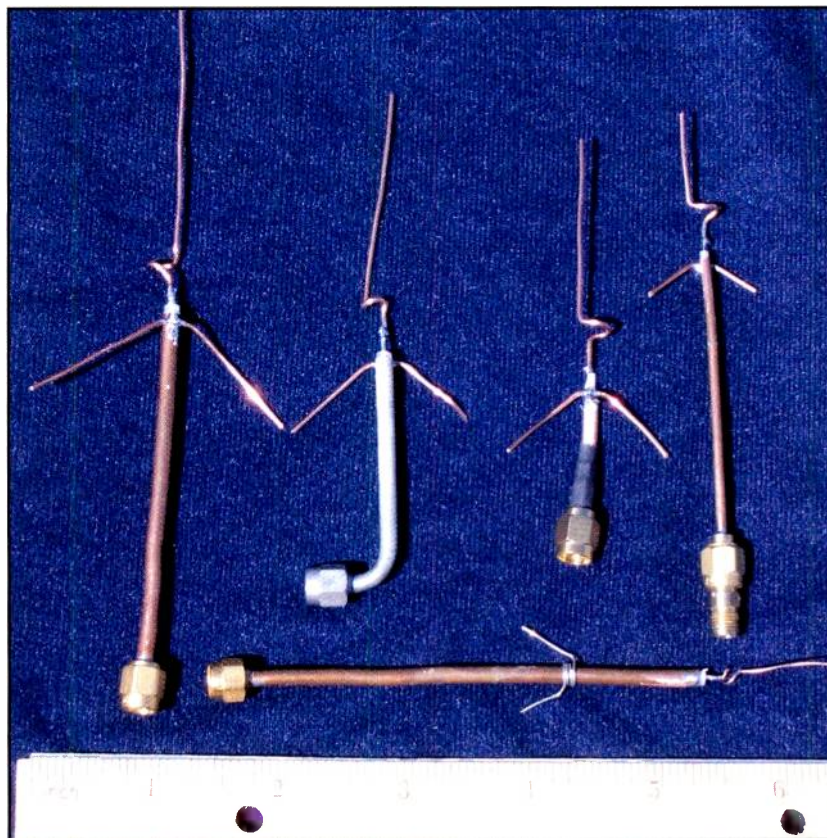

Photo A. Easy-to-build 5/8-wavelength verticals for 2.4, 3.4, and 5.8 GHz.

Using **Figure 1** as a guide, cut your center element to length. Now bend it around a small screwdriver, drill bit, etc. until the total length is correct per **Figure 2**. Now solder the element to the center of the coax.

Next cut your radial per **Figure 2** and solder the middle of the wire to the coax at the end of the shield or braid (in effect, we're using one wire as two radials). Now bend them back about 30 degrees. This doesn't have to be precisely 30 degrees, but it does help the impedance match or SWR to bend them back a bit.

That's it, your 5/8-wave ground

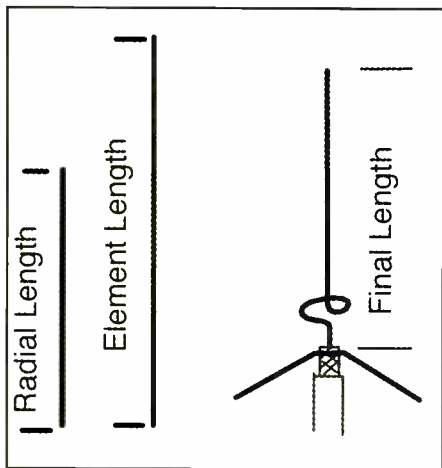

Figure 1. Dimensions

Band	Radiator	Radials	Final Length
2.4 GHz	3.5"	2.4"	3.25"
3.4 GHz	2.5"	1.8"	2.3"
5.8 GHz	1.45"	1.0"	1.25"

Figure 2. Lengths

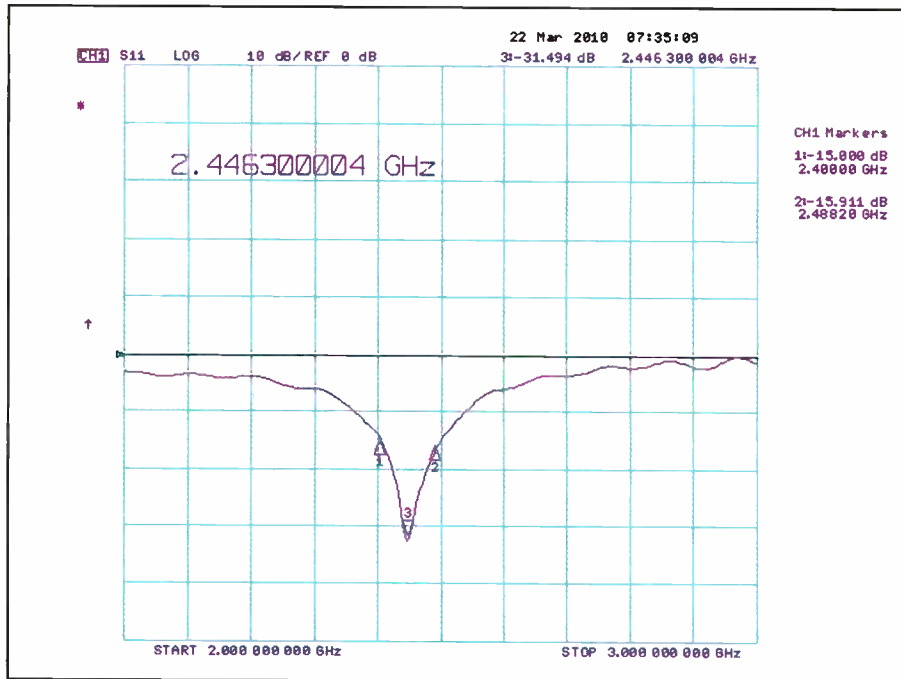

Photo C. Network analyzer plot of the 2.4-GHz vertical.

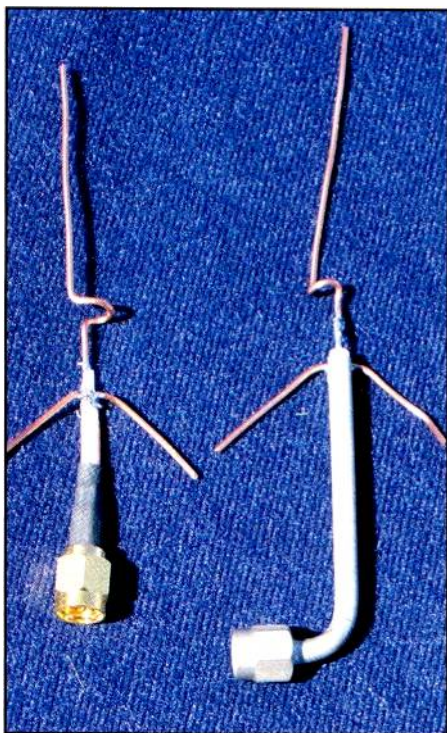

Photo B. Close up of the prototype 5/8-wave verticals.

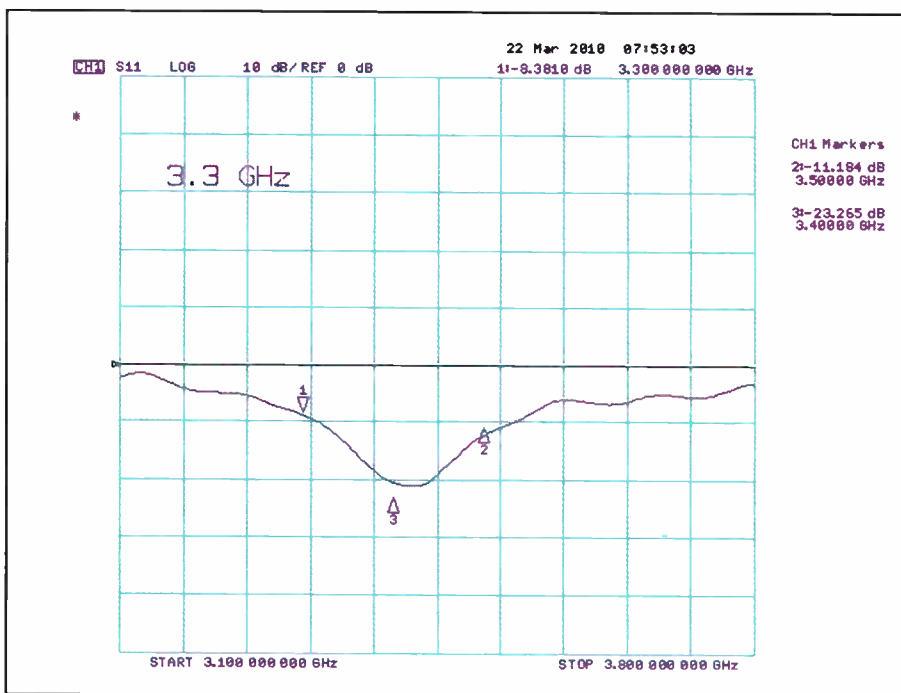

Photo D. Network analyzer plot of the 3.4-GHz vertical.



plane is ready to go, just like the ones in **Photo B**.

## Scaling

Now let's say you need a test antenna for 4.9 GHz; just take the 5.8-GHz dimensions and multiply the lengths by 5.8/4.9, or 1.18. Or perhaps you wish to build a 1.8-GHz version; then take the 2.4-GHz dimensions and multiply by 2.4/1.8, or 1.33.

This scaling is okay for small changes, but if you wish to make a big jump in frequency, then you need to scale the diameter of the 18-gauge wire as well.

## Performance

In **Photo C** we have the network analyzer plot of the 2.4-GHz antenna. The antenna has a better than -15 dB return loss across the entire 2.4-GHz band. This works out to a better than 1.5 to 1 SWR over the whole 2.4 GHz band and a 1.05 SWR in the middle of the band.

In **Photo D** we have the network analyzer plot of the 3.4-GHz antenna. While there's not a lot of WiFi-type activity on 3.4 GHz now, it is growing quickly. This antenna has a -10 dB return loss from 3.3 to 3.5 GHz, or a 2 to 1 SWR over the band.

By the way, that bit of artifact you see in the plot, where the marker is not on the line, was introduced as I reached over to push the "SAVE" button and my arm got close enough to the antenna to change the SWR a bit. I'm afraid I was a little too quick on the draw and wound up saving before the marker could move to the correct position.

In **Photo E** we have (you guessed it!) the 5.8-GHz network analyzer plot. This antenna has a better than 2 to 1 SWR from 5.5 to 6.1 GHz with an SWR of 1.05 at 5.8 GHz. That's more than enough bandwidth to cover the WiFi part of the band.

These antennas work just as well hanging upside down as they do pointing upwards, which means you can simply build one on the end of a length of coax and hang it from the ceiling or off a shelf.

And don't be disappointed that it offers only 3.12 dBi of gain. As I've mentioned before, several years ago I sent up the antenna range for 2.4 GHz and invited the local computer WiFi club over to check it out. It was amazing how many of the "+7 dBi" gain computer antennas measured less than 0 dBi. I've never seen one of those small computer WiFi antennas come even close to its published gains. So while the numbers are not impressive, the little guys

probably work better than the high dollar antennas at the computer store.

## Questions, Questions

Here's one for our readers. The 5/8-wave vertical is a 3/4-wavelength wire shortened to a 5/8-wavelength actual length. Back in the 1970s the 7/8-wave vertical was popular for a while. This antenna is a full wavelength of wire shortened to a 7/8 actual length.

Getting back to my earlier point, as you can see in **Photo F**, the 7/8-wave has some big upward lumps in the pattern, but at the horizon it has more gain than a 5/8-

wave antenna. On HF, when mounted on typical ground with no radials, the 7/8ths greatly out performs, or should I say out simulates, a 5/8ths vertical. Does anyone have any idea why these antennas lost favor with the antenna industry? I don't know of any company producing 7/8-wave whips at this time.

Again I welcome your questions, suggested construction projects, and possible topics for future columns. Just drop me an Email at [wa5vjb@cq-vhf.com](mailto:wa5vjb@cq-vhf.com) or you can visit [www.wa5vjb.com](http://www.wa5vjb.com) for other antennas projects. I always look forward to hearing from our readers.

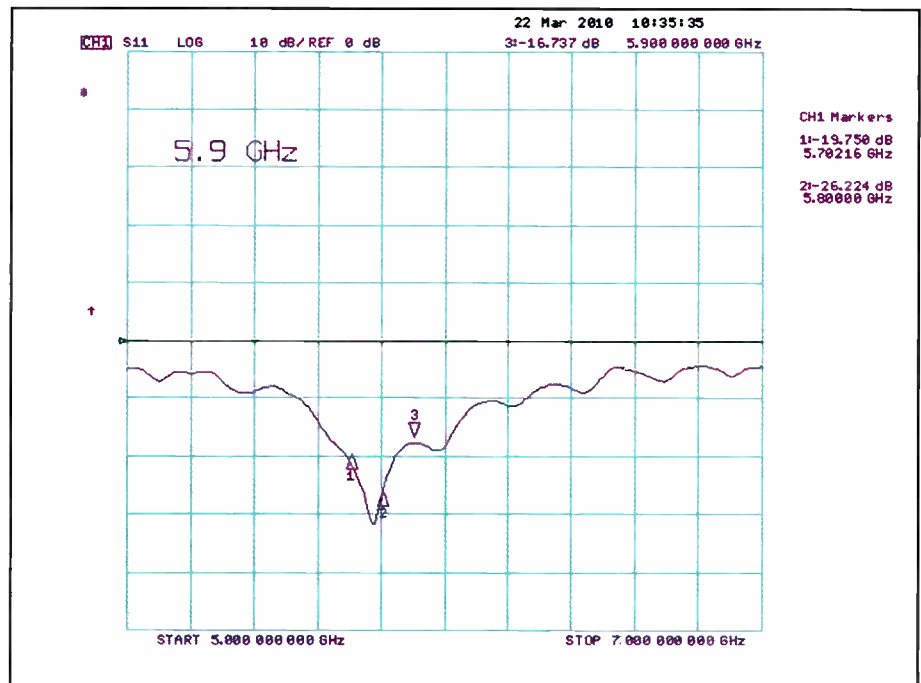

Photo E. Network analyzer plot of the 5.8-GHz vertical.

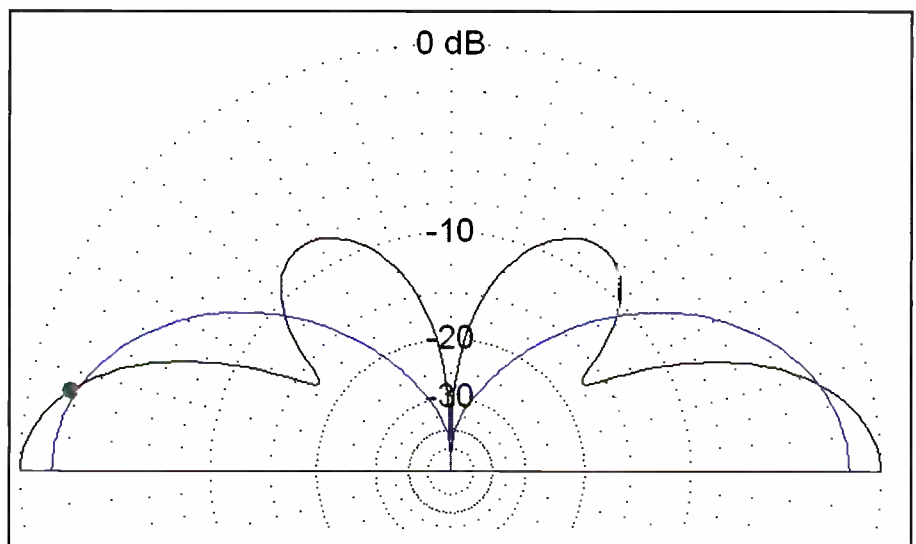

Photo F. Pattern plots of a 5/8-wavelength and a 7/8-wavelength vertical.

## Radio Phonies And Real Top-40

by Shannon Huniwell  
melodyfm@yahoo.com

**W**e begin this month with an especially fun bit of arcana I recently learned about. Because its owner could not afford a tape-delay machine, one modest little radio station transmitted a single-sided talk show. The program, aptly dubbed *Complaint Department*, consisted of the host answering listeners' phone calls, repeating what they were saying to him—as the callers' voices were not broadcast—and then responding to their comments.

By the second edition of the show, several complaints about how horribly boring it was to hear dead air in between the initial caller comment and his response caused the host to ride gain on a record album featuring morose instrumen-

*“Successfully pulling off that subterfuge, the host continued his new approach to his call-in show...he'd disguise the complaints' source by wrapping the fake caller comments in the form of questions.”*

tal selections whenever he wasn't talking. Adding a little salt to the host's wound, that show's only caller simply offered an unkind assessment of the music.

Truth be told, this small-town Louisiana AM at the top of the band didn't have sufficient coverage to generate enough callers to fill the half-hour “public affairs programming” slot promised to the Federal Communications Commission in the station's original FCC application. Between the 500 watts it radiated to a rural community and the old talk show rule of thumb that only one listener in 10 ever phones such a program, the hope it could drum-up a robust lineup of fascinating callers represented great expectations indeed!

No tapes of the misery exist today, though the poor cub announcer who hosted the early 1970s incarnation of *Complaint Department* (and years later relayed the story to my Dad) remembers a true turning point in the show's unlikely history.

“After begging for calls for at least 10 minutes during my third Saturday morning suffering through this so-called *phone-in* program,” he said, “I went into kind of a panic trance. Without much in the way of forethought, I sort-of flipped out, made up a phony caller name, and just started repeating what some non-existent person was supposedly telling me.”

On his way into the station for that show, the host—who was relatively new to town—had nearly gotten T-boned by a driver trying to turn left from the road's right shoulder. The details of this potential disaster were fresh in his mind when he shifted into imaginary caller mode.

“Yes, good morning, *Complaint Department*. What's on your mind?” the announcer began routinely. “You say that some idiot in a blue Chevy 4-door sedan almost killed you on Route 153 this morning? You say she was a middle-aged woman

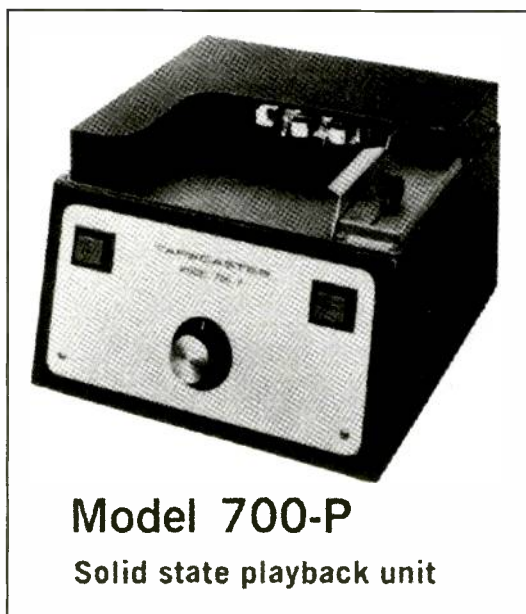

**Model 700-P**  
**Solid state playback unit**

By lining up the playback head before the record head and then using a cartridge containing a little over 50 inches of tape, one make a basic cart machine offer seven seconds of delay. The model 700-P play-only from Tapecaster, shown here, looked like its sister model, the 700-R/P record/playback, except for the latter's record button and input VU meter. Tapecaster officials quickly learned of the head flip modification that clever engineers performed and soon marketed their own, ready-to-roll delay machine and pre-loaded “short” length carts.



A 1990s reissue of Plasticville's WPLA-TV, this model has reverse coloring from the original red building/white roof, as well as an all white—as opposed to half white/half red—transmitting tower. The original beacon was red glow-in-the-dark plastic, as opposed to the white piece (no doubt conveniently borrowed from Plasticville's miniature street lamp globes) shown here.



In toy train legend, WPLA was FCC-licensed to Plasticville, an idyllic community that could be in any state one cared to place it. Though the words “television station” were embossed in the front wall, some model railroaders not only fitted the pylon with other call letters more appropriate to their layout, but might re-label the place “radio station.” Detail-oriented modelers also equipped the top of the station's stick with a tiny “grain of wheat” bulb to light up, as would a real beacon.

who looked like she was drunk? I see...You couldn't get her entire license plate number but think it was something like 3B957, and the car had a bumper sticker that said something about Kisatchie National Forest?”

Successfully pulling off that subterfuge, the host continued his new approach to his call-in show. Hoping to sound innocent, he'd disguise the complaints' source by wrapping the fake caller comments in the form of questions. He intended to be just specific enough to cause listeners to think they might know who was being discussed on the air. “You hate going to the Creston Post Office because one of the clerks there has incredibly bad breath? You say that you're writing fewer letters these days as a result?”

Nothing was off limits during *Complaint Department*. Well, almost nothing...the host had sense enough to avoid lambasting station advertisers, and halitosis was the most extreme bodily problem he'd allow his “callers” to cover. Sometime during the program's second month, real people began to call in. So did several businessmen who wanted to sponsor what was developing into a “must hear” half-hour.

“It was a big relief to finally field real callers who were fired-up about various pet peeves unrelated to my performance,” the fellow told my father. Some turned out to be rather revealing about local folks whom they graphically identified.

“That's when I had to do a lot of paraphrasing over the air,” he said. “You'd be surprised what people would tell me once they could anonymously take a jab at someone who aggravated them in some way. When teenagers began clogging the line an hour before *Complaint Department* aired in order to have me transmit dirt on their former friends and current school teachers, I realized my ruse had become a 500-watt monster, albeit one that brought in a surprising amount of ad revenue.”

The last complaint the announcer heard at the station came from its sales manager who was mad when the imaginative host accepted a more lucrative post at an AM/FM in Shreveport. “Apparently my replacement had a tough time quickly processing the incoming calls and smoothly translating them on the air within good taste,” he recalled. “I happened to catch the show a couple of weeks after I'd left and noticed most of the beefing was being spewed by the new host. ‘Slow down!’ he kept demanding. ‘You're talking so fast that I can't make sense of what you're saying!’ Then advertisers started complaining the show had lost its unique pizzazz.”

How did things turn out? The show's creator heard through the grapevine that the station eventually dumped *Complaint Department* in lieu of a free, pre-recorded and less confronta-

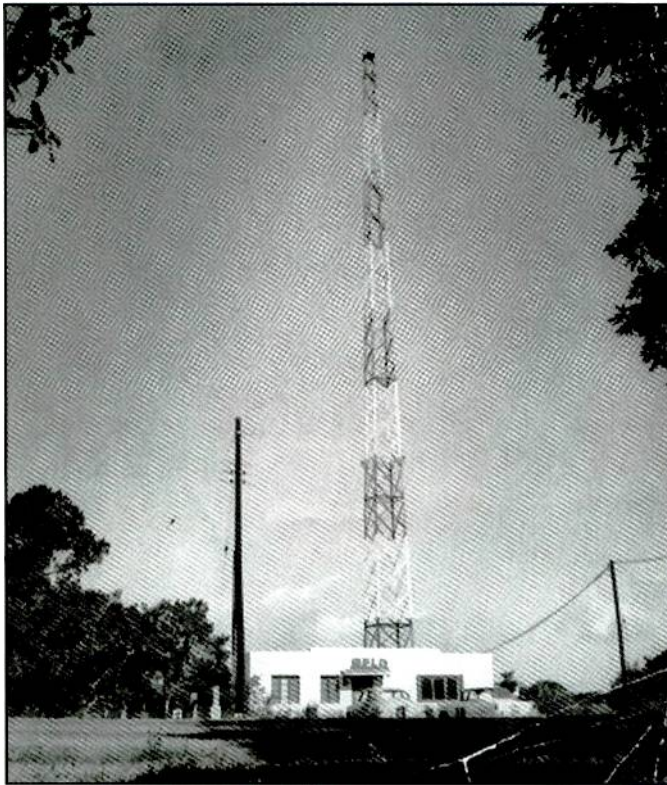

Here's the real WPLA. It's unlikely that the Plant City, Florida, AM had any connection to its Plasticville counterpart, but the two sure look like kissing cousins—each with an antenna just a few feet away. The actual WPLA's tower was acquired "used" from an Orlando-area AM and rebuilt as WPLA's stick. It's nice to think that model maker Bachmann Brothers, Inc., was influenced by this circa-1950 photo (found for sale on eBay) when designing a faux-TV broadcasting facility for Lionel, Marx, and American Flyer train layouts, but hundreds of small radio and television stations of the period were housed in such plain-Jane cinderblock/flat-roofed buildings adjacent to their transmission towers.

tional public affairs program produced by the U.S. Department of Agriculture.

### "Stop Glorifying 1960s Radio!"

That shrimpy AM in the Sportsman's Paradise wasn't the only media outlet fielding gripes. Not long ago, my reader response email was converted into a virtual complaint department by a woman upset about how I often paint radio in the LBJ-era with a Norman Rockwell brush. "Stop ruining the pages of an otherwise decent communications magazine with your idyllically cutesy stories about local radio stations set in the 1960s!" she scolded me. "It was a terrible time to be a young lady employed in the broadcasting business," the woman said.

She told me she'd worked in radio circa 1967, finding it to be filled with lecherous DJs, mean managers, self-centered salacious salesmen, and generally staffed by "a bunch of fakes who came across as egotistical phonies." I thanked the woman for taking the time to email and gently reminded her that unfortunately crummy people can be found in most any profession.

Anyway, because I don't mind making lemonade from sour lemons, the complainer's communiqué prompted me to picture a "fake" broadcast station that might bring back real memories



In the 1980s–90s Lionel rival, Mike's Train House, offered WRKNG in its toy train catalogs. The fact that the station was named with one call letter too many may have had something to do with not wanting to step on any legitimate AM's or FM's toes. Then again, the moniker might serve as a nod to that old train tune, "I've Been WoRKING on the Rail Road." Not shown, but worth mentioning, is Lionel's radio station accessory, WLLC. It was based on a modest Lionel rail-side building and topped with a four-legged self-supporting tower reconstituted from the toy train firm's oil derrick and water tower accessories. WLLC's unique characteristic came in the form of audio from a transistor radio fitted within the station's studio.

for millions of toy train enthusiasts who outfitted their layouts with model buildings from *Plasticville*.

According to Bickerton and Nole's, *Plasticville, An Illustrated Price Guide*, Bachmann Brothers, Inc., began marketing plastic accessories for electric train buffs in 1947. This initial foray came in the form of "a picket fence designed for use on toy train platforms." About three years later, Bachmann added a Lincoln-esque log cabin to its fledgling inventory and thereafter introduced "six to eight new items a year until the sixties when the O and S line was gradually replaced with the HO and N gauge."

During its mid-to-late 1950s heyday, Bachmann's Plasticville series boasted a robust range of miniature architecture from churches to mobile homes. Among the firm's "commercial structures," was WPLA. First cataloged in 1957 (as Plasticville #1618), WPLA had two labeling descriptions: "TV Station" and "TV Transmitting Station." The latter seemed far more logical, considering the building's supposed real-life counterpart's size of approximately 1,500 square feet—a space inadequate for studios, front lobby, offices, engineering shop, restrooms, as well as the transmitter.

WPLA's kit consisted of 11 pieces, including a press-on decal for the front glass doors that said "Plasticville Television Station." Besides the faux chimney pylon sporting the call, WPLA, the station's most evocative component was what Bachmann termed an "antenna pole." Whenever the manufacturing run produced white walls for the WPLA building, the roof and lower half of the tower were molded in red. This color scheme got reversed in subsequent runs and (as in the pictured example from my modest collection) some 1990s reissues were predominantly one hue.

It's interesting to note that while Bachmann often topped its Plasticville houses, police station, and apartment building with tiny dipole antennas, the TV stick was void of such elements.

A couple of little plastic VHF batwings might have made the scene more lifelike. Perhaps, though, WPLA-TV was an imaginary ultra-high frequency facility, giving the then-new UHF television band the old college try up around Channel 35 somewhere in the vast Middle America that Plasticville represented. I like to think so, and I envision the entire top end of the WPLA tower as its UHF pylon-type antenna system. Broadcast savvy model railroaders probably saw WPLA's stick as more replicative of a self-supporting AM transmission set-up.

My father remembers a radio engineer friend's model pike featuring an altered WPLA. The fellow had substituted his employer's AM station's call letters for the WPLA sign, affixed a section of matchbook cover (advertising the real AM's frequency and logo) over the embossed "Plasticville Television Station" wording under the front window, moved the tower out in back of the station building, and linked the two via a neatly scratch-built catwalk on which a run of copper wire served as the transmission line. In place of the red plastic glow-in-the-dark plastic globe atop of the tower, the guy delicately installed a tiny bulb that could be seen blinking lazily when the train room's main lights were extinguished.

## Will The Real WPLA Please Stand Up!

In the absence of a Bachmann designer's sworn testimony, one could argue that



For \$2.25, serious Eisenhower-era model railroaders could buy the ingredients to construct an HO gauge radio or TV station that looked so much like a real broadcast transmitter site that one might be tempted to see if it truly sent out a signal! Lightning Hobbies of Pottstown, Pennsylvania, offered this kit. Unlike Plasticville's WPLA, which could be snapped together in a couple of minutes, Lightning's station required an experienced modeler's woodworking skill and patience.

somebody in the Philadelphia-based firm had made a pilgrimage to Plant City, Florida, where the life-size, Federal Communications Commission-licensed WPLA existed. Then again, the Bachmann folks probably didn't consult specifications of the actual WPLA facility, an AM outlet as opposed to one with the video status of our diminutive plastic subject. Both station buildings, the actual and the representation, were constructed primarily with concrete blocks, real or

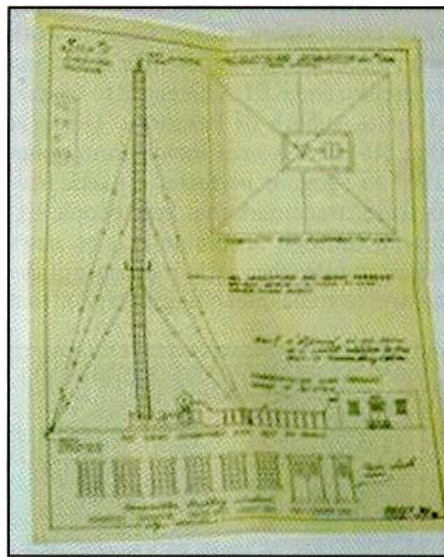

The instructions for Lightning Hobbies' Radio-TV Station had the detail of an architect's plans. The tower drawing rivaled those of actual steel fabricators such as Rohn, Stainless, and Utility. There were even directions for crafting an above ground transmission line/catwalk, from transmitter shack to tower-base, typically the province of FM, TV, or old-style AM installations piping RF to a stick in marshy real estate. Talented HO model builders often "kit-bashed" or modified buildings like Lightning's. Doing so allowed for even greater realism and possible customization that gave homage to a favorite station in the modeler's life.

depicted. This was a common material for many light commercial structures, and hundreds of such box-like broadcasting operations were established in the United States from the 1930s through 1960s.

The fascinating Radioyears.com, a broadcast history website, chronicles Plant City radio and other station stories, but it doesn't mention any connection between the true WPLA and the Plasticville version.

It begins WPLA's saga with a July 1949 debut on 1570 kHz. *White's Radio Log* shows this original incarnation as boasting 250 watts with a sunrise-to-sunset FCC authorization. WPLA's founder, a local businessman, W. A. Smith, located the station's white block studio/transmitter building at 1507 South Collins Street in Plant City. Had it been possible to position the place a bit further down the road, the station's address could have matched its frequency. (Various *Radio Daily-Radio Annual/Television Yearbook* entries show the locale with several conflicting addresses such as 1607 and 1570 S. Collins, as well as W. Alsobrook St.)

Such symmetry little mattered to Smith, though, as he knew 1570 wasn't the best spot on the AM dial and it would be better to finagle a lower wavelength, especially if it came with more power than WPLA's original quarter kilowatt. About seven years after he put the station on the air, Smith convinced the Commission to grant WPLA a construction permit to move down to a much nicer, less crowded section of AM neighborhood, at 910 kHz. This reinvented "low dial" WPLA quadrupled its output, but continued as a non-directional daytime operation via its impressive four-legged self-supporting tower.

In 1974, Smith sold the station to his son who formed a business partnership with WPLA's general manager. By the early 1980s, this duo had secured a CP from the FCC permitting nighttime service from a new east/west directional array in Dover, Florida, about five miles west of Plant City. Eventually, power was raised to 5000 watts around-the-clock.

Now shooting a stronger signal into nearby Tampa, WPLA became attractive to broadcasters looking for a facility that could be recast and reformatted to reach the lucrative Tampa/St. Petersburg market. An outfit seeking such potential acquired WPLA in 1987, dropped the local-sounding Country/Southern Gospel-oriented format, ditched the Plasticville calls, and abandoned the little cin-

derblock headquarters in favor of a more cosmopolitan Tampa address.

*Radioyears.com* reports that WPLA's old home got converted into a daycare center. Perhaps some of the kids attending there caught sight of the imposing tower out back and thought, "Wow! It'd be fun to look down from the top of that thing!" That proud steel structure stood watch over acres of folks—young and old—on its surrounding landscape until succumbing to rust and being cut-up for scrap in early 2003.

## "Dump That Dithering DJ!"

The above directive isn't an exact quote; it's a paraphrase of what yet another radio pal of my Dad's recalls hearing around the time the FM he managed and hosted during its morning show added to its schedule the most famous weekend program in music radio history.

Like many small market stations operated in a Mom & Pop genre, "works cheap" often trumped other qualifications of the part-time air staff at the 3000-watt facility. One such minimum-wage teenage employee was apparently so void of announcing talent that the station owner (who'd hastily hired the boy after the sudden resignation of another broadcast novice who got a *better* offer at an Exxon gas station) demanded that my father's friend can the kid. The *coup-de-gras* was delivered after the boy stammered through a live furniture commercial in which he misspoke "sexual sofa" in place of "sectional sofa," and then hiccupped through about 20 minutes of a Sunday afternoon locally produced contemporary music show that attempted to keynote the week's top selling records. Adding insult to this vocal injury was the fact that the station seldom possessed anywhere close to the requisite 40 of the current hits for such a program. Spinning otherwise unheard of, so-called "extras" culled from odd albums and "stiff" 45s that dribbled into the record library filled those painfully obvious musical holes.

My Dad's buddy convinced his boss that finding stellar weekend air talent and/or securing dependable Saturday/Sunday employees who'd stay long-term would remain elusive in small town radio. Having all the latest singles on hand could be no sure thing, either. What he could promise, however, was a minimum of mistakes and a maximum of first-rate DJ programming if the on-air liabilities could be limited to just a few minutes per

hour—even if the weekend announcer lineup changed every few months.

His remedy arrived in the form of a pre-recorded show needing only someone who could pronounce the call letters reasonably well in a normal voice and operate a control board and turntable. Within a month, the FM's once wince-worthy weekend schedule included the golden tones and fascinating sentence structure of Casey Kasem and his American Top-40.

## Chronicling Casey's Coast-To-Coast

Detroit-native Kamal "Casey" Kasem became a radio fan while listening to the set wafting a bit of background in his Lebanese parents' grocery store. After graduating college in the mid-1950s, Kasem signed on as an announcer with WJBK in the Motor City. His upbeat and genuinely warm delivery made him a fast favorite among programmers of the then-new rock and roll radio scene.

Finding that California offered some of the best weather and most exciting radio employment, Kasem opted to work with Golden State outlets like KYA San Francisco and KRLA, licensed to the Los Angeles suburb of Pasadena. DJing at that 50-kW LA-area locale from about 1963 to 1969, he perfected a music trivia teaser trademark that kept people listening through a commercial or news break while they tried guessing the answer to some interesting statement that

begged a question without ever asking anything. For example, Kasem might billboard his next record with the super-sincerely delivered words, "Coming up, a #1 hit ballad by two girls and a guy who met in the lobby of a record company after being told they had no talent...I'll explain in a couple minutes." Listeners who stayed were later rewarded with interesting facts rivaling the best saga of Paul Harvey's *Rest of the Story*, all skillfully and succinctly transmitted over the musical introduction of the mystery group's record.

On July 4, 1970, he used this effective tactic plus 40 of the country's favorite contemporary hits to debut a weekend DJ program dubbed *American Top-40*. Not only did the show offer listeners who'd never phone a radio station the chance to guess answers to musical personality trivia, but *AT-40* also generated suspense by the simple process of counting down to the song that had snagged the honor of being *Billboard* magazine's hottest hit. With Kasem's instantly recognizable and pleasing voice, the informational and musical ingredients, plus heartfelt listener song dedications read by Kasem, it was a recipe for delicious weekend radio. Kasem served as *AT-40*'s host until 1988

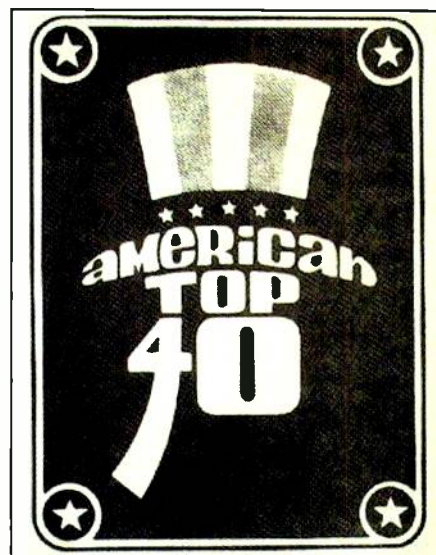

One of the most visually significant images in post-World War II radio history, the incredibly clever Uncle Sam *American Top-40* logo, circa 1976.

This is a promotional advertisement for Casey Kasem's radio show. At the top, it reads "The Man Who Taught The World How To Count To 40. Backwards." Below this is a black and white portrait of Casey Kasem. Underneath the photo, there is a block of promotional text: "This man's show is the most popular musical radio program in the world. Because everyone wants to know how the top songs are doing as Casey counts down to Number One. And because Casey's fascinating tidbits about the stars as well as his long-discover dedications are such fun. So join the listeners who wouldn't say it's a weekend without American Top 40. And it's easy. Because Casey's on over 500 stations coast to coast. Including one where you live." To the right of this text is a small graphic that says "AMERICAN TOP 40". At the bottom of the ad, it says "ABC CONTEMPORARY RADIO NETWORK".

By the late 1970s, every weekend over 500 radio stations aired *American Top-40* with Casey Kasem. Many were affiliates of ABC's Contemporary radio network, a favorite service of hit music radio programmers wanting short news, sports, and celebrity features geared toward the 18- to 34-year-old demographic. This ad ran in news magazines like *TIME*.

when he switched to another syndication company to captain several competing count-down-style series. A decade later, he returned to the original *AT-40* show and remained through early 2004. Along the way, he also became known for an impressive roster of voiceover work.

*AT-40* was initially run on less than 10 stations. Because most of them were AM, the three-hour show was recorded monophonically. By 1972, though, enough FMs had joined the growing list of affiliates (which later topped 1,000) that the program's distributor, Watermark, decided to cut the *AT-40* discs in stereo. Another hour was added to the show in 1978.

It was common practice for a station to run the show at least twice per weekend, typically from 2 to 6 p.m. Saturdays and 6 to 10 p.m. Sundays. *Pop'Comm* reader Joe Locklear recalls one of those Sunday evening airings sometime during the winter of 1973. He and a diverse carpool of college classmates were on Route 84 near Hartford, Connecticut, silently heading back to school after a weeklong break.

"We were an odd assembly," he admitted. "A rather serious divinity major, a star football player, an irreverent hippie stoner, and me, Mr. White-bread Average with a temperamental 6-cylinder Ford Falcon, all thrown together only for want of a cheap ride and my need for gas money. Once on the highway and having exhausted all small talk, I could think of nothing else but to turn on the Ford's Philco radio—the only truly dependable component in the entire vehicle."

He recounted that WPOP 1410, then a respected medium-market rocker, was buttoned in and running *AT-40* and that within 10 minutes the future Methodist minister was enthusiastically teaming up with the atheist hipster to solve some music history mystery posed by Casey Kasem. "The program was nothing short of compelling," Locklear declared, "...a wonderful way to pass the time and learn a few new things."

No mention of Kasem or the show with which he'll always be associated would be complete without noting the "great radio stations" announcement he faithfully issued during every hour of *AT-40*. No doubt begun as part program identification/part appreciation to the affiliates supporting the program, the scripted salute went like this: "*American Top-40* is heard in 50 states and around the world every week on great radio stations like [call letters here]."

My Dad's radio colleague vividly remembers the weekend when Kasem's



Here's what the announcer or "board operator" on duty readied when preparing to engineer a local airing of the weekly *American Top-40* program. Prior to CD and satellite distribution, the show was mailed to stations in the form of (usually) four, 33.3-rpm vinyl records. An enclosed set of cue sheets showed the "board op" where to insert local commercials and IDs. What happened to the discs after the show ran? Some got thrown out, a few—especially in small market stations that seldom received free music from major record labels—got their songs recycled to tape carts and added to the playlist, and some were given away to lucky listeners. In fact that might have been the source of the package for an eBay seller who listed these items on that auction site.

nod was directed at the friend's one-horse FM. "I had pulled into a hardware store parking lot," he said, "and was just about to shut off the engine and get out of my car when Casey announced our call letters. What a thrill it was for me!" And for the station owner, too, who later had the brief segment put on tape cart and played for years as a station promo/ID.

"For that Sunday's airing of *AT-40*—even though we could have played the

program disc anytime in the production room—the boss, his wife, and a couple others of us had a little pizza party in the studio and raised a cheer as our call letters were enunciated by Casey Kasem. It was such a great moment that all the usual complaining we all did at the station stopped for nearly a week!"

*And so ends another day of broadcast history at Pop'Comm...*

**WorldRadio**  
is part of the CQ family!

**Articles In June WorldRadio Online will include:**

- Trail-Friendly Radio • DX World
- Propagation • Aerials

View the issue in its entirety - visit  
<<http://www.cq-amateur-radio.com>>  
Click on the WorldRadio Online link!

**WorldRadio Online**  
25 Newbridge Road  
Hicksville, NY 11801  
1-800-853-9797 FAX 516-681-2926

**CQ 2 Great Books**

**33 Simple Weekend Projects**  
by Dave Ingram, K4TWJ  
Do-it-yourself electronics projects from the most basic to the fairly sophisticated. Includes practical tips and techniques.  
Order No. 33PROJ **\$17.95**

**2010 World Radio TV Handbook**  
The most up-to-date info on mediumwave, shortwave and FM broadcasts & broadcasters. Reviews, maps and more!  
Order No. WRTH **\$35.00**

Shipping & Handling: US \$7 for first book, \$3.50 for 2nd and \$2 for each additional. Foreign: calculated by weight & destination.

**CQ Communications, Inc.**  
25 Newbridge Road, Hicksville, NY 11801  
800-853-9797 • [www.cq-amateur-radio.com](http://www.cq-amateur-radio.com)

## Is Communications Technology Helping Or Hurting?

by Mitch Gill, NA7US,  
NA7US@yahoo.com

The technology of communications is changing so quickly that I don't believe anyone has a grasp on where it's going. On one hand, sophisticated equipment is available to almost anyone, thanks largely to the Internet. On the other, proven technology seems to be falling into obsolescence. Is this a problem? I believe it may be. Let's take a look and see if you agree with me.

### U.S. Predators As Prey

For a mere \$25.95 you can download a program called SkyGrabber from the Internet. The SkyGrabber website describes it as an offline satellite Internet downloader that "accepts free to

*"SkyGrabber was designed to steal video feeds from satellites, not intelligence from Predator drones or any other video stream, but someone figured out that application."*

air (FTA) satellite data (movie, music, pictures) by digital satellite TV tuner card (DVB-S/DVB-S2) and saves information onto a hard disk." It's been receiving press lately for a far more serious reason: its use by Iraqi insurgents to record unencrypted video from satellites that broadcast U.S.



U.S. Air Force maintenance personnel from the 432nd Aircraft Maintenance Squadron out of Creech Air Force Base, Nevada, conduct pre-flight maintenance on an RQ-1 Predator unmanned aerial vehicle at Aeropuerto Rafael Hernandez outside Aguadilla, Puerto Rico. The U.S. military recently discovered that insurgents were intercepting video transmissions from unmanned Predators flying over Iraq. (U.S. Air Force photo by Tech. Sgt. James Harper)



Predators drone uplinks. While SkyGrabber may have been designed to steal copyrighted material transmitted via satellite and save it to a hard disk, it can intercept any data that's transmitted in the open—even video from a Predator. And it doesn't even require an Internet connection.

Iraqi insurgents had discovered a perfect tool in SkyGrabber. All they had to do was point an antenna at the right satellite to capture the Predator video. Authorities were unaware this was being done until a laptop was found with the software and Predator video files on it.

What's astounding to me about this news is that the U.S. was apparently transmitting intelligence gathered by Predator drones without encrypting the video.

## Home Front

One of the fastest paths toward innovation has always been finding new applications for existing technology. With advances putting high-tech capabilities that were once the provenance of governments in anyone's hands the possibilities become pretty disturbing.

SkyGrabber was designed to steal video feeds from satellites, not intelligence from Predator drones or any other video stream, but someone figured out that application. And it doesn't stop there. There's no reason a technically savvy criminal couldn't do the same with, say, a police helicopter's video stream.

It's easy to imagine a scenario involving some creative thief robbing a bank and escaping on foot using a small computer and handheld dish antenna. Perhaps having found another use for a piece of software, he'd see the helicopter in the distance as it searches for him through the night with thermal imaging. As the helicopter got closer he'd check his heat signature on his palmheld computer and use the knowledge to his advantage.

The military can do this, but I don't know if SkyGrabber or any other commercially available offering has the capability to monitor thermal imaging transmitted in the clear. I would love to hear from any of our readers who have heard of such software—or are even using it.

There are plenty of innocent hobby reasons to want to monitor thermal imaging being transmitted in the clear. In addition to tanks, ships and helicopters shoot and transmit thermal video for a variety of reasons.

If you do intercept any video and you know where it came from, you'd be doing



U.S. Air Force Maj. Jeff Bright, a Predator pilot from the 432nd Wing out of Creech Air Force Base, Nevada, goes over a pre-flight check list for an RQ-1 Predator unmanned aerial vehicle at Aeropuerto Rafael Hernandez outside Aguadilla, Puerto Rico. (U.S. Air Force photo by Tech. Sgt. James Harper)

a public service by letting the local FBI or Department of Homeland Security know. Remember if you can monitor something, so can others.

## Radio Over IP (ROIP): Leading To True Interoperability Or False Sense Of Security?

Do you pay one price to a cable provider for cable TV, Internet, and phone service? If so, you're using VoIP (Voice over Internet Protocol), which simply means that you're talking over the Internet.

RoIP, or Radio over Internet Protocol, is similar in that it uses the Internet to connect many radios through an IP interface. There are many advantages to this, such as enabling large geographic areas to be monitored at the same time. In our National Guard operations center, I can listen to any police frequency in the entire state, or I can choose as many or as few as I want to monitor. I can also talk to them.

Moreover, I can literally add different agencies that are using RoIP and give them the ability to talk to each other. This can be a very powerful tool if an incident occurs that requires the response of many different agencies. The involved agencies simply connect to the Internet and are then interconnected with everyone they

need to be. That's all good, isn't it? Not necessarily. It can lead to an over-reliance, I'm afraid. Here's the issue.

What happens to all this great technology if the Internet itself goes down? Many people think that's not possible, but I don't agree.

I live in the Northwest near one of the major fault lines. If major earthquake occurred (and we've seen many lately) it would sever all cables. Anyone south of that fault line would lose all cable Internet. Or what if there's a cyber attack that's successful in disrupting the Internet here in the U.S. (it's happened elsewhere)? And what if one day an enemy decides to detonate a nuclear weapon miles above us? The resulting electromagnetic pulse (EMP) will fry almost all electronics and the only thing that may survive is the old tube radios.

## Let's Hear From You

The bottom line is that I love and use the most modern technology, but I'm still wary of it, and I try not to rely totally on it. There are people out there who would use technology against us in creative ways, and I also see our own agencies becoming—I believe—overly dependent on the Internet and computers. What do you think? I'd like to hear your thoughts.

## Generate Some Fun On Field Day—Safely!

by Kirk Kleinschmidt, NTØZ  
kirk@cloudnet.com

The weekend of June 26, 2010, is all about preparing for the worst by doing what we do best: communicating when others can't to help those affected by disasters big and small. I'm talking about Field Day, of course. It's been an amateur radio mainstay activity for decades, and always takes place on the fourth full weekend of June.

As detailed elsewhere in this issue, Field Day participants operate from remote "field" locations, singly and in groups. Competing in a friendly contest-like atmosphere, participants try to work as many other FD ops as possible, in as many ARRL Sections as possible during the time constraints of the event. In the process, ops gain expe-

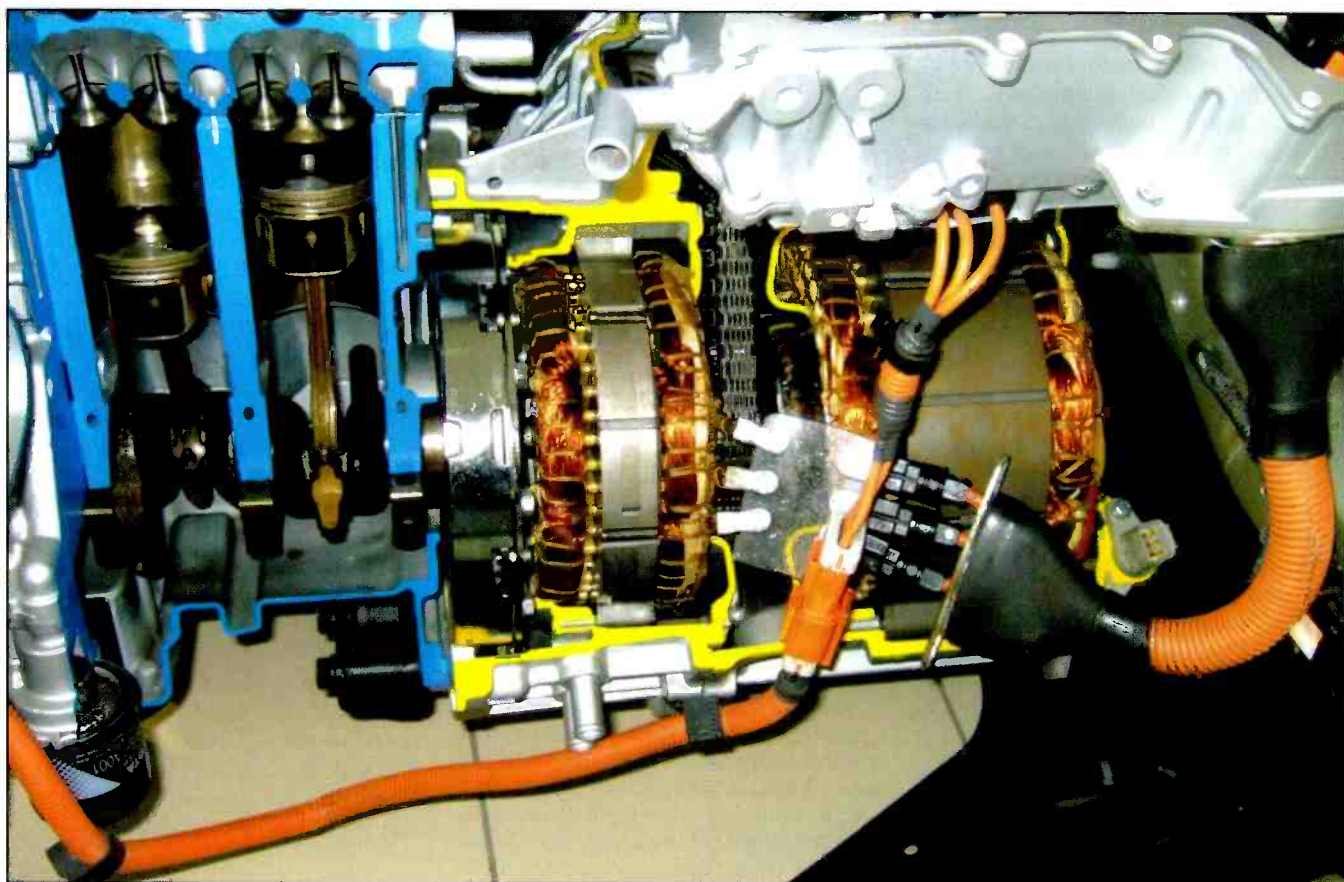

If you own a Toyota Prius (or other hybrid vehicle) your Field Day power plant is already in your inventory! As shown in the photo, this second-generation Prius power plant contains a 30-kW DC generator that you can tap for portable power situations by adding a DC-to-AC inverter. For a single transceiver, a small power inverter that plugs into the vehicle's dash-panel accessory power socket will do nicely. For bigger loads you'll have to add a large computer-type inverter used in uninterruptible power supplies. You can buy a high-quality 2-kW inverter unit on eBay *sans* batteries (which you don't need anyway because your hybrid car already has them) for about \$150. You'll have to add a high-current DC socket to the back end of your car, but with the Prius, at least, it's pretty straightforward.

The Internet and even the print media are awash in stories about Prius owners who powered their home's lights and appliances during recent winter storms and power outages with similar setups. And you wouldn't be the first ham to power a Field Day site with a hybrid car. A nice write-up, with photos, can be found at [www.aprs.org/FD-Prius-Power.html](http://www.aprs.org/FD-Prius-Power.html). In a decade or two, 5-kW hydrogen fuel cells will come in lunchbox-size packages. Until then, a hybrid car makes a classy and handy portable generator, tent, transporter, air conditioner, etc.! (Photo courtesy of Wikimedia Commons)

rience in operating under less-than-ideal conditions, similar to those usually encountered during communications emergencies, such as those caused by hurricanes, tornados, floods, or even earthquakes, as we just saw with the recent blockbusters in Haiti and Chile.

One of the most important lessons learned by FD ops is how to power their equipment while somewhere other than in the comfort of their home shacks. After all, you can have the best gear and the best radio operating techniques, but if you don't have power, you're out of the game!

Battery power, backed by solar and wind generation, can keep stations on the air for the initial response to almost any emergency, but sooner or later someone's going to fire up a gas, diesel, or propane-powered generator. Because portable generators are used extensively at FD sites all over North America, this month's column focuses on generator power and how to use it safely.

## Portable Generators 101

Portable power generators are essentially "backwards" motors, converting mechanical energy (shaft rotation) into electrical energy. They're a lot like automotive alternators, are powered by lawnmower engines, and put out 120 VAC.

For traditional generators, as the engine spins an AC generator (alternator), the voltage and frequency of the AC output vary with the rotational speed of the engine. If the engine is running too fast or too slow, the unit's voltage and frequency will



Want a QRP-size portable generator for this year's Field Day outing that doesn't pack a QRO price tag? Generac's smallest inverter generator, the iX800, puts out 850 watts (peak) of 117 VAC. This little bugger weighs only 30 pounds or so and features a tiny 38-cc overhead-valve engine, low-oil shutdown, overload protection, and circuit-breaker protected AC outlets. Designed by the Wisconsin-based company to be a low-cost alternative to Honda's EU series, the iX800 is relatively quiet at 64 dBa (it's not quite as quiet as the Honda, but it's one-third the price) and is national park approved. With a light load you can expect about five hours of run time per half-gallon tank of gasoline. Check with the manufacturer, [www.generac.com](http://www.generac.com), about voltage regulation and potential RFI issues if you're concerned; I couldn't find this data in any of the available online literature.

be proportionally high or low (*too* high or *too* low can cause big problems). If the engine speed is correct, the output voltage and frequency will approximate the power supplied by the AC mains—a 120-VAC sine wave with a frequency of 60 Hz. (Most units in this category are designed to operate at 3600 rpm, which contributes greatly to their *notoriously* loud sound levels.)

Traditional units use several electronic and mechanical methods to keep voltage and frequency values stable as engine speeds vary. Many gens use mechanical "regulators" to keep the shaft turning at the about the right speed. If the shaft slows down because of increasing generator demand, the governor "hits the gas" to bring the shaft speed up to par (and vice versa). More sophisticated units also have electronic regulators to help keep the output steady near 120 V/60 Hz.

The newest breed of portable generators takes the output of a high-frequency AC generator (as high as 20 kHz), converts it to DC, and uses a solid-state power inverter to produce highly regulated AC output. The process is a lot like that used in the switching power supplies found in desktop computers (and ham rigs) for the past 20 years or so.

The plusses of inverter generators are many, and the minuses few. Inverter units are smaller, *dramatically* quieter (think VW Beetle compared to a jet engine), and feature load regulation of 1 to 3 percent—which some power cooperatives can't even match!

The potential downsides are RFI and cost. Some inverter gens, although very well regulated, produce "noisy" AC power that can affect some ham rigs, especially on HF (even with affected units, the noise isn't usually detectable on VHF/UHF, or while operating on FM). Not every radio is affected by every generator (which has caused frustration in the ranks), so the best bet is to "try before you buy" and test your radio with the generator you're about to purchase. Inverter gens are almost always more expensive than their conventional cousins, but the differential has come down in recent years.

## Make The Right Choice

For Field Day—or any day—your generator must be able to safely power all the devices that will be attached to it. For most ham radio stuff, simply add up the power requirements of all powered devices, add a reasonable safety margin (25 percent), and choose a suitably powerful generator that meets that plus all your other requirements.

If you're planning to power a table saw or an air conditioner, however, things get more complicated. Electric motors need a *lot more power* to start up than they do to keep running. For example, a motor that takes 1000 watts to run may take 3000 watts to start the shaft turning. Light bulbs, soldering irons, space heaters, and most radios don't require extra start-up power, but be sure to plan accordingly.

Generator size and weight vary according to power output and generator type. Low-power units are lightweight and physically small, while beefier models are larger and weigh more. Inverter generators tend to be smaller in general across all class sizes.

Tiny camper models (800- to 1000-watt output) are amazingly small and lightweight, but most micro-size gens lack sufficient regulation and may not be recommended for powering solid-state devices. On the other hand, some teeny gens can put out a whopping 90 A of 12-VDC for charging batteries. If your gear is battery-powered, you may still be in luck. The very process of strapping a big deep-cycle battery across the gener-

ator's DC output can cure a multitude of sins. Still, if you're using a mini-gen to maintain a battery-powered FD operation, the best way to use the 12-VDC output of one of these "el cheapo" units is to charge one battery while using another. That way your expensive radio gear isn't exposed to potentially lethal power while the "generator of questionable parentage" is up and running! A deep-cycle battery is much more tolerant of power excursions.

Most portable generators are driven by small gas engines. Basic models are powered by standard side-valve engines. These are usually noisy and short-lived. More expensive models have OHV (overhead valve) engines, pressure lubrication, low-oil shutdown, cast-iron cylinder sleeves, oil filters, and electronic ignition systems.

Some units, especially those designed for medical applications, are powered by propane, which can be conveniently and reliably stored for years at a time (unlike gasoline). Other units, usually designed for high-power loads or extended run times, are powered by diesel engines.

Smaller generators have small gas tanks (and larger ones, predictably, have larger tanks)—but they may *not* need more frequent refueling. Some small

engines are more efficient than their larger counterparts and may run for half a day while powering small loads. Remember, generator run times are typically specified for 50-percent loads. If you're running closer to max capacity, your run times may be seriously degraded. The opposite is also true. "Extended Run" models usually have more efficient engines and larger gas tanks. Typical portable generators run from three to nine hours on a full tank of gas at a 50-percent load.

As previously mentioned, voltage and frequency regulation—or lack thereof—should significantly influence your buying decision. While *any* generator can safely power light bulbs, heating elements, and power saws, when it comes to computers, TVs, and expensive ham radios, inverter units or better traditional units with mechanical or electronic regulation are almost certainly required, if only for peace of mind!

With no load, traditional generators typically put out 130 volts at 62–63 Hz. As loads increase, frequency and voltage decrease. Under full load, output values may fall as low as 105 volts at 58–59 Hz. Normal operating conditions are somewhere in between. When buying a traditional generator, if "electronic voltage regulation" isn't mentioned on the box, consider calling the manufacturer before you buy. And although you might get lucky, don't expect expert help from the salespeople at your local hardware store: they're used to helping contractors who want to power lights and saws.

## Caveat Emptor

At the risk of making a blanket statement, let me warn you that the quality of most gensets offered for sale at local and chain home and building supply stores is *horrible*. The same goes for eBay and many other online sellers. A recent stroll down the aisles of two "big box national chain building and home stores" revealed nothing but off-brand gens with questionable specs and quality—nothing I'd want hooked up to my ham rig. Do your research before buying and consider products from reputable generator manufacturers such as Honda, Yamaha, Subaru, Onan, and Kohler.

## Be Safe!

A typical Field Day site is a wonderland of distractions. Set the excitement aside—if only temporarily—when it's time to site, install, operate, and maintain your power generator! Before starting the

engine, read the user manual—at least twice—cover to cover. Carefully follow the instructions regarding engine oil, throttle, and choke settings (if any). Be sure you understand how the unit operates and how to use the receptacles, circuit breakers, and connectors.

Make sure the area is clean, dry, and unobstructed. Portable generators should be set up *outdoors* only! Do *not* operate gas-powered engines in closed spaces, inside passenger vans, or inside covered pickup beds, etc., unless the genset is built into an RV and is designed for that type of service.

If rain is a possibility, set up an appropriate canopy or protective shelter. Keep the generator and any attached cords dry.

Generator exhaust systems can get hot enough to ignite certain materials. Keep the unit several feet away from buildings, tent flaps, and people (some inverter gens are so quiet you could work SSB five feet away), and keep the gas can (and other flammable stuff) at a safe distance. Don't touch hot engines or mufflers!

When refueling, shut down the generator and let things cool off for a few minutes. You'll probably catch some flack from the operators, so try to announce the "power outage" in advance, if possible. Or call it a mandatory potty break...

Don't smoke when refueling and don't spill gasoline onto hot engine parts (hence the cooling-off period before refueling). A flash fire or explosion will ruin your outing, at a minimum. Keep a small fire extinguisher nearby, and if you refuel at night, use a light source that can't ignite the gasoline.

Your site's extension cords *must* have intact, waterproof insulation, three "prongs" and three wires, and must be sized according to loads and cable runs. Use 14–16 gauge, three-wire extension cords for low-wattage runs of 100 feet or less. For high-wattage loads, use heavier 10–12-gauge, three-wire cords designed for RV service. If you use long extension cords to power heavy loads, you may damage your generator and/or your radio gear. Try to position extension cords so they won't be tripped over or run over by vehicles. And don't run electrical cords through standing water or over wet, sloped terrain.

## Now You're Ready To Hit The Field

Using the right generator *in the right way* will help make your Field Day safe and successful. See you in the boonies!

## 2010/11 Calendar & Subscription Special!

Ham Radio's finest calendar!



Get a **FREE** calendar with any **CQ Amateur Radio, CQ VHF or Popular Communications 3-year subscription!**

**CQ Amateur Radio** both for only **\$96.95\***  
36 issues plus a **FREE** calendar

**Popular Communications** both for only **\$85.95\***  
36 issues plus a **FREE** calendar

**CQ VHF** both for only **\$78.00\***  
12 issues plus a **FREE** calendar

\*Domestic subscription price.

Visit website for foreign prices & item info:  
<http://store.cq-amateur-radio.com>.

**CQ Communications, Inc.**  
25 Newbridge Rd., Hicksville, NY 11801  
1-800-853-9797 FAX 516-681-2926

## The Sun In Sonic And Visual Art— A Creative Aid For Solar Scientists

by Tomas Hood,  
NW7US, nw7us@arrl.net

*“By applying music and art to a set of live solar wind data, scientists may now take a “sonic” view of solar weather, allowing scientists to hear patterns that their eyes might miss!”*

During the last decade, amazing advances have been made in the tools and techniques used to research our nearest star. For example, solar scientists now have at their command an array of space weather satellites and space craft that enable researchers to see in much greater detail the dynamic moment-by-moment activity of the sun. With precision instruments, scientists look for patterns and cycles, causes and effects that could help us understand the way our sun works.

A new research technique is being developed by researchers at the University of Michigan’s Department of Atmospheric, Oceanic and Space Sciences and the School of Music. By applying music and art to a set of live solar wind data, scientists may now take a “sonic” view of solar weather, allowing scientists to hear patterns that their eyes might miss! This data is usually represented visually, as numbers or graphs, but University of Michigan researchers have “sonified” the data—they’ve created an acoustic, or musical, representation of it.

The researchers’ primary goal was to try to hear information that their eyes might have missed in solar wind speed and particle density data gathered by NASA’s Advanced Composition Explorer satellite. The process of sonification isn’t new; in fact, it’s how Geiger counter radiation detectors emit clicks in the presence of high-energy particles. “What makes this project different is the level of artistic license I was given,” said composer and recent U-M School of Music alumnus Robert Alexander.

The product, which Alexander says is “in between art and science,” sounds appropriately primal and otherworldly. In one version, Alexander used what he describes as a tribal drum beat to represent the rotation of the sun, and he layered the voice of a singer (his sister) to represent another variable, say the charge state of carbon atoms, for example.

“Every piece of scientific data tells a story. I’m expressing this story through music,” Alexander said. “These sonifications present scientific data in a way that is immediately visceral.”

### The Sun And The Interplanetary Magnetic Field (IMF)

Each planet has a magnetic structure. The Earth has a North and South Pole, and magnetic

field lines run from pole to pole, forming a donut shape of magnetic flux energy. The sun has a magnetic structure, as well, but its structure can become quite complex, with several intertwined poles. The sun even reverses its north and south poles each solar cycle.

The sun’s magnetic field permeates the entire solar system, and beyond. This region that stretches from the sun outward past the end of the solar system is called the *heliosphere*. The magnetic field that originates in the sun and stretches out through the heliosphere is called the *Interplanetary Magnetic Field* (IMF). The IMF interacts with the Earth and is a primary cause of space weather.

The IMF sprawls out away from the sun in the form of a huge “current sheet,” a vast expanding surface where complex magnetic field lines run from one solar pole far out into the solar system, arching back again along this sheet to return to the sun’s other pole. These magnetic field lines therefore have polarities that change from north (plus) to south (minus). An IMF flux line that is oriented “northward” is oriented toward the sun, while one oriented “southward” is directed away from the sun. We report IMF orientation using the  $B_z$  (“B sub Z”) index; when the  $B_z$  is negative, it indicates a southerly oriented IMF.

The huge solar current sheet that expands away from the sun is 10,000 km thick and extends past the orbit of Pluto. The entire heliosphere is organized around this giant sheet, which carries an electrical current that is about 16 orders of magnitude less than that of the current carried in an ordinary light bulb.

Ordinarily, the current sheet circles the sun’s equator, spreading out in a wavy sheet that might resemble a dancer’s skirt that flies up while the dancer is spinning around or the curves of a conch shell (**Figure 1**). As Earth orbits the sun, it dips in and out of the main structure of this wavy current sheet. Again, on one side of this sheet, the sun’s magnetic field lines point northward (toward the sun); on the other side they point southward (away from the sun).

South-pointing solar magnetic field flux lines tend to connect with Earth’s own magnetic field (think of holding two bar magnets together, one bar magnet’s north pole against the other bar’s south pole). Solar wind energy can then penetrate

the local space around our planet and fuel geomagnetic storms.

## The Art Of Solar Wind Data

Riding the IMF is the solar wind, the stream of charged particles that emanates

from the sun. It fills the solar system and interacts with the planets, says Jason Gilbert, a research fellow in the Department of Atmospheric, Oceanic and Space Sciences.

The sun, of course, is a huge ball of energy, and a great amount of that ener-

gy is released out away from the sun through various events and mechanisms. Solar flares, coronal mass ejections (CMEs), and coronal holes are just some examples of the release of energy and material from the sun out into the heliosphere (**Figure 2**).

The satellite data used in this sonification project at the U-M comes from the Solar Wind Ion Composition Spectrometer (SWICS) and the Solar Wind Ions Mass Spectrometer (SWIMS) instruments on board the Advanced Composition Explorer (ACE) satellite (see [www.srl.caltech.edu/ACE/](http://www.srl.caltech.edu/ACE/)). These instruments are optimized for measurements of the chemical and isotopic composition of solar and interstellar matter. Both instruments are time-of-flight mass spectrometers with electrostatic analyzers, though each is optimized for different measurements. ACE was successfully launched from a Delta II rocket in August 1997. It went to an orbit around the L1 point, which allows the SWICS and SWIMS instruments to record the solar wind composition without any satellite trajectory-related interruptions.

“In this sonification, we can actually hear in the data when the temperature goes up, or when the density increases,” says Gilbert.

While the researchers didn’t detect new information in this initial experiment, they see possibilities. “I am excited for sonification’s potential in research, but I think more work will need to be done to realize that potential,” says Jim Raines, research computer specialist with the Department of Atmospheric, Oceanic and Space Sciences.

Thomas Zurbuchen, an associate dean in engineering and an atmospheric science professor, conceived the idea of the sonification project and is proud of these initial results. “To me, this project exemplifies what U-M is about: creativity reaching seamlessly across many fields to create something new,” says Zurbuchen.

Be sure to watch the podcast about this art at [www.ns.umich.edu/podcast/video2.php?id=1210](http://www.ns.umich.edu/podcast/video2.php?id=1210). Even more details are given in an interview found at [www.loe.org/shows/segments.htm?programID=10-P13-00010&segmentID=7](http://www.loe.org/shows/segments.htm?programID=10-P13-00010&segmentID=7). Finally, check out the art and music in the video located at [www.youtube.com/watch?v=kryCbFRJCyk](http://www.youtube.com/watch?v=kryCbFRJCyk).

## HF Propagation

With the recent increase in sunspot activity and related space weather, the

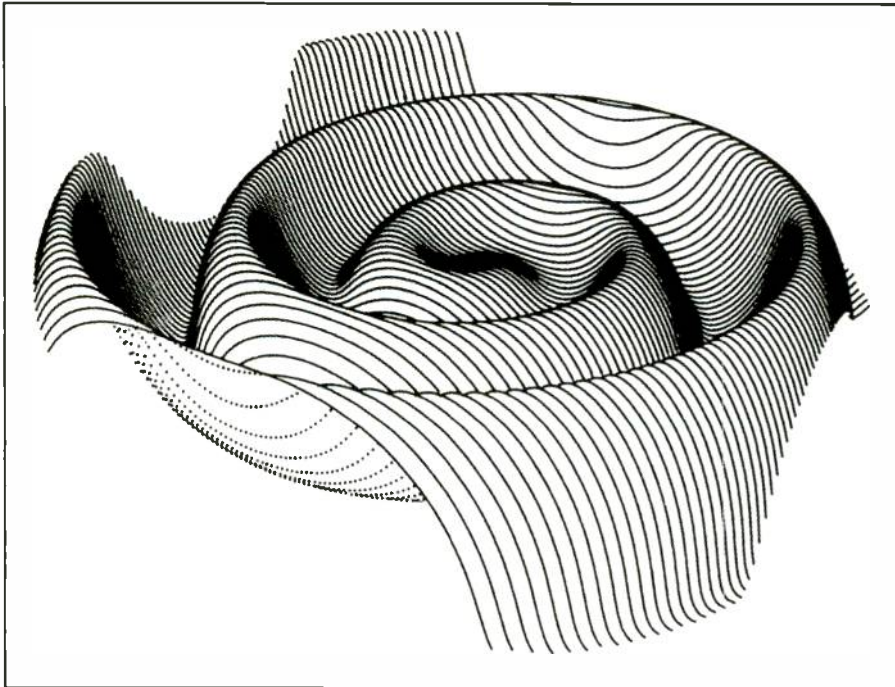

The heliospheric current sheet extends to the outer reaches of the Solar System, and it is the result of the influence of the sun’s rotating magnetic field on the plasma in the interplanetary medium. On this sheet ride the solar winds (see text). This figure illustrates how its shape resembles a ballerina’s skirt. (Image courtesy J.R. Jokipii, University of Arizona)

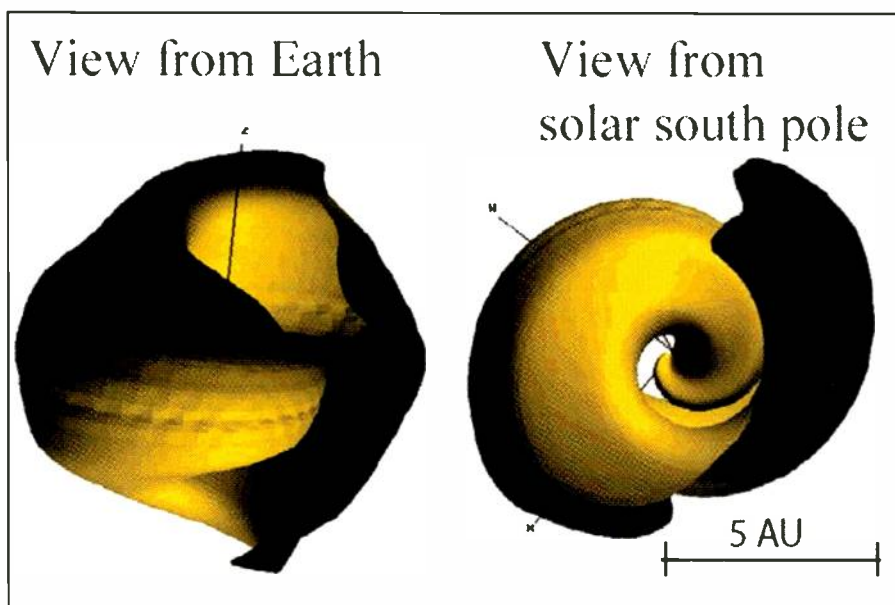

The shape of the heliospheric current sheet in March 2000 as calculated by the Blue Horizon supercomputer using data from several space craft. Here it more closely resembles a conch shell. (Image courtesy NASA)

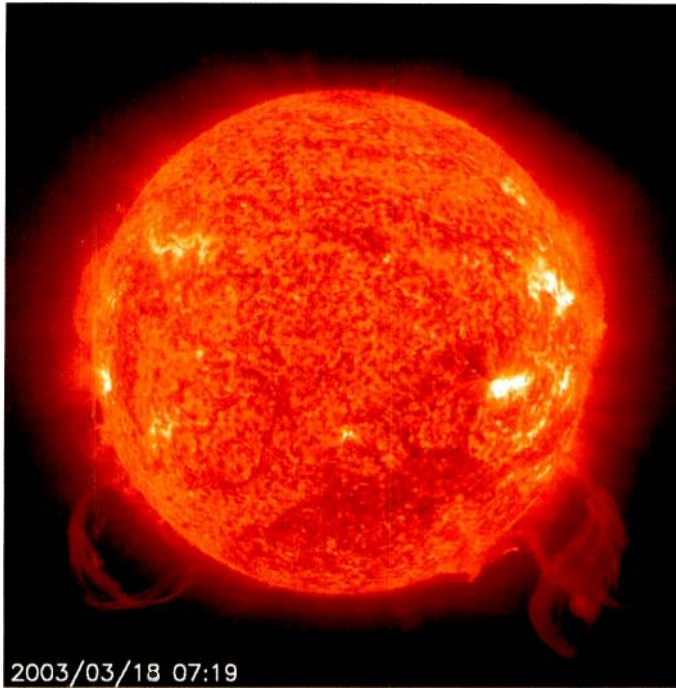

Two large solar prominences in extreme ultraviolet light (ionized helium at 304), roughly the same size but quite different in structure, appeared on the sun on March 18, 2003. The observation of two large prominences in one image makes this one of the most spectacular captured. Prominences are large clouds of relatively cool, dense plasma suspended in the sun's hot, tenuous corona. Magnetic fields built up enormous forces that propelled particles out beyond the sun's surface. The one on the right—and possibly both—was associated with a flare and a coronal mass ejection that blasted away from the sun at about the time this image was captured. The twisting nature of the one on the right is of particular interest to some solar physicists who believe that eruptive events like this are the sun's way of getting rid of magnetic fields that are twisted up too tightly, like the rubber bands that run model airplanes. For a sense of scale, the prominences extend about 20 Earths out from the sun. They both had disappeared by the time the next image was taken six hours later. As this plasma rides the solar wind away from the sun, some of it arrives at Earth. Special instruments aboard scientific research spacecraft record the passage. This data is being "put to music" as a new research method to discover patterns that may be missed by visual inspection of the raw data (see text). (Image courtesy NASA)

propagation of shortwave radio signals is highly variable (Figure 3). June is a month of typical summer-time radio propagation on the shortwave (HF) bands. Solar absorption is expected to be at seasonally high levels, resulting in generally weaker signals during the hours of daylight when compared to reception during the winter and spring months. Nighttime usable frequencies to most parts of the world are higher than at any other time of the year, while the daytime usable frequencies are generally lower than are those during winter.

At the highest end of the HF spectrum, propagation from DX locations east and west is a rare event. North and south paths will be hot, especially around sunrise and sunset. Nineteen and 16 meters will be the most reliable daytime DX band, while 19 and 22 may offer some nighttime openings on periods with higher flux levels.

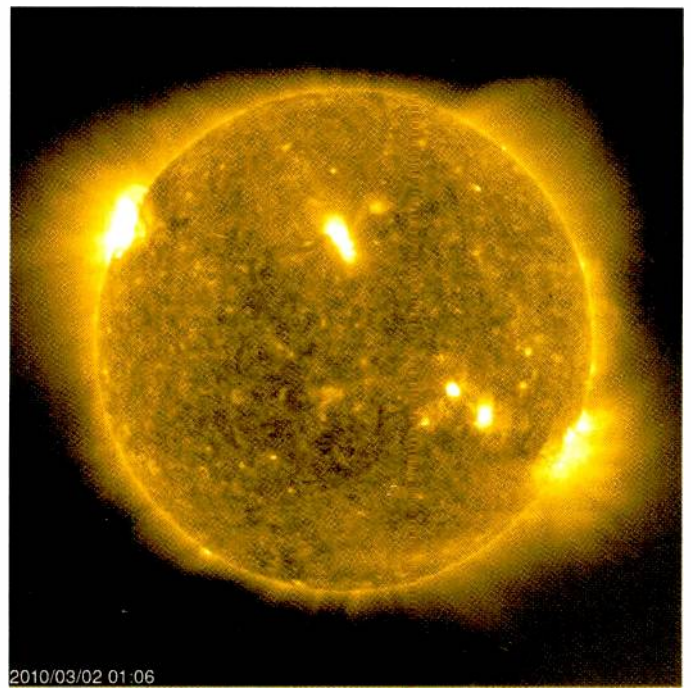

The EIT (Extreme ultraviolet Imaging Telescope) image of the active sunspot region on March 2, 2010. A number of active regions (bright areas) kept the 10.7-cm flux in the 80s. (Image courtesy Solar and Heliospheric Observatory)

Twenty-five and 31 meters will be fairly good in the evenings and mornings. At night, those paths that remain open will be marginal. The most reliable band for both daytime and nighttime should be a tossup between these two bands.

Forty-one and 49 meters should offer good DX conditions during the night despite higher static. Look for Europe and Africa as early as sunset. After midnight, start looking south and west for Pacific, South America, and Asia. Short-skip should be possible out to about 750 miles during the daytime.

Expect some openings on 75 and 90, similar to how 40 meters will be acting. Fairly frequent short-skip openings up to 1,000 miles are possible during darkness, but expect very few daytime openings with all the static and absorption. Mediumwave and 120-meter propagation is rough in the summer due to the high static and higher overall absorption caused by the short nights and higher *D*-layer ionization.

Watch for solar coronal holes to cause degradation of HF propagation. These coronal holes spew out huge clouds of solar plasma toward Earth, creating geomagnetic disturbances that cause the ionosphere to lose its ability to refract HF radio waves. At least one week of poor propagation is expected during June because of coronal hole activity.

Thunderstorm noise and other natural static increases considerably during June and the summer months, masking exotic DX signals. This can make catching weak DX signals a true challenge.

## VHF Conditions

The summertime sporadic-*E* ( $E_s$ ) season for the Northern Hemisphere begins in force in May, with June seeing strong and frequent  $E_s$  openings. Within the normal *E*-layer region of the ionosphere, regions of abnormally intense ionization are

Optimum Working Frequencies (MHz) - For June 2010 - Flux = 87, Created by NW7US

UTC	00	01	02	03	04	05	06	07	08	09	10	11	12	13	14	15	16	17	18	19	20	21	22	23
TO/FROM US WEST COAST																								
CARIBBEAN	22	22	22	22	20	18	17	16	14	13	12	12	13	15	16	17	19	20	20	21	21	22	22	22
NORTHERN SOUTH AMERICA	30	29	29	27	24	22	20	19	18	16	16	15	15	17	20	22	24	25	26	27	28	29	29	30
CENTRAL SOUTH AMERICA	27	25	23	21	19	18	17	16	15	14	14	17	17	19	21	23	25	26	27	28	29	30	30	29
SOUTHERN SOUTH AMERICA	23	16	15	15	14	14	13	13	13	12	12	12	12	16	19	21	23	24	26	27	28	29	28	26
WESTERN EUROPE	13	13	12	11	10	10	14	13	12	12	11	12	15	17	19	20	20	21	21	20	20	19	18	16
EASTERN EUROPE	10	9	9	9	13	16	14	13	12	11	11	10	14	16	18	19	20	19	19	18	17	14	11	10
EASTERN NORTH AMERICA	26	26	26	25	25	24	22	20	19	17	16	16	17	19	20	22	23	24	24	25	26	26	26	26
CENTRAL NORTH AMERICA	15	15	14	14	14	14	13	12	11	10	9	9	9	10	11	12	12	13	13	14	14	14	14	15
WESTERN NORTH AMERICA	8	8	8	8	7	7	7	7	6	6	5	5	5	5	5	6	6	7	7	7	7	7	8	8
SOUTHERN NORTH AMERICA	24	24	23	23	23	22	21	19	17	16	15	14	13	14	16	18	19	20	21	22	22	23	23	23
HAWAII	19	20	20	20	20	19	19	18	16	15	14	12	11	11	12	14	15	16	17	18	18	18	19	19
NORTHERN AFRICA	18	16	15	14	13	13	14	14	13	12	11	13	16	17	19	20	20	21	21	21	21	21	20	19
CENTRAL AFRICA	18	17	16	15	14	15	15	14	13	12	11	13	16	17	19	20	20	21	21	22	22	22	22	20
SOUTH AFRICA	15	14	14	13	13	13	14	20	18	18	18	18	19	20	21	22	23	24	24	21	20	18	17	16
MIDDLE EAST	15	14	14	14	16	16	14	13	12	11	11	10	14	17	18	19	20	21	21	20	20	19	18	16
JAPAN	20	20	21	21	21	20	20	19	18	16	15	14	13	13	15	14	14	14	15	16	17	18	18	19
CENTRAL ASIA	21	22	22	21	21	21	20	20	19	17	16	15	13	13	13	15	17	17	16	15	15	15	18	19
INDIA	19	19	19	19	18	16	14	13	12	11	10	10	10	10	9	9	9	9	11	15	16	17	18	18
THAILAND	18	19	21	21	21	20	19	18	16	15	14	13	12	13	15	17	18	17	16	15	14	14	16	16
AUSTRALIA	30	30	31	31	31	30	30	28	26	23	21	19	18	17	16	15	14	14	13	13	17	23	26	29
CHINA	19	19	20	20	21	20	19	18	17	15	14	13	12	11	13	16	17	15	15	15	15	16	17	18
SOUTH PACIFIC	30	30	30	29	28	26	23	16	15	15	14	14	13	13	13	12	12	12	12	21	25	27	28	29
UTC TO/FROM US MIDWEST																								
CARIBBEAN	25	25	25	25	23	21	19	17	16	15	14	14	15	17	19	20	21	22	23	24	25	25	25	25
NORTHERN SOUTH AMERICA	27	27	26	24	22	20	19	17	16	15	14	13	14	17	19	21	22	23	24	25	26	26	27	27
CENTRAL SOUTH AMERICA	27	25	23	21	19	18	17	16	15	14	14	16	18	20	22	24	25	27	28	28	29	30	30	29
SOUTHERN SOUTH AMERICA	22	16	15	15	14	14	13	13	13	12	12	12	14	18	21	23	24	26	27	28	28	29	28	26
WESTERN EUROPE	16	14	13	12	11	11	13	13	12	12	14	16	17	19	19	20	21	21	21	20	20	19	18	18
EASTERN EUROPE	11	10	10	9	9	14	14	13	12	11	13	16	17	19	19	20	21	20	20	19	18	17	14	11
EASTERN NORTH AMERICA	19	19	18	18	18	16	15	14	12	12	11	11	12	14	15	16	16	17	18	18	19	19	19	19
CENTRAL NORTH AMERICA	9	9	9	8	8	8	7	7	6	6	5	5	5	6	7	7	7	8	8	8	8	9	9	9
WESTERN NORTH AMERICA	15	15	15	14	14	14	13	12	11	10	9	9	9	10	11	12	12	13	13	14	14	14	15	15
SOUTHERN NORTH AMERICA	17	17	16	16	16	15	14	12	11	11	10	9	9	10	12	13	14	14	15	16	16	16	16	16
HAWAII	23	23	23	23	23	23	21	19	17	16	15	14	13	13	14	16	18	19	20	21	22	22	22	22
NORTHERN AFRICA	21	20	18	17	16	15	15	15	15	15	15	17	18	19	19	20	20	21	21	21	21	21	21	21
CENTRAL AFRICA	18	17	16	15	14	14	16	15	14	14	15	17	18	19	19	20	20	21	21	21	21	21	21	20
SOUTH AFRICA	15	14	14	13	13	13	12	21	19	18	18	19	22	23	25	26	28	28	25	21	19	17	16	15
MIDDLE EAST	15	14	14	14	14	16	14	13	12	12	14	16	18	19	20	20	21	21	21	21	20	20	18	17
JAPAN	20	20	21	21	20	20	19	18	16	15	14	13	13	15	17	16	15	15	15	15	17	18	19	19
CENTRAL ASIA	21	21	21	21	20	19	18	17	15	14	13	12	13	15	17	18	19	18	16	15	15	15	18	19
INDIA	13	15	16	17	16	14	13	12	11	11	13	16	17	17	16	15	12	10	10	9	9	9	9	9
THAILAND	17	19	20	20	19	18	17	15	14	13	12	11	13	16	17	19	20	19	17	16	15	14	14	15
AUSTRALIA	30	31	31	31	30	30	29	27	25	21	20	18	17	16	15	14	14	13	13	13	18	24	27	29
CHINA	19	20	20	19	18	17	15	14	13	12	11	13	16	17	18	16	15	14	13	14	13	14	16	17
SOUTH PACIFIC	30	30	29	29	27	25	22	16	15	14	14	13	13	13	12	12	12	12	22	25	27	29	29	29
UTC TO/FROM US EAST COAST																								
CARIBBEAN	20	20	20	19	17	15	14	13	12	11	11	11	13	14	16	17	18	18	19	20	20	20	20	20
NORTHERN SOUTH AMERICA	24	24	23	21	19	17	16	15	14	13	12	12	14	16	18	19	20	21	22	23	23	24	24	24
CENTRAL SOUTH AMERICA	27	25	23	21	19	18	17	16	15	14	14	17	19	21	23	25	26	27	28	28	29	29	29	29
SOUTHERN SOUTH AMERICA	20	16	15	15	14	14	13	13	13	12	12	12	18	20	22	24	26	27	28	28	29	29	27	25
WESTERN EUROPE	17	16	15	13	12	12	13	14	14	14	15	17	17	18	19	19	20	20	20	20	20	19	19	18
EASTERN EUROPE	12	12	11	10	10	13	14	14	14	15	16	18	18	19	20	20	21	21	20	20	19	18	16	13
EASTERN NORTH AMERICA	9	9	9	9	8	7	6	6	5	5	5	5	6	7	7	8	8	8	8	9	9	9	9	9
CENTRAL NORTH AMERICA	20	20	19	19	19	17	16	14	13	12	12	12	13	14	16	17	17	18	19	19	20	20	20	20
WESTERN NORTH AMERICA	26	26	26	25	25	24	22	20	18	17	16	16	16	19	20	22	23	24	24	25	26	26	26	26
SOUTHERN NORTH AMERICA	20	20	20	20	19	17	16	14	13	12	11	11	12	14	15	16	17	18	19	19	20	20	20	20
HAWAII	25	25	25	25	25	24	22	20	18	17	16	15	15	14	14	16	18	19	21	22	23	24	24	24
NORTHERN AFRICA	22	20	18	17	15	15	16	16	18	20	21	22	23	24	25	25	25	25	25	25	25	24	24	24
CENTRAL AFRICA	18	17	16	15	14	14	15	16	16	18	20	21	22	23	24	25	25	25	25	25	25	24	22	20
SOUTH AFRICA	15	14	14	13	13	13	12	18	17	16	17	20	22	24	25	26	27	28	25	20	19	17	16	15
MIDDLE EAST	19	17	16	16	16	14	14	14	15	16	17	18	19	20	20	21	21	21	22	22	22	21	21	21
JAPAN	20	20	20	20	19	18	17	15	14	14	14	15	17	18	17	16	15	15	15	16	17	18	19	19
CENTRAL ASIA	21	21	20	19	18	17	15	14	13	13	14	16	17	18	19	20	20	18	17	16	15	15	17	19
INDIA	9	9	9	9	14	15	14	13	12	13	16	17	18	19	20	20	19	18	17	15	11	10	10	10
THAILAND	17	18	19	18	17	15	14	13	12	13	15	17	18	19	20	20	21	20	18	17	16	15	14	14
AUSTRALIA	30	31	30	30	29	28	25	23	21	19	18	17	16	15	15	14	13	13	13	13	19	24	27	29
CHINA	19	20	20	19	17	16	15	13	12	14	16	18	19	19	18	16	15	14	13	13	13	14	16	18



formed. Through June, you can expect to see 20 to 24 days with some  $E_s$  activity. Usually these openings are single-hop events with paths up to 1,000 miles, but double-hop is possible during June. Look for  $E_s$  on lower VHF frequencies throughout the day, but especially in the afternoon.

A seasonal decline in trans-equatorial (TE) propagation occurs by June, though an occasional opening may still be possible on the low VHF bands toward South America from the southern tier states and the Caribbean region. The best time to check for TE openings is between 9 and 11 p.m. local daylight time. These TE openings will be north-south paths that cross the geomagnetic equator at an approximate right angle.

It might be possible to catch a tropospheric ducting event. Watch for high-pressure weather systems, where ducting is most likely to develop.

## Current Solar Cycle Progress

The Dominion Radio Astrophysical Observatory at Penticton, BC, Canada, reports a 10.7-cm observed monthly mean solar flux of 84.7 for February 2010, up from January's 81.1. This shows a consistent climb since August, 2009. The 12-month smoothed 10.7-cm flux centered on August 2009 is 72.1, also indicating a steady rise. The predicted smoothed 10.7-cm solar flux for June 2010 is about 87, give or take about 8 points.

The Royal Observatory of Belgium reports that the mean monthly observed sunspot number for February 2010 is 18.6, a nice jump up from January's 13.1. The lowest daily sunspot value during January 2010 was eight (8), occurring on February

4 and 5. The highest daily sunspot count for February was 39 on February 8. The 12-month running smoothed sunspot number centered on August 2010 is 4.8. A smoothed sunspot count of 29 is expected for June 2010, give or take about 8 points.

The observed monthly mean planetary A-Index ( $A_p$ ) for February 2010 is four (4). The 12-month smoothed  $A_p$  index centered on August 2009 is 3.8. Expect the overall geomagnetic activity to be unsettled to stormy during June, triggering possible aurora. At the time of writing, the forecast holds that June will be an active month, with occasional strong geomagnetic storms due to recurring coronal holes, flares, and possible CMEs (if flaring occurs from sunspot activity). Visit the last-minute forecast page at [http://hfradio.org/lastminute\\_propagation.html](http://hfradio.org/lastminute_propagation.html) for the latest propagation condition forecast that incorporates the geomagnetic conditions expected based on the 27-day rotation of the sun.

## I'd Like To Hear From You

I invite you to visit my online propagation resource at <http://propagation.hfradio.org/>, where you can get the latest space data, forecasts, and more, all in an organized manner. If you're on Facebook, check out <http://tinyurl.com/fb-spacewx> and <http://tinyurl.com/fb-nw7us>.

Do you have a question that you'd like me to tackle in this column? Drop me an email or send me a letter, and I'll be sure to cover it. I'd love to hear any feedback you might have on what I have written. See you on the air!

Until next month, 73 de NW7US



# Amateur Radio books & dvds

## Lew McCoy on Antennas



by Lew McCoy, W1ICP  
Lew presents his invaluable antenna information in a non-intimidating way. **\$19.95**

## The Quad Antenna



by Bob Haviland, W4MB  
A comprehensive guide to the construction, design and performance of Quad Antennas. **\$19.95**

## W6SAI HF Antenna Handbook



by Bill Orr, W6SAI  
Inexpensive, practical antenna projects that work! Guides you through the building of wire, loop, Yagi & vertical antennas. **\$19.95**

## The NEW Shortwave Propagation Handbook



by W3ASK, N4XX & K6GKU  
A comprehensive source of HF propagation principles, sunspots ionospheric predictions. **\$19.95**



## The Short Vertical Antenna & Ground Radial

by Jerry Sevick, W2FMI  
Small but solid guide walks you through the design and installation of inexpensive, yet effective short HF vertical antennas. If antenna restrictions are a problem - this book could keep you on the air. **\$10.00**

## Understanding, Building & Using Baluns & Ununs

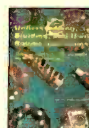

by Jerry Sevick, W2FMI  
The successor to Baluns and Ununs. New material and designs, with crystal clear explanations of how and why they work. **\$19.95**

## VHF Propagation

### A Guide For Radio Amateurs

by WB2AMU & WB6NOA



A comprehensive source-book on VHF propagation. Tropo Ducting, Sporadic-E, Aurora, Meteor Scatter, F<sub>2</sub> Prop, TEP and more! **\$15.95**

## "Getting Started" DVD Paks

### CQ Ham Radio Welcome Pak

Includes 3 programs:  
Ham Radio Horizons  
Getting Started in Ham Radio  
Getting Started in VHF

### CQ VHF Specialty Pak

Includes 3 programs:  
Getting Started in Satellites  
Getting Started in VHF  
Getting Started in Packet

### CQ HF Specialty Pak

Includes 2 programs:  
Getting Started in DXing  
Getting Started in Contesting



1 - \$24.95  
2 - \$45.95  
3 - \$65.95

## HR Anthologies

**\$19.95 ea.**



**Buy all 4 for only \$75**

Enjoy collections of the best material published in *Ham Radio* magazine, conveniently arranged by subject and original publication date. Choose your interest, your time period and choose your anthology!

- Homebrewing Techniques ..... Order # AHOME
- Test Eqpt & Repair Techniques ..... Order # ATEST
- Antennas - 1968 - 1972 ..... Order # ANTS1
- Antennas - 1973 - 1975 ..... Order # ANTS2
- All 4 for \$75 and FREE Shipping. Order # ASET**

Shipping & Handling - U.S. and possessions - add \$7 for the first book, \$3.50 for 2nd and \$2 for each additional. FREE shipping & handling on orders over \$100 (merchandise only). Foreign - Charges are calculated by order weight & destination.



**CQ Communications, Inc. 25 Newbridge Road, Hicksville, NY 11801**  
**1-800-853-9797 • View more items @ [www.cq-amateur-radio.com](http://www.cq-amateur-radio.com)**



# The Night Hawk Receiver: Revisiting A “Radio Connection” Classic

by Peter J. Bertini  
radioconnection@juno.com

*“The Night Hawk is a spin-off of the two-tube Doerle set that appeared in the 1934 Official Short Wave Manual by Hugo Gernsbeck...”*

Way back in 2001 we looked at something called the “Night Hawk” receiver project in “The Radio Connection,” as this column was then called. Richard Yingling, a *Pop’Comm* reader who contributed some follow-up improvements, recently contacted me to see if I had any interest in a pursuing an updated Night Hawk that would tie up some loose ends. My answer is a resounding, Yes! It was an extremely popular project back then, and I’m betting it will be again.

Here’s what Richard had to say:

I still get requests for information on the Night Hawk or “One-Tube All-Bander.” The Night Hawk debuted in the January 2001 issue of *Popular Communications*, with follow-up pieces in the May and July issues. The July follow-up included my suggested improvement of adding a 10- $\mu$ F, 160-volt capacitor across the regeneration potentiometer to reduce control noise.

I still have the original article on the One-Tube All-Bander, which was written by David Green, W6FFK, and appeared in the January 1967 issue of *Electronics Illustrated*. The 1967 article is also on the Web at [www.mines.uidaho.edu/~glowbugs/12at7\\_regen.html](http://www.mines.uidaho.edu/~glowbugs/12at7_regen.html).

The Night Hawk is actually a spin-off of the two-tube Doerle set that appeared in the *1934 Official Short Wave Manual* by Hugo Gernsbeck, which has been reprinted by Lindsay Publications. The Doerle used a pair of type-30 triode tubes. A similar design, the Twinplex, was also described in the *1934 Official Short Wave Manual*. It uses a

type-19 dual-triode vacuum tube. Other versions make use of the octal-based 6SN7 dual-triode tube. Green’s One-Tube All Bander described in the *Electronics Illustrated* article used a 12AT7 miniature 9-pin dual.

I use my Night Hawk set to. This requires the detector to be oscillating to copy continuous wave, or CW, signals. The amplifier also prevents the detector from reradiating a signal from the oscillating regenerative detector. The grounded grid circuit is easy to add to the Night Hawk and is less trouble to get functioning than my old 12BA6 tuned RF amplifier. (I did not design the circuit; it’s based on a design by C.F. Rockey in the August 1955 issue of *Science and Mechanics*.)

I have two versions of the Night Hawk: one that uses a fixed coil, which I use to copy amateur radio signals; and one with plug-in coils, which I use for AM and shortwave listening. The set pictured in Photos A and B is the version I use for amateur radio work.

Photo A. This Heathkit IG-62 color bar generator, an inexpensive flea market find, yielded the tubes, sockets, enclosure, and many parts that were reworked into Richard’s ham version of the Night Hawk regenerative receiver.



I've made some modifications to the original circuit. First, I added a grounded grid radio frequency amplifier to the input (see Figure 1). This stage isolates the antenna from the detector, preventing unwanted antenna loading from causing the detector to drop in and out of regeneration. Further, the amplifier eliminates the need for a variable coupling trimmer. The second change is the use of a second audio amplifier stage. The original audio amplifier is followed with a second stage of the same design as the original Night Hawk audio stage. These changes are shown

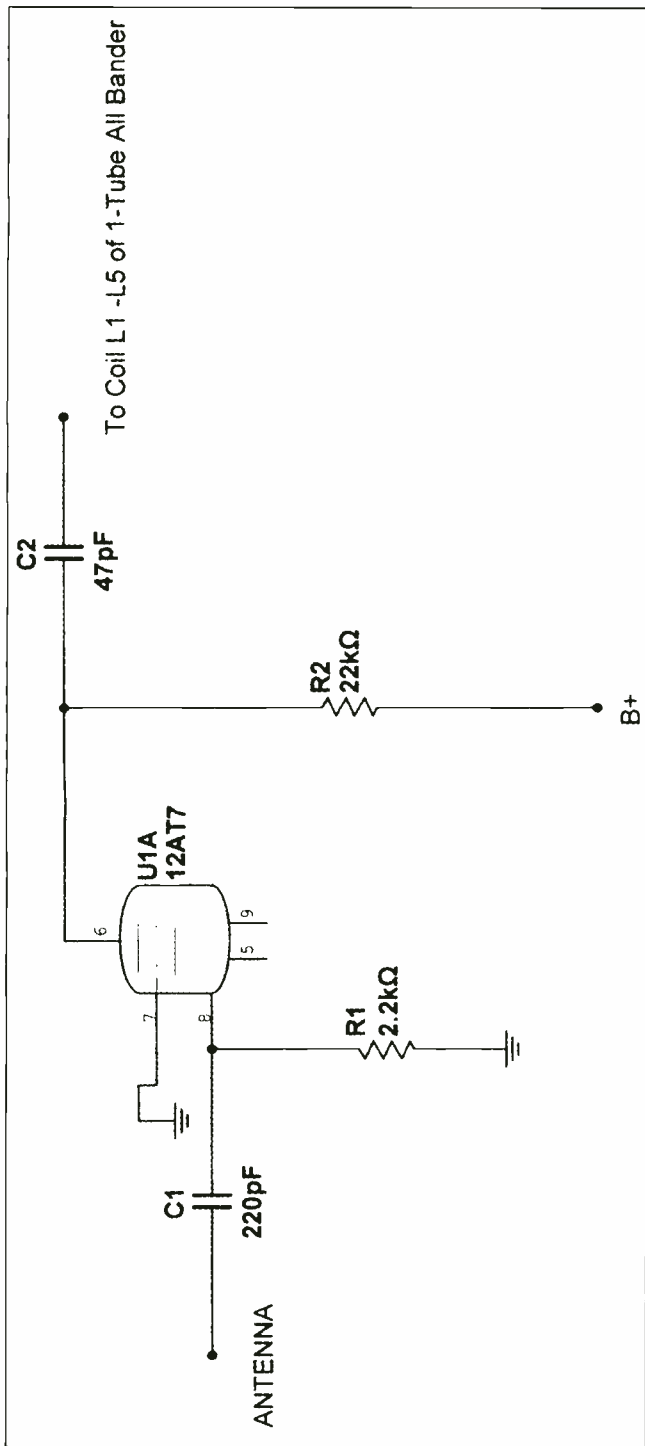

Figure 1. Richard's simple grounded grid amplifier stage improves oscillator isolation and simplifies operation by eliminating the variable antenna coupling capacitor.

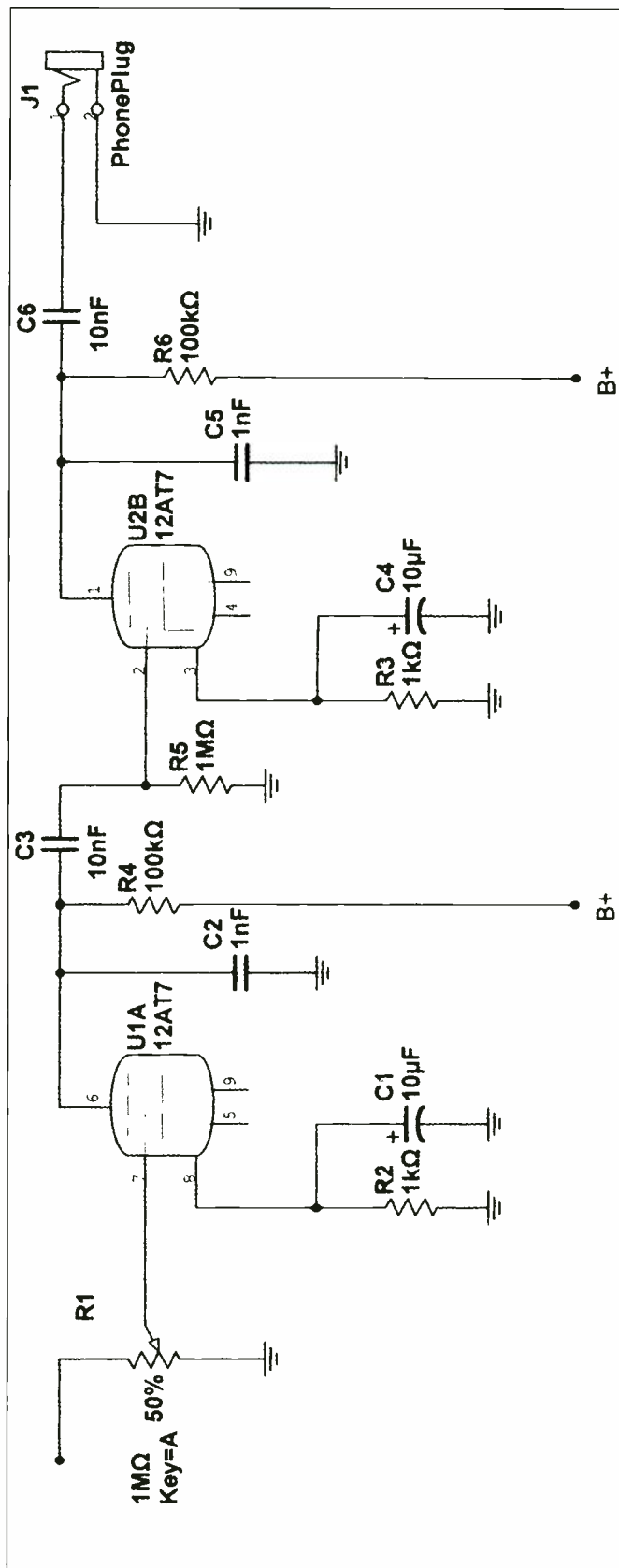

Figure 2. The second triode section from another 12AT7 yields an additional stage of audio amplification. Two 12AT7 triodes are used: one tube serves as the RF amplifier and detector; the other as the dual-stage audio amplifier.

in the schematic in Figure 2.

My Night Hawk also has a 1-pF band spread capacitor paralleling the main tuning capacitor. The band spread capacitor is tuned via a vintage National Radio Velvet Vernier dial. A second vernier drive is cascaded with the Velvet Vernier to allow very fine-tuning of CW signals. The set shown is housed in a reworked Heath Kit IG-62 color bar dot generator chassis—something I had picked up at a flea market. The unit had a couple of 12AT7 tubes and a great transformer in the power supply section, which I put to good use in the Night Hawk.

I built my shortwave and broadcast band version of the Night Hawk in 1998 on an old Knight Kit sweep generator chassis. It also has the grounded grid RF amplifier and additional audio stage. I added a gas tube regulator to that set for the regenerative detector to improve stability.

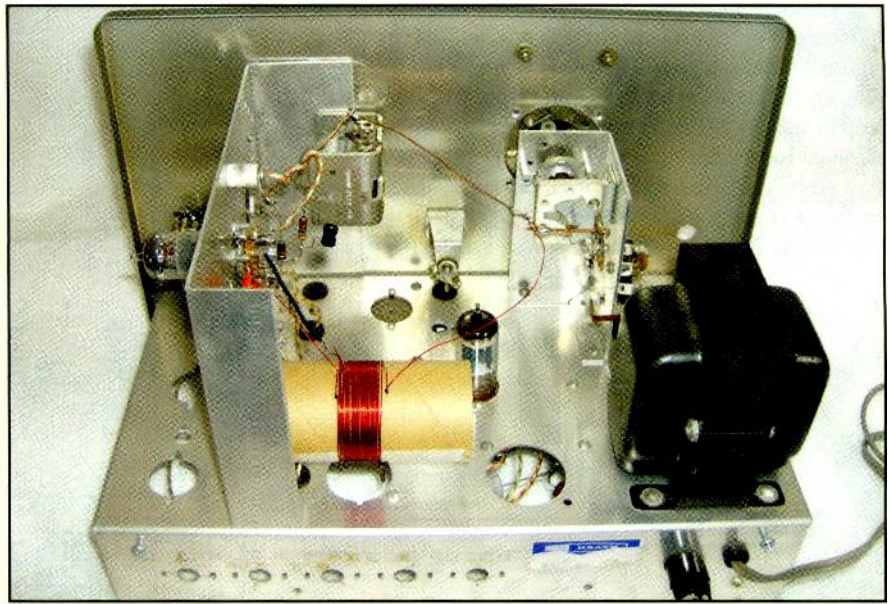

Photo B. Here's a peak behind the front panel showing the inner workings and construction details.

## A Retrofit That Keeps On Giving

Thanks, Richard! It's good to see that—as all good things should—the Night Hawk just keeps coming back.

I'm sure many newer readers will have many questions, but don't worry! We'll be back on the subject again next month with

a parts list and more construction details. Also, Richard is making up small, inexpensive resistor and capacitor kits for those interested in building either the original or upgraded Night Hawk.

Stay tuned for more info! Until next time, keep those soldering irons warm, and those old tubes glowing!



**Going Green has never been more exciting!**

**SPECIAL OFFER BELOW!**

*Monitoring Times* is the leading monthly publication for shortwave and scanner listening. If it's on the airwaves, we report about it! Each month will bring you 80 pages packed with features, projects, frequencies, reviews and ideas. Our subscribers quote that we are "invaluable," "a must-have," and "worth every penny." So if you are interested in radio, you can't afford to be without *Monitoring Times*. But if paper and the Post Office isn't your thing, then there is also MTX PRESS!

Before the rising prices of gasoline, and before going "green" became a sales pitch, *Monitoring Times* created MTX PRESS. The full version of the magazine you've come to depend on, in full electronic form. You get more with our digital magazine than you could ever have with print. The entire magazine is full color. All of the web links are clickable, so if you see a link to a website that you want to visit, just click on it! Want to email an author? Just click on their email address at the top of their column, and MTX PRESS opens your email program, drops in their address, and is ready for your input! All of this, and it's even CHEAPER than the regular print version! Plus, you'll get it faster than you would your print copy, no matter where you are in the world. Now is the time to go digital. Sure, it's saving a tree and saving some gas, but it's also getting you what you need, when you want it. *Subscribe today!*

For a mere \$19.95 U.S., **MTX PRESS** gives you *Monitoring Times* magazine

- in PDF format viewable with free software, delivered by FTP
- viewable in b i l i a t e r (the whole magazine, not just what you see in the print version) on your computer screen
- easily navigated by clicking on the Table of Contents
- printable using your own computer printer
- searchable to find every mention of a topic or station schedule
- importable into your frequency databases
- compatible with software to convert text to audio for sight impaired listeners

**If you order MTX PRESS NOW, you will get 14 ISSUES for the price of 12! That's right, for only \$19.95 you'll get an EXTRA 2 MONTHS AND MTXTRA! Just mention code MTOPOCOMM when you place your order!**

*To find out if this new subscription is the delivery solution for you, you may download a sample issue for free! Just go to <http://www.grove-ent.com> to find out how.*

Now with **MTXTRA**

Not only do you now have the complete *Monitoring Times* magazine, in full color, but for no extra cost, we are now adding **MTXTRA**, which will have a worldwide broadcast guide with ALL offered languages, not just English! So no matter where you are in the world, *Monitoring Times* has something just for you!

**GROVE**

800-438-8155

828-837-9200 fax: 828-837-2216

order@grove-ent.com

7540 Highway 64 West

Brasstown, NC 28902

**WWW.GROVE-ENT.COM**

# Amateur Radio: The Next Generation— Growing The Hobby Through The FRS Connection

by Gordon West,  
WB6NOA  
WB6NOA@arrl.net

You can't argue the fact: We hams are an elite, but aging group. We're about 650,000 strong, but we're getting grey, so we need younger people in the ham radio hobby to join us to keep our ranks from shrinking. Plus, an influx of new blood will add vitality that will make us even stronger than our numbers.

Where will we find them? This month I've got two terrific suggestions, and they're both close to home and they both involve the Family Radio Service: your local Field Day and your neighborhood CERT team.

## Hams Supporting FRS CERT Teams

Heavens—is it true? Can hams really be working with UHF CB radio operators? You bet. And because of this cooperation, community emergency response teams will quickly learn all about what our hobby can offer. Specifically, I'm talking about some dedicated people who are using both the Family Radio Service and Amateur Radio Service to help their fellow citizens. How does this work? Let's start at the beginning...

## FRS History— Why It's A Natural Fit

The Family Radio Service was adopted in the summer of 1996, but actually got its start 40 years

*"...neighborhood disaster preparedness programs encouraged CERT members to purchase FRS radios and hold weekly nets. I had good fortune to be involved with some of them and here's how it worked."*

earlier than that as the Class A Citizens Band. Back then, the Vocaline UHF CB radio was put on frequency by squeezing twin capacitor plates until reception sounded clear. A few watts out on the vacant UHF frequencies led to some amazing long-range contacts!

Class A CB ultimately morphed into the UHF General Mobile Radio Service (GMRS) with specific channel assignments (see box).

A GMRS station required FCC licensing, and these stations could run up to 50 watts of power. The channel pair 462.675 MHz/467.675 MHz could also be used for the purpose of soliciting or rendering assistance to a traveler, or for communicating in an emergency pertaining to the immediate safety of life or immediate protection of property.

The FCC ultimately allowed licensed GMRS operators full use of *all* channels, rather than

Base Station, Mobile Relay Fixed, and Mobile		Mobile Station, Control Station, or Fixed Station, operated Duplex	
Channel 1	462.550	Channel 1	467.550
Channel 2	462.575	Channel 2	467.575
Channel 3	462.600	Channel 3	467.600
Channel 4	462.625	Channel 4	467.625
Channel 5	462.650	Channel 5	467.650
Channel 6	462.675	Channel 6	467.675
Channel 7	462.700	Channel 7	467.700
Channel 8	462.725	Channel 8	467.725

just a single channel pair assignment. GMRS operators could also communicate simplex direct by talking on the repeater output channels near 462 MHz.

Further, the FCC established the following repeater output interstitial frequencies for small base stations and portable operations:

462.5625	462.6625
462.5875	462.6875
462.6125	462.7125
462.6375	

If these frequencies sound familiar, that's because they're the first group of channels (Channels 1 through 7) allocated to 1/2-watt FRS radio users.

This means licensed GMRS operators could legally transmit up to 5 watts of effective radiated power among themselves, and to *unlicensed* FRS Channel 1 through 7 users.

Remember, the 462-MHz channels are interstitial to GMRS repeater *outputs* (*High IN, Low OUT*), so if you're hammered with interference, it could be powerful 50-watt repeaters on each side of your low power, simplex operation.

FRS Channels 8 through 14 are interstitial to GMRS repeater *inputs*, so interference should be less. Also, FRS Channels 8 through 14 are not shared with higher-power licensed GMRS stations. These allocations are as follows:

467.5625	FRS Channel 8
467.5875	FRS Channel 9
467.6125	FRS Channel 10
467.6375	FRS Channel 11
467.6625	FRS Channel 12
467.6875	FRS Channel 13
467.7125	FRS Channel 14

Another twist is that interstitial GMRS communications on FRS Channels 1 through 7 are  $\pm 5$ -kHz deviation, and FRS equipment is limited to 2.5-kHz deviation, making the little FRS radios less "loud" when received on a typical GMRS transceiver. Also, the little radios on FRS Channels 1 through 7 "clip out" greater receive deviation signals, so any GMRS user wanting to chat with an FRS user must talk well away from his radio's microphone!

## The Neighborhood Connection

Community Emergency Response Teams, made up of dedicated volunteers trained in disaster preparedness and response, popped up all over the country

when FEMA dollars were abundant to support this valuable program. In some parts of the country, well-established CERT teams continue their training, and serve their communities well. Such is the case in several coastal cities here in southern California where neighborhood disaster

preparedness programs encouraged CERT members to purchase FRS radios and hold weekly nets. I had the good fortune to be involved with some of them and here's how it worked.

Participants on FRS channels were made well aware that their 1/2-watt sig-



The next generation of hams is getting top-notch training through Teen CERT. This outreach program educates students about disaster preparedness for hazards that may impact their area and trains them in basic disaster response skills. Pictured is Jason Alexander, CERT volunteer and Teen CERT instructor (right) assisting an unidentified student during a recent Teen CERT exercise at Mira Loma High School, Sacramento, California. (Photo by Andy Cruz)



Licensed radio amateurs have unrivalled technical and operating skills, plus a strong drive to help their communities, but as a group we're going a little gray. We need to actively attract our successors.



One way of spreading the message is to join forces with other groups. Here FEMA Community Relations (CR) Specialist Annette Moreno-Robinson, Community Emergency Response Team (CERT) member Josephine Brown, State Emergency Response Team (SERT) member Ann Farior, and FEMA Public Information Officer (PIO) Renee Bafalis provide door-to-door outreach for potential Tropical Storm Fay affected residents. Hams can play a vital role. (FEMA/George Armstrong)

nals wouldn't quite travel the advertised range figures printed on the equipment brochure. We simply converted miles to blocks, so an advertised five-mile-range FRS radio might typically work for up to five blocks away. Five blocks was plenty for neighbors to check in with each other, on a pre-determined channel, on the weekly evening net.

The ham radio angle enters the picture with those ham operators who would spend the dollars for a GMRS license, allowing them to communicate with 10 times the power of the 1/2-watt FRS radios on the first seven interstitial channels. The ham/GMRS base station operator would mainly be a monitor, as the GMRS rules require keeping communications "within the family." Nonetheless, the ham/GMRS control operators would log all the traffic they heard from the local neighborhood, and then switch to their usual ham bands to pass that traffic on to a ham net control operator, who would compile the information and then pass it on to the local emergency operations center (EOC).



There's no better way to promote our hobby than Field Day, and kids love it. The action starts with the pros warming up the bands and for fun GOTA (Get On The Air; see text) contacts with the kids.



When kids hear the sounds of CW, they all want to try out the Field Day challenge to send their name in dots and dashes for a fun certificate.



Field Day fan Karen S., KI6EYG, is cooking with gas on 6 meters.

What this program does is turn hundreds of FRS low-power users into neighborhood-condition reporters on FRS. Their signals are picked up by ham/GMRS operators with outside 70-cm collinear base station antennas, who then sort and relay the important calls, using their ham radios, to their ham net EOC counterparts.

“It was like watching the tide go out fast forward, and then watching it come back in, as a surge, quite rapidly, re-flooding the bay...” is how one FRS-equipped observer described the recent tsunami conditions along southern California harbors. Any ham operator with UHF extended receive capability can take part in such FRS relays, even though they’re not actually transmitting to these FRS stations outside of their ham band limits. They become “passive” and reporting monitors.

## Gearing Up—FRS Radio Field Testing Revisited

Some FRS equipment lends itself to being received farther. While all FRS gear is limited to a 1/2 watt on Channels 1 through 14, the physically larger radios among the equipment offerings frequently offer an improved signal as well as improved transmit audio.

During recent heavy rains throughout southern California we found that palm-sized FRS radios don’t “get out” as well as larger FRS 1/2-watt transceivers. The bigger FRS radios could also pull in the 10 NOAA weather stations and offer louder audio output. As I’ve mentioned before (see “Tech Showcase” May 2010 *Pop’Comm*) one of our group’s favorite transceivers is the full-sized, bright yellow Uniden GMR2872-2CK GMRS/FRS transceivers. These nifty 22-channel devices are fully submersible, down to three feet underwater for thirty minutes and also float. They offer very loud audio output, direct call, caller ID, auto-channel change, recharge ability, and up to 6,300 tone squelch/channel combinations to ensure multiple CERT teams only hear their own local CERT units.

If the operator has a GMRS license, he or she may also use Channels 15 through 22, the additional “talk around” output channels of distant GMRS repeaters. FRS Channels 8 through

14 gave us field strength measurements to a 1/2-watt ERP output, and FRS Channels 1 through 7 could be increased in power level for those operators holding a valid GMRS license. Although our repeated tests found that this slight amount of additional power did not significantly increase range, it *did* allow us to overcome interference from distant CERT teams miles away.

On these Uniden units, the annoying “Roger” beep tones could be silenced. CERT teams are encouraged to menu-off the beeps that would drive any sane ham radio operator over the edge when monitoring!

These Uniden radios also have a vibration mode to alert you to an incoming call, or a missed call, with enough calling features to satisfy any ham operator wanting “the works.” During the rainstorms, we appreciated the weather alert feature that sounded off several times with an approaching water spout! We also loved the convenience of dropping the FRS/GMRS Unidens in the double charger holder for a fast recharge.

Ham radio groups, looking to take on some new excitement, are seeing some great opportunities—and many challenges—working with unlicensed CERT members with FRS equipment. But out of every 10 *unlicensed* CERT members, one or two really get excited about talking well beyond the block—and this is where the next generation of ham radio candidates is found.

## The Field Day “Kid Connection”

The amateur radio Field Day event, which falls on June 25, 26, and 27 this year, provides the perfect opportunity for ham radio recruitment because it provides the perfect way to make a “kid connection.”

In between busily working up contact points during this annual event, ham operators frequently will offer a special GOTA (Get On The Air) station, which is ideal for kids. This Field Day station allows for relaxed, “third party” contacts under the supervision of a licensed Field Day ham.

“A great way to attract the kids to this station is our use of loaner FRS radios,” says veteran Field Day op Julian Frost, N3JF. “The idea is to give the kids a little practice on FRS mak-



ing radio contacts to unknown stations at an alternate Field Day location," he explains, showing the script he uses to get the kids talking. Once they complete a few contacts on FRS, those who get turned on to two-way radio next get to work as third party ops at a regular ham radio station. "Those kids who get excited about talking on small handhelds are perfect candidates for the introduction of ham radio."

Another Field Day "kid draw" is what's known as the long board, featuring individual code keys and oscillators.

"The kids love banging on the keys, so we take this time to show them the difference between the short sounds and long sounds of Morse code while teaching them a few simple characters," says Suzy West, N6GLF, another Field Day fan.

"We even have a battery-operated electronic keyer and Bencher paddles for some kids who are really adept at sending well-executed SOS, and other simple characters. Some kids seem to have a more musical feel for the code and do quite well," adds West.

"The kids' area of Field Day will be radio active!" predicts our local Field Day Chairman, WE6COP, "Cork, the cop," here in southern California.

"We have FRS radios with automatic position reporting system GPS ability, all on license-free channels, just for teaching the kids on scene," says Cork, displaying a collection of FRS radios with more features than most ham radio dual-band HTs could ever have! Of course, he'll also have Kenwood and Yaesu APRS 2-meter ham gear for the "big guns." But, for this one southern California Field Day operation, the kids will get a very warm radio welcome—with plenty of FRS equipment to try out.

## Make Your Own Connection

FRS radios are not toy walkie-talkies down on 46/49 MHz. These 1/2-watt UHF radios are serious narrowband communication devices that could be life-savers in a widespread emergency. They are just as much a 1/2-watt UHF transceiver as any small ham set switched down to low power—now that's something worth considering, and putting to work to grow our hobby.

I hope to hear you on the air for the next CERT net or operating during Field Day! Now stand by for some for important traffic!

## readers' market

**Advertising Rates for Readers' Mart:** Non-commercial ads are 30 cents per word, including abbreviations and addresses; minimum charge \$6.00 per issue. Ads from firms offering commercial products or services are \$1.00 per word; minimum charge \$20.00 per issue. Boldface words are \$1.20 each (specify which words). Leading key words set in all caps at no additional charge. All ads *must be prepaid in full* at time of insertion; a 5% discount is offered for prepaid 6 time insertions. All ads must be typewritten double spaced.

**Approval:** All ad copy is subject to Publisher's approval and may be modified to eliminate references to equipment and practices which are either illegal or otherwise not within the spirit or coverage scope of the magazine.

**Closing Date:** The 10<sup>th</sup> day in the third month preceding date of publication. Because the advertisers and equipment contained in Readers' Market have not been investigated, the Publisher of *Popular Communications* cannot vouch for the merchandise listed therein. Direct all correspondence and ad copy to: Attention: Classified Dept., PC Readers' Market, 25 Newbridge Rd., Hicksville, NY 11801.

**SuperBertha.com** ULTIMATE LONG BOOM OWA YAGIS: Designed by WA3FET and K3LR. Scott W3TX. 814-881-9258.

**COMMUNICATIONS MONITORING ANTENNAS.** HF/VHF/UHF Super Discone \$49.75. AntennaCraft Scantenna \$47.70. 30-1200 MHz. 4-12 dB Log Periodic \$69.50. 806-900 MHz. 13 dB 9 element Yagi \$74.00. MURS/GMRS Dual Band Base \$48.95. All prices **INCLUDE** Priority S&H&I. See these antennas plus many, many more for Amateur, Business, CB, and Monitoring radio, plus cellular phone antennas on the web at: [www.antennawarehouse.com](http://www.antennawarehouse.com) MC/Visa Order line 877-680-7818. To help maintain our low pricing, we do not print catalogs.

**FOR SALE - DRAKE TR-7/TR-7A/R-7/R-7A Service kit.** Includes: 13 Extender Boards and Digital Jumper Card. \$64.75 includes postage. See <http://wb4hfn.com/Services/W7AVK/tr7ext2.htm> Bob W7AVK, 5581 Panorama Drive, Moses Lake, WA 98837, w7avk@arrl.net, 509-750-7589.

**SuperBertha.com** CUSTOM ROTATING POLES: No guy wires, entire pole rotates, stack all your antennas, rotor at ground level, 50ft to 300ft high, EIA-TIA-222-G. Starting at \$37,799.00. Scott W3TX, 814-881-9258.

## ADVERTISERS' INDEX

Advertiser	Page #	Website Address
AOR USA, Inc. ....	26,27,Cov III .....	<a href="http://www.aorusa.com">www.aorusa.com</a>
Advanced Specialties .....	39 .....	<a href="http://www.advancedspecialties.net">www.advancedspecialties.net</a>
C. Crane Company .....	29 .....	<a href="http://www.ccrane.com">www.ccrane.com</a>
CQ Bookshop .....	55,75 .....	<a href="http://www.cq-amateur-radio.com">www.cq-amateur-radio.com</a>
Communications Electronics .....	5 .....	<a href="http://www.usascan.com">www.usascan.com</a>
Computer Aided Technologies .....	45 .....	<a href="http://www.scancat.com">www.scancat.com</a>
Etón Corporation .....	14,15 .....	<a href="http://www.etoncorp.com">www.etoncorp.com</a>
Grundig .....	14,15 .....	<a href="http://www.etoncorp.com">www.etoncorp.com</a>
HamTestOnline .....	37 .....	<a href="http://www.hamtestonline.com">www.hamtestonline.com</a>
Homeland Security .....	45 .....	<a href="http://www.ready.gov">www.ready.gov</a>
ICOM America, Inc. ....	Cov. IV .....	<a href="http://www.icomamerica.com">www.icomamerica.com</a>
MFJ Enterprises, Inc. ....	3 .....	<a href="http://www.mfjenterprises.com">www.mfjenterprises.com</a>
Monitoring Times .....	78 .....	<a href="http://www.grove-ent.com">www.grove-ent.com</a>
PowerPort .....	37 .....	<a href="http://www.powerportstore.com">www.powerportstore.com</a>
QCWA .....	37 .....	<a href="http://www.qcwa.org">www.qcwa.org</a>
RSGB Books .....	48 .....	<a href="http://www.cq-amateur-radio.com">www.cq-amateur-radio.com</a>
REACT International, Inc. ....	56 .....	<a href="http://www.reactintl.org">www.reactintl.org</a>
Scanner Master .....	31 .....	<a href="http://www.scannermaster.com">www.scannermaster.com</a>
Weather Defender .....	49 .....	<a href="http://www.weatherdefender.com">www.weatherdefender.com</a>
Universal Radio .....	1 .....	<a href="http://www.universal-radio.com">www.universal-radio.com</a>
<a href="http://www.RFfun.com">www.RFfun.com</a> .....	39 .....	<a href="http://www.RFfun.com">www.RFfun.com</a>
Yaesu .....	Cov II .....	<a href="http://www.vxstdusa.com">www.vxstdusa.com</a>

Reach this dynamic audience with your advertising message, contact Arnie Sposato at 253-853-4080, FAX 253-853-4070, or e-mail: [advertising@popular-communications.com](mailto:advertising@popular-communications.com).

## The Joys Of Modern Communication (Or Why Bill Should Get A 2-Meter Rig)

by Bill Price, N3AVY  
chrodoc@gmail.com

*“...apparently some ‘protective circuitry’ has prevented any trickle of current from flowing through the cigarette lighter to charge the phone.”*

**M**any of the things that happen to Norm are so unbelievable that my readers will think I make them up. I may embellish them, but generally, they’re reported pretty much as they happen.

Well, this one happened to me. And, believe me—with all due apologies to Dave Barry—I’m *not* making this up!

Some two weeks ago I attended the Virginia HarmonicaFest. That’s not quite like a hamfest, and it would not be germane to the story except that while I was there I (and my two traveling companions) caught some horrible strain of bronchitis that has left us all coughing and hacking for well over two weeks, much to the chagrin of our respective physicians.

I had returned to my workplace where I was so completely run down that I eventually had to leave my HPJIE\* early and head home to Cowfield County to rest. After a nap, I found no chicken soup or similar comfort food in the cupboard, and I thought it would be easiest to drive to the nearby shopping center where I could get some hot & sour soup from the Chinese restaurant. The long-suffering Mrs. N3AVY took the ride and went inside to buy the soup. I shut off the engine. Oh, if life only had a rewind button.

As I shut off the engine, the fuel pump (electric, of course) breathed its last, and the car would not restart when she came out. The time was about 9 p.m. I surmised that I was just having fuel delivery problems (well, in a way I was *right!*) and reached for my cell phone, which was about a mile away—at home. All I needed, I thought, was a can of ether (starting fluid), which was “normally in the car,” and jumper cables, which were also “normally in the car.” Of course, I had just cleaned out the car and not put these items back.

Several well meaning but ill-equipped people saw me with the hood up and offered/tried to help. I couldn’t even borrow their cell phones to call friends—including my best friend and mechanic Charlie Brown (not his real name)—because I didn’t know any of their phone numbers. Only my cell phone knew them, and it was safely at home. By now I was running the battery down by trying all my “tricks.”

After some doing, my wife was able to call a friend whose phone number was listed in the phone book in the restaurant, and that friend took her home to get

the cell phone, jumper cables, and some ether. This is when I ran the battery down completely and learned that there was no fuel getting to the injectors. By this time, the restaurant had closed, everyone in the entire shopping center had left, and when I went to call Charlie Brown, my cell phone battery went dead.

There I was, unable to walk home, with a broken-down car that would be towed if left overnight in the shopping center lot for more than the cost of having it towed home, and I can’t bring up the cell phone to retrieve numbers because it takes over a minute for it to reactivate when I turn it on and by then the feeble battery craps out once again. And apparently some “protective circuitry” has prevented any trickle of current from flowing through the cigarette lighter to charge the phone.

Pounding on the dashboard only hurt my hands and scared Mrs. N3AVY.

There are no pay phones. There are no businesses open. I waited for Superman to show up, but he was probably saving people with *real* problems. Oh...did I mention that I was really sick and coughing and hacking through this whole event?

Finally, I thought to take a 9-volt battery from an electronic metronome that was still in the car, touched the appropriate terminals to the cigarette-lighter plug of my cell phone charger, and prayed that 9 volts would be enough to bring the phone to life. The battery got warm. I held it like that until it was no longer warm and turned on the phone. It gave me enough charge to get through to Charlie Brown, who came, quietly diagnosed the problem and told me to lock it up. He then drove us home, where I called a wrecker.

Years ago, I could change a mechanical fuel pump under the hood before the batteries of an incandescent flashlight failed me—and I usually kept a spare fuel pump in the trunk. I had no cell phone and this type of thing would happen late at night miles from a pay phone, where I could call my dad for advice (or a ride home). I sure miss those days—and my dad.

*(Bill would love to give Charlie Brown the credit he deserves by giving his real name, but then everyone in Cowfield County would know how nice he is and they’d never leave him alone.—ed.)*

\*High-Paying Job in Electronics

# AR2300 "Black Box" Professional Grade Communications Receiver

**Introducing a new generation of software controlled "black box" receivers!**



**Available in professional and consumer versions, the AR2300 covers 40 KHz to 3.15 GHz\***

*With the new AR2300 "black box" receiver from AOR, up to three channels can be monitored simultaneously. Fast Fourier Transform algorithms provide a very fast and high level of signal processing, allowing the receiver to scan through large frequency segments quickly and accurately. All functions can be controlled through a PC running Windows XP or higher. The AR2300 features advanced signal detection capabilities which can detect hidden transmitters. An optional external IP control unit enables the AR2300 to be fully controlled from a remote location and send received signals to the control point via the internet. It can also be used for unattended long-term monitoring by an internal SD audio recorder or spectrum recording with optional AR-IQ software for laboratory signal analysis. The AR2300 appeals to federal, state and local law enforcement agencies, the military, emergency managers, diplomatic service, news-gathering operations, and home monitoring enthusiasts.*

*Discover exceptional performance, state of the art specifications and a receiver with a menu of optional extras that can be configured to your own needs and specifications.*

- Receives AM, wide and narrow FM, upper and lower sideband, CW modes, and optional APCO-25
- Up to 2000 memory channels (50 channels X 40 banks) can be stored in the receiver
- Alphanumeric channel labels
- Fast Fourier Transform algorithms
- Operated by a Windows XP or higher computer through a USB interface using a provided software package that controls all receiver functions
- An I/Q output port that allows the user to capture up to 1 MHz of bandwidth onto a computer hard drive or external storage device
- An SD memory card port that can be used to store recorded audio
- Analog composite video output connector
- CTCSS and DCS squelch operation
- Two selectable Type N antenna input ports
- Adjustable analog 45 MHz IF output with 15 MHz bandwidth
- Optional AR-I/Q Windows software facilitates the easy storage and playback of transmissions captured within up to 1 MHz bandwidth or, signals can be subjected to further analysis.
- An optional GPS board can be used for an accurate time base and for time stamping digital I/Q data.
- The triple-conversion receiver exhibits excellent sensitivity across its tuning range.
- Powered by 12 volts DC (AC Adapter included), it may be operated as a base or mobile unit.
- Software-driven operating selections include IF bandwidth, frequency, mode, filters, a screen-displayed graphical "S-meter," memory inputs, volume and squelch settings and more
- Professional (government) version is equipped with a standard voice-inversion monitoring feature



® The Serious Choice in Advanced Technology Receivers

**AOR U.S.A., Inc.**  
20655 S. Western Ave., Suite 112  
Torrance, CA 90501, USA  
Tel: 310-787-8615 Fax: 310-787-8619  
info@aorusa.com • www.aorusa.com

*\*Cellular blocked for US consumer version. Unblocked version available to qualified purchasers with documentation. Specifications subject to change without notice or obligation.*

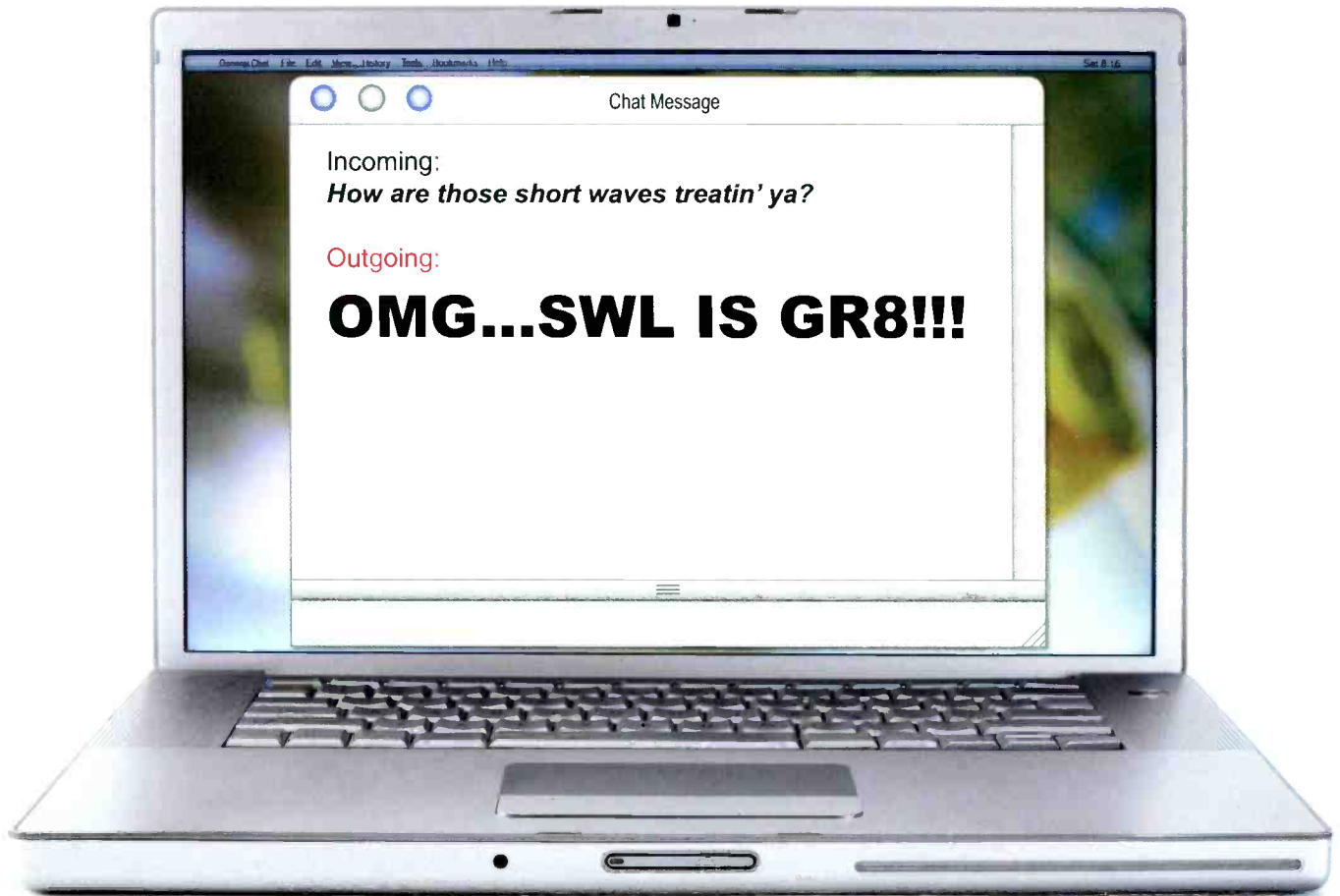

Listening to shortwave over the air is part science, part art. There's something magical about turning a knob on a box and opening an earful of life in another part of the world. No Ethernet cables. No server shut-downs. No broken links. Just hundreds to thousands of miles of air between the station and you, with your IC-R75.

**IC-R75. IDEAL FOR SHORTWAVE AND MORE.**

  
**ICOM**<sup>®</sup>