

45635

# POPULAR COMMUNICATIONS

NOVEMBER 2008

Shortwave Listening • Scanning • AM & FM • Radio History

## Digital Radio Mondiale— The Cutting Edge Of Shortwave

A Pop'Comm  
Redux  
New Columns!  
New Look!

Amateur Radio's  
D-STAR Spearheads  
Innovation, p. 20

Tech Showcase:  
Microtelecom's Perseus  
Software-Defined  
Radio, p. 25

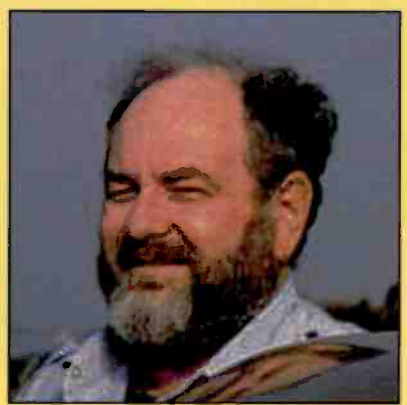

Tom Kneitel, *Pop'Comm's*  
Founding Editor, Becomes  
Silent Key, p. 4

\*\*\*\*\*SCH 5-DIGIT 66061 3948

PC 296145 FEB 09 1

DAVID C STEARNS

2639 W WHITNEY ST

OLATHE KS 66061-6011



**PLUS: Best AM DXpeditions •  
ICOM's IC-R2500 Up Close •  
The 60-Meter Challenge**

# THE PROFESSIONAL STANDARD

The compact desk-top VR-5000 is Yaesu's most versatile Communications Receiver ever! With ultra-wide frequency coverage and a host of operating features, you'll be on top of the monitoring action with the VR-5000!

- CONTINUOUS FREQUENCY COVERAGE: 100 kHz ~ 2.6 GHz / LSB, USB, CW, AM-Narrow, AM, Wide AM, FM-Narrow, and Wide FM (cellular frequencies are blocked)
- 2000 MEMORY CHANNELS / 100 MEMORY GROUPS
- DUAL RECEIVE
- DIGITAL SIGNAL PROCESSING / BANDPASS FILTER, NOISE REDUCTION, NOTCH FILTER, NARROW CW PEAK FILTER (Optional DSP-1 requires)
- REAL-TIME SPECTRUM SCOPE
- WORLD CLOCK WITH UTC/LOCAL SETTINGS
- PRESET SHORTWAVE BROADCAST STATION MEMORY BANK
- EXTENSIVE SCANNING CAPABILITY/SMART SEARCH™

## ● AND MUCH, MUCH MORE...

- "RF Tune" Front-end Preselector (1.89-1000 MHz)
- 20 dB Attenuator for strong signal environments
- IF Noise Blanker
- DVS-4 Digital Voice Recorder (option) with two memories of up to 8 seconds each
- 10.7 MHz IF Output Jack
- Field Strength Meter
- Audio Tone Control
- All-Mode Squelch Control for silent monitoring
- Password-protected Panel and Dial "Lock" feature
- Display Dimmer/Contrast Control
- Clone Capability for copying memory information from one VR-5000 to another
- Personal Computer Interface Port
- Two Antenna Ports
- Audio Wave Meter provides display of incoming signal's wave characteristics

## COMMUNICATIONS RECEIVER

# VR-5000

0.1~2599.99998MHz\*  
LSB/USB/CW/AM-N/AM/  
WAM/FM-N/WFM  
\*Cellular blocked

Enjoy the wide world of communications monitoring with the action-packed VR-5000, available from your Yaesu Dealer today!

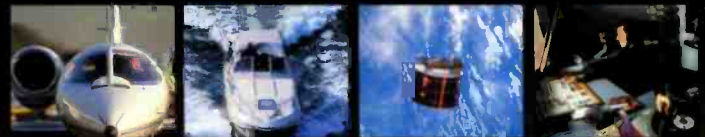

### All-Mode Wideband Receiver **VR-500**

- Frequency coverage : 0.1-1299.99995 MHz\*\*
- Modes : NFM, WFM, AM, USB, LSB, CW
- Multiple Power Source Capability
- Polycarbonate Case

- Real-Time 60-ch\* Band Scope \*Range 6 MHz / Step 100 kHz
- Full Illumination For Display And Keypad
- Convenient "Preset" Operating Mode
- Front-end 20 dB Attenuator

For the latest Yaesu news, visit us on the Internet:  
<http://www.vertexstandard.com>

Specifications subject to change without notice. Some accessories and/or options may be standard in certain areas. Frequency coverage may differ in some countries. Check with your local Yaesu Dealer for specific details.

**YAESU**  
Choice of the World's top DX'ers™

Vertex Standard  
US Headquarters  
10900 Walker Street  
Cypress, CA 90630 (714)827-7600

# Universal Radio — Quality equipment since 1942.

**ICOM**

**R75**



Universal Radio is pleased to offer the **Icom R75-12** receiver. With full coverage from 30 kHz to 60 MHz; all longwave, medium wave and shortwave frequencies are supported plus extended coverage to include the 6 meter amateur band. Some innovative features of the R75 include: FM Mode Detection (but not the FM broadcast band), Twin Passband Tuning, Two Level Preamp, 99 Alphanumeric Memories, four Scan Modes, Noise Blanker, Selectable AGC (FAST/SLOW/OFF), Clock-Timer, Squelch, Attenuator and backlit LCD display. Tuning may be selected at 1 Hz or 10 Hz steps plus there is a 1 MHz quick tuning step plus tuning Lock. The front-firing speaker provides solid, clear audio. The back panel has a Record Output jack and Tape Recorder Activation jack. The supplied 2.1 kHz SSB filter is suitable for utility, amateur, or broadcast SSB. However, two optional CW/SSB filter positions are available (one per I.F.). The formerly optional **UT-106 DSP board** is now included and factory installed! A great value.

Order #0012 **Call for price.**

**ICOM**

**PCR1500  
R1500**



The **Icom PCR1500** wideband computer receiver connects externally to your PC via a USB cable. This provides compatibility with many computer models, even laptops. Incredible coverage is yours with reception from 10 kHz to 3300 MHz (less cellular gaps). Modes of reception include AM, FM-Wide, FM-Narrow, SSB and CW. (CW and SSB up to 1300 MHz only). The PCR1500 comes with an AC adapter, whip antenna, USB cable and Windows™ CD. #1501 **\$479.95**

The **Icom R1500** is similar to the above, but also includes a controller head for additional operation independent of a PC. #1500 **\$579.95**

**ICOM**

**PCR2500  
R2500**



The **Icom PCR2500** wideband computer receiver uses a similar form-factor to the PCR1500, but has several enhancements, including two powerful features: **dual watch** (the radio can receive two signals simultaneously) and **diversity reception** (two antennas can be connected at the same time and employed to provide stable reception). The optional UT-118 Digital Unit provides D-STAR® digital voice reception and the optional UT-121 supports APCO25 digital voice decoding. The R2500 is shown above. #2501 **\$699.95**

The **Icom R2500** is similar to the PCR2500, but includes a controller head for additional operation independent of a PC. #2500 **\$879.95**

**BONUS**

**ICOM Bonito CS 4.5 Software included!**

A \$69.00 value included with your R1500/R2500, PCR1500/2500 purchase for a limited time.

**Special Note:** Prices shown for the R1500/PCR1500 and R2500/PCR2500 reflect the \$20 Icom limited time mail-in rebate.



**R5**

The **R5** covers 150 kHz to 1309.995 MHz (less cellular gaps) in: AM, FM Narrow and FM wide. 1200 memories store: frequency, mode, step size, duplex direction and offset, CTCSS tone, tone squelch and skip settings. Other features include: attenuator, LCD lamp, AM ferrite bar antenna, auto power off, CTCSS decode, weather function and battery save. A great value at under \$200.00. **Call or visit website for price.**



**R20**

The **Icom R20** covers an incredible 150 kHz to 3304.999 MHz (less cellular) with 1250 alphanumeric memories, bandscope and SSB/CW. It has: two VFOs, dual watch, voice scan control, NB, large two line LCD and CTCSS/DTCS/DTMF. A built-in **IC audio recorder** can record up to 4 hours of reception! With charger, Li-ion battery, belt clip and strap. **Call for price.**



**RX7**

The new **Icom IC-RX7** is a slim and smart wideband receiver that tunes from 150 kHz to 1300 MHz (less cellular and gaps) in: AM, FM-N and FM-W modes. It has a large, backlit LCD display. It is rain resistant and has CTCSS and DTSC decode is built in. Other features include: keypad, RF Gain, Attenuator, Auto Power save, Voice squelch, AM band ferrite rod antenna and 1650 scannable alphanumeric memories. With BP-224 Li-ion battery, belt clip and charger. List \$364.00 Order #5007 **\$299.95**



The **Icom R9500** clearly raises the bar for professional receivers. Covering 5 kHz to 3335 MHz, this instrument represents the state-of-the-art in receiver technology! Visit the Universal website for complete details.

**www.universal-radio.com**

◆ Visit our website or request our free 112 page catalog for other exciting ICOM products.

**Universal Radio, Inc.**  
6830 Americana Pkwy.  
Reynoldsburg, Ohio  
43068-4113 U.S.A.

☎ 800 431-3939 Orders & Prices  
☎ 614 866-4267 Information  
☎ 614 866-2339 FAX Line  
✉ dx@universal-radio.com



Universal Radio is also pleased to carry the complete ICOM amateur radio equipment line. The **IC-7800** shown.

- Visa
- MasterCard
- Discover
- JCB
- Prices and specs. are subject to change.
- Special offers are subject to change.
- Returns subject to a 15% restocking fee.
- Prices shown are after mfg. coupons.

**universal  
radio inc.**

# POPULAR COMMUNICATIONS CONTENTS

NOVEMBER 2008  
Volume 27, Number 3

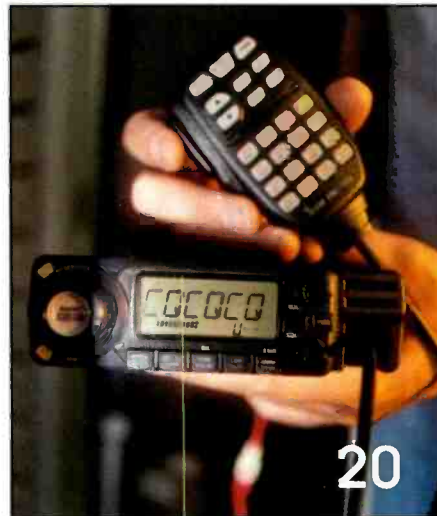

## COLUMNS

- 30 ScanTech**  
Up Close: The ICOM IC-R2500 Communications Receiver  
*by Ken Reiss*
- 36 Civil Aviation Monitoring**  
What's New In Aviation Communications?  
*by Tom Swisher, WA8PYR*
- 39 The Antenna Room**  
CB Antenna Basics, And Revisiting HDTV Antennas  
*by Kent Britain, WA5VJB*
- 42 World Band Tuning Tips**  
World News, Commentary, Music, Sports. And Drama At Your Fingertips
- 54 Global Information Guide**  
A New Shortwave Outlet Is Borno, An Austrian Radio Threat, Mas From Mexico, And More  
*by Gerry L. Dexter*
- 60 Broadcast Technology**  
DXpedition! The Signals Are Biting For Intrepid Broadcast Monitors  
*by Bruce A. Conti*
- 71 Ham Discoveries**  
Sixty Meters—The Perfect Channel For A Challenge!  
*by Kirk Kleinschmidt, NT0Z*
- 74 The Propagation Corner**  
Solar Cycle 24: Are We There Yet?  
*by Tomas Hood, NW7US*
- 76 Utility Communications Digest**  
Whiskey For My Men, ALE For My Radios  
*by John Kasupski, KC2HMZ*
- 84 The Loose Connection**  
Norm's Bus Stowaway  
*by Bill Price, N3AVY*

## FEATURES

- 16 Digital Radio Mondiale—The Cutting Edge Of Digital Radio**  
Moving Shortwave Broadcasting Into The 21st Century  
*by Don Rotolo, N2IRZ*
- 20 D-STAR's All-digital Voice And Data Rigs Push Technology Forward**  
A Current Dearth Of Equipment Doesn't Deter Hams' Experimentation  
*by Jason Togyer, KB3CNM*
- 25 Tech Showcase**  
**Microtelecom's Perseus: The Next Generation Of Software-Defined Radio**  
*by Dan Srebnick, K2DLS*



*This Month Pop'Comm Debuts Three New Columns...*

- 12 Horizons**  
Radio's Place In An Evolving Landscape  
*by Rob de Santos*
- 64 RF Bits**  
Situational Awareness Through The Automatic Packet Reporting System  
*by Dan Srebnick, K2DLS*
- 69 EmComm Essentials**  
Emergency Communications And The Radio Hobbyist (aka YOU)  
*by John Kasupski, KC2HMZ*

## ON THE COVER

It's not a question of if, but when, Digital Radio Mondiale (DRM), the international standard for shortwave broadcasting, will be adopted. While the industry is taking its time catching up, a little effort on your part will unveil the amazing audio quality it offers. See "Digital Radio Mondiale—The Cutting Edge Of Digital Radio," by Don Rotolo, N2IRZ, beginning on page 16, for more. (Cover photo of the Thomson HP-RCA rotatable curtain antenna, specifically optimized for DRM, courtesy Thomson Broadcast & Multimedia)

## DEPARTMENTS

- 4 Tuning In**  
An Editorial
- 6 Newsworthy**  
Unwired, Washington Beat, And InfoCentral
- 13 Our Readers Speak Out**  
Letters
- 44 Power Up**  
Radios & High-Tech Gear
- 53 The Pop'Comm Trivia Corner**

**web:** [www.popular-communications.com](http://www.popular-communications.com)

# Tap into secret Shortwave Signals

Turn mysterious signals into exciting text messages with the **MFJ MultiReader™!**

**MFJ-462B**  
**\$199<sup>95</sup>**



Plug this self-contained MFJ Multi-Reader™ into your shortwave receiver's earphone jack.

Then watch mysterious chirps, whistles and buzzing sounds of RTTY, ASCII, CW and AMTOR (FEC) turn into exciting text messages as they scroll across an easy-to-read LCD display.

You'll read interesting commercial, military, diplomatic, weather, aeronautical, maritime and amateur traffic . . .

## Eavesdrop on the World

Eavesdrop on the world's press agencies transmitting *unedited* late breaking news in English -- China News in Taiwan, Tanjug Press in Serbia, Iraqi News in Iraq -- all on RTTY.

Copy RTTY weather stations from Antarctica, Mali, Congo and many others. Listen to military RTTY passing traffic from Panama, Cyprus, Peru, Capetown, London and others. Listen to hams, diplomatic, research, commercial and maritime RTTY.

## Super Active Antenna

"World Radio TV Handbook" says MFJ-1024 is a "first-rate easy-to-operate active antenna . . . quiet. . . excellent dynamic range. . . good gain. . . low noise. . . broad frequency coverage."

Mount it outdoors away from electrical noise for maximum signal, minimum noise. Covers 50 KHz-30 MHz.

Receives strong, clear signals from all over the world. 20 dB attenuator, gain control, ON LED.

Switch two receivers and auxiliary or active antenna. 6x3x5 in. Remote has MFJ-1024\* \$159<sup>95</sup> 54" whip, 50 feet coax. 3x2x4 inches. 12 VDC or 110 VAC with MFJ-1312, \$15.95.

## Indoor Active Antenna

Rival outside long wires with this tuned indoor active antenna. "World Radio TV Handbook" says MFJ-1020C is a "fine value. . . fair price. . . best offering to date. . . performs very well indeed."

Tuned circuitry minimizes intermod, improves selectivity, reduces noise outside tuned band. Use as a preselector with external antenna. Covers 0.3-30 MHz. Tune, Band, Gain, On/Off/Bypass Controls. Detachable telescoping whip. 5x2x6 in. Use 9 volt battery, 9-18 VDC or 110 VAC with MFJ-1312, \$15.95.

## Compact Active Antenna

Plug this MFJ-1022 compact MFJ all

band active antenna into your receiver and you'll hear strong, clear signals from all over the world, 300 KHz to 200 MHz including low, medium, shortwave and VHF bands. Detachable 20" telescoping antenna. 9V battery or 110 VAC MFJ-1312B, \$15.95. 3/8x1 1/4x4 in.

**MFJ-1020C**  
**\$99<sup>95</sup>**



**MFJ-1022**  
**\$69<sup>95</sup>**



Listen to maritime users, diplomats and amateurs send and receive *error-free* messages using various forms of TOR (Telex-Over-Radio).

Monitor Morse code from hams, military, commercial, aeronautical, diplomatic, maritime -- all over the world -- Australia, Russia, Japan, etc.

Monitor any station 24 hours a day by printing transmissions. Printer cable, MFJ-5412, \$11.95.

Save several pages of text in memory for later reading or review.

## High Performance Modem

MFJ's high performance *PhaseLockLoop™* modem consistently gives you solid copy -- even with weak signals buried in noise. New threshold control minimizes noise interference -- greatly improves copy on CW and other modes.

## Easy to use, tune and read

It's easy to use -- just push a button to select modes and features from a menu.

It's easy to tune -- a precision tuning indicator makes tuning your receiver easy for best copy.

It's easy to read -- front-mounted 2 line 16 character LCD display has contrast adjustment.

Copies most standard shifts and speeds. Has

MFJ *AutoTrak™* Morse code speed tracking.

Use 12 VDC or use 110 VAC with MFJ-1312D AC adapter, \$15.95. 5 1/2"Wx2 1/2"Hx5 1/4"D inches.

## WiFi Yagi Antenna -- 15 dBi 16-elements extends range

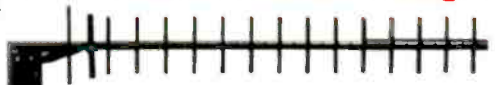

16-element, 15 dBi WiFi Yagi antenna greatly extends range of 802.11b/g, 2.4 GHz WiFi signals. 32 times stronger than isotropic radiator. Turns slow/no connection WiFi into fast, solid connection. Highly directional -- minimizes interference.

N-female connector. Tripod screw-mount. Wall and desk/shelf mounts. Use vertically/horizontally. 18Wx2 1/4"Hx1 1/4"D inches. 2.9 ounces.

MFJ-5606SR, \$24.95. Cable connects MFJ-1800 WiFi antennas to computer.

Reverse-SMA male to N-male, 6 ft. RG-174. MFJ-5606TR, \$24.95. Same as MFJ-5606SR but Reverse-TNC male to N-male.



## Eliminate power line noise!

Completely eliminate power line noise, lightning crashes and interference *before they get into your receiver!* Works on all modes -- SSB, AM, CW, FM, data -- and on all shortwave bands. Plugs between main external antenna and receiver. Built-in active antenna picks up power line noise and cancels undesirable noise from main antenna. Also makes excellent active antenna.

MFJ-1026  
**\$199<sup>95</sup>**

## MFJ Antenna Matcher

Matches your antenna to your receiver so you get maximum signal and minimum loss.

MFJ-959C  
**\$119<sup>95</sup>**

## High-Gain Preselector

High-gain, high-Q receiver preselector covers 1.8-54 MHz.

MFJ-1045C  
**\$89<sup>95</sup>**

## Dual Tunable Audio Filter

Two separately tunable filters let you peak desired signals and notch out interference at the same time. You can peak, notch, low or high pass signals to eliminate heterodynes and interference. Plugs between radio and speaker or phones. 10x2x6 inches.

**MFJ-959C**  
**\$119<sup>95</sup>**

**MFJ-1045C**  
**\$89<sup>95</sup>**

**MFJ-752C**  
**\$119<sup>95</sup>**



## MFJ Shortwave Headphones

Perfect for shortwave radio listening for all modes -- SSB, FM, AM, data and CW. Superb padded headband and ear cushioned design makes listening extremely comfortable as you listen to stations all over the world!

MFJ-392B  
**\$24<sup>95</sup>**

## High-Q Passive Preselector

High-Q passive LC preselector boosts your favorite stations while rejecting images, intermod and phantom signals. 1.5-30 MHz.

Preselector bypass and receiver grounded positions. Tiny 2x3x4 in.

## Super Passive Preselector

Improves any receiver! Suppresses strong out-of-band signals that cause intermod, blocking, cross modulation and phantom signals.

MFJ-1046  
**\$119<sup>95</sup>**

## MFJ Shortwave Speaker

This MFJ *ClearTone™* restores the broadcast quality sound of shortwave listening. Makes copying easier, enhances speech, improves intelligibility, reduces noise, static, hum. 3 in. speaker handles 8 Watts. 8 Ohm impedance. 6 foot cord.

**MFJ-281**  
**\$12<sup>95</sup>**



## MFJ All Band Doublet

102 ft. all band doublet covers .5 to 60 MHz. Super strong custom fiberglass center insulator provides stress relief for ladder line (100 ft.).

Authentic glazed ceramic end insulators and heavy duty 14 gauge 7-strand copper wire.

## MFJ Antenna Switches

MFJ-1704 \$79<sup>95</sup>

MFJ-1702C \$39<sup>95</sup>

MFJ-1704 heavy duty antenna switch lets you select 4 antennas or ground them for static and lightning protection. Unused antennas automatically grounded. Replaceable lightning surge protection. Good to 500 MHz. 60 dB isolation at 30 MHz. MFJ-1702C for 2 antennas.

## Morse Code Reader

Place this MFJ-461 pocket-sized MFJ Morse

Code Reader near your receiver's speaker. Then watch CW turn into solid text messages on LCD. Eavesdrop on Morse Code QSOs from hams all over the world!

## MFJ 24/12 Hour Station Clock

MFJ-108B, \$21.95. Dual 24/12 hour clock.

Read UTC/local time at-a-glance. High-contrast 5/8" LCD, brushed aluminum frame. Batteries included. 4 1/2"Wx1 Dx2H inches.

**Dealer/Catalog/Manuals**  
Visit: <http://www.mfjenterprises.com>  
or call toll-free 800-647-1800

• 1 Year No Matter What™ warranty • 30 day money back guarantee (less s/h) on orders direct from MFJ

**MFJ ENTERPRISES, INC.**  
300 Industrial Pk Rd. Starkville, MS 39759 PH: (662) 323-5869  
Tech Help: (662) 323-0549

FAX: (662) 323-6551 8-4:30 CST. Mon.-Fri. Add shipping. Prices and specifications subject to change. © 2008 MFJ Enterprises, Inc.

## In Fondest Remembrance

Tom Kneitel, W4XAA (ex-K2AES), SK  
Editor, *Pop'Comm*, 1982–1995

by Edith Lennon, N2ZRW  
editor@popular-communications.com

*“[Tommy Kneitel] left behind a prodigious body of work, not the least of which is the magazine in your hands, a living monument to his fertile mind and great energy. And so, in these pages, we celebrate both that work and the man behind it.”*

Many, perhaps most, of you have already heard this sad news. *Pop'Comm's* founding editor Tom Kneitel, W4XAA (ex-K2AES), passed away on August 22, 2008, at age 75 after a long illness. On that day he left behind his wife of 54 years, Judy, seven surviving children (one son died tragically young), 10 grandchildren, a multitude of friends, and us—the countless radio hobbyists who are indebted to him. For many, perhaps most, of us, he was our introduction, our inspiration, our guide, literally defining the radio listening hobby. He also left behind a prodigious body of work, not the least of which is the magazine in your hands, a living monument to his fertile mind and great energy. And so, in these pages, we celebrate both that work and the man behind it.

To most who knew him, he was Tommy, a witty storyteller, a sometimes-mischievous rascal, and an exacting professional who cultivated a slightly gruff demeanor that was belied by almost everything else about him.

As well known as Tommy was to everyone in the radio hobby, very few of his readers knew he had contracted polio at age 14, which left him with a permanent limp and led to his requiring a wheelchair in later life. It was to help him through this early convalescence that relatives gave him his first radio, igniting the lifelong passion that influenced so many people. He was a workaholic with a steel-trap memory who always had a shortwave receiver, scanner, or some other kind of radio on while he labored at his typewriter, sometimes for 18 hours a day.

Some of his other loves, according to Judy, were junk food, radio history, playing with words (once criticized for negative comments about the venerable ARRL, he famously responded, “I don’t care when they were founded, I just want to know when they will be losted”), and his family. He sang frequently (“His voice was good, but he sang such terrible songs,” said Judy).

Born in Brooklyn, New York, in 1933, Tommy hailed from a creative family. His grand-

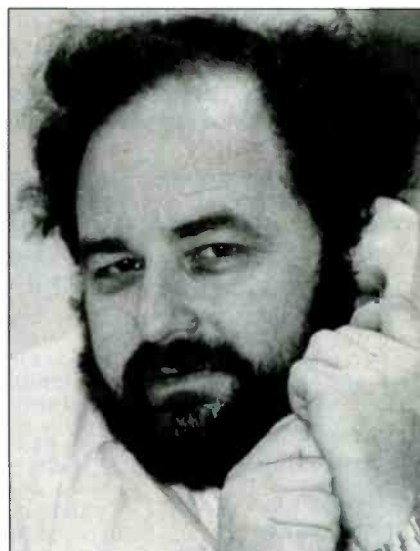

father was animation pioneer Max Fleischer who, along with his brother Dave, developed and patented the rotoscope, a mechanism used for transferring live action film into animated cartoons through tracing, a technique still used today. Fleischer was also the wellspring for cultural icons Betty Boop, Popeye, and the “bouncing ball” sing-along aid. Tommy’s father, Seymour Kneitel, was also a prolific animator, best known for his work with Fleischer Studios and its successor, Famous Studios.

Tommy was equally imaginative and found inspiration everywhere, coming up with ideas for inventions, gadgets, and silly gimmicks, including “pet crystals” during the pet rock craze (they were actually marketed and sold by a brother of CQ’s first publisher, bringing in a decent buck, according to Judy).

But Tommy’s special talent was the written word, and he wielded it with wit and dexterity—and often very strong opinions. By the 1950s and ’60s he was writing for *Popular Electronics* and *Electronics Illustrated* and started the *Popular Electronics* registered shortwave monitor pro-

gram, which issued unofficial "WPE" call signs to active SWLs. Over the years, he authored of a multitude of books on CB, scanning, and other radio-related topics. Among the best known (and controversial) were *Tomcat's Big CB Handbook: Everything They Never Told You* ("Tomcat" was his CB handle); *Time in on Telephone Calls* and *The "Top Secret" Registry of U.S. Government Radio Frequencies: 25 to 470 MHz*. Willing to try his had at seemingly anything, in the 1960s he even wrote training films for the U.S. Army.

His association with CQ Communications began in the early 1960s when he became the founding editor of *S9*, a CB magazine launched by then-CQ magazine publisher Cowan Publishing, Inc. According to Dick Ross, K2MGA, CQ's (and, of course, *Pop'Comm's*) current publisher, he was "one of the most creative people I've known in my life... He came up with the name *S9* and created the whole editorial package." When *S9* closed, he and Dick launched *Pop'Comm* in 1982. (Dick shares his own memories of Tommy here; see "So Long, Tomcat.")

Incredibly driven, he'd get up at 5 or 6 in the morning and, according to Judy, "go into the office, put in a couple of hours, by 9 he was socializing, and by 10 he was on his way home." That was where the real work began, hunched over a typewriter in a home brimming with children.

"He liked noise in the house, having the kids around, but he didn't want to be disturbed when he was working, so he hung a sign on his door that said 'knock or in any way disturb me and I'll rip your arm right off and beat you over the head with the bloody stump,'" laughed Judy.

Whenever the family needed additional money, for a kid's braces or a summer at camp, "Tommy would sit down at the typewriter, and he'd do some freelance," said Judy, who also served as his sounding board. "Every single thing he ever wrote he read out loud to me. It was a way of editing and also seeing how it was going to read."

Tommy helmed *Pop'Comm* until 1995, when he gave up day-to-day editorial responsibilities. "He didn't want to retire from *Pop'Comm*, but his health was not good and he just couldn't keep up with those deadlines anymore as editor," said Judy. He postponed stepping down as head of the magazine he started as long as he could, however, and through various illnesses, including a heart attack,

he'd work on it from his hospital bed.

Of course, he never really left *Pop'Comm* at all. His impression is stamped on it forever, just one of the legacies of his brilliant and tenacious mind.

I asked Judy a while ago if she knew the origins of the name Kneitel. "It's German-Austrian, I think, and means 'lit-

tle knot,' she told me. "Apparently his family were candle makers and 'Kneitel' refers to the little knot you tie at the end of a candle when you're going to dip it."

Givers of light. How appropriate. We will miss yours.

(Continued on page 70)

## So Long, Tomcat

Tommy was an amazingly prolific writer, one of those people whose fingers seem to have a direct connection to his imagination. It's little known among the readers of Tommy's publications that he was sometimes a magazine's sole contributor. That's right, he sometimes wrote the entire magazine...everything from the editorial to the features to the columns to both sides of the letters to the editor! He could have masterful "arguments" with himself, complete with name-calling!

His repertoire of pen names numbered in the dozens, each with its own style, its own quirks, and its own point of view. Along the way he created characters and personas that survived for years and which drew fan mail from around the globe.

Personas were very important to Tommy. He (as well as his younger brother Kenny) was stricken with polio as a teenager, and he walked with a serious limp for the rest of his life, at least as long as he was able to walk at all. For his own reasons, Tommy chose never to reveal his condition to his audience. Quite the opposite, he adopted a persona of an adventurer, an Ernest Hemingway of the airwaves, so to speak. He almost never appeared anywhere in person, choosing to relate to his followers through the printed word or the radio.

Long-time followers of Tommy may remember the photos, though, that showed up occasionally in *S9* or *Pop'Comm*. He'd appear wearing a bush jacket, or holding a rifle, or leaning casually against a dusty Range Rover, seemingly in the African plains somewhere. Yes, he owned a rifle or two (never fired by him!), and he owned a bush jacket, but usually the shots were taken at a shopping mall somewhere by his wife Judy, using someone's personal vehicle as a prop. For over 40 years he carried it off perfectly, and only those closest to him ever knew the truth.

His amazing creativity helped us lesser editors out of many a jam over the years. More than a few times, as editor of *CQ* or as the poor sucker charged with the responsibility of seeing to it that words appeared on every editorial page of any number of magazines, I'd find myself walking into Tommy's little office lamenting the column that never showed up, or the feature article that ran two pages short, or the full page ad that dropped out at the last moment before deadline. He'd ask, "What would you like to fill the space with?" Radio history? Humor? Something controversial? It was always hard to fathom that I was being offered a choice of great material that didn't even exist yet! He'd then say, "Give me a half hour" or "Give me 20 minutes."

Sure enough he'd come limping into my office with a few hundred words of super copy cranked out on his manual Royal typewriter, and bearing one of his amazingly plausible pseudonyms. Need an illustration to go with it? No problem. He'd rummage in a bottom desk drawer and come up with the perfect clipping from an old magazine or newspaper, or an ancient postcard or QSL scavenged from flea markets throughout the Northeast.

I'm ashamed to say that the seat-of-the pants filler from Tommy was sometimes the best-received piece in the issue! But that's what Tommy did best: He was the wordsmith of wordsmiths. He was the best! Our world is poorer without the Tomcat.

—Dick Ross, K2MGA, Publisher, *Popular Communications*

## The Weirder Side Of Wireless

by Staff

### No Privacy For Privates

In their efforts to keep air travelers safe, Transportation Security Administration officials will be taking the gloves off—and everything else, at least electronically—for passengers at 12 airports across the country that are to install full-body scanners beginning next year.

For clearance under this new high-tech system, would-be travelers (hopefully selected at random) will step into phone booth-like “millimeter wave machines,” where beams of radio frequency energy will be projected onto their bodies. The scanners will “look” through clothing to create a highly detailed 3D silhouette of the traveler—warts and all. The resulting images, which one CNN reporter described as showing “every contour of my body, including my private parts,” will be sent electronically to viewing stations in another room, or even another city, where screeners will examine them for anything untoward.

While a blurring feature prevents the screeners from seeing a passenger’s face, not much else is left to the imagination. The images from the machine will be deleted once the traveler is cleared to fly.

### Turtle Collar

An Eastern box turtle, affectionally dubbed Turtle No. 72 and equipped with a GPS tracker attached to its shell, led (literally) to the arrest of Isiah Johnson, 19, of Chevy Chase, Maryland. Johnson was charged with possession of marijuana with intent to distribute after the turtle wandered into a patch of marijuana plants growing in Washington, D.C.’s Rock Creek Park.

National Park Service researcher Ken Ferebee had been monitoring Turtle No. 72, one of three in the area being tracked by the radio transmitters, for seven years, occasionally venturing into the woods to visit her. On one of those occasions her signal led him to a stand of suspicious vegetation—about 10 four-foot-tall cannabis stalks. Ferebee contacted the police who surveilled the area, arresting the urban farmer when Johnson showed up, apparently to check on this crop, which had an estimated street value of \$6,500.



### The Last HOPE For Hackers

Both privacy and tracking were highlighted at what was actually the seventh—and not the last—HOPE (Hackers On Planet Earth) biennial hacker conference held in New York’s Hotel Pennsylvania July 18–20. Some of HOPE’s estimated 3,000 attendees participated in a people-tracking experiment by wearing RFID (Radio Frequency Identification) badges so they could see first hand the potential and pitfalls of a technology that may soon be used to track drivers licenses, credit cards, clothing, tires, passports—even some people. The hackers’ findings: the technology is insecure (they would know) and puts peoples’ privacy and safety at serious risk.

Besides electronic privacy and security, other topics covered in presentations and demonstrations included electronic voting system problems, phone phreaking, media consolidation, radio communications, the intelligence community, and electronic surveillance countermeasures.

The overall theme of HOPE, according to one organizer, “is using technology in ways to make our society a better place.” For descriptions and audio of all the HOPE talks, visit [www.thelasthope.org/talks.html](http://www.thelasthope.org/talks.html).



# KENWOOD

Listen to the Future

## Kenwood & AvMap The Ultimate APRS<sup>®</sup> Combination

TM-D710A



AvMap G5



Two Great Companies...Providing One Outstanding Solution!

**KENWOOD U.S.A. CORPORATION**  
Communications Sector Headquarters  
3975 Johns Creek Court, Suite 300, Suwanee, GA 30024-1298  
Customer Support/Distribution  
P.O. Box 22745, 2201 East Dominguez St., Long Beach, CA 90801-5745  
Customer Support: (310) 639-4200 Fax: (310) 537-8235

[www.kenwoodusa.com](http://www.kenwoodusa.com)  
ADS435507



**AvMAP**  
A C-MAP GROUP COMPANY



Maps

[www.geosat.us](http://www.geosat.us) • e-mail: [info@geosat.us](mailto:info@geosat.us)  
1.800.363.2627

## Medical Alert For DWT (Driving While Texting)

The American College of Emergency Physicians issued an alert about the danger of serious accidents involving “unsafe texting practices.” Doctors cite rising reports from around the country of injuries involving text-messaging pedestrians, bicyclists, boaters, and even motorists. The dangerous behavior is, not surprisingly, especially prevalent among teenagers, and a survey conducted by AAA and *Seventeen* magazine found 46 percent of them admitting to driving while texting.

While some serious accidents and even deaths have been attributed to unsafe texting, most injuries involved walking into lamp posts, stop signs, or walls or tripping over curbs. One 15-year-old girl, however, fell off her horse while texting, suffering head and back injuries, and a 13-year-old girl suffered burns sustained while texting her boyfriend as she cooked noodles.

Many states have banned driving while texting and talking on cell phones without a hands-free device, but the Illinois General Assembly has taken that a step further with its HB 4520. This proposed bill would prohibit a pedestrian from

using a wireless telephone while crossing a roadway, a petty offense punishable by up to a \$25 fine.

New to the lexicon: defensive walking?

## Bad Buddy

The Associated Press reported that a mother in Huntington, West Virginia, is seeking a recall of a Fisher-Price walkie-talkie after her three-year-old’s “toy” picked up some salty talk about drugs and strip clubs, peppered with references to 10-4 and other CB jargon. The mother, Deborah Pancaro, said she contacted Fisher-Price after she heard the conversation, during which a man also said he was driving on the Pennsylvania Turnpike, about 275 miles north of Huntington; the walkie-talkie, which is sold exclusively at Wal-Mart, supposedly had a range of about 20 feet.

In addition to its apparent Olympian feats of distance reception—at least in this instance—the walkie-talkie lets children “role-play animal rescues like the Diego character does on the cartoon series *Dora the Explorer* and *Go, Diego, Go!*” said the AP report, and that the toy is to be discontinued, according to Wal-Mart’s website.

## Washington Beat

# Capitol Hill And FCC Actions Affecting Communications

by Richard Fisher,  
K16SN

## FCC Should Be More Transparent, Accountable, Congressman Says

Saying the Federal Communications Commission should be more transparent and accountable to the public, a Texas Congressman has introduced legislation to change how the commission conducts business.

According to a report in *Radio* magazine’s “Currents” on-line newsletter, the FCC Procedural Reform for Openness and Clarity Encouraging Sensible Solutions Act’s provisions include offering the public at least 60 days to respond to proposed rule changes, modifications, or deletions. After that, to consider the changes, the FCC would have to take at least an additional 30 days. Rep. Joe Barton (R-TX), ranking member of the House Committee on Energy and Commerce, is the legislation’s sponsor.

The FCC’s operations and Commission chairman Kevin Martin’s leadership have been under investigation by the committee after Martin pushed through media ownership rules just before the 2007 holiday season, “Currents” reported. In addition, the bill would require that all FCC commissioners “have sufficient time to review the specific language or any changes to the language of any proposal.

“The goal of the legislation is to promote decision-making transparency, encourage public com-

ment, and improve decision-making and general workflow.” the published report said.

## Management Change At Sirius XM Follows FCC Merger Approval

Joseph Clayton has stepped down as chairman of Sirius Satellite Radio and Gary Parsons, formerly chairman of XM, has been named chairman of the recently formed Sirius XM Radio. The move comes on the heels of the high-profile merger of the two satellite radio services, approved by the FCC earlier this year. In addition, Warren Lieberfarb and Michael McGuinness have resigned from the board of directors. The Sirius XM board of directors has been increased from eight to 12.

## APCO Releases 9-1-1 Deployment, Management Practices

The American National Standard (ANS) has been released by The Association of Public-Safety Communications Officials (APCO) International outlining practices for deploying and managing wireless 9-1-1.

APCO ANS 1.103.1-2008: Wireless 9-1-1 Deployment and Management Effective Practices Guide, approved by ANSI, “is designed to increase

the Public Safety Answering Point (PSAP) managers' understanding of the technology application and the ability to better manage wireless calls, as well as public and responder expectations," an APCO news release said.

"The Effective Practices are a result of Project LOCATE's wireless accuracy testing, which was started in 2005 and reported on in 2007."

For more information, visit the APCO Web site at [www.apcostandards.org](http://www.apcostandards.org).

### **Westwood One Enters Traffic Partnership**

Westwood One and Airsage have entered a multi-year agreement to combine traffic speed and flow information from cell phone signals with Westwood One's traffic incident reporting. The commuter traffic information's accuracy will be improved, Westwood One's Metro Traffic says. Airsage gathers data from cell phone systems, which it then analyzes to report traffic speed and flow information.

### **Mercedes To Offer HD Radio In Some '09 Models**

Certain Mercedes-Benz automobile models, including the 2009 M-, R-, GL-, G-Class SUVs and E-Class, will include HD radio receivers as the company mounts an effort to offer buyers upgraded entertainment systems.

All 2009 Mercedes-Benz SUVs and E-Class models will feature a head unit incorporating a 6 1/2-inch color display with an in-dash, six-disc

CD/DVD changer, and Bluetooth interface to operate a cell phone through the audio system, according to published reports. In addition, the unit can be outfitted with an optional iPod/MP3 media interface, Sirius XM satellite radio, HD Radio, and human voice control of navigation, phone, and audio systems. The new system can display route maps and directions for the optional navigation system, which officials said can show Sirius traffic data and restaurant ratings.

### **FCC Raises Amateur Radio Vanity Callsign Fees**

The cost of obtaining or renewing an amateur radio vanity callsign is being hiked 60 cents, from \$11.70 to \$12.30, the FCC reports. The fee will increase 30 days after notice of the increase is published in the Federal Register. The vanity callsign fee has fluctuated over the 12 years of the current program, from a high of \$50 to a low of \$11.70. The Commission said it anticipates some 15,000 amateur radio vanity callsign "payment units"—or applications—during the 2009 fiscal year. That will amount to more than \$184,000 in fees. The fee is due not only when applying for a new vanity callsign, but also upon renewing a vanity callsign for a new 10-year term.

Amateurs with "personalized" callsigns issued prior to 1996 are exempt from the vanity callsign regulatory fee at renewal. Congress did not authorize the FCC to collect regulatory fees until 1993. Such "heritage" vanity callsign holders do not appear as vanity licensees in the FCC amateur radio database

## **InfoCentral**

# **News, Trends, And Short Takes**

by D. Prabakaran

### **BBG Expands VOA's Georgian Broadcasts And Postpones Their Closure**

The U.S. Broadcasting Board of Governors (BBG) implemented "surge broadcasting" in Georgian in response to the crisis in the breakaway province of South Ossetia. News and information from the Voice of America (VOA) and Radio Free Europe/Radio Liberty (RFE/RL) reaches audiences in Georgia via shortwave radio, in-country FM broadcasts, television, and the Internet.

Radio Free Europe/Radio Liberty (RFE/RL) added an additional hour of radio programming in Georgian for a total of four hours each day beginning August 11, 2008. Programs are now broadcast both via local FM and shortwave. RFE/RL has been providing first-hand accounts of events from journalists on the ground, includ-

ing continuous live blogs. It also provides a one-hour weekly television program via Georgian Public Broadcasting.

On August 9, 2008, the VOA's Georgian broadcasts increased to one hour from a half-hour daily in the wake of the fighting. Broadcasts, including reports from inside the country, are carried on an FM network as well as on shortwave. As of press time, the programs were repeated on shortwave at 1700-1800 UTC, but no frequencies were listed on VOA's website. News in Georgian is also available on the Internet at [www.VOA News.com/Georgian](http://www.VOA News.com/Georgian).

The Administration's FY 2008 budget, as approved by Congress, provided that all BBG broadcasting to Georgia was to be done by RFE/RL after September 30, 2008. However, given the critical nature of events in Georgia, the BBG approved continuation of VOA Georgian surge broadcasts for the foreseeable future.

# POPULAR COMMUNICATIONS

## EDITORIAL STAFF

Edith Lennon, N2ZRW, Editor

(E-mail: editor@popular-communications.com)

Richard S. Moseson, W2VU, Editorial Director

(E-mail: w2vu@popular-communications.com)

Tom Kneitel, W4XAA (ex-K2AES), SK

Founding Editor

## CONTRIBUTING EDITORS

Peter J. Bertini, K1ZJH, Restoration/Electronics

Kent Britain, WA5VJB, Antennas And Accessories

Bruce A. Conti, AM/FM Broadcasts

Rob de Santos, Trends In Technology

Gerry L. Dexter, Shortwave Broadcast

Richard Fisher KI6SN, Capitol Hill News

Mitch Gill, NA7US, Homeland Security

Tomas Hood, NW7US, Propagation

Shannon Huniwell, Classic Radio

John Kasupski, KC2HMZ, UtilityComm/EmComm

Kirk Kleinschmidt, NT0Z, Amateur Radio

Mark Meece, N8ICW, Military Monitoring

D. Prabakaran, News

Bill Price, N3AVY, Humor/Communications

Ken Reiss, Technical/Scanning

Dan Srebnick, K2DLS, Computers And Radio

Bob Sturtevant, AD7IL, Puzzles And Trivia

Tom Swisher, WA8PYR, Civil Aviation

Jason Togyer, KB3CNM, Cartoons

Gordon West, WB6NOA, General Radio Comm.

## BUSINESS STAFF

Richard A. Ross, K2MGA, Publisher

Arnold Sposato, N2IQO, Advertising Manager

Emily Leary, Sales Coordinator

Sal Del Grosso, Accounting Manager

Doris Watts, Accounting Department

## CIRCULATION STAFF

Melissa Gilligan, Operations Manager

Cheryl DiLorenzo, Customer Service Manager

Ann Marie Auer, Customer Service

## PRODUCTION STAFF

Elizabeth Ryan, Art Director

Barbara McGowan, Associate Art Director

Dorothy Kehrwieder, Production Director

Emily Leary, Production Manager/Webmaster

Hal Keith, Technical Illustrator

Larry Mulvehill, WB2ZPI, Photographer

A publication of



CQ Communications, Inc.  
25 Newbridge Road  
Hicksville, NY 11801-2953 USA

Popular Communications (ISSN-0733-3315) is published monthly by CQ Communications, Inc., 25 Newbridge Road, Hicksville, NY 11801. Telephone (516) 681-2922. FAX (516) 681-2926. Web Site: <http://www.popular-communications.com/> Periodicals Postage Paid at Hicksville, NY and at additional mailing offices. Subscription prices (payable in U.S. dollars): Domestic—one year \$32.95, two years \$58.95, three years \$85.95. Canada/Mexico—one year \$42.95, two years \$78.95, three years \$115.95. Foreign Air Post—one year \$52.95, two years \$98.95, three years \$145.95.

U.S. Government Agencies: Subscriptions to Popular Communications are available to agencies of the United States government, including military services, only on a cash with order basis. Requests for quotations, bids, contracts, etc. will be refused and will not be returned or processed.

Entire contents copyright © 2008 by CQ Communications, Inc. Popular Communications assumes no responsibility for unsolicited manuscripts, photographs, or drawings. Allow six weeks for change of address or delivery of first issue.

Printed in the United States of America.

POSTMASTER: Send address changes to Popular Communications, 25 Newbridge Road, Hicksville, NY 11801.

## EC Earmarks Single Radio Frequency For Road Safety And Traffic Management

In an effort to curb road accidents and traffic jams, the European Commission has decided to reserve, across Europe, part of the radio spectrum for smart vehicle communications systems (so called co-operative systems). Based on wireless communication technology, they allow cars to "talk" to other cars and to road infrastructure providers, and can be used to warn other drivers of slippery roads or of a crash that's just happened.

In Europe, smart vehicle communication systems are being touted for their potential to make driving safer. Statistics show that in 2006, more than 42,000 people died in road accidents in the European Union, more than 1.6 million were injured, and that every day there are some 7,500 km of traffic jams on EU roads. The Commission says its decision is also intended to foster investment in smart vehicle communication systems by the automotive industry, while also spurring public funding in essential roadside infrastructure.

The decision provides a single EU-wide frequency band that can be used for immediate and reliable communication between cars, and between cars and roadside infrastructure. This 30 MHz of spectrum in the 5.9 GHz band will be allocated by national authorities across Europe, without barring other services already in place (such as radio amateur services).

## China Jammed International Radio Stations During Olympics

Chinese authorities jammed the Chinese, Tibetan and Uyghur-language broadcasts of several international radio stations, despite having promised to respect press freedom and the free flow of information during the Olympic Games, said Reporters Without Borders (RSF).

According to RSF, an international media outcry had forced the Chinese government to stop blocking access to websites, but there was no similar gesture toward the international radio stations, such as the BBC, Voice of America, Radio Free Asia, and Voice of Tibet.

RSF had confirmed from various sources in China that the jamming of

Chinese-language broadcasts by the BBC, VOA, RFA and Sound of Hope (a station linked to the Falun Gong) and Tibetan and Uyghur-language broadcasts by RFA and Voice of Tibet had not stopped before or during the Olympic Games. The jamming of Tibetan-language programs had even been stepped up.

The staff of Voice of Tibet, a station based in Norway that broadcasts Tibetan and Chinese-language programs to Tibet, reported an increase in jamming of their three shortwave frequencies. The Chinese authorities use eight broadcasts from six different points within China to make Voice of Tibet inaudible. Around 100 antennas have been installed in Tibet to jam international radio broadcasts.

## Australia Acts To Stop Hizbollah TV Station

Australia is taking action to close down a controversial satellite television station that broadcasts anti-Israeli programs. The Al-Manar channel is run by Lebanon's Hizbollah movement and is received in Australia via Indonesia's Indosat satellite. Al-Manar, which means "the beacon," describes itself as championing resistance to Israel and the U.S. and offers programs that call on people to support the fight against Israel.

The Australian authorities are threatening to take action against the Indosat company, arguing that al-Manar openly supports terrorism. The satellite firm has a three-year contract with al-Manar, and says it is purely a business deal and that it does not interest itself in what the station broadcasts.

## Kiribati: National Radio Struggles To Stay On Air

Radio Kiribati is facing an acute shortage of daily earnings and had to cut its staffing to remain on air. *Pacific Magazine* reported that the national radio station's acting manager, Tibwere Bobo, said the problem began when Radio Kiribati's AM transmission was off-air due to a break down in the transmitter.

The station maintained its FM transmission, which only covers South Tarawa and the remote Line and Phoenix Groups, but money generated from this service on a daily basis is minimal and not enough to cover the daily expense of Radio Kiribati transmissions. ■

# Big Savings on Radio Scanners

## Uniden® SCANNERS



### Bearcat® 796DGV Trunk Tracker IV with free scanner headset

Manufacturers suggested list price \$799.95  
CEI Special Price \$519.95

1,000 Channels • 10 banks • CTCSS/DCS • S Meter  
Size: 6.5" Wide x 6" Deep x 2.3" High

Frequency Coverage: 25.000-512.000 MHz., 806.000-956.000 MHz.  
(excluding the cellular & UHF TV band), 1,240.000-1,300.000 MHz.

When you buy your Bearcat 796DGV TrunkTracker package deal from Communications Electronics, you get more. The GV means "Great Value." With your BC796DGV scanner purchase, you also get a free deluxe scanner headphone designed for home or race track use. Headset features independent volume controls and 3.5 mm gold right angle plug. The 1,000 channel Bearcat 796DGV is packed with features to track Motorola Type I/II/III Hybrid, EDACS, LTR Analog Trunk Systems and Motorola APCO 25 Phase I digital scanner including 9,600 Baud C4FM and CQPSK. Also features control channel only mode to allow you to automatically trunk many systems by simply programming the control channel, S.A.M.E. weather alert, full-frequency display and backlit controls, built-in CTCSS/DCS to assign analog and digital subaudible tone codes to a specific frequency in memory, PC Control and programming with RS232C 9 pin port (cable not supplied), Beep Alert, Record function, VFO control, menu-driven design, total channel control and much more. Our CEI package deal includes telescopic antenna, AC adapter, cigarette lighter cord, DC cord, mobile mounting bracket with screws, owner's manual, trunking frequency guide and one-year limited Uniden factory warranty. For maximum scanning enjoyment, order magnetic mount antenna part number ANTMNBNC for \$29.95. For complete details, download the owners manual from the [www.usascan.com](http://www.usascan.com) web site. For fastest delivery, order on-line at [www.usascan.com](http://www.usascan.com).

### Bearcat® BCT8 Trunk Tracker III

Manufacturer suggested list price \$299.95  
CEI Special Price \$169.95

250 Channels • 5 banks • PC Programmable  
Size: 7.06" Wide x 6.10" Deep x 2.44" High

Frequency Coverage: 25.000-54.000 MHz., 108.000-174.000 MHz., 400.000-512.000 MHz., 806.000-823.995 MHz., 849.0125-868.995 MHz., 894.0125-956.000 MHz.

The Bearcat BCT8 scanner, licensed by NASCAR, is a superb preprogrammed 800 MHz trunked highway patrol system scanner. Featuring TrunkTracker III, PC Programming, 250 Channels with unique BearTracker warning system to alert you to activity on highway patrol link frequencies. Preprogrammed service searches makes finding interesting active frequencies even easier and include preprogrammed police, fire and emergency medical, news agency, weather, CB band, air band, railroad, marine band and department of transportation service searches. The BCT8 also has preprogrammed highway patrol alert frequencies by state to help you quickly find frequencies likely to be active when you are driving. The BCT8 includes AC adapter, DC power cable, cigarette lighter adapter plug, telescopic antenna, window mount antenna, owner's manual, one year limited Uniden warranty, frequency guide and free mobile mounting bracket. For maximum scanning enjoyment, also order the following optional accessories: External speaker ESP20 with mounting bracket & 10 feet of cable with plug attached \$19.95. Magnetic Mount mobile antenna ANTMNBNC for \$29.95.



### Bearcat® BCD396T Trunk Tracker IV

Suggested list price \$799.95/CEI price \$519.95  
APCO 25 9,600 baud compact digital ready

handheld TrunkTracker IV scanner featuring Fire Tone Out Paging, Close Call and Dynamically Allocated Channel Memory (up to 6,000 channels), SAME Weather Alert, CTCSS/DCS, Alpha Tagging.  
Size: 2.40" Wide x 1.22" Deep x 5.35" High

#### Frequency Coverage:

25.000-512.000 MHz., 764.000-775.9875 MHz., 794.000-823.9875 MHz., 849.0125-868.8765 MHz., 894.0125-956.000 MHz., 1240.0000 MHz.-1300.0000 MHz.

The handheld BCD396T scanner was designed for National Security/Emergency Preparedness (NS/EP) and homeland security use with new features such as **Fire Tone Out Decoder**. This feature lets you set the BCD396T to alert if your selected two-tone sequential paging tones are received. Ideal for on-call firefighters, emergency response staff and for activating individual scanners used for incident management and population attack warning.

**Close Call Radio Frequency Capture** - Bearcat exclusive technology locks onto nearby radio transmissions, even if you haven't programmed anything into your scanner. Useful for intelligence agencies for use at events where you don't have advance notice or knowledge of the radio communications systems and assets you need to intercept. The BCD396T scanner is designed to track Motorola Type I, Type II, Hybrid, SMARTNET, PRIVACY PLUS, LTR and EDACS® analog trunking systems on any band. Now, follow UHF High Band, UHF 800/900 MHz trunked public safety and public service systems just as if conventional two-way communications were used. **Dynamically Allocated Channel Memory** - The BCD396T scanner's memory is

organized so that it more closely matches how radio systems actually work. Organize channels any way you want, using Uniden's exclusive dynamic memory management system. 3,000 channels are typical but **over 6,000 channels are possible** depending on the scanner features used. You can also easily determine how much memory you have used and how much memory you have left. **Preprogrammed Systems** - The BCD396T is preprogrammed with over 400 channels covering police, fire and ambulance operations in the 25 most populated counties in the United States, plus the most popular digital systems. **3 AA NiMH or Alkaline battery operation and Charger** - 3 AA battery operation - The BCD396T includes 3 premium 2,300 mAh Nickel Metal Hydride AA batteries to give you the most economical power option available. You may also operate the BCD396T using 3 AA alkaline batteries. **Unique Data Skip** - Allows your scanner to skip unwanted data transmissions and reduces unwanted birds. **Memory Backup** - If the battery completely discharges or if power is disconnected, the frequencies programmed in the BCD396T scanner are retained in memory. **Manual Channel Access** - Go directly to any channel. **LCD Back Light** - A blue LCD light remains on when the back light key is pressed. **Autofilter** - Automatically turns the blue LCD backlight on when your scanner stops on a transmission. **Battery Save** - In manual mode, the BCD396T automatically reduces its power requirements to extend the battery's charge. **Attenuator** - Reduces the signal strength to help prevent signal overload. The BCD396T also works as a conventional scanner to continuously monitor many radio conversations even though the message is switching frequencies. The BCD396T comes with AC adapter, 3 AA nickel metal hydride batteries, belt clip, flexible rubber antenna, wrist strap, SMA/BNC adapter, RS232C cable, Trunk Tracker frequency guide, owner's manual and one year limited Uniden warranty. Not compatible with AGEIS, ASTRO or ESAS systems. Order on-line at [www.usascan.com](http://www.usascan.com) or call 1-800-USA-SCAN.

### More Radio Products

Save even more on radio scanners when purchased directly from CEI. Price includes delivery in the continental USA excluding Alaska.

Bearcat 898T 500 channel TrunkTracker III base/mobile.....	\$209.95
Bearcat 796DGV Digital 1,000 ch. TrunkTracker IV base/mobile.....	\$519.95
Bearcat BCD396T APCO 25 Digital scanner with Fire Tone Out.....	\$519.95
Bearcat 246T up to 2,500 ch. TrunkTracker III handheld scanner.....	\$214.95
Bearcat Sportcat 230 alpha display handheld sports scanner.....	\$184.95
Bearcat 278CLT 100 channel AM/FM/SAME WX alert scanner.....	\$129.95
Bearcat 248CLT 50 channel base AM/FM/weather alert scanner.....	\$104.95
Bearcat 244CLT 30 channel base AM/FM/weather alert scanner.....	\$94.95
Bearcat 92XLT 200 channel handheld scanner.....	\$105.95
Bearcat 72XLT 100 channel handheld scanner.....	\$89.95
Bearcat BR330T handheld shortwave/scanner with Fire Tone out.....	\$274.95
Bearcat BCT8 250 channel information mobile scanner.....	\$169.95
Bearcat 350C 50 channel desktop mobile scanner.....	\$96.95
AOR AR16BQ Wide Band scanner with quick charger.....	\$199.95
AOR AR3000AB Wide Band base/mobile receiver.....	\$1,079.95
AOR AR8200 Mark III Wide Band handheld scanner.....	\$594.95
AOR AR8600 Mark II Wide Band receiver.....	\$899.95
Deluxe Independent Dual Volume Control Racing Headphone.....	\$29.95
Scancat Gold For Windows Software.....	\$99.95
Scancat Gold for Windows Surveillance Edition.....	\$159.95

### Bearcat® BC246T Trunk Tracker III

Suggested list price \$399.95/CEI price \$214.95  
Compact professional handheld TrunkTracker III scanner featuring Close Call and Dynamically Allocated Channel Memory (up to 2,500 channels), SAME Weather Alert, CTCSS/DCS, Alpha Tagging.  
Size: 2.72" Wide x 1.26" Deep x 4.6" High

#### Frequency Coverage:

25.000-54.000 MHz., 108.000-174.000 MHz., 216.000-224.9800 MHz., 400.000-512.0000 MHz., 806.000-823.9875 MHz., 849.0125-868.9875 MHz., 894.0125-956.000 MHz., 1240.0000 MHz.-1300.0000 MHz.

The handheld BC246T TrunkTracker scanner has so many features, we recommend you visit our web site at [www.usascan.com](http://www.usascan.com) and download the free owner's manual. Popular features include **Close Call Radio Frequency Capture** - Bearcat exclusive technology locks onto nearby radio transmissions, even if you haven't programmed anything into your scanner. **Dynamically Allocated Channel Memory** - Organize channels any way you want, using Uniden's exclusive dynamic memory management system. 1,600 channels are typical but **over 2,500 channels are possible** depending on the scanner features used. You can also easily determine how much memory is used. **Preprogrammed Service Search (10)** - Makes it easy to find interesting frequencies used by public safety, news media TV broadcast audio, Amateur (ham) radio, CB radio, Family Radio Service, special low power, railroad, aircraft, marine, racing and weather frequencies. **Quick Keys** - allow you to select systems and groups by pressing a single key. **Text Tagging** - Name each system, group, channel, talk group.



**ID**, custom search range, and S.A.M.E. group using 16 characters per name. **Memory Backup** - When power is lost or disconnected, your BC246T retains the frequencies that were programmed in memory. **Unique Data Skip** - Allows the BC246T to skip over unwanted data transmissions and birds. **Attenuator** - You can set the BC246T attenuator to reduce the input strength of strong signals by about 18 dB. **Duplicate Frequency Alert** - Alerts you if you try to enter a duplicate name or frequency already stored in the scanner. **22 Bands** - with aircraft and 800 MHz. The BC246T comes with AC adapter, 2 AA 1,800 mAh nickel metal hydride batteries, belt clip, flexible rubber antenna, wrist strap, RS232C cable, Trunk Tracker frequency guide, owner's manual and one year limited Uniden warranty. For more fun, order our optional deluxe racing headset part #HF24RS for \$29.95. Order now at [www.usascan.com](http://www.usascan.com) or call 1-800-USA-SCAN.

### Buy with Confidence

#### Order on-line and get big savings

For over 37 years, millions of communications specialists and enthusiasts worldwide have trusted Communications Electronics for their mission critical communications needs. It's easy to order. For fastest delivery, order on-line at [www.usascan.com](http://www.usascan.com). Mail orders to: Communications Electronics Inc., P.O. Box 1045, Ann Arbor, Michigan 48106 USA. Price includes \$30.00 UPS Ground shipping/handling/insurance per scanner to a street address in the continental USA excluding Alaska. Add \$20.00 shipping for all accessories. For shipments to Canada, Puerto Rico, Hawaii, Alaska, Guam, P.O. Box, APO/FPO, USPS Priority Mail or UPS 2 business day delivery, add \$30.00. Michigan residents add sales tax. No COD's. For Bearcat scanners your satisfaction is guaranteed or return item in unused condition in original packaging within 61 days for refund, less shipping charges. 10% surcharge for net 10 billing to qualified accounts. All sales are subject to availability, acceptance and verification. Prices, terms and specifications are subject to change without notice. We welcome your Discover, Visa, American Express, MasterCard, IMPAC or Eurocard. Order toll free, call 1-800-USA-SCAN or 1-734-996-8888 if outside Canada or the USA. FAX anytime, dial 1-734-663-8888. Dealer and international inquiries invited. Order your radio scanners from Communications Electronics today.

### For credit card orders call 1-800-USA-SCAN

e-mail: [cei@usascan.com](mailto:cei@usascan.com)

[www.usascan.com](http://www.usascan.com)

PO Box 1045, Ann Arbor, Michigan 48106-1045 USA  
For information call 734-996-8888 or FAX 734-663-8888  
Price schedule effective January 2, 2006 AD #010206 © 2006 Communications Electronics Inc.



COMMUNICATIONS  
ELECTRONICS INC.

Emergency Operations Center

Visit [WWW.USASCAN.COM](http://WWW.USASCAN.COM) • 1-800-USA-SCAN

## Radio's Place In An Evolving Landscape

by Rob de Santos  
commhorizons@gmail.com

**W**elcome to a new column about the trends affecting the communications hobby. As the name indicates, this page will focus on the *horizons* of communications—the cutting edge as it comes into view—and we'll explore the latest products and ideas that are changing the world and how they may affect the readers of *Pop'Comm*. Sometimes we'll review a new product, sometimes we'll discuss the digital transformation affecting every aspect of the media, and sometimes I'll share my musings about where we might find ourselves down the road.

By way of an introduction, I've been a short-wave and scanner hobbyist since 1978. These days I am an avid consumer of everything from satellite radio to the Internet. I have an Internet-based business that requires me to stay abreast of the latest technological trends. I've got a long professional background in technology including stints in aerospace and computers. I'm sure I've even met many of you already during visits to the Winter SWL Festival in Kulpsville, Pennsylvania, and other meetings over the years. And I look forward to hearing from you.

Your feedback is welcome as we take this journey. Let me know what you think and what topics you'd like to see discussed and we'll consider those, too.

Perhaps no change in the communications world has been more dramatic than the integration of computer technology with almost every tool in our daily lives. The communications hobby has been no exception to this trend. As a consequence of the decreases in cost and increases in power brought about by new technology, radio is now undergoing wrenching changes in its distribution. While once the only way we received radio was via the "ol' box on the bedside stand" or perhaps in our cars via analog AM and FM, things are now in tremendous flux.

Consider the options today: HD radio; satellite radio (Sirius, XM, and WorldSpace); Internet distribution (through your computer and via stand-alone Internet devices); cable (Music Choice and similar services, including selected Sirius and XM channels); portable devices (everything from the venerable Walkman to MP3

players); and cell phones (soon to be a billion dollar music market). And there's more to come.

So what does that mean, both for radio producers and consumers? Beyond the obvious creation of more choices for consumers it probably means that we're entering a period of "Darwinian" selection. Some content producers won't survive, others may adapt and thrive, and some new "species" will appear on the scene. We've already had a bit of the latter with the profusion of thousands of Internet-based "radio stations." Conventional AM and FM stations have put themselves out on the Internet or created podcasts to get their programs heard. HD radio is the industry and government answer to the digital transition and its success remains unclear. (We'll be taking a more detailed look at HD radio in a future column.)

The changes also mean that the market is being divided into smaller and smaller chunks. The days when one program or station could have market shares of 25 to 50 percent in a geographic area are fading fast. This may mean leaner times for the biggest radio outlets, but it might also mean a wider market geographically.

A few radio stations have recognized the "new markets." They now have listeners in places that not long ago would have been impossible to reach, clear around the world. In the past, short-wave listeners might be the only fortunate people to get an occasional newscast from Poland or a sporting match from Australia. Now, no matter where you are, if you have a computer or an "Internet radio" you can listen to the local traffic report from Warsaw or news from your old hometown. Via podcasts, stations have national and international listenership, for even topical radio programs, that they might never have achieved before. And we listeners have opportunities that all this opens up for us. For instance, I have a list of programs that I only listen to in my car after having downloaded them via podcast each week. This "time-shifting," first observed with VCRs a couple of decades ago, is now a fact of life in radio.

What do the changes mean for the radio hobbyist? Computers have made the monitoring and

listening hobby much different than it was just a generation ago. Word of your latest "DX" catch can wind its way around the world in just minutes so other listeners can jump right in and immediately confirm it. Logging catches is now a matter of instantly recording info into a database or perhaps cross checking which stations might be on that frequency. The radios we use are changing rapidly, too, as software-defined radios are becoming a reality and reprogrammable digital signal processing technology makes it possible to instantly upgrade a device.

Sadly, broadcasters in the shortwave bands have been disappearing with almost monthly regularity. It was only two decades ago when debate raged about whether the "mega" broadcasters were destroying chances to hear smaller stations and how little spectrum space was available. Now, shortwave is increasingly a minor product of the VOA, BBC, and others and aimed only at third world countries. Combine that with the extended solar minimum, and at some times of the day the bands seem almost empty here at my listening post.

The hobbies of ham radio and radio listening in general are also facing an aging population of enthusiasts. Whether you think that's the "fault" of the technological changes, failure to recruit younger members, or something else, it's clear that the world of the communications hobbyist will of necessity be a very different place in a few more years. Do hams have a future role as experimenters and in local and national emergencies? I'm sure you have your own thoughts about this.

We live in a dynamic time with the world of communications undergoing change at a dizzying pace. Over the coming months, I look forward to being your guide to the new horizons of radio and communications.

Speculating on future trends was always a dangerous business, but as food for thought here are a few predictions for the next few years:

- AM and FM radio will be a smaller, leaner world than it is today, but it will survive.

- The Internet will be increasingly important as a formal and back channel means of distribution.

- HD could potentially reach critical mass for FM, but may never do so for AM in its current form.

Drop me a note or email and let me know if you agree or disagree. See you next month. ■

## FEEDBACK

### Our Readers Speak Out

#### On A Notorious Radio

Dear Editor:

I really enjoyed the article on the RS-111 ("The Watergate Rig: The Most Infamous Spy Radio," by Terry O'Laughlin, June 2008 *Pop'Comm*). I was in the Army assigned to a branch that worked closely with a civilian intelligence agency. For part of the time I was with the First Radio Research Company (Project Crazy Cat). While I was in the Army I worked on many various types of CEI/WJ radios and they were superb. Your article brought back some good memories, thanks.

Frank Kelly  
Via Email

Dear Editor:

I just wanted to say "thanks" for the great article on the WJ RS-111—"the most infamous spy radio." Aside from the story behind the receiver and the Watkins-Johnson Company, it was a fascinating look into how communications technology was instrumental in changing the course of history.

It's not very often that a communications receiver becomes front-page news! I hope you will continue to publish future articles of this type.

Bob, W9RAN  
Via Email

Dear Editor:

I just finished reading Terry O'Laughlin's article entitled "The Watergate Rig: The Most Infamous Spy Radio" in the June issue of *Pop'Comm*. I wanted to let you know how much I enjoyed the article. It was very well written. Terry took me back to a different period in our history and showed the important role that radio played in that infamous event. The article also reminds us of how far radio has come in a relatively short period. The Watkins Johnson RS-111 was a top spy radio back in the late '60s and early '70s. Today we can buy more capable radios for a fraction of the price and size from many of the radio dealers that advertise in *Pop'Comm*. I would love to see more articles like Terry's in future *Pop'Comm* issues. Keep up the good work.

Don Young, N2DY  
Via Email

Dear Editor:

I was in the flea market at Dayton

Hamvention in the late 1970s and I found a Watkins Johnson RS-111. It was an early one, serial number 111 and type RS-111-1a. I owned it for years but I could never find out the serial number of the Watergate receiver. I eventually traded it for a RACAL HF receiver. I've always wondered "what if?"

Does anybody know the serial number of the real one?

Don Davis, WB3AXQ  
Via Email

*The author responds...*

Dear Don:

The serial number plate on the original was removed by James McCord. Watkins-Johnson had records of every single radio they ever sold. The info on older units was stored on a Wang mainframe. One of my sources tells me the records disappeared when the Wang was trashed 15 years ago. Another one told me the records were kept in paper form, but there is too much sensitive information in those records for them to be made public.

The Watergate radio was most likely an RS-111-1B-12. I have a photo of the actual radio on my website at <http://watkins-johnson.terryo.org/CEI-Receiver/RS-111.htm>. I found it after I completed the story.

Thanks for reading.

Terry O'

#### Kudos For Mountain Wave

Dear Editor:

I am not a subscriber to your magazine, but do pick one up at Barnes & Noble every so often. The July issue is one of the best you have produced. *Every* article was fact-filled and extremely interesting to me.

I am a Ham with a General class license, but spend most of my airtime on the VHF/UHF repeaters due to my membership in the local RACES organization. Of course, I found the article on Mountain Wave ("Life-Support—Mountain Wave Emergency Communications," by Roy Stevenson) to be the most interesting. It was a well-written and in-depth account of a great organization.

Thanks to all at your organization for providing such an excellent magazine.

David Turk, KR6DGT  
Via Email

# GRUNDIG

TIMELESS PERFORMANCE

50<sup>th</sup>  
Anniversary

# LISTEN TO THE WORLD



## G4 WORLD RECORDER

AM/FM/Shortwave Portable  
Radio with MP3 And SD player | \$200.00

- AM/FM-stereo and Shortwave (3000-29999KHz)
- Digital Display world-band radio
- Digital tuning methods including Auto-scan, Manual-San, Direct Key-in and Manual Tuning
- FM Station Tuning Storage (ATS) provides automatic acquisition of the strongest stations in your area
- Built-in 1GB/2GB flash, USB 2.0 high speed transmission



CONSUMER DIGEST  
BEST BUY AWARD 2007

## G5 GLOBAL TRAVELER

AM/FM/Shortwave with SSB | \$150.00

- AM/FM-stereo and Shortwave (1711-29999 KHz)
- Single Side Band (SSB)
- Digital Phase Lock Loop (PLL) dual conversion
- Digital Display world-band radio
- Station name input features allow a 4-character input of the stations call letters



## G6 AVIATOR

AM/FM/Shortwave with SSB | \$100.00

- AM, FM, Aircraft Band (117-137 MHz) and Shortwave (1711-30000 KHz)
- Dual conversion
- Three types of automatic scan tuning
- 700 memories with 4 character page naming
- 3 programmable alarm timers (volume and frequency can be preset)



Receives  
AM Band



Receives  
FM Band



Receives  
Shortwave Band



Alarm  
Clock



Headphone  
Jack





### Satellit 750

AM/FM/Shortwave Radio with SSB | \$300.00

- AM, FM, Aircraft Band (118-137 MHz) and Shortwave (1711-30000 KHz)
- Set 9/10 KHz AM tuning; set FM tuning range
- Single Side Band (SSB)
- Auto/Manual/Direct frequency key-in and station memory tuning
- 1000 station memories (each band 100 memories, 500 customizable)



### GS350DL FIELD RADIO

AM/FM/Shortwave Radio | \$100.00

- AM (530-1710 KHz), FM (88-108 MHz) and Shortwave – continuous coverage
- Highly sensitive and selective analog tuner circuitry with AM/SW frequency lock
- Rotary volume control
- Main tuning knob and independent fine-tuning control knob
- Variable RF gain control

Grundig Radio Line By:

**etón**  
re.inventing radio  
www.etoncorp.com  
1-800-793-6542

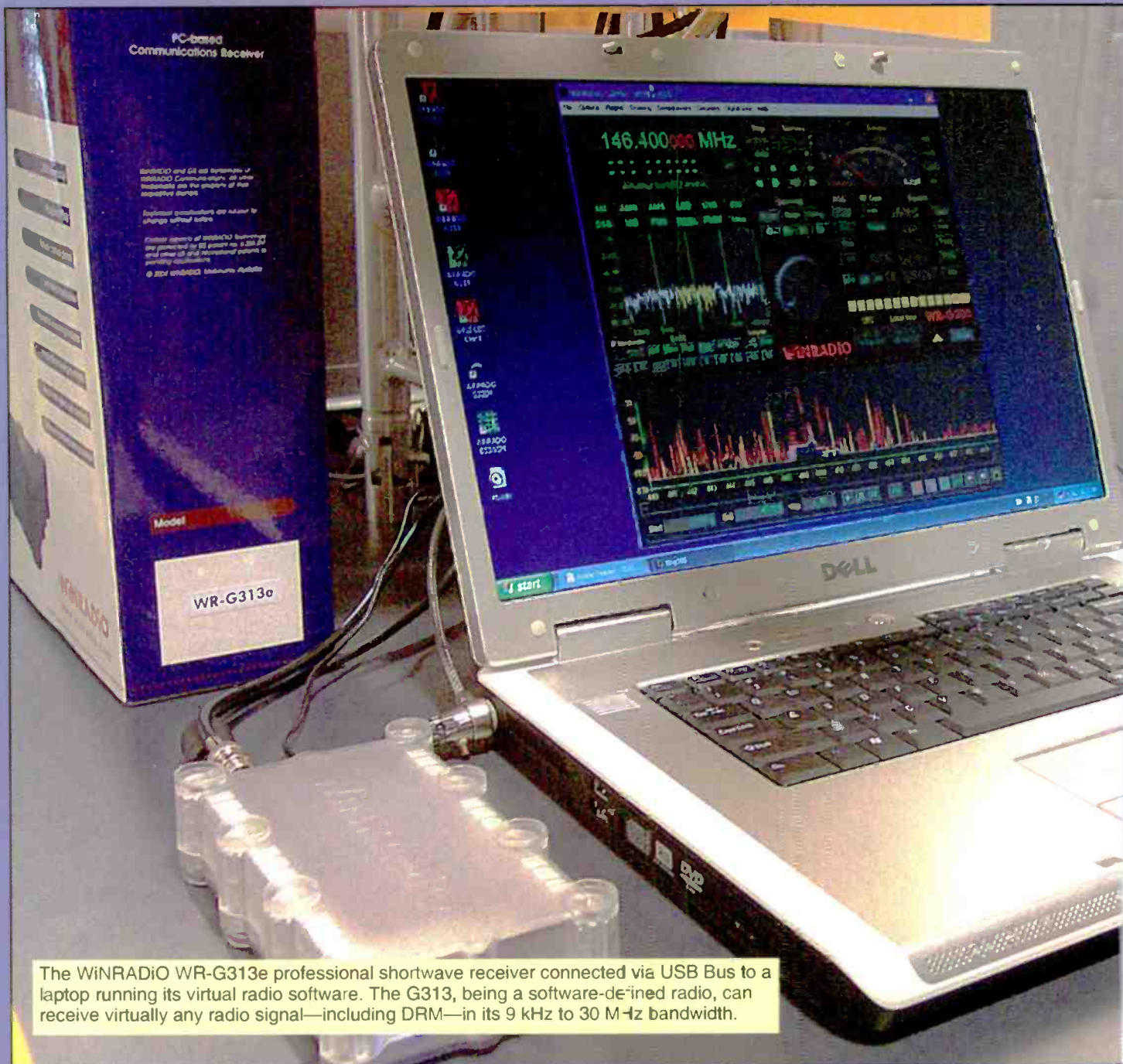

The WinRadio WR-G313e professional shortwave receiver connected via USB Bus to a laptop running its virtual radio software. The G313, being a software-defined radio, can receive virtually any radio signal—including DRM—in its 9 kHz to 30 MHz bandwidth.

# Digital Radio Mondiale— The Cutting Edge Of Digital Radio

*Moving Shortwave Broadcasting Into The 21st Century*

by Don Rotolo, N2IRZ



As with almost everything in modern life, even our beloved shortwave broadcasts have gone digital. While you've probably known about digital broadcasts for years, knowing about it and listening to it are two different things. To help bridge that gap, in this article, I'll explore the topic in detail, explain who is transmitting in digital, and how you can listen in.

Before we do that, though, let's take a quick look at the international standard for digital shortwave (below 30 MHz) broadcast, Digital Radio Mondiale (DRM). While not exactly new—it's been around in some form since the 1990s—there are still only a few stations that use it regularly.

DRM (not to be confused with the concept of *digital rights management*) is an international standard that was developed in the previous century and adopted over six years ago for worldwide use on frequencies under 30 MHz. DRM is an intelligent and flexible approach to moving shortwave broadcasting into the 21st Century, allowing for more efficient use of the broadcast spectrum while offering greatly enhanced program quality and services. More recently, action has been taken to extend the use of DRM up into higher frequencies, including FM.

### The Technology In Brief

Digital audio forms the basis for digital broadcasting. I don't want to get deeply into the technology, but it helps to know that to convert an analog audio signal into a digital data stream, one uses an Analog-to-Digital Converter (ADC). A discussion of ADCs could fill several books, so I'll keep it simple: An ADC samples the analog signal tens of thousands (for audio) of times each second, and converts the signal voltage at the instant of sampling into a number. If we convert the "stream" of numbers back into voltages (using a Digital-to-Analog Converter, or DAC), the reproduced signal can be indistinguishable from the original. The level of fidelity depends on several factors, including the time between samples and the smallest change in voltage the ADC can discern.

The DRM standard calls for a digitally encoded signal, made up of dozens of relatively narrow radio carriers, each carrying a small part of the larger "payload" of digital data. Sophisticated software techniques are used to keep these closely spaced carriers from interfering with each other, and also prevent fading or mild interference from affecting sound quality. Different versions of the standard allow for signals that are 4.5, 5, 9, 10, 18 and 20 kHz wide.

The basic signal, which for the broadcast standard is 4.5 kHz wide, carries not only the program payload (the

actual voice or music signal, sometimes mixed with data), but also information to control the receiver (which decoding scheme to use, etc.) and program content information (artist, title, upcoming programs, etc.). The information used to describe the basic signal attributes is sent on the Fast Access Channel (FAC), which is sent continuously, repeating a few times per second. This allows for a receiver to scan across the band and find DRM signals with minimal decoding delay. The Service Description Channel (SDC) tells the receiver which decoding scheme to use to start converting the data from the Main Service Channel (MSC) back into audio.

The DRM signal uses OFDM (Orthogonal Frequency Division Multiplexing) with several QAM (Quadrature Amplitude Modulated) signals to make up the signal. If these terms are new to you, think of it like this: Take a small piece of the digital data and carefully modulate it into a very narrow, but precise, AM carrier, perhaps only a few dozen Hertz wide, which carries only a small piece of the digital data "stream." Now, pack a hundred or more of those carriers (that's the "Frequency Division" part) next to each other into the Main Service Channel, and you can get some real data capacity. Since you know the content of each signal, you can control them so they don't interfere with each other (that's the "Orthogonal" part), making for a very efficient signal.

It doesn't hurt that the voice, music or data being sent by DRM is very heavily processed and compressed. Schemes such as MPEG-4 AAC, CELP, HVXC, SBR, and PS all work to minimize the amount of data needed to reproduce the original audio signal. For those really interested in the technical details, visit the DRM website [www.drm.org](http://www.drm.org) and follow the links on "The System" page to the specifications. The latest version is 195 pages of some fairly detailed information—it's a great read if you're an insomniac.

Most broadcasters are using wider-bandwidth versions of the DRM standard, generally 10 kHz wide, which includes more "program information," but the control information will still reside in the relatively narrow basic carrier. The encoding scheme can be changed even on the fly, perhaps for greater resistance to interference, with the receiver able to track these changes instantly. Broadcasters with wider bandwidth available will use it to improve signal fidelity as well as robustness (the ability of a signal to overcome noise, fading, multipath, Doppler distortion and other interference).

Don Rotolo is an electrical engineer and amateur radio operator who writes the "Digital Connections" column for our sister publication, *CQ Amateur Radio*.

Some broadcasters make very good use of the data capabilities of their DRM signals. Listening to Deutsche Welle, for example, one can find a page of news bulletins delivered as HTML hyperlinks, which when clicked “magically” open the full text of the news story in a browser—all delivered via DRM and not the Internet. I’ve been told that the BBC World Service sends a text version of its Shipping Forecast via DRM as well. Obviously, you need to be using a computer to take advantage of these features.

One nifty trick DRM can use is a superposition of a compatible AM signal atop the digital signal, so listeners with traditional analog radios and those with digital radios can both hear the programming on the same channel. This is particularly important to broadcasters serving economically disadvantaged areas, where money to purchase a DRM-capable radio may be difficult to come by. I’m not aware of any broadcasters actually doing this, however, since it does occupy somewhat more bandwidth.

Another DRM trick to increase the perceived audio fidelity is spectral band replication (SBR). The high-frequency portions of an audio signal are mostly noise-like, a kind of a hissing sound. SBR encodes the loudness and duration of these sounds, and at the receiver, the SBR decoder just kind of hisses at the right moments. The effect is amazing: Your mind really hears a much wider audio range than is actually present. To experience this stunning effect for yourself, try the audio samples at the DRM website.

## Receiving DRM

A detailed search of the Internet revealed a disappointing fact: off-the-shelf receivers for Digital Radio Mondiale are not easy to find in the United States, and are somewhat expensive from Europe. Most of the DRM fans on the DRM NA discussion group on Yahoo (<http://groups.yahoo.com/group/drmna/>) seem to be using modified receivers and either the freeware Dream software or the commercial DRM Software Radio.

(A side note about the DRM NA discussion group: This is where all of the hardcore DRM fans congregate, and where you can hear the latest news about DRM. The folks there are friendly, offering advice and opinions on most any aspect of DRM, including equipment selections. If you’re at all interested in listening to DRM, this is the place to get started.)

Anyway, back to listening: You don’t necessarily need a DRM radio to listen. Software has been developed that harnesses the power of your computer and sound card to decode the DRM signals. Most DRM listeners in the United States are doing it this way.

The only fly in this ointment is the need for an extremely distortion-free signal for your sound card to decode. The regular audio output from your receiver is not going to work. Instead, you need to pick out the signal from within the radio at the intermediate frequency (IF) stage and bring that out to your sound card, before all the radio’s audio filtering and shaping. The IF needs to be low enough that your sound card can “hear” it, but high enough so you don’t lose any information.

A value of 12 kHz for the IF seems to be the standard, and several radios on the market are easily modified to pick off this signal. Some don’t even need modification: the TenTec RX-320D has a 12 kHz IF signal available on the rear panel, while the ICOM PCR-1000 (and PCR-100) has a wide enough audio chain to allow direct audio output (use the 50 kHz filter in USB mode, tune 12 kHz above the DRM frequency) without modification. Brand new, an RX-320D goes for about \$370, not a bad price for that hot receiver.

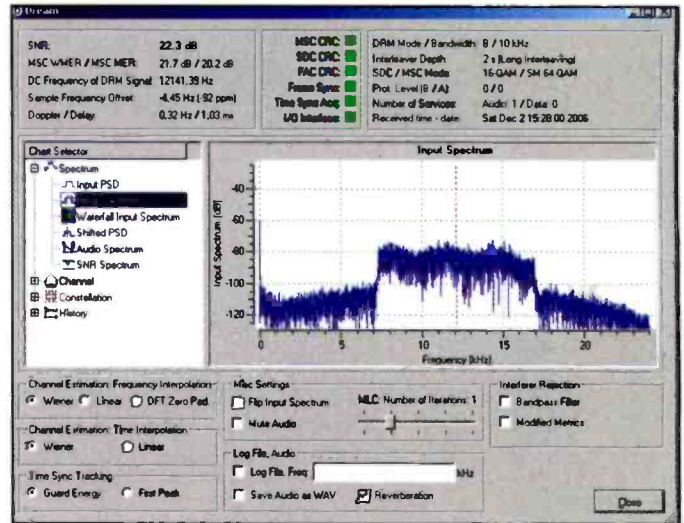

A screen capture of the Dream software receiving Radio Canada International on 9800 kHz from Sackville, Canada, here in Northern New Jersey on a modified Yaesu FT-847. Note the clearly defined 10-kHz signal. Image courtesy of Mark A. Phillips G7LTT/N12O, who also modified the radio. His website at [www.g7lft.com/drm](http://www.g7lft.com/drm) showcases his DRM experiments.

For radios that have a 455 kHz IF, you can get a 455-to-12 kHz downconverter, such as the one from I5XWW, which I have seen for about \$30 fully assembled, about \$10 less for a kit at <http://shop.ebay.it/merchant/i5xww>. Detailed instructions for converting several radios can be found at [www.drmrx.org](http://www.drmrx.org) and on Mark Phillips’ G7LTT’s webpage at [www.g7lft.com/drm](http://www.g7lft.com/drm).

Dream is freeware available online under the GNU public license from Sourceforge (<http://drm.sourceforge.net/>), but this is real “source code,” meaning the raw software that still needs to be compiled to run on a computer. The reason sourceforge doesn’t offer it as an .EXE file is one of licensing; there are some intellectual property rights that need to be respected. However, there are several SWL companies that have a license to distribute Dream for a nominal media charge (a few dollars to cover the cost of the CD and mailing), such as I5XWW’s (see <http://xoomer.alice.it/i5xww/software.htm>). Note that, as freeware, no guarantees of bug-free and stable operation are made.

If you want commercial-quality performance, then DRM Software Radio is what you need. DRM Software Radio is a commercial product available from WinRADIo ([www.winradio.com/home/drm.htm](http://www.winradio.com/home/drm.htm)) that allows effortless DRM listening. The WinRADIo receivers are software-defined radios (SDRs), which are inherently able to provide the necessary wideband, distortion-free signal required (see this month’s “Tech Showcase” on MicroTelecom’s Perseus SDR radio for an in-depth look at one offering). Most any SDR will work with DRM Software Radio, including FlexRadio and SoftRock offerings.

If fiddling with software and modifying radios isn’t for you (but remember, MicroTelecom’s Perseus or TenTec’s RX0320D don’t need modification!), you’ll be happy to know that a Google Web search revealed that there are several websites offering DRM-capable radios and converters—simply plug, tune, and listen.

The Morphy Richards radio is advertised by igear ([www.igear.com](http://www.igear.com)) on special for only 169 Euros (about \$230), not including shipping. The Himalaya DRM-2009 was seen for 250 Euros (about \$340) at Charly Hardt ([www.charly-hardt.de/](http://www.charly-hardt.de/)

## Table. Selected Schedule Of DRM Programming

Many of the following stations are easily heard in the United States, depending on conditions of course. Valid in August 2008, by the time you read this, schedules may have changed; you can also visit [www.drm.org](http://www.drm.org) for an up-to-date schedule of DRM broadcasts.

Time (UTC)	Days	kHz	Target	Program	Language	Site
0000-0059	Daily	9790	Eastern US	TDPradio	Music	Radio Canada, Sackville
1505-1705	Daily	9800	Eastern US	Radio Canada Int'l	English	Radio Canada, Sackville
1945-2030	Daily	9800	Eastern US	Vatican Radio	English	Radio Canada, Sackville
2230-2300	Daily	9800	Eastern US	Radio Sweden	English	Radio Canada, Sackville
2300-2400	Daily	9800	Eastern US	Radio China Int'l	English	Radio Canada, Sackville
0800-0900	Daily	12060, 15545	Europe	Voice of Russia	English	VoR, Taldom
2200-0400	Daily	1575	Europe	OldieStar Radio	German	OldieStar, Berg/Sachsen Germany
2300-1345	Daily	9755	N America	Vatican Radio	English	Vatican Radio, Vatican
2200-0300	Daily	11675	N America	MOI Kuwait	Arabic	Ministry of Interior, Kuwait
1551-1850	Daily	6170	Pacific	Radio New Zealand Int'l	English	RNZI, New Zealand
0800-1359	Daily	13810	Europe	Deutsche Welle	Various	DW, Sines, Portugal

drm.html), a German-language website. Note that all these websites advertise that they will ship worldwide, and customers outside Europe don't have to pay the 19-percent value-added tax (VAT), a significant savings that will probably pay a good portion of the shipping charges. One program provider, TDPradio, has a link on its website ([www.tdpradio.com/](http://www.tdpradio.com/)) to buy DRM receivers.

There are other radios available for DRM reception—most of them somewhat more expensive than those listed above—so there are products out there. I was unable to find anything but books about Digital Radio Mondiale on [www.amazon.com](http://www.amazon.com), and no actual radios on [www.ebay.com](http://www.ebay.com). Not finding any products on two of the largest retail sites on the continent does lead me to one unfortunate conclusion: You need to get creative to find a plug-n-play Digital Radio Mondiale receiver in the United States.

One small ray of hope lies up to our north, in Alaska. Digital Aurora Radio Technologies of Delta Junction, Alaska, has recently been granted permission by the FCC to operate experimental radio station WE2XRH for a two-year period to experiment with statewide DRM in the 5-, 7-, and 9-MHz shortwave bands. Their focus is to perform propagation tests, signal-to-noise and field strength level checks, along with bit rate and audio quality measurements. Perhaps this could be the start of domestic AM shortwave broadcasting in the United States? One can only hope, because such a shift in the FCC's attitude will create a huge market for shortwave receivers.

More than one integrated-circuit manufacturer has recently announced DRM chip sets, and I have heard that inexpensive mass-market receivers coming out of

India and China are coming closer to reality. Give it two or three years, in my estimation, for a DRM receiver under \$150 to appear—sooner if we see some action from the FCC.

### Who Is Broadcasting?

If we're going to make an effort to listen to DRM, perhaps we should at least have some idea about what we'll be able to hear.

First, the bad news: There was nothing that I found on DRM that can't also be heard on an analog broadcast. Programming exclusive to DRM is still nonexistent, since few broadcasters can afford to alienate listeners. Broadcasters simply transmit the same programming on different frequencies, or at different times, in analog mode—sometimes simultaneously, which led to an interesting discovery: There is a definite delay between the analog signal and the DRM signal, caused by the time necessary to first encode, then decode, the digital signal. (Thanks to Mark Phillips, G7LTT, for sharing that tidbit.)

Now for the good news: DRM programming is of far better quality—no static crashes or atmospheric hiss, no muffled low-fi music—nothing but near-FM quality audio, sometimes in stereo! While the casual listener might not find it worth investing in equipment and/or software to listen to DRM—especially since it's all available on AM already—the real SWL aficionado will find it well worth the investment. Simply put, DRM is much easier to listen to, for longer periods, than any analog broadcast.

Some selected DRM programming, valid during August 2008 when this was written, is provided in the "Selected

Schedule of DRM Programming" Table. By the time you read this, stations likely have moved to their fall lineup already. For an up-to-date listing of DRM broadcasts, including programming, transmitting station, frequency, ties, etc., visit the main DRM website's Live Broadcast Schedule (go to [www.drm.org](http://www.drm.org), and follow the "For Listeners" link to the Live Broadcast Schedule). Here you can find almost every broadcaster's DRM schedule, sortable by time, location, language, target market, and more.

### An Amazing Way To Listen To Radio

While DRM is no longer in its infancy, it can be said to be still in the toddler stage. Nevertheless, it is no longer a matter of if, but when, broadcasters will adopt the standard. Certainly a few years at least will have to pass before the receiver market catches up with the broadcast world. In any case, if you're at all interested in the cutting edge of digital, you can combine that with your love of broadcast radio by getting involved with DRM. Commercial radios for DRM reception are available if you look hard enough, or you can use your existing receiver and some software to leverage your computer's sound card to listen. The sound quality is far higher than standard AM, even though a smaller bandwidth can be used, potentially leading to an increase in the number of broadcast channels available worldwide.

I hope this introduction to DRM has explained a little bit about this relatively new way of listening to radio. So much more information is yours for the asking, especially on the Internet. Take some time, listen to the audio samples on [www.drm.org](http://www.drm.org), and prepare to be amazed. ■

# D-STAR's All-Digital Voice And Data Rigs Push Technology Forward

## ***A Current Death Of Equipment Doesn't Deter Hams' Experimentation***

by Jason Togyer, KB3CNM

**I**t combines the portability of a walkie-talkie with the reach of the Internet.

It allows hams to send data files to one another at speeds up to 128 kbps at little or no cost.

It's a technology that's been field-tested for almost 10 years, but which still offers plenty of room for "tinkerers."

So why haven't more amateurs jumped onto the D-STAR bandwagon?

D-STAR—the acronym stands for "Digital Smart Technologies for Amateur Radio"—allows hams to transmit voice and data at the same time over the same frequency. Developed in the late 1990s by Japan's then-Ministry of Posts and Telecommunications, D-STAR was intended to create a two-way digital radio and high-speed data network for the Japanese postal service.

In 2001, the Japanese government, in cooperation with the Japan Amateur Radio League (JARL), published a set of D-STAR standards for the ham bands. By 2002, ICOM America had introduced D-STAR-equipped radios for use on 1.2 GHz (23 cm); mobile, base, and handheld rigs in the 144-MHz (2-meter) and 440-MHz (70-cm) bands debuted a few years later, while D-STAR repeaters were introduced in 2006.

With D-STAR-equipped radios and their home computers, hams can transmit data to one another in simplex mode or through a D-STAR-capable repeater. D-STAR repeaters also can be linked to one another via the 10-GHz band to create a complete wireless network independent of cell towers or the Internet. And if those repeaters are linked to Internet gateways, they can talk or send data to other hams around the world.

"Anyone who invests in D-STAR now is on the cutting edge," says Terry Jones, W4TL, of Flowery Branch, Georgia. "It's like when single-sideband took over from AM back in the '50s,"

Jason Togyer, KB3CNM, is an amateur, shortwave, and AM DX enthusiast. He works for the School of Computer Science at Carnegie Mellon University in Pittsburgh and part-time at two local radio stations. Multi-talented, he is also *Pop Comm's* "Spurious Signals" cartoonist.

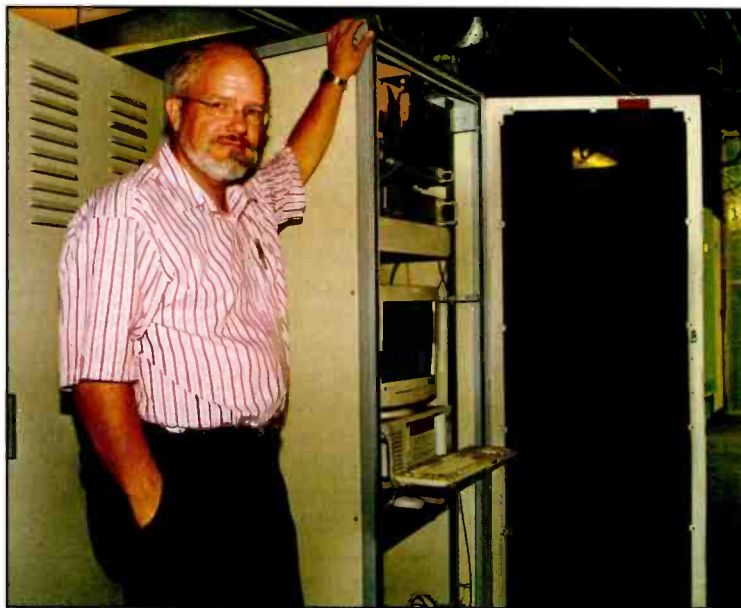

Pittsburgh's North Hills Amateur Radio Club put western Pennsylvania's first D-STAR repeater on the air last year in 2007, says Bob Hoffman, N3CVL, pictured here. (KB3CNM photo)

says Jones, an assistant director of the SouthEastern Repeater Association (SERA). "It's got a lot of potential."

### **The Adoption Process**

An all-digital mode of two-way communication that links RF with the Internet would seem to be exactly what the American Radio Relay League (ARRL) was talking about in May, when it announced at Dayton Hamvention that advancing new technologies would become the "fifth pillar" of amateur radio.

But while D-STAR enthusiasm is rising, awareness among average hams seems limited. Ask a random group of hobbyists



Members of the North Hills Amateur Radio Club and employees of Hollidaysburg, Pennsylvania-based MultiComm, Inc., prepare to put up a new UHF antenna for use by the club's D-STAR repeater. (NHARC photo by Bob Morris, K2RK)

at your Sunday-morning hamfest about D-STAR and you might get a lot of blank stares. A few hams might even get hostile, decrying the technology as “the death of ham radio” because of its incompatibility with analog FM (although all of ICOM’s D-STAR rigs also work as analog radios), or because D-STAR requires a proprietary chip. Some of the resistance is natural; after all, hams are a flinty-eyed bunch of folks, demanding that new technologies prove themselves before they plunge in. (They’re also frugal when it comes to buying new equipment. The main rig in the author’s car is a 30-year-old Clegg!) And it’s not the first technology in amateur radio that took a while to catch on; the current 2-meter band was established in 1945, but it didn’t get much usage until the late 1960s, and it didn’t really take off until the mid-1970s.

The exact number of hams currently using D-STAR isn’t easy to estimate. One clue comes from the number of repeaters currently in use. There were about 100 D-STAR repeater gateways in the United States this summer, and another dozen in Canada. By comparison, there are an estimated 8,000 conventional FM amateur repeaters in North America. Another clue comes from the number of users registered worldwide to use D-STAR Internet gateways; in August, there were about

3,700 call signs in the network. (Registration isn’t compulsory, so not all D-STAR users bother.) Considering that D-STAR rigs on 2 meters and 70 cm have been available for less than five years, the adoption rate is actually pretty good.

Dan Thompson, N8WKM, of Hopkins, Michigan, a member of the

Western Michigan Privately Owned Repeater Group, speculates that the soft economy has discouraged some amateurs from buying D-STAR-capable radios. Otherwise, he says, they’re excited about the chance to use digital voice on the ham bands: “A lot of people that I’ve talked to say this has been one of the biggest boosts and one of the most exciting things they’ve seen in amateur radio in the last 10 to 15 years.”

One serious problem is that of the “Big Three” Japanese amateur-equipment manufacturers, only ICOM is committed to offering D-STAR radios in the United States or Canada (one of the company’s receivers with a D-STAR option, the ICOM R-2500, is covered in depth in this month’s “ScanTech”). Kenwood sells a D-STAR rig in Japan, but reviews indicate that it’s a rebranded ICOM radio. Yaesu (Vertex Standard) doesn’t support D-STAR at all.

Two U.S. amateurs, Maurice “Mo” Wheatley Jr., AE4JY, and Robin Cutshaw, AA4RC, have designed what they call the “DV-Dongle”—a plug-in for any USB-equipped computer that allows it to decode D-STAR signals and communicate with D-STAR radios.

### What Makes This Box Tick

D-STAR is powered by a patented analog-to-digital encoding system, or codec, called Advanced Multi-Band Excitation (AMBE), developed by Digital Voice Systems, Inc. (DVSI), of Westford,



By design, the digital stream transmitted by D-STAR-equipped radios includes the user’s callsign, which is programmed into the “MYCALL” field. ICOM America is the only manufacturer selling D-STAR-capable radios in the United States; the company’s ID-800H is shown here. (KB3CNM photo)



After registering for access to the Internet at their nearest D-STAR gateway, users are able to call CQ through any D-STAR-equipped repeater anywhere in the world. (KB3CNM photo)

Massachusetts. Some XM Satellite Radio channels and satellite telephone systems reportedly also use the AMBE codec.

Using an AMBE chip supplied by DVSI, D-STAR radios transmit a 4800-bps digital stream; 2400 bps of that is used for audio and 1200 bps is used for error correction. The remaining 1200 bps is used for data, which can be sent to D-STAR VHF/UHF rigs via an RS-232 connection or a USB port. If 1200 bps doesn't sound too impressive—after all, that's the speed of the acoustic modem on an old Commodore 64—then step up to a rig on the 23-cm band, where D-STAR radios can pass 128 kbps of data via an Ethernet connection.

Unlike packet radio, where digital data is converted into audio tones that can be heard over a conventional FM transceiver, D-STAR signals can't be received by analog radios. Regular VHF/UHF two-way FM transceivers use analog audio to modulate the frequency of a carrier wave. D-STAR radios use a variation of frequency-shift keying called Gaussian minimum-shift keying, or GMSK, to change the "on" and "off" bits of the digital data stream into tiny variations in the frequency of the carrier. Using the AMBE

codec and GMSK packs the maximum amount of voice and data into a minimum amount of bandwidth—less than 2 kHz on the 2-meter and 70-cm bands, versus about 2.5 kHz on regular FM.

Compressing the audio into just 2400 bps comes at a loss of quality—voices over D-STAR rigs sound something like a telephone call turned into a low bit-rate MP3. Some people, like Jones, think D-STAR audio is actually a little bit cleaner than analog FM, because there's no static or fading. "You're either there or you're not," he says. But when a D-STAR receiver does start to lose a signal, the audio can get garbled. Bob Hoffman, N3CVL, helped set up the Pittsburgh area's first D-STAR repeater for the North Hills Amateur Radio Club (NHARC). He says D-STAR users call the garbled audio the "R2D2 effect," after the robot from the *Star Wars* series that talked only in bleeps and bleeps.

Sending data over ham frequencies isn't anything new—packet radio has been around for nearly 30 years—but D-STAR is the first system for amateur radio operators to allow simultaneous digital voice and data transmission on the same carrier frequency.

Not surprisingly, the new technology is supplanting the old. NHARC's D-STAR machine, W3EXW, replaced a packet repeater on the same output frequency (444.350 MHz) that had been operating for at least 15 years. Hoffman says the packet machine was silent for weeks at a time when the plug was finally pulled. (At some point before the official end in June 2007, he says, the repeater failed and nobody noticed.)

## Power In The Potential

Emergency communicators are particularly excited about D-STAR's data transmission capability. In addition to his role with SERA, Jones is national communications coordinator for the North American Mission Board's (NAMB) Southern Baptist Disaster Relief Ministry, which prepares meals, provides cleanup crews, and offers communications and technical support after storms, floods, and other catastrophic events. NAMB has access to two portable D-STAR-equipped repeaters, Jones says, and plans to use them so that relief crews can communicate and send field reports to one another and NAMB headquarters in Alpharetta, Georgia.

Before using a D-STAR radio for the first time, users have to program the rig with their callsigns, and part of the digital stream sent by each radio includes the user's call. Ray Novak, N9JA, manager of ICOM America's amateur division, says some search and rescue organizations are linking GPS receivers to the data ports of D-STAR radios carried by their volunteers; each time a volunteer keys his or her mic, the other radios on the network can automatically track both their callsign and location. Other amateurs are experimenting with slow-scan TV and text-messaging over D-STAR data channels.

"What it can do is really limited only by people's imagination," Novak says. "Whatever you can push through the serial port on your computer, you can use with D-STAR. On 1.2 GHz, you've got an ISDN-level data connection, so if you're a storm-chaser and there's a tornado sighting, you can be looking at the local Doppler radar system. Or you can set up an email network." Many applications are available for free download at the D-STARusers.org website.

With their built-in 10-GHz microwave relays, D-STAR repeaters don't need wires to connect to one another, but the "killer-app" for D-STAR is probably its ability to integrate amateur radio with the



## The VoIP Option For Global Contacts

Amateur-radio operators who want to talk through their local repeater to far-away hams using the Internet have other options besides D-STAR.

Though each of these systems operates differently, all use transceivers linked to local servers to create Internet gateways. These gateways pass messages from place to place using voice over IP (VoIP) technology.

A few of the better-known systems include:

- EchoLink, created by Jonathan Taylor, K1RFD, of Ridgefield, Connecticut ([www.echolink.org](http://www.echolink.org))
- eQSO, developed by Paul Davies, MØZPD, an amateur from West Midlands, U.K. ([www.eQSO.org](http://www.eQSO.org))
- Internet Radio Linking Project (IRLP), developed by a Canadian amateur, David Cameron, VE7LTD, of North Vancouver, B.C. ([www.irlp.net](http://www.irlp.net))
- Wide-Coverage Internet Repeater Enhancement System (WIRES), created by Yaesu, the amateur-radio division of Vertex Standard ([www.vxstd.com/en/wiresinfo-en/](http://www.vxstd.com/en/wiresinfo-en/))

Internet. Although there are other applications and systems available to connect repeaters over the Internet using voice-over-IP technology (see sidebar), none of them offer D-STAR's data-handling capability. Through a D-STAR repeater connected to an Internet server, amateurs can talk and exchange files not only across town, but around the world, using their transceiver with almost any personal computer.

D-STAR servers use the Internet protocol suite to send both digital audio and data from place to place. (It's the same system, usually called TCP/IP, that's used to route Web and email traffic to the correct servers.) Hams who want access to D-STAR's Internet gateway must first register their callsign through a D-STAR server that's already trusted by the other servers on the network. Most radio clubs maintaining D-STAR servers offer a website where local users can register—the NHARC, for example, is registering Pittsburgh-area hams at [dstar.nharc.org](http://dstar.nharc.org)—though some clubs require hams to join before using their D-STAR repeater. Once the administrator of the local D-STAR "gateway" approves the user's registration, the user's callsign is sent to the other servers on the network.

Besides their own callsigns, D-STAR users who want to use their local repeaters have to program their radios with those callsigns as well. They can also enter the callsigns of distant repeaters that are linked to D-STAR gateways on the Internet, as well as the callsigns of other hams using D-STAR. That additional information allows the D-STAR network to route QSOs to the appropriate locations. The D-STAR network also tracks where each active callsign was last heard.

Want to call your buddy in Baltimore while he's in Baton Rouge? As long as you're both registered, and you've both got your rigs turned on, the network will find him. In addition to calling other D-STAR users directly, hams can also call "CQ" through their local repeaters or through D-STAR-equipped repeaters anywhere in the world.

With a computer connected to the Internet through a D-STAR radio and a D-STAR gateway, users can check email, surf the Web, access their home network, or do almost anything else that requires Internet capability.

That was what first attracted Cutshaw, a computer-networking consultant from the Atlanta suburbs who saw a D-STAR demonstration at Dayton Hamvention in 2004. "Being able to do networking with ham radio was really intriguing," he says. Since then, Cutshaw and members of the Atlanta Radio Club have installed several D-STAR repeaters in the metro area, and he's gone on to write some of the most popular software packages for operators of repeaters used as D-STAR gateways. One of his programs, "dPlus," allows operators to link their repeaters directly to one another over the Internet, create voice mail systems, and record and playback audio over repeaters.

But among D-STAR users, Cutshaw is probably best known for creating the DV-Dongle with Wheatley, an electrical engineer from Duluth, Georgia. The Dongle, which retails for about \$200, allows any Windows or Macintosh personal computer with a USB port to access the D-STAR gateway without a D-STAR-equipped radio.

"We were a little bit worried when we came out with the DV-Dongle," Cutshaw

## RadioActiveRadios

#1 Big Audio Champion Of The World

CB, 10m Radios plus professional repairs and modifications.

Performance Radios

Be sure to check out the SuperWackPack!!

[www.RadioActiveRadios.com](http://www.RadioActiveRadios.com)

520-374-2626 (9-5:30 PST, M-F)

## The Radio Company

THE RADIO COMPANY

- Nascar Scanners
- Accessories
- HH/Base Scanners
- Mobile Satellite TV
- CB Radios
- GPS
- 10m Radios

All The Brands You Want At Low Low Prices.

[www.theradioco.com](http://www.theradioco.com)

866-544-scan (7226)

## CQ 2009/10 calendars

Ham Radio's finest calendar!



## Amateur Radio Operators Calendar

This 15 month calendar (January 2009 through March 2010) includes dates of important Ham Radio events such as major contests and other operating events, meteor showers, phases of the moon, and other astronomical information, plus important and popular holidays.

Fifteen spectacular images of some of the biggest most photogenic shacks, antennas, scenics and personalities. People you work, the shacks you admire, the antenna systems you dream about!

**Order today!**

CQ Communications, Inc.

25 Newbridge Rd,  
Hicksville, NY 11801

800-853-9797

FAX 516-681-2926

[www.cq-amateur-radio.com](http://www.cq-amateur-radio.com)

says. "We thought ICOM wasn't going to like it, because it had the potential of taking away sales of their D-STAR radios. But, in fact, they've embraced it, because now they can point to an alternate manufacturer of gear that does D-STAR." And the DV-Dongle allows amateurs to experiment with D-STAR at a low cost.

Still, the DV-Dongle isn't, strictly speaking, ham radio, and it's also the only commercial D-STAR product available in the U.S. that doesn't come from ICOM.

## Road Blocks And Innovation

Cutshaw and others say the lack of equipment from Kenwood, Yaesu, or other big amateur radio manufacturers is a serious barrier to some hams. "I've been an ICOM user ever since day one," says Hoffman, a licensed amateur since 1982, "and if something came out from ICOM, I'd tend to gravitate toward it. I think people who started out with Kenwood or Yaesu would tend to stick with them, too."

The lack of inexpensive used D-STAR equipment is another obstacle to amateurs who are used to scrounging parts at ham-fests or converting old commercial-band radios for ham use. The NHARC, for instance, operates several amateur repeaters that are converted from old Motorola commercial VHF/UHF radios. Hoffman says they're "almost bulletproof" and can be



Antennas for the North Hills Amateur Radio Club's repeaters, including its D-STAR-equipped 70-cm rig on 444.350 MHz, are located on the tower of Pittsburgh's educational television station, WQED-TV (13). (NHARC photo by Bob Morris, K2RK)

picked up for a few hundred dollars at most. By comparison, a D-STAR repeater requires an ICOM controller that retails for about \$1,400 and an additional ICOM-built RF module for each of four available services: 1.2-GHz voice, 1.2-GHz high-speed data, 440-MHz voice and data, and 144-MHz voice and data. Those modules retail for anywhere from \$1,100 to \$1,600 each.

Of course, the technology is still pretty new, too. There aren't a lot of used 2008 plasma TVs or hybrid cars on the market, either; time will inevitably rectify the lack of good second-hand equipment.

Converting a commercial two-way FM radio, or a conventional amateur repeater from another manufacturer, to D-STAR service is theoretically possible. "That's the holy grail," Cutshaw says. "The problem is that many of the radios out there have filters that block the part of the spectrum that D-STAR would use."

Some amateurs are close to homebrewing their own D-STAR equipment. In April 2007, Wheatley demonstrated his prototype of a homemade D-STAR transceiver that uses a chip from DVSI, but he admitted that he was having trouble getting the RF section to lock onto the signal fast enough to allow the chip to decode the data stream. Earlier this year, Japanese amateur Satoshi Yasuda, 7M3TJZ, unveiled an adapter for ICOM's UT-118 digital unit—the plug-in module that adds D-STAR capability to compatible ICOM radios. Yasuda says his adapter allows any manufacturer's transceiver to work as a D-STAR radio, as long as it can pass 9600 bps of data. With Yasuda's adapter and the UT-118, some rigs that were used for packet radio—and which are now gathering dust—might find a new lease on life.

As Jones points out, "Product support for D-STAR has been slow in coming, but it's getting there." And as more amateurs experiment with the technology, he says, solutions to problems are being resolved in the field "in the true spirit of amateur radio."

## "Perfect Technology To Tinker With"

In the meantime, D-STAR enthusiasts are spreading the word. A DVD of Cutshaw's D-STAR presentation at this year's Dayton Hamvention is available from Amateur Radio Video News ([www.arvidnews.com](http://www.arvidnews.com)). Up in Michigan, Thompson and John Boluyt, N8EOD, of Walker, Michigan, recently conducted a D-STAR forum that attracted about 40 participants, and they gave away a D-STAR handheld as a door prize. Hoffman has already demonstrated D-STAR for members of one Pittsburgh-area radio club, and is preparing to talk to another club soon. "Whether the club puts a repeater on the air or not, I think they ought to learn about it," he says.

Cutshaw agrees that amateurs owe it to themselves to take another look at D-STAR. Contrary to the widespread misconception that D-STAR is only for so-called "appliance operators," he says it's actually a great opportunity for hams bored with conventional two-way VHF and UHF to experiment with new technology.

"It's something new and different and a little bit technical," Cutshaw says. "For people who don't just want to sit and talk on the radio but who want to get in and tinker, this is the perfect technology to tinker with."

I'd like to thank Bob Hoffman, N3CVL, of the North Hills Amateur Radio Club in Pittsburgh ([www.nharc.org](http://www.nharc.org)) for technical assistance, and Ray Novak, N9JA, and Diane Morrison, KE7PCS, of ICOM America ([www.icomamerica.com](http://www.icomamerica.com)) for their assistance with the loan of an ID-800H transceiver for evaluation.—KB3CNM

## Microtelecom's Perseus: The Next Generation Of Software-Defined Radio

by Dan Srebnick, K2DLS  
k2dls@arrl.net

Radios used to be built out of electronic parts. These parts make up the functional building blocks of a receiver. A basic receiver might contain a demodulator, an IF stage, a mixer, an RF amplifier, and an audio amplifier. The performance of receiver designs vary, based upon the individual and combined characteristics of the selected components.

To change the performance of a receiver, we can modify it by substituting a component with one of higher quality or different characteristics. For example, there have been many popular receiver upgrades over the past few years based

upon replacing a stock filter with a better quality filter. One of the most popular filter upgrades of all time was the Kiwa filter upgrade for the RadioShack DX-394 general-coverage receiver. The replacement filter typically has a narrower bandwidth or better adjacent frequency rejection characteristics.

What if we could virtualize the components? The idea would be to put as little as possible of the radio function into hardware. Perhaps only pre-selection and pre-amplification need to be controlled in hardware, and we can transfer the tasks of demodulation, filtration, and amplifica-

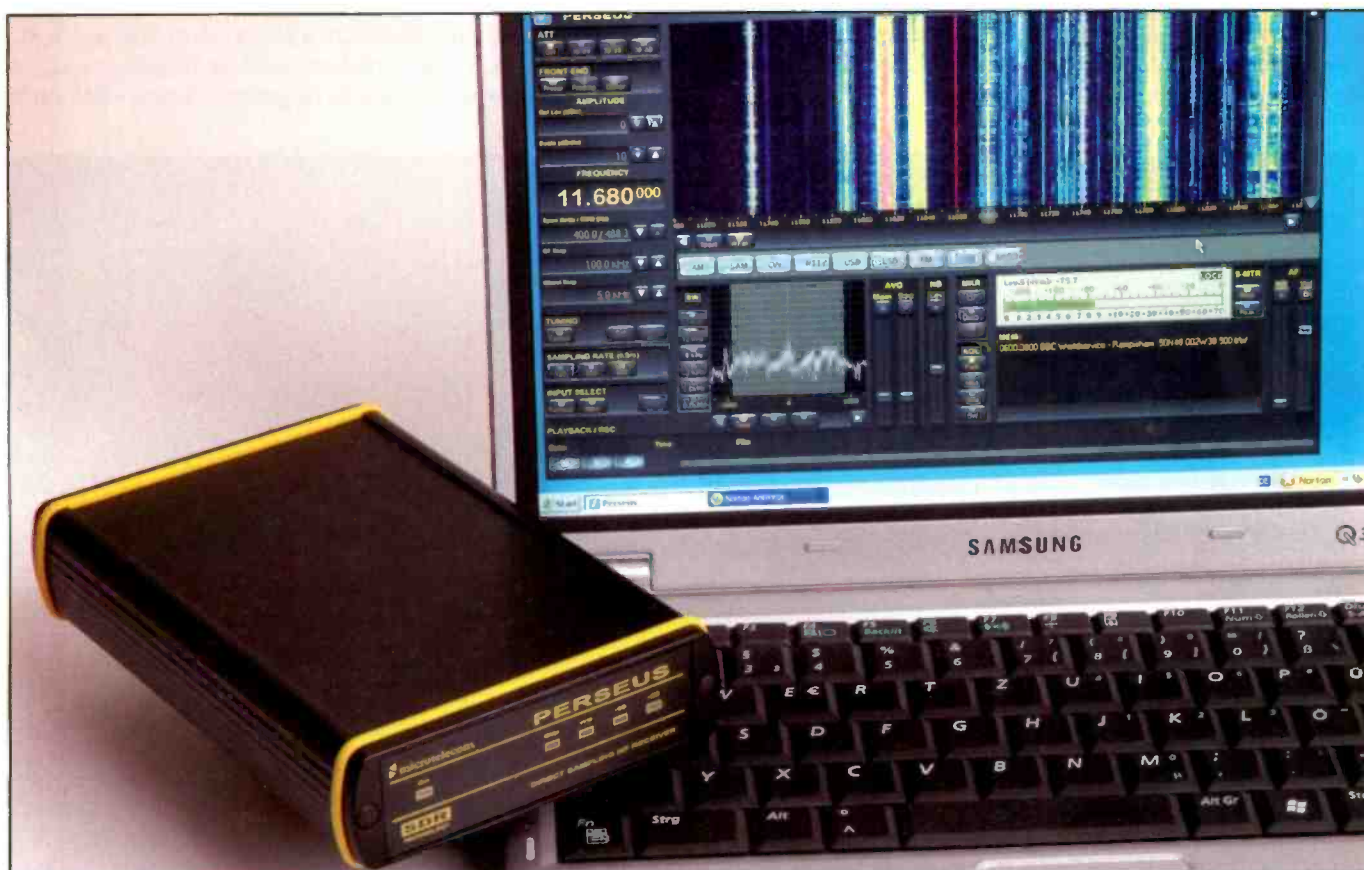

The Perseus software-defined radio supports the display and recording of an 800-kHz chunk of spectrum. A planned update will double this to 1600 kHz.

tion from hardware into software. Wouldn't that open a whole world of new possibilities? The performance of the radio could be completely redesigned through software improvements, as opposed to hardware changes, offering extreme flexibility. For example, new methods of modulation could be decoded by adding code to existing software. An open architecture could enable the use of any third-party decoding program.

This concept is called software-defined radio (SDR). While not new, SDR is moving into its second generation. Italy's Microtelecom, a privately held high-tech company founded in 1998 that develops and manufactures radios and telecommunication devices for special applications, has an impressive entry into the market: the Perseus SDR. The legendary Perseus was a son of Zeus and half brother of the more famous Hercules, and his radio namesake does a rather Herculean job of conquering the spectrum up to 40 MHz. I had a brief opportunity to play with the Perseus in the listening room at the last Winter SWL Festival in Kulpsville, Pennsylvania (see *Pop'Comm* February 2008 for more on this not-to-be-missed annual event), so I was thrilled when Stefan Brockmann of SSB-Electronic GMBH and Gerry Rodski, K3MKZ, at SSB Electronic USA, offered up an evaluation unit.

## Putting It Together

In addition to the Perseus box, which is about the size of a paperback book, a computer is needed to allow the software to run. The sound card in your computer acts as the audio amplifier stage and your headphones or speakers complete the chain. It took me about five minutes to get the radio up and running. I had to install the provided USA electric plug by sliding it onto the provided modular "wall wart" assembly, connect an antenna using the provided BNC to SO-239 adapter, plug the provided USB cable into the Perseus and my computer, and install the software drivers.

My recent vintage laptop runs Vista, and when I plugged in the USB cable Vista noted that an unknown device had been plugged in and offered to install a driver. I received a warning about an unsigned driver, but with full trust in Nico's software (Nico Palermo, IV3NWV, is the brains behind both the hardware and software of this exciting receiver), I installed the driver for the Perseus HF receiver.

The installation process for the software is simple, but it's missing the nice touch of an automated installation package. Instead, I needed to create a subdirectory for Perseus under my Program Files directory. I then copied and pasted the radio software into that folder and manually created a desktop shortcut to the Perseus.exe executable. This process could be improved by using an automated Installshield or Wise installation package. Nico is adding features regularly to the software and the updates are available free of charge via the Perseus website at <http://microtelecom.it/perseus/>. But, again, the entire process still only took me minutes. The excellent user manual came on the installation CD and is also available for download from the Perseus website mentioned above.

The software for this radio requires a minimum of Windows 2000 SP4, and also runs on Windows XP SP2 or Vista. There is no Mac or Linux support at this time and it is not known if any such support is planned. The software was developed using Microsoft Visual Studio C++ and there is a developer's kit based on Visual Studio, so the software appears to be firmly entrenched in the Windows world.

## Up And Running

I started out by tuning in a strong local AM broadcast station, WCBS 880 kHz. There are a few ways to tune in a station with the Perseus. You can "mouse over" the frequency pane and use the mouse wheel to change frequency; double click on the

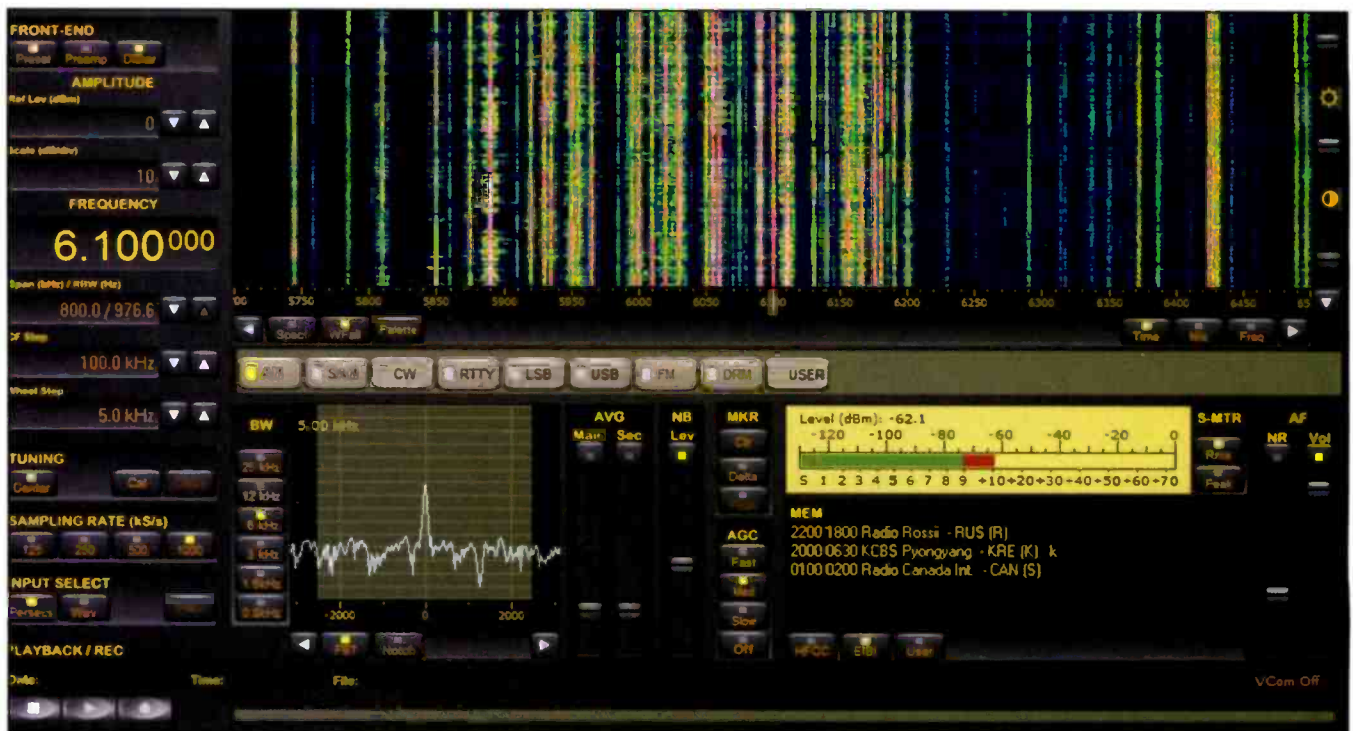

Figure 1. An 800-kHz waterfall display with the Perseus SDR tuned to 6100 kHz @ 2109 UTC. Note the lower spectrum display of the user-tailored bandwidth and the EIBI database displayed in the lower right window (see text).

frequency pane and use the popup direct entry windows; click on the graphical waterfall or spectrum display; and a few others. I found that I would typically use the graphical display to make short frequency hops, use the mouse scroll feature for slightly greater frequency differences, and use the popup direct entry method for greater frequency hops.

While these are all satisfactory, I mentioned to Gerry of SSB Electronic USA that the ability to just directly enter a frequency on a numeric keypad and press enter would also be desirable. Gerry said that this is an often-requested feature and he wouldn't be surprised if Nico adds it to a later version of the software. Another nice enhancement would be the ability to hit the up or down arrows on the keyboard to change frequency.

Initially I used the radio's waterfall display (Figure 1). It felt comfortable, based upon my experience using PSK31 and RTTY on the ham bands. But once I switched over to the spectrum graph, I never went back. Imagine being able to look at a chunk of spectrum and see where the signals are (more on this below). This was quite revealing. I could see, once and for all, that IBOC (In-Band On-Channel) digital signals on mediumwave are spectrum hogs. Take a look at Figure 2, which shows the wide bandwidth of the WABC signal transmitted on 770 kHz. The signal appears to be 30 kHz wide! Another interesting signal to watch was the 60-meter "pinger" as it swept downward through the band.

My testing was conducted during July and August, the peak of the thunderstorm season in the northeast United States. The noise reduction "circuit" in the software was effective at removing much thunderstorm static. My location also suffers from

occasional local electrical interference, and the noise blanker was effective in eliminating this nuisance as well.

The passband tuning and notch filtering is controlled from within the small graphical window at the bottom of the screen, between the bandwidth (BW) and averaging (AVG) controls. Imagine if you could shape your filtering or notching any way you want to eliminate or sidestep interfering signals. Stop imagining, because now you can. It's all under your control. This is an outstanding feature of this receiver.

## Wideband Recording

Never again will devoted listeners miss an evening of exciting DX because something took them away from their shacks. Maybe you can't be awake to tune through the AM broadcast band on Monday morning during the transmitter maintenance window for many stations, but what if you could record the entire AM broadcast band for later playback? Today, the Perseus supports the display and recording of an 800-kHz chunk of spectrum, and a planned update targeted for fall 2008 will double this to 1600 kHz.

This type of spectrum recording demands a lot of processing power. I'm using a 1.6-GHz dual core laptop, and spectrum recording at the 1-Mbps rate led to jitter. That is to be expected as Perseus' manual states that for full performance, the software requires a 2.5-GHz dual core processor. I could, however, sample reliably at 500 kbps, which allows for spectrum recording at 400 kHz. To playback, you select the file to play using the controls on the lower left of the software display, then use the spec-



Figure 2. Here you can clearly see the 30-kHz digital IBOC sidebands of WABC 770 kHz in New York. BCB DXers have been complaining about the QRM of the IBOC sidebands for some time now. The Perseus spectrum display is set to 100 kHz in this instance.

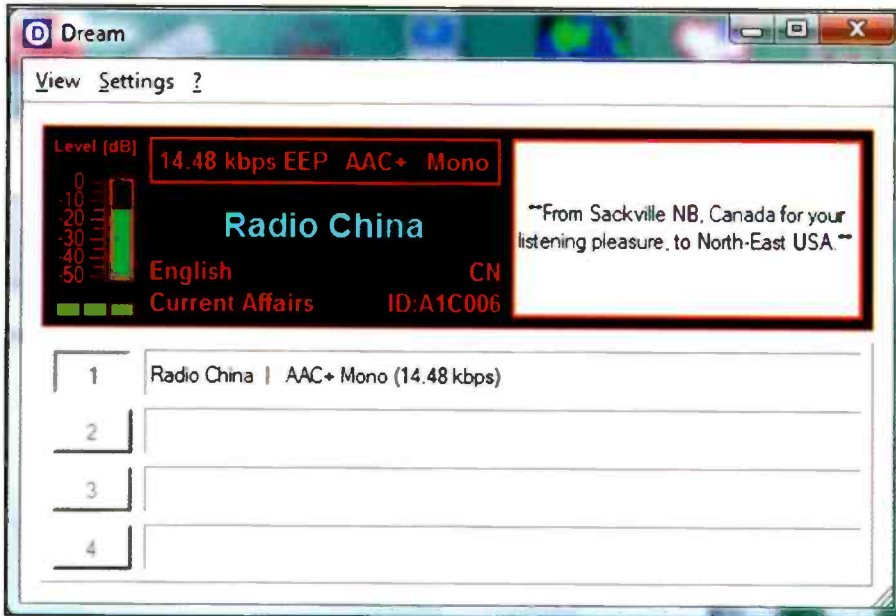

Figure 3. Dream DRM software decoding a DRM transmission from China Radio International via Sackville.

trum graph or waterfall to select, in real time, what you want to hear. This is nothing short of amazing and must be experienced personally to fully understand what a revolution in radio technology the Perseus represents.

## Extensibility

It readily occurred to me that if I could pipe the output of my computer sound card into a different program, I could decode modes that are not directly embedded into the Perseus software. I had visions of DRM, PSK31, SSTV, and RTTY dancing in my head. Thanks to an innovative piece of software called Virtual Audio Cable (<http://software.muzychenko.net/eng/vac.html>), those visions proved not to be hallucinations as VAC provides a way to patch the audio output of one program in to the audio input of another (I'll talk more about VAC in an upcoming "RF Bits" column).

## Life Is But A Dream

My first extensibility mission was to finally hear a shortwave Digital Radio Mondiale broadcast in my own shack. I'd heard some of the DRM tests broadcast during my last pilgrimage to the Winter SWL Festival and had thought about the 12-kHz IF mod to my Kenwood TS-2000, but liked this possibility better. Research showed that the way to decode a DRM broadcast is to take the digital signal from the 12-kHz IF out and plug it into the input

of a sound card on a computer running appropriate software. I noted that the Perseus had a DRM mode, so I configured VAC to take the Perseus output and run a virtual cable between it and the Dream DRM software (<http://drm.sourceforge.net/>). The Dream DRM software provides the digital decoding that pipes a clear digital audio signal from the radio to your computer's soundcard.

Figure 4. This shows the CPU utilization of my laptop while decoding DRM broadcasts from TDRadio.

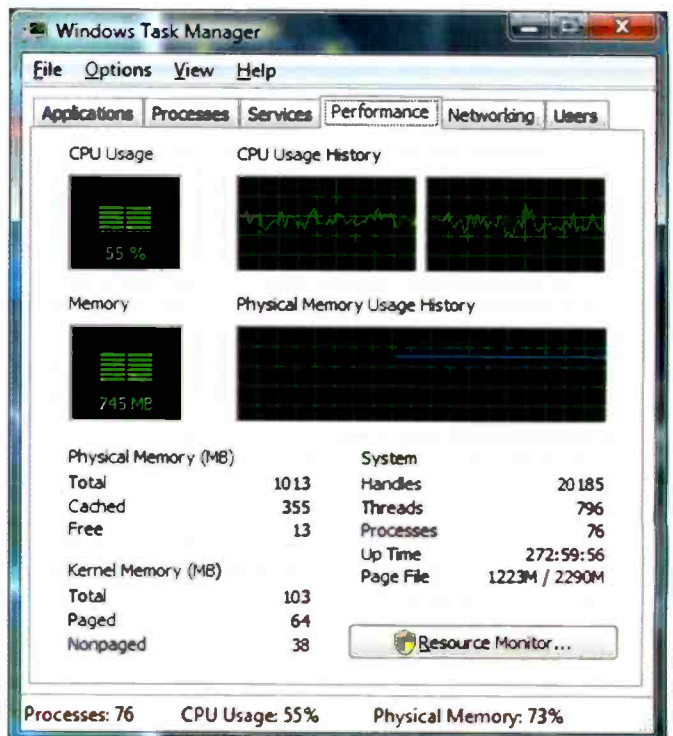

The results were spectacular for an HF broadcast, and while I can't share the audio with you, **Figure 3** shows the Dream screen from a listening session of China Radio International via Sackville, Canada. I listened to other DRM digital HR programming, including dance music at 20.96 kbps from TDRadio, and it sounded great in headphones. I am now a believer in at least the potential of DRM.

I noticed a few dropouts, but I believe that had more to do with my PC than with the Perseus or the DRM transmission. At idle, my CPU utilization runs at about 5 percent. When decoding DRM, average CPU was up around 55 percent (see **Figure 4**).

## Longwave Makes All The Differential

I've always been fascinated by the spectrum below 500 kHz. It's where radio started, and while there are some broadcast stations in Europe, Asia, and Africa on longwave, in the rest of the world it's home to strange signals and sounds. Here, too, the Perseus is up to the task. On June 30, I received Europe No. 1 on 183 kHz from Germany at a signal level of S4.5. This was topped by Radio Monte Carlo on 216 kHz coming through at S6 on July 1. The noise blanker and synchronous detector really helped in each case. Such feats of summer reception are outstanding by any definition. I look forward to

this winter when I plan to use the graphical spectrum display to “see” where the carriers of the 9-kHz offset European mediumwave stations are visible in between the 10-kHz separated North American stations.

I spent one winter on longwave learning CW while listening to the low-frequency aeronautical beacons that fill the band. I also noticed some very strong digital signals and soon learned that they are differential global positioning system (DGPS) beacons. Using the Perseus, VAC, and a program called DSC Decoder (www.coaa.co.uk/dscdecoder.htm), I was able to decode the identity of some of these strong beacons; the results are shown in Figure 5.

## Perseus Vs. The Drake

While the Perseus in my shack sits atop the Kenwood TS-2000, it is side by side with the Drake R8B. The Drake is a very capable receiver, but with its DSP noise reduction and configurable filters, there were times that the Perseus exceeded the R8B’s ability to make a signal intelligible. This was the case one Sunday evening when I was trying to pull a pirate on 1710 kHz out of the mud. The brother of Hercules won this battle, while the venerable Drake waddled away in defeat.

## The Final Analysis

This is a full-featured radio. It is very sensitive—it is as selective as you want it to be. Conversely, where signals are of sufficient fidelity, the selectivity can be broadened to enjoy enhanced frequency response. With its extensibility model, it will decode any mode for which a software program with sound card input exists. The flexibility of the configurable filters will help you evade the worst QRM (interference, that is), and the noise blanker and noise reduction features work. The integrated EIBI and HFCC databases (if you’re unfamiliar with these, see www.eibi.de.vu and www.hfcc.org) advise you of what you may be receiving on the shortwave broadcast bands. Perseus has earned a valued place in my shack and gets two thumbs up from me. Microtelecom has put together a fine entry in the SDR marketplace.

Perseus retails for \$1,299 and is distributed in the USA by SSB Electronic USA (Web: www.ssbusa.com; Telephone: 570-868-5643). It is also available through radio dealers such as Universal Radio. ■

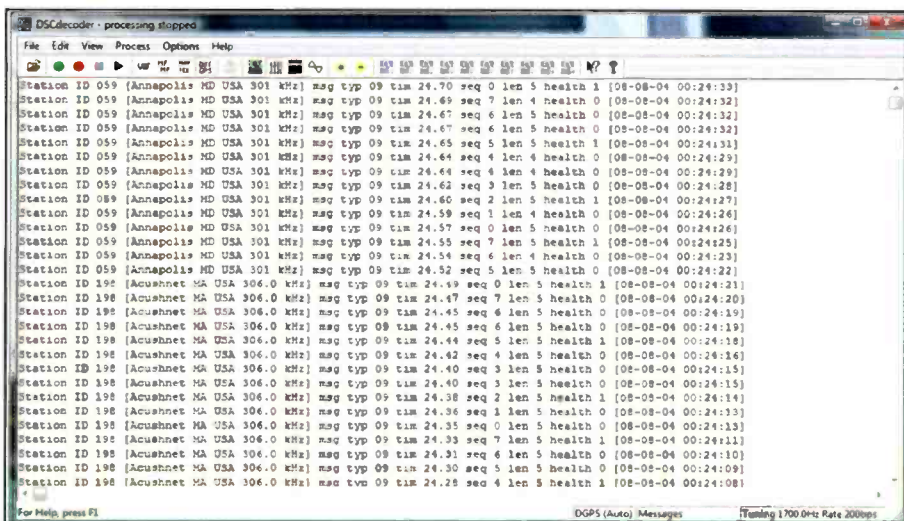

Figure 5. DSC Decoder provides the ability to decode DGPS station identifiers (see text). Here we’re receiving beacons from MA and MD in NJ.

**ADVANCED SPECIALTIES INC.**  
 Orders/Quotes 1-800-926-9HAM  
[www.advancedspecialties.net](http://www.advancedspecialties.net)

**BIG ONLINE CATALOG**

BCD996T  
 6000 Channel Digital Trunking Scanner

UNIDEN BEARCAT & GRE DIGITAL SCANNERS  
 • CB • AMATEUR • RADIOS & ACCESSORIES

ALINCO • YAESU • GALAXY  
 • GRECOM • COBRA

(201)-VHF-2067  
 114 Essex Street, Lodi, NJ 07644  
 Closed Sunday & Monday

**FREE SAMPLE COPY!**

**ANTIQUE RADIO CLASSIFIED**  
*Antique Radio's Largest-Circulation Monthly Magazine*

Articles - Classifieds - Ads for Parts & Services  
 Also: Early TV, Ham Equip., Books, Telegraph, 40's & 50's Radios & more...  
 Free 20-word ad each month. Don't miss out!

1-Year: \$45 (\$60 by 1st Class)  
 6-Month Trial - \$24. Foreign - Write.

A.R.C., P.O. Box 802-T15, Carlisle, MA 01741  
 Toll free: (866) 371-0512; Fax: (978) 371-7129  
[www.antiqueradio.com](http://www.antiqueradio.com)

## Tigertronics Signalink USB



**Built-in Sound Card!**

**Only \$99.95** + Shipping  
 Model SL-1+ still just \$69.95

[www.tigertronics.com](http://www.tigertronics.com)

Once again Tigertronics sets the pace in digital operating! The Signalink™ USB combines the legendary performance of our SL-1+ with a state of the art “built-in” USB Sound Card. This ground breaking innovation delivers top notch performance while eliminating the need to attach to your existing sound card. Front panel controls and simplified installation make this the ultimate interface! The Signalink™ USB supports *all* sound card digital and voice modes and works with *all* radios. It is fully assembled and comes complete with printed manual, software, and all cables. Visit our website for the exciting details!



**Order Toll Free!**  
**800-822-9722**  
 541-474-6700

Tigertronics 154 Hillview Drive Grants Pass, Oregon 97527

# Up Close: The ICOM IC-R2500 Communications Receiver

by Ken Reiss  
radioken@earthlink.net

*“Both the PCR2500 and R2500 versions are full-blown communications receivers in a small box. Actually, they both offer two receivers in one...”*

**I**COM introduced its first black box receiver some time ago with the IC-PCR1000, the first full-featured receiver built from the ground up as a computer-controlled device. This proved to be a popular receiver, despite the absolute need for a computer to control the unit. The PCR1000 required a 9-pin serial port, something that has unfortunately all but disappeared from the computer world, and I know many PCR1000 and Optoscan fans who still maintain older computer systems just as dedicated scanner control computers for that reason. Many third-party applications were written to take advantage of the unique features the PCR1000 offered, and it appears that its successors, the IC-R1500 and IC-R2500, will also have a wealth of software at their disposal. This month, we start an in-depth look at those latter receivers. We'll concentrate on the IC-R2500, but most of the information applies to the IC-R1500 as well.

The versatile IC-R2500 communications receiver would be a welcome addition to any shack, but has a few surprises up its sleeve to make

it even more attractive. Part of a growing family of computer-controlled receivers, two versions are offered of both models: the PCR1500 and PCR2500 are the computer-controlled-only variations; the R1500 and R2500 are the same receiver, but with the addition of a control head and a few other accessories in the package to make the system truly unique. The control head allows for remote operation of the unit, although not all functions are available. It would be an excellent system for a mobile application.

The real meat of the systems, however, is in the main unit. Both the PCR2500 and R2500 versions are full-blown communications receivers in a small box. Actually, they both offer two receivers in one—the main difference from its smaller cousin, the 1500, which does not have the sub receiver capability (see below).

The R2500 (we'll stick with that nomenclature for the sake of ease) is quite a step up from the PCR1000, with a price tag to match. List price is just over \$1,000, but the street price appears to be closer to \$899. What you get for your money, how-

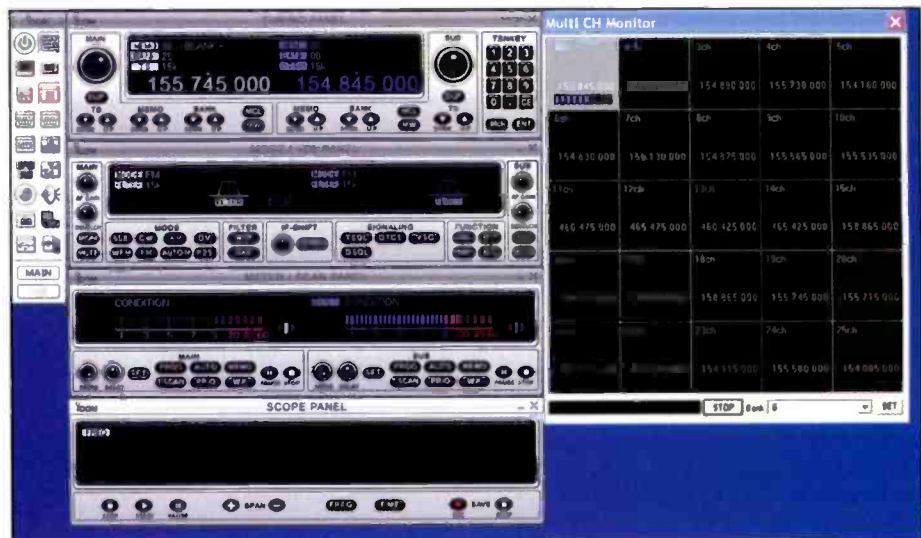

Photo A. The Multi Channel monitor allows for monitoring of 25 channels for activity. When a signal is detected, the color (shown on Channel 1) indicates the relative strength of the signal. Descriptions and other information can also be entered if known.



# HEAR. THERE. EVERYWHERE.

## RX-320D

**LISTEN TO THE WORLD ON YOUR PC! NOW USB READY!**

General coverage from 100 kHz – 30 MHz. "Black box" receiver connects to your PC via serial port or USB connector. Your PC provides the operation horsepower. A 12 kHz I-F output is included for decoding DRM transmissions with your PC sound card (user supplies decoding software). Download the actual operating software from our website for a pre-purchase test drive. **\$369**

## RX-340

**USED BY GOVERNMENTS WORLDWIDE!**

HF SWL receiver, 5 kHz – 30 MHz. IF stage DSP. Sync AM/selectable sideband, SAM, AM, SSB, ISB, CW, FM. Over 90 bandwidth filters, programmable AGC, built-in high stability TCVCXO. Completely remote controllable via RS-232 interface. DRM ready, no modification needed (user supplies decoding software). 90-264 VAC operation. **\$4,250**

## 1254

**KIT BUILDING IS A WORLD OF FUN!**

Build your own HF SWL receiver with our model 1254 shortwave receiver kit. 500 kHz – 30 MHz coverage in 2.5 kHz steps with clarifier control allowing tuning of all frequencies. LED digital readout. AM, SSB, CW capable. Complete step-by-step instructions and all components included. See our website for information on other available kits! **\$195**

1185 Dolly Parton Pkwy., Sevierville, TN 37862 **800-833-7373** [www.tentec.com](http://www.tentec.com)

Mon-Fri 8:00-5:30 EST We accept Visa, MC, American Express, and Discover Office: (865) 453-7172 Service: (865) 428-0364



RX-320D



RX-340



1254



ever, represents a substantial upgrade from that original computer-controlled receiver.

The R2500 is truly groundbreaking and unique for a consumer receiver in a couple of ways. First, we have those two receivers we mentioned. These are referred to as main and sub, and each has an antenna jack. The sub receiver does not have quite the frequency range of the main receiver, unfortunately, as diversity reception would be quite useful on HF as well (more about that shortly). The sub receiver coverage runs from 50 to 1300 MHz (less the cellular frequencies in the United States); the main receiver can receive from 10 kHz all the way to over 3000 MHz.

Both the main and sub receivers are triple conversion and capable of all-mode reception, including AM, FM Wide, FM Narrow, SSB, and CW (SSB and CW from 0.5 to 1300 MHz only. Even at the \$1000 price point, dual computer-controlled triple conversion receivers represent quite a bargain, but there's more. Continuous tone code squelch system (CTCSS) and digital coded squelch (DCS) are both supported and easy to use in the VHF/UHF portion, which is where it's appropriate. With an optional board,

APCO-25 can also be decoded as well as the amateur radio D-STAR, with different options (for more on D-STAR, see "D-STAR's All-digital Voice And Data Rigs Push Technology Forward" elsewhere in this issue).

With the included software, 26 banks of 100 channels each are active at any one time, but it's a simple matter to save and load memory sets to disk for a virtually unlimited memory capability. While used with the control head, memory is limited to 1,000 channels with an additional 100 channels for scan edges. The memory channels of the control head can be loaded with the cloning mode of the software, making that a painless operation.

## Dual Watch

One of the options that dual receivers offer is the ability to listen to two frequencies at a time, one on the main unit and one on the sub unit. Hams and commercial receivers have had this feature for years, and many dedicated hobbyists have simply used two or more receivers to accomplish this. Of course, in the scanner world, this became tremendously popular with the advent of trunked systems. Unfortunately, the R2500 does not

have trunking capability out of the box, but it would seem ideal for some enterprising software developer to add that capability. The R2500 does, however, have dual-watch capability, so monitor-

## Frequency Coverage Of The IC-R2500

The IC-R2500 is a full-spectrum receiver with coverage from 10 kHz to 3000 MHz (with a few gaps, depending on national market version). This is what you get:

### US Version, Main Receiver

.010-809.999  
851.000-866.999  
896.000-1810.999  
1852.000-1867.999  
1897.000-2035.899  
2354.000-2811.999  
2853.000-2868.999  
2898.000-3109.799  
3136.000-3154.799  
3181.000-3299.999

Sub receiver covers 50 MHz to 1300 MHz, with the same gaps as above.

ing one HF channel on the main band while keeping an ear on a VHF channel on the sub band is quite easy.

## Diversity Reception

Another very cool feature that has only been found on high-end military receivers up until now is *diversity reception*. Diversity reception refers to using two receivers on the same frequency but with different antennas (in military applications, they quite often use *very* different antennas, even miles apart). The receiver then automatically selects the receiver with the strongest signal. This only operates on the VHF/UHF portion of the bands that is covered by the sub receiver, but it can be an extremely fun feature to play with. Under certain conditions, it might make the difference between getting an ID and losing it in the noise.

## Options

The R2500 can have three optional boards installed. The first is a UT-106 digital signal processing (DSP) board. This unit, like many of the ICOM DSP units for previous receivers, operates in the audio section of the receiver. It does provide some very useful features for HF listening fans, such as automatic notch filtering and noise reduction, though VHF/UHF listeners will probably not get much use out of this accessory.

More interesting for VHF/UHF users are the other optional units. One is the UT-108 DTMF decoder, which will read touch-tones and optionally activate the squelch control. This would be useful for some remote control operations, or as part of a repeater, but probably not worthwhile for the more casual listener. Another unit that can go in that same slot (you can only have one) is the UT-118 D-STAR voice reception board. This board provides for both digital decoding of the voice signal and callsign squelch capability, so that you only receive calls from those you're interested in.

A third option is the UT-122 for decoding the APCO-25 digital signals in use by many public safety agencies (seemingly more by the day). As mentioned, this does not include automatic trunked system following, but many more pure digital/non-trunked signals are expected to show up in the next few years as the transition to narrow band digital modulation begins to catch on. Of course, with software, the unit could also follow a digital trunking system, at least in theory.

## Bandscope

Of course, it wouldn't be a computer-controlled receiver without the almost obligatory bandscope function. While very useful in some cases, the R2500 adds a new twist. You can run the standard frequency bandscope so that you can see activity up and down the band from the active frequency, or you can watch one frequency for activity for up to 100 minutes. This visual history of how busy the channel is might prove interesting for search activities and may be useful for HF utility listeners as well. You also have the ability to record a data file that can be analyzed later, and if desired the actual audio can be recorded to disk as well.

## Multi Channel Display

Another interesting feature of the R2500's is found in the Multi Channel Monitor screen (**Photo A**). Up to 25 memory channels can be programmed for scanning in the Multi Channel Scan screen. Once started, the channels display in a



Photo B. The included software from ICOM gives you a choice of three main receiver presentations. This simple screen is perfect for basic operations and casual listening while using the computer for other tasks.



Photo C. For a more full-featured operation, the receiver screen looks and feels like a dual VFO communications receiver. A bandscan function is also available at the bottom of the display.

window while the main receiver is used to scan. When activity is found, the Multi Channel Display lights up with a color indicating the relative signal strength of the received signal. Clicking on the box in the Multi Channel Display will lock the receiver on to that frequency. The sub receiver can also be used while this is running for listening to another frequency or checking the activity in more detail. This is a very neat feature for searching out new frequencies.

## Connections And Controls

More good news is that the R1500 and the R2500 both use the USB port for computer control. After a simple install (despite rather daunting instructions in the manual about drivers) I was ready to plug the receiver in and have it up and running. The setup program on the included ICOM software CD was all that was necessary on my Windows XP system. There



Photo D. The compo (short for component) view provides the most detailed controls. The scope shown in this picture is in the unique "Time" mode, providing an historical view of activity for up to 100 minutes.

are instructions provided for Windows 98, 2000 and ME, although the instructions say that for XP and 2000 you only need to install the driver if multiple units will be connected to the computer (now there's an interesting thought...).

Once the driver is dispensed with, the main application can be started—and that's where the fun begins! The software from ICOM features several control screen modes, depending on your preference. Some include more features than others, but all are functional for some purpose or another.

The receiver screen (Photo B) puts a single communications receiver panel on your screen with most of the functions you'd expect to find on a good communications receiver. The software uses left

and right clicks to adjust rotary knobs for volume and squelch (not bad, but not as intuitive as they might be) and clicks for everything else. Clicking on either the main or sub buttons at the bottom of the panel, or just clicking on the frequency of the main or sub receiver, will switch modes quickly.

The compo (short for component) screen (Photo C) looks like a stack of stereo components with each section controlling a piece of the receiver (PCR1000 users will recognize this screen). There are probably more features available on this screen than on any other, since multiple windows are available to present various pieces of information. The components include the Tuning Panel, Mode/Vol panel, Meter/Scan Panel and Scope (band

scope) panel. Each can be turned on or off depending on what you're using at the time.

Last, but not least, is the simple screen (Photo D), which provides just what it says it does: the basic controls for a simple receiver to use for listening when the serious tools and controls are not necessary. Switching between the screens is (you guessed it) very simple, so I found myself using the simple screen as kind of a default mode while I was using the computer for other things, and then I'd switch back to the more complex screens when necessary. You'll find some approach that works for you, too.

## Truth Is Beauty

The R-2500 is a true communications receiver built to ICOM's long history of high standards. Because the receiver is dependent on computer control, a simple change in software in the future will allow it to do things that haven't even been thought of at this stage.

Next month, we'll take closer look at the included software and the multitude of functions offered as well as the performance of the receiver itself. Until then, Good Listening!

## Frequency Of The Month

Each month we ask our readers to let us know what they're hearing on our "Frequency Of The Month." Give it a listen and report your findings to me here at "ScanTech." We'll pick a name at random from the entries we receive and give that lucky winner a free one-year subscription, or extension, to Pop'Comm.

Our frequency this month will be **154.115**. Have a listen and see what you hear. Send the results to me (even if you don't hear anything) and we'll enter your name in the drawing for a subscription to *Popular Communications*. Please include your address and make sure to put the frequency as the subject of your email or on the outside of the envelope for correct routing. Send your entry (or other questions) to radioken@earthlink.net or via more traditional methods to Ken Reiss, 9051 Watson Rd. #309, St. Louis, MO 63126.

Our most recent winner is **Bruce Boehrs of Blaine, Minnesota**, who writes,

Just a quick note to let you know that I receive a hit every morning and evening commuting to and from work on 457.9375 MHz as I pass near a large railroad switchyard on the west side of St. Paul, Minnesota. Sure enough, I can hear data sounds coming through the static on my GRE America PSR-500 scanner. There's quite a lot of rail traffic through this part of the Twin Cities, as evidenced by sitting in the stands at Midway Stadium (without my scanner) last night watching the St. Paul Saints play minor league baseball.

The stadium sits on the north side of the street with east-west rail lines passing just to the north of the stadium and to the south of the street. It's such a part of the game at Midway that the announcer makes a joke of it by announcing "train" in a deadpan delivery every time one passes.

Thanks for the submission and congratulations, Bruce. Come on, let's hear from everyone (and don't forget that address!).

## 2009/10 Calendar & Subscription Special!

**Buy both and you'll save up to 62% on your subscription and**



**get FREE shipping on your calendar!**

Use the card bound-in here to take advantage of this special offer!

Insert your order information, fax or mail the card in the postage-paid envelope bound in to the back of this issue - as page 51.

## Popular Communications

25 Newbridge Rd., Hicksville, NY 11801  
1-800-853-9797 FAX 516-681-2926

## What's New In Aviation Communications?

by Tom Swisher, WA8PYR  
airscan65@gmail.com

*"[ADS-B] is a great advance for aviation safety as it will not only allow aircraft to see other aircraft in their immediate area, but will also allow controllers to better use the airspace in their area..."*

There's a new hobby afoot in Europe, and it may just be showing up over here next: monitoring Automatic Dependent Surveillance-Broadcast (ADS-B). This is a new aircraft control technology being used in Europe, and to a limited extent in the United States, that allows better tracking of aircraft for safety reasons.

ADS-B is pretty simple when it comes right down to it. Aircraft, vehicles, buildings, and other objects broadcast a periodic message giving their identification, a latitude/longitude position report, altitude, speed and any other necessary information. Other aircraft and ground stations can then receive these transmissions to provide cockpit or ground station display of surrounding traffic and other critical information.

While effective, radar is based on a signal being sent out, bouncing off the aircraft and returning to the radar station. Position is determined by the direction the antenna is pointing,

while the time lag between the radar signal being sent out and then a reflection received gives the range. To get velocity information, the radar tracks the object over a period of time and gives an approximate speed.

This works reasonably well, but the problem with radar is that as the signal moves farther from the transmitter, the beam widens, making the returned signal less precise. Adding ADS-B makes the system quite a bit more accurate than standard radar, as it relies on the navigation system of the aircraft (typically GPS these days) for accurate position reports rather than the returned radar reflection.

This is a great advance for aviation safety as it will not only allow aircraft to see other aircraft in their immediate area, but will also allow controllers to better use the airspace in their area; by making highly accurate position reports available, aircraft can be spaced more closely with a



The cockpit of a Boeing 777. The integrated displays use information from various sources, such as ADS-B, to provide situational awareness for the pilots. (Photo courtesy of AviationEarth)

high degree of safety and reliability, as well as allowing flight under conditions where it might not otherwise be feasible or safe.

ADS-B works over a variety of transmission systems, including 1090 MHz Mode-S and VHF data links. Some of the necessary equipment in some cases may already be in place in aircraft, such as cockpit displays. In addition to position reports of surrounding traffic, these displays can also show ground features, weather, obstructions such as antenna towers or buildings, airport maps, and other useful information. It can also be used on the ground for ground control radar, providing better collision avoidance and runway incursion protection, as well as controlling runway lighting, better and more accurate distress signals for search-and-rescue events, and much better control of general aviation aircraft. Since GA aircraft often don't provide position reports when flying under visual flight rules, an automatic position report will make airspace safer by showing the positions of these aircraft.

### ADS-B Heads West

Implementation of ADS-B in the United States is scheduled for an eight-year timeline starting in 2006. Between 2006 and 2009, aircraft and obstacles can be equipped voluntarily; starting in 2010, installation of ADS-B ground stations will occur throughout the United States, with completion and full use expected by 2014. Some stations are already in service, including several in the Gulf of Mexico, where the FAA has been installing ADS-B ground stations on oil and gas platforms to enhance the incomplete radar coverage of the area. The information from these stations is sent back to Houston ARTCC to allow coverage that did not exist before.

Other users in the United States include cargo carriers, which can use ADS-B to better manage their traffic flow; the University of North Dakota, which is testing ADS-B on its fleet of aircraft; and Embry-Riddle Aeronautical University, which is using ADS-B on its training aircraft for better safety.

### Hearing It Here

So how do you monitor ADS-B? Well, at the moment there aren't too many ADS-B users in the United States, but since it has been mandated in Europe since 2005 (we won't get into the United States being behind the curve...again), you just might

be able to snag messages from aircraft of European carriers. Monitor 1090 MHz to see if you catch anything.

As far as a home-based display similar to that offered by ACARS-D and other similar software, there isn't much out there. Companies like Javiation, AirNav Systems, and others offer software that will do the trick, but it's quite expensive and out of reach of most hobbyists. However, like the development of freely available ACARS-monitoring software, it's only a matter of time before someone develops hobbyist-level software that will give you your own little

radar screen, right on your laptop. In the meantime, stay tuned to ACARS for your local position report.

### The Shortwaves Fly

Remember, don't discount HF (high frequency, or shortwave) voice monitoring. There's plenty out there to hear, especially on the overseas routes monitored by ARINC, which provides coverage over ocean areas where there is no radar. All you need is a fairly simple shortwave receiver and a piece of wire hung in a tree, and you can pick up all kinds of aviation

**For 45 years  
our volunteers have  
endured long hours  
and tough  
working conditions  
for no pay.**



**And 9 out of 10  
would do it again.**

**TO FIND OUT WHY  
contact**

**REACT International, Inc.**

**(301) 316-2900 • (866) REACT-9-9**

**5210 Auth Rd., Ste. 403, Suitland, MD 20746**

**REACT.HQ@REACTintl.org**

**www.REACTintl.org**



While over 10 years old, this Sangean ATS-803A receiver is quite capable of receiving shortwave aviation transmissions.

traffic. You may not even need the wire in the tree, as the telescoping antenna included with a portable receiver is often good enough to receive lots of transmissions.

If you're looking to get started in shortwave monitoring, you'll be happy to know that there are plenty of good, relatively inexpensive receivers available out there, both portable and desktop. Just make sure whatever you buy is capable of single-sideband reception, or at least includes a BFO (beat frequency

oscillator). A good portable is an excellent place to get started, with new models available from Grundig, Kaito, and Sangean. Good used models are also available, including the Sangean ATS-803A and Grundig YB-400. Both the Sangean and Grundig are excellent choices for a used receiver and offer extensive AM, FM, and shortwave coverage, and feature a BFO to allow reception of single-sideband (upper and lower) signals.

Thanks to Doug Bell in Canada, we've got a few loggings for you to start with; all are upper sideband and the frequency is given in kilohertz (to convert to megahertz, divide by 1000):

**05547:** KAL 062 wkg San Francisco with position report.

**05549:** AUSTRIAN 66 wkg Gander radio with position report.

**05598:** SPEEDBIRD 247 wkg Santa Maria with position report, given frequency handoff.

**08825:** ALITALIA 687 wkg NY Radio with position report and altitude change request.

**08864:** AEROFLOT 335 wkg Gander radio with position report and SELCAL check.

**08891:** Icelandic Radio wkg CONTINENTAL 83 (B777/Delhi>Newark) with ATC altitude change.

**08933:** DELTA 124 wkg NY LDOC with preflight SELCAL check.

**11330:** CUBANA 401 wkg NY Radio with SELCAL check.

**11330:** AIR CANADA 960 wkg NY radio with position report.

That's it for this time. Send in your loggings, information about your local airport, or ideas for things you would like to see in this column. ■

## Airport Spotlight

Our featured airport for this issue is Mobile Downtown Airport in Mobile, Alabama. Also known as the Brookley Field or the Brookley Complex, Mobile Downtown is a huge installation with rail access, a deep-water port on Mobile Bay, and direct access to Interstate 10, in addition to the airfield itself. The facility also hosts a large complement of aerospace industries employing thousands of area residents.

The facility got its start as Bates Field, the city's first municipal airport. The facility was taken over by the U.S. Army in 1938 and renamed Brookley Army Air Field; the rail and port access made the facility particularly attractive from a logistics standpoint. Brookley was a major supply base during World War II, generating over 15,000 jobs, and after the formation of the Air Force continued its role as a major repair and supply facility. The base began to be downgraded in 1964 and was finally closed in 1969, after which it was returned to the City of Mobile and renamed Mobile Downtown Airport.

Today, Mobile Downtown is considered a feeder (or "reliever") airport and sees over 85,000 aircraft operations per year, including general aviation, military, and commercial. Here are the frequencies for your listening enjoyment:

Tower/CTAF:	118.8/251.1
Ground:	121.7/239.3
Approach/Departure:	118.5
Unicom:	122.95
ATIS:	135.575
National Guard:	125.525, 49.85

An aerial view of the Brookley Field complex. Running from upper right to center left are I-10 and the CSX railroad tracks, and on the right side, the waters of Mobile Bay. (Photo courtesy of US Geological Survey)



# CB Antenna Basics, And Revisiting HDTV Antennas

by Kent Britain, WA5VJB  
wa5vjb@cq-amateur-radio.com

**M**odulation and antennas certainly have some of the more interesting CB Urban Myths attached to them. For instance, you've no doubt heard something like "more talk power makes a mobile get out like a base station"... "cleans up your modulation," etc. Yes, there are many interesting claims about antennas floating around, so let's go over what's really happening.

## Antenna Length

A bigger engine generally goes faster and has more horsepower (we'll skip over turbo charg-

ing and nitro methane for now), and a longer antenna generally works better than a shorter antenna. Despite the advertising claims, 99 percent of the time a four-foot-long antenna works better than a three-foot-long antenna. In short, you want the longest antenna that will easily fit into your garage or carport. For those of you who park outside, your limit becomes the annoying noises the antenna makes when it scrapes the underside of an overpass or the "kabong" noises as you go under trees.

## Antenna Placement

For mobile use, an ideal CB antenna would be a quarterwave whip in the middle of your vehicle's roof (see **Photo**). The pattern is very even in all directions with less than 1 dB of variation (**Figure 1**).

You also have the option of the typical trunk lid mount, with the antenna in the gap between the trunk lid and the back window. On the 11-meter band the radio waves are over 33 feet long, so the roof of the car really doesn't block very much of the wave; in fact, the strongest signal is off the front to the car (**Figure 2**)—a good pattern for talking in the direction of where you're going versus where you've been. A 102-inch whip, a base load, or a center load antenna would all have pretty much the same pattern.

In **Figure 3** we have the pattern for the 102-inch whip, or a pretty long fiberglass whip, mounted on the back bumper. In this setup the antennas are usually mounted off to the side and you can still get in and out of the trunk. The pattern is pretty lumpy, but again you see the strongest signal in the direction of the most metal, which will generally be the case.

These patterns will hold for most cars and midsize pickup trucks. You'll get good patterns for your F150-type pickup, but that extended cab with dulle wheels would have a few more lumps; those lumps represent only about 1/2 of an S-Unit, though, and driving around you'd never hear the difference.



This month we cover CB antenna basics and the effects of different mounting options.

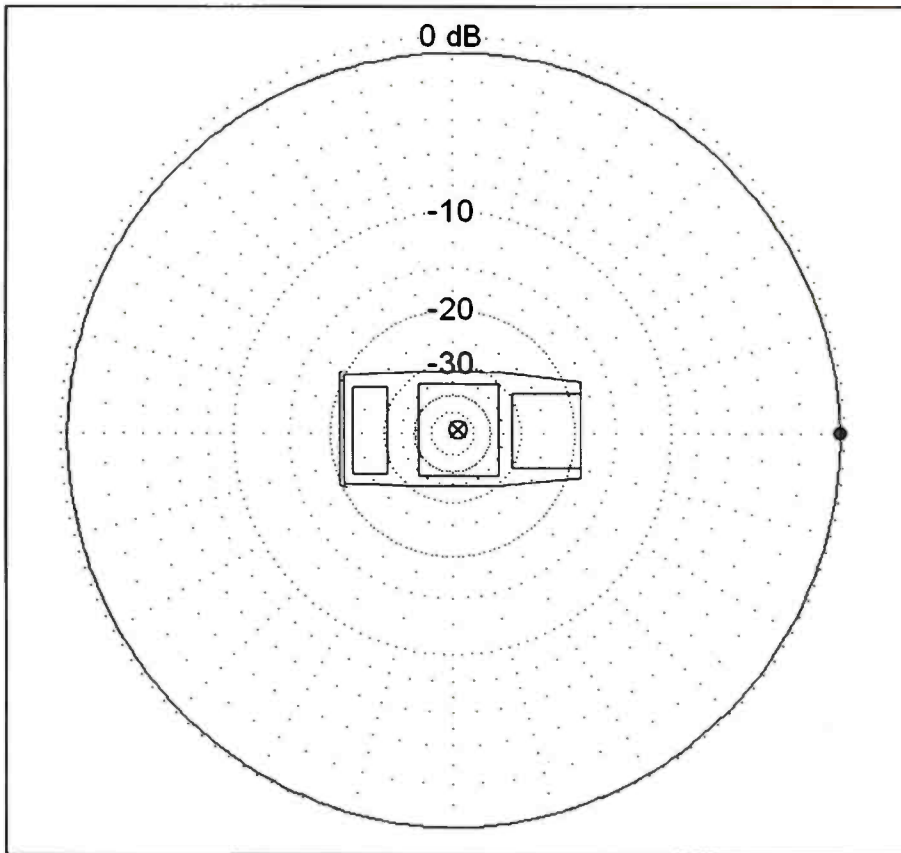

Figure 1. Pattern for a CB antenna in the middle of the roof.

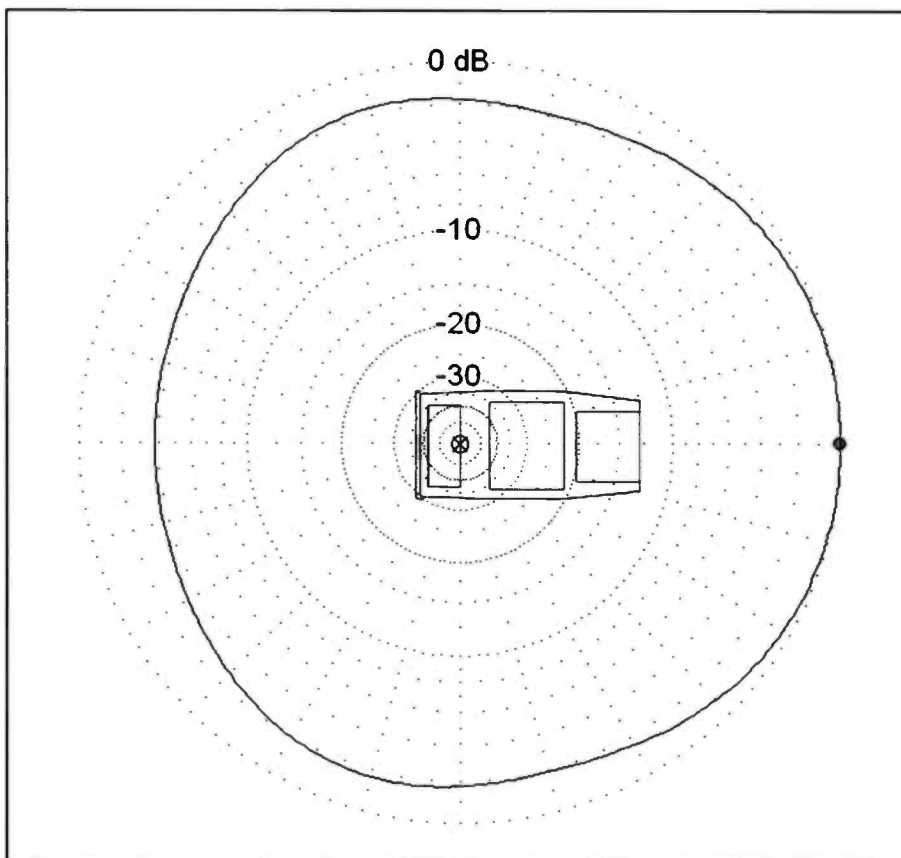

Figure 2. Pattern for a CB antenna on the trunk lid.

The bottom line for CB: You want the longest antenna you can get in the garage!

## Letters Letters, We Get Letters

From *Pop'Comm* reader Ed we get this comment on the last column about HDTV antennas: "But you don't need any special antennas to get HDTV!" Well, Ed, yes and no.

In most cases your regular old TV antenna or even rabbit ears will work fine for Digital TV. Go ahead, try it; if they work, they work. But DTV has some issues that analog NTSC TV did not, and one of them is multipath. On analog NTSC a reflection off a water tower, building, mountain, etc. would show up as a "ghost" on your TV screen.

Knowing that the picture tube scans left to right in  $69 \mu\text{s}$ , we can have a little fun with your "ghost": If your TV screen is 15 inches across, then the TV signal was delayed  $1/15$  of  $69 \mu\text{s}$  or  $.0000046$  seconds. Radio waves, like light, travel at 182,000 miles per second (for you chaps who are about to jump all over me with a more exact number, that value is in a vacuum!), giving us  $.0000046 \times 182000 = .39$  miles. That means if your ghost is 1 inch to the right of the main picture, it's a signal that traveled an extra .39 miles (Figure 4).

As I said, the beam is scanning from left to right, and since the ghost is a delayed signal, a ghost appears to the right of the image.

The 8 VSB modulation used with DTV has a different set of problems. The symbol rate is right at 6 Megabits/second. Now two waves arriving about  $1/5,000,000$  second apart—or  $1/5$  of one millionth of a second—can confuse the receiver. It's getting two bit streams and they don't agree. So ghost signals that are so close together that you would never see them on an NTSC analog TV are confusing the heck out of a DTV. This means your DTV really likes an antenna with a little gain and a cleaner pattern. But, again, if rabbit ears are working for you, go with them.

The bottom line on TV antennas: Analog TV doesn't like reflections that are out there a ways; DTV doesn't like reflections that are within a few hundred feet.

In all fairness the better DTV receivers have an *adaptive equalizer*. A good adaptive equalizer will look at the various bit streams arriving at the TV set and correct the waveforms to pick out the best signal. You can even have two signals arrive with



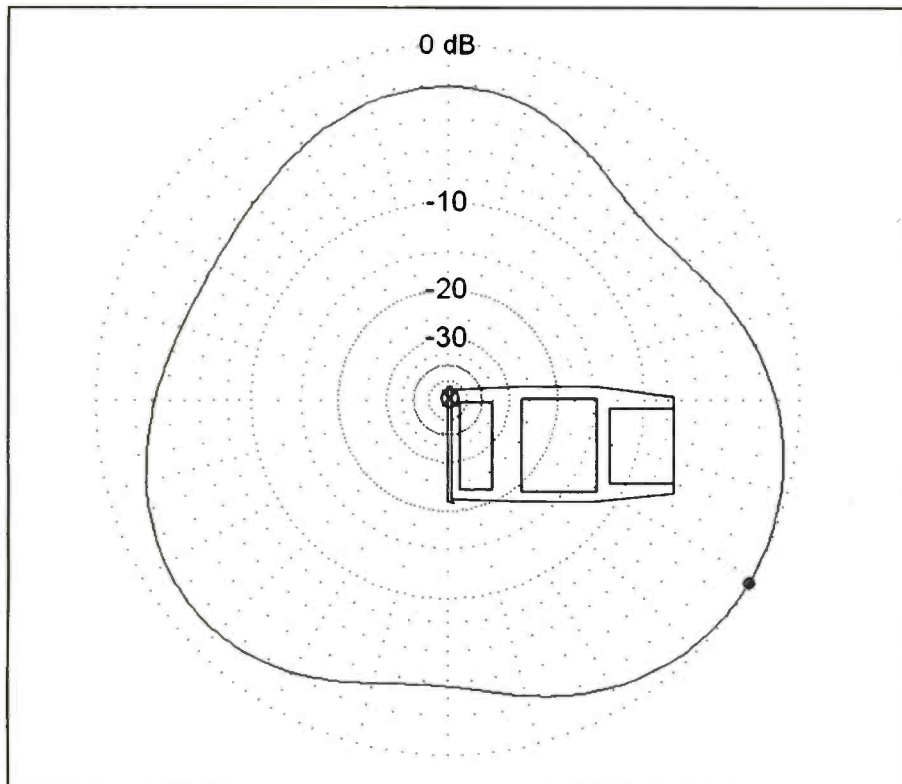

Figure 3. Pattern for a CB antenna mounted on the back driver side bumper.

the same signal strength, and the equalizer will pick out one signal and ignore the other.

There are some situations that can still confuse the DTV receiver, but they're pretty good at picking out the best signal these days. And you'll never see a ghost on your screen anymore! You might see blocks and picture lock-ups, but no ghosts!

To fend off the next letter ("Well, why don't we just go to the European OFDM modulation for DTV?"), OFDM, which stands for orthogonal frequency-division multiplexing, has its own set of problems. First OFDM requires the TV transmitters to run twice as much power. That's a big difference in the electric bills at the end of the month for the broadcasters using OFDM versus 8VSB. But the main difference is OFDM's poor immunity to pulse noise. The spark plug from one motor scooter can shut down TV reception for an entire English village. There are "noise blanker"-like circuits and spike removal software for OFDM modulation, but you still lose data packets during the blanking.

### Real-Time Virtual Radar

Lastly, I would like to put out a request to hear from the scanner community about Real-Time Virtual Radar. In a nutshell, by listening at 1090 MHz, this lets

you pick up the data from aircraft transponder beacons and build a map of almost all aircraft in the skies for 100 miles or so. This is very popular in Europe, yet I've heard almost nothing about it in the United States. If using Virtual Radar is becoming popular, I can easily produce families of 1090 MHz antennas. Let me know.

### Coming Up...

Next time I want to expand more on loading coils, ground planes, oil-filled

## CC WiFi Internet Radio



Receive Your Favorite Stations\*  
Over 11,500 Available Worldwide

- Excellent, Clear Audio
- Works on Any Broadband Signal
- Real, MP3, WMA Formats
- 99 Presets
- Wireless or Direct Connection via Ethernet Jack, Line-Out, Headphone, Signal Strength Indicator
- No Subscription Fee

\* Your favorite station must stream audio.  
You must have broadband internet service.

\$214<sup>95</sup>

# C. CRANE

## Free Catalog

800-522-8863 • [ccrane.com](http://ccrane.com)

coils, capacitance hats, and—if I have any room left—the most abused antenna topic: the 5/8 whip.

As always we appreciate your questions and suggestions for column topics. Just drop me an email at [wa5vjb@cq-amateur-radio.com](mailto:wa5vjb@cq-amateur-radio.com). I also have additional antenna articles at my website, [www.wa5vjb.com](http://www.wa5vjb.com).

Now, go get some more antennas up in the air! ■

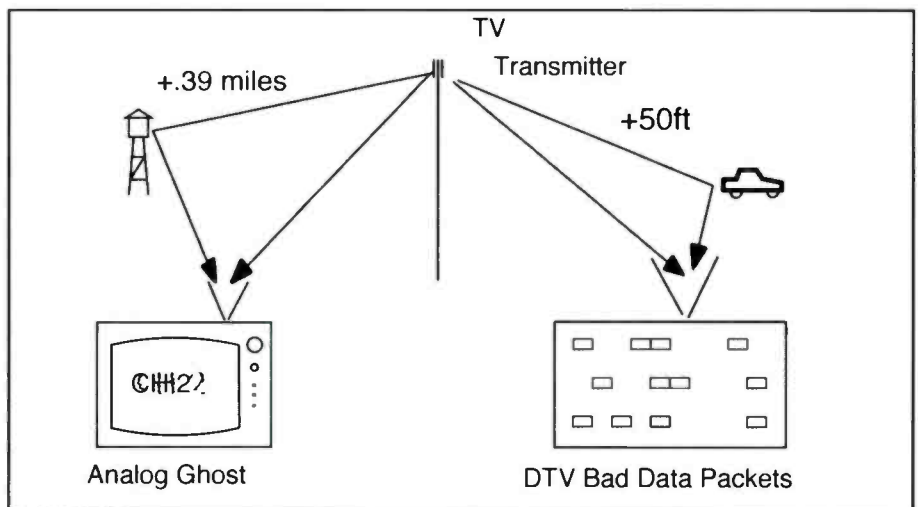

Figure 4. Ghost signals versus digital inter symbol interference.

## BROADCASTING

### World Band Tuning Tips

# World News, Commentary, Music, Sports, And Drama At Your Fingertips

This listing is designed to help you hear more shortwave broadcasting stations. The list covers a variety of stations, including international broadcasters beaming programs to North America, others to other parts of the world, as well as local and regional shortwave stations. Many of the transmissions listed here are not in English. Your ability to receive these stations will depend on time of day, time of year, your geographic location, highly variable propagation conditions, and the receiving equipment used.

AA, FF, SS, GG, etc. are abbreviations for languages (Arabic, French, Spanish, German). Times given are in UTC, which is five hours ahead of EST, i.e. 0000 UTC equals 7 p.m. EST, 6 p.m. CST, 4 p.m. PST.

UTC	Freq.	Station/Country	Notes	UTC	Freq.	Station/Country	Notes
0000	7345	Radio Prague, Czech Republic		0300	4976	Radio Uganda	
0000	9845	Radio Nederland, Bonaire Relay,		0300	6160	CKZN, Canada	
0000	9735	Radio Cairo, Egypt	AA	0300	6070	CVC-La Voz, Chile	SS
0000	7205	IBC-Tamil, England, via Germany	Tamil	0300	4950	Radio Nacional, Angola	PP
0000	9955	WRMI, Florida		0300	6100	Radio Republica, via England	SS
0000	6190	International Radio of Serbia	Italian	0330	6175	Voice of Vietnam, via Canada	
0030	11690	Radio Vilnius, Lithuania		0330	5975	Voice of Turkey	
0030	4835v	Radio Maranon, Peru	SS	0400	4755	Radio Imaculada, Brazil	PP
0100	9870	Radio Prague, Czech Republic		0400	3975	Radio Budapest	HH
0100	11895	Radio Boa Vontade, Brazil	PP	0400	4790	Radio Vision, Peru	SS
0100	9870	Radio Austria International		0400	7275	RTV Tunisienne, Tunisia	AA
0100	9870	All India Radio	Hindi	0400	13635	Voice of Russia	
0100	9665	Voice of Russia, via Moldova		0400	4965	The Voice-Africa, Zambia	
0100	9440	Radio Slovakia International		0400	4915	Radio Difusora Macapa, Brazil	PP
0100	7335	Vatican Radio	various	0400	6110	Radio Fana, Ethiopia	Amharic
0100	9770	Sri Lanka Broadcasting Corp.		0400	7140	Radio Algerienne, Algeria, via England	AA
0100	7250	Voice of Russia, via Armenia		0430	4799	Radio Cultural Coatan, Guatemala	SS
0130	9495	VOIRI, Iran		0430	5915	Radio Zambia	
0130	6010	Radio Sweden International, via Canada		0500	4905	RN Tchadienne, Chad	FF
0200	5025	Radio Rebelde, Cuba	SS	0500	9580	Africa Number One, Gabon	FF
0200	11710	Radio Argentina al Exterior		0500	4777	Radio Gabon	FF
0200	9925	Voice of Croatia, via Germany		0500	4770	Radio Nigeria	
0200	4780	Radio Buenas Nuevas, Guatemala	SS	0500	3200	Trans World Radio, Swaziland	various
0200	9510	Radio Farda, USA, via Germany	Farsi	0500	4780	Radio Djibouti	FF
0200	9610	Vatican Radio	SS	0500	6250	Radio Nacional, Equatorial Guinea	SS
0200	9480	Voice of Russia		0500	5030	Radio Burkina, Burkina Faso	FF
0200	5070	WWCR, Tennessee		0500	5005	Radio Nacional, Equatorial Guinea	SS
0200	6973	Galei Zahal, Israel	HH	0600	9615	Radio New Zealand International	
0300	5910	Marfil Estereo, Colombia	SS	0600	6080	Voice of America Relay, Sao Tome	
0300	7140	BBC Cyprus Relay	AA	0600	4760	ELWA, Liberia	
0300	7270	Radio Cairo, Egypt	AA	0600	6165	Croatian Radio	EE/Croatian
0300	7110	Radio Ethiopia	Amharic	0600	7200	Radio Bulgaria	FF
0300	4052.5	Radio Verdad, Guatemala	SS	0700	6010	Radio Mil, Mexico	SS
0300	9420	Voice of Greece	Greek	0730	9800	Trans World Radio, Monaco	
0300	3250	Radio Luz y Vida, Honduras	SS	0730	9525	Cotton Tree News, Sierra Leone, via Ascension	
0300	3255	BBC Relay, South Africa		0900	4825	Radio Cancao Nova, Brazil	PP
0300	5010	Radio Madagasisikara, Madagascar	Malagasy	0900	3220	HCJB, Ecuador	Quechua
0300	7265	Voice of Turkey		0900	3925	Radio Nikkei, Japan	JJ
0300	9535	Radio Exterior de Espana	SS	0900	7145	Radio New Zealand International	
0300	4940	Radio Amazonia, Venezuela	SS	0900	4905	Radio Difusora Amazonas, Brazil	PP
0300	9630	Radio Nacional Venezuela, via Cuba	SS	0930	4700	Radio San Miguel, Bolivia	SS
0300	9720	RT Tunisienne, Tunisia	AA	0930	4800	Radio Transcontinental, Mexico	SS
0300	6040	Vatican Radio, via Canada	SS	0930	3280	La Voz del Napo, Ecuador	SS
0300	4930	Voice of America, Sao Tome Relay					

UTC	Freq.	Station/Country	Notes	UTC	Freq.	Station/Country	Notes
1000	4717	Radio Yura, Bolivia	SS	1700	15205	Broadcasting Svc of the Kingdom, Saudi Arabia	AA
1000	5446	AFN/AFRTS, USA via Florida		1700	11815	Radio Exterior de Espana, Spain	SS
1000	4815	Radio El Buen Pastor, Ecuador	SS	1730	17885	BBC Ascension Is. Relay	FF
1000	6890	KNLS, Alaska		1730	9980	Adventist World Radio, Guam	
1030	5039	Radio Libertad, Peru	SS	1730	15475	Africa Number One, Gabon	FF
1030	5765	AFN/AFRTS, USA via Guam		1800	9815	Voice of America, Botswana Relay	PP
1030	4775	Radio Tarma, Peru	SS	1800	12005	RTV Tunisienne, Tunisia	AA
1030	4909	Radio Chaskis, Ecuador	SS	1830	17630	Radio France International	SS
1100	7260	China Radio International	Mandarin	1830	15390	Bible Voice, England, via Germany	
1100	9580	Radio Australia		1900	9855	Radio Kuwait	
1100	6045	Radio Universidad, Mexico	SS	1930	15630	Voice of Greece	Greek
1100	3205	Radio West Sepik, Papua New Guinea		2000	13600	Radio Tirana, Albania	
1100	4825	La Voz de la Selva, Peru	SS	2000	11990	Radio Kuwait	
1100	9425	WHRI, Indiana	GG	2000	11735	Radio Tanzania, Zanzibar	Swahili
1100	7200	Radio Rossii, Russia	RR	2000	9330	WBCQ, Maine	
1130	11750	China Radio International, via Canada		2000	9890	Voice of Russia	
1130	9455	Radio Free Asia, USA, via Northern Marianas	Camodian	2100	15400	BBC Ascension Is. Relay	
1130	3215	Radio Manus, Papua New Guinea	Pidgin	2100	15345	RTV Marocaine, Morocco	AA
1200	9400	Radio Bulgaria	BB	2100	15190	Radio Africa, Equatorial Guinea	
1200	9560	Radio Australia		2100	15205	Deutsche Welle, Germany, Rwanda Relay	
1200	6020	Radio Australia		2100	15110	Radio Exterior de Espana, Spain	
1200	4920	Radio Republik Indonesia, Biak, Indonesia	II	2100	15495	Radio Kuwait	AA
1200	9740	BBC Singapore Relay		2100	13755	RDP International, Portugal	PP, irreg.
1200	9910	Trans World Radio, Guam	CC	2100	15590	WRNO, Louisiana	
1200	9430	Far East Bc. Service, Philippines	Mandarin	2100	13820	Radio Marti, USA	SS
1200	7580	Voice of Korea, North Korea	KK	2200	17860	China Radio International, via Canada	PP
1200	11700	Radio Liberty, USA, via Philippines	RR	2200	15455	Radio Canada International	SS
1200	9735	Radio Taiwan International	JJ	2200	11620	All India Radio	
1200	9650	KBS World Radio, South Korea		2200	7450	RS Makedonias, Greece	Greek
1200	13590	CVC-Australia, via Zambia	FF	2200	7380	Radio Nederland, Madagascar Relay	
1200	3385	Radio East New Britain, Papua New Guinea	Pidgin	2200	15600	Radio Taiwan International, via Florida	
1200	4790	Radio Republik Indonesia, FakFak	Indonesian	2200	7185	Radio Romania International	
1230	12130	KWHR, Hawaii		2200	12120	Far East Bc. Company, Philippines, via Saipan	CC
1230	9335	Voice of Korea, North Korea	KK	2230	9760	Cyprus Broadcasting Corp	Greek, wknds
1230	9795	Radio Nederland, via Singapore	Indonesian	2300	9550	Radio Havana Cuba	
1230	11825	Voice of America Philippines Relay	Mandarin	2300	7170	China Radio International, via Mali	CC
1230	9835	Radio Thailand		2300	11700	Radio Bulgaria	
1230	15240	Radio Sweden International		2300	11780	Radio Nacional Amazonia, Brazil	PP
1300	9525	Voice of Indonesia	various	2300	17795	Radio Australia	
1300	9760	Voice of America Philippines Relay		2300	9575	Radio Medi Un, Morocco	FF/AA
1300	11625	Radio Thailand	Mandarin	2300	12000	HCBJ, Ecuador	SS
1300	9625	CBC Northern Quebec Service, Canada		2300	17605	Radio Japan/NHK, via Bonaire	JJ
1400	11705	Radio Japan/NHK, via Canada		2300	7475	Voice of Greece	Greek
1400	12025	Far East Broadcasting Assn, England, via UAE		2300	11865	Voice of Germany, via Rwanda	GG
1400	13740	China Radio International, via Cuba		2300	15720	Radio New Zealand International	
1400	15410	CVC International, Chile	PP	2300	13755	Voice of America, Thailand Relay	
1400	6015	Shiokaze, Japan	KK	2300	9610	Radio Romania International	
1400	21695	Radio Jamahiriya, Libya		2300	13680	Radio Nacional Venezuela, via Cuba	SS
1400	17770	Radio Solh, USA, via England	Pashto/Dari	2300	15345	Radio Argentina al Exterior	SS
1500	17680	CVC-La Voz, Chile	SS	2330	6100	Radio Canada International	
1600	13770	All India Radio	Hindi	2330	11815	Radio Brazil Central	PP
1600	9920	Trans World Radio, Guam	CC	2330	7135	RTV Marocaine, Morocco	AA
1630	17605	Radio France International	FF	2330	4845	Radio Mauritanie, Mauritania	AA
1630	9930	Radio Free Asia, via Northern Marianas	CC	2330	9720	Radio Veritas Asia, Philippines	Burmese
1700	15560	RDP International, Portugal	PP	2330	6300	Radio Nacional de la RASD, Algeria	SS
1700	15120	Voice of Nigeria	various	2330	7440	Radio Ukraine International	

# New, Interesting, And Useful Communications Products

by Staff

## Motorola's APX 7000 Multi-Band Portable Radio

First responders (as well as those who monitor them) will be pleased to learn about the APX 7000, a new portable radio from Motorola that provides instant interoperability for mission critical situations. Motorola's fourth generation P25 subscriber offers multi-band interoperability in one radio (700/800 MHz and VHF), backwards and forwards compatibility (FDMA and TDMA), and integrated GPS for outdoor location tracking. The dual-sided radio has both an audio and data side, providing optimal functionality and loud and clear audio in a compact, rugged package. A custom-designed mic on both the audio and data sides independently suppresses most background noise, detects male and female voices, and uses a digital vocoder to process and enhance the remaining speech after it is filtered from harsh background noise.

According to a company news release, the APX radios were "[d]esigned with input from public safety officials, social sciences, and on-site testing under severe physical conditions," and offer "applications including integrated GPS, text messaging, intelligent lighting and user controlled radio profiles." The APX is P25 Phase 1-compliant and will be upgradeable to P25 Phase 2. When available, TDMA systems will double the voice capacity. APX radios will also support future applications including Bluetooth as they become available.

The APX 7000 is scheduled to be generally available during the second quarter of 2009. For more information, visit [www.motorola.com](http://www.motorola.com).

Motorola's APX 7000 is a full-featured multi-band portable P25 radio with integrated voice and data designed for first responders and public-safety users.

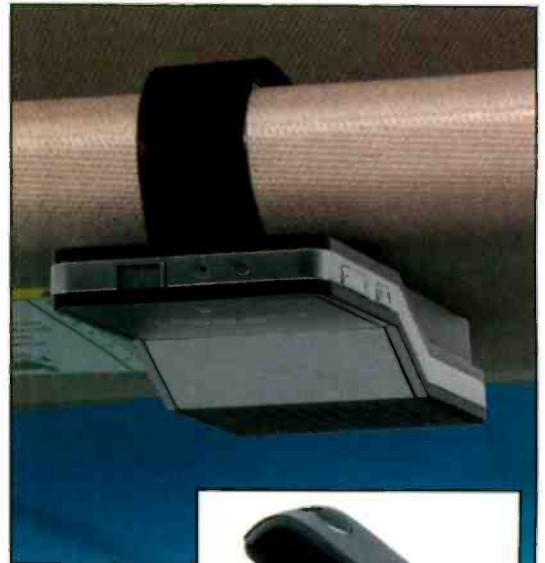

The Tritton AX Visor Bluetooth hands-free kit functions as a portable speakerphone for Bluetooth cell phones supporting headset or hands-free profiles. It automatically detects between hands-free "car mode" and "speakerphone mode."

## The Tritton AX Visor Bluetooth Hands-Free Kit

The Tritton AX Visor Bluetooth hands-free kit functions as a portable speakerphone when linked to a Bluetooth cell phone supporting headset or hands-free profiles. The AX Visor will also automatically detect between hands-free "car mode" and "speakerphone mode." In "car mode" the unit will activate the unidirectional microphone, while in "speakerphone mode" the omnidirectional microphone is activated. An integrated accelerometer will detect vibration in a vehicle and automatically connect to the paired phone. Underneath the black bezel is an OLED screen that provides information to the user, including caller ID (displays automatically reversible when device is used upside down).

The Tritton AX Visor is Bluetooth V1.2 compliant; supports headset and hands-free profiles for hands-free function with Bluetooth phones; supports car hands-free (unidirectional microphone) and speakerphone mode (omnidirectional microphone). It offers high-performance built-in speaker and dual microphones; up to 15 hours of talk time and 400 hours of standby time; convenient charging via AC/DC adapter, cigar jack or USB.

The Tritton AX Visor is available at many popular retail outlets, such as J&R and Costco; prices ranges from approximately \$88 to \$112. For more information, visit [www.trittontechnologies.com](http://www.trittontechnologies.com).

## Two MFJ Atomic Clock Offerings

Read both UTC and local time at a glance with the MFJ-121B (\$79.95) Dual Time Zone Atomic Clock. The MFJ-121B displays 24/12-hour time simultaneously, but allows you to set each independently. Its automatic backlight lights up every day at your preset time for eight hours. Mounted in a silver-metallic, hard-plastic frame, it features easy-to-read 2 x 1-inch (HW) LCD numerals, an exclusive UTC zone, and a running seconds display. It is compact (7 1/4 x 11 3/8 x 1 inches, HWD), can mount on a wall or desk, and uses four AA batteries. Daylight savings time can be disabled.

There's no need for batteries or to set time with the MFJ-123B (\$79.95) solar-powered Eternity Atomic Clock, which the company advertises, works "for an eternity." It receives WWVB signals, measures 6 1/4 x 9 1/2 x 1 inches (HWD) with 2-inch time digits, offers a choice of 24- or 12-hour time, and has indoor

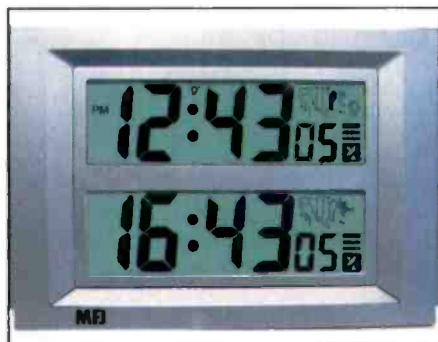

The MFJ-121B displays 24/12-hour time simultaneously, but you can set each independently.

temperature, running seconds, month/date and day-of-week displays. Housed in a silver metallic wall- or desk-mountable casing, it offers a power on/off switch for when clock is in storage or not in use.

For additional information, visit [www.mfjenterprises.com](http://www.mfjenterprises.com) or call 800-647-1800.

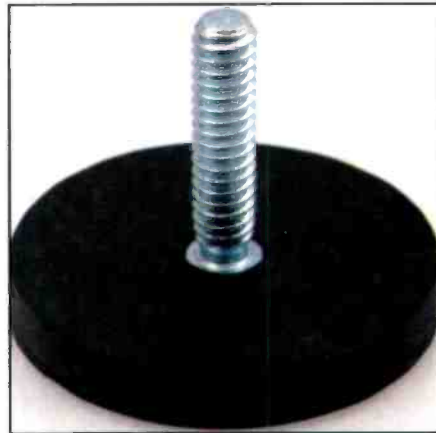

Adams "Neo RB" magnetic assemblies with rubber coatings can be used for antenna mounts, as bases for work lights and emergency lights, and more.

## Adams Rubber-Coated Magnetic Assemblies

Adams Magnetic Products has introduced Neodymium Round Base ("Neo RB") magnetic assemblies with rubber coatings. Adams engineers and fabricates this rare earth magnetic material into steel-encased assemblies and applies a protective rubber coating that resists rust and scratches.

Typical uses include antenna mounts; holders for vehicle flags, signs and banners; and bases for work lights and emergency lights.

According to the company, these Neo assemblies are up to 32 times stronger than individual ceramic magnets. Adams' Neo Round Base products, with stud and standoff pieces, have a pulling force of 20-, 32-, or 105-pounds. Encased in steel, they are available in standard black rubber coating and in diameters of 1.677, 2.574, and 3.471 inches. Additional sizes and strengths may be specified.

For more information and pricing on Adams' Neo round base, rubber-coated magnetic assemblies or other magnetic products, visit [www.adamsmagnetic.com](http://www.adamsmagnetic.com), or call 800-747-7543.

## INFORMATION & ORDERING WWW.SCANCAT.COM

INTERNET DOWNLOADS AVAILABLE  
**ORDER TOLL FREE**  
**888-722-6228**

### COMBO CD SPECIAL

ScanCat-Lite-Plus.....	Reg. \$29.95
Mr. Scanner FCC Public Safety.....	29.95
Nat-Com's FCC Scancat Files.....	9.95
Bonus Disk Of Frequencies.....	15.00
	<b>\$84.85</b>

**NOW \$49.95**

**PLUS FREE** Scanning Magazine(s)  
*(Current Issues While Supplies Last)*

## SCANCAT®

Since 1989, The Recognized  
Leader in Computer Control



Once you use SCANCAT with YOUR radio, you'll NEVER use your radio again WITHOUT SCANCAT!

### ScanCat-Lite-PLUS

Reg. \$39.95 - Limited Time Special \$29.95

#### Program Your Scanner

As Easy As 1-2-3-CLICK!

SC-Lite Supports PRO-83, PRO-95, PRO-96, BC246 & over 15 more Trunking Scanners

**Now It's Easier Than Ever To Use Your ScanCat Software.**

**FREE** walk-you-through set up video to get you going fast.

[www.scancat.com](http://www.scancat.com) **You Tube**  
Click on learn as you view.

### ScanCat Gold for Windows

Version 8.50 \$99.95

Supports all radios in ONE program - share files with all radios.

Two Scanning modules:

A Simple Basic Module - for beginners  
**Plus**—An Advanced Scanning System for the "experts".

**ScanCat Gold for Windows-SE** - \$159.95

### "ScanCat-SE" Additional Features

- Long term logging of frequencies to hard drive.
- Record Audio to hard drive using sound card.
- Improved spectrum analysis.

Skysweep Decoder Software \$99.95



### COMPUTER AIDED TECHNOLOGIES

F.O. Box 18285 Shreveport, LA 71138

ORDERS: (318) 687-4444 FAX: (318) 686-0449

Info/Tech Support: (318) 687-2555

(9 a.m. - 3 p.m. Central M-F)

## INTERNET DOWNLOADS AVAILABLE INFORMATION & ORDERING WWW.SCANCAT.COM

# Holiday Gift Ideas from CQ



## 2009/10 calendar from CQ

15-Month Calendar (January 2009 through March 2010)

This fifteen month calendar includes dates of importance to Ham Radio operators, such as major contests and other operating events, meteor showers, phases of the moon and other astronomical information, plus important and popular holidays. These calendars are not only great to look at, they're truly useful, too!

**CQ Amateur Radio Operators Calendar** —brings you 15 spectacular images of some of the biggest, most photogenic shacks, antennas, scenics and personalities. These are the people you work, shacks you admire, and the antenna systems you dream about! Order No. HRCAL



**ONLY  
\$10.95**

## Cds Ham Radio Magazine on CD

Enjoy quick and easy access to every issue of this popular magazine, broken down by years!

**SPECIAL!  
Save \$5  
on each CD set**

**ON SALE - only \$54.95 ea.**

Three sets, each containing 4 CDs

1968-1976 Order No. HRCD1 ~~\$59.95~~

1977-1983 Order No. HRCD2 ~~\$59.95~~

1984-1990 Order No. HRCD3 ~~\$59.95~~

**Buy All 3 Sets and Save \$49.90!**

Order No. HRCD Set **\$129.95** (Reg. \$149.95)



## Passport to World Band Radio

2009 Edition is bigger & better

The World's #1 selling shortwave guide is bigger and better! Includes exhaustive chart shows world broadcasters by frequency and time indicating station power and language.



Order No. PASS **\$22.95**

## CQ HF Operator's Survival Guide

Get this booklet absolutely Free with any order!

This guide contains great-reading articles and information that take the mystery out of operating on HF, DXing, Contesting, award hunting, propagation, QSLing and much more! Includes a HF band chart!

Order No. HF Surv ~~\$2~~



**FREE  
with every  
order!**

Shipping & Handling: U.S. & Possessions-add \$7 for the first item, \$3.50 for the second and \$2 for each additional item. FREE shipping on orders over \$100 to one U.S. address. Foreign-calculated by order weight and destination and added to your credit card charge.

# more great gifts!



**\*Spend \$100  
and get FREE  
shipping!**

## MIL SPEC Radio Gear Korean to Present Day by Mark Francis, KIØPF



Detailed write-ups for many familiar sets: PRC-25/-77, RT-68, PRC-1099, GRC-106, GRR-5, R-392 and more. Over 230 pages of operation, modification, and maintenance tips and info, including 200+ illustrations. Useful hints and mods, and more!

Order No. MILSPEC ~~\$27.95~~ **\$25**

## The NEW Shortwave Propagation Handbook by W3ASK, N4XX & K6GKU



This authoritative book on shortwave propagation is your source for easy-to-understand information on sunspot activity, propagation predictions, unusual propagation effects and do-it-yourself forecasting tips.

Order No. SWP **\$19.95**

## The Complete DXer



Third Edition  
The joy of the chase, the agony of defeat, the thrill of victory are the stuff of The Complete DXer, a book that is almost as seductive as the DX chase it describes. It excites, it entertains, it teaches!

Order: COMPDXer **\$19.95**

## Heathkit - A Guide to the Amateur Radio Products by Chuck Penson, WA7ZZE



Greatly expanded 2nd Edition - a must for collectors and Ham history buffs. A terrific trip down memory lane for any Ham. Pick up this 328 page volume and you won't be able to put it down!

Order No. HEATHKIT **\$29.95**

## The Short Vertical Antenna and Ground Radial by Sevick, W2FMI



This small but solid guide walks you through the design and installation of inexpensive, yet effective short HF vertical antennas. With antenna restrictions becoming a problem, it could keep you on the air!

Order No. SVERT **\$10.00**



## HR Anthologies

~~\$19.95~~

**Sale \$18 ea.**

**Buy all 4 for only \$70**

Enjoy collections of the best material published in *Ham Radio* magazine, conveniently arranged by subject and original publication date. Choose your interest, your time period and choose your anthology!

- Homebrewing Techniques ..... Order # AHOME
- Test Eqpt & Repair Techniques ..... Order # ATEST
- Antennas - 1968 - 1972 ..... Order # ANTS1
- Antennas - 1973 - 1975 ..... Order # ANTS2
- All 4 for \$70 ..... Order # ASET

## 2009 World Radio TV Handbook



2009 Edition - scheduled for release November 25th. Order now for shipment immediately upon release. You will not be charged until your book ships.

Up-to-date info on mediumwave, shortwave, and FM broadcasts and broadcasters. Articles of interest to both listeners and dxers, reviews of the latest equipment, maps with SW transmitter sites and more.

Order No. WRTH **\$35.00**

## W6SAI HF Antenna Handbook by Bill Orr, W6SAI



One of ham radio's most respected authors, W6SAI was known for his easy-to-understand, down-to-Earth, writing style. In keeping with this tradition, this book is a thoroughly readable text for any antenna enthusiast, jam-packed with dozens of inexpensive, practical antenna projects that work!

Order No. HFANT **\$19.95**

## "Up Two" by G3SXW



Are you a DX'er? Have you longed to be on the other side of the pile-ups? Do you dream of taking a rig to exotic locations? If your answer to any of the above questions is yes, this book is intended to bring you the vicarious thrills of operating from exotic places.

Order: UPTWO **\$19.95**

## Contesting in Africa Multi-Multi on the Equator by Roger Western, G3SXW & the Voo Doo Contest Group



A compelling array of contesting and DXing experiences from one of the most unique operating venues on earth, the African continent.

Order No. AFRI **\$19.95**

## "Getting Started" DVD Paks

Our renowned "Getting Started" videos grouped together on DVDs!



### CQ Ham Radio Welcome Pak

1 DVD contains 3 programs:  
Ham Radio Horizons  
Getting Started in Ham Radio  
Getting Started in VHF  
Order # HAMDVD ~~\$24.95~~ **\$19.95**

### CQ VHF Specialty Pak

1 DVD contains 3 programs:  
Getting Started in Satellites  
Getting Started in VHF  
Getting Started In Packet  
Order # VHFDVD ~~\$24.95~~ **\$19.95**



Buy any combination of DVDs and save!

- 1 Pak for ~~\$24.95~~ - **\$19.95**
- 2 Paks for ~~\$49.95~~ - **\$35.95**
- 3 Paks for ~~\$74.95~~ - **\$50.95**

### CQ HF Specialty Pak

1 DVD contains 2 programs:  
Getting Started in DXing  
Getting Started in Contesting

Order # HFDVD ~~\$24.95~~ **\$19.95**



Call 1-800-853-9797 or FAX your order to 516-681-2926  
You can also order on our web site: [www.cq-amateur-radio.com](http://www.cq-amateur-radio.com)

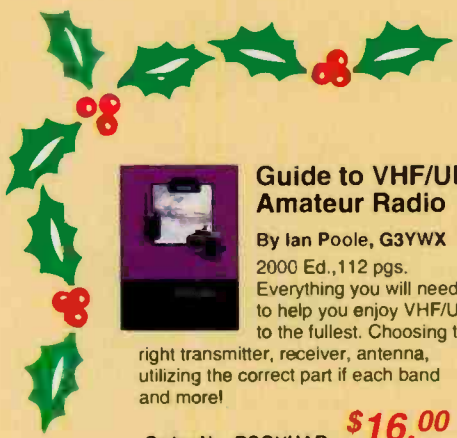

# RSGB Books



## Guide to VHF/UHF Amateur Radio

By Ian Poole, G3YWX  
2000 Ed., 112 pgs.  
Everything you will need to help you enjoy VHF/UHF to the fullest. Choosing the right transmitter, receiver, antenna, utilizing the correct part if each band and more!

Order No. RSGVUAR

**\$16.00**



## HF Antenna Collection

2nd Ed., 2002. 252 pages.  
A collection of outstanding articles and short pieces which were published in *Radio Communication* magazine. Includes single- and multi-element, horizontal and vertical antennas, extremely small transceiving and receiving antennas, feeders, tuners and much much more!

Order: RSHFAC

**\$33.00**



## IOTA Directory

Edited by Roger Balister, G3KMA.  
2007 Ed.  
Fully updated, lists all islands that qualify for IOTA, grouped by continent, and indexed by prefix. Details the award rules, includes application forms.

Order: RSIOTA

**\$18.00**

## Antenna Toolkit 2

By Joe Carr, K4IPV  
RSGB & Newnes, 2002 Ed., 256 pgs.  
A definitive design guide for sending and receiving radio signals. Together with the powerful suite of CD software included with this book, the reader will have a complete solution for constructing or using an antenna; everything but the actual hardware!



Order: RSANTKIT2

**\$48.00**



## Practical Wire Antennas 2

By Ian Poole, G3YWX  
2005 Edition, 176 pages  
This significantly expanded and fully revised edition includes designs for a wide range of practical wire antennas. Just about every type of wire antenna you could possibly imagine with complete and easy to understand designs.

Order: RSPWA2

**\$23.50**

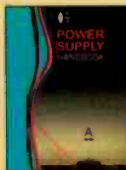

## Power Supply Handbook

By John Fielding, ZS6JF  
2006 Ed., 288 pages.  
How power supplies work, selecting components, building and modifying supplies, measuring the finished supply, batteries, chargers, test equipment - it's all here!

Order: RSPSH

**\$28.50**

## Low Power Scrapbook

2001 Ed., 320 pages.  
Choose from dozens of simple transmitter and receiver projects for the HF bands and 6m, including the tiny Oner transmitter and the White Rose Receiver. Ideal for the experimenter or someone who likes the fun of building and operating their own radio equipment.



Order: RSLPS

**\$18.00**



## HF Amateur Radio

2007 Second Ed.  
HF or short wave bands are one of the most interesting areas of amateur radio. This full revised and expanded second edition guides you through setting up an efficient amateur radio station, equipment to choose, installation, the best antenna for your location and MUCH more.

Order: RSHFAR

**\$23.00**



## The Antenna Experimenter's Guide

2nd Ed., 1996. 160 pages.  
Takes the guesswork out of adjusting any home-made or commercial antenna, and makes sure that it is working with maximum efficiency. Describes RF measuring equipment and its use, constructing your own antenna test range, computer modeling antennas. An invaluable companion for all those who wish to get the best results from antennas!

Order: RSTAEG

**\$32.00**

## RSGB Technical Compendium



2000 Ed., 297 pages  
All of the technical material from a whole year's RadCom in a single volume. Every "Technical Topics," every "In Practice," and "Eurotek" along with all the technical info from "Down to Earth!"

Order: RSTC

**\$33.00**

## QRP Basics

By Rev. George Dobbs, G3RJV  
2003 Edition, 208 pages  
How to get the best results from a QRP station whether from home or outdoors. How to construct your own station, complete transmitters, receivers and some accessories. Sections include toroidal coils, construction techniques and equipping a work station.



Order: RSQRPB

**\$28.50**

## The Low Frequency Experimenter's Hdbk

By Peter Dodd, G3LDO  
2000 Ed., 296 pages  
An invaluable and reference written to meet the needs of amateurs and experimenters interested in low power radio techniques below 200kHz.



Order: RSLFEH

**\$33.00**

## Technical Topics Scrapbook 1985-1989

By Pat Hawker, G3VA  
1993 Ed., 346 pages  
A collection of popular "Technical Topics" culled in RadCom. Info, ideas, mods and tips for amateurs!



Order: RSTTC89

**\$18.00**

## VHF/UHF Amateur Radio

Edited by Andy Barter, G8ATD  
2nd Ed., 320 pages.  
Guides you through the theory and practice of VHF/UHF operating and transmission lines. Includes information on getting started, antennas, constructing your own equipment, satellite ops, local nets and specialized modes.



Order: RXVUH

**\$29.50**



## Technical Topics Scrapbook 1995-1999

By Pat Hawker, G3VA  
2000 Ed., 314 pages  
This third compilation of "Technical Topics" articles is a fascinating collection of circuit ideas, antenna lore, component news and scientific discussion, all at the most practical level

Order: RSTTC99

**\$27.50**



## HF Antennas for All Locations

By Les Moxon, G6XN  
RSGB, 2nd Ed., 322 pages  
Design and construction of hundreds of antennas. No matter what your location, there's one for you!

Order: RSHFAAL

**\$33.50**

Shipping & Handling: U.S. & Possessions-add \$7 for the first item, \$3.50 for the second and \$2 for each additional item. FREE shipping on orders over \$100 to one U.S. address. Foreign-calculated by order weight and destination and added to your credit card charge. Magazine subscription prices include shipping and handling charges.



# More great CQ books!



**Back by Popular Demand!**

## McCoy on Antennas

by Lew McCoy, W1ICP

Unlike many technical publications, Lew presents his invaluable antenna information in a casual, non-intimidating way for anyone!

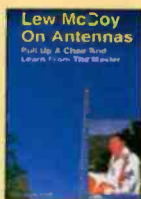

Order No. MCCOY **\$19.95**

**Back by Popular Demand!**

## Understanding, Building & Using Baluns & Ununs

by Jerry Sevick, W2FMI

The successor to the popular and authoritative Baluns and Ununs. Great deal of new tutorial material, and designs not in previous book, with crystal clear explanations of how and why they work.

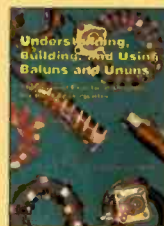

Order No. 2BU **\$19.95**

## The Vertical Antenna Handbook

by Paul Lee, N6PL

Learn basic theory and practice of the vertical antenna. Discover easy-to-build construction projects.



Order No. VAH **\$17.95**

## The Quad Antenna

by Bob Haviland, W4MB

A comprehensive guide to the construction, design and performance of Quad Antennas.

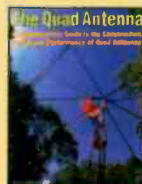

Order No. QUAD **\$19.95**

## 33 Simple Weekend Projects

by Dave Ingram, K4TWJ



Do-it-yourself electronics projects from the most basic to the fairly sophisticated. You'll find: station accessories for VHF FMing, working OSCAR satellites,

fun on HF, trying CW, building simple antennas, even a complete working HF station you can build for \$100. Also includes practical tips and techniques on how to create your own electronic projects.

Order No. 33PROJ **\$17.95**

# magazines at holiday sale prices!



**Sale Ends 12/31/08**

## CQ Amateur Radio

CQ's editorial content is aimed squarely at the active ham. Within each issue, CQ's features and columns cover the broad and varied landscape of the amateur radio hobby from contesting and DXing to satellites and the latest digital modes. CQ includes equipment reviews, projects, articles on the science as well as the art of radio communication and much, much more.

**Holiday Special!** Domestic Rates: 1 year ~~\$38.95~~ **\$34.95** - 2 yrs ~~\$68.95~~ **\$62.95** - 3 yrs ~~\$98.95~~ **\$90.95**  
 Canada/Mexico: 1 year ~~\$48.95~~ **\$47.95** - 2 yrs ~~\$92.95~~ **\$88.95** - 3 yrs ~~\$138.95~~ **\$129.95**  
 Foreign: 1 year ~~\$61.95~~ **\$59.95** - 2 yrs ~~\$116.95~~ **\$112.95** - 3 yrs ~~\$171.95~~ **\$165.95**

## Popular Communications

The world's most authoritative monthly magazine for shortwave listening and scanner monitoring. Features scanner monitoring of police; fire, utility and aircraft communications; international shortwave listening; CB radio; amateur radio; FRS and more.

**Holiday Special!** Domestic Rates: 1 year ~~\$32.95~~ **\$30.95** - 2 years ~~\$58.95~~ **\$54.95** - 3 years ~~\$86.95~~ **\$79.95**  
 Canada/Mexico: 1 year ~~\$42.95~~ **\$40.95** - 2 years ~~\$78.95~~ **\$74.95** - 3 years ~~\$116.95~~ **\$109.95**  
 Foreign: 1 year ~~\$52.95~~ **\$50.95** - 2 years ~~\$98.95~~ **\$94.95** - 3 years ~~\$145.95~~ **\$139.95**

## CQ VHF

The all-time favorite magazine for the VHF/UHF enthusiast is better than ever. This quarterly magazine focuses on Ham radio above 50 MHz. Regular columns include: Antennas, OpEd, Satellites, VHF Propagation, & FM.

**Holiday Special!** Domestic Rates: 1 year ~~\$26.00~~ **\$24.00** - 2 years ~~\$52.00~~ **\$48.00** - 3 years ~~\$78.00~~ **\$72.00**  
 Canada/Mexico: 1 year ~~\$36.00~~ **\$34.00** - 2 years ~~\$72.00~~ **\$68.00** - 3 years ~~\$108.00~~ **\$102.00**  
 Foreign: 1 year ~~\$39.00~~ **\$37.00** - 2 years ~~\$78.00~~ **\$74.00** - 3 years ~~\$117.00~~ **\$111.00**

Call 1-800-853-9797 or FAX your orders to 516-681-2926  
 You can also order on our web site: [www.cq-amateur-radio.com](http://www.cq-amateur-radio.com)

**GIFT ORDER FORM**

Send these items, as my gift, to address listed below!

**15-Month Calendar**

- 2009/10 Ham Ops Calendar #HRCAL \$ 10.95
- HR MAGAZINE on CD**
- 1968-1976 #HRCD1 \$54.95
- 1977-1983 **SALE!** #HRCD2 \$54.95
- 1984-1990 #HRCD3 \$54.95
- ALL 3 Sets #HRCDSets \$129.95
- 2009 Passport to World Band Radio #PASS \$22.95
- HF Operator's Survival Guide **FREE with any purchase!**

**MORE Great Gifts!**

- MilSpec Radio Gear **SALE!** #MILSPEC \$25.00
- Heathkit-A Guide to AR Pdts #HEATHKIT \$29.95
- 2009 World Radio TV Handbook #WRTH \$35.00
- W6SAI HF Antenna Hdbk #HFANT \$19.95
- New Shortwave Prop Hdbk #SWP \$19.95
- Short Vertical Ant/Ground Radials #SVERT \$10.00
- "UP Two" #UPTWO \$19.95
- Complete DXer #COMPDXer \$19.95
- Homebrewing Techniques #AHOME \$18.00
- Test Eqpt & Repair Techniques #ATEST \$18.00
- Antennas 1968-1972 **SALE!** #ANT1 \$18.00
- Antennas 1973-1975 #ANT2 \$18.00
- ALL 4 Anthologies #ASET \$70.00
- Contesting in Africa #AFRI \$19.95

**GETTING STARTED DVD Paks**

- CQ Ham Radio Welcome Pak #HAMDVD \$19.95
- CQ HF Specialty Pak **SALE!** #HFDVD \$19.95
- CQ VHF Specialty Pak #VHFDVD \$19.95
- Any 2 \$35.95  Any 3 \$50.95

**RSGB BOOKS**

- Guide to VHF/UHF Ham Radio #RSGVUAR \$16.00
- Antenna Toolkit 2 #RSANTKIT2 \$48.00
- Practical Wire Ants 2 #RSPWA2 \$23.50
- QRP Basics #RSQRPB \$28.50
- VHF/UHF Handbook #RXVUH \$29.50
- HF Antenna Collection #RSHFAC \$33.00
- Power Supply Hdbk #RSPSH \$28.50
- Antenna Experimenter's Guide #RSTAEG \$32.00
- Low Frequency Exp. Hdbk #RSLFEH \$33.00
- Tech Topics Scrapbook '95-99 #RSTTC99 \$27.50
- IOTA Directory #RSIOTA \$18.00
- Low Power Scrapbook #RSLPS \$18.00
- HF Amateur Radio #RSHFAR \$23.00
- RSGB Tech Compendium #RSTC \$33.00
- Tech Topics Scrapbook '85-89 #RSTTC89 \$18.00
- HF Antennas for All Locations #RSHFAAL \$33.50

**MORE Great CQ Books!**

- Lew McCoy on Antennas #MCCOY \$19.95
- Vertical Antenna Handbook #VAH \$17.95
- Understanding, Building & Using #2BU \$19.95
- The Quad Antenna #QUAD \$19.95
- 33 Simple Weekend Projects #33PROJ \$17.95

**MAGAZINES AT HOLIDAY SALE PRICES**

**CQ Amateur Radio**

- 1 yr \$34.95  2 yrs \$62.95  3 yrs \$90.95

**Popular Communications**

- 1 yr \$30.95  2 yrs \$54.95  3 yrs \$79.95

**CQ VHF**

- 1 yr \$24.00  2 yrs \$48.00  3 yrs \$72.00

*U.S. Rates -Canadian/Foreign rates on previous page.*

Send the items checked above as a gift from me.

Send to:

Name \_\_\_\_\_  
 Address \_\_\_\_\_  
 City \_\_\_\_\_ State \_\_\_\_\_ Zip \_\_\_\_\_

- Check/Money Order enclosed  Bill my credit card

**ORDER FORM - Send these items to me!**

**15-Month Calendar**

- 2009/10 Ham Ops Calendar #HRCAL \$ 10.95
- HR MAGAZINE on CD**
- 1968-1976 #HRCD1 \$54.95
- 1977-1983 **SALE!** #HRCD2 \$54.95
- 1984-1990 #HRCD3 \$54.95
- ALL 3 Sets #HRCDSets \$129.95
- 2009 Passport to World Band Radio #PASS \$22.95
- HF Operator's Survival Guide **FREE with any purchase!**

**MORE Great Gifts!**

- MilSpec Radio Gear **SALE!** #MILSPEC \$25.00
- Heathkit-A Guide to AR Pdts #HEATHKIT \$29.95
- 2009 World Radio TV Handbook #WRTH \$35.00
- W6SAI HF Antenna Hdbk #HFANT \$19.95
- New Shortwave Prop Hdbk #SWP \$19.95
- Short Vertical Ant/Ground Radials #SVERT \$10.00
- "UP Two" #UPTWO \$19.95
- Complete DXer #COMPDXer \$19.95
- Homebrewing Techniques #AHOME \$18.00
- Test Eqpt & Repair Techniques #ATEST \$18.00
- Antennas 1968-1972 **SALE!** #ANT1 \$18.00
- Antennas 1973-1975 #ANT2 \$18.00
- ALL 4 Anthologies #ASET \$70.00
- Contesting in Africa #AFRI \$19.95

**GETTING STARTED DVD Paks**

- CQ Ham Radio Welcome Pak \$19.95
- CQ HF Specialty Pak **SALE!** \$19.95
- CQ VHF Specialty Pak \$19.95
- Any 2 \$35.95  Any 3 \$50.95

Mail orders in this postage-paid envelope →

**RSGB BOOKS**

- Guide to VHF/UHF Ham Radio #RSGVUAR \$16.00
- Antenna Toolkit 2 #RSANTKIT2 \$48.00
- Practical Wire Ants 2 #RSPWA2 \$23.50
- QRP Basics #RSQRPB \$28.50
- VHF/UHF Handbook #RXVUH \$29.50
- HF Antenna Collection #RSHFAC \$33.00
- Power Supply Hdbk #RSPSH \$28.50
- Antenna Experimenter's Guide #RSTAEG \$32.00
- Low Frequency Exp. Hdbk #RSLFEH \$33.00
- Tech Topics Scrapbook '95-99 #RSTTC99 \$27.50
- IOTA Directory #RSIOTA \$18.00
- Low Power Scrapbook #RSLPS \$18.00
- HF Amateur Radio #RSHFAR \$23.00
- RSGB Tech Compendium #RSTC \$33.00
- Tech Topics Scrapbook '85-89 #RSTTC89 \$18.00
- HF Antennas for All Locations #RSHFAAL \$33.50

**MORE Great CQ Books!**

- Lew McCoy on Antennas #MCCOY \$19.95
- Vertical Antenna Handbook #VAH \$17.95
- Understanding, Building & Using #2BU \$19.95
- The Quad Antenna #QUAD \$19.95
- 33 Simple Weekend Projects #33PROJ \$17.95

**MAGAZINES AT HOLIDAY SALE PRICES**

**CQ Amateur Radio**

- 1 yr \$34.95  2 yrs \$62.95  3 yrs \$90.95

**Popular Communications**

- 1 yr \$30.95  2 yrs \$54.95  3 yrs \$79.95

**CQ VHF**

- 1 yr \$24.00  2 yrs \$48.00  3 yrs \$72.00

*\*U.S. Rates -Canadian/Foreign rates on previous page.*

Send the items checked above to me:

Name \_\_\_\_\_  
 Address \_\_\_\_\_  
 City \_\_\_\_\_ State \_\_\_\_\_ Zip \_\_\_\_\_

- Payment information:**  Check/Money Order Enclosed  
 Bill my:  MasterCard  Visa  Discover  AmExpress  
 Credit Card Number: \_\_\_\_\_ ExpirationDate: \_\_\_\_\_

--	--	--	--

**Shipping & Handling: US & Possessions**-add \$7 for the first item, \$3.50 for the second and \$2 for each additional item. **FREE** shipping on orders over \$100 (merchandise only) to one domestic address. **Foreign**-calculated by order weight and destination and added to your credit card charge. **Magazine subscription** prices include shipping and handling charges.

# Trivia And Toons

by R.B. Sturtevant, AD7IL

**Q.** How are scientists able to make predictions about things like El Niño and La Niña?

**A.** As you've probably noticed we're getting a lot more information about ocean currents and their effect on the weather and the environment. Scientists have been compiling especially good information since about 2000, when measuring devices, known as PALACE floats, were dropped into the sea at various points. The devices sink to a predetermined level and float along collecting information on water temperature, salinity, direction of drift, oxygen content, water density, and more.

After about 10 days, they pop up to the surface for an hour or so and send off a radio message to the nearest satellite. The satellite passes the information on via a download to a ground station which sends it all in for correlation. There are thousands of PALACE units out there, but since they're only about three and a half feet long and stay submerged most of the time you're unlikely to see any. They don't send QSL cards, either.

**Q.** The Allies broke codes on the German Enigma machine, but did the Germans ever break any of the high-level codes of the British or Americans?

**A.** No they didn't, because they didn't really try. And, it may surprise you to know that nobody ever broke the Enigma codes.

First, after Dunkirk, the Germans picked up a lot of Type X British code machines. The Type X was so similar to the Enigma that the Germans could have sued the British for patent infringement if there hadn't been a war on. Both machines were patterned after a commercially available German machine, also called Enigma, that appeared in the 1920s. The Germans realized that the machine was so complicated and could produce so many variations of a message that it was foolish to even attempt decoding (the number of possible variations produced by an Enigma machine was estimated as about the same as the number of molecules in the universe!). Therefore, they spent almost no time on the Command Level codes, opting instead to use their resources on lower level Diplomatic and Tactical codes used by lower level military commanders. The British

Navy relied on Book codes, which in time were very simple for the Germans to read.

**Q.** What are some of the problems that can develop in radio navigation?

**A.** Well, assuming that the RDF (radio direction finding) equipment is working correctly in, say an airplane, there are still some things that can go wrong. For instance, if you're a pilot working out a course that crosses a coastline at an acute angle, the radio signal can possibly be refracted. This can also happen if the signal bounces off a mountain or other terrain feature. Your homing frequency could be working another station broadcasting on or close to your desired frequency and giving you false readings. Your direction finder could turn into a "thunder storm finder" if it starts pointing in the direction of a large storm generating lightning rather than a homing beacon.

**Q.** When did the Navy start putting radios on ships?

**A.** The first fleet maneuvers evaluating radio's usefulness took place in 1903. When the Navy got started with radio it was buying sets from various civilian suppliers. This created a major problem, particularly in the maintenance field. Often just when a sailor got to know how to repair all the equipment on his ship, he'd get transferred and find a whole new bunch of equipment, built by different manufacturers, for him to learn. It was not until late in 1916 that the Navy set up a receiver design laboratory at Washington Navy Yard.

**Q.** Given the unreliability of World War I wireless why did the Allies give up on pigeons?

**A.** Well, they didn't really. You're right that Allied commanders didn't trust wireless, because it tended to break down when the batteries got wet in the trenches, and pigeons winged their way right into World War II. They were easier to move from place to place than telegraph, and Air Observers, called Pigeon Pitchers, learned how to throw a pigeon out of an airplane faster than they learned Morse code. But unlike radio signals, pigeons could be shot by enemy snipers, become confused by smoke and shelling, and were susceptible to gas attacks.

The straw that broke the camel's back, however, was when a General commanding a Brigade wanted to let the rear troops know when his lead infantry unit needed support. A trusted soldier was given a pigeon and told to release the bird when the enemy was found and engaged. After several days of waiting, the General got this priority message: "I am absolutely fed up with carrying this bloody bird all over France."

Several other commanders were also put off when they drafted "Must Get Through" messages to find that their "Pigeon Man" (the least sought-after job in the Signal Corps) had eaten his charges because rations were delayed in getting to the front. In no war ever fought by America has a radio operator eaten his transmitter.

## SPURIOUS SIGNALS

By Jason Togyer KB3CNM



# A New Shortwave Outlet Is Borno, An Austrian Radio Threat, Mas From Mexico, And More

by Gerry L. Dexter  
gdex@genevaonline.com

**N**igeria has a new shortwave outlet: Borno Radio Television. It's refurbished its domestic AM and FM outlets, providing improved service to additional Nigerian states beyond Borno. BRTV has already received a license for shortwave and plans provide service to Chad, Niger, and Cameroon. Back in earlier days Nigeria had a shortwave outlet in most of its major cities, including Borno's capital, Maidugari (on 6100). Over time most of these fell victim to neglect and disrepair and went out of service. Perhaps by next month we'll have some idea of the frequency and schedule. But this certainly qualifies as some rare good news!

WRNO has assumed a more or less regular schedule now on 15590 local days and 7505 evenings, the latter proving to be particularly strong.

According to log reporter Bob Fraser in Belfast, Maine, Austrian Radio is threatening to

end all English language shortwave at the end of the year unless "listeners come to our aid." I assume that means letters of support rather than financial contributions

CFRX in Toronto may well be back on the air by the time you read this. Just a couple of steps need to be taken before it's ready to go. It will be interesting to note how they do competing against CVC-Santiago, now also using 6070, and often doing quite well there.

HCJB is said to have ceased its SSB transmissions on 21455, which has been used for broadcasts to Europe in German. That unit has been turned over to experiments with DRM.

Another Mexican has shown up. Merida on 6105 is being heard by a few monitors, although poorly. It's broadcasting the local Candela FM using the same 250-watt transmitter it used years ago. Eventually it hopes to broadcast around the clock, devoting half the time to the Mayan language. Mexico continues to offer DX challenges with difficult-to-hear outlets on 4800, 6045, (now) 6105 and 9600v.

It wasn't just Radio Singapore International that took a dive at the end of July—it took all its other feeds down with it as well. All the various FM services, languages, and formats formerly carried on shortwave have also been trashed. I guess if you're past a certain age you're automatically considered out of touch and no longer worth the notice of your nearby, friendly media giant.

## Reader Logs

Remember, your shortwave broadcast station logs are always welcome. But *please* be sure to double or triple space between the items, list each logging according to the station's *home country*, and include your last name and state abbreviation after each. Also needed are spare QSLs or good copies you don't need returned, station schedules, brochures, pennants, station photos, and anything else you think would be of interest. And, if you want to get really crazy, a photo of you at your listening post would also be welcome.



Rich Parker, Pennsburg, Pennsylvania, has been busy redoing his shack. He built this desk/console from salvaged scrap lumber.

## Help Wanted

We believe the "Global Information Guide" offers more logs than any other monthly SW publication (417 shortwave broadcast station logs were processed this month!). Why not join the fun and add your name to the list of "GIG" reporters? Send your logs to "Global Information Guide," 213 Forest St., Lake Geneva, WI 53147. Or you can email them to [gdex@genevaonline.com](mailto:gdex@genevaonline.com). (See the column text for formatting tips).

*\*Not all logs get used; there are usually a few which are obviously inaccurate, unclear, or lack a time or frequency.*

Here are this month's logs. All times are in UTC. Double capital letters are language abbreviations (SS = Spanish, RR = Russian, AA = Arabic, etc.). If no language is mentioned, English (EE) is assumed.

**ALBANIA**—Radio Tirana, 13600-Shijak with Albanian folk songs at 2014. (Charlton, ON)

**ARGENTINA**—RAE/Radio Nacional, 11710 in EE/SS at 0115. (Linonis, PA) 0233 with EE including DX pgm. Into FF at 0330. (D'Angelo, PA) 15345 in SS at 2118. (Brossell, WI) 2305. (Charlton, ON)

**ASCENSION IS.**—BBC South Atlantic Relay, 15400 at 2100. (Linonis, PA) 2208. Also 17885 in FF at 1735. (MacKenzie, CA) 17850 at 1818. (Charlton, ON) 21470 at 1658. (Strawman, IA)

**AUSTRALIA**—(Shepparton except as indicated)—6020/9580/9590 at 1110. Also 9475/9560 at 1200 (Yohnicki, ON) 9580 at 1015 taking a beating from a Firedrake jammer on 9575. (Barton, AZ) 1055 with sports. (Charlton, ON) 9710 at 0805. (Ng, Malaysia) 13630 at 2150, 15515 at 0440, 17785 at 2306 and 17795 at 2306. (MacKenzie, CA) 15515 at 0530. (Wood, TN)

ABC Northern Territories Service, 2325, Tennant Creek, at 1152 just above the noise level. (Brossell, WI) 2485, Katherine, with talk at 1240. (Ng, Malaysia)

CVC International, 17830-Darwin in CC at 0430. (MacKenzie, CA)

**AUSTRIA**—Radio Austria Intl, 9440 at 0120. (Yohnicki, ON) 9870 with "Report From Austria" heard at 0105. (Fraser, ME)

**BANGLADESH**—Bangladesh Betar, 7250 at 1230 with EE news and commentary. (Ng, Malaysia)

**BOLIVIA**—Radio Yura. Yura, 4716.9 at 0105 with SS talk, woman laughing. Poor. (D'Angelo, PA) Good at 1030 with CP music. (Wilkner, FL)

Radio San Jose, SJ de Chiquitos, 5580.2 with CP music heard at 0000. (Wilkner, FL)

Radio San Miguel, Riberalta, 4699.3 heard at 0940 with religious chorus and man talking, then slow female vocal. (Wilkner, FL)

Emisoras Camargo, Camargo, 3390.3 at 2350. (Wilkner, FL)

**BONAIRE**—Radio Nederland Bonaire Relay, 9590 in SS at 0312, 11970 in DD at

2310, 15540 in DD at 2212 and 17605 in SS at 2327. (MacKenzie, CA) 9845 at 0009 and 17775 at 2020. (Wood, TN) 9845 at 0035. (Fraser, ME) 9845 Bonaire Relay with news at 0032 and 17605 Bonaire in SS heard at 2306. (Charlton, ON)

**BRAZIL** (All in PP—*gld*)—Radio Brazil Central, Goiania, 11815 at 2329 with discussion, IDs, Brazil pops. (D'Angelo, PA)

Radio Difusora Acreana, Rio Branco, 4885 with live sports coverage at 0205. (Brossell, WI)

Radio Boa Vontade, Porto Alegre, 11895 at 0145 with mentions of Brazil, hymn and sermon. (Paszkievicz, WI)

Radio Imaculada, Campo Grande, 4755 at 0445 with talk, prayers, ID, address and phone numbers. (Wood, TN)

Radio Missoes da Amazonas, Obidos, 4865 at 1025. Poor with possible preaching. (Wood, TN)

Radio Cancao Nova, Cachoeira Paulista, 4825 at 0911 with soft ballads and anmts. Slow paced if this was a wake-up show. (Ronda, OK)

Radio Nacional Amazonas, Rio, 11780 heard at 1250. (Brossell, WI) 1747 with Brazilian vocals. (MacKenzie, CA) 2259 with many mentions of Brazil. (Charlton, ON)

**BULGARIA**—Radio Bulgaria, 9400 in presumed BB at 1201. (Brossell, WI) 9700 in BB. (Wood, TN) 11700-Plovdiv at 2312. (Charlton, ON) 2330. (MacKenzie, CA)

**CANADA**—Radio Canada Intl, 6100 at 2335. (Fraser, ME) 9515-Sackville in FF at 1729. (Charlton, ON) 15455 in SS at 2227, //11990. (MacKenzie, CA)

**CHAD**—Radio Nationale Tchadienne, 7120 at 2220 with traditional African songs and drums, ID in FF at 2227, anthem at 2228 and off at 2230. (Ronda, OK)

**CHILE**—CVC-La Voz, Santiago, 17680 in SS with WWV time signal monitored at 1238. (Brossell, WI) 1545 in SS. (Charlton, ON) 2220 in SS. (MacKenzie, CA)

**CHINA**—China Radio Intl, 6145 via Canada at 2307, 13630 via Mali at 2112 and 15220 via Canada in CC at 1550. (Charlton, ON) 7140-Shijazhuang in RR at 1250, 7170 via Mali in CC at 2340, 7190-Jinhua in JJ at 1211, 7260-Jinhua in listed Mandarin at 1102 and 11980-Kunming closing at 1254. (Brossell, WI) 9570 via Albania in CC at 0314, 9665 via Brazil in SS at 0307, 9690 via Spain at 0305, 11840 via Canada at 2305, 15160 in

CC at 0447 and 17860 via Canada in PP at 2226. (MacKenzie, CA) 11750, //6040 at 1150. (Fraser, ME) 15785 at 0131 with "Voices From Other Lands." (Ng, Malaysia) 13650 via Albania at 1102. (D'Angelo, PA)

Qinghai PBS, Xining, 5990 in Tibetan at 1150. (Ng, Malaysia)

Firedrake Jammer, 7280 against Sound of Hope at 1110, 11590 at 1245 vs. RFA-Kuwait and 12040 going after VOA-Philippines at 1256. (Brossell, WI) 9335 at 1733, //9540, 9865 monitored at 1833, 9930 at 1643 and 15430 at 2318. (MacKenzie, CA)

**COLOMBIA**—Marfil Estereo, Puerto Lleras, 5910 at 0200 in SS with good Latin music. (Linonis, PA) 0356 with Latin vocals, Wanner in SS, ID at 0400. (D'Angelo, PA)

**CROATIA**—Voice of Croatia, 9925 via Germany on Croatian art 0245. (MacKenzie, CA) 2315. (Charlton, ON)

**CUBA**—Radio Havana Cuba, 9550 at 2311. (Charlton, ON) 12000 in SS at 1154. (Yohnicki, ON)

Radio Rebelde, 5025 in SS at 1155. (Yohnicki, ON)

**CYPRUS**—Cyprus Broadcasting Corp., 9760 at 2230-2245 with Greek music and anmts. (Linonis, PA)

**CZECH REPUBLIC**—Radio Prague, 7345 with "Panorama" at 0020, //9440. (Fraser, ME) on churches in Prague at 2245. (Linonis, PA) 9440-Sabota at 0021, ending at 0027. (Charlton, ON) 9870 with apparent news on top of AIR at 0110. Several mentions of Prague. (Strawman, IA) 17540 at 1320. (Ng, Malaysia)

**ECUADOR**—Radio El Buen Pastor, Saraguro, 4815 in SS with slow vocal at 0950. (Wilkner, FL)

HD2IOA, Guayaquil, 3810 at 0522 with time pips and SS time anmts. No tone shift at the minute mark. (Wood, TN)

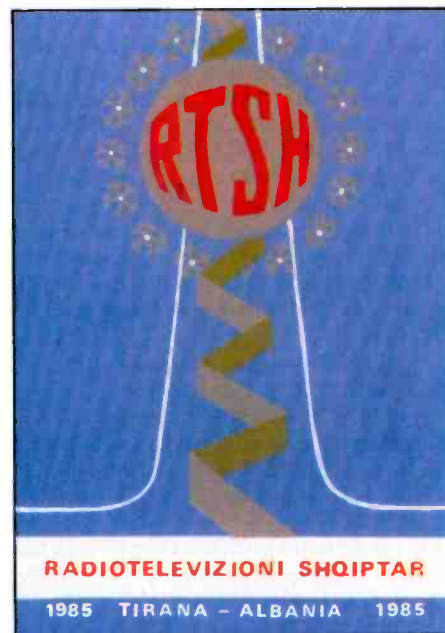

Radio Tirana sent this Christmastime QSL to Mike Adams of Florida in 1985.

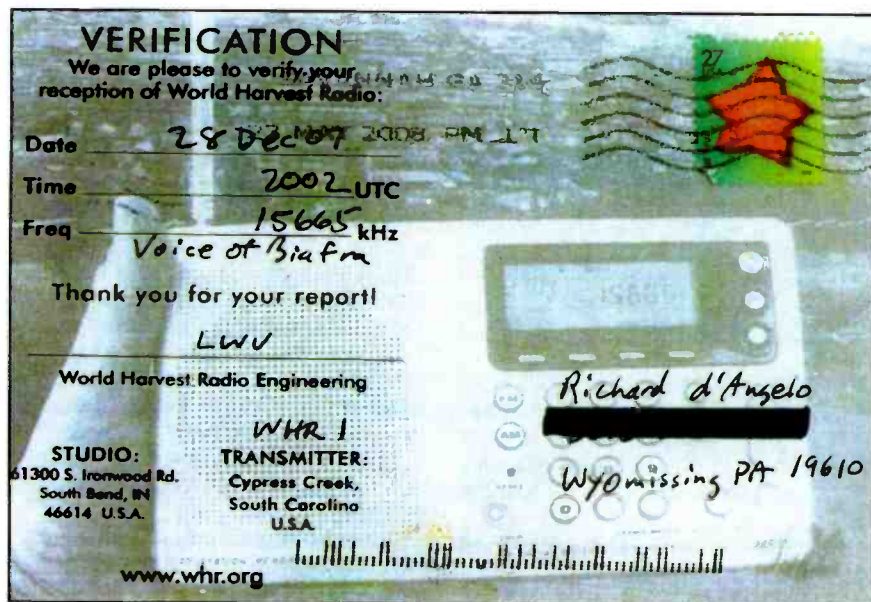

The "business" side of this stylish QSL confirms Rich D'Angelo's reception of the Voice of Biafra, aired on WHRI facilities.

HCJB, 3220 at 0940. (Wilkner, FL) 0906 with man in Quechua. (Ronda, OK) 9745 in SS at 0302, 9780 in GG at 0255. 1200 in SS at 2312. 12020 in PP at 2345 and 12045 in GG at 2342. (MacKenzie, CA) 12020 in PP at 2308. (Charlton, ON)

**EGYPT**—Radio Cairo/Egyptian Radio, 7270 at 0300 in AA. (Branco, NY) 0320. (MacKenzie, CA) 9280 with AA lesson at 0005. also 17835 with news at 1230. (Ng, Malaysia) 2315 with news in EE. (Charlton, ON) 9735-Abis in AA at 0003. (Wood, TN) 11550 with mailbag at 2200. (Brossell, WI)

**ENGLAND**—BBC, 3255 via South Africa at 0313 and 7140 Cyprus Relay in AA at 0314. (Brossell, WI) 6005 via South Africa at 0329. (MacKenzie, CA) 7120 South Africa Relay at 0420. (D'Angelo, PA) 9740 Singapore Relay at 1221. (Ronda, OK)

Bible Voice, 13590 via Germany with religious pgm at 1834. (Charlton, ON)

FEBA Radio, 12025 via UAE with "Back to God Hour" at 1400. (Ng, Malaysia)

IBC-Tamil, 7205 via Wertachtal with long talks in Tamil. ID and apparent news at 0030, closing anmts at 0059. (D'Angelo, PA)

**EQUATORIAL GUINEA**—Radio Africa, 15190 with sermon heard at 2115. (Brossell, WI)

**ETHIOPIA**—Radio Ethiopia, 7110 with Afropops at 0324. (Strawman, IA)

**FRANCE**—Radio France Intl, 17630 Montsirey Relay in SS with pops, W host at 1826. (MacKenzie, CA) 17850 with pops in FF at 1648. (Strawman, IA)

**GABON**—RTV Gabonaise, Moyabi, 4777 in FF heard at 0504 ending ID with frequency anmts and into Afropop. (Wood, TN)

Africa No. One, 9580 at 0555 in FF with weekday wake up pgm. (Wood, TN) 15475 in FF at 1728. (Charlton, ON)

**GERMANY**—Deutsche Welle, 9775

Rwanda Relay in GG at 2350, 9825 in GG at 0250 and 11865 Rwanda Relay in GG at 2320. (MacKenzie, CA) 15120 Rwanda Relay with EE news features at 2030. (Wood, TN) 15205 Rwanda Relay on world debt at 2115. (Brossell, WI) 15340 Singapore Relay with mailbag at 0905. (Ng, Malaysia) 15445 Sri Lanka Relay in AA at 1724. (Charlton, ON)

**GREECE**—Voice of Greece, 7475 with talk and songs in Greek at 2335. (Brossell, WI) 9420 at 2350 and 15630 at 1837, both in Greek. (Charlton, ON) 9420 in Greek at 0305. (MacKenzie, CA) 2350 with songs in Greek. M anncr in EE. (Fraser, ME)

RS Makedonias, 7450 in Greek at 2215-2245. (Linonis, PA)

**GUAM**—Adventist World Radio, 9720 in CC at 1221. (Brossell, WI) 9920 in CC at 1648. (MacKenzie, CSA)

Adventist World Radio/KTWR, 9910 at 1227 with ID and website in CC, off at 1229. (Brossell, WI) 9980 in EE at 1750. (MacKenzie, CA)

**GUATEMALA**—Radio Verdad, Chi-

quimula, 4052.5 at 0430 with SS preaching, many references to "verdad." (Wood, TN) 0600 with religious music. (Wilkner, FL)

Radio Buenas Nuevas, San Sebastian, 4799v at 0451 in SS with many accordion numbers. (Wood, TN) 1030 with anncr, rustic music. (Wilkner, FL)

**HAWAII**—KWHR/World Harvest Radio 9930 with "Voice of Praise" at 0820. (Ng, Malaysia) 12130 with religious music at 1258. (Brossell, WI)

**HUNGARY**—Radio Budapest, 3975-Jaszbereny in HH at 0403 but barely above the noise floor. (Wood, TN)

**HONDURAS**—Radio Lutz y Vida, San Luis, 3250 at 0330 with SS and religious talk. ID and closing anmts at 0352. (D'Angelo, PA)

**INDIA**—All India Radio, Chennai, 4920 with Indian traditional music at 0020. (Ng, Malaysia) 9870-Bangaluru in HH at 0100 and 11620-Aligarh at 2200. (Fraser, ME) 11585-Delhi with talks in Hindi at 1247. (Brossell, WI) 13770-Bangaluru in Hindi heard at 1640. (Paszkiwicz, WI)

**INDONESIA**—Radio Republik Indonesia, Biak (Papua), 4920 at 1200 with flutes, soft music and talk in Indonesian. (Brossell, WI)

Voice of Indonesia, 9525-26 at 1225 in JJ, anmts at TOH. In EE at 1315 re-check. (Strawman, IA) 1252 in JJ at 1252, into Korean at 1300 (should have been in EE then). KK was stopped in mid-sentence at 1313 and into EE news in mid-sentence. (Ronda, OK)

**IRAN**—VOIRI, 9495 with EE commentary at 0145. (Charlton, ON)

**JAPAN**—Radio Japan/NHK, 9650 via UAE in JJ at 2251, closed at 2300. Also 9759-Yamata in JJ at 1228. (Ronda, OK) 9835 in JJ at 1740, 13650 in Burmese at 2338 and 15265 in JJ at 2322. (Mackenzie, CA) 11705 via Canada at 1425 and 17605 via Bonaire in JJ at 2307. (Charlton, ON) 11985 with EE news in progress at 1409. (Strawman, IA) 13740 via UAE in JJ at 1833. (Wood, TN)

Radio Nikkei, 3925 in JJ at 0945. (Barton, AZ) 0959. (Strawman, IA)

**KUWAIT**—Radio Kuwait, 9855 in AA at 1952, news at 2000. Also 11990 at 2012 in EE with hip hop and pops. (Wood, TN) 17885 in AA at 1215. (Ng, Malaysia)

### This Month's Winner

To show our appreciation for your loggings and support of this column, each month we select one "GIG" contributor to receive a free book. Readers are also invited to send in loggings, photos, copies of QSL cards, and monitoring room photos to me at *Popular Communications*, "Global Information Guide," 25 Newbridge Rd., Hicksville, NY 11801, or by email to [gdex@genevaonline.com](mailto:gdex@genevaonline.com). The email's subject line should indicate that it's for the "GIG" column. So, come on, send your contribution in today!

Jerry Strawman, Des Moines, Iowa, is this month's winner. A copy of the 2009 edition of *Passport to World Band Radio* is destined for use at Jerry's shack. And there should be a copy in your radio den, as well! Contact Universal Radio (or any book dealer) and get your copy immediately. Please mention *Pop'Comm* and the "Global Information Guide" when writing.



IBRA Radio, based in Sweden, is transmitted via Wertachtal, Germany. (Thanks Rich D'Angelo, Pennsylvania)

**LITHUANIA**—Radio Vilnius, 7325 with **EE** at 2332. (Brossell, WI) 9875-Stikunai in **EE** from 2330-0000. (Linonis, PA) 2340 with news and actualities. Closed at 0000. (Strawman, IA)

2346. (Charlton, ON) 11690-Sitkunai in **LL** at 0013. (Wood, TN) 0030 with **EE** discussion. (Branco, NY)

**MADAGASCAR**—Radio Madagasikara, 5010 heard at 0220 in presumed Malagasy with non-stop ballads. (Brossell, WI)

**MALAYSIA**—RT Malaysia, Kuching (Sarawak), 5030 with Koran at 1350. (Ng, Malaysia)

**MAURITANIA**—Radio Mauritanie, 4845 in **AA** at 2328. (Brossell, WI)

**MEXICO**—Candela FM, Merida, 6105 in **SS** at 1100 with various IDs, slogans and jingles. (Wilkner, FL)

XERTA/Radio Transcontinental, Mexico City, 4800 monitored at 0945 with **EE** ID mentioning "in the 60-meter band" and internet URL. **SS** ID mentioning "voz popular," then similar ID in **EE**. (Wilkner, FL)

Radio Mil, Mexico City, 6010 at 0748 with several **SS** anmts. ID, phone numbers and address. Romantic vocals. (D'Angelo, PA)

Radio Universidad, San Luis Potosi, 6045 with **OC**, classical music heard at 1102. (Wilkner, FL)

**MONGOLIA**—Mongolian Radio, 4895 with Mongolian music at 1135. (Ng, Malaysia)

Voice of Mongolia, 12085 in **CC** at 1000. (Ng, Malaysia)

**MONOCO**—Trans World Radio, 9800 at 0732 with religious pgm, ID monitored at 0744, closedown at 0749. (D'Angelo, PA)

### In Times Past...

Here's your blast from the past for this month...

**RUSSIA**—Radio Chechnya Svoboda (Radio Free Chechnya), St. Petersburg, Russia, 12045 in Chechnya at 0402 on August 22, 2000. (Dexter, WI)

**MOROCCO**—RTV Marocaine, 7135 in **AA** at 2326. (Brossell, WI) 15345 in **AA** with **ME** music heard at 2042. (Wood, TN)

Radio Medi Un, 9575 in **FF/AA** at 2300. (Charlton, ON) 2342 in **AA/FF**. **AA** ID at 0000. (Ronda, OK)

**NETHERLANDS**—Radio Nederland, 7380 in (p) **DD** at 2215. (Linonis, PA) 9795 via Singapore in Indonesian at 1232. (Ronda, OK)

**NEW ZEALAND**—Radio New Zealand Intl, 7145 at 0830 with Pacific Island news and some NZ local items. Moved to 9655 at 1100. (Linonis, PA) 9615 at 0623 with features, ID at 0632. (D'Angelo, PA) 15720 with news/weather at 0100. (Ng, Malaysia)

Mailbag pgm at 0330. (Barton, AZ) 2310 with poor audio. (Charlton, ON) 2324 news items and comments. (MacKenzie, CA)

**NIGERIA**—Radio Nigeria, Kaduna, 4770 with **EE** talks at 0516. (Wood, TN) 0534 with tribal vocals. (D'Angelo, PA)

Voice of Nigeria, 7255 at 2200 with **EE** news and local music. (Linonis, PA) 9690-Ikorodu at 1623 in Igbo. (Charlton, ON) 15120-Ikorodu in **EE** at 1720. News summary at 1730. (D'Angelo, PA) 1945. (Wood, TN)

**NORTH KOREA**—Voice of Korea, 7580 in **KK** at 1215 and 9335 in **KK** at 1237. (Brossell, WI) 1630 with soprano vocal. (Barton, AZ) 11710 at 1317 with usual **EE** propaganda. (Strawman, IA)

**OPPOSITION**—Radio Marti (to Cuba), 9565-Greenville in **SS** at 1732. (Charlton, ON) 13820 in **SS** at 2145. (MacKenzie, CA)

Radio Free Asia, 9455 via Northern Marianas in Cambodian at 1151. Also 11540 Northern Marianas in Burmese at 1415. (Strawman, IA) 9930-Northern Marianas, in **CC** at 1545. 13740 Saipan in **VV** at 2330 and 17880 Saipan in Mandarin at 0420. (MacKenzie, CA)

Radio Liberty, 11700-Philippines in **RR** at 1216. (Brossell, WI)

Radio Free Europe, 7175 via Germany in **RR** at 0315. (Brossell, WI)

Radio Nacional de la RASD, Algeria (to Morocco), 6300-Rabouni at 2336 with **SS** vocals and anncr. (D'Angelo, PA)

Radio Farda (to Iran), 9510 heard at 0208

in Farsi with **ME** vocals, frequent IDs. (D'Angelo, PA)

**PAPUA NEW GUINEA**—Radio West Sepik, Vanimo (New Guinea), 3205 (p) between 1030-1100. (Wilkens, FL)

**PERU** (*All in SS-gld*)—Radio Libertad, Junin, 5039 at 1030 with up-tempo music and M anncr. (Wood, TN) 1102 "en action Radio Libertad...nueva voz. (Wilkens, FL)

Ondas del Huallaga, Huanuco, 3329v at 1030. (Wilkner, FL)

Radio San Nicolas, San Nicolas, 5470.8 at 0006. "Maria en el corazon de mi amor." (Wilkner, FL)

Reyna de la Selva, Chachapoyas, 5486.7 at 1040. (Wilkner, FL)

Radio Bolivar, Ciudad Bolivar, 5460.1 at 0000, "en Valencia la senorita linda...belle." (Wilkner, FL)

Radio Manantial, Huancayo, 4990.9 at 1000. (Wilkner, FL)

Radio Sicuani, Sicuani, 4826v at \*1102, also 0010. (Wilkner, FL)

La Voz de la Selva, Iquitos, 4824.5 from \*1058 with "musica Andina." (Wilkner, FL)

Radio Tarma, Tarma, 4774.9 at 1030. (Wilkner, FL)

Radio Maranon, Jaen, 4835.6 at 2355-0010. (Wilkner, FL)

Radio Vision, Chiclayo, 4790 monitored at 0551 with preaching and echo effects. (Wood, TN)

**PHILIPPINES**—Radio Veritas Asia, 6115 in **EE**, then into **CC** at 2100. Also 11935 with **EE** ID and into Tamil at 0030. (Ng, Malaysia) 9720 at 2234 in listed Burmese. (Ronda, OK)

Far East Broadcasting Co., 9430 in Mandarin at 1225. (Strawman, IA) 9920 in **VV** at 1748. (MacKenzie, CA)

**PIRATES**—Northwoods Radio, 6925u variously at 0106 (on 6950), 0116 and 0126. Loon sounds at sign on. Address as northwoodsradio@yahoo.com, rock. (Hassig, IL) Noted at 0125, 1219. \*1957, parodies on America, loon IS and email. (Zeller, OH) 0134 with political satire, several IDs. (Wood, TN)

Wolverine Radio, 6925u, variously at 0043, \*0153 and 2336 guitar IS. ID, obscure rock. The IDs continue to sound like "Long Range Radio" to me. Still no address. (Zeller, OH) 0155 with variety of rock and jazz. (Hassig, IL)

The Crystal Ship, 5385.5 at 0000, 0121 with patriotic march, Yankee Doodle and similar, then into rock, usual "official voice of the blue states republic." Mention of a parallel 6700. (Zeller, OH) 0207 rock, ID and more rock. Mention of 6700. (D'Angelo, PA) 6700 at 0007 and 0134, patriotic marches and songs, 76 Trombones, some soft rock. (Hassig, IL) 0140 but very poor here on this frequency. (Zeller, OH)

WBNY, 6925u, at \*0110, also 1316 and 2250 with usual Commander Bunny stuff. (Zeller, OH)

Psycho/Sycko Radio, 6925u at 0205 and 0316 with various audio clips, a "real" pirate saying "Arrr-Arrr," bizarre heavy metal and



The much-used Julich transmitter site in Germany.

much talk about radio. (Hassig,, IL) 0309 with apparent live best and mentions of being on 6925.1 USB. (Wood, TN) 0318 with rock, ID mentioning "the spirit of pirate radio." (D'Angelo, PA)

Kraker Radio/Radio Jamba Intl, 6925u at 0128 with profane attacks on specific individuals. (Zeller, OH) (The Sediment Culture strikes again!)

WJPL, 6925u (t) at 1940 with parody of a NYC call-in show, discussion of bad taste. Frequency mentioned was 91.1. Others have convinced me this was a replay of an old WJPL show from New York. (Zeller, OH)

MAC Radio, 6850 at 0135. Played "Hang On Sloppy," European IS, and blues. (Hassig, IL)

Voice of Brian Wilson, 6925u \*2200, \*2221 with story about a man who finds a radio in his attic. Pgm continued story at 2221. (Zeller, OH)

Sunshine Radio, 6925u at 1800 very weak with rock. (Zeller, OH)

Chris the Pirate Radio, 6925u at 1423-1454. \* (Zeller, OH) Talking about outing people behind the pirate broadcasters. (Zeller, OH)

"Hour of Slack" relay, 6925u at 2321 with a parody about large groups of the population destined to be shot. Those who are not will be The "normal ones"—followers of J.B. "Bob" Dobbs. (Zeller, OH)

WTCR, 6925u at 0227 with rock and reggae from the 1900s. Belfast address and usual slogan of 20th Century radio. (Zeller, OH)

Radio El Loco, 6925u at 0234. No clear ID caught. Comedy pgm, one voice with a Spanish accent. (Wood, TN)

Radio Appalachia, 6924.8 at 2221 with banjo, then a bunch of rock thing snips and more banjos until clear ID at 2329. No address anncd. (Zeller, OH)



The Voice of Turkey. (Thanks Bob Combs, New Mexico)

Radio Free Speech, 6925u at 2319 with "Bill O Rights," parody of US NA at close. (Zeller, OH)

**PORTUGAL**—RDP Intl, 15560 with jazz at 1730. (Barton, AZ)  
**ROMANIA**—Radio Romania Intl, 7185 with "World of Culture" at 2210. (Fraser, ME) 9610 with Romanian pops at 2320. (Charlton, ON) 9790 at 2240 with telephone interview. (Linonis, PA)

**RUSSIA**—Voice of Russia, 7155-Komsomolsk-na-Amur in CC at 1300, 7175-Petropavlovsk in JJ at 1209, 7300-Khabarovsk in CC at 1105 and 12065-Chita in VV at 1242. (Brossell, WI) 7200 in CC at 1325. (Ng, Malaysia) 9435-Petropavlovsk at 0312 and 9860 via Vatican at 0245. (MacKenzie, CA) 9480 at 9230 with jazz show. (Linonis PA) 9665-Grigoriopol at 0136. (Charlton, ON) 9890, //12070 at 2010. (Fraser, ME) 13775-Vladivostok at 0415. (Barton, AZ)

Kamchatka Radio, 6075-Petropavlovsk at 1200 with bells IS and into Radio Rossii. (Brossell, WI)

Yakutsk Radio, 7200 at 1100 with ID, Radio Rossii pgmng. (Brossell, WI)

Radio Kyzyl, 6100 at 1200 sign on and RR news. (Brossell, WI)

**SAOTOME**—Voice of America Relay, 6060 with M playing pops at 0647. (Wood, TN) 6080 at 0607 with news. (D'Angelo, PA)

**SAUDI ARABIA**—BSKSA, 15205-Riyadh in AA with Koran at 1718. (Charlton, ON)

**SERBIA**—Intl Radio of Serbia, 6185 at 0100 with EE items. (Linonis, PA) 6190-Bijeljina at 2359 opening with news. Into II at 0030. (D'Angelo, PA) 0058 with news, several IDs. (Paszkiwicz, WI)

**SIERRA LEONE**—Cotton Tree News, 9525 via Ascension at 0735 with EE news, ID, talk in vernaculars, cut in mid-sentence at 0800. (D'Angelo, PA)

**SLOVAKIA**—Radio Slovakia Intl, 9440-Sobota reading listener letters at 0123. (Charlton, ON)

**SOUTH KOREA**—KBS World Radio, 9650 via Canada at 1226. (Yohnicki, ON) 1225. (Fraser, ME) 9770 in CC at 1130. (Ng, Malaysia)

**SPAIN**—Radio Exterior de Espana, 6155 at 2300. (Ng, Malaysia) 9535 in SS at 2355. (Charlton, ON) 9535 at 0330 in SS, 11680 in SS at 2335, 11815 Costa Rica Relay in SS at 1750 and 15110 in SS at 2200. (MacKenzie, CA) 15110 in SS at 2130 and 17595 in SS at 1656. (Barton, AZ)

**SWEDEN**—Radio Sweden Intl, 6010 via Canada at 0145. (Linonis, PA) 9490 via Canada at 0000. (Branco, NY) 9490 in Swedish monitored at 0320. (MacKenzie, CA)

**TAIWAN**—Radio Taiwan Intl, 9735 in listed JJ at 1207. (Brossell, WI) JJ at 1302. (Strawman, IA) 15600 via Florida at 2210. (Fraser, ME)

**TANZANIA**—Radio Tanzania, 11735-Zanzibar at 2002. (Strawman, IA) 1812 in Swahili. (Charlton, ON)

**THAILAND**—Radio Thailand, 7160 in presumed Thai at 1320. (Brossell, WI) 9835 with EE news at 1230. (Ng, Malaysia)

**TUNISIA**—RT Tunisienne, 7275 in AA at 0321. (Brossell, WI) 0425. (Yohnicki, ON) 9720 at 0230 with AA music, talk. (Linonis, PA) 0346 with news in AA at 0400. (D'Angelo, PA) 12005 at 1827. (Wood, TN)

**TURKEY**—Voice of Turkey, 7265//7325 with "DX Corner" at 0320. (Brossell, WI) 7325 in EE at 0332. (MacKenzie, CA) 9785 at 1916 in TT with modern Turkish music. (Charlton, ON) 13685 on Turkish cinema at 1315. (Ng, Malaysia)

**UKRAINE**—Radio Ukraine Intl., 7440 at 0230. (Linonis, PA) 0327 in UU. (MacKenzie, CA) 2330 with folk music and fairy tale readings. (Blanco, NY)

**USA**—Voice of America, 7255 Thailand Relay at 1150, into presumed Thai. (Brossell, WI) 9575 via Madagascar at 0424. (D'Angelo, PA) 9760 Philippines Relay at 1405 and 11825 in Mandarin at 1231. (Strawman, IA) 9335 Kuwait Relay in Dari at 1730, 13755 at 2318, 15410 at 11803. (MacKenzie, CA) 9815 via Bonaire in PP at 1820. (McKenzie, CA)

AFN/ARTS, 5446u-Key West at 1036 and 5746u-Guam at 1036. (Wood, TN) 12133.5-Key West monitored at 1244. (Brossell, WI)

WHRI, 9425 in GG at 1113. Unlisted. (Brossell, WI)

WEWN, Vandiver, 11530 in SS at 1735, 15410 via Morocco at



1800. (Charlton, ON) 15665 heard at 2203. (MacKenzie, CA)

Adventist World Radio, 5915 via Wertachtal at \*0259 EE and intro Tigrigna. (D'Angelo, PA) 11780 via Germany at 1756. (MacKenzie, CA)

Trans World Radio, 12085 via Novosibirsk, Russia, at (0045 to 0130\* in listed Bhojpur. (D'Angelo, PA)

WRMI, Miami, 9955 at 0007 with "Viva Miami" pgm. (Wood, TN)

Family Radio/WYFR, 11875 via Ascension at 2140. (D'Angelo, PA)

WBCQ, Monticello, 9330 religious pgm at 2006. (Wood, TN)

WWV, Ft. Collins, 20000 at 0001. (Mackenzie, CA)

**VATICAN**—Vatican Radio, 6040 via Canada in SS at 0320, 7305 in SS at 0335 and 13785 in CC at 0002. (MacKenzie, CA) 7335 in Tamil at 0106. (D'Angelo, PA) 15595 in AA at 1555. (Charlton, ON) 9610 in SS at 0200. (Branco, NY)

**VENEZUELA**—Radio Nacional (*all via Cuba—gld*), 9630 in SS at 0310 and 13680 in SS at 2327. (MacKenzie, CA) 13750 in SS at 2330. (Branco, NY) 15250 in SS at 2302. (D'Angelo, PA) 2316. (Charlton, ON)

Radio Amazonas, Puerto Ayacucho. (t) 4940v at 0524 in SS. Music and possible ID, but poor. (Wood, TN)

**VIETNAM**—Voice of Vietnam, 6175 via

Canada at 0130 in VV. (Charlton, ON) 0220 in EE/VV. (Linonis, PA) EE at 0345. (Mackenzie, CA) 0355. (Branco, NY)

**ZAMBIA**—The Voice-Africa, 4965 at 0147 with upbeat hymns. (Brossell, WI) 0446, including "CVC" ID. (D'Angelo, PA)

CVC Intl. 13590 at 1931. (Charlton, ON) 13590 in FF at 1238. (Brossell, WI)

And, once again, order is restored! Hat's off and glasses raised in thanks and appreciation to the following folks who submitted logs this time: Robert Wilkner, Pompano Beach, FL; Rick Barton, Phoenix, AZ; Stewart MacKenzie, Huntington Beach, CA; William Hassig, Mt. Prospect, IL; Robert Brossell, Pewaukee, WI; Joe Wood, Greenback, TN; Michael Yohnicki, London, ON; Jerry Strawman, Des Moines, IA; George Zeller, Cleveland, OH; Jim Ronda, Tulsa, OK; Robert Charlton, Windsor, ON; Jack Linonis, Hermitage, PA; Mike Branco, Islip, NY; Peter Ng, Johor, Malaysia; Rich D'Angelo, Wyomissing, PA; Sheryl Paszkiewicz, Manitowoc, WI; and Robert Fraser, Belfast, ME. Thanks to each one of you and, until next month, good listening! ■



**WorldPack II**  
Hands free transport for your mobile radio and power supply.



**Worldpouch for FT-817**  
Sleek 2-part fanny pack—maximum room for accessories.

**RadioBox**  
Padded, quality constructed, professional carry case for your late model mobile radio and gear.



**BagBattery**  
12V, 8 amp hour gel cell battery in tough, weatherproof padded bag.

831-427-8197 • KC6QLB  
www.powerportstore.com



# Monitoring Times

## ORDER TODAY!



Do you own a radio, a shortwave receiver, a scanning receiver, or a ham radio? Then Monitoring Times® is your magazine! Open a copy of MT, and you will find news, information, and tips on getting more out of your radio listening. In fact, it's the most comprehensive radio hobby magazine in the U.S.

MT Express - Not only do we offer a premium monthly printed magazine, but we also offer the popular MT Express digital version of Monitoring Times. This is the best way to get your magazine as soon as it's released, right from the internet! All you have to have is an internet connection with an e-mail address and you're ready for all the excitement of a truly interactive publication. For less than the cost of a printed subscription, you get the full magazine in pdf format with color photos throughout and active links to all web sites mentioned in the text.

Packed with up-to-date information concisely written by the top writers in the field, Monitoring Times® is your foremost guide to profiles of broadcasting and communications installations; home projects; and tips on monitoring everything from air, sea, and space to distant ports of call.

800-438-8155

828-837-9200 fax: 828-837-2216

WWW.GROVE-ENT.COM

order@grove-ent.com  
7540 Highway 64 West  
Brasstown, NC 28902



### Order today to start your monthly reference!

7540 Hwy. 64 West, Brasstown, NC 28902  
1-800-438-8155 US and Can., 828-837-9200, Fax 828-837-2216  
e-mail: grove@grove-ent.com

	6 Months	One Year	Two Years	Three Years
US Rates	<input type="checkbox"/> \$15.50	<input type="checkbox"/> \$28.95	<input type="checkbox"/> \$51.95	<input type="checkbox"/> \$74.95
US 1st Class	<input type="checkbox"/> \$30.00	<input type="checkbox"/> \$57.95	<input type="checkbox"/> \$112.00	<input type="checkbox"/> \$164.00
Canada 5th class*	<input type="checkbox"/> \$28.50*	<input type="checkbox"/> \$59.95*	<input type="checkbox"/> \$95.95*	<input type="checkbox"/> \$142.95*
Foreign International†	<input type="checkbox"/> \$38.75†	<input type="checkbox"/> \$79.95†	<input type="checkbox"/> \$151.95†	<input type="checkbox"/> \$225.95†
Electronic Subscription	<input type="checkbox"/> \$19.95	<input type="checkbox"/> \$38.95	<input type="checkbox"/> \$78.95	<input type="checkbox"/> \$117.95

\*All payments must be in U.S. Funds drawn on a U.S. Bank!

Name \_\_\_\_\_ Address \_\_\_\_\_  
City \_\_\_\_\_ State \_\_\_\_\_ Zip \_\_\_\_\_ Country \_\_\_\_\_  
CEP \_\_\_\_\_ Exp. Date \_\_\_\_\_ C/P2 Code \_\_\_\_\_  
Signature \_\_\_\_\_  
Email address \_\_\_\_\_  
MasterCard, Visa, and Discover Card accepted

Or just go to [www.grove-ent.com](http://www.grove-ent.com) to order NOW!

# DXpedition! The Signals Are Biting For Intrepid Broadcast Monitors

by Bruce A. Conti  
BAConti@aol.com

**L**ike astronomers searching the heavens for new stars, or marine biologists exploring the depths for new species, there are long-distance (DX) radio communications enthusiasts (DXers) who will go to extremes scanning the AM radio dial for exotic broadcast signals. These hardy DXers will go on a DXpedition, a radio expedition to a remote location far from the electrical noise and dial congestion of the city.

The best DXpedition locations are typically close to the ocean where the high conductivity of salt water can significantly improve reception. Not all good DX locations require an ocean view though, as we see here with our roundup of DXpedition reports and loggings, beginning in the desert southwest where distant AM radio signals were caught by surprise. All times are UTC.

## Skull Valley, Arizona

"I had quite an experience camping on a ranch between Iron Springs and Skull Valley, Arizona, hearing a bunch of DX on the last day, at midday."



Rick Barton takes a coffee break at his desert southwest DX campsite

exclaimed Rick Barton, an avid mediumwave DXer and regular Broadcast Technology contributor. "I don't know if it was great conditions or the location at Skull Valley, but if this is common then I may want to move there! I tuned in 640 KFI Los Angeles just before high noon. I didn't think I should be able to get LA at noon in Arizona, but I got an absolutely clear ID on it and some other stations before it was all over."

**640 KFI Los Angeles, California**, at 1901 with "KFI Traffic," then time check, "KFI news time 12:01."

**660 KTNN Window Rock, Arizona**, at 1845 with drums, Native American music, announcements and local spots in Navajo language.

**680 KNBR San Francisco, California**, at 1900 heard with an ID as "The Sports Leader."

**720 KDWN Las Vegas, Nevada**, at 1830 with talk and promo for "The Jerry Doyle Show."

**1270 KDJI Holbrook, Arizona**, at 2230 with replay of Hannity program and ID, "KVWM Show Low and KDJI Holbrook."

**1380 KLPZ Parker, Arizona**, at 1930 heard with music and IDs.

## Bermuda

Boston Area DXers club member Ross Comeau made sure he didn't forget to pack a radio for a Bermuda family vacation earlier this year. After all, Bermuda is a location many DXers have dreamed of visiting, so Ross wasn't about to pass up this opportunity. "It was interesting to DX from this location, about 700 miles offshore from the Carolinas, with plenty of salt water for radio signals to bounce off of, and located a lot closer to Europe, Africa, the Caribbean and South America," reported Ross. "My DXing consisted of evenings only, as the days were filled with other activities. Once the rest of my family settled into an evening of winding down with the TV, the DX session began out on the patio. With a Radio Shack DX-399 receiver, passive loop antenna, a notebook, pen, *WRTH*, and enough light from the hotel room to guide me, an evening of pleasurable DX was assured."



Ross Comeau outside the VSB Bermuda broadcast studios.

"In general terms, Cuban stations were plentiful, as well as numerous American stations from Boston down to Miami," said Ross of the overall experience. He continued,

There were so many Cuban stations, especially from the Radio Rebelde network, that writing down each one would have made these loggings a Cuban special. European signals were limited, perhaps due to my relatively late evening starting times, but the 1521 Saudi Arabia powerhouse came through loud and clear. I also visited the VSB radio studios while on the island. Having verified numerous broadcast stations, including VSB, this was the first time I'd ever actually been to a distant station that I QSLed. The DX received is just one more reason to love Bermuda as I hope to do this again.

**555 ZIZ Basseterre, St. Kitts & Nevis,** at 0013 BBC news program with discussion of Indonesian land issues; fair to good signal.

**570 CMDC Radio Reloj, Santa Clara, Cuba,** at 0228 several Radio Reloj IDs, constant time pips and some Morse code, mentions of Santiago and Cuba; booming signal!

**620 One Caribbean Radio, St. John's, Antigua,** heard at 0012 likely this with discussion in English, but with definite Caribbean accents; fair.

**630 WUNO San Juan, Puerto Rico,** at 0115 frequent mentions of Puerto Rico, doorbell and laser sound affects, and a generally lengthy talk. Despite severe interference from other Spanish speaking stations, managed to nail a clear "NotiUno" ID at 0132. Good to poor with severe fading and interference.

**660 WFAN The Fan, New York,** at 0142 noted with ID, promos, and ad for Sovereign Bank; good.

**680 WAPA San Juan, Puerto Rico,** at 0100 Spanish talk with numerous mentions of Puerto Rico and a jingle on the hour. Then WRKO Boston took over with talk about Bruins hockey. At this point, my wife Sue sent me up to the hotel to get a drink, during which time she was nice enough to listen to the radio, and reported hearing a jazz/blues station underneath WRKO, but no Spanish talk.

**700 Nationwide News Network, Hague, Jamaica,** at 0122 a political discussion about the crime problem in Jamaica. The Prime Minister and elections were also discussed, followed by a PSA about animals in Jamaica. Fair to good signal.

**790 WAXY South Miami, Florida,** at 0243, "The Ticket, your

home for Florida Marlins baseball," ads for timeshares, and promo for the Kevin Rogers show. Mentioned "27 years serving southern Florida." Good to strong signal.

**800 PJB TransWorld Radio, Bonaire, Netherlands Antilles,** heard at 0037 English religious programming from "Pastor Chuck," and a discussion of God's promises and Leviticus. Piano music at 0055, TWR address of PO Box 388, Bonaire, Netherlands Antilles given. Strong signal.

**1030 WBZ Boston, Massachusetts,** at 0222 Bruins hockey play by play; strong.

**1215 Virgin Radio, United Kingdom,** at 0205 pop music including "I Don't Want to Miss a Thing" by Aerosmith. Fair with moderate noise and much fading.

**1450 VSB1 Hamilton, Bermuda,** heard at 0027 1940s style of light jazz and 1950s doo-wop music. Signal came in with FM-like quality (of course).

**1521 BSKSA Dubai, Saudi Arabia,** at 0004 talk in presumed Arabic, with a severe het from 1520 WWKB Buffalo. The het was overwhelming, and the presumed Saudi station was fair to weak. At 0022 a booming signal with Koran and talk in Arabic and many mentions of Arabiya; no het from 1520 WWKB.

**1540 WDCD Albany, New York,** at 0033 a religious program with excited preaching, discussing a "mixture of light and darkness." Hoping to hear the Bahamas, but at 0130 heard clear WDCD Albany ID. Fair.

## Cape Cod, Massachusetts

After an old-fashioned antenna raising, Chris Black, N1CP, hosted a get-together at his home in West Yarmouth, giving several DXers the opportunity to experience mediumwave reception from this prime Massachusetts seacoast location. "The first order of business was the completion of a SuperLoop terminated loop antenna at the nearby home of fellow broadcast DXer Marc DeLorenzo with custom transformers and a phasing unit provided by Mark Connelly, WA1ION," said Chris. He continued,

By mid-afternoon, over a dozen DXers from all over New England had arrived. We had AM and FM radios going, including two varieties of the new software-defined radios, the RFSpace SDR-IQ and the WinRadio 313e. Both have their strong points and many got a chance to experiment with this new technology. We also had demonstrations of longwave aero beacon or NDB (non-directional beacon) DXing as well as the marine weather and safety NAVTEX broadcasts on 490 and 518 kHz, which require software to decode the SITOR mode B 100 baud transmissions. Following some good sunset mediumwave transatlantic receptions, we adjourned to a local restaurant to recap the day.

**657 RNE5 Madrid, Spain,** at 0000 fair in 660 WFAN New York slop; fanfare, "Radio Nacional de España, Informativos," parallel 684 kHz.

**666 RDP Antena 1, Portugal,** monitored at 2359 poor, in WFAN slop; woman in Portuguese, RDP time pips parallel 720 kHz.

**684 RNE1 Sevilla, Spain,** at 2359 good in 680 WRKO splatter; folk vocal parallel 738 kHz, time pips, and news.

**693 BBC Radio 5, United Kingdom,** at 2358 telephone talk, "909, 693" ID; good with synchro echo noted from delay between multiple network stations on the frequency.

**720 RDP Antena 1, Portugal,** at 2359 talk in Portuguese and RDP time pips heard under WGN Chicago, parallel 666 kHz. No sign of RNE5 Canary Islands.

**738 RNE1 Barcelona, Spain,** heard at 2359 folk music vocal parallel 684 kHz, not parallel 657 or 747 kHz, then 2400 time pips and news now parallel all RNE frequencies.

**750 YVKS Caracas, Venezuela,** at 0058 Leones de Caracas baseball coverage; good.

**765 RSR Option Musique, Sottens, Switzerland,** at 0100 jingle, "Option Musique, deux heures" time check, and news; good.



The DX flag marked the spot on Cape Cod for the get-together hosted by Chris Black, N1CP.

**770 HJXX Bogotá, Colombia**, at 0100 heard under WABC New York with an RCN network jingle and concert promo, parallel 760 kHz.

**790 CMAQ Radio Reloj, Pinar del Río, Cuba**, at 0200 news, minute marker, code ID, and syncopated clock; a good signal over unidentified Spanish.

**820 TBN Charlestown, St. Kitts & Nevis**, at 0200 "This is the Trinity Broadcasting Network..." and TBN promo; fair, over Radio Reloj, Cuba.

**837 France Info, Nancy, France**, at 0200 fanfare, France Info ID and time check into news, parallel 792 kHz.

**864 France Bleu, Villebon-sur-Yvette, France**, at 2200 France Bleu ID with montage, jingle with "Vingt trois heures" time check into a pop French vocal; good.

**882 BBC Radio Wales, Washford, England**, monitored at 2159 a brief announcement in English and orchestra instrumentals; good.

**1026 SER Spain**, heard at 0049 fair to good despite salt water path proximity to 1030 WBZ; talk parallel a good 1116 kHz signal.

**1134 Glas Hrvatske, Zadar, Croatia**, at 2020 an excellent S9+10 signal with sports commentary.

**1179 Radio Sweden International, Sölvesborg, Sweden**, at 2030 signature bells and ID into presumed Russian program per listings; excellent.

**1377 France Info, Lille, France**, at 2027 heard through 1380 WMYF splatter; news/talk in French.

## Cape Spear, Newfoundland

Allen Willie is a resident of St. John's, Newfoundland, where Marconi complet-

ed the legendary first transatlantic wireless communication in 1901. Despite already living in such a DX hotspot, a trip to a remote location away from city noise can still be well worth the effort. "I took the opportunity on a beautiful evening here to run down to Cape Spear, the most easterly point in North America, for some sunset ultralight DXing," reported Allen. "Transatlantic signals were in early, and by halfway through the session were very strong for the most part. Using the SRF-M37V barefoot ultralight receiver, logs were as follows."

**621 RNE Canary Islands**, monitored at 2340 heard with Spanish commentary; fair signal.

**693 RDP1 Azores**, at 2339 noted with a woman in Portuguese; good.

**909 BBC Five Live, United Kingdom**, at 2322 with talk in English; very strong.

**999 COPE Madrid, Spain**, at 2328 with commentary in Spanish, disco bumper music and ID; good.

**1008 Radio Punto, Canary Islands**, heard at 2340 commentary and ID in Spanish; very strong.

**1035 Radio Clube, Portugal**, at 2331 talk in Portuguese; good.

**1044 SER San Sebastian, Spain**, at 2332 a woman in Spanish parallel 1080 kHz; good.

**1053 LJB Tripoli, Libya**, at 2338 Arabic chants; very strong.

**1071 Radio Euskadi, Spain**, at 2320 commentary in Spanish; fair.

**1251 Voice of Africa, Tripoli, Libya**, monitored at 2330 commentary in Arabic; very strong.



**DXpedition to Haida Gwaii**  
Masset, Queen Charlotte Islands, Canada

**1314 RNE5 Cuenca, Spain**, monitored at 2344 talk in Spanish with Radio Nacional de España ID; fair.

**1377 France Info, Lille, France**, at 2317 news report in French about Canada; good.

**1431 Radio Sawa, Djibouti**, at 2325 news in Arabic, mentions of Iraq and Israel; good.

**1449 LJB Misurata, Libya**, at 2326 Arabic music; very strong.

**1494 France Bleu, Bastia, Corsica**, at 2345 talk in French; fair.

**1521 BSKSA Duba, Saudi Arabia**, monitored at 2318 commentary in Arabic; very strong.

**1575 Radio Farda, United Arab Emirates**, monitored at 2326 Arabic music and ID; good.

## Queen Charlotte Islands, British Columbia

The Queen Charlotte Islands of the Pacific northwest, or Haida Gwaii as it is referred to by natives, is where five skilled mediumwave DXers gathered for what's been described as the best ever DXpedition on this side of the world. "This DXpedition will go down as one of my most enjoyable and perhaps exhausting DXpeditions ever," wrote host Walt Salmaniw in retrospect. He continued.

Arriving during prime DX season, I immediately began DXing using an existing short 400-ft north/south Beverage. Upon the arrival of my first two guests, Bruce Portzer and Chuck Hutton, we proceeded in erecting a virtual DXers' paradise with numerous antennae including more Beverages, a Wellbrook phased array, and a small corner fed loop. Conditions for the most part were wonderful. My last morning appeared to be as good as an Asian opening as I've ever heard! John Bryant and Guy Atkins later joined us after a minor ferry delay, and jumped right into the serious DXing. Although quite cramped, we nonetheless were all quite comfortable, and enjoyed the sites and cuisine of Haida Gwaii.



Cabot Tower and the view overlooking St. John's harbor where Marconi achieved the historic first transatlantic wireless contact in 1901.

**549 Voice of Vietnam, My Van, Vietnam**, at 1245 parallel to 783 and possibly 1089 kHz at the same time. Strong at 1334 and parallel to 702 kHz.

**610 CKRW Whitehorse, Canada**, at 0542 on top with "You've got it locked on CKRW," then rock music. Weather, news headlines, and ID for CKRW 610 Whitehorse heard at 1331 UTC.

**684 Andaman Islands**, at 1425 Indian music parallel to shortwave 4760 kHz. Reception varied from poor to quite good.

**684 RNE1 Sevilla, Spain**, at 0413 heard with possible news and commentary at fair level. Later paralleled to 738 RNE1 Barcelona.

**810 LPRT Whitehorse, Canada**, heard at 0630 Environment Canada's rarely reported weather channel from Whitehorse heard here with continuous loop in English and French of local weather. Heard under co-channel KGO at fair level.

**810 AFN Tokyo, Japan**, monitored at 1453 R&B and rock music, AFN mention. Good, but fading and taking turns with other transpacific signals including Radio Rossii.

**837 France Info, Nancy, France**, at 0442 noted at fair level only, but definite French parallel 1206 and 1377 kHz.

**891 Chaîne 1, Algiers, Algeria**, at 0403 noted on the actual frequency of 890.97 kHz and programming was in Arabic. No ID heard, but this is the only Arabic speaker listed.

**990 JORK Kochi, Japan**, at 1315 with NHK1 phone talk parallel 594 after domestics faded out, faint Chinese talk in background.

**1008 GrootNieuws Radio, Flevoland, Netherlands**, monitored at 0425 Christian easy listening music, announcement, "Dit iss Grootnieuws Radio." Fair.

**1030 WBZ Boston, Massachusetts**, heard at 0500 a good signal way atop KTWO

Wyoming with several call IDs, then CBS news.

**1053 TalkSport, United Kingdom**, at 0429 good with ads, promo for rugby coverage, ID, and sports talk, perfect copy with Drake R8A receiver in 4 kHz selectivity.

**1134 Glas Hrvatske, Zadar, Croatia**, at 0351 good with pop music and talk in eastern European language, three slow time pips 0400 then woman with news. At 0405 sudden strong fade-up revealing clear "Glas Hrvatska" ID.

**1215 Virgin Radio, United Kingdom**, at 0340 with IDs, chatter, songs at sometimes excellent level. Heard several other evenings and usually the strongest European on the band.

**1251 Libyan Jamahiriya, Tripoli, Libya**, at 0342 fair but separable from 1250 with North African music, Arabic talk, and Koran, approaching Tripoli sunrise; fair to good.

**1260 JOIR Sendai, Japan**, at 1313 Japanese talk parallel to 1557 kHz. Poor to fair signal beneath strong Canadian sports talk show on 1260 kHz.

**1350 JOER Hiroshima, Japan**, at 1454 once dawn broke, domestic splatter was reduced to a minor nuisance with JOER well heard. Heard on other mornings equally well.

**1368 Manx Radio, Isle of Man**, at 0430 an ad in British-accented English surfaced briefly, gave a phone number mentioning "On Man, call..." Also a possible mention of Isle of Man later in the ad. Had bits of pop music before and after.

**1395 Big L, Trintelhaven, Netherlands**, at 0448 fair with oldies, promo giving station mailing address and phone number in England, "The Heart & Soul of Rock & Roll, Big L 1395."

**1422 RTA Algiers, Algeria**, at 0329 North African music good, Germany later took over the channel.

**1422 DLF Heusweiler, Germany**, at 0430

fair with jazz, Deutschlandfunk ID, time pip, into news in German, noted at many rechecks, sometimes better than 1420 domestics.

**1440 JOWF Sapporo, Japan**, at 1450 and always here dominating the channel as dawn approached. S9+20 dB signal of romantic Japanese flute music and female vocals in Japanese.

**1458 Capital Gold, Manchester, England**, monitored at 0401 fair to poor; news, weather for Manchester, promo with mentions of Capital Gold and "This is Gold."

**1530 VOA Pinheira, São Tomé**, at 0319 noted under KFBK at various times, caught mentions of Washington and Africa. Finally IDed 0430 with VOA mentions, VOA jingle, then Portuguese program; approaching São Tomé sunrise.

**1548 Deutsche Welle, Trincomalee, Sri Lanka**, at 1335 loud and clear in German; male and female announcers with news items or commentary. Deutsche Welle ID at 1345, and again at 1400. Drifting signal by approximately 30 Hz clearly seen on SDR-1000 spectrum display.

**1566 County Sound, Guildford, England**, at 0506 fair to poor with oldies, "County Sound Radio, 1566 mediumwave" ID. Listed as 750 watts!

## DXcellent!

As you can see, whether it's a well coordinated group event or an impromptu solitary effort, there's nothing like the excitement of a DXpedition for exotic and rare distant signals. May these DXpedition accounts inspire you to step outside your comfort zone for a new DXperience. Then share your story here in "Broadcast Technology." Until next time, 73 and Good DX! ■

# Situational Awareness Through The Automatic Packet Reporting System

by Dan Srebnick, K2DLS  
k2dls@arrl.net

Welcome to "RF Bits," a new bi-monthly column on computers in the radio hobby. Before I dive into my first submission, I thought I'd introduce myself. Since I recently turned 50, I've been doing a whole lot of self evaluation and discovery. But one thing is for sure: I am a radio guy. I have been since I was four years old and listened to funny sounds coming out of my father's Grundig Majestic 1088 tabletop receiver. My first television DX session occurred at age five when, early one summer morning, I noticed that *Captain Kangaroo* was coming in on a normally vacant channel.

If radio is somehow involved, I've tried it. I've

scanned the bands from longwave to mediumwave, and shortwave to VHF and UHF. I've contacted the International Space Station on 2 meters and once I even made a frequency modulated lightwave contact across my driveway.

I'm also an information technology (IT) guy. I was a beta tester for AOL and thought that it would never go anywhere. I had Internet email in 1992. I have worked as a software developer—we were called programmers in those days—a network engineer, and a sysadmin. I was involved in information security well before the term identity theft slipped into common usage. So it makes sense that *Pop'Comm* editor Edith

*"The amateur [Automatic Packet Reporting System] protocol provides a method of taking input from many sources and mapping them onto a display that shows location of resources, sensor alarms, weather data, and allows for exchange of text messages and bulletins."*

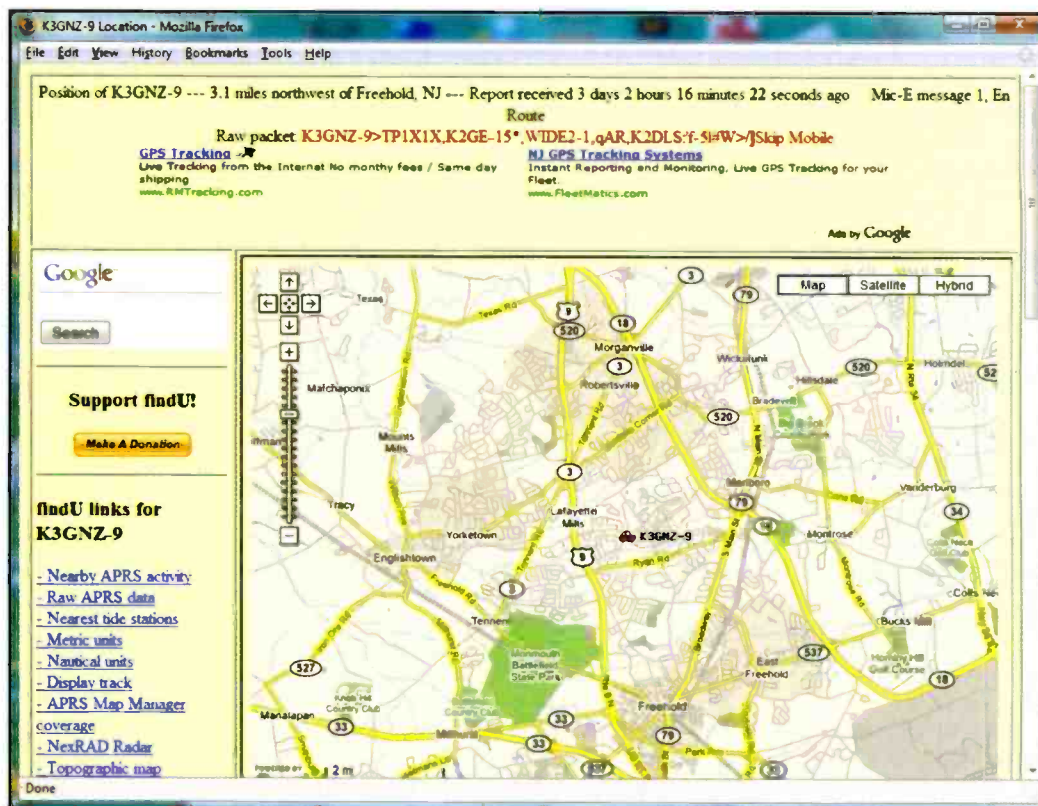

Figure 1. This map shows the current position of K3GNZ-9 (see text).

Lennon invited me to explore that place where radio and computing come together as one. There will be a lot of ground to cover, and I welcome your input as we move forward, but let's take that dive in right now and look at something I recently addressed in a feature for *Pop'Comm*, Automatic Packet Reporting System (APRS), and how that relates to what's known as situational awareness.

## Situational Awareness And APRS

Situational awareness refers to full and accurate knowledge of the current body of conditions that need to be considered to make an operational decision. Total situational awareness is necessary to ensure a successful military or police action, air safety, utility plant operation, and traffic management. The amateur APRS protocol provides a method of taking input from many sources and mapping them onto a display that shows location of resources, sensor alarms, weather data, and allows for exchange of text messages and bulletins.

## Take A Position

The most typical application that comes to mind when APRS is mentioned involves the use of a global positioning system (GPS) device as input to a mobile APRS data radio operating on 144.39 MHz. The APRS position report is a formatted data message sent at 1200 bps using a terminal node controller (TNC) and an FM-capable transceiver. The TNC includes a radio modem that generates the tones used to transmit the APRS data stream over the normal FM modulated signal.

The format of an APRS position report looks like this:

```
K2DLS>APU25N,NE2E-15*,WIDE
2-1,qAS,N2ARC:=4023.01N/07412.02
W-PHG2220 Dan in Aberdeen, NJ
```

Now you may not think that this string of data is too useful, but what if you could take the position and map it? The website [findu.com](http://findu.com), a database archiving weather, position, telemetry, and message info, allows you to do just that. Take a look at **Figure 1**. This is a mapped position report for K3GNZ (Skip), one of the active members of my local radio club. The [findu.com](http://findu.com) website is made aware of a station's position via the following method:

The station sends an APRS position report, which is received by an APRS station, called an iGate, connected to the Internet. The iGate station sends the

Call	callbook	msg	wx	lat	lon	distance	direction	Last Position
N2NQW-9	**			40 30300	-74 28750	0.0		06:22:20:07
K3GNZ-9	**			40 30300	-74 28750	0.0		03:02:21:42
K3GNZ	**			40 30300	-74 28767	0.0	W	00:04:21:25
K3GNZ-7	**	**		40 31100	-74 28683	0.5	N	00:05:44:51
N2SMV-10	**			40 27000	-74 29167	2.0	S	00:00:05:12
K2GE-15	**			40 28033	-74 33000	2.9	SW	00:00:08:27
KB2EAR	**			40 25067	-74 30000	3.2	S	01:00:07:40
CW8087	**	**		40 24583	-74 38833	7.0	SW	00:00:05:31
CW6852	**	**		40 39883	-74 21417	7.2	NE	02:20:28:39
K2DLS	**	**	**	40 39583	-74 20867	7.3	NE	00:00:07:19
N2WQL	**			40 20900	-74 37850	7.9	SW	07:07:35:13
KC2OBC-9	**			40 41500	-74 36450	8.2	NW	00:00:00:16
WB2ONA-12	**			40 41867	-74 37033	8.5	NW	04:23:05:56
K2GE-14	**	**		40 41883	-74 37067	8.6	NW	00:00:09:17
CW2192	**	**	**	40 15583	-74 26867	8.9	S	00:00:01:01
N2CYM-9	**	**	**	40 42683	-74 37733	9.2	NW	00:06:07:24
CW8271	**	**	**	40 19367	-74 41300	10.0	SW	00:00:09:23
K2GE-6	**	**	**	40 44850	-74 37000	10.0	NW	00:00:03:26
CW0479	**	**	**	40 43717	-74 38933	10.1	NW	00:00:05:50
WA2NKK-2	**	**	**	40 45933	-74 35033	10.1	NW	00:19:44:47

Figure 2. All objects in the general area of K3GNZ-9 are displayed.

position report on to the core APRS-IS servers. Findu.com obtains the position report via the APRS-IS servers and can plot the object and its position on a map. Findu.com will then map all position reports that it receives through the APRS iGates.

In an emergency situation, the ability

to map objects and their locations becomes extremely useful. Also useful is the ability to determine which objects (or stations) are in close proximity to one another. [findu.com](http://findu.com) can take an object's location and find all other APRS objects in the general area (see **Figure 2**).

Another way to find out what



Figure 3. Active APRS stations in my area. Note how the icon indicates the object's type or purpose.





According the Citizen Weather Observer Program webpage ([www.findu.com/citizenweather/signup.html](http://www.findu.com/citizenweather/signup.html)):

The Citizen Weather Observer Program (CWOP) is a private-public partnership with three main goals:

- to collect weather data contributed by citizens;

- to make these data available for weather services and homeland security;

- and to provide feedback to the data contributors so that they have the tools to check and improve their data quality. In fact, the web address, [wxqa.com](http://wxqa.com), stands for weather quality assurance.

Non-hams can also participate in the CWOP program, using the Internet as their transport for weather reports. This is a great way to help out your community. I find it interesting to look at the quality control analysis of my weather data as compared to the other weather stations in my area. The Meteorological Assimilation Data Ingest System (MADIS) project (<http://madis.noaa.gov/>) takes CWOP weather data and performs quality control checks on the data. Two thumbs up on the quality control analysis is what I aim for. To see the quality control analysis of my recent CWOP data, take a look at <http://weather.gladstonefamily.net/site/AS690>.

## Watch That Water Level

The recent floods in the heart of our nation show us the importance of situational awareness concerning the height of rivers and streams. With that in mind, some members of the Raritan Bay Radio Amateurs, a Sayreville, New Jersey, radio club, decided not to just talk about the tides but to do something about them. A few members of the clubs are also involved in supporting the South River Office of Emergency Management.

Last year, they deployed three FloodAdvisor devices along the South River in Central New Jersey. The FloodAdvisor is a self-contained water level reporting device with an integrated 1.5-watt APRS transmitter. If water levels are within normal tolerance, the APRS maps will display an H2O icon. However, as the water level rises above a preset flood mark, the icons will change to a "wave crest" icon, indicating that flooding may soon become a problem. The units will run for eight to 12 months on a single lantern battery. Battery life is prolonged by limiting reports to a short burst, once every 30 minutes.

One of the original sensors went silent last summer. The Pirates of South River (argh, Matey!) were dispatched on the South River Rescue Squad boat to investigate, and discovered that part of K2GE-6 had snapped off. The sensor was replaced and all is now well. You can use [findu.com](http://www.findu.com) to query the status of K2GE-5, K2GE-6 or K2GE-7; [www.findu.com/cgi-bin/water.cgi?call=K2GE5&last=120](http://www.findu.com/cgi-bin/water.cgi?call=K2GE5&last=120) shows the water levels as reported by the K2GE-5 FloodAdvisor over the last 120 hours.

## How Are Conditions?

Understanding of current propagation on 2-meter VHF is also part of situational awareness. The APRS network provides a simple way to understand how 2-meter signals are propagating. An APRS radio connected to an iGate has the ability to report what stations are being heard, and which have been heard directly, without benefit of digipeater. My iGate does just that, and the results can be seen on the screenshot from the [findu.com](http://www.findu.com) website in **Figure 5**.

As you can see, I am currently receiving WA2EE-1 at a distance of 103 km. This is on a J Pole antenna connected to my Alinco TR-135TP APRS radio. The J Pole is mounted on a pole in the yard and does not clear my roof, so this indicates that we may be in for a decent 2-meter enhancement this evening.

Jon Harder, NØØE, has a website that maps current 2-meter propagation characteristics, based upon this APRS data, at

[www.mountainlake.k12.mn.us/ham/aprs/index.html](http://www.mountainlake.k12.mn.us/ham/aprs/index.html).

Hopefully conditions are good at your location, too.

## From The Mailbag

I want to thank Alex, KM5YT, for making me aware of a very useful software driver called a "Virtual Audio Cable." It does exactly what the name describes, by allowing one to patch the audio output of one software-controlled device, such as sound card, into the input of another software-controlled device, such as a DRM decoder. This driver came in handy during my recent testing of the Perseus SDR receiver. I'll have more to say about the Perseus, and about VAC, next time. ■

## Licensed Before 1983?

QCWA invites you to join with those distinguished amateurs licensed 25 years or longer. Request an application from:

QCWA, Inc., Dept. P  
PO Box 3247  
Framingham, MA 01705-3247  
[www.qcwa.org](http://www.qcwa.org)



**PERSEUS** 10kHz + 30 MHz. SDR  
UP TO 1600 kHz. REAL TIME SPECTRUM DISPLAY AND RECORD  
SENSITIVITY: -131 dBm. (500 Hz. BW) 3rd order IP + 31 dBm.  
DYNAMIC RANGE: 104 dB (CW, 500 Hz. BW)



[www.ssbusa.com](http://www.ssbusa.com)

570-868-5643

# Emergency Communications And The Radio Hobbyist (aka YOU)

by John Kasupski, KC2HMZ  
kc2hmz@verizon.net

This month, I have the privilege of introducing a new bimonthly column dealing with emergency communications, or EmComm for short. This new column, which I am further privileged to have been asked to write, will deal with all the various forms of EmComm as it pertains to those of us involved in the hobby of radio. The scope of the column will run the gamut from hams involved in ARES, RACES, or other EmComm groups to REACT, the numerous Citizen Corps programs, and just plain average citizens using the available tools, including various forms of radio, to enhance their families' security and preparedness during difficult times.

My practical experience in disaster-related operations began in January 1977, when the area I live in was hit by what history now calls The Blizzard Of '77. Since I've previously mentioned it more than once in the pages of *Pop'Comm*, I won't repeat the details of that event. Suffice to say that I gained some valuable EmComm experience then, and also some experience helping

out at a Red Cross shelter that had been set up for victims of that storm.

Fast-forward 31 years. I'm currently a member of two EmComm teams, one of which I coordinate with another one of its members. I am also a trained CERT (Community Emergency Response Team) volunteer, a communications specialist with a local (county-level) implementation of the Civilian Medical Corps, and a trained SKYWARN spotter. Each of these associations in the EmComm field has resulted in various training opportunities for me. They've also provided the chance to participate in both exercises and actual disaster-related operations related to one incident or another that's happened where I live. For instance, in October of 2006, in between EmComm duties, I again found myself helping out at a Red Cross shelter that had been set up for victims of a severe winter weather event.

In the 31 years since I got my first experience after that storm, I've learned many things, but a



Photo A. This EmComm vehicle is equipped to support Amateur Radio Communications Teams up to ARCT-1 level of certification. We'll discuss that in upcoming columns. (Photos by the author)



Photo B. Craig Andersen, K1CRA, created this setup in a retired ambulance, including amateur radio television (ATV) among its capabilities.

few points in particular will guide me in my authorship of this column.

### Lessons Learned

The first of these points is that *preparedness* and *training* are the keys to successful operations to mitigate any type of incident. When the chips are down, the efforts we've made in order to prepare, and the training we have acquired along the way, are what gets us through. This is true whether you're an EmComm or other volunteer or a professional first responder.

To those who have dedicated themselves to working for the good of their communities in some capacity, either as volunteers or as professionals, these two points quickly become highly evident. My next point will become evident—but it is quite difficult to achieve.

You see, the whole concept of preparedness, in your community or in mine, can be visualized as a triangle. The government agencies that are concerned with disaster mitigation constitute one of the three legs, with the private sector (businesses and non-governmental organizations that are active in disaster mitigation) constituting the second. The third leg of the triangle is the average citizen or family—the general public.

It's easy enough to get the first two legs of the triangle established. In the first case, it's always been considered one of the duties of governments at all levels to *attempt* to ensure the well being of its citizens during emergencies. I use the word "attempt" because, by definition, a disaster overwhelms the resources available

for dealing with the incident. Disasters by their very nature frustrate efforts by the government to deal with them.

As for the private sector, organizations like the Red Cross, Salvation Army, and countless others have also made disaster mitigation their mission. Businesses are relatively easy to convince, because it's quite obvious that preparedness is beneficial to the bottom line and therefore in the best financial interests of businesses to prepare for the worst.

It's the general public that's difficult to reach, for various reasons. For example, how do you get people living in poverty to put away food for an emergency when they're already scrounging for their next meal? Worse yet, the public as a whole prefers to think that all those horrible events on the evening news could never happen to them. Earthquakes, hurricanes, tornadoes, floods, fires, acts of terrorism are all things that happen somewhere else, not here...until, that is, they finally *do* happen right here. Then, if we've failed to prepare for such an eventuality, we look up just in time to discover that we've become victims of the disaster. Not only are we in no position to help others, but we need help *from* others, and that in a situation where the people who need help will no doubt greatly outnumber the people who are in a position to provide assistance.

So, in addition to reporting on the efforts of various EmComm teams or groups, this column will also address how you and your family can become better prepared for disaster. These opportunities exist in abundance, whether or not you're

**TERRORISM FORCES  
US TO MAKE A  
CHOICE. WE CAN BE  
AFRAID. OR  
WE CAN BE READY.**

**READY**

**WWW.READY.GOV**

**1-800-BE-READY**



### When does my subscription expire?

Your subscription expiration information is located in the top line of the address label on each issue. Here's a rundown of what each of the numbers stand for:

Expiration Month = January Year (14)=2014

# of Copies

PC 12345 JAN 14 1  
RICH MOESON W2VU  
25 NEWBRIDGE ROAD  
HICKSVILLE, NY 11801-2345  
//////// (Bar Code)////////

First group of digits are the magazine's ID#; (CQ, PC, VHF).

Next group of digits your account number.

Followed by your expiration date month and year.

The last number denote the number of copies you receive.

**Additional questions?** Call or e-mail us anytime. We'll need your full name, address and zip code to process your inquiry.

**CQ Communications, Inc.**

516-681-2922; fax 516-681-2926;

or e-mail us at

<circulation@cq-amateur-radio.com>

part of an EmComm team or other group that's involved in the local emergency services community. It will be up to me to tell you about them; it will be up to you to take advantage of them. Please don't wait until it's too late to do so!

My last point for this month is related to your frame of mind. Regardless of what physical efforts you make toward preparedness, it's important to develop the proper mindset as well. That's because, in our efforts to avoid becoming the vic-

tim of something, the principles of personal security and situational awareness are of prime importance. Too many people sail through life relatively oblivious to what's going on around them. We need to stay informed, and we need to use all the tools at our disposal to accomplish this. That includes paying attention to things like the weather forecast, and paying attention to what people around you are doing (or not doing) when you're in a public place. It includes planning what

you and your family are going to do in the event of an emergency: Where are you going to go? How are you going to get there? How are you going to communicate with other family members?

These considerations all come under the umbrella of personal security and situational awareness, the importance of which cannot be emphasized enough. In any kind of an emergency, the unavoidable elements of fear, confusion, anxiety, and stress are abundant. Under such conditions, people don't necessarily think clearly and may make bad decisions. By planning ahead in this regard, you provide yourself and your family members with a safe blueprint for where to go and what to do.

## Radio's Place—And Yours

Once you and your family are safe, perhaps you can turn your attention to helping others. However, even if you don't, at least you'll have avoided becoming a victim, and have kept your family from becoming victims. Radio, of course, can play a part in this; after all your family does need to communicate, and radio is one form of communications that's available to everyone. Furthermore, radio, as has been demonstrated time and again, continues to work when other forms of personal communications, such as telephone networks, have gone down due to overloading or actual destruction in the disaster itself.

This column, then, will cover quite a bit of territory. I'll write it not only for people already involved in EmComm, but also for those who wish to become involved. I'll write it for those who simply wish to apply the principles that EmComm personnel have learned to protect themselves and their loved ones from becoming victims when the infamous balloon goes up.

As always, your input is welcomed and encouraged. I'm one person who has accumulated knowledge of the subject material, but I'm certainly not the only person who has, so feel free to fire off an email to the address that appears at the beginning of this column.

When Rich Arland was writing the "Homeland Security" column in this magazine, he often observed that "preparedness is not optional." To those words of wisdom, I will only add that preparedness is also not accidental. Becoming a victim can happen by accident—to avoid becoming a victim, you have to work at it! ■

## Tuning In (from page 5)

### Pop'Comm Today

It's more than fitting that in the same issue we say goodbye to the originator of this magazine that we should introduce a new phase in its development. At their best, magazines are a bit like life forms, changing, growing, developing, and changing again in response to their environment. *Pop'Comm's* undergone many tweakings and updates in its history, and this month we unveil another round.

Most obvious, of course, is the fresh, new design our production department wizards, Liz Ryan, art director, and Barbara McGowan, associate art director, have given it, starting right on the cover. It will now be easier to find at a glance what interests you and that much easier to read once you get there.

In addition to the physical changes we've refocused editorial content to better serve a changing readership in a changing world. Here's a quick rundown of what's new:

"Unwired"—Our hobby has a wonderfully quirky side to it that adds so much to the degree of fun involved. We revel in that with this addition to our news section and hope you'll enjoy the "Weirder Side Of Wireless" (and send us your own weird discoveries).

"Horizons"—This new monthly column bites off a lot as it follows trends in communications technology and attempts to glean hints of what the future may hold for radio hobbyists. But in this fast-paced environment, that's just what readers need.

"RF Bits"—This bimonthly column will examine the intersection of radio and computing, inarguably the most dynamic area of radio-related technology. It will touch on the Internet, podcasting, software-defined radio, software, digital modes, and, soon, stuff we don't even know about yet.

"EmComm Essentials"—Being able

to put their skills to use for the public good is the reason many of our readers are active radio operators in the first place. This column (also bimonthly) will look at all the different radio services that can be used for public service/safety, what equipment is being used, and how operators can best serve their communities.

### Other Changes

No longer in the magazine as a separate column is "REACT In Action." The important work REACT Teams do will be covered in the "EmComm Essentials" column as well as in features like last month's "A Nine-Year-Old CB Radio Hero" by former REACT columnist Ron McCracken.

To paraphrase William Shakespeare, "what's in a name change?" The answer is, still the terrific material brought to you by Tom Swisher, WA8PYR, in his "Plane Sense" column, only now it's called "Civil Aviation Monitoring." And we're giving the nod to the man, the ham, the legend behind "Radio Resources," Gordon West, WB6NOA, by making that column a namesake. Look for "Gordon West's Radio Ways" in an upcoming issue.

As always, we welcome your feedback and suggestions. Please contact me or any of the magazine authors directly and tell us what you think.

### A Clarification

Concerning the feature "Data Communications Via The International Space Station" in our September issue, it was pointed out to me that the subtitle—"What It Takes To Work This Sky-High APRS Digipeater (Hint: Not A Ham License)"—may have been misleading to some readers as the word "work" implies a two-way contact. While non-hams can receive the signals, they cannot transmit on the APRS frequencies. We regret any possible confusion.

## Sixty Meters—The Perfect Channel For A Challenge!

by Kirk Kleinschmidt, NTOZ  
kirk@cloudnet.com

**S**ummers have channels, as do CB radios and TV sets. The English have a *big* channel (and a *channel* underneath it), plus the picturesque Channel Islands (as do Californians). Cable TV has the History Channel and the Weather Channel, among many others. Stereos have two—and sometimes four—channels. And certain newagers claim to channel the energies of others.

Everyone uses channels, except in ham radio, right? Isn't that what ham radio beginners of yesteryear sought so doggedly—the ability to leave behind crystal control (channelization) and grab onto the silky smooth freedom afforded by the knob of a variable-frequency oscillator, the VFO?

Freedom from crystals and channels was a defining privilege available to those who studied hard and passed the amateur radio tests required for admission into the select group of radio exper-

imenters who could roam the bands at a whim. Go here. Go there. Go anywhere!

Want to know what's going on at the upper end of 40 meters? Turn the knob and find out! Don't like that high-pitched CW note? *Carefully* tweak the VFO and listen to the musical note of your choosing! CB radio jockeys, embassies, and even military ops, had channels—but we had VFOs!

### Freedom Was Ours, Right? Well...Mostly.

VHF/UHF ops are still channel-bound in some ways, which is a good and useful thing. The coordination of repeater inputs and outputs, for example, serves the greater good. Even the use of calling frequencies—channels of sorts—helps hams connect on sparsely populated bands that may open and close in a flash. With an exception for a “gentlemen's agreement” here or there, most HF hamming is VFO-controlled from band edge to band edge...except for our oddball “ham band” at 60 meters which, as you may already know, is *channelized*!

Getting started on our unusual and challenging five-channel ham band, from 5332 to 5405 kHz, is what this month's column is all about.

### 60 Meters, Warts And All

A stroke of the FCC's pen in mid-2003 gave U.S. amateurs secondary access to five discrete channels between 5332 and 5405 kHz—not your typical ham band, to be sure. And operating there isn't for everyone. Sixty-meter ops have to behave well, follow substantial restrictions, both operational and “electrical,” and stay out of the way of primary users (the military and the government, mostly). That's what secondary access means: Hams can't interfere with comms between primary users, and we have to stop transmitting on a particular frequency when asked to by primary users.



Steve Redway, G4TRA, who lives a bit northeast of Bristol, England, is an avid 60-meter op. Despite operating from a smallish suburban lot, at last count the 61-year-old (who also likes classic British sports cars) has worked 49 countries and 27 U.S. states as part of the UK's “5-MHz experiment.”

The U.S. ham frequencies are *centered* on 5332, 5348, 5368, 5373, and 5405 kHz, the last of which is allocated to UK hams, who have a similar channelized allocation at 5 MHz. Discrete channels—instead of even a small ham band such as our secondary allocation at 10 MHz—were the result of a compromise between the National Telecommunications and Information Agency (NTIA), which administers spectrum occupied by government licensees, the band's primary users, and the FCC. Essentially, the FCC was seeking a small secondary allocation near 5 MHz (at the request of hams), but the NTIA freaked out at the last second, agreeing only to the five discrete channels, which are available to General and higher-class licensees only.

Hams can transmit *only* USB at a maximum of 50 watts effective radiated power (ERP) and an audio bandwidth that doesn't exceed 2.8 kHz. All transmitted energy must be centered on the prescribed channels, which makes sense in government-speak, but takes some tweaking to accommodate the way hams measure frequencies and sidebands. Let's look at these restrictions one at a time.

**50 Watts ERP**—In the simplest terms, amateurs' maximum power for 5-MHz operation is equivalent to running 50 watts to a dipole—not a whole lotta power for non-QRPers! If you have an antenna that performs better than a dipole at 5 MHz, you have to do the math and reduce your RF output power to come in under the ERP limit set for the band. Conversely, if you're using a short mobile whip on your car, you must similarly do the math to determine how much additional power you can transmit to reach the 50-watt ERP limit.

Make sure you understand that the limit applies to transmitting power only. If you're fortunate enough to have a giant spider web of Beverage antennas for *receiving*, feel free to use them. For transmitting, it's back to the dipole, or whatever.

**Audio Bandwidth**—Most modern ham rigs are designed to have a transmitted audio bandwidth of between 2.4 and 2.8 kHz, and some DPS-based radios are even adjustable. And while it's difficult to imagine a 50-watt USB signal interfering with a primary user, there are a few precautions that make sense. This isn't the place to try out your "broadcast-quality" audio. Don't overmodulate, and turn off your RF speech processor, RF clipper, etc. If you have the ability to tailor your

transmit audio with a microphone equalizer or DSP, reign in those high- and low-frequency audio responses. Not enough to sound muffled and muddy, but enough to maintain compliance.

**Channel Centering and USB**—When the NTIA/FCC specify that your transmitted signal must be centered on 5332 kHz, for example, and not exceed 2.8 kHz in "width," that makes perfect sense in a decidedly non-ham fashion. Hams don't measure SSB frequencies "centered" on a particular frequency. We measure our carrier frequencies, which are offset by 1.5 kHz above or below the "channel center," depending on whether we're using upper or lower sideband.

In practical terms, which also happen to be approved by the NTIA in this situation, hams should set the frequencies displayed on their radios to 1.5 kHz *below* the allocated channel frequencies to make sure their USB signals are properly centered. Sound confusing? It's not, really. For Channel 1, 5332 kHz, set your rig to 5330.5 kHz. See the "Frequencies And Tuning" chart for the rest of the frequencies. For best results, enter the correct amateur tuning frequencies into your rig's memory for fast and accurate access.

### Frequencies And Tuning

Channel Center	Amateur Tuning
5332 kHz	5330.5 KHz
5348 kHz	5346.5 kHz
5368 kHz	5366.5 kHz
5373 kHz	5371.5 kHz
5405 kHz	5403.5 kHz*

\* common with UK channel allocation

Why use USB when the amateur convention is to use LSB below 20 meters? A reasonable guess is that USB is standard for government and military ops, and using USB only would give a primary user a better chance of communicating with a ham op on the same frequency. If we were operating PSK31 or some other non-USB mode, that would be practically impossible.

The FCC's rules for 5-MHz operation total fewer than 170 words and are spelled out in §97.303(s). How's that for uncharacteristic brevity?

### Radios

Some, but not all, modern ham transceivers can operate at 5 MHz or can be made to do so. Some rigs work right out

of the box (especially the latest models), some can be enabled by simply down-loading new firmware, and some require cutting a diode or jumper wire on an internal circuit board. These tweaks may enable your rig to operate from "DC to daylight," far outside the 60-meter band, so be sure to figure out consequences in advance. In addition to "greatly expanded" operation, snipping that diode may void your warranty. That said, point your Web browser to [www.ac6v.com/techref.htm#MODS](http://www.ac6v.com/techref.htm#MODS) for the lowdown on modifying your own rig.

If you have a favorite classic rig that works fine for SSB on the traditional ham bands, but doesn't have memory capabilities or drifts up and down a bit, don't try to use it on 60 meters. Remember, if things get out of hand, the NTIA could eliminate our fun with a wave of its mighty hand.

### On The Air

Operating at 5 MHz with 50 watts SSB isn't the easiest thing to do, although with everyone similarly handicapped, there are no "big guns" to step on your signal. Although with winter approaching (less noise and better propagation at low frequencies) things will probably perk up, static crashes and local electrical noise can plague operations below 20 meters. And with only five available channels, two of which are in use by primary users pretty much around the clock, 5 MHz will probably be unlike any hamming you've done to date.

Working hams on 60 meters is a bit like working through a repeater. It's not as formal, but hams break in now and then for quick signal reports and short QSOs. Ragchews aren't the norm, but when conditions are open locally or regionally, but shut down for longer ranges, ragchews are possible. And because emergency communications between the Southeast U.S. and the Caribbean actually prompted the creation of a 5-MHz allocation, you'll even hear regional emergency nets practicing for the real thing. Because of the band's unique operational and technical restrictions, 60-meter ops tend to be supportive, friendly, and downright cordial—a lot like 160-meter ops. You should do the same. There's just not enough room for traditional techniques at 5 MHz.

With 50 watts of SSB to a dipole, 60-meter signals will rarely "peg" your S-meter. QRP ops, however, will be in hog heaven. We've spent years working CW and SSB on 80 and 160 meters with 10

watts PEP or less, so 50 watts is big-time! Start by listening and, if you have the right gear and an appropriate license, test the waters. As you can imagine, propagation falls between 80 and 40 meters, with daytime signals out to several hundred miles, and nighttime signals to both coasts and beyond (with a lot of static and potential interference from primary users). You'll soon learn whether 5 MHz is your kind of band!

## DX, Operating Awards, Etc.

The thought of y'all working DX on 60 meters makes some regulatory types shiver. You see, the entire U.S. allocation at 5 MHz is more than a little tenuous. And DX fever can prompt illegal high power, a quick switch to illegal killer antennas, and worst of all, unsporting behavior on a few channels in the middle of radio nowhere that are supposed to be beacons of cordiality. This fear also extends to awards chasing, contesting, and anything else that might be fun!

So, remember that good behavior and strict compliance are *mandatory* for our continuing use of our tiny 5-MHz sliver of a band. And, as long as you can behave yourselves, check out the CQ Sixty Meters website (not affiliated with CQ magazine) at [www.60meters.net](http://www.60meters.net) for a ton of information about rules, regs, awards, contests, propagation—the works! Be sure to scroll down the entire page/site, because a lot of desirable links are near the bottom.

I was somewhat surprised to find that several people have worked all U.S. states and a ton of “countries” on 60 meters. I knew that UK hams share a common channel with U.S. hams and work across the pond regularly, but I didn't know that a lot of other countries have similar 60-meter allocations, and many that don't have official status there seem to “look the other way” when their hams work stations there.

## Operating Tips

Here are some pointers to keep in mind to get the most out of your experience on 60 meters:

- Make sure that you're on frequency and that you've turned off all audio processing, compression, etc., and are outputting a clean, fresh signal with no “enhancements.”

- Keep your antenna simple, especially at first. A dipole and 50 watts will work just fine.

- DSP audio processing (IF shift, noise blanker, notch filter) may be necessary for

*“...most HF hamming is VFO-controlled from band edge to band edge...except for our oddball “ham band” at 60 meters which, as you may already know, is channelized!”*

best reception. The deck is somewhat stacked against you, so fight back!

- Operators at 5 MHz are courteous (and expect courtesy). Practice the golden rule.

- Some channels, in some regions, are essentially useless for ham operations because of round-the-clock signals from military or government primary users. It goes with the territory.

- Listen to the band for a while before you mod your rig. Sixty meters isn't for everyone.

Whether specifically allocated or otherwise, 60-meter operation seems to be well (self) managed, with no reports of intentional interference, bad behavior, and excessive power. If you're looking for a new challenge, 60 meters may be your “channel.” See you there! ■

## Earn Your HAM RADIO LICENSE The Quick and Easy Way! No Morse Code Required!!



**GTWM**  
\$18.95  
+ \$6 S&H

Start earning your Technician ham license today! Get on the air and enjoy the fun hobby of amateur radio. Learn from the “Master” – Gordon West, WB6NOA. Study manual includes all possible test Q&A and more – or study at your PC using interactive practice exam software – NCS \$44.95 + \$6 S&H.



**GSTD**  
\$19.95  
+ \$6 S&H

*Getting Started in Electronics* is a complete electronics course in 128 pages! Forrest Mims teaches you the basics, takes you on a tour of analog and digital components, explains how they work, and shows how they are combined for various applications. 100 electronic circuits you can build and test!

## The W5YI Group

POB 565101 – Dallas, TX 75356

Order today on the web or call:  
[www.w5yi.org](http://www.w5yi.org) ♦ 800.669.9594

Want to know more about ham radio? Call us!  
Mention this ad to receive a free gift with your order!

# ATOMIC TIME

1010 Jorie Blvd. #332  
Oak Brook, IL 60523  
1-800-985-8463  
[www.atomictime.com](http://www.atomictime.com)



14" LaCrosse Black Wall  
WT-3143A \$22.95  
This wall clock is great for an office, school, or home. It has a professional look, along with professional reliability. Features easy time zone buttons. Just set the zone and go! Runs on 1 AA battery and has a safe plastic lens.

ADWA101 - \$49.95

Digital Chronograph Watch  
ADWA101 \$49.95  
Our feature packed Chrono-Alarm watch is now available for under \$50! It has date and time alarms, stopwatch backlight, UTC time, and much more!



WT-3143A - \$22.95



LaCrosse Digital Alarm  
WS-8248U-A \$49.95  
This deluxe wall/desk clock features 4" tall easy to read digits. It also shows temperature, humidity, moon phase, month, day, and date. Also included is a remote thermometer for reading the outside temperature on the main unit. approx. 12" x 12" x 1.5"

WS-8248 - \$49.95

1-800-985-8463  
[www.atomictime.com](http://www.atomictime.com)  
Quantity discounts available!



WT-5720U - \$24.95

LaCrosse WT-5720UU Clock \$24.95  
This digital projection clock is great for travel and fits in a small space. Shows 12 or 24 hour time, time zone, and alarm time. Size 5.25" x 1.25" x 4"

Tell time by the U.S. Atomic Clock - The official U.S. time that governs ship movements, radio stations, space flights, and warplanes. With small radio receivers hidden inside our timepieces, they automatically synchronize to the U.S. Atomic Clock (which measures each second of time as 9,192,631,770 vibrations of a cesium 133 atom in a vacuum) and give time which is accurate to approx. 1 second every million years. Our timepieces even account automatically for daylight saving time, leap years, and leap seconds. \$7.95 Shipping & Handling via UPS. (Rush available at additional cost) Call M-F 9-5 CST for our free catalog.

## Solar Cycle 24: Are We There Yet?

by Tomas Hood, NW7US,  
nw7uw@arrl.net

*“While the cycle ‘officially’ started in March 2008, we’re all wondering when the sunspot activity will really start...”*

Everyone in the radio hobby who relies on the sun for supporting long-range communications via the shortwave radio spectrum is waiting with mixed emotions for the start of Solar Cycle 24. While the cycle “officially” started in March 2008, we’re all wondering when the sunspot activity will *really* start, when the steady rise of the sunspot numbers will usher in world-wide excitement on the higher HF bands.

I’ve reported before that it’s not unusual to see a prolonged period of quiet between two solar cycle periods. There’s even evidence that solar cycle minimums may occur in double “valleys,” just as the peak of a cycle may occur twice. It’s not a surprise that we’re still in the depths of a “sleeping” sunspot cycle.

There is a lot of chatter, however, that this prolonged silent period has been good for some forms of DX. The report from the lowest bands is not very encouraging, however. Many report that activity on 160 and 80 meters is disappointing, if not discouraging. Perhaps, though, we ought to see what transpires this month and through the winter. With the planetary A-Index ( $A_p$ ) averaging lower this time around (as compared to the last solar cycle minimum, as illustrated in the two comparison charts of **Figure 1**), and with the possible slight increase in sunspot activity, could we see some more encouraging and exciting “top band” activity?

Tropical band DXing has been moderately exciting. So has AM-band (mediumwave) DXing. Again, I believe that there has been some benefit from the lower  $A_p$  numbers recorded in the last 12 months.

Looking at **Figures 2 and 3**, we do see that the predicted rise in Solar Cycle 24 should begin right away. This rise has been forecasted for several months now, and as each new month of real data is added to the equations used to create the forecast, there’s been very little change in this forecast. This could mean that by the time you read this, we’ll be seeing a slight increase in the number of sunspots peppering the solar disc.

Stay tuned: each month will reveal the unfolding story of the new cycle. And, please write in with any reports of your observations of DXing on any of the radio bands.

### HF Propagation

Paths on 31 through 19 meters are becoming ever more reliable between North America and Europe in the mornings and between North America and Asia during the late afternoon hours. The strongest openings occur for a few hours after sunrise and during the sunset hours. Thirty-one and 25 meters will often remain open into many areas late into the night and will open early in the morning, especially when part of the propagation path moves through sunlit regions. Twenty-two and 19 may still offer nighttime paths, though these will become less reliable later in November.

Nineteen, 22, and 25 meters compete with 16 for the good daytime DX during November. They will open for DX just before sunrise and should remain open from all directions throughout the day, with a peak in the afternoon. Nighttime conditions will favor openings from the south and tropical areas. Since the Southern Hemisphere has long daylight hours, DX paths on these bands from stations in the south will be common.

The all-season bands, 31 and 25 meters, are crowded and signals are usually very strong and steady. Twenty-five meters is expected to be an excellent band for medium distance (500 to 1,500 miles) reception during the daylight hours. Longer distance reception (up to 2,000 to 3,000 miles) should be possible for an hour or two after local sunrise, and again during the late afternoon and early evening. Heavy congestion will occur here since many international and domestic broadcasters make use of 25 meters. Thirty-one meters, the backbone of worldwide shortwave broadcasting, will provide medium-distance daytime reception ranging between 400 and



1,200 miles. During November, reception up to 2,500 miles is possible during the hours of darkness, and until two to three hours after local sunrise. Thirty-one meters, too, is highly congested, making reception of weak exotic signals a bit more of a challenge.

Thirteen and 16 meters will be open during a fair number of days through November when flux levels remain above 100. Paths from Europe and the South Pacific as well as from Asia, at least during days of higher solar flux levels, are common, especially on 16 meters. Look

for best conditions from Europe and the northeast before noon and from the rest of the world during the afternoon hours. Reception from the South Pacific, Australia, New Zealand, and the Far East should be possible well into the early evening. At this stage in the solar cycle, the 10.7-cm flux levels are too low to sustain band openings at these frequencies for long, if at all.

Seventy-five through 120 meters are coming alive, though. Signals below 120 meters are improving, too. Throughout November, expect an improvement in nighttime DX conditions on these bands. Since the night is longer, and there is the seasonal decrease in static "noise" levels, expect good long-range DX on the low bands, starting with signals from closer locations right after sunset, and then extending to areas farther away as the night develops. Europe should be possible in the late evening. DX paths will move farther west through the night. By morning openings from Asia should be common.

## VHF Conditions: Meteor Showers

One of the largest yearly meteor showers occurs during November. This year, however, we expect a modest showing. Appearing to radiate out of the constellation of Leo, this shower is known to create intense meteor bursts. Large, spectacular visuals might occur only 10 to 20 times per hour during the peak. Remember, though, that when we're talking about meteor scatter radio propagation, we count any meteor-formed plasma clouds that will support VHF radio signals.

The best time to work meteor scatter off the Leonids is around 11:30 p.m., local time, in the Northern Hemisphere. The shower should increase in rate the closer you get to midnight, and then move toward pre-dawn. The shower period starts on November 10 and ends on November 23, with the expected peak occurring on the night of November 17. Expect about 20 visuals per hour during the peak.

## Working Meteor Scatter

Meteors are particles (debris from a passing comet) ranging in size from a speck of dust to a small pebble, and some move slowly while some move fast. When you view a meteor, you typically see a streak that persists for a little while after the meteor vanishes. This streak is called the *train* and is basically a trail of glowing

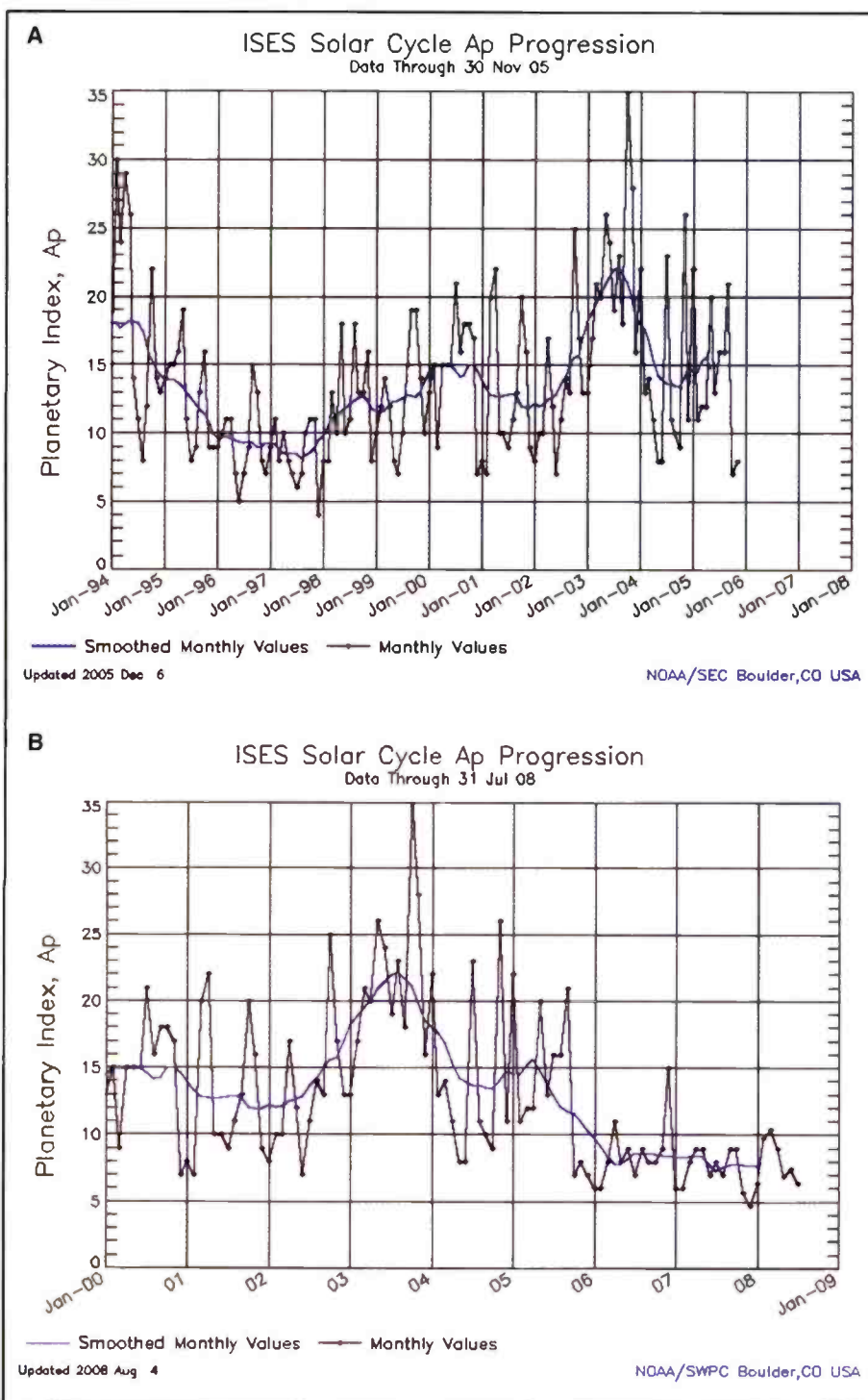

Figure 1(A) and (B). The graph on the top (A) records the planetary  $A_p$  progression from January 1994 through November 2005. Look at the period from about January 1996 through January 1999, which covers the solar cycle minimum between Solar Cycles 22 and 23. Now, look at the current solar minimum recorded in the graph on the bottom (B), which shows a generally lower  $A_p$  activity than during the last cycle minimum shown in the top chart. (Source: NOAA/SEC)

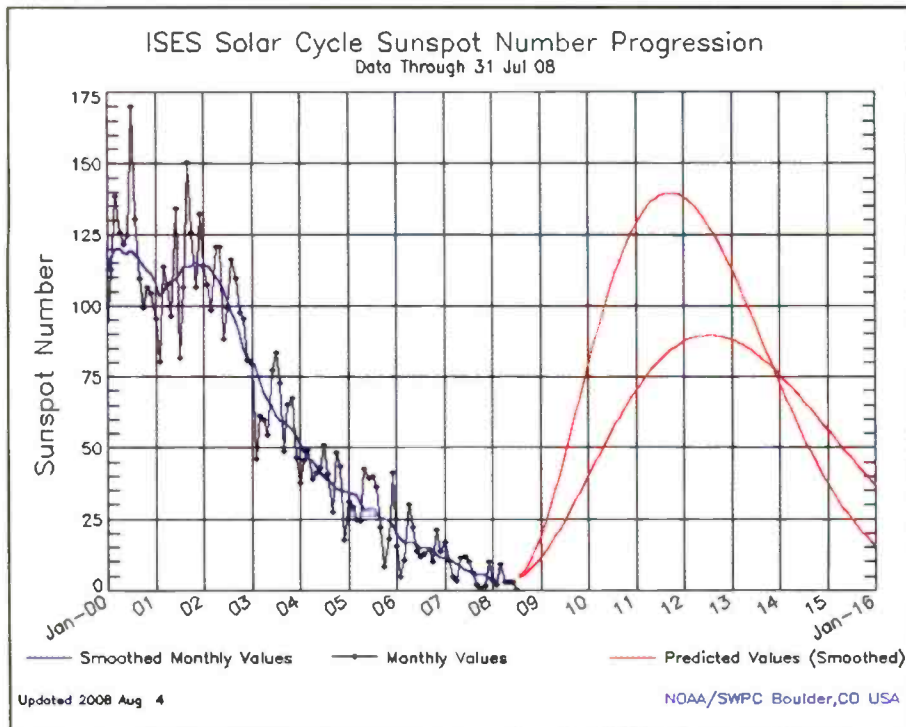

Figure 2. The current Solar Cycle progression as of August, 2008. This chart records the sunspot activity. The red line indicates the predicted rise in activity. Let's hope that this rise in activity occurs! (Source: NOAA/SEC)

plasma left in the wake of the meteor. Meteors enter the Earth's atmosphere traveling at speeds of over 158,000 miles per hour. Besides being fast, the Leonids usually contain a large number of very bright meteors. The trains of these bright meteors can last from several seconds to several minutes. It is typical for these trains to be created in the *E* layer of the ionosphere.

Meteor scatter propagation is a mode where radio signals are refracted off these trains of ionized plasma. Because the trains are in the *E* layer, the range of a meteor scatter contact is between 500 and 1,300 miles. The frequencies that are best refracted are between 30 and 100 MHz. However, with the development of new software and techniques, frequencies up to 440 MHz have been used to make successful radio contacts off of meteor trains.

Lower VHF frequencies are more stable, and last longer, off ionized trains. A six-meter contact may last from a second to well over a minute. The lower the frequency, the longer the specific "opening" made by a single meteor train. Conversely, a meteor's ionized train that supports a 60-second-long refraction on

## The Ap Index And Understanding Propagation Terminology

The Ap index, or Planetary A index, is a 24-hour averaging of the Planetary K index. The Planetary K index is an averaging of worldwide readings of Earth's geomagnetic field. High indices ( $K_p > 5$  or  $A_p > 20$ ) mean stormy conditions with an active geomagnetic field. The more active, the more unstable propagation is, with possible periods of total propagation fade-out. Especially around the higher latitudes and at the polar regions, where the geomagnetic field is weak, propagation may disappear completely. Extreme high indices may result in aurora propagation, with strongly degraded long-distance propagation at all latitudes. Low indices result in relatively good propagation, especially noticeable around the higher latitudes, when trans-polar paths may open up. Maximum K-index is 9, and the A-index can exceed well over 100 during very severe storm conditions, with no maximum.

Classification of A indices is as follows:

A0-A7 = quiet	A30-A49 = minor storm
A8-A15 = unsettled	A50-A99 = major storm
A16-A29 = active	A100-A400 = severe storm

**Solar Flux Index (SFI):** This flux number is obtained from the amount of radiation on the 10.7-cm band (2800 MHz). It is closely related to the amount of ultraviolet radiation, which is needed to create the ionosphere. Solar Flux readings are more descriptive of daily conditions than the Sunspot Number. The higher the Solar Flux (and, therefore, the higher the Sunspot Number), the stronger the ionosphere becomes, supporting refraction of higher frequencies.

**Ionosphere:** A collection of ionized particles and electrons in the uppermost portion of the Earth's atmosphere, which is formed by the interaction of the solar wind with the very thin air particles that have escaped Earth's gravity. These ions are responsible for the reflection or bending of radio waves occurring between certain critical frequencies, with these critical frequencies varying with the degree of

ionization. As a result, radio waves having frequencies higher than the Lowest Usable Frequency (LUF) but lower than the Maximum Usable Frequency (MUF) are propagated over long distances.

**Smoothed Sunspot Number (SSN):** Sunspots are magnetic regions on the sun with magnetic field strengths thousands of times stronger than the Earth's magnetic field. Sunspots appear as dark spots on the surface of the sun. Temperatures in the dark centers of sunspots drop to about 3700° K (compared to 5700° K for the surrounding photosphere). This difference in temperatures makes the spots appear darker than elsewhere. Sunspots typically last for several days, although very large ones may last for several weeks. They are seen to rotate around the sun, since they are on the surface, and the sun rotates fully every 27.5 days.

Sunspots usually occur in a group, with two sets of spots. One set will have positive, or north, magnetic field while the other set will have negative, or south, magnetic field. The field is strongest in the darker parts of the sunspots (called the "umbra"). The field is weaker and more horizontal in the lighter part (the "penumbra").

Galileo made the first European observations of sunspots in 1610. The Chinese and many other early civilizations have records of sunspots. Daily observations were started at the Zurich Observatory in 1749; continuous observations were begun in 1849.

The Sunspot Number is calculated by first counting the number of sunspot groups and then the number of individual sunspots. The Sunspot Number is then given by the sum of the number of individual sunspots and 10 times the number of groups. Since most sunspot groups have, on average, about 10 spots, this formula for counting sunspots gives reliable numbers even when the observing conditions are less than ideal and small spots are hard to see. Monthly averages (updated monthly) of the Sunspot Numbers show that the number of sunspots visible on the sun wax and wane with an approximate 11-year cycle.

For more information, see <http://prop.hfradio.org>.

## Optimum Working Frequencies (MHz) - For November 2008- Flux = 68, Created by NW7US

UTC	00	01	02	03	04	05	06	07	08	09	10	11	12	13	14	15	16	17	18	19	20	21	22	23	
TO/FROM US WEST COAST																									
CARIBBEAN	17	13	11	10	10	10	9	9	9	9	8	8	8	8	15	17	18	19	20	20	20	20	19	19	
NORTHERN SOUTH AMERICA	24	22	17	14	13	13	12	12	12	11	11	11	11	11	18	22	24	26	27	27	27	27	26	26	
CENTRAL SOUTH AMERICA	24	21	15	14	13	13	12	12	12	12	11	11	11	11	19	23	25	26	27	27	27	27	26	25	
SOUTHERN SOUTH AMERICA	26	24	20	15	14	13	13	12	12	12	12	11	11	11	16	22	24	25	26	26	26	27	27	28	27
WESTERN EUROPE	8	8	8	8	8	8	7	7	7	8	8	8	8	7	8	12	13	13	12	11	9	8	8	8	
EASTERN EUROPE	8	8	8	8	7	7	7	7	8	8	8	8	8	7	7	10	12	11	9	9	8	8	8	8	
EASTERN NORTH AMERICA	19	16	12	11	11	11	10	10	10	10	9	9	9	9	16	19	20	21	22	22	22	22	21	20	
CENTRAL NORTH AMERICA	11	10	8	7	6	6	6	6	5	5	5	5	5	5	9	10	11	12	12	12	12	12	12	12	
WESTERN NORTH AMERICA	6	6	5	4	3	3	3	3	3	2	2	2	2	2	3	5	6	6	6	6	6	6	6	6	
SOUTHERN NORTH AMERICA	19	17	14	11	10	10	10	9	9	9	9	9	9	8	12	16	18	19	20	21	21	21	20	20	
HAWAII	18	17	16	15	13	10	9	9	8	8	8	8	7	7	7	7	14	16	17	17	18	18	18	18	
NORTHERN AFRICA	8	8	8	8	8	8	8	8	8	8	8	8	8	8	11	13	14	15	15	12	10	9	9	9	
CENTRAL AFRICA	10	10	9	9	8	8	8	8	8	8	8	8	8	7	9	12	14	14	15	12	12	11	11	10	
SOUTH AFRICA	17	13	11	11	10	10	10	10	9	9	9	9	9	9	15	18	19	20	20	20	20	20	19	18	
MIDDLE EAST	8	8	8	8	8	8	8	8	8	8	8	8	8	7	7	11	12	10	9	9	9	8	8	8	
JAPAN	16	16	15	14	13	10	9	9	8	8	8	8	8	8	8	8	8	8	8	8	8	13	15	16	
CENTRAL ASIA	16	16	15	14	13	10	9	9	8	8	8	8	8	8	8	8	8	10	10	9	9	15	17		
INDIA	7	12	11	9	8	8	8	8	8	8	7	7	7	7	7	8	7	7	7	7	7	7	7	7	
THAILAND	16	15	15	14	12	9	9	9	8	8	8	8	8	8	8	8	8	10	10	10	10	10	9	13	
AUSTRALIA	23	24	25	23	20	15	14	13	13	12	12	12	11	11	11	11	11	15	14	13	16	18	20	22	
CHINA	15	15	14	13	11	9	9	9	8	8	8	8	8	8	8	8	8	8	8	8	8	8	8	12	
SOUTH PACIFIC	26	26	25	23	19	15	14	13	13	12	12	12	11	11	11	11	15	14	16	19	21	22	24	25	
TO/FROM US MIDWEST																									
CARIBBEAN	18	13	12	12	11	11	10	10	10	10	10	9	9	17	20	22	23	23	24	24	23	23	22	21	
NORTHERN SOUTH AMERICA	21	18	15	14	13	12	12	11	11	11	10	10	10	17	20	22	24	25	26	26	26	25	24	23	
CENTRAL SOUTH AMERICA	22	16	15	14	13	13	12	12	12	12	11	11	11	21	23	24	25	26	27	27	28	27	26	24	
SOUTHERN SOUTH AMERICA	24	21	17	16	15	14	13	13	12	12	12	12	11	17	21	23	24	25	26	26	27	27	27	26	
WESTERN EUROPE	8	8	8	8	8	7	7	7	7	8	7	7	7	12	14	15	15	14	14	12	10	9	9	8	
EASTERN EUROPE	8	8	7	7	7	7	7	7	8	8	8	7	10	11	11	11	10	9	8	8	8	8	8	8	
EASTERN NORTH AMERICA	13	9	9	8	8	8	7	7	7	7	7	7	7	11	13	15	15	16	16	16	16	16	15	14	
CENTRAL NORTH AMERICA	6	5	4	4	3	3	3	3	3	3	3	3	3	3	5	6	7	7	7	7	7	7	7	7	
WESTERN NORTH AMERICA	11	10	9	7	6	6	6	6	5	5	5	5	5	5	9	11	11	12	12	12	12	12	12	12	
SOUTHERN NORTH AMERICA	13	11	8	8	7	7	7	6	6	6	6	6	6	6	11	13	14	14	15	15	15	15	14	14	
HAWAII	20	19	17	14	11	11	10	10	9	9	9	9	9	9	9	12	17	19	20	21	21	21	21	20	
NORTHERN AFRICA	10	9	9	9	8	8	8	8	8	8	8	8	10	14	15	16	17	17	17	16	12	12	11	11	
CENTRAL AFRICA	10	9	9	9	8	8	8	8	8	8	8	8	9	13	15	16	17	17	17	12	12	11	11	10	
SOUTH AFRICA	17	14	13	13	12	12	12	12	11	11	11	11	17	22	24	25	26	27	27	27	26	24	22	20	
MIDDLE EAST	8	8	8	8	8	8	8	8	8	8	8	8	8	12	14	15	15	13	10	9	9	9	8	8	
JAPAN	15	15	13	10	9	9	9	8	8	8	8	8	8	8	8	8	8	8	8	8	8	12	15	16	
CENTRAL ASIA	15	14	13	9	9	9	8	8	8	8	8	8	8	8	8	8	10	10	10	10	9	9	13	16	
INDIA	7	7	7	7	7	7	7	7	7	7	7	7	7	7	7	7	7	7	7	7	7	7	7	7	
THAILAND	14	13	11	9	9	8	8	8	8	8	8	8	8	8	8	10	11	10	10	10	10	10	9	9	
AUSTRALIA	23	24	22	18	14	13	13	12	12	12	11	11	11	11	11	16	15	15	14	14	16	19	21	22	
CHINA	14	13	11	9	9	8	8	8	8	8	8	8	8	8	7	8	8	8	8	8	8	8	8	11	
SOUTH PACIFIC	26	24	22	16	14	14	13	13	12	12	12	11	11	11	11	15	15	15	17	20	22	23	24	25	
TO/FROM US EAST COAST																									
CARIBBEAN	14	11	10	10	9	9	9	8	8	8	8	8	13	16	17	18	19	19	19	19	19	18	18	16	
NORTHERN SOUTH AMERICA	18	16	15	14	13	12	11	11	10	10	10	9	14	17	19	21	22	23	23	23	23	23	22	20	
CENTRAL SOUTH AMERICA	20	18	17	16	15	14	13	13	12	12	12	14	19	21	23	24	25	26	27	27	27	27	25	23	
SOUTHERN SOUTH AMERICA	23	20	18	17	16	15	14	13	13	12	12	12	18	20	21	23	24	25	26	27	27	27	27	25	
WESTERN EUROPE	8	8	8	7	7	7	7	7	7	7	7	11	14	15	15	15	15	15	14	13	11	9	8	8	
EASTERN EUROPE	8	8	8	7	7	7	7	7	8	7	7	9	13	13	13	13	12	11	9	8	8	8	8	8	
EASTERN NORTH AMERICA	5	4	4	4	3	3	3	3	3	3	3	3	5	6	7	8	8	8	8	8	8	7	7	6	
CENTRAL NORTH AMERICA	13	9	9	9	8	8	8	7	7	7	7	7	7	12	14	15	16	17	17	17	17	16	15		
WESTERN NORTH AMERICA	19	16	12	11	11	11	10	10	10	10	10	9	9	9	16	19	20	21	22	22	22	22	21	20	
SOUTHERN NORTH AMERICA	15	11	10	9	9	8	8	8	8	8	8	7	7	13	15	17	18	18	19	19	18	18	17	16	
HAWAII	20	17	12	12	11	11	10	10	10	10	10	9	9	9	10	9	14	19	21	22	23	23	22	21	
NORTHERN AFRICA	10	10	10	10	10	9	9	9	9	9	9	17	19	21	21	22	22	21	20	17	12	12	11	11	
CENTRAL AFRICA	11	10	10	10	10	10	10	9	9	9	17	19	21	22	22	22	21	18	14	13	12	12	11	11	
SOUTH AFRICA	15	14	13	13	12	12	12	12	11	11	11	20	24	26	27	27	27	27	27	27	26	24	22	16	
MIDDLE EAST	9	9	9	8	8	8	8	8	8	8	8	13	15	16	17	17	18	17	12	12	11	11	10	10	
JAPAN	13	10	9	9	9	8	8	8	8	8	8	8	8	8	8	8	8	8	8	8	8	11	14	15	
CENTRAL ASIA	12	9	9	9	8	8	8	8	8	8	8	8	8	8	11	10	10	10	10	10	9	9	14		
INDIA	8	8	8	8	8	7	7	7	7	8	8	8	11	13	15	13	10	9	9	9	8	8	8	8	
THAILAND	9	9	9	8	8	8	8	8	8	8	8	8	8	12	12	11	10	10	10	10	10	10	9	9	
AUSTRALIA	23	20	15	14	13	13	12	12	12	11	11	11	11	11	18	16	15	14	14	14	17	19	21	22	
CHINA	10	9	9	9	8	8	8	8	8	8	8	8	8	9	9	8	8	8	8	8	8	8	8	8	
SOUTH PACIFIC	24	21	16	15	15	14	13	13	12	12	12	11	11	17	16	15	15	16	19	21	23	24	25	26	

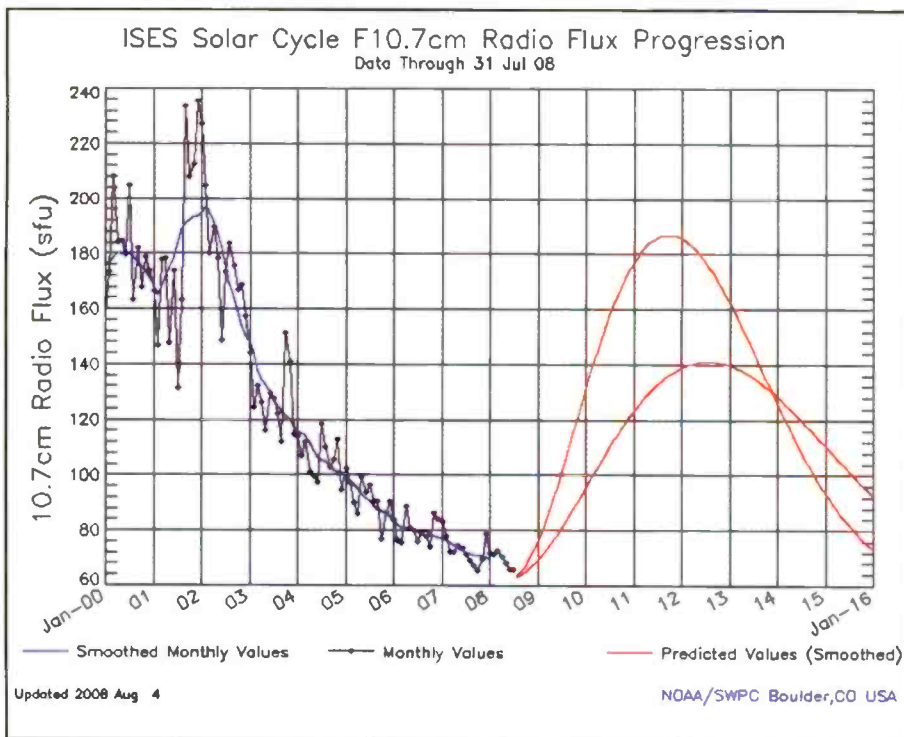

Figure 3. This chart records the current Solar Cycle progression of the "F 10.7-cm Radio Flux" activity. It also indicates that we're at the very edge of the new cycle, Solar Cycle 24, and that forecasts predict a steady increase in solar activity. (Source: NOAA/SEC)

6 meters might only support one-second refraction of a 2-meter signal. Special high-speed digital modulation modes are used on these higher frequencies to take advantage of the limited available time, like high-speed CW, in the neighborhood of hundreds of words per minute.

## Current Solar Cycle 23 Progress

The Dominion Radio Astrophysical Observatory at Penticton, BC, Canada, reports a 10.7-cm observed monthly mean solar flux of 65.8 for July 2008. The 12-month smoothed 10.7-cm flux centered on January 2008 is 70.0. The predicted smoothed 10.7-cm solar flux for November 2008 is 68, give or take about 4 points.

The Royal Observatory of Belgium reports that the monthly mean observed sunspot number for July 2008 is 0.5, down from June's 3.1. The lowest daily sunspot value recorded was zero (0), on July 1-17, 19, and July 21-31. The highest daily sunspot count was 8 on July 18 and July 20. The 12-month running smoothed sunspot number centered on January 2008 is 4.2. A smoothed sunspot count of 12, give or take about 2 points, is expected for November 2008.

The observed monthly mean  $A_p$  for July 2008 is 6. The 12-month smoothed  $A_p$  index centered on January 2008 is 7.7. Expect the overall geomagnetic activity to be varying greatly between quiet to active during November. You can refer to the "Last Minute Forecast" published in *CQ* magazine, or at [http://hfradio.org/lastminute\\_propagation.html](http://hfradio.org/lastminute_propagation.html) for the outlook on conditions during November. The days indicated as "Low Normal," "Below Normal," and "Disturbed" are those days when the geomagnetic conditions range between disturbed and stormy.

## I'd Like To Hear From You

Please take a look at what's new at my propagation Web site, <http://propagation.hfradio.org/>. Included on the site is an up-to-the-day "Last Minute Forecast" that you may use to access the latest forecast for the month. In addition, if you have a cell phone with Internet capabilities, try <http://wap.hfradio.org/>.

Do you have a question that you'd like me to tackle in this column? Drop me an email or send me a letter, and I'll be sure to cover it. I'd love to hear any feedback you might have on what I've written. ■

## The NEW Shortwave Propagation Handbook

The single most comprehensive source of information on HF propagation is once again available from CQ!

- Principles of ionospheric propagation
- Solar cycle predictions
- Stunning photography
- Ionospheric forecasting
- Specific predictions for Cycle 23
- Analysis of HF propagation prediction software
- Unusual HF and VHF ionospheric propagation
- Expansive references and data sources
- How to access NOAA's geophysical databases
- "Do-it-yourself" propagation predictions/charts
- Scores of charts, tables, and summary information
- Overview of WWV and WWVH propagation services

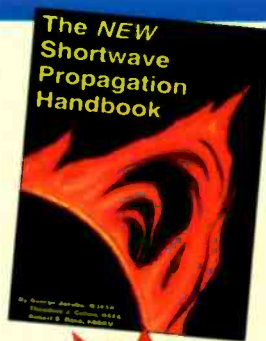

**\$19.95**  
plus \$7 s.h.

**Order Today!!!!**



**CQ Communications, Inc.**

**25 Newbridge Road, Hicksville, NY 11801**

**Phone 516-681-2922 • FAX 516-681-2926**



## Whiskey For My Men, ALE For My Radios

by John Kasupski, KC2HMZ,  
kc2hmz@verizon.net

**W**hile those of you who listen to country music will recognize the title of this month's column as paraphrasing the Toby Keith's hit song "Whiskey For My Men, Beer For My Horses," it's really not advisable to pour beer, whiskey, or any other liquids into our radios. Fortunately, the ALE in the title doesn't refer to beer but is, rather, an acronym for Automatic Link Establishment, a worldwide standard for HF radio communications that enables stations to make contact despite constantly changing propagation conditions and interference, with

or without highly skilled radio operators behind the rig. This is accomplished through the magic of microprocessor control, but does require some knowledge for an operator to understand its use.

ALE is used worldwide by utility stations and hams. Its primary benefit is that it can automatically find the HF frequency that's optimal for both sides of the communication link, eliminating guesswork by operators (as well as the fatigue of listening to static while monitoring on HF!) searching for the best frequencies to



Photo A. The red box at right is a KY-8 voice cryptographic unit. (KC2HMZ photo)



Photo B. The space shuttle *Endeavour* is slated to fly this month in mission STS-126. (NASA photo)

communicate between stations. The basic idea is to let the radio, rather than the operator, handle the “bullwork” (i.e., maintaining information on propagation conditions, what stations are on a net, and the best frequency to use to contact a station on a net).

The most commonly used (by utility stations) basic protocol standard for ALE is MIL-STD 188-141B, developed in 1999 by the U.S. Department of Defense. It’s basically a 2-kHz-wide, eight-tone MFSK (multi frequency shift keying) signal sent at a rate of 125 baud and formatted in 24-bit frames, with each frame consisting of a 3-bit preamble followed by three 7-bit long ASCII characters. Decoding at the receiving end employs DSP (digital signal processing) techniques to decode the signal at a negative signal-to-noise ratio, thus allowing the receiving station to pull the signal out even if it’s below the noise level.

While military, government, and commercial HF utility stations commonly use expensive radios that are equipped by their manufacturers to handle ALE, we hobby listeners don’t need to beg, borrow, or steal one of these pricey beauties in order to receive ALE signals. For example, if you’re a ham who has already got an HF transceiver mated to a computer that you can use to control your rig, it’s quite possible that the program PC-

ALE by Charles Brain, G4GUO, already supports your radio (it supports a surprisingly lengthy list of rigs), and all you need to do to decode UTEs using ALE (as well as to operate in this mode on the ham bands) is to install and configure the program. If this doesn’t work, there are other hardware (Hoka 300-32) and software (MultiPSK, SkySweeper, WaveCom, Monteria Centurion, Multimode) options available, some commercial and some of the freeware/shareware variety.

I’ve used MultiPSK along with a Kenwood TS-450S and a Tigertronics SignalLink USB interface to effortlessly decode ALE transmissions from various networks, simply by installing the program, placing it into the proper mode, and tuning to an appropriate frequency. You can also use this setup to operate in ALE on the ham bands (in fact, there’s an excellent tutorial on setting up MultiPSK for ALE operation on MultiPSK author Patrick Lindecker. F6CTE’s website ([http://f6cte.free.fr/ALE\\_and\\_ALE400\\_easy\\_with\\_Multipsk.doc](http://f6cte.free.fr/ALE_and_ALE400_easy_with_Multipsk.doc)).

### What’s The Frequency, Kenneth?

If you don’t understand the above reference, ask Dan Rather (or look him up on Wikipedia), but suffice it to say that we do need to know the appropriate frequency, or frequencies. Where to tune? An exhaustive list of known ALE networks would probably fill several pages, but here are some of the most commonly monitored networks to help you get started.

One favorite target for ALE fans is the U.S. Air Force. Its HF-Global Command System (HF-GCS) ALE Network has 16 or so ground stations communicating with various U.S. and allied assets using the following frequencies (in kHz): 3137, 4721, 5708, 6721, 9025, 11226, 13215, 15043, 18003, and 23337. There are also the USAF SIPRNET (5702, 5708, 6715, 8968, 11181, 17976, 27870) and NIPRNET (3068, 4745, 5684, 8965, 11199, 13242, 17973, 20631) networks.

The U.S. Army National Guard has an ALE network using the following frequencies: 4882.0, 4924.5, 5202.0, 8047.0, 10816.5, 14653.0, 16338.5, and 17458.5 kHz.

Another favorite listening target—judging from loggings reported by listeners—seems to be the so-called COTHEN (Customs Over-The-Horizon Enforcement Network) network. COTHEN has been around for a long time and is highly recognizable to experienced UTE monitors. Once a network used for voice communications primarily by U.S. Customs and DEA (Drug Enforcement Administration) assets, today much of the voice traffic uses Parkhill encryption or ANDVT, but ALE is also frequently heard here, and the U.S. Coast Guard and other subagencies of the Department of Homeland Security can be heard on ALE as well. The frequencies are 5732.0, 7527.0, 8912.0, 10242.0, 11494.0, 13907.0, 15867.0, 18594.0, 20890.0, 23214.0, and 25350.0 kHz.

Mark Cleary, of Charleston, South Carolina, maintains the hobby’s definitive reference on the COTHEN network, which is regularly updated, and published on his Lowcountry Listening Post blog (<http://lowcountry-listening-post.blogspot.com/>). Also, for the convenience of our readers (and with Mark’s kind permission), a PDF version of the latest version of Mark’s COTHEN/ALE Guide on the “Utility Communications Digest” library page, which is at <http://utecomm-digest.kc2hmz.net/library.htm>.

You’ll want to keep the current version of Mark’s COTHEN/ALE guide, as well as his latest USCG Asset list, handy while listening to help you identify the stations you monitor on this network, so be sure to grab them, from Mark’s site



Photo C. Delta II rocket lifting off from Cape Canaveral, as is scheduled to occur again this month. (USAF photo)

or mine, before the next winter storm knocks out your Internet access.

## Reader Mailbag

After reading our August column, reader Bruce Ames, KE6HPK, of Fresno, CA, checked in via e-mail with some very interesting comments stemming from the photos of the equipment aboard the *USS*

*Little Rock* that appeared in that column.

Referring to the photo, which appears again here (see **Photo A**), Bruce identifies the red box at the far right side of the picture, saying, "During the late '60s and '70s, this would have been a 'classified' picture. The red box is a remote control unit for a highly state-of-the-art (at the time) T/Sec (Transmission Secure) KY-8 voice cryptographic unit. KY-8's were one

of the first all-digital tactical crypto units designed for immediate voice encryption and were used by all branches of the services. The ancillary red control head was primarily shipboard." Bruce noted that during his time in the service of the United States, he was a KY-8 specialist, and he kindly provided a link to a related webpage, which has a photo of a KY-8 base unit and some additional information on this military secure voice system of the period ([www.jproc.ca/crypto/ky08.html](http://www.jproc.ca/crypto/ky08.html)).

Bruce went on to note that the equipment shown in Photo D on page 77 of the August issue is a UGC-6 Teletype unit (not a UCG-6 as I mistakenly called it in the article!). He pointed out that the acronym stands for Utility General Communications and provided a URL for a webpage with more information on U.S. Navy teletype equipment of the 1950s and early 1960s, including the UGC-6; on this page you'll also find a link to more photos of a UGC-6, as well as photos and information on similar equipment the U.S. Navy employed ([www.virhistory.com/navy/navy-tty.htm](http://www.virhistory.com/navy/navy-tty.htm)).

## November Space Launches

Although we mentioned these in a previous column, it's now time to plan for tuning in for the comms related to this month's space launches.

The first of these is the launch of the space shuttle *Endeavour* (**Photo B**), scheduled as of press time for 9:31 a.m. EST on November 10 from the Kennedy Space Center, for the STS-126 mission to deliver a multi-purpose logistics module to the International Space Station.

Another launch is scheduled as of press time for November 20 from the Cape Canaveral Air Force Station, with NASA slated to launch a Delta II for the Missile Defense Agency, carrying a mid-course tracking technology demonstrator that's part of an evolving ballistic missile defense system. **Photo C** shows a Delta II lifting off from Cape Canaveral on a defense-related mission last November.

Since launch schedules change often, it's advisable to check the official NASA website for updates to the scheduled launch dates and times. You can find the latest info at [www.nasa.gov/missions/highlights/schedule.html](http://www.nasa.gov/missions/highlights/schedule.html).

## On To Our Readers' Logs

As usual, many thanks and a tip of the "Utility Communications Digest" hat to this month's contributors: Al Stern, Satellite Beach, FL (ALS); Steven Jones,

Lexington, KY (SJ/KY); Glenn Valenta, Lakewood, CO (GV/CO); and Mac McCormick, Savannah, GA (MM/GA).

**5574.0:** San Francisco ARINC working various AC in USB and SELCAL at 0312Z. (GV/CO)

**5696.0:** USCG CAMSLANT wkg CG 2001 (C-130J, CGAS Elizabeth City NC); CG 2001 announces on final at homeplate; secures guard, in USB at 0002Z. (ALS)

**5732.0:** 707 and LNT in ALE followed by CG 1707 (HC-130) wkg CAMSLANT for ops/position report in USB. at 2317Z; J12 and OPB in ALE followed by 12C (HH-60J, CG 6012) wkg PANTHER (OPBAT), reports departing scene, in USB at 0216Z; 701 and LNT in ALE followed by CG 1701 (HC-130) wkg CAMSLANT for radio check in USB at 0245Z; J34 and LNT in ALE followed by JULIET 34 (HH-60J, CG 6034) wkg CAMSLANT for ops/position report in USB at 0248Z. (MM/GA)

**5800.0:** Enigma V2A numbers station, in AM with extremely wide modulated CW at 0631Z. (GV/CO)

**6474.0:** KSM historic station with Night of Nights IX special unpublished freq in CW at 0357Z. (GV/CO)

**7336.5:** Enigma M51 numbers station w/fast machine-sent 5L group traffic, messages NR 35 to NR 37 and standard header format w/single letter for month and time stamp of UTC+2 hours, heard previously on 5420.0, 6201.0, 6950.0, 6963.0 and 9141.0 kHz, good signal w/deep fading in CW at 0331Z. (SJ/KY)

**7527.0:** J33 and OPB in ALE followed by 33C (HH-60J, CG 6033) wkg PANTHER (OPBAT) for ops/position report in USB at 2232Z; J34 and LNT in ALE followed by CAMSLANT wkg JULIET 34 (HH-60J, CG 6034) for ops/position report in USB at 0128Z; J12 and OPB in ALE followed by 12C (HH-60J, CG 6012) wkg PANTHER (OPBAT), passing on scene, in USB at 0142Z. (MM/GA)

**8379.0:** SXSM, ADAMASTOS, 17,792-ton Greece-registered bulk carrier w/request to send email to management company Empros Lines via WLO, Shipcom R., Mobile, AL on paired 8419.0 kHz in SITOR-A at 2320Z. (SJ/KY)

**8389.5:** JMMU, KAIWO MARU, 2,556-ton 4-masted sail training vessel operated by Japan's National Institute for Sea Training w/AMVER/PR and 5-digit SELCAL 27197, 400 miles south of the Aleutian Islands, in SITOR-A at 0506Z; DSEM7, HANJIN SAN FRANCISCO, 62,799-ton South Korea-registered container ship 350 miles south of the Aleutian Islands, w/BBXX format WX OBS, callsign, MMSI and abbreviated ID "HJSF" in SITOR-A at 0635Z. (SJ/KY)

**8419.5:** PPR, Rio de Janeiro R., Brazil w/dle marker, fair signal not heard for quite a while, in CW+SITOR-A at 0306Z. (SJ/KY)

**8574.0:** NMC, USCG CAMSPAC, Point Reyes, CA w/marker during Maritime Radio

Historical Society commemorative event, also using 6383.0 kHz, in CW at 0232Z. (SJ/KY)

**8582.5:** KLB, Seattle Marine R., Marysville, WA w/marker during Maritime Radio Historical Society commemorative event in CW at 0351Z. (SJ/KY)

**8642.0:** KPH, Globe Wireless, Point Reyes, CA w/marker during Maritime Radio Historical Society commemorative event, also using 6477.5 and 12808.5 kHz, in CW at 0051Z. (SJ/KY)

**8764.0:** USCG maritime weather manually being read with tropical storm Bertha updates in USB at 0523Z; USCG Master station Pacific with garbled automated test count in USB at 0546Z. (GV/CO)

**8806.0:** Unid YL Russian conducting phone patch, in USB at 0545Z. (GV/CO)

**8828.0:** ZKAK, Auckland, New Zealand VOLMET in USB at 0621Z. (GV/CO)

**8971.0:** WAFER 21 (P-3C, USN) wkg GOLDENHAWK (TSC Brunswick, ME) to relay traffic to their maintenance, in USB at 1438Z; WAFER 21 wkg GOLDENHAWK and advising they were resuming normal tasking, in USB at 1603Z; WAFER 21 wkg GOLDEHNAWK and passing Spare Group 8, in USB at 1752Z. (MM/GA)

**9186.0:** Two unid. stations w/brief handset traffic, "DE RA" before QSY to frequency unreadable due to sender's atrocious fist, in CW at 0135Z. (SJ/KY)

**10871.7:** "D" beacon, Black Sea Fleet, Odessa/Sevastopol, Ukraine, very weak in CW at 0243Z. (SJ/KY)

**10871.8:** "P" beacon, Baltic Fleet, Kaliningrad, Russia, very weak in CW at 0346Z. (SJ/KY)

**11175.0:** HF-GCS station MCCLELLAN with unheard AC for phone patch in USB at 2157Z. (GV/CO)

**11175.0:** HF-GCS Station ANDREWS wkg KING 22 (NY-ANG C-130, Gabreski Airport, Long Island, NY) for phone patch to DSN number for North Island NAS Base Ops; Andrews corrects KING 22 who had been attempting to get patch to wrong number, KING 22 reports departed KFOK (Gabreski) at 1300Z; ETA to KNZY (North Island NAS) is 2130Z; passes acft tail number as 82102 (88-2102), in USB at 1800Z. (ALS)

**11175.0:** HF-GCS Station GUAM wkg "Maintenance on Aircraft 0349" (on ground) for radio check in USB at 1845Z; HF-GCS Station ANDREWS wkg "LA 05A" (P-3C, NAS Jacksonville VP-5) for phone patch to NAS Jax TSC in USB at 1849Z. (ALS)

**11175.0:** HF-GCS Station ELMENDORF wkg REACH 913 for phone patches to Hickam AFB, in USB at 0036Z; HF-GCS Station ANDREWS passes an EAM of 137 characters, in USB at 1625Z; ANDREWS with 28-character EAM in USB at 1545Z. (ALS)

**11494.0:** 704 and TSC in ALE followed by 1704 (HC-130) wkg SERVICE CENTER for phone patch to Sacramento Air ref "another hard transmitter fail" in USB at 0021Z. (MM/GA)

**12479.0:** 3FSA8, EVER DIVINE, 55,604-ton Panama-registered container ship w/MMSI and abbreviated ID "DVIN" in SITOR-A at 1355Z; A8CG5, SELINDA, 28,107-ton Liberia-registered bulk carrier w/MMSI and abbreviated ID "SELI" in SITOR-A at 0022Z. (SJ/KY)

**12482.0:** 3EGV4, WAIMEA, 73,049-ton Panama-registered bulk carrier w/MMSI and abbreviated ID "WAIM" in SITOR-A at 1708Z; Unid. vessel w/SELCAL XVSP (1095) for NMF, USCG COMMSTA Boston, MA, station not listed for this mode or frequency, no contact, in SITOR-A at 1729Z. (SJ/KY)

**12488.0:** 9HCU7, VITAPRIDE, 69,153-ton Malta-registered bulk carrier w/AMVER/PR in the Gulf of Mexico 100 miles north of the Yucatan Peninsula and headed toward the Yucatan Strait en route to Puerto Bolivar, Colombia, arrive in 4 days, included MMSI, INMARSAT-C ID and abbreviated ID "VPRD," report filed w/KLB in Seattle instead of WLO in Mobile, AL for some reason, in SITOR-A at 1840Z. (SJ/KY)

**12695.5:** KFS, Globe Wireless, Point Reyes, CA w/marker during Maritime Radio Historical Society commemorative event in CW at 0227Z. (SJ/KY)

**13131.0:** Unid YL Russian conducting phone patch, suspect ARKHANGELSK Radio, weak but very readable, in USB at 2216Z. (GV/CO)

**13297.0:** Piarco Radio wkg Air Jamaica 091; passes msg "Off at 2325Z"; also heard wkg a Martinair flight; in USB at 2329Z. (ALS)

**13297.0:** USAF MARS Operator AFAIRE (Maine) wkg ROLLER 25 (C-130H, NV-ANG, Reno-Tahoe IAP) for phone patch to DSN number for (NV-ANG Base Ops) in USB at 1650Z; USAF MARS Operator AFA6PF (Los Angeles, CA) wkg REACH 6006 (C-17A #96-0006, Charleston AFB 437AW) in USB at 1540Z. (ALS)

**13297.0:** USAF MARS Operator AFA6PF (Los Angeles, CA) wkg MAKO 16 for phone patch to NAS Norfolk in USB at 1552Z; USAF MARS Operator AFA1QW (Greenwood IN) wkg RECON 79 in USB at 1623Z. (ALS)

**13297.0:** USAF MARS Operator wkg PACK 91 (KC-135R, NH-ANG Pease ANGB) for phone patch to DSN number for NAS Key West Base Ops, says "We are Air National Guard dedicated tanker for weekend"; looking to RON until noon on Sunday; says they called earlier from NAS New Orleans to get PPR, in USB at 1934Z. (ALS)

**13297.0:** USAF MARS Operator wkg PACK 91 for phone patch to Eglin AFB Billeting; rqsts rooms for 2 officers, 5 enlisted, then calls Hurlburt Field Billeting with same request, in USB at 1947Z; USAF MARS Operator AFA1QW wkg BOLT 26 (KC-135R, MacDill AFB 6AMW) for phone patch to MacDill re: status of receiver acft coming from Eglin, in USB at 1538Z. (ALS)

**13297.0:** USAF MARS Operator



AFA1QW wkg REACH 169T for phone patch to DSN number for IL-ANG, Peoria, IL re 1900Z ETA to Peoria, in USB at 1708Z; AFA1QW wkg KING 54 (MC-130P #66-0212, CA-ANG, Moffett Fed Field) for phone patch to DSN number for Andrews AFB "Minuteman" ANG Readiness Center, reports 1538Z departure from Patrick AFB; expects 6 hrs en route to KIKR (Kirtland AFB), en route home to Moffett Field; in USB at 1540Z. (ALS)

**13927.0:** AFA1QW wkg KING 54 for M&W phone patch to commercial number in California, tells family member will be home at Moffett Field tonight, in USB at 1544Z; AFA1QW wkg GOOSE 77 (MC-130E, Duke Field, 919SOW 711SOS) for phone patch re: 1549Z departure, in USB at 1555Z. (ALS)

**13927.0:** AFA1QW wkg VIPER 91 for phone patch to Command Post in USB at 1629Z; AFA1QW wkg VIPER 91 (C-130, prob GA-ANG Savannah) for phone patch to Savannah CP in USB at 1655Z; AFA1QW wkg MACE 99 (C-130, SC-ANG, McEntire ANGB) for phone patch to DSN number at McEntire ANGB in USB at 1701Z. (ALS)

**13927.0:** USAF MARS Operator AFA1YV (Binghamton, NY) wkg NATO 16 (Boeing 707/CT-49A, #LX-N19997, Geilenkirchen, Luxembourg) AWACS), at location 35.154N 89.13W, for phone patch to Majors Airport, Greenville, TX; passes 2045Z ETA, reports coming in for airplane upgrade, has cargo; in USB at 1953Z. (ALS)

**13927.0:** USAF MARS Operator AFA1EN (Shelbyville, IN) wkg SHARK 75 (C-130 on Coronet Oak Mission), at FL240, 100 miles North of Cancun, for p/p to Duty Ops; reports departed MPTO (Tocumen IAP, Panama) as fragged, ETA to KGPT (Gulfport) 2135Z; requests pass to Customs office at Gulfport, in USB at 2013Z. (ALS)

**13927.0:** USAF MARS wkg GATOR 86 (T-43A, Randolph AFB 12FTW) for phone patch; says Gator 77 is on same routing, in USB at 1525Z; USAF MARS Operator AFA6PF (Los Angeles) wkg HOIST 99 (KC-10A, McGuire AFB 514AMW) for phone patch to commercial number in Florida, passes official message in USB at 1629Z. (ALS)

**13927.0:** USAF MARS Operator AFA1QW (Greenwood, IN) wkg REACH 6002 (C-17A #60-0002, Charleston AFB 437AW) for M&W phone patch to a Georgia number in USB at 1713Z. (ALS)

**13993.0:** USAF MARS Transcon Net Operator AFA1FF (NCS) in comms with AFA2SO, AFA2UZ, AFA2MK for check-ins in USB at 1405Z. (ALS)

**16685.5:** 9VKH2, *EAGLE PHOENIX*, 106,127-ton Singapore-registered crude oil tanker w/AMVER/FR for arrival at Chesapeake City Anchorage, MD, included MMSI and abbreviated ID "EPHO," in SITOP-A at 1630Z. (SJ/KY)

**16910.0:** HLJ Seoul Radio, good levels, in CW at 2301Z. (GV/CO)

**16914.0:** KSM, QSX marker w/freq list at very good levels, in CW monitored at 1928Z. (GV/CO) ■

## readers' market

**Advertising Rates for Readers' Mart:** Non-commercial ads are 30 cents per word, including abbreviations and addresses; minimum charge \$6.00 per issue. Ads from firms offering commercial products or services are \$1.00 per word; minimum charge \$20.00 per issue. Boldface words are \$1.20 each (specify which words). Leading key words set in all caps at no additional charge. All ads *must be prepaid in full* at time of insertion; a 5% discount is offered for prepaid 6 time insertions. All ads must be typewritten double spaced.

**Approval:** All ad copy is subject to Publisher's approval and may be modified to eliminate references to equipment and practices which are either illegal or otherwise not within the spirit or coverage scope of the magazine.

**Closing Date:** The 10<sup>th</sup> day in the third month preceding date of publication. Because the advertisers and equipment contained in Readers' Market have not been investigated, the Publisher of *Popular Communications* cannot vouch for the merchandise listed therein. Direct all correspondence and ad copy to: Attention: Classified Dept., PC Readers' Market, 25 Newbridge Rd., Hicksville, NY 11801.

**SuperBertha.com** ULTIMATE LONG BOOM OWA YAGIS: Designed by WA3FET and K3LR. Scott W3TX. 814-881-9258.

**COMMUNICATIONS MONITORING ANTENNAS,** HF/VHF/UHF Super Discone \$49.75, AntennaCraft Scantenna \$47.70, 30-1200 MHz, 4-12 dB Log Periodic \$69.50, 806-900 MHz, 13 dB 9 element Yagi \$74.00, MURS/GMRS Dual Band Base \$48.95. All prices **INCLUDE** Priority S&H&I. See these antennas plus many, many more for Amateur, Business, CB, and Monitoring radio, plus cellular phone antennas on the web at: [www.antennawarehouse.com](http://www.antennawarehouse.com) MC/Visa Order line 877-680-7818. To help maintain our low pricing, we do not print catalogs.

**FOR SALE - DRAKE TR-7/TR-7A/R-7/R-7A Service kit.** Includes 13 Extender Boards and Digital Jumper Card. \$64.75 includes postage. See <http://wb4hfn.com/Services/W7AVK/tr7ext2.htm> Bob W7AVK, 5581 Panorama Drive, Moses Lake, WA 98837, w7avk@arrl.net, 509-750-7589.

**SuperBertha.com** CUSTOM ROTATING POLES: No guy wires, entire pole rotates, stack all your antennas, rotor at ground level, 50ft to 300ft high, EIA-TIA-222-G. Starting at \$37,799.00. Scott W3TX, 814-881-9258.

## ADVERTISERS' INDEX

Advertiser	Page #	Website Address
AOR USA, Inc.	Cov III	<a href="http://www.aorusa.com">www.aorusa.com</a>
Advanced Specialties	29	<a href="http://www.advancedspecialties.net">www.advancedspecialties.net</a>
Antique Radio Classified	29	<a href="http://www.antiqueradio.com">www.antiqueradio.com</a>
Atomic Time, Inc.	73	<a href="http://www.atomictime.com">www.atomictime.com</a>
C. Crane Company	41	<a href="http://www.ccrane.com">www.ccrane.com</a>
CQ Amateur Radio Calendars	23	<a href="http://www.cq-amateur-radio.com">www.cq-amateur-radio.com</a>
CQ Holiday Gifts	46-50	<a href="http://www.cq-amateur-radio.com">www.cq-amateur-radio.com</a>
Communications Electronics	11	<a href="http://www.usascan.com">www.usascan.com</a>
Computer Aided Technologies	45	<a href="http://www.scanat.com">www.scanat.com</a>
Eton Corporation	14, 15	<a href="http://www.etoncorp.com">www.etoncorp.com</a>
Grundig	14, 15	<a href="http://www.etoncorp.com">www.etoncorp.com</a>
Homeland Security	69	<a href="http://www.ready.gov">www.ready.gov</a>
ICOM America, Inc.	Cov. IV	<a href="http://www.icomamerica.com">www.icomamerica.com</a>
Kenwood	7	<a href="http://www.kenwoodusa.com">www.kenwoodusa.com</a>
MFJ Enterprises, Inc.	3	<a href="http://www.mfjenterprises.com">www.mfjenterprises.com</a>
Monitoring Times	59	<a href="http://www.grove-ent.com">www.grove-ent.com</a>
PowerPort	59	<a href="http://www.powerportstore.com">www.powerportstore.com</a>
QCWA	67	<a href="http://www.qcwa.org">www.qcwa.org</a>
RadioActiveRadios	23	<a href="http://www.radioactiveradios.com">www.radioactiveradios.com</a>
REACT International, Inc.	37	<a href="http://www.reactintl.org">www.reactintl.org</a>
SSB America	67	<a href="http://www.ssbusa.com">www.ssbusa.com</a>
Ten-Tec	31	<a href="http://www.tentec.com">www.tentec.com</a>
Tigertronics	29	<a href="http://www.tigertronics.com">www.tigertronics.com</a>
Universal Radio	1	<a href="http://www.universal-radio.com">www.universal-radio.com</a>
W5YI Group, The	73	<a href="http://www.w5yi.org">www.w5yi.org</a>
Yaesu	Cov II	<a href="http://www.vxstdusa.com">www.vxstdusa.com</a>

Reach this dynamic audience with your advertising message, contact Arnie Sposato at 253-853-4080, FAX 253-853-4070, or e-mail: [advertising@popular-communications.com](mailto:advertising@popular-communications.com).

## Norm's Bus Stowaway

by Bill Price, N3AVY

*"Norm was talking to a local on a repeater when his traveling companion waddled up the aisle to the front of the bus and caught his eye—well, caught his nose first..."*

I heard from Norm recently. He drove the "bus" from Maine to Florida awhile ago, back when he could do it for only (that's only!) \$1000 worth of diesel. I have a feeling he won't be driving it to the grocery store much.

Of course, many of you might be tempted to ask if Norm had any adventures while heading down. In a word, yes. My ever-thrifty friend towed his car behind the bus for the thousand-plus mile journey, and because he had read of an RV driver who had a tire go flat or a wheel-bearing seize and catch fire on the towed vehicle, and that tire then lit a forest on fire, causing the federal government to send the errant driver a bill for some 28 zillion dollars in damages, Norm established a regimen of stopping frequently to check the towed vehicle at regular intervals. But wait—there's more!

Norm is a consummate ham. He's the kind of person every 2-meter operator enjoys talking with. He's got lots of tales to tell (and a lot he wouldn't dare tell) and with his history of working in the ham radio equipment industry, he's got a lot of information to share.

This kept Norm chatting almost constantly during his trip along I-95, and when he wasn't talking on 2 meters he'd catch a little music or talk radio. But the important thing with Norm was stopping to check that car he was towing. The one he couldn't see with his mirrors. Some people might have thought he was paranoid, but he stopped every 50 miles, give or take a mile, finding himself a safe spot to pull off the road, just for a moment.

How I wish I could have been a fly on the wall of that bus when Norm was checking the wheels on the car, and the little skunk was attracted by the aroma of fresh microwave popcorn and scooted through the open door and up the stairs of the bus. Oh, be still my heart, I'd give a whole dollar to have been there when he noticed the visitor.

The way he tells it (and he's always been pretty honest with me), he noticed the skunk smell—

though not too strong—right after he got back into the bus and started it up again. After a while he realized the smell was not going away, and he wondered if he hadn't hit a poor skunk with the back wheels of the bus. There was not much he could do about it, though, so he just kept driving. Norm was talking to a local on a repeater when his traveling companion waddled up the aisle to the front of the bus and caught his eye—well, caught his nose first—as he turned his head and saw the little fellow eating a cookie from the package by his feet.

Norm has always had a "polite" mouth, rarely uttering anything you couldn't repeat in Sunday school, but he says he was glad there was no one monitoring that frequency when he saw the skunk. And he was glad the guy he was talking to was not offended and had the smarts to talk him through a slow, gentle "landing" to get to the side of the road without unduly exciting his visitor.

Norm said he sat for about an hour, in the driver's seat, wishing for a restroom, trying to coax the little fellow to go down the stairs and out the door (which he opened with a lever from the driver's seat) until, finally, he reached behind him and got a tuna sandwich he'd lost interest in a few hundred miles back. It seemed to be just the right inducement for "Pepe" to disembark so Norm could shut the door and drive off quickly, which he did.

He only went a mile till he was sure he was far enough from his little visitor, then got out and checked his tires. This time he shut the door behind him.

Sometimes I wish I could give you his callsign so you could listen for him along the I-95 corridor, but a long time ago I promised him anonymity in exchange for all the wonderful adventures he's given to these pages. His real name isn't Norm, but if you think you're working him someday, you might just ask "Hey—are you the one Bill calls Norm?" Either confused silence or spontaneous laughter will tell you the answer. ■

# AR-ALPHA

## Communications Receiver

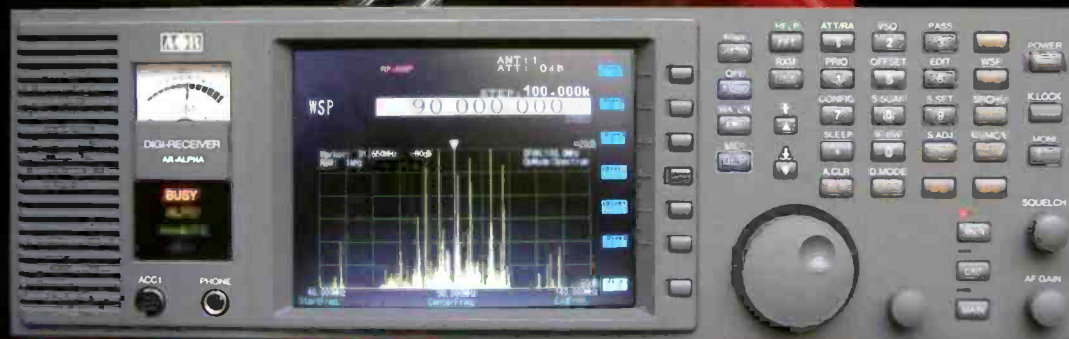

- Multi-mode unit capable of receiving AM (synchronous), ISB, RZ-SSB, USB, LSB, CW, WFM including FM stereo, NFM, APCO-25 digital, and TV in both NTSC and PAL formats
- 6-inch TFT color panel can display received video signals or depict spectrum activity over a wide choice of bandwidths including a "waterfall" function to show signal activity over a specified time period

## Welcome to the Future!

*AOR proudly introduces the AR-ALPHA, the first in a new class of professional monitoring receivers!*

*Designed to cover 10KHz to 3.3GHz, with no interruptions,\* this receiver features a 6-inch color TFT display, five VFOs, 2000 alphanumeric memories that can be computer programmed as 40 banks of 50 channels, 40 search banks, a "select memory" bank of 100 frequencies, and a user designated priority channel. It includes APCO-25 digital and a DVR with six channels that can record up to a total of 52 minutes audio. Monitoring professionals will appreciate the world class engineering and attention to detail that makes the AR-ALPHA such an amazing instrument.*

- Composite video output on the rear panel of the unit
- Selectable IF bandwidths: 200 Hz, 500 Hz, 1 KHz, 3 KHz, 6 KHz, 15 KHz, 30 KHz, 100 KHz, 200 KHz and 300 KHz along with the ability to shift the IF.
- CTCSS and DCS selectable squelch functions
- DTMF tone decode
- Built-in voice-inversion descrambling
- CW pitch control, AGC, AFC
- Auto-notch feature
- User selectable spectrum display function from 250 KHz through 10 MHz in 1 KHz increments. Above 10 MHz bandwidth, it can display 20 MHz, 50 MHz, 100 MHz or 1 GHz, but above 20 MHz bandwidth, no audio will be available
- Resolution bandwidth is also user-selectable in increments of 1 KHz, 4 KHz, 32 KHz, 64 KHz, and 128 KHz
- Fast Fourier Transform (FFT)
- Rear panel connections include 12 VDC power, RS-232C, USB 2.0, I/Q output with 1 MHz bandwidth, two antenna ports (one SO-239 and one Type N) and up to four antennas may be selected through the receiver's controls with the optional AS5000 antenna relay selector.
- Use desktop or with 19" rack mount

*The AR-ALPHA redefines excellence in professional monitoring receivers. No wonder so many monitoring professionals including government, newsrooms, laboratories, military users and more, rely on AOR.*



AOR U.S.A., Inc.  
20655 S. Western Ave., Suite 112, Torrance, CA 90501, USA  
Tel: 310-787-8615 Fax: 310-787-8619  
info@aorusa.com • www.aorusa.com

Specifications subject to change without notice or obligation.  
\*Documentation required for qualified purchasers in the USA.

# Designed for the track...

## NEW IC-RX7 Stylish Scanner with Smart Interface

Sleek, fast, and able to hit the track even during a rain storm, the 'RX7 is Icom's first receiver to achieve the IPX4 water resistant rating. Besides its sleek and aerodynamic design, it's what's under the hood that will really put you in the race — power and performance! A newly developed user-interface allows you to zip around the track and frequencies, qualifying you for pole position with Li-ion battery performance that will have your friends hitting the pits way before you. Join the winning circle and visit an authorized Icom dealer today!

### Features:

- 0.150 - 1300.000 MHz\*
- High Speed Scan and Search
- AM, FM, WFM
- Computer Programmable (Optional CS-RX7)
- 1650 Alphanumeric Memory Channels
- Water Resistance Equivalent to IPX4

*...and good for everyday use.*



During recent "on-track" tests, the 'RX7 passed expectations with flying colors! Here's what some enthusiasts had to say:

"We were able to listen at all three races, including practice and qualifying without recharging!"

"The ability to select a channel by the car number made listening to the races even more fun!"

"We were able to see the car number, the driver's name, and the race type all at the same time!"

\*Frequency specs may vary. Refer to owner's manual for exact frequency specs.  
©2008 Icom America Inc. The Icom logo is a registered trademark of Icom Inc.  
All specifications are subject to change without notice or obligation. 30069

**ICOM**