



45635

POPULAR COMMUNICATIONS

DECEMBER 2007

Scanning The Season

- **New York City Sizzles**, pg. 10
- **Great (Affordable!) Gift Ideas**, pg. 44

PLUS...Programming 101 For The GRE PSR-500 • Motorola's DTR410 Frequency-Hopping Radio • Military Gear Mecca

*****SCH 5-DIGIT 66061
02 000380028 2902 2712
MR. DAVID C STEARNS KCODAA
2639 W WHITNEY ST
OLATHE KS 66061-6011



THE PROFESSIONAL STANDARD

The compact desk-top VR-5000 is Yaesu's most versatile Communications Receiver ever! With ultra-wide frequency coverage and a host of operating features, you'll be on top of the monitoring action with the VR-5000!

- **CONTINUOUS FREQUENCY COVERAGE: 100 kHz ~ 2.6 GHz / LSB, USB, CW, AM-Narrow, AM, Wide AM, FM-Narrow, and Wide FM (cellular frequencies are blocked)**
- **2000 MEMORY CHANNELS / 100 MEMORY GROUPS**
- **DUAL RECEIVE**
- **DIGITAL SIGNAL PROCESSING / BANDPASS FILTER, NOISE REDUCTION, NOTCH FILTER, NARROW CW PEAK FILTER (Optional DSP-1 requires)**
- **REAL-TIME SPECTRUM SCOPE**
- **WORLD CLOCK WITH UTC/LOCAL SETTINGS**
- **PRESET SHORTWAVE BROADCAST STATION MEMORY BANK**
- **EXTENSIVE SCANNING CAPABILITY/SMART SEARCH™**

● AND MUCH, MUCH MORE... ●

- "RF Tune" Front-end Preselector (1.89-1000 MHz) ● 20 dB Attenuator for strong signal environments ● IF Noise Blanker ● DVS-4 Digital Voice Recorder (option) with two memories of up to 8 seconds each ● 10.7 MHz IF Output Jack ● Field Strength Meter ● Audio Tone Control ● All-Mode Squelch Control for silent monitoring ● Password-protected Panel and Dial "Lock" feature ● Display Dimmer/Contrast Control ● Clone Capability for copying memory information from one VR-5000 to another ● Personal Computer Interface Port ● Two Antenna Ports ● Audio Wave Meter provides display of incoming signal's wave characteristics

COMMUNICATIONS RECEIVER VR-5000

0.1~2599.99998MHz*
LSB/USB/CW/AM-N/AM/
WAM/FM-N/WFM
*Cellular blocked

Enjoy the wide world of communications monitoring with the action-packed VR-5000, available from your Yaesu Dealer today!



Wideband Receiver VR-120D

- Wideband Coverage: 0.1-1299.995* MHz AM/FM/Wide-FM
- Rugged outdoor-ready case construction
- Ultra-long battery life
- BNC-type antenna connector
- Straightforward 4-button operation
- Versatile 640-channel memory system



All-Mode Wideband Receiver VR-500

- Frequency coverage : 0.1-1299.99995 MHz**
- Modes : NFM,WFM,AM,USB, LSB, CW
- Multiple Power Source Capability
- Polycarbonate Case
- Real-Time 60-ch* Band Scope *Range 6 MHz / Step 100kHz
- Full Illumination For Display And Keypad
- Convenient "Preset" Operating Mode
- Front-end 20 dB Attenuator

For the latest Yaesu news, visit us on the Internet:
<http://www.vertexstandard.com>

Specifications subject to change without notice. Some accessories and/or options may be standard in certain areas. Frequency coverage may differ in some countries. Check with your local Yaesu Dealer for specific details.

YAESU
Choice of the World's top DX'ers™

Vertex Standard
US Headquarters
10900 Walker Street
Cypress, CA 90630 (714)827-7600

Universal Radio — Quality equipment since 1942.



E1 XM

GRUNDIG YB-300PE

FREE
Receive a **FREE**
Grundig YB-300PE
with your Eton E1
purchase!



OPTION

The **etón E1 XM** is the world's first radio that combines AM, FM, shortwave and XM Satellite radio into one ultra high-performance unit. The E1 is an elegant confluence of performance, features and capabilities. The look, feel and finish of this radio is superb. The digitally synthesized, dual conversion shortwave tuner covers all shortwave frequencies. Adjacent frequency interference can be minimized or eliminated with a choice of three bandwidths [7.0, 4.0, 2.5 kHz]. The sideband selectable Synchronous AM Detector further minimizes adjacent frequency interference and reduces fading distortion of AM signals. IF Passband Tuning is yet another advanced feature that functions in AM and SSB modes to reject interference. AGC is selectable at fast or slow. High dynamic range permits the detection of weak signals in the presence of strong signals. All this coupled with great sensitivity will bring in stations from every part of the globe. Organizing your stations is facilitated by 500 user programmable presets with alpha labeling, plus 1200 user definable country memories, for a total of 1700 presets. You can tune this radio many ways such as: direct shortwave band entry, direct frequency entry, up-down tuning and scanning. Plus you can tune the bands with the good *old fashioned* tuning knob (that has *new fashioned* variable-rate tuning). There is also a dual-event programmable timer. Whether you are listening to AM, shortwave, FM or XM, you will experience superior audio quality via a bridged type audio amplifier, large built in speaker and continuous bass and treble tone controls. Stereo line-level output is provided for recording or routing the audio into another device such as a home stereo. The absolutely stunning LCD has 4 levels of backlighting and instantly shows you the status of your radio.

Many receiver parameters such as AM step, FM coverage, beep, kHz/MHz entry etc., can be set to your personal taste via the preference menu. The E1 has a built in telescopic antenna for AM, shortwave and FM reception. Additionally there is a switchable antenna jack [KOK] for an external antenna. Universal also sells a PL259 to KOK antenna jack adapter (#1052 \$14.95) as well as a sturdy angled Lucite radio stand (#3873 \$16.95).

The E1 comes with an AC adapter or may be operated from four D cells (not included). 13.1"W x 7.1"H x 2.3"D Weight: 4 lbs. 3 oz. We are shipping latest production. Get a **Free YB-300PE** with your E1 for a limited time.
E1 XM Order #0101 \$499.95

AUDIOVOX
CNP2000



The Eton E1 is XM ready, so you may purchase the Audiovox CNP2000DUO XM antenna module at any time. It has a 25 foot cable. (An optional XM-EXT50 50 foot extension cable is also available #4905 \$39.95.)
CNP2000DUO Order #0072 \$58.95

Note: The CNP2000 DUO antenna module and XM subscription are sold separately. Activation and monthly subscription fee required for XM.

The **Grundig YB-300PE Professional Edition** covers: AM, FM stereo and shortwave from 2.3-7.8 and 9.1-26.1 MHz. Tune via Direct keypad entry, 24 memories, Band button, scanning plus Up and Down tuning. The YB-300 PE features a large LCD display with display lamp for momentary illumination. Other refinements include: 24 Hour Clock, DX-Local Switch, sleep timer, Scan and Lock. The side of the radio features the DC input jack, the external antenna input jack and earphone output jack. Includes an AC adapter, vinyl carrying case, carrying strap, plug in external wire antenna, Manual and stereo earphones. Operates from three AA cells. Titanium colored case 5.9 x 3.5 x 1.25 inches 13 oz. Originally introduced at \$99.00.

YB-300PE Order #0300 \$49.95

► Purchase your Eton E1 from Universal Radio before 12/31/07 and receive a **FREE Grundig YB-300PE** with your order!

etón E5

FREE
Receive a **FREE**
Grundig FR-200
with your Eton E5!



The **etón E5** is a world class portable radio covering long wave, AM, FM and shortwave. It offers SSB-Single Side Band, 700 memories, keypad entry, scanning and a 24 hour clock timer. You also get: Line Output, Local/DX Switch, Wide-Narrow selectivity and external SW antenna jack. Operates from four AA cells (not supplied) or the included AC wall adapter. Comes with a manual, wrist strap, protective case, wire antenna and ear buds. 6.675 x 4.125 x 1.125" 12.2 oz. One year limited warranty.
List \$169.95 Order #0055 \$149.95

► Purchase your Eton E5 from Universal before 12/31/07 and receive a **FREE Grundig FR-200 AM/FM/SW wind-up emergency radio** with your order!

**universal
radio inc.**

Universal Radio, Inc.
6830 Americana Pkwy.
Reynoldsburg, Ohio
43068-4113 U.S.A.

☎ 800 431-3939 Orders & Prices
☎ 614 866-4267 Information
☎ 614 866-2339 FAX Line
✉ dx@universal-radio.com

www.universal-radio.com

◆ Visit our website for more exciting new and used shortwave radios.

- Visa
- MasterCard
- Discover
- JCB
- Prices and specs. are subject to change.
- Special offers are subject to change.
- Returns subject to a 15% restocking fee.
- Prices shown do not include shipping.

Contents

POPULAR COMMUNICATIONS

Volume 26, Number 4

December 2007

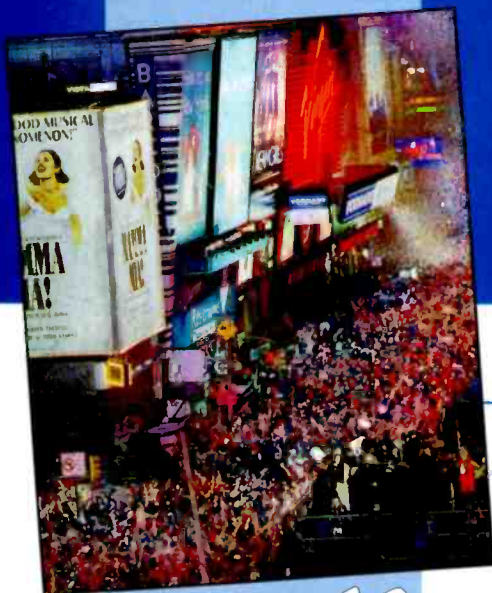

10



54



57

Features

- 10 Scanning Heats Up For The Holidays In New York City**
Big Apple Frequencies Crackle With Action—
Here's How To Catch Them by Ed Muro, K2EPM
- 44 Affordable Holiday Gift Ideas**
Great Goodies To Give (Or Get!) That Won't
Empty Your Wallet by Gordon West, WB6NOA
- 54 Programming The GRE PSR-500 Advanced Digital Scanner**
Could It Be Any Easier? by Rich Wells

Columns

- 16 A Scannist's Wish List** ScanTech
- 19 You've Been Good, Here's How To Reward Yourself This Season** Broadcast Technology
- 24 Ham Radio Equipment: Such A Deal I Have For You!** Ham Discoveries
- 28 "Hello...?" Shortwave Fadeouts And Lost Signals** The Propagation Corner
- 35 Bob Ryan's Doerle Twinplex:
A Simple One-Tube Battery-Powered Radio** The Wireless Connection
- 42 World News, Commentary, Music, Sports, And Drama At Your Fingertips** World Band Tuning Tips
- 57 IBA In Abeyance And More Dust-Biters** Global Information Guide
- 66 The Motorola DTR410 Frequency-Hopping Radio** Tech Showcase
- 69 A New Jersey Triad** Military Radio Monitoring
- 72 A Mecca For Military Gear Collectors And Aficionados** Homeland Security
- 76 Wait A Minute...It's December Already?** Utility Communications Digest
- 84 Ho-Ho-Holy Mackerel!** The Loose Connection

Departments

- 4 Tuning In**—An Editorial
- 6 InfoCentral**—News, Trends, And Short Takes
- 8 Washington Beat**—Capitol Hill And
FCC Actions Affecting Communications
- 75 The Pop'Comm Trivia Corner**

On The Cover

Scanning is never hotter than when it's cold outside—at least in New York City. Whether you're one of the more than eight million inhabitants, or one of the Holiday Season's visitors (who *double* that number!), you'll want to read our cover story, "Scanning Heats Up For The Holidays In New York City," starting on page 10, for tips on how to snag the excitement. (Cover, Rockefeller Center, by Larry Mulvehill, WB2ZPI)

Visit us on the Web: www.popular-communications.com

Tap into secret Shortwave Signals

Turn mysterious signals into exciting text messages with the MFJ MultiReader™!

MFJ-462B
\$199⁹⁵

Plug this self-contained MFJ MultiReader™ into your shortwave receiver's earphone jack.

Then watch mysterious chirps, whistles and buzzing sounds of RTTY, ASCII, CW and AMTOR (FEC) turn into exciting text messages as they scroll across an easy-to-read LCD display.

You'll read interesting commercial, military, diplomatic, weather, aeronautical, maritime and amateur traffic . . .

Eavesdrop on the World

Eavesdrop on the world's press agencies transmitting *unedited* late breaking news in English -- China News in Taiwan, Tanjug Press in Serbia, Iraqi News in Iraq -- all on RTTY.

Copy RTTY weather stations from Antarctica, Mali, Congo and many others. Listen to military RTTY passing traffic from Panama, Cyprus, Peru, Capetown, London and others. Listen to hams, diplomatic, research, commercial and maritime RTTY.

Super Active Antenna

"World Radio TV Handbook" says MFJ-1024 is a "first-rate easy-to-operate active antenna... quiet... excellent dynamic range... good gain... low noise... broad frequency coverage."

Mount it outdoors away from electrical noise for maximum signal, minimum noise. Covers 50 KHz-30 MHz.

Receives strong, clear signals from all over the world. 20 dB attenuator, gain control, ON LED.

Switch two receivers and auxiliary or active antenna. 6x3x5 in. Remote has 50 feet coax. 3x2x4 inches. 12 VDC or 110 VAC with MFJ-1312, \$15.95.

Indoor Active Antenna

Rival outside

long wires with this

tuned indoor active

antenna. "World

Radio TV Handbook"

says MFJ-1020C is a

"fine value... fair

price... best offering to

date... performs very well indeed."

Tuned circuitry minimizes inter-

mod, improves selectivity, reduces

noise outside tuned band. Use as a

preselector with external antenna.

Covers 0.3-30 MHz. Tune, Band,

Gain, On/Off/Bypass Controls. Detach-

able telescoping whip. 5x2x6 in.

Use 9 volt battery, 9-18 VDC or

110 VAC with MFJ-1312, \$15.95.

Compact Active Antenna

Plug this com-

act MFJ

all band active antenna into your

receiver and you'll hear strong, clear

signals from all over the world. 300

KHz to 200 MHz including low,

medium, shortwave and VHF

bands. Detachable 20" telescoping



Listen to maritime users, diplomats and amateurs send and receive *error-free* messages using various forms of TOR (Telex-Over-Radio).

Monitor Morse code from hams, military, commercial, aeronautical, diplomatic, maritime -- all over the world -- Australia, Russia, Japan, etc.

Monitor any station 24 hours a day by printing transmissions. Printer cable, MFJ-5412, \$11.95.

Save several pages of text in memory for later reading or review.

High Performance Modem

MFJ's high performance PhaselockLoop™ modem consistently gives you solid copy -- even with weak signals buried in noise. New threshold control minimizes noise interference -- greatly improves copy on CW and other modes.

Easy to use, tune and read

It's easy to use -- just push a button to select modes and features from a menu.

It's easy to tune -- a precision tuning indicator makes tuning your receiver easy for best copy.

It's easy to read -- front-mounted 2 line 16 character LCD display has contrast adjustment.

Copies most standard shifts and speeds. Has

MFJ AutoTrak™ Morse code speed tracking.

Use 12 VDC or use 110 VAC with MFJ-1312D AC adapter, \$15.95. 5 1/4"Wx2 1/2"Hx5 1/4"D inches.

WiFi Yagi Antenna -- 15 dBi 16-elements extends range

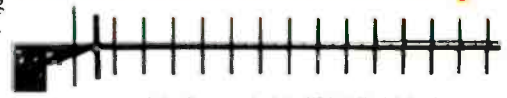

16-element, 15 dBi WiFi Yagi antenna greatly extends range of 802.11b/g, 2.4 GHz WiFi signals. 32 times stronger than isotropic radiator. Turns slow/no connection WiFi into fast, solid connection. Highly directional -- minimizes interference.

N-female connector. Tripod screw-mount. Wall and desk/shelf mounts. Use vertically/horizontally. 18Wx2 1/4"Hx1 1/4"D inches. 2.9 ounces.

MFJ-5606SR, \$24.95. Cable connects MFJ-1800/WiFi antennas to computer.

Reverse-SMA male to N-male, 6 ft. RG-174.

MFJ-5606TR, \$24.95. Same as MFJ-5606SR but Reverse-TNC male to N-male.

Eliminate power line noise!



Completely eliminate power line noise, lightning crashes and interference before they get into your receiver! Works on all modes -- SSB, AM, CW, FM, data -- and on all shortwave bands. Plugs between main external antenna and receiver. Built-in active antenna picks up power line noise and cancels undesirable noise from main antenna. Also makes excellent active antenna.

MFJ Antenna Matcher

Matches your antenna to your receiver so you get maximum signal and minimum loss. MFJ-959C Preamp with gain \$119⁹⁵

control boosts weak stations 10 times. 20 dB attenuator prevents overload. Select 2 antennas and 2 receivers. 1.6-30 MHz. 9x2x6 in. Use 9-18 VDC or 110 VAC with MFJ-1312, \$15.95.

High-Gain Preselector

High-gain, high-Q receiver preselector covers 1.8-54 MHz.

Boost weak signals 10 times with low noise dual gate MOSFET. Reject out-of-band signals and images with high-Q tuned circuits. Push buttons let you select 2 antennas and 2 receivers. Dual coax and phono connectors. Use 9-18 VDC or 110 VAC with MFJ-1312, \$15.95.

Dual Tunable Audio Filter

Two separately tunable filters let you peak desired signals and notch out interference at the same time. You can peak,

notch, low or high pass signals to eliminate heterodynes and interference. Plugs between radio and speaker or phones. 10x2x6 inches.

MFJ Shortwave Headphones

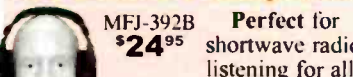

Perfect for shortwave radio listening for all modes -- SSB, FM, AM, data and CW. Superb padded headband and ear cushioned design makes listening extremely comfortable as you listen to stations all over the world! High-performance driver unit reproduces enhanced communication sound. Weighs 8 ounces, 9 ft. cord. Handles 450 mW. Frequency response is 100-24,000 Hz.

High-Q Passive Preselector

High-Q passive LC preselector boosts your favorite stations while rejecting images, intermod and phantom signals. 1.5-30 MHz. Preselector bypass and receiver grounded positions. Tiny 2x3x4 in.

Super Passive Preselector

Improves any receiver! Suppresses strong out-of-band signals that cause intermod, blocking, cross modulation and phantom signals. Unique Hi-Q series tuned circuit adds super sharp front-end selectivity with excellent stopband attenuation and very low passband loss. Air variable capacitor with vernier. 1.6-33 MHz.

MFJ Shortwave Speaker

This MFJ ClearTone™ restores the broadcast quality sound of shortwave listening. Makes copying easier, enhances speech, improves intelligibility, reduces noise, static, hum. 3 in. speaker handles 8 Watts. 8 Ohm impedance. 6 foot cord.

MFJ All Band Doublet

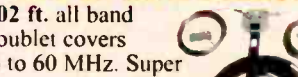

102 ft. all band doublet covers .5 to 60 MHz. Super strong custom fiberglass center insulator provides stress relief for ladder line (100 ft.). Authentic glazed ceramic end insulators and heavy duty 14 gauge 7-strand copper wire.

MFJ Antenna Switches



MFJ-1704 heavy duty antenna switch lets you select 4 antennas or ground them for static and lightning protection. Unused antennas automatically grounded. Replaceable lightning surge protection. Good to 500 MHz. 60 dB isolation at 30 MHz. MFJ-1702C for 2 antennas.

Morse Code Reader



Place this pocket-sized MFJ Morse Code Reader near your receiver's speaker. Then watch CW turn into solid text messages on LCD. Eavesdrop on Morse Code QSOs from hams all over the world!

MFJ 24/12 Hour Station Clock



Dual 24/12 hour clock. Read UTC/local time at-a-glance. High-contrast 5/8" LCD, brushed aluminum frame. Batteries included. 4 1/2"Wx1Dx2H inches.

Dealer/Catalog/Manuals

Visit: <http://www.mfjenterprises.com> or call toll-free 800-647-1800

• 1 Year No Matter What™ warranty • 30 day money back guarantee (less s/h) on orders direct from MFJ

MFJ MFJ ENTERPRISES, INC.
300 Industrial Pk Rd, Starkville, MS 39759 PH: (662) 323-5869
Tech Help: (662) 323-0549
FAX: (662) 323-6551 8-4:30 CST, Mon.-Fri. Add shipping.
Prices and specifications subject to change. (c) 2008 MFJ Enterprises, Inc.

by Edith Lennon, N2ZRW, Editor

Holiday Wishes

Clockwork has done its duty, and it's again the time of year when thanksgiving, gift-giving, resolution-making, and the general slowing down for a moment of stock-taking coincide.

Because of the magazine's scheduling, it's October as I write this, so I'm taking stock early. And as I do I find myself especially grateful for something that's been in the news and is dear to all of us: technology. I don't mean iPhones, GPSs, or new scanners. I mean Technology, writ large with a capital "T," and how it has improved lives, and right now, hopefully, is saving many.

The technology I'm talking about is not found under a tree, but in the hands of some very brave people in Myanmar, formerly Burma. At tremendous personal risk, they have been reporting, with tools most of us take for granted, on the military's crackdown on anti-government protests.

They're being called citizen journalists and cyber dissidents and are facing down one of the world's most repressive and closed regimes, where the only media is state run and even government webpages were reported down after stepped-up censorship. Armed with cell phones and digital cameras and hunkered down before the too-few Internet links, technology-savvy citizens smuggled text messages, still photos, and videos, including images of the death of Japanese journalist Kenji Nagai, to a watching world via email, Web proxy sites, and blogs.

One blog in particular, "ko htike's prosaic collection," has been a major conduit of information. London-based Ko Htike has been posting graphic descriptions and images, sent to him by dozens of sources within Myanmar, which are being snatched up by the global media.

Another channel for the smuggled digital content is the Democratic Voice of Burma, an opposition-run shortwave radio and television service based in Norway. Founded in 1992 by exiled Burmese students, it has broadcast nearly real-time images and information about the events. The Thailand-based online magazine *The Irrawaddy*, which is published by an independent news organization that covers Myanmar and Southeast Asia and was also founded by exiles, has played a huge role, too, in publicizing the unfolding events as documented by camera-wielding witnesses.

Belatedly realizing the power of the images streaming out of the country, the government responded with a total blackout of information. Internet cafes were closed, Internet and cell phone service providers shut down, and cameras confiscated on the streets. There were reports of foreigners being expelled and their electronic equipment seized, and a mysteriously timed computer virus compromised the website of the *The Irrawaddy*.

As of this writing, information out of the country has slowed to a trickle, but trickle it does. And the story is still smuggled out through cell phones or any other means technology has made available. Ko Htike vows to continue, as do The Democratic Voice of Burma and *The Irrawaddy*. They'll continue to publish on the Internet the content the cyber-dissidents manage to get through to them.

Referring to the Internet, as reported in the *New York Times*, Frank A. Moretti, executive director of the Center for New Media Teaching and Learning at Columbia University, said, "For those of us who study the history of communication technology, this is of equal importance to the telegraph, which was the first medium that separated communications and transportation."

The history of Myanmar itself reflects the human consequences of technology. In a previous uprising there, in 1988 before cell phones captured images to be streamed across the globe, the brutal government suppression left an estimated 3,000 dead. Today, the government admits to a handful of casualties, while some dissident groups put the number as high as 200. It's assumed there's a greater reluctance to harm monks, who have led the protests, because they are especially revered in Myanmar, but few doubt that the digital eyes of the world are staying the government's hand. For now.

My wish for the coming year is that the technical expertise of these cyber dissidents, and others like them, will continue as a force for good in the world.

And I wish you and yours a safe and happy Holiday Season.

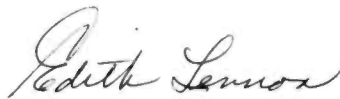

POPULAR COMMUNICATIONS

EDITORIAL STAFF

Edith Lennon, N2ZRW, Editor

(E-mail: editor@popular-communications.com)

Tom Kneitel, W4XAA, Senior Editor

Richard S. Moseson, W2VU, Editorial Director

(E-mail: w2vu@popular-communications.com)

CONTRIBUTING EDITORS

Rich Arland, W3OSS, Homeland Security

Peter J. Bertini, K1ZJH, Restoration/Electronics

Kent Britain, WA5VJB, Antennas And Accessories

Bruce A. Conti, AM/FM Broadcasts

Gerry L. Dexter, Shortwave Broadcast

Richard Fisher K16SN, Capitol Hill News

Tomas Hood, NW7US, Propagation

Shannon Huniwell, Classic Radio

John Kasupski, KC2HMZ, Utility Communications

Kirk Kleinschmidt, NT0Z, Amateur Radio

Ron McCracken, WPZX-486/KG4CVL, REACT

D. Prabakaran, News

Bill Price, N3AVY, Humor/Communications

Ken Reiss, Technical/Scanning

Bob Sturtevant, AD7IL, Puzzles and Trivia

Tom Swisher, WA8PYR, Military Monitoring

Jason Togyer, KB3CNM, Cartoons

Gordon West, WB6NOA, Radio Resources

BUSINESS STAFF

Richard A. Ross, K2MGA, Publisher

Arnold Sposato, N2IQO, Advertising Manager

Emily Leary, Sales Coordinator

Sal Del Grosso, Accounting Manager

Doris Watts, Accounting Department

Melissa Gilligan, Operations Manager

Cheryl DiLorenzo, Customer Service Manager

Ann Marie Auer, Customer Service

PRODUCTION STAFF

Elizabeth Ryan, Art Director

Barbara McGowan, Associate Art Director

Dorothy Kehrwieler, Production Director

Emily Leary, Production Manager/Webmaster

Hal Keith, Technical Illustrator

Larry Mulvehill, WB2ZPI, Photographer

A publication of



CQ Communications, Inc.
25 Newbridge Road
Hicksville, NY 11801-2953 USA

Offices: 25 Newbridge Rd., Hicksville, NY 11801, Telephone 516-681-2922. Fax 516-681-2926. Web site: www.popular-communications.com.

Periodical postage paid at Hicksville, NY 11801 and additional offices. Statement of Ownership, Management and Circulation, September 29, 2007. Popular Communications, 25 Newbridge Road, Hicksville, NY 11801. Publication #0733-3315. Issued monthly, subscription price \$32.95 per year (12 issues). Publisher: Richard A. Ross, Editor: Edith Lennon; owned by CQ Communications, Inc. Stockholders: Richard A. Ross. Circulation (Average of Preceding 12 Months): Net Press Run 23,529. Mail Subscriptions 9,152. Sales Through Dealers and News Agents 11,041. Other Classes Mailed 200. Total Paid 20,393. Free Distribution 262. Total Distribution 20,655. Copies Not Distributed 1,215. Total 21,870. Circulation (single issue nearest filing date): 25,200. Mail Subscriptions 9,202. Sales Through Dealers and News Agents 11,847. Other Classes Mailed 200. Total Paid 21,249. Free Distribution 281. Total Distribution 21,530. Copies Not Distributed 1,105. Total 22,635 s/Dorothy Kehrwieler, Business Manager. Entire contents copyrighted 2007 by CQ Communications, Inc.

Printed in U.S.A.

Postmaster: Please send change of address to: Popular Communications, 25 Newbridge Rd., Hicksville, NY 11801

Popular Communications invites your comments, questions, criticisms, compliments, article submissions—in a word, your thoughts. Write to me at editor@popular-communications.com.

SANGEAN

A WORLD OF LISTENING



WiFi

Powered By:



RECIVA

Sangean America, Inc.

2651 Troy Avenue, South El Monte, CA 91733

Tel: 888.SANGEAN Fax: 626.579.6806

e-mail: info@sangean.com

www.sangean.com

WFR-20 WiFi Internet Radio & Media Player

Access over 6,000+ Internet Radio Stations.
And listen to media stored on your computer.

- Listen to radio stations from around the country, from around the world
- Play your music collection from your computer
- Wired or wireless connection
- High quality Full-range Stereo Speakers (2 x 5W)
- Large, Easy-to-read 3-line display
- Extra large Clock display
- 12 or 24 hour clock format
- Full display brightness adjustment
- Four Alarm timers (radio or buzzer)
- Sleep timer with gentle fade
- Auxiliary Input socket for iPod, MP3 player, etc
- Line Output socket
- Headphone socket
- Intuitive Menu system
- Operate from single rotary control or remote control
- Compact, stylish remote control
- High-gloss Piano-black finish
- Acoustically tuned cabinet
- Audio Formats: MP3/WMA/AAC/WAV/AIFF/FLAC/REAL
- WiFi (802.11g/b) and Wired Ethernet connections
- (10/100 Mbps, RJ-45)
- Connects to Windows Shares or UPNP servers
- Dimensions (W X H X D): 290 x 115 X 215
- Weight 2.98kg

News, Trends, And Short Takes

World's First Range Of DAB+ Radios By Year End

DAB technology company Frontier Silicon and applied research organization Fraunhofer IIS have teamed up with tier one audio manufacturers to deliver the world's first range of DAB+ radios. Solutions incorporating Frontier Silicon's multi-standard digital radio SoC Chorus 2 with Fraunhofer's audio decoder IP are being designed into products from specialist brands including Bush, Grundig, Magicbox, Ministry of Sound, Pure, Revo, Tivoli and others, which will be available in shops by the end of this year.

DAB (based on MPEG 1 layer II) is achieving great success in the UK and Denmark, with over well over 5 million units shipped to date and growing at a rate of 12 percent per year on year in the UK alone. Countries that have yet to roll out DAB, however, are looking to use DAB+, which uses MPEG-4 HE AAC v2 codec, enabling a greater number of radio channels to be broadcast within a set radio spectrum. Australia has officially committed to transmit DAB+ in 2009 and many other countries including Canada, Italy, Switzerland, Czech Republic, Malta, Israel, Hungary, Kuwait, Malaysia, and New Zealand are expected to follow suit soon.

Congress May Come Up With Bill To Avert VOA Cuts

EurAsia.net, which reports that plans to eliminate the Voice of America's Uzbek language service are likely to be shelved due to opposition in both houses of the U.S. Congress. The House of Representatives and the Senate have recommended "sufficient funding to fully restore the reductions proposed in the fiscal year 2008" and "continuing broadcasting which the administration proposed for language service reduction," including Uzbek.

In June, the House Subcommittee on State, Foreign Operations and Related Programs recommended a budget allocation of \$194 million to the Voice of America—\$22.5 million more than the station's 2007 budget and \$15.7 million more than the 2008 request from the Board of Broadcasting Governors (BBG), which manages VOA and Radio Free Europe/Radio Liberty (RFE/RL). In July, the Senate's Subcommittee for State, Foreign Operations and Related Programs recommended a budget of \$187 million for VOA, some \$8.7 million more than the 2008 request from the BBG.

A joint House-Senate conference will address the existing \$7 million discrepancy between the two proposed budgets and come up with a unified spending bill. According to a spokeswoman for the Senate Committee on Appropriations, "the conference committee should definitely happen

before Christmas. We can't say exactly when, but the sooner the better. Senator [Robert] Byrd [a West Virginia Democrat and the committee's chairman], is anxious to get the bill through."

WRN Provides Satellite Services For Radio Station For The Blind

WRN, the UK-based television and radio transmission company, is providing comprehensive satellite uplink and capacity and EPG (Electronic Program Guide) services for Insight Radio, the newest radio station on the Sky platform.

Insight Radio is the radio station of the Royal National Institute for the Blind (RNIB) and Europe's first radio station for blind and partially sighted people. It broadcasts online at www.insightradio.co.uk, in the Glasgow area on 101 FM, and now on Sky. The Sony Award-winning station provides blind and partially sighted listeners with quick and easy access to information and public services as well as leisure, recreational, and social opportunities. The station is funded by the RNIB with support from stakeholder organizations, including Glasgow City Council, East Renfrewshire Council, South Lanarkshire Council, and the British Wireless for the Blind Fund.

Insight Radio is using WRN's existing ON AIR channel 0188, which is used by stations seeking fast access to the Sky platform and its penetration into more than 8.6 million homes across Britain and Ireland. It has previously played host to Virgin Radio, Yorkshire Radio, and the British Forces Broadcasting Service. WRN is also supplying EPG data compilation and submission services.

Japanese Satellite Crashes, Russia Suspends Launches

A Japanese television satellite crashed just after take-off, prompting suspension of all satellite launches by Proton rocket from Russia's Baikonur Cosmodrome space center in the steppes of Kazakhstan, Russian news agencies reported. The JCSat-11 satellite crashed to Earth just 135 seconds after blasting off on the Russian Proton-M at 04:42 a.m. (2242 GMT), the Interfax news agency said. The rocket plunged into a remote corner of the Central Asian ex-Soviet republic and no one was reported hurt.

The JCSat-11, intended to retransmit television broadcasts, was to have covered Japan, the Asia Pacific region, and the Hawaii island group. Japan's JSAT Corp said that the failure would have minimal effect since the new satellite was only planned as a replacement for an older version. "This satellite was launched as a successor to an in-orbit backup satellite. The failure does not affect the communications and broadcasting services currently offered," JSAT said.

Big Savings on Radio Scanners

Uniden®

SCANNERS



Bearcat® 796DGV Trunk Tracker IV with free scanner headset

Manufacturers suggested list price \$799.95

CEI Special Price \$519.95

1,000 Channels • 10 Banks • CTCSS/DCS • S Meter
Size: 6 1/8" Wide x 6 9/16" Deep x 2 3/8" High

Frequency Coverage: 25.0000-512.0000 MHz., 806.0000-956.0000 MHz. (excluding the cellular & UHF TV band), 1,240.000-1,300.000 MHz.

When you buy your Bearcat 796DGV Trunk Tracker package deal from Communications Electronics, you get more. The GV means "Great Value." With your BC796DGV scanner purchase, you also get a free deluxe scanner headphone designed for home or race track use. Headset features independent volume controls and 3.5 mm gold right angle plug. The 1,000 channel Bearcat 796DGV is packed with features to track Motorola Type I/II/III Hybrid, EDACS, LTR Analog Trunk Systems and Motorola APCO 25 Phase I digital scanner including 9,600 Baud C4FM and CQPSK. Also features control channel only mode to allow you to automatically trunk many systems by simply programming the control channel. S.A.M.E. weather alert, full-frequency display and backlit controls, built-in CTCSS/DCS to assign analog and digital subaudible tone codes to a specific frequency in memory, PC Control and programming with RS232C 9 pin port (cable not supplied), Beep Alert, Record function, VFO control, menu-driven design, total channel control and much more. Our CEI package deal includes telescopic antenna, AC adapter, cigarette lighter cord, DC cord, mobile mounting bracket with screws, owner's manual, trunking frequency guide and one-year limited Uniden factory warranty. For maximum scanning enjoyment, order magnetic mount antenna part number ANTMMBNC for \$29.95. For complete details, download the owners manual from the www.usascan.com web site. For fastest delivery, order on-line at www.usascan.com.

Bearcat® BCT8 Trunk Tracker III

Manufacturer suggested list price \$299.95

CEI Special Price \$169.95

250 Channels • 5 Banks • PC Programmable

Size: 7.06" Wide x 6.10" Deep x 2.44" High

Frequency Coverage: 25.0000-54.0000 MHz., 108.0000-174.0000 MHz., 400.0000-512.0000 MHz., 806.0000-823.9950 MHz., 849.0125-868.9950 MHz., 894.0125-956.0000 MHz.

The Bearcat BCT8 scanner, licensed by NASCAR, is a superb preprogrammed 800 MHz trunked highway patrol system scanner. Featuring TrunkTracker III, PC Programming, 250 Channels with unique BearTracker warning system to alert you to activity on highway patrol inlink frequencies. Preprogrammed service searches makes finding interesting active frequencies even easier and include preprogrammed police, fire and emergency medical, news agency, weather, CB band, air band, railroad, marine band and department of transportation service searches. The BCT8 also has preprogrammed highway patrol alert frequencies by state to help you quickly find frequencies likely to be active when you are driving. The BCT8 includes AC adapter, DC power cable, cigarette lighter adapter plug, telescopic antenna, window mount antenna, owner's manual, one year limited Uniden warranty, frequency guide and free mobile mounting bracket. For maximum scanning enjoyment, also order the following optional accessories: External speaker ESP20 with mounting bracket & 10 feet of cable with plug attached \$19.95. Magnetic Mount mobile antenna ANTMMBNC for \$29.95.



Bearcat® BCD396T Trunk Tracker IV

Suggested list price \$799.95/CEI price \$519.95

APCO 25 9,600 baud compact digital ready handheld TrunkTracker IV scanner featuring Fire Tone Out Paging, Close Call and Dynamically Allocated Channel Memory (up to 6,000 channels), SAME Weather Alert, CTCSS/DCS, Alpha Tagging.

Size: 2.40" Wide x 1.22" Deep x 5.35" High

Frequency Coverage:

25.0000-512.0000 MHz., 764.0000-775.9875 MHz., 794.0000-823.9875 MHz., 849.0125-868.9765 MHz., 894.0125-956.0000 MHz., 1240.0000 MHz.-1300.0000 MHz.

The handheld BCD396T scanner was designed for National Security/Emergency Preparedness (NS/EP) and homeland security use with new features such as **Fire Tone Out Decoder**. This feature lets you set the BCD396T to alert if your selected two-tone sequential paging tones are received. Ideal for on-call firefighters, emergency response staff and for activating individual scanners used for incident management and population attack warning.

Close Call Radio Frequency Capture - Bearcat exclusive technology locks onto nearby radio transmissions, even if you haven't programmed anything into your scanner. Useful for intelligence agencies for use at events where you don't have advance notice or knowledge of the radio communications systems and assets you need to intercept. The BCD396T scanner is designed to track Motorola Type I, Type II, Hybrid, SMARTNET, PRIVACY PLUS, LTR and EDACS® analog trunking systems on any band. Now, follow UHF High Band, UHF 800/900 MHz trunked public safety and public service systems just as if conventional two-way communications were used. **Dynamically Allocated Channel Memory** - The BCD396T scanner's memory is organized so that it more closely matches how radio systems actually work. Organize channels any way you want, using Uniden's exclusive dynamic memory management system. 3,000 channels are typical but **over 6,000 channels are possible** depending on the scanner features used. You can also easily determine how much memory you have used and how much memory you have left. **Preprogrammed Systems** - The BCD396T is preprogrammed with over 400 channels covering police, fire and ambulance operations in the 25 most populated counties in the United States, plus the most popular digital systems. **3 AA NiMH or Alkaline battery operation and Charger** - 3 AA battery operation - The BCD396T includes 3 premium 2,300 mAh Nickel Metal Hydride AA batteries to give you the most economical power option available. You may also operate the BCD396T using 3 AA alkaline batteries. **Unlque Data Skip** - Allows your scanner to skip unwanted data transmissions and reduces unwanted birds. **Memory Backup** - If the battery completely discharges or if power is disconnected, the frequencies programmed in the BCD396T scanner are retained in memory. **Manual Channel Access** - Go directly to any channel. **LCD Back Light** - A blue LCD light remains on when the back light key is pressed. **Autolight** - Automatically turns the blue LCD backlight on when your scanner stops on a transmission. **Battery Save** - In manual mode, the BCD396T automatically reduces its power requirements to extend the battery's charge. **Attenuator** - Reduces the signal strength to help prevent signal overload. The BCD396T also works as a conventional scanner to continuously monitor many radio conversations even though the message is switching frequencies. The BCD396T comes with AC adapter, 3 AA nickel metal hydride batteries, belt clip, flexible rubber antenna, wrist strap, SMA/BNC adapter, RS232C cable, Trunk Tracker frequency guide, owner's manual and one year limited Uniden warranty. Not compatible with AGEIS, ASTRO or ESAS systems. Order on-line at www.usascan.com or call 1-800-USA-SCAN.



Bearcat® BC246T Trunk Tracker III

Suggested list price \$399.95/CEI price \$214.95

Compact professional handheld TrunkTracker III scanner featuring Close Call and Dynamically Allocated Channel Memory (up to 2,500 channels), SAME Weather Alert, CTCSS/DCS, Alpha Tagging.
Size: 2.72" Wide x 1.26" Deep x 4.6" High

Frequency Coverage:

25.0000-54.0000 MHz., 108.0000-174.0000 MHz., 216.0000-224.9800 MHz., 400.0000-512.0000 MHz., 806.0000-823.9875 MHz., 849.0125-868.9875 MHz., 894.0125-956.0000 MHz., 1240.0000 MHz.-1300.0000 MHz.

The handheld BC246T TrunkTracker scanner has so many features, we recommend you visit our web site at www.usascan.com and download the free owner's manual. Popular features include **Close Call Radio Frequency Capture** - Bearcat exclusive technology locks onto nearby radio transmissions, even if you haven't programmed anything into your scanner. **Dynamically Allocated Channel Memory** - Organize channels any way you want, using Uniden's exclusive dynamic memory management system. 1,600 channels are typical but **over 2,500 channels are possible** depending on the scanner features used. You can also easily determine how much memory is used. **Preprogrammed Service Search (10)** - Makes it easy to find interesting frequencies used by public safety, news media TV broadcast audio, Amateur (ham) radio, CB radio, Family Radio Service, special low power, railroad, aircraft, marine, racing and weather frequencies. **Quick Keys** - allow you to select systems and groups by pressing a single key. **Text Tagging** - Name each system, group, channel, talk group ID, custom search range, and S.A.M.E. group using 16 characters per name. **Memory Backup** - When power is lost or disconnected, your BC246T retains the frequencies that were programmed in memory. **Unique Data Skip** - Allows the BC246T to skip over unwanted data transmissions and birds. **Attenuator** - You can set the BC246T attenuator to reduce the input strength of strong signals by about 18 dB. **Duplicate Frequency Alert** - Alerts you if you try to enter a duplicate name or frequency already stored in the scanner. **22 Bands** - with aircraft and 800 MHz. The BC246T comes with AC adapter, 2 AA 1,800 mAh nickel metal hydride batteries, belt clip, flexible rubber antenna, wrist strap, RS232C cable, Trunk Tracker frequency guide, owner's manual and one year limited Uniden warranty. For more fun, order our optional deluxe racing headset part #HF24RS for \$29.95. Order now at www.usascan.com or call 1-800-USA-SCAN.



Buy with Confidence
Order on-line and get big savings
 For over 37 years, millions of communications specialists and enthusiasts worldwide have trusted Communications Electronics for their mission critical communications needs. It's easy to order. For fastest delivery, order on-line at www.usascan.com. Mail orders to: Communications Electronics Inc., P.O. Box 1045, Ann Arbor, Michigan 48106 USA. Price includes \$30.00 UPS Ground shipping/handling/insurance per scanner to a street address in the continental USA excluding Alaska. Add \$20.00 shipping for all accessories. For shipments to Canada, Puerto Rico, Hawaii, Alaska, Guam, P.O. Box, APO/FPO, USPS Priority Mail or UPS 2 business day delivery, add \$30.00. Michigan residents add sales tax. No COD's. For Bearcat scanners your satisfaction is guaranteed or return item in unused condition in original packaging within 61 days for refund, less shipping charges. 10% surcharge for net 10 billing to qualified accounts. All sales are subject to availability, acceptance and verification. Prices, terms and specifications are subject to change without notice. We welcome your Discover, Visa, American Express, MasterCard, IMPAC or Eurocard. Order toll free, call 1-800-USA-SCAN or 1-734-996-8888 if outside Canada or the USA. FAX anytime, dial 1-734-663-8888. Dealer and international inquiries invited. Order your radio scanners from Communications Electronics today.

Buy with Confidence

Order on-line and get big savings

For over 37 years, millions of communications specialists and enthusiasts worldwide have trusted Communications Electronics for their mission critical communications needs. It's easy to order. For fastest delivery, order on-line at www.usascan.com. Mail orders to: Communications Electronics Inc., P.O. Box 1045, Ann Arbor, Michigan 48106 USA. Price includes \$30.00 UPS Ground shipping/handling/insurance per scanner to a street address in the continental USA excluding Alaska. Add \$20.00 shipping for all accessories. For shipments to Canada, Puerto Rico, Hawaii, Alaska, Guam, P.O. Box, APO/FPO, USPS Priority Mail or UPS 2 business day delivery, add \$30.00. Michigan residents add sales tax. No COD's. For Bearcat scanners your satisfaction is guaranteed or return item in unused condition in original packaging within 61 days for refund, less shipping charges. 10% surcharge for net 10 billing to qualified accounts. All sales are subject to availability, acceptance and verification. Prices, terms and specifications are subject to change without notice. We welcome your Discover, Visa, American Express, MasterCard, IMPAC or Eurocard. Order toll free, call 1-800-USA-SCAN or 1-734-996-8888 if outside Canada or the USA. FAX anytime, dial 1-734-663-8888. Dealer and international inquiries invited. Order your radio scanners from Communications Electronics today.

For credit card orders call
1-800-USA-SCAN

e-mail: cei@usascan.com

www.usascan.com

PO Box 1045, Ann Arbor, Michigan 48106-1045 USA
 For information call 734-996-8888 or FAX 734-663-8888
 Price schedule effective January 2, 2006 AD #010206 © 2006 Communications Electronics Inc.



COMMUNICATIONS ELECTRONICS INC.

Emergency Operations Center

More Radio Products

Save even more on radio scanners when purchased directly from CEI. Price includes delivery in the continental USA excluding Alaska.

Bearcat 898T 500 channel TrunkTracker III base/mobile.....	\$209.95
Bearcat 796DGV Digital 1,000 ch. TrunkTracker IV base/mobile.....	\$519.95
Bearcat BCD396T APCO 25 Digital scanner with Fire Tone Out.....	\$519.95
Bearcat 246T up to 2,500 ch. TrunkTracker III handheld scanner.....	\$214.95
Bearcat Sportcast 230 alpha display handheld sports scanner.....	\$184.95
Bearcat 278CLT 100 channel AM/FM/SAME WX alert scanner.....	\$129.95
Bearcat 248CLT 50 channel base AM/FM/weather alert scanner.....	\$104.95
Bearcat 244CLT 30 channel base AM/FM/weather alert scanner.....	\$94.95
Bearcat 92XLT 200 channel handheld scanner.....	\$105.95
Bearcat 72XLT 100 channel handheld scanner.....	\$89.95
Bearcat BR330T handheld shortwave/scanner with Fire Tone out.....	\$274.95
Bearcat BCT8 250 channel information mobile scanner.....	\$169.95
Bearcat 350C 50 channel desktop/mobile scanner.....	\$96.95
AOR AR16BQ Wide Band scanner with quick charger.....	\$199.95
AOR AR3000AB Wide Band base/mobile receiver.....	\$1,079.95
AOR AR8200 Mark IIIB Wide Band handheld scanner.....	\$594.95
AOR AR8600 Mark II Wide Band receiver.....	\$899.95
Deluxe Independent Dual Volume Control Racing Headphone.....	\$29.95
Scantcal Gold For Windows Software.....	\$99.95
Scantcal Gold For Windows Surveillance Edition.....	\$199.95

Visit WWW.USASCAN.COM • 1-800-USA-SCAN

Capitol Hill And FCC Actions Affecting Communications

Disaster Information Reporting System Launched

The Public Safety and Homeland Security Bureau's Communications Systems Analysis Division has launched a Web-based system called the Disaster Information Reporting System (DIRS) "to collect the information needed to determine the status of communications services in affected areas," according to the FCC's website.

"In the event of a major disaster like hurricane Katrina, the Department of Homeland Security (DHS) and the [Federal Communications Commission] need to have an accurate assessment of the status of communications services in the disaster area, particularly during restoration efforts," the FCC announced. During major disasters, communications providers will be able to update information on the status of various types of communications equipment daily.

"DIRS will collect information on the status of switches, public safety answering points (used for E911), interoffice facilities, cell sites, broadcast stations and cable television systems," the FCC said. "The Commission will analyze, chart and map this information and it will be shared with DHS."

More information can be obtained by searching DIRS through the FCC's Internet site at www.fcc.gov.

Organizations Support 911 Modernization Legislation

Two national organizations have jointly voiced support for 911 modernization before the U.S. House Subcommittee on Telecommunications and the Internet of the Committee on Energy and Commerce.

In a statement on its website, the Association of Public Safety Communications Officials (APCO) International and the National Emergency Number Association said the 911 Modernization and Public Safety Act of 2007 is important because it:

1. strengthens the Federal Communications Commission's (FCC) Voice over Internet Protocol (VoIP) E9-1-1 Order by codifying the obligation of all Internet Protocol (IP)-enabled voice service providers to provide E9-1-1 in accordance with FCC regulations,
2. provides needed tools to assist in the completion of E9-1-1 deployment for VoIP service in all parts of the United States; and
3. addresses the issue of Next Generation (NG) 9-1-1 service.

"Our nation's 9-1-1 system is a vital public safety and homeland security asset," NENA President Jason Barbour said to the subcommittee, as reported on APCO's website. "Everyday 9-1-1 callers seek critical emergency assistance and are the eyes and ears helping others during emergencies in local communities and assisting with our nation's homeland security.

"Modern communication capabilities offer an opportunity to improve the system as we know it, but they also offer challenges," he said. "The 9-1-1 community must embrace and react to the change quickly to better serve the American public, industry and the mobile consumer in all emergencies. We need help from Congress to do so."

Pennsylvania Radio Operator Fined For Illegal Operation

Ronald Mondgock, former Novice class licensee KA3OMZ, has been issued a Notice of Apparent Liability for Forfeiture by the FCC, alleging he "apparently willfully and repeatedly" operated "radio

transmitting equipment on the frequencies 439.850 MHz and 147.560 MHz without a license." The Commission is recommending a fine of \$10,000.

Acting on a tip, the Philadelphia office of the FCC launched an investigation into Mondgock's alleged operation on unauthorized VHF frequencies and also "determined that Mondgock's Novice Class license for amateur radio station KA3OMZ had been in dismissal status as of March 17, 2006."

FCC agents visited Mondgock at his residence. "During the interview Mondgock admitted that he operates radio transmitting equipment on the frequency 439.850 MHz from his residence and vehicle and he owns and operates a repeater station on the frequency 147.560 from the One Commerce Square in Philadelphia," the Commission said. Mondgock acknowledged that his Novice license "was expired and that his license did not authorize him to operate" on those VHF frequencies.

In spite of being warned to discontinue operation, the FCC determined that Mondgock continued unauthorized transmissions. "Because Mondgock operated an amateur radio station after being warned that he no longer had authority to do so and because he admitted to such unauthorized operation," the FCC wrote, "we find that the violation was willful. Because the violation continued for more than one day, it was repeated."

DoD And ARRL Grapple With PAVE Paws Radar Site Interference

Officials from the American Radio Relay League met in teleconference with members of the Department of Defense regarding amateur radio repeaters interfering with the Air Force's PAVE Paws radar system.

As reported in the League's *ARRL Letter*, Regulatory Branch Manager Dan Henderson, N1ND, said "the DoD acknowledges that it has seen changes at some repeater sites, but not all of them." Henderson said DoD has revisited the Massachusetts repeaters, located near Otis Air Force Base on Cape Cod, to "remeasure the numbers. Some Massachusetts repeater owners have volunteered to completely turn off their systems and some others have made changes, but more is needed at both PAVE Paws radar sites."

The DoD has identified additional sources of interference in Massachusetts, Henderson said. "This was not really unexpected and is part of what has become an ongoing project. The ARRL will begin working with these repeater owners as soon as the DoD provides us with specific information," he said.

The *ARRL Letter* further reported that in California, "where more than 100 repeaters are being scrutinized by the DoD, Henderson said the majority of repeaters have not been mitigated: 'The Air Force has not had a chance to revisit Beale Air Force Base for new measurements, but it will be happening soon.'"

A number of California repeater owners have decided to take no further action about mitigating the interference unless they receive official notice from the FCC, according to some reports. "If these reports are true," Henderson said, "it is unfortunate. The FCC has stayed abreast of the discussions between the League and the DoD, and they are prepared to act appropriately if they are contacted by the DoD."

Henderson added that "the DoD has indicated they are willing to allow the ARRL to continue its attempts to mitigate the interference; however, they have expressed a sense of urgency that this must come to a conclusion. Those waiting for FCC action may find it coming sooner rather than later."

KENWOOD

Listen to the Future

New RC-D710

The RC-D710 is a standalone 1200/9600 bps TNC with APRS firmware



KENWOOD
Listen to the Future

www.kenwoodusa.com



TM-G707A



TM-V7A



TM-D700A

With the supplied accessories the RC-D710 is a full upgrade to the TM-V71A. The TM-V71A will have full functionality of the TM-D710A by exchanging the TM-V71A panel with the RC-D710.

This is where it gets interesting!

PG-5J connection kit makes the RC-D710 a complete standalone APRS/TNC for your current radio. This option allows connectivity with previous and current Kenwood models* as an external modem.

*Compatible models include: TM-D710A / TM-V71A / TM-D700A / TM-G707A / TM-V7A / TM-733A / TM-255A / TM-455A

KENWOOD U.S.A. CORPORATION

Communications Sector Headquarters

3975 Johns Creek Court, Suite 300, Suwanee, GA 30024-1298

Customer Support/Distribution

P.O. Box 22745, 2201 East Dominguez St., Long Beach, CA 90801-5745

Customer Support: (310) 639-4200 Fax: (310) 537-8235



www.kenwoodusa.com
ADS#41307



ISO 9001 091A
Registered
Communications Equipment Division
Kenwood Corporation
©2003 Kenwood

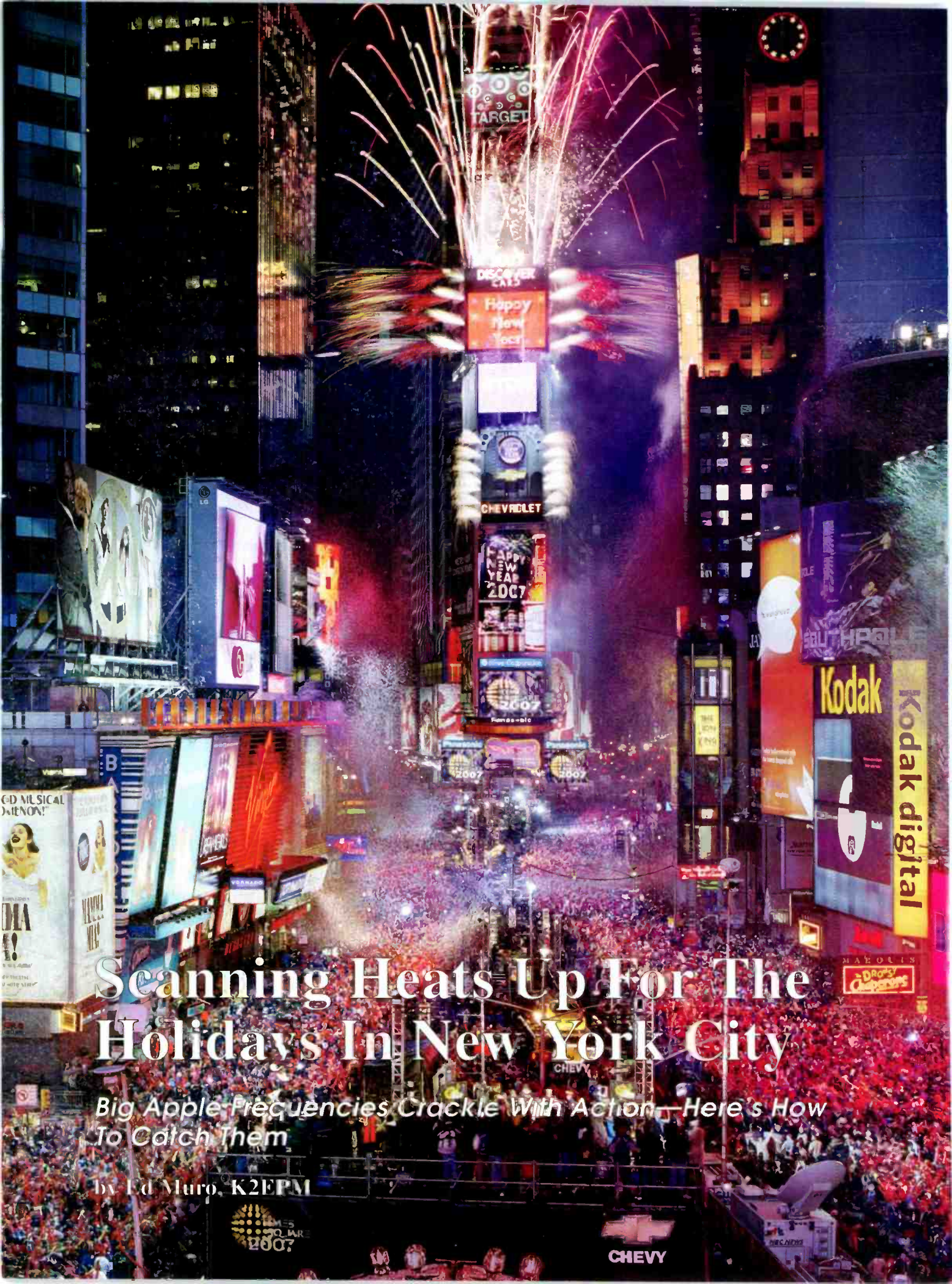

Scanning Heats Up For The Holidays In New York City

Big Apple frequencies crackle with action—here's how to catch them

by Ed Muro, K2EPM

NEW YORK
YEAR
2007

CHEVY

Some places in this country are real “hotbeds” for scanning. In some other places you have a better chance of hearing a cow moo than even mundane activity on your scanner, never mind an armed robbery. As a seasoned scanner aficionado for over 30 years, I consider myself lucky to have grown up in one of those hotbeds: the New York Metro area.

And that bed is at its hottest when it’s cold outside. Right now, during the Holiday Season, New York City is just screaming with scanner action. From Thanksgiving Day right on through New Year’s Eve, New York City is full of action both on the streets and on the radio. In fact, New York City has so much scanner activity that it can actually be a bit intimidating—until you realize you just can’t listen to it all at once.

Even if you don’t live in the area or plan a visit anytime soon, you may still pick up some valuable tips for Holiday Season Scanning right in your own town.

Breaking It Down

If you had the opportunity to read Ken Reiss’ “ScanTech” column in the October 2007 issue, you’ll remember that he presented two scanning strategies: a geographic method and an event method.

For my day-to-day scanning I use the geographic method, meaning I’ll monitor the specific frequencies employed by the borough I happen to be in, or am interested in (for out-of-towners, that’s Manhattan, the Bronx, Staten Island, Brooklyn, and Queens). However, I do have a bank’s worth of notable frequencies that are used on a “citywide” basis that I’ll always keep on. However, when it comes to Holiday Season action, whether it’s the Macy’s Thanksgiving Day Parade or New Year’s Eve in Times Square, a broad approach is needed, and this fits right in with Ken’s “event scanning” method.

The most effective way to set up your scanner for New York City during the Holiday Season starts with you sitting down and doing a little planning. We’ll start with the absolute basics: First, you’ll need a piece of paper and something to write with. Keeping in mind that 80 percent of the big-time Holiday action is going to take place in Manhattan, start by making a list of the services and agencies you want to monitor there. Of course, you’ll need a decent scanner with a capacity of 200 channels or better and some basic trunktracking features. Though not entirely necessary, it’s helpful if your scanner is computer programmable.

What You’ll Want To Listen To

In your day-to-day scanning during the Holiday Season, you’re going to see increased activity in a number of areas. First, as happens with any influx of visitors, the more people there are in the city, the busier the entire gamut of Public Safety frequencies will be. So, you’re naturally going to want to monitor Police, Fire, and EMS traffic.

Ed Muro, K2EPM, has been a radio hobbyist since his early teens. He served three terms as vice-president of the Long Island Mobile Amateur Radio Club and is a public information officer and VE for the ARRL.

New York’s Time Square explodes in light and sound at midnight in the annual New Year’s Eve frenzy. Catch the action on your scanner.
← (Photo courtesy Countdown Entertainment, LLC)

Scanning Targets At A Glance

When you’re setting up your scanner for Holiday Season monitoring in New York City, you’ll definitely want to consider these radio services.

- Public Safety: Police, Fire, EMS
- Traffic: Enforcement Agencies/Traffic Reporting Services
- Mass Transit Operations and Transit Law Enforcement
- Tourist Destination and Shopping Operations and Security
- News Media and Broadcasting
- Business Band Frequencies/FRS/Itinerant Frequencies/Start and DOT Frequencies (these will be used by stores, shopping centers, hotels, restaurants, and tourist destinations, both for general use and by vendors catering to specific events)

Police protection is provided by the NYPD. Over the years, the NYPD has absorbed a number of other police agencies, making it a little easier to create your list of monitoring targets. You’ll want to monitor the frequency of the local precinct where you’ll be, the Manhattan Transit Division Frequency, plus several frequencies that are used on a citywide basis (see “NYPD Manhattan Bank”). Additionally, the MTA Bridges & Tunnels frequencies will see more activity, as will the NYPD Traffic Enforcement agents. You also will probably want to monitor several MTA (Rail) Police Frequencies and possibly the New York City Park Police.

The brave souls of the FDNY, whose efforts you can monitor as they protect life and property, have a long, proud heritage. Organized firefighting began in New York way back in 1648 with the formation of bucket brigades. Seventy-four years later, in 1731, fire brigades were put into service. Two hand-drawn pumpers, brought from distant London, were the first fire engines to be used in the colony. They were designated Engine Company 1 and Engine Company 2. Following the Revolutionary War, the brigades were reorganized and incorporated as the Fire Department of the City of New York.

As of March 17, 1996, Emergency Medical Service within the City of New York has been provided by the New York City Fire Department EMS Bureau. Implementation of the Certified First Responder Defibrillator (CFR-D) program has helped create a true, three-tiered emergency medical system in New York City. CFR-D is the first and basic level of training, followed by Basic Life Support, and then Advanced Life Support. The merger of FDNY and the NYC Emergency Medical Service has made this tiered response more seamless and effective, generating a downward trend in response times and saving the lives of countless people. It’s good to think what you’re monitoring has an excellent success rate!

In addition to such Public Service fare, you’ll also see increased activity associated with store communications. Stores use radios all the time, either for stocking purposes or security. Hunting down frequencies for various stores can be a challenge and a lot of fun at the same time, especially if you have one of the newer scanners with Signal Stalker technology. In addition to business band frequencies, stores also sometimes employ what’s commonly referred to as the colored “dot” frequencies and—right or wrong, as far as legality goes—FRS radios. Each year, as far back as I can remember, the New York DX Association (NYDXA), had published an annual listing of hol-

iday shopping frequencies for local area malls. Check out the NYDXA website at www.nydx.info/index.html.

Other frequencies I enjoy monitoring during the Holiday Season are those used by the various traffic reporting agencies. In years past there were two competing companies that provided traffic services to the local media: Shadow Traffic and Metro Traffic Control. These now appear to have merged under one corporation owned by the Westwood One Network. Metro Networks/Shadow Broadcast Services is the largest traffic gathering and reporting operation in the world.

At this time of year the airports and bus terminals will also see increased use, as will their radio systems. The Port Authority of New York and New Jersey, the operating agency of the airports and bus terminals, uses a trunked system as well as a number of conventional channels. (See "Trunked Radio System Info" for more trunked targets.)

Tourism, of course, gets a huge boost in New York City during the Holidays. Not only does the transportation infrastructure see an increase in activity because of that, but also most tourist destinations and hotels. You might find it interesting to seek out the operational and security frequencies for the Empire State Building, Rockefeller Center (home to the famous Christmas tree and ice skating rink), Lincoln Center, and Radio City Music Hall.

Special Events

Moving away from the general scanning during the Holiday Season to more specific events, you should be thinking about Macy's Thanksgiving Day Parade (some of you luckier folks may have this magazine in hand by then, and if not, you can catch it next year) and the New Year's Eve celebration in Times Square.

Obviously the Public Safety agencies are going to be a primary monitoring target during both events. For the Thanksgiving Day Parade there will be people providing support for filling up the balloons, getting the floats ready, and providing food service to the workers. Most of this activity is "monitor-able," unless the vendors use Nextel.

Frequencies you're going to find extremely interesting to listen to, on both Thanksgiving Day and New Year's Eve, are those used by the news media and broadcast services (see "News Media Frequencies"). All the media outlets will

NYPD Manhattan Bank

Manhattan North Patrol Borough (PBMN)

Radio Zone	PCTS	Frequency	PL
Zone 5	19-23	476.3875	151.4
Zone 6	20-CP-24	476.3125	167.9
Zone 7	25-28-32	476.6375	186.2
Zone 8	26-30	476.3625	100.0
Zone 9	33-34	476.8875	110.9
PBMN	Manhattan North	471.0625	110.9

Manhattan South Patrol Borough (PBMS)

Name	PCTS	Frequency	PL
Zone 1	1-5-7	476.5625	100.0
Zone 2	6-9	476.4375	110.9
Zone 3	10-13	476.3375	123.0
Zone 4	MTS-17-MTN	476.5875	136.5
PBMS	Manhattan South	471.0875	100.0

NYPD Manhattan South Transit District	160.905
NYPD Manhattan North Transit District	160.500
NYPD Transit new Manhattan UHF Rptr	471.0875
Parking Enforcement Manhattan	470.6125
Sanitation Manhattan	453.600

FDNY-EMS Manhattan Bank

FDNY Manhattan	154.250
High Rise Repeater	483.0125
Subway Repeater Ch 1	460.5750
Subway Repeater Ch 2	460.6250
FDNY - EMS Manhattan North	483.2375
FDNY - EMS Manhattan Central	483.4875
FDNY - EMS Manhattan South	483.3625

Citywide Bank

<i>NYPD:</i>	
SOD-ESU	470.8375
DET-1	470.7375
SPIN	470.6625
TRAFFIC-HWY	470.8125
CW-1	470.6875
CW-2	470.7125
CW 3	470.8625
CW IO	482.6875
MANHATTAN IO	482.7125
FDNY Citywide	154.4300
Parking Enforcement CW	471.1625
Parks Dept Security	151.2050
NYPD Transit CW	160.6950
FDNY-EMS CW	478.0125
Port Authority of NY/NJ Bridges / Tunnels	453.800
US Park Police	166.3250
MTA Police Manhattan Division	155.760
MTA Police LIRR/Penn Station	160.320
<i>MTA Bridges & Tunnels (formerly TBTA):</i>	
Throgs Neck Bridge/Whitestone Bridge	453.550
Triborough Bridge/VZ Bridge/ Henry Hudson Bridge	453.575
Simplex 1	458.6125
Simplex 2	458.9875

Different PLs may be employed at different facilities.

Legend:

DET = Detective Channel SPIN = Special Investigations Unit
 SOD = Special Operations Division CW = Citywide
 ESU = Emergency Service Unit IO = Interoperability Channel

SPECIAL HOLIDAY DISCOUNTS OFF OUR ALREADY LOW PRICES



HAM RADIO OUTLET

WORLDWIDE DISTRIBUTION



TUNE IN THE WORLD WITH ICOM

IC-R1500 Wide Band Receiver

Mobile or PC Controlled Single Band Receiver

- 0.01 - 3299.99 MHz*
- AM, FM, WFM, USB, LSB, CW
- 60 Channels Per Sec Scan
- Optional DSP Capability
- 1000 Memory Channels (remote), Unlimited Memory Channels (PC)



IC-R2500 Wide Band Receiver

Mobile or PC Controlled Dual Band Receiver

- 0.01 - 3299.99 MHz*
- AM, FM, WFM, USB, CW, DV** and P25** (Main)
- AM, FM and WFM (Sub)
- 1000 Memory Channels (remote), Unlimited Memory Channels (PC)



IC-PCR1500 Computer Controlled Receiver

The Whole World in a Little Black Box

- 0.01 - 3299.99 MHz*
- AM, FM, WFM, USB, LSB, CW
- Single Antenna Port
- Three Operating Screen Options
- Unlimited Memory Channels
- PCR Digital Record



IC-PCR2500 Computer Controlled Receiver

Dual Receivers in One Box

- 0.01 - 3299.99 MHz*
- AM, FM, WFM, SSB, CW, DV** and P25** (Main)
- AM, FM and WFM (Sub)
- Unlimited Memory Channels



IC-R75 HF Receiver

Pull Out the Weak Signals

- 30 kHz - 60.0 MHz
- Twin Passband Tuning (PBT)
- Commercial Grade
- Optional DSP w/Auto Notch
- Triple Conversion
- AM, FM, S-AM, USB, LSB, CW, RTTY
- 101 Alphanumeric Memory Channels



IC-R9500 Wide Band Receiver

Professional Communications Receiver

- 0.005 - 3335 MHz*
- +40 dBm 3rd Order Intercept Point and 109 dB Dynamic Range*¹
- Multi-Function High Performance Spectrum Scope
- ±0.05 ppm High Frequency Stability
- ±3 dB** Accuracy of dBμ/dBμ(emf)/dBm Meter
- Professional Grade Operation, Functionality and Build
- SSB/CW/AM Mode Auto Tuning Function



IC-R5 Wide Band Receiver

Compact Performance

- 150 kHz - 1.3 GHz*
- AM, FM, WFM
- 1250 Alphanumeric Memory Channels
- CTCSS/DTCS Decode
- Weather Alert Scan
- Dynamic Memory Scan (DMS)
- Weather Resistant
- Includes 2 AA Ni-Cds
- Pre-programmed TV & Icom's Shortwave "Hot 100" Channels



IC-R20 Wide Band Receiver

Advanced Performance

- 0.150 - 3304.0 MHz*
- AM, FM, WFM, SSB, CW
- 1000 Memory Channels
- Dual Watch Receiver
- 4 Hour Digital Recorder



Did you know that Icom also makes radios for Marine, Avionic, and Land Mobile applications? See store for more info!



ANAHEIM, CA
(Near Disneyland)
933 N. Euclid St., 92801
(714) 533-7373
(800) 854-6046
Janet, KL7MF, Mgr.
anaheim@hamradio.com

BURBANK, CA
1525 W. Magnolia Bl., 91506
(818) 842-1786
(800) 854-6046
Eric, K6EJC, Mgr.
Magnolia between
S. Victory & Buena Vista
burbank@hamradio.com

OAKLAND, CA
2210 Livingston St., 94606
(510) 534-5757
(800) 854-6046
Mark, W17YN, Mgr.
I-880 at 23rd Ave. ramp
oakland@hamradio.com

SAN DIEGO, CA
5375 Kearny Villa Rd., 92123
(858) 560-4900
(800) 854-6046
Tom, KM6K, Mgr.
Hwy. 163 & Claremont Mesa
sandiego@hamradio.com

SUNNYVALE, CA
510 Lawrence Exp. #102
94085
(408) 736-9496
(800) 854-6046
Howard, W6HOC, Mgr.
So. from Hwy. 101
sunnyvale@hamradio.com

NEW CASTLE, DE
(Near Philadelphia)
1509 N. Dupont Hwy., 19720
(302) 322-7092
(800) 644-4476
Rick, K3TL, Mgr.
RT.13 1/4 mi., So. I-295
delaware@hamradio.com

PORTLAND, OR
11705 S.W. Pacific Hwy.
97223
(503) 598-0555
(800) 854-6046
Leon, W7AD, Mgr.
Tigard-99W exit
from Hwy. 5 & 217
portland@hamradio.com

DENVER, CO
8400 E. Iliff Ave. #9, 80231
(303) 745-7373
(800) 444-9476
John N5EHP, Mgr.
denver@hamradio.com

PHOENIX, AZ
1939 W. Dunlap Ave., 85021
(602) 242-3515
(800) 444-9476
Gary, N7GJ, Mgr.
1 mi. east of I-17
phoenix@hamradio.com

ATLANTA, GA
6071 Buford Hwy., 30340
(770) 263-0700
(800) 444-7927
Mark, KJ4VO, Mgr.
Doraville, 1 mi. no. of I-285
atlanta@hamradio.com

WOODBRIIDGE, VA
(Near Washington D.C.)
14803 Build America Dr.
22191
(703) 643-1063
(800) 444-4799
Steve, W4SHG, Mgr.
Exit 161, I-95, So. to US 1
virginia@hamradio.com

SALEM, NH
(Near Boston)
224 N. Broadway, 03079
(603) 898-3750
(800) 444-0047
Chuck, M1UC, Mgr.
Exit 1, I-93;
28 mi. No. of Boston
salem@hamradio.com

*Cell bands blocked. Frequency coverage may vary. Refer to owner's manual for exact frequency specs **Optional *1 At 14.1 MHz **10 to 70 dBμ signal between 100 kHz to 3335 MHz at 25 °C ◆Check with HRO for details or restrictions on any offers or promotions. © 2007 ICOM America, Inc. Dec. 07. The ICOM logo is a registered trademark of ICOM, Inc. 9803

CALL TOLL FREE

Phone Hours: 9:30 AM - 5:30 PM
Store Hours: 10:00 AM - 5:30 PM
Closed Sun.

West.....800-854-6046
Mountain.....800-444-9476
Southeast.....800-444-7927
Mid-Atlantic...800-444-4799
Northeast.....800-644-4476
New England..800-444-0047

Look for the
HRO Home Page
on the
World Wide Web
http://www.hamradio.com

AZ, CA, CO, GA,
VA residents add
sales tax. Prices,
specifications,
descriptions,
subject to change
without notice.

Toll free, incl. Hawaii, Alaska, Canada; call routed to nearest store; all HRO 800-lines can assist you, if the first line you call is busy, you may call another.



have reporters on the streets filing their reports, and nothing makes watching a parade more interesting than listening to a producer cue his cameras.

On New Year's, as soon as the celebration is over, thousands of people, some intoxicated, will head on down into the subways to make their way home, and you'll surely find some interesting communications on the transit frequencies. But, while all this is happening below ground, upstairs you'll find a well-tuned clean-up operation being carried out by the New York City Department of Sanitation. Within hours, they'll have cleaned up tons of trash and debris, including the annual, almost-incomprehensible 3.5 tons of confetti dumped on Times Square as the clock strikes midnight.

Wishing You Merry (But Wise) Monitoring

Armed with this information, you should be well on your way to enjoying endless hours of scanner listening in New York City during the Holiday Season. Hopefully, you've also picked up some useful tips if your Holiday plans keep you

closer to home, wherever that may be.

And please remember, wherever you may be, to monitor wisely. In this post-911 world if you plan on taking a handheld scanner to some event, make sure you use discretion and don't make a "public spectacle" of yourself. Think about the places you'll be going, and when in doubt, leave the radio home or hidden. Certain tourist spots require you to pass through metal detectors, so be prepared to explain what you're doing. If you're a licensed amateur radio operator keep a copy of your license on you. The last thing we want is for a well-intentioned radio hobbyist to be mistaken for a "techno-geek terrorist."

I hope you've found this article enjoyable and informative and, most of all, that you and yours have a safe and happy Holiday Season.

Trunked Radio System Info

In addition to the conventional radio frequencies listed, there are a number of very active trunked radio systems in the New York Metro area that you're going to want to monitor, including:

The New York City Department of Information Technology and Telecommunications (DOITT) system: Operates the city's 311 Citizens Phone Service Center, which provides the public with information and services relating to over 300 agencies and organizations. The agency also manages the city's official website (nyc.gov), data center, data network, telephone systems, radio network, and cable television network, NYC TV. As the IT arm of the city, DOITT operates a Motorola trunked system where you'll find 80 percent of the radio traffic for city agencies outside the NYPD and FDNY.

FDNY's Bureau of Emergency Medical Service: Operates a trunked system used mostly for administrative purposes.

New York City Transit Authority: Operates a Motorola Type II trunked system for its bus operations within the city. Additionally, a second trunked system is operated by the Department of Transportation for the former private bus lines that were consolidated into the MTA system.

Port Authority of NY/NJ: Operates an EDACS trunked system that's used extensively at the airports and other venues.

The information you need for these systems in order to program your radio is widely available on the Internet. The two most reliable sources of this data are Charlie Hargrove's website at www.n2nov.net and RadioReference.com (point your browser to <http://www.radioreference.com/modules.php?name=RR&ctid=1855> for info specific to New York City).

Charlie's website is comprehensive and has everything you need for New York City. The beauty of the RadioReference.com website, however, is the ability to import the data directly into various software applications, such as Win96 for the RadioShack Pro-96 scanner.

News Media Frequencies

WABC	
News Desk	450.050
News Desk	455.050
IFB	455.5125
Helicopter	455.6125

WCBS	
Traffic helicopter	450.0875
Traffic helicopter	455.700
IFB	450.2875
IFB	450.3875
Control to Field	450.0500
Selden Repeater / ENG	450.2875
Selden Repeater / ENG	450.0875

WNBC	
News 4 Copter	450.8875
News 4 Copter	450.4125
News 4 Copter	450.5375
IFB	450.7500
IFB	450.3875
NBC Network Desk	161.670

WNYW FOX	
450.1875	
450.85	
455.1875	
450.3125	

WWOR/UPN	
Television News Desk	450.4875
Radio News Desk - Simplex	450.25

WPXI / WB11	
450.3125	
450.9250	

Note: For media outlets not covered, search 450-456 MHz. Also keep in mind cell phones may now be used.

World's #1 Selling Shortwave Guide!

PASSPORT to World Band Radio



Edition 2008

If you need it, **PASSPORT TO WORLD BAND RADIO** has it within 20 helpful chapters in over 550 pages.

PASSPORT'S frequency-by-frequency Blue Pages section is almost a book by itself. This quick-access guide offers details for each of the world's stations—frequencies, times, days, locations and powers. Also, target zones, network affiliations, languages and even if there's jamming.

Trusted by over a million readers since 1984.
WWW.PASSBAND.COM

PASSPORT'S program guide, "What's On Tonight," builds on this with hour-by-hour descriptions of news, music and entertainment shows in English. Station contacts and web simulcasts?

PASSPORT'S "Addresses PLUS" is the industry bible, crammed with juicy tips. Other chapters include the history of Casbah Radio and how an Islamic kingdom has nurtured Christian broadcasting.

PASSPORT REPORTS tests, evaluates and rates dozens of the latest portable, PC controlled, professional, tabletop and emergency receivers—outdoor and indoor antennas, too. *Outside* magazine minces no words, "The best. They tell you what's good about the good, bad about the bad, and advertisers be damned."

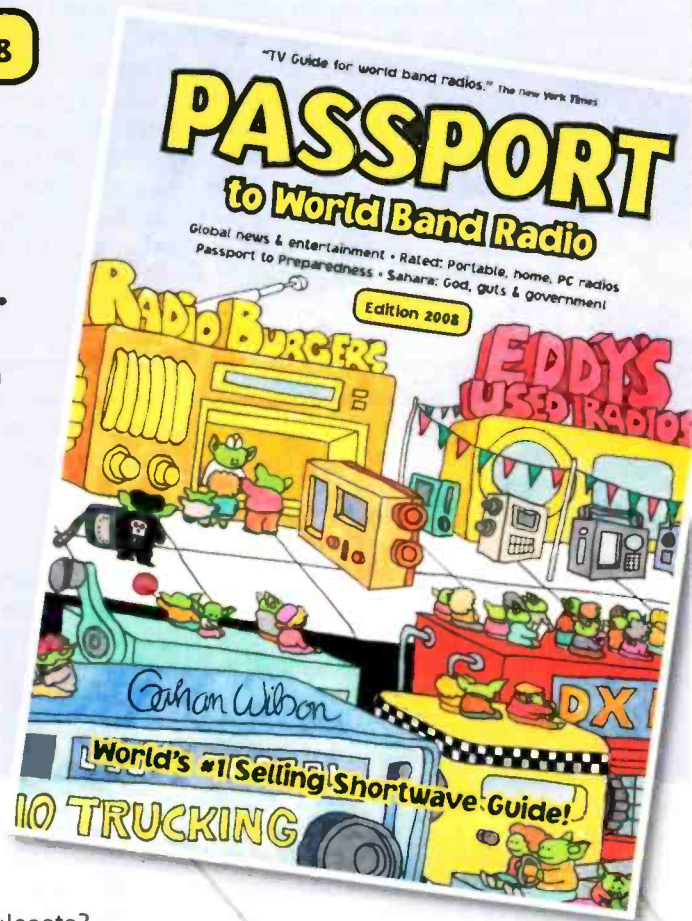

PASSPORT TO WORLD BAND RADIO is the world's #1 selling guide to shortwave listening.
Available from major dealers and bookstores, or by fast, free Priority Mail direct from the publisher:

PASSPORT to World Band Radio Edition 2008

Box 300
Penn's Park, PA 18943

\$22.95, ISBN 978-0-914941-66-8 (0-914941-66-6)
24/7 automatic ordering (215) 598-9018
Fax (215) 598 3794

mktg@passband.com
www.passband.com

A Scannist's Wish List

Every radio enthusiast and gadget freak has a long wish list *most* of the time... and the holidays are sure to add a few things to it. From the latest iPods to digital video recorders, all sorts of gadgets are probably already on your wish list, or your shopping list. There's certainly no shortage of electronic gizmos competing for attention this year and every year.

The problem that we radio people have is that people who are outside the hobby don't know what to get us, or how to pick a good one even if they have some vague idea. If you're new to scanning, you may be struggling with some of the same questions. Heck, even if you're experienced and fairly well equipped, you may *still* be struggling for ideas yourself (what *else* can you get!?). Let's see if I can help the cause a bit. Just take a read through and then leave the magazine laying open to the page with something circled...that should work.

Scanners

No doubt, you've had your eye on a couple of new models this year. There aren't as many to choose from as there have been in the past, but the ones that are offered are some great choices.

Uniden (www.uniden.com)

Uniden is one of very few companies left that makes a pure scanner—a scanner for the sake of scanning as opposed to adding scanning functions to a communications receiver or ham radio. Uniden and RadioShack are about the only game in town if you need a trunking scanner; between them, they manufacture all the trunking-capable receivers, something no communications receiver has yet tried. Let's take a look at some of their offerings.

BCD996T—Not new this year, but now widely available, the BCD996T is a top-of-the-line mobile scanner, with digital trunking to boot. Combining Trunktracker IV technology and APCO-25 with 6,000 (yes, *six thousand*) channels, the BCD996 is the company's current top-end unit. It includes CTCSS (Tone Squelch) and DCS (Digital Code Squelch) for help with interference, numerous search modes, and lots of other features. As mentioned, it's a Trunktracker IV receiver, which means it follows APCO-25 digital. Motorola, EDACS, and LTR trunking systems. That's most of the non-proprietary ones! This one is sold by RadioShack under the Uniden name, as well as through other Uniden dealers. List price \$599.

BCD396T—The BCD396T is a handheld version of the 996. It puts 6,000 channels with Trunktracker IV and APCO-25 digital right in your pocket. The BCD396 is a state-of-the-art scanner in a handheld package. Frequency coverage includes 25–512, 764–956 (excluding cellular and the 776–794 range) and 1240 to 1300 MHz. Street Price is around \$530.

BC246T—If you don't need digital trunking, you've got a few more options and the price drops a bit. The Uniden BC246T is a handheld Trunktracker that includes most of the features most of us need, without the cost of the digital decoder. Its 2,500



Uniden's BCD996T top-of-the-line mobile scanner combines Trunktracker IV technology and APCO-25 with digital trunking and 6,000 channels!

channels are dynamically allocated as needed into "systems" for receiving. A system can be a trunked system or a group of conventional channels that go together for whatever reason you like. As many as 200 systems can be programmed, making the 246 a very versatile handheld scanner. Slightly older with Trunktracker III technology, it's still a good scanner for many users. List price is \$299.99 at RadioShack.

BC898T—For a base unit or a large mobile installation, try the BC898T, a 500-channel unit that's a great starter for trunking. A decent conventional scanner as well, the 500 channels are divided into 10 banks and are easy to switch on and off. The 898T can receive Motorola Type I and II, Smartnet, LTR, and EDACS trunking systems. Street price is about \$220.00

BC72XLT—If you don't need trunking or 800-MHz reception and just want a basic scanner, the 72XLT might be up your alley. Its 100 channels in 10 banks, in a nice compact handheld package, will remind many of us of days gone by. The 72XLT is marketed as a racing scanner and is sometimes packaged in a "racing pack," for about \$40 more, that includes a set of over-the-ear headphones, helpful for hearing at the track. Street price of the BC72XLT alone is \$89.95.

RadioShack (www.radioshack.com)

RadioShack offers a few models other than Uniden that are also worth your consideration. Many are made by GRE, the company that manufactured the still-popular PRO-2006 (an old conventional scanner that still excites people when you mention it) and has recently stepped out on its own (see below).



The BC246 is one of the newer Trunktracker III technology radios. It's also one of very few trunking scanners to use AA batteries, which can be handy in an emergency.



The RadioShack PRO-528 is the clonable handheld counterpart to the PRO-433, a new 1,000-channel, triple-trunking receiver that's upgradeable to comply with the proposed rebanding of many frequencies.



The RadioShack PRO-96 is a very versatile scanner both for conventional and trunking use. It also is one of very few receivers that can decode APCO-25 digital. If you don't have a digital system in your area, you probably will soon. This is a scanner worth looking at.

PRO-443—An interesting new receiver this year is the PRO-443, which is the first radio I've seen that's being marketed as upgradeable to comply with the rebanding that's proposed for many frequencies. It also allows cloning from its memory to the handheld counterpart of the 443, the PRO-528. The unit includes a SAME Weather alert function as well as military air coverage, according to the information available at press time. There are 1,000 channels and a triple-trunking interface for Motorola, EDACS, and LTR. Sorry, no digital option is mentioned. Price is \$169.99—a great deal if the performance measures up!

PRO-528—This is the handheld counterpart to the PRO-443 and can be programmed by cloning from one receiver to another. Nice feature. Frequency coverage does not include the military air range, which is unfortunate, but at \$169.99 it sounds like a receiver worth checking out.

PRO-96—This handheld features APCO-25 digital as well as Motorola and EDACS trunking. It offers 5,500 memories, many of which are pre-programmed so you can get right to scanning. There's also a PRO-2096 base/mobile version if you're interested. While not new this year, it's still a great receiver. Street price \$500.

GRE (www.greamerica.com)

Of course, Uniden and RadioShack don't have a lock on the receiver market, just the "scanner" market...or do they? By the time you read this, GRE, the company that makes many of RadioShack's non-Uniden scanners, is expected to begin shipping its own line of receivers that will include trunking.

GRE's powerful PSR-500 can handle Motorola, EDACS, and LTR, will decode and "squelch" on P25 Network Access Codes, and uses GRE's exclusive automatic adaptive digital tracking and AGC functions for great reception of digital signals. It offers 1,800 dynamic memory locations.

I won't go into it in detail here since it's covered elsewhere in this issue and was recently reviewed in this magazine (see "Programming The GRE PSR-500 Advanced Digital Scanner" in this issue and "The GRE PSR-500 Advanced Digital Scanner," August *Pop'Comm*). It certainly looks like an interesting lineup!



Specialty Receivers

Many ham and communications receivers are still offered by companies like ICOM, AOR, JRC, and Yaesu, to name a few. Most of these have some kind of scanning capability, but it's usually not their primary focus. Depending on where you are and what you want from a radio, you might be quite happy with one of these specialty receivers.

Don't count out what these other manufacturers are offering, but be aware that you might be trading some features. If you have questions, let us know and perhaps we can do a column in the future on communications receivers and other specialized equipment, but for now, here's a short overview

AOR (www.aorusa.com)

The AR-Alpha looks to be a very interesting receiver. Coverage is continuous from 10 kHz to 3.3 GHz, covering all of the AM broadcast, shortwave and public safety spectrum, as well as a bunch of other stuff where there isn't much to listen to. Intended at first as a government-only receiver, it features an LCD panel with readout of frequency and has a spectrum display unit built right in. The government version is available



AOR's impressive AR-Alpha was initially marketed as a government-only receiver, but a consumer version is planned for later release. That one will hopefully be a bit more affordable than the \$13,999 government version price tag.



The ICOM IC-PCR2500 triple-duty base/mobile PC-controlled scanner is available both with and without a mobile control head and makes a very nice communications receiver in a small package.

now, but a consumer version is planned for later release (possibly in time for Christmas). The list price for the government edition is a whopping \$13,999.00, but hopefully the consumer one will be a tad more affordable. It will still be an

expensive receiver no matter how you look at it.

For something a little more down to earth, have a look at the AR8600 Mark IIB. This is a wideband receiver with some scanning capabilities. The receiver covers from 530 kHz to 3 GHz (minus the cellular range) in a variety of modes. The AR8600 can be computer-controlled as well, if you're interested in that function. It's a nice receiver for any use, but small enough to be mounted in a mobile installation. Street price is around \$900.00.

ICOM (<http://icomamerica.com>)

Another computer-controlled receiver is the ICOM IC-PCR2500. It's available both with and without a mobile control head and also makes a very nice communications receiver in a small package. Its street price seems to be around \$700.

If you're looking for wideband coverage in a handheld unit, the ICOM IC-R20 is worth a look. It's a communications



The ICOM IC-R20 is a communications receiver in a small package. It offers 150 kHz to 3.3 GHz coverage (less cellular) and 1,250 memories.

receiver in a small package and its 150 kHz to 3.3 GHz coverage (less cellular) gives you all sorts of things to listen to. Check this one out in person if you get the chance; as a communications receiver, it may not quite live up to your expectations from a traditional scanner. It offers 1,250 memories (1,000 for normal memory use, 250 for special settings and auto store). Street price on this one is around \$500.

Check Them Out

That's it for this year's Scannist's Wish List, now go and check them out. Even if the budget's tight, it's always a lot of fun learning about what's out there. Good hunting and happy shopping!



CCRadio-SW

Amazing High Performance!

- Very Sensitive, Dual Conversion
- Bass, Treble, RF Gain Controls
- Deep Bass for a 12" Portable
- AM/SW 520kHz-30MHz, FM
- 50 Memories, Wide/Narrow Switch
- Built-in Twin Coil Ferrite™ Antenna
- External Antenna Jacks, AM-IF Out
- Built-in Battery Charger

\$149⁹⁵

C. CRANE

Free Catalog

800-522-8863 • ccrane.com

Frequency Of The Month

Each month we ask our readers to let us know what they're hearing on our "Frequency Of The Month." Give it a listen and report your findings to me here at "ScanTech." We'll pick a name at random from the entries we receive and give the lucky winner a free one-year gift subscription, or extension, to *Pop'Comm*. Our winner from last month is **Sandy Danziger** of Bradenton, Florida. Congratulations, Sandy.

Our frequency for this month will be **151.955**. Let me know what you can hear. Even if you don't hear anything on that frequency in your local area, you can still enter with that information! We'll put all submissions in for the drawing!

Send in your submission via regular mail to Ken Reiss, 9051 Watson Road, #309, St. Louis, MO 63126, or via email to radioken@earthlink.net. "Frequency Of The Month" entries must have the frequency in the subject of the e-mail, or on the outside of the envelope in order to be processed and entered correctly, and they must include your address for the subscription if you should win...sorry, but we can't write or email you back and ask for it.

You've Been Good, Here's How To Reward Yourself This Season

It's time once again for the annual "Broadcast Technology" holiday gift guide. Here are some gift ideas in every price range sure to please the broadcast DXer and radio enthusiast. They're my top picks going into 2008.

HD Radio Receiver

Responding to customer requests for digital outputs, analog mode, and other advanced features, Sangean has released a deluxe "X" version of the HDT-1 component system HD digital receiver. The model HDT-1X includes additional professional features like SPDIF digital outputs, split audio and forced analog modes, compatible with hybrid analog/digital and all-digital mode AM/FM broadcasts. Split audio allows the broadcast engineer to monitor both the analog and digital signal synchronization in hybrid mode. Forced analog allows the listener to manually turn off digital reception in fringe areas where the digital signal is marginal.

By the way, the HDT-1/1X is an excellent FM tuner too, highly rated by broadcast DXers. Considering the professional features, the HDT-1X is very reasonably priced at \$249.99 from Universal Radio (www.universal-radio.com).

Software-Defined Radio

Thanks to economical high-speed analog-to-digital converter technology and cheap computer memory, software-defined radio (SDR) receivers are quickly replacing old-fashioned tabletop communications receivers. To my opinion, the RFSpace SDR-IQ is the best value among SDR receivers today. Pending FCC approval, it was originally introduced in the United States as an "OEM" chassis-less assembled circuit board. RFSpace obtained FCC approval in September, so the SDR-IQ is now available as a complete unit for \$499.95 from Universal Radio. The OEM version has been discontinued.

In terms of versatility and performance the SDR-IQ has it all. Covering



The deluxe Sangean HDT-1X HD digital component system receiver.

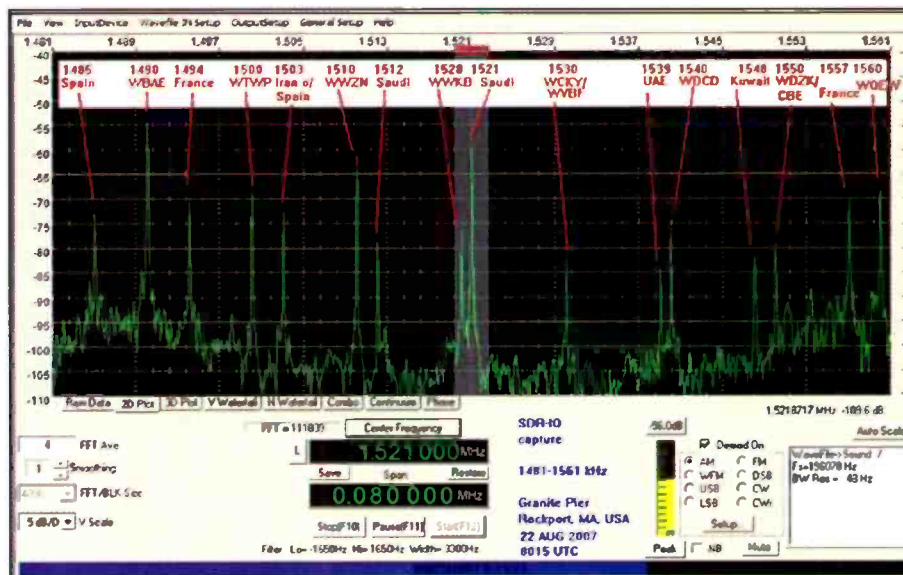

Mark Connelly used the RFSpace SDR-IQ to capture this chunk of spectrum with 1521 Saudi Arabia highlighted in the center.

500 Hz to 30 MHz in 1 Hz steps, the IQ provides a spectrum analyzer display to visually monitor signals over a wide range or to zoom into to accurately measure frequency. As much as 190 kHz of RF bandwidth can be recorded into computer memory for later playback, with the ability to tune around just like live DXing. Performance is comparable to that of high-end communications receivers. The IQ is powered by USB from your computer and does not require a separate external power supply, making it an ideal laptop companion. If you're considering a new receiver, the SDR-IQ should be at the top of the list.

SDR Tuning Knob

Add an analog-feel knob to your SDR with the Griffin PowerMate USB Multimedia Controller (www.griffintechology.com).

It's great for those who prefer to tune up and down the dial with a knob instead of a mouse. The PowerMate is an assignable USB controller knob typically used for managing volume, scrubbing audio files, or scrolling video frames. It can be assigned to any application that uses key commands. Get your hands on one for under \$45, including shipping, from Amazon.com.



The Griffin PowerMate USB control knob can give a software-defined radio the familiar feel of an analog receiver.



Fill 'er up at the local DX station!

DX Oil Collectibles

Memorabilia displaying the DX diamond logo of the former Sunray and DX Oil Company (now Sunoco) is a hot commodity among DXers of all types. DX flags, patches, baseball caps, and, yes, even a can of "DX Power" oil are novelty gifts that only a DXer would appreciate. eBay is the first place to look for DX Oil items. Search for DX oil, DX gas, and D-X. You might be surprised at the number of DX Oil items on the auction block. Who knew these things would ever become valuable?

Common Mode Choke

It's one of the best-kept secrets in AM broadcast DXing, but you have to go to Australia to find it. The common mode choke is the miracle device for removing noise from the coaxial lead-in of an outdoor antenna. It's a special type of filter that literally chokes out noise common to the shield and center conductor of a coaxial lead-in.

Quite often the shield of a coaxial lead-in will act like an antenna itself, picking up unwanted signals that couple with the desired signals on the center conductor. Installing a common mode choke between the coax and receiver will eliminate extraneous buzzes and noise picked up by the lead-in, leaving only the signals being picked up by the antenna for clean reception. It's especially effective on



The WinRADiO common mode choke could be the solution to your RF noise problems.

longwave frequencies where noise tends to be more of a problem.

The only common mode choke available commercially that's appropriate for AM broadcast DXing comes from WinRADiO in Australia, manufacturer of the commendable 313e SDR. The WinRADiO WR-CMC-30 common mode choke is specified for DC to 30 MHz, covering longwave, mediumwave, and shortwave. The choke isn't stocked by the primary retailer of WinRADiO SDRs in the United States, so you'll have to shop online direct from WinRADiO in Australia (www.winradio.com). The WR-CMC-30 is listed on the website in the Antenna Accessories section and sells for \$49.95, plus airmail shipping, from the land of Down Under.

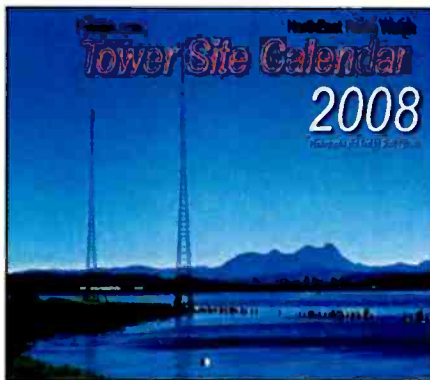

The 2008 Tower Site Calendar by Scott Fybush.

Tower Site Calendar

The 2008 Tower Site Calendar by Scott Fybush features 14 full-color, high-quality images of transmitter sites from coast (WGAN Portland) to coast (KAST Astoria, the cover shot). Along the way, the calendar visits WESX Salem; Ingraham Hill in Binghamton; Armstrong Tower in New Jersey for a dramatic late-night shot; WFIL/WNTP in Philadelphia; WBNS in Columbus; Rib Mountain in Wausau, Wisconsin; KFKA in Greeley, Colorado; Mount Spokane in Spokane; Black Mountain above Las Vegas; KFBK in Sacramento; and KROQ above Los Angeles. And there's an action shot of the demolition of the old WOR towers in New Jersey last January.

The previous two calendars have sold out, and this year's edition is expected to be another sellout. It's available for \$17 (pending a small price increase) exclusively from fybush.com. Meanwhile everyone wants to know, when is the coffee table book coming out?

The National Radio Club's AM Radio Log

The National Radio Club's AM Radio Log is a must-have for anyone interested in AM broadcast DXing. The Log contains radio station listings and information unavailable from any other single source. It's compiled by the National Radio Club (NRC), which is celebrating 75 years of service to the DX community. The 2007-08 28th Edition, released in September, comes packed with vital statistics for every AM radio station in the United States and Canada.

The extensive coverage of network affiliations in the Log is especially useful to assist with station identification. It also includes handy separate compilations of regional groups and syndicated programs carried by national networks. Hearing WILK on 910 kHz? A quick check of the Log finds 910 WBZU carrying the WILK Network along with 980 WILK, 1300 WKZN, and 103.1 WILK-FM. Get your Log for \$25.95 from Universal Radio or the National Radio Club (www.nrcdxas.org).

Now, back to our regularly scheduled programming...

Broadcast Loggings

Here are this month's selected DXcellent logs from reporters across the United States. All times are UTC.

558 RNE5 synchros, Spain, at 0325 poor to fair yet easily past WIND and CFOS interference with Spanish talk parallel many others during a period when Spain really peaked. (Kazaross-WI)

702 BSKSA Radio 2, Duba, Saudi Arabia, at 0300 Algeria time pips under, then Saudi time pips, woman with ID in Arabic, "...il-Mamlaka al-Arabiya as-Saudiya," fanfare into news. Commencing Arabic program channel two at this time per WRTH. Thanks to Henrik Klemetz and Mika Makelainen on RealDX for help with the ID. I subsequently listened to Radio 2 streaming audio at 2100 UTC and heard exactly the same time pips and fanfare into news. 702 audio uploaded to dxclipjoint.com/loco_the_dx_cat. New log. (Conti-NH)

711 RTM Addakhla, Western Sahara, at 0410 poor to fair with very poorly modulated Arabic talk into music on huge carrier trashing 710 kHz. (Kazaross-WI)

780 KKOHO Reno, Nevada, at 1058 had been mixing with an unidentified Mexican station, promo for "Wolf Pack Sports" (U. of Nevada-Reno) and ID, "News-Talk 780, KKOHO." (Barton-AZ)

783 Radio Mauritanie, Nouakchott, Mauritania, at 0053 parallel 4845 with a cap-

HEAR BOTH SIDES OF WORLD EVENTS

RX-340

USED BY GOVERNMENTS WORLDWIDE!

HF SWL receiver, 5 kHz – 30 MHz. IF stage DSP. Sync AM/selectable sideband, SAM, AM, SSB, ISB, CW, FM. Over 90 bandwidth filters, programmable AGC, built-in high stability TCVCXO. Completely remote controllable via RS-232 interface. DRM ready, no modification needed (user supplies decoding software). 90-264 VAC operation. **\$4,250**

RX-320D

LISTEN TO THE WORLD ON YOUR PC!

General coverage from 100 kHz – 30 MHz. "Black box" receiver connects to your PC via one serial port. Your PC provides the operation horsepower. A 12 kHz I-F output is included for decoding DRM transmissions with your PC sound card (user supplies decoding software). Download the actual operating software from our website for a pre-purchase test drive. **\$359**

1254

KIT BUILDING IS A WORLD OF FUN!

Build your own HF SWL receiver with our model 1254 shortwave receiver kit. 500 kHz – 30 MHz coverage in 2.5 kHz steps with clarifier control allowing tuning of all frequencies. LED digital readout. AM, SSB, CW capable. Complete step-by-step instructions and all components included. See our website for information on other available kits! **\$195**



RX-340



RX-320D



1254



1185 Dolly Parton Pkwy., Sevierville, TN 37862 **800-833-7373** www.tentec.com
 Mon-Fri 8:00-5:30 EST We accept Visa, MC, American Express, and Discover Office: (865) 453-7172 Service: (865) 428-0364

PELLA Koranic vocal; over CFDR slop. (Connelly-MA) At 0023 the first audible transatlantic signal of the evening, parallel 4845 with weird Arabic/Afro music. Later up to fair level with Arabic stringed music. WBBM phase nulled. (Kazaross-WI)

801 2RF Radio Italia, Gosford, New South Wales, Australia, at 1346 armchair copy at times with a man in Italian. I could not remember if I had this one QSLed, so I paused to go check for the QSL, and when I returned KTWG Guam had taken over the channel! (Martin-OR)

820 KUTR Taylorville, Utah, a nice QSL card received in 10 days for follow-up report to CE John Dehnel. Mentioned he was surprised at my reception as they have a null at night to the northwest. I am very pleased with this one. Address: KUTR, 55 North, 300 West, Salt Lake City, UT 84180. MW QSL 2960. (Martin-OR)

999 BSKSA Radio Quran, Tabuk, Saudi Arabia, at 0015 good, over co-channel Spain; a man in a distinctive voice (a high talker), then Koran, parallel delayed Radio Quran streaming audio. (Conti-NH)

1017 2KY Sydney, Australia, at 1329 my old friend from the '60s was dominant, a very good signal, about S5-6, with "Give a call here at 2KY." (Martin-OR)

1044 RTMA/C, Sebââ-Aioun, Morocco, at 2331 excellent with a lively rural berbère female vocal and percussion. 2353 Koran,

2358 national anthem, 2400 off. (Conti-ME) At 2338 a rustic Berber male vocal and guitar picking; good with WBZ IBOC phased. 2353 parallel 936 kHz with Koran; at monster level, crushing co-channel Spain. (Connelly-MA)

1062 Danmarks Radio, Kalundborg, Denmark, at 0340 a good signal with several repetitions of interval signal alternating between chimes and an announcement, 0345 a woman in Danish, seemed to be reading weather data. Open carrier through 0400. (Conti-NH)

1062 Rai Radiouno synchronos, Italy, at 0350 signing on with test tones; under Denmark. (Conti-NH)

1071 3EL Maryborough, Victoria, Australia, at 1356 with Wings "Silly Love Songs" and a great "Radio 1071" ID at 1352, then by 1358 it was stronger with a cluster of spots and "1071 3EL" ID, logging this new call, after many years. I heard this one in 1979 the first time with the calls 3CV. (Martin-OR)

1125 Glas Hrvatske, Deanovec, Croatia, at 2348 good, well over co-channel Spain; Croatian rock vocals parallel an excellent 1134 and 6165 kHz. (Conti-NH)

1134 Glas Hrvatske, Zadar, Croatia, at 0144 fair in slop from phased local WISN; Slavic language music then talk. (Kazaross-WI) At 0317 talk by a man in assumed Croatian language. Fair signal. (Beu-TX)

1206 France Info, Bordeaux, France, at 0143 very good and listenable in the 6 kHz fil-

ter; mellow music parallel 945 kHz. A very easy transatlantic signal to receive in the mid-west. (Kazaross-WI)

1215 Virgin Radio synchronos, United Kingdom, at 0053 poor to fair over co-channel Spanish, subaudible het, and some slop; rock music. (Kazaross-WI) At 0427 assumed with rock music briefly audible with fair signal peak. (Beu-TX)

1280 VSB2 Hamilton, Bermuda, at 0258 good with a Christian hymn, 0300 ID, "You're listening to BBN on WYFQ-FM Wadesboro-Charlotte." (Conti-ME)

1296 Radio XL, Langley Mill, United Kingdom, at 0110 fair with high energy DJ, jingles, and Bollywood dance club-style Indian music. (Conti-NH)

1385.92 Radio Rurale, Labé, Guinea, at 2253 an a cappella African vocal; poor, getting piled on by slop from 1380 WMYF and 1390 WPLM. (Connelly-MA) At 2319 an excellent signal with a man speaking in vernacular accompanied by a stringed instrument. 2329 announcement in French. 2330 brief open carrier, then off. (Conti-ME)

1431 Radio Sawa, Arta, Djibouti, at 0026 parallel 1548 Kuwait with segment of Bush speech in newscast; loud. 0117 Arabic news; excellent. 0144 Arabic male dance vocal with African influences, then Radio Sawa ID; huge, much stronger than adjacent 1430 WXKS, WNSW, and WENE jumble. (Connelly-MA)

1460 XECB San Luis Río Colorado,

Mexico, at 0230 modern Latin vocals and lots of trios norteño music with ID and slogan, "¡Radio Ranchito!" (Barton-AZ)

1470 XERCN Tijuana, Mexico, at 1015 a talk program, spot for "Club Psycho," and ID with slogans "Radio Hispana" and "La Voz de la California." Very good signal. (Barton-AZ)

1494 France Bleu, Bastia, Corsica, at 0016 "Long Train Running" by the Doobie Bros.; over France Info. 0147 parallel 864 kHz with French music; mixed with co-channel France Info station. (Connelly-MA)

1521 BSKSA Duba, Saudi Arabia, at

0113 Koranic male vocal; huge/local-like, annihilating 1520 kHz. (Connelly-MA) At 0247 talk by a man in Arabic. Fair and steady signal. (Beu-TX)

1539 Radio Aap Ki Duniya, Al Dhabbaya, United Arab Emirates, at 0014 Urdu news by a woman; to good peak, alone on channel. Thanks to Mauno Ritola for ID help: exact same program was found stored in IBB/VOA online archives. Possibly the first USA reception of this. (Connelly-MA)

1700 XEPE Tecate, Mexico, at 0105 no actual callsign ID given, but numerous refer-

ences to San Diego, promos for morning programs, slogan "San Diego 1700 AM, the Talk of San Diego," into "Mike Reagan Show." This must be a change in format, as it had been all business and finance programming, using the slogan "Cash 1700, Where Money Talks!" (Barton-AZ)

Thanks to Rick Barton; Mike Beu, KD5DSQ; Mark Connelly, WA110N; Neil Kazaross; and Patrick Martin.
For now, 73 and Good DX!

FCC Callsign Changes

New Call	Location	Freq	Old Call	New Call	Location	Freq	Old Call
WYDE	Birmingham, AL	1260	WLGD	KBPO	Port Neches, TX	1150	KUHD
WLYG	Hanceville, AL	1170	WXRJ	WLOY	Rural Retreat, VA	660	KWRR
WNTM	Mobile, AL	710	WPMT	WAJL	South Boston, VA	1400	New
WEZZ	Monroeville, AL	930	WYNI	WXJC-FM	Cordova, AL	92.5	WPHC
WHOA	Saraland, AL	770	New	KFSE	Kasilof, AK	106.9	KZNZ
KXLJ	Juneau, AK	1330	KTNL	KKHJ-FM	Pago Pago, AS	93.1	KKHJ
KKHJ	Leone, AS	900	New	KZGL	Flagstaff, AZ	103.7	KFZA
KEVT	Sahuarita, AZ	1210	KQTL	KVGG	Salome, AZ	101.9	New
KGBA	Calexico, CA	1490	KICO	KQTH	Tucson, AZ	104.1	KZPT
WXXY	Dover, DE	1600	WAMS	KAIA	Blytheville, AR	91.5	KOUX
WNZF	Bunnell, FL	1550	WAYI	KLRM	Melbourne, AR	90.3	KAEN
WJXL	Jacksonville Beach, FL	1010	WIOJ	KAJL	Adelanto, CA	92.7	KELT
WDCO	Cochran, GA	1440	WDXQ	KQZT	Covelo, CA	96.9	New
WIGO	Morrow, GA	1570	WSSA	KJLL-FM	Fountain Valley, CA	92.7	KLIT
WSEG	Savannah, GA	1400	WHGM	KGBA-FM	Holtville, CA	100.1	KGBA
KSPZ	Ammon, ID	980	KUPI	KAJR	Indian Wells, CA	95.9	New
WFFX	East St. Louis, IL	1490	WESL	KSXE	Kingsburg, CA	106.3	KFYE
WSHY	Lafayette, IN	1410	WLAS	KNAH	Merced, CA	106.3	KHPO
WSVX	Shelbyville, IN	1520	WKWH	KBWF	San Francisco, CA	95.7	KMAX-FM
WGRK	Greensburg, KY	1540	WAKY	KFRC-FM	San Francisco, CA	106.9	KIFR
WRME	Hampden, ME	750	New	KMVQ-FM	San Francisco, CA	99.7	KFRC-FM
WCXH	Monticello, ME	710	WREM	KHJL	Thousand Oaks, CA	92.7	KMLT
WFGO	Orono, ME	1530	New	KWIR-LP	Colorado Springs, CO	107.1	New
WTWT	Frederick, MD	820	WTOP	KEZF	Eaton, CO	88.9	KKGN
WBEO	Pocomoke City, MD	1070	New	KKNZ-LP	Fort Collins, CO	101.5	New
WQLR	Kalamazoo, MI	1660	WQSN	KRKQ	Mountain Village, CO	95.5	New
WJNL	Kingsley, MI	1210	WLDR	KSRX	Sterling, CO	97.5	New
WLDR	Petoskey, MI	750	WWKK	KRMX-FM	Wellington, CO	94.3	KKQZ
KYES	Baxter, MN	1180	New	WPSF	Clewiston, FL	91.5	New
KRJJ	Brooklyn Park, MN	1470	KZTG	WCQQ-LP	Destin, FL	101.1	New
WYHL	Meridian, MS	1450	WFFX	WCKT	Lehigh Acres, FL	107.1	WZJZ
WZNH	Fitzwilliam Depot, NH	870	New	WGRV-LP	Melbourne, FL	93.1	WGRZ-LP
WKDR	Lancaster, NH	1450	New	WEBZ	Mexico Beach, FL	99.3	WPBH
WTAA	Pleasantville, NJ	1490	WTKU	WAET-LP	Palm Bay, FL	107.9	WGRV-LP
WJMO	Cleveland, OH	1300	WERE	WZJZ	Port Charlotte, FL	100.1	WCKT
WERE	Cleveland Heights, OH	1490	WJMO	WPBH	Port St. Joe, FL	93.5	WEBZ
WZOQ	Lima, OH	940	WLJM	WBOJ	Cusseta, GA	103.7	New
CHTO	Toronto, ON	1690	New	WEBH	Cuthbert, GA	91.9	New
KLAD	Klamath Falls, OR	960	KKJX	WMVW	Peachtree City, GA	91.7	New
WSAN	Allentown, PA	1470	WYHM	WHKV	Sylvester, GA	106.1	WRXZ
WLFJ	Braddock, PA	1550	WURP	WACF	Young Harris, GA	95.1	New
WUBA	Philadelphia, PA	1480	WDAS	KHWA	Holualoa, HI	92.1	New
WRWA	Reading, PA	1340	WKAP	KLHI-FM	Kahului, HI	92.5	KORL-FM
WYEL	Mayaguez, PR	600	WAEL	KORL-FM	Waianae, HI	101.1	KLHI-FM
CJLO	Montreal, QC	1690	New	KAWO	Boise, ID	104.3	KTMV
WRNN	Myrtle Beach, SC	1450	WQJM	KTPZ	Hazelton, ID	94.3	KMPA
WQLA	La Follette, TN	960	WGLH	KTMB	Mountain Home, ID	99.1	KTPD
KCKM	Monahans, TX	1330	KLBO	KIRQ	Twin Falls, ID	102.1	KISY
KWMF	Pleasanton, TX	1380	KAJG	WZPN	Farmington, IL	96.5	WRIA

New Call	Location	Freq	Old Call	New Call	Location	Freq	Old Call
WOTW	Monee, IL	88.9	WJCG	KRYP	Gladstone, OR	93.1	KTRO-FM
WAZU	Peoria, IL	90.7	New	KSHD-LP	Shady Cove, OR	99.1	New
WVBB	Columbia City, IN	106.3	WSHY	WILK-FM	Avoca, PA	103.1	WFEZ
WDVL	Danville, IN	88.1	New	WRTJ	Coatesville, PA	89.3	New
WGL-FM	Huntington, IN	102.9	WWGL	WBRX	Cresson, PA	94.7	WBXQ
WKMV	Muncie, IN	88.3	WWMU	WLRI-LP	Gap, PA	92.9	WLIZ-LP
WCKZ	Orland, IN	91.3	WBNI-FM	WPKV	Nanty Glo, PA	90.7	WLGY
WIKV	Plymouth, IN	89.3	WRXH	WBXQ	Patton, PA	94.3	WBRX
WBNI-FM	Roanoke, IN	94.1	WCKZ	WRFF	Philadelphia, PA	104.5	WUBA
WQKV	Rochester, IN	88.5	WHNI	WTZN-FM	Pittsburgh, PA	93.7	WRKZ
WIFE-FM	Rushville, IN	94.3	WKWH-FM	WUZZ	Saegertown, PA	94.3	WHUZ
WITT	Zionsville, IN	91.9	New	WRNI-FM	Narragansett Pier, RI	102.7	WAKX
KIIC	Albia, IA	96.7	KLBA-FM	WNOW-FM	Gaffney, SC	105.3	WAGI-FM
KKSY	Anamosa, IA	95.7	New	WRNN-FM	Socastee, SC	99.5	WRNN
KXFT	Manson, IA	99.7	New	KLMP	Rapid City, SD	88.3	KTPT
KWER	Waverly, IA	89.9	New	KTPT	Rapid City, SD	97.9	KLMP
KRLE	Oberlin, KS	91.3	KOEN	KOAR	Spearfish, SD	90.7	KSPF
WKAO	Ashland, KY	91.1	New	WZKV	Dyersburg, TN	90.7	WKNQ
WKYB	Burgin, KY	105.9	New	WIJW	Harriman, TN	92.7	WBZH
WAKY	Radcliff, KY	103.5	WASE	WLCD-LP	Jackson, TN	98.7	WJKR-LP
WVLK-FM	Richmond, KY	101.5	WLRO	WKZP	McMinnville, TN	103.9	WTRZ-FM
WKR-D-FM	Shelbyville, KY	101.7	WLPP	WLND	Signal Mountain, TN	98.1	WKXJ
KITA	Iota, LA	89.5	KPKL	WUUS-FM	South Pittsburg, TN	97.3	WNGA
KFXZ-FM	Opelousas, LA	105.9	KTSJ	WTRZ	Spencer, TN	107.3	WKZP
WTLP	Braddock Heights, MD	103.9	WGYS	WTAI	Union City, TN	88.9	WUKV
WZXH	Hagerstown, MD	91.7	New	KIFR	Alice, TX	88.3	KEAM
WPRS-FM	Waldorf, MD	104.1	WXGG	KGHY	Beaumont, TX	88.5	New
WOCN-FM	Orleans, MA	104.7	WKPE-FM	KBWM	Breckenridge, TX	100.1	New
WKPE-FM	South Yarmouth, MA	103.9	WOCN-FM	KLTR	Brenham, TX	94.1	KULF
WGTX	Truro, MA	102.3	WCDJ	KHTZ	Caldwell, TX	107.3	KLTR
WTWS	Harrison, MI	92.1	WVXH	KJXJ	Cameron, TX	103.9	KXCS
WVFM	Kalamazoo, MI	106.5	WQLR	KHPS	Camp Wood, TX	89.7	New
KBVB	Barnesville, MN	95.1	KRVI	KKEV	Centerville, TX	103.5	New
KPCS	Princeton, MN	89.7	New	KXBT	Dripping Springs, TX	104.9	KXXS
KRLP	Windom, MN	88.1	KQRW	KXXS	Elgin, TX	92.5	KKLB
KHRS	Winthrop, MN	105.9	New	KULF	Ganado, TX	104.7	KZAM
WNEV	Friars Point, MS	98.7	New	KEVE	Ingram, TX	96.5	New
WHTU	Newton, MS	97.9	WYHL	KHMR	Lovelady, TX	104.3	New
WMSB	Senatobia, MS	88.9	WKNA	KKLB	Madisonville, TX	101.3	New
KJCG	Missoula, MT	88.3	New	KKLK-LP	Marfa, TX	98.9	New
KNPE	Hyannis, NE	97.9	New	KMBV	Navasota, TX	92.5	KHTZ
KYOY	Kimball, NE	100.1	KBFZ	KHPO	Port O'Connor, TX	91.9	KCPC
KTIC-FM	West Point, NE	107.9	KWPN-FM	KCPC	Sealy, TX	90.7	New
KUUT	Farmington, NM	89.7	KUSW	KLQB	Taylor, TX	104.3	KXBT
KUSW	Flora Vista, NM	88.1	KUUT	KBAR-FM	Victoria, TX	100.9	KEPG
KLIT	Hobbs, NM	90.9	New	KURR	Hurricane, UT	103.1	New
KOBH	Hobbs, NM	91.7	New	WVTI	Brighton, VT	106.9	New
KVSF-FM	Pecos, NM	101.5	KWRP	WWEM	Rustburg, VA	91.7	New
KZXQ	Reserve, NM	104.5	KLBZ	WIGO-FM	White Stone, VA	104.9	WIGO
KKIM-FM	Santa Fe, NM	94.7	KBOM	WFGM-FM	Barrackville, WV	93.1	WBVQ
WEXT	Amsterdam, NY	97.7	WBKK	WJJJ	Beckley, WV	88.1	New
WXRK	New York, NY	92.3	WFNY-FM	WVRW	Glenville, WV	107.7	New
WGKV	Pulaski, NY	101.7	WSCP-FM	WHAA	Adams, WI	89.1	New
WYKV	Ravena, NY	94.5	WBOE	WJZX	Brookfield, WI	106.9	WFMR
WYAI	Scotia, NY	93.7	WOOB	WWJA	Janesville, WI	91.5	New
WCRR	S. Bristol Township, NY	107.3	WSNP	WDSW	Westby, WI	103.9	New
WYBH	Fayetteville, NC	91.1	New	KQMY	Cheyenne, WY	97.9	KQLF
WRYN	Hickory, NC	89.1	New	KLOF	Gillette, WY	88.9	KDMN
KJTW	Jamestown, ND	89.9	New	KMLT	Jackson, WY	88.3	KNIL
CBI	Sydney, NS	97.1	New	KUWY	Laramie, WY	88.5	New
WKRI	Cleveland Heights, OH	92.3	WXRK	KVLZ	Sheridan, WY	89.9	KSHW
WGWV	Grove City, OH	88.1	New	KWDU	Upton, WY	93.5	New
WEGE	Lima, OH	104.9	WUZZ-FM	KYES-TV	Anchorage, AK	5	KYES
WOAR	South Vienna, OH	88.3	WVSO	KBBC-TV	Bishop, CA	20	New
WWSR	Wapakoneta, OH	92.1	WZOQ	KVSN	Pueblo, CO	48	New
KOCD	Wilburton, OK	103.7	KESC	KCWV	Duluth, MN	27	New
KOPA	Woodward, OK	95.9	KAZY				

Ham Radio Equipment: Such A Deal I Have For You!

Now that the Holidays are right around the corner and the Federal Reserve has just cut interest rates a half-percent (again) in an attempt to spur unbridled spending among the already-credit-strapped masses, my thoughts turn to buying new ham gear for that special ham in my family—me!

Yes, I've been making a list and checking it twice (a day), and if you ask those who are in the know, I've definitely been nice enough for Santa to grace my shack with at least one goodie!

I have a few items that always seem to float to the top of my list. An Elecraft K3 would be nifty, Santa. And I don't even care if it's a pre-production sample. Now that Elecraft has a huge cult following, "pre-production engineering sample" is just another phrase for "highly sought-after collectors' item!" And if you can't accommodate the slight extra bulge in your toy bag, an Elecraft K2 would be just fine.

Why not get crazy, you say, and ask Santa for an ICOM IC-7800 or a Ten-Tec Orion II? Okay! Done! And, while you're at it, old boy, why not drop off an NRD-630 or a Rohde & Schwarz ESMC? Whoo-hoo! Party at my house!

The coordinated alien abduction of my townhouse association would be extra appreciated, as would my lifetime appointment as Townhouse Tower Facilitator. For that present, oh cheerful

bearded one, I will definitely keep my room clean all year round.

Okay. Enough of my tortured Christmas wish list. What about your list? Are you a beginning ham who is wondering how much this stuff is gonna cost? We'll briefly examine that topic this month and I'll reminisce a bit about how expensive ham gear used to be 20 or 30 years ago. Why? So you can see how truly inexpensive gear is today when you consider inflation and the present value of the dollar (not to mention modern gear's tiny size and gigantic performance when compared to radios of yesteryear).

The Good Old (Expensive) Days

Have you ever checked out the equipment ads in old ham radio magazines from the '40s through the '60s? That's best done, by the way, by perusing the pages of actual, musty-smelling magazines. The effect is somewhat diminished by reading electronic copies. Those beautiful receivers and transmitters (yes, mostly separates!) made by Collins, National, Drake, Hammarlund, etc., had stellar price tags to match their stunning appearances—especially in the currency of the day! A premium receiver might have set you back \$1,000 or more, and you could add a transmitter for about the same! Even

in the '60s you could buy a new car with all the extras for less than it cost to buy a Collins transmitter/receiver combo!

Don't believe me? A 1968 Camaro SS cost a measly \$2,588. A '66 Ford 100 Pickup was \$1,795. In 1968, a Collins 51S-1 ham/shortwave receiver cost more than \$2,000. Drake's R4, while more affordable, still cost \$600 and was for ham bands only (plus a 500-kHz "auxiliary band" or two if you bought the proper crystal). Even Swan's 350—a real budget transceiver back in the day, complete with scary TV sweep tubes as finals—weighed in at about \$500.

So, according to the inflation/purchasing power calculators I found at www.westegg.com, a radio that cost \$500 in 1968 would be a whopping \$2,917 in '06! That Collins 51S-1 would be \$11,600 today—exactly the cost of ICOM's top-of-the-line IC-7800 transceiver!

Apples And Apples?

It's interesting that top-of-the-line equals top-of-the-line, then and today. But what about performance and overall value? Does the venerable 51S-1 offer the ultimate performance and value of ICOM's 7800? Not hardly, although more than a few Collins collectors might sharply disagree with me!

Let's look at it the other way. It's even more interesting. As you can see elsewhere in this month's column, I've been playing around with ICOM's entry-level HF rig, the IC-718. After a small rebate, the rig costs about \$525 new and as little as \$475 for a factory-refurbished unit (online). In 1968 dollars, that's an amazing \$90! Not bad for a radio that does stuff that a 1968 radio couldn't even dream of.

Thanks to the cold, hard numbers, I hope you can see that ham gear, (much like personal computers), is priced at an historical low. You can get good used gear for a song, and new gear for not much more. And, with respect to collectors everywhere, today's gear performs twice as well at a tenth of the cost. (Don't get me wrong: I like collecting and using older gear, especially stuff made by



If you've been extra, extra good perhaps there'll be an Elecraft K3 waiting for you under the tree.



Food for thought...Did you know that a Collins 51S-1, adjusted for inflation, would cost \$11,600 today—right up there with today's top-of-the-line rigs?!

Collins, Drake, and National. Its mil-spec quality and mechanical elegance is fabulous, and the harmonic-rich sound that comes from vacuum-tube audio amplifiers is something to behold, um, listen to. I'm simply talking about features, performance and inflation-adjusted costs.)

What Santa Will Spend On You

To help you calculate expenses, let's look at several popular ham activities and whip up some cost estimates for getting set up in each. These are "from scratch" estimates and averages. As always, your mileage may vary. If you shop and scrounge carefully you can probably beat these prices by a healthy margin. If your cash reserves are more plentiful, you can easily spend a bit more to buy more exotic gear.

These figures cover new gear only. If you really want to save money, look for good used equipment, which can save you as much as 70 percent up front. The art of buying used ham gear is another topic entirely. If you're a newcomer, make sure you have help from experienced buyers, or buy your gear from a reputable, established dealer. I've always had good luck at Burghardt's in Watertown, South Dakota (www.burghardt-amateur.com) and Universal Radio in Reynoldsburg, Ohio (www.universal-radio.com).

Some items in the equipment lists show up more than once (a ham transceiver is the ultimate multipurpose

device!), and some items aren't mentioned at all (feedlines, miscellaneous hardware, and so on). These items affect the total price, of course, but they're too numerous to consider here.

HF SSB/CW

A typical entry-level multimode HF transceiver will set you back about \$700. Additional items may include a five-band beam antenna (\$450), a multiband dipole antenna (\$65), a high-performance vertical antenna (\$350), a modest 50-foot tower and rotator (\$2,000), and an antenna tuner (\$175).

If you demand tower-mounted, high-performance antennas, you can easily sink a large wad of money into a beam, tower, and rotator. If you don't mind the performance trade-off, an antenna tuner and a dipole will serve you nicely—and save you several kilobucks. Another popular alternative is to try low-power (QRP) operating. QRP transceivers typically cost \$200 to \$600, and power supply requirements are minimal.

Regardless of their power levels, many new transceivers are teeny when compared to radios built 30 years ago. This fact alone has made mobile and portable operation a snap. In the bad old days, when your radio was the size and weight of a dorm fridge, fixed operation was highly desirable!

2-Meter FM: Mobile or Handheld

A new mobile FM transceiver will set you back about \$160, while a decent

Earn Your HAM RADIO LICENSE The Quick and Easy Way! No Morse Code Required!!



Start earning your Technician ham license today! Get on the air and enjoy the fun hobby of amateur radio. Learn from the "Master" – Gordon West, WB6NOA. Study manual includes all possible test Q&A and more – or study at your PC using interactive practice exam software –

GWTM
\$18.95
+ \$6 S&H

Getting Started in Electronics is a complete electronics course in 128 pages! Forrest Mims teaches you the basics, takes you on a tour of analog and digital components, explains how they work, and shows how they are combined for various applications. 100 electronic circuits you can build and test!



GSTD
\$19.95
+ \$6 S&H

The W5YI Group

POB 565101 – Dallas, TX 75356

Order today on the web or call:
www.w5yi.org ♦ 800.669.9594

Want to know more about ham radio? Call us!
Mention this ad to receive a free gift with your order!

CENTERFIRE ANTENNA MFG. CO.

Deluxe Discone Base Antenna

SO-239, Tuneable
Stainless Steel/Aluminum



Dual Band TX
144-156
440-448 MHz
Receive 30-1300 MHz
Peak Receive
120-500 MHz

\$34.95

Ground Plane Base Antenna

SO-239, Tuneable
Stainless Steel/Aluminum
Lifetime Warranty

144-148 MHz.....\$29.95
150-156 MHz.....\$29.95
220-225 MHz.....\$29.95
420-470 MHz.....\$29.95
108-121 Scan.....\$37.95
121-137 Air Scan \$36.95

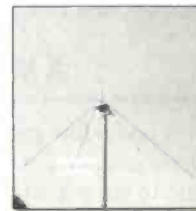

All prices include US Priority Postage
See our entire line of antennas online:

www.CenterfireAntenna.com

PO Box 8305, South Bend, IN 46660

handheld rig can be purchased for about \$140. Two- or three-band radios cost about twice as much in each category. Mobile and base station antennas weigh in at about \$30 to \$75 each.

You can cut some corners on antennas here, too. If you're willing to settle for a basic, quarter-wave ground-plane antenna at home, you can buy one for about \$20. A quarter-wave mobile antenna with a magnetic base can be yours for only \$25.

Most HTs (handheld transceivers) are less expensive than mobile radios. Each has advantages and disadvantages. HTs are convenient and versatile, but they lack the power for reliable, wide-area coverage. Even with a base antenna at home, you may need an amplifier to extend your range, particularly on simplex. Mobile rigs won't fit into your pocket, but they have plenty of power and are usually loaded with additional features.

RTTY/PSK31/Digital Modes on HF

These days, most digital-mode operation on the HF bands relies on an audio interface (\$50 to \$100) and a personal computer equipped with a standard sound card (\$250 to \$1,000). If you're Old School you might use a multimode communica-

tions processor (MCP) or even a dedicated RTTY terminal (\$300), which acts as the middleman between your transceiver and the computer, translating shifting audio tones into manageable data.

SSB and CW on 6 and 2 Meters

Nowadays, many new "HF" transceivers also cover 6 and/or 2 meters, and with the cost of dedicated VHF transceivers topping the cost of multimode "DC-to-daylight" rigs, you're almost better off buying an "HF through VHF" transceiver to get started on 6 and 2 meters (\$600). This trend has given a tremendous boost to weak-signal work on these bands. Accessories include gain antennas (\$125), 150-watt monoband amplifiers (\$250), and whatever tower/rotator combo you decide on.

Serious SSB/CW work on these bands demands a beam antenna, and the larger the better. A rotator is also necessary, but a tower is optional. Many weak-signal ops do just fine with roof-mounted arrays. Others take their gear on the road, working contests and activity weekends from hilltops or even skyscrapers.

How Low Can The Price Go?

Nestled into the recesses of my low-tech operating position is ICOM's entry-level HF transceiver/general-coverage receiver, the IC-718. With a price tag of \$525 to \$575, it represents today's low-cost, high-feature radios made possible by advances in electronics and manufacturing technologies over the past two decades.

I was curious about how much ham radio goodness could be packed into such an affordable radio, and because I had pored over the reviews at eham.net, I knew that most everybody thought the IC-718 was a fine business radio. The reviewers told me that the radio was extremely reliable, did just about everything under the sun, and was the deal of the century. In using the IC-718 on SSB, CW, and PSK on all the HF bands I found little reason to disagree.

Cool Stuff

The radio has dual VFOs, direct-key frequency entry, DSP noise reduction that works well, full-break-in CW, computer control, and a nice balance of front-panel controls versus things that have to be set up in submenus.

One feature I was very surprised to see (pleasantly surprised) is that the radio puts out 100 watts at full power and less than 2 watts at minimum power (with no fiddling with the rear-panel ALC connector, etc.). As a long-time QRP operator, who still chases low-band DX with 100-watt output, I thought the ability to choose from such a wide range of power outputs was fabulous.

A Wish List For The IC-718

I had a few minor issues with the radio but, in its defense, these issues exist in other radios, too. There's no tune control, and to put out a low-power carrier for antenna tuning purposes you have to send a string of dits, use an external keyer that has a tune button, switch to AM mode and key the mic, or make an "ICOM tune switch" out of a switch and a resistor that attach-



ICOM's entry-level HF transceiver/general-coverage receiver, the IC-718, is quite a bargain this season. Here's hoping you'll find one with a bow on it.

es to a rear-panel Molex connector. Push *that* button and the radio puts out a 10-watt carrier for tuning purposes and then switches back to whatever mode and power setting you had dialed in before you pressed the button. A tune button should be built in and on the front panel and not limited to ops who use the accessory auto-tuner that connects to the Molex connector in question!

This IC-718 didn't have a CW filter installed and, as a mostly CW op, I missed that. The IF-shift control helped a bit, as did the excellent DSP noise-reduction module. If I were to use this little rig long-term, I'd definitely pick up a CW crystal filter from ICOM or a Collins mechanical filter from W4RT Electronics (which has lots of nifty accessories for this radio and a great many others).

A Bargain (In Any Year)

Whether you're thinking in today's dollars (\$525) or 1968 dollars (\$90), the IC-718 is a real bargain for beginning HF ops or anyone who needs a solid, flexible, basic HF rig or short-wave receiver. We truly have come a long way!

—NTØZ

Towers and Rotators—Bucking the Trend

So what's *not* cheap these days? Towers, tower hardware and accessories, and antenna rotators! While everything else "hammy" was becoming affordable, the heavy iron (and aluminum) was going sky high.

When I was a teenage ham (more reminiscing) I worked for two TV repair shops, mostly installing towers and rooftop antennas. Just the hint of liability prevents teenagers from doing that kind of part-time work today (!), but I enjoyed it—and I obviously survived it!

After a long season of erecting towers in our TV reception "fringe area" 100 miles northwest of Minneapolis (a tornado had been very good for business), the shop owner discovered that he had an "extra" Rohn HBX-48, 48-foot self-supporting tower—the same kind we installed for our TV customers—in the storage shed. To this day I don't know whether my Dad had worked out a fast one behind the scenes, but the shop owner gave the extra tower to me as sort of an end-of-season bonus, and I put it up in the backyard with the help of a friend who worked as a communications tech at a nearby National Guard training facility.

I was more than pleased because I had been struggling to find the \$250 required to buy just such a tower! According to the inflation calculator referenced above, that tower should cost about \$775 in 2006 dollars. In reality, it's more like \$1,200 to \$1,400, concrete, shipping, and accessories not included. Rotators shared the same fate.

I'm not sure why, but it's a pet peeve of mine.

Smart Shopping

Although the gear (most of it) is more affordable than ever, you can soften the impact on your bank account even further by using the following tips:

- Don't be an impulse shopper. You may drool at the first sight of a beautiful piece of equipment, but don't make a hasty decision. Take the time to check with several dealers and find the lowest price. Look in the mail-order catalogs and on the Web, too. With a little patience, you may save a substantial amount of money.

- Shop at hamfests. Amateur Radio equipment dealers attend many of the larger hamfests and they often offer special prices on new equipment. If you're in the market for computer hardware, check out the computer shows that pop up from

time to time. You'll find some tremendous bargains there.

- Sell your current equipment. There's always a market for good used gear. By selling off some of your older equipment, you can accumulate enough money to take the sting out of a new purchase.

- Don't buy more than you need. When you're evaluating equipment, beware of

the "bells-and-whistles" syndrome. It's easy to be captivated by a 2-meter FM radio that includes every feature known to mankind. But think for a moment. Do you need dozens of programmable memories? Do you need paging capability? Do you need to receive out-of-band signals? If the answer is "no," look for a less expensive, less feature-packed radio.



Gearharness
Hands free transport for your handheld and other gear.



Leather & Neo Pouches
Custom sizes to fit your handheld.



Radio Wallet
Travel case for your handheld and accessories.



www.powerportstore.com

FREE SAMPLE COPY!

ANTIQUE RADIO CLASSIFIED

Antique Radio's Largest-Circulation Monthly Magazine

Articles - Classifieds - Ads for Parts & Services
Also: Early TV, Ham Equip., Books, Telegraph, 40's & 50's Radios & more...

Free 20-word ad each month. Don't miss out!



1-Year: \$39.49 (\$57.95 by 1st Class)

6-Month Trial - \$19.95. Foreign - Write.

A.R.C., P.O. Box 802-T14, Carlisle, MA 01741

Phone: (978) 371-0512; Fax: (978) 371-7129

Web: www.antiqueradio.com

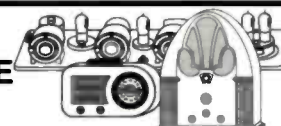

www.jrc.co.jp/

JRC

NRD-545

*Legendary Quality.
Digital Signal Processing.
Awesome Performance.*



FREE
Set of ST-3 Deluxe Headphones with Purchase
This offer valid until 12/31/07

With the introduction of the NRD-545, Japan Radio raises the standard by which high performance receivers are judged.

Starting with JRC's legendary quality of construction, the NRD-545 offers superb ergonomics, virtually infinite filter bandwidth selection, steep filter shape factors, a large color liquid crystal display, 1,000 memory channels, scan and sweep functions, and both double sideband and sideband selectable synchronous detection. With high sensitivity, wide dynamic range, computer control capability, a built-in RTTY demodulator, tracking notch filter, and sophisticated DSP noise control circuitry, the NRD-545 redefines what a high-performance receiver should be.

- LSB, USB, CW, RTTY, FM, AM, AMS, and ECSS (Exalted Carrier Selectable Sideband) modes.
- Continuously adjustable bandwidth from 10 Hz to 9.99 kHz in 10 Hz steps.
- Pass-band shift adjustable in 50 Hz steps up or down within a ± 2.3 kHz range.
- Tracking notch filter, adjustable within ± 2.5 kHz in 10 Hz steps, follows in a ± 10 kHz range even when the tuning dial is rotated.
- Continuously adjustable AGC between 0.04 sec and 5.1 sec in LSB, USB, CW, RTTY, and ECSS modes.
- Computer control capability.
- 1,000 memory channels that store frequency, mode, bandwidth, AGC, ATT, and (for channels 0-19) timer on/off.
- Built-in RTTY demodulator reads ITU-T No. 2 codes for 170, 425, and 850 Hz shifts at 37 to 75 baud rates. Demodulated output can be displayed on a PC monitor through the built-in RS-232C interface.
- High sensitivity and wide dynamic range achieved through four junction-type FETs with low noise and superior cross modulation characteristics.
- Noise reduction signal processing adjustable in 256 steps.

JRC *Japan Radio Co., Ltd.*

Japan Radio Co. Ltd., New York Office
2125 Center Ave, Ste 208 Fort Lee, NJ 07024
Voice: 201 242 1882 Fax: 201 242 1885

“Hello...?” Shortwave Fadeouts And Lost Signals

You finally have a few moments and decide to sit at your operating station. You're ready to try calling a general CQ, or maybe you're even more energetic and have decided to tap out your "CQ" on your favorite straight key. You have the radio nicely tuned, and the band has activity. You're tuning around, looking for a clear frequency, and you hear someone else calling, "CQ..."

You decide to answer. The other operator's signal is clear and strong. When it's time to answer the call, you send your call sign several times and then turn it back over. Excellent. The other operator answers you and tells you that he hears you very well. Now it's your turn again.

You start by telling him your name, then your location, and then you tell him a bit about your weather and station. You then sign with your call sign and turn it back over for him to respond. And, you wait. You hear hiss. You wait a bit longer. Now, you're wondering if you might have somehow offended him, or that perhaps he didn't like the way you operated. You wait a bit

longer. Then you call him and ask if he's still there. There's no reply. Just hiss.

What could have happened? You might think that the other operator was just being rude. It makes you wonder why you even bothered getting on the radio. The operators these days!

However, could it be possible that he was called away by a family emergency? Perhaps his power went out. Or the antenna was cut!

I remember operating one Saturday, carrying on a nice conversation. The bands were solid, and the conversation was already over half an hour long. All of a sudden, everything went dead—no signal from the other operator. My radio was still working. I glanced out the window, and looking down from the second floor "radio shack," I glanced at my antenna. Amazingly, a moving truck that arrived at the neighbor's house was being driven between the houses and had cut my antenna down! Snap! There was no way for me to let the other operator know that I was down for the count.

The Ap Index And Understanding Propagation Terminology

The Ap index, or Planetary A index, is a 24-hour averaging of the Planetary K index. The Planetary K index is an averaging of worldwide readings of Earth's geomagnetic field. High indices ($K_p > 5$ or $A_p > 20$) mean stormy conditions with an active geomagnetic field. The more active, the more unstable propagation is, with possible periods of total propagation fade-out. Especially around the higher latitudes and at the polar regions, where the geomagnetic field is weak, propagation may disappear completely. Extreme high indices may result in aurora propagation, with strongly degraded long-distance propagation at all latitudes. Low indices result in relatively good propagation, especially noticeable around the higher latitudes, when trans-polar paths may open up. Maximum K-index is 9, and the A-index can exceed well over 100 during very severe storm conditions, with no maximum.

Classification of A indices is as follows:

A0–A7 = quiet	A30–A49 = minor storm
A8–A15 = unsettled	A50–A99 = major storm
A16–A29 = active	A100–A400 = severe storm

Solar Flux Index (SFI): This flux number is obtained from the amount of radiation on the 10.7-cm band (2800 MHz). It is closely related to the amount of ultraviolet radiation, which is needed to create the ionosphere. Solar Flux readings are more descriptive of daily conditions than the Sunspot Number. The higher the Solar Flux (and, therefore, the higher the Sunspot Number), the stronger the ionosphere becomes, supporting refraction of higher frequencies.

Ionosphere: A collection of ionized particles and electrons in the uppermost portion of the Earth's atmosphere, which is formed by the interaction of the solar wind with the very thin air particles that have escaped Earth's gravity. These ions are responsible for the reflection or bending of radio waves occurring between certain critical frequencies, with these critical frequencies varying with the degree of

ionization. As a result, radio waves having frequencies higher than the Lowest Usable Frequency (LUF) but lower than the Maximum Usable Frequency (MUF) are propagated over long distances.

Smoothed Sunspot Number (SSN): Sunspots are magnetic regions on the sun with magnetic field strengths thousands of times stronger than the Earth's magnetic field. Sunspots appear as dark spots on the surface of the sun. Temperatures in the dark centers of sunspots drop to about 3700° K (compared to 5700° K for the surrounding photosphere). This difference in temperatures makes the spots appear darker than elsewhere. Sunspots typically last for several days, although very large ones may last for several weeks. They are seen to rotate around the sun, since they are on the surface, and the sun rotates fully every 27.5 days.

Sunspots usually occur in a group, with two sets of spots. One set will have positive, or north, magnetic field while the other set will have negative, or south, magnetic field. The field is strongest in the darker parts of the sunspots (called the "umbra"). The field is weaker and more horizontal in the lighter part (the "penumbra").

Galileo made the first European observations of sunspots in 1610. The Chinese and many other early civilizations have records of sunspots. Daily observations were started at the Zurich Observatory in 1749; continuous observations were begun in 1849.

The Sunspot Number is calculated by first counting the number of sunspot groups and then the number of individual sunspots. The Sunspot Number is then given by the sum of the number of individual sunspots and 10 times the number of groups. Since most sunspot groups have, on average, about 10 spots, this formula for counting sunspots gives reliable numbers even when the observing conditions are less than ideal and small spots are hard to see. Monthly averages (updated monthly) of the Sunspot Numbers show that the number of sunspots visible on the sun wax and wane with an approximate 11-year cycle.

For more information, see <http://prop.hfradio.org>.

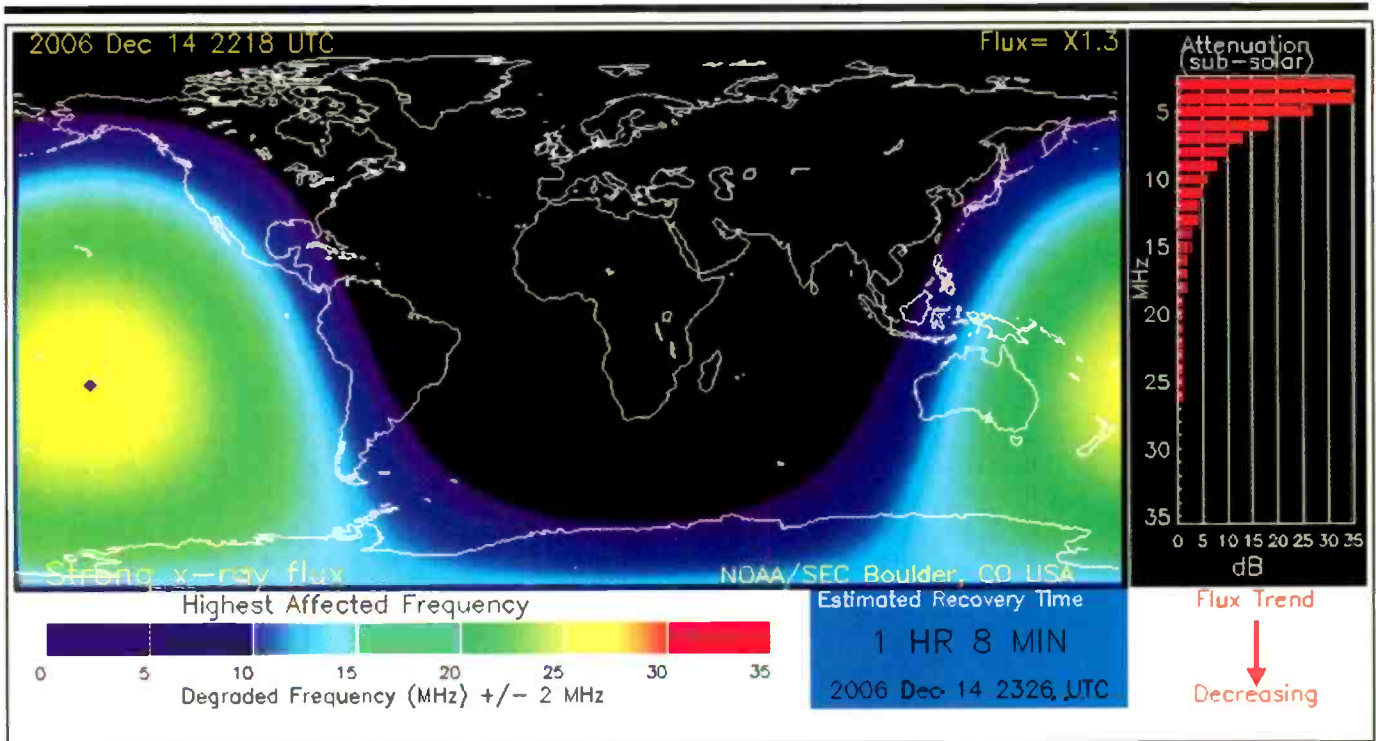

Photo A. This is an illustration of the operational impact of x-ray flux on HF radio communications. Notice the frequencies and the areas that are affected. Long-range communications using HF radio waves (3–30 MHz) depend on reflection of the signals in the ionosphere. Radio waves are typically reflected near the peak of the F₂ layer (~300 km altitude), but along the path to the F₂ peak the radio wave signal suffers attenuation due to absorption by the intervening ionosphere. Absorption occurs during x-ray flares, and the bigger the flare, the greater the absorption.

As can be seen in this illustration, geometric effects cause D-region ionization to be greatest at the sub-solar point, where the sun is directly overhead. The amount of ionization and absorption falls off with distance from the sub-solar point, reaching zero at the day/night terminator. The night-side of the Earth is unaffected.

This model consists of four dynamic components: a global frequency map, an attenuation bar graph, status messages, and an estimated recovery clock. All of the components update continuously, driven by one-minute GOES x-ray flux data. (Source: SEC/NOAA)

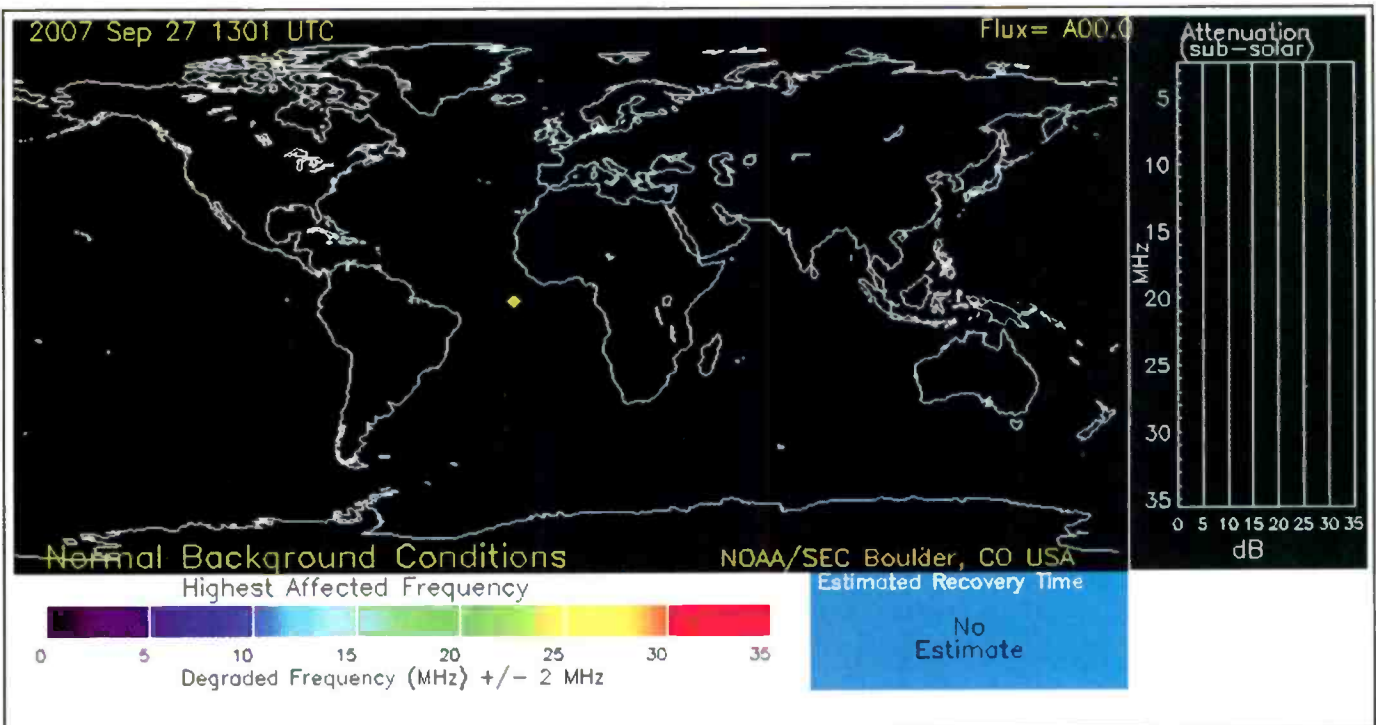

Photo B. In this illustration, there is no observed x-ray flare activity and no ionospheric propagation degradation due to absorption. (Source: SEC/NOAA)

Optimum Working Frequencies (MHz) - For December 2007 - Flux = 80, Created by NW7US

UTC	00	01	02	03	04	05	06	07	08	09	10	11	12	13	14	15	16	17	18	19	20	21	22	23
TO/FROM US WEST COAST																								
CARIBBEAN	17	14	11	11	10	10	10	9	9	9	9	9	9	9	13	17	19	20	20	21	21	21	20	19
NORTHERN SOUTH AMERICA	25	23	18	15	14	13	13	13	12	12	12	12	12	11	15	22	25	26	27	28	28	28	27	27
CENTRAL SOUTH AMERICA	25	22	15	15	14	13	13	13	12	12	12	12	12	12	17	23	25	27	27	28	28	28	27	26
SOUTHERN SOUTH AMERICA	27	25	21	15	15	14	13	13	13	12	12	12	12	12	21	25	26	27	28	28	28	29	29	28
WESTERN EUROPE	8	8	8	8	8	8	8	8	8	8	8	8	8	8	8	10	11	10	10	9	8	8	8	8
EASTERN EUROPE	8	8	8	8	8	8	8	8	8	8	8	8	8	8	8	8	10	10	9	9	9	9	8	8
EASTERN NORTH AMERICA	19	16	12	12	11	11	11	10	10	10	10	10	10	14	18	20	21	22	22	22	22	22	22	21
CENTRAL NORTH AMERICA	11	10	8	7	6	6	6	6	6	5	5	5	5	5	5	8	10	11	12	12	12	12	12	12
WESTERN NORTH AMERICA	6	6	5	3	3	3	3	3	3	3	3	3	2	2	2	5	5	6	6	6	6	6	6	6
SOUTHERN NORTH AMERICA	19	18	14	11	11	10	10	10	10	9	9	9	9	9	9	16	18	20	20	21	21	21	21	20
HAWAII	18	18	17	16	13	10	10	9	8	8	8	8	8	8	8	8	13	16	17	18	18	19	19	19
NORTHERN AFRICA	9	9	8	8	8	8	8	8	8	8	8	8	8	8	8	12	13	14	15	11	10	10	9	9
CENTRAL AFRICA	11	9	9	9	9	8	8	8	8	8	8	8	8	8	8	11	13	14	14	13	12	12	11	11
SOUTH AFRICA	17	13	12	11	11	10	10	10	10	10	10	9	9	9	14	17	19	20	20	21	21	20	20	19
MIDDLE EAST	8	8	8	8	8	8	8	8	8	8	8	8	8	8	8	11	10	10	9	9	9	9	8	8
JAPAN	17	16	15	14	12	10	9	9	9	8	8	8	8	8	8	8	8	8	8	8	8	11	15	16
CENTRAL ASIA	16	16	15	14	12	10	9	9	9	9	8	8	8	8	8	8	8	8	10	10	10	10	11	16
INDIA	8	8	8	8	8	8	8	8	8	8	8	8	8	8	8	8	8	8	8	8	8	8	8	8
THAILAND	16	15	14	13	11	9	9	9	9	8	8	8	8	8	8	8	8	8	11	10	10	10	10	10
AUSTRALIA	25	26	26	24	21	15	14	14	13	13	13	12	12	12	12	12	16	15	14	17	19	21	23	23
CHINA	14	15	14	13	10	9	9	9	9	8	8	8	8	8	8	8	8	8	8	8	8	8	8	10
SOUTH PACIFIC	27	27	26	24	19	15	14	14	13	13	13	12	12	12	12	14	16	17	20	22	23	25	26	26
TO/FROM US MIDWEST																								
CARIBBEAN	19	13	13	12	12	11	11	11	10	10	10	10	10	16	20	22	23	24	24	24	24	24	23	21
NORTHERN SOUTH AMERICA	22	18	14	13	13	12	12	11	11	11	11	11	11	16	21	24	25	26	26	27	27	26	25	24
CENTRAL SOUTH AMERICA	22	16	15	14	14	13	13	12	12	12	12	12	12	20	24	26	27	28	29	29	29	28	27	25
SOUTHERN SOUTH AMERICA	25	21	16	15	14	14	13	13	13	12	12	12	12	15	22	23	25	26	27	28	28	29	28	27
WESTERN EUROPE	8	8	8	8	8	8	8	8	8	8	8	8	8	8	10	13	14	14	13	12	9	9	9	8
EASTERN EUROPE	8	8	8	8	8	8	8	8	8	8	8	8	8	8	11	13	13	12	9	9	9	9	8	8
EASTERN NORTH AMERICA	13	9	9	8	8	8	8	7	7	7	7	7	7	8	13	15	16	16	17	17	17	16	15	15
CENTRAL NORTH AMERICA	6	5	4	4	3	3	3	3	3	3	3	3	3	3	4	6	7	7	7	7	7	7	7	7
WESTERN NORTH AMERICA	11	10	9	7	7	6	6	6	6	6	5	5	5	5	9	10	11	12	12	13	13	12	12	
SOUTHERN NORTH AMERICA	13	12	8	8	8	7	7	7	7	7	6	6	6	6	10	13	14	15	15	15	15	15	14	14
HAWAII	20	19	18	14	12	11	11	10	10	10	9	9	9	9	9	9	17	19	21	21	22	21	21	21
NORTHERN AFRICA	10	10	9	9	9	9	8	8	8	8	8	8	8	8	12	15	16	17	17	17	16	13	12	11
CENTRAL AFRICA	10	10	9	9	9	9	8	8	8	8	8	8	8	8	12	14	16	16	17	17	13	12	11	11
SOUTH AFRICA	17	15	14	13	13	13	12	12	12	12	12	12	12	21	24	26	27	27	28	28	27	26	24	22
MIDDLE EAST	8	8	8	8	8	8	8	8	8	8	8	8	8	9	13	14	15	13	10	10	9	9	9	9
JAPAN	15	14	13	10	9	9	9	9	8	8	8	8	8	8	8	8	8	8	8	8	8	10	14	16
CENTRAL ASIA	15	14	12	10	9	9	9	9	8	8	8	8	8	8	8	8	11	10	10	10	10	10	10	16
INDIA	8	8	8	8	8	8	8	8	8	8	8	8	8	8	8	8	8	8	8	8	8	8	8	8
THAILAND	14	13	10	9	9	9	9	8	8	8	8	8	8	8	8	8	11	11	11	10	10	10	10	10
AUSTRALIA	25	25	23	18	15	14	14	13	13	12	12	12	12	12	12	17	16	15	15	17	20	22	23	23
CHINA	13	12	10	9	9	9	9	8	8	8	8	8	8	8	8	8	8	8	8	8	8	8	8	8
SOUTH PACIFIC	27	25	23	17	15	14	14	13	13	12	12	12	12	12	12	17	16	16	18	21	22	24	25	26
TO/FROM US EAST COAST																								
CARIBBEAN	14	11	10	10	9	9	9	8	8	8	8	8	12	16	18	19	20	20	20	20	19	18	17	17
NORTHERN SOUTH AMERICA	19	15	14	13	13	12	11	11	10	10	10	10	14	18	21	22	23	24	24	24	24	23	22	21
CENTRAL SOUTH AMERICA	19	17	16	15	14	14	13	13	12	12	12	12	21	23	25	26	27	28	29	29	29	28	26	24
SOUTHERN SOUTH AMERICA	23	19	18	17	16	15	14	13	13	13	12	12	18	21	22	24	25	26	27	28	28	29	28	26
WESTERN EUROPE	8	8	8	8	8	8	8	7	7	7	7	8	13	15	15	15	15	14	13	10	9	9	8	8
EASTERN EUROPE	8	8	8	8	8	8	8	8	8	8	8	8	9	10	10	9	9	9	9	8	8	8	8	8
EASTERN NORTH AMERICA	5	4	4	4	4	3	3	3	3	3	3	3	3	6	7	8	8	8	8	8	8	8	7	7
CENTRAL NORTH AMERICA	14	10	9	9	9	8	8	8	8	8	8	7	7	9	14	15	16	17	17	18	17	17	16	15
WESTERN NORTH AMERICA	19	16	13	12	11	11	11	10	10	10	10	10	10	10	15	19	20	22	22	23	23	22	21	21
SOUTHERN NORTH AMERICA	15	11	10	10	9	9	9	8	8	8	8	8	8	8	12	15	17	18	19	19	19	19	18	17
HAWAII	20	17	13	12	12	11	11	11	10	10	10	10	10	10	10	10	10	19	21	23	23	23	23	22
NORTHERN AFRICA	11	11	10	10	10	10	10	10	10	10	10	10	15	19	21	22	23	22	20	18	13	12	12	11
CENTRAL AFRICA	11	11	10	10	10	10	10	10	10	10	10	10	15	19	21	22	23	23	21	19	13	13	12	11
SOUTH AFRICA	15	14	14	13	13	12	12	12	12	12	12	19	24	26	28	28	29	29	29	28	27	26	23	17
MIDDLE EAST	10	9	9	9	9	8	8	8	8	8	8	10	14	16	17	18	18	18	13	12	11	11	10	10
JAPAN	13	10	9	9	9	9	8	8	8	8	8	8	8	8	8	8	8	8	8	8	8	8	13	15
CENTRAL ASIA	11	10	9	9	9	9	8	8	8	8	8	8	8	8	11	11	11	10	10	10	10	10	14	14
INDIA	8	8	8	8	8	8	8	8	8	8	8	8	8	8	8	8	8	8	8	8	8	8	8	8
THAILAND	10	9	9	9	9	8	8	8	8	8	8	8	8	11	12	12	11	11	11	10	10	10	10	10
AUSTRALIA	24	21	15	15	14	13	13	13	12	12	12	12	12	12	19	18	17	16	15	15	18	20	22	24
CHINA	10	9	9	9	9	8	8	8	8	8	8	8	8	9	9	9	8	8	8	8	8	8	8	8
SOUTH PACIFIC	25	21	16	15	14	14	13	13	12	12	12	12	12	14	18	17	16	17	20	22	24	25	26	27

There could be another reason, however that one operator simply disappears in the middle of a conversation. If the radio signal is being propagated by way of the ionosphere, a number of conditions might occur that would effectively end a two-way radio communications.

Sudden Ionospheric Disturbances And Other Nuisances

Radio signals are susceptible to a variety of ionospheric disturbances. Some are well understood and can even be predicted with reasonable accuracy. Others occur in a more random fashion and are harder to predict.

One of the most basic forms of ionospheric disturbances is associated with solar flares. As you know from previous months when we explored solar flares, these x-ray flares produce enormous amounts of radiation. While most solar flares do not impact the state of the Earth's ionosphere with enough energy to cause widespread communications blockages, some flares that do have sufficient energy cause short periods where communications via the ionosphere is impossible. When such a flare occurs, and the ionosphere no longer propagates a radio signal, it's known as a "shortwave fadeout." This condition may last anywhere from a few minutes to over an hour and is directly tied to the intensity of the flare, as well as to how quickly the flare energy rises, peaks, and then fades.

Solar flare effects on the ionosphere are limited to the daytime only. When the sun sets on the ionospheric *D* region, the source of x-ray ionization disappears, which allows the *D* region to return to normal conditions. For this reason, only radio signal paths that are illuminated by the sun are susceptible to shortwave fadeouts.

Radio signals are less susceptible to shortwave fadeouts on higher frequencies, because signal absorption is inversely proportional to the square of the radio frequency. Therefore, absorption on 1.8 MHz is much higher for a signal that passes through the *D* region than for a signal that has a frequency of 18 MHz.

If you want to monitor a worldwide map that graphically illustrates the minute-by-minute *D*-region absorption condition as a function of a solar flare (in real-time), visit www.sel.noaa.gov/rt_plots/dregion.html (see **Photos A** and **B**). I've watched this map during large flares and confirmed the shortwave fadeout that was being displayed.

HF Propagation

The late autumn DX season is in full swing! Listeners throughout the Northern Hemisphere are actively chasing mediumwave (MW) DX of AM broadcast stations from all over North, Central, and South America, and from Europe and Asia. It's easier to catch such difficult signals at this time of year because conditions are most favorable to propagation of this spectrum of radio frequencies. Shortwave DX is hot, too, especially on the mid- to low-HF bands from early evening until late at night, and then again from early morning through high noon.

December 22 marks the start of winter this year, with the sun sitting at its yearly southern-most point in the sky. This is the day with the shortest daylight period of the year for observers situated north of the equator.

Long hours of darkness make for a less-energized ionosphere. Since the *D* layer of the ionosphere is less ionized during the winter, MW and the lower SW frequencies are less absorbed than during the summer season, so they can be better propagated by

the *E* and *F* layers. Additionally, the seasonal decrease in weather-related noise makes it easier to hear the weaker DX signals on the lower frequencies. With thunderstorms few and far between, storm-related static and noise is greatly reduced.

Geomagnetic activity tends to quiet down during the winter months. The most active geomagnetic seasons are centered on the two equinoxes, in the spring and autumn. We are also in the very bottom of the current solar cycle so very few flares occur and, therefore, very few, if any, shortwave fadeouts. This results in more stable and reliable propagation in the shortwave spectrum, especially on the lower frequencies. When a flare of significant size does occur during these periods of quiet, however, they can take us by surprise. The bands sound great and we hear many signals well—then, when we least expect it, the signal is gone and nothing can be heard. Don't blame the other operator, as it could actually be a sudden ionospheric disturbance!

December is well enough past the autumnal equinox and the associated peak auroral activity to support transpolar propagation. With this overall reduction of geomagnetic activity and the decrease of radio signal absorption comes more stable high-latitude propagation. MW DXers enjoy catching broadcast station transmissions from over the North Pole. SW DXing over high-latitude paths becomes exciting, even if the higher-frequency bands might be dead.

At this time of year we also experience an improvement of radio wave propagation below 500 kHz and on the MW broadcast band. The MW broadcast band refers to the frequencies between 530 kHz and 1750 kHz. The Low Frequency (LF) range is the band of frequencies between 30 kHz and 300 kHz. Very Low Frequencies (VLF) are those ranging between 3 kHz and 30 kHz, though the practical lower edge of the VLF band starts at 10 kHz. Medium Frequencies (MF) range from 300 kHz to 3000 kHz. Radio waves in the LF and VLF spectrum propagate differently than those of MF and above.

Between 300 kHz and 520 kHz, the lowest part of the MF and just below the MW broadcast band, the characteristics of propagation are a mix between those of the lower HF spectrum and those of LF. The VLF and LF bands are usually referred to as the longwave (one word) bands. The VLF band extends from 10 to 30 kHz, and the LF from 30 to 300 kHz. During the winter season, MW transmissions can be heard over much greater distances than during summer.

Fairly good DX openings are expected on 19 and 16 meters, remaining open towards the west during the early evening. Nineteen meters will be the hottest daytime band, while 22 and 25 meters will become a close second. These start with early morning openings in all directions until about an hour or two after sunrise, and then remain open into one place or another throughout the day until early evening. When conditions are good (days with low geomagnetic activity, and higher solar sunspot activity), 22 through 16 meters are likely to remain open towards the south and west from early evening until about midnight.

The best bands for around-the-clock DX will be 31 and 25 meters. Twenty-five meters continues to be an excellent band for medium distance (500 to 1,500 miles) reception during the daylight hours, with longer distance reception (up to 2,000 to 3,000 miles) possible for an hour or two after local sunrise, and again during the late afternoon and early evening.

From midnight to sunrise, 41 and 31 meters promise some of the hottest nighttime DX during December. The first DX openings should be toward Europe and the east during the late afternoon, then move across the south through the hours of darkness, while remaining open into most parts of the world. Just

after sunrise, openings will be more in a westerly direction. Low seasonal noise will make DXing a pleasurable endeavor.

For short-skip openings during December, try 90 through 41 meters during the day for paths less than 250 miles, and 90 down to 120 meters at night for these distances. For openings between 250 and 750 miles, try 41 meters during the day, and both 90 and 120 at night. For distances between 750 and 1,300 miles, 22 through 31 should provide daytime openings, while 41 down to 90 will be open for these distances from sunset to midnight. After midnight, 90 meters will remain open out to about 1,300 miles until sunrise. Try 31 and 41 meters again for about an hour or so after sunrise. Between 1,300 and 2,300 miles, openings will occur on 22 through 16 meters, with fewer on higher bands, during the daylight hours. During sundown to midnight, check 22 through 41 meters for these long-distance openings, and then check 41 down to 90 meters after midnight until sunrise. Try 41 and 31 meters again for an hour or so after sunrise.

DX openings on 120 and 90 meters during the hours of darkness and into the sunrise period, with considerably decreased static levels, are a sure bet during the longer hours of darkness in the northern latitudes. Look for openings toward Europe and the south from the eastern half of the United States and towards the south, the Far East, Australasia, and the South Pacific from the western half of the country. Ninety meters should peak towards Europe and in a generally easterly direction around midnight, and then open in a generally westerly direction with a peak just after sunrise. The band should remain

open towards the south throughout most of the night.

Propagation On VHF And Above

Quite a bit of meteor shower activity is expected this month, which should result in improved conditions for meteor-scatter openings on the VHF bands for distances up to about 1,000 miles.

When a meteor burns up in the atmosphere, its intense heat creates an ionized trail, making it possible for radio signals to propagate off the ionized trail much like they would off the ionosphere. The annual Geminids meteor shower, which will appear from December 7 to December 17, will peak on December 14 at 1416 UTC. The maximum hourly rate typically reaches 80. However, this year, we are expecting 120 per hour.

The Geminids is a great shower for those trying the meteor-scatter mode of propagation, since you won't have to wait until after midnight to catch it. The radiant rises early, but the best operating time will be after midnight local time. This shower also boasts a broad maximum, lasting nearly one whole day, so no matter where you live, you stand a decent chance of working some VHF/UHF signals off a meteor trail. For a complete list of meteor showers in December, visit www.imo.net/calendar/2007.

A secondary seasonal peak in sporadic-E ionization should also result in some short-skip openings on low VHF between distances of about 800 and 1,300 miles. A rare occurrence of aurora during days of stormy geomagnetic activity is

possible, providing some unusual short-skip openings on low VHF.

There's considerably less likelihood for transequatorial VHF openings during December, but look for a possible opening between the southern states and locations deep in South America. The best time to look for these is between about 8 and 11 p.m. local time.

Current Solar Cycle Progress

The Dominion Radio Astrophysical Observatory at Penticton, BC, Canada, reports a 10.7-cm observed monthly mean solar flux of 69.2 for August 2007. The 12-month smoothed 10.7-cm flux centered on January 2007 is adjusted to 77.5, and for February the reported flux is 76.9. The predicted smoothed 10.7-cm solar flux for December 2007 is 80, give or take about 17 points.

The Royal Observatory of Belgium reports that the monthly mean observed sunspot number for August 2007 is 6.2, down from July's 10. The lowest daily sunspot value recorded was zero (0), on August 1, 2, 14, 16, 17, 18, 19, and 20. The highest daily sunspot count was 17 on August 31. The 12-month running smoothed sunspot number centered on February 2007 is 11.6. A smoothed sunspot count of 22, give or take about 12 points, is expected for December 2007.

The observed monthly mean planetary A-Index (Ap) for August 2007 is 6, and the July Ap is adjusted to 8. The 12-month smoothed Ap index centered on February 2007 is 8.4. Expect the overall geomagnetic activity to be quiet to active during most days in December.

I'd Like To Hear From You

You can join in with others in discussing space weather, propagation, and shortwave or VHF listening, at <http://hfradio.org/forums/>. Be sure to check out the latest conditions, as well as the educational resources about propagation that I have put together for you at <http://prop.hfradio.org/>. I also provide a WAP/WML resource for wireless devices. If you want the latest propagation information, like the solar flux, Ap reading, and so forth, check out <http://wap.hfradio.org/>, the wireless version of my propagation site.

Please don't hesitate to write and let me know about any interesting propagation that you have noticed. Do you have questions about propagation? I look forward to hearing from you.

Happy signal hunting!

Pop'Comm December 2007 Reader Survey Questions

This month we'd like to ask you about your hobby around the Holidays. Please use the Reader Survey Card and circle all appropriate numbers. Thanks for participating.

Around the Holidays do you typically...?

Treat yourself to a new communications toy	1
Buy a hobby-related gift for someone else	2
Get a hobby-related gift from someone else	3
Sigh and enjoy the socks	4

How helpful is the editorial content in Pop'Comm in making your gift-giving decisions?

Extremely helpful	5
Moderately helpful	6
Not very helpful at all	7
I really don't buy anything	8

How helpful are the advertisements in Pop'Comm in making your gift-giving decisions?

Extremely helpful	9
Moderately helpful	10
Not very helpful at all	11
Again, not a shopper	12

Bob Ryan's Doerle Twinplex: A Simple One-Tube Battery-Powered Radio

Several years have past since we presented our version of Alfred Morgan's popular Boy's First Receiver project. Alfred Powell Morgan was a noted author of books aimed at young budding scientists, and many of his vintage radio and electronic books are still extremely popular and sought after.

Fast forward to the present. A few columns back I spotlighted a project idea submitted by a faithful reader and friend, Bob Ryan of Hemet, California. Bob had gifted us with one of his homemade regenerative one-tube receivers. He whimsically dubbed his creation The Dumpster Diver Special as it was mainly composed of items that could have been salvaged from the trash bin. While all the major components were fitted and the basic layout followed that used in countless one-tube regenerative receivers of yore, nothing was wired and no circuit was suggested.

Bob's challenge to us was to design a working receiver from these beginnings. I confess that the receiver has been awaiting a fitting conclusion for a few years. This column will be dedicated to that closure.

The Doerle Twinplex

The Doerle Twinplex was a popular SW receiver kit first advertised in magazine ads back 1934. The original Doerle circuit was built around the then-newly available type 19 dual-triode vacuum tube. Various iterations of the Doerle regenerative receiver remain popular with experimenters to this day. The 6SL7 vacuum tube has been used in AC powered versions.

The completed Dumpster Diver Special is loosely based on the Doerle, with some important changes. First, the type 19 vacuum tube has a 2-volt filament and was intended for use with a wet cell (lead acid) type A battery. Bob had only provisioned a single D cell holder on the Dumpster Diver Special. Using a type 19 tube would require two D cells and a rheostat to adjust the filament voltage down to 2 volts—as was done in our previous receiver projects using 2-volt 1H4 vacuum tubes. Alas, there was no room on Bob's prototype to accommodate either item.

Another consideration was that the prototype included an octal socket, while the type 19 is a six-pin base. Also, while the type 19 isn't particularly rare or overly expensive, I suspected there might a lower cost alternative. Finally, the 19 filament is current hungry and isn't a good match for dry cells.

The 1G6 Dual Triode

The 1G6 dual triode—an octal-based tube with a 1.5-volt filament—was suggested as a replacement. The 1G6 was designed for push-pull Class B audio output service, and with 90 volts on the plate it only draws 1 mA of current for Class B service. It sells for about one third the type 19 tubes' price, making it even more attractive!

A view of my finished Dumpster Diver, with a 1G6 installed, is shown in **Photo A**. Bob's Dumpster Diver Special

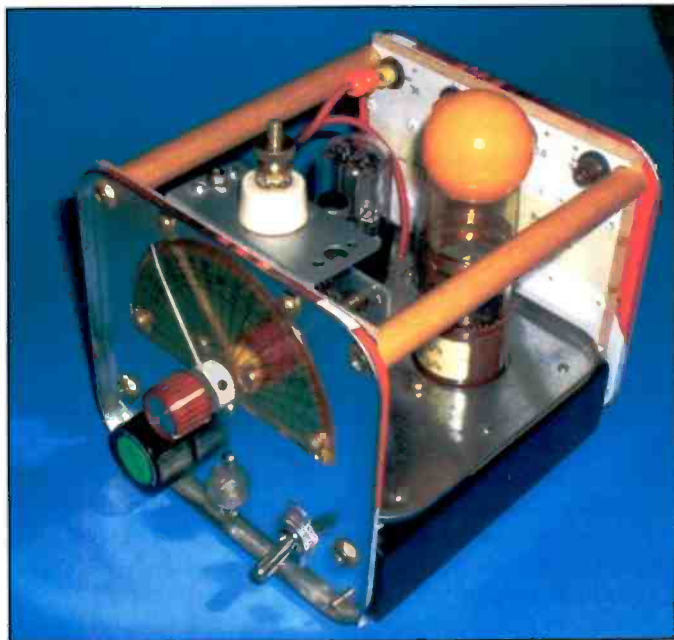

Photo A. Here's my finished version of Bob Ryan's Dumpster Diver Special. The Dumpster Diver was loosely modeled on the popular 1934 Doerle Twinplex shortwave receiver kit. Bob's clever dial scale and pointer arrangement is discussed in the text.

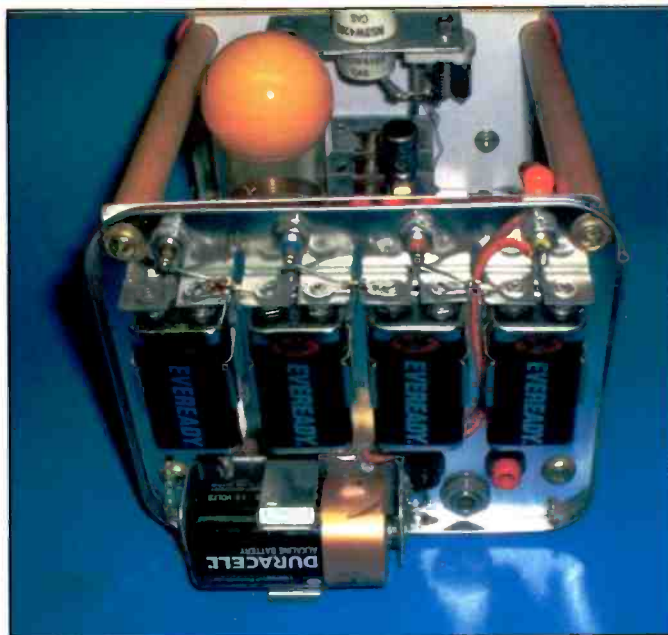

Photo B. Bob included four metal Keystone holders for four 9-volt transistor batteries and a single metal Keystone holder for a single D cell for the filament supply. This limited the B+ to 36 volts maximum.



Photo C. The bank of 9-volt batteries was wired in series, and each of the tie points included a pin jack to select the optimum detector voltage. This scheme would work well with sets based on Alfred Morgan designs, which often worked well with 9 or 18 volts on the detector plate.

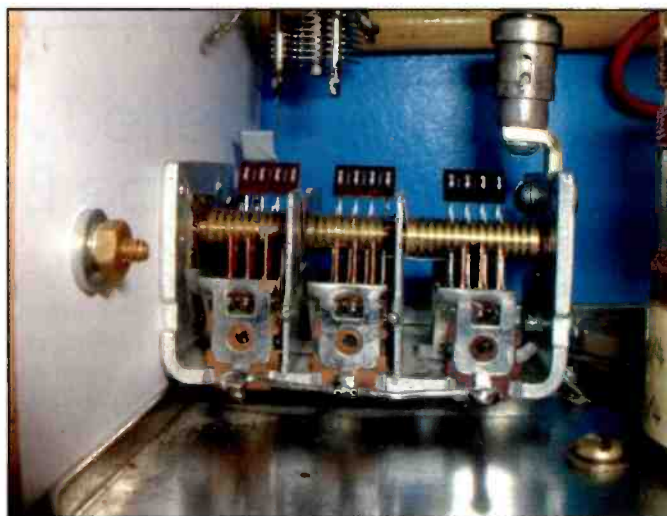

Photo D. The three sections of the tuning capacitor are wired in parallel for a total of 140 pF. This capacitor is a surplus item from Fair Radio Sales.

chassis included metal Keystone brand battery holders for four 9-volt transistor batteries, limiting the available B+ voltage to 36 volts. Bob even provided a means of using pin jacks to select lower battery voltages for the detector (see Photos B and C). I'll explain how this problem was solved later, but I'd suggest to anyone contemplating this construction to add at least a few more 9-volt batteries to bring the B+ up to 54 volts or more. It will make operation a tad more reliable and the coil design less critical.

If you don't mind adding the rheostat and extra D cell, a 2-volt 1J6 octal dual-triode can be used in lieu of the type 19. The 1J6 will also outperform a 1G6 at low plate voltages.

The Circuit

Let's get started. The schematic is shown in **Figure 1**. The main tuning capacitor¹ is a three-section variable with all three

sections paralleled together for a maximum capacitance of 140 pF. This is component C1 on the schematic and is shown in **Photo D**. The 140-pF value was a popular tuning capacitor, and it was the tuning capacitor value specified by Morgan for the original Boy's First Receiver. This value gives good shortwave bandsread, and limiting the L/C requires less fiddling with the regen control setting. The trade off is that more than one coil will be needed to fully cover the 520 to 1720 kHz AM BCB and FIS (fixed information service) stations.

This capacitor has a built-in vernier speed reduction drive. Bob devised a clever dial system for the receiver. He salvaged a metal collar insert from an old knob and mounted this item on

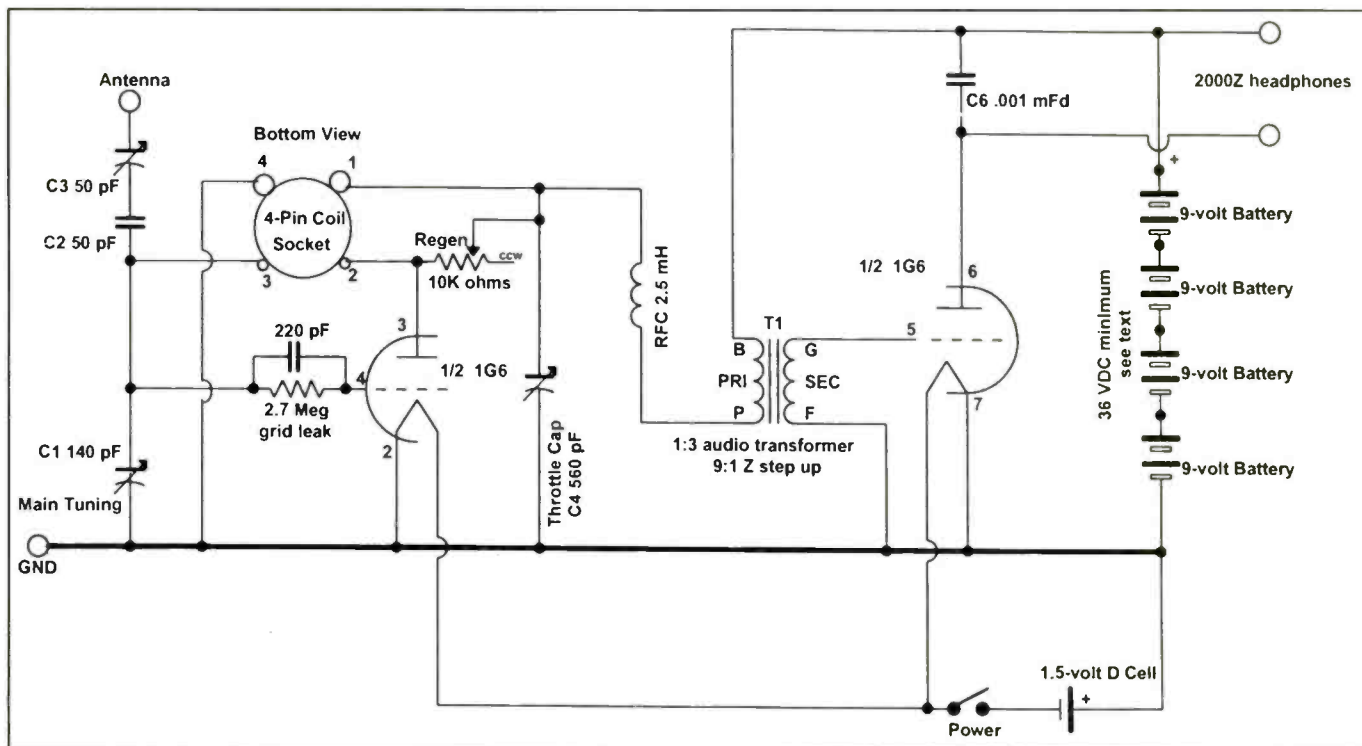

Figure 1. This is the schematic for Bob Ryan's Dumpster Diver Special receiver.

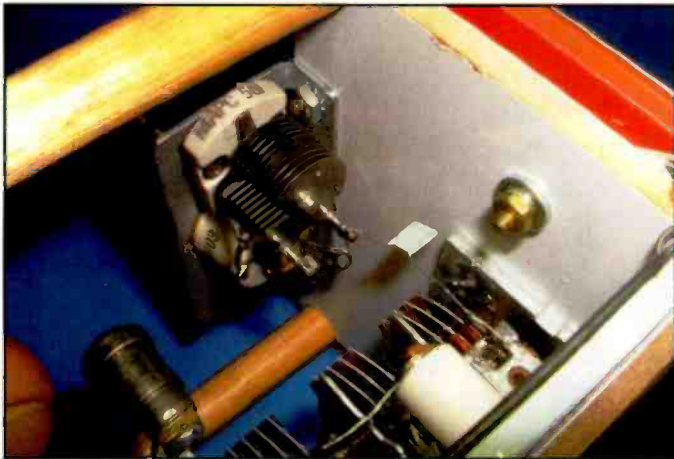

Photo E. The antenna is coupled to the high end of the tuned antenna coil using a 50-pF air variable and a fixed 25-pF ceramic capacitor wired in series. The variable is adjusted for the strongest signal possible, but not to the point where regeneration ceases.



Photo F. Here's the under chassis wiring. I used vintage cloth insulated wire salvaged from old TV service test cables. I'm sure Bob will approve! Bob included a pilot lamp on prototype. This isn't mentioned in the text since I felt it shortened the D cell life.

the inner reduced speed shaft. (The tuning shaft is concentric to the inner slower speed shaft.) The needle for the dial indicator was removed from the arm of a cheap dime store protractor; this part is fitted to one of the setscrew mounting holes on the salvaged collar. The dial scale is a dime store plastic protractor!

Antenna Coupling

Bob's set originally included two 50-pF ceramic air trimmers. As shown in **Photo E**, one was removed, and the remain-

RSGB Books from CQ

View more RSGB Books on page 48 of this issue!



Practical Receivers for Beginners

By John Case, GW4HWR
RSGB, 1996 Ed., 165 pages
Selection of easy-to-build receiver designs suitable for amateur bands (including microwaves) and simple fun projects and test equipment.

Order: RSPRN **\$26.50**



Technical Topics Scrapbook 1985-1989

by Pat Hawker, G3VA
RSGB, 1st Ed., 1993, 346 pages
A collection of popular 'Technical Topics' articles by Pat Hawker published in RadCom magazine during the years 1985 through 1989. A wealth of information, ideas, modifications and tips for the radio amateur.

Order: RSVUDXB **\$18.00**



VHF/UHF Antennas

By Ian Poole, G3YWX

RSGB, 2002 Ed, 128 pages
Investigates the exciting area of VHF and UHF antennas. VHF and UHF bands provide an exciting opportunity for those wishing to experiment, while the antenna sizes at these frequencies do not occupy great amounts of space.

Order No. RSVUANT **\$25.00**



Digital Modes for All Occasion

By Murray Greenman, ZL1PBPU
RSGB, 2002 Ed., 208 pages.
Simply the most "complete" book on Digital Modes available. Over 100 Illustrations!

Order: RSDMFAC **\$28.50**



Backyard Antennas

RSGB, 1st Ed., 2000, 208 pgs.
Whether you have a house, bungalow or apartment, Backyard Antennas will help you find the solution to radiating a good signal on your favorite band.

Order: RSBYA **\$33.00**



Antenna Topics

by Pat Hawker, G3VA
RSGB, 2002 Ed. 384 pages.
A chronological collection of selections of G3VA's words over the years. Hundreds of areas and subjects are covered.

Order No. RSAT **\$33.00**

Shipping and Handling: US and Possessions \$5.00 for first book, \$2.50 for the second, and \$1 for each additional book. **FREE SHIPPING ON ORDERS OVER \$75.00** (merchandise only). Foreign - Shipping will be calculated by order weight and destination and will be added to your credit card charge.

CQ Communications Inc.

25 Newbridge Rd., Hicksville, NY 11801

Order Toll-Free 800-853-9797 ♦ Fax 516-681-2926 ♦ www.cq-amateur-radio.com

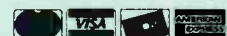

ing trimmer was wired for C3 per the schematic (this variable capacitor is used to set the desired antenna coupling). Shorter antennas, or going higher in frequency, as a rule require less coupling capacity.

Since 50 pF is a bit more capacity than is usually needed, I added a 50-pF ceramic in series with it. Removing a few rotor stator plates would do the same thing, but why irreversibly ruin an otherwise good part? Too much coupling may keep the set from being able to go into regeneration. The grid leak is comprised of a 220-pF silver mica capacitor and a 2.7-megohm resistor in parallel. A bottom view of the wired chassis can be seen in **Photo F**.

Regeneration Control

Photo F gives a good view of the under chassis construction and components. The traditional variable potentiometer approach was used for setting the regeneration point via a front panel control. But, here's where I tried something different. I included the traditional 2.5-mH RFC in this design, although many builders feel that it isn't needed. The RFC keeps RF off the audio interstage transformer, and it also forces the RF return path through bypass capacitor C4.

Capacitor C4 is a 560-pF compression mica. This is used as a throttle capacitor, and adjusting its value sets the regeneration point. But note this is an under chassis adjustment; it's mounted on the ceramic four-pin coil socket as shown in **Photos F** and **G**. The front panel regeneration control is done via the 10K-ohm regeneration control potentiometer. Capacitor C4 is used to compensate for variations between different plug-in coils for differ-

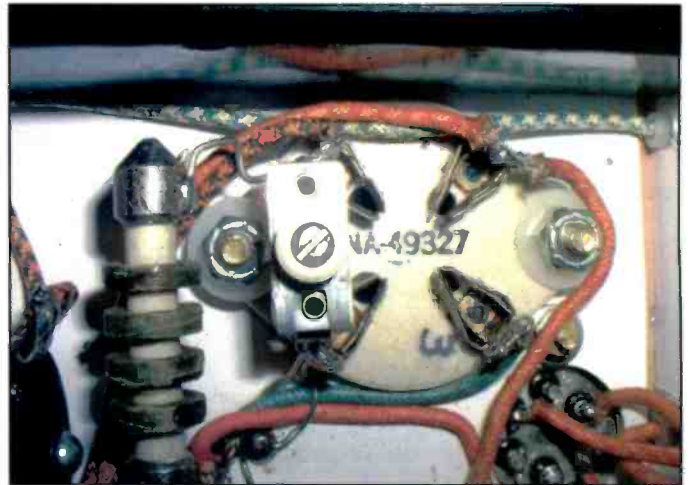

Photo G. Here's a close-up of the compression mica throttle capacitor. It was soldered directly between pins four and one of the four-pin ceramic coil socket. The "stator," or outside plates, of the compression is the side that goes to ground. This keeps the adjustment screw at ground potential and prevents interaction with a metallic tuning tool.

ent bands of different designs. Capacitor C4 is adjusted to give the 10K-ohm potentiometer smooth regeneration authority.

Note that the coil pin out follows the coil layout suggested by Alfred Morgan, and many of the commercially made four-pin coils dating from the 1930s and 1940s also follow this convention, with some exceptions! I've tried many homemade and commercial coils in this receiver with usually good results. But

2 CQ calendar 2

15 months of value January 2008 through March 2009

This year's calendar brings you 15 spectacular color images of some of the biggest, most photogenic shacks, antennas, scenics and personalities from across the country!

Calendar includes dates of important Ham Radio events such as major contests and other operating events, meteor showers, phases of the moon, and other astronomical information, plus important and popular holidays. The CQ Ham Radio Operators calendar is not only great to look at, it's truly useful, too!

Still Only
\$10.95 ea.
\$2 s/h



CQ Communications, Inc.

25 Newbridge Road, Hicksville, NY 11801

Call 1-800-853-9797 or FAX 516-681-2926 • www.cq-amateur-radio.com



Figure 2. The plug-in coils are wound on 1.25-inch four-pin coil forms. Separate coils are needed for segments of the AM BCB and various short-wave bands of interest.

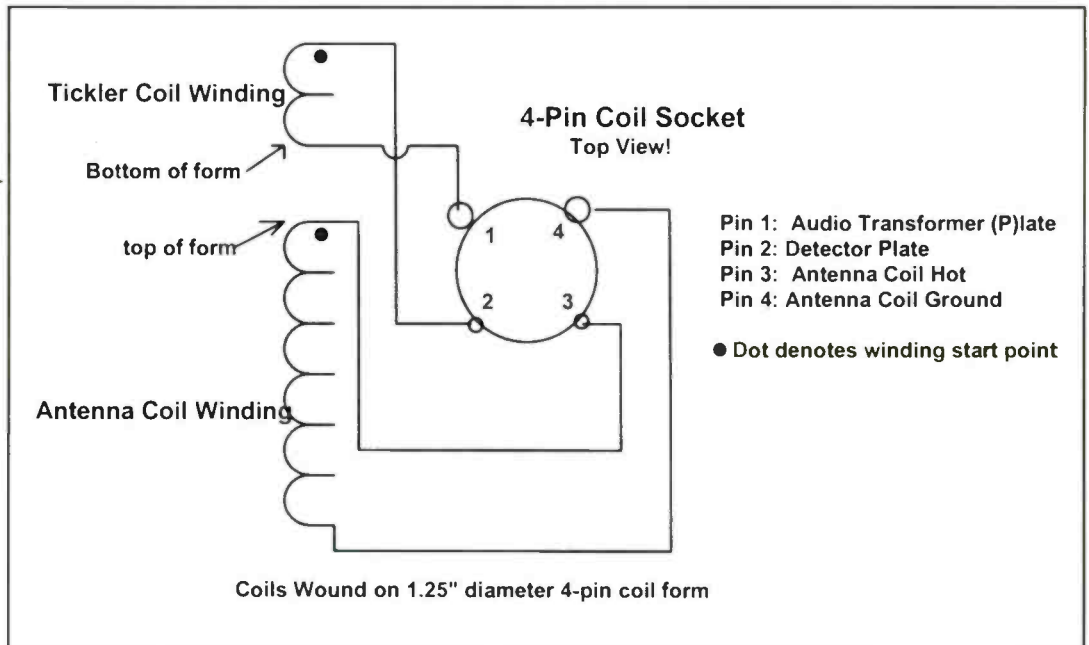

it's difficult to have a coil design that will universally work on all possible receiver layouts! Expect to find that the number of turns on the tickler coil, and its distance from the antenna coil winding, may need careful adjustment to achieve the best sensitivity and reliable regeneration. If you wish, the compression mica can be replaced with a fixed 500-pF to .001- μ Fd mica capacitor.

Plug-In Coil Sets

The coils described for our earlier Alfred Morgan receiver projects will serve here as well. The BCB coils I've experimented with have used between 200 to 75 turns of #24 AWG enamel wire on the antenna coil winding, and 20 to 10 turns on the tickler coil winding. The shortwave coil antenna windings have been between 25 and six turns on the antenna winding, with a single gauge spacing between adjacent windings to reduce proximity effect, and eight to six turns on the tickler. The layout for the coil windings is outlined in **Figure 2**. A few sample coils, made by Bob Ryan, are shown in **Photo H**.

I mentioned earlier that low B+ voltages (under 45 volts) might stop regeneration and low audio. Here's a solution. Instead of wiring the A+ filament supply with the positive going to the filament and negative to ground, reverse the cell so the polarity follows that shown in the schematic in **Figure 1**. This gives the grid a slightly positive bias, and shifts the tube's operating region closer to Class A than Class B. Actually, the tube is probably even closer to Class C than Class B with low plate potentials! If possible, increase the battery voltage as suggested earlier.

Audio Interstage Transformer

The Doerle uses transformer coupling between the regenerative detector and the single audio amplifier stage. The transformer should have a turn ratio of about 1:2 or 1:3. These ratios will give us a voltage gain of 2 or 3, and provide much greater audio amplification than simple RC coupling would provide.

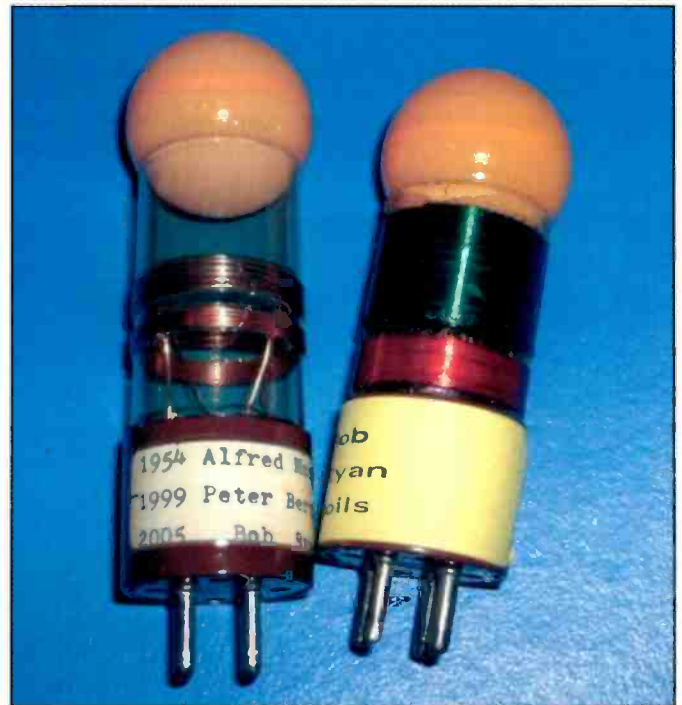

Photo H. Bob's eye for detail and craftsmanship is well illustrated in these two fine examples of his homemade four-pin plug-in coils.

Note that the impedance transformation is the square of the winding ratio. That is, a 1:2 turns ratio yields a 1:4 impedance (Z) transformation. While audio transformers with higher than 1:3 turn ratios were made, a 1:2 step up is entirely adequate here.

While new audio interstage transformers are available², they are a bit pricey, and I wanted to keep with Bob's recycling philosophy! Bob had included a small surplus audio transformer (**Photo I**), which I suspect might be another Fair Radio surplus item. The transformer has a 20,000-ohm center-tapped primary and a center-tapped 600-ohm secondary

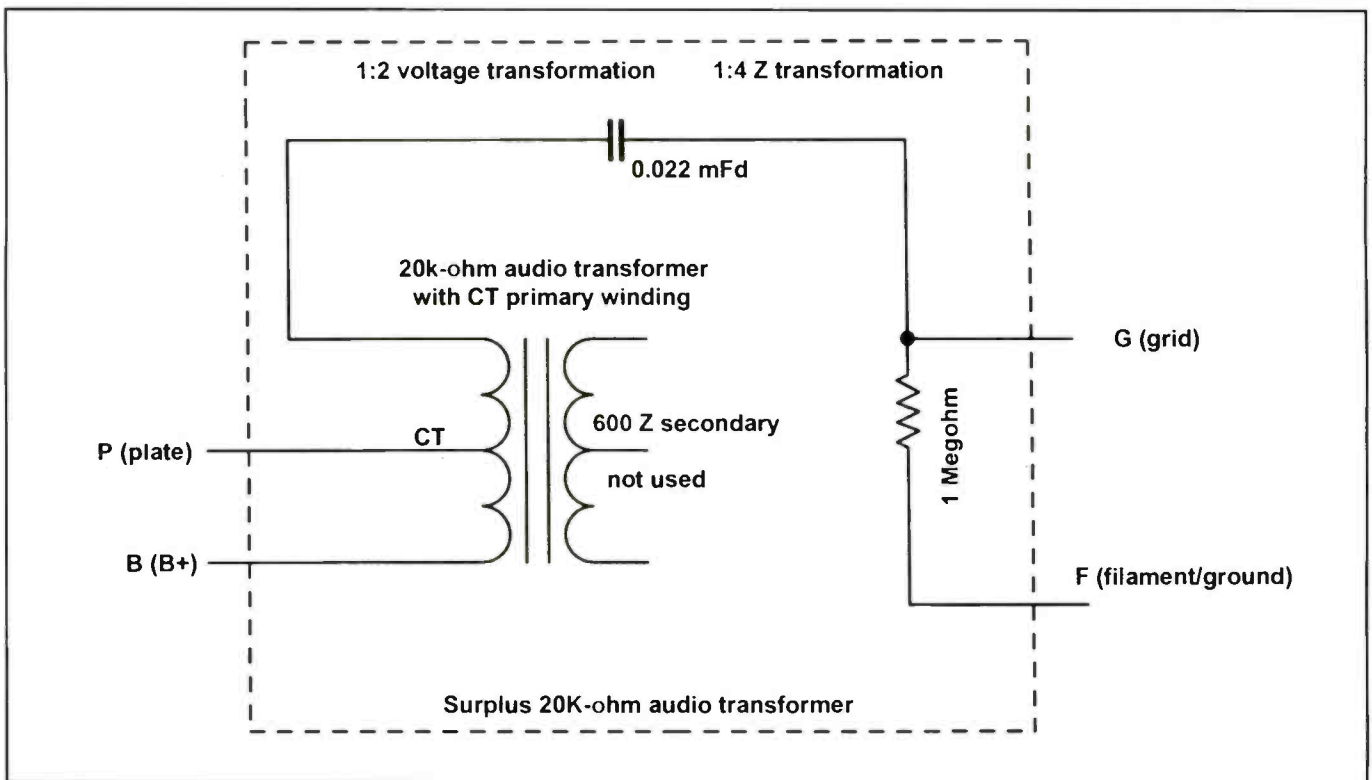

Figure 3. Here's how to adapt a center-tapped transformer winding for use as an audio 1:2 interstage. Small power transformers with dual voltage 110/220-VAC primary windings might do well in this application!



Photo 1. The Doerle Twinplex used a vintage audio interstage between the detector and audio stages to provide voltage gain. Bob's chassis provided a 20,000-ohm center-tapped audio transformer. I was able to wire up the CT primary autotransformer in similar fashion to provide the same gain for the recovered detector audio.

winding. On a hunch, I wired the transformer as shown in **Figure 3**. The primary is used as an autotransformer and gives a 1:2 voltage step-up between the detector and audio stage. Eliminating the secondary winding requires the addition of two components: the .022- μ Fd coupling capacitor and 1-megohm grid bias resistor.

If you're up to experimenting, it might be interesting to try something similar using small power transformers. For example, I've seen small PC board-mount power transformers with dual 110/220-VAC primaries being sold by surplus vendors for a few dollars each. These dual-voltage primaries might work quite well as audio autotransformers, with some limited frequency response.

One other quick note here: Since Bob included a quarter-inch phone jack on the rear apron, I wired the 600-ohm secondary to the jack so the set could be used as a one-tube regenerative receiver with lower impedance headphones. Disconnecting the 2000-ohm headphones from the pin jacks removes the B+ from the audio amplifier plate and turns off that stage.

And To You And Yours...

I'd like to take this opportunity to wish my readers a joyous Holiday Season, and to thank you for the kind and helpful feedback received over the years.

Until next time, keep those soldering irons hot and those old tubes glowing!

A final note, if anyone builds a copy of this project, we'd love feedback and photos! 73!

References

1. Many of these surplus components are available from Fair Radio Sales, 2395 St. Johns Rd., Lima, OH 45804; Phone: 419-223-2196; Fax: 419-227-1313; Web: www.fairradio.com.
2. Radio Daze, LLC, 7620 Omnitech Place, Victor, New York 14564; Phone: 585-742-2020; Toll-free order line: 877-653-8823; Fax: 800-456-6494; Web: www.radiodaze.com.

SIX WAYS TO TAKE CONTROL!



PSR-500

- **PSR-500** Digital Trunking Handheld Scanner
- **PSR-600** Digital Trunking Desktop/Mobile Scanner

- Intuitive "Object Oriented" User Interface Design
- Powerful and Flexible Scan List Functionality
- Menu Driven Programming with Context Sensitive Help
- Upgradeable CPU and DSP Firmware
- Flexible Free-Form Memory Organization
- GRE's Exclusive V-Scanner Technology
- Multi-System Trunking
- P25 NAC Functionality
- Remote Control Capability
- Exclusive ALERT LED
- Audible alarms
- GRE's Exclusive Automatic Adaptive Digital Tracking
- GRE's Exclusive Digital AGC
- In-Dash mountable *PSR-600 only
- Plus, most of PSR-300/400 features!

- **PSR-300** Triple Trunking Handheld Scanner

- **PSR-400** Triple Trunking Desktop/Mobile Scanner

- Motorola Analog, EDACS, LTR
- 1,000 CH / 1,500 TGID
- CTCSS / DCS
- 20dB attenuator
- SAME (FIPS) / Weather alert
- Skywarn
- Spectrum Sweeper
- Signal strength meter
- Alpha-Tag LCD display
- Backlit keys and LCD display
- Upgradeable CPU firmware
- In-Dash mountable *PSR-400 only
- PC Programmable, and MORE!



PSR-400

PSR-200



- **PSR-100** Handheld Scanner
- **PSR-200** Desktop Scanner

- 200 CH
- SAME (FIPS) / Weather alert
- 5 One touch Service Searches
- Skywarn
- Spectrum Sweeper *PSR-100 only
- Backlit LCD Display
- PC Programmable, and MORE!



>> Please visit www.greamerica.com for more detailed information

© 2007 GRE America, Inc., 425 Harbor Blvd., Belmont, CA 94002

tel: (650) 591-1400 fax: (650) 591-2001 email: scanner-sales@greamerica.com web: www.greamerica.com

All specifications are subject to change without notice or obligation.



World News, Commentary, Music, Sports, And Drama At Your Fingertips

This listing is designed to help you hear more shortwave broadcasting stations. The list includes a variety of stations, including international broadcasters beaming programs to North America, others to other parts of the world, as well as local and regional shortwave stations. Many of the transmissions listed here are not in English. Your ability to receive these stations will depend on time of day, time of year, your geographic location, highly variable propagation conditions, and the receiving equipment used.

AA, FF, SS, GG, etc. are abbreviations for languages (Arabic, French, Spanish, German). Times given are in UTC, which is five hours ahead of EST, i.e. 0000 UTC equals 7 p.m. EST, 6 p.m. CST, 4 p.m. PST.

UTC	Freq.	Station/Country	Notes	UTC	Freq.	Station/Country	Notes
0000	9420	Voice of Greece	Greek	0230	11955	BBC Oman Relay	
0000	9570	China Radio International, via Albania		0230	4790	Radio Vision, Peru	SS
0000	9460	Radio Cairo, Egypt		0230	7279	Radio Cairo, Egypt	
0000	9775	Radio Romania International		0230	11710	Radio Argentina al Exterior	SS
0000	9665	Voice of Russia, via Moldova	SS	0230	4885	Radio Clube do Para, Brazil	PP
0000	11690	Radio Vilnius, Lithuania		0300	7250	Russian Radio Intl., via Armenia	RR
0000	6055	Radio Exterior de Espana, Spain		0300	4810	Radio Transcontinental, Mexico	SS
0000	9845	Radio Nederland Bonaire Relay		0300	4780	Radio Djibouti	FF/AA
0000	15385	Voice of America Philippines Relay	CC	0300	7210	Radio Fana, Ethiopia	Amharic
0000	9265	WMLK, Pennsylvania		0300	9870	Radio Prague, Czech Republic	
0030	15405	HCJB, Ecuador	unid	0300	4825	Radio Cancao Nova, Brazil	PP
0030	4780	Radio Cultural Coatan, Guatemala	SS	0300	9970	RTBF, Belgium	
0030	5025	Radio Rebelde, Cuba	SS	0300	11855	BBC Relay, Oman	Farsi
0030	6145	Radio Japan/NHK, via Canada		0300	11910	Voice of the Islamic Republic of Iran	Dari
0030	4426.5	Radio Bambamarca, Peru	SS	0300	5985	Sudan Radio Service, US, via Rwanda	
0100	4826	Radio Sicuani, Peru	Quechua	0300	5010	RTV Malagasy, Madagascar	Malagasy
0100	6135	Radio Cairo, Egypt	SS	0300	9805	Radio Farda, USA	Farsi
0100	4052.5	Radio Verdad, Guatemala	SS	0300	4965	The Voice-Africa, Zambia	
0100	11780	Radio Nacional Amazonia, Brazil	PP	0300	9860	Voice of Russia, via Vatican	
0100	3250	Radio Luz y Vida, Honduras	SS	0330	7110	Radio Ethiopia	Amharic
0100	9599	Radio UNAM, Mexico	SS	0330	4965	Radio Santa Monica, Peru	SS
0100	11905	Sri Lanka Broadcasting Corp.		0330	9780	Republic of Yemen Radio	AA
0100	12085	Trans World Radio, India, via Russia	Nepali	0330	7180	Voice of the Broad Masses, Eritrea	unid
0100	5995	Radio France International	SS	0330	6009	La Voz de su Concencia, Colombia	SS
0130	5930	Radio Slovakia International		0330	3340	HRMI/Radio Misiones, Honduras	SS
0130	4690	Radio San Miguel, Bolivia	SS	0330	11675	Radio Kuwait	AA
0130	4800	Radio Buenas Nuevas, Guatemala	SS	0330	9435	Voice of Russia	
0130	6255	The Mighty KBC, Netherlands, via Lithuania	Saturdays	0330	3240	Trans World Radio, Swaziland	vern.
0130	9770	Voice of Turkey	SS	0330	3396	Radio Zimbabwe	EE/vern
0200	7335	CHU, Canada	FF/EE	0330	5014	Radio Altura, Peru	ss
0200	9685	Channel Africa, South Africa		0400	5975	Voice of Turkey	
0200	9905	Voice of the Islmic Republic of Iran	SS	0400	4909	Radio Chaskis, Ecuador	SS
0200	6035	La Voz del Guaviare, Colombia	SS	0400	4775	Trans World Radio, Swaziland	GG
0200	9925	Voice of Croatia, via Germany		0400	9765	Radio V. of the People, Zimbabwe, via Madagascar	EE/vern
0200	4755	Radio Educacao Rural, Brazil	PP	0430	7275	RT Tunisienne, Tunisia	AA
0200	4815	Radio Buen Pastor, Ecuador	SDS	0430	6155	Radio Austria International	GG
0200	3320	Radio Sondergrense, Souh Africa	Afrikaans	0430	7235	Radio Atalia, Italy	
0200	12110	Radio Liberty, USA	unid	0430	4770	Radio Nigeria	
0200	5890	Radio Thailand, via USA		0430	6175	Voice of Vietnam, via Canada	

UTC	Freq.	Station/Country	Notes	UTC	Freq.	Station/Country	Notes
0430	4976	Radio Uganda		1400	17770	Channel Africa, South Africa	
0430	9515	Voice of Russia, via Germany		1500	12005	Radio Free Asia, via No. Marianas	Mandarin
0500	9575	Radio Medi Un, Morocco	AA	1500	15245	Voice of Korea, North Korea	
0500	9615	Radio New Zealand		1530	12005	Voice of America Relay, Sri Lanka	unid
0500	7255	Voice of Nigeria		1530	17605	Radio France International	
0500	4777	Radio Gabon	FF	1600	13590	Bible Voice Broadcasting, England, via Germany	
0530	5005	Radio Nacional, Equatorial Guinea	SS	1600	15205	BSKSA, Saudi Arabia	AA
0530	4835	RTV Maliene, Mali	FF	1600	11570	Radio Pakistan	
0600	9525	Cotton Tree News, Sierra Leone, via England		1600	17735	Radio Rebelde, Cuba	SS
0730	10320	AFN/AFRTS, via Hawaii	usb	1700	15580	Voice of America Relay, Botswana	
0800	6030	Radio Marti, USA	SS	1700	12050	Radio Cairo, Egypt	AA
0800	13362	AFN/AFRTS, via Guam		1730	11620	All India Radio	
0800	15725	KHBN, Palau	unid	1730	11735	Radio Romania International	
0830	11955	CVC International, Australia		1730	15475	Africa Number One, Gabon	FF
0900	6150	Media Corp. Radio, Singapore		1800	15235	Radio Canada International	
0900	5755	KAIJ, Texas		1800	17850	Radio Exterior de Espana Relay, Costa Rica	SS
0900	7355	KNLS, Alaska	RR	1800	13640	Radio Sultanate of Oman	AA
0930	5035	Radio Aparecida, Brazil	PP	1800	15495	Radio Kuwait	AA
0930	5995	Radio Australia		1800	11775	Caribbean Beacon, Anguilla	Gene Scott
1000	6095	Radio New Zealand		1830	11795	Deutsche Welle, Germany, via Portugal	
1000	5446	AFN/AFRTS, Key West	usb	1900	15730	Voice of America Relay, Sao Tome	
1000	3976	Radio Republik Indonesia, Pontianak (Borneo)	II	1900	15385	KJES, New Mexico	
1030	3925	Radio Nikkei, Japan	JJ	1900	9855	Radio Kuwait	AA
1030	3280	La Voz del Napo, Ecuador	SS	1930	11590	Kol Israel	
1100	11550	Radio Taiwan International	unid	1930	11915	BSKSA, Saudi Arabia	AA
1100	7210	Voice of Vietnam	VV	1930	15120	Voice of Nigeria	various
1100	7185	Bangladesh Betar		1930	11810	RT Algerienne, via England	AA
1130	9525	Voice of Indonesia		1930	9580	Africa Number One, Gabon	FF
1130	2485	ABC Northern Territory Service		1930	11680	BBC	
1130	4605	Radio Republik Indonesia, Serui (Papua)	II	2000	11865	Deutsche Welle, Germany, Rwanda Relay	
1200	7280	Voice of the Strait, Fuzhou, China	Mandarin	2000	13720	Radio Tirana, Albania	
1200	6045	Radio Universidad, Mexico	SS/irregular	2000	15315	Radio Nederland, Bonaire Relay	
1200	15295	Voice of Malaysia		2000	11710	Voice of Korea, North Korea	
1200	7235	Radio Singapore International		2000	11625	Vatican Radio	
1200	6250	Peoples Broadcasting Station, N. Korea	KK	2000	15260	Adventist World Radio, via Germany	FF
1200	3315	Radio Manus, Papua New Guinea	EE/Pidgin	2000	12085	Radio Damascus, Syria	various
1200	11605	Radio Free Asia, via Taiwan	various	2000	15320	Voz Cristiana, Chile	SS
1200	9740	BBC		2030	11695	Radio Budapest, Hungary	HH
1230	9600	Radio Rebelde, Cuba	SS	2030	9830	Radio Jordan	AA
1230	9580	Radio Australia		2030	11735	Radio Tanzania, Zanzibar	AA
1300	9820	All India Radio (Goa)		2030	15315	Radio Canada Intl, via England	RR
1300	9670	KBS World Radio, South Korea		2100	17680	Voz Cristiana, Chile	SS
1300	2850	Central Peoples Broadcasting Station, N. Korea	KK	2100	9415	Radio Prague, Czech Republic	
1300	11845	Radio Marti, USA	SS	2100	21455	HCJB, Ecuador	SS
1300	15450	Voice of Turkey		2100	17630	Radio France Intl, via French Guiana	SS
1300	9920	KFBS, Saipan	VV	2100	5470	Radio Veritas, Liberia	
1300	12105	Adventist World Radio, Guam		2100	9710	RT Algerienne, Algeria, via England	AA
1300	15240	Radio Sweden		2130	11975	China Radio International, via Mali	FF
1330	13740	China Radio International, via Cuba					
1400	17870	Radio Jamahiriya/Voice of Africa, Libya					
1400	15560	RDP International, Portugal	PP				

Affordable Holiday Gift Ideas



Great Goodies To Give (Or Get!) That Won't Empty Your Wallet

by Gordon West, WB6NOA

“Hey Gordo, have you personally played with the radio accessory from...?” is a common and welcome phone call I get about once a day. Like you, I am an avid radio guy, constantly ordering new gizmos to play with in the classroom and to get me through all my radio days here on the West Coast.

Here's what's hot on my list for this gift season.

Wet Battery Replacement

I just returned from T32 Christmas Island after volunteering for three weeks of radio communications setup for clinics and the one doctor/hospital on this remote island. After a rough water landing on a nearby island, some submersible marine HTs survived seawater encounters, but I couldn't remove the lithium ion battery pack in time to prevent meltdown. (Only the radio is advertised as submersible—not the battery chamber or the battery!)

The manufacturer of a marine VHF radio wanted over \$100 for a replacement battery pack. When I went to Batteries America, the 7.4-volt, 1600-mAh battery pack was less than half the price, at \$42.95, and they offer second-day delivery, too. If you have a scanner or a ham, marine, or GMRS handheld and are in the market for a replacement battery pack, check out www.batteriesamerica.com to see their complete line of batteries, chargers, and accessories. They can even repower your electric razor, cordless phone, and power tools, too, at well below half cost of an original, brand name manufacturer battery.

When I phoned, a friendly operator took my call, double checked that the battery I ordered was indeed a proper fit for the specific manufacturer radio, and got my new rechargeables all the way across the country in just two days! Batteries America is a division of Yost, also known as “Mr. NiCad,” and a toll free order number of 1-800-308-4805. Their replacement batteries run \$49 and up.

Mod Mania

I have a new ICOM IC-7000 HF/VHF/UHF ham transceiver, and the color LCD display can also do television... well, until everything goes digital. The equipment manufacturer, knowing hams will be hams, disabled the feature so you're not rolling down the expressway watching the latest ballgame from behind

Gordon West, WB6NOA, is *Pop'Comm's* “Radio Resources” columnist and an expert on cool gadgets.



When I needed it... This replacement lithium ion battery from Batteries America was half the regular store price and it came in two days!

the wheel. A couple of whacked diodes and you're ready to roll (safely), right? Now I realize my eyesight is not as good as when I was eight years old, but I think sub-miniature technology really is getting smaller, so I need to know exactly which diodes to eliminate and their precise location on the board. Enter mods.dk (www.mods.dk), an online directory of thousands of radio, shortwave, and scanner products.

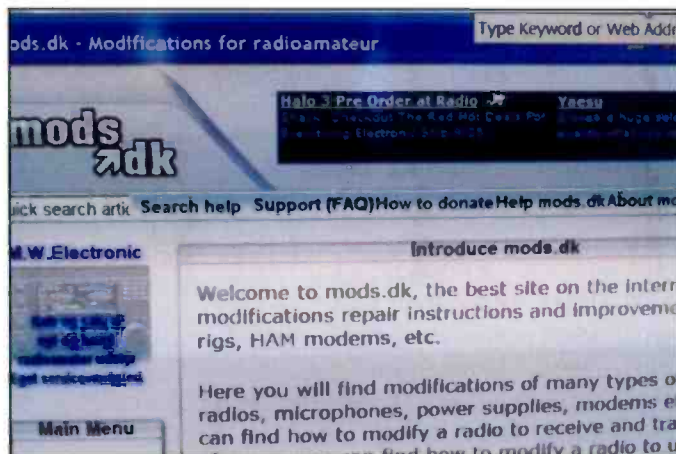

Got a modification to do? *Mods.dk* will give you one free mod a day. But I suggest you send them the requested \$20 VIP donation and support the site.



PulseTech's XC100-P Xtreme Charge five-stage, 2.5-amp charger works great (but it's noisy on HF!).

You can start out by enjoying one free modification download a day. You'll like the color screens and expanded views of these tiny components. But I suggest you help support mods.dk with your own unique modification or improved board photos of an existing mod, or a simple \$20 bill donation. You'll upgrade to VIP status and become a mods.dk regular with enhanced mod lookup benefits.

If you're looking to improve the performance of a specific radio or scanner, toss in your 20 bucks and get an unlimited gander at some straightforward rig updates.

Pulse Boost

Emergency radio responders rely on portable gelled batteries for you-never-know-when emergencies. The sealed gelled battery won't spill or boil over, minimizing the risk of battery acid accidents. Gelled batteries are enhanced with pulse-type charging. Short pulses of charging increase the life cycles of 12-volt batteries by minimizing the size of lead sulphite crystals on the plate. This "smart" charger will first bulk the battery up to 14.8 volts, then drop back to an absorption and saturation charge, and then let the voltage drop down to 13.8 volts for float maintenance.

The XC100-P Xtreme Charge five-stage, 2.5-amp charger from PulseTech (www.pulsetech.com) revives several of my sluggish 12-volt batteries and keeps

some relatively new gel cells in tip-top condition. Color LEDs indicate how the battery is accepting the short pulse charges (about 22 to 28 per second). Keep the charger well away from any short-wave or high-frequency receiving antennas. It emits a little RFI, so you may need to pull the plug during portable HF operation. The XC100-P sells for around \$99.

WiFi HiFi And SW, Too

My home computer is dedicated to business emails and browsing the Internet. It likely plays Internet music, but I chose to leave that job up to a separate Internet music receiver. When talking to my ham friends at C. Crane in Fortuna, California (www.ccrane.com), they told me I *had* to listen to the thousands of audio channels from around the world on a Tangent Quattro Internet radio that, at \$349, has been selling like hotcakes to long-range radio enthusiasts.

The C. Crane Tangent Quattro works off your home or office WiFi hotspot. Just add the power adaptor (110 VAC-to-12 VDC), turn it on, and it will scan for your home or office wireless network. Press Select and enter your encryption code if your system is protected. In a few seconds, you'll be connected and ready to scan the thousands of stations in the station preset menu. You can scan by country, station content, or call letters.

While not all stations were on the air, I found literally hundreds of stations,

INFORMATION & ORDERING
WWW.SCANCAT.COM

INTERNET DOWNLOADS AVAILABLE
ORDER TOLL FREE
888-722-6228
Holiday Special

ScanCat-Lite-Plus.....	Reg. \$29.95
Mr. Scanner FCC Public Safety.....	29.95
Nat-Com's FCC Scancat Files.....	9.95
Bonus Disk Of Frequencies.....	15.00
	\$84.85

NOW \$49.95
PLUS FREE Scanning Magazine(s)
(Current Issues While Supplies Last)

SCANCAT®
Since 1989, The Recognized
Leader in Computer Control

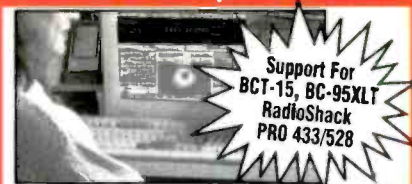

Once you use SCANCAT with YOUR radio, you'll NEVER use your radio again WITHOUT SCANCAT!

ScanCat-Lite-PLUS
Reg. \$39.95 - Limited Time Special \$29.95

Program Your Scanner
As Easy As 1-2-3-CLICK!
SC-Lite Supports PRO-83, PRO-95, PRO-96, BC246 & over 15 more Trunking Scanners

Scancat-Gold for Windows
Version 8.50 \$99.95

Supports all radios in ONE program - share files with all radios.
Two Scanning modules:
A Simple Basic Module - for beginners
Plus—An Advanced Scanning System for the "experts".

Scancat-Gold for Windows-SE
\$159.95

All the features of our "Standard Scancat" plus additional functions.

- Long term logging of frequencies to hard drive.
- Record Audio to hard drive using sound card.
- Improved spectrum analysis with several great graphical analysis screens.

Skysweep Decoder Software

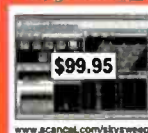

Advanced Digital Signal Processing Software For HF/VHF Applications

All you need is any Windows® soundcard
demo on our website

JUST OUT NEW VERSION

COMPUTER AIDED TECHNOLOGIES

P.O. Box 18285 Shreveport, LA 71138
ORDERS: (318) 687-4444 FAX: (318) 686-0449
Info/Tech Support: (318) 687-2555
(9 a.m. - 3 p.m. Central M-F)

INTERNET DOWNLOADS AVAILABLE
INFORMATION & ORDERING
WWW.SCANCAT.COM



The C. Crane Tangent Quattro Internet radio tuned to our local WiFi hotspot.



The new CCRadio-SW, also from C. Crane, is a great performer on both longwave broadcast and shortwave AM.

offering a huge variety of music and talk, from many different countries as well as the United States.

The Tangent also has rich audio and plenty of bass, plus an earphone jack that mutes the external speaker. When changing stations and selections, there's about a 15-second pause for the radio to "digest" the new streaming audio. The neat blue screen tells you what's happening. Your favorite stations can be stored in a preset.

This same radio can also allow access to your audio files via Windows Shares. There's an auxiliary input jack for connecting an external sound source, like an MP3 player, CD, or other.

Will this type of reception ever replace traditional shortwave listening?

Jessica Gillette, one of the marketing team members at C. Crane says absolutely "No!" In fact, the company also introduced me to its new high-performance CCRadio-SW (\$149), an AM, stereo FM, and AM double sideband shortwave radio. The shortwave reception was extremely "hot" right off the whip antenna. Shortwave listening features like RF gain control, bandwidth control, fast and slow tuning, with 50 memories put it in the "big boys" class, right along with my trusty CCRadioPlus, which does TV and VHF weather, but not shortwave like the new CCRadio-SW.

With twin Ferrite antenna coils for AM radio reception, I was picking up skywave stations with ease, setting the

side-mounted local/DX switch to the preferred DX position for maximum reception. If you get one of the brand new units, double check that your switch is set on DX!

The radio will run on AA batteries, rechargeable or alkaline, or D cells, or off the AC adaptor. When you hook up to AC, it will check to see if you have AA rechargeable batteries installed, and, if you do, they get a recharge, too. This saves you the hassle of removing and recharging the AAs in a separate charger. Smart radio! Check it out!

Shortwave And Scanners Here

When I was playing with the Internet radio, I wanted the opinion of legendary shortwave expert Fred Osterman, of Universal Radio (www.Universal-Radio.com). I knew he could fill me in on shortwave radio versus Internet radio. Fred carries a complete line of both technologies and assures me both reception systems will live in harmony for many years to come. He points out that Universal Radio customers are avid over-the-air enthusiasts and get just as much thrill out of *how* the signals come in as they do from the actual content. Fred's trained staff is composed of shortwave listeners and scanner buffs, and they'll take the time with every customer to explain all the exciting developments surrounding the high-frequency airwaves, including the unique experience of decoding streaming audio coming from the Internet on five different models of Internet radio they offer at Universal Radio.

The Universal Radio team travels to numerous ham radio and shortwave radio conventions to spread the word about the excitement of "wireless reception," whether it comes in at 12 MHz or 2.4 GHz. I even watched them at a recent ham radio show preprogram a scanner just to make sure the new listener/customer would get reception as soon as they hit home. Now that's taking care of their customers!

Gordo Tested, Gordo Approved

This brief review of items for your Holiday Gift List is based on equipment I have personally tuned and tested. I liked what I replaced, downloaded, charged, and heard! All these items come with my stamp of approval.

Holiday Gift Ideas from Pop' Comm



2008/09 calendar from CQ

15-Month Calendar - January 2008 through March 2009

This fifteen month calendar includes dates of important Ham Radio events such as major contests and other operating events, meteor showers, phases of the moon, and other astronomical information, plus important and popular holidays. This calendar is not only great to look at, it's truly useful, too!

CQ Amateur Radio Operators Calendar — brings you 15 spectacular images of some of the biggest, most photogenic shacks, antennas, scenics and personalities. These are the people you work, shacks you admire, the antenna systems you dream about!

Order No. HRCAL



cds Ham Radio Magazine on CD

Enjoy quick and easy access to every issue of this popular magazine, broken down by years!

**SPECIAL!
Save \$5
on each CD set**

ON SALE - only \$54.95 ea.

Three sets, each containing 4 CDs

1968-1976 Order No. HRC1 ~~\$59.95~~

1977-1983 Order No. HRC2 ~~\$59.95~~

1984-1990 Order No. HRC3 ~~\$59.95~~

Buy All 3 Sets and Save \$49.90!

Order No. HRC Set **\$129.95** (Reg. \$149.95)



Passport to World Band Radio

2008 Edition, scheduled for release in December. Order now for shipment immediately upon release. You will not be charged until we ship the book to you.

The world's #1 selling shortwave guide! The world at your fingertips! Gives details on what to buy and where to tune.



Order No. PASS **\$22.95**

Understanding, Building & Using Baluns & Ununs

by Jerry Sevick, W2FMI

The successor to the popular and authoritative Baluns and Ununs. Great deal of new tutorial material, and designs not in previous book, with crystal clear explanations of how and why they work.



Order No. 2BU **\$19.95**

Shipping & Handling: U.S. & Possessions - add \$5.00 for the first item, \$2.50 for second and \$1.00 for each additional item. FREE shipping on orders over \$75. Foreign-calculated by order weight and destination and added to your credit card charge. Magazine subscription prices include shipping and handling charges.

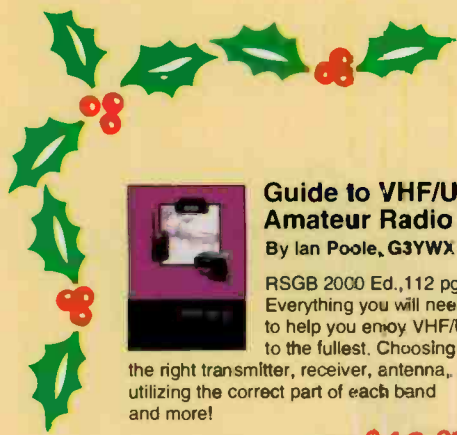

RSGB Books

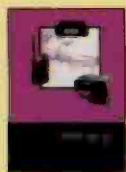

Guide to VHF/UHF Amateur Radio

By Ian Poole, G3YWX

RSGB 2000 Ed., 112 pgs. Everything you will need to help you enjoy VHF/UHF to the fullest. Choosing the right transmitter, receiver, antenna, utilizing the correct part of each band and more!

Order No. RSGVUAR

\$16.00



HF Antenna Collection

RSGB, 2nd Ed., 2002. 252 pages.

A collection of outstanding articles and short pieces which were published in *Radio Communication* magazine.

Includes single- and multi-element, horizontal and vertical antennas, extremely small transmitting and receiving antennas, feeders, tuners and much much more!

Order: RSHFAC **\$33.00**



IOTA Directory

Edited by Roger Balister, G3KMA
RSGB, 2007 Ed..

Fully updated, lists all islands that qualify for IOTA, grouped by continent, and indexed by prefix. Details the award rules and includes application forms.

Order: RSIOTA **\$16.00**

Low Power Scrapbook

RSGB, 2001 Ed., 320 pages.

Choose from dozens of simple transmitter and receiver projects for the HF bands and 6m, including the tiny Oneer transmitter and the White Rose Receiver. Ideal for the experimenter or someone who likes the fun of building and operating their own radio equipment.

Order: RSLPS **\$18.00**



Antenna Toolkit 2

By Joe Carr, K4IPV

RSGB & Newnes, 2002 Ed., 256 pgs. A definitive design guide for sending and receiving radio signals. Together with the powerful suite of CD software included with this book, the reader will have a complete solution for constructing or using an antenna; everything but the actual hardware!

Order: RSANTKIT2

\$48.00



Practical Projects

Edited by Dr. Brown, M5ACN
RSGB 2002 Ed., 224 pages.

Packed with around 50 "weekend projects," Practical Projects is a book of simple construction projects for the radio amateur and others interested in electronics. Features a wide variety of radio ideas plus other simple electronic designs and a handy "now that I've built it, what do I do with it?" section. Excellent for newcomers or anyone just looking for interesting projects to build.

Order: RSPPP **\$23.00**

The Antenna File

RSGB, 2001 Ed., 288 pages.

50 HF antennas, 14 VHF/UHF/SHF antennas, 3 receiving antennas, 6 articles on masts and supports, 9 articles on tuning and measuring, 4 on antenna construction, 5 on design and theory, and 9 Peter Hart antenna reviews. Every band from 73kHz to 2.3GHz!

Order: RSTAF **\$33.00**



The Antenna Experimenter's Guide

RSGB, 2nd Ed., 1996. 160 pages.

Takes the guesswork out of adjusting any home-made or commercial antenna, and makes sure that it is working with maximum efficiency.

Describes RF measuring equipment and its use, constructing your own antenna test range, computer modeling antennas. An invaluable companion for all those who wish to get the best results from antennas!

Order: RSTAEG **\$32.00**



HF Amateur Radio

RSGB, 2007 Second Ed.

HF or shortwave bands are one of the most interesting areas of amateur radio. This fully revised and expanded second edition guides you through setting up an efficient amateur radio station, equipment to choose, installation, the best antenna for your location and MUCH more.

Order: RSHFAR **\$23.00**

Radio & Electronics Cookbook

By George Brown, M5ACN
RSGB, 2001 Ed.



A collection of the very best weekend projects from D-I-Y RADIO magazine. Step-by-step instructions make this book ideal for hams wanting to build their skills and knowledge.

Order: RSREC **\$33.00**

Amateur Radio

Mobile Handbook

RSGB, 2002 Ed., 128 pages.

Covers all aspects of this popular part of the hobby. It includes operating techniques, installing equipment in a vehicle and antennas, as well as maritime and even bicycle mobile. This is essential reading if you want to get the most out of your mobile station.

Order: RSARMH **\$21.00**



The Low Frequency Experimenter's Hdbk

By Peter Dodd, G3LDO

RSGB, 2000 Ed., 296 pages.

An invaluable reference written to meet the needs of amateurs and experimenters interested in low power radio techniques below 200kHz.

Order: RSLFEH **\$33.00**



RSGB Prefix Guide

RSGB, 8th Ed., 2007. 80 pages.

Guide's prefix IDs and info has been fully updated. Provides a listing of prefixes and their entities, continent, CQ Zone, ITU Zone, latitude and longitude and much more.

Order: RSPFXG **\$15.00**



VHF/UHF Handbook

Edited by Dick Biddulph, M0CGN

RSGB, 2002 Ed., 317 pages. One of the most complete guides on the theory and practice of reception and transmission on VHF/UHF bands. Specialized modes such as data and TV are also covered. Includes hundreds of illustrations and photos.

Order: RXVUH **\$33.00**



Technical Topics Scrapbook

1995-1999

By Pat Hawker, G3VA

RSGB, 2000 Ed., 314 pages.

This third compilation of 'Tech Topic' articles is a fascinating collection of circuit ideas, antenna lore, component news and scientific discussion, all at the most practical level.

Order: RSTTC99 **\$26.50**



RF Components & Circuits

By Joe Carr, G3YWX

RSGB, 2002 Ed., 416 pages.

A complete self-study course in RF technology, with concise reference text to dip into in a readable and straightforward format.

Order: RSRFCC **\$45.00**

Shipping & Handling: U.S. & Possessions-add \$5 for the first item, \$2.50 for the second and \$1 for each additional item. FREE shipping on orders over \$75. Foreign-calculated by order weight and destination and added to your credit card charge. Magazine subscription prices include shipping and handling charges.

magazines at holiday sale prices!



CQ Amateur Radio

CQ's editorial content is aimed squarely at the active ham. Within each issue, CQ's features and columns cover the broad and varied landscape of the amateur radio hobby from contesting and DXing to satellites and the latest digital modes. CQ includes equipment reviews, projects, articles on the science as well as the art of radio communication and much, much more.

Domestic Rates: 1-year ~~\$36.95~~; 2 yrs ~~\$68.95~~; 3 yrs ~~\$96.95~~

Holiday Special! **\$34.95** **\$62.95** **\$90.95**

Canada/Mexico: 1-year ~~\$48.95~~; 2 yrs ~~\$92.95~~; 3 yrs ~~\$135.95~~

Holiday Special! **\$47.95** **\$88.95** **\$129.95**

Foreign: 1-year ~~\$61.95~~; 2 yrs ~~\$116.95~~; 3 yrs ~~\$171.95~~

Holiday Special! **\$59.95** **\$112.95** **\$165.95**



Popular Communications

The world's most authoritative monthly magazine for shortwave listening and scanner monitoring. Editorial content consists of features on scanner monitoring of police, fire, utility and aircraft communications; international shortwave listening; CB radio; amateur radio; FRS; GMRS; monitoring radio digital communications, including CW, RTTY, SITOR, etc; AM/FM commercial broadcasting; weather and communications satellites; telephone equipment and accessories; radio nostalgia; alternative radio; clandestine radio; and military radio.

Domestic Rates: 1-year ~~\$32.95~~; 2 yrs ~~\$58.95~~; 3 yrs ~~\$85.95~~

Holiday Special! **\$30.95** **\$54.95** **\$79.95**

Canada/Mexico: 1-year ~~\$42.95~~; 2 yrs ~~\$78.95~~; 3 yrs ~~\$115.95~~

Holiday Special! **\$40.95** **\$74.95** **\$109.95**

Foreign: 1-year ~~\$52.95~~; 2 yrs ~~\$98.95~~; 3 yrs ~~\$145.95~~

Holiday Special! **\$50.95** **\$94.95** **\$139.95**



CQ VHF

The all-time favorite magazine for the VHF/UHF enthusiast is better than ever. This quarterly magazine's editorial content focuses on Ham radio above 50 MHz. Regular columns include: Antennas, Airborne Radio, HSMM, Satellites, VHF Propagation, FM and more!

Domestic Rates: 1-year ~~\$26.00~~; 2 years ~~\$52.00~~; 3 years ~~\$78.00~~

Holiday Special! **\$24.00** **\$48.00** **\$72.00**

Canada/Mexico: 1-year ~~\$30.00~~; 2 years ~~\$72.00~~; 3 years ~~\$108.00~~

Holiday Special! **\$34.00** **\$68.00** **\$102.00**

Foreign: 1-year ~~\$39.00~~; 2 years ~~\$78.00~~; 3 years ~~\$117.00~~

Holiday Special! **\$37.00** **\$74.00** **\$111.00**



Call 1-800-853-9797 or FAX your orders to 516-681-2926
You can also order on our web site: www.cq-amateur-radio.com

more great gifts!



***Spend \$75
and get FREE
shipping!**

MIL SPEC Radio Gear Korean to Present Day by Mark Francis, KI0PF

SALE!



Detailed write-ups for many familiar sets: PRC-25/-77, RT-68, PRC-1099, GRC-106, GRR-5, R-392 and more. Over 230 pages of operation, modification, maintenance tips and info, including 200+ illustrations. Useful hints and mods, and more!

Order No. MILSPEC ~~\$27.95~~ **\$25.00**

Heathkit - A Guide to the Amateur Radio Products

by Chuck Penson, WA7ZZE



Greatly expanded 2nd Edition - a must for collectors and Ham history buffs. A terrific trip down memory lane for any Ham. Pick up this 328 page volume and you won't be able to put it down!

Order No. HEATHKIT **\$29.95**

2008 World Radio TV Handbook

2008 Edition, scheduled for release in December. Order now for shipment immediately upon release. You will not be charged until we ship the book.



Up-to-date info on mediumwave, shortwave, and FM broadcasts and broadcasters. Articles of interest to both listeners and DXers, reviews of the latest equipment, maps with SW transmitter sites and more.

Order No. WRTH **\$29.95**

W6SAI HF Antenna Handbook by Bill Orr, W6SAI

One of ham radio's most respected authors, W6SAI was known for his easy-to-understand, down-to-earth, writing style. In keeping with this tradition, this book is a thoroughly readable text for any antenna enthusiast, jam-packed with dozens of inexpensive, practical antenna projects that work!



Order No. HFANT **\$19.95**

CQ HF Operator's Survival Guide

NEW!

This guide contains great-reading articles and info that take the mystery out of operating on HF, DXing, Contesting, award hunting, propagation, QSLing and much more! Includes an HF band chart!



Order No. HFSurv **\$2.00**

The NEW Shortwave Propagation Handbook

by W3ASK, N4XX & K6GKU

This authoritative book on shortwave propagation is your source for easy-to-understand information on sunspot activity, propagation predictions, unusual propagation effects and do-it-yourself forecasting tips.



Order No. SWP **\$19.95**

The Short Vertical Antenna and Ground Radial

by Sevick, W2FMI

This small but solid guide walks you through the design and installation of inexpensive, yet effective short HF vertical antennas. With antenna restrictions becoming a problem, it could keep you on the air!



\$10.00

"Getting Started" DVD Paks

Our renowned "Getting Started" videos grouped together on DVDs!

NEW!



CQ Ham Radio Welcome Pak

1 DVD contains 3 programs:
Ham Radio Horizons
Getting Started in Ham Radio
Getting Started in VHF

Order # HAMDVD \$24.95

CQ HF Specialty Pak

1 DVD contains 2 programs:
Getting Started in DXing
Getting Started in Contesting

Order # HFDVD \$24.95



CQ VHF Specialty Pak

1 DVD contains 3 programs:
Getting Started in Satellites
Getting Started in VHF
Getting Started in Packet

Order # VHFDVD \$24.95

Buy any combination of DVDs and save!

1 Pak for \$24.95

2 Paks for \$45.95

3 Paks for \$65.95

The Complete DXer

by Bob Locher, W9KNI

Third Edition

The joy of the chase, the agony of defeat, the thrill of victory are the stuff of The Complete DXer, a book that is almost as seductive as the DX chase it describes. It excites, it entertains, it teaches!



Order No. COMPDxer **\$19.95**

HR Anthologies

~~\$18.95~~

Sale **\$18.00 ea.**

Buy all 4 for only **\$70.00**



Enjoy collections of the best material published in Ham Radio magazine, conveniently arranged by subject and original publication date. Choose your interest, your time period and choose your anthology!

Homebrewing Techniques Order # AHOME
Test Eqpt & Repair Techniques Order # ATEST
Antennas - 1968 - 1972 Order # ANTS1
Antennas - 1973 - 1975 Order # ANTS2
All 4 for \$70 Order # ASET

Contesting in Africa

Multi-Multi on the Equator

by Roger Western, G3SXW
& the Voo Doo Contest Group



A compelling array of contesting and DXing experiences from one of the most unique operating venues on Earth, the African continent.

Order No. AFRI **\$19.95**

Call 1-800-853-9797 or FAX your order to 516-681-2926
You can also order on our web site: www.cq-amateur-radio.com





GIFT ORDER FORM

Send these items, as my gift, to address listed below!

15-Month Calendar

- 2008/09 Ham Ops Calendar #HRCAL \$ 10.95

HR MAGAZINE on CD

- 1968-1976 #HRC1 \$ 54.95
- 1977-1983 **SALE!** #HRC2 \$ 54.95
- 1984-1990 #HRC3 \$ 54.95
- ALL 3 Sets #HRCSet \$129.95
- 2008 Passport to World Band Radio #PASS \$ 22.95
- Understanding, Building & Using #2BU \$ 19.95

MORE Great Gifts!

- MilSpec Radio Gear **SALE!** #MILSPEC \$25.00
- Heathkit-A Guide to AR Pdts #HEATHKIT \$29.95
- 2008 World Radio TV Handbook #WRTH \$29.95
- W6SAI HF Antenna Hdbk #HFANT \$19.95
- HF Operator's Survival Guide #HFSurv \$ 2.00
- New Shortwave Prop Hdbk #SWP \$19.95
- Short Vertical Ant/Ground Radials #SVERT \$10.00
- Complete DXer #COMPDXer \$19.95
- Homebrewing Techniques #AHOME \$18.00
- Test Eqpt & Repair Techniques #ATEST \$18.00
- Antennas 1968-1972 **SALE!** #ANT1 \$18.00
- Antennas 1973-1975 #ANT2 \$18.00
- ALL 4 Anthologies #ASET \$70.00
- Contesting in Africa #AFRI \$19.95

GETTING STARTED DVD Paks

- CQ Ham Radio Welcome Pak \$24.95
- CQ HF Specialty Pak \$24.95
- CQ VHF Specialty Pak \$24.95
- Any 2 \$45.95 Any 3 \$65.95

RSGB BOOKS

- Guide to VHF/UHF Ham Radio #RSGVUAR \$16.00
- Antenna Toolkit 2 #RSANTKIT2 \$48.00
- Antenna File #RSTAF \$33.00
- AR Mobile Handbook #RSARMH \$21.00
- VHF/UHF Handbook #RXVUH \$33.00
- HF Antenna Collection #RSHFAC \$33.00
- Practical Projects #RSPP \$23.00
- Antenna Experimenter's Guide #RSTAEG \$32.00
- Low Frequency Exp. Hdbk #RSLFEH \$33.00
- Tech Topics Scrapbook '95-99 #RSTTC99 \$26.50
- IOTA Directory #RIOTA \$16.00
- Low Power Scrapbook #RSLPS \$18.00
- HF Amateur Radio #RSHFAR \$23.00
- Radio & Electronics Cookbook #RSREC \$33.00
- RSGB Prefix Guide #RSPFXG \$15.00
- RF Components & Circuits #RSRFCC \$45.00

MAGAZINES AT HOLIDAY SALE PRICES

CQ Amateur Radio

- 1 yr \$34.95 2 yrs \$62.95 3 yrs \$90.95

Popular Communications

- 1 yr \$30.95 2 yrs \$54.95 3 yrs \$79.95

CQ VHF

- 1 yr \$24.00 2 yrs \$48.00 3 yrs \$72.00

*U.S. Rates -Canadian/Foreign rates on previous page.

Send the items checked above as a gift from me.

Send to:

Name _____

Address _____

City _____ State _____ Zip _____

- Check/Money Order enclosed Bill my credit card

Insert your gift message here:

Photocopy this form for additional gift orders!

ORDER FORM - Send these items to me!

- 2008/09 Ham Ops Calendar #HRCAL \$ 10.95

HR MAGAZINE on CD

- 1968-1976 #HRC1 \$ 54.95
- 1977-1983 #HRC2 **SALE!** \$ 54.95
- 1984-1990 #HRC3 \$ 54.95
- ALL 3 Sets #HRCSet \$129.95
- 2008 Passport to World Band Radio #PASS \$ 22.95
- Understanding, Building & Using #2BU \$ 19.95

MORE Great Gifts!

- MilSpec Radio Gear **SALE!** #MILSPEC \$25.00
- Heathkit-A Guide to AR Pdts #HEATHKIT \$29.95
- 2008 World Radio TV Handbook #WRTH \$29.95
- W6SAI HF Antenna Hdbk #HFANT \$19.95
- HF Operator's Survival Guide #HFSurv \$ 2.00
- New Shortwave Prop Hdbk #SWP \$19.95
- Short Vertical Ant/Ground Radials #SVERT \$10.00
- Complete DXer #COMPDXer \$19.95
- Homebrewing Techniques #AHOME \$18.00
- Test Eqpt & Repair Techniques #ATEST \$18.00
- Antennas 1968-1972 **SALE!** #ANT1 \$18.00
- Antennas 1973-1975 #ANT2 \$18.00
- ALL 4 Anthologies #ASET \$70.00
- Contesting in Africa #AFRI \$19.95

GETTING STARTED DVD Paks

- CQ HR Welcome Pak \$ 24.95
- CQ HF Specialty Pak \$ 24.95
- CQ VHF Specialty Pak \$ 24.95
- Any 2 \$45.95 Any 3 \$65.95

RSGB BOOKS

- Guide to VHF/UHF Ham Radio #RSGVUAR \$16.00
- Antenna Toolkit 2 #RSANTKIT2 \$48.00
- Antenna File #RSTAF \$33.00
- AR Mobile Handbook #RSARMH \$21.00
- VHF/UHF Handbook #RXVUH \$33.00
- HF Antenna Collection #RSHFAC \$33.00
- Practical Projects #RSPP \$23.00
- Antenna Experimenter's Guide #RSTAEG \$32.00
- Low Frequency Exp. Hdbk #RSLFEH \$33.00
- Tech Topics Scrapbook '95-99 #RSTTC99 \$26.50
- IOTA Directory #RIOTA \$16.00
- Low Power Scrapbook #RSLPS \$18.00
- HF Amateur Radio #RSHFAR \$23.00
- Radio & Electronics Cookbook #RSREC \$33.00
- RSGB Prefix Guide #RSPFXG \$15.00
- RF Components & Circuits #RSRFCC \$45.00

MAGAZINES AT HOLIDAY SALE PRICES

CQ Amateur Radio

- 1 yr \$34.95 2 yrs \$62.95 3 yrs \$90.95

Popular Communications

- 1 yr \$30.95 2 yrs \$54.95 3 yrs \$79.95

CQ VHF

- 1 yr \$24.00 2 yrs \$48.00 3 yrs \$72.00

*U.S. Rates -Canadian/Foreign rates on previous page.

Send the items checked above to me:

Name _____

Address _____

City _____ State _____ Zip _____

Payment information:

- Check or /Money Order Enclosed
- Bill my credit card: MasterCard Visa
- Discover American Express

--	--	--	--

Credit Card Number:

Expiration Date: _____

Shipping & Handling: U.S. & Possessions-add \$5 for the first item, \$2.50 for the second and \$1 for each additional item. **FREE** shipping on orders over \$75. **Foreign**-calculated by order weight and destination and added to your credit card charge. **Magazine subscription** prices include shipping and handling charges.



Programming The GRE PSR-500 Advanced Digital Scanner

Could It Be Any Easier?

by Rich Wells

With the Holidays just around the corner, it's very likely that many readers will find one particularly exciting item under their trees: the new GRE PSR-500 digital handheld scanner! This scanner is likely the most technologically advanced receiver on the consumer market today. And while that's definitely reason to brag, it might be a cause for concern for some would-be buyers.

Rich Wells, N2MCA, is best known for his Internet presence as creator of Strong Signals (www.strongsignals.net), for writing countless detailed and timely reviews, and for his collection of over 100 receivers and scanners.

One of the reasons GRE decided to pursue a direct sales path to customers is to more closely control the development of such complex radios. GRE has been concerned of late that scanning receivers have grown too complex to use, creating undue frustration. According to GRE, this has resulted in people leaving the hobby as well as fewer newcomers entering the fray. It's hard enough to get people to part with several hundred dollars without requiring a degree in astrophysics to properly use these complex electronic marvels!

By communicating directly with end users, GRE is taking an aggressive approach to radio design, where advanced technology is coupled with ease of use right from the drawing board. The design team has gone to great lengths to make this radio as



You've ripped the wrapping paper off, now feast your eyes upon this—your very own PSR-500!



Your new scanner, all lit up and on display. The sight's enough to make any scannist's mouth water.

easy to use as possible. But this doesn't mean it will be able to read your mind and program itself auto-magically!

With that in mind, at this festive season *Pop'Comm* is going to give you a little present: a quick tutorial to help get you up and running as soon as possible after you rip open that beautifully wrapped package.

Where To Start

The first place to start with any piece of advanced equipment is the owner's manual, so take some time to familiarize yourself with this 120-page document. You don't have to learn it all in your first sitting but start by getting a view of the big picture, begin to learn the various terms and develop a grasp of all this scanner is capable of doing.

Starting with the Introduction section would be wise. This is no generic, one-size-fits-all-type of superficial documentation. This introduction gives you a peek into the design process of the radio and how the design team came up with what's called Object Oriented Scanning. By taking a 30,000-foot view of the organization of what gets programmed into a scanner's memory, the design team came up with an approach that lends itself to an easy-to-understand methodology.

The overall concept is as simple as stating that you program objects into memory and then you scan those objects. Thus you have a scanner whose programming and usage is oriented around objects. An object is then just a holding cell in memory for a certain type of "thing" to be scanned. This "thing" can be either a trunked system (TSYS), a talk-group ID (TGRP), a conventional frequency (CONV), a search limit (LMIT), a service search (SRVC), or a spectrum sweeper (SWPR).

The memory on the PSR-500 is also not constrained by the old-school method of hard-coded banks and channels (for example, a total capacity of 500 channels broken up into 10 banks of 50 channels each). While the PSR-500 does not have fixed bank limitations, it is restrictive in that each memory object must be assigned to at least one of the 20 Scan Lists. When the radio is actively scanning, the numeric keypad is used to select which Scan Lists are being scanned and which are not.

The PSR-500 uses a dynamic pool of 1,800 objects that are allocated on demand. When creating a new object, it's taken from the pool and an object which is deleted is then returned to the pool for use. To see how easy it is to program an object, let's work through a practical example.

PSR-500 Programming 101

Out of the box, the PSR-500's memory is empty, which is indicated by the "Press NEW to create objects" message displayed on the LCD. For a little reality check, press the GLOB soft key and then use the down arrow key on the five-way selector until the cursor is on the menu item labeled "Memory Info." Press the SEL key and the display will tell you how many items are currently programmed into the memory and the amount of memory space that's free for creating new objects. To get back to the main menu,

press the DONE soft key, followed by the EXIT soft key.

Since some of you will undoubtedly open up your very own PSR-500 this Holiday, let's work through an actual example to help get you started.

We want to create a new object, so we'll press the NEW soft key as indicated by the LCD message. The display then prompts us to select the type of object we'd like to create. For this exercise, let's create a trunked system (TSYS) object. Now, while there is no TSYS soft key, there is a TGRP soft key for creating a talk group ID (which is a component of trunked system monitoring). This TGRP is the means by which we'll create the underlying trunked system.

Pressing the TGRP soft key brings up a menu (notice the "Talkgroup" heading label) that will prompt us to confirm or override the default settings for our new talk group. The first item in the menu allows us to select which of the 20 Scan Lists this TGRP object will be available to. For now we'll just leave this TGRP in the #1 default Scan List.

Notice that the next line of the menu contains TSYS and next to it the "NEW" option. We press the down arrow key to



GRE's design team did a superb job making the PSR-500 user friendly and easy to program. It practically converses with you.

go to this line and then press SEL. This brings up the Trunked System menu, which will allow us to program our desired trunked system information needed to scan this object. The first menu item is prompting us to select the type of trunking system, whether Motorola 800/900, Motorola VHF/UHF, P25, EDACS Narrow (or Wide) or LTR. Use the right and left arrow keys to select the proper system type. For this example, we'll leave it at the default Motorola 800/900 selection.

Pressing the down arrow key brings us to the Tag menu item, which allows us to program up to 16 characters of text to be used as a label for this TSYS. For this example, we'll just leave the default "System" text as is.

Pressing the down arrow key takes us to the Frequencies menu, which will allow us to enter all the physical frequencies needed to track this TSYS. As indicated by the label on the end of this line, pressing SEL puts the radio in frequency programming mode indicated by the "System Freqs" header label. Now it is just a matter of entering all the needed system frequencies followed by the ENT key. For this example, using the Motorola 800/900 system, we will just enter the control channel frequencies since that's all the PSR-500 really needs.

To enter more frequencies, simply press the down arrow to go to the next line, key in another frequency and finish the entry by pressing ENT. Continue doing this until all the needed frequencies have been input. Once done, press the SAVE soft key to save this information under the TSYS object.

This takes us back to the TGRP menu. The next line in the menu is for specifying the numeric value for this talk group ID. By default, the PSR-500 uses a "wildcard" ID, which matches any system ID. For this example, we're going to take the easy way out and just leave this wildcard ID there. The next menu line is titled "Type" which allows us to pick what type of wildcard the radio will search for. By default, this is a "Group" wildcard, but it can be changed to "Private" to have the radio listen to all private talk group IDs. We'll leave this as "Group" for now.

The next menu line item is "Tag" and is used to program a specific alphanumeric text tag to uniquely identify this ID. Since we're using the default wildcard ID, we'll also leave the default "Wildcard" tag alone. With the TGRP and TSYS programming complete, press the SAVE soft key to save all these changes and exit back into the object program menu.

To see what effect our little programming exercise has on memory capacity, press the PGM key followed by the GLOB soft key, scroll down to the "Memory Info" line, and press SEL. Next to "Total Items" will be a count of "2" objects (one for the TSYS and one for the TGRP).

With that done, pressing SCAN will put the PSR-500 into scan mode where it will monitor the programmed TSYS for activity. If all was entered correctly, it should be able to locate and track a control channel indicated by the "T" icon in the upper left corner of the LCD. If any group ID is detected, the scan will stop to display the frequency the traffic is on and the actual ID of the active talk group.

Let's Review

If you consider everything we did for this example, we entered very little information and were largely prompted at each stage of the process. There were no special function keys or modes to remember. For the most part, we scrolled through the menus and pressed the desired soft keys for almost all of the needed actions.

Thinking about the example as a whole, we had to press NEW, select TGRP, edit the TSYS, select the trunked system type, enter the control channel frequencies, and that was it! After only a couple of minutes of work (if you could really call it that) we were ready to start listening to traffic on a Motorola 800/900 trunked radio system. Does life get any better than this? Other memory object types (CONV, LMIT, SRVC, SWPR) are even easier to program and use!

Now this was a trivial example, but it goes to show just how easy and user friendly this radio is. This type of exercise is what real users will attempt right after they take the radio out of the box and want it to produce immediate results.

With the basic data entered, it now becomes an exciting adventure to work your way through all the menu options to program in alpha tags, LCD and keypad lighting, LED alert color and illumination style, audible alert tones, delay times, and so much more. But I will say that the best thing you can do is make use of the Detailed Menu Reference section of the manual because it contains a listing of all the object types and their menu settings along with what they mean and the various selections for each setting.

Keep in mind that this is a complex radio but GRE and its design team have done a superb job making it very manage-



Here we're editing an object, as discussed in the text. The screen shows the trunking system (TSYS) menu with trunking Type, Tag, and Freq selections.

able for end users. If your radio doesn't do what you think it should, there's a 99.99-percent chance that it's due to user error and not a fault of the radio itself. The more familiar you become with the manual, the less chance there is that you'll be unduly frustrated. And the more you know about all that the PSR-500 can do, the more enjoyable you'll find it, because it will do just about anything any scanner fanatic could ever ask of it.

Santa Let You Down? Go Treat Yourself!

So, if you've been thinking about taking the plunge and getting a PSR-500—with or without Santa's help—but were concerned it might be too complicated for you, rest assured; it's not. Those who plunk down their hard-earned money to acquire their very own PSR-500 will not be disappointed. This radio is a gem and should provide owners with years of exciting listening. It may be technologically advanced, but it's sure a pleasure to program and use.

Until next time, strong signals and happiest of monitoring!

IBA In Abeyance And More Dust-Biters

It's getting to be an almost annual event, sans Ferris wheels and fireworks. Israel has made yet another cut in its international broadcasts. In this version it's all phases and all departments at the Israel Broadcasting Authority, which have taken hits. If the world map shows any country on the planet that needs a bigger and stronger international voice than does Israel, I have yet to spot it. Either that or my Rand McNally is really, really out of date! There is also word that all IBA short-wave broadcasts will end at the first of the year!

A fire at the transmitter of Deutschland Radio, Berlin, has put that station off the air and a rather large number of bucks (sorry, "Euros") would be needed to put things right. And word is that the "Eur-tired" syndrome has sprung up and the station bigwigs aren't going to bother with a rebuild. Thus 6005 from Germany is gone for good. Originally this was RIAS, Radio In American Sector.

It's still sitting in the box labeled "rumor," not yet finding its way into the fact file, but word is that Radio Atalia (formerly RAI) has not received Italian government funding for 2008. So it appears we may be looking at yet another shutdown before long, perhaps even before you've read these words. Another one bites the dust.

That Cotton Tree News (Sierra Leone) broadcast which followed those of Star Radio (Liberia) via Ascension has now been moved to Rampisham using 13760 at 0730, which should make reception still tougher. Neither of those two broadcasters have a shortwave facility in their own country.

Radio Vanuatu has reactivated its 3945 transmitter. Not only that but they're getting two new 10-kW units, meaning that the outlet on 7260 will probably also be refreshed.

Radio Vision in Chiclayo, Peru, has been reactivated on 4790 and is being heard during our evening hours, usually with religious programming.

Reader Logs

Remember, your shortwave broadcast station logs are always welcome. But please be sure to double or triple space between the items, list them by country as they are here and include your last name and state abbreviation after each log. Also much wanted are spare QSLs or good color copies, station schedules, brochures, pennants, station photos, and anything else you think would be of interest. And, c'mon now, where's that photo of you at your listening post? Okay, let's get to it!

ALASKA—KNLS, 7335 in RR at 0945. (Barton, AZ) 1230 in EE. (Patterson, Philippines)

ALBANIA—Radio Tirana, 13720-Shijak at 2001 with ID, frequencies and times. (Charlton, ON)

ALGERIA—RT Algerienne, 9710 via Wooferton at 2126 with long AA talk, Koran recitations. (D'Angelo, PA) 11810 via Wooferton in AA at 1949 to 2000 sign off. (Ronda, OK)

ANGUILLA—Caribbean Beacon, 6090 at 0210 with Dr. Scott preaching. Also 11775 at 1010 with Scott's widow pleading for donations. (Maxant, WV) 1825 with pop gospel and Scott preaching. (MacKenzie, CA)

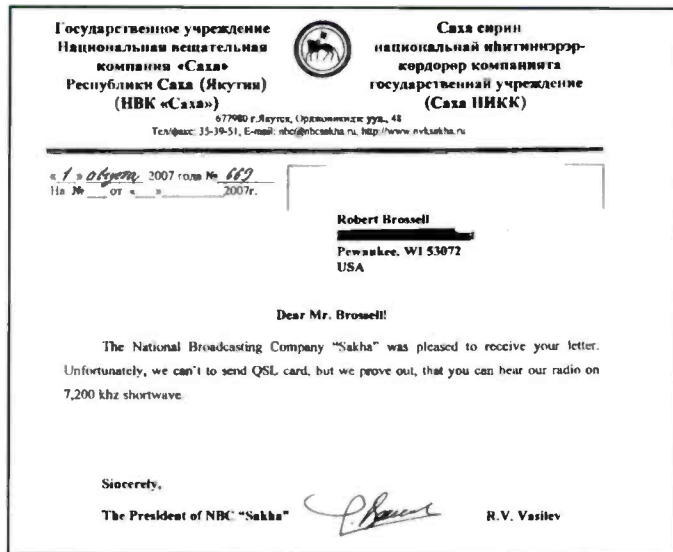

It took a few tries for Bob Brossell to snare this rare QSL from Radio Yakutsk, Russia.

ARGENTINA—RAE, 11710 in PP at 0027. (Parker, PA) 0245-0300 close in SS. (Linonis, PA) 15345 at 1800 sign on with multi-lingual IDs, into Argentine folk music. Completely covered by BSKSA at 1815. (Wood, TN) 2005 in SS. (Charlton, ON) 2228. (MacKenzie, CA)

ASCENSION ISLAND—BBC, 15400 in EE at 2240. (MacKenzie, CA) 2132 with "On Screen." (Parker, PA) 2038 and 17830 at 1608. (Charlton, ON) 21630 in FF at 1217. (Patterson, Philippines)

AUSTRALIA—Radio Australia, 5995-Brandon at 0955. (Patterson, Philippines) 9580 at 1240. (Readore, TX) 1259. (Charlton, ON) 9580 at 1045 and 15515 with cricket at 0115. (Maxant, WV) 9580-Shepparton at 1758, 12080-Brandon with news at 2300 and 17785 at 2242. (MacKenzie, CA) 12080-Brandon at 0446 with a phone-in show on ABC's broadcasting policies. (Ronda, OK) 15230-Shepparton in newscast at 0012 and 15240-Shepparton with reggae and interviews at 0353. (Parker, PA) 15515 with Australian Rules football match at 0417. (Wood, TN)

ABC Northern Territories Service, VL8A-Alice Springs on 2310 at 1940 and VL8T-Tennant Creek on 2325 at 1955. (Patterson, Philippines) VL8T, 2325-Tennant Creek with ending a program at 1030 and then into news headlines. //VK8K-2485-Katherine. (Taylor, WI)

CVC Intl, 11955-Darwin at 0901. (Patterson, Philippines) 13775 with hymns at 0455 and 15170 in CC heard at 2328. (Parker, PA)

AUSTRIA—Radio Austria Intl, 6155 at 0440 with classical music and GG anmts. (Ronda, OK) 9870 with multilingual IDs at 0158 over "Blue Danube" theme. (Brossell, WI) 9870 at 0940 with "Report From Austria," 13775 at 1505 with "Austria Today" features and 13785 at 0535. (Maxant, WV) 13775 via Sackville to 1559 abrupt close. (Charlton, ON)

AZERBAIJAN—Voice of Azerbaijan (t) 6111 at 1130 in Turkish with fanfare and man with anmts possibly mentioning "Baku," "Azeri" and "Ankara." (Taylor, WI)

BANGLADESH—Bangladesh Betar, 7185 at 1137 with EE news, ID, man and music bridges. South Asian music. (Taylor, WI)

BELARUS—RS Belarus, Minsk, 7105 at 2125 with news, light instl music, local vocals. //7390 and 7440, both weak. (Alexander, PA)

Help Wanted

The "Global Information Guide" consistently presents more shortwave broadcast loggings than any other monthly SW publication! (A whopping 667 shortwave broadcast loggings were processed this month!*) Why not join your fellow SWLs, let us know what you're hearing, and also become eligible for our monthly shortwave book prize! Send your logs to Gerry Dexter, "Global Information Guide," 213 Forest St., Lake Geneva, WI 53147. Or e-mail them to gdex@genevaonline.com (please see the column text for basic formatting tips.) Come join the party—we look forward to hearing from you!

**Not all logs get used; there are usually a few which are obviously inaccurate, unclear, or lack a time or frequency.*

BELGIUM—RTBF Intl, 9970 at 0255 with open carrier prior to instl music open at 0258, time pips at 0300, ID, opening anmts in FF and news in FF by woman. (D'Angelo, PA)

BOLIVIA—Radio San Miguel, (p) Riberalta, 4690 very weak at 1030 with slight reverb. (Strawman, IA) 0145 with SS talk, local music, ballads, and instrumentals. (Alexander, PA) 4930 with M/W in SS at 0350. (Parker, PA) (4690 is the current frequency—gld)

BONAIRE—Radio Nederland Relay, 9845 at 0232. (Parker, PA) 9845 at 2036 and

A Guide To "GIG-Speak"

Here's a partial list of abbreviations used in the "Global Information Guide."

*	— (before or after a time) time the station came on or left the air	LSB	— lower sideband
(l)	— (after a frequency) lower sideband	LV	— La Voz, La Voix (the voice)
(p)	— presumed	MW	— mediumwave (AM band)
(t)	— tentative	NBC	— National Broadcasting Corporation (Papua New Guinea)
(u)	— (after a frequency) upper sideband	OA	— Peru/ Peruvian
v	— variable time or frequency	OC or O/C	— open carrier
//	— in parallel	PBS	— People's Broadcasting Station
AA	— Arabic	PP	— Portuguese
ABC	— Australian Broadcasting Corporation	PSA	— public service announcement
AFN	— Armed Forces Network	QQ	— Quechua
AFRTS	— Armed Forces Radio TV Service	QRM	— man-made interference
AIR	— All India Radio	QRN	— noise (static)
Alt	— alternate	QSL	— verification
AM	— amplitude modulation, AM band	RCI	— Radio Canada International
Anmt(s)	— announcement(s)	Rdf.	— Radiodifusora, Radiodiffusion
Anncr	— announcer	REE	— Radio Exterior de Espana
AWR	— Adventist World RadioBC broadcast(er)	RFA	— Radio Free Asia
BSKSA	— Broadcasting Service of Kingdom of Saudi Arabia	RFE/RL	— Radio Free Europe/Radio liberty
CA	— Central America	RNZI	— Radio New Zealand International
CC	— Chinese	RR	— Russian
Co-chan	— co-channel (same frequency)	RRI	— Radio Republik Indonesia
comml(s)	— commercial(s)	RTBF	— RTV Belge de la Communate Françoise
CP	— Bolivia, Bolivian	Relay	— transmitter site owned/operated by the broadcaster or privately operated for that broadcaster
CRI	— China Radio International	relay	— transmitter site rented or time exchanged.
DD	— Dutch	SA	— South America
DJ	— disc jockey	SEA	— Southeast Asia
DS	— domestic service	SCI	— Song of the Coconut Islands (transition melody used by Indonesian stations)
DW	— Deutsche Welle/Voice of Germany	s/off	— sign off
EE	— English	s/on	— sign on
ECNA	— East Coast of North America	SIBC	— Solomon Is. Broadcasting corp.
f/by	— followed by	sked	— schedule
FEBA	— Far East Broadcasting Association	SLBC	— Sri Lanka Broadcasting Corporation
FEBC	— Far East Broadcasting Company	SS	— Spanish
FF	— French	SSB	— single sideband
freq.	— frequency	SWL	— shortwave listener
GBC	— Ghana Broadcasting Corp	TC	— time check
GG	— German	TOH	— top of the hour
GMT	— Greenwich Mean Time (UTC)	TT	— Turkish
HH	— Hebrew, Hungarian, Hindi	TWR	— Trans World Radio
HOA	— Horn of Africa	Unid	— unidentified
ID	— station identification	USB	— upper sideband
II	— Italian, Indonesian	UTC	— Coordinated Universal Time (as GMT)
Int/Intl	— international	UTE, ute	— utility station
Irr.	— irregular use	Vern	— vernacular (local) language
IRRS	— Italian Radio Relay Service	via	— same as "relay"
IS	— interval signal	VOA	— Voice of America
JJ	— Japanese	VOIRI	— Voice of Islamic Republic of Iran
KK	— Korean	WCNA	— West Coast of North America
		ZBC	— Zimbabwe Broadcasting Corporation

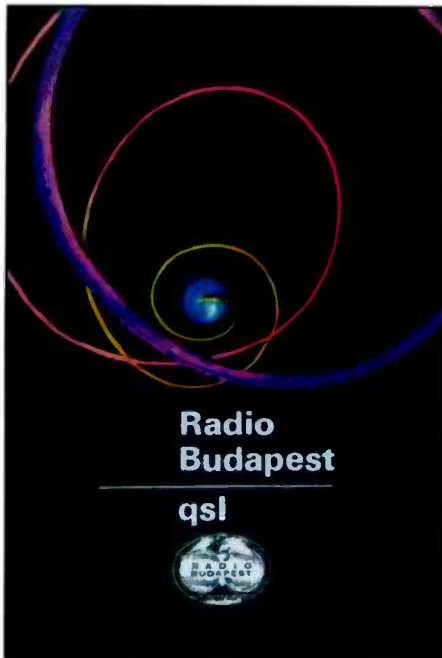

Radio Budapest is no longer broadcasting in anything but Hungarian. (Thanks Rich D'Angelo)

17735 at 2036. (Charlton, ON) 11675 with an interview at 1115 and 15440 in DD with interview at 2254. (Maxant, WV) 15315 at 1924. (Readore, TX) 15315 at 2020. (Maxant, WV) 17735 at 2010. (Fraser, ME)

BOTSWANA—VOA Relay, 12080 heard at 0415 and soon into "Daybreak Africa." (Ronda, OK) 15580 in EE at 1739. (Charlton, ON)

BRAZIL—(All in PP) Radio Cancao Nova, Cachoeira Paulista, 4825 with music at 0340. (Parker, PA)

Radio Novo Tempo, Campo Grande, 4895 with talks at 0432. (Parker, PA)

Radio Cultura Ondas Tropicais, Manaus, 4845.2 at 0047 with talk. (Parker, PA) 0140 with non-stop PP vocals. (Ronda, OK)

Radio Iguatemi (p) Sao Paulo, 4875 with woman anncr at 0420. (Parker, PA)

Radio Difusora Acreana, Rio Branco, 4885 with music and ID heard at 0345. (Parker, PA)

Radio Educadora 6 de Agosto, Xapuri, 3255 with man anncr heard at 0104. Weak. (Parker, PA)

Radio A Voz do Coracao Imaculado, Anapolis, 4885 with sermon heard at 0246. (Parker, PA)

Radio Difusora, Londrina, 4815 with guitar and vocals at 0247. (Parker, PA)

Radio Municipal, Sao Gabriel da Cachoeira, 3375 with talk heard at 0045. (Parker, PA)

Radio Brazil Central, Goiania, 4985 with two man dialogue heard at 0448. (Parker, PA)

Radio Cultura, Araraquara, 3365 with talk at 0524. (Parker, PA)

Radio Caiari, Porto Velho, 4785 with music at 0125. LSB helps with the CODAR QRM. (Parker, PA)

Radio Roraima, Boa Vista, 4876 with woman anncr at 0207. (Parker, PA)

Radio Educacao Rural, Campo Grande, 4755 with talk heard at 0215. (Parker, PA)

Radio Nacional, Macapa, 4915 with music and huge signal heard at 0440. (Parker, PA)

Radio Aparecida, Aparecida, 5035 with vocal at 0502. (Parker, PA) 6135 at 0915 with anmts and QRM from Radio Santa Cruz. (Alexander, PA)

Radio Clube do Para, Belem, 4885 at 0030 with instl music, full ID and frequency anmts. (D'Angelo, PA) 0131 with more talk than I've ever heard on this station. (Wood, TN) 0144 with rapid-fire talk and mentions of Para and Belem. (Ronda, OK) 0424 with music and echo ID. (Parker, PA)

Radio Nacional Amazonia, Brasilia, 11780 at 1954. (Charlton, ON) 2230. (MacKenzie, CA) 0115. (Linonis, PA)

BULGARIA—Radio Bulgaria, 9400 in BB at 0447 and into RR at 0500. (MacKenzie, CA) 9700 with news at 2330. (Brossell, WI) 9700 at 2307, 11700 at 2304 and 11800 in BB at 1952. (Charlton, ON) 9700 at 2310 and 11700 at 0225. (Maxant, WV)

Radio Varna, 9900 at 2050 with Euro and U.S. pops. anthem at 2100 and news in BB. (Alexander, PA)

BURKINA FASO—Radio Burkina, 5030 at 2230 with Afro-pops, local folk and FF talk. Off at 2400. (Alexander, PA) 2347 to 0001 close. (D'Angelo, PA)

CANADA—Radio Canada Intl, 6100-Sackville at 2358. (Parker, PA) 6100 at 0030 on raw materials exports, 9515 at 1515 on colleges and universities there and 15325 at 2020. (Maxant, WV) 7230 via Germany in AA at 0325. (Brossell, WI) 9515-Sackville at 1619, 15235-Sackville at 1808 and 15325-Sackville at 2004. (Charlton, ON) 11700 via Kunming at 0034. (Patterson, Philippines) 11790 via Madagascar in AA at 0325. (Ronda, OK)

CBC Northern Quebec Service, 9625-Sackville in FF at 1614. (Charlton, ON) 2258 in local dialect. (Maxant, WV)

CHU time station, 7335 with EE/FF time anmts at 2245. (Maxant, WV)

CHILE—CVC/La Voz, 9635-Santiago in SS at 1735, 15410-Santiago in PP at 2007 and 17680-Santiago in SS at 1605. (Charlton, ON) 15320 in SS at 2030. (Maxant, WV) 15410-Santiago in PP at 2140 and 17680-Santiago in SS with call-ins at 2115. (Parker, PA)

CHINA—China Radio Intl, 7190 in CC at 1430. (Barton, AZ) In JJ at 1219, 9570 in Cantonese at 1235 and 9675 in RR at 1310. (Readore, TX) 9550 via Cuba at 1330 on books in China. (Maxant, WV) 9570 via Albania at 0010, 9650-Sackville at 1308, 13740 via Cuba at 1409 and 15220 via Sackville in Mandarin at 1454. (Charlton, ON) 9570 via Albania in CC at 0346, 11895 at 1828 in CC and 13700-Sackville in SS at 2245. (MacKenzie, CA) 9675-Shijiazhuang in Mandarin at 1300; (Strawman, IA) 11975 at 2156 in FF. (Brossell, WI) 13740 via Cuba at 1520. (Fraser, ME)

Voice of the Strait, Fuzhou, 7280 in

Mandarin at 1140. (Strawman, IA) 1222. (Readore, TX) 2256. (Foss, Philippines)

Hulunbair People's Broadcasting Station, Hailar, 3900 in CC heard at 1352. (Foss, Philippines)

Xizang PBS, Lhasa (Tibet) 6200 with classical music at 1723. (Foss, Philippines)

Firedrake Music Jammer, 7470 against RFA-Mongolia, 11540 fighting RFA-Kuwait at 1545, 11785 on VOA-Thailand and 12025 versus RFA-Northern Marianas at 1550. (Brossell, WI) 9355 against RFA-Saipan at 1746. (MacKenzie, CA)

COLOMBIA—La Voz de su Concencia, 6009.4 at 0020 with EE preaching translated into SS by another man, soft instl music at 0049, and ID. Wiped out by Radio Sweden sign on at 0100. (D'Angelo, PA)

La Voz del Guaviare, San Jose de Guaviare, 6035 at 0032 with M/W anncrs. SS news items, phone calls, ad string, jingle ID. (D'Angelo, PA) 0215 with similar programming, no ID at 0230, then and blasted by Vatican Radio via Canada in FF. (Ronda, OK)

CROATIA—Croatian Radio/Voice of Croatia, 6165 at 2215 with "Croatia Today" news program. Into SS at 2228. Stronger on //9925 via Germany where the 2215 broadcast was repeated at 0200 while 6165 was blocked by Radio Nederland. (Alexander, PA) 6165 discussing Colombia at 0215. (Maxant, WV) 9925 via Germany with national news at 0210. (Brossell, WI) in Croatian at 0310. (MacKenzie, CA) 2239 in Croatian. (Charlton, ON)

CUBA—Radio Havana Cuba, 9550 with Arnie Coro talk on oil pollution at 2248. (MacKenzie, CA) 2324. (Patterson, Philippines) 2300. (Fraser, ME) 11760 with DX program at 2050. (Maxant, WV)

Radio Rebelde, 5025 in SS at 0130. (Linonis, PA) 0140. (Wood, TN) 0455 with SS anmts. (Parker, PA) 9600 in SS at 1244. (Readore, TX) 11655 in SS at 1730 and 17735 in SS at 1700. (Charlton, ON) 17735 at 1700 with ID and SS special on Castro's birthday. (Ronda, OK)

CYPRUS—Cyprus Broadcasting Corp., 7210 at 2221 with apparent radio play in Greek. Off in mid-sentence at 2233, parallels 5930 (poor) and 9710 (good). (D'Angelo, PA) (*weekends-gld*)

CZECH REPUBLIC—Radio Prague, 9415 at 2120. (Maxant, WV) 9415 at 2244, 11600 at 2143 and 17485 in Czech at 1748. (Charlton, ON) 9870 at 0318. (MacKenzie, CA) 11600 at 2146. (Brossell, WI)

DIEGO GARCIA—AFN/AFRTS, 12759u at 0825. (Patterson, Philippines)

DJIBOUTI—Radio Djibouti 4780 at 0300 with sign on, opening AA anmts some HoA music and Koran heard at 0303. (Alexander, PA)

ECUADOR—HCJB, 3220 in Quechua at 1100. (Ronda, OK) 9745 at 0410 in SS with Christian music in EE and SS. (Readore, TX) 11960 in SS at 1430. (Maxant, WV) 12000 in SS at 2248 and 12040 in Low German at 2250. (MacKenzie, CA) 15405 in unid language,



This VOA QSL shows the Briech (Morocco) Relay Station, which has ten 500-kW transmitters! (Thanks Rich D'Angelo)

NASB

Representing private shortwave
broadcasters in the USA

Besides official stations like
the Voice of America, there
are more than 20 privately-
owned radio stations in the
U.S. licensed by the Federal
Communications Commission
(FCC) to broadcast
internationally on shortwave.
In 1989 several of these
stations established the
National Association of
Shortwave Broadcasters.

National Association of Shortwave Broadcasters

The National Association of Shortwave Broadcasters (NASB) is a "trade" organization dedicated to promoting shortwave broadcasting.

listed in Rawang to 0100 when they go into EE. (Barton, AZ) 21455 in SS at 2055. (Parker, PA)

La Voz del Napo. Tena, 3279.7 in SS monitored at 0216 and 3280 in SS at 0130. (Parker, PA) 0415 with religious talk and vocals. (Ronda, OK)

Radio Buen Pastor, Saraguro, 4815 in SS at 0148. (Parker, PA)

Radio Chaskis, Otavalo, 4909.2 at 0232 with continuous rustic music, some vocals with one very brief anmt by man at 0403. Off suddenly at 0320. (D'Angelo, PA) 0410 with SS talk and local music. (Alexander, PA)

EGYPT—Radio Cairo/Egyptian Radio, 6135 in SS at 0115. Much better on parallels 7270 and 9360. (Alexander, PA) 7270 at 0204 with "The Koran and its Truths." (Brossell, WI) 0240. (Readore, TX) 9460 with music and news at 2300 and 9990 with Egyptian music at 2110. (Maxant, WV) 9460-Abu Zabal with AA lessons at 0005, 9990-Abis with AA songs at 2227 and 12050-Zabal in AA at 1732. (Charlton, ON)

ENGLAND—BBC, 3255 via Meyerton to Southern Africa at 0500, 9410-Rampisham on Robert Mugabe at 2025. 15090 with news at 2230. 15315 in GG at 2118 and 15335//15360 at 0002. (Parker, PA) 9660 on terrorists in the UK at 1120. (Maxant, WV) 9740 at 1250. (Readore, TX) 9915 in AA at 0315, 11945 via Japan in CC at 2226, 12095 at 2257 and 13640 Cyprus Relay at 2200. (MacKenzie, CA) 11680 in AA at 2034 and 15325 via Canada in RR at 1602. (Brossell, WI) 11680-Skelton in AA at 1955. (Charlton, ON) 11740 via Russia at 0752, 13745 via Uzbekistan in Hindi at 0124. (Patterson, Philippines) (t) 11855 Oman Relay under WYFR in Farsi monitored at 0320 and (t) 11955-Oman Relay weak with muffled audio to 0300 close. (Ronda, OK)

Bible Voice Broadcasting, 13590 via Germany at 1609. (Brossell, WI)

EQUATORIAL GUINEA—Radio Nacional, Bata, 5005 at 0531 with abrupt sign on with local music and SS talk. Very weak. (Alexander, PA)

ERITREA—Voice of the Broad Masses, 7100 at 0356 sign on with Program One service. IS, talk in local language, HoA music. 7180 (ex-7175) also 0356 sign on with Program 2 service. Similar content. (Alexander, PA)

ETHIOPIA—Radio Ethiopia, 7110. Geja at 0300 sign on with opening anmts in local language, talk and short breaks of local music. Poor to fair, //5990 very weak under a DRM signal and 9704.1 with low modulation. (Alexander, PA)

FRANCE—Radio France Intl, 5995 at 0100 with SS interview. (Linonis, PA) 17605-Issoudun with EE news at 1604. (Charlton, ON) 17630 French Guiana Relay in SS at 2105. (Parker, PA)

GABON—Radio Gabon, 4777 at 0456 with instl opening, possible anthem, sign on anmts and into news. (Wood, TN) 0458 sign on with FF news at 0500, into highlife music. (D'Angelo, PA) 0501 abrupt sign on with ID, FF and Afro-pops. (Alexander, PA)

Africa Number One, 9580 in FF with reggae at 2047. (Parker, PA) 15475 at 1818 in FF with commentary and Afro-pops. (Wood, TN) 17630 in FF at 1631. (Charlton, ON) This or the Afro-pops station at 1520 with what sounded like a live rap concert, FF and EE lyrics. Shifted to studio talk at 1529-34. Off at 1559 per Africa Number One sked. Believed Afropops jammer hovered between 17630-660 at various times. (Ronda, OK) (this mystery continues—gld)

GERMANY—Deutsche Welle, 6075-Wooferton in GG at 2228, 7245 via Sri Lanka Relay at 0043 and 9620 via Sines Relay in AA at 2005, 11795 via Sines at 1914. Patterson, Philippines) 7225 via England at 0432, 9825 Rwanda Relay in GG at 0320, 11690 in AA at 1820, 11865 Sines Relay in GG at 2233 and 15640 via Russia at 2250 in GG. (MacKenzie, CA) 11795 in GG at 1951 and 11865-Rampisham at 2030. (Charlton, ON) 11865 Rwanda Relay at 2025. (Brossell, WI) 15205 Rwanda Relay at 2112 and 15275 also Rwanda in GG at 1533. (Parker, PA)

GHANA—Ghana Broadcasting Corp. (t), 4915 monitored at 0900 with news of Africa in EE. (believed inactive now—gld)

GREECE—Voice of Greece, 7495 in GG at 2335 and 9420 at 0015. (Maxant, WV) 9420 in GG at 0001. (Charlton, ON) 0354. (MacKenzie, CA) 0440. (Parker, PA) 15630 in GG at 0815. (Patterson, Philippines)

GUATEMALA—Radio Cultural Coatan, San Sebastian, 4780 in SS at 0056. (Wood, TN) 0206. (Brossell, WI) 0220. (Ronda, OK) 0226. (Parker, PA) 1037. (Strawman, IA)

Radio Buenas Nuevas, San Sebastian, 4800 in SS at 0126. (Parker, PA) 0205. (Brossell, WI)

Radio Verdad, Chiquimula, 4052.5 in SS at 0152. (Wood, TN) 0156. (Ronda, OK) 0202. (Brossell, WI) 0452. (Readore, TX) 0457. (Parker, PA)

GUINEA—RT Guineenne, 7125 with FF highlife vocals at 2240, FF talk, drums. Russian carrier and test tones dominated from 2255. (D'Angelo, PA)

HAWAII—KWHR, Naalehu, 13650 at 0729. (Patterson, Philippines)

AFN/AFRTS, Pearl Harbor, 10320u at 0820. (Parker, PA)

HONDURAS—Radio Luz y Vida, San Pedro Sula, 3250 in SS at 0050. (Parker, PA)

HRMI/Radio Misiones Internacionales. (t) 3340 with SS religious talk and EE translations. Religious music at 0734. Poor in T-storm static. (Alexander, PA)

INDIA—All India Radio, 4920-Chennai at 0020 with flute, woman in Hindi, male Hindi vocals to 0030 ID and EE news. (D'Angelo, PA) 9445-Bangaluru at 2225. (Charlton, ON) 9820-Panaji (Goa) at 1300 sign on with Sindi vocals with tabla. Barely audible above the noise. (Strawman, IA) 9910-Panaji with EE news at 0030 to Southeast Asia. (Parker, PA) 11620-Bangaluru at 1345, 11715-Delhi/Khampur in Nepalese at 0138 and 15075-Bangaluru in Hindi at 0324. (Patterson, Philippines) 10330-Bangluru in unid language at 0201 and 11985 in presumed Hindi at 0215 sign on. (Brossell,

WI) 11985-Bangaluru at 0235 with songs in listed Kannada. (Ronda, OK) 10330-Bangaluru in Hindi at 0405 and 11620 with General Overseas Service at 1745. (Maxant, WV) 15020 on domestic travel at 1032. (Foss, Philippines)

INDONESIA—Voice of Indonesia, 9525 in Korean at 1130. (Readore, TX) 1740 in SS. (MacKenzie, CA) 2009 in EE. (Patterson, Philippines)

Radio Republik Indonesia-Cimangis, 11860 in II heard at 0202. (Patterson, Philippines)

RRI, Pontianak, 3976 at 1039 in presumed II. (Foss, Philippines) 1051 with threshold signal. (Strawman, IA) (p) At 1108 with ARO QRM. (Ronda, OK)

RRI, Serui (Papua) 4605 in II with country-western heard at 1417. (Foss, Philippines)

IRAN—Voice of Islamic Republic of Iran/Voice of Justice, 7235 at 0147 with man/woman alternating anti-American comments. (Strawman, IA) 9495 at 0205. (Maxant, WV) 9905 in SS at 0200. (Brossell, WI) 11910-Kalamabad in listed Dari at 0310 and 12025-Sirjan in listed Armenian at 0307. (Ronda, OK)

ISRAEL—Kol Israel, 9400 in FF at 1944 and 11590 in FF at 1927. (Charlton, ON) 11585 in HH at 2215. (MacKenzie, CA) 2255. (Brossell, WI) 11590 with EE news to 0344. (Ronda, OK)

ITALY—Radio Atalia (RAI) 7235 at 0447 with feature, sports and ID. (Wood, TN) 6110 in II at 0130. (Linonis, PA) 11800 in II at 2310. (Brossell, WI) 11800 in II at 2240 and 15380 in II at 1840. (MacKenzie, CA) 11875 with news at 2050. (Charlton, ON) 17790 via Ascension in II at 1614. (Charlton, ON)

JAPAN—Radio Japan/NHK, 5960 via Canada in JJ at 0420, 9535 at 1742, 9835 in JJ at 1804, 11970 in FF/SS at 1820, 15265 via Bonaire in JJ at 2330 and 17825 in JJ at 2237. (MacKenzie, CA) 5960 in JJ at 0444, 6110 in JJ at 0500, 9695 in Indonesian at 1305 and 11705 in Italian at 1300. (Readore, TX) 5975 via Rampisham at 0513 and 7230 via Wooferton at 0512 with "What's Up Japan?" (Parker, PA) 6120 via Canada at 1115 on early

This Month's Winner

To show our appreciation for your loggings and support of this column, each month we select one "Global Information Guide" contributor to receive a free book. Readers are invited to send in loggings, photos, copies of QSL cards, and monitoring room photos to me at *Popular Communications*, "Global Information Guide," 25 Newbridge Road, Hicksville, NY 11801, or by e-mail to popularcom@aol.com. The e-mail's subject line should indicate that it's for the "Global Information Guide" column. So come on, send your contribution in today!

Our book winner this month is Brian Alexander who receives a 2008 edition of *Passport to World Band Radio* from Universal Radio. If you still aren't on the list to receive Universal's great free catalog of neat things radio it's high time you took action. Call them at (614) 866-4267, email them at dx@universal-radio.com, or drop them a note at 6830 Americana Parkway, Reynoldsburg, OH 43068. You'll be dealing with super people!

TV there. (Fraser, ME) 6120 at 1005 on Tokyo financial markets and 6145 via Canada with "Report From Tokyo." (Maxant, WV) 0012. (Charlton, ON) 13650-Yamata at 0005. (Patterson, Philippines)

Radio Nikkei, Tokyo, 3925 in JJ at 1022. (Strawman, IA) 1032 and 6055 in JJ heard at 1005 (Patterson, Philippines) 1213 with western classical music. (Taylor, WI)

JORDAN—Radio Jordan, 9830 in AA at 2025. (Brossell, WI) 11810 in AA at 1946. (Charlton, ON)

KUWAIT—Radio Kuwait, 9855-Kabd with AA call-ins at 1946. (Charlton, ON) 2155 (Parker, PA) 2248. (Brossell, WI) 11675 in AA at 0331. (Ronda, OK) 11990 in AA at 1800 sign on and EE opening anmts, local AA music, U.S. and Euro-pop, news at 1830 more pops, pgm on Kuwaiti women at 1900. (Alexander, PA) 1830 with EE pgms and several IDs as "Radio State of Kuwait." Also 15495 at 1810 with ME vocals. (Wood, TN) 11990 at 1915 with pops and features to 2100 close. (D'Angelo, PA)

LAOS—Lao National Radio, 6130 in Lao at 1015. (Patterson, Philippines)

LIBYA—Radio Jamahiriya/Voice of Africa, 17870 with African pops, EE IDs, talk about human rights, news from 1435-1443, readings from the Green Book, //17725. (Alexander, PA)

LITHUANIA—Radio Vilnius, 11690 in Lithuanian heard at 0023. (Charlton, ON)

The Mighty KBC, 6255 at 0140 with US pops, IDs, promos, anmts in EE/GG, acknowledging reception reports. Saturdays only. (Alexander, PA)

MADAGASCAR—RTV Malagasy, 5010 in Malagasy at 0330. (Brossell, WI)

MALAYSIA—Radio Malaysia, 5965 in presumed Malay at 1632 with vocals. (Foss, Philippines) 6175-Kajang in II at 1150. (Taylor, WI) 15295-Kajang in EE at 0347. (Patterson, Philippines)

MALI—RTV du Mali, 4835.5 from 0556 IS, anthem and FF opening, local music. Low modulation but somewhat better on //5995. (Alexander, PA) 0647 with local guitar, brief drop-ins by woman, more guitars. (Taylor, WI) 2324 with FF vocals and man anncr. 0000 with close down anmts and anthem. (D'Angelo, PA)

MEXICO—Radio Universidad, San Luis Potosi, 6045 in SS at 1218 with man in SS, music bridge, ID. (Taylor, WI)

Radio Educacion, Mexico City, 6185 at 0914 with Ella Fitzgerald, SS man anncr. (D'Angelo, PA)

Radio UNAM, Mexico City, 9599 at 0035 with classical music, SS anmts, possible radio drama. Irregular and difficult due to Cuba on 9600. Also at 0135 and 2100. Used ECSS-LSB mode to avoid QRM. (Alexander, PA)



Radio Prague's broadcasts via WRMI were QSLed with this card.

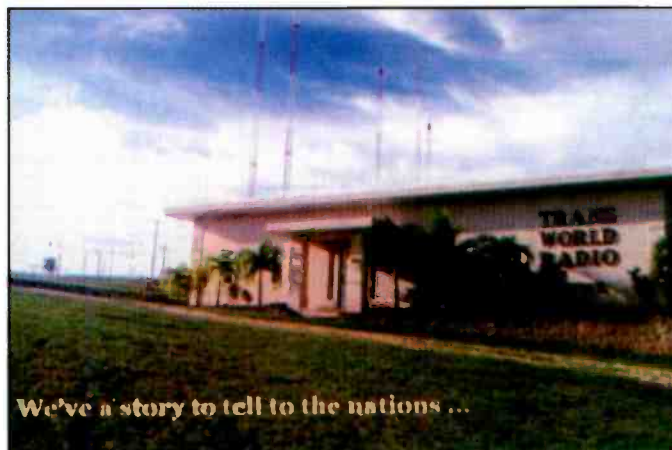

Trans World Radio's station on Guam.

Radio Free Asia



Created and funded by the U.S. Congress, Radio Free Asia (RFA) began in March 1996. As a surrogate broadcast network, RFA is dedicated to the free flow of accurate, timely, unbiased news, information and commentary that is banned in Asian countries where such news reports are unavailable. It also aims to promote freedom of opinion and expression, including the freedom to seek, receive, and impart information and ideas through any medium, regardless of frontiers. Mandated to broadcast in Burmese, Cantonese, Khmer, Korean, Lao, Mandarin, Tibetan, Uyghur and Vietnamese, English is spoken only when appropriate.

RFA is headquartered in Washington, DC with offices in Asia and correspondents throughout the world. Please listen to our programs and learn more from our website at www.rfa.org.

RFA
RADIO FREE ASIA



Created and funded by the U.S. Congress, Radio Free Asia (RFA) began in March 1996. As a surrogate broadcast network, RFA is dedicated to the free flow of accurate, timely, unbiased news, information and commentary that is banned in Asian countries where such news reports are unavailable. It also aims to promote freedom of opinion and expression, including the freedom to seek, receive, and impart information and ideas through any medium, regardless of frontiers. Mandated to broadcast in Burmese, Cantonese, Khmer, Korean, Lao, Mandarin, Tibetan, Uyghur and Vietnamese, English is spoken only when appropriate.

RFA is headquartered in Washington, DC with offices in Asia and correspondents throughout the world. Please listen to our programs and learn more from our website at www.rfa.org.

RFA
RADIO FREE ASIA



Created and funded by the U.S. Congress, Radio Free Asia (RFA) began in March 1996. As a surrogate broadcast network, RFA is dedicated to the free flow of accurate, timely, unbiased news, information and commentary that is banned in Asian countries where such news reports are unavailable. It also aims to promote freedom of opinion and expression, including the freedom to seek, receive, and impart information and ideas through any medium, regardless of frontiers. Mandated to broadcast in Burmese, Cantonese, Khmer, Korean, Lao, Mandarin, Tibetan, Uyghur and Vietnamese, English is spoken only when appropriate.

RFA is headquartered in Washington, DC with offices in Asia and correspondents throughout the world. Please listen to our programs and learn more from our website at www.rfa.org.

RFA
RADIO FREE ASIA



Created and funded by the U.S. Congress, Radio Free Asia (RFA) began in March 1996. As a surrogate broadcast network, RFA is dedicated to the free flow of accurate, timely, unbiased news, information and commentary that is banned in Asian countries where such news reports are unavailable. It also aims to promote freedom of opinion and expression, including the freedom to seek, receive, and impart information and ideas through any medium, regardless of frontiers. Mandated to broadcast in Burmese, Cantonese, Khmer, Korean, Lao, Mandarin, Tibetan, Uyghur and Vietnamese, English is spoken only when appropriate.

RFA is headquartered in Washington, DC with offices in Asia and correspondents throughout the world. Please listen to our programs and learn more from our website at www.rfa.org.

2005
The Year of the Rooster

RFA
RADIO FREE ASIA



Created and funded by the U.S. Congress, Radio Free Asia (RFA) began in March 1996. As a surrogate broadcast network, RFA is dedicated to the free flow of accurate, timely, unbiased news, information and commentary that is banned in Asian countries where such news reports are unavailable. It also aims to promote freedom of opinion and expression, including the freedom to seek, receive, and impart information and ideas through any medium, regardless of frontiers. Mandated to broadcast in Burmese, Cantonese, Khmer, Korean, Lao, Mandarin, Tibetan, Uyghur and Vietnamese, English is spoken only when appropriate.

RFA is headquartered in Washington, DC with offices in Asia and correspondents throughout the world. Please listen to our programs and learn more from our website at www.rfa.org. (Logo by Tom Sanderson)

18th Annual Winter SWL Festival
March 11-12, 2005

RFA
RADIO FREE ASIA



Created and funded by the U.S. Congress, Radio Free Asia (RFA) began in March 1996. As a surrogate broadcast network, RFA is dedicated to the free flow of accurate, timely, unbiased news, information and commentary that is banned in Asian countries where such news reports are unavailable. It also aims to promote freedom of opinion and expression, including the freedom to seek, receive, and impart information and ideas through any medium, regardless of frontiers. Mandated to broadcast in Burmese, Cantonese, Khmer, Korean, Lao, Mandarin, Tibetan, Uyghur and Vietnamese, English is spoken only when appropriate.

RFA is headquartered in Washington, DC with offices in Asia and correspondents throughout the world. Please listen to our programs and learn more from our website at www.rfa.org.

Richard Richter
President, Radio Free Asia
1996 - 2005

RFA
RADIO FREE ASIA



Created and funded by the U.S. Congress, Radio Free Asia (RFA) began in March 1996. As a surrogate broadcast network, RFA is dedicated to the free flow of accurate, timely, unbiased news, information and commentary that is banned in Asian countries where such news reports are unavailable. It also aims to promote freedom of opinion and expression, including the freedom to seek, receive, and impart information and ideas through any medium, regardless of frontiers. Mandated to broadcast in Burmese, Cantonese, Khmer, Korean, Lao, Mandarin, Tibetan, Uyghur and Vietnamese, English is spoken only when appropriate.

RFA is headquartered in Washington, DC with offices in Asia and correspondents throughout the world. Please listen to our programs and learn more from our website at www.rfa.org.

EDXC 2005
Prague, Czech Republic
April 28 - May 2, 2005

RFA
RADIO FREE ASIA



Created and funded by the U.S. Congress, Radio Free Asia (RFA) began in March 1996. As a surrogate broadcast network, RFA is dedicated to the free flow of accurate, timely, unbiased news, information and commentary that is banned in Asian countries where such news reports are unavailable. It also aims to promote freedom of opinion and expression, including the freedom to seek, receive, and impart information and ideas through any medium, regardless of frontiers. Mandated to broadcast in Burmese, Cantonese, Khmer, Korean, Lao, Mandarin, Tibetan, Uyghur and Vietnamese, English is spoken only when appropriate.

RFA is headquartered in Washington, DC with offices in Asia and correspondents throughout the world. Please listen to our programs and learn more from our website at www.rfa.org.

9
years of
broadcasting
excellence.
September 29
1996 - 2005

TORINO



Created and funded by the U.S. Congress, Radio Free Asia (RFA) began in March 1996. As a surrogate broadcast network, RFA is dedicated to the free flow of accurate, timely, unbiased news, information and commentary that is banned in Asian countries where such news reports are unavailable. It also aims to promote freedom of opinion and expression, including the freedom to seek, receive, and impart information and ideas through any medium, regardless of frontiers. Mandated to broadcast in Burmese, Cantonese, Khmer, Korean, Lao, Mandarin, Tibetan, Uyghur and Vietnamese, English is spoken only when appropriate.

RFA is headquartered in Washington, DC with offices in Asia and correspondents throughout the world. Please listen to our programs and learn more from our website at www.rfa.org.

RFA
RADIO FREE ASIA



Created and funded by the U.S. Congress, Radio Free Asia (RFA) began in March 1996. As a surrogate broadcast network, RFA is dedicated to the free flow of accurate, timely, unbiased news, information and commentary that is banned in Asian countries where such news reports are unavailable. It also aims to promote freedom of opinion and expression, including the freedom to seek, receive, and impart information and ideas through any medium, regardless of frontiers. Mandated to broadcast in Burmese, Cantonese, Khmer, Korean, Lao, Mandarin, Tibetan, Uyghur and Vietnamese, English is spoken only when appropriate.

RFA is headquartered in Washington, DC with offices in Asia and correspondents throughout the world. Please listen to our programs and learn more from our website at www.rfa.org.

50th
ANNIVERSARY
1956 - 2006

DSWCI
The Danish ShortWave Club International

RFA
RADIO FREE ASIA



Created and funded by the U.S. Congress, Radio Free Asia (RFA) began in March 1996. As a surrogate broadcast network, RFA is dedicated to the free flow of accurate, timely, unbiased news, information and commentary that is banned in Asian countries where such news reports are unavailable. It also aims to promote freedom of opinion and expression, including the freedom to seek, receive, and impart information and ideas through any medium, regardless of frontiers. Mandated to broadcast in Burmese, Cantonese, Khmer, Korean, Lao, Mandarin, Tibetan, Uyghur and Vietnamese, English is spoken only when appropriate.

RFA is headquartered in Washington, DC with offices in Asia and correspondents throughout the world. Please listen to our programs and learn more from our website at www.rfa.org.

The Father of Radio

Guglielmo Marconi
1874-1937

10



Created and funded by the U.S. Congress, Radio Free Asia (RFA) began in March 1996. As a surrogate broadcast network, RFA is dedicated to the free flow of accurate, timely, unbiased news, information and commentary that is banned in Asian countries where such news reports are unavailable. It also aims to promote freedom of opinion and expression, including the freedom to seek, receive, and impart information and ideas through any medium, regardless of frontiers. Mandated to broadcast in Burmese, Cantonese, Khmer, Korean, Lao, Mandarin, Tibetan, Uyghur and Vietnamese, English is spoken only when appropriate.

RFA is headquartered in Washington, DC with offices in Asia and correspondents throughout the world. Please listen to our programs and learn more from our website at www.rfa.org.

1996 - 2006
Celebrating
10 years of
broadcast
excellence.

RFA
Radio Free Asia



Created and funded by the U.S. Congress, Radio Free Asia (RFA) began in March 1996. As a surrogate broadcast network, RFA is dedicated to the free flow of accurate, timely, unbiased news, information and commentary that is banned in Asian countries where such news reports are unavailable. It also aims to promote freedom of opinion and expression, including the freedom to seek, receive, and impart information and ideas through any medium, regardless of frontiers. Mandated to broadcast in Burmese, Cantonese, Khmer, Korean, Lao, Mandarin, Tibetan, Uyghur and Vietnamese, English is spoken only when appropriate.

RFA is headquartered in Washington, DC with offices in Asia and correspondents throughout the world. Please listen to our programs and learn more from our website at www.rfa.org.

20th ANNIVERSARY
MARCH 8-10, 2007

1987 - 2007

RFA
Radio Free Asia



Radio Free Asia (RFA) began in March 1996. The purpose of RFA is to provide a forum for a variety of opinions and voices from within specific Asian countries. As a "surrogate" broadcaster, RFA also provides news and commentary while broadcasting only in local languages and dialects; most broadcasts include news of specific local interest.

RFA can be heard in Mandarin, Cantonese, Uyghur, and the Wu dialect, Tibetan (Lhas, Amdo, and Kham); Burmese; Khmer; Cambodian; Korean to North Korea; Lao; and Vietnamese.

RFA's main broadcast center is in Washington, DC with offices in Asia and correspondents throughout the world. Please listen to our programs often and learn more from our website at www.rfa.org.

2007
THE YEAR
OF THE
PIG

RFA
Radio Free Asia



RFA provides accurate and timely information, news and commentary about events in Asia. It is a forum for a variety of opinions and voices from within Asian nations whose people do not fully enjoy freedom of expression.

RFA broadcasts only in local language and dialects - in Mandarin, Cantonese, Uyghur, and the Wu dialect, Tibetan (Lhas, Amdo and Kham), Burmese, Khmer, Vietnamese, Korean to North Korea, Lao, and Vietnamese.

RFA adheres to the highest standards of journalism and strives for accuracy, balance and fairness in its editorial content. In addition to its news programming and commentaries, RFA broadcasts works of literature and notification that have been banned in RFA's target countries.

11
years of
broadcasting
excellence
September 29
1996-2007

Here, before your very eyes, is a complete set of all the Radio Free Asia QSL cards RFA has issued so far. (Thanks AJ at RFA)

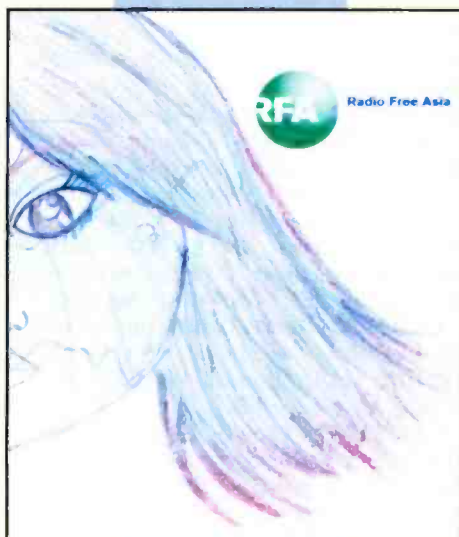

Radio Transcontinental, Mexico City, 4810 at 0104 with local music, SS anncr. (Wood, TN) 0140 with lively SS vocals, ID. Best in USB. (Ronda, OK)

MOROCCO—Radio Medi Un, 9575 at 0510 with woman in AA, music drop ins. Into non-stop music at 0519. (Ronda, OK)

NAMIBIA—Namibian Broadcasting Corp., Windhoek, 3270 at 0110 with EE news before QRM took it out. (Parker, PA)

NETHERLANDS—Radio Nederland, 5905 Madagascar Relay in EE at 2026. (Patterson, Philippines) 6165 relaying Radio Budapest pgmng at 0500. (Maxant, WV) 12080 Madagascar Relay at 1555. (Brossell, WI) 11655 Madagascar Relay heard at 1934. (Charlton, ON)

NEW ZEALAND—Radio New Zealand, 6095 at 0900. (Linonis, PA) 0934. (Patterson, Philippines) 1053 plus 15720 with "Hidden Treasures" pgm at 2235. (Charlton, ON) 0901 with news. (D'Angelo, PA) 1005 with news from National Radio. Also 9615 on real estate at 0520 and 11725 with DJ at 2045. (Maxant, WV) 9615 with news at 0510. (Ronda, OK) 13730 at 0450 and 15720 at 2247. (MacKenzie, CA) 13730 at 0245. (Readore, TX) 15720 with news at 2003. (Parker, PA)

NIGER—La Voiz du Sahel, 9705 at 2235 with FF talk and ballads. Korean at 2253, distinctive fanfare and choral anthem at 2259, short tone and off. Sunday close is at 2200. (Alexander, PA)

NIGERIA—Radio Nigeria, Kaduna, 4770 at 0430 sign on with opening, prayer, some religious songs to news at 0445. (D'Angelo, PA)

Voice of Nigeria, 7255 in an African dialect at 2301. (Brossell, WI) 9690 at 0758 sign on, into talk in vernacular and local vocals. (Alexander, PA) 15120 in FF at 0739. (Patterson, Philippines) 1927. (Charlton, ON) 1932. (Wood, TN)

NORTH KOREA—Voice of Korea, 9335 in EE at 1302. (Readore, TX) 11710 on the former Soviet Union at 1016. (Wood, TN) 1030 with "Songs of Korea—A Land of New Morning Sun." (Parker, PA) heard at 1510 but poor. (Charlton, ON)

KCBS, 2850 in KK with lively mixed choirs. Radio drama in KK at 1335. (Foss, Philippines) 11680 in KK at 0730. (Patterson, Philippines) 11710 in KK at 1232. QRM from RAE in Japanese. (Taylor, WI)

Pyongyang Broadcasting Station, 6250 in KK at 1158. (Patterson, Philippines)

NORTHERN MARIANAS—KFBS-Saipan, 9920 with VV service at 1305. (Strawman, IA)

OMAN—Radio Sultanate of Oman, 13640 in AA at 1812. (Parker, PA)

OPPOSITION—Radio Marti (to Cuba) 6030 in SS at 0845. (Linonis, PA) (p) 7405 via UK in SS at 1225. (Parker, PA) 11845 in SS at 1305. (Readore, TX) 11930-Greenville in SS at 1944. (Charlton, ON)

Radio Nacional de la RASD (to Morocco), 6300 at 2240 with live sports. (Brossell, WI)

Cotton Tree News, 9525 at 0748 with end of news in local language, EE ID and drums to close at 0800. (D'Angelo, PA) (now using 13760 via Rampisham—gld)

Radio Free Asia, 11605 via Taiwan with EE ID and into Tibetan at 1200. (Brossell, WI) (t) 12005 via Northern Marianas in Mandarin at 1507. (Ronda, OK) 15430 via Northern Marianas in CC at 2300. (MacKenzie, CA) 21690 via Northern Marianas in CC at 0347. (Patterson, Philippines)

Radio Republica (to Cuba) (p) 5910 via UK in SS at 2356. (Parker, PA)

Denge Mesopotamia. (to Kurds) 11530 via Moldova at 1245 with call-ins in Kurdish. (Taylor, WI)

Sudan Radio Service, 5985 via Rwanda at 0315 on schools in Sudan. (Alexander, PA)

Radio Farda (to Iran) 9805 via Morocco in Farsi at 0329 and 9865 via Morocco in Farsi at 0323. (MacKenzie, CA) 12110 via Sri Lanka in Uzbek at 0225. 15290 via Morocco in Farsi at 0723 and 21690-Tinian in CC at 0347. (Patterson, Philippines)

Radio Liberty, 9760 via Morocco in listed Tajik at 0349 to 0359 close. (Ronda, OK) 11700 via Tinang in RR at 0750 and 17730 via Udon Thani, Thailand, in RR at 0827. (Patterson, Philippines) 12110 in an Asian language at 0204. (Brossell, WI)

Radio Voice of the People (to Zimbabwe) 9765 via Madagascar at 0400 sign on with local music, opening anmts in local language and EE ID, more local language. EE from 0439-0455 but hard to understand due to a thick accent. Off at 0455. Also a very weak music loop jammer underneath from 0449. (Alexander, PA) 0401 with IDs and frequencies, EE and an African language, upbeat Afropops. (Ronda, OK) 0450 on human rights. Off at 0455. (Brossell, WI)

Radio Free Afghanistan, 15090 via Kuwait Relay in Dari at 0948. (Patterson, Philippines)

PAKISTAN—Radio Pakistan, 11570 in CC at 1226. (Patterson, Philippines)

PALAU—KHBN, Korrer, 15725 in unid language at 0843. (Patterson, Philippines)

PAPUA NEW GUINEA—Radio Manus, Lorengau, 3315 in Aussie-accented EE at 1204, later into Pidgin. Lost by 1210. (Ronda, OK)

PERU—Radio Ancash, Huancayo, 4990 with music and SS heard at 0453. (Parker, PA)

Radio Bambamarca, Bambamarca, 4426.5 weak with SS talk at 0058. (Parker, PA)

In Times Past...

Here's your monthly shortwave "blast from the past":

UNIVERSITY OF THE PACIFIC, Suva, Fiji Islands, 12140 at 0510 on August 22, 1989, broadcasting college courses in upper sideband. (Dexter, WI)

Radio Luz y Sonido, Huanuco, 3234.2 at 0227 fair to poor with impassioned SS preaching. (Ronda, OK)

Radio Andahuaylas, Andahuaylas, 4840 with man anncr and music heard at 0040. (Parker, PA)

Radio Sicuani, Sicuani, 4826 in Quechua with man/woman talks at 0027. (Parker, PA)

Radio Santa Monica, Cusco, 4965 in SS with music at 0436. (Parker, PA)

Radio Altura, Cerro de Pasco, 5014.4 at 0335 with male SS anncr hosting pgm of huaynos. Off at 0404 without anthem. (D'Angelo, PA)

PHILIPPINES—Radio Veritas Asia, 11820 in II at 2318. (MacKenzie, CA) 15280 in Urdu at 0106. (Patterson, Philippines)

PIRATES—WBNY/Radio Bunny, 6925u variously heard at 0009, *0016, *0008 *1728 and *2153. Commander Bunny running for president. Some programs included possible SSTV modulation, "attention monkeys" and claimed that Kracker Radio, Radio Jambu and some of the other pirates support him. (Zeller, OH) 0010 on his presidential campaign. (D'Angelo, PA) 0020. Commander Bunny t-shirts available on eBay. (Wood, TN)

The Crystal Ship, 3274.6 at 0308 with pgm of rock, occasional IDs. (D'Angelo, PA) 5385.5 at 0153 with vintage rock. Never heard a pirate in this range before. Also 5485 heard at 0028 with "The Poet" critical of Bush and policies. Belfast address. Also 6854.1 with John Poet hosting rock. No politics on this show. "We want the Airwaves" at 0251 close. Belfast address or tcsshortwve@yahoo.com. (Zeller, OH)

WMPR, 6925 at 2213 and next day at 2214 with instl dance, no address. ID for "micro power radio." (Zeller, OH) (p) at 2215 with techno dance. (Wood, TN)

WHJR, 6925 at 0024 with ID for Hey Joe Radio and "WHJR—All Joe all the time." (Wood, TN)

Kracker Radio, 6925u monitored at 2353 including "Mission Impossible" theme, odd tunes, ad for Commander Bunny's presidential campaign. Heard no address announced. Station says it's affiliated with Radio Jambu International. (Zeller, OH)

MAC, 6850 at 0048 with Paul Starr show, various old pop/rock things. Off with National Anthem and laughter. (Hassig, IL)

RPR, 6925u heard at 1806. Apparent new station with mix of rock and orchestral. Mentioned "Real Pirate Radio." Another ad for Commander Bunny, which mentioned "a carrot in every pot." Discussed QSLs and asked for reports to the Free Radio Network. (Zeller, OH)

Long Range Radio, 6925.5u monitored at 0254 two men talking, a "Dial a Ho" sketch, interview with some comedian, ad for Generation X-lax. No address. Zeller, OH)

Voice of Captain Ron, 6925u with Dr. Selsyn of Radio Mouser. At 0255 talked of possible meeting at the next Winterfest. (Parker, PA)

Ozfest Radio, 6925 at 0045 with anmts in a falsetto voice. Impossible to understand with summer noise and static. Country-western song. (Hassig, IL)

Truck Driving Man, 6925u at 1740 (ID assumed). Various instrumental pop tunes and format announced as a station that plays instrumentals. (Zeller, OH)

Radio Jambu Intl, 6925u at 0105 with rock and discussion. Mention of Kracker Radio. Belfast address. (Zeller, OH)

Radio Is My Friend; My Friend Is Radio, 6925.6 at 0127 sign on. Return of the story about Graham Carter at the Cherokee Asylum in Iowa complaining of his situation there. Probably using the same transmitter as Mind Botch Radio, below. (Zeller, OH)

Mind Botch Radio, 6925.6 heard at 0035 open. Some rock, then pgm of country. Announced 6925 and asked for reports to FRN. (Zeller, OH)

Weekend Music Radio, Scotland, 6400.7 at 2240 with ID, pops. Poor in t/storm static. (Alexander, PA)

PORTUGAL—RDP Intl., 15295 in PP at 0150. (Linonis, PA) Classical guitar at 2358. (Parker, PA) 15560 in PP at 1403. (Charlton, ON) 1600 with presumed news in PP. (Brossell, WI)

ROMANIA—Radio Romania Intl., 9635 in SS at 0340 and 9645 in EE with classical selections at 0343. (MacKenzie, CA) 9675-Tiganesti in heavy QRM at 2231, 9775 in SS at 0008 and 11735-Tiganesti in EE at 1743. (Charlton, ON) 9775 in EE heard at 0017. (Parker, PA)

RUSSIA—Voice of Russia, 7250 via Armenia in RR at 0232. (Wood, TN) 9435 at 0333, 9830 in SS at 0155. (Brossell, WI) 0333. Also 9860 at 0312. (MacKenzie, CA) 9860 via Vatican at 0330, 13775-Vladivostok on history of Kremlin at 0235. //13635. (Ronda, OK) 9665 via Moldova at 0230. (Maxant, WV) 0017 in SS. And 15455-Armavir in Finnish at 2014. (Charlton, ON) 12065-Komosomolsk-Amur in RR at 0221. (Patterson, Philippines) Yakutsk Radio, 7200 in RR at 0325. (Brossell, WI)

SAO TOME—VOA Relay. Pinheira, 15730 with jazz pgm in FF at 1915. (Ronda, OK) 2025. (Charlton, ON)

SAUDI ARABIA—BSKSA, 9870 in AA at 2102. (Parker, PA) 1926 in AA and 11915 in AA at 1946. (Charlton, ON) 15205 with Koran recitations at 1603. (Brossell, WI) 17895 in AA at 0738. (Patterson, Philippines)

SINGAPORE—Radio Singapore Intl., 6000-Kranji, at 1000 in CC. And 6080-Kranji at 1221. (Patterson, Philippines) 6150 with woman anncr and U.S. pops at 0900. (Linonis, PA) 7235 in KK at 1206. (Readore, TX)

SOUTH AFRICA—Channel Africa, 17770-Meyerton at 1510 on economics there and in Mozambique. (Fraser, ME) 1544. (Charlton, ON)

Radio Sondergrense, 3320-Meyerton to the Northern Cape region in Afrikaans at 0145. (Parker, PA) 0155 with pop vocals and phone in. (Ronda, OK)

SOUTH KOREA—KBS World Radio, 9560 via Canada at 0230. (Maxant, WV) 0243. (Readore, TX) 9570-Kimjae at 1355. (Patterson, Philippines) 9670-Kimjae at 1304. (Charlton, ON)

SPAIN—Radio Exterior de Espana, 3350 Costa Rica Relay at 0203 in SS. (Ronda, OK) 0029, and 15110-Nobeljas in SS at 2104. (Parker, PA) 6055 in EE at 0010, 12015-Nobeljas in AA at 1939, 15110-Nobeljas in SS at 1558 and 17850 Costa Rica Relay in SS at 1802. (Charlton, ON) 6055 at 0010 and 9625 Costa Rica at 2025. (Maxant, WV) 9535 with contemporary Spanish music at 0000, not as good on //9630. (Barton, AZ) 12015 in AA at 2140. (Brossell, WI) 11815 via Costa Rica in SS at 1814. (MacKenzie, CA) 15110 in SS at 2237

SRI LANKA—Sri Lanka Broadcasting Corp., 11905-Ekala in Hindi at 0214. (Patterson, Philippines)

SWEDEN—Radio Sweden, 6010 via Canada on police speeding crackdown at 2045. (Maxant, WV) 6065-Horby in EE at 1945. (Patterson, Philippines) 15240 heard at 1352 on Anne Franks in Amsterdam. (Charlton, ON)

SWAZILAND—Trans World Radio, 3200 in German at 0423 but very poor. (Ronda, OK) 3240 in Ndaul language to close at 0345. Also 4775 in German at 0418. (D'Angelo, PA)

TAIWAN—Radio Taiwan Intl., 9680 via Florida with CC news at 0605. (Maxant, WV) 11550 in an Asian language at 1115 and 11665 in CC at 1548. (Brossell, WI) 11520-Paochung in Indonesian at 1000 and 15320-Paochung in EE at 0335. (Patterson, Philippines) 11715 in CC at 2243 and 15440 via Florida in CC at 0248. (MacKenzie, CA)

THAILAND—Radio Thailand, 5890 (via Greenville—gld) at 0224. (Readore, TX)

TUNISIA—RT Tunisienne, 7275 in AA at 0327. (Brossell, WI) 0434 in AA. (MacKenzie, CA)

TURKEY—Voice of Turkey, 7170-Ermiler in EE at 2055. (Patterson, Philippines) 9770 in SS at 0150. (Brossell, WI) 11980-Ermiler in TT with Koran recitations at 0410. (Parker, PA) 13750 in AA at 1515. (Fraser, ME) 15450 in EE at 1312. (Strawman, IA)

TURKMENISTAN—Turkman Radio, 5015 at 1553 in apparent political discussion in presumed Turkmen. (Foss, Philippines)

UGANDA—Radio Uganda, 4976 at 0300 with opening music, IDs. EE and Swahili anmts, local tribal music. (D'Angelo, PA) 0330 with rock. (Brossell, WI) 0441. (Parker, PA)

UKRAINE—Radio Ukraine Intl., 7440 with domestic news items at 0005. (Maxant, WV) 0222 in UU. (Brossell, WI) 2320 with DX program. (Fraser, ME)

UNITED STATES—Voice of America, 9760 Philippines Relay at 1400 and 13740 Thailand Relay in CC at 0734. (Patterson, Philippines) 9760 with "Jazz America" at 1305, 15445 at 1926. (Readore, TX) 11720 Morocco Relay in FF at 2036, 11510 Sri Lanka Relay in an Asian language at 1543 and 11625

Morocco Relay with EE ID and into Asian language at 1205. 11990 Northern Marianas Relay in CC at 1230 and 12005 Sri Lanka Relay in an Asian language at 1550. (Brossell, WI) 13640 Northern Marianas Relay in an Asian language at 2249 and 17775 Thailand Relay in CC at 2248. (MacKenzie, CA) 15145 Philippines Relay in Special EE at 2323. And 15385 Philippines Relay in CC at 0005. (Patterson, Philippines)

WYFR/Family Radio, 9755-Florida at 0937 and 11895 via Taiwan at 0826. (Patterson, Philippines) 11610 via Germany in AA at 2150 and 11875 via Ascension at 2314. (Brossell, WI)

KAIJ, Dallas, 5755 heard at 0446. (Readore, TX) 0938. Also 9480 at 1220 (Patterson, Philippines)

AFN/AFRTS, 5446u-Key West at 1013. Also 7811u-Key West at 0240 (Wood, TN) 13362u-Guam heard at 0815. (Patterson, Philippines)

WWCR, Nashville, 5070 at 0151 with a block of DX pgms. (Wood, TN)

KJES, Vado, NM, 11715 at 1510. (Maxant, WV) 15385 at 1900 with acoustic guitar, vocals, some responsive readings. (Barton, AZ)

Adventist World Radio, 12105 via Guam at 1321. (Patterson, Philippines) 15260 via Julich at 2011. (Ronda, OK)

Trans World Radio, 11840-Guam heard at 0800. (Patterson, Philippines) 12085 via Novosibirsk in listed Nepali heard at 0116. (Ronda, OK)

WMLK, Bethel, PA, 9265 at 0005 with choirs. (MacKenzie, CA) 1735. Still just 50 KW. (Maxant, WV)

WHRI, 7310-Cyprus Creek at 0030. (Fraser, ME)

WBCQ, Monticello, ME, 7415 heard at 0255 with "The Lost Discs Radio Show." (Parker, PA)

WEWN, Vandiver, AL, 5810 with Mother Angelica at 0400. (Maxant, WV) 5850 at 0923. (Patterson, Philippines)

VATICAN—Vatican Radio, 4005 in Italian at 0315. (Parker, PA) 5995-Santa Maria di Galeria in EE at 2044. (Patterson, Philippines) 6040 at 0245 in FF. (Maxant, WV) 7250 in Polish at 0424. (Readore, TX) 11625 heard at 2008. (Charlton, ON)

VENEZUELA—Radio Nacional 11670 at 2220 with SS speech and 11705 in SS at 2225. Also 13680 in SS at 2304 (MacKenzie, CA) 11670 at 2227 with SS music pgm. (Barton, AZ) 11675 at 2225 with SS talk about Argentina and into SS vocals. Also 13680 in SS at 1435 with sudden signal loss. (Maxant, WV). 15250 in EE at 2300; into SS at 2314. (Parker, PA) (all via Cuba—*gld*)

VIETNAM—Voice of Vietnam, 5925 in VV at 0806. (Patterson, Philippines) 6175 via Canada in EE at 0230. (Readore, TX) 7210 in presumed VV at 1152. (Foss, Philippines)

ZAMBIA—The Voice-Africa (Christian Voice) 4965 at 0320 with EE religious talk and choir. Another canned religious program at 0330. (D'Angelo, PA) 9430 at 0506 with

listener's letters and contemporary Christian music. (Wood, TN)

ZIMBABWE—Radio Zimbabwe, 3396 at 0350 with tribal singing, ID and news in EE at 0400. Later into the Shona language. (D'Angelo, PA)

And once again, order is restored! To quote George M. Cohan: "My mother thanks you. My father thanks you. My sister thanks you. And I thank you."

Robert Brossell, Pewaukee, WI; Marty Foss, Guinayangan, Philippines; Stewart MacKenzie, Huntington Beach, CA; Gerald Readore, TX; Robert

Charlton, Windsor, ON; Robert Fraser, Belfast, ME; Rick Barton, Phoenix, AZ; Brian Alexander, Mechanicsburg, PA; George Zeller, Cleveland, OH; Jerry Strawman, Des Moines, IA; Joe Wood, Greenback, TN; T.C. Patterson, Cebu, Philippines; Richard Parker, Pennsburg, PA; William Hassig, Mt. Prospect, IL; Jack Linonis, Hermitage, PA; Jim Ronda, Tulsa, OK; Charles Maxant, Barboursville, WV; Rich D'Angelo, Wyomissing, PA; and Mark Taylor, Madison, WI. Well done, all!

Until next month, good listening!

When Disaster Strikes...



REACT is Ready!

REACT Teams work with local, state, and national disaster response agencies. Often **REACT** plays a unique role in disaster relief because **REACT** is the only volunteer communications organization whose members are trained to use **all types of two-way communications** from CB to packet radio, Amateur radio to GMRS.

Fortunately, disasters don't happen every day. **REACT** Teams maintain their readiness and serve the public by monitoring emergency channels and by providing communications services for a variety of activities and community events.

Find out how **you** can be part of the **REACT** Team! Visit www.reactintl.org to find a Team in your area – or information on starting your own Team.



REACT International, Inc.
(301)316-2900 or (866)REACT99
5210 Auth Rd., Ste. 403 * Suitland, MD 20746

The Motorola DTR410 Frequency-Hopping Radio

I have seen the next step in personal portable communications devices: the Motorola DTR series of Frequency-Hopping Spread-Spectrum (FHSS) radios. I'm always keeping an eye out for neat, exotic communications equipment and the opportunity to experiment with new radio technology, so when I discovered the DTR series two-way radios on Motorola's product website, I had to check them out.

The DTR series is comprised of 1-watt license-free handheld transceivers, which operate in the 902–928 MHz band, along with many other Part 15 and ISM (Industrial, Scientific, Medical) devices. (This 33cm band is also shared with the amateur radio service.) Unlike other license-free radio services, such as FRS, MURS, and CB, which operate on a single analog FM or AM frequency per channel, the DTR series radios use digital modulation and FHSS. This means they are less susceptible to interference and can't be received by scanners, offering more privacy to users. Motorola claims a two-mile range with these units, just like many FRS radio manufacturers claim a two-mile range with their little 1/2 watt, 460 MHz handhelds. But anyone who has played with FRS knows that you're lucky to get a half-mile to a mile under most circumstances. How well do these DTR radios work in comparison? Read on.

First Some Background

FHSS is nothing new. The military has been using it for years with their SINCARS (Single Channel Ground/Air Radio System) radios. Instead of staying on one frequency when transmitting, a FHSS radio "hops" through a number of different frequencies in a pseudo-random sequence. This reduces the vulnerability of the communications to interference and interception. More commonly, FHSS is used by 802.11 "Wi-Fi" wireless computer networks and by many cordless telephones operating in the 902–928 MHz, 2.4 GHz, and 5.8 GHz ISM bands.

Some amateur radio operators are experimenting with FHSS communications. But while FHSS is fairly common in industrial, government, military, amateur, wireless networking, and consumer telephone applications, until Motorola's DTR radios were introduced there were no dedicated two-way FHSS radios available in a relatively inexpensive, license-free package.

The company makes three models of DTR radios for the U.S. market. The basic entry-level version is the DTR410 (the model tested for this review). The DTR410 features six "public talkgroups." For the purposes of keying-up and talking, think of these as channels on an FRS or CB radio. The other two models are the DTR550 and DTR650. These are interoperable with the DTR410 as they, too, can communicate over the same six public talkgroups. Additionally, the DTR550 and DTR650 can operate in a private "unit-to-unit" mode, and the DTR650 can act as a supervisor radio, enabling the user to remotely monitor and disable other DTR units. Other than these firmware differences, these are basically the same 1 watt, 900 MHz FHSS radio.

The Paces

The first thing I wanted to do with these radios was to try hearing them with a scanner. I set up a RadioShack PRO-83 with its "Signal Stalker" feature, a frequency counter, a spectrum analyzer, and an old Optoelectronics R-10 Interceptor.

I started with the PRO-83. This little \$100 scanner's near-field signal detector has changed how many hobbyists look for new frequencies. I turned it on, made sure the 800/900 MHz band was selected, and keyed up the DTR410. Nothing. Nada. Zip. I then did a more traditional frequency search of 902–928 MHz and found a donut shop's drive-through, a couple of baby monitors, and some amateur radio operators on a local 927 MHz repeater. Nothing from the DTR though. Neat!



The Motorola DTR410 digital FHSS license-free transceiver represents a technological trend in two-way radio. This advanced technology is becoming increasingly affordable to non-government users.

Next in line was the Optoelectronics R-10 Interceptor. Finally, I heard something. This deceptively capable piece of intercept gear (masquerading as an innocent piece of test equipment) emitted a popping noise that sounded nothing like analog audio. So not only do DTR radios use frequency hopping, they also use digital audio modulation!

After that test, the frequency counter and spectrum analyzer results were anti-



An FCC plaque adorns the marble walls of the Empire State Building, walls the DTR410's signal navigated around, all the way from the 50th floor down to the lobby—with no windows in sight. The signal path of the I wait FHSS isn't known, but a conventional VHF or UHF handheld transceiver probably couldn't make it.

climactic, as they confirmed what I already knew about the DTR radios. The frequency counter tried to lock onto the DTR signal, but didn't have a fast enough gate time and simply gave readings around 900 MHz. An Optoelectronics Digital Scout or similar counter with a faster gate time might be able to display the exact frequencies. The spectrum analyzer gave me a nice view of a frequency-hopping signal.

One other notable thing about the DTR410 is that it requires another unit on the same "channel" in order to key up, or it will beep and display an error message. This is a nice feature because if your radio keys up you can generally assume that at least one person is within range. This also allows solo communications range tests if you have nobody to play with. Fortunately, I had help from some friends to check out these units.

First among them was Hank, a fellow military veteran who shares my interest in radio communications and is my usual conspirator in playing with things technological. The two of us headed up Interstate 91 towards Keene, New Hampshire, and parts beyond. Talking car-to-car we achieved about a two-mile range between radios, which lived up to Motorola's claims. Driving around various towns in southern New Hampshire, the units consistently gave us a range of about a mile to a mile and a half. Hiking in the region's mountainous terrain, that range decreased

to about a half a mile to three-quarters.

After playing with the DTR410s up north, I called my friend Bernie, another electronics hobbyist, who suggested the

most RF-intense, interference-plagued, radio-unfriendly environment between us: New York City. The two of us were soon walking down 33rd Street seeking a suitable place to test Motorola's claimed in-building operating range of 25 stories. Heading in the general direction of Herald Square we saw the tallest thing on the New York skyline—the Empire State Building—and figured "Why not?" While I remained in the lobby, Bernie took one of the radios and went in, keying up from the 25th floor with perfect audio quality. Then he keyed up from the 30th floor with perfect audio quality. By the time he got up to the 51st floor, his audio was getting "digitized" and unreadable. Impressive. In the meantime, I scanned the DTR410's public talkgroups looking for other DTR users. We decided to try walking away from each other at ground level for the next test and managed to stay in touch for about six blocks. Considering the urban terrain and RF noise floor we were dealing with, we were again quite impressed.

Manhattan was also the only place I encountered anyone else using DTR radio channels during the several weeks I played with them. While scanning the public talkgroups I heard some user activ-

1010 Jorie Blvd. #332
Oak Brook, IL 60523
1-800-985-8463
www.atomictime.com

ATOMIC TIME



ADWA 01 - \$49.95

14" LaCrosse Black Wall WT-3143A \$26.95

This wall clock is great for an office, school, or home. It has a professional look, along with professional reliability. Features easy time zone buttons, just set the zone and go! Runs on 1 AA battery and has a safe plastic lens.



WT-3143A - \$26.95

Digital Chronograph Watch ADWA101 \$49.95

Our feature packed Chrono-Alarm watch is now available for under \$50! It has date and time alarms, stopwatch backlight, UTC time, and much more!

LaCrosse Digital Alarm WS-8248U-A \$64.95

This deluxe wall/desk clock features 4" tall easy to read digits. It also shows temperature, humidity, moon phase, month, day, and date. Also included is a remote thermometer for reading the outside temperature on the main unit, approx. 12" x 12" x 1.5"

WS-8248 - \$64.95

LaCrosse WS-9412U Clock \$19.95

This digital wall / desk clock is great for travel or to fit in a small space. Shows indoor temp, day, and date along with 12/24 hr time, apx 6" x 6" x 1"

WS-9412U - \$19.95

1-800-985-8463
www.atomictime.com
Quantity discounts available!

Tell time by the U.S. Atomic Clock - The official U.S. time that governs ship movements, radio stations, space flights, and warplanes. With small radio receivers hidden inside our timepieces, they automatically synchronize to the U.S. Atomic Clock (which measures each second of time as 9,192,631,770 vibrations of a cesium 133 atom in a vacuum) and give time which is accurate to approx. 1 second every million years. Our timepieces even account automatically for daylight saving time, leap years, and leap seconds. \$7.95 Shipping & Handling via UPS. (Rush available at additional cost) Call M-F 9-5 CST for our free catalog.

ity on the Channel 1 public talkgroup. But if other DTR users within range of where I tested these radios were using the higher-end DTR550 or DTR650 in private-call mode, I would have heard nothing on the DTR410s six public talkgroups.

What's In It For You

Individuals, groups, and small businesses looking for greater two-way radio privacy are in luck with these DTR radios, and the fact that scanner receivers cannot monitor them is unlikely to change anytime soon. They're not much more expensive than some higher-end VHF/UHF business-band radios, which can easily be monitored with scanners. If you were assembling a new small portable radio system from scratch, it might be worth considering Motorola's DTR radios, as they can be better managed and have unique features not found in similarly priced analog portables (more on these features later.) These radios are license-free, fairly uncomplicated, and ready to "plug-and-play." They could also be ideal for short-range use by CERT, Search & Rescue, and disaster response teams.

Besides having 15 and 25 public talkgroups, respectively, the higher-end DTR550 and DTR650 have additional features. The first is the ability to use them for unit-to-unit private talkgroup communications. Each radio is preprogrammed with an ID number from Motorola that can be changed by the user. By using these ID numbers with the private-call function, the public talkgroups are bypassed for an even greater level of privacy.

The security-minded will also appreciate that the DTR650 can be configured as a supervisor radio, allowing management functions such as Remote Monitor and Remote Disable.

Remote Monitor allows a supervisor radio to remotely key up another radio and listen to audio in its vicinity before timing out after one minute. This could be used as a nice security feature by placing one or more DTR radios in strategic locations and covertly monitoring any audio (where allowed by law). Remote Disable would be useful in dealing with stolen radios and channel abuse by system users. As its name implies, this is a "kill" command that shuts down a radio, rendering it unusable until re-enabled by a supervisor DTR650 radio.

Something New To Enjoy

While some scanner hobbyists may decry the advent of more affordable FHSS radios as a hindrance to their monitoring activities, previous two-way radio technology developments have far from ended the hobby. Radio communications monitoring is a diverse pastime, enjoyed by intelligent and forward-thinking individuals, many of whom will view FHSS technology as another challenge to be embraced with open arms.

As spectrum overcrowding becomes more of an issue, expect to see more FHSS radios from different manufacturers. No matter what your current two-way radio needs are, you should take a look at these radios—they represent the future.

The Motorola DTR410 lists for about \$335 each. Motorola calls it a "Business" class product so it's available through numerous retailers, some of which advertise it online for under \$240. The DTR550 and DTR650 are "Commercial" models and only available through Motorola dealers (the DTR550 lists at around \$385, but is advertised online by some Motorola dealers for under \$320; the DTR650 lists at around \$400, but some Motorola dealers advertise it for under \$350).



Monitoring Times

ORDER TODAY!



Do you own a radio, a shortwave receiver, a scanning receiver, or a ham radio? Then Monitoring Times® is your magazine! Open a copy of MT, and you will find news, information, and tips on getting more out of your radio listening. In fact, it's the most comprehensive radio hobby magazine in the U.S.

MT Express - Not only do we offer a premium monthly printed magazine, but we also offer the popular MT Express digital version of Monitoring Times. This is the best way to get your magazine as soon as it's released, right from the internet! All you have to have is an internet connection with an e-mail address and you're ready for all the excitement of a truly interactive publication. For less than the cost of a printed subscription, you get the full magazine in pdf format with color photos throughout and active links to all web sites mentioned in the text.

Packed with up-to-date information concisely written by the top writers in the field, Monitoring Times® is your foremost guide to profiles of broadcasting and communications installations; home projects; and tips on monitoring everything from air, sea, and space to distant ports of call.

800-438-8155

828-837-9200 fax: 828-837-2216

WWW.GROVE-ENT.COM

order@grove-ent.com
7540 Highway 64 West
Brasstown, NC 28902

GROVE

Order today to start your monthly reference!

7540 Hwy 64 W, Brasstown, NC 28902
1-800-438-8155 US and Can., 828-837-9200, Fax 828-837-2216
e-mail: order@grove-ent.com

	6 Months	12 Months	18 Months	24 Months
US Rates	\$15.95	\$28.95	\$37.95	\$44.95
US Int'l Class	\$36.00	\$57.95	\$71.00	\$84.00
Canada Service*	\$25.95	\$39.95	\$47.95	\$54.95
Foreign International*	\$38.95	\$59.95	\$71.95	\$84.95
Electronic Subscription	\$19.95	\$38.95	\$57.95	\$67.95

*All payments must be in U.S. Funds drawn on a U.S. Bank!

Name _____ Address _____
City _____ State _____ Zip _____ Country _____
CLP _____ Exp. Date _____ C/PZ Code _____
Signature _____
E-mail address _____
MasterCard, Visa, and Discover Card accepted!

Or just go to www.grove-ent.com to order NOW!

A New Jersey Triad

Welcome to New Jersey, home to three important and well-known adjoining facilities of the U.S. military: McGuire Air Force Base, Fort Dix, and the Naval Air Engineering Station Lakehurst.

Between them, they provide a lot to listen to, so let's dive right on in.

McGuire Air Force Base

Part of the U.S. military since its opening in 1937, McGuire Air Force Base is an important part of the international mobility mission of the U.S. Air Force.

Originally called Rudd Field, and hosting a single dirt airstrip, the base was originally opened to provide for the aviation needs of the adjacent Fort Dix army base. Located 15 miles from Trenton, the base was dramatically expanded during World War II. It became part of the Air Force in 1947 and was then named for Major Thomas McGuire, a World War II air ace who was killed in action.

Home of the 305th Air Mobility Wing, McGuire handles a great deal of logistics traffic; using C-17A aircraft, the base can originate many flights carrying a vast amount of materiel to support the various military missions of the United States. Its proximity to the major cities of the north-

eastern United States means it is strategically located to meet those logistics needs.

Subordinate units of the 305th Wing include the 305th Maintenance Group, comprised of four squadrons handling maintenance operations; the 305th Mission Support Group, eight squadrons with responsibility for base operations, security, and communications; the 305th Operations Group, whose four squadrons handle airlift and midair refueling operations; and the 305th Medical Group, comprised of four squadrons responsible for the medical needs of the 305th Wing.

McGuire also hosts the Navy's Patrol Squadrons 64 and 66, Anti-Submarine Squadron 94, and Marine Air Group 49. Other units based at McGuire include the 108th Air Refueling Wing of the New Jersey Air National Guard; the 21st Expeditionary Mobility Task Force; Detachment 1 of the 373rd Training Squadron; and the Air Mobility Command's Test and Evaluation Squadron.

Also a part of McGuire AFB is the Air Mobility Warfare Center. While it's physically located on Fort Dix, the AMWC is part of McGuire AFB. The function of the AMWC is advanced education, training, and testing of Air Force personnel. The AMWC handles, among other things, training and education in transportation

flight, air refueling tanker tactics, air mobility, and combat aircrew training. A recent addition is the Air Mobility Battle Lab, which researches innovations in air mobility, logistics, and mobility command and control.

Fort Dix/McGuire AFB Trunked System

406.7500	408.1625	409.3500
406.9500	408.3500	409.5625
407.3625	408.5625	410.0000
407.5625	408.9500	413.2000

Fort Dix Talkgroups

1616	Police 1
1648	Police 2
1680	General Operations
1712	Police Emergency
1744	Fire 1
1776	Fire 2
1808	Fire Emergency
1840	Range Control
1872	Range Control
1904	Range Management
1936	EOC 1
1968	EOC 2
2000	Inmate Labor
2032	Civil Engineering 1
2064	Civil Engineering 2
2320	EOD

McGuire Air Force Base Talkgroups

16	Command Net 1
112	305th Maintenance Squadron
144	Base Supply
240	Flight Line
272	305th Aerial Port operations
304	305th Communications Squadron
336	Civil Engineering 1
368	Civil Engineering 2
400	Disaster Preparedness
432	305th Medical Group 1
656	Fire Command
688	Fire Operations
848	Air Mobility Warfare Center
880	305th Transportation Squadron
1136	Command Net 2
1232	305th Medical Group 2
2192	Base Operations



A C-17A Globemaster taxis in to park on the ramp at McGuire AFB. (Photo courtesy U.S. military DefenseLink)



Air Force troops drive their Humvee through red smoke during training at Fort Dix. (Photo courtesy U.S. military DefenseLink)

McGuire AFB Aviation Frequencies

124.150/363.800	Approach/ Departure
120.250/290.900	Arrivals
135.200/335.800	Clearance Delivery
118.650/255.600	McGuire Tower
121.800/275.800	McGuire Ground
110.600/270.100	ATIS
134.100/372.200	Pilot to Dispatcher
134.100/319.400	Command Post
239.800	Metro (Weather)

244th Aviation Brigade, the 50th Brigade of the 42nd Infantry Division, and a host of support and training units.

Fort Dix also hosts the Fort Dix Federal Correctional Facility, a low-security institution for male offenders.

Naval Air Engineering Station Lakehurst/ Maxfield Field

We've all seen it and heard it...that famous newsreel footage of the German airship *Hindenburg* crashing to the ground in flames in 1937. The place where that happened, Naval Air Station Lakehurst, is still an active facility of the U.S. Navy.

Known today as Naval Air Engineering Station Lakehurst, the base was opened by the Army in 1917 as Camp Kendrick, an ammunition proving ground. It was redubbed NAS Lakehurst in 1921, and rapidly became the world's

One of the most important functions of McGuire AFB—just as when it was first opened—is serving the aviation needs of adjacent Fort Dix. Fort Dix has for many years been a major transshipment point for military personnel heading overseas, and many thousands of them have started their journey via the runways at McGuire.

The airfield at McGuire has two runways, 06/24 and 18/36. The field has its own radar approach control facility, which handles air traffic control, not only for MAFB but also for transitory aircraft, as well as various other airports in the area, including among others the Trenton-Robbinsville Airport, the Naval Air Engineering Station in Lakehurst, the Atlantic City International Airport, and the Philadelphia International Airport.

Fort Dix

The adjacent facility, and original reason for McGuire's existence, Fort Dix was named for Major General John Dix, a veteran of the Civil War and the War of 1812 and who later served in many high-ranking government posts. Opened in 1917, during World War I, to support training of units for the fighting in France, Fort Dix rapidly became the largest military facility in the northeastern United States. Originally named Camp Dix, the facility served as a separation (known then as demobilization) center after the end of the war.

Fort Dix served as a training center for

many years, becoming a Basic Training Center in 1947. It served this function until the early 1990s, even hosting a mock Vietnamese village during the Vietnam War, but the basic training function was eliminated by the first round of realignment. The base then became an advanced training center for the Army Reserve and continues this function today.

Units based at Fort Dix include the 5th Battalion of the 174th Infantry Brigade, the 63rd Ordnance Battalion, the 3rd Basic Combat Training Brigade, the

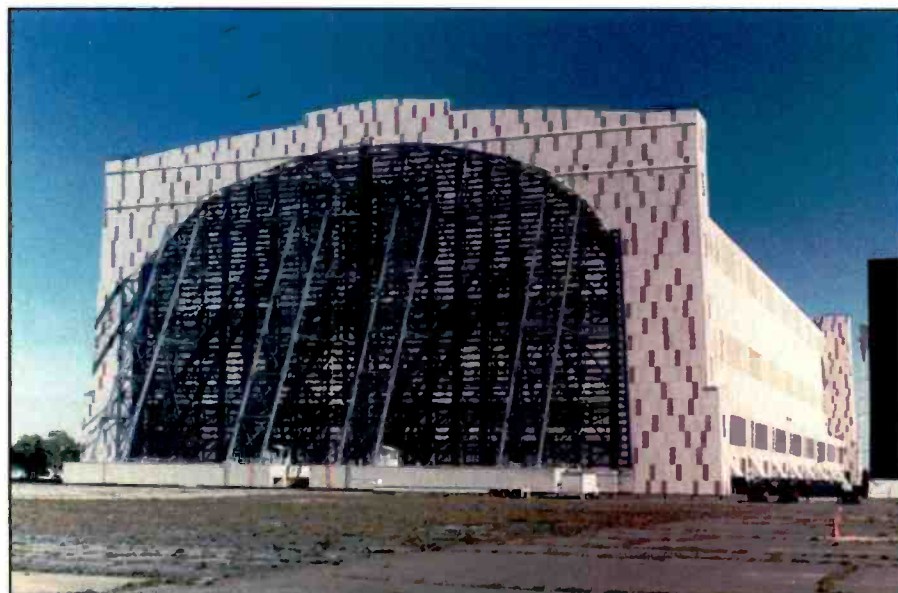

Hangar 1 at the Naval Air Engineering Station Lakehurst is a National Historic Landmark and was once (maybe still?) the largest single room on Earth. (U.S. Navy photo)



Firefighters training with a new illuminated hose being developed at Lakehurst. The new hose is intended to aid disoriented firefighters in finding their way to safety. (Photo courtesy U.S. military DefenseLink)

leading development facility for lighter-than-air craft. It served in this capacity until 1961, when the Navy discontinued its airship program. Its relatively unique capabilities made it a natural for the German government to use for landing its airships during their trans-oceanic flights, one of which ended in the demise of the *Hindenburg*.

To this day, the base at Lakehurst contains the old airship hangars, including Hangar 1, a National Historic Landmark and once (and perhaps still) the largest single room on Earth. Also remaining are parts of the old "high mast" used for mooring Navy airships, as well as the well-marked site of the *Hindenburg* crash, which is marked out in the shape of the crashed airship.

During and after World War II, Navy blimps engaged in anti-submarine patrols

used the base. It also continued airship development and became the leading center for the development of aircraft launch and recovery systems like those used on aircraft carriers—missions the base continues today.

Maxfield Field, the airfield component of Navy Lakehurst, has two operational runways, 6/24 and 15/33, as well as two test runways. The first of these is 12,000 feet long and includes a built-in steam catapult system, arrester gear, and a Fresnel Lens Optical Landing System (the "meatball," source of the "call the ball" heard during aircraft carrier landings). The other is several thousand feet long and also holds an arresting gear system.

The Future?

McGuire AFB, Fort Dix, and Lakehurst will continue their missions into the future, but will no longer be separate facilities. The latest round of realignment has decreed that McGuire AFB, Fort Dix, and the Naval Air Engineering Station Lakehurst be merged into the new Joint Base McGuire/Dix/Lakehurst, with command and operations headquartered at McGuire.

The entire area is well worth spending some time in. Whether you're planning on doing the Holidays' circuit or visiting the shore in warmer weather, make sure to check out the *Hindenburg* museum at Lakehurst. Don't forget to take your scanner, though, and check the sidebars for frequencies, because there's a lot to listen to!

NAS Lakehurst Frequencies

140.20000	Fire Tactical 1
140.05000	Fire Dispatch
140.05000	Fireground
140.12500	Fire Operations
139.50000	Command Net
140.12500	Security
158.65000	Fire Tactical 2
127.775/360.200	Lakehurst Tower
118.375/352.400	Lakehurst Ground
121.500/243.000	ATIS
41.2500	Army Reserve Operations
255.700	Army Operations

ADVANCED SPECIALTIES INC.

Orders/Quotes 1-800-926-9HAM

www.advancedspecialties.net

BIG ONLINE CATALOG



BCD996T
6000 Channel Digital
Trunking Scanner

UNIDEN BEARCAT DIGITAL
SCANNERS • CB • AMATEUR •
RADIOS & ACCESSORIES

ALINCO • YAESU • GALAXY
• RANGER • COBRA

(201)-VHF-2067

114 Essex Street, Lodi, NJ 07644



Closed Sunday & Monday



ELECTRIC RADIO MAGAZINE

Tired of modern radios you can't work on and are hard to understand? ER is the monthly magazine for you! Send \$1 for a sample to:

ER, PO Box 242,
Bailey CO 80421-0242
720-924-0171 or email:
1Editor2@indra.com
WWW.ERMAG.COM



RentScanner.com



- Try before you buy
- One week to one month
- AR8200MKIII, PRO-96, BCD396T
- Starting at \$23
- Mention Pop'Comm for a free 1-week extension!

www.rentscanner.com

WE'RE ON THE WEB

Check out our
Web site at:

www.popular-communications.com

Licensed Before 1982?

QCWA invites you to join with those distinguished amateurs licensed 25 or more years ago. Request an application form:

QCWA, Inc., Dept. P

PO Box 3247

Framingham, MA 01705-3247

www.qcwa.org



In Pennsylvania, A Mecca For Military Gear Collectors And Aficionados

Each year, around the third weekend of the month of September, hundreds of military collectors and aficionados gather at the West End Fairgrounds near Gilbert, Pennsylvania, for what has become one of the major northeast gatherings of Military Vehicle Preservation Association (MVPA) and Military Radio Collector's Association (MRCA) members. This is basically a "Show-And-Tell" on steroids!

MVPA/MRCA members from all over the Mid-Atlantic states and New England flock to the Gilbert Fairgrounds to show off their latest restoration efforts, buy, sell, swap pieces of military hardware and electronic equipment, meet old friends, and make new ones. The historical significance of this event is not lost on first-time attendees, either. The overall theme of the weekend is fun, fellowship, and keeping the history of the vehicles and electronics alive for future generations to enjoy.

This is my sixth trip to an MRCA meet, and each year the attendance has grown and the quality of exhibits and presentations has improved dramatically. Although the meet starts "officially" at 1200 L on Friday, true military communications (MilCom) collectors often arrive early on Friday morning. The truly dedicated arrive on Thursday afternoon to pick over the offerings at the flea market before others get there.

Friday Fun

Among the most interesting things about this yearly event are the radio exercises that are conducted on Friday afternoon. Following an official briefing by the event staff, several two- and three-person groups grab their radio gear, hop in a vehicle, and charge off to remote areas, like Big Pocono Mountain, to



Al Klase, N3FRP, shows my grandson, Llyam, how to tune up the "Angry Nine" (AN/GRC-9) HF radio set at the MRCA meet at the Gilbert, Pennsylvania, Fairgrounds. Llyam had a great time for two days learning all about MilCom radio sets, antennas, and how to set up and operate them.



Here's Ted Young, W3PWW, at the controls of his GRC-19 radio set, which he uses as Net Control Station for the Old Military Radio Net for each Saturday morning of the MVPA/MRCA Military Meet at 0500 Eastern time.

set up their gear, erect antennas, and make contact with the headquarters station located at the Fairgrounds. Each year participants push the capabilities of their vintage and antique military radio equipment to the limit.

This year was the first time near Vertical Incident Skywave (NVIS) operation was tried on the HF bands. The overall consensus of the participants was that NVIS propagation worked quite well, even using 50- and 60-year-old radio equipment!

The evening culminated with a meal at Studebaker's, the local home-style eatery in the immediate area. Well-fed MRCA members returned to the Fairgrounds ready for some telling of tall tales well into the night. I had my grandson, Llyam, with me and we decided that we had had enough fun for one day and took leave of our fellow MRCA members and retired to our camp trailer for a good night's sleep.

Saturday's Reveille, And Lots To Learn

Thankfully no one blew a bugle! The MRCA members started gathering around 0600 and soon had radios working. Prior to this Ted Young, W3PWW, conducted the Old Military Radio Net (OMRN) on 3885 kc (AM, of course) from the MRCA HQ station. Over the last 10 years, Ted has been the Net Control Station (NCS) for the OMRN each Saturday morning. Ted's station is a completely reconditioned GRC-19, comprised of an R-392 receiver and a T-195 AM transmitter.

MRCA attendees were busily setting up their respective equipment displays. Each year these displays get better and better. Some of the radio equipment on display consisted of extremely rare pieces of MilCom gear. For instance, the first "walkie-talkie" that was designed specifically for military use was the BC-611 that Al Klase, N3FRP, had acquired. This set

A Deeper Understanding

To talk with the MVPA and MRCA members and folks like them is to receive an oral history lesson centered upon a piece of comm gear or military vehicle. This hobby forces the participant to become part electronics technician and part historian, because it's virtually impossible to undertake and successfully complete a MilCom restoration without researching and becoming intimately familiar with the technology of the time. The really neat part of the process is that the more you read and find out about a particular piece of MilCom gear, the more you find out about the history of the period and how, when, where, and by whom it was used.

One shining example of this is the Navy TBM. This low-band VHF set featured a regenerative receiver and a simple transmitter. Was this an AM or FM set? The answer, "Yes!" This particular set was extremely unstable; sometimes the receiving station could hear the regen receiver of the transmitting station better than the other station's transmitter! In reality these were very primitive sets but were used very effectively by the Navajo Code Talkers in the Pacific Theater of Operations.

In my personal restoration efforts of several of my clandestine (spy/special ops) radio sets, I have discovered the colorful and extremely dangerous lives of the Studies and

Observations Group (SOG) members attached to Military Assistance Command-Vietnam (MAC-V). These stalwart and adventurous special ops groups comprised of three U.S. Army Green Berets and nine indigenous ops, would be inserted into North Vietnamese-controlled areas of Cambodia and Laos, mostly along the Ho Chi Min Trail. Their mission: to gather intelligence on the North Vietnam Army units, kidnap NVA troops (preferably officers), and assess bomb damage inflicted by the incessant B-52 "Arc Light" bombing missions. Often these teams would land under fire, spend two to five days on the ground literally running through the jungle for 18 to 20 hours per day, and be extracted under fire. The attrition rate (read "death toll") of these teams was extremely high. Yet they continued to accomplish their mission despite terrible odds and knowing that their "number could come up" virtually any time.

The equipment they used varied from the PRC-25 low-band VHF FM transceiver, to the PRC-64 four-channel CW/AM phone radio set, and virtually anything in between. Other SOG radio sets included the PRC-74 SSB/CW pack set along with the TRC-77 six-channel CW radio and the GRC-109 CW set. My research into the radio gear led me to the SOG missions and added a whole new dimension to my understanding of the war in Vietnam.

was lifted virtually from the pages of *QST* and author Russ Hull's experimental equipment of the late 1930s. In addition to all this great historic gear, Al showcased a really neat prototype of a spy receiver acquired from the estate of a former AT&T engineer.

Breck Smith, K4CHE, had his portable field table set up complete with camo netting, steel pot, and a GRR-5/R-174 receiver from the 1950s. Also on display at Breck's area was a working PRC-10 6-meter FM transceiver. The defacto 6-meter squad radio frequency is 51.0 mc, with an alternate of 51.4 mc. This weekend, 51.0 was extremely active as various members in attendance would demo their low-band VHF gear during the meet.

If there are active military vehicle collectors and radio enthusiasts in your area, you might want to load up 51.0 and 51.4 mc into your scanner and monitor those frequencies for activity, especially on weekends during the late spring into the early fall. Once you find out where a meet will be taking place, why not plan to attend. If nothing else, you'll be thoroughly entertained and amazed at the workmanship and outstanding abilities of these vehicle and electronics restorers.

There were several presentations at this year's meet. The first presentation showcased several off-line encryption units from WWII. I never knew that we even had stuff like that! It was a great topic for discussion. Although eBay has hyper-inflated the prices of these primitive crypto pieces (average price was around \$2,500!), you can still find them occasionally at yard and estate sales for under \$500, which is a good buy. Although you are prohibited from using codes and ciphers on the amateur bands, these communications accessories would make great additions to MilCom displays.

Llyam wasn't too impressed with the presentations and after a couple of hours became bored. Shortly after the presentations finished Al, Llyam, and I were sent out the end of the

Fairgrounds to set up two radio sets for an on-site demonstration. After a short drive to the operating location we had the gear unpacked and Llyam received some "character building" on-the-job training regarding assembling a whip antenna, the proper way to coil antenna and counter poise wires and other types of cabling, and, last but not least, how to properly crank the hand-cranked generator on the GRC-9 radio set!! Al even let Llyam use his WWII BC-611 handie-talkie for several field



Under the heading of "How to keep a 10-year-old busy," here's grandson Llyam cranking away on the generator for the vintage GRC-9 radio set. After a brief go at the generator, Llyam confided in me that it takes a LOT of effort to make that radio work!

tests. To say that my 10-year-old grandson was stoked would be an understatement.

Technology From An Historical Perspective

Keeping these old military vehicles and radio gear perking right along is a time-intensive job, to say the least. Discovering the history of these old pieces of gear and becoming an expert in their repair is only one phase of the collection/restoration process. Each piece of gear has a unique history (see "A Deeper Understanding"). Much of the gear was developed to fill a critical need to fight a war. The equipment was designed to be extremely rugged and to function under unbelievably harsh conditions. Not only that, much of the gear was state of the art or on the cutting edge of the technology of the day.

Of course, today we look at these *old relics* and wonder how anyone could have used them to communicate. However, during WWII, radio was a pivotal technology and arguably determined that conflict's outcome.

Radio was to WWII what the airplane was to WWI. It completely changed the way we prosecuted the war. No longer were frontline troops effectively isolated during combat. With the introduction of squad radios, like the BC-611 handie-talkie and the BC-1000 "walkie-talkie," the troops in the trenches had instant access to higher command levels and could call in all-important artillery strikes to relieve assaults on their positions. The Americans' ability to coordinate several types or layers of artillery fire in quick succession was extremely effective in blunting any enemy assault. This was all coordinated and executed via radio. Those same 60-year-old sets work just as well



This radio stuff is not all fun. Here N3FRP and Llyam troubleshoot a problem on a vintage WWII BC-611 "handie-talkie." Llyam was eager to learn and is hot on the trail of his Technician ham ticket.

today as they did on the battlefields of WWII in the 1940s, thanks to the efforts, and dare we say love, of MilCom radio collectors/restorers.

What It's Really All About

The MRCA meet allowed me to recharge my MilCom batteries, so to speak. Plus, in bringing Llyam along, I felt that I had fueled the "radio fire" that I had started months earlier when we were working on the Tuna-Tin II transmitter together. It was great to see Llyam being accepted by the MRCA gang. They treated him like a rock star and he really stole the show. I had the distinct impression that many of the MRCA members who talked with Llyam saw themselves in earlier years.

It's great to see a young person bitten by "the Radio Bug." It gives me hope that our hobby will continue to grow well into the next generation and beyond. Llyam now has to compose an essay for presentation to his class about his trip to the MRCA/MVPA meet. It will be fun to read his comments about the things he saw and took part in during the meet.

That's all for this month. Have a safe holiday season and remember:

Preparedness is not optional!

**TERRORISM FORCES
US TO MAKE A
CHOICE. WE CAN BE
AFRAID. OR
WE CAN BE READY.**

READY

WWW.READY.GOV

1-800-BE-READY



Radio Fun And Going Back In Time

Q. The Battle of Midway was one of the main turning points in World War II. Did radio play any part in that decisive action?

A. It sure did. When President Roosevelt was asked by a radio newscaster where the planes for the Doolittle Raid (April 18, 1942) had come from he said, "from our secret base in Shangri La," referring to the John Hilton book *Lost Horizons*, which was popular at the time.

Hearing that broadcast, Japanese Intelligence scoured the maps of the Pacific and thought that Shangri La might be a code name for Midway Island. Plans were drawn up immediately to expand the area of Japanese control by taking Midway.

About the time of the Battle of the Coral Sea (May 8) American code breakers teased out a Japanese plan for a major offensive against an objective whose code designation was AF. American military planners looked for possible Japanese targets and came up with two places that might be AF, Midway Island and the Aleutian chain in Alaska.

Admiral Nimitz, who was at Pearl Harbor, ordered a fake unencoded message to be sent from Midway to Pearl Harbor indicating that Midway was having trouble with its saltwater treatment plant and was in danger of running out of drinking water. Soon Navy intercept operators learned the Japanese thought AF was running out of drinking water. This told the code breakers at Pearl Harbor that the traffic involving the major build up in the plan meant a major attack on Midway.

The Japanese and American fleets maneuvering around the Island maintained radio silence. When they launched planes, however, both fleet radio direction finding units gave everyone the locations of all the carriers during the battle (June 4 through 7). The rest of that heroic fight was up to the pilots and gunners and those who directly supported them.

Q. What are nulls and what causes them?

A. A null is a place where radio signals can't be picked up because of an obstruction that blocks the signals. Tall buildings or mountains can cause a null

because the incoming signal is diffracted by the top edge of the obstruction, causing interference with signals from the bottom of the obstruction and the end of the null zone.

There are many known nulls in the world. One of the best known is the Andean null, which runs from the west coast of South America out to sea. Its size changes with local atmospherics and propagation. In 1947, when Thor Heyerdahl made the famous Kon-Tiki expedition, his radio operators reported not being able to pick up signals from the east, except those on the west coast of South America, for 27 of their 101 days at sea.

Q. Are signal soldiers who operate highly secret electronics equipment authorized to leave a position if it is likely to be captured and the equipment fall into enemy hands?

A. No! During the Korean War, the North Korean and Chinese Forces made a major offensive against United Nations Forces on April 22, 1951. With the objective of the South Korean capital of Seoul, the Communists attacked the British 29th Independent Infantry Brigade Group, which was holding a crossing of the Injin River. Two Divisions of the Chinese 63rd Army attacked the Brits who were holding the flank of an American Force. The 1st Battalion, Gloucester Regiment (Infantry) was holding the entrance to a pass and was becoming isolated from the rest of the UN Forces.

As the two days of fighting progressed, the 29th was gradually with-

drawn, which left the Gloucester surrounded. On a hill overlooking the Gloucester Battalion was a Royal Signals detachment that was operating a Rear Link Wireless connecting the Gloucester with its Headquarters. The men operating the Link held their position until they were captured with the rest of the Gloucester and spent 28 months in captivity.

Signals soldiers are soldiers, just like everyone else. They hold until relieved.

Q. When did propaganda by short-wave radio get started?

A. Well, it all started with Lenin who made voice via radio a national priority. In August 1925 a shortwave station in Moscow went on the air. It had been started in 1920 but wasn't ready for regular broadcast service for about five years, when the funeral of the Minister of Defense in Red Square was broadcast in French, German, and English. In 1926 Romania was attacked over a dispute about Bessarabia.

In 1926 the Soviet Government broadcast words of support to striking British miners. These, however, were special broadcasts. Regular broadcasts were begun in October-November of 1929 and were initially in German. French and English broadcasting started a few days later. At first, each program lasted one hour. Daily broadcasts began in January 1930 and propounded the basic principle of "great and holy hatred of capitalism."

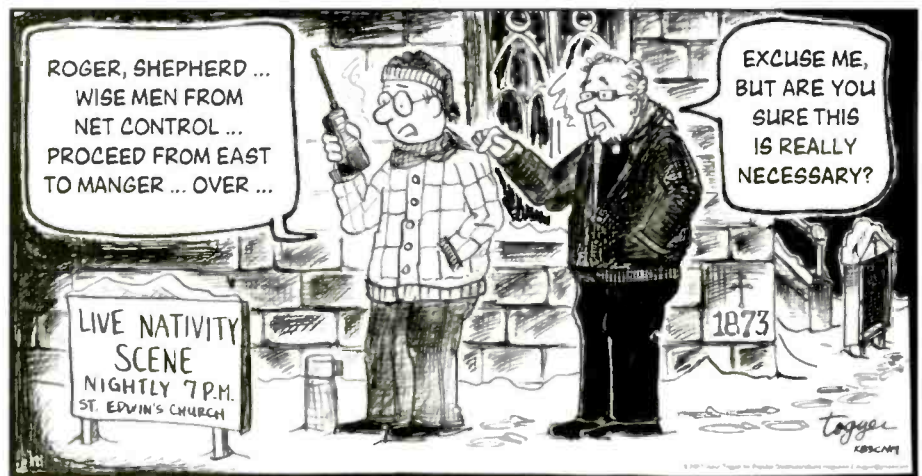

Wait A Minute... It's December Already?

It simply *can't* be December already. It seems like I just wrote my December 2006 column last week! How can an entire year have possibly gone by that quickly? Impossible!

Oh, wait...my editor now informs me that it is, indeed, December, proving once again that behind every successful man, there stands a woman, telling him that he's wrong. Okay, it's December. That pile of snow outside the window isn't the result of a hallucination, and the ice that has formed around the aluminum elements of your all-band vertical HF antenna is just that—ice, not cobwebs—and is a sign of the season rather than an indication that you need to use that antenna more often.

I still think you should use that antenna more often. Not only is radio fun, but maybe a 100 watts or so of good, old-fashioned RF radiation will send that ice somewhere else where it will be better appreciated. Somewhere like, say, the North Pole, where even as I type, Santa Claus is loading up his sleigh, while the elves give last-minute reminders to the reindeer on avoiding hazards to aviation, such as your all-band vertical HF antenna.

Exactly what he's loading depends (as we all know, of course) on who's been naughty and who's been nice. Just before writing this column, I visited Santa at the North Pole (just a routine part of doing research for the column, of course) and received an insider's look at what Santa is bringing everybody this year. For example, for Edith Lennon, N2ZRW, our editor, an entire year during which nobody misses a deadline. My word, she must have been *extremely* nice this year!

Looks like Santa's loading up a lot of neat goodies for all of you other nice boys and girls out there, too, but I'm not telling you what he's got for all of you. It wouldn't be right to spoil the surprise. I will say that I didn't see a single stick or lump of coal anywhere in sight, unless you count the burning wood in the fireplace, where Mrs. Claus warms herself beside the fire. Turns out she's a very nice lady, and even offered to knit me a pair of mittens, just like the ones she made Santa many years ago. It was truly a wonderful offer, but I had to politely decline. After all, I have a deadline to make, and it's pretty tough to type while wearing mittens. Therefore, I left her, and Santa, with the same best wishes for a safe and joyous holiday season that I hereby extend to all who read these words. To deliberately misquote Saint Nick himself (along with Clement Clarke Moore, the guy who wrote the poem "Twas the Night Before Christmas"), "Merry Christmas to all, and to all, good DX!"

An "Old Friend" Returns To The Logbooks

Back in the good old days when utility stations dealing with the weather were more plentiful on the HF bands, the frequency 11120.0 was part of a network used by the U.S. Air Force for weather information transmissions. Old-timers in the utility monitoring game will remember capturing RTTY and WeFax transmissions from stations with callsigns like KAWN (which was the USAF Automatic Digital Weather Switch, located at Carswell AFB in Texas, now known as NAS Joint Reserve Base



Photo A. USAF Global Weather Center at Offutt AFB, NE, circa 1995.
(Courtesy of Daniel Geis, Air Weather Association)

Fort Worth) and KGWC (which was the USAF Global Weather Center at Offutt AFB in Nebraska; see **Photo A**).

These and other stations were active on 11120.0 and other frequencies that were used for this purpose, and which can be found in some of the very old loggings you can still dig up on the Internet. Then they disappeared from use, and 11120.0 had not been logged for many, many years—until this month, when Allan Stern of Satellite Beach, Florida, caught this "old friend" of a frequency being used as a discrete by a station in the HF-GCS (Global Communications System) that was providing a morale and welfare (M&W) phone patch for U.S. military personnel.

The log in question that AI submitted shows REACH 8054, a C-17A inbound to its home base at Charleston AFB in South Carolina, using the 11120.0 frequency for the phone patch after being sent there by the HF-GCS ground station following initial contact on 11175.0. AI reports that the pilot double-checked the HF-GCS operator to confirm that he had heard the frequency correctly. AI wrote, "I tuned to it, and a few seconds later, REACH 8054 came up. The phone patch was long enough for me to check the frequency several times as I entered it into my database."

AI went out of his way to assure us that this was no error or typo, the frequency was 11120 and, specifically, that it was *not* 11220, as some speculated when he posted the information on this contact to some of the Internet email reflectors that specialize in military radio comms and HF utility stations. Now, I've known AI long enough to know that if he said it was 11120, it was 11120, but the point is that apparently, this old 11120 frequency has been recycled, so don't be shocked if you find it in use as an HF-GCS discrete.

In the "good old days" various lists of the discrete frequencies used by the various HF-GCS ground stations were often published, broken down by which stations used which frequencies. I don't think there's much point to maintaining such lists any longer now that the HF-GCS stations are no longer



Photo B. USAF C-5B, callsign REACH 8054, departs Patrick AFB in Florida. (Photo by and courtesy of Allan Stern)

manned, but are instead remotely controlled from Andrews AFB or the backup system at Offutt AFB. To begin with, the initial contact is made on one of the seven HF-GCS primary frequencies (4724.0, 6712.0, 6739.0, 8992.0, 11175.0, 13200.0, or 15016.0), and then the discrete frequency to be used is announced there before the stations switch to the discrete. Furthermore, we've just seen one example of a discrete being used that hasn't been published or logged in years. So, I think the value of any such list would be purely academic. Just do what AI did: listen on the primary frequencies and pay attention when the HF-GCS operator passes the discrete frequency!

AI also contributed a photo he took of a C-5B aircraft, REACH 6017 (tail number 86-0017), during a recent departure from Patrick AFB, near AI's Satellite Beach location (see **Photo B**). AI noted that this aircraft is now based at Westover ARB in Massachusetts, with the 439AW, having recently moved there after previously serving the 436AW at Dover AFB.

Thanks and a tip of the "Utility Communications Digest" hat to AI for the above information and for the nifty photo as well!

USCG Asks Mariners To Use Correct MMSIs

Another reader who's earned a tip of the columnist's hat this month is Steven Jones of Lexington, Kentucky. Steve's contribution of logs this month was followed a short time later with a heads-up on an item he found in an online newslet-

ter he subscribes to. In that item, from the "Maritime Global Net Newsletter," it's noted that the U.S. Coast Guard has become concerned that many users of marine radios (see **Photo C**) equipped with Digital Selective Calling (DSC) and/or the Automatic Information System (AIS) are not properly entering an assigned Maritime Mobile Service Identity (MMSI) into these devices, or are even failing to obtain and register an MMSI for their vessels.

As the Coast Guard notes, when users of this equipment fail to program the MMSI, enter a false MMSI, or fail to update a previously programmed radio with an MMSI assigned to the new vessel aboard which the equipment is used, should the vessel be in distress the arrival of rescue services is thereby delayed. In fact, the Coast Guard notes that the lack of an MMSI will render AIS inoperable and, in any event, may make the radio incapable of using the distress alerting features built into those devices.

We've dealt with DSC and the other components of the Global Maritime Distress and Safety System (GMDSS), as well as its VHF cousin, the AIS, in this column previously. However, the subject of the MMSI is worth examining in more detail, since an MMSI is, or is *supposed to be* (hence the Coast Guard's concern regarding the matter) an all-inclusive electronic identity for the maritime station to which it is registered.

For UTE monitors who are set up to receive these communications modes, the MMSI makes it possible to identify the station(s) that are being monitored. Since you can't QSL stations you don't identi-

fy first, let's examine the information the MMSI gives us and how to use it to identify the sources of the signals regularly logged and, in Steve's case, regularly submitted to this *Pop'Comm* column.

There are four kinds of MMSIs: ship station identities, coast station identities, group ship station identities, and group coast station identities. Each MMSI is a nine-digit number, and from the first digit we can determine which kind of MMSI we're dealing with. If the first digit of an MMSI is a zero, it's either a ship group identity or a coast station or group of coast stations. Ship stations' MMSIs will begin with a digit from 2 to 7. So, now, for the sake of example, let's suppose we caught a station using the MMSI of 366766840. What can we determine from this?

To begin with, we know from the first three digits (366) that this is a vessel of American registry. The first three digits of an MMSI are Maritime Identification Digits (MID), allocated by the International Telecommunication Union (ITU) by country. The 366 MID is allocated by ITU to the United States, so this is an American vessel.

Second, since there's a trailing zero at the end of the MMSI, we know that this vessel is either already equipped with an Inmarsat C earth station, or is expected to be so equipped in the foreseeable future. The number of trailing zeroes at the end of an MMSI is significant: If a vessel is fitted with an Inmarsat B, C, or M ship earth station, or is expected to be in the foreseeable future, the MMSI will generally have three trailing zeroes, but in the case of Inmarsat C, can have one trailing zero. An MMSI with no trailing zeroes indicates that the vessel is fitted with an Inmarsat A ship earth station, or has satellite equipment other than Inmarsat.

Finally, if we have Internet access, we can visit the ITU's website and determine the particulars of the vessel. To do this, we point our web browsers to the following URL:

www.itu.int/cgi-bin/htsh/mars/ship_search.sh#start

That will bring us to a page on the ITU website that allows us to search for ship particulars based on the vessel's ship name, callsign, or MMSI—or, optionally, based on an Emergency Position Indicating Radio Beacon (EPIRB) ID code or Hex ID code. The search page allows the use of full or partial strings and supports use of an asterisk as a wildcard character.

If we type the MMSI we're using as our example, 366766840, into the MMSI box and click the button that reads Submit Query, after a few seconds we will learn that the MMSI in question belongs to a vessel named *Defender*, and by clicking on the vessel's name we can pull up the page of ship particulars, where we can see, among other things, that the owner of the vessel is Crowley Marine Services, Inc.

I've deliberately used this vessel's MMSI as an example because *Defender* is a "frequent flyer" that's often logged by readers of the "Utility Communications Digest." It, along with many other vessels owned by the same company, is regularly heard on 4149.0 and other frequencies, in HF SSB voice communications with coast station WPE in Jacksonville, Florida, or with other vessels in Crowley's fleet.

As a matter of fact, there are several such logs accompanying this month's column, and there are a few logs of *Defender* among them. I've logged vessels from this fleet many times myself, particularly on 4149.0 kHz. Often, the signal coming from the vessels is much stronger than the signal coming from the shore station they are working, as they take turns checking in with position reports, weather, sea state, vessel engine parameters, and other information.

Of course, these vessels aren't giving their MMSIs in voice communications, and at any rate they do give their callsigns (which, in the case of *Defender*, is WBN3016) so we don't need the MMSIs to identify them. However, for digital UTE enthusiasts, the MMSI is an excellent tool for identifying a station, and now that you've read this month's column, you know exactly how to use this tool, if you didn't already.

The Latest On BPL

Because of the potential that Broadband over Power Line (BPL) technology has for interfering with HF communications, this column has been keeping an eye on developments with respect to this issue. For those who have just joined us, BPL (or, as it's known in some countries, PLT, for Power Line Telecommunication) is a largely experimental technology being tested and deployed to provide broadband Internet service over the same power lines that deliver commercial electrical power to homes and businesses.

These systems use frequencies in the 10–30 MHz range, which has been used for decades by ham radio operators, shortwave broadcasters, and a variety of government, military, and commercial communications systems. Since power lines are unshielded and will act as antennas for the signals they carry, BPL has the potential to completely wipe out the utility (pun intended) of the 10–30 MHz range for HF communications purposes.

In early September, the North Atlantic Treaty Organization (NATO) issued a report of the effects that NATO expects widespread BPL deployment to have on HF communications. The entire report is available online for downloading at the following URL:

[http://ftp.rta.nato.int//PubFullText/RTO-TR-IST-050/\\$\\$TR-IST-050-ALL.pdf](http://ftp.rta.nato.int//PubFullText/RTO-TR-IST-050/$$TR-IST-050-ALL.pdf)

Incidentally, I have a highly technical term that I use to describe URLs such as the one above, but it's not fit for inclusion in this magazine, so let's deal with it another way. If you have trouble typing the above URL (and I will assure you that I certainly did!), you'll find a link to this document (as well as a link to the ITU webpage mentioned in the preceding section)

on my "Utility Communications Digest" website, which is at this URL:

<http://utecomm-digest.kc2hmz.net>

That's a little easier to type than that other monstrosity! The NATO report is a 9 MB file in portable document format (PDF), which can be read on multiple computer platforms using free software. If you don't have a PDF reader, you'll also find links on the "Utility Communications Digest" website to help you find one.

Now, to get back to the subject at hand. The NATO report warns that based on transmitter power levels, estimated BPL market penetration, and duty cycle, there is a high probability that BPL would result in increased noise levels at sensitive receiver sites.

"Increase of the existing HF noise floor by widespread use of PLT...will bring up problems for Military Radio Users as well as for HF Communication Intelligence (COMINT) in all NATO countries. The signal-to-noise ratio thus may be reduced for tactical and strategic HF radio as well as for fixed sensitive COMINT sites," the NATO report states.

While this comes as no surprise to anyone who has been paying attention to this issue all along, with this report, NATO adds its voice to those of other bodies that have warned about the dangers of BPL. To date, these have included the American Radio Relay League (ARRL, the national organization representing ham radio), the National Telecommunications and Information Administration (NTIA, the U.S. government agency that serves as the President's principal adviser on telecommunications and information policy), the Department of Homeland Security, the United States Department of Justice, Aeronautical Radio, Inc. (ARINC, the leading provider of communications for the aviation industry), and many others too numerous to list here.

In fact, ARRL Laboratory Manager Ed Hare, W1RF1, noted that NATO's report "pretty much echoes the ARRL's pleadings during the BPL rulemaking," and added that the research on which the findings in the report were based "advanced the state of the art and determined that the aggregate noise from large scale deployment of BPL will increase worldwide noise levels by sky-wave propagation."

Hare was referring to studies conducted by the Information Systems Technology group, part of NATO's Research and Technology Organization (RTO), which were the basis for the findings described in the report. NATO noted that since existing power lines are not designed for transmitting telecommunications with data rates as high as those used by BPL, those power lines "will cause unintentional RF emissions which may adversely affect the established radio noise floor directly, or by cumulative propagation from many such sources. The existing HF background noise possibly may be increased via ground wave and/or sky wave propagation."

Personally, I find it interesting to note that at a time when the FCC is prepared to issue orders to shut down numerous ham radio repeaters in the 70cm band to avoid interference to military PAVE PAWS radar systems in Massachusetts and California, the Commission remains bullish on BPL, despite plentiful and growing evidence that it is going to trash a significant portion of the HF spectrum, not only for military use, but also for government, aviation, maritime, public safety, CB, amateur communications, and shortwave broadcasting. In many instances, particularly with respect to aeronautical and military

users, this represents a massive amount of day-to-day communications.

So, what's the answer to this problem? In the end, this is an issue that is being driven by economic factors, namely potential revenue and a high demand from the public for broadband Internet access. As I see it, the points that the FCC is missing here are twofold:

1. Technical issues with BPL ironically make it uneconomical in rural areas, where its deployment would have the most impact on the availability of broadband Internet access, and

2. Destroying a large portion of wireless spectrum is not justifiable in light of the fact that BPL is not the only way to deliver broadband Internet access.

If the FCC is going to remain technically lacking and friendly to big-business interests lobbying on this issue, maybe the FCC's fellow government agencies, along with the military, the aviation and maritime industries, hams, and shortwave broadcasters, should follow suit. That is, come up with a massive lobbying effort of their own and hammer away at these two points, to both the FCC and Congress, until the information finally sinks in.

Or, as Rich Moseson, W2VU, editor of *Pop'Comm's* sister publication, *CQ Amateur Radio*, suggested in March 2004 in a letter to the *Wall Street Journal*, perhaps it's time to ask why BPL is so important to the FCC in the first place. As Moseson noted, the FCC is an agency with a policy of not promoting any one

particular technology, yet it is violating that policy regularly while continuing to champion a technology that figures to create massive interference problems and whose economic potential is questionable. So I'd like to now add my own voice to Mr. Moseson's. I, too, would like to know exactly why the FCC is ignoring what is in the best interests of its licensed radio services and has instead provided a free pass for what ARRL Chief Executive Officer David Sumner, K1ZZ, correctly refers to as "spectrum pollution."

Our Readers Log In

Last, but certainly not least, I'm going to give out one last tip of the "Utility

Glossary Of Utility Terms And Acronyms

AFB—Air Force Base

ALE—Automatic Link Establishment, a link control system that includes automatic scanning, selective calling, sounding, and channel selection, without human intervention using processor control.

AM—Amplitude Modulation

ANDVT—Advanced Narrowband Digital Voice Terminal, a secure voice mode used by the military.

ATC—Air Traffic Control

CAMSLANT—Communications Area Master Station Atlantic, the U.S. Coast Guard's primary HF radio station for the Atlantic region, located at Portsmouth, Virginia.

CAMSPAC—Communications Area Master Station Pacific, the U.S. Coast Guard's primary HF radio station for the Pacific region, located at Pt. Reyes, California.

COMMSTA—Communications Station, for example: COMMSTA Kodiak, a communications station of the U.S. Coast Guard, located at Kodiak, Alaska.

CGAS—Coast Guard Air Station

Cut Numbers—The use of letters in place of numbers when sending a long string of numbers, for brevity's sake. This is often done by "numbers" stations, such as sending one long dash instead of five normal dashes to indicate a zero, or the letter N instead of the number nine, etc.

CW—Continuous Wave (Morse code)

DE—The Morse code operating prosign DE, meaning "from," as in DE NMN, meaning from station NMN

D-Layer Absorption—A phenomenon where the sun's rays ionize the D layer of the atmosphere causing it to absorb, rather than propagate (reflect/bounce), radio signals at certain frequencies.

Duplex—A means of radio communication where a station can both transmit and receive at the same time.

EAM—Emergency Action Message, coded instructions commonly sent by U.S. military stations. Despite the name, they usually aren't emergency traffic at all.

EHF—Extremely High Frequency (30-300 GHz)

FAX—Facsimile, a transmission mode used to send maps, charts, and other non-textual material.

FEMA—Federal Emergency Management Agency, a part of the Department of Homeland Security.

FM—Frequency Modulation

Ham Station—A licensed station operating in the Amateur Radio Service under the control of an operator who is licensed to operate the station.

HF—High Frequency (3-30 MHz)

LINK-11—Also called TADIL-A for TACTical DIGital Link, a secure digital data mode used by the military. Utilizes a 16-tone data modem to allow assets to share digital information, such as radar data.

M/V—Merchant Vessel

NAS—Naval Air Station

Propagation—The means by which radio signals get from one place to another; some forms are quite simple (such as line of sight) while others are much more complex (such as EME, or earth-moon-earth).

QRM—Man-made interference to radio signals

QRN—Natural interference to radio signals, such as the static crashes often heard due to thunderstorms

QSO—A contact between two or more stations

QSY—Change frequency.

QTH—Location

RTTY—Radio TeLeTYpe

SELCAL—SElective CALLing, a method for activating a radio or data terminal at one station without disturbing other stations that are monitoring the same frequency.

Simplex—A means of radio communication where a station may transmit or receive at any given time, but not do both at the same time.

SITOR—Simplex Teletype Over Radio, a transmission mode used to transmit text messages over radio. There are two SITOR modes: SITOR-A (also called AMTOR) uses Automatic Repeat Request (ARQ); SITOR-B uses Forward Error Correction (FEC).

SWL—Shortwave Listener, a person who enjoys listening to short-wave radio stations.

UHF—Ultra-High Frequency (300-3000 MHz)

USAF—United States Air Force

USB—Upper Sideband

USCG—United State Coast Guard

USMC—United States Marine Corps

USN—United States Navy

UTC—Coordinated Universal Time, formerly known as Greenwich Mean Time, and also commonly referred to as ZULU time and abbreviated as in 1200Z.

UTE—Utility Station

Utility Station—Stations transmitting material that is not intended for reception by the general public and is not originating from an amateur (ham) station.

VHF—Very High Frequency (30-300 MHz)

VOLMET—Station that transmits aeronautical weather information. Comes from a French term that literally means, "flying weather."



Photo C. Modern marine radios, such as this ICOM IC-M802, need a valid MMSI programmed into them for best results. (Courtesy of ICOM America)

Communications Digest" hat—this time to the city of Lexington, Kentucky.

That's because I'm about to introduce this month's excellent batch of reader-submitted utility loggings, and the list of contributors (who also rate a tip of the hat and a big thanks!) for this month looks like this: Glenn Valenta, Lakewood, CO (GV/CO); Allan Stern, Satellite Beach, FL (ALS); Steven Jones, Lexington, KY (SJ/KY); Mark Cleary, Charleston, SC (MC/SC); Chris Gay, Lexington, KY (CG/KY); and your columnist, John Kasupski, Tonawanda, NY (JK/NY).

As you can see, Lexington, Kentucky, has produced *two* contributors this month, while no other place has produced more than one, thus making Lexington, Kentucky, the world leader. Now, this is certainly not intended as a knock on those communities that did indeed produce the other contributors this month. However, the rest of you are batting zero! I'm optimistic that this will provide incentive to get your own community on the map (so to speak) by submitting your utility loggings to me at the email address that appears at the beginning of this column.

3016.0: Shanwick MWARA wkg var. a/c voice and SELCAL in USB monitored at 0202Z. (JK/NY)

3137.0: 44192 (KC-10A) ALE initiated direct dial call to TACC at 0020Z. (MC/SC)

3476.0: Gander Radio wkg REACH 8055

(Charleston AFB C-17A at FL 350), which passes position report and reports being west-bound, in USB at 0448Z. (ALS)

3485.0: Gander VOLMET, in USB at 0602Z. (JK/NY)

4009.5: USN MARS net, NNN0GAC and others, in USB at 0009Z. (JK/NY)

4013.5: USN MARS net, NNN0BDW and others, in USB at 0010Z. (JK/NY)

4036.0: AAR7AL as apparent NCS for U.S. Army MARS net, in USB monitored at 0154Z. (JK/NY)

4149.0: WPE (Crowley Marine, Jacksonville, FL) wkg tugs calling in position reports, fuel consumption, elapsed time, time-to-destination, etc; WBN-3012 QSYs to 8294 for comms/w tug *Defender*, in USB at 0512Z; WPE working WBN-4382 *Sea Horse* in USB at 0150Z; WPE working tugboat *DEFENDER* in USB at 0510Z. same vessel heard numerous other nights at various times; WPE working WBN5040 in USB at 0505Z, same vessel heard another night around this time; WPE wkg WBN-3015 in USB at 0503Z; WPE wkg tugboat WBN-3013 passing formatted status report including ETA of 0200, in USB at 0513Z. (ALS)

4270.0: CFH, Halifax, Canada, with FAX transmission at 0537Z. (JK/NY)

4316.0: USCG New Orleans (NMG), maritime WX, also heard parallel transmission from USCG Portsmouth, VA (NMN) on parallel 4426.0, in USB at 0534Z. (JK/NY)

4721.0: ADW (Andrews HF-GCS) clg 523573 (KC-135R) in ALE USB heard at 1350Z. (MC/SC)

4772.0: Link-11 data transmission at 1827Z. (MC/SC)

4865.0: Link-11 data transmission at 0147Z. (MC/SC)

4991.0: SF1 (FBI, San Francisco, CA) clg SD1 (FBI, San Diego, CA) in ALE USB at 0959Z. (MC/SC)

5000.0: Animated simplex QSO, 2 OM/SS, under time station WWV, frequent mention of "la plata" in USB at 2344Z. (SJ/KY) (Spanish for "the silver"—jk)

5058.5: CL1 (FBI, Cleveland, OH) clg OM2 (FBI, Omaha, NE) in ALE USB at 0616Z. (MC/SC)

5383.5: Various military stations with tri-graph callsigns (VØL TØ1 TIC H1C O1E A1E) doing radio checks, VØL never answered, in USB at 0538Z. (GV/CO)

5505.0: Shannon VOLMET w/avi WX, readable despite noisy condx, in USB at 0137Z. (JK/NY)

5547.0: San Francisco Radio wkg American 102 in voice and SELCAL, in USB at 0514Z. (GV/CO)

5616.0: Gander (OM op) and Shanwick (YL op) MWARAs working aircraft in voice and SELCAL, noisy but readable, in USB at 0135Z. (JK/NY)

5696.0: USCG CAMSLANT Chesapeake wkg "D4D" in USB at 1858Z. (ALS)

5717.0: RESCUE 313 (CC-130) p/p via HALIFAX MILITARY to HALIFAX SEARCH. Ground party passes posit of vessel, in USB at 2342Z. (MC/SC)

5732.0: CG 1711 (HC-130, CGAS Elizabeth City) departing Clearwater requests guard from CAMSLANT, in USB heard at 1334Z. (MC/SC)

5732.0: USCG CAMSLANT Chesapeake wkg "J-38" (OPBAT-assigned HH-60J, CG-6038, CGAS Clearwater, FL) for position report, location 28-19 N, 82-22 W, in USB at 2240Z; CAMSLANT working CG 1711 (HC-130H, CGAS Elizabeth City, NC) who reports on final approach to Greenville A/P and secures guard, in USB at 1448Z. (ALS)

5881.5: T5B159 (5-159 AVN) clg R00191 (CH-47D) in ALE USB at 1331Z. (MC/SC)

6265.5: BOKB. *AN JI JIANG*, 4,926-ton China-registered bitumen tanker w/MMSI, abbreviated ID "AJJG" plus TEST, HELP and MED commands, in SITOP-A heard at 0753Z. (SJ/KY)

6502.5: RUH981 (UH-60) clg WAROPS (1-228 AVN, Soto Cano AB) in ALE USB at 1159Z. (MC/SC)

6697.0: MINCEMEAT (U.S. Military) with EAM broadcast, in USB at 2242Z. (MC/SC)

6706.0: TRENTON MILITARY wkg CANFORCE 2529, in USB monitored at 2207Z. (MC/SC)

6761.0: REACH 8055 working ETHYL 31 for AR coord in USB at 0051Z. (MC/SC)

6855.0: UNID YL/SS with 5-fig grps (ENIGMA V2A) in AM at 2105Z. (CG/KY)

6911.5: R23316 (UH-60A) clg KJSTNG (PA ARNG, Johnstown-Columbia Airport) in ALE USB at 0209Z. (MC/SC)

6932.0: UNID with 5-fig cut no. grps (ENIGMA M8A) in CW at 2106Z. (CG/KY)

6985.0: R23548 (UH-60A) clg TC189 (C/1-189 AVN, SD ARNG) in ALE USB at 0204Z. (MC/SC)

7527.0: RESCUE 34 (HH-60J, CGAS Clearwater) wkg CAMSLANT to report they have located ELT coming from Melbourne Airport, in USB at 1337Z. (MC/SC)

7642.0: 1QWFAA (USAF MARS station) sounding in ALE USB at 2341Z. (MC/SC)

7778.5: NK1 (FBI, Newark, NJ) clg QT1 (FBI, Quantico, VA) in ALE USB at 1502Z. (MC/SC)

8294.0: Crowley Marine Tugboat WBN-3012 wkg tug *Defender* in USB monitored at 0516Z. (ALS)

8337.6: SHARK 07 clg CG 2105 (HU-25, CGAS Miami), in USB at 1222Z. (MC/SC)

8379.0: KRNJ, *SEALAND QUALITY*, 58,869-ton U.S.-registered container ship w/callsign only, in SITOR-A at 0537Z; 3FGZ3, *PARNASO*, 99,471-ton Panama-registered VENTFLEET crude oil tanker w/AMVER/SP for departure from Guaranao Pilot St., Venezuela en route to Delaware Pilot St., arrive in 4 days, in SITOR-A at 0543Z; C6FR7, *TROPICAL MORN*, 11,979-ton Bahamas-registered refrigerated cargo ship w/AMVER/PR 50 miles north of Colombia coast, en route to Cartagena, arrive in 16 hours, in SITOR-A at 0612Z; C6FY2, *DOLE CALIFORNIA*, 11,800-ton Bahamas-registered container ship w/AMVER/FR for arrival at Puerto Cortes, Honduras, in SITOR-A at 0621Z; V7ET2, *CROWLEY SUN*, 9,200-ton Marshall Islands-registered Ro-Ro cargo ship w/AMVER/SP for departure on regular run from Port Everglades, FL, to Santo Tomas de Castilla, Guatemala, arrive in 2 days, in SITOR-A at 0831Z; WDD3768, *RESERVE TIDE*, U.S.-registered offshore tug/supply ship w/callsign and vessel name in SITOR-A at 1313Z; V7HJ3, *BULK CANADA*, 63,886-ton Marshall Islands-registered bulk carrier w/weak garbled AMVER/PR in SITOR-A at 0058Z. (SJ/KY)

8381.0: HSB3318, *THOR ENERGY*, 42,529-ton Thailand-registered general cargo ship w/AMVER/PR en route to Salvador, Brazil, arrive in 11 days, in SITOR-A at 1601Z; HBDU, *MAERSK JENAZ*, 39,228-ton Switzerland-registered container ship w/AMVER/PR at 1,200 miles ENE of Cayenne, French Guiana, en route to Vitoria, Brazil, having problems sending the PR, tried twice, in SITOR-A at 0239Z; 9HIR5, *TROPICAL LAND*, 10,973-ton Malta-registered refrigerated cargo carrier w/MMSI and abbreviated ID "TLND" in SITOR-A heard at 0300Z. (SJ/KY)

8386.0: 3FLZ7, *HANIHE*, 44,911-ton Panama-registered container ship w/partial MMSI and abbreviated ID "HNHE" in SITOR-A at 0655Z; C6F18, *FALSTER SPIRIT*, 95,416-ton Bahamas-registered crude oil tanker w/brief msg and MMSI in SITOR-A at 2317Z. (SJ/KY)

8388.0: 3ECX3, *M.V. EQUULEUS LEADER*, 20,141-ton Panama-registered

vehicles carrier w/AMVER/PR 100 miles south of Halifax, Nova Scotia and en route to Jacksonville, FL, arrive in 3 days, MMSI and abbreviated ID "EQLX" also, in SITOR-A at 1510Z; ELSR7, *TARAN*, 70,321-ton Liberia-registered bulk carrier w/AMVER/SP for departure from Norfolk, VA, en route to Annaba, Algeria, in SITOR-A monitored at 0451Z. (SJ/KY)

8389.5: HPY1, *BUM YOUNG*, 19,999-ton Panama-registered chemical/oil products tanker w/AMVER/PR 150 miles off N. California coast, due to arrive at San Francisco a few hours later, in SITOR-A at 0330Z. (SJ/KY)

8391.0: Unid. vessel w/TEST msg to TAH, Istanbul Radio, Turkey, on 8431.0 kHz, good signal here, in SITOR-A at 0415Z. (SJ/KY)

8734.0: SVO, Olympia Radio, YL with repeating freq list in USB at 0429Z. (GV/CO)

8764.0: NMN CAMSLANT with manually read WX, copy difficult due to multipath echo, in USB at 0529Z. (GV/CO)

8776.0: ANTIDOTE (U.S. Military) with MAINSAIL call in USB at 2146Z. (MC/SC)

8788.0: WLO, Mobile, AL with WX in USB at 1901Z. (MC/SC)

8806.0: WLO, Mobile, AL with WX in USB at 1901Z. (MC/SC)

8912.0: JULIET 03 (MH-60J, CGAS Elizabeth City), p/p via SERVICE CENTER to E-CITY AIR regarding SAR case, reports they are hoisting 4 children and 1 adult off vessel, in USB at 2329Z. (MC/SC)

8971.0: TRIDENT 43 (P-3C) wkg GOLD-ENHAWK regarding GATOR, in USB at 1201Z. (MC/SC)

8971.0: GOLDENHAWK (Brunswick NAS TSC) wkg FIGHTING TIGER 21 (P-3C, Brunswick NAS VP-8); clear then encrypted, in USB at 1045Z. (ALS)

8983.0: CG 2113 (HU-25, CGAS Miami) departing for Great Inagua requests guard from CAMSLANT, in USB monitored at 1320Z. (MC/SC)

8983.0: USCG CAMSLANT and CG-2120 calling each other for flight following for about three minutes before finally establishing contact, in USB at 0103Z. (JK/NY)

8983.0: USCG CAMSLANT wkg CG-2124 (HU-25D, CGAS Miami) for flight following, in USB at 1550Z; CAMSLANT wkg CG-2120 (HU-25A, CGAS Cape Cod) who reports departure from CGAS Miami, in USB at 1850Z; CAMSLANT working RESCUE 6E in USB at 1856Z. (ALS)

8992.0: REACH 671 p/p via Puerto Rico and Lajes HF-GCS to HILDA Meteo, in USB at 2302Z. (MC/SC)

9007.0: CANFORCE 3909 (CC-130) opening watch with TRENTON MILITARY, in USB at 0123Z. (MC/SC)

9020.0: Link-11 data transmission at 2133Z. (MC/SC)

9025.0: CG 1502 (HC-130, CGAS Elizabeth City) ALE initiated p/p to LANTAREA to report they have located sailing vessel, in USB at 2012Z. (MC/SC)

10320.0: AFRTS Pearl Harbor feed S-9 here w/talkshow with somewhat surprising title of "We Can Wipe Out China" in USB at 0343Z. (GV/CO)

10780.0: CAPE RADIO transmitting test counts in preparation for using the frequency for the landing of Space Shuttle STS-118 orbiter, in USB at 1005Z. (ALS)

10780.0: CANOE 03, p/p via CAPE RADIO to PEACHTREE, in USB at 1407Z. (MC/SC)

11120.0: REACH 8054 (a Charleston AFB C-17A) via USAF HF-GCS for M&W phone patch; will land later today at Charleston, in USB at 2157Z. (ALS)

11175.0: HF-GCS ANDREWS wkg OTIS 09 (KC-130J, Cherry Point MCAS VMGR-252) for phone patch to DSN number at Kirtland AFB, Albuquerque NM; reports 2300Z ETA, bringing engine to repair VMGR-252 C-130 now on ground at Kirtland; then patch to commercial number for the FBO at Albuquerque, in USB at 1954Z; ANDREWS wkg BEARCAVE for radio check (BEARCAVE is an old U.S. Customs callsign, last heard in 2003 according to my logs; was definitely Bearcave and not Bearcove, the ETR Range Control callsign), in USB at 2010Z; ANDREWS working SHARK 17 (YL op, probably C-130 on Coronet Oak/Caribbean mission) for phone patch to DSN number for Barksdale AFB Metro; rqsts 1700Z WX for KEFD in USB at 1600Z. (ALS)

11175.0: HF-GCS Station ANDREWS with 28-character EAM DAC2BQ etc. in USB at 1558Z; ANDREWS with 20-character EAM SWTNPO, etc. in USB at 2320Z; ANDREWS wkg Navy RU 960 (Point Mugu C-130T) for phone patch to commercial number for a USN Point Mugu function; tries second number, requests Point Mugu call destination to arrange for vehicle, in USB at 2031Z; ANDREWS wkg REACH 1311 (possibly KC-135R 61-0311) for radio check only, in USB at 2223Z. (ALS)

11175.0: HF-GCS Station LAJES wkg BLUE 21 (Coronet Mission tanker) for phone patch to DSN number at Pease IAP, NH in USB at 1515Z; HF-GCS Station HICKAM wkg ASCOT 5311 (RAF C-130) for phone patch to HILDA METRO, requests 0800Z WX for PGUA (Anderson AFB, Guam), in USB at 0610Z. (ALS)

11175.0: HF-GCS Station PUERTO RICO wkg REACH 177 for phone patch to unknown recipient, reports approaching destination; ETA 0200; requests Diplomatic Clearance to land, in USB at 2354Z; PUERTO RICO wkg TEAL 70, a Hurricane Hunter aircraft flying a Hurricane Dean mission, for a phone patch; asks ground station if storm has been upgraded for intensity yet, in USB at 2220Z; PUERTORICO working TEAL 70 for phone patch to National Hurricane Center in Miami; passes extensive report on Hurricane Dean characteristics, in USB at 2320Z. (ALS)

11175.0: RED TALON 712 (P-3C) via

HF-GCS ground station for phone patch; requests to redeploy southward to point X-ray, in USB at 1930Z; U.S. Navy TACAMO aircraft via HF-GCS ground station for phone patch to DSN number for RADIATION at Offutt AFB; RADIATION asks for call on orderwire; acft is troubleshooting a comms problem. In USB at 2304Z. (ALS)

11175.0: HF-GCS Station OFFUTT wkg REACH 8535 for phone patch to McChord AFB CP, passes tail number 90-0035; ETA McChord 0530Z. Maintenance Status A2 for #2 anti-ice temperature low, in USB at 0040Z; OFFUTT wkg S4JG (USN anonymity call-sign) for radio check in USB at 1310Z and on another day at 0800Z; OFFUTT working REACH 31223 for radio check in USB at 1518Z; OFFUTT working GOLD61 (Coronet Mission tanker) for radio check on two radios in USB at 2231Z. (ALS)

11205.0: REACH 554 c/g SMASHER for radio check in USB at 1130Z. (MC/SC)

11220.0: MINCEMEAT wkg Andrews HF-GCS, in USB at 1906Z. (MC/SC)

11232.0: Trenton Military wkg CANFORCE 2647 for phone patch in USB at 1625Z. (ALS)

11232.0: PEACH 33 (E-8 JSTARS) p/p via TRENTON MILITARY to PEACHTREE for WX, in USB at 2129Z. (MC/SC)

12293.0: KSM, Bolinas CA with WX forecast in CW at 2030Z. (CG/KY)

12353.0: Tug *Defender* wkg WPE Jacksonville, in USB at 1711Z. (MC/SC)

12479.0: ZCDJ6, *BARCELONA EXPRESS* (former *CP SINALOA*). 40,744-ton Bermuda-registered container ship w/AMVER/PR 900 miles east of Daytona Beach, FL, and sailing west, in SITOR-A at 1429Z; P3BN8, *HANJIN KAOHSIUNG*, 43,925-ton Panama-registered container ship w/AMVER/PR 200 miles SE of Halifax, Nova Scotia, en route to Antwerp, Belgium, to arrive in 6 days, in SITOR-A at 1520Z; HPNU, *STEVE N*, 40,605-ton Panama-registered LPG tanker w/MMSI and callsign, in SITOR-A at 2158Z. (SJ/KY)

12482.0: C6QD2, *MARACAS BAY*, 30,957-ton Bahamas-registered chemical/oil products tanker w/MMSI and abbreviated ID "MARA" in SITOR-A at 0001Z. (SJ/KY)

12490.0: 3EJS2, *CHEMBULK TORTOLA*, newbuilt 19,800-ton Panama-registered chemical/oil products tanker w/MMSI and abbreviated ID "TRTA" plus HELP and TEST commands in SITOR-A at 1626Z; H9GP, *NAVIOS ALEGRIA*, 76,270-ton Panama-registered bulk carrier w/MMSI and abbreviated ID "ALGR" in SITOR-A at 1749Z; V7MU5, *HELENA*, 73,744-ton Marshall Islands-registered bulk carrier w/AMVER/PR 600 miles east of Cayenne, French Guiana, en route to Baltimore, MD, arrive in 8 days, in SITOR-A at 0442Z. (SJ/KY)

12535.5: Unid. vessel w/SELCAL QVXV (2010) for XSG, Shanghai R., China in SITOR-A at 1949Z; probably same vessel heard w/SITOR-B traffic to XSG on 16780.5 kHz about 45 minutes later. (SJ/KY)

12557.0: Unid. vessel w/SELCAL MKCV (4360) and TEST msg to TAH, Istanbul Radio, Turkey, in SITOR-A monitored at 2135Z. (SJ/KY)

13170.0: Olympia Radio, Athens, Greece, YL/EE with voice beacon. Listening on channels 806, 1232, 1640, 2217 USB at 2002Z. (CG/KY)

13927.0: USAF MARS operator AFA1WP (Boston MA) wkg REACH 2533 (possibly Grand Forks KC-135R 62-3533, but could be WY-ANG C-130H 92-1533) for phone patch in USB at 1614Z; USAF MARS Operator AFA4DD (TX) wkg EVAC 60410 (C-130H 86-0410, Pittsburgh 911ARW), 30 min north of Tampa, FL, for phone patch to coordinator at commercial number in 813 area code, passes ETA Tampa 1730Z w/two litter patients, in USB at 1709Z; USAF MARS Operators AFA1QW then AFA1EN (Shelbyville, IN) wkg REACH 312, over Cocoa Beach, FL, for M&W phone patches to two commercial numbers in South Carolina, is en route to landing in Maryland; in USB at 1507Z. (ALS)

13927.0: USAF MARS Operator AFA1EN (Shelbyville, IN) wkg HAWK 02 (Dyess B-1 bomber) for phone patch to Ops; asks status of HAWK 01; HAWK 02 says they

are unable to take gas, in USB at 1620Z; AFA1EN wkg REACH 920 (NY-ANG C-130 over Canada, southbound), for phone patch to DSN number at Stratton ANGB, NY, reports 2 hours out; ETA 4:15 p.m. local; is told to delay landing until 4:30 p.m., also makes M&W patch to Massachusetts phone number, in USB at 1807Z. (ALS)

13927.0: USAF MARS Operator AFA6PF (Los Angeles, CA) wkg DAWG 01 (off east coast of Florida, near Vero Beach) for phone patch, then QSY to 14606.0; simultaneously, Dawg 01 calls San Francisco Radio on VHF and they provide freq 11342.0 for his phone patch, but unheard on 11342, in USB at 1523Z; AFA6PF wkg NV-ANG C-130 ROLLER 78 (tail 79-0478, over Albuquerque, NM) for phone patch to DSN number at Reno IAP, announces inbound, in USB at 1725Z; AFA6PF wkg ROCCO 73 (KC-135 out of McGuire AFB, over St Louis, en route to Phoenix) for phone patch to DSN number at McGuire AFB, then makes 772 Area Code M&W phone patch, in USB at 1504Z. (ALS)

13927.0: USAF MARS Operator AFA6PF (Los Angeles, CA) wkg SENTRY 60 (E-3 AWACS, Tinker AFB) for phone patch to DSN number for RAYMOND 24 (Tinker AFB) in USB at 1819Z; AFA6PF wkg SHARK 80 (C-130) for phone patch to SMASHER (AF South Flight Monitoring Facility, Key West, FL), passes position 17-17 North, 77-45 West (south of Jamaica); ETA MHSC (Soto Cano AB, Honduras) of 1740Z, in USB at 1519Z; another day heard AFA6PF working SHARK 80 (C-130, over Honduras) for another phone patch to SMASHER, passes takeoff time from Soto Cano AB of 1739Z, in USB at 1751Z. (ALS)

13927.0: USAF MARS Operator AGA2PA (Patrick AFB) wkg EVAC 7224 (over Calif) before QSY to 7633.5, in USB at 1710Z. (ALS)

13927.0: USAF MARS Operator AFA2HF (Orange City FL) wkg REACH 1002 for phone patch with CP; ETA 1520Z; requests customs for 15 personnel, in USB at 1240Z; USAF MARS Operator AFA2XD (Satellite Beach, FL) wkg SHARK 80 (C-130) for phone patch to DSN number for SMASHER (SOUTHAF Flight Monitor, Key West, FL); aircraft passes arrival MGGT (Guatemala) 1509Z, departed MGGT 1553Z, ETA MHSC (Soto Cano AB, Honduras) 1638Z; passes current position 14-50 N, 88-29 W, heading 114, alt 15,000 feet, in USB at 1620Z; USAF MARS Operator AFA3HS (Leawood, KS) wkg SENTRY 50 (AWACS E-3, Tinker AFB) for phone patch in USB at 2014Z. (ALS)

13927.0: HOBBY 29 (WC-130J, Keesler AFB, airborne 140 miles NW of San Juan), via USAF MARS for phone patch to St. Croix Ops for Hurricane Hunter Ops, reports 30 min out, in USB at 2027Z; RAVEN 908 (Little Rock C-130 over west TX) via USAF MARS for M&W phone patch in USB at 1621Z; REACH 315 via USAF MARS for phone



Blow Out SALE VIDEOS

NOW ONLY \$5.95 ea.

While supplies last!

Buy all 7 for only \$39.95









CQ's Getting Started VIDEOS

Ham Radio Horizons: The Video
 Getting Started in Packet Radio
 Getting Started in Ham Radio
 Getting Started in Contesting
 Getting Started in DXing
 Getting Started in VHF
 Getting Started in Amateur Satellites

Shipping & Handling: U.S. & Possessions - add \$3 for the first video, \$1 for each additional. Free shipping on orders over \$75. Foreign S&H calculated by order weight and destination and added to your credit card charge.

CQ Communications Inc.
 25 Newbridge Rd., Hicksville, NY 11801
 516-681-2922; Fax 516-681-2926
 Order Toll-Free 800-853-9797

patch to a commercial number in Wisconsin, gives location at 37N 109W at 35,000 feet, coordinates place the aircraft over the "four corners" where Utah, Nevada, Colorado, and New Mexico meet; in USB at 1856Z. (ALS)

13927.0: SENTRY 23 (E-3 AWACS, Tinker AFB) via USAF MARS for phone patch to DSN number for Tinker AFB Radar Maintenance; reports unable to power-up radar; ground walks pilot through fault-isolation checklist, in USB at 1900Z. (ALS)

13927.0: SENTRY 50 (E-3 AWACS, Tinker AFB) via USAF MARS for phone patch to DSN number for RAYMOND 24 (Tinker AFB) then to DSN number for CORNERSTONE (also at Tinker) and passes formatted report in USB at 2151Z. KING 52 (C-130 over Florida) via USAF MARS for phone patch to DSN number for Andrews AFB Minuteman Ops, then patch to DSN number for San Juan ANGB, PR; reports inbound on PPR 07228 with 30 pax; then phone patch to DSN number for DMAFB Southcom Metro, gets WX for TJSJ (San Juan) for landing at 2015Z, in USB at 1818Z. 1850Z: EVAC 60410 (Pittsburgh 911AWC-130H) for phone patch to DSN number at Pittsburgh, reports inbound with 1830Z ETA, in USB at 1818Z. (ALS)

14325.0: Hurricane Watch Net, W6LMJ in West Palm Beach, FL, comms about a station in Jamaica, in USB at 2140Z: Hurricane Watch Net, announced they will be working tomorrow regarding Hurricane Dean, and reports that if comms degrade on the 14325 frequency they will use 7268 or 3950 kHz, in USB at 2306Z. (ALS)

16687.5: A8HP6, *ECUADOR STAR*, 10,581-ton Liberia-registered refrigerated cargo ship w/brief traffic in English to CBV, Chilean Navy, Valparaiso plus MMSI and vessel name, in SITOR-A at 2015Z. (SJ/KY)

16696.5: ZCDJ3, *ROME EXPRESS* (former CP CHALLENGER), 40,744-ton Bermuda-registered container ship w/partial AMVER 2,360 miles east of Jacksonville, FL, en route to Port Everglades, in SITOR-A at 1310Z; P3BN8, *HANJIN KAOHSIUNG*, 43,925-ton Panama-registered container ship w/AMVER/PR 250 miles east of Halifax, Nova Scotia, en route to New York, arrive in 2 days. MMSI and abbreviated ID "HAKS" also, in SITOR-A at 1523Z; same vessel heard 8 days later on 12479.0 kHz en route to Belgium; VRCP2, *SAGA FRONTIER*, 46,550-ton Hong-Kong registered new-built general cargo ship w/AMVER/PR 150 miles SSE of Acapulco, Mexico and sailing WNW, in SITOR-A at 1930Z. (SJ/KY)

13927.0: REACH 353, morale p/p via AFN2AC, Miami, FL, in USB at 1803Z. (MC/SC)

16721.0: Two unid. stations in QSO w/poor handsent CW at 0115Z, seems to be in Spanish ("cambia"). (spanish for "it changes"—jk) (SJ/KY)

17436.0: UNID YL/SS with "Atencion 48055 30284 45166" repeated, then into 5-fig grps (ENIGMA V2A), in AM monitored at 1700Z. (CG/KY)

readers' market

Advertising Rates for Readers' Mart: Non-commercial ads are 30 cents per word, including abbreviations and addresses; minimum charge \$6.00 per issue. Ads from firms offering commercial products or services are \$1.00 per word; minimum charge \$20.00 per issue. Boldface words are \$1.20 each (specify which words). Leading key words set in all caps at no additional charge. All ads *must be prepaid in full* at time of insertion; a 5% discount is offered for prepaid 6 time insertions. All ads must be typewritten double spaced.

Approval: All ad copy is subject to Publisher's approval and may be modified to eliminate references to equipment and practices which are either illegal or otherwise not within the spirit or coverage scope of the magazine.

Closing Date: The 10th day in the third month preceding date of publication. Because the advertisers and equipment contained in Readers' Market have not been investigated, the Publisher of *Popular Communications* cannot vouch for the merchandise listed therein. Direct all correspondence and ad copy to: Attention: Classified Dept., PC Readers' Market, 25 Newbridge Rd., Hicksville, NY 11801.

COMMUNICATIONS MONITORING ANTENNAS, HF/VHF/UHF Super Discone \$49.75, AntennaCraft Scantenna \$47.70, 30-1200 MHz, 4-12 dB Log Periodic \$69.50, 806-900 MHz, 13 dB 9 element Yagi \$74.00, MURS/GMRS Dual Band Base \$48.95. All prices **INCLUDE** Priority S&H&I. See these antennas plus many, many more for Amateur, Business, CB, and Monitoring radio, plus cellular phone antennas on the web at: www.antennawarehouse.com MC/Visa Order line 877-680-7818. To help maintain our low pricing, we do not print catalogs.

REPEATERS, REPEATERS, REPEATERS! New complete systems, parts, pieces, lines and antennas. If you need it for a repeater, we have it! CookTowersInc@aol.com or toll free at 877-992-2665

FOR SALE - DRAKE TR-7/TR-7A/R-7/R-7A Service kit. Includes 13 Extender Boards and Digital Jumper Card. \$64.10 includes postage. See <http://pweb.amerion.com/~w7avk> Bob W7AVK, 5581 Panorama Drive, Moses Lake, WA 98837, w7avk@arrl.net, 509-766-2777.

R-390(A) - RAPID QSY! Toolmaker converts your Kilocycle knob to beautiful spinner type with machined, knurled crank and refinishes with Mil-Spec black hard coat, \$75. Refinish all 17 knobs and add new white lines on 15. \$55. Postpaid to tower 48, Parker, 1205 Sleepy Hollow Road, Pennsburg, PA 18073

ADVERTISERS' INDEX

Advertiser	Page #	Website Address
AOR USA, Inc.	Cov III	www.aorusa.com
Advanced Specialties	71	www.advancedspecialties.net
Antique Radio Classified	27	www.antiqueradio.com
Atomic Time, Inc.	67	www.atomictime.com
C. Crane Company	18	www.ccrane.com
CQ Holiday Specials	47-53	www.cq-amateur-radio.com
Centerfire Antenna	25	www.centerfireantenna.com
Communications Electronics	7	www.usascan.com
Computer Aided Technology	45	www.scanat.com
Electric Radio Magazine	71	www.ermag.com
GRE America	41	www.greamerica.com
Ham Radio Outlet	13	www.hamradio.com
Homeland Security	74	www.ready.gov
ICOM America, Inc.	Cov. IV	www.icomamerica.com
JRC, Japan Radio Co., Ltd.	27	www.jrc.co.jp/
Kenwood	9	http://www.kenwoodusa.com
MFJ Enterprises, Inc.	3	www.mfjenterprises.com
Monitoring Times	68	www.grove-ent.com
Passport To World Band Radio	15	www.passband.com
PowerPort	27	www.powerportstore.com
QCWA	71	www.qcwa.org
RSGB	37	www.cq-amateur-radio.com
REACT International, Inc.	65	www.reactintl.org
RentScanner	71	www.rentscanner.com
Sangean	5	www.sangean.com
Ten-Tec	21	www.tentec.com
Universal Radio	1	www.universal-radio.com
W5YI Group, The	25	www.w5yi.org
Yaesu	Cov II	www.vxstdusa.com

Reach this dynamic audience with your advertising message, contact Arnie Sposato at 253-853-4080, FAX 253-853-4070, or e-mail: advertising@popular-communications.com.

Ho-Ho-Holy Mackerell!

The first Christmas I remember occurred when I was about three-and-a-half years old. I remember the smell of hot 3-in-One oil being made into smoke in the engine of an electric train, the lights on our tree were wired in parallel, so one bad bulb did not take an entire string with it. Those hot lights had their own smell, too—not unlike a dusty tube radio glowing in some corner of the living room.

My folks made Christmas magical for me, and I would sometimes arise as early as 2 a.m. on Christmas morning, just as Mr. and Mrs. Claus were retiring for the night, and they would head me off at the stairway with a convincing warning. I don't think I ever slept past 6 a.m. on any Christmas morning, until I assumed the role of Mr. Claus and was dragged out of bed at some unholy hour by the young man who would carry on the family name. I knew that grandpa Claus was chuckling as he rolled over for another couple of hours of uninterrupted sleep.

Even though I'm the "girthy" one, it was Norm who thought he should play Santa for a local service club. Norm has never done anything in a simple way. What I mean is that if there is an easy way and an extremely complex way to accomplish the same goal, Norm will always opt for—and talk *me* into helping with—the toughest way possible. Some of you may remember the tales of the bus. I rest my case.

We got to the costume rental place in plenty of time for Norm to get a good Santa suit, and one in his size, too. The shop even provided the padding so that we didn't have to resort to pillows, and we got some help from a thespian friend who found us a white beard that *glued on* to Norm's face so that those who gave it a tug would be surprised by its reality.

Norm tried on his suit and padding—even the hat and boots—but just held the beard on with string for the trial run. Other than being a bit shorter than your conventional Santa, he was perfect, and his years of public speaking gave him the polished voice of a convincing Santa. All he needed was a few reindeer and an unlimited charge account at Mega-Lo-Mart and he could take over the job for real.

Now, on to the difficult part. Norm wanted to be as omniscient as Santa himself. He wanted to know every child's name without being told. He wanted to know about brothers and sisters, and maybe some hints from Mom or Dad about what would be under the tree, so as not to promise a pony to a city dweller or some such *faux pas*.

Enter the ham bands. FM. Two meter. Very low power, with hidden headsets and mics. We tried out a few ideas and it worked fine, but we were concerned with station IDing and the correctness of the whole thing (if we mentioned gifts by brand name, was it a commercial use of the band, etc.), so we opted for a pair of commercial VHF walkie-talkies that we could borrow from a contractor friend of Norm's. We could use them on low power to keep us out of all the nearby commercial communications going on in our fair-sized metropolis, while not violating any rules of amateur communication.

We coordinated with the service club that sponsored the Santa thing, and the mall management that gave us a spot for

"...[Jason] slipped off Santa's lap and kicked him in the shin—an action shot captured by our photographer friend and which remains on Norm's wall to this day..."

Santa's big red chair, and we even let a local camera shop shoot some instant pictures for those who wanted them. We were pros! We were just like downtown!

I just wore a red Santa jacket and hat, which hid my headset and mic, and identified me as the gatekeeper of Santa Land. This put me in the perfect position to speak to Mom or Dad, get the names, and all the rest of the information to pass on to Santa just as the child approached to sit on his lap.

On the big day—that big shopping day right after Thanksgiving—Norm glued on his beard as he was taught, dressed himself in his costume, and drove to the mall. He had already put the headset and mic under his hat and beard, and we were chatting on 2 meters as we both headed in the same direction. The batteries were fully charged, everything was planned to the last detail. Dare I say, "nothing could go wrong"?

Mary and Susie and Johnny and Mark came and went, with their family history and the hints of what they would want under the tree bringing wide-eyed amazement from the children. A few tugged gently on his beard, but it was Santa's amazing knowledge of every aspect of their lives that kept them believing for at least another year.

It was truly amazing how, just as I was about to tell Norm one young man's name (Jason), someone on the same frequency called his co-worker, "Charlie."

Norm never noticed that it wasn't my voice, and he hoisted Jason up on his lap and said, "Hi, Charlie! And have you been a good boy this year?" and while the boy was looking strangely at him, and I was trying to catch his eye, Norm never caught on to the mistake, and asked poor Jason what he was hoping to find under the tree this year.

It was the most inopportune time for that unknown communicator to point out to his friend Charlie "the blonde babe in the Camaro," and you can just imagine how Jason and his father reacted when Santa asked with surprise, "You want a blonde babe in a Camaro?"

Jason was not as convinced as the other kids, because he said something to Norm which I heard through Norm's mic, but won't repeat here because Jason would only get into trouble, then he slipped off Santa's lap and kicked him in the shin—an action shot captured by our photographer friend and which remains on Norm's wall to this day as a reminder that no good deed ever goes unpunished.

The remainder of the season went on without too much of a hitch—unless you count the kid who yelled out, "Hey! Santa's wearing a *wire!*"

Watch What Happens!

The SR2000A is an ultra-fast spectrum display monitor that lets you SEE received signals in FULL COLOR

AOR SR2000A Frequency Monitor

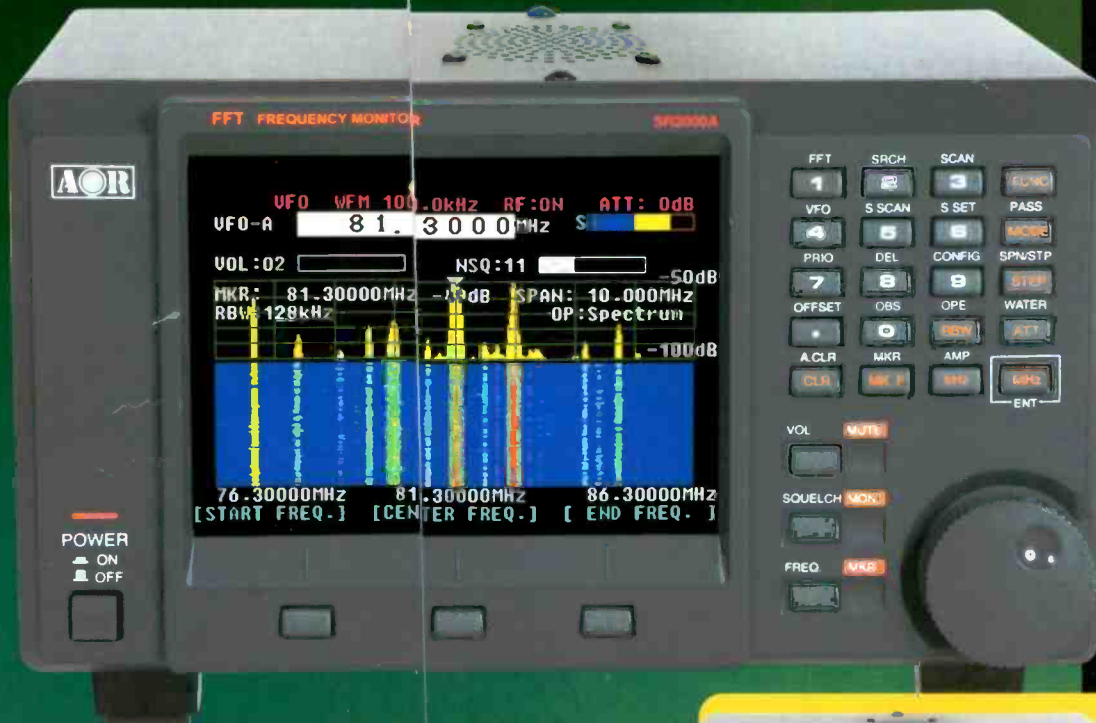

- Frequency coverage: 25MHz ~ 3GHz (no gaps)*
- Ultra-stable, high-sensitivity triple-conversion receiver
- External video output (composite video)
- AM/NFM/WFM/SFM/TV receive modes
- Displays up to 40MHz of spectrum bandwidth (20MHz or 40MHz selectable)**
- P25 decoding function available with optional P25-8600
- Waterfall (time) display function
- 1000 memory settings (100ch x 10 memory banks)
- Average or peak value readings

Using the power of FFT (Fast Fourier Transform) algorithms with a powerful receiver covering 25MHz ~ 3GHz*, the SR2000A features a color monitor that displays up to 40MHz spectrum



- Video display function (NTSC/PAL/SECAM auto select)***
- 5 inch TFT color LCD display
- Versatile color display uses state of the art digital signal processing

bandwidth or video display of NTSC, PAL or SECAM signals. Ultra-sensitive, incredibly fast, yet easy to use, with a high quality internal speaker for crisp, clean audio signals.

Scans 10MHz in as little as 0.2 seconds! Instantly detects, captures and displays transmitted signals.

- High speed FFT search quickly captures new signal transmissions
- Easy menu-driven operation
- PC control through RS232C serial port or USB interface

AOR

Authority on Radio Communications

AOR U.S.A., Inc.
20655 S. Western Ave., Suite 112, Torrance, CA 90501, USA
Tel: 310-787-8615 Fax: 310-787-8619
info@aorusa.com http://www.aorusa.com

*Government version. Cellular blocked for US consumer version.

**No audio is available when the frequency span is set to 20MHz or 40MHz.

***No audio available while displaying video signal on the LCD. If both video and audio need to be monitored simultaneously, an optional (external) TV2000 is required.

Just in time to connect you for the holidays



IC-R9500 Icom's Ultimate Wide Band Receiver

We've raised the bar with our super performance, multiple function wide band "measuring" receiver. The IC-R9500 has normal and wide spectrum scope functions. With five roofing filters before the first amp, two independent 32 bit floating point DSP processors, and 7-inch wide color TFT LCD, this is something to get excited about!



MOBILE OR PC CONTROLLED WIDE BAND RECEIVERS

IC-R1500

0.01 - 3299.99 MHz*
AM, FM, WFM, USB, LSB, CW
Fast Scan
Optional DSP
1000 Memory Channels
PCR Upgradeable

IC-R2500

0.01 - 3299.99 MHz*
AM, FM, WFM, SSB, CW (Main)
AM, FM and WFM (Sub)
1000 Memory Channels
D-STAR Compatible (Option UT-118)
P25 (Option UT-122)

Select Icom receivers are now on sale for the holidays. Visit your authorized Icom dealer today!



IC-R20
ADVANCED
WIDE-BAND RECEIVER
0.150 - 3304.0 MHz*
AM, FM, WFM, SSB, CW
1000 Memory Channels
Dual Watch Receiver
4 Hour Digital Recorder



IC-R5
COMPACT
WIDE-BAND RECEIVER
0.5 - 1300.0 MHz*
AM, FM, WFM
1250 Memory Channels
CTCSS/DTCS Decode
Weather Alert



IC-R75
WIDE BAND RECEIVER
0.03 - 60.0 MHz
Triple Conversion
Twin Passband Tuning
Digital Signal Processing (DSP)

For the love of DC to Daylight.



*Frequency coverage may vary. Refer to owner's manual for exact frequency specs.
©2007 Icom America Inc. The Icom logo is a registered trademark of Icom Inc. All specifications are subject to change without notice or obligation. 9804