

45635

# POPULAR COMMUNICATIONS

JULY 2001

## Is Your Town Next? How To Be Radio Ready—page 64

**Shortwave's  
Future...Page 8**

**Showcase Trio:**  
**MFJ Line Noise Meter**  
**Garmin GPS III Plus**  
**MFJ 20-Meter Transceiver**

U.S. \$4.99 / Canada \$6.99



\*\*\*\*\*3-DIGIT 641  
02 000386028 2202 2107  
MR. DAVID C STEARNS KCODAA  
109 W 98 TER  
KANSAS CITY MO 64114-4122



# PROFESSIONAL-GRADE MONITORING IN THE FIELD

Rugged and compact, the new Yaesu VR-120 Hand-Held Communications Receiver provides leading-edge performance on the shortwave, public safety, and military-communications bands. All at a surprisingly affordable price.

- RUGGED OUTDOOR-READY CASE CONSTRUCTION
- ULTRA-LONG BATTERY LIFE
- BNC-TYPE ANTENNA CONNECTOR
- STRAIGHTFORWARD 4-BUTTON OPERATION
- WIDEBAND FREQUENCY COVERAGE WITH EASY ACCESS
- SPECIAL "PRESET MODE" AIDS IN QUICK TUNING
- CATCH ALL THE SHORTWAVE BROADCAST ACTION FROM AROUND THE WORLD
- SUPER-SIMPLE ONE-TOUCH MEMORIES FOR HIGH PRIORITY STATIONS
- VERSATILE 640-CHANNEL MEMORY SYSTEM
- WIDE SELECTION OF SCANNING MODES
- EXPANDED FUN AND GAMES
- AND MUCH, MUCH MORE. . .

## COMMUNICATIONS RECEIVER

### VR-120

Wideband Coverage: 0.1~1299.995\* MHz AM/FM/WFM

\*Cellular / Image / restricted frequencies Blocked



Actual Size

## Tomorrow's Technology - Today THE PROFESSIONAL STANDARD

### COMMUNICATIONS RECEIVER VR-500

0.1~1299.99995 MHz\*  
LSB/USB/CW/AM/FM/WFM  
All-Mode Wide-Band Receiver

\*Cellular blocked



### COMMUNICATIONS RECEIVER VR-5000

0.1~2599.99998MHz\*  
LSB/USB/CW/AM-N/AM/  
WAM/FM-N/WFM  
All-Mode Wide-Band Receiver

\*Cellular blocked

For the latest Yaesu news, visit us on the Internet:  
<http://www.vxstd.com>

Specifications subject to change without notice. Some accessories and/or options may be standard in certain areas. Frequency coverage may differ in some countries. Check with your local Yaesu Dealer for specific details.



Choice of the World's top DX'ers™

Vertex Standard  
US Headquarters  
17210 Edwards Road,  
Cerritos, CA 90703 (562)404-2700



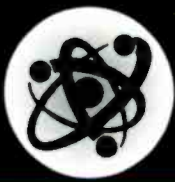

# LENTINI

COMMUNICATIONS, INC.

Toll Free  
**1-800-666-0908**

In CT **860-666-6227**

## ICOM

### PCR1000



**\$349.95**  
Special Sale price w/ICOM coupon

#### Communications Receiver For Computer

- Covers .01-1300MHz
- All Mode WFM, FM, AM, SSB, CW.
- Employs Band-Tracking RF Filters.
- Connects to Your PC Exter.
- PCR100, Similar to, PCR1000 Less SSB **\$199.95 SALE** UPS included

### IC-R10



- Wideband, All Mode Receive Capability From 100 kHz to 1300 MHz.
- 1000 Memory Chan. With 8-Character Alphanumeric Names.
- Many Other Features!

**\$299.95** Special Sale price w/ICOM coupon UPS included

### IC-R8500



#### Communications Receiver

- Wideband, All Mode Receive From 0.1 to 2000 MHz.
- Many Features Similar to IC-R10

CALL FOR PRICING!

### IC-R2

#### Ultra Compact, Super Wide Band

- The New Mini- Sized Scanner From ICOM is Now Available.
- 500kHz-1.3GHz (Less Cellular) AM/FM/WFM
- Loud And Crisp Audio, Backlit LCD.
- Triple Conversion, Built-In Attenuator.
- 400 Memories, 8 Banks of 50 Chan.
- CTCSS Tone Squeich and Tone Search.
- Includes 2 AA Size Ni-Cd Batteries and Charger.
- PC Programmable (Software and Connection Cable Optional).
- More!

**SPECIAL \$159.95**



### IC-R75



**\$579.95** UPS Inc.

#### NEW IC-R75 HF Receiver

- Receives .03-60MHz, AM/FM/SSB/CW/RTTY
- Triple Conversion Receiver
- Synchronous AM detection
- Twin Passband Tuning
- Automatic Notch Filter
- Front Mounted Speaker
- Optional Digital Signal Processing
- Up to Two Optional Filters

**IC-R3 \$429.95**

- Wide Band RX (.5-2450MHz)
- 2 Inch TFT Display
- Lithium Ion Battery
- PL Decoder/Scan
- Computer Programmable
- 450 Mem.
- 6 Char. Alpha-Nur Connector
- More!!



## ALINGO

### DJ-X2T

- Mini Size Multi-Mode Wide Band Comm Receiver
- AM/FM/WFM
- 700 Memories
- Freq Coverage 5-1000MHz Less Cellular



**NEW!**

### DJ-X10

- Wide Range Receiver
- Multi-Mode Reception From 1 to 2000MHz.
- Channel Scope.
- AM/WFM/FM/SSB/CW.
- 1200 Memories.
- Superb Sensitivity, Clear Sound.



Call For \$\$

### AR8200 MARK IIB

**NEW!**

- 5-2040MHz (Less Cellular)
- AM/NFM/WFM/SSB/CW.
- New TCXO Black Case.
- Telescopic Antenna Included
- Much More!



**\$559.95**

## AOR USA, Inc

### AR8600



- New Mobile/Base Unit.
- Freq Range 530kHz-2040MHz (Less Cellular)
- Supplied With TCXO
- All-Modes.
- Much More!

**\$849.95**

CALL FOR MORE INFO & PRICING  
Unblocked versions available to qualified agencies

**ALSO AVAILABLE**

AR5000+3  
AR7030 Plus  
SDU5500  
ARD-2

FULL LINE OF AOR ACCESSORIES

## uniden

### BC895XLT "TrunkTracker"



**\$219.95** UPS Included

SC180 \$174.95  
SC200 \$199.95  
UPS included

### BC245XLT Handheld "TrunkTracker II"



**\$219.95** UPS Included

**WinScan 780** Software \$69.95  
Optional programming cable included FREE!

### BC780XLT TrunkTracker III



- 500 Channel, 10 Banks, 10 Priority Channels
- Continuous Band Coverage: 25MHz to 1.3GHz
- Tracks EDACS™, Motorola, E.F. Johnson
- Alpha Tagging, 2 Line Alpha Display
- CTCSS/DCS
- AM/FM/WFM Modes
- Base/Mobile Design
- More

**\$349.95**

Drake Shortwave Radios  
R8B (new) \$1159.95 + \$14UPS

SONY	ICF-2010	CALL \$\$
SONY	ICF-7600G	CALL \$\$
SONY	ICF-SW07	CALL \$\$
SONY	ICF-SW77	CALL \$\$
MAGNUM	MAGNUM 257 30W	
	10 Meter Mobile	\$199.95
RANGER COMMUNICATIONS	RCI-2950DX	
	10/12 Meter Mobile	\$299.00

RCI-2970DX	10/12 Meter Mobile	\$429.00
RCI-2980	10 Meter Base	\$429.00
RCI-2990DX	10 Meter Base, 100W	\$629.00
RCI-6300 FTB	10 Meter Mobile	\$439.00
RCI-6900 FTB	10 Meter Mobile, SSB	\$479.00
TR-296 FDX CB Mobile, AM/SSB, 5-Digit Counter, All Chrome		\$229.95

## GRUNDIG Shortwave

**NEW!**  
Grundig Satellit 800  
**\$499.95**  
\$15 UPS  
Call for Availability

Yacht Boy 400PE  
**\$199.00**  
UPS Included

Yacht Boy 205 Analog Shortwave  
**SALE \$49.95**

HOURS: M-F 10am - 6pm SAT 10am-4pm (June-August-Saturday 10am-1pm) UPS Ground (48 states)

C.O.D.'s OK  
SAME DAY SHIPPING

Conn Sales Infor. & Tech Help **860-666-6227**

Web Site: [www.lentinicomm.com](http://www.lentinicomm.com)



**21 Garfield St. Newington, CT 06111**



# Contents

## POPULAR COMMUNICATIONS

Volume 19, Number 11

July 2001



6



12



16

### 8 Shortwave Broadcasting In The 21st Century

*Will Shortwave Survive The Next Few Years?*

by Bob Padula

### 16 Technology Showcase

*MFJ's Line Noise Meter*

by Harold Ort, N2RLL

### 24 Technology Showcase

*Garmin GPS III Plus*

by Alan Dixon, N3HOE

### 30 Technology Showcase

*MFJ's 20-Meter SSB Transceiver*

by Harold Ort, N2RLL

### 64 Organizing Scanner Banks

*Overheard*

by Ken Reiss

12 *Working With EPIRBs*

Radio Resources

18 *The Nighthawk*      *The Wireless Connection—formerly The Radio Connection*

28 *How To Get The Most Out Of Operating FM*  
Ham Discoveries—formerly *The Ham Column*

32 *Cambodia Clandestine Broadcasts To The World*      *Clandestine Communiqué*

36 *CB Daze And Enforcement News*      *On-The-Go-Radio—formerly CB Scene*

40 *Navigating International SW Bands The Easy Way*      *World Band Tuning Tips*

44 *We Interrupt This Webcast*      *Broadcast Technology—formerly Broadcast DXing*

50 *Shortwave Relays: Figuring Out Who's On From Where!*  
*Global Information Guide—formerly Listening Post*

56 *Old Meets New On The Internet*      *iWaves*

59 *Nassau County PD Asks To Use Ch. 19 TV Frequencies*      *Washington Beat*

60 *Classified Satellite Found By Monitors*      *Space Monitor*

63 *America The Beautiful—And A Competition No One Wins*  
*Pirate & Alternative Radio—formerly The Pirate's Den*

68 *Monitoring Hot Spots, And An Emergency Landing!*      *Utility Radio Review*

78 *Resource Of The Month: RadioShack.Com*      *Radio & The Internet*

80 *Confessional Amnesty*      *The Loose Connection*

### Departments

- 4 *Tuning In* — An Editorial
- 6 *Our Readers Speak Out* — Letters
- 42 *Power Up: Radio & High-Tech Gear*  
— formerly *Product Parade*
- 76 *Readers' Market*
- 77 *VIP Spotlight* — formerly *How I Got Started*

### On The Cover

Today you've got to expect the unexpected, and program your scanners accordingly. Just as the Sarasota County, Florida sheriff SWAT Team practices, you should have special scanner banks programmed for major events, and practice monitoring these banks in case disaster strikes. (Photo by Larry Mulvehill)

Visit us on the Web: [www.popular-communications.com](http://www.popular-communications.com)



# Universal Radio - Quality equipment since 1942.

## SANGEAN ATS-909



Free SR-1BC  
requires purchase of ATS-909



## FREE FREE FREE Sangean SR-1BC AM/FM Mini Radio

The **ATS-909** is the flagship of the Sangean line, covering all LW, AM and shortwave frequencies plus FM. Features include: wide-narrow, single side band, 5 tuning methods, 307 alphanumeric presets, 3 event clock timer and illuminated LCD. Requires four AA cells (not supplied). Includes: AC adapter, case and roll-up antenna plus a free SR-1BC AM/FM mini radio (a \$29.95 value!). #1909 **\$239.95**

## COMMUNICATIONS RECEIVERS



YAESU



Universal Radio carries an excellent selection of new and used communications receivers. JRC NRD-545 shown.

## GRUNDIG



The Grundig **YB-300PE** provides affordable AM, FM and shortwave reception (2.3-7.3 and 9.5-26.1 MHz). Enjoy keypad entry, 24 memories, backlit digital display, clock. With AC adapter, stereo earphones and case. New with one year warranty. #0300 **\$99.95**

Reconditioned. Save \$30 #2300 **\$69.95**

Reconditioned radios have the same warranty and supplied accessories as new.

## YB-300PE & YB-400PE



The deluxe Grundig **YB-400PE** covers all LW, AM, FM and SW frequencies. It features two bandwidths, SSB, 40 memories, clock and keypad. With AC adapter, stereo earphones, wind-up antenna and case. New with one year warranty. #0400 **\$199.95**

Reconditioned. Save \$60 #4073 **\$139.95**

## WIDEBAND RECEIVERS & SCANNERS



Universal carries an extensive line of scanners and wideband receivers from all major manufacturers including AOR, Alinco, ICOM, Yaesu and Uniden-Bearcat. The AOR AR8200 is shown. All major ham lines are also stocked.

## COMMERCIAL RECEIVERS



The Ten-Tec **RX-340** is the ultimate receiver! Advanced D.S.P. at under \$4000.

## UNIVERSAL M-450v1.5

The **Universal M-450v1.5** reader displays: RTTY, SITOR, FEC-A, ASCII, SWED-ARQ and Weather FAX (to the printer port) plus the **ACARS** aviation teletype mode.

DTMF, CTCSS and DCS are also supported. Features a big two-line, 20 character LCD and parallel port. Operates from 12 VDC or with the supplied AC adapter. No computer or monitor is required. Made in U.S.A. #0450 **\$399.95**

Please visit our website for other specialized amateur and shortwave products.



**Universal Radio, Inc.**  
6830 Americana Pkwy.  
Reynoldsburg, Ohio  
43068-4113 U.S.A.

800 431-3939 Orders & Prices  
614 866-4267 Information  
614 866-2339 FAX Line  
dx@universal-radio.com

## RADIO BOOKS

### • A Family Affair - The R.L. Drake Story

*John Loughmiller KB9AT*, reveals the behind-the-scenes history of the famous R.L. Drake Company, focusing on the glory days, when Drake was king in amateur radio. Every ham and SWL knew R.L. Drake from the outside, but now the inside story of this incredibly interesting company is told. This book also includes 150 pages of useful circuits and modifications for many Drake amateur radios. An entertaining read and a great technical reference for every Drake owner. Printed October 2000. Over 300 pages and 23 chapters. #1487 **\$29.95**

Brand New!

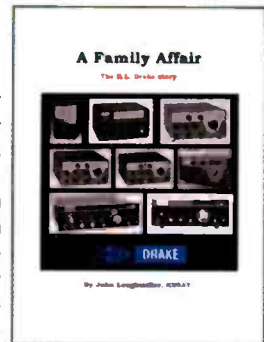

### • Grundig Ocean Boy - 40 Years

By *Thomas Baier* Brand New!

Here are all the details for each model of the famous Grundig Ocean Boy line. Over 65 photos, facts, commentary and specs on this long lived line. Printed in Germany in English/German. ©2001 Over 90 pages, perfect bound. #3358 **\$19.95**

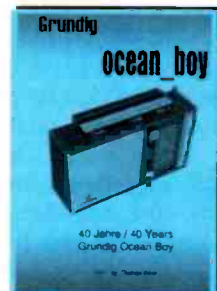

### • Grundig Satellit - All Models in Word & Picture

By *Thomas Baier* Brand New!

Here are the full details for each model of the famous Grundig Satellit line. Tons of photos, facts, commentary and specifications on this venerable line. Includes: Satellit 205, 208, 210, 1000, 2000, 2100, 3000, 3400, 1400 2400, 4000, 600, 650, 300, 400, 500, 700, 900 and 800 models. 126 pages with 120 photos. #2416 **\$19.95**

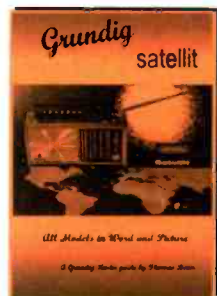

### • Pirate Radio By A. Yoder With audio CD!

Here is the incredible saga of America's underground illegal broadcasters (with audio CD). 326 pages. #3038 **\$24.95**

### • Discover DX'ing! By J. Zondlo Second Edition

Hear distant AM, FM and TV stations. #0019 **\$5.95**

### • Communications Receivers - The Vacuum Tube Era By R.S. Moore Fourth Edition

Key facts, figures and photos for shortwave receivers of the Golden Era 1932-1981. 141 Pages. #2945 **\$19.95**

U.S. orders under \$100 ship for \$4.95, under \$500 for \$9.95.

## www.universal-radio.com

- Visa
- MasterCard
- Discover
- Prices and specs. are subject to change.
- Returns subject to a 15% restocking fee.
- Free 100 page catalog on request.

universal  
radio inc.



# tuning in

an editorial

## The "General" Situation

*Editor's Note: We haven't had a guest editorial for some months, so let's turn the keyboard over to Bob Leef this month. Robert K. Leef has been in the radio communications business for 29 years and is a published writer in several magazines. Bob is an amateur licensee, KB6DON, and GMRS license holder KAB5295. He is the founder of Repeater Users Group, the Radio Communications Monitoring Association, and Crest REACT/Crest Communications. Bob has worked for 33 years with volunteer emergency radio communications organizations.*

The General Mobile Radio Service (GMRS) is a two-way radio service licensed by the Federal Communications Commission. It was originally known as Class A Citizens Band about 40 years ago. Using FM at 462 and 467 MHz frequencies in the UHF band, it is popular today in many areas of the U.S. for personal communications covering up to 60 miles or more by using repeaters where available. (The FCC information line says they don't know how many licensees there are — a person would have to count them).

GMRS is also the chameleon of the FCC's Wireless Telecommunications Bureau. It constantly changes color regarding the amount of the license fee, who may use the service, and what frequencies are authorized for which users, etc.

### Strange Bedfellows

Having been in touch with many users, I get the following picture. Proliferation of FRS on GMRS frequencies has created the strange bedfellows of a licensed and unlicensed service on seven common frequencies. There is an argument in favor of the situation that it allows intercommunication and that some FRS users who hear GMRS communications will want to upgrade to GMRS to cover more distance. Then there is the argument against the situation: interference by FRS, many times by children, to GMRS users who each paid \$85 for a license to

have meaningful communications. Is combining licensees with non-licensees compatible if it's all in the name of personal communications?

### That Darned \$85 FCC License Fee!

The FCC's GMRS license fee of \$85 is too high for the five-year period. It discourages some users from licensing, resulting in a certain amount of unlicensed illegal use. By listening to communications on any given channel you may or may not hear a call sign, since some licensees fail to identify properly in GMRS (a common problem in many radio services). There is a possible light at the end of the tunnel: a petition was received April 16 at the FCC to either extend the license period to 10 years or reduce the fee from \$85 to \$25 for five years. This petition is expected to be assigned a Rule Making number by the FCC in early June.

### Observation: An Unjust Limitation

REACT groups are denied modification by the FCC of grandfathered licenses or the granting of new team licenses. While personal licensees may use any repeater on any frequency for their routine communications (with permission of the repeater operator), the public service mission of such an organization, which includes emergency and assistance, is restricted to the frequency it was originally licensed for. Moreover, these REACT groups around the country cannot add another repeater to improve coverage for their public service activities. This seems to be incompatible with the enhancement of personal communications and public safety that is supposed to be the objective of the General Mobile Radio Service.

### Complicated FCC Rules

Complicated and conflicting GMRS rules and regulations by the FCC can

(Continued on page 62)

## POPULAR COMMUNICATIONS

### EDITORIAL STAFF

Harold Ort, N2RLL, SSB-596, Editor

(Internet e-mail: PopularCom@aol.com)

Tom Kneitel, K2AES/SSB-13, Senior Editor

(Internet e-mail: tsksksk@juno.com)

Alycia Nicholzen, Assistant Editor

Richard S. Moseson, W2VU, Online Coordinator

(Internet e-mail: W2VU@amsat.org)

### CONTRIBUTING EDITORS

Ed Barnat, TCA-44, CB SSB

Peter J. Bertini, K1ZJH, Restoration/Electronics

Paul Carr, N4PC, Antennas

Bruce Conti, AM/FM Broadcasts

Joseph Cooper, Utility Radio

Gerry L. Dexter, Shortwave Broadcast

Laura Quarantiello, Legislative Affairs

Jock Elliott, SSB-734, Citizens Band and FRS

Eric Force, Radio and the Internet

Bill Hoefler, KB0ULJ, Aviation Communications

Kirk Kleinschmidt, NT0Z, Amateur Radio

Bill Price, N3AVY, Humor/Communications

Ken Reiss, Technical/Scanning

Keith Stein, Space Comms

Edward Teach, Pirate and Alternative Radio

Gordon West, WB6NOA, Radio Resources

### BUSINESS STAFF

Richard A. Ross, K2MGA, Publisher

Donald R. Allen, W9CW, Advertising Mgr.

Emily Leary, Sales Assistant

Sal Del Grosso, Accounting Manager

Ann Marie DeMeo, Accounting Department

Catherine Ross, Circulation Manager

Melissa Gilligan, Operations Manager

Denise Kells, Data Processing

### PRODUCTION STAFF

Elizabeth Ryan, Art Director

Barbara McGowan, Associate Art Director

Dorothy Kehrrieder, Production Manager

Emily Leary, Assistant Production Manager

Hal Keith, Technical Illustrator

Larry Mulvehill, WB2ZPI, Photographer

A publication of



CQ Communications, Inc.  
25 Newbridge Road  
Hicksville, NY 11801-2953 USA

Offices: 25 Newbridge Road, Hicksville, NY 11801. Telephone (516) 681-2922. FAX (516) 681-2926. Web Site: <http://www.popular-communications.com/> Popular Communications (ISSN-0733-3315) is published monthly by CQ Communications, Inc. Periodical class postage paid at Hicksville, NY and additional offices. Subscription prices (payable in U.S. dollars): Domestic—one year \$28.95, two years \$51.95, three years \$74.95. Canada/Mexico—one year \$38.95, two years \$71.95, three years \$104.95. Foreign Air Post—one year \$48.95, two years \$91.95, three years \$134.95.

U.S. Government Agencies: Subscriptions to Popular Communications are available to agencies of the United States government, including military services, only on a cash with order basis. Requests for quotations, bids, contracts, etc. will be refused and will not be returned or processed.

Entire contents copyright © 2001 by CQ Communications, Inc. Popular Communications assumes no responsibility for unsolicited manuscripts, photographs, or drawings. Allow six weeks for change of address or delivery of first issue.

Printed in the United States of America.  
Postmaster: Please send change of address to Popular Communications, 25 Newbridge Road, Hicksville, NY 11801.

The world's first VHF/UHF scanner • Tunes in to everything but cell phones • Wireless video monitor - excellent tool for Surveillance

# The sky's the limit.

## IC-R3

### World's First Video Scanner!

Never before has this much excitement been in the palm of your hand. The IC-R3 brings you more than the usual audio you get from an ordinary scanner. Wide tuning range allows you to see and hear the excitement behind the scenes. Large easy to read color display for frequency settings and video reception. All in a compact easy to carry package.

Whether you're a hobbyist wishing to go beyond regular voice communications or a professional who does wireless video security or counter-surveillance - nothing else comes close to the 'R3 in price or versatility. Clearly, the IC-R3 represents a quantum leap in monitoring technology.

#### Here are just a few of the many video signals to monitor.

- 420-440, 902-928 & 1240-1300 MHz: Amateur TV frequencies
- 902-928 MHz: Part 15 video equipment; "VCR Rabbits"™ & wireless security cameras
- 2150-2162 MHz: Omni-directional transmission of point to multipoint video signals

Frequencies courtesy of Scanning USA, Feb. 2001 -Something new to monitor, by Tom Filecco



Limited time offer.  
See dealer for details.

0.5-2450 MHz† • 450 Memory Channels with Alphanumeric Names • CTCSS with Tone Scan • 4 Level Attenuator • Telescoping Antenna with BNC Connector • Four Way Action Joystick • Lithium Ion Power • *and* a 2" Color TFT Display with Video/Audio Output

Limitless uses • The world's first audio scanner/pocket TV combo

†Cellular frequencies blocked; unblockable versions available to FCC approved users.  
©2001 ICOM America, Inc. 2380 116th Ave NE, Bellevue, WA 98004 • 425-454-8156. The ICOM logo is a registered trademark of ICOM, Inc. All specifications are subject to change without notice or obligation. R3POP COM4K1

See what you've been missing

[www.icomamerica.com](http://www.icomamerica.com)

**ICOM**



# our readers speak out

Each month, we select representative reader letters for "Our Readers Speak Out" column. We reserve the right to condense lengthy letters for space reasons and to edit to conform to style. All letters submitted must be signed and show a return mailing address or valid E-mail address. Upon request, we will withhold a sender's name if the letter is used in the magazine. Address letters to: Harold Ort, N2RLL, SSB-596, Editor, Popular Communications, 25 Newbridge Road, Hicksville, NY 11801-2909, or send E-mail via the Internet to <popular-com@aol.com>.

---

## Please, Stop!

---

**Dear Editor:**

Do you know of a device which will change a traffic light from red to green as you approach it?

Harry Cohen

**Dear Harry,**

*And you'd want one for??*

---

## Leave It To Uncle

---

**Dear Editor:**

I sent you a news item that may be of interest to your readers. It appeared in the *Toronto Star*. The implications, if this device were placed into service, would be to track and locate a cellular phone customer.

The U.S. government on one hand doesn't want anyone to listen to a cell phone conversation, but on the other hand would like to be able to track the movements of a user. I have mixed feelings about this technology and the potential for abuse.

Larry Lamb,  
Cavan, Ontario

**Dear Larry:**

*Thanks for the news clipping. Like the article said, the concern isn't about tracking just 911 callers, but the millions of others using cellular phones. But why not? It's a pattern, you know. After all, government satellites can see you watering your garden, getting on a bus, and talking to your neighbor over the fence. They can see if you've planted tulips or daffodils. They can check your E-mails, Internet chat room conversations, check on your bank accounts, take photos of you crossing the street, and run your license plate without you even knowing it while you sit at an intersection. Ain't technology grand?*

---

## Loves That February Issue!

---

**Dear Editor:**

I had to write and say I think the February issue of *Popular Communications* is your finest to date. I thoroughly enjoyed "Tropical Band Radio In The Center Of South America." It's a sad fact of life to see that I have more money wrapped up in my amateur radio (and listening) station — just for hobby pursuits

— than those in South America have who are running a daily commercial broadcast station. Is anyone planning to go to Eastern Europe to do another article like this? Fascinating!

Great issue, keep up the good work. I read practically every issue cover to cover.

73,  
Cliff Dunning, Missouri

**Dear Cliff:**

*Thank you for your kind letter. Actually I was thinking about sending columnist Ken Reiss somewhere — Poland is nice this time of year!*

---

## Instant Interest

---

**Dear Editor:**

I am new at shortwave listening. When I retired I came across your magazine in a doctor's office and was instantly interested. I bought a Sangean 818 and am having a lot of fun. I was just wondering if there is another antenna you could use in a high-rise building.

Melvin Williams  
Chicago, IL

**Dear Melvin:**

Thanks for your note. I also use a Sangean 818 when traveling and staying in hotels - many times well inside the structure. My antenna of choice is a 20-foot stranded wire with an alligator clip at one end. I've had excellent results simply collapsing the telescoping whip and clipping the wire to the base of the radio's antenna. You could always purchase an active antenna, but try the inexpensive route first.

---

## Same Old Baloney - I Got Mine, You Get Yours

---

*Note: I deliberately held off using this fellow's letter because I wanted to see where amateur radio would be a couple years down the pike, and if the majority of peoples' attitudes mirror his. I've personally found they don't.*

Editor

**Dear Editor:**

What we had and have is a group of people that were finally successful in dumbing down the standards of amateur radio. What we observed was a group of people that told us to be open minded, don't be so judgmental, we need to be fair, what about a medical condition? There are a lot of would-be good OPs and technical folks out there that just can't get past the code. I guess those are the ones on the two-meter machines in the major metropolitan areas, real gems, and wait till they get on the crowded HF bands. Yes, this is a mirror group of the new pop culture of "I want it now, and I don't want to have to work for it." It is my right and entitlement as a American citizen and I demand it be given to me."



---

An amateur license would require one to study code and theory months on end; this would require a student to put out a lot of time and effort. This was a struggle for most of us but we all did it for the prize was well worth the sacrifices. And I think that is what is behind this whole mess. Sacrifice, yes in a day were time is ever more precious then before or so it seems. Today one would like to have a shortcut to getting amateur radio license . . . who wants to sacrifice in this day and age to get an amateur radio license? . . . But what is wrong with the old adage that you work for what you get. Does this not produce a better operator when a standard of competency is kept and the bar is not lowered? We know this makes a better person out of one that is expected to achieve. It exercise and stimulates the mind, requires discipline, perseverance, yes you could say that keeping a standard not only keeps character in check but also builds it up and encourages others around to do the same.

Maybe I don't belong to the league anymore; maybe they don't represent my interest in amateur radio. I never thought I would see the day, but it may very well be upon us, the day amateur radio was dumbed down.

Daniel Baker, KM6CQ  
Antelope, CA

**Dear Daniel:**

I don't have enough ink or Tylenol to rebut your letter as I'd like to, but will give it a shot. First, ever since the dawn of Man (with apologies to Gloria Steinham) folks have looked at a better, easier way of doing things; work and play alike. I suppose some dummies would argue that the day seat belts were mandated in all U.S. vehicles was a bad day for America because getting a few bumps, bruises and contusions on the road of life was a good thing. And I suppose also, according to your theory of the world, that since you were born - probably 1905-1915 - the whole darned world has deteriorated to such rubble as to make your life completely miserable. Not so, Daniel!

Guess what? The good old days are here now! I suppose you'd prefer to carry an old M-14 or pilot a B-17, and use radios that weighed three tons. Not me. I'll take the wimpy way out; new Kevlar head and body armor, a new M-16, and smaller radios. You know what I think? I think some people just like to moan and groan because they had it pretty tough compared to today and WISH they were growing up now, not 50 years ago. I'll take the casual Fridays at work (who the heck NEEDS a tie anyway?), lighter and smaller radios (who NEEDS behemoths anyway?), high-tech medical gizmos and the dozens of out-of-this-world discoveries made as I type this (yes, we can go to the moon in a tin can, but why would you want to when newer, safer craft exist?) and digital readout on my radio (unless part of being a real radio operator is 'guessing' what frequency you're on). Who needs a radio hobby that is populated with old, outdated, and cantankerous cronies when folks can look elsewhere for enjoyment?

Daniel, we had to change the face of Amateur Radio, not to "dumb it down" as you say, but to give it what a wonderful, fun hobby needs: new life and a chance for survival in a time when so many things in life vie for our attention. We can sit in the driveway with the 'ol Desoto and crank the starter and watch the world go by or get off the porch and run like life means something, because it does, and it's a lot more than clinging to the past and letting a good thing go down the tubes. To that end,

we're making headway. I for one came from the ranks of the dreaded CB band; operated there for years until becoming a No Code Tech a few years ago. Frankly, because I cherish my license and privileges I personally try my best to be a good - no, great operator - and I'm proud of it. I recently upgraded to General, and guess what, Daniel - there are more old-time hams on 20-meters (NOT new licensees, mind you) claiming stake to frequencies, operating at power far beyond the legal limit and FCC requirement to use the minimum power necessary to conduct a QSO, and all manner of shenanigans that frankly, I'm not very proud of, and you shouldn't be either. These, my friend, are, for the most part, longtime hams. They are not in major metro areas on 2-meters, but they're shouting to the world their ignorance, arrogance and disrespect for others. This is the legacy you leave behind and what so many new No Code Techs are working so hard to overcome. I submit to you that the real dumbing down of amateur radio is an ongoing process that began the minute you got your code requirement under your belt and your fellow ham did not - until now.

---

## Needs AH-100 Pack

**Dear Editor:**

It was a very long winter — lots of snow. One of my Cobra walkie-talkies went down, but Cobra had me back on the air in a week! I use my radios for emergencies and outside. Have also been monitoring Andrews Global.

I'm still looking for that "AA" battery pack for my Cherokee AH-100.

Thank you,  
Joseph Del Rossi,  
Bucks County, Pennsylvania

**Dear Joseph:**

*I decided to print your letter hoping some readers can offer their assistance. You already have the basic NiCd pack, but you'd also like an AH-100 "AA" plastic holder so you may use your own alkalines. If anyone can help Joseph, please write to me at Pop'Comm.*

---

## Eroding Freedom

**Dear Editor:**

Right on, Harold, great editorial. I was listening to a station in Mt. Home FM on the way to work and I realized we have almost lost all of the hometown stations. We don't have it in Harrison — we used to on AM but now everything is taped, and there is no person on the mike. That's not good. But the Mountain Home station still has the old-fashioned person at the mike, giving the news and weather. I think we need to keep the local connection. We keep giving away little bits of freedom and I don't think that's right. Change is good. I'm not an old fogey against any change, but let's not give our freedom away just because some out-of-touch bureaucrat does not have all the facts. What would happen if we taken over by some foreign government just because we didn't communicate on a local basis? And if we don't communicate locally, how can we communicate nationwide? OK, I will get off my soapbox, but I think you did a helluva good job on your editorial.

73,  
Mel, WB5RND



# Shortwave Broadcasting In The 21st Century

## Will Shortwave Survive The Next Few Years?

By Bob Padula

Last fall I undertook a three-week trip to Europe, mainly to attend the annual conference of the European DX Council (EDXC) in Barcelona, Spain. As a consulting professional broadcast engineer and writer, I am an associate member of the EDXC, which comprises broadcasters, professionals, private individuals, and most European-based DX Clubs, representing several thousand DX enthusiasts.

After the Conference, I spent some two weeks touring Spain by bus, then flew on to Zurich via Iberia Airlines, for a three day stop, before the long haul (24 hours) back to Melbourne via SwissAir and British Airways, through Singapore and Sydney.

With me I had my ever-faithful Sangean 818A portable receiver that has served me well on my various overseas travels, and works very well with small antennas. This radio had accompanied me to the jungles of Sabah, to the wild rivers of Northern Thailand, across Vietnam, to the rainforests of Northern Australia, and of course to many countries in Europe during an earlier trip.

### The EDXC Conference

The three-day meeting, about 20 km from downtown Barcelona, was arranged in cooperation with the Barcelona DX Association (BDXA). It attracted over 50 participants, and was ably led by EDXC Secretary-General Risto Vahakainu (Finland), assisted by Francisco Rubio (BDXA), and included a day tour to the IBB's Spain Transmitting Station at Playa-de-Pals, and a morning excursion to Barcelona and environs. There was a visit to the Observatory Tower just outside of Barcelona, followed by an evening banquet at the "Cabassa Castano" restaurant in nearby Sant Cugat.

### Conference Nuts And Bolts

The Conference featured several expert presentations on current and emerging trends for SW broadcasting, with discussions on such important topics as:

- The Future of International Broadcasting (by Francisco Rubio, BDXA)
- Listening for Content — an evaluation code for SW broadcasts (by Enrique Fernandez, formerly of Radio Moscow)
- Broadcasters' Forum, a panel discussion by the represen-



*Will shortwave sites such as this BBC station in Thailand become dinosaurs in the next few years?*

tatives of Deutsche Welle, IBB, RFA, Radio Vlaanderen International, Vatican Radio, Radio Austria International, Radio Prague, and Radio Korea International

- Introduction to Radio Free Asia (by Andrew Janischek, Technical Director of RFA, Washington)
- The influence of the Internet on DX Clubs (by Anker Petersen, Chairman, Danish Shortwave clubs International).

*On shortwave, the Internet, and satellite, here's the latest shortwave schedule from Radio Netherlands.* →



# Radio Netherlands at-a-glance programme and frequency guide

Valid from March 25th – October 27th 2001. Times are Universal Time Co-ordinated (UTC) (same as GMT)

## North America

23.30 UTC = 16.30 PDT / 19.30 EDT local times  
Frequencies: 6165 and 9845 kHz

04.30 UTC = 21.30 PDT / 00.30 EDT local times  
Frequencies: 6165 and 9590 kHz

**SUNDAY** 01.25 Ends  
23.30 News  
23.35 Sincerely Yours  
23.55 Week Ahead  
00.00 Dutch Horizons  
00.30 Aural Tapestry  
01.00 News  
01.05 Wide Angle  
01.25 Ends  
04.30 News  
04.35 Sincerely Yours  
04.55 Week Ahead  
05.00 Dutch Horizons  
05.30 Ends

**MONDAY** 23.30 Newsline  
00.00 Research File  
00.30 EuroQuest  
01.00 Newsline  
01.25 Ends

04.30 Newsline  
05.00 Research File  
05.30 Ends

**TUESDAY** 23.30 Newsline  
00.00 Music 52-15  
00.30 A Good Life  
01.00 Newsline  
01.25 Ends  
04.30 Newsline  
05.00 Music 52-15

**WEDNESDAY** 23.30 Newsline  
00.00 Documentary  
00.30 Dutch Horizons  
01.00 Newsline

01.25 Ends  
04.30 Newsline  
05.00 Documentary

**THURSDAY** 23.30 Newsline  
00.00 Basement Sessions  
00.30 Research File  
01.00 Newsline  
01.25 Ends

04.30 Newsline  
05.00 Basement Sessions  
05.30 Ends

**FRIDAY** 23.30 Newsline  
00.00 A Good Life  
00.30 Documentary  
01.00 Newsline  
01.25 Ends

04.30 Newsline  
05.00 A Good Life  
05.30 Ends

**SATURDAY** 23.30 News  
23.35 Europe Unzipped  
23.55 Insight  
00.00 Aural Tapestry  
00.30 Roughly Speaking  
01.00 News  
01.05 Europe Unzipped  
01.25 Ends

04.30 News  
04.35 Europe Unzipped  
04.55 Insight  
05.00 Aural Tapestry  
05.30 Ends

## Africa (continued)

18.30 Newsline  
19.00 The Research File  
19.30 Basement Sessions  
20.00 Newsline  
20.25 Ends

**FRIDAY** 17.30 Newsline  
18.00 A Good Life  
18.30 Newsline  
19.00 Documentary  
19.30 A Good Life  
20.00 Newsline  
20.25 Ends

**SATURDAY** 17.30 News  
17.35 Europe Unzipped  
17.55 Insight  
18.00 Aural Tapestry  
18.30 News  
18.35 Europe Unzipped  
18.55 Insight  
19.00 Roughly Speaking  
19.30 Aural Tapestry  
20.00 News  
20.05 Europe Unzipped  
20.25 Ends

## Europe

10.30 UTC = 11.30 UK / 12.30 CET local times  
Frequencies: 6045 and 9860 kHz

20.30 UTC = 21.30 UK / 22.30 CET local times  
Frequency: 1512 kHz (AM) / Mediumwave

**SUNDAY** 10.30 News  
10.35 Wide Angle  
10.55 Week Ahead  
11.00 Aural Tapestry  
11.30 Dutch Horizons  
12.00 News  
12.05 Sincerely Yours

20.30 News  
20.35 Sincerely Yours  
20.55 Week Ahead  
21.00 Dutch Horizons  
21.30 Aural Tapestry  
22.00 News  
22.05 Wide Angle  
22.25 Week Ahead

**MONDAY** 10.30 Newsline  
11.00 EuroQuest  
11.30 Research File  
12.00 Newsline

20.30 Newsline  
21.00 Research File  
21.30 Euroquest  
22.00 Newsline

**TUESDAY** 10.30 Newsline  
11.00 A Good Life  
11.30 Music 52-15  
12.00 Newsline

20.30 Newsline  
21.00 A Good Life  
21.30 Music 52-15  
22.00 Newsline

**WEDNESDAY** 10.30 Newsline  
11.00 Dutch Horizons  
11.30 Documentary  
12.00 Newsline

20.30 Newsline  
21.00 Documentary  
21.30 Dutch Horizons  
22.00 Newsline

**THURSDAY** 10.30 Newsline  
11.00 Research File  
11.30 Basement Sessions  
12.00 Newsline

20.30 Newsline  
21.00 Basement Sessions  
21.30 Research File  
22.00 Newsline

**FRIDAY** 10.30 Newsline  
11.00 Documentary  
11.30 A Good Life  
12.00 Newsline

20.30 Newsline  
21.00 Roughly Speaking  
21.30 Documentary  
22.00 Newsline

**SATURDAY** 10.30 News  
10.35 Europe Unzipped  
10.55 Insight  
11.00 Roughly Speaking  
11.30 Aural Tapestry  
12.00 News  
12.05 Europe Unzipped

20.30 News  
20.35 Europe Unzipped  
20.55 Insight  
21.00 Aural Tapestry  
21.30 Roughly Speaking  
22.00 News  
22.05 Europe Unzipped  
22.25 Insight

## Asia, Far East, Pacific

09.30 UTC = 18.30 Japan / 17.30 Australia  
(Western) local times  
Frequencies 9790, 12065 and 13710 kHz

14.30 UTC = 20.00 India local time  
Frequencies: 9890, 11835 and 12075 kHz

**SUNDAY** 09.30 News  
09.38 Sincerely Yours  
09.55 Week Ahead  
10.00 Dutch Horizons  
10.30 News  
10.35 Wide Angle  
10.55 Week Ahead  
11.00 Aural Tapestry  
11.30 Ends

14.30 News  
14.38 Sincerely Yours  
14.55 Week Ahead  
15.00 Dutch Horizons  
15.30 Aural Tapestry  
16.00 News  
16.08 Wide Angle  
16.25 Ends

**MONDAY** 09.30 Newsline  
10.00 Research File  
10.30 Newsline  
11.00 EuroQuest  
11.30 Ends

14.30 Newsline  
15.00 Research File  
15.30 EuroQuest  
16.00 Newsline

**TUESDAY** 09.30 Newsline  
09.36 Europe Unzipped  
09.55 Insight  
10.00 Aural Tapestry  
10.30 News  
10.36 Europe Unzipped  
10.55 Insight  
11.00 Roughly Speaking

14.30 Newsline  
15.00 Music 52-15  
15.30 A Good Life  
16.00 Newsline

**WEDNESDAY** 09.30 Newsline  
10.00 Documentary  
10.30 Newsline

11.00 Dutch Horizons  
11.30 Ends  
14.30 Newsline  
15.00 Documentary  
15.30 Dutch Horizons  
16.00 Newsline

**THURSDAY** 09.30 Newsline  
10.00 Basement Sessions  
10.30 Newsline  
11.00 Research File  
11.30 Ends

14.30 Newsline  
15.00 Basement Sessions  
15.30 Research File  
16.00 Newsline

**FRIDAY** 09.30 Newsline  
10.00 A Good Life  
10.30 Newsline  
11.00 Documentary

14.30 Newsline  
15.00 A Good Life  
15.30 Documentary  
16.00 Newsline

**SATURDAY** 09.30 News  
09.36 Europe Unzipped  
09.55 Insight  
10.00 Aural Tapestry  
10.30 News  
10.36 Europe Unzipped  
10.55 Insight  
11.00 Roughly Speaking

14.30 News  
14.36 Europe Unzipped  
14.55 Insight  
15.00 Aural Tapestry  
15.30 Roughly Speaking  
16.00 News  
16.06 Europe Unzipped

## Africa

17.30 UTC = 19.30 South Africa local time

Frequencies: 6020, 7120 and 11655 kHz (then from 18.30 UTC we add 9895, 13700, 17605 and 21590)

**SUNDAY** 17.30 News  
17.35 Sincerely Yours  
17.55 Week Ahead  
18.00 Dutch Horizons  
18.30 News  
18.35 Wide Angle  
19.00 Aural Tapestry  
19.30 Dutch Horizons  
20.00 News  
20.05 Sincerely Yours  
20.25 Ends

**MONDAY** 17.30 Newsline  
18.00 Research File  
18.30 Newsline  
19.00 EuroQuest  
19.30 Research File  
20.00 Newsline  
20.25 Ends

**TUESDAY** 17.30 Newsline  
18.00 Music 52-15  
18.30 Newsline  
19.00 A Good Life  
19.30 Music 52-15  
20.00 Newsline  
20.25 Ends

**WEDNESDAY** 17.30 Newsline  
18.00 Documentary  
18.30 Newsline  
19.00 Dutch Horizons  
19.30 Documentary  
20.00 Newsline  
20.25 Ends

**THURSDAY** 17.30 Newsline  
18.00 Basement Sessions

20.30 Newsline  
21.00 Research File  
21.30 Euroquest  
22.00 Newsline

**TUESDAY** 10.30 Newsline  
11.00 A Good Life  
11.30 Music 52-15  
12.00 Newsline

20.30 Newsline  
21.00 A Good Life  
21.30 Music 52-15  
22.00 Newsline

**WEDNESDAY** 10.30 Newsline  
11.00 Dutch Horizons  
11.30 Documentary  
12.00 Newsline

Radio Netherlands



Tracking down which frequencies (in kHz) come from which sites – Bonaire 6165, 9590, 9790 and 9845 / Flevoland 9895, 11655 and 13700 / Irkutsk 13710 / Jülich 6045 / Madagascar 6020, 7120, 9890 and 11835 / Petropavlovsk 12065 / Tashkent 12075 / Wertachtal 9860 / Wolvertem 1512 AM / Mediumwave

Key to satellite transmission: Astra RNW1/2 = Astra 1G, 19.2° East, Transponder 109, 12.574 GHz/H, MPEG2/DVB. AsiaSat 2: 105° East, Transponder 10B, 4.000 GHz/H, MPEG2/DVB (European Bouquet). Intelsat 707, 1° West, Transponder 23B, 3.915 GHz/RHCP, MPEG2/DVB.

Note, all satellite transmissions are 'Free to Air' (FTA).

For more information: [www.rnw.nl/en](http://www.rnw.nl/en)



(At Anker's invitation, I gave a summary of the present circumstances and trends for the Internet delivery of radio monitoring news, based on my experiences with the Electronic DX Press).

The Conference discussed a range of issues concerning SW broadcasting, from the perspectives of the organizations who are committed to funding and delivery, especially in the present era of fierce competition from satellite and Internet platforms.

- Radio Vlaanderen International will not be investing any further funds into shortwave broadcasting for replacement of the present facilities.

- IBB reported that Russian people don't have satellite receivers or personal computers, and shortwave radio is regarded as the prime means of communication. The Finland office of the IBB has 25 contract monitors in strategic locations, with about 25,000 technical observations being sent in each week. Individual reports from DXers are not considered suitable, and extensive use is being made of remote monitoring systems, where audio samples and scans can be made at any time.

- International SW broadcasting is regarded by many as having no clear goals, or objectives, and little feeling for listener needs. Links with listeners must be strengthened. Smaller broadcaster are being urged to improve their image and presence, knowing that SW radio is cheap and mobile, and is available anywhere, unlike the Internet.

- HF Digital Radio. In March 1998, a group of broadcasters, transmitter and receiver manufacturers, network operators, and research bodies signed a "Memorandum of Understanding" to develop a system with characteristics as described above. Later that year a formal consortium agreement was completed, putting in place a body committed to the development of a digital standard for the AM bands below 30 MHz. Digital Radio Mondiale (DRM) was established.

The DRM Technical Committee, working in a very tight time frame, developed a standard sufficiently robust to submit to the ITU. Also, it conducted a series of propagation tests using five converted transmitters around the world. These tests were for the purpose of proving that the theory would work out in practice. DRM is encouraging adoption of the proposed standard, as well as continuing the more detailed development work, and testing the system.

Estimates from the transmitter industry indicate that modern transmitters could be converted to digital at a cost of about \$100,000 per transmitter.

The aim is to have digital receivers in the marketplace in late 2001 or early 2002. One of DRM's goals is that a receiver bought anywhere in the world will work anywhere in the world. For this to succeed, it is important that a standard emerges from the work of the ITU that meets the needs of the global broadcasting industry. As a result, DRM has started to work with USADR to promote the adoption of a global standard. This will reduce the cost of new receivers and make the product more attractive to the consumer.

Research indicates that there are an estimated 2.5 billion receivers in the world, of which 60% are estimated to have short-wave coverage. Although it may not be possible to arrive at a single worldwide standard for digital broadcasting, it is hoped that there will be sufficient coordination such that a single receiver will be capable of receiving any of the systems that go into actual use.

The agreed timescale for introduction of DRM is:

- January 2001: start the standardization process
- December 2001: complete the standardization process
- 2002: first transmissions of the initial prototype receivers
- 2003: official start in conjunction with the ITU's World Radiocommunication Conference (WRC)

Current information on DGM is available from <http://www.drm.org>. The EDXC Conference provided a refreshing opportunity to meet not only with many people who are involved in the management of international broadcasting, but also with many customers (i.e., listeners), and representatives of the major European DX Clubs.

The 2001 EDXC Conference is scheduled for Budapest, Hungary, in August, and the Council's Website is: <http://www.swl.net/edxc>.

It is obvious that international shortwave broadcasting in the 21st century will be subject to massive change; the audience is no longer "listeners," but "customers." Unless broadcasters can move into the 21st century, marshal and harness new forms of technological, financial, and delivery infrastructures, as well as demonstrate to their owners that they have a solid, expanding audience base, they will not survive.

## The PALS Transmitting Station

The International Broadcasting Bureau (IBB), an agency within the U.S. government, operates its Spain transmitting station at Pals. This is a coastal resort, in the extreme northeastern part of the country some 40 km south of the French border, in a tourist area known as the Costa Brava. It is about 120 km north of Barcelona, just off the main highway to Marseilles. It has many villas, holiday apartments, guesthouses, and hotels, surrounded by pine tree forests, and looks out on the Mediterranean Sea. The transmitting station is situated adjacent to the residential areas, right on the beach, at geographical coordinates 41N59.21, 3E12.06.

The station occupies an area of some 82 acres of unobstructed beachfront property, and operates six transmitters each of 250 kW. Four identically matched units provide excellent flexibility from which to choose various power output combinations as broadcasting situations require.

The station can operate in the following modes:

1. Six single units of 250 kW
2. Four single units operating at 250 kW, and two matched units combined into a single transmitter running at 500 kW
3. Two single units operating at 250 kW, and four matched units combined into two separate transmitters, each operating at 500 kW
4. Two single units operating at 250 kW, and four matching units combined into single unit operating as a super-powered million watt transmitter.

Output is routed via a computer-driven antenna switch matrix to four groups of curtain arrays of nine antennas. These are situated ideally for first-hop coverage of audiences in the principal population areas of the Community of Independent States, in the adjacent Baltic area, and the former USSR.

Program feeds from Washington come to the station via satellite. The Satellite Interconnect System "SIS" delivers the U.S. government's non-military International radio programs to broadcasting stations worldwide. Overseas stations, such as





Vatican Radio has been a mainstay on shortwave for years.

staff. Housekeeping was first class, and carrier frequency deviation on all transmitters is maintained to within 10 Hertz.

Some of the transmitters are quite old, dating back to 1959, being Continental, and General Electric units. There is a new Continental unit, installed in 1997, which was relocated from Gloria, Portugal.

The station is an unusual mix of old and new technology, with the older equipment adjacent to 21st century hi-tech computerized switching gear, satellite antennas/links, and state-of-the-art transmitter monitoring and control facilities. Digital frequency readout displays are rack-mounted on the newer transmitters, and other indicators reveal various parameters such as modulation depth and swing, antenna current, RF antenna input power, and overall power consumption.

The Pals station clearly serves a vital role in the global network of IBB facilities, providing coverage into the former USSR area, and with six high powered transmitters, it obviously is regarded by the U.S. government as a strategically important and crucial mission. It remains to be seen whether this facility will continue to be permitted by the Spanish government.

Special thanks to the Barcelona DX Association for their excellent work in arranging the tour, and to the station's staff for taking time off from their normal duties to host a group of 40 visitors around this interesting broadcasting facility. Furthermore, there were no security restrictions on what we could photograph, whether digital, video, or conventional.

The current operational schedule for the Pals station can be downloaded from the IBB's Frequency Management Database System, (FMDS), accessed at [http://sds.his.com:4000/fmds\\_w/index.html](http://sds.his.com:4000/fmds_w/index.html) ■

Pals, and affiliates de-multiplex and decode the T1 carriers into individual programs and distribute these to broadcasting facilities for regional audiences. The satellite connection system is based on geostationary INTELSAT satellites named AOR and IRO (Atlantic Ocean Region and Indian Ocean Region).

Pals transmits programs of Radio Free Europe, Voice of America and Radio Liberty. It does not broadcast Radio Free Asia services.

Output is targeted on azimuths ranging from 41 degrees to 63 degrees, essentially in a northeasterly direction from Pals. The station does not have the capability at present of transmitting on the 21 or 26 MHz bands due to antenna limitations, and neither does it work in the new 13 or 18 MHz bands.

Daily output (as at the time of the visit) comprised programs from:

- VOA: 5.5 hours
- RFE: 3 hours
- RL: 20.5 hours

I was impressed not only by the efficiency of the facility, but also at the compliance with safety standards and maintenance procedures, and the professionalism and skills of the technical

# Mobile DXer

by Dave Mangels, AC6WQ

NEW Book!  
Hot Off the  
Press!

A practical guide to Mobile DXing - an exciting, challenging and rewarding facet of today's Amateur Radio!

Here's a sampling of what you'll find inside:

- ✓ Lightning Preparedness
- ✓ Tuning mobile HF Antennas
- ✓ Propagation & Mobile DXing
- ✓ Mobile HF Antennas & Tuners
- ✓ The Language of Mobile DXing
- ✓ The Versatility of Mobile DXing
- ✓ Selecting & Installing Mobile HF Radios
- ✓ Tools, Tactics & Techniques... and more!

Only \$12.95

Plus \$2 shipping & handling

CQ Communications, Inc.

25 Newbridge Road, Hicksville, NY 11801

Phone 1-800-853-9797 • Fax 516-681-2926

Shop on line at [www.cq-amateur-radio.com](http://www.cq-amateur-radio.com)



### Working With EPIRBs

The term EPIRB refers to an emergency position-indicating radio beacon. Aircraft owners call them ELT — emergency locator transmitter. The military sometimes calls them WARBLERS because that's what the modulated signal sounds like on the VHF bands.

Modern-day emergency position indicating radio beacons now do a lot more than just send a warbling tone on international distress frequency **121.5 MHz** and its second harmonic, primarily used by the military, **243 MHz**. The modern-day EPIRB for marine use carries a second transmitter inside, signaling a user identification data stream on **406 MHz**. The Federal Communications Commission, specifically for this encoded data stream, has allocated several 406 MHz channels.

And it gets better yet. This same 406 MHz data signal may also include global positioning system (GPS) imbedded coordinates in degrees, minutes, and fractions of a minute, either identifying where the EPIRB was activated, or every six minutes encoding a new GPS-derived position from an internal GPS receiver. One GPS manufacturer, NAT, Inc., calls their 406 MHz EPIRB with built-in GPS a GPIRB. Other manufacturers like ACR and Pains-Wessex may simply advertise their 406 MHz EPIRB with BUILT-IN GPS (Pains-Wessex SOS model) or the ACR Rapidfix 406 MHz EPIRB with GPS interface.

When out on the high seas, a 406 MHz activated EPIRB would certainly give a more precise updated position every six minutes if the GPS were built in, right? This is indeed correct, so EPIRB manufacturers stuff a small GPS board on the inside, tie it to the every-six-minute 406 MHz data stream upload, and hope that the GPS system within the bobbing over-

board 406 EPIRB is at the crest of a wave in order to get a download from GPS mid-earth-orbit satellites — four satellites in view simultaneously are necessary for the position fix.

The way ACR does it is to take the data stream from an onboard running GPS receiver, regularly download the posi-

tion, and in an emergency the deployed EPIRB continues to transmit the last position that could be a maximum of six minutes old from the time the EPIRB was pulled from its mount and activated.

But what happens if the activated EPIRB and the overboard Tom Hanks in the life raft begins to drift? Will an old GPS position throw rescuers off?

“When we get within a mile or two of the reported GPS position, we let our onboard 121.5 MHz homer take us into the exact location of the activated EPIRB,” comments a United States Coast Guard rescue pilot explaining how the EPIRB system works over the water.

“It is the 121.5 MHz signal that we home in on,” repeats the Coast Guard pilot. If this is the case, why spend all the extra bucks on an EPIRB with the 406 MHz signal, with or without GPS?

The answer is 95 percent false alarms at 121.5 MHz. That's right — nearly every 121.5 MHz activated EPIRB leads to unintentional activation where an ELT activated on a hard landing, or a boat owner pulls the GPS equipment from the mount to do a little varnish work, not realizing it was a self-activating unit.

The 121.5 MHz signal is usually first picked up by the COSPAS-SARSAT low-earth-orbit satellite system. This is a 25-year-old emergency network that has saved thousands of lives around the world. It's operated by the United States, Canada, France, and Russia. Polar-orbiting satellites, doing double duty as weather satellites, constantly retransmit (like a repeater) any signal coming in on 121.5 MHz and 243 MHz. The COSPAS-

SARSAT acts like a carrier-operated repeater, faithfully retransmitting on a microwave band anything it hears on 121.5 MHz and 243 MHz. Because these are low-earth-orbiting satellites, their simultaneous retransmission of an emergency warbling tone only covers a couple thousand miles of ocean area that must be within mutual view of the activated EPIRB and a ground mission control center on land. It could take several hours of satellite passes before the geom-



*The ACR handheld direction finder.*



# AOR AR8200 Mark II B & AR8600 Receivers

## Welcome to the Top Shelf



AOR wide-range communications receivers are designed and built for the serious user. Among our customers are governments and government agencies, news gathering operations, military units, laboratories, public safety operations and more. If you are a demanding user who expects the best, you're ready for AOR, The Serious Choice in Advanced Technology Receivers.™ Don't look for AOR on the bottom shelf at your local discount store, you won't find us there. For dealer locations, check our web site, [www.aorusa.com](http://www.aorusa.com)



Technology so advanced,  
it's patented (US Patent 6,002,924).

### AR8200 Mark II B

**Base performance in a hand-held receiver!**

- 530 KHz ~ 2040 MHz \* coverage
- 1,000 memory channels (20 banks) with alphanumeric labeling
- Computer control and programming (requires optional cable)
- Download free control software from AOR web site
- "All Mode" reception includes "super narrow" FM plus wide and narrow AM and USB, LSB, CW and standard AM and FM modes
- True carrier reinsertion in USB and LSB modes  
Includes 3 KHz SSB filter!
- Detachable MW antenna with negative feedback
- Optional internal slot cards expand capabilities. Choose from Memory Expansion (up to 4,000 memories), CTCSS Squelch & Search, Tone Eliminator, Voice Inverter\*\* and Record Audio (saves up to 20 seconds of audio)
- Tuning steps programmable in multiples of 50 Hz in all modes
- 8.33 KHz airband step is correctly supported
- Noise limiter and attenuator
- Lighted keys
- Band activity "scope" display with "save trace" capability
- Four-way side panel rocker switch allows one-hand operation
- Large display includes A and B VFO frequencies and signal strength meter
- Battery Save function with Low Battery indicator
- Operates on 12 VDC external power
- 4 AA Ni-Cd batteries supplied, also uses standard AA dry cells
- BNC antenna connector
- Wide choice of accessories

See us at Dayton  
Booths 451 & 452

### AR8600 Base/Mobile

**Think of it as a magnet for signals.**

- Temperature Compensated Crystal Oscillator (TCXO) ultra-stable frequency reference
- Coverage from 530 KHz ~ 2040 MHz\*
- Receive Modes: WFM, NFM, SFM, WAM, NAM, USB, LSB, CW
- New front end and RF stages for superior sensitivity
- 2 VFOs (A/B)
- 1000 memory channels (20 banks x 50 memories/bank)
- Alphanumeric channel labels
- Scan rate up to 37 channels/second
- Add up to 3 optional slot cards: Tone eliminator, CTCSS, Voice Inversion\*\*, Recording, External memory
- Accommodation for Collins® Mechanical Filters
- RS-232C port
- 10.7 MHz IF output (WFM mode only) can be used with SDU 5500 Spectrum Display Unit.
- 12 VDC operation
- BNC antenna connection
- Download free control software from AOR web site

**AOR**<sup>TM</sup>  
Authority On Rad o

AOR U.S.A., Inc.  
20655 S. Western Ave., Suite 112, Torrance, CA 90501, USA  
Tel: 310-787-8615 Fax: 310-787-8619  
info@aorusa.com • [www.aorusa.com](http://www.aorusa.com)

\*Cellular blocked. Unblocked version available to authorized users, documentation required. \*\*Available to authorized users only. Specifications subject to change without notice or obligation. All trademarks remain the property of their respective owners.



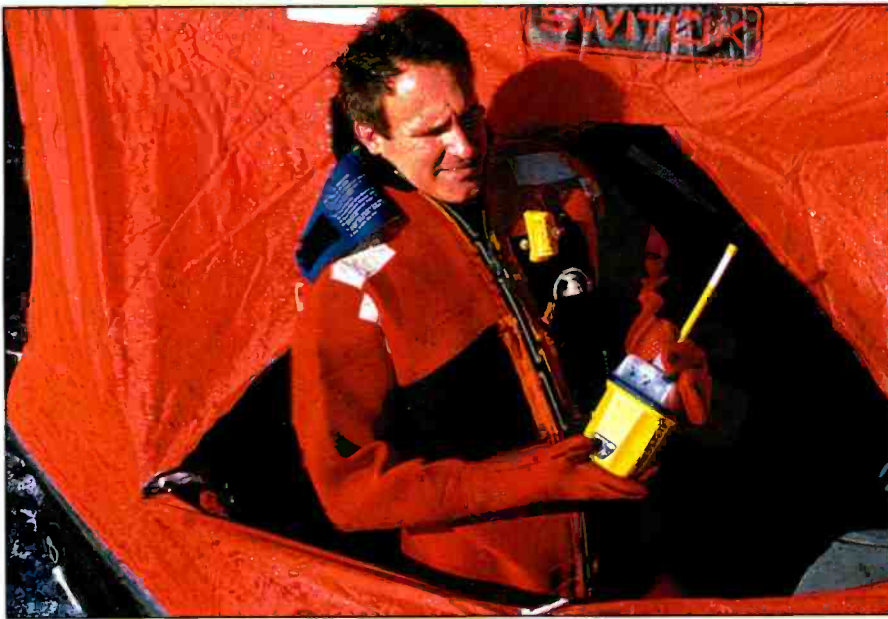

Marine EPIRB signals on 121.5 and 406.025 MHz at the same time.  
(Photo courtesy ACR)

etry would allow mutual reception of the 121.5 MHz signal. And in some ocean regions, the geometry would never work for a 121.5 MHz signal to be simultaneously received by a land station.

About 11 years ago, 406 MHz added to the 121.5 MHz signal allowed the satellite to store and forward an alert. Computer programs would then trace back in time where the activation was heard, and on several more passes, through Doppler sift, be able to calculate the approximate position of an on-water 121.5 MHz signal.

### Today's New EPIRB

But usually the signal was not found on the water, but at a local airport. Or at a local yacht harbor. Or at a local store selling EPIRBs. Once again, false alarm.

But the 406 MHz imbedded identification, in a database maintained by NOAA, now allows the mission control center to start making phone calls to see whether or not this COULD be a real activation. Most of the time, it would be explained that they were recently cleaning the boat, and indeed there was no real emergency, and they would go down to the boat and figure out how the EPIRB became activated. But every once in a while, mission control center might make a phone call, and one very worried wife would say indeed her husband was out on the high seas, headed from here to there, and yes, last report was he was in some heavy weather. Indeed, this EPIRB alert needs immediate attention.

And any 406 MHz signal that contains latitude and longitude will also give rescue control center operators a "heads up" on probably an accidental activation if the coordinates turn out in a local yacht harbor, or a "for real" activation if the activation is located in an area ravaged by a major storm.

Besides the new generation of polar-orbiting weather satellites that do double duty as EPIRB signal repeaters and store and forward 406 MHz messengers, the 406 MHz data stream is also stored and forwarded by 4 GEOSARs that relay the call back to mission control center, for additional alerts that someone has activated a 406 MHz EPIRB with its accompanying 121.5 MHz local direction-finding signal.

406 MHz EPIRBs that activate automatically are Category 1, Class 1, with some sort of hydrostatic water-activated mount. Manually deployable Category 2 EPIRBs must be pulled out of their secure mount, and a protective cover opened up to reveal the submersible on switch. While the activated EPIRB doesn't make any sound at all to the activator, there are indications of it on transmit by either a flashing strobe or some sort of visual LED indicator. It is the lack of any audible sound, in my opinion, that leads to many EPIRBs getting false activated, and no one near them knowing that the unit is actually turned on and signaling to overhead satellites. If every five minutes they would make one loud squeak, much like a smoke alarm, this would give the owner/operator a clue that the thing is on the air without them aware of this situation.

But let's get back to the 121.5 MHz signal, an integral part of the new modern 406 MHz EPIRB. Soon you may read that 121.5 MHz EPIRBs will no longer be offered for sale. This is not actually a completely true statement — what you will soon



An older and much larger 121.5 marine EPIRB.



hear is that any EPIRB for maritime use offered for sale must be 406 MHz, but be assured that the 406 MHz EPIRB will also contain the 121.5 MHz signal. This means that all of the rescue agencies throughout the world with \$1,000 steer left-steer right direction-finding equipment will always be able to home in on the local 121.5 MHz signal.

But you don't necessarily need a \$1,000-plus automatic direction finder that says steer left or steer right to home in on the 121.5 MHz signal. ACR Electronics, a world leader in safety and survival technologies, has developed a completely submersible 121.5 MHz EPIRB small enough to wear on a life preserver, yet capable of putting out a distress signal on 121.5 MHz that could be easily received by aircraft, search and rescue boats, and although not necessarily intended for this purpose, even detected by the low-earth-orbit COSPAS-SARSAT satellite system.

This EPIRB and its associated handheld direction-finder unit may be the perfect answer for water rescue teams, scuba divers, ski patrols, lake patrols, and in heavy terrain rescues. This is NOT a \$1,000 system.

to sweep the antenna horizontally to determine a broad incoming signal direction. When using the equipment, we were able to tell exactly which end is pointing to the incoming signal, and we could also see the effects of multipath reflected signals as slightly reduced signal strength indications. A built-in amplifier lets you listen in to the warbling 121.5 MHz signal.

## Getting Close To The Signal

As we approach the activated EPIRB, in our case an accidental activation at our local airport, we then switched from the most sensitive signal indication function down to the least sensitive, adding the necessary attenuation to always keep the signal strength LED readouts in the center of the scale. It took us only about 10 minutes to walk right up to the aircraft that was getting fuel and the pilot was exclaiming that he had made an extremely hard landing moments ago. This we knew — without him knowing it, the ELT was indeed activated.

ACR Electronics feels that this system has so much merit for search and rescue

agencies that they offer a "trainer" EPIRB that transmits on an adjacent frequency of 121.775 MHz for tests and training. The receiver already has this test frequency built in on Channel 2. Search and rescue agencies might contact ACR Electronics ([www.acrelectronics.com](http://www.acrelectronics.com)) and ask for the availability of the test frequency EPIRB that looks identical to their compact mini-B 121.5 MHz EPIRB. The test EPIRB was well marked as TEST ONLY, so there would be no mistaking that this would not operate on 121.5 MHz.

Many amateur radio emergency clubs, REACT teams, and flyers and boaters have an active interest in perfecting their 121.5 MHz EPIRB-finding skills. Clearly ACR Electronics is looking to equip these teams and operators with low-cost, direction-finding receivers and transmitters that could be used in an emergency, or a test transmitter for training. If you think your organization may want to get involved in tracking EPIRB signals, I suggest contacting ACR for the latest on their VECTA direction-finder system and the miniature personal EPIRB (products 2769 and 2766).

## Can Be Carried On Your Belt Or In Your Pocket!

The ACR mini-B 300 EPIRB operates on 121.5 MHz with about 1 watt of power that will stay on the air for 24 continuous hours. The EPIRB is small enough to be carried on a belt, or even put in a pocket. Water rescue teams and even scuba divers to withstand 250 feet of submersion for up to 65 hours may also use it. Although it doesn't work UNDER water, nonetheless, it will survive deep IN water, and begin signaling as soon as the operator activates it and holds it up just out of the water.

The other "end" of this rescue system is a sensitive, two-channel, super-heterodyne receiver with twin calibrated signal strength scales to a dual-element, direction finding, antenna system. The sensitive, direction-finding receiver, in the standby mode, inputs all 121.5 MHz signals from a one-quarter wavelength, remote, omni-directional antenna. As soon as the signal is picked up, the direction-finder system sounds an alert. The operator then disconnects the omni-directional antenna, unfolds the twin folded dipole antennas, and then begins

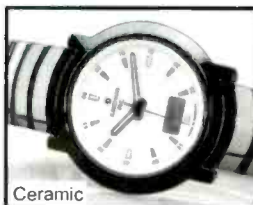

Ceramic

Junghans Atomic Ceramic sapphire lens, ceramic band, LCD for day, date, zone luminous, w-resistant 100ft, all ceramic-harder than steel \$790



atomic radio with 2 alarms and temperature, day, date, LCD \$39.95



NEW

Junghans Atomic Carbon Fiber Watch, stainless bezel, sapphire lens, LCD day, date, time zone, carbon/leather band, 7 models \$279

## ATOMIC TIME™

...self setting

...correct time

...atomic clock

World's most exact time... atomic clocks, atomic watches and weather stations

- for any time zone
- synchronized to the u.s. atomic clock in colorado
- accurate to 1sec. in 1 mil. years
- engineered in germany

### complete line of atomic clocks

JUNGHANS MEGA CERAMIC Watch luminous, never scratches, 5 models  
JUNGHANS MEGA CARBON Watch  
JUNGHANS MEGA CLOCKS \$47-109  
JUNGHANS SOLAR WATCHES \$279  
ATOMIC SPORTS WATCHES \$129  
ATOMIC SCHOOL/OFFICE CLOCKS  
Oregon Scientific Weather Stations,  
Weather Forecast, World Time, NOAA  
Radios, Radio Controlled Clocks  
Atomic Digital Wall Clocks \$59...

call for our FREE Brochure

or go to [www.atomictime.com](http://www.atomictime.com)

credit card orders call toll free

**1-800-985-8463**

30 Day Money Back Guarantee  
send checks incl. s&h \$6.95 to

ATOMIC TIME, INC.  
1010 JORIE BLVD.  
OAK BROOK, IL 60523



Atomic dual alarm clock with temperature day and date, 2AA Batteries black 3.5x4.5x2" \$29.95



black arabic 12" wall clock for home or office • \$59.95 (wood \$69.95)



Atomic Sports Watch Silver Polymer Case, LCD for day, date or seconds 100 ft water resistant black leather band \$129



# technology showcase

by Harold Ort, N2RLL, Editor

new product performance analysis

## MFJ's Line Noise Meter: MFJ-852

If I told you that you could track down and pinpoint most of the noise ruining your radio reception, what would it be worth to you? Fact is, most of us, at one time or another, have been plagued with noise that frequently nearly ruins our radio activity. I know I have, so when the folks at MFJ Enterprises came out with their MFJ Line Noise Meter I decided to give it a try.

There are days here in the suburbs that it's just a slight trickle of noise; barely worth pursuing, and then there are those instances where I'm sure I couldn't hear the BBC near 6 MHz if I were sitting atop their antenna array because of the noise level!

My neighborhood probably isn't much different than most; average size yard, birds chirping, cars making their way down a city street a block away, telephone and electric poles dotting the landscape (we're still in the Dark Ages when it comes to hanging wires on trees without limbs, instead of burying them like most modern countries, but that's another story). Ah, those electric utility poles. What would you do without them? Perhaps the question is, what to do *with* them? Short of firing up the chain saw in a fit of rage or banging the pole with a sledgehammer, help is on the way!

### Finding The Noise Is Easy — Curing It, Another Matter

The handy MFJ Line Noise Meter is about the size of an older transistor radio, but with the antennas protruding out from the sides of the little rectangular box. It's a simple receiver operating in the 135 MHz region of the radio spectrum — prime listening territory to help you find noise fast! Remember, if you're getting braps and zaps at this VHF frequency, you're probably within feet, not miles of the offending electrical apparatus. (You can certainly use your spare transistor radio or boom box tuned to a vacant part of the AM dial — the higher, the better, or even an FM radio, BUT your results won't be anything close to using the MFJ unit simply because this "radio" receives in AM — no annoying FM hiss, and you get a lot closer to the noise source at 135 MHz).

*Look at this mess! Remember, it isn't always the pole with the infamous transformer that's to blame for radio noise. A broken insulator, dead bird or squirrel, lightning arrester, or loose pole hardware can be a real radio nightmare.*



*There it goes — the blasted fish tank heater. Our camera's flash brightened the meter too much, but that little heater switch is causing a major problem throughout the broadcast band and well into the shortwave spectrum.*





Like most homes today, we've got light dimmers, a doorbell transformer, a fishtank heater, computers and a FAX machine — any or all can wreak havoc on your radio reception. Using the MFJ Line Noise Meter is straightforward, but even so, the provided manual gives you a good overview and instructions on tracking down radio noise. The unit runs on a 9-volt battery (not included), and because the battery compartment is accessed only by removing a few screws, I decided to put a long-life lithium battery in the meter. Push the red on/off button, pull out the telescoping whip antennas and you're in business. Thoughtfully, MFJ has even included a headphone jack so you don't have to just rely on the provided large analog meter; you can hear the noise as it rises and falls depending on how you turn as you null the noise.



MFJ's Line Noise Meter is well worth the \$99.95.

Holding the unit out in front of your body, you're "pointing" the receiver at the noise. Turn your body to one side and you're moving perpendicular to the noise. It took me exactly 10 minutes to locate a utility pole a block away, write down the number of the pole and call New Jersey's GPU to correct the problem. Of course getting the power company (or telephone or even cable company) investigator to look into the problem is another matter, but most are cooperative if you're polite, honest, and have already found the offending pole or transformer with the MFJ Line Noise Meter.

### In The Home

Tracking down radio noise is sort of a hobby within a hobby; after a while you become pretty adept at not just using the meter, but identifying certain noise sources by the intensity and sound unique to each situation. And, just for the record, it isn't always the fishtank heater or light dimmer that's the culprit! Case in point: We've got a total of three light dimmers — frankly, I despise them all just because they're there, I think. I've recently been able to track down and eliminate a 40-watt "candle-type" bulb in the living room that was on the light dimmer circuit, but God Save The Light Dimmer, it turned out to be a *defective bulb!* Then there was my recent adventure locating a horrible S-9+ noise right in the shack — turned out to be the FAX machine.

With the MFJ meter I've also collapsed the two telescoping antennas (fully extended, be careful of your kid's and pets eyes, and breaking the antennas going through doorways) to get really close to noise sources. If you're getting a good, solid reading on the meter with this receiver, you're practically on top of the noise!

I like the MFJ Line Noise Meter because it's super sensitive and well worth the \$99.95 (I know you'd pay twice that to find a noise source if you're nearly ready for the looney bin because you can't use your radios!). Honestly, there's another reason this gadget is well worth it: you look more "professional" and onto something with the meter than you do using a traditional AM/FM radio or boom box. Believe me, I've been down that road — literally — and when you look professional with a small pair of mono headphones (or even an earplug) and this meter, your business of tracking down noise is simply going to go better. And if the noise is coming from your neighbor's light switch or heating pad, you're ahead of the game by letting them listen and *see* for themselves just how bad the noise is — and you just might be doing them a favor locating the noise. Defective switches, blankets, and lamp sockets have a nasty habit of doing more damage than ruining our radio reception!

What might MFJ have added to this handy must-have Line Noise Meter? Nothing, in my opinion; it's housed in a sturdy hard plastic case, the direction-finding dipole antenna is balun isolated, and the antennas are easily removed for storage or transporting the unit. My MFJ Line Noise Meter (Item No. 852) has paid for itself many times over the past few weeks, and sits atop a shelf in my radio room, ready for action at a moment's notice.

For more information on the MFJ Line Noise Meter or any other MFJ Enterprises product, contact the company directly at 662-323-5869, write to them at P.O. Box 494, Mississippi State, MS 39762 or E-mail MFJ at [mfj@mfjenterprises.com](mailto:mfj@mfjenterprises.com). Be sure to tell them you read about the Line Noise Meter in *Popular Communications* magazine. ■

## Antenna Book SPECIAL! 4 GREAT books for only \$54.95!



### W6SAI Antenna Handbook by Bill Orr, W6SAI

Inexpensive practical antenna projects that work!

### Building & Using Baluns & Ununs

by Jerry Sevick, W2FMI

Info and designs on transmission line transformer theory!

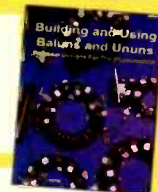

### The Quad Antenna

by Bob Haviland, W4MB

Design, construction, characteristics and applications of quad antenna!

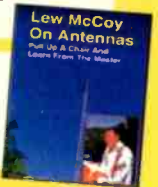

### McCoy on Antennas by Lew McCoy, W1PC

Lew presents his invaluable antenna information in a casual, non-intimidating way for anyone!

Please add \$4 shipping/handling for each set ordered.  
Foreign orders- shipping/handling charges are calculated by order weight and destination.

Phone, fax or mail your order in today!

**CQ Communications, Inc.**

25 Newbridge Road, Hicksville, NY 11801

516-681-2922 ♦ Fax 516-681-2926

Visit our web site! [www.cq-amateur-radio.com](http://www.cq-amateur-radio.com)



## The Nighthawk

I've had numerous requests to begin with the original 1-Tube All-Bander as it was described by David J. Green K3KNY (latter W6FFK) in the January 1967 issue of *Electronics Illustrated Magazine*, rather than jumping into our planned upgraded model featuring an RF stage and an additional audio stage to permit a speaker to be used. So be it. For those who asked, the original schematic, along with my suggested changes for the power supply section, is featured in this column. Readers who are only interested in building a Chinese copy of the original set can now do so, but those of you interested in adding the RF and audio stages should wait until the final design is tested and published. The new supply is beefier than the original, and will easily handle an add-on RF amplifier and audio stages at a later date. I'll provide data on wiring the supply so the set can use either six or 12-volt filament tubes. This is so experimenters can use a cheaper 6BQ7 in lieu of the more costly 12AT7; and also allows subbing either a six or 12-volt tube in the RF and audio sections. In other words, the older All-Bander and newer Nighthawk design will be YK2 junk-box friendly!

### Updating The Nighthawk Power Supply

Last May's column showed several possible power supply schemes using back-to-back filament transformers to power vacuum tube equipment. Alas, as several of you have noted,

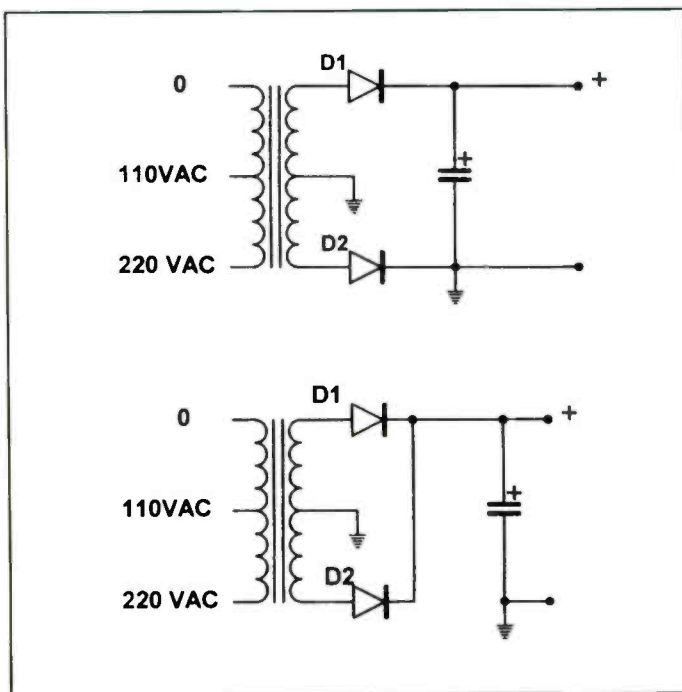

Figure 1: Here's a corrected representation of the full-wave power supply! The drawing in Figure 1A would result in the lower diode effectively shorting one-half of the secondary high-voltage winding.

Table 1

C1	4-30 pF ceramic trimmer
C2 - C7	Reference coil chart, ceramic or silver micas, NPO
C8	365 pF air variable capacitor
C9	100 pF ceramic disc NPO or silver mica, 50 volts minimum
C10, C11	.01 mFd ceramic discs, 3-kV line bypass UL rated recommended
C12	470 pFd ceramic disc, 400 VDC or greater
C13, C17	.01 mFd ceramic disc or mylar, 400 VDC or greater
C14A, B	Dual Bander (use two 22 mFd @ 160VDC)
C14	Nighthawk 22 mFd @ 160 VDC electrolytic
C18	Nighthawk 22 mFd @ 160 VDC electrolytic
C15	10mFd @ 25 VDC electrolytic
C16	.001 mFd disc ceramic or Mylar, 400 volts or greater
C17	Nighthawk, 10 mFd @ 160 VDC electrolytic
F1	1/2 amp fuse and mount
J1	RCA phono jack for antenna connector
J2	3/4" Phone Jack
L1-L7	Coils wound on octal tube bases
PL1	Octal tube base
R1	3.3 megohms @ 1/2 watt
R2	270K-ohms @ 1/2 watt
R3	50K-ohms, linear taper pot
R4	1-megohm, audio taper pot
R5	1,800 ohms @ 2 watts carbon or wire wound
R6	1,000 ohms @ 1/2 watt
R7	100K-ohms @ 1/2 watt
S1	SPST switch, toggle or part of R4
SO1	Octal tube socket for coils
SR1	All-Bander, use 1N4007
D1, D2	Nighthawk, Silicon rectifier, use 1N4007
T1	All-bander secondary 125 volts @ 15mA, 6 volts @ 0.6A
T2, T3	Nighthawk Marlin P. Jones 7839-TR (see text)
V1	12AT7 or 6BQ7 (see text)
misc.	Box, chassis, 9-pin miniature tube socket, terminal strips, knobs, AC cord

This is the combined parts list for both the One-Tube All-Bander and updated Nighthawk. We've noted the important changes made to reflect components more commonly available in 2001.

there was a rather serious drafting error in Fig. 1B, which illustrated a basic full-wave rectifier using the full tapped primary winding of a dual-voltage 110/220 transformer. The original and corrected drawings are shown in Figs. 1A and 1B. Where can you find inexpensive transformers? We pondered the question last May, and have since found a source — Marlin P. Jones & Associates, Inc., P.O. Box 12685, Lake Park, FL 33403-0685 has 'em. Marlin's selection features models with 12 or 24-volt center-tapped secondary windings, and 110/220 dual-voltage primary windings. A good example is their model 7839-TR, which sells for only \$2.99 in single lot quantities and has a 12-volt two-amp center-tapped rating and a 110/220VAC dual primary. Two of these will easily power the Nighthawk and the planned accessories! As an added bonus, this means the set is







# SE SIGNAL ENGINEERING'S

High Performance CB & 10 Meter Antennas

## SUPERHAWK



## WHITE LIGHTNING THE Four Element Antenna

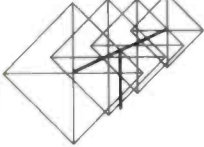

## LIGHTNING 6

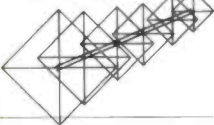

**Goldenrod**  
45 Spyder A+  
Broadband Hi  
powered MOBILE

**THUNDER 8**  
Hi Gain  
Bi-Directional  
OMNI  
Electronically  
Steerable

**And, also,  
NEW QUAD  
LIGHTNING 8**  
THE most  
POWERFUL  
CB base in the  
world today!

ALL SE PATENTED rotary beams are true quads and OUTPERFORM their counterparts (quad/yagi types). SE's patented SFS matching system makes SE QUADS the most technologically advanced antennas in the world today.

If your dealer doesn't have SIGNAL ENGINEERING, write or call for full specs. DEALER inquiries invited.  
MasterCard, VISA, AMEX, Discover

## SIGNAL ENGINEERING

1172 Aster Avenue, #E, Sunnyvale, CA 94086

Phone: (408) 247-2300

Website: www.signalengineering.com

## Full 800 MHz Scanners



### AOR AR-8200MKII

Wideband Portable receiver

- 0.5 to 2040 MHz continuous. (unblocked)

- NFM, WFM, NAM, WAM, USB, LSB & CW

- Alphanumeric memory identification

**\$699** us

- Spectrum scan

- Computer control

- Flexible dynamic memory bank layout

- Optional CTCSS & Extra memory boards



### ALINCO DJ-X2

Credit Card Wideband  
portable receiver

- 0.5 to 999 MHz continuous. (unblocked)

- NFM, WFM, AM - 700 memory channels

- Lithium Ion Battery

- RF detector (Bug finder)

**\$299** us

- Clear crisp AF audio - Menu system

- Weighs 7 oz., 15mm thin, SMA connector



### ICOM IC-R3 (unblocked)

**\$645** us "Portable receiver with  
built-in TV receiver!"

- Wide frequency coverage, 0.5 to 2450 MHz.

- Modes of operation AM, FM, WFM, AM

- 450 memory ch, 6 character alphanumeric

- TV picture receive capability, NTSC, M, PAL B/G

ICOM

AOR

ALINCO

OPTOELECTRONICS

YUPITERU

Guaranteed Delivery to USA.

# Radioworld

Phone:

**416-667-1000**

FAX: (416) 667-9995

sales@radioworld.ca

4335 Steeles Ave. W., Toronto, ON Canada M3N 1V7

www.radioworld.ca

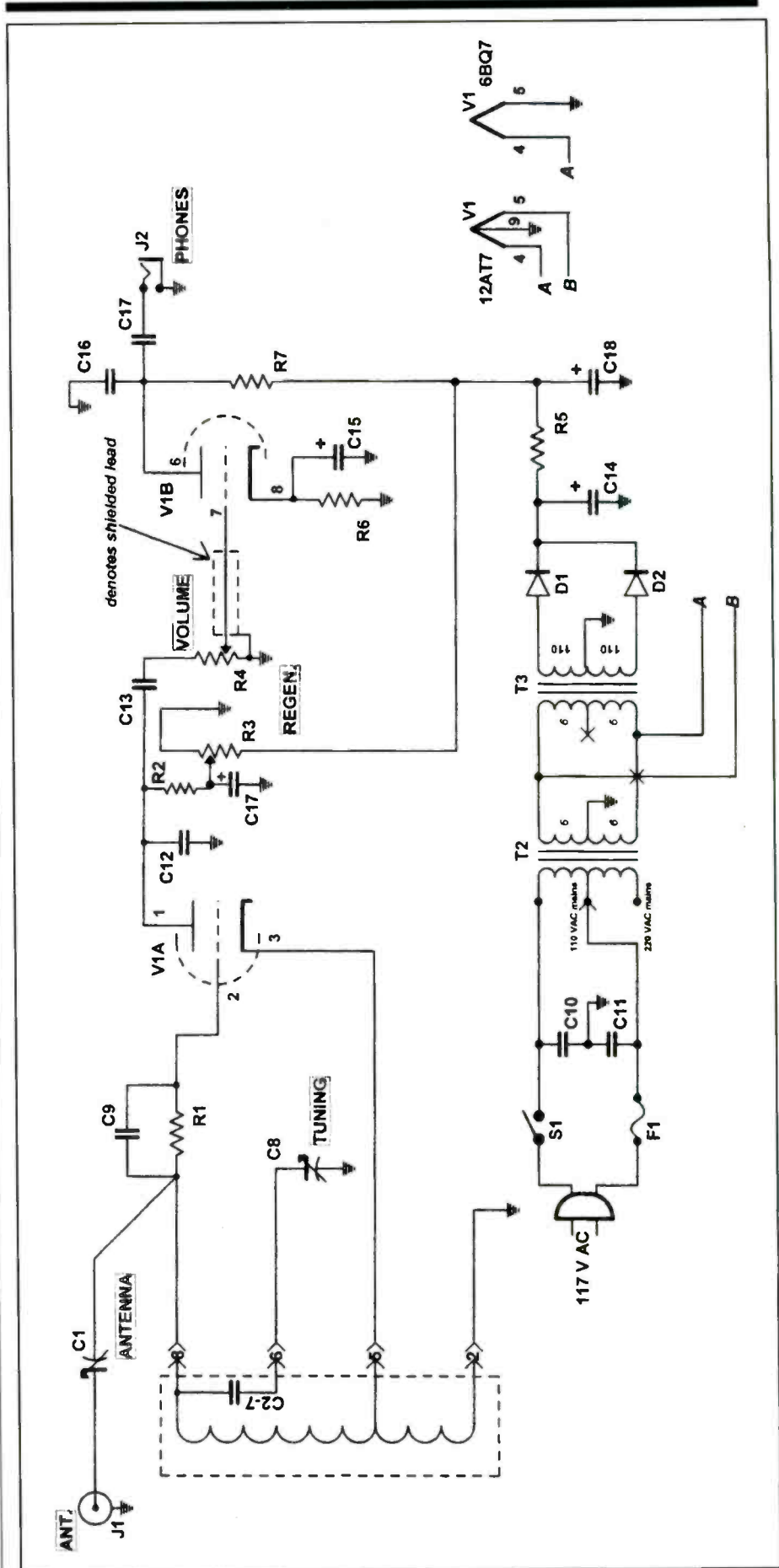



Figure 3: My version of the Nighthawk, an updated revision of David Green's original One-Tube All Bander from 1967.

capacitance of two series capacitors will never exceed the value of the smaller of the two. **Formula 1** shows how to calculate the effective capacitance of two capacitors in series. This is also the same basic formula for determining the value of parallel resistors.

$$\frac{C1 \times C2}{C1 + C2} = Cx$$

Formula 1: You'll need to do a little simple math to figure the final value for two capacitors in series.

If you have them, you can substitute Bakelite coil forms, or salvaged tube bases with matching early four, five, six, or seven pin sockets, for the coil forms. The coil windings are simply scramble wound over the tube bases — no tedious solenoid windings as done in the Boy's First Receiver project! Whew! All coils are simply scramble wound using number 28 AWG enameled magnet wire. I strongly suggest using the magnet wire with heat-strippable insulation; a 1/2 pound spool is available from Hosfelt Electronics; use their part number 36-370. Contact Hosfelt at 2700 Sunset Blvd., Steubenville, Ohio 43952-1158; or on their order line at 888-264-6454. I also suggest getting a copy of the Antique Electronic Supply catalog. They are a good source of resistors and tube sockets and other materials for this project. You can reach them at 800-706-6789. Another good source of materials is Mendelson Electronics, 340 East First Street, Dayton, Ohio 45402, or call 800-344-6324.

To reclaim the tube bases, wrap the tubes in old newspapers or several layers of heavy cloth. While wearing protective goggles and gloves, gently tap the tube's glass envelope with a small hammer until it shatters. Carefully remove all of the glass shards from the tube base, and dispose of the glass and tube elements. Do not attempt to salvage bases from mercury rectifier tubes! Once the glass and old glue have been cleaned out, use a hot soldering iron clean out the leads and old solder from the tube pins. This is done by heating the pin until the old solder melts, and then gently tapping the socket against an old wood board so the solder and wire

**YOU AIN'T HEARD NOthin' YET!**

Since 1967, CRB Research has been the world's leading publisher and supplier of unique hobby and professional books and information including:

- Scanner Frequency Guides
- Shortwave Freq. Guides
- Military/ Federal Comm.
- Broadcast Station Registries
- Undercover Communications
- & Other Related Topics!

New titles are constantly being added to our exciting catalog. If it's interesting and unusual, we've got it.

**YOU'LL SEE.**

**CRB RESEARCH**  
P.O. Box 56, Commack, NY 11725  
Ph: (631) 543-9169 FAX: (631) 543-7486  
e-mail: sales@crbbooks.com  
www.crbbooks.com

Ask for our latest FREE catalog.

**FREE SAMPLE COPY!**

**ANTIQUE RADIO CLASSIFIED**

*Antique Radio's Largest-Circulation Monthly Magazine*

Articles - Classifieds - Ads for Parts & Services  
Also: Early TV, Ham Equip., Books, Telegraph, 40's & 50's Radios & more...  
Free 20-word ad each month. Don't miss out!

 1-Year: \$39.49 (\$57.95 by 1st Class)  
6-Month Trial - \$19.95. Foreign - Write.  
A.R.C., P.O. Box 802-T14, Carlisle, MA 01741  
Phone: (978) 371-0512; Fax: (978) 371-7129  
Web: www.antiqueradio.com

## Accessorize Your Portable!

Whatever your interest in hobby radio, **PRYME Radio Products** has an accessory item for you! We manufacture a full line of aftermarket products for all types of portable radios, from microminiature Family Radios, to scanning receivers, to amateur or commercial handheld radios. Our accessories are reliable, innovative, and affordably priced. We provide accessories for all major brands of radio including Motorola, Kenwood, Icom, Vertex, Uniden, and many, many more!

### Audio Accessories

Our innovative audio products have made us famous. From the comfort of our SPM-400 mini-boom microphone to the low-profile of our EH-1 "invisible" ear phone and SPM-700 surveillance mic, we have the right accessory for the job!



### Antennas for Handhelds

Most stock antennas for scanners or portable radios are extremely poor. Upgrading to a better antenna can make a huge difference in performance. Our antenna products are specifically designed for maximum performance and durability.

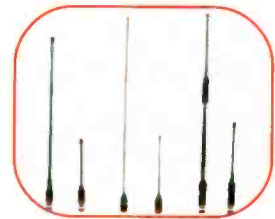

### Batteries / Portable Power

We offer many models of rechargeable battery pack for today's most popular handheld radios, as well as a number of portable "power stations" for those who need "power to go."



Order on-line from our entire line of high quality, accessories. Visit our **on-line store** on the web at:

<http://www.prymebattery.com>

**PRYME**  
Radio Products

by **PREMIER Communications Corp.**

480 Apollo St. #E • Brea, CA 92821

Phone: 714-257-0300 • Fax: 714-257-0600

Web: <http://www.adi-radio.com>



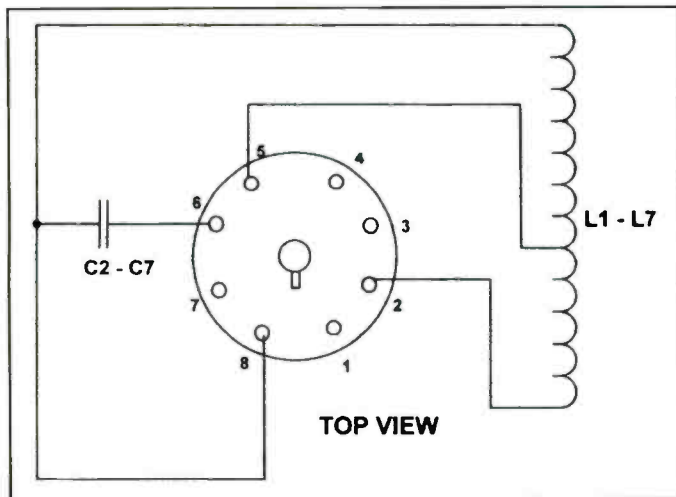

Figure 4: Here's the coil winding details. A small hole should be drilled through the tube base wall above pins two, five and eight. Begin the winding at pin two, and install the tap at pin five (simply twist the wire loop together, tin with a hot iron, and insert and solder in the tube pin). The finished end of the winding goes to pin eight; however it should not be soldered until the appropriate handsread capacitor (C2 - C7) or wire jumper is placed between pins six and eight inside of the tube base.

Table 2

Coil Chart	Number of turns	Capacitors
(Capacitors are ceramic or mica, NPO)		
L1	.55 to 1.5 MHz broadcast band 80T, tap at 20T from ground end	wire jumper
L2	1.65 to 2.0 MHz 160 meters 75T, tap at 20T from ground end	C2 = 47 pF
L3	3.5 to 4.3 MHz 80/75 meters 29T, tap at 8T from ground end	C3 = 47 pF,
L4	6.5 to 8.5 MHz 40 meters 13T, tap at 3T from ground end	C4 = 47 pF
L5	9.5 to 9.7 MHz 31 meters 12T, tap at 3T from ground end	C5 = 27 pF
L6	14 to 14.5 MHz 20 meters 8T, tap at 4T from ground end	C6 = 10 pF
L7	21 to 22 MHz 15 meters 5T, tap at 2T from ground end	C7 = 10 pF

These are the coil details for the Nighthawk, based on the original designs by David Green back in 1967. His coils favored the Amateur Bands; hopefully we can explore some useful Shortwave band versions in a future column.

remnants are knocked from the pin. I find adding a bit of fresh solder often helps things along since reheating old solder a number of times causes it to oxidize and not flow freely. The Nighthawk uses the same coils as those in the One-Tube All-Bander, and are wound as shown in the Coil Chart of Table 2. You'll need to drill a few small holes around the socket perimeter so the coil



Photo 1: What can go wrong when a wax capacitor fails? This line-bypass let go with a spectacular display of smoke and flame!

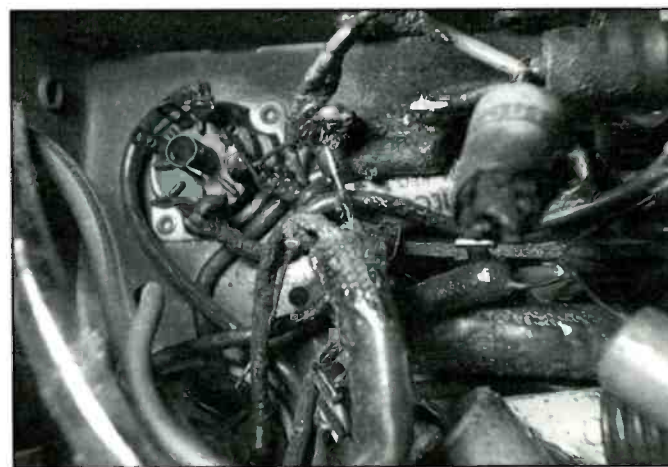

Photo 2. Some more evidence of the superficial damage caused by the pyrotechnic display. Fortunately, the damage appears to be far worse than it really is.

wires can enter the base and reach their respective pins. When used, the bandsread cap is bridged across pins six and eight, otherwise a wire jumper is used across pins six and eight.

When wiring up the REGEN and VOLUME controls (R3 and R4 respectively), the grounds for those controls should be associated with the arm nearest the wiper at the full CCW (Counter Clock Wise) rotation. In others words, the settings for minimum regenerative action and lowest volume.

### Where There's Smoke There's Fire

Here are a few interesting photos submitted by rec.antique.phono+radio contributor Scott Harvey. Scott posted links to several photos that illustrate what can happen when a wax capacitor finally decides to let go. We've touted replacing vintage wax caps when encountered, and Harvey's photos prove the wisdom of doing so. Photos 1 and 2 graphically illustrate the intense pyrotechnics accompanying the demise of this AC line bypass cap in a set Scott has just acquired. When asked about using his photos in the column, Scott's comment to us was brief: "Sure, go ahead and use them! The information deserves wider dissemination — these things [wax capacitors] are dangerous!" Until next month, 73! ■

# Come With Us On a Fascinating Journey to Explore the Excitement of Amateur Radio and the Mystery of Basic Electronics

Basic Technology  
for the  
Amateur Radio  
Enthusiast



Alpha Delta Communications, Inc. presents  
"Tour, Journey Through  
Basic Electronics and Amateur Radio"  
23-55  
PROMOTIVISION • 5929 Baker Road, Suite 460 • Minneapolis, MN 55349

*"These Alpha Delta training materials and Alpha Delta/Outbacker Antennas are an integral part of our Gordon West Radio School programs. We use them in our classrooms, Communications Van and mobile marine activities. They are very effective, fun to use and I highly endorse them."*

*Gordon West, WB6NOA*

**Video & Book  
\$39.95**

Author:  
Alice Narramore  
Training Director  
Alpha Delta  
Communications, Inc.

Technical Consultant:  
Don Tyrrell, WBAD  
President  
Alpha Delta  
Communications, Inc.

The Alpha Delta *video/book* production "**Basic Technology for the Amateur Radio Enthusiast**" is a simple straightforward program that takes you on this journey, explaining the wonderment of the hobby along the way.

The *video* shows how radio waves are formed and how electrons move to do work, and explains terms like voltage, current, power, resistance and other terms you'll hear relating to the hobby. You will even go with a miniature "**tour guide**" on a

walk through a receiver printed circuit board. He will show you how amplification, power supplies, radio frequency and audio amplifiers and other parts of a radio work. He will also explain what "semiconductors" are all about. Neither the video nor the book get into math or formulas--**we've kept it simple.**

The *book* is designed for the non-technical person interested in joining the hobby or the amateur operator who would like to know more about "what's behind the dials", and explains the fascination of the hobby in detail. The book is ideal as a support tool for someone who is being mentored by an "Elmer", and for amateurs involved with **school system programs**. The program was designed by our Training Director who formerly did college course development and was director of training for a major electronics company.

This **video/book program** is not a study guide for a specific license class but bridges the gap between study guides and programs that go into technical detail with formulas, math, circuits and theory. In fact, it is a great support program for license study guides, and the **new FCC License restructuring**. **Every aspiring or existing amateur should have this wonderful program in his or her collection!**

**"Basic Technology for the Amateur Radio Enthusiast" video & book \$39.95**

At your Alpha Delta dealer or direct plus \$5.00 s/h in the U.S., Exports quoted



**ALPHA DELTA COMMUNICATIONS, INC.**



P.O. Box 620, Manchester, KY 40962 • Phone (606) 598-2029 • Fax (606) 598-4413

**Toll Free Order Line: 888-302-8777**

**Website: [www.alphadeltacom.com](http://www.alphadeltacom.com)**



# technology showcase

by Alan Dixon, N3HOE/KST8678 <n3hoe@juno.com>

new product performance analysis

## Garmin GPS III Plus

By now, everyone involved in both the telecommunications world and in the automotive world knows of the coming revolution in telematics. For those just becoming aware of this development, telematics refers generally to devices and systems that serve in communications and navigation of highway vehicles. Telematics as related to motor vehicles is similar to avionics as related to aircraft. Given this, one might be led to think that telematics systems are being devised primarily for commercial trucks and motor carriers. Actually though, telematics *is* for you!

The myriad of new and some not-so-new devices for the automobile can be confusing. You can outfit your car with goodies ranging from an ordinary cell phone to sophisticated concierge services that direct you to the nearest restaurant. You may have seen recent television commercials for certain high-end automobiles, where the driver receives personalized directions to a restaurant at the touch of a button. Mobile e-mail retrieval and possibly Internet browsing will soon be available in your car. What the press releases and advertisements for these mobile data services often don't bother to mention is that most of these services come with a price tag attached. And I am not referring to the cost of the equipment itself. There is the matter of recurring monthly fees to consider. So you pay a cell phone bill. And you pay a few more bucks for your pager service. Does anyone have any idea how much a satellite music radio subscription to your car will cost? By the time you throw in call waiting and message storage space on a server, a person could be into a second mortgage.

Did that dampen your techie enthusiasm just a bit? Well then, follow my steps here. You will find, as I have, that you can indeed enjoy caviar on a beef jerky budget, in a manner of speaking. It is possible to enjoy some of the most innovative high-tech telematic devices without the burden of recurring monthly service charges. We will explore one such example right now. The U.S. Department of Defense's Global Positioning System (GPS) constellation of satellites provides for highly reliable navigation on highways, waterways, and just about any place outdoors. There are excellent devices on the market enabling you to take advantage of GPS capabilities and features. And best of all the service is free of monthly charges, subscriptions, and nasty contracts.

### Mobile Navigating Made Easy!

The Garmin GPS III Plus is one of the best designs of a mobile/portable GPS unit that I have come across. This Garmin unit has a differential-ready 12-channel parallel receiver, capable of tracking up to 12 satellites simultaneously. To call this unit merely a GPS satellite receiver is to do it a serious injustice, however. The GPS III Plus is a complete digital mobile navigational computing system. It has so much functionality, so many features, and does so much that if the GPS network were to suddenly crash, you might not miss it too terribly much!

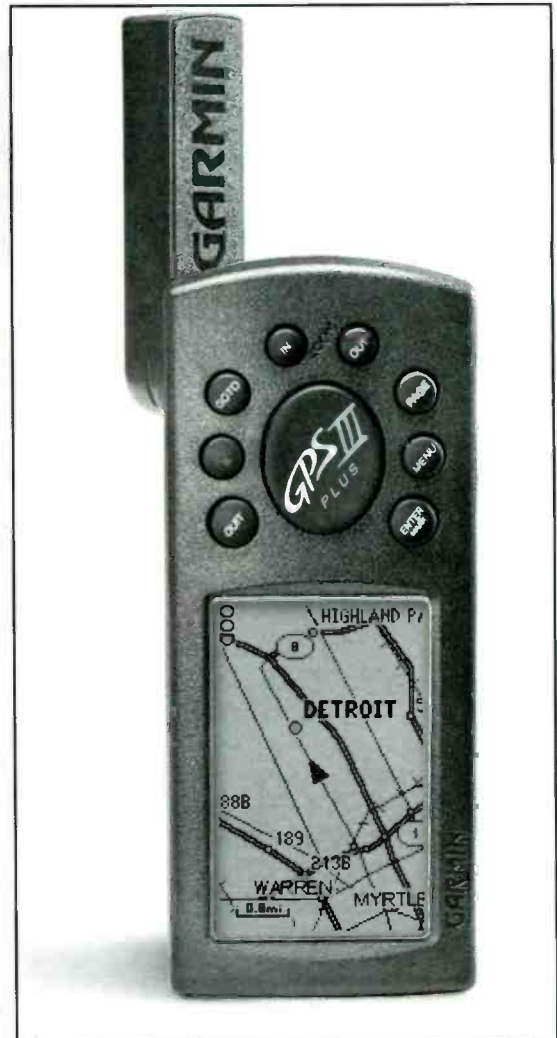

*The Garmin GPS III Plus is a superb mobile GPS system with no monthly user fees!*

That's right, this unit's built-in map database will still get you where you are going just the same as a road atlas would, perhaps even more easily. Most GPS units are designed primarily for either marine use or for outdoor recreational use such as hiking. With the inclusion of an embedded highway atlas and a highway road emulation view screen, the GPS III Plus is specifically well suited for automotive application.

The GPS III Plus lists somewhere in the neighborhood of \$400, but can be found on the street for about thirty dollars under that figure, or perhaps even a bit less. For mobile telematic use, you will likely want the dash mount bracket for about \$32, and the cigarette lighter cable for about \$23 and some change. Yes, an individual can invest a bit more than \$450 in



*For the outdoor enthusiast, Garmin's Fishing Hot Spots database is a must-have.*

your hand, in spite of its scant weight of approximately nine ounces, with batteries. Additionally, it is rated "waterproof" to IPX7 standards and able to withstand 6 G's force, according to Garmin's specs.

Screen resolution appears to be quite good, at 100 x 160 pixels with gray scale. My eyes tell me that this is an improvement over the Garmin GPS II, which appeared grainier, and I don't recall seeing shades of gray on the other unit. One note of interest is that the screen simulations at the Garmin Web site are, in my estimation, terrible! Don't even bother looking for them. The real thing is much better — excellent, in fact.

Check out this cluster of buttons! The rocker switch is centered on the right hand side of the face panel. Eight function buttons surround it. The labeling is at a 45-degree angle in order to be easily read from either the horizontal or vertical positions. The larger rocker switch button is a screen navigational device, and works like a computer mouse or trackball. The light bulb icon button, at 12 o'clock, powers the unit on and off. It is also used to access a menu pop-up to adjust screen contrast and screen backlighting level. Keypad backlighting brightness appears to be constant. Lighting can be set to come on at the touch of a key, or it can be set to no light timeout, for mobile installation use. The Enter/Mark key is at 7 o'clock. It works essentially as the "Enter" key on your computer or calculator does. Additionally, in the appropriate screen, this button is used to mark your present position. The Menu key is at 6 o'clock, and a single press brings up the pertinent menu for the screen that you are in presently. Press it twice to go to the Main Menu. At about 5 o'clock we have the page button, used to go to the next screen. But wait! Want to go back to the previous screen? Press Quit, which is also used to restore an errant data entry, such as mislabeling a waypoint, back to the default data. Use the Go To button at 1 o'clock to open your way point list in order to select a destination point. Finally, the GPS III Plus has a Zoom In button and a Zoom Out button. These controls will take you through the 24 map scales, from screen widths of 500 feet through 3000 miles.

### Satellite Status Page

Let's have a look at the first screen now, the Satellite Status Page. Power up the unit, and look at the customary bootup copy-right and disclaimer screens. You will soon come to the first of the GPS III Plus's six main pages. You will see a sky view "radar" type screen with range rings. The exact positions of all GPS satellites within view of your location will be visible with a two-digit number, essentially a tactical call sign for each bird. To the right of the sky view, each of the 12 satellites being received will have a bar graph showing relative signal strength and data acquisition status. You are tracking the sky! And there is a battery level meter up the left side of the screen, when internal batteries are being used. Pressing the menu button while in any of the main screens brings up that screen's menu. Again, there are too many functions to mention here. However, one menu option to note here is the Track Up function, which keeps the satellite sky view oriented to the user's direction of travel. The four cardinal compass points are also indicated on the outer range ring. With Track Up off, North is always shown at the top of the screen.

From the Satellite Status Page, press the Page key, and go to the Position Page screen. Along the top we have a horizontal sliding compass scale labeled in degrees. The user's direction

this setup. But remember, you won't be paying some \$10–20 or more a month for services. GPS reception is free, you own the hardware, and substantial databases come preloaded in the GPS III Plus. Yes, there are optional detailed map databases available at extra cost, but they are by no means necessary. Naturally, the preloaded data can become somewhat outdated after a number of years, but it may be updated with the purchase of new MapSource software from Garmin, if desired. And there's no telling what third-party software or public domain software may become available for this unit in the future.

Typically in *Pop Comm* product reviews, we systematically go over an item's features and functionality from top to bottom. The GPS III Plus's features and menus are entirely too numerous and diverse to be covered in that manner in a single article, however. The unit's 96-page owner's manual is testimony to that! Instead, we will examine some of the more outstanding features found in the unit's six main screens or "pages." Do not be intimidated by the sophistication of the GPS III Plus, however. It is essentially ready to use right out of the box. Breeze through the main screens and see which one you find most useful. That's basically all you have to do or know to operate this electronic marvel.

First, let's take a quick look at the front panel. It is amazingly clean. Out of the box, hold the unit horizontally in your hand, so that the viewing screen will be in the "landscape" position. This is how you will mount and view the GPS III Plus in your vehicle. The screen is on the left, and there are eight pushbuttons and a four-way rocker switch to the right. The entire unit is wedge-shaped. According to manufacturer's specifications, it measures 6.15 inches wide by 2" high by 1.23" deep, as viewed in this orientation. The screen itself measures approximately 2-3/8" wide by 1-1/2" high. The GPS III Plus' screen orientation can be toggled to either portrait or landscape orientation simply by pressing and holding the Page button. The screen is backlit, and to my pleasant surprise, so are the buttons. The GPS III Plus is solid as a brick. You can feel it in



of travel is shown at the center pointer. This screen has eight additional data fields into which you can program the data of most interest to you. This can be items such as speed — present, average, or maximum; Latitude/ Longitude, trip odometer and timer supply voltage, sunrise time, sunset time, etc. Specifications have changed since the introduction of the GPS III series, so the specific number of displayed data choices may have changed. Our test unit had nearly two dozen such data choices. Customize this screen any way that you want, from the generous menu!

## Seeing Is Believing!

Press page again from the Position Page, in order to get to the sweetest feature of the GPS III Plus, the Map Page. You have got to see this to believe it! You get a reasonably detailed highway atlas type map, with the level of detail that you would expect, depending on the scale chosen. The map screen has the “look and feel” of a printed road atlas, in terms of visual clarity. This is not one of those cheesy GPS map displays I have seen that looks like a three-year old drawing on a chalkboard. Want more detail? Use the appropriate button to zoom in. The “closer” you look, the more detail that will come into view. For example, if you are looking at a large portion of a state, names for only the largest cities will be shown. Bring your range down to just a few miles and not only will many town names come into view, so will names of major streets.

Use your rocker pad to pan around. When you do, an arrow cursor will come into view. Now, place the cursor over a highway exit and watch the exit number appear, along with standard DOT-type icons indicating services available. But there's more! Press the Enter key and watch the Exit Info Page, a detailed sort of “road sign,” come up. This page shows your route number, exit number, intersecting route number (if applicable), and other information, such as the distance to the exit. The services icons also appear. Isn't that great? Whoa! Keep looking. Click on one of these icons, maybe the knife-and-fork

symbol indicating restaurants or say, perhaps the gas pump symbol. Choose from one of the restaurants or service stations listed on this Services Near Exit screen. If you are near a large interchange in a metropolitan area, you will likely see several of the big franchise names, among others, listed by name.

Enough on-board data for you yet? Oh no, we're not done here. Point to one of these gas station brand names and hit Enter. Up comes the Exit Service Detail Page. Now you know whether that particular service station has diesel or propane too, a car wash, or even a convenience store! The GPS III Plus will even tell you where the service station is in relation to the exit, such as, “South of Exit.” Not having had the opportunity yet to tour the country with this unit, I cannot vouch for the completeness or accuracy of its information database. But in merely conducting a palmtop tour through the GPS III Plus, I can certainly see that there is a wealth of data, at least as pertains to interstate highway facilities. Remember that rich guy with the luxury car, in the TV commercial, getting automated directions to a restaurant? Uh-huh! Now, this can be you.

The Map Page can be oriented with north always up, as you view it, or with your direction of travel always up. It's your choice. On the right side of the map, there are four data fields. These can be set to just about any of the data choices available in the Position page. By default, one of the fields is an easy-to-read arrow. When you have entered a destination waypoint such as “Home,” the arrow will always point in the general direction of the desired destination.

If you ever get done browsing in the Map Page, press the Page button to get to the Compass Page. If you want something closer to bare-bones navigation, then this is for you. You get a compass dial with the cardinal points (North, etc.) and four data fields off to the right. These data fields can be set up as you like, much the same way as the Map screen. When a destination waypoint has been set, the needle points to your destination, while the outer compass ring rotates to show where the four compass points are in relation to your direction of travel. Now that you're oriented, press Page.

Now, look at the Highway page. I almost feel as if I am piloting a plane when I view this screen. What you get is a sort of artificial horizon. You will see a roadway, white line up the middle, heading straightforward toward a vanishing point on the horizon. Although this horizon doesn't appear to tilt as you bank around a curve, the roadway image will, when a course is set, tend to bend left, right, or zigzag. This is according to the relative position of each route waypoint. The top of the Highway Page also has a horizontal slider compass scale, similar to that of the Position Page, described above.

The final main page is the Active Route Page. Here, you can manage your stored routes, including lists of waypoints along the course and view automatically updated distances to those waypoints. Routes can be created with the map function, using the rocker to point to waypoints along the route, and clicking on those points. The GPS III Plus owner's manual has complete instructions on how to create and best use stored routes. Of course, the GPS III Plus has a TracBack “electronic breadcrumb” feature that allows users to retrace their steps.

The Garmin GPS III Plus has several other important features among those too numerous to mention here. The attached antenna at the back of the unit may be removed, revealing a standard BNC jack for an external antenna connection. The GPS III Plus mounted on the dashboard with its attached antenna will nearly always “see” the four satellites required for three-

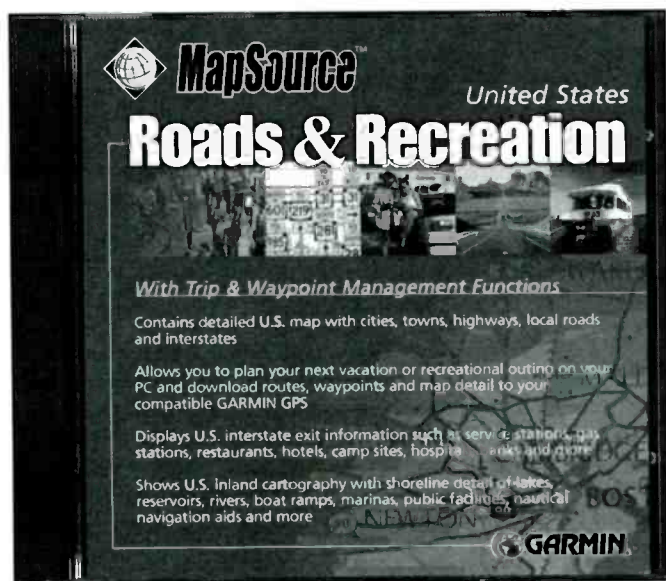

*Garmin's Roads And Recreation optional database makes an already great GPS system even better.*



dimensional navigation. But if you want to pick up anywhere near the maximum twelve birds simultaneously, you will want to invest in an externally mounted antenna. Garmin and others offer a number of these. Most are essentially flat bulbous or bottle cap shaped affairs. You won't be using anything like a whip antenna at the 1.6 GHz frequency range of GPS.

There is also a data/power port on the back of the GPS III Plus. The mobile power cord connects here. So, alternately, does the included data cable. You can update software yourself, with the 9-pin RS-232 connection on the far end of the data cable. And yes, this unit is capable of accepting additional differential positioning data from a VHF differential transmitting site. The optional outboard Garmin GBR 21 receiver can be tuned right from the GPS III Plus screen. It provides correction data in RTCM SC-104 format. In eight years of professional GPS use though, I haven't found any need for pinpoint differential precision in highway driving, even when the military's Selective Availability "skewing" was active. Output data from the GPS III Plus is in the NMEA 0183 interface format. The database of the GPS III Plus contains some 103 different map datums, with WGS 84 set as default. Unless you are using GPS for mapmaking or engineering purposes, and know exactly what you are doing, leave this setting alone!

For more information on the GPS III Plus, and to view or download the entire owner's manual, visit the Garmin Web site at <www.garmin.com>.

When using any GPS unit in a vehicle, always be careful to give traffic and road conditions appropriate attention. Never let a navigation or communication device, or anything else for that matter, distract your driving. Use your GPS unit to plan your trip before you start.

Welcome to the digital age, where amazingly, not every amenity comes with a service subscription fee. You might already own a radar detector with free digital Safety Warning System alerting. You may even have a 911-only cellular phone for emergencies — no fees there. Of course, you've got your traditional FM stereo for tunes and for and those important rush hour traffic reports, as well as your conventional CB for highway conditions and directions. Now, why not have "free" GPS service in your car, for only an investment in equipment? Be sure to check out the Garmin GPS III Plus first!

Rave Review  
Pop Comm  
April '96

SEE US ON THE WEB!  
www.vikingint.com

# Professional 10 HOUR RECORDER

"BUILT LIKE A BATTLESHIP"

- Heavy duty commercial recorder - NOT improvised from consumer models
- 12, 14, and 16 hour models also available
- BUILT-IN voice activation (add \$30)
- Applications information included
- Dimensions: 11.5 x 7.0 x 2.75"

**SPECIAL Pop Comm Price.. \$159**

FREE AD-PAPE SPECIAL EQUIPMENT CATALOG!

COOs OK Calif. residents add tax. Sorry, no credit cards. Free catalog USA only, other countries \$5

**Viking Systems International** 100 North Hill Drive #42, Brisbane, CA 94005  
Factory Direct Phone: (415) 467-1220 • Fax: (415) 467-1221 "Since 1971"

CALL TOLL FREE

(800) 292-7711  
Orders Only

Se Habla Español

# C&S SALES

Order On-Line @ www.cs-sales.com

CALL, E-MAIL OR  
WRITE FOR OUR  
FREE

64 PAGE CATALOG!  
(800) 445-3201

### Digital Multimeters

<p><b>Elenco Model M-1740</b></p> <p><b>\$34.95</b></p> <p>11 Functions: • Freq. to 20MHz • Cap. to 20µF • AC/DC Voltage • AC/DC Current • Resistor Test • Transistor Test • Free Holders • Alarm (1.5mA sales spec) Model M-2780 - \$19.95 (9 functions)</p>	<p><b>Elenco Model LCM-1950</b></p> <p><b>\$69.95</b></p> <p>• Large 1 1/4 Digit LCD • Autorange frequency to 1MHz • Capacitors to 400µF • Inductors to 40mH • Resistance to 400kΩ • Logic Test • Diode &amp; Transistor Test</p>	<p><b>Fluke Model 87111</b></p> <p><b>\$319</b></p> <p>Features high performance AC/DC voltage and current measurement, frequency, duty cycle, resistance, conductance, and capacitance measurement.</p>
---	---	--

### Test Instruments

<p><b>Elenco 3MHz Sweep Function Generator with built-in 60MHz frequency counter Model GF-8046</b></p> <p><b>\$195.95</b></p> <p>This sweep function generator with counter is an instrument capable of generating square, triangle, and sine waveforms, and TTL CMOS pulse over a frequency range from 0.2Hz to 2MHz.</p> <p>GF-8025 Without Counter \$139.95</p>	<p><b>Elenco Handheld Universal Counter 1MHz - 2.8GHz Model F-2800</b></p> <p><b>\$99</b></p> <p>Features 10 digit display, 16 segment and RF signal strength bargraph. Includes antenna, NICAD battery, and AC adapter. Modelized to 10MHz. C-2800 Case with Belt Clip \$14.95</p>	<p><b>Elenco Power Supply Model XP-581</b></p> <p><b>\$85</b></p> <p>• Fully Regulated Power Supplies in 1 Unit • 20 Voltages: 5 Volt @ 2A @ 1A @ 500mA @ 2.5 Volt @ 2A @ 1A @ 500mA @ 5 Volt @ 2A @ 1A @ 500mA @ 12 Volt @ 2A @ 1A @ 500mA @ 15 Volt @ 2A @ 1A @ 500mA @ 20 Volt @ 2A @ 1A @ 500mA @ 25 Volt @ 2A @ 1A @ 500mA @ 30 Volt @ 2A @ 1A @ 500mA @ 35 Volt @ 2A @ 1A @ 500mA @ 40 Volt @ 2A @ 1A @ 500mA @ 45 Volt @ 2A @ 1A @ 500mA @ 50 Volt @ 2A @ 1A @ 500mA @ 55 Volt @ 2A @ 1A @ 500mA @ 60 Volt @ 2A @ 1A @ 500mA @ 65 Volt @ 2A @ 1A @ 500mA @ 70 Volt @ 2A @ 1A @ 500mA @ 75 Volt @ 2A @ 1A @ 500mA @ 80 Volt @ 2A @ 1A @ 500mA @ 85 Volt @ 2A @ 1A @ 500mA @ 90 Volt @ 2A @ 1A @ 500mA @ 95 Volt @ 2A @ 1A @ 500mA @ 100 Volt @ 2A @ 1A @ 500mA @ 105 Volt @ 2A @ 1A @ 500mA @ 110 Volt @ 2A @ 1A @ 500mA @ 115 Volt @ 2A @ 1A @ 500mA @ 120 Volt @ 2A @ 1A @ 500mA @ 125 Volt @ 2A @ 1A @ 500mA @ 130 Volt @ 2A @ 1A @ 500mA @ 135 Volt @ 2A @ 1A @ 500mA @ 140 Volt @ 2A @ 1A @ 500mA @ 145 Volt @ 2A @ 1A @ 500mA @ 150 Volt @ 2A @ 1A @ 500mA @ 155 Volt @ 2A @ 1A @ 500mA @ 160 Volt @ 2A @ 1A @ 500mA @ 165 Volt @ 2A @ 1A @ 500mA @ 170 Volt @ 2A @ 1A @ 500mA @ 175 Volt @ 2A @ 1A @ 500mA @ 180 Volt @ 2A @ 1A @ 500mA @ 185 Volt @ 2A @ 1A @ 500mA @ 190 Volt @ 2A @ 1A @ 500mA @ 195 Volt @ 2A @ 1A @ 500mA @ 200 Volt @ 2A @ 1A @ 500mA @ 205 Volt @ 2A @ 1A @ 500mA @ 210 Volt @ 2A @ 1A @ 500mA @ 215 Volt @ 2A @ 1A @ 500mA @ 220 Volt @ 2A @ 1A @ 500mA @ 225 Volt @ 2A @ 1A @ 500mA @ 230 Volt @ 2A @ 1A @ 500mA @ 235 Volt @ 2A @ 1A @ 500mA @ 240 Volt @ 2A @ 1A @ 500mA @ 245 Volt @ 2A @ 1A @ 500mA @ 250 Volt @ 2A @ 1A @ 500mA @ 255 Volt @ 2A @ 1A @ 500mA @ 260 Volt @ 2A @ 1A @ 500mA @ 265 Volt @ 2A @ 1A @ 500mA @ 270 Volt @ 2A @ 1A @ 500mA @ 275 Volt @ 2A @ 1A @ 500mA @ 280 Volt @ 2A @ 1A @ 500mA @ 285 Volt @ 2A @ 1A @ 500mA @ 290 Volt @ 2A @ 1A @ 500mA @ 295 Volt @ 2A @ 1A @ 500mA @ 300 Volt @ 2A @ 1A @ 500mA @ 305 Volt @ 2A @ 1A @ 500mA @ 310 Volt @ 2A @ 1A @ 500mA @ 315 Volt @ 2A @ 1A @ 500mA @ 320 Volt @ 2A @ 1A @ 500mA @ 325 Volt @ 2A @ 1A @ 500mA @ 330 Volt @ 2A @ 1A @ 500mA @ 335 Volt @ 2A @ 1A @ 500mA @ 340 Volt @ 2A @ 1A @ 500mA @ 345 Volt @ 2A @ 1A @ 500mA @ 350 Volt @ 2A @ 1A @ 500mA @ 355 Volt @ 2A @ 1A @ 500mA @ 360 Volt @ 2A @ 1A @ 500mA @ 365 Volt @ 2A @ 1A @ 500mA @ 370 Volt @ 2A @ 1A @ 500mA @ 375 Volt @ 2A @ 1A @ 500mA @ 380 Volt @ 2A @ 1A @ 500mA @ 385 Volt @ 2A @ 1A @ 500mA @ 390 Volt @ 2A @ 1A @ 500mA @ 395 Volt @ 2A @ 1A @ 500mA @ 400 Volt @ 2A @ 1A @ 500mA @ 405 Volt @ 2A @ 1A @ 500mA @ 410 Volt @ 2A @ 1A @ 500mA @ 415 Volt @ 2A @ 1A @ 500mA @ 420 Volt @ 2A @ 1A @ 500mA @ 425 Volt @ 2A @ 1A @ 500mA @ 430 Volt @ 2A @ 1A @ 500mA @ 435 Volt @ 2A @ 1A @ 500mA @ 440 Volt @ 2A @ 1A @ 500mA @ 445 Volt @ 2A @ 1A @ 500mA @ 450 Volt @ 2A @ 1A @ 500mA @ 455 Volt @ 2A @ 1A @ 500mA @ 460 Volt @ 2A @ 1A @ 500mA @ 465 Volt @ 2A @ 1A @ 500mA @ 470 Volt @ 2A @ 1A @ 500mA @ 475 Volt @ 2A @ 1A @ 500mA @ 480 Volt @ 2A @ 1A @ 500mA @ 485 Volt @ 2A @ 1A @ 500mA @ 490 Volt @ 2A @ 1A @ 500mA @ 495 Volt @ 2A @ 1A @ 500mA @ 500 Volt @ 2A @ 1A @ 500mA</p>
<p><b>20MHz Sweep / Function Generator with Frequency Counter Model 4040</b></p> <p><b>\$425</b></p> <p>• 0.2Hz to 20MHz • AM &amp; FM Modulation • Burst Operation • External Frequency counter to 30MHz • Linear and Log Sweep</p>	<p><b>Elenco RF Generator with Counter Model SG-9500</b></p> <p><b>\$225</b></p> <p>Features internal AM mod. of 100µV, 100µV output 130MHz 35MHz Audio output 150µV 1V RMS. SG-9500 (analog with counter) \$134</p>	<p><b>Elenco Power Supply Model XP-603</b></p> <p><b>\$85</b></p> <p>• 0.30VDC @ 3A Output • 3A Fused Current Protection • Current Limiting Short Protection • 0.025Ω Output Impedance</p>
<p><b>10MHz Model 4017 \$325</b> <b>5MHz Model 4011 \$255</b> <b>3MHz Model 4003 \$205</b></p>	<p><b>Elenco 10Hz - 1MHz Digital Audio Generator Model SG-9300</b></p> <p><b>\$225</b></p> <p>Features built-in 150MHz frequency counter, low distortion and sine-square waves. SG-9300 (w/10 counter) \$124</p>	<p><b>Elenco SL-5 Series</b></p> <p>Electronically controlled, ideal for professionals, students, and hobbyists. Available in kit form or assembled.</p> <p><b>As Low As \$29.95</b></p> <p>Works w/ any iron! Turn any soldering iron into a variable iron.</p> <p>Features: • Custom Grip Handle • Soldering Tip (optional) with Grounded Tip for Soldering Sensitive Devices Easily • Replaceable Uses Long Life Platen Conical Tip • Heavy Steel Non-Slip Base • High Heat Funnel • Adjustable, left or right side • Steel Tray for Sponges/Pad • Sponges/Pad</p>

### Elenco Educational Kits

<p><b>Model AR-2N6K</b></p> <p><b>\$34.95</b></p> <p>2 Meter / 6 Meter Amateur Radio Kit</p>	<p><b>Model AM-780K</b></p> <p><b>\$11.95</b></p> <p>2 IC Radio Kit</p>
<p><b>Model M-1005K</b></p> <p>Digital Multimeter Kit</p> <p><b>\$19.95</b></p> <p>• 18 Ranges • 1 1/2 Digit LCD • Transistor Test • Mode Test</p>	<p><b>Model RCC-7K</b></p> <p>Radio Controlled Race Car Kit</p> <p><b>\$29.95</b></p> <p>7 Functions</p>

### Digital/Analog Trainer

**Elenco Model XK-550**

Elenco's advanced designed Digital/Analog Trainer is specially designed for school projects. It is built on a single PC board for maximum reliability. It includes 5 built-in power supplies, & function generator with continuity, variable sine, triangular, and square waveforms. All power supplies are regulated and protected against shorts.

**\$165**

**Specifications**  
Power Supplies:  
• 1.25V to 20VDC @ 5A  
• 1.25V to 15V @ 1A  
• 1.25V to 20VDC @ 5A  
• 1.25V to 15V @ 1A  
• 1.2V 25% @ 1A  
• 1.2V 25% @ 1A  
• 1.2V 25% @ 1A

**Function Generator:**  
• Waveforms: Sin, Square, Triangle, Complementary Square  
• Frequency: 1Hz to 100kHz in 5 steps  
• Continuously variable

**Digital Section:**  
• Data Switches: 8 DIP1  
• 8 5V, Low Ohm  
• Logic Switches: 2 no bounce with complementary output  
• "OR" voltage level 2.0V max. "OFF" 10V max.

Guaranteed Lowest Prices

UPS SHIPPING: 48 STATES 5%  
OTHERS CALL FOR DETAILS  
IL Residents add 8.25% Sales Tax  
SEE US ON THE WEB

**C&S SALES, INC.**

150 W. CARPENTER AVENUE  
WHEELING, IL 60090  
FAX: (847) 541-9904 (847) 541-0710  
http://www.cs-sales.com  
e-mail: sales@cs-sales.com

15 DAY MONEY BACK GUARANTEE  
2 YEAR FACTORY WARRANTY

PRICES SUBJECT TO CHANGE WITHOUT NOTICE



# discoveries connecting as a radio amateur

## How To Get The Most Out Of Operating FM

How time flies. It was just over 10 years ago that the FCC created the codeless Technician class ham license — the ruling took effect in February 1991. At the time, ham radio's ranks grew by leaps and bounds. History had been made. For the first time, American hams were on the air without passing a code exam! It's still *the* way to get involved in amateur radio. Most folks can study a few weekends and then take written exam Elements 2 and 3A, get their license, and get all ham privileges above 30 MHz! Not bad, considering this was Extra Class territory not long ago.

But once you've got that "ticket" then what? How do you get on the air, make new friends, and have fun with your new hobby? It's easier than you think — and you don't need a bankroll or loan from Uncle Willie to make it happen.

### Getting Started — The Basics

Chances are you've already made several friends at the local ham club where you tested — and perhaps even studied — so take advantage of those acquaintances by asking questions. You'll find that hams are just like you and me — sometimes it just takes something to break the ice — your common interest in radio, for example — to get invited to their shack or even out to shop for some equipment and antennas. Don't say no! Go for it! Sure, you can do the research by yourself, but it's infinitely more fun with an "expert" at your side.

Unless you've got a very cooperative spouse or someone who really understands ham radio, don't plan on getting a new mobile transceiver right away. That'll come in time. I'd recommend a good handheld (walkie-talkie) radio — maybe even a dual band (operates on 2-meters and 70 cm). They all come standard with a flexible-rubber antenna (commonly called a rubber duck), rechargeable battery and belt clip. It couldn't be easier to get on the air. No worry about large antennas — unless you want the increased range a telescoping antenna provides — or routing wires through a vehicle, antenna placement, grounding, and even theft. For now, let's keep it simple. You'll be surprised what you can do with that small handheld!

By far, the most excitement, best range, and most people will be found on a repeater. Simply, a repeater is no more than a "relay" — it picks up your signal on one frequency and retransmits it on another frequency (in this case, both on 2-meters, for example) at higher power. So you're in downtown Milford and from experience you know that using simplex (transmitting and receiving on the same frequency) your range is pretty much limited to a few miles, depending on terrain. But through Milford's repeater you're able to talk 40 miles away to a ham three towns south of you!

But how do you *find* a repeater frequency? And when you do, how do you make contact? Good questions — and the answers are just as easy. I haven't counted the number of repeaters around the U.S., but for sake of argument, let's say there are many hundreds. Operated by clubs and sometimes individuals, these repeaters are listed in the *ARRL Repeater Directory* — probably one of the most sought-after books in ham radio. Get this

These MFJ handheld antennas cost from \$9.95 to \$16.95 and offer increased range over your existing rubber-duck antenna.



little pocket-sized book! It's only a few dollars, and worth every cent. You'll use it constantly from home, work, and even on vacation because within seconds you'll have the frequency and any special access codes necessary to use a repeater whether it's in Idaho or New York City. Did I say get the book today?

In this column, I won't be overwhelming you with details about purchasing that first handheld except to recommend not making your first handheld a bells and whistles radio gizmo that takes three hours to learn to operate. Stay basic — for your own sanity — and so you don't lose interest in a fantastic hobby that doesn't have to be complicated and daunting. Secondly, dump the duck. That's right, as soon as you open the box with that shiny new handheld, toss the rubber antenna and get a replacement. Call the folks at MFJ Enterprises, Inc. at 662-323-5869 or online at [mfjenterprises.com](http://mfjenterprises.com) and ask about their telescoping antennas for handhelds that run from \$9.95 to \$24.95. We've said it dozens of times, but in case anyone missed it: You can have a bazillion dollar radio, but if you're using a cheap antenna, your on-air performance will suffer — often drastically. So whether it's MFJ or another manufacturer, get a quality handheld antenna (but be careful with that telescoping antenna so you don't break the connector on the top of your radio!).

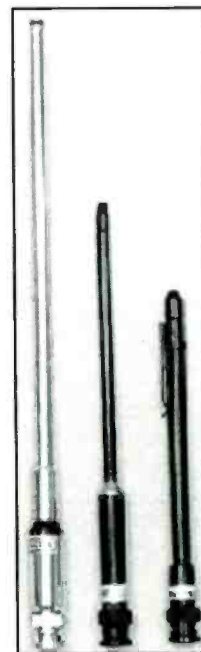

### First Contact

I remember mine, and chances are you'll remember yours, too. Make sure you're all set with the exact frequency (offset and code programmed if it's not an "open" repeater) as noted in the *Repeater Directory*. Now, listen. And listen some more. We hams are pretty good at talking, but sometimes we need to listen more to truly become better communicators. Enough said on that topic. Does the repeater have an audible courtesy tone that alerts you to go ahead and transmit? If the frequency is clear, go ahead and give your call letters once. Or you can add "monitoring" to your call letters, signaling others that you'd like to strike up



ICOM's IC-2GXAT is an excellent 2-meter handheld with 40 memories and auto-repeater operation.

The Alinco DJ-V5 is a compact dual-band transceiver with 200 memories and alphanumeric display.



a conversation. Maybe you're in the brand new downtown park or sitting outside the mall. Announce your call letters and add, "monitoring from Smithtown Park." Sometimes that's all it takes to pique someone's interest to talk with you. And there's certainly nothing wrong with quickly adding, "Looking for my first repeater contact" after your call letters.

Remember to always yield to other hams wishing to join the conversation and to identify your station properly. One of my pet peeves — and it can become yours, if you're trying to enter an ongoing conversation — are "quick and long talkers." Those are the folks who either ignore the repeater's courtesy tone or monopolize the repeater, going from topic to topic so by the time it's your turn to talk you've forgotten the first thing he or she mentioned! Please resist the temptation to hog a repeater. Very often technology will give such operators a not-so-subtle reminder by "timing out" — that is temporarily shutting down for a few seconds. You know you're especially long-winded if it happens to you!

You may have heard CBers and amateur operators on shortwave calling CQ to initiate a contact. It's not a good practice on a repeater. And remember that it costs money to purchase, maintain, and operate the repeater. So if you find yourself repeatedly using a specific local repeater, join the club and pay the dues. After all here's another chance to make friends, go out for lunch once in a while, and pay your way for using their "machine."

Remember, with that simple handheld you can expand your ham radio horizons beyond your wildest expectation — later on you might want to buy a 2-meter or 440 linear amp. That handheld is perfect for operating from your home, too. Install an inexpensive vertical antenna and that handheld suddenly becomes a powerful FM base station. And of course you can always add on a detachable microphone, spare rechargeable batteries, and even operate the transceiver from one of those portable jump start batteries sold in hardware and auto supply stores. Think of the possibilities — and have a ball on FM! ■

## To Order Back Issues

Only  
**\$4.00**  
Per  
Issue

When ordering back issues include the following information: Name, address, city, state & zip. Please make a list of the issues you're requesting. When paying by credit card send the number along with the expiration date. Check, Money Order, Mastercard, VISA, Discover and AMEX accepted.



For Faster Service  
**Fax 1-516-681-2926**

Popular Communications  
25 Newbridge Road, Hicksville, NY 11801  
Phone: 1-516-681-2922

# RUGGED PERFORMER



optional speaker  
(also available in chrome)



FCC Type-Accepted

Two-Year Warranty

At last! A line of CB radios that measure up to the harsh requirements of the trucking world! These rugged transceivers are designed to withstand the shock and vibration of long hours on the road in an attractive low-profile package that will complement any instrument panel.

The Texas Ranger TR-900 series feature advanced design techniques for unrivaled performance, including a new low noise/high gain receiver with advanced noise filtering, voltage fluctuation protection and instant Channel 19 access. The optional weather receiver will make your travel safer and will not disturb you when the radio is turned off.

And get this: the FCC-type accepted 900 series comes with a two year warranty!

This is one serious CB at a price that will make you smile. Pick up the 900 series model that's right for you.

Call us today and we'll help you find your local dealer.

Four 900 Series models to choose from:

Features	TR-936	TR-939WX	TR-966	TR-969WX
AM	•	•	•	•
SSB			•	•
2-Color Transmit/Receive Indicator	•	•	•	•
External Speaker Jack	•	•	•	•
PA Jack	•	•	•	•
Tone Switch	•		•	
Clarifier Control			•	•
RF Gain/SWR Cal Switch	•		•	
RF Gain Control		•		•
RF Power Control		•		•
Roger Beep Switch	•	•		•
Talk Back		•		•
Dimmer Control	•		•	
Weather Channels		•		•
Optional External Frequency Counter	•	•	•	•
Optional External Speaker	•	•	•	•

**RANGER**  
Communications, Inc.

Toll-free: (877) 536-0772

Email: rci@rangerusa.com/PC website: www.rangerusa.com  
401 West 35th Street National City, CA 91950



### MFJ's 20-Meter SSB Transceiver

**D**on't let the low power fool you: MFJ's manual for their 12-watt PEP transceiver says, "Compare it with your 100-watt rig — you'll be amazed by the signal reports." Now, I remember from my early CB days in the '60s using three watts to work the world that I couldn't really compete with Kilowatt Carl in Texas — at least on his level — but most of the time my three watts did one heck of a job. It must have; just look at those old QSLs from Sweden, Germany, and South America! So I knew when I finally upgraded to General class ham this year my rig of choice wouldn't be a mega-watt marvel with more bells and whistles than I'd probably ever use — or need, for that matter.

Long before I tested for General I knew the route I was going to take; QRP — low-power operation. And the rig was going to be the 20-meter MFJ SSB transceiver that sells for a whopping \$249.95 (with microphone).

Twenty meters is a good all-around band, usually regardless of where we are in the sunspot cycle, day or night, summer or winter. I purchased the radio from MFJ a couple months before my code test and tuned around the band, getting a feel for the analog tuning dial and 20-meter propagation.

#### Compact And Quiet

The MFJ-9420 is a 20-meter only rig that operates side-band from 14.150–14.350 from any 13.8 Vdc power supply that provides 2-amps. That's right, 2 amps, not 15 or 20! (You can purchase the optional MFJ-4110 AC wall adapter to make your station a complete MFJ package, if you wish). Using my 12-Vdc solar panel setup (see the September 1999 *Pop'Comm*) or a small portable Prestone or other portable lead acid battery, this small (2 1/2" x 6 1/2" x 6") lightweight base station doubles as a portable, mobile, or emergency rig on a moment's notice.

Operation couldn't be easier; there are a total of four controls on the panel; the red on/off button, tune on/off, tuning knob, and volume control. It's that simple. The lighted analog s-meter is easy to read, the tuning has a very smooth, professional feel and the audio from the three-inch speaker is outstanding — in fact, I rarely have the volume cranked up past the 10-o'clock position. I was on the air 10 minutes after the MFJ rig arrived at my doorstep. The manual is an easy-read with plenty of operating tips, a troubleshooting checklist, schematic, and parts list.

My very first contact with the MFJ-9420 was with N4ICE on the maritime net on 14.300 MHz; my signal report 5/7. Since then I've effortlessly talked with Clive in Tampa, Salvo in Sicily, Ian, EI3Y in Ireland, Marco, 9A7C in Croatia, Cheryl, N0WBV, in Denver, George in Prague, and Mark, 4Z8BB, near Tel Aviv. All of these contacts, plus numerous stateside QSOs were made with a simple 20-meter wire dipole 25-feet off the ground. It's interesting to hear a fellow amateur talk about his or her high-power equipment, antenna arrays, and speech processors. Then

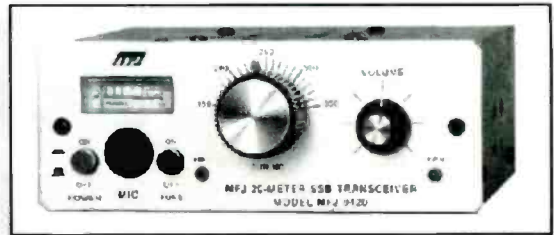

*MFJ's 20-Meter SSB Transceiver packs a punch for only \$249.95.*

I tell them I'm running the MFJ-9420 — about 12 watts — and a dipole. You can imagine their comments; everything from "fantastic signal and audio . . ." and ". . . really sounds great!" to "You're 5/8 here in Miami . . ."

Fact is, I talk loud most of the time. I know that people think I've got a built-in amplifier of some sort! But this MFJ-9420 is helping me realize I don't have to talk loud or shout into the mic. It made me crazy, but on several occasions I spoke with a normal, low voice into the mic. Audio reports were excellent, plus I didn't wake up the neighbors!

The 9420 is also superb on receive. My yardstick of comparison — and admittedly, not a fair one — is my Drake R8B. Meter readings aside, as I learned years ago, it's always what you hear with your ears, not see on a meter that matters. The MFJ-9420 nearly performed on a par with the R8B set to the 2.3 kHz bandwidth (standard USB filter). Powerhouse hams were still slightly annoying, but the MFJ rig was selective enough to keep the boys in Kilowatt Alley at bay while I had a QSO with DF7EV in Munich — my first overseas HF contact. His signal was just as audible and only slightly affected by the big boys a few kHz away on the MFJ rig as on the R8B — quite a feat! MFJ says the receiver's IF selectivity is -6dB at 2.5 kHz; sensitivity is <.5uv for 12dB S/N.

Want to operate CW? Purchase the optional CW Module, MFJ-415B for \$49.95, plug it into the 9420 and you're in business. I liked the MFJ 20-Meter transceiver so much I recently got their 40-meter transceiver (MFJ-9440, also \$249.95 with mic) and in a few days will be active on 40 meters. Personally, I think these MFJ rigs are an excellent way to experience the thrill of talking around the world without taking out a second mortgage. Have I broken into a 20-meter pileup? No, not yet. But I'll probably try again tomorrow!

For more information on the MFJ 2-Meter SSB transceiver, Model MFJ-9420, contact MFJ Enterprises, Inc. directly at P.O. Box 494, Mississippi State, MS 39762, phone 662-323-5869, FAX 662-323-6551 or E-mail them at [mfj@mfjenterprises.com](mailto:mfj@mfjenterprises.com). Visit MFJ on the Web at [www.mfjenterprises.com](http://www.mfjenterprises.com) and be sure to tell them you read about their fantastic MFJ-9420 in *Pop'Comm*!



# Summer Specials



## books...

**Keys, Keys, Keys** by Dave Ingram, K4TJWJ

You'll enjoy nostalgia with this visual celebration of amateur radio's favorite accessory. This book is full of pictures and historical insight. Order No. KEYS . . . ~~\$9.95~~ **Now only . . . \$5.95**

**Vertical Antenna Handbook** by Capt. Paul H. Lee, N6PL

Learn basic theory, design and applications. Also includes easy construction projects. Order No. VAH . . . ~~\$9.95~~ **Now only . . . \$6.95**

**33 Simple Weekend Projects** by Dave Ingram, K4TJWJ

Do-it-yourself electronics projects from the most basic to the fairly sophisticated. You'll find: station accessories for VHF FMing, working OSCAR satellites, fun on HF, trying CW, building simple antennas, build a complete working HF station for \$100! Includes practical tips and techniques on how to create your own projects. Order No. 33PROJ . . . ~~\$15.95~~ **Now only ...\$9.95**

**The NEW Shortwave Propagation Handbook** by W3ASK, N4XX & K6GKU

A comprehensive source of HF propagation principles, sunspots, ionospheric predictions, with photography, charts and tables galore! Order No. HFANT ...**\$19.95**

**W6SAI HF Antenna Handbook** by Bill Orr, W6SAI

Inexpensive, practical antenna projects that work! Guides you through the building of wire, loop, Yagi and vertical antennas., Order No. HFANT ...**\$19.95**

**Building and Using Baluns and Ununs** by Jerry Sevick, W2FMI

The source for the latest information and designs on transmission line transformer theory. Discover new applications for dipoles, yagis, log periodics, beverages, antenna tuners, and countless other examples. Order No. BALUN ...**\$19.95**

**McCoy on Antennas** by Lew McCoy, W1ICP

Unlike many technical publications, Lew presents his invaluable antenna information in a casual, non-intimidating way for anyone! Order No. MCCOY ...**\$15.95**

**The Quad Antenna - Second Printing** by Bob Haviland, W4MB

An authoritative book on design, construction, characteristics and applications of quad antennas. Order No. QUAD ...**\$15.95**

## antenna book special...

W6SAI HF Antenna Handbook, McCoy on Antennas, Building and Using Baluns and Ununs, The Quad Antenna- Order all four antenna books for only \$54.95. That's a savings of \$16.85 ...Order No. ANT4

All 4  
for only  
**\$54.95!**

## videos...

~~\$19.95~~  
**Now Only**  
**\$12.95 ea.**

All 7 for \$69.95

Ham Radio Horizons: The Video...Order No. VHOR

Getting Started in VHF...Order No. VVHF

Getting Started in Ham Radio...Order No. VHR

Getting Started in DXing...Order No. VDX

Getting Started in Packet Radio...Order No. VPAC

Getting Started in Amateur Satellites...Order No. VSAT

Getting Started in Contesting...Order No. VCON

## calendars...

Amateur Radio Calendar or Classic Radio Calendar  
Fifteen months (January 2001 through March 2002)

~~\$10.95~~  
**Now only**  
**\$6.95 ea.**

fax us : 516-681-2926 • call us 1-800-853-9797

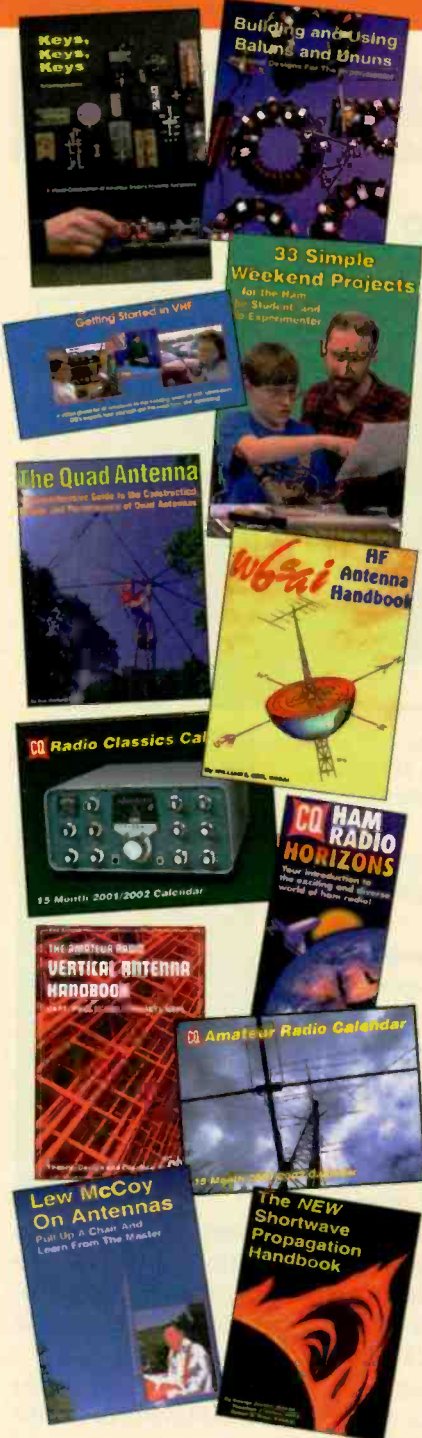

Visit Our Web Site  
[www.cq-amateur-radio.com](http://www.cq-amateur-radio.com)

Name \_\_\_\_\_ Callsign \_\_\_\_\_  
Street Address \_\_\_\_\_  
City \_\_\_\_\_ State \_\_\_\_\_ Zip \_\_\_\_\_

Qty	Item #	Description	Price	Total Price
U.S. and possessions - add \$4 shipping/handling. Foreign - shipping/handling charges are calculated by order weight & destination.			Shipping/Handling	
			Total	

Method of payment  Check  Money Order  Visa  MasterCard  Discover  American Express

Credit Card No. \_\_\_\_\_ Expiration date \_\_\_\_\_



CQ Communications Inc., 25 Newbridge Rd., Hicksville, NY 11801/516-681-2922; Fax 516-681-2926



# clandestine communiqué

by Gerry L. Dexter

tuning in to anti-government radio

## Cambodia Clandestine Broadcasts To The World

There's a new clandestine to tell you about this month. Not only is the station a new one, but so is the target area: Cambodia, which hasn't had much broadcast attention paid to it in recent years. The new station is called the **Voice of Justice** and is operating as the mouthpiece of the Sam Rainsy Party. Mr. Rainsy is a leading opponent of the current government and one of those who helped found Nordon Sihanouk's party, FUNCINPEC several years ago. The Voice of Justice airs a one-hour program in Cambodian, aired on Saturdays from 1000–1100 on **15455**. The station is claiming it's located in a nearby country but it seems equally likely that the broadcast is coming from one of the usual relay suspects, perhaps Germany's DTK transmitter at Julich, or perhaps one of the Russian government transmitters in the Asian part of Russia. Reception reports for the Voice of Justice can be sent to 49, Street 214, Phnom Penh, Cambodia.

The station of the FARC narco-guerrillas in Colombia is providing some fairly regular reception now, especially if you live in the Eastern Time zone. Check for **La Voz de la Resistencia** on **6233.8** at around 1130 to past 1200. Richard D'Angelo hears them at 1137 tune and Brian Alexander from 1125 with Latin music, announcements in Spanish and Spanish talks.

The **National Radio of the Arab-Saharan Democratic Republic** still hasn't found a frequency it can live with. Recently it's been noted on both **7357** and **7460**. Pete Becker in Washington state found them on the former spot at 0750, running to sign off at 0800, all in Arabic. Pete notes that the carrier stayed on for several minutes past 0800. Robert Montgomery in Pennsylvania had them there at 2120 to 2200 in French with news items and short music interludes. A full ID was given just before they signed off at 2200. (Sometimes they stay on until 2300.)

When conditions are good **The Voice of the People of Kurdistan** can still be heard on **6995** at its 0300 (plus or minus) sign-on. This broadcast runs until 0700. There's another one from 1345 to 2100. **4060** is also used. This station speaks for the Patriotic Union of Kurdistan and broadcasts in Kurdish and Arabic. The transmitter is at Al-Sulaymaniya, within Iraqi Kurdistan. Reception reports can be sent to: PUK, Postfach 210231, 10502 Berlin, Germany.

**The Voice of Tibet's** most recent schedule has it operating from 1212 to 1300 on **15655** (via Almaty, Russia) and **15705** via Dushanbe in Tibetan and other local dialects. Reports go to Wellhavensgat 1, 0166 Oslo, Norway.

**The Democratic Voice of Burma** is on the air from transmitters in Julich, Germany, Kvitsoe, Norway, as well as Tajikistan. It's operating from 1245 to 1345 on **17485**, 1440 to 1455 on **11850** and **17485** and 2300–2355 on **9430** and **11820**. Reports can be sent to Maung Maung Myint, P.O. Box 6720,

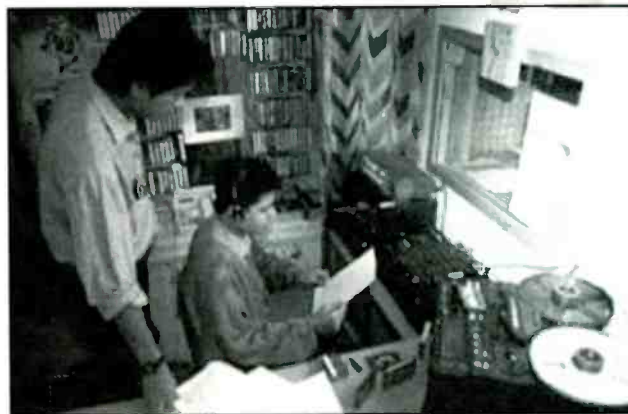

Student announcers on the air at the Democratic Voice of Burma. (Photo courtesy Clandestineradio.com)

Skt. Olavs Plass, Norway. The Free Burma Organization sponsors the broadcasts.

**The Voice of the People** is the name used for anti-government broadcasts aimed at Zimbabwe and created by former employees of the official Zimbabwe Broadcasting Corporation. This is supposedly a non-partisan operation aimed at providing an alternative to the official government radio. The program is aired over the facilities of the Radio Netherlands relay station in Madagascar. Unfortunately for North Americans, the time/frequency pairing doesn't offer us much chance at reception. It airs from 1700 to 1755 on **7120**. The address is Radio VOP, P.O. Box CY3093, Causeway, Harare, Zimbabwe.

**Radio Tele-Liberte** is one of the stations active in the Congo conflict. This one speaks on behalf of the Movement for the Liberation of the Congo (MLC) and broadcasts from the town of Gbadolite, in the northwest part of the country. The most recent schedule has them in French and English from 1200 to 1600 on **12925** and 1800 to 2300 on **15725**.

That covers things for this time. Remember, we are always eager to receive any loggings you may make of clandestine broadcasts. Also much sought are operating schedules, background information on sponsoring groups, transmitter locations, addresses and so on. Copies of any QSLs received from clandestine stations would also be very welcome. Thanks for your continued interest and support!

Until next month, good hunting!

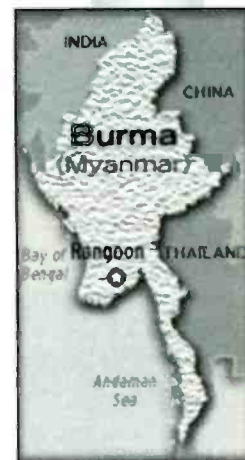

# pop'comm survey

## july 2001

Circle Reader Service #

Circle Reader Service #

1. Do you discuss what you hear on shortwave radio with others?

Yes 1  
No 2

2. What most seems to interest non-shortwave radio listeners when you talk about international radio?

News and commentary 3  
Music 4  
Sports 5  
Programs for shortwave enthusiasts 6  
Dramas/plays 7  
Travel or tourist information 8  
Intrigue (utility radio) 9

3. What's their typical response when you talk about shortwave radio?

Very interested 10  
Somewhat interested 11

Few are interested 12  
None are interested 13  
Not sure 14

4. During the week, how much time do you spend listening to international shortwave radio news and commentary?

A few minutes - less than an hour 15  
About an hour 16  
More than two hours 17  
Three or four hours 18  
More than four, but less than eight 19  
More than eight hours 20

5. I regularly read news magazines

Yes 21  
No 22

6. I have a special room dedicated to my radio activity

Yes 23  
No 24

**Super Video Sale!**

## getting started videos

**Getting Started in Ham Radio**— How to select equipment, antennas, bands, use repeater stations, grounding, basic soldering.

**Getting Started in VHF**—Intro to VHF. Repeater usage, packet, satellites and more exotic VHF op modes.

**Getting Started in DXing**— Top DXers share experiences with equipment, antennas, op skills and QSLing.

**Getting Started in Packet**—De-mystify packet. Info on making contacts, bulletin boards, networks, satellites.

**Getting Started in Amateur Satellites**— How ops set up stations. Locate and track ham satellites.

**Getting Started in Contesting**— Advice and op tips from Ken Wolf, K1EA, K1AR and others!

**Ham Radio Horizons**—Step-by-step instructions for the prospective ham on how to get involved.

~~\$19.95~~ each— Now \$12.95 Buy more and save!

Buy 2 or 3 for \$11.95 each Buy 4 to 6 for \$10.95 each

Buy all 7 for your Club for only ~~\$99.95!!~~ Now \$69.95!!



Name \_\_\_\_\_  
Address \_\_\_\_\_  
City \_\_\_\_\_  
State \_\_\_\_\_ Zip \_\_\_\_\_

Qty \_\_\_\_\_  
 Getting Started in Ham Radio  
 Getting Started in VHF  
 Getting Started in DXing  
 Getting Started in Packet Radio  
 Getting Started in Ham Satellites  
 Getting Started in Contesting  
 Ham Radio Horizons  
 Total Videos X \$ \_\_\_\_\_  
 = \$ \_\_\_\_\_  
 Shipping/ handling \$ \_\_\_\_\_  
 Total \$ \_\_\_\_\_

U.S. and possessions - add \$4 shipping/handling.  
Foreign - shipping/handling charges are calculated by order weight & destination.

Also available in PAL format.

Credit Card No. \_\_\_\_\_ Expiration date \_\_\_\_\_  
 Method of payment  Check  Money Order  Visa  MasterCard  Discover  American Express



**Call Toll-Free  
1-800-853-9797**

**CQ Communications, Inc., 25 Newbridge Rd., Hicksville, NY 11801/516-681-2922; Fax 516-681-2926**



## CB Daze And Enforcement News

*Do you remember CB, when it was at its peak?  
They'd almost bust the doors down, just to get a peek.  
At the latest rigs and the hottest mics.  
Ah, the D-104 which everyone liked!*

Well, yes, Larry Shaunce, I do. Thanks for the poem, all 14 stanzas of it (I can't include the whole poem here but if anyone wants a copy via E-mail drop me a note). It brought back a lot of memories and even a few smiles. Now before you go thinking that I think the good old days of CB are gone, stop. I don't. My memories of the medium go back farther than that. During the '70s, the time that Larry is writing about, a time when CB was so overcrowded that you couldn't string two words together without someone keying over you for a 10-36, we used to call the '50s and '60s the good old days. Those good old days were when it was hard to find anyone to talk to on the radio. In order to get a good conversation going you had to make a few telephone calls to get your friends to turn on their rigs. Hey, sounds like the real good old days are back!

Oh, what the heck, here's more verse:  
*There was Kraco, Handic, Midland, and Craig  
And rarely a contact that I couldn't make  
SBE, Johnson, Hy-gain, and Royce  
And don't forget Browning, the DX'ers top choice*

Yes, there sure were a lot of radios; some of them were pretty good. I still get questions about them to this very day. Like from David Frazier of Waldorf, Maryland, [dfsa@erols.com](mailto:dfsa@erols.com), who is still running a Royce I-639 and needs information about a Midland 79-265. And John, [h-card@home.com](mailto:h-card@home.com), who is looking for a radio he saw advertised in 1975. He doesn't remember its name, but it was made by a company called Gould or

Gold. He does remember that it was a separate transmitter/receiver type, with a light cream-colored plastic housing, and was marketed as a high-end unit. Anybody know where he can find one?

Jim Belles, NH6CN/W8, [belles@uplogon.com](mailto:belles@uplogon.com), has been reading *Pop'Comm* ever since he found a copy in the enlisted barracks lounge at NavComSta, Guam, in 1987. These days Jim spends "quite a bit of time on the rural roadways of Michigan's Upper Peninsula — out of range of even most of our local 2 meter repeaters." He is looking for a CB "companion" for those long drives. Due to lack of space he has been thinking about an

*True Freebanders are not renegade troublemakers. They, like their brethren in the amateur service, are more interested in quality long-distance communications as illustrated in these stunningly exotic QSL cards.*

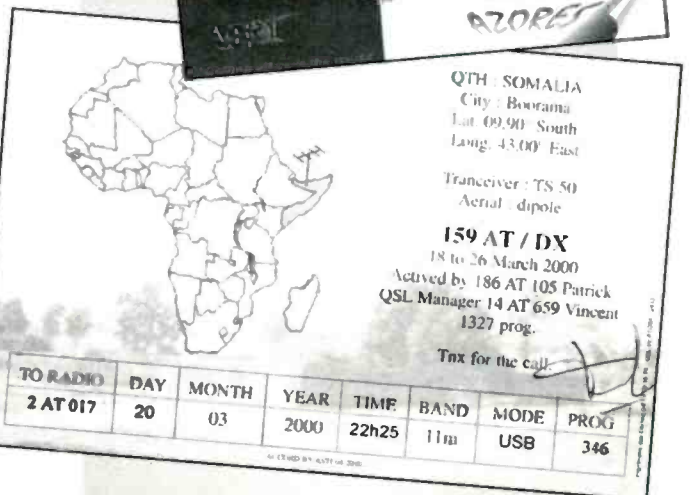

SSB-equipped handheld like the Cherokee AH-100 SSB CB HT. Unfortunately, this radio is no longer manufactured. If any one knows where Jim can find one, or a radio with similar features, we would both like to know.

## Enforcement News?

Terry, from Santa Cruz, California, writes to express his frustration over what he perceives to be a lack of protection of vital radio services in his area. He feels that this shortcoming is due, at least in part, to the FCC wasting precious time and resources chasing DXers who work "upstairs." "We have bigger problem here than a few CB Freebanders," he explains. "Commercial fishermen in our area are trading in their FCC-approved marine radios for illegally modified two-meter amateur gear." Terry points out that the modified ham gear can operate all over the VHF spectrum where it is often used for nefarious activities. He says that the locals often report the bootleggers they hear operating on frequencies assigned for use by police, fire, medical, and even the FBI but nothing ever seems to happen to them. Terry's main concern is that this intrusion into the public safety bands could be dangerous. He is afraid that "These imbeciles will kill somebody with this dangerous activity." Terry thinks the FCC's efforts to crack down on Freebanders is misdirecting valuable resources that could be put to better use elsewhere. "Show me a CB radio that can jam active police channels," he says, "and I'll eat the damned thing."

Terry, I agree with you. The Freeband, that is to say opera-

tion in the otherwise unused portions of the 11-meter band, is not a major problem, just a constant irritation to certain portions of the Amateur community and therefore to the Commission. I further agree with you that the FCC has many more and larger issues to deal with, such as the ones that are threatening public safety communications in your area. I do, however, disagree with your assertion that they are wasting "large" amounts of limited resources pursuing Freeband operators. I don't think that they are. Let me tell you why.

As you may recall, up until a very few years ago, enforcement actions in and around 11-meters were minimal to non-existent. Even today, with enforcement at what has to be an all-time high, actions against Freebanders have been few. Further, as far as I can see and I follow this quite closely, so far not one of these actions has been a pure Freeband play. The few operators that have rightly or wrongly been described as Freebanders, that have received fines or letters, have been engaged in practices and activities far above and beyond those that traditional Freebanders would consider acceptable. For the most part, they have had to work long and hard and have made real nuisances of themselves. They have been Amateurs who, perhaps blatantly or heavy handedly, have ventured into the CB and other areas of the 11-meter band or renegades, like your fishermen, who persistently venture into Amateur or other actively occupied bands. I'll bet that if you check, you will find that each of them operated in a manner that allowed concerned local citizens — not the FCC — to locate, identify, and document their violations. This is something that you and other citizens of the Santa Cruz area must persist

**CQ**  
ham radio's best calendars

**SUMMER SPECIAL**  
Only \$6.95 ea. +\$2 s/h  
new 2001-02 editions!

Hot off the presses, our widely acclaimed calendar series is back with CQ's new 2001-02 editions. You'll refer to your CQ calendar time after time as you search for the schedules of upcoming ham events and conventions. Public holidays and valuable astronomical information will be right by your side, too!

Enjoy 15 months of use (January 2001 through March 2002) with this year's editions. Each month you'll be treated to some of the greatest photography in all of amateur radio.

**The 2001-2002 CQ Radio Classics Calendar**  
Enjoy this year's selection of 15 magnificent images of some of the finest in vintage ham gear: Allied, Babcock, Collins, Harvey Wells, Hammarlund, Hallicrafters, Heathkit, Hunter, Globe, Millen, RME, Radio Engineering Labs, Harvey Radio Labs, Tri-State Electronics, and more.

**The 2001-2002 CQ Amateur Radio Calendar**  
Featured are 15 terrific professional color photographs of some of the most interesting stations, the biggest antenna systems, the most famous operators, and average hams throughout the USA.

available directly from CQ and from your local dealer!

**For Fastest Service call**  
1-800-853-9797 or FAX 516-681-2926  
CQ Communications, Inc.  
25 Newbridge Road, Hicksville, NY 11801



## The "Smokin' Gunn II"

two element directional beam.

"Small in Size"

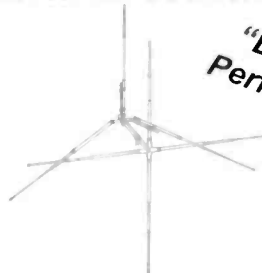

"Large in Performance"

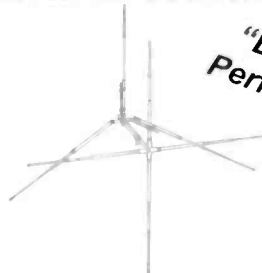

**For information and pricing, contact any of the following Dealers:**

Barker Electronics Lawrenceville, IL 618-943-4236	Hess Electronics Doran, VA 540-963-3557	R & R Communications Wilmington, DE 302-475-1351	In Canada, Contact: Durham Radio Whitby, Ontario 905-665-5466
Big Buffalo's Hide Norwich, CT 800-455-1557	Hi Tech Repair Montgomery, NY 845-457-3317	TC Radio Watha, NC 910-285-5841	
C & S Radio Owings, MD 410-257-9481	Joe's Trading Shop Youngsville, NC 919-556-4299	T.J.'s CB Shop Wytheville, VA 540-637-6552	
Fry Enterprises Nashville, TN 615-262-1862	L&M Electronics Elkin, NC 336-957-4933	Walt's CB & Scanner Asheville, NC 828-254-3048	

**CALL FOR A "FREE" CATALOG ON ANTENNAS**  
JO GUNN Enterprises, L.L.C.  
3138 County Road 30  
Ethelsville, AL 35461  
(205) 658-2229 • Fax: (205) 658-2259  
Hours: 9 a.m. - 5 p.m. (CST) Tues - Friday  
Answering System After Hours  
Check out our web site at  
[www.jogunn.com](http://www.jogunn.com) for "Monthly Specials"  
Dealer inquires, please call.





# Bill's 2 Way

CB Radio Equipment



uniden KENWOOD MIDLAND

CHEROKEE ICOM & Cobra

TEXAS RANGER maxon Galaxy

**FREE CATALOG!**

"We are the **DISCOUNT LEADER** in sales of scanners, FRS, CB, GMRS radios and accessories."

**1-888-710-4094**

**Bill's CB & 2-Way Radio Service**

PO Box 306, Morgan Hill, CA 95038-0306  
 Tech Line: (408) 782-0064 FAX: (408) 782-2985  
 e-mail: sales@bills2way.com  
 Website: http://www.bills2way.com



**High Performance  
 CB Antennas**

For decades, MACO has meant high-performance CB base station and mobile antennas—made in the USA! Call us or visit our website for more information on our products.

- Base Station Antennas
- Mobile Antennas
- Cable Assemblies
- Mobile Hardware
- Power Supplies
- Accessories

Call or write for free catalog and name of reseller nearest you!

**(800) 238-7258**

MACO MANUFACTURING

4091 Viscount Avenue

Memphis, TN 38118

Ph. (901) 794-9494 Fax (901) 366-5736

www.majestic-comm.com/maco

in doing until you achieve your desired results.

Case in point. In last month's column, I included a note from UFO17 from Adrian, Michigan, complaining about a long running radio interference problem caused by a local manufacturing plant. They knew the who, they know the when, they know the where. They had completed most, if not all, of the time consuming legwork. That information was then forwarded to the FCC. For the most part, all the Commission had to do was write it up. The offending company now "has mail." We still don't know how it will work out, but it looks like it has a good chance of solving the problem. The FCC has all of the complaints it can handle, and then some. If you really need to get something done don't complain! Do your homework, build a good case, and deliver it to the Commission on a silver platter. The results could surprise you.

Speaking of surprises, imagine how surprised Michael Kinney of Sherman Oaks, California, Neil Holcomb of Kings Mountain, North Carolina, Arthur C. Cook III of Greenwich, NY, a/k/a KC2FZD were when they went to their respective mailboxes and found personal invitations to call W. Riley Hollingsworth, Special Counsel, Enforcement Bureau of the FCC.

It seems that Mr. Hollingsworth is keen to know: Why Mr. Kinney is transmitting

in the Amateur Band and operating over-power in the CB band? How come Mr. Holcomb has been working the 10-Meter Amateur band, as well as other frequencies near 30 MHz and if he really does run non-certified and overpowered equipment on the CB band? And why Mr. Cook is transmitting sound effects and recordings of other operators on CB, and otherwise deliberately interfered with ongoing communications on the CB service channels? Damned Amateurs! Wouldn't you love to be a fly on the wall when they make the call?

## July And August Mixers

For those of us who find the act of "randomly contacting" on the air very exciting and alluring, why not make plans to attend the next, regularly scheduled on-air CB Mixer? They are held, wherever you are, on the last Saturday of the month. The next two will be on the 28<sup>th</sup> of July and the 25<sup>th</sup> of August from 9 p.m. until 10 p.m. local time. SSB operators work channel 36 LSB. AM operators work channel 23.

Well, that is it for now. Thanks for writing me here at the magazine or via the Internet where my address is ed@bar-nat.com. And as always, if you can (especially July 28<sup>th</sup> and August 25<sup>th</sup>) — catch me on the radio! 73

# YOU AIN'T HEARD NOTHIN'

Since 1967, CRB Research has been the world's leading publisher and supplier of unique hobby and professional books and information.

### Books & Information include:

- |                                   |                                |                           |
|-----------------------------------|--------------------------------|---------------------------|
| • Scanner Frequency Guides        | • Broadcast Station Registries | • Survival Communications |
| • Shortwave Frequency Guides      | • Electronic Espionage         | • Surveillance            |
| • Military/Federal Communications | • Undercover Communications    | • Covert Operations       |
|                                   |                                | • & Other Related Topics! |

New titles are constantly being added to our exciting catalog. If it's interesting and unusual, we've got it. **YOU'LL SEE.**

ASK FOR  
 BIG FREE  
 CATALOG

# CRB RESEARCH

P.O. Box 56, Commack, NY 11725

Ph: (631) 543-9169 FAX: (631) 543-7486 e-mail: sales@crbbooks.com www.crbbooks.com



# Tap into secret Shortwave Signals

Turn mysterious signals into exciting text messages with the MFJ MultiReader™!

Plug this self-contained MFJ MultiReader™ into your shortwave receiver's earphone jack.

Then watch mysterious chirps, whistles and buzzing sounds of RTTY, ASCII, CW and AMTOR (FEC) turn into exciting text messages as they scroll across an easy-to-read LCD display.

You'll read interesting commercial, military, diplomatic, weather, aeronautical, maritime and amateur traffic ...

## Eavesdrop on the World

Eavesdrop on the world's press agencies transmitting *unedited* late breaking news in English -- China News in Taiwan, Tanjug Press in Serbia, Iraqi News in Iraq -- all on RTTY.

Copy RTTY weather stations from Antarctica, Mali, Congo and many others. Listen to military RTTY passing traffic from Panama, Cyprus, Peru, Capetown, London and others. Listen to hams, diplomatic, research, commercial and maritime RTTY.

Listen to maritime users, diplomats and amateurs send and receive *error-free* messages using various forms of TOR (Telex-Over-Radio).

Monitor Morse code from hams, military, commercial, aeronautical, diplomatic, maritime

## Super Active Antenna

"World Radio TV Handbook" says MFJ-1024 is a "first-rate easy-to-operate active antenna... quiet... excellent dynamic range... good gain... low noise... broad frequency coverage."

Mount it outdoors away from electrical noise for maximum signal, minimum noise. Covers 50 KHz-30 MHz.

Receives strong, clear signals from all over the world. 20 dB attenuator, gain control, ON LED.

Switch two receivers and auxiliary or active antenna. MFJ-1024 \$139<sup>95</sup> 6x3x5 inches. Remote has 54 inch whip, 50 feet coax, 3x2x4 inches. 12 VDC or 110 VAC with MFJ-1312, \$14.95.

## Indoor Active Antenna

Rival outside long wires with this *tuned* indoor active antenna.

"World Radio TV Handbook" says MFJ-1020B is a "fine value... fair price... best offering to date... performs very well indeed."

Tuned circuitry minimizes intermod, improves selectivity, reduces noise outside tuned band. Use as a preselector with external antenna. Covers 0.3-30 MHz. Tune, Band, Gain, On/Off/Bypass Controls. Detachable telescoping whip. 5x2x6 in. Use 9 volt battery, 9-18 VDC or 110 VAC with MFJ-1312, \$14.95.

## Compact Active Antenna

Plug this compact MFJ all band active antenna into your receiver and you'll hear strong, clear signals from all over the world, 300 KHz-200 MHz including low, medium, shortwave and VHF bands.

Detachable 20 inch telescoping antenna. 9 volt battery or 110 VAC MFJ-1312B, \$14.95. 3 1/2x1 1/4x4 in.

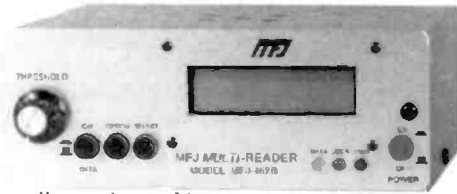

-- all over the world -- Australia, Russia, Japan, etc. MFJ-462B **\$179<sup>95</sup>**

## Printer Monitors 24 Hours a Day

MFJ's exclusive TelePrinterPort™ lets you monitor any station 24 hours a day by printing transmissions on an Epson compatible printer. Printer cable, MFJ-5412, \$9.95.

## MFJ MessageSaver™

You can save several pages of text in an 8K of memory for re-reading or later review.

## High Performance Modem

MFJ's high performance PhaseLockLoop™ modem consistently gives you solid copy -- even with weak signals buried in noise. New threshold control minimizes noise interference --

## Eliminate power line noise!

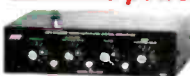

MFJ-1026 \$179<sup>95</sup>

**New!** Completely eliminate power line noise, lightning crashes and interference before they get into your receiver! Works on all modes -- SSB, AM, CW, FM, data -- and on all shortwave bands. Plugs between main external antenna and receiver. Built-in active antenna picks up power line noise and cancels undesirable noise from main antenna. Also makes excellent active antenna.

## MFJ Antenna Matcher



Matches your antenna to your receiver so you get maximum signal and minimum loss.

Preamp with gain control boosts weak stations 10 times. 20 dB attenuator prevents overload. Select 2 antennas and 2 receivers. 1.6-30 MHz. 9x2x6 in. Use 9-18 VDC or 110 VAC with MFJ-1312, \$14.95.

## Dual Tunable Audio Filter



Two separately tunable filters let you peak desired signals and notch out interference at the same time. You can peak, notch, low or high pass signals to eliminate heterodynes and interference. Plugs between radio and speaker or phones. 10x2x6 in.

## High-Gain Preselector



High-gain, high-Q receiver preselector covers 1.8-54 MHz. Boost weak signals 10 times with low noise dual gate MOSFET. Reject out-of-band signals and images with high-Q tuned circuits. Push buttons let you select 2 antennas and 2 receivers. Dual coax and phono connectors. Use 9-18 VDC or 110 VAC with MFJ-1312, \$14.95.

## CW, RTTY, ASCII Interface



MFJ-1214PC \$149<sup>95</sup>

Use your computer and radio to receive and display brilliant full color FAX news photos and incredible WeFAX weather maps. Also RTTY, ASCII and Morse code. Frequency manager lists over 900 FAX stations. Auto picture saver.

Includes interface, easy-to-use menu driven software, cables, power supply, manual and JumpStart™ guide. Requires 286 or better computer with VGA monitor.

## High-Q Passive Preselector

High-Q passive LC preselector boosts your favorite stations while rejecting images, intermod and phantom signals. 1.5-30 MHz. Preselector bypass and receiver grounded positions. Tiny 2x3x4 inches.

## Super Passive Preselector



**New!** Improves any receiver! Suppresses strong out-of-band signals that cause intermod, blocking, cross modulation and phantom signals. Unique Hi-Q series tuned circuit adds super sharp front-end selectivity with excellent stopband attenuation and very low passband attenuation and very low passband loss. Air variable capacitor with vernier. 1.6-33 MHz.

## Easy-Up Antennas

How to build and put up inexpensive, fully tested wire antennas using readily available parts that'll bring signals in like you've never heard before. Antennas from 100 KHz to 1000 MHz.

greatly improves copy on CW and other modes.

## Easy to use, tune and read

It's easy to use -- just push a button to select modes and features from a menu.

It's easy to tune -- a precision tuning indicator makes tuning your receiver easy for best copy.

It's easy to read -- the 2 line 16 character LCD display with contrast adjustment is mounted on a brushed aluminum front panel for easy reading.

Copies most standard shifts and speeds. Has MFJ AutoTrak™ Morse code speed tracking.

Use 12 VDC or use 110 VAC with MFJ-1312B AC adapter, \$14.95. 5 1/4xw2 1/4hx5 1/4D inches.

## No Matter What™ One Year Warranty

You get MFJ's famous one year *No Matter What™* limited warranty. That means we will repair or replace your MFJ MultiReader™ (at our option) *no matter what* for one full year.

## Try it for 30 Days

If you're not completely satisfied, simply return it within 30 days for a prompt and courteous refund (less shipping). Customer must retain dated proof-of-purchase direct from MFJ.

## MFJ Antenna Switches



MFJ-1704 heavy duty antenna switch lets you select 4 antennas or ground them for static and lightning protection. Unused antennas automatically grounded. Replaceable lightning surge protection. Good to 500 MHz. 60 dB isolation at 30 MHz. MFJ-1702C for 2 antennas.

## World Band Radio Kit

Build this regenerative shortwave receiver kit and listen to signals from all over the world with just a 10 foot wire antenna. Has RF stage, vernier reduction drive, smooth regeneration, five bands.

## 21 Band World Receiver

MFJ's MFJ-8121 new 21 Band World Receiver lets you travel the world from your armchair! Listen to BBC news from London, live music from Paris, soccer matches from Germany and more! Covers 21 bands including FM, Medium Wave, Long Wave and Shortwave. Sony® integrated circuit from Japan, multicolored tuning dial, built-in telescopic antenna, permanent silkscreened world time zone, frequency charts on back panel. Carrying handle. Operates on four "AA"s. Super compact size!

## Free MFJ Catalog

and Nearest Dealer... 800-647-1800

<http://www.mfjenterprises.com>

• 1 Year *No Matter What™* warranty • 30 day money back guarantee (less s/h) on orders from MFJ

**MFJ ENTERPRISES, INC.**  
Box 494, Miss. State, MS 39762  
(662) 323-5869; 8-4-30 CST, Mon.-Fri.  
FAX: (662) 323-6551; Add s/h  
Tech Help: (662) 323-0549

Prices and specifications subject to change. (c) 1998 MFJ Enterprises, Inc.



# world band

## tuning tips *your monthly international radio map*

This listing is designed to help you hear more shortwave broadcasting stations. The list includes a variety of stations, including international broadcasters beaming programs to North America, others to other parts of the world, as well as local and regional shortwave stations. Many of the transmissions listed here are not in English. Your ability to receive these stations will depend on time of day, time of year, your geographic location, highly variable propagation conditions, and the receiving equipment used.

AA, FF, SS, GG, etc. are abbreviations for languages (Arabic, French, Spanish, German). Times given are in UTC, which is five hours ahead of EST, i.e. 0000 UTC equals 7 p.m. EST, 6 p.m. CST, 4 p.m. PST.

UTC	Freq.	Station/Country	Notes	UTC	Freq.	Station/Country	Notes
0000	3280	La Voz del Napo, Ecuador	SS	0300	9860	Radio Rossi, Magadan, Russia	RR
0000	9870	KTWR, Guam	various	0300	15205	Broadcasting Service of the Kingdom, Saudi Arabia	AA
0000	13760	Voice of Korea, North Korea		0300	11840	Radio Yuzhno Sakhalinsk, Russia	RR
0000	9795	Voice of Vietnam, via Canada		0300	11940	Radio Romania Int'l	
0030	4965	Christian Voice, Zambia		0300	17675	Radio New Zealand Int'l	
0030	9780	Republic of Yemen Radio	AA	0300	9575	Radio Medi-Un, Morocco	AA
0030	4980	Ecos del Torbes, Venezuela	SS	0300	7465	Radio Norway	NN
0030	15570	Vatican Radio	unid.	0300	11580	Far East Broadcasting/ KFBS, N. Marianas	CC
0030	9605	Vatican Radio		0300	11995	Voice of America, Tinian, N. Marianas	
0030	7215	Radio Tashkent, Uzbekistan		0300	15310	BBC relay, Oman	
0030	21605	UAE Radio, Dubai		0300	11735	Voice of Korea, North Korea	
0030	9560	Radio Ukraine Int'l		0330	7255	Voice of Nigeria	
0030	7285	Radio Thailand	VV	0330	5020	La Voix du Sahel, Niger	FF
0045	7275	RT Tunisienne, Tunisia	AA	0330	15120	Radio New Zealand Int'l	
0100	9655	Voice of Turkey		0330	11815	Radio Exterior de Espana, via Costa Rica	SS
0100	7300	Voice of Turkey		0330	7210	Qatar Broadcasting Service	AA
0100	6200	Xizang PBS, Tibet	unid.	0330	6458.5	Armed Forces Network, Puerto Rico	USB
0100	13695	Radio Thailand		0330	17745	RDP Int'l, Portugal	PP
0100	15280	BBC relay, Thailand		0330	11675	RDP Int'l, Portugal	PP
0100	4990.9	Radio Apinte, Suriname		0330	11705	Voice of America relay, Philippines	
0100	9385	Radio Ukraine International		0345	15190	Radio Pilipinas, Philippines	
0100	11745	Radio Taipei Int'l	CC	0400	9465	Far East Broadcasting/KFBS, N. Marinas	unid.
0100	9500	Trans World Radio, Swaziland		0400	6673.6	Radio Andina, Peru	SS
0130	9905	Swiss Radio Int'l, via French Guiana	GG	0400	12065	Far East Broadcasting, Philippines	unid.
0130	9495	Radio Sweden		0400	9665	Radio Romania Int'l	
0200	15170	Radio Exterior de Espana, via Costa Rica	SS	0400	11740	Radio Romania Int'l	
0200	15425	Sri Lanka Broadcasting Corp.		0400	15140	Radio Sultanate of Oman	AA
0200	12085	Radio Damascus, Syria		0400	9737v	Radio Nacional, Paraguay	SS
0200	15574	Radio Korea Int'l, South Korea		0400	11570	Radio Pakistan	
0200	7180	Voice of Russia, via Moldova		0400	4890	NBC, Papua New Guinea	
0200	9650	Radio Korea Int'l, via Canada		0400	13700	Radio Netherlands, via Bonaire	
0230	11970	Adventist World Radio, via South Africa	unid.	0400	9810	Radio Netherlands, via Madagascar	DD
0230	3255	BBC, via South Africa		0400	13625	Radio Free Asia, USA, via Northern Marianas	CC
0230	11640	World Beacon, USA, via South Africa		0415	11770	Radio Mexico Int'l	SS/EE
0230	17870	Channel Africa, South Africa		0430	9705	Radio Mexico Int'l	SS
0230	17560	Broadcasting Service of the Kingdom, Saudi Arabia	AA	0430	6185	Radio Educacion, Mexico	SS
0300	9525	Channel Africa, South Africa		0430	2390	Radio Huayacocotla, Mexico	SS
0300	15420	BBC Relay, Seychelles Is.		0430	11675	Radio Kuwait	AA
0300	7290	Voice of America relay, Sao Tome					
0300	11885	Far East Broadcasting Assn., Seychelles Is.	unid.				

UTC	Freq.	Station/Country	Notes	UTC	Freq.	Station/Country	Notes
0430	9875	Radio Lithuania		1300	9820	Radio Havana Cuba	
0430	4800	Radio Lesotho		1300	5019.7	Ecos del Atrato, Colombia	SS
0430	4895	Radio Malaysia	unid	1300	21550	Voz Christiana, Chile	SS
<b>0500</b>	12015	Voice of Mongolia	RR	<b>1330</b>	5990	China Radio Int'l, via Cuba	
0500	17725	Radio Jamahiriya, Libya	AA	<b>1400</b>	9635	Voz Cristiana, Chile	SS
0500	13620	Radio Kuwait	AA	1400	9625	CBC Northern Service, Canada	
0500	6145	Radio Japan/NHK, via Canada		<b>1500</b>	5960	Radio Monte Carlo, Monaco, via Canada	AA
0500	11910	Radio Jordan	AA				
0500	17810	Radio Japan/NHK	II	1500	7340	Voice of America relay, Botswana	
0500	11690	Radio Jordan		<b>1530</b>	17865	Radio Austria Int'l, via Canada	
0500	11915	Radio Japan/NHK, via Gabon		<b>1600</b>	4681.5	Radio Paititi, Bolivia	SS
0500	15084	Voice of Islamic Republic of Iran	Farsi	1600	4716.7	Radio Yura, Bolivia	SS
0500	15140	All India Radio	RR	1600	17750	Radio Australia	
0500	15185	All India Radio	unid.	1600	7335	CHU time station, Canada	FF/EE
0500	3250	Radio Luz y Vida, Honduras	SS	1600	9635	Radio Nacional, Colombia	SS
<b>0530</b>	15075	All India Radio	unid.	1600	9630	Radio Aparecida, Brazil	PP
0530	5948.8	Voice of Guyana		1600	9775	Voice of America relay, Botswana	
0530	3300	Radio Cultural, Guatemala	SS	1600	9489.8	Radio Rossi, via Abkhazia (Georgia)	RR
0530	4800	Radio Buenas Nuevas, Guatemala	SS	1600	9580	Radio Australia	
<b>0600</b>	5042.5	Radio Verdad, Guatemala	SS	<b>1615</b>	9965	Voice of Armenia	unid
0600	15615	Adventist World Radio, Guam	various	<b>1630</b>	7270	Radio Tirana, Albania	Alb.
0600	17705	Voice of Greece, via Delano, CA	Greek	1630	17570	RTBF Int'l, Belgium, via Germany	FF
0600	9420	Voice of Greece	Greek	<b>1700</b>	7105	BBC, via Ascension Is.	
<b>0630</b>	7400	Deutsche Welle, Germany, via Russia	GG	1700	11915	Radio Gaucha, Brazil	PP
0630	17860	Voice of Germany, via Rwanda	GG	1700	4885	Radio Clube do Para, Brazil	PP
<b>0700</b>	15485	Radio Africa Int'l, USA, via Germany		1700	7400	Radio Bulgaria	
0700	15475	Africa Number One, Gabon	FF	1700	5030	China National Radio (CPBS), China	CC
0700	11850	Radio France Int'l, via Gabon	FF	1700	11850	Radio Canada, via South Africa	
0700	15210	Radio France Int'l		1700	5054	Faro del Caribe, Costa Rica	SS
<b>0730</b>	9580	Africa Number One, Gabon	FF	1700	13660	Radio Vlaanderen Int'l, Belgium, via Bonaire	
<b>0800</b>	11910	Radio France Int'l, via Gabon	FF	<b>1730</b>	9570	China Radio Int'l, via Cuba	
0800	6940	Radio Fana, Ethiopia	unid.	1730	11710	Adventist World Radio, via Austria	Amharic
<b>0900</b>	15400	Radio Finland	Finnish	<b>1800</b>	11600	Radio Prague, Czech Republic	
0900	9865	Radio Finland	Finnish	1800	5956.4	Caracol Villivencio, Colombia	SS
0900	15220	BBC, via Antigua		1800	5985	Radio Congo, Congo Rep.	FF
0900	9915	BBC, via Canada		1800	12095	BBC, via Cyprus	
0900	21810	Radio Finland	Finnish	<b>1830</b>	9400	Radio Bulgaria	
<b>0930</b>	9990	Radio Cairo		1830	6160	CKZU, Canada	
0930	12095	BBC, via Ascension Is.		<b>1900</b>	11800	RAI Int'l, Italy	II
<b>1000</b>	12050	Radio Cairo, Egypt	AA	1900	15265	Voice of America, via Sri Lanka	unid.
1000	4840	Radio Interoceanica, Ecuador	SS	1900	17820	Radio Canada Int'l, via UAE	
<b>1030</b>	9735	Wales Radio Int'l, via England		<b>1930</b>	3925	Radio Tampa, Japan	JJ
1030	17660	HCJB, Ecuador		<b>2000</b>	3220	Radio Morobe, Papua New Guinea	
<b>1100</b>	7180	Radio Denmark, via Norway	DD	<b>2015</b>	3290	Radio Centro, Ecuador	SS
1100	9945	Radio Denmark, via Norway	DD	<b>2100</b>	3310	Radio Mosoj Chaski, Bolivia	SS
1100	21745	Radio Prague, Czech Republic		<b>2130</b>	3316	Sierra Leone Broadcasting Service	
1100	17485	Radio Prague, Czech Republic		<b>2200</b>	3355	Radio Difusora 6 de Agosto, Brazil	PP
<b>1130</b>	11585	Kol Israel		2200	4388.9	Radio Imperio, Peru	SS
1130	17705	Kol Israel		2200	4760	ELWA, Liberia	
1130	11787	Radio Baghdad, Iraq		2200	4770	Radio Nigeria	
1130	7120	RAI Int'l, Italy		2200	4801	XERTA, Mexico	SS
1130	11605	Kol Israel		<b>2230</b>	4845	Radio K'ekchi, Guatemala	SS, vern.
<b>1200</b>	6180	Radio Nacional Amazonia, Brazil	PP	2230	4875	Radio Roraima, Brazil	PP
1200	15260	Voice of the Islamic Republic of Iran	unid.	2230	4915	Radio Cora, Peru	SS
<b>1230</b>	9570	Radio Havana Cuba		2230	4930	Radio Barahona, Dominican Republic	SS
1230	4915	Ghana Broadcasting Corp.		2230	5010v	Radio Misiones Int'l, Honduras	EE/SS
<b>1245</b>	15330	KTWR — Trans World Radio, Guam		<b>2300</b>	5047	Radio Togo	FF
<b>1300</b>	21780	Deutsche Welle, Germany		2300	5100	Radio Liberia	
1300	11715	All India Radio		2300	5765	Armed Forces Network, Guam	USB
1300	4819	La Voz Evangelica, Honduras	SS	2300	6045	Radio Santa Rosa, Peru	SS
1300	17780	KWHR, World Harvest Radio, Hawaii		<b>2345</b>	7190	Radio Liberty, via Morocco	unid.



## radios & high-tech gear

*review of new, interesting and useful products*

### Midland FRS With Weather For Consumers With Champagne Taste

As the old saying goes, "everyone talks about the weather, but no one ever does anything about it." Although they don't claim to be able to change the weather, Midland Consumer Radio has made it easier to talk about it by introducing a new Family Radio Service (FRS) two-way radio with the ability to receive National Weather Service broadcasts. According to Robert J. Thetford, Midland's vice president of sales, "Our surveys reveal this as one of the most requested features for FRS radios." Available in a new champagne gold color, their SpeakEasy model 75-517 is an attractive addition to their full line of two-way radios.

Thetford feels that the 75-517 will be a top seller, because "The 75-517 has the same basic design as our incredibly popular model 75-515, plus it has the new color and weather reception. We have packed an incredible amount of features into a value-priced FRS radio."

FRS radios have become extremely popular across the country, due to their low cost, ease of use, and clear FM transmission on any one of 14 channels for up to two miles. In some areas, such as a crowded ski slope or amusement park, it is recommended to have a "privacy code" system to filter out the signals of others on the same channel. Midland's 75-517 not only has the standard 38 CTCSS codes for this purpose, but also has 83 digital DCS codes, bringing the total code/channel combinations up to an incredible 1694 — the most of any FRS on the market. With this impressive choice of coding options, as well as a Page button to send an attention grabbing alert tone, users can be sure to use their FRS radio without receiving unwanted transmissions, even at the busiest amusement park or ski slope. Plus, you don't have to be afraid to use your radio out in the weather, because it's water-resistant design gives you improved reliability for indoor or outdoor use.

Midland has also included an improved 36-setting voice activation they call "eVOX," which allows "hands-free" use without a headset. Six sensitivity levels and six delay settings allow eVOX use in almost any setting. Optional headsets are available for times when quieter operation is desired, such as while hunting.

Nine channel memory settings make it easy to switch to a pre-



*The new Midland 75-517 FRS SpeakEasy transceiver.*

determined channel/code combination, and both busy or open Channel Scan are available. Dual Watch allows easy monitoring of two channels. Midland's Stealth Squelch circuit automatically quiets annoying popping noises at the start and end of transmissions, and maximum FCC allowed output power provides up to a two-mile range over land and five miles over water, depending on conditions and terrain.

Additional features include a large backlit LCD panel that is easy to read and displays 12 different functions. Button locking prevents accidental changes. A five-note roger beep and power-on tone can be user disabled for extremely quiet operation. Belt clip and hand strap are included.

The 75-517 has dependable Surface Mount Technology (SMT) circuitry for years of trouble-free use. A flexible rubber antenna adds durability. The "battery save" option helps extend battery life, and a battery indicator warns when the 3 "AA" batteries are low (batteries not included). A convenient jack is provided for in-unit charging of optional NiCd batteries, when used with the optional wall charger, model 18-396 or the drop-in desk charger 18-383. A two-unit desktop charger (18-385) is also available separately. Use the built-in microphone and speaker, or an optional speaker/microphone or headset (sold separately).

The SpeakEasy 75-517 measures 2-1/16"W x 3-7/8"H x 1-1/16"D, and is expected to be available in stores this fall. The 75-517 has a general retail price of only \$79.95 each.

Midland Consumer Radio was the first to introduce a 14 channel FRS radio to the market. In addition, Midland is the oldest manufacturer of CB radios in the U.S., and a leader in weather/hazard alert radios. Since 1959, Midland has stayed on the forefront of two-way radio technology, offering the latest features at value prices. They offer a full line of CB and FRS handheld and mobile radios, marine radios, antennas, and accessories.

For more information, contact Midland Consumer Radio, Inc. 1670 N. Topping Ave, Kansas City, MO 64120-3865; phone 816-241-8500; FAX 816-241-5713; E-mail [midlndcb@midlandradio.com](mailto:midlndcb@midlandradio.com), or visit Midland's Website at [www.midlandradio.com](http://www.midlandradio.com)

### Alinco Introduces DR-235 And DR-435 FM Mobile/Base Ham Transceivers

Alinco USA has announced two new models in its Amateur Radio product line — the DR-235 (222 MHz) and the DR-435 (440 MHz) FM mobile/base transceivers. "Built in response to popular demand, these are exciting and affordable additions to our growing family of products," said Katsumi, "Naky" Nakata, KE6RD. "They are similar in style and function with the DR-135 which means they also have the ability to operate with our optional internal packet boards."

Included with the new models, Alinco is also introducing a new feature-packed microphone, the EMS-57. In addition to basic microphone operation, the operator can use the backlit keypad to enter frequencies, switch from VFO to Memory operation (and back), select the transceiver's call channel, execute the radio's autodialer memory function, select the transmitter's



power output setting and temporarily defeat the receiver's squelch setting.

Both transceiver models have a large, seven-character alphanumeric display, 100 memory channels, ignition key on/off feature, theft alarm feature, CTCSS and DCS encode/decode and DTMF encode functions along with European Tone Bursts. Ten autodial memories are available along with scan modes and extended receive capabilities. The attractive new units can be ordered in either traditional black or classic pewter color schemes in an attempt to blend the units with newer car interiors. Each unit is constructed in massive heat-sink chassis assemblies, negating the need for a cooling fan.

Digital operators can also order the optional EJ-41U packet board that fits inside either transceiver. With the board installed, 1200 or 9600 bps packet operations can be achieved by connecting a computer to the rear panel DSUB9 port. Operation begins by selecting the digital operating mode on the transceiver's front panel, (or from memory,) with no modifications to the radio and no need to remove the microphone. The radios will also work with external TNC units connected to the rear panel serial port. "This is important news for packet operators,"



Alinco's new DR-235 amateur transceiver.

said Nakata. "We are aware many packet networks use 222 and 440 MHz for linking digital systems. The DR-235 also has the ability to operate in the special 219-220 MHz allocation set aside for forwarding operations."

Another digital feature is a front panel Data Port that can be used for GPS input, cloning, or as part of the unit's anti-theft operation. "The GPS input can be used for APRS operations, perhaps opening new bands to that area of interest," Nakata said.

The DR-235T features include 25/10/5 watt power output settings, extended receive from 216-280 MHz, transmits from 222-225 MHz, and has the ability to operate on MARS frequencies as well as the special digital allocation from 219-220 MHz. The memory channels can operate in any split frequency configuration, with transmission limited to the ham frequency allocation.

The DR-435T operates from 430-450 MHz, with extended receive from 350-511 MHz (FM) 35/10/5 watt output settings and the ability to operate odd repeater splits on any memory channel (transmits only 430-450 MHz).

Nakata added, "While the technology is impressive, Alinco has worked very hard to make the new transceivers affordable. We believe they are priced significantly lower than competitor's products that have been previously available in the 222 and 440 MHz marketplace. We certainly hope the amateur radio community will take notice of the significant value found in these new offerings and use this opportunity to get active on these bands, particularly 222, where valuable spectrum was lost once before." MSRP for the DR-235 is \$335.95 and the DR-435 price will be announced soon. Dealers are free to set their own prices and often sell below the MSRP. ■

## DEDICATED TO THE SCANNING AND SHORTWAVE ENTHUSIAST. WE'RE MORE THAN JUST SOFTWARE!

### SCANCAT® GOLD for Windows

Since 1989, The Recognized Leader in Computer Control

Once you use SCANCAT with YOUR radio, you'll NEVER use your radio again WITHOUT SCANCAT!

SCANCAT supports almost ALL computer controlled radios by: AOR, DRAKE, KENWOOD, ICOM, YAESU and JRC (NRD) Plus PRO-2005/6/35/42 (with OS456/535), Lowe HF-150, and Watkins-Johnson.

#### Announcing Scancat-Gold for Windows Version 8.0

We've added a lot of new features to our latest Scancat. AND...We have made it EASIER than EVER! Scancat-Gold for Windows-New Features for Ver 8.0

**NOW SUPPORTS BC780, BC895, BC245, Pro2052**

- Completely redesigned Graphical Interface
- Two Scanning modules:
  - A Simple Basic Module - for beginners
  - Plus**
  - An Advanced Scanning System for the "experts".
- New "Folder Tabbed" GUI puts everything at your fingertips
- Faster scanning speeds
- Extensive on screen help
- Completely revised printed manual
  - Over 160 pgs.
- EXPANDED trunking support for BC780, BC895, BC245 and Pro2052
- Supports all radios in ONE program - share files with all radios.
- Monitor and log all TalkGroup activity - Export to other files.
- Completely revised trunking database management with expanded capabilities. Makes programming your radio a breeze!
- Expanded import from databases such as EXCEL.
- NO ONE supports your "Trunk Tracker" with more features!

#### STILL THE SAME GREAT PRICE:

Scancat-Gold for Windows .....\$99.95  
 Scancat-Gold for Windows-SE .....\$159.95  
 Upgrades: Scancat-Gold for Windows .....\$39.95 + S&H\*  
 Scancat-Gold for Windows-SE .....\$79.95 S&H\*  
\*WITHIN 1 YEAR OF ORIGINAL PURCHASE S&H \$5 U.S. \$7.50 FOREIGN

#### Scancat-Gold for Windows-SE - improved Features for Ver 8.0

All the features of our "Standard Scancat" plus these additional functions:

- Long term logging of frequencies to your hard drive.
- Record Audio to hard drive using your computer's soundcard.
- NEW - Records audio when "Trunktracking" or conventional scanning.
- Improved spectrum analysis with several great graphical analysis screens.

#### MAGIC for Windows

PUT SOME ORDER IN YOUR LIFE!

If You're Not Using MAGIC, You're Only Enjoying Half The Hobby.

- Magic is a super conversion utility that will read and write to over 10 database formats
- Creates databases from plain ASCII text.
  - Finds single or multiple frequencies located anywhere in source files and creates perfectly aligned database files.
  - Converts: SCANCAT, ASCII text, comma delimited, HTML, DBase, ScanStar, RadioManager and ScannerWear.
  - WINRADIO, "WRM" files and PCR1000 ".MCH" files.

**MAGIC for Windows \$34.95**  
(plus \$5.00 S & H)

#### LIMITED TIME OFFER!

Limited Time Thru 9/1/2001

Scancat Gold for Windows \$99.95  
 Magic for Windows 34.95  
 Disk of Frequency Files 15.00  
**Regular Price \$149.90**  
**SPECIAL \$124.95**  
 For "SE" Add: \$39.95  
**"SPECIAL SCGM"**

#### "UNI-VERSATILE" INTERFACE

- Supports ICOM/IC-R10, AR8000, AR16B, YAESU and SCOUT.
- Comes with 6 FOOT cable, and adapters to fit all units within a single package (Must Specify Yaesu)
- Unlike "single radio" adapters, can be used with ANY radio supported, simply change the adapter, then "Plug and Play."
- Expandable in future with a simple add on adapter.
- No external power required. Draws power from computer.
- "Reaction Tune" scout with NO modifications to radio.



**AR-820B Cables/Interfaces -CALL!**  
**BC-895 Cables \$29.95**

**CAT-232C "UNIVERSATILE INTERFACE" \$99.95 + s & h**

FREE FREQ FILES

WEBSITE - [www.scancat.com](http://www.scancat.com)

E-MAIL - [info@scancat.com](mailto:info@scancat.com)

FREE DEMOS



SCANCAT is a registered trademark of Computer Aided Technologies.

Order direct or contact your favorite dealer

**COMPUTER AIDED TECHNOLOGIES** P.O. Box 18285 Shreveport, LA 71138

Phone: (318) 687-4444

FAX: (318) 686-0449

Info/Tech Support: (318) 687-2555 (9 a.m. - 1 p.m. Central M-F)

Toll-Free Orders  
**888-SCANCAT**  
 888-722-6228



# broadcast technology

by Bruce Conti <baconti@aol.com>

terrestrial AM, FM—and satellite radio news

## We Interrupt This Webcast. . .

Radio stations across the country have been pulling the plug on Internet broadcasts. Clear Channel has instructed all of its over 1,200 stations coast-to-coast to cease simulcasting on the web, amid worries that artist unions will demand increased compensation for worldwide Internet broadcasts. The two major music industry unions, ASCAP and BMI, have asked for double the royalties, charging that over-the-air and Internet audio represent two separate broadcasts. Adding to the fray, contract talks with the Hollywood commercial actors union stalled over the same issue. Stations that continue to broadcast over the Internet are being asked to blackout any national ad campaigns from their webcasts while the actors' contract is in dispute. Ironically most radio stations aren't really making any additional money with Internet radio. Advertisers are more interested in the local audience, and consider Internet broadcasting a novelty. For example, the fact that a local car dealership's commercial can be heard around the world via the Internet doesn't translate into more advertising revenue for the station. On the other hand, the music industry argument may hold merit, as it is indeed a global business. Will the outcome mean the end of Internet radio simulcasts? Stay tuned!

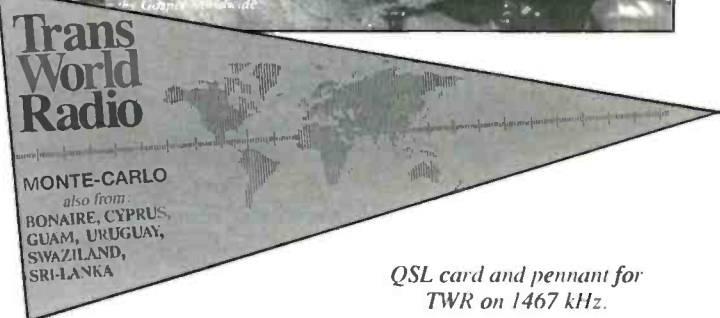
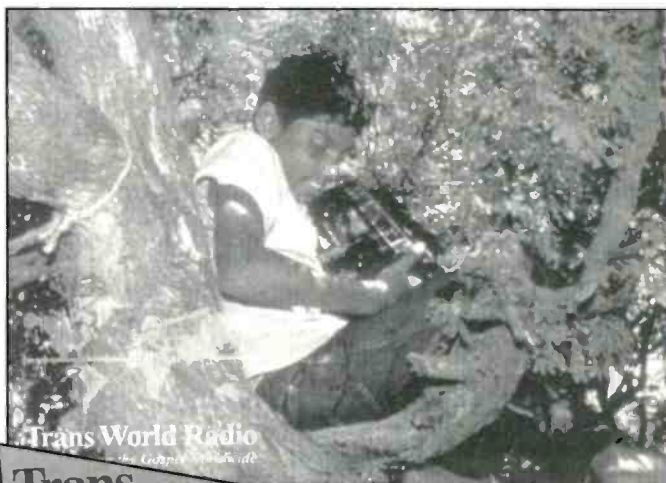

### Baseball Fans Strike Out

In an unrelated move that has computer users crying foul, Major League Baseball has given fans the brush-off over the

### Flagship Stations Of Major League Baseball

#### AL EAST

Baltimore Orioles	WBAL 1090
Boston Red Sox	WEEI 850
	WRCA 1330 (Spanish)
New York Yankees	WABC 770
Tampa Bay Devil Rays	WFLA 970
Toronto Blue Jays	CHUM 1050

#### AL CENTRAL

Chicago White Sox	WMVP 1000
Cleveland Indians	WTAM 1100
Detroit Tigers	WXYZ 1270
Kansas City Royals	KMBZ 980
Minnesota Twins	WCCO 830

#### AL WEST

California Angels	KLAC 570
Oakland A's	KABL 960
Seattle Mariners	KIRO 710
Texas Rangers	KRLD 1080
	KESS 1270 (Spanish)

#### NL EAST

Atlanta Braves	WSB 750
Florida Marlins	WQAM 560
	WQBA 1140 (Spanish)

Montreal Expos	CKAC 730 (French)
New York Mets	WFAN 660
Philadelphia Phillies	WPHT 1210

#### NL CENTRAL

Chicago Cubs	WGN 720
Cincinnati Reds	WLW 700
Houston Astros	KTRH 740
	KXYZ 1320 (Spanish)
Milwaukee Brewers	WTMJ 620
Pittsburgh Pirates	KDKA 1020
St. Louis Cardinals	KMOX 1120

#### NL WEST

Arizona Diamondbacks	KTAR 620
	KPNX 1040 (Spanish)
Colorado Rockies	KOA 850
Los Angeles Dodgers	KXTA 1150
	KWKW 1330 (Spanish)
San Diego Padres	KOGO 600
	KURS 1040 (Spanish)
San Francisco Giants	KNBR 680
	KZSF 1370 (Spanish)



outlets. The all-ears kids network can now be heard on 550 AM in Rhode Island in addition to 1450. A list of Mickey Mouse affiliates can be found at the Radio Disney website.

## A Tale Of Two Stations

Reminiscent of the early days of radio, WTIC Hartford, Connecticut and KRLD Dallas, Texas, both with 50 kW on 1080 kilohertz, coordinated a special AM radio propagation experiment with the National Radio Club. The club's E-mail server promulgated news of this test just days before it took place. According to a verification letter from KRLD Director of Engineering Erik Disen, "Infinity Radio Division's WTIC and KRLD cooperated in a coordinated silent period. This enabled many east coast DXers to hear KRLD for the first time. There was a business purpose to all this from our perspective. KRLD went off the air to replace its 'common-point' antenna ammeter, while WTIC was looking for stations on 1080 that might have been causing interference."

KRLD was the first to go off the air, leaving the frequency clear for reception of WTIC by listeners to the west. While both stations were off, DXers in the east reported reception of Radio Cadena Habana, Cuba, WVCG Coral Gables, Florida, and Radio Barcelona, Venezuela on 1080. KRLD was widely heard in the east upon returning to the air prior to WTIC. In conclusion, Erik writes, "By staggering our off-air times, we hopefully made it enjoyable for everyone! I myself have been an on-again, off-again BCB DXer for over 40 years. To me, it is part of the magic of radio. I am lucky to be able to actually work in such a wonderful industry as high-power AM. It is also still very successful as a business. I might add."

reception of Internet broadcasts. Beginning this season, radio stations are required to blackout their webcasts during over the air broadcast of baseball games. If you've attempted to follow the play-by-play via the Internet, then you may have instead encountered the following message: To listen to the games, visit [www.mlb.com](http://www.mlb.com). Major League Baseball now charges a subscription fee for season-long access to all team broadcasts via its own website. Fortunately for DXers, baseball games are still available free of charge via AM radio.

## Sporting News Radio

One-On-One Sports is now Sporting News Radio. While the name has changed, the talk hosts remain the same. Outrageous, yet popular pontificators Nasty Nestor Aparicio, Papa Joe Chevalier, and bartender Rick Ballou will continue to tend to listener phone calls and special guests, now with longer segments for in-depth discussions. Despite relatively low ratings, sports talk radio has become one of the most lucrative radio formats. Advertisers are attracted to the loyal and attentive audience versus music listeners who readily switch stations during commercial breaks. Other nationwide sports talk networks heard across the AM dial include ESPN Radio, the Sports Fan Network, and the latecomer Fox Sports Radio. In Canada, the CHUM radio group is launching The Team sports talk network.

## More Network News

In Washington DC, listen for WWRC Business Radio to replace the Music of Your Life on 1260. The change makes way for the new Dynamite Talk WTNT on 570. In Puerto Rico, NotiUno is taking over the WSKN Super Kadena Noticias network. San Diego listeners will find talk radio prankster Phil Hendrie on KGB-FM, moving there from KSDO 1130 AM. Hendrie is also heard on KFI Los Angeles. After a brief retirement from WOR New York on 710, John Gambling has returned with a weekend show on WABC 770. Three generations of Gamblings kept New Yorkers informed and entertained in the morning on WOR for over 75 years. The move reinforces WABC's reign as the number one talk station in the nation. Radio Disney continues to add to their collection of low-power AM

## QSL Information

**730 CJNW** Vancouver, British Columbia, form letter received in 43 days, signed by Mark Friesen-CE. Address: 700 West Georgia Street, Suite 200, Vancouver, BC V7Y 1K9. (Martin, OR)

**880 KRVN** Lexington, Nebraska, QSL card, decals, and sticker received in eight days, signed Vern Killion, CE. Address: 1007 Plum Creek Parkway, Lexington, NE 68850. (Marcher, CA) Congratulations to "Farm Radio" KRVN, celebrating 50 years of service!

**990 KHBZ** Honolulu, Hawaii, verification statement written on my letter in 16 days, signed Brian Loughison. Address: 650 Iwilei Rd #400, Honolulu, HI 96817-5317. (Martin, OR)

**1040 KFSR** Fresno, California, "Fresno State Radio" NOAA weather and traffic information station. Address: Fresno State University, Speech & Arts Building, 5201 N. Maple Ave., Fresno, CA 93740. (Jackson, CA)

**1080 KRLD** Dallas, Texas, verification letter and refrigerator magnet in 12 days for report and postage in response to coordinated propagation test with WTIC, signed Erik Disen, Director of Engineering. Address: 1080 Ballpark Way, Arlington, TX 76011. (Conti, NH)

**1197 JOWL** Asahikawa, Japan, full-detail beautiful photo QSL card of station in 30 days for taped report, not signed.



## Pending

New Call	Location	Freq.	Old Call
KMCJ	Colstrip, MT	99.5	KBPY
KUQL	Wessington Springs, SD	98.3	KGGK
WKIO-FM	Ravenswood, WV	93.1	WMOV-FM

## Changes

New Call	Location	Freq.	Old Call
KAZG	Scottsdale, AZ	1440	KSLX
KIEV	Burbank, CA	1500	KRCK
KSRK	Carmel Valley, CA	540	KIEZ
KOME	Clovis, CA	1630	KNAX
KWST	El Centro, CA	1430	KAMP
KJQI	San Rafael, CA	1510	KMZT
KCFR	Denver, CO	1340	KKYD
WPBI	Delray Beach, FL	1420	WDBF
WFXJ	Jacksonville, FL	930	WNZS
WCSN	Chicago, IL	820	WYPA
KFTI	Wichita, KS	1070	KFDI
WAIA	Beaver Dam, KY	1600	WSNR
WSNR	Newark, NJ	620	WJWR
WGYM	Hammonton, NJ	1580	WONZ
WUSS	Pleasantville, NJ	1490	WGYM
WBRJ	Marietta, OH	910	WYLI
WHKW	Warren, OH	1440	WRBP
WBZV	Loretto, PA	1400	WEBG
WOQI	Adjuntas, PR	1020	WPJC
KNAX	Fort Worth, TX	1630	KOME
WRJR	Claremont, VA	670	WHRP
WVTS	Charleston, WV	950	WQBE
WDVM	Eau Claire, WI	1050	WEIO
WDYF	Dothan, AL	90.3	New
WRVX	Eufaula, AL	97.9	WDMT
WCSN-FM	Orange Beach, AL	105.7	WCSN
KNAG	Grand Canyon, AZ	90.3	New
KWFM-FM	Green Valley, AZ	97.1	KCEE
KOYT	Tucson, AZ	92.9	KWFM-FM
KCEC-FM	Wellton, AZ	104.5	KBHV
KSEH	Brawley, CA	94.5	KWST
KSLG-FM	Hydesville, CA	94.1	KBHN
KPSL-FM	McFarland, CA	102.9	KSUV-FM
KLRM	San Luis Obispo, CA	97.1	KWQH
KPRU	Delta, CO	103.3	KVOD-FM
KVOD	Denver, CO	90.1	KCFR
WYZR	Lafayette, FL	99.9	WWFO
WJHW	Bainbridge, GA	101.9	New
WUWG	Carrollton, GA	90.7	WWGC
WCLR	Arlington Heights, IL	88.3	New
WUEZ	Carterville, IL	95.1	WXLT
WXLT	Christopher, IL	103.5	WUEZ
WRPW	Colfax, IL	92.9	WSNI
WYCA	Crete, IL	102.3	WVJM
WVJM	Lansing, IL	106.3	WYBA
WEJE	Auburn, IN	102.3	WCKZ
WYBA	Hammond, IN	92.3	WYCA

WCKZ	Roanoke, IN	94.1	WYSR
KDWD	Emmetsburg, IA	100.1	KEMB
KCAR-FM	Galena, KS	104.3	KBGZ
KWBI	Great Bend, KS	91.9	New
WUHU	Smiths Grove, KY	107.1	WBLG-FM
KQLQ	Rayville, LA	92.3	KTJC
WDVT	Harwich Port, MA	93.5	WYST
WTWV	Mashpee, MA	101.1	WWKJ
WOUF	Beulah, MI	92.1	WSRI
WQTX	Charlotte, MI	92.7	WVIC
WDVD	Detroit, MI	96.3	WPLT
WZRZ	Frankenmuth, MI	93.7	New
WVIC	Jackson, MI	94.1	WXIK
WYVN	Saugatuck, MI	92.7	WEVS
WGVY	Cambridge, MN	105.3	KZNT
WGVZ	Eden Prairie, MN	105.7	KZNZ
WGVX	Lakeville, MN	105.1	KZNR
WZLD	Petal, MS	106.3	WMFM
KMCV	High Point, MO	89.9	KBMF
KSCV	Springfield, MO	90.1	KAKU
WZCR	Hudson, NY	93.5	WTHK
WMHU	Jamestown, NY	101.9	WHUG
WJVT	Port Henry, NY	92.1	WLCQ
WKIX	Goldsboro, NC	102.3	WKIX-FM
WYMY	Goldsboro, NC	96.9	WYMY-FM
WCHH	Harrisburg, NC	92.7	WCCJ
WKVE	Semora, NC	106.7	WPXX
KQHR	Hood River, OR	90.1	New
KZRI	Welches, OR	90.3	New
WHUG	Cooperstown, PA	107.7	WMHU
WQZI	Laporte, PA	103.9	WRPA
WVYA	Williamsport, PA	89.7	New
WSMA	Hormigueros, PR	92.1	WEGM
WEGM	San German, PR	95.1	WCTA-FM
WHHT	Seneca, SC	98.1	WPEK
WAYW	New Johnsonville, TN	89.7	WHYQ
WRMX-FM	Norris, TN	106.7	WXVO
WKVZ	Ripley, TN	94.9	WTRB-FM
KPDB	Big Lake, TX	98.3	New
KOYE	Frankston, TX	96.7	KLIS
KPUS	Gregory, TX	104.5	KKPN
KHKX	Odessa, TX	99.1	KWBI
KKPN	Rockport, TX	102.3	KBTE
KJQN	Brigham City, UT	100.7	KYBG
KFVR-FM	Nephi, UT	103.9	KYKN-FM
KUDD	Roy, UT	107.9	KFVR-FM
WEXM	Exmore, VA	106.1	New
WGRX	Falmouth, VA	104.5	WFAL-FM
WZRV	Front Royal, VA	95.3	WDRV
WPZE-FM	Petersburg, VA	99.3	WPLZ-FM
WPLZ-FM	Richmond, VA	105.7	WJRV
KEXP-FM	Seattle, WA	90.3	KCMU
WZNW-FM	Bethlehem, WV	105.5	WZNW
WZJO	Dunbar, WV	94.5	WBES-FM
WYNW	Birnamwood, WI	92.9	New

Address: STV Broadcasting Co Ltd, 1-1, Nishi 8-chome, kita 1-jo, Chuo-ku, Sapporo 060-8705. Japan QSL #110. (Martin, OR)

**1220 WLSD** Big Stone Gap, Virginia, handwritten letter received in 21 days for tentative taped report, signed Ray Church, DJ. 44 watts non-directional at night, one of my best domestic MW catches! Address: 724 Park Avenue NW, Norton, VA 24273. (Martin, OR)

**1440 CKJR** Wetaskiwin, Alberta, after several tries I finally received a E-mail QSL in 90 days, signed Brent Downie GM. I sent a taped report to 5220 51st Avenue, Wetaskiwin, AB T9A 3E2. E-mail address: bdownie@ab.tri.ca (Martin, OR)

**1467 TransWorld Radio**, Roumoules, France. QSL card, pennant, and schedule in 55 days for report and one IRC, signed John Moore. The QSL card indicates the transmitter location as Monte Carlo with a power of 1000 kW. Address: BP 349, MC 98007, Monaco. (Conti, NH)

**1660 WGIT** Canovanas, Puerto Rico, full-detail QSL letter in Spanish received in 18 days for a taped report, mentions station is 10 kW days and 1 kW nights, signed Aureo A. Matos & Olga Rosario, Presidentes. Address: WGIT La Gigante 1660 AM, P.O. Box 7, Moca, PR 00676. Puerto Rico QSL #2, a really tough area to hear in the Pacific northwest. (Martin, OR)

**1700 Burbank Airport**, California, a new TIS/HAR station giving parking and terminal information, QSL signed Rosalyn Hairston. Address: 2627 N. Hollywood Way, Burbank, CA 91505. (Jackson, CA)

**1700 WEUP** Huntsville, Alabama, verification letter signed Mark Goodwin, GM. Address: 2609 Jordon Lane NW, Huntsville, AL 35816. As far as I know, this is the only letter QSL ever issued other than E-mail, after several phone calls. (Jackson, CA)

## Broadcast Loggings

The largest cluster of sunspots in at least 10 years has produced some spectacular displays of northern lights in southern latitudes. Auroral conditions can produce some spectacular AM DX opportunities as well. Listen for enhanced reception of Central and South American stations during periods of high solar activity. All times are UTC.

**530 CIAO** Brampton, Ontario, heard with everything from French to Chinese languages and music, and mentions of the Toronto Blue Jays in English. Best times for reception are early mornings. (Klingman, NY)

**680 WINR** Binghamton, New York, at 2300 with simulcast of WBNG-TV Action News. WINR is otherwise a Music of Your Life station. (Klingman, NY)

**800 CHML** Hamilton, Ontario, at 1110 with Good Morning Ontario syndicated program, a good signal despite splatter from WGY 810. (Klingman, NY)

**900 XEW** Mexico at 1010 excellent with ID, "Musica, a travez de la Cadena W, azul y plata" and Mexican pop music. (Conti, NH)

**940 XEQ** Mexico at 1020 excellent with ID, "En la Cadena Q, verde y oro, la radio viva" and frequent UTC-6 time checks. (Conti, NH)

**1000 XEOY** R. Mil. Mexico at 1025 fair, a woman singing "Es Radio Mil" and Spanish versions of U.S. oldies. (Conti, NH)

**1060 KYW** Philadelphia, Pennsylvania, at 0330 traffic report followed by news and weather, very clear with a three-foot wire antenna in the basement and an old "Sparton Polo" tube-type radio. (Gillespie, MI)

**1060 XEEP** R. Educacion, Mexico, at 1015 good with a nostalgic vocal parallel 6185 kHz, no sign of KYW due to auroral conditions. (Conti, NH)

**1140 WRVA** Richmond, Virginia, at 0005 with commercials, then ID, "WRVA 1140 News Talk Radio" into call-in show, received very clear with a three-foot antenna in the basement hooked to an antique Stroberg-Carlson tube-type receiver. (Gillespie, MI)

**1360 WRSR** Binghamton, New York, formerly WKOP, at 1956 with oldies music and "Rockin' Solid Gold" jingle. (Klingman, NY)

Thanks to Dan Gillespie, Gary Jackson, Nile Kelly, Rich Klingman, Sterling Marcher, and Patrick Martin. 73 and good DX! ■

*If you enjoy radio communications you'll love....*

## POPULAR COMMUNICATIONS

**POPULAR COMMUNICATIONS**  
**SAVE UP TO 58%**

Get fast home delivery of  
**Popular Communications** and  
save \$30.93 a year over the newsstand  
price. Save even more on 2 or 3 year subs.



The World's largest, most authoritative  
monthly magazine for Shortwave Listening  
and Scanner Monitoring. Read by more  
active listeners than all other listening  
publications combined!

- 1 year - 12 issues **\$28.95**  
(Save \$30.93)
- 2 years - 24 issues **\$51.95**  
(Save \$67.81)
- 3 years - 36 issues **\$74.95**  
(Save \$104.69)

**SUBSCRIBE TODAY!**

Canada/Mexico—One year \$38.95, two years \$71.95, three years \$104.95;  
Foreign Air Post—one year \$48.95, two years \$91.95, three years \$134.95,  
Payable in US dollars only Note: Allow 6-8 weeks for delivery of first issue.

Mail orders to: **Popular Communications,**  
25 Newbridge Road, Hicksville, NY 11801  
**FAX 516-681-2926**



### Shortwave Relays: Figuring Out Who's On From Where!

**R**elays, relays, relays! It seems as if there's a new one every time you turn on the radio these days! Last month we mentioned that Adventist World Radio is now using Radio Austria International's site at Moosebrunn, beaming to Europe, Africa, Pakistan, and the Middle East over the 300 kW transmitters there. In this instance, though, the total number of relays didn't increase. Moosebrunn replaces AWR's use of Slovakia's site at Rimavska Sabota. And Radio Sweden's recent arrangement, which lets it, be heard over RCI's Sackville site.

The newest such agreement involves USA-based World Beacon, which is now on the air via the United Arab Emirates site near Abu Dhabi. This facility is now being managed by Merlin Communications, so it won't be a surprise if we start hearing other broadcasters using these transmitters in the future. Indeed, we have a log report from Radio Canada International via the UAE! Figuring out what's coming from where is getting more and more complicated — and interesting. So it helps us

to no end if you can mention the relay site in your logs, if there was one.

**Radio Misiones Internacional** (Radio M.I.) was active on 5890 some months ago (probably a year or two the way time flies). Then it vanished. But now it is back, using **5010** (often in upper sideband) operating from 1200 to 0430. It's a religious broadcaster run by IMF World Missions, based in California. There are some English language programs, including one around 0400, which runs up until sign-off time.

Another station, which has been here and gone and repeated the pattern more than once, is the Mexican XERTA. Lately it has been hovering around **4810** but sometimes occupies **4813**, where it is buried under a mountain-sized RTTY signal. The only way we've been able to pick anything out is by using upper sideband and a very narrow filter.

Radio Pyongyang is no more! No, they haven't gone off the air, it's simply one of those name changes stations like to do now and then in an attempt to improve their image or signal some sort of shift in national intentions. Anyway,

you're supposed to refer to it as the **Voice of Korea**. Never mind that the word "North" is missing!

HCJB says it has gotten the first of several OKs they need from the government of Australia towards going on the air from a site at Kunumurra in Western Australia. Signals in your phones from this site are probably a good two years off.

Meantime, **Christian Voice**, via the Darwin, Australia site are scheduled as follows: 0000–0300 on **17775**; 0000–0900 on **21680**, 0700–0900 on **17820**, 0900–1400 on **13775**, 1000–1200 on **17825**, 1200–1700 on **13795**, 1400–1700 on **13730**, 1700–1900 on **11890**, 1700–2100 on **9720** and 2100–0000 on **9865**. All of these are in English, beamed mostly to Asia.

Alan Wiener, former pirate broadcaster and now owner of WBCQ shortwave station in Maine, intends to put a shipboard shortwave station on the air "soon." Plans are for the ship, the M/V Katie, (Belize registry) to tour the east and Gulf coasts this spring and then sail to Belize. The shipboard transmitter will carry programming from WBCQ and other sources.

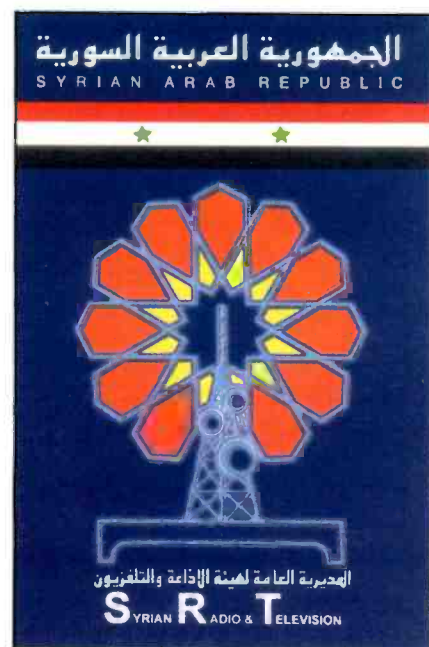
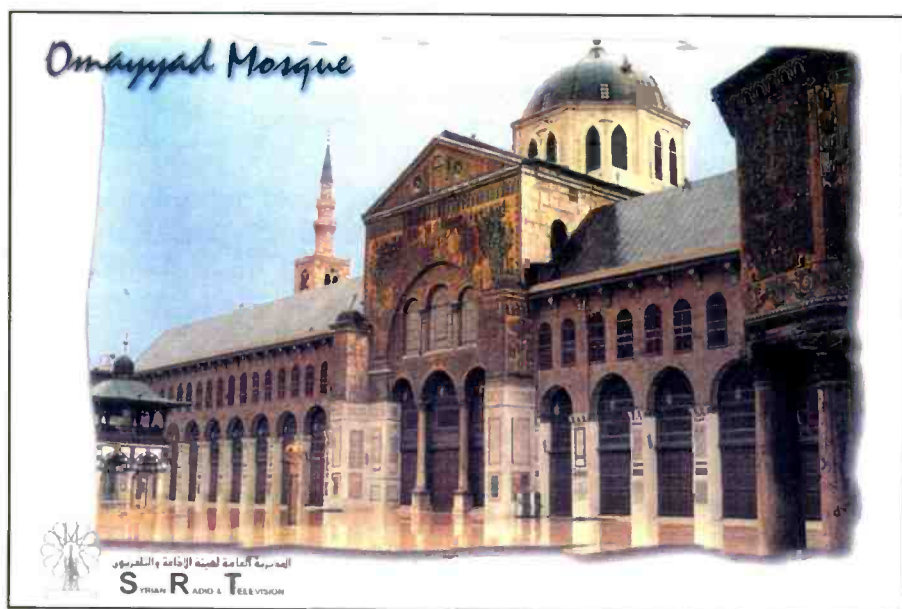

Two beautiful full color QSLs from Syrian Radio-TV. The one with the tower was for reception on 783 kHz mediumwave. (Unidentified contributor)

Shipboard broadcasting has been tried in the past. The only successful attempt we can recall is the Voice of America's "Courier," which did its thing in the Panama Canal Zone and then in Greece several decades ago. Other pirate or semi-legal ventures haven't made it. We'll try and keep you posted on this one.

The winner of this month's book prize is Dave Jeffrey of Niagara Falls, NY, who never misses getting a log report in to us! Thanks for your rock solid support! Dave now owns a copy of *The Shortwave Guide* by Harry Helms, courtesy of Universal Radio. If you don't have a copy of Universal's mammoth catalog on your bookshelf, you certainly should. Everything you could possibly need to further the enjoyment of your hobby is in there. Get a copy by calling Universal at 614-866-4267 or E-mailing dx@universal.com or let the post office deliver your request to: Universal Radio, 6830 Americana Parkway, Reynoldsburg, OH 43068.

Now the other commercial: your short-wave broadcast logs are always sought and always welcome here. Just remember to list your catches by country, double or triple space the logs and add your last name and state abbreviation after each. We're also looking for spare QSL cards we can use as illustrations. Also station schedules, photos — anything along those lines you'd care to lay on us! Thanks for your continued interest and support!

Here are this month's logs. All times are in UTC, which is five hours ahead of EST, i.e. 0000 UTC equals 7 p.m. EST, 6 p.m. CST, 5 p.m. MST, and 4 p.m. PST. Double capital letters are language abbreviations (FF = French, AA = Arabic, SS = Spanish, etc.). If no language abbreviation is included the broadcast is assumed to have been in English.

**ABKHAZI** — Radio Rossi via Abkhazia Radio, **9489.7** at 0255 with time pips. ID in RR, followed by news, then continuous talk with only an occasional song mixed in. RTBF (Belgium) via Julich hits the air at 0357. Must be Abkhazia, not Samara, on this oddball frequency. (D'Angelo, PA)

**ALBANIA** — Radio Tirana, **7270** at 0030 in Albanian. News with music between segments. (Newbury, NE)

**ARMENIA** — Voice of Armenia, **4810** at 0347 with brief talk, continuous vocals until choral vocal (anthem?). ID and News. //9965 was good, while this frequency was poor to fair. (D'Angelo, PA) (*In Armenian?* — Ed.) **9965** at 0403 with choral singing and announcements in presumed Armenian. (Brossell, WI) 2039 in EE with IS, anthem, ID, schedule, news. (Burrow, WA)

#### Abbreviations Used in Listening Post

AA	Arabic
BC	Broadcasting
CC	Chinese
EE	English
FF	French
GG	German
ID	Identification
IS	Interval Signal
JJ	Japanese
mx	Music
NA	North America
nx	News
OM	Male
pgm	Program
PP	Portuguese
RR	Russian
rx	Religion/ious
SA	South America/n
SS	Spanish
UTC	Coordinated Universal Time (ex-GMT)
v	Frequency varies
w/	With
WX	Weather
YL	Female
//	Parallel Frequencies

**ASCENSION ISLAND** — BBC relay, **7105** at 0308 with news of Africa. (Brossell, WI) **15400** at 2000. (Jeffery, NY)

**AUSTRALIA** — Radio Australia, **6020** at 1350 with IS. ID. **9475** at 1230. (Northrup, MO) **6020** at 1317 and **9580** at 1119. (Miller, WA) **9580** at 1320. (Newbury, NE) **11650** at 1250. (Brossell, WI) **15240** at 0000. (Jeffery, NY) **17750** at 0113. (Foss, Philippines)

**AUSTRIA** — Adventist World Radio, via Moosbrunn, **11710** at 0300, listed in Amharic. Sign on at 0300 with multi-lingual IDs, some audio troubles from 0301-0305, then music with occasional child and/or female announcers for a minute or two at a time. (Silvi, OH) Radio Austria Int'l, **17865** via Sackville, Canada, in EE at 1647, //6155, **7235**. (Miller, WA) 1650. (Burrow, WA) 1730. (Barton, AZ)

**BELGIUM** — Radio Vlaanderen Int'l, **13660**, via Madagascar with Radio World at 2231. (Sanchez, NM) (*All references here show Bonaire — Ed.*) RTBF, **17570** via Germany, in FF at 1806 with man and woman presenters, ID and off. (Newbury, NE)

**BOLIVIA** — Radio Paititi, **4681.5** at 2336 with female announcer in SS. Too weak to get an ID. Continuous talks of news, then typical Latin music and possible ID at 2358. (Montgomery, PA) Radio Yura, **4716.7** at 2345 with female in SS with long talks and flute music interludes. Possible ID as "La Voz del Layof" at 2358. (Montgomery, PA)

**BOTSWANA** — Voice of America relay, **7340** at 0259 with IS, ID. (Jeffery, NY) 0318. (Brossell, WI) **9775** at 0420. (Newbury, NE)

**BRAZIL** — Radio Gaucha, Porto Alegre, **11915** at 0022 in PP with music. QRM from HCJB. (Miller, WA) Radio Clube do Para. Belem, **4885** at 0530 in PP with easy listening PP ballads. (Linonis, PA) Radio Nacional da Amazonia, 6180 in PP with local music, phone calls. (Newbury, NE)

**BULGARIA** — Radio Bulgaria, **7400** at 0321 with program on the arts in Bulgarian. (Brossell, WI) 0340 with letters program on a Sunday. (Limbach, PA) **9400** at 0029. (Miller, WA) 0633 in GG. (Becker, WA) 1714 in GG. (Burrow, WA)

**CANADA** — CKZU, relay CBU Vancouver, **6160** at 0620. (Becker, WA) News at 1704. (Miller, WA) CHU time station, **7335** at 1325 with time checks. (Northrup, MO) Radio Monte Carlo relay, **5960** in AA at 0400. (Watts, KY) CBC Northern Service, **9625** with "Northern Lights" music program at 0550. (Limbach, PA) Radio Canada Int'l, **9640** at 1320. (Sanchez, NM) **11850** via South Africa at 0536. (Becker, WA) **11905** at 0519 and **17710** at 1555. (Miller, WA)



Here's a shot of "part of" Rick Barton's shack in Arizona, showing two classic radios — a Zenith Transoceanic sitting on top of one of those great Hammarlund 600 series.



**CHILE** — Voz Cristiana, **9635** in SS at 1131, **21550** in SS at 1808. (Miller, WA) **11690** in SS at 0529. (Smith, WA) **21500** in SS at 1455. (Northrup, MO)

**CHINA** — Central People's Broadcasting Station/China National Radio, **5010** in CC at 1255. //**5030, 5090, 5163**. (Miller, WA) **5030** (tentative) at 1222. (Barton, AZ) **9170** in CC at 1325 and **7620** in CC also at 1325. (Northrup, MO) **9830** in CC at 1320. (Brossell, WI) **11630** from Lingxhi with news in CC from 2145–2200. (Linonis, PA) **11800** in CC at 0052 and **17770** in CC at 0544. (Foss, Philippines) China Radio Int'l. **5990** via Cuba in EE at 2305. **9570** via Cuba at 0120. **9690** via Spain at 0310. (Sanchez, NM) 2335. Also **9855** in CC at 1241. (Jeffery, NY) **9380** in CC at 1320 and **9440** in CC at 1330. (Northrup, MO). **9570** via Cuba at 1315. (Newbury, NE) **15500** via Mali at 2225. (Becker, WA)

**COLOMBIA** — Ecos del Atrato, Quibdo, **5019.7** at 0340 in SS with nonstop news with frequent IDs as "Radionet." (D'Angelo, PA) Caracol Vilavicencio, **5956.4** at 1040 in with LA music. SS DJ chatter. mentions of Caracol and Colombia, phone talk. (Alexander, PA) Radio Nacional, **9635** in SS at 0018 with Latin music. (Miller, WA)

**CONGO** — Radio Congo, **5985** at 2020 with FF ID by woman at 2028, man with various music tunes and into talk. (Montgomery, PA)

**COSTA RICA** — Faro del Caribe, **5054** with news in SS at 2255. (Miller, WA) **5054.9** at 0438 with long talks, easy relaxed music segments until ID by man at 0500, vocals to 0515 and another ID. (D'Angelo, PA) RFPI, new **7450** at 0320. (Jeffery, NY)

**CUBA** — Radio Havana Cuba, **5965** in SS at 0138. **9820** at 0214 (Sanchez, NM) **6000** at 0433. (Weronka, NC) **9550** at 0515. (Limbach, PA) **9820** suddenly off at 0333. Back by 0340. //**6000**. (Smith, WA). 0424. (Newbury, NE) **11705** upper sideband at 0100. //**6000, 9820**. (Watts, KY)

**CYPRUS** — BBC relay on **12095** at 0510. (Becker, WA)

**CZECH REPUBLIC** — Radio Prague, **6200** at 0205 with local features, **11600** at 0434 and off at 0457. (Limbach, PA) **7345** at 0120. (Linonis, PA) **11600** at 0440. (Weronka, PA) **17845** at 1720. Off at 1727. (Burrow, WA) **21745** with Czech poetry at 1425. (Barton, AZ)

**DENMARK** — Radio Denmark, via Norway, **7180** in DD at 0653. (Becker, WA) **9945** at 0333 in DD. (Miller, WA)

**DIEGO GARCIA** — Armed Forces Network, **4319** at 2229 with rock. "You Are Listening to AFN" (canned) IDs at 2235 and 2239. Awful ute QRM. (D'Angelo, PA)

**ECUADOR** — HCJB, **9745** at 0323. (Miller, WA) **0419**. (Newbury, NE) **9745//11840** at 0430. (Smith, WA) **9780** to Europe at 0720. (Barton, AZ) **11840** at 0435. (Limbach, PA) **17660** to India at 2300. (Silvi, OH) Radio Interoceanica, 0300 with SS announcements, light instrumental romantic ballads, commercials, jingles, phone talk. (Alexander, PA) 1006 with instrumental music, announcements, vocals, ID. (Paszkwicz, WI)

**EGYPT** — Radio Cairo, **9855** at 0427 with AA pops. Also **12050** in AA at 2323. (Newbury, NE) **9900** in AA at 0330. (Miller, WA). 0345 with impassioned speech in AA. (Brossell, WI) **2130** in EE with time pips, anthem, ID, news, more IDs. (Burrow, WA) **12050** in AA at 0520. (Becker, WA)

**ENGLAND** — Wales Radio Int'l. **9735** at 0300 with news, features and music. (Jeffery, NY) BBC, **5990** at 1658. **12095** at 2248 and **17840** at 1644. (Miller, WA) **6175** via Canada at 0200. **17840** via Canada at 1819. (Newbury, NE) **6175** via Canada at 0422. **6190** via South Africa at 0420. **11765** via South Africa at 0541. (Becker, WA) **7325** at 0352. (Newbury, NE) **7330** (via Russia, gld) At 1325. (Northrup, MO) **9915** at 1308. **15220** via Antigua at 1252. (Sanchez, NM) **11955** at 0510 and **15360** at 0100. (Limbach, PA)

**ETHIOPIA** — Radio Fana, **6940** with IS at 0329, ID in unid. language under static and fading. (Brossell, WI) 0350 with possible news by woman, short music bit, 0400 ID and continued with long talks. (Montgomery, PA)

**FINLAND** — YLE Radio Finland, **9865** in Finnish to Africa and Middle East at 0548. (Becker, WA) **15400** at 1556 in Finnish with IS. (Miller, WA) **21810** in Finnish at 1600. (Northrup, MO)

**FRANCE** — Radio France Int'l, **7140** via Japan in CC at 1254.

NAVAL MEDIA CENTER  
Mobile Detachment TWO  
2713 Mitscher Road SW  
Naval District Washington Anacostia Annex  
Washington, DC 20373-5819

ARMED FORCES  
Radio  
Television  
SERVICE

March 14, 2001

Robert Brossell

Dear Robert,

This letter serves as confirmation of your January 1, 2001, reception of Armed Forces Radio and Television. The signal originates from Naval Computer and Telecommunications Area Master Station, Key West, Florida at 12689.5 khz and Naval Computer and Telecommunications Station, Puerto Rico at 6458.5 khz.

Naval Computer and Telecommunications Area Master Station, Key West, Florida broadcasts with a 48 foot inverted cone antenna from Boca Chica, Florida with 8 kilowatts of power. Naval Computer and Telecommunications Station, Puerto Rico broadcasts with a ground-based, omnidirectional wire antenna with a 30 foot diameter. The signal is broadcast at 10 kilowatts from Isabela, Puerto Rico.

AFRTS shortwave radio transmissions have historically existed to provide AFRTS radio service to U.S. Navy vessels and outlying military posts receiving limited American radio or television through other means. The signals will be in existence for a limited time until a new technology, which is currently being tested, allows for reception of AFRTS via satellite.

We are pleased that you have received the AFRTS shortwave signal and thank you for your interest and confirmation of the signal's quality.

Sincerely,



Michael Foutch  
Chief Broadcast Operations Specialist

*Robert Brossell in Wisconsin got this letter QSL from AFRTS confirming reception of both Key West and Puerto Rico.*

**9790** in FF at 2137. (Newbury, NE) **11850** (via Gabon) at 0400 with IS, ID in FF, news. (Linonis, PA) **11910** via Gabon in FF at 0405 with talks and high-life music. (Brossell, WI) **12015, 17850 and 21645** all in EE at 1600. **15210** in FF at 1603. (Miller, WA)

**GABON** — Africa Number One, **9580** in FF at 0602. (Miller, WA) **15475** in FF at 1700 with news, ID at 1710. (Burrow, WA)

**GERMANY** — United Methodist Church, via Julich, **15485** to Africa in EE at 1700. **13810** barely audible. (Watts, KY) **15485** at 1808 with news about Africa. (Paszkwicz, WI) (Now calling themselves Radio Africa International. gld) Deutsche Welle, **5905**, via Petropavlovsk-Kamchatka, Russia, in GG at 1040. **17810** via Antigua in GG at 2006. **17860** via Rwanda in GG at 1940. (Sanchez, NM) **6100** in GG at 0428. **7400** via Irkutsk, Russia in GG at 1051. (Becker, WA) **9535** via Canada in GG at 0314. (Miller, WA) **21780** in EE at 1600. (Limbach, PA) **21840** in FF at 1550. (Northrup, MO)

**GHANA** — Radio Ghana, **3285, //3366** at 2245 with EE man announcer with Paul Robson program, ID at 2258 and into country/western program. (Montgomery, PA)

**GREECE** — Voice of Greece, **9375** at 1930 with ID, schedule, news. (Burrow, WA) **9420** at 0558 with IS, woman announcer. **17705** via Delano, CA in Greek at 1924. (Miller, WA) VOA relay, **9760** at 1300. (Newbury, NE) **11865** in AA at 0534. (Becker, WA)

**GUAM** — Adventist World Radio, **15615** at 1100. Listed for Mandarin from 1100–1500, but had EE from tune in to 1300. Gave web site as "http://www.vohc.com" in EE at 1320. Switched to presumed Mandarin at 1328. (Silvi, OH) KTWR/Trans World Radio, **9870** in CC at 1317. (Brossell, WI) **15330** at 0909 with EE religious programming. (Jeffery, NY) 1300, listed as Mandarin to 1330. Swatow 1330–1400 and Cantonese at 1400. Mostly talk with KTWR ID's each half hour. **15395** at 1330 listed as Muslim-Bengali to 1345 and Santhali 1345–1400. Lots of interesting and unusual music. (Silvi, OH)

**GUATEMALA** — Radio Verdad, **4052.5** at 0015 with SS talks, religious music. (Alexander, PA) Radio Cultural, **3300** with SS religious music at 0723. (Miller, WA) Radio Buenas Nuevas, San Sebastian, **4800** in SS at 1220. (Miller, WA)

**GUYANA** — Voice of Guyana, **5948.8** at 0810 with Koran recitations, EE religious talk, Hindi vocals, local music, promos for Guyana rally, mentions of upcoming programs. (Alexander, PA)

**HAWAII** — KWHR, **17780** at 0541 with Bible teaching. (Foss, Philippines) Radio Luz y Vida, **3250** at 1116 with man in EE and woman translating it into SS. (Montgomery, PA) La Voz Evangelica, **4819** (varies to 4822) at 0520 to 0600 with SS sermon and possible Bible study. (Linonis, PA)

**INDIA** — All India Radio, **10330** at 1519 in unid. language. **11620** from Bangalore at 1931 in EE. (Miller, W) **11715** from Aligarh at 2142 with Indian music. (Newbury, NE) **2215** presumed to Europe in EE. (Linonis, PA) **15075** from Bangalore, 0317 in unid. language. (Jeffery, NY) **15140** (Bangalore) with Indian music at 1705, announcements in RR at 1713 and abruptly off at 1715. (Brossell, WI) **15185** (Aligarh) At 0339 in unid. language. (Jeffery, NY)

**INDONESIA** — Voice of Indonesia, **9525** at 2000 with ID, schedule, program notes, news. (Burrow, WA) Radio Republik Indonesia, Jakarta, **15125** at 0554 with pops, man and woman in unid. language. ID 0600. (Foss, Philippines)

**IRAN** — Voice of the Islamic Republic of Iran, **7115** at 1552 with news, comment, ID at 1558, music bridge, more political news. (Burrow, WA) **7270** at 1649 in unid language. (Miller, WA) **15084** with music at 1340. (Northrup, MO) 1705 with conversation between a man and woman in Farsi. (Brossell, WI) **15125** at 0328 in unid. language and **15260** at 0428 in unid. language. (Jeffery, NY)

**IRAQ** — Radio Baghdad, **11784.9** at 0234 with EE news, local music, IDs. Good level but the usual muffled audio. (Alexander, PA) **11785**, variable to **11789** at 0515 in AA with Holy Koran, ID in AA and EE but I couldn't get clear copy. (Linonis, PA)

**ISRAEL** — Kol Israel, **7500/9435** with regional and national news at 0500. (Limbach, PA) **7545** at 0159 with news in HH. **9435** in HH at 0307, 1627 sign-off. (Miller, WA) **7545** in AA at 0551. (Smith, WA) **11585** at 2210 in presumed HH. (Linonis, PA) **11605** at 1655 with IS, time pips. ID, news. (Burrow, WA) 2007 in EE. (Newbury, NE)

**ITALY** — RAE International, **7120** at 0439 ending program with "This is RAI International from Italy," birds IS and off at 0440. (Burrow, WA) **11800** in II at 2235 and **17660** in II at 1722. (Miller, WA)

**JAPAN** — Radio Tampa, **3925** at 0959 with ID, chimes and exuberant woman announcer in JJ. (Smith, WA) 1245 with web address in JJ. (Barton, AZ) Radio Japan/NHK, **6120** via Canada at 1132. **11915** via Gabon in

II to Europe at 0531. (Becker, WA) **6145** via Canada at 0004. **17825** in JJ at 2215. (Sanchez, NM) **11875** in JJ at 2239. (*11870?* — Ed.) **17810** in II at 2256. (Miller, WA) **17685** at 0137. (Foss, Philippines)

**JORDAN** — Radio Jordan, **11690** in EE at 1630 with country-western and contemporary things, news at 1700, ID 1703, more news. (Burrow, WA) **11930** in AA at 1241. (Miller, WA) 2310 in AA. Under Radio Marti. (Newbury, NE)

**KENYA** — Kenya Broadcasting Corp., **4885** at 1241 in unid. language with some sort of lesson. (Miller, WA) (*No way most of us will ever hear this at that hour! It's very rare even in the evening* — Ed.)

**KUWAIT** — Radio Kuwait, **9855** in AA at 2129. (Newbury, NE) **11675** in AA at 0207. (Smith, WA) 0330. (Brossell, WI) 2215. (Linonis, PA) 2231. (Miller, WA) **11990** at 1757 from AA into EE at 1800. (Burrow, WA) **13620** in AA at 1535. (Barton, AZ)

**LESOTHO** — Radio Lesotho, **4800** at 0356 with tribal vocals, talk by man, and ID prior to 2+1 time pips and woman with news. (D'Angelo, PA)

**LIBYA** — Radio Jamahiriya, **17725** in AA at 1632 with very muddled conversation on phone. (Miller, WA) Voice of Africa EE segment at 1734. Back into AA at 1741. (Burrow, WA)

**LITHUANIA** — Radio Vilnius, **9875** (direct) at 0045 with features, ID and off at 0100. (Burrow, WA) 0046 with music and ID in EE. (Jeffery, NY)

**MALAYSIA** — Radio Malaysia, **4895** from Sarawak with news in unid language at 1302. **7295** heard at 1702 with news, "Midnight Magic" music dedication program. (Miller, WA)

**MOROCCO** — Radio Medi-Un, **9575** in AA at 1529 with Arabic music. (Miller, WA)

**MONGOLIA** — Voice of Mongolia, **12015** monitored at 2001 in EE with IS, ID, program notes, feature about the Mongolian New Year. (Burrow, WA)

**MEXICO** — Radio Huayacocotla, **2390** at 0030. Man with news in SS, local music. Off at 0100 after what sounded like the ID at 0056. Difficult copy as it was just above the noise floor. (Montgomery, PA) Radio Educacion, **6185** at 0400 in SS with ID by woman. (Smith, WA) 0850 with classical music. (Newbury, NE) Radio Mexico Int'l, **9705** at 2345-0000 in EE with ID and talk. QSL'd in just 10 days! (Linonis, PA) **11770** at 2303 with EE ID and Internet address. (Newbury, NE)

**NETHERLANDS** — Radio Netherlands, **7375**, via Petropavlovsk-Kamchatka, Russia, in DD at 1330 with news, sports. (Northrup, MO) **9810** via Madagascar in DD at 0328. (Miller, WA) **11655** at 2018. (Newbury, NE)

**NETHERLANDS ANTILLES** — Radio Netherlands relay, **9845** at 0023 in EE. (Newbury, NE) **13700** at 1833. (Jeffery, NY)

**NEW ZEALAND** — Radio New Zealand, **15120** in EE at 1830 with sports program, ID at 1834 and into unid. language. Schedule

shows EE to 1900. Back to EE again at 1844 to 5 o'clock news and extensive weather. More IDs and music/weather. Into unid language at 1855. At 1900 six time pips and ID, news. **17675** not heard. (Montgomery, PA) **17675** at 0031 with classical music. (Foss, Philippines) 0310 with mailbag program. (Jeffery, NY)

**NIGER** — La Voix du Sahel, **5020.5** at 2240 with high life vocals and FF talks to brief ID and flute music, choral anthem at 2300. (D'Angelo, PA)

**NIGERIA** — Voice of Nigeria, **7255** at 0448 with IS, orchestral music. ID "You are listening to the Voice of Nigeria, Lagos." (Burrow, WA) 0500 with IS, ID and various types of African music. Have they quit using the talking drums IS? (Linonis, PA)

**NORTH KOREA** — Voice of Korea, **11710** at 1659 with IS, anthem, march music at 1700. (Brossell, WI) **11735** at 0130 in EE with the usual stuff. (Linonis, PA) 0150 with traditional music, 0156 with schedule, sign-n with ID "This is the Voice of Korea." 1900 in EE with IS, ID, news. (Burrow, WA) **13760** at 1500. **6575**, **9335** and **11710** not audible. (Silvi, OH)

**NORTHERN MARIANAS** — VOA Tinian relay, **11995** at 0804. (Paszkievicz, WI) Far East Broadcasting Co., /KFBS on **9465** at 1603 in unid. language with religious music. (Miller, WA) 11580 in CC. 1255 an Internet address, ID, religious music. (Brossell, WI)

**NORWAY** — Radio Norway, **7465** at 0300 with EE news. (Miller, WA) (*Sunday, UTC* — Ed.) 0320 in NN. (Brossell, WI)

**OMAN** — Radio Sultanate of Oman, **15140**, 1400-1500 in EE with variety of US and local pops. News at 1430, ID, woman anncr. Poor under HCJB. (Alexander, PA) Heard immediately after All India Radio signed off at 1715. (Brossell, WI) BBC relay, **15310** at 0645. (Foss, Philippines)

**PAKISTAN** — **4890** at 0000 with female anncr in Arabic with prayers, then to long talks as possible news. Tentative ID, **15100.1** at 1600 with EE IDs by woman at 1602 and 1604. Very poor modulation. ID again at 1608, headline reviews. Off at 1614. (Montgomery, PA) **11570//115100** in EE at 1600 with IS, ID, time pips, news. (Burrow, WA) **15175** at 0655 with very exotic sounding music. (Foss, Philippines)

**PAPUA NEW GUINEA** — **4890** in EE with pops monitored at 1243. (Miller, WA)

**PARAGUAY** — Radio Nacional, **9737v**, 0243 to 0259 close. Talks and news features with remote reports, etc. ID and TC at 0252 with long sign off announcements beginning at 0255, followed by national anthem. (D'Angelo, PA) 2349 in SS. (Miller, WA)

**PERU** — Radio Andina, **6673.6**, Huancabamba, 0040 with SS announcements, ID, OA music. (Alexander, PA) Radio Sicuani, Sicuani, **4826.4** at 1023 with SS announcements, vocals, possible ID, time check, jingle. (Paszkievicz, WI)



**PHILIPPINES** — Radio Pilipinas, **15190** at 1858 with "Philippines Today." ID at 1906 and into business report. (Burrow, WA) **1920** with continuous vocals until full ID and sign-off at 1930. (D'Angelo, PA) Far East Broadcasting Company, **12065** at 2246 with religious program in unid. language. (Miller, WA) VOA relay, **6110** at 1113. (Becker, WA) **1310**. (Newbury, NE) **11705** at 1226. (Jeffery, NY) **11715** at 1250. (Brossell, WI)

**PORTUGAL** — RDP International, **11675** at 0741 in PP beamed to ECNA. News in PP at 0730. (Becker, WA) **12076** at 0215 to 0300 close. PP talks, instrumental music, ID, off with anthem. Fair level. Clean audio with no distortion in FM mode. (Alexander, PA) **17745** in PP at 1635, // **21655**, **21800**. (Miller, WA) 1920 with live sports coverage. (Sanchez, NM)

**PUERTO RICO** — AFN, **6458.5** USB at 0202 with live sports. (Jeffery, NY)

**QATAR** — (presumed). Qatar Broadcasting Service, **7210** at 0304 in AA with recitations. (Jeffery, NY)

**ROMANIA** — Radio Romania Int'l, **9665** at 0430 in EE with letters. (Limbach, PA) **11740** at 1658 with IS, ID and news. (Burrow, WA) **11940** at 0215 with "Cards on the Table." (Weronka, NC) Radio Studio, **6235** at 2121 in RR with U.S. pops. IDs in several languages and finally at 2130 gave it as "Radio Studio. St. Petersburg, Russia" with E-mail studiosw@metroclub.ru and postal addresses. Several IDs before that. The first sounded like Radio Padanica, which was repeated a number of times, then changed to Radio Volla and repeated several times, then to Radio Gardarika. Similar routine the next night. (Montgomery, PA) Radio Yuzhno-Sakhalinsk, **11840** at 0717 with Radio Rossii relay. // **9860** and another possible parallel on **9530**. (Becker, WA) Radio Magadan, **7320** with Radio Rossii relay in RR at 0644. **9530** at 0623 in RR. Also heard on another day at 0700 with IS. ID "Radio Magadan ... programa Radio Rossii." **9860** in RR at 0717, // **9530**. (Becker, WA) Radio Rossii, **9860** at 0549. This is their overseas service in RR to Europe and ECNA from Moscow. Some QRM from Finland. (Becker, WA) Voice of Russia, **6145** from Kharbarovsk in CC at 1129. **12020** from Petropavlovsk, **15445** from Kharbarovsk and **15595** from Komsomolsk, // **17595** Petropavlovsk-Kamchatka. All around 0520. (Becker, WA) **6270** at 0220. (Weronka, NC) **7180** from Moldova at 0300. (Sanchez, NM) **0440**. (Limbach, PA) **1705**. (Miller, WA)

**RWANDA** — Deutsche Welle relay, **17860** in GG monitored at 2212. (Becker, WA)

**SAO TOME** — VOA relay, **7290** at 0345. (Newbury, NE) **13600** at 1616. (Barton, AZ)

**SAUDI ARABIA** — Broadcasting Service of the Kingdom, **9870** in AA at 2132. (Newbury, NE) **15170**//**15275** at 0417 in AA with recitations, talk by man. (Jeffery, NY) **15205** with Holy Koran at 1717. (Brossell, WI) **17560** at 1721. (Miller, WA)

**SEYCHELLES** — Far East Broadcasting Assn., **11885** at 0130 in possible SS. Lots of fading but heard an ID. (Linonis, PA) BBC relay, **11730** at 0345. (Brossell, WI) **15420** at 0541. (Jeffery, NY)

**SINGAPORE** — BBC relay, **7160** at 1708. (Miller, WA) **11955** at 2314. (Newbury, NE) **15310** at 0254. **15360** at 0548. (Foss, Philippines)

**SOUTH AFRICA** — Channel Africa, **9525** at 0427 with IDs in FF/EE and into FF. (Limbach, PA) **17870** at 1700 with time pips, news. BBC in background. (Miller, WA) 1728 with sports, ID, ID in possible Afrikaans and into news. (Burrow, WA) BBC relay, **3255** at 0410. (Montgomery, PA) Africa World Beacon, **11640** at 2016 with a shoutin' preacher. (Newbury, NE) Adventist World Radio, **11970** at 0525 in presumed Yoruba. Address for something in Lagos, Nigeria. ID in EE, FF and other languages, then off. (Becker, WA)

**SOUTH KOREA** — Radio Korea Int'l, **9515** via Canada at 1615 with "Shortwave Feedback." (Linonis, PA) **9650** via Canada at 1139. (Miller, WA) **1148**. (Becker, WA) **15575** at 0226. (Jeffery, NY) **0231**. (Foss, Philippines)

**SPAIN** — Radio Exterior de Espana, **6055** in EE at 0140. **17850** (via Costa Rica) in SS at 2013. **21700** in SS at 2002 (Sanchez, NM) **11815** (via Costa Rica) in SS at 0105. (Smith, WA) **15170** via Costa Rica in SS at 1305. (Brossell, WI) **21610** in SS at 1814. (Miller, WA)

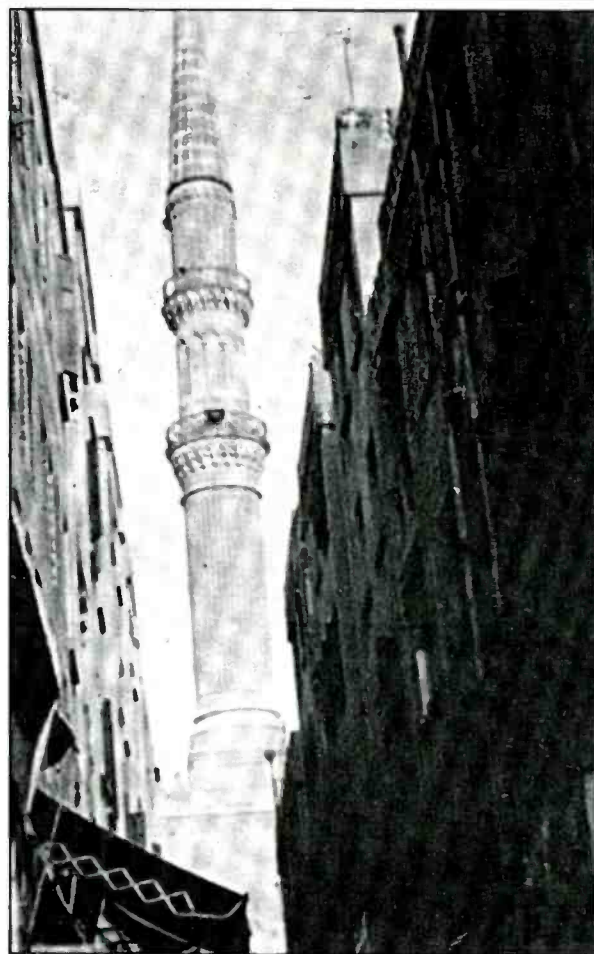

*A black and white view of a scene in Cairo decorates the face of this 1985 QSL from Radio Cairo, courtesy of Jack Linonis, PA.*

**SRI LANKA** — Sri Lanka Broadcasting Corp., **15425** at 0210 with male announcer introducing the next tune, by Willie Nelson (eek! gld). Tune ended, next one started. I listened until the 8th tune and gave up. Apparently the announcer put on a Willie Nelson album and went out to breakfast. (Montgomery, PA) VOA relay, **15250** at 0230. (Newbury, NE) **15265** at 1617. (Miller, WA)

**SURINAME** — Radio Apintie, **4990.9** at 0413 with "Car Wash" and other memorable songs until promo announcement that included an ID at 0432. (D'Angelo, PA)

**SWEDEN** — Radio Sweden, **9495** at 0130. (Linonis, PA) Here and // **9560** via Canada, at 0230 with "60 Degrees North." (Jeffery, NY)

**SWITZERLAND** — Swiss Radio International, **9905** (via French Guiana) at 0137. (Sanchez, NM) **9905**//**9885** at 0440. (Limbach, PA) **0331** in GG. Also **12010** via Singapore in FF at 1536. (Miller, WA) **13790** (via Germany) // **15555** (direct!) at 1732. Slight delay between frequencies, with 15555 ahead. (Burrow, WA)

**SWAZILAND** — Trans World Radio, **9500** at 1802 with news with occasional interludes of music between items. ID by woman at 1816, then by man with program change at 1818. Suddenly off at 1827. Scheduled to 1900. (Montgomery, PA)

**SYRIA** — Radio Damascus, **12085** at 2005 with music, IDs at 2008 and 2011. (Burrow, WA)

**TAIWAN** — Radio Taipei Int'l, **5950** via WYFR at 0357 in EE. Into CC at 0400. (Limbach, PA) **9590**//**9680** at 0200. (Sanchez, NM) **9610** at 1321 in Asian language. (Newbury, NE) **11745** in CC at 1245. (Brossell, WI) **11825** via WYFR in CC at 0141. (Foss, Philippines) Central Broadcasting System, **9365** in CC at 1400. (Northrup, MO)

**THAILAND** — Radio Thailand, **7285** at 1102 with EE ID and into VV. (Becker, WA) **9535** to Europe at 1900 with ID, news. (Burrow,



Here's Wisconsin's Robert Brossell in his listening post. The receiver is a JRC-NRD 535. In addition to his prowess as a DXer, Bob's taste in magazines is also first rate!

WA) 9810 at 1242 with news, "That's the national news from Radio Thailand." (Brossell, WI) 1250. (Barton, AZ) 13695 at 0045-0100 in EE. (Linonis, PA) BBC relay, 15280 at 0347. (Foss, Philippines)

**TIBET** — Xizang PBS, 5950 in unid. language at 0940. (Miller, WA) 6200 with 0900 sign-on, anthem, talks in Asian language. (Newbury, NE)

**TURKEY** — Voice of Turkey, 7300 at 0326. (Newbury, NE) 9445 in TT at 2325. 9460 in TT at 0309. (Miller, WA) 9665 in EE at 0418. (Limbach, PA) 0443. (Burrow, WA)

**TUNISIA** — RTT Tunisienne, 7275, AA music monitored at 0649. (Becker, WA)

**UKRAINE** — Radio Ukraine Int'l, 9385 at 0433 with IDs at 0438 and 0443. (Burrow, WA) 9560 at 2200-2300 with EE news, //5905. (Alexander, PA)

**UNITED ARAB EMIRATES** — Radio Canada Relay, 17820 with EE scheduled from 1800-1900. //21570 via Rampisham (England) not as strong. (Silvi, OH) UAE Radio, Dubai, 13675 at 1630 in EE with music, ID, news. EE ended 1635 and into AA. (Burrow, WA) 21605 at 1600 in EE. (Linonis, PA)

**UZBEKISTAN** — Radio Tashkent, 7215 at 0100 sign-on with IS, ID, news, local folk music. Much better in //7105. (Alexander, PA)

**VATICAN CITY** — Vatican Radio, 6205 at 2157 sign on with IS, into CC at 2200. Site listed as Khabarovsk, Russia. (Alexander, PA) 9605 at 0303 in EE. (Weronka, NC) 15570 at 1622 in unid. language. (Miller, WA)

**VENEZUELA** — Ecos del Torbes, San Cristobal, 4980, 0115 in SS with Latin music. (Linonis, PA) 0250. (Miller, WA) (This one has become operationally spotty — Ed.)

**VIETNAM** — Voice of Vietnam, 9730 at 1808 with ID and news. (Miller, WA) 9795 (via Canada) at 0325. (Miller, WA) 0355. (Weronka, NC)

**YEMEN** — Republic of Yemen Radio,

9779.6 at 1756 in EE with IS, anthem, schedule, ID and into news. (Burrow, WA)

**ZAMBIA** — Christian Voice, 4965 at 0115 to 0259 close. Contemporary Christian music, brief EE religious messages. ID 0217. (Alexander, PA)

And that, friends, is it! Sound all the trumpets there are in a salute to the following who took the time and effort to report all the above goodies: Marty Sanchez, Rio-Rancho, NM; Robert Brossell, Pewaukee, WI; Mark Northrup, Gladstone, MO; Pete Becker, Clarkson, WA; Bruce R. Burrow,

Snoqualmie, WA; R.C. Watts, Louisville, KY; Marty Foss, Guinayangan, Philippines; Lee Silvi, Mentor, OH; Dave Jeffery, Niagara Falls, NY; Brian Alexander, Mechanicsburg, PA; David Weronka, Benson, NC; Richard D'Angelo, Wyomissing, PA; Mike Miller, Issaquah, WA; Ed Newbury, Kimball, NE; Adam Smith; Sheryl Paszkiewicz, Manitowoc, WI; Jack Linonis, Hermitage, PA; Rick Barton, Phoenix, AZ, and Brian Limbach, Pittsburgh, PA. Thanks to each one of you!

Until next month, good listening! ■

When seconds count,  
**REACT**  
needs you....



...to summon for help for an injured motorist, an elderly woman trapped in a fire, a trucker stranded in a blizzard, a drowning child!



As a REACT volunteer radio monitor, you may be the only communication life-line for someone in serious trouble. You relay messages from those desperate for help to police, fire, or emergency services.

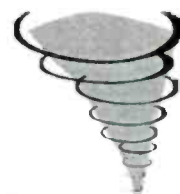

Your REACT team may also use CB, GMRS, Amateur, and other radio services to provide safety communications for events like parades, marathons, and even balloon races. The fellowship with other REACT members at team meetings and annual conventions is an added bonus, as is help with licensing, equipment advice, and radio training.

*"The mission of REACT International is to provide public safety communications to individuals, organizations, and government agencies to save lives, prevent injuries, and give assistance wherever and whenever needed. We will strive to establish a monitoring network of trained volunteer citizen-based communicators using any and all available means to deliver the message."*

Add a new, exciting challenge to your life.  
Volunteer. Help save lives and property,  
**JOIN TODAY!**

**REACT INTERNATIONAL, INC.**

Phone (301) 316-2900

Fax (301) 316-2903

Web: [www.reactintl.org](http://www.reactintl.org)  
5210 Auth Road, Suite 403  
Suitland, MD 20746



• PROUD RECIPIENT OF THE PRESIDENT'S VOLUNTEER ACTION AWARD •

**RADIO EMERGENCY ASSOCIATED COMMUNICATIONS TEAM**



## Old Meets New On The Internet



Post-modern radio for the new millennium.

**W**ABY.COM. "Post Modern Radio for the New Millennium" — I'm not sure how the folks at waby.com define that phrase but to me, it means, if you like great music, you'll LOVE this one-of-a-kind Internet radio station. You'll also notice something strange; the total absence of format boundaries normally imposed by traditional broadcasters on their stations and listeners. At waby.com, artists cover a range of styles that transcend conventional format limits. Combined, they create a listening experience you won't find anywhere else on the radio — or online for that matter. And, that's just the live broadcasting part. Visit their "on demand" Specialty Programs section and enjoy over 40 hours of original programming that includes: Sid Mark's Sounds of Sinatra, The Bill Miller Show (America's favorite nostalgia radio show), Totally Broadway (Classics from 30 Broadway shows), Jukebox Down Low (Country Standards), Ella Fitzgerald, George Gershwin music, Nat King Cole, sounds of Cole Porter, Swing, New Dogs Old Tricks (Contemporary artists performing the standards) and Come Softly (Great Love Songs). Super programming and excellent audio quality are yours for the listening at waby.com. Don't miss it at <http://www.waby.com/>.

### CNN On The Web

CNN.COM/AUDIO — On Demand! Cable News Network needs no introduction, but did you know about their "on demand" audio page? If not, you've been missing an impressive streaming audio resource. Start off with "Top Stories" — a digest of the day's top stories updated by CNN Radio every



Check out CNN's impressive streaming audio resource!

30 minutes, 24 hours a day. Then select from a myriad of other topics including: Sports, Money, Business, Health, Entertainment, Computer Technology, Science and Technology, Environmental issues, and much more. If you can't get to a TV, just move over to the Live Networks side of the page and listen to the same CNN programming currently being aired. Select from CNN, Headline News, CNN Sports Illustrated, CNN International and CNN en Español. Visit and bookmark: <http://www.CNN.com/audio/>.

### International Broadcasting

Radio Free Europe/Radio Liberty is a private, international communications service to Eastern Europe and Southeastern Europe, Russia, the Caucasus, Central Asia, and the Middle East, funded by the U.S. Congress. In the broadcast region,



Hear "native language" broadcasts from these countries.



Stay ahead of the streaming media curve at this awesome resource!

RFE/RL radio programs reach 35 million listeners who rely on RFE/RL's daily news, analysis, and current affairs programming to provide a coherent, objective account of events in their region and the world. Concentrating on events within this region, RFE/RL provides information to bolster democratic development and market economies in countries where peaceful evolution to civil societies is of vital national interest to the United States. RFE/RL, with over 1,000 freelance reporters, operates one of the most comprehensive news operations in the region, with 24 bureaus spanning 11 time zones of Central and Eastern Europe and the former Soviet Union. RFE/RL broadcasts over 800 hours a week from its operations center, located in Prague, the Czech Republic. Its multilingual website features both audio and text formats. Be sure to visit RFE/RL's home page for com-

plete information and news including standard SW broadcast frequencies and schedules. They're at <http://www.rferl.org/realaudio/>.

## Streaming Media

If your interest in streaming media is more than casual and/or you're considering implementing streaming media on your website, Streamingmedia.com is for you. It's the #1 online resource for professionals seeking industry news, information, articles, directories, and services. The site features thousands of original articles, hundreds of hours of audio/video content, weekly newsletters read by over 100,000 subscribers, and a wide range of services and resources dedicated to the streaming media industry. The site is simply <http://www.streamingmedia.com/>.

## TechTV

TechTV is an on-air and online network dedicated to the digital lifestyle, based on the premise that high tech doesn't have to be hard. TechTV helps viewers (and website visitors) improve their computer knowledge and participate more fully in the digital age. Via television, new users are introduced to the ways computers, the Internet, and other digital wonders can help them at work and at home. By expanding on the television shows' content with additional information and resources, TechTV.com substantially enhances their traditional broadcasting model. If your interest is sparked by something you see on television, you can easily find out more about it on their audio and video rich site. To that end, you'll find stories, features, links to other resources and more at TechTV.com. Whether you start at their homepage,

# GET ON THE *MT EXPRESS*

## Monitoring Times is Now On Line!

Now-Receive your subscription to *Monitoring Times* with no delays due to mailing, no lost or torn copies. Be the first to receive breaking news from the frontier of communications!

For less than the cost of a subscription in the U.S., you can be reading the entire *Monitoring Times* magazine anywhere in the world before U.S. subscribers receive their printed copies! Active utilities loggings, world hotbed frequencies, international broadcasting schedule changes, new product announcements! This is the exact same magazine that has gained a worldwide reputation for reliable radio information that's easy to understand, and products and projects of proven value.

For a mere \$19.95 U.S., *MT Express* gives you *Monitoring Times* magazine

- in PDF format viewable with free software
- delivered by FTP (10 MB file)
- viewable in brilliant color on your computer screen
- easily navigated by clicking on the Table of Contents
- printable using your own computer printer
- searchable to find every mention of a topic or station schedule
- compatible with software to convert text to audio for sight impaired listeners

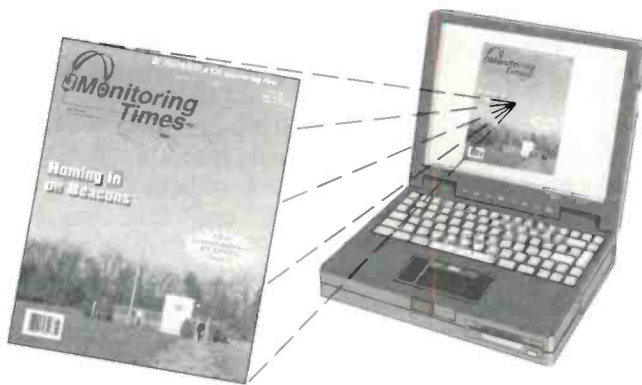

To find out if this new subscription is the delivery solution for you, you may download the August 1999 issue for free! Just go to <http://www.grove-ent.com> to find out how.

One year subscription to *MT Express*—only \$19.95 U.S., or for even greater savings, \$11 in addition to your printed subscription of \$24.95 in the U.S. Mastercard, Visa and DiscoverCard accepted. All payments must be in US funds drawn on a US bank.

**ORDER NOW BY CALLING TOLL-FREE (800) 438-8155, OR E-MAIL [order@grove-ent.com](mailto:order@grove-ent.com)**





The on-air and online network that makes high tech easy.

with the “best of today’s content” or go directly to the pages for each television show, you’ll find TechTV.com high on quality content, easily navigated and a resource you’ll visit often. Check ‘em out! Visit TechTV at <http://www.techtv.com/news/>.

### Car Talk

“Cartalk.com is the Web site of Car Talk, starring Tom and Ray Magliozzi (a.k.a “Click and Clack The Tappet Brothers”). They have a weekly show on 450 National Public Radio sta-



Listen to America’s funniest auto mechanics.

tions, and a newspaper column in 300 papers. They’ve been described as America’s funniest auto mechanics — “the Marx Brothers meet Mr. Goodwrench.” They’ve been featured on ABC’s 20-20, CBS News “60 Minutes,” and lots of other programs with numbers in their titles. And, aside from being amateur comedians, they really know cars. The URL below will take you to Cartalk’s “Radio” show but be sure to visit the other sections of the site to find out more about these M.I.T.-educated grease monkeys and other (serious) auto-related material. Visit <http://cartalk.cars.com/radio/>.

### Like Television — Broadband Media Network

“LikeTelevision — The Broadband Media Network, is a recognized leader in delivering video applications over public (Internet) and private networks. In 1999, the company developed the IGS process, which creates high-quality video files at very-low data rates. To demonstrate their technology, the company created LikeTelevision.com, a web site with thousands of



Streaming video at its best — You’ll find thousands of videos available on demand at this site!



### Need Media Players?

REALPLAYER 8 BASICÆ  
<http://www.real.com>

WINDOWS MEDIA PLAYERÆ  
<http://www.microsoft.com/downloads/>

APPLE’S QUICK TIME PLAYER  
<http://www.apple.com/quicktime/download/>

WINAMPÆ  
<http://www.winamp.com/>

Get your player(s) or upgrades/updates at the URLs above.

videos clips encoded using the IGS process.” Their huge library (of mostly vintage material) is well organized, fast, and easy to navigate. Over a terabyte of classic television, movies, cartoons, music videos, vintage commercials, sci-fi, and comedy await your mouse click. It’s a nice diversion from regular TV and provides an insight into the evolution of “streaming” technology. While designed primarily for folks with broadband Internet access, (Cable, DSL, etc.) slideshow presentations are available for those with normal modem dial-up capabilities. Take a peek at <http://tesla.liketelevision.com/>.

Well, that’s it for this month. If you have a favorite streaming media resource, or possibly looking for one, be sure to let me know about it. Chances are that other *Popular Communications* readers will be interested too. Until we meet again, happy listening and viewing. ■

### Nassau County PD Asks To Use Ch. 19 TV Frequencies

The Nassau County, New York Police Department has filed an application and request for waiver asking to utilize frequencies allocated to television Channel 19, located between 500–506 MHz. NCPD claims that Channel 19 cannot be used for television station broadcasts in the New York metropolitan area due to existing digital TV allocations in New Hampshire on Channel 18, a television station on Channel 20 in Waterbury, Connecticut, and public safety agencies using Channel 19 in northern New Jersey. They further assert that these frequencies can be used to alleviate a serious radio spectrum shortage and congestion of NCPD's existing voice radio system. NCPD is asking for waiver of the Commissions Rules, 47 C.F.R., Sections 90.303, 90.307, and 90.311, and any other rules as needed. The FCC will grant such waivers only if it determines that no other spectrum allocated for public safety use is available, there will be no harmful interference with other spectrum users, public safety use of the frequencies is consistent with other public safety spectrum allocations in the geographic area, the unassigned frequencies were allocated for their present use not less than two years prior to the grant of the application at issue, and the grant of the application is consistent with the public interest.

#### ARRL: Let's Expand Amateur 216–220 MHz For Full Access

The ARRL is asking the FCC to expand the secondary amateur allocation at 219–220 MHz to provide hams with access to the entire 216–220 MHz band. This request is in response to a Notice of Proposed Rule Making (ET Docket 00-221) proposing to reallocate 27 MHz of spectrum, including 216–220 MHz, from government to non-government use. 219–220 MHz, in limited use by amateurs for point-to-point digital messaging, is already secondary to the Automated Maritime Telecommunications System (AMTS). Though the FCC says it will protect AMTS from interference, it failed to assure hams of protection in the 219–220 MHz slice of spectrum. The ARRL has "expressed fears that additional co-primary users will essentially foreclose what limited opportunities there are now for amateurs to make use of the 219–220 MHz segment." One means of accommodating amateur operations would be to open up the entire 216–220 MHz band for ham use on a non-interference basis.

#### L.A. County 2.4 GHz Application Denied

The FCC has denied an application from the County of Los Angeles, California, for an experimental license permitting airborne microwave TV downlinks (TVDL) in the 2402–2448 MHz frequency range. An experimental license to operate TV downlink in the same band by the City of Los Angeles was also denied. The ARRL, AMSAT, and others had filed formal objections to these permits, calling them a "foot in the door" toward a permanent residence in the 2.4 GHz band, which also contains an Amateur primary domestic allocation at 2402–2417 MHz and a secondary allocation in the rest of the affected band. Though

the County and City of Los Angeles already have authorization to operate in the 2.450–2.483.5 GHz band under Part 90 rules, they were seeking an experimental TVDL authorization due to coordination and interference problems.

#### Indiana Antenna Bill Dead; Nevada Bill Still Breathing

Across the nation the current legislative session is ripe with proposed antenna bills. Amateur radio operators in Nevada are pushing for PRB-1 preemptions and the Nevada Assembly's Government Affairs Committee heard testimony on Assembly Bill 61, where almost no opposition to the three sections of the bill relating to ham radio were encountered. AB 61, introduced by Assemblyman Bob Beers, WB7EHN, would require municipal ordinances to "reasonably accommodate amateur service communications" and "constitute the minimum level of regulation practicable to carry out the legitimate purpose of the governing body." Section 3 of the bill — which did raise some concern — would make void and unenforceable any provision in a deed covenant, restriction or condition precluding amateur service communications or which unreasonably restricts the placement, screening or height of a station antenna structure in any way that would diminish performance. A sub-committee will be formed to resolve Section 3 issues. For more information visit [www.cvrc.net/AB61/](http://www.cvrc.net/AB61/).

Unfortunately, a similar bill in Indiana has failed to survive the General Assembly session. SB 331 died in the middle of its third reading in the state senate. It may be resurrected in the next session, however, according to ARRL State Government Liaison Dennis Gilbey, K9JZZ. Though SB 331 seeks to incorporate the majority of PRB-1 into state law, it also seeks to prohibit cities from restricting ham antennas of less than 75 feet above ground level (AGL). Though ten states have already incorporated PRB-1 into their laws, only three include minimum regulatory height limits — Oregon, Virginia, and Wyoming.

#### CB 155-Mile Limit Challenge

Former Washington Beat editor Alan Dixon reports that the FCC has finally responded to their error regarding his petition for reconsideration on the 11-meter Citizen's Band 155-mile distance limitation. RM-9807, filed by Dixon, was turned down last year, but his petition for clarification and partial reconsideration has been lost in limbo since its submission on September 19, 2000. Finally, the FCC responded, saying "we anticipate issuing a public notice for your petition in the very near future. The public notice will be published in the Federal Register establishing the filing cycle for interested parties to address your petition." The notice was published on April 2, 2001, and lasted for 25 days. Dixon said that the "petition for reconsideration seeks only to permit emergency 27 MHz CB communications beyond 155 miles. For the many of us who monitor the CB airwaves, there needs to be no doubt that we can respond on the air to calls for assistance from distant stations." ■



## Classified Satellite Found By Monitors

**O**K, first things first. In our first column in the May issue of *Pop'Comm* we stated the NASA ER-2 aircraft climbed at a rate of "6,000 feet per second." Of course that's incorrect, it should have been 6,000 feet per *minute*. Now back to your regularly scheduled column.

In October 1999 Ivan Artner of Hungry reported through an Internet E-mail group called **Hearsat** reception of radio signals from an unidentified satellite on **258.15 MHz NFM** mode. After careful analysis of the signal and orbital period of the object, members of HearSat believe they have identified the satellite as "USA 81" (catalog #21949). This satellite is believed to be part of a trio that includes USA 32 and USA 45. These three satellites were launched by the U.S. military in the late '80s early '90s for as a Space Based Wide Area Satellite Surveillance program. U.S. Space Command and the North American Aerospace Defense Command (NORAD), who have the job of tracking everything in earth orbit, do not release orbital information for these three satellites, which suggest that USA 81 is still engaged in a classified mission. It's unclear if USA 45 is still in orbit. However, USA 32 is still orbiting, but may not be active. It does not appear to be using the same frequency as USA 81. But with a little help from satellite observers monitoring the night skies, the amateur community has compiled their own set of two-line orbital elements for USA 81. This data can be saved as a text file and loaded into a satellite tracking program to display the position of USA 81 as it orbits the earth.

Here are the latest available USA 81 two-line orbital elements from amateur satellite observer Mike McCants; USA 81 258.155N1 21949U 92023A 01020.72516086 0.00000250 00000-0 97147-4 0 012 21949 85.0050 16.9707 0003000 61.8275 298.1724 14.29955569 05

HearSat member John David Corby (located in Canada, 43.89 degrees North/80 degrees West) reports the signal appears consistently with every pass of USA 81. The center frequency is 258.155 MHz and can be heard clearly using narrowband FM mode (NFM). Corby used a simple dipole connected directly to a handheld receiver to monitor the satellite's passes. He reports receiving maximum signal strength on his S-meter indoors. The signal sounds like high-speed data.

"One interesting note is that over several passes that I have monitored, the signal stops suddenly just south of my QTH (near Toronto, Canada) on northbound passes," Corby said in an E-mail to the HearSat group. "This happens while the signal is very strong and the satellite's position is high in my sky. This may indicate that it has completed its downlink to its ground station in the United States. If my latitude and longitude represents the limit of the controlling ground station's range to the satellite, I surmise that it is controlled from a base on or near the U.S. west coast or southwest," he said.

Satellite monitors on the U.S. west coast confirmed the USA 81 signal using an AOR-3000 receiver working a five element Yagi cut to 260 MHz used also for UHF Follow-On satellite

NASA Shuttle Training Aircraft arrives at Shuttle Landing Facility, Fla. (Photo: NASA).



monitoring. Monitors are guessing USA 81 is using PSK modulation. USA 81 was launched April 25, 1992 aboard a Titan II rocket from Vandenberg Air Force, Calif. Any corroborating reports from elsewhere in the world would be appreciated.

Disclaimer: HearSat is only interested in amateur monitoring of radio signals from Earth-orbiting space vehicles. HearSat is not interested in, nor attempting to compromise the security of any space mission — John David Corby, Hearsat.

## New NASA Aircraft

NASA's Johnson Space Center plans to purchase three replacement Gulfstream G-1159 (G-II) aircraft, according to sources within the agency. These three G-II aircraft will serve as replacement aircraft for the aging fleet of Shuttle Training Aircraft (STA). The STAs are highly modified G-II aircraft used to train astronauts in the landing phase of the space shuttle orbiter. NASA currently has two STAs (radio call signs NASA944 and NASA947).

NASA requires that the replacement aircraft shall not have more than 12,000 airframe hours and not involved in any accident or undergone significant structural repairs. Unconfirmed reports indicate two of these new STAs will receive tail numbers 945 and 948.

In other related news, NASA plans to renew their lease of approximately 47,000 square feet of hangar and support space at 8101 and 8102 Boeing, El Paso International Airport, Texas. Approximately 20,000 sq. ft requires a minimum ceiling height of 35 ft to handle NASA-owned Grumman Gulfstream II aircraft and other aircraft operations. NASA intends to lease the hangars from the City of El Paso, El Paso International Airport, Texas.

## International Space Station Packet Radio Report

David Bate of Canada reports reception of amateur radio packet transmissions from the International Space Station (ISS);



An artist's rendition of a communications relay satellite (Photo: National Reconnaissance Office).

## High-Performance SWL Antennas

The award-winning Eavesdropper™ antennas include our Zap Trapper™ Electronic Gas Tube Lightning Arrestors. Receive-only design shunts damaging transients to ground at only 1/7th the voltage buildup as compared to the commonly available 200 watt transmit-type arrestors, providing maximum solid state receiver protection. Protect your investment—combine an excellent shortwave receiving antenna with the best receiver protection money can buy.



- Completely assembled and ready to use
- 8 trap circuits for 11-90 meter coverage.
- All connections soldered and enclosed in ultrasonically-welded, hermetically-sealed trap covers

- Only 42' overall length
- Includes 50' of 450 lb. test nylon rope
- Quick-acting transient suppression

Model C includes weatherproofed center connector for your coax & coax sealant

Model T includes 100' twinlead feedline

Model Sloper—End fed, coil-loaded, includes Zap Trapper™, 67 ft. length

Either model, \$89.95 ea. Please add \$6.00 for UPS shipment to lower 48 states. COD add an additional \$5.00. Illinois residents add 8.25% sales tax. Foreign shipping quoted.

### Antenna Supermarket

P.O. Box 563 Palatine, IL 60078 Tel (847) 359-7092 Fax (847) 359-8161

At your dealer or direct • Visa & Mastercard accepted

Packet via ISS (NOCALL) at 2345-2355

2:Fm N1QAG To CQ Via NOCALL\* [23:49:17]

1:Fm N1QAG To CQ Via NOCALL\* [23:49:17]

1:Fm W4SV To CQ Via NOCALL\* [23:49:30]

2:Fm W4SV To CQ Via NOCALL\* [23:49:30]

2:Fm N2QBR To CQ Via NOCALL\* [23:49:46]

hi n1qag

1:Fm N2QBR To CQ Via NOCALL\* [23:49:46]

hi n1qag

1:Fm W4SV To CQ Via NOCALL\* [23:49:51]

good evening all

2:Fm W4SV To CQ Via NOCALL\* [23:49:51]

good evening all

1:Fm W3IP To CQ Via NOCALL\* [23:51:13]

2:Fm W3IP To CQ Via NOCALL\* [23:51:13]

2:Fm K5PK To EM96TD Via NOCALL\* [23:51:27]

1:Fm K5PK To EM96TD Via NOCALL\* [23:51:27]

1:Fm W4SV To CQ Via NOCALL\* [23:51:30]

2:Fm W4SV To CQ Via NOCALL\* [23:51:30]

2:Fm N2QBR To CQ Via NOCALL\* [23:52:03]

hi n1qag

1:Fm N2QBR To CQ Via NOCALL\* [23:52:03]

hi n1qag

1:Fm VE2FDA To BEACON Via NOCALL\* [23:52:07]

Francois (ve2fda@amsat.org)

2:Fm VE2FDA To BEACON Via NOCALL\* [23:52:07]

Francois (ve2fda@amsat.org)

1:Fm K5PK To EM96TD Via NOCALL\* [23:53:23]

2:Fm K5PK To EM96TD Via NOCALL\* [23:53:23]

What would you like "Space Monitor" to do for you? What articles and information would be of particular interest to you? Let us know. We look forward to hearing from you and serving you.

### Monitoring Reports

All times in UTC. All voice transmissions in English unless otherwise noted.

**10780:** Radio check between CANAVERAL CONTROL and CAPE RADIO at 0118, USB mode (Duke Rumley, A14DR-N Central, N.C.). 50.110: Mir de-orbit heard with 50-foot, 6 meter yagi antenna pointed towards s/w from Nipomo, CA. Sounded like a meteor (Tony — KC6NB1).

**126.900:** NASA 921 (T-38N based at Ellington Field, TX) performing low approach then landing on runway 23R at Wright-Patterson Air Force Base, AM mode. Also heard on 134.450 (Lewis Rand — Ohio).

**128.625:** NASA 607 and NASA 616 (DHC-6 Twin Otter and

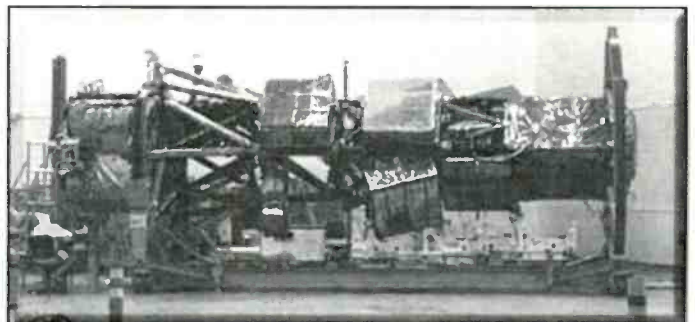

A reconnaissance satellite under construction (Photo courtesy National Reconnaissance Office)



Learjet based at Cleveland Int'l., OH) talking with NASA Ops, AM mode (Chuck Rapacki — Detroit, MI).

**137.500:** NOAA 15 weather satellite heard, NFM mode (Rick KB0VBZ — Aurora, Colo.)

**143.625:** Russian voice heard from International Space Station at 1530, NFM mode. Interestingly, the amateur satellite frequency 435.075 came alive at the same time (Vern Modeland — Arkansas, Ozarks).

**150.000:** Russian navigation satellite Nadezhda 3 confirmed active again at 0020, NFM mode (John David Corby — Canada).

**235.400:** NASA 2 (Gulfstream based at Ellington Field, Tex.) and NASA 960 (T-38N, Ellington) heard, AM mode. Also caught NASA928 (WB-57 based at Ellington Field, TX) calling NASA Ops (Tom M.).

**257.800:** NASA843 (F-18, based at Edwards AFB) landed at Boeing Field, AM mode (Franz Loew — Seattle, WA).

**261.550:** Intermittent strong unmodulated carriers on this freq from Pacific satellite communications. The first one appeared at 0425 (Tony — Oregon).

**264.900:** CW (Morse code) signal received loud and clear from Russia's "Gonets D-1 2" satellite at 2222 using an ICOM IC-R10 handheld receiver with a directly connected dipole cut for 260MHz. This satellite requires patience to hear because it emits a short (< 1 second) data burst every 60 seconds. Gonets is an abandoned store-and-forward communications system. (John David Corby — Canada).

**265.450:** Full-quieting carrier in NFM mode at 0600. "Unless LEASAT F2 has fired up, the only sat I know of with me in it's footprint using this freq is UFO F4 at 177.6 degrees west (265.450 is channel 7 Papa). Carrier went off abruptly at 0645. Have previously heard data on this channel (John Batty VK4MBK — Queensland Australia). Carrier was also confirmed by Tony in Oregon.

**289.600:** NASA 908, (T-38N, based at Ellington Field, Tex.), cleared to Lubbock Intl, AM mode (Sandy — Denver, Colo.).

**307.900:** NASA 931 (KC-135A, Ellington Field) talking to Indianapolis Center, AM mode (Chuck Rapacki — Detroit, Mich.).

**343.700:** NASA 851 (F-18 based at

Edwards AFB, Calif.) heading to high-altitude supersonic corridor. NASA852 (same at NASA851) "like to proceed down to Victorville." (D.Stijovich — March Field, Calif.).

**348.700:** NASA 809 heard (ER-2 based at Edwards AFB, Calif.), AM mode (D. Stijovich — March Field, Calif.)

**369.900:** NASA 806 (ER-2 based at Edwards AFB) heard, AM mode (D.Stijovich — March Field, Calif.).

Note: Keith Stein is the editor of SpaceCluster.Com (<http://www.spacecluster.com>). You can contact him via E-mail at [kstein@spacecluster.com](mailto:kstein@spacecluster.com). ■

---

## Tuning In (from page 4)

cause users, manufacturers, and at times the FCC itself, to be confused. Some rules have been added or deleted in one place without any reference in another place. It appears the entire structure has been remodeled so many times it is in serious need of being entirely rebuilt. Due to this large body of rules and regulations some people, in frustration, just disregard them. This creates a lack of respect for the rule of law and the FCC as well. The FCC may be understaffed and not able to undertake the needed re-write, but there are a couple user groups that might volunteer to do it if asked.

So, here's a suggestion: the FCC could approve a citizen task force of individuals and industry representatives to recommend simplified rules and regulations for GMRS. Also, a short version could be included with each radio. Remember how it was done with CB?

---

## Manufacturer And Vendor Responsibility

Some manufacturers and vendors lack the responsibility of clearly advising buyers about the licensing requirement for certain radio models. A few companies don't even seem to be aware they are making such a radio. Since the introduction of FRS models there is a wish to "move up" to GMRS on the part of some users when they become aware of its existence. Manufacturers at first answered this desire with some nice two-watt handhelds operating on simplex (non-repeater) frequencies, but these go from the unlicensed to the licensed category when the power goes above 1/2-watt. In the last couple months at least one two-watt brand has appeared with repeater capability. Most of these handhelds appear to the public as just being a larger FRS radio.

Some vendors also don't know or seem to care. Try asking a clerk at the neighborhood builder's supply or office sup-

ply store about whether the handheld radio for sale requires a license.

Here is a "worst case" scenario. When contacted about this lack of information on the licensing requirement, the headquarters of a nationally circulated sports equipment catalog asked for an apology for having bothered them for such a non-issue. (Eventually they wised up). Meanwhile, responsible retailers such as a major U.S. electronics retail store chain clearly marks the appropriate models "FCC license required." A couple other companies have taken the suggestion that they do the same, and have added the term.

There is a lack of a good working relationship and any large influential representation at the FCC for the GMRS constituency. Interesting thought: Can Charleton Heston be made into a radio spokesperson? But that might be a bad idea because any relationship needs to be non-confrontational or else it will be self-defeating and counterproductive.

Lest this all sounds too negative, there are some good things happening. For one, the Website, [www.gmrsweb.com](http://www.gmrsweb.com), previously lauded in *Popular Communications*, has developed a code of ethics for GMRS retailers and users. Secondly, a new resource for licensees is available at [www.G-M-R-S.org](http://www.G-M-R-S.org) where a listing of available repeaters around the country has just started as a free convenience. Last but not least are the Websites established by volunteers to make it easier in filing for a license: [www.gmrsweb.com](http://www.gmrsweb.com) and <http://www.gwi.net/~bgore/gmrsweb.html>. A big thank you to those who care and want to maintain the service as something useful.

The Notice of Rulemaking process by the FCC should include a period of comment by the public on the petition referred to earlier. You and I may be able to change the chameleon's color from black to white! Watch *Popular Communications* for developments on the situation! ■

## America The Beautiful — And A Competition No One Wins

Things are a little thin this time around. It's a good thing Tim Taylor was at his post and on duty; he's the star of the show this month!

**KIPM, 6950 USB** at 0306 with Alan Maxwell, Outer Limits theme song, mention of a story called "The War Hound" (Tim says the title is tentative) and then the story with mentions of astronauts, biological weapons, and aphrodisiacs as weapons. Later Maxwell said he had to make a decision whether or not to stay in this weird type of story land he's created. Address given at 0332 as P.O. Box 69, Elkhorn, NV 68022. (Tim Taylor, PA)

**Take It Easy Radio, 6955 USB** at 0452 with a fake interview with someone from the British Isles, parody about a flatulence competition in which the United States wins. I'm certain I heard Radio Neptune air this same comedy sketch. Tier gave an ID at 0509 and said hello to listeners. At 0511 the station operator mentioned the ID and address (P.O. Box 1, Belfast, NY 14711). Then the tune "Desperado" and off at 0534. (Taylor, PA) **6950 USB** at 0100 telling listeners to take Friday off. Played an Eagles tune for Lee Reynolds. (Jerry Coatsworth, Ontario)

**Pirate Radio Central, (tentative) on 6955 USB** at 0536 with rock tune, mention of "pirate radio," and mention of a "pirate radio special." Sounded like a young female voice accompanying the program. Possible phone conversation, tune called "Gotta Keep 'Em Separated." Sexy talk between the female and the station operator, then a fake or recorded phone call. Mentioned the Free Radio Network and the ACE. Operator said "I'm otta here" followed by rock, then another fake phone conversation. Sign off at 0607. (Taylor, PA)

**Crunch Radio, 6950 USB** at 0352 with opera type music. The operator mentioned Crunch Radio at 0404 and played old-fashioned style music, song maybe titled "Once Upon a Star." Another ID at 0407 and patriotic song "America the Beautiful" at 0409. Another ID at 0410 and off the air at 0411. No address copied. (Taylor, PA)

**WHYP, 6950 USB** at 1505 with a program called "How to Set Up and Operate



veronica 1224

21 - 31 August 1999

*Thanks to Col. R.C. Watts in Kentucky for this QSL from Dutch pirate Radio Veronica.*

Your Own Pirate Radio Station." Aired a song called "Alright Now" at 1505. At 1510 WHYP rigged up a mock pirate station, which they called JBCN (James Brown Communications Net). The advice included using a good antenna and noted "any pirate broadcasting for the first time has to contact James T. Arthur ahead of time, or rather before transmitting." At 1534 they played a song called "Riverboat Fantasy." Later, James talked about low power stations. At 1541 WHYP and Captain Ron (from the Voice of Captain Ron Shortwave) were talking about how to patch up a pirate radio studio. Captain Ron talked about the importance of grounding your radio equipment. All the while he was talking about this he was pretending to get shocked, yelling and screaming. Later WHYP talked about putting up an antenna with "Pirate Pete." Sign-off was at 1603. (Taylor, PA) Full-data QSL received. Shows Alan Maxwell and Sal Amoniac taking a break at the croquet grounds. Also sent a 1978 Bernie Parent Flyers Card. (Bill Flynn, PA)

**Radio Neptune, 6950v** at 0328, relaying (tentative) CBC. ID for Radio Neptune at 0329 and mailing address as P.O. Box 109, Blue Ridge Summit, PA

17214 and mentioned "broadcasting from the CBC" and gave an ID. At 0340 they played "Soul Man" by the Blues Brothers. At 0342 the operator aired some sort of parody and later said to send a cassette tape of the broadcast in order to get a QSL. Then came the flatulence contest, which I think I also heard on Take It Easy Radio. At 0407: "73s from Neptune," and an ID. Sign-off was at 0308. (Taylor, PA)

**Psycho Radio, 6950 USB** heard at 0224 with some old-time music and then a story of some kind, similar to KIPM's story-telling style. Closed with a mention of a raspberry freeze recipe. Off the air at 0234.

**Z-100, 6955 USB** at 0112 with oldies music. Quick QSL after an E-mail report. (Coatsworth, Ontario)

**Unidentified, 6950 USB** at 1414 with the song "Parents Just Don't Understand." Went off the air at 1419. (Taylor, PA)

Thanks to Tim Taylor and the others who were able to contribute this time. There's activity out there so keep at it and keep sending in those reports, not to mention our need for copies of pirate QSLs. Thanks a lot for all your help. We'll have another go at it next month! ■



## Organizing Scanner Banks!

A good way to start a debate in scanner crowds is to bring up the subject of banks, and how best to organize them. There are probably as many variations on the basic methods as there are scanner enthusiasts, but there are some basics we can cover to get you thinking about what would work best for you. I'll apologize in advance if I left out your favorite method, but they only give me so much space. In our weekly Radio Listener's Conference on AOL (every Thursday night 9-11 p.m. ET Keyword: SCAN then follow the links for Conferences & Chat) we've had some lively discussion on this subject.

If you think about it for a minute, banks are really the "channels" of your scanner. Bear with me for a second, and forget about channels in the "200 channel scanner" sense. I'm thinking more like TV channels; programs you want to listen to on your scanner. Groupings of things that make some sense to monitor together because they have something in common.

Switching on and off a bank can be done rapidly — much more rapidly than locating a particular frequency and locking it out (on most scanners anyway). It's also easy to tell which banks are turned on or off. Making use of this "grouping" function allows you to get much more mileage, and ultimately information, from your scanner.

### Service Or Geography?

Most of the methods I have seen come down to separating the channels by the type of service that uses them — police, fire, medical, ham, etc. or by area. All of the south stuff in one bank, north in another, etc. Quite frankly, I hadn't really given it a whole lot of thought until I started messing with computer control systems and it became possible to reorganize banks quickly and easily.

I had always been pretty much a service fan. All of the county police channels in one bank, city in another, state and outlying areas in another. Then there was a bank for fire, and then it depended on the radio as to how much room I had to put together any others. This method works quite well if you're interested in a particular department or section of scanning. Or if you seldom listen to a particular service, but want to have them handy for when something does happen (assuming, of course, that you have open banks to store them in). This method also works well for scanning from a fixed location, like mostly at home.

The primary disadvantage of this method comes to light when you get into a busy environment. If you have a busy police department with several channels, it's entirely possible that your scanner can be held up for quite some time plowing its way through — stopping here and there as it goes. Perhaps some of the channels are not of much interest, but if they are grouped together by service, you'll probably have them active. It's entirely possible that you'll get tied up on some major event in

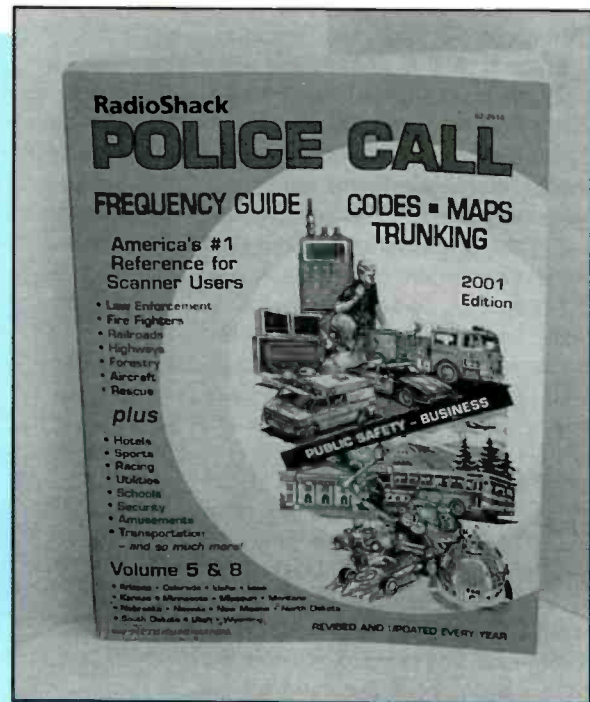

*If you've been scanning for a while and haven't looked at a recent edition of Police Call, available at your local RadioShack, you should. It can give you a surprising amount of information on the use of many frequencies to help you organize your banks for normal listening or special events.*

the police bank and miss some other event in another bank. Of course, there's no complete cure for this, but you can mitigate the damages a bit by planning. And another radio doesn't hurt either. Eventually, if there's enough traffic, you'll either have to give up listening to some channels or add another radio just to have a chance of hearing what's happening.

### Geographically Speaking

The other popular method of organizing is by area. All the south side stuff is in one bank, all of the north in another. This means that probably some channels will have to be duplicated, like mutual aid and point-to-point channels that are in use no matter where you are. Things like fire dispatch and medical services may also not follow clean geographic lines and have to be duplicated as well. Seems like a waste of channels.

Well, back in the old days of four and 16 channel scanners, I would have agreed. Of course, most of the four and 16 channel radios don't have banks anyway, so the point was moot. However, with today's 200, 400, and even 1000 channel radios,

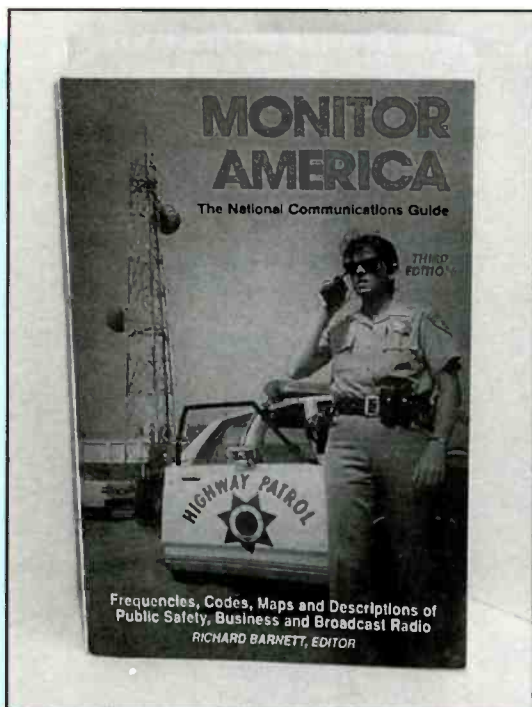

*Monitor America is another valuable resource, particularly for those that travel to different parts of the country. It's available from many dealers nationwide.*

some duplication begins to be a little more tolerable, and even make some sense at times.

Another case in point: Our county is divided into four precincts. Each of the precincts has its own dispatch channel. There's a detective channel, a car-to-car channel and an emergency channel that are shared county wide. As I mentioned earlier, I used to keep all of the police channels in one bank and scan them all full time.

The problem is that in the car, particularly with a handheld, if you're up in the north precinct, you can't hear much of what's going on in the south. It's simply too far away to get much but static. The older I get, the less tolerance I have for static. (I have a theory that this has something to do with the static I get from Harold over when the next column will be done, but I haven't been able to come up with any scientific proof).

In addition, there are several municipalities within the county (somewhere around 80), some of which have their own police departments, and some that do not. Some of the municipalities that have their own departments also have their own dispatch, but some contract it out to other departments or even the county. The county has an additional two channels dedicated just to these municipalities, one for north side stuff and one for the west group. So in addition to listening to the county precinct you're in, you also have to follow these municipal channels, and there may be a bunch.

So I got the bright idea, why not give each precinct a bank? It could include the precinct channel, any municipalities in that precinct that I care to listen to, the fire dispatch channels that cover that area and the shared channels that I want to listen to

most of the time. In addition, I created a bank of all fire, one for air stuff (when I'm near the airport at lunch time) and one or two left over for experimental stuff or special events.

Works like a charm. I simply switch banks on and off like I used to use channels, but now, I'm not missing all the action on other frequencies in the area. The trade off is that there is a lot of duplication in my scanner, and there are several banks with very few channels in use. Oh well.

## Event Scanning

A friend of mine is a nut for special events. Hmmm, come to think about it, even if he didn't like special events, I'd be half right. Anyway, he groups many of his scanner banks by event. He has a handful of channels that he likes to listen to all the time, and dedicates one or two banks in one of his scanners to that, mostly grouped by geography. It's mostly local stuff that he's interested in tracking. The rest of the banks in his radios are dedicated to one type or another of special event scanning, some of which border on services, but some do not.

There's a bank for severe weather events. Any time during the year that severe weather threatens, he flips this bank on and immediately has access to the highway department, weather observation channels, ham radio frequencies that are used for storm spotting, etc.

You can make sort of a challenge out of this type of thinking. Consider an event that is likely to occur in your area. What would happen, say, if the president came to your town? Ok, if you live in the District, this won't be very challenging, but if you live somewhere else, think about it. What kind of frequencies might be active because of a VIP visit? Would the person receive secret service protection? They're mostly encrypted, so you can't listen to them, but activity on those channels might tip you off that something was about to happen.

Would your local police have a role? Sometimes they're used to provide traffic control and other assistance. What frequencies might they use? How about medical services, or fire?



*If you look closely above the keys, you'll see the designation for the second 10 banks. This is the PRO-2052 keypad, but a few other models also feature the 20-bank arrangement.*



News coverage? You can fill up a bank pretty quickly with good possibilities.

Now, depending on where you live, you might have to wait a long time to see just how good your guesses were. But once it happens, it can be quite a lot of fun, and get you in on the action just a bit earlier. Particularly if you have more than one radio and can dedicate a bank to channels you don't need very often, it can be quite a lot of fun to plan. Even if you can't spare a bank, you can think about the frequencies and write them down somewhere. That way, you'll have the planning done if you hear something's happening and can reprogram quickly. You do have a list of the frequencies that are normally in your scanner, don't you?

### School Or Factory Disaster?

Another possibility might be if a factory, school, or other major facility near you had a major "event." Could be a celebration of some sort, could be a disaster situation. With the recent rash of school violence, there are all sorts of possibilities. SWAT operations are occurring on a seemingly more frequent basis in many parts of the country. Do you know where to find your local special operations? Our county has a frequency set aside for these types of events, but once at the scene they switch to an unpublished and unannounced channel. Since it's all low power stuff, you won't hear much unless you're too close for comfort!

What frequencies would be in use? What outside agencies might be called in? If you are located within listening distance of any large facility, chances are that they use radio during their day-to-day operations, most of which are probably very boring. But if something happens, having those handy might get you information that you wouldn't have until the news at 11. In the event of a major disaster like a chemical spill, that could be very good information to have in advance. Hopefully, you'll never get to test your theory, but it's fun to plan. And maybe they'll have a smaller event or drill just for you to test things out on.

### Multi Radio

Notice that I mentioned my friend's radios were programmed for events. Many scanner enthusiasts end up in a

## **Banks You Might Consider**

Here are a few ideas to get you started. This list is by no means exhaustive.

### Service

Police  
Fire  
Medical  
Media  
Aviation  
Military  
Ham  
Business  
Malls  
Casinos  
Unknown or Experimental  
Schools  
Railroads  
Busses/Taxis  
All the time stuff  
Mutual Aid/Shared frequencies  
Maritime, Lake, River

### Geographic

City  
County

Local  
North, South, East, West  
Out of state  
Your City  
Neighboring city  
Precinct or District

### Special Banks

Airport problems  
Parade/Fair  
Rail Accident  
Major vehicle accident  
River/Lake/Ocean incident  
Industrial incident  
VIP Visit  
Jail or prison incident  
Major media event  
Sports event  
Severe Weather  
Natural Disaster  
Major Fire  
Riot or other civil disturbance  
Concert or Theatre Event

very short time with more than one radio. There are many reasons for this ranging from upgrading a first scanner to just needing more channels. The first thought that many beginners have is that they'd like to sell the old radio, but sometimes when the reality of what that radio will bring on the used market, or the realization that a second radio with different features might be handy to have around from time to time, many wind up keeping the second radio. And then the third, and then . . .

More advice from the AOL Radio Listener's Conference: Armadillo's first law: You can never have too many radios. At one time, having more radios meant more channels. At one time, more channels meant an extra four, eight or 16 channels, and every one was a precious (and expensive if you had to buy crystals) resource. That's simply not true in these days of multi-hundred channel receivers that are so common.

What is more useful about having more radios is really two things: the most important is more BANKS. You can switch them on and off quickly and easily without reprogramming anything, which makes you better able to follow the action as it is happening.

The other thing that multiple radios allow is listening to more things at once. In a busy environment, or during a major event, lots of folks are likely to be talking at the same time. By assigning different functions to different radios, you can be much more likely to catch the important stuff.

I know many enthusiasts have a dedicated "fire radio" that is normally programmed with only fire dispatch channels. The theory is that something on the fire channels is much more likely to be a big important event than the other stuff we listen to most of the time. Once an interesting event is dispatched, the fire radio could have banks to switch on for the local or fireground channels used by a particular department. This leaves your regular scanner free to listen to all the routine police, air, ambulance, drive through window traffic, and other things that are interesting when nothing is happening. But you won't miss the big fire because somebody was running a license plate, or ordering lunch.

### Trunking Systems

Trunktracker radios have made the need for organization quite apparent.



*This unique base scanner features 20 banks of 50 channels each. Extra banks and channels make it very convenient to have event banks pre-loaded.*

While many of the newer trunktracking receivers can in fact mix conventional and trunked banks into a single radio, it may not be at all practical. Large trunking systems are busy almost all the time, and even if you're only interested in a few select channels, there's a good chance that something will occur while you're off in the conventional mode that you'll miss. It is possible, but my experience with even moderate trunked systems dictates that two receivers is a much better option.

You can, however, still group your ID lists together in banks, or scan lists as they're called, at least on most radios. Most trunk system listeners eventually settle on a group of IDs they like to listen to, and have another group that they don't want to hear at all. Using the ID list function allows you to group those IDs that you do want to listen to into logical "channels" or "virtual banks" in your scanner. By turning them on and off, depending on

what's happening at the time, you'll find your listening can have a lot more continuity. You'll hear the outcome of more stuff, and the follow-up calls will make sense to you. Even on a busy system, if you pick and choose your IDs carefully, it will increase your understanding of what you're hearing.

### What Do You Use?

As you can see, there's no one right answer to this question. It depends a lot on the kind of events that you are likely to see in your area, as well as how much you want to listen to. There's a balancing act between scanning too much so that you can't really follow anything, and listening only to one channel so you follow all that traffic, but miss everything else. One of the revelations from a recent AOL conference on this topic is that a lot of people are using multiple radios to over-

come some of the limitations of capacity versus time to scan through the list.

I've also discovered that my mobile needs are completely unrelated to what I listen to at home. I've solved the mobile problem with the geographic method. At home, I'm still working on a geographic/event system that works, but I'm getting there.

### We Have A Winner!

Our winner of the frequency of the month contest for this quarter is **Dino Davila** of St. Louis, MO. Dino sent in an entry on 152.485 which was in the column back in February of 2001. Dino correctly pointed out, as did several others, that this frequency is not an allocatable channel, but rather 152.480 is what it should be. Oops. I actually had another frequency in mind, but it somehow got transposed in typing. My apologies, and congrats to Dino!

Our frequency this month is **42.02** since we haven't been down to the low band for a while. It's summer and anything's possible here at this time of year, so even if you don't have a local signal, plug it in and let it run for a while. You might hear some very interesting things! Send them in and we'll enter your name in our next drawing!

### Your Input Needed

I'm always interested in your comments or questions. And don't forget to enter the Frequency of the Month contest! Send information to Ken Reiss, 9051 Watson Rd. #309, St. Louis, MO 63126. Send any complaints to Harold — he needs the excitement! Until next month, good listening! ■

### The Adventures of Scanner Dweeb by M. A. Coletta

With \$\$\$ costs sky rocketing... small town police departments can't afford new digital systems...

So they have improvised by speaking logic-ally into their analog radios...



### Digilog ???

00111101010110  
11101001101110  
001110111011101

[www.ScannerDweeb.com](http://www.ScannerDweeb.com)



### Monitoring Hot Spots, And An Emergency Landing!

This month's column asks a very basic question — "why do you monitor ute signals?" Is it simply to log the day-in day-out routine of the commercial, military, or political world? Or is it to use the power of modern radio communications to "be there" where the action happens, and experience real life drama as it is taking place.

If you are interested in really using your radio monitoring tools and skills to their fullest, then the hints and tips that are going to be provided to you this month will help increase your chances of hearing some really exciting events on the air. Best of all, the person who is going to do this is one of our own contributors — **Craig A. Rose** of Santa Clara, CA.

Craig will demonstrate, though a recent personal monitoring experience, how to do more with your radio than simply log routine signals. He will show you how to follow an emergency event, and then interpret what you heard. The key to success, as Craig will show, is by being properly prepared ahead of time, and by developing a consistent monitoring routine.

I've also got lots of good logs! I have to say that the number of contributors has remained consistent, along with the quantity and quality of logs that they have been sending in. I'm also getting some great ideas for future columns, along with offers for more guest contributors. Please keep it up!

The final group of modern German Navy vessel identifications and callsigns will also be provided this month, along with a great picture from one of our contributors of a visit from two German ships mentioned last month to the port of Savannah, Georgia. I'm afraid though that in order to put the callsigns in I'm going to have to put the readers letters over to next month.

So enough of the housekeeping chores, let's get down to the real story here.

#### Catching The Action!

Over the past few months I've been looking at a number of basic issues that affect your ability to do good ute monitoring. At this point it should be clear that you need a combination of things in order to be successful at what you do.

The starting point is a good antenna and monitoring radio that provides the quietest background noise possible in order to hear weak or distant stations. This must then be combined with a good list of frequencies that can be accessed fast, preferably through pre-programmed memories on the radio or through an externalized computerized scanning system.

Rather than tuning the radio by hand, the most effective way to capture activity is by scanning a group of frequencies over and over while waiting for something to take place. Using the scanning capability of a modern monitoring receiver that is either built in, or controlled by the external computer and software does this best.

While the scanning capabilities of the new generation of radios is excellent, the truth of the matter is that there is just too

much RF real estate in the HF band to be able to be everywhere at once. So what you need to do is develop a monitoring strategy that puts you in the right place at the right time to hear something interesting more often than not.

The most obvious way to start is by looking at the many ute services that are available for monitoring and select the one that interests you, and then begin researching what it is and how it is used.

Some, such as aviation, are highly active and contain lots of routine traffic on their assigned frequencies. Others, such as marine or land service, may be less frequent, but more interesting due to their locations and activities.

The real trick to all of this lies in knowing which services are active on what frequencies, and at what time. There is no point listening for marine activity when the shipping season is over, and likewise aviation activity varies according to the time of day and travel season as well.

I'm sure all of this makes common sense when you read it here, but too often people overlook the obvious and become disappointed radio monitors as a result.

In general, if you don't have a lot of time to spend on the radio, make up a list of easily acquired targets and capture them. The more success you have, even if it is a routine event, will keep your interest up longer than if you spend too much time listening to static.

However, if you do have the time to invest in monitoring, and the proper set up of equipment, then you can troll for the more elusive station. Even then you should have a specific goal and purpose behind that use of monitoring time.

Ultimately, though, what you really need to be able to do is get the most out of any event that is different or unusual. All too often an inexperienced or impatient radio monitor may pass over an important event such as an emergency because they did not understand what they were hearing.

That's where the real skill of ute monitoring comes in — being able to understand and interpret what you are hearing after you have located the signal.

#### Emergency Landing — The Delta Flight 79 Story

At the end of March, the town of Cold Bay in Alaska had an unexpected visitor. A Delta Airlines jet was forced to make an unscheduled landing in the Alaska Peninsula community 40 miles from the start of the Aleutian Islands.

Delta Flight 79, flying from Los Angeles to Tokyo, carried 220 passengers and an unknown number of crewmembers when it landed at the wind-swept, treeless community on tundra 625 miles Southwest of Anchorage.

The small town of only 65 found themselves having to accommodate over 200 stranded airline passengers as repairs were made on the aircraft.

Just before this event was taking place, Craig Rose of Santa Clara, California, had returned home to his apartment from work and had turned his monitoring radios on, as well as his computer in order to check his eEmail and surf the Internet.

His collection of rigs is made up of the following:

ICOM R-71A  
Yaesu FRG-7  
Yaesu FRG-8800  
Sony ICF7600  
Bearcat 245-XLT  
Bearcat 895-XLT

And because he is in an apartment, his antenna is a random length of wire strung up around the ceiling. Despite this rather limited antenna set-up Craig was still able to make a number of interesting logs. Here is what he heard at that time.

**6.637.0 0808Z USB:** TWA 8557 and TWA Dispatch discussing divert options due 1/8-mile visibility in fog at Mazatlan. Pilot was emphatic about diverting and breaking from hold as did not expect fog to decrease until local morning. It was finally agreed that they would divert to Puerto Vallarta.

**11.175.0 0126Z USB:** PINION 56 (U-2 Beale, AFB) with HF radio check via Hickam (heard locally on scanner and he was above 60,000).

**11.175.0 2239Z USB:** AIREVAC 6136 with p/p via McClellan to Eielson Dispatch advising they are running late and coordinating number of pax (packages) to be p/u for transport to McChord.

**11.244.0 0303 USB:** ASTRA 33 with message of one group for TRUCKMAN (busy freq. for apparent exercise).

**11.247.0 0243Z USB:** ASCOT 3201 with flight watch message to unknown ground station and request for WX at Dakar, Ascension, Tel Aviv, Lisbon, Las Palmas.

**11.282.0 2313Z USB:** NAVY RX115 reporting level at 33,000 via San Francisco Radio.

**11.384.0 0833Z USB:** American 973 with position report, SELCAL check via Tokyo Radio and Tokyo advises SIGMET for moderate to severe turbulence in area.

**17.946.0 0109Z USB:** Delta 79 in communication with San Francisco Radio and declaring emergency due to cabin filling with smoke and loud noise in cabin over row 15. Discussion of best locations to divert including Cold Bay, King Salmon and Anchorage as San Francisco provided WX for locations. Then switch freq. due traffic and fading between aircraft and Delta Maintenance.

**21.964.0 0120Z USB:** Delta 79 via San Francisco Radio in p/p to Delta Flight Control to determine divert options. Flight Control provided WX for Cold Bay, King Salmon, and Anchorage several times. Determination was made to land Cold Bay on 10,000 runway there. Oakland ARTCC also endorsed and gave emergency clearance to land Cold Bay (pilot of MD-11 from L.A. to Tokyo was very calm during emergency).

How did Craig handle the situation as he heard it? Let him tell you in his own words.

## Craig's Story

Listening to the HF aero bands has been my focus since I began monitoring. During this event I just happened to have the ICOM tuned to **17.946.0** to listen in for any standard military traffic reporting positions and the like.

My normal practice is to arrive home in the afternoon and tune to a couple of the active aero freqs for that time of day. Typically I will catch up on the latest news, stock market activity, and E-mail while monitoring.

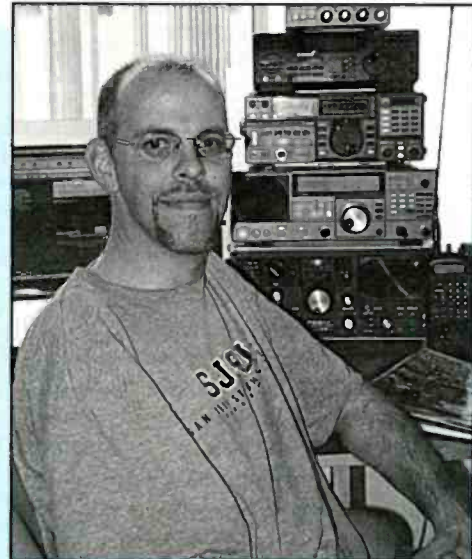

*Craig A. Rose of Santa Clara, California, at his station. Craig monitored the Delta Flight 79 emergency. In the background are his ICOM R-71A, Yaesu FRG-7, Yaesu FRG-8800, Sony ICF7600, Bearcat 245-XLT, and 895-XLT*

The thing that caught my attention, besides the content of the traffic between Delta 79 and San Francisco Radio, was the tone of the controller's voice. He distinctly asked if Delta 79 was declaring an emergency, and he sounded very concerned. I began to scribble the notes of their conversation, and I even called my wife in to take a listen.

My first reaction to this incident was to think good thoughts for those folks while transmitting a heads-up to other folks over the Internet.

As the incident transpired the pilot discussed whether he should monitor the malfunction and attempt a landing at King Salmon, and if things were improving, maybe even shoot for Anchorage.

As it turned out this was not to be as everyone involved, while giving the pilot the greatest discretion, agreed that a divert to Cold Bay (the closest runway capable of handling a heavy jet) was the best bet for the safety of all involved.

I also used the Internet to determine what the facilities, weather, and population were like in Cold Bay. Throughout this process I received several E-mails from folks all over the United States and the Pacific Rim as they tried to catch the communications between the aircraft and ground facilities.



This was a great help as I was experiencing severe fading at this point. Overall, I believe the Internet acted as a powerful tool in sharing the information as well as allowing for others to monitor this event.

## The Bottom Line

Craig's experience shows that you have to have certain things in place in order to successfully monitor a real hot event, but that does not have to include a big antenna or expensive rig. As Ron Perron explained to us last month, a good portable radio with a simple whip antenna can pick up significant traffic (such as the German Navy) if you know when and where to listen. Craig's story only serves to underscore that important fact.

As Craig also mentions in his story, it was the little changes in routine, such as the shift in the tone of the voices of the people involved, which caught his attention and made him really focus on the monitoring target more closely. Gaining that feel for the ute targets that you are monitoring, and noticing when something is different or out of the ordinary, only comes with time and practice.

The best way then to really be in the right place at the right time is to listen to a group of active frequencies as often as possible. Often the best way is to do it as Craig does, as part of several activities, such as having it in the background as you surf the 'net.

Too often it is the case of "a watched kettle never boils" for radio too, so don't sit there staring at the radio while listening to static as it scans through the frequencies. Let the computer or radio do the work, and you log only when the squelch kicks in and brings up a signal with significant routine traffic (e.g. you do not have to log every little thing that you hear on the air).

Likewise have as many resources on hand as possible. Atlases, references books, Websites, and E-mail contacts all are important to you when events unfold. Do your homework as well, and keep up to date on current events that are taking place so that you can interpret flare-ups or emergency situations.

Again, and most important of all, know what things are suppose to be like — e.g. standard operating procedures — when things are normal so that you know when they are not.

And how about the people on board the flight? After a good breakfast of biscuits, bacon, and sausage by the people of Cold

Bay, the passengers reboarded the plane and flew to Anchorage. They finally headed off for Tokyo without any further incidents.

## Speaking Of Logs

Again we have a good selection of logs this month. There is a good mix of aviation, naval, military, and embassy traffic here.

**000:** STATION, Anytown, USA. summary of traffic heard in MODE at 0000 Z (UTC), personal comments here (JC)

**366:** YMW NDB Maniwaki Quebec, Canada 0328 Z. (LH)

**388:** NDB: MM Beacon Fort McMurray, Alberta, Canada (LH)

**3212:** UNID: Scandinavia 19.50 FEC Sends only one message "DETTE E TESTE FRA SENDBORG GOC HOLD N GOD AFTEN ALLESAMEN. VENLIG H SEN NNNN," then shuts down. (PT)

**3485:** VFG: Gander VOLMET 0522 USB w/aviation WX. /6604/10051/ (MADX)

**4015:** AEIUSA: Heidelberg, Germany, 20.06 PACTOR 200/200 MARS station sending information on operation of "European Gateway" to AEM1WF, Neidenbach, Germany. (PT)

**4125:** KCI-95 (NWS-Cold Bay) Providing live maritime WX for Alaska coastal waters and taking requests and reports (by area) from fishing ships at sea including a report of 80 knot winds and freezing sea foam! 0549Z USB (CR)

**4214:** ZSC: Capetown R FEC 1755Z To All Stations Navarea and IGAT Warnings in Force! (RH2)

**4232:** FUF: FF Ft de France RTTY 75/850 0523Z Test tape (RH2)

**4245.5:** ZSO: SAN Durban MFSK/32 0604Z 54.5 Repeated call-up sigs! (RH2)

**4271:** CFH: CF Halifax FAX 120/576 0519Z Poor chart! (RH2)

**4510:** UNID: French Forces 19.26 ARQ-E 184.6/400 Idling all night. (PT)

**4640:** UNID: numbers YL EE 2/22/01 0020utc 051, 254, 840. etc. (LH)

**5206.5:** AT3TPA: U.S. Army MARS Scranton, Pennsylvania, 0220 PACKET 300/200 wkg AAR3JE: U.S. Army MARS Philadelphia w/exercise message for the U.S. Army Corps of Engineers in Philadelphia. (MADX)

**5207:** E17: The English Lady 0210 AM w/YL/EE/5FGs (x2) already in progress. QRT at 0219 w/'87 (x2) 00000". (MADX)

**5219:** UNID: UNID location RTTY 75/150 0555 Often heard at this time. (RH2)

**5293:** AWC Calcutta Air 1300 RTTY 50/400 AFTN tlc to Dhaka (ML)

**5450:** Shannon Volmet, Ireland 2308Z. (LH)

**5505:** Shannon Volmet, Ireland 2/27/01 0018 Z. (LH)

**5628:** Air Canada 004 Reporting level at 360 via San Francisco Radio. USB 1357Z (CR)

**5667:** Delta 56 Requests flight level 330 via San Francisco Radio. USB 1404Z (CR)

**5696:** Camslant/Coast Guard Helo 6001 radio guard and position. (LH)

**5696:** RESCUE 2135 wkg CAMSLANT. Flight ops normal, position: 2721N 07940W USB 0557Z (MADX)

**5696:** CAMSLANT: 0557 USB wkg STINGRAY 31: USCG HU-25C #2131 (CGAS Miami). (MADX)

**5717:** Halifax Military Coast Guard 2333Z 45 SELCAL and say they were using 6994 as backup. (LH)

**5862.5:** NNNOASG: Director Navy and Marine Corps Mars Region Four 0608 PACTOR 100/200 c/g UNID. (MADX)

**6322:** ZSC: Capetown R ARQ 0545Z 1D Marker (RH2)

**6416:** WLO: Mobile R ARQ 0541Z 1D Marker (RH2)

**6449.7:** PWZ33: Brasil Navrad Meteomarinha Reports in PP RTTY 75/850 0604Z (RH2)

**6449.7:** PWZ33: Brasil Navrad RTTY 75/850 0614Z WX/PP (RH2)

**6491.5:** LOR: AN Puerto Belgrano RTTY 75/170 0535Z GENOIO + RY/1D/SG (RH2)

**6496:** CFH: CF Metoc Halifax RTTY 75/850 0528Z WX forecasts (RH2)

**6516:** UNID Marine Simplex. 2327Z Fishermen talk of freshwater fish. (LH)

**6577:** N.Y. Atc TWA 64 2059Z With SELCAL and location (LH)

**6655:** Japan Air 62 With position report to Tokyo Radio and is advised that new primary of 5.628.0 and secondary of 10.048.0. USB 1431Z (CR)

**6693:** UNID Request you try again in the green (LH)

**6712:** EAM For OPTION via Andrews. USB 0210Z (CR)

**6715:** RCAF-Vancouver Military With aero WX including fest for Port Hardy and Sand Spit. USB 1450Z (CR)

**6745:** Trenton Military 1315z Switched from 11232 to this freq to work UNID a/c with WX brief. Propagation very poor due to solar flare. Could not hear a/c. Trenton wanted to keep this freq as primary. (DS2)

**6754:** CHR: Trenton Military 0631 USB w/aviation WX. (MADX)

**6768:** V2: Atencion Numbers Station 0404 AM w/YL/SS/5FGs. Already in progress. (MADX)

**6882.5:** S2D Dhaka Air BGD 1220 RTTY 50/850 w/QJH VGZRYFYZ tape for Calcutta (ML)

**7903.5:** BA1: FBI Baltimore 2104 MIL-STD 188-141A wkg QT1: FBI Quantico. No follow-on tlc noted. (MADX)

**8047:** LAT: National Guard Latham, N.Y. 1854 MIL-STD 188-141A w/sounding call. (MADX)

**8047:** GUS: UNID National Guard 2044 MIL-STD 188-141A wkg MMA: NGuard Milford MA. No follow-on tlc noted. (MADX)

**8097:** V2: Atencion Numbers Station 0602 AM YL/SS w/5FGs already in progress. (MADX)

**8130.5:** UNID: British Mil? 10.16 Piccolo 12(?) Encryption all day. Frequency increment used, xxxx.51, looks like British mil. Still going strong at 19.00 as signal fades away. (PT)

**8152:** UNID Marine Simplex Talk 2309 Z of getting on a computer in Georgetown Guyana. (LH)

**8167:** UNID 2340 USB 2xYL chatting on yacht network. Other networks can be found on 8143 and 8191. (MADX)

**8176:** Sydney Radio (VIS) with maritime weather and call for traffic. USB 0714Z (CR)

**8192.5:** 5ST: ASECNA Antan Aero data ARQ-E3 48/400 0452Z (RH2)

**8194:** FDG: Bordeaux, France 16.27 ITA2 50/170 "TEST2FDG" plus Le Brick, RY's and count all squeezed on to one line with no spaces. Note narrower than usual shift. (PT)

**8387.5:** UDUi UPS Pallada 1209 ARQ w/UDUI log on and crew msgs to Nakhodka (ML)

**8395:** UITZ PB Kapitan Kabalik 1347 ARQ ship and crew msgs to Preobrazheniye (ML)

**8397:** UAKG PR Vlad Orion 1210 ARQ clg Vladivostok w/UFZ DE UAKG PR VLAD ORION to ship t/c (ML)

**8412:** UGXV RTMS Uraniya 1140 RTTY 50/170 svc and crew msgs to unkwn (ML)

**8450:** 5AB: Benghazi Radio 0620 CW w/call tape. (MADX)

**8582:** PWZ33: Brasil Navrad RTTY 75/850 0550Z WX forecasts in PP Navarea V (RH2)

**8595:** UFL Vladivostok rdo 1100 FEC NAVAREA XIII wngs and local WX in EE (ML)

**8682.3:** NMC: USCG San Fran FAX 120/576 1531Z Super WX chart — as usual! (RH2)

**8711:** BLE: UK Military 0150 MIL-STD 188-141A/USB clg GBA: UK Military (Gibraltar?). (MADX)

**8764:** Camslant/Wc7528 2337Z Station wanted to know about frequencies used in the Caribbean. (LH)

**8764:** NMO: USCG Honolulu 0603 USB w/MIB. Remotely keyed from NMC: CAMSPAC Point Reyes. //6501// (MADX)

**8788:** UNID 2338 Z Phone patch from Godfather. (LH)

**8828:** KVM70: Honolulu VOLMET 0604 USB w/aviation WX. (MADX)

**8940.5:** UNID: British Mil 0110 PICCOLO on 8940.51 w/encrypted t/c. (MADX)

**8942:** Brunei 97 with position report via Manila Radio. USB 1314Z (CR)

**8942:** United 853 Reports level at 390 via Manila Radio, then handed of to Singapore Radio with SELCAL check. USB 1315 (CR)

**8957:** EIP: Shannon VOLMET 0108 USB w/aviation WX. (MADX)

**8971:** BLUE STAR Working with MARCUS-07, MARCUS-07 is barely readable by Blue Star. Blues Star advises 07 to RTB early, "at this time." 0105Z (JH)

**8971:** GOLDENHAWK 2116Z With TRIDENT-747. Trident-747 passes SPARE GROUP 35, 2100. EST RENDEZVOUS 30 MINUTES. Requested updated position on., and asked that GH notify WHISKEY OSCAR "WE'RE 30 MINUTES LATE WITH REN-

DEZVOUS, CALLING IN THE BLIND, NO JOY." (JH)

**8971:** TANGO 71C 2119Z With GOLDENHAWK. Asked if GoldenHawk could relay; passed on station time of 2115Z. (JH)

**8971:** LK564 2129Z With GOLDENHAWK, with 564 requesting GOLDENHAWK initiate imagery and text file from his end. Imagery reception was unsuccessful. When queried, G Hawk advised the image was that of a P3C3. LK564 advised he was having problems with his computer. (JH)

**8971:** BLUE STAR 1230Z Says THIS IS SIDECAR 711, RADIO CHECKS (no response). (JH)

**8980:** Camslant/Sac Air/ 1706 2331Z Phone patch to 1706 to let them know that a support arm for a landing gear was found from their craft on the runway should not be a problem when landing. (LH)

**8983:** NMN wrking B6P(?) 1300z NMN requests ZDK to 12megs. (DS2)

**8983:** CAMSLANT: 2128 USB w/kg RESCUE 2139: HU-25C #2139. (MADX)

**8983:** RESCUE 2139: USCG HU-25C 2155 USB w/kg CAMSLANT. "Request you assume my radio guard. Airborne from CGAS Miami on an ELT search." At 2215. CAMSLANT w/kg RESCUE 2139 with instruction to RTB. (MADX)

**8992:** IRONWEED With EAM message (also simulcast on 321.000 UHF). USB 2000Z (CR)

**8992:** ANDREWS 1339Z Broadcasts six character EAM "FOR OWNERSHIP." (JH)

**8992:** OFFUTT2100Z Broadcasts 20-character EAM, simo on 11244 and 15016 kHz; echoed by OFFUTT at 2200Z. (JH)

**8992:** BOBBY-51 1150Z (tanker acft) with THULE, p/p LAJES. Bobby-51 asked about WOLF-01 situation. Bobby-51 would be 20-30 minutes late at rendezvous for AR (aerial refueling) and was concerned about the fuel issue for WOLF-01. Asked LAJES to contact WOLF-01 on UHF to advise them. (WOLF-01 probably fighter aircraft.) (JH)

**8992:** OFFUTT 1500Z broadcasts two 75-character EAM messages, simo on 11244, 13200 and 15016 kHz (JH)

**8992:** ANDREWS 1737Z Broadcasts 75FKB6 28-character EAM, simo on 11175, 11244, 13200, and 15016 kHz. Echoed by OFFUTT on all RFs at 1740Z; and by SALINAS on 15016 kHz at 1742Z. SALINAS signed off with "ANDREWS, CORRECTION, SALINAS OUT." (JH)

**8992:** ANDREWS 2133Z Broadcasts to ROLLCALL a six character EAM message (KO2PGA), simo on 11175, 11244, 13200, and 15016 kHz. (JH)

**8992:** ANDREWS 2142Z Broadcasts "FOR DEWLAP" a 20-character EAM message (KO3FJI) simo on all GHFS RFs. Echoed by OFFUTT on the same RFs at 2144Z. (JH)

**8992:** ANDREWS 0718Z Broadcasts "89 CHARACTER MESSAGE FOLLOWS," P5EZBEEAM 89-character message, simo on all GHFS RFs. (JH)

**8992:** ANDREWS 1745Z Broadcasts to MAINSAIL "FOR CLOVERCLUB" NNQMYV 20-character EAM message, simo

on all GHFS RFs. Echoed by OFFUTT on same RFs at 1747Z. (JH)

**8992:** OFFUTT 2030Z Broadcasts BZY5DT 28-character EAM message, simo on 11244, 13200, and 15016 kHz. MCCLELLAN started to echo this EAM on 8992 and 11244 at 2035Z, but interrupted with "DISREGARD TRANSMISSION, OUT." (JH)

**8992:** MCCLELLAN 2037Z Broadcasts NNUS2F six character EAM, simo on all GHFS RFs. Echoed by THULE with the address CORNSTALK on 8992, 11175, and 15016 at 2040Z. (JH)

**8992:** MCCLELLAN 2045Z Broadcasts BWS6XW 28 character EAM, simo on all GHFS RFs. Echoed by THULE at 2048Z; and by MOONCALL (abn CP) on 8992 and 11244 at 2113Z. (JH)

**8992:** CODY-01 1342Z With ANDREWS phone patches to 357 Ops Squadron. GUN-RUNNER (AFRES CP). C-130 enroute to Vok Field as fraged, with maintenance problems and bad weather. Advised he could not continue mission. (JH)

**8992:** PUERTO RICO 2123Z Broadcasts 28 character EAM message, all GHFS RFs except 11175. Echoed by ANDREWS at 2130Z on 8992, 11244, and 15016 kHz. (JH)

**8992:** SENTRY-41 (AWACS) 2134Z In p/p with Tinker AFB CP (RAYMOND CONTROL); passed operational data to RAYMOND O Control. (JH)

**9007:** Trenton Military /UNID 0054 Report thunderstorm in Oklahoma area. (LH)

**9033.1:** Kernal Blitz D-Day landing exercise (San Diego) Medical net with comms between Hospital Ship Mercy, Fleet Hospital, DOCTOR PEPPER, regarding various live actors, "patients" and movement of injured to local hospitals. USB 0258Z (CR)

**9040.7:** 5YE: Nairobi Meteo RTTY 100/850 1740Z WX codes (RH2)

**9232:** CRC4: UNID CANFORCE 0415 MIL-STD 188-110A/188-141A w/kg UNID station. (MADX)

**9247.2:** FJY2: DTRE Kerguelen I ARQ-E3 200/400 0520Z Idling Strong sigs! (RH2)

**10100.7:** DDK9: Hamburg Meteo WX codes RTTY 50/400 0440Z (RH2)

**10467.7:** RFTPA: Ndjameina, Chad 19.23 ARQ-E3 200/400 Service t/c to RFFVA, Paris, via FDZ cct. (PT)

**10536:** CFH: CF Halifax RTTY 75/8500450Z WX forecasts (RH2)

**10712.5:** FDY: Orleans, France 16.25 ITA2 50/220 Le Brick, RY's etc. Note narrower than usual shift. (PT)

**10780:** KING-22 2224Z With CAPE RADIO, p/p DSN 456-7632, RESCUE OPS. KING-22 ETA on station 2400Z, current loc over West Virginia, "CAPTAIN BROCK WILL BE SOC." (JH)

**10780:** FREEDOM STAR 1326Z With CAPE RADIO, radio check. Freedom Star advised he'd be working the Cape Radio later on (missed) freq. (JH)

**10873.7:** RFVINVS: FS La Nivose 1940 ARQ-E3 100/400 Navy Vessel LA NIVOSE with 5-1g t/c to ALLINDI and RFGW, Paris, via RUN, Le Port — Djibouti, circuit. (PT)



10917.7: RFTJ: FF Dakar CdeV on TJF cid ARQ-E3 48/400 0742Z (RH2)  
11039: DDH9: Hamburg Meteo RTTY 50/400 1756Z Freq info file://147.3 and 14467.3 kHz (RH2)  
11121.7: 9MR: Malay Navrad RTTY 50/850 1845Z WX/Malay to ALL Ships SABAH and SARAWAK (RH2)  
11153: NAVY On SAM with HF radio check via Andrews 4967.6 USB 2229Z. Advising they have departed KTCM and will arrive PHIK at 0540Z. Informs Andrews they will be reporting at the top and bottom of each hour during flight. (CR)  
11175: PACOM 01 with p/p attempt via Hickam to busy number then switched to discrete for second p/p attempt. USB 0218Z (CR)  
11175: PUMA 03 with p/p via Elmendorf to Dyess Metro for arrival WX at Dyess, Tinker, or McConnell. USB 0256Z (CR)  
11175: RAZOR 26 with p/p via McClellan to Northrop Grumman advising radar malfunction and mission aborted. USB 0256Z (CR)  
11175: JAMBO 21 with HF radio check via McClellan. USB 1943Z (CR)  
11175: ANVIL 51 with p/p via Hickam to Travis CP advising arrival at 0220Z. USB 0126Z (CR)  
11175: REACH 8056 (C-17) with p/p via Hickam to Yokota CP advising in blocks at 0950Z, then p/p to Yokota Metro. USB 0652Z (CR)  
11175: Coast Guard 1700 calling MAINSAIL on "8992 upper" ans by Hickam. USB 2005Z 1700 then requests a p/p, but is advised to meet Hickam on 15.016 due weak signal. (CR)  
11175: KING 74 with p/p via Hickam to Elmendorf metro for 0200Z arrival WX at Vancouver B.C. (CYVR) USB 0109Z. (CR)  
11175: GUCCI 17 with HF radio check via Hickam USB 0139Z. (CR)  
11175: KING 21 with p/p via Hickam to KING OPS USB 0235Z Advising they are cancelling drop times due to WX being out of limits. (CR)  
11175: FOCUS (962nd AWACS) with p/p via Elmendorf to metro for 1700 local arrival WX then p/p to CP with ops rep. USB 0101Z (CR)  
11175: DRAGON 77 Calling SKYBIRD and GIANT TALK (blast from the past!) for HF radio check and finally reached Hickam. USB 0351Z (CR)  
11175: PINION 53 (U-2) with HF radio check and p/p via West Coast to Beale CP for radio check. USB 1923Z (CR)  
11175: GRIZZLY 12 with p/p via West Coast to Eagle Control advising he has split from formation with Grizzly 11 and is heading to San Francisco to burn fuel and will RTB after that. USB 1941Z (CR)  
11175: FIGHTING TIGER 22 with p/p via Hickam to HIGH VOLTAGE advising "correction to lima time." USB 0526Z (CR)  
11175: NAVY 49676 With p/p via McClellan to SAMCOM advising enroute and need frequency assignment for mission. SAMCOM

advises primary 277 (11.153.0) and secondary 291 (13.960.0). 2220Z USB (CR)  
11175: SHADOW 38 With p/p via Puerto Rico to COYOTE requesting status of SHADOW 05 and 07, then advised that they "are baseball at this time." 0253Z USB (CR)  
11175: TACIT 44 With p/p via Offutt to RAYMOND 37 with no answer, then to STRIKE OUT CONTROL requesting status of DARK 45 (B-1B) and they are advised that flight was cancelled due WX. USB 0234Z (CR)  
11175: Arizona Air Guard Radio Maintenance with HF radio check via McClellan. USB 2012Z (CR)  
11175: NEWSCAST With communications test. USB 0039Z (CR)  
11175: PIREP2050Z From REACH-5240. C-141. flight level 330. 4138N 9433W. temperature minus 54 Celsius. winds 295/22. (JH)  
11175: RESORT-782236Z With ASCENSION, p/p to LAJES, requesting weather, and requested "DASH ONE FOR YOUR LOCATION TO FINAL DESTINATION LTAG." Wanted to know if the bowling alley was open all night at Lajes. Answer was yes. (JH)  
11175: OFFUTT 1410Z Broadcasts IDECENT REQUEST YOU ECHO THE FOLLOWING, followed by a SKYKING mess. (JH)  
11175: TUNE-75 2014Z With THULE, p/p to KEFLAVIK BASE OPS. ETA 0200Z. Then p/p to USAF AMOC. ETA CYQX 2200Z. ETA BIKF (KEFLAVIK) 0200Z. TUNE-75 also relayed TUNE-03 info to KEFLAVIK. (JH)  
11175: TORCH-77 2159Z With ASCENSION, p/p to (sounds like YAKHOV OPS). Aircraft advised he was one hour from blocks on India ramp. (JH)  
11175: SAM-300 1335Z de ANDREWS RADIO CHECK 1 2 3 3 2 1. (JH)  
11175: NAVY LL79 1740Z With THULE, p/p DSN 476-2108 VPA DUTY OFFICE. ETA Brunswick 2005Z, may go to "PAX RIVER" due to weather. Was advised that local flight ops were on-going at Brunswick. (JH)  
11175: SPAR-66 2013Z With THULE, p/p ANDREWS VFE, requested the working RF for Andrews. (JH)  
11175: NAVY LN543 2034Z With ASCENSION, p/p NAVY DUTY FLEET MAINTENANCE, Maintenance discussion, and aircraft reported unsafe gear port side, barber pole and light on handle. Flt Maint. wanted to know if he was flying dirty or clean, etc. Flt Maint. Recomm. acft RTB "TO SIG" at 2105Z. Acft requested weather for Subic Bay. (JH)  
11175: PAGENTRY TEST2204Z 1 2 3 3 2 1 PAGENTRY OUT. (JH)  
11175: CHILL-31 1943Z Working with THULE, p/p Minot AFB metro. Requested weather update for IRON 609 (restricted flight region?). Weather forecasts for "GOLF, WHISKEY, LIMA, ZULU" were passed separately for each phonetic letter. At 2012Z CHILL-31 had p/p through ANDREWS to

Minot Scheduled confirming AR (aerial refueling) (JH)  
11175: REACH 7X1 In p/p with McGuire AFB CP and metro at 2002Z. ETA McGuire 2230Z, one pallet 3,000 pound offload. 60 pounds hazardous cargo with no special handling, two passengers. Requested customs and agriculture meet the aircraft. (JH)  
11175: MAINSAIL 2010Z Says THIS IS TITAN-18 GROUND RADIO CHECK, HOW COPY (no response) (JH)  
11175: YANKEE-77 1723Z Working with ANDREWS, p/p DSN 922-2431, PENSACOLA BASE OPS (answered by SHERMAN BASE OPS). Yankee-77 advised he was having maintenance difficulties and was returning to Stewart AFB, and would not require Sherman Base Ops services today. (JH)  
11178: HUNTER 01: poss RAF Nimrod 0438 USB wkg PJK: Royal Netherlands Navy Suffisant Curaco. "Can you confirm that you received my last on RATT?" (MADX)  
11181: PACOM 01 with p/p via Hickam to SPAR OPS. USB 0222Z (CR)  
11214: Trenton Military/716 2338 With phone patch, 716 needed WX advisory for Fort Knox? (LH)  
11214: Trenton Military 2058Z with a phone patch to Dover Meteo. (LH)  
11214: SENTRY 32: USAF E-3 AWACS 2008 USB c/g TRENTON MILITARY "on 11232." At 2009, SENTRY realized that he was on the wrong freq, then came up on 11232. (MADX)  
11232: TRENTON2205Z Military passes weather info for Winnipeg to CAMFOR-484. Also said primary freq was 11232, secondary 9007 kHz (JH)  
11232: SENTRY 32: USAF E-3 AWACS 2009 USB wkg Trenton Military w/pp to Robbins Metro (DSN 965-xxxx). Number was invalid, and SENTRY cancelled the request. SENTRY also IDed as CHALICE CHARLIE. (MADX)  
11244: Andrews with EAM for COOKER. USB 0100Z (CR)  
11244: MANGROVE2207Z (airborne CP) broadcasts 32-character EAM, ends with "THIS COMPLETES MESSAGE OF 32 CHARACTERS." (JH)  
11253: RAF VOLMET 2342 USB YL/EE w/aviation WX. (MADX)  
11263: UNID Unknown OMs in EE with mention of satellite. USB 0351Z (CR)  
11282: PETRO 62 With position report via San Francisco Radio. USB 1948Z (CR)  
11282: RATS 62 With position report via San Francisco Radio. USB 1955Z (CR)  
11282: REACH 7169 with position report via San Fran radio and is advised to contact Seattle Center at 128 west. USB 1853Z (CR)  
11282: RANGER 71 with position report via San Francisco Radio. USB 0133Z (CR)  
11384: Northwest 74 with position report via San Francisco Radio followed by SELCAL check and advised to contact Guam. USB 1432Z (CR)

- 11387: Sydney VOLMET with aero WX for locations including Melbourne and Sydney. 1457Z USB (CR)
- 11396: Qantas 52 with altitude report and SELCAL check via Brisbane Radio. 1429Z USB (CR)
- 11536: HMF49: Pyongyang, N. Korea 13.30 ITA2 50/250 KCNA press agency in EE. (PT)
- 12190.2: RFVI: Le Port, Reunion 16.50 ARQ-E3 100/400 Controle de Voie to self via ITT circuit to Mayotte. (PT)
- 12211: UNID: FAPSI 1644 Crowd36 (RH2)
- 12239: UNID: FAPSI RTTY 75/500 1609Z 5LG on Link 70004 (RH2)
- 12359: Southbound 2, Vax498 daily maritime net. (LH)
- 12491: UAKL SS Agat 0936 ARQ crew msg to Kholmok (ML)
- 12570: UFFH M/V Kourilskoe Ozero 1046 ARQ msg to unkwm (ML)
- 12729: UFL Vladivostok rdo 2300 FEC NAVAREA XIII and local WX wngs in EE, 2330 tfc list (ML)
- 12745.5: JJC: Kyodo Tokyo FAX 60/576 0620Z JJ Newspaper —Readable — (by Japanese!) (RH2)
- 12857: RFTJE: FN Dakar RTTY 75/850 2010Z Test tape (RH2)
- 12947.7: UNID: FAPSI 0545Z Crowd36 (RH2)
- 13053.5: VIE: UNID Australia? ARQ 1545Z Marker. Can't find this callsign in CFL or K'fuss (RH2)
- 13059.5: KFS: San Francisco R ARQ 1550Z Marker — not in K'fuss! (RH2)
- 13110: WLO (Mobile, AL) with automated WX broadcast schedule and maritime traffic list. USB 0159Z (CR)
- 13200: JGO-21 (JAY GEE OH 21) 2008Z With OFFUTT, p/p HILDA EAST, then BANGOR OPS (MAINIAC CONTROL). Notified both centers that he was a C-17, tail number 91190, diverting to Bangor AFB, KBGR, because of weather. Requested customs and agr coordination. MAINIAC CONTROL advised they were monitoring UHF 311. (JH)
- 13211: SAM 204 with req. via Andrews to FAX crew orders to Hickam. USB 1944Z (CR)
- 13215: UNID ? Brief transmission between JULIET and WARLOCK with mention of AITC launch. USB 2010Z (CR)
- 13288: San Francisco Radio to Japan Air 69 Request from Oakland Center when they can accept flight level 360 USB 2313Z (CR)
- 13288: Northwest 1 with position report to San Francisco Radio Request for results from the Masters golf tournament and is told that Woods defeated Duval. USB 2315Z. (CR)
- 13288: Korean Air enroute 024 Cleared by San Francisco Radio to flight level 340 via Oakland Center. USB 2319Z (CR)
- 13288: Japan Air 25 enroute Requesting flight level 360 and results of Masters golf tournament. USB 2320Z (CR)
- 13342: Continental 1 with p/p via San Francisco Radio to Continental Dispatch discussing possible divert for medical emergency. Decision is made to rely on doctor that is on the aircraft and press on to Honolulu with a 2250Z ETA. (CR)
- 13375: UNID Numbers in groups of five repeated twice by female with mild English accent. USB 1533Z (CR)
- 13530: KAWN: Offutt AFB? RTTY 75/850 0540Z WXEE (RH2)
- 13565: UNID: UK Mil Cyprus? MFSK 195.3/300 1615Z Linked with 18789.0 kHz (RH2)
- 13593.7: RFFLA: Paris, France 11.27 ARQ-E3 192/400 ALFAN with tfc to RFTJCF/AIG1948 also CdeV from PROVENCE on LFA, Paris — Dakar cct. (PT)
- 13597: JMH4: Tokyo Meteo FAX 120/576 1833Z Good chart — could read text! (RH2)
- 13846.7: RFQP: Djibouti 16.15 ARQ-E3 100/400 Controle de Voie to self being returned on RUN, Le Port — Djibouti circuit. (PT)
- 14373.4: MNRV: WA SANT Net PACTOR 200/200 0715Z Long birthday Msgs\SS to Josef fm Winnie, Nancy and Sagragrio. (RH2)
- 14544.2: DZZ: Budapest, Hungary 15.20 FEC-A 192/850 French Embassy with message conf. reception of TFC, then shut down. (PT)
- 14640: XWK01A Khaosan Pathet Lao Vientiane LAO 0855 RTTY 50/350 ID tape, 0950 local NX EE (ML)
- 14700: BAA: Beijing Met 1200 RTTY 50/1600 id tape (poor copy) and AAXX WX (ML)
- 14700: UNID: China?? 15.20 ITA2 50/1500 Meteo station with WX info originating from BABJ/Beijing. Note huge shift. (PT)
- 14731.7: RFVI: Le Port, Reunion 16.00 ARQ-E3 192/400 Relaying flight info message from RFFIC/MARINE DIPERMIL PARIS to AIG 2133 on ITT circuit to Mayotte. (PT)
- 14759.5: GYU: Gibraltar 13.50 Piccolo 6 Op chat to unknown station. (PT)
- 14780: UNID: UK mil Cyprus? MFSK 195.3/300 1814Z Can't find the duplex! (RH2)
- 14876.7: RFLIG FF Cayenne 1045 ARQ-E3 192/400 5LG msg to RFLI Fort de France, cct RTI (ML)
- 14926.7: RFFIC: Paris, France 19.30 ARQ-E3 192/400 5-lg tfc to RFTJD, Libreville, Gabon being relayed on TJD, Dakar — Libreville, circuit. (PT)
- 15016: Coast Guard 1700 calling MAINSAIL then p/p via Hickam to number. USB 2006Z 1700 initiates p/p with unidentified station (tremendous fading) and is advised to make contact with fishing vessel and order them back to port in Honolulu. (CR)
- 15016: EAM For GRANDMOTHER via Andrews. USB 121Z (CR)
- 15016: KING 60 with p/p via Hickam to GUN-RUNNER advising they are HC-130 (tail #44860) departed KDMA enroute KPDX then p/p to ACCLIMATE advising of arrival time at their station. USB 2000Z (CR)
- 15016: OFFUTT 2110Z Broadcasts two EAM messages, 28 characters each. The first was echoed by ANDREWS at 1948Z: both echoed by THULE on 8992 kHz at 2117Z; the second echoed by PUERTO RICO on all GHFS RFs except 11175 at 2125Z. (JH)
- 15675.7: RFFVAEA: Naqoura, Lebanon 21.00 ARQ-E3 200/400 Service messages to RFFVA, Paris, on FKW cct. (PT)
- 15675.7: FKW: Sarajevo?? 18.30 ARQ-E3 200/400 Yesterday was unable to sync with this signal but today OK in ARQ-E3. Sends only "QSL FKW 006," "DE FKW INT ZDK TON 19 ZES2" and "QSL 20?" First time I have seen them using Circuit ID as callsign (PT)
- 15794: UNID: UK mil Cyprus MFSK 195.3/300 1800Z (RH2)
- 15860: S97: Swedish Embassy-Abidjan 2325 2400bd QPSK wkg UNID. Signoff with MIL-STD 188-141A. (MADX)
- 16009.7: Egyptian Embassy Dar es Salaam (JG MKF KDP DKJ) 1230 ARQ ATU-80 msg to Cairo (ML)
- 16140.3: UNID: Spain?? 14.20 ITA2 50/400 Slow hand-typed tfc in SS, mixed in with SSB tfc in SS. (PT)
- 16163: GYU RN Gibraltar 1100 PICCOLO-6 svc msgs to unkwn (ML)
- 16240: W3S: Islamabad, Pakistan 09.40 FEC-A 192/400 French Embassy. Calling P6Z, Paris, with RY's and COMMENT ME RECEVEZ-VOUS. (PT)
- 16260: W3S French Embassy-Islamabad 1015 FEC-A 192/850 clg P6Z Paris then to idling (ML)
- 16284.5: MKD: Akrotiri, Cyprus 15.31 Piccolo 6 British mil. with op chat to unknown station. (PT)
- 16324.7: UNID: prob RFTJD: French Forces Libreville 1937 ARQ-E3 192/400 w/plaintext tfc in French regarding Libreville. Text was broken and sync was intermittent. (MADX)
- 16324.7: RFTJ: Dakar, Senegal 19.40 ARQ-E3 192/400 Controle de Voie being returned on Libreville — Dakar circuit, JDJ. (PT)
- 16338.7: Algiers, Algeria 14.55 Coquelet 8 Tfc in AA and 5-lg tfc from MAE to various Middle East Embassies. (PT)
- 16338.7: Algiers, Algeria 15.50 Coquelet 8 MAE with svc message to "AMBALG LE CAIRE." (PT)
- 16376: LSD376: Buenos Aires R RTTY 75/850 1955Z WXSS "de 305 Oceanica" (RH2)
- 16631.7: Egy Embassy Tfc\AA with Cairo — thought the Gippos had closed out ARQ!? Luanda ARQ 1130Z (RH2)
- 16685.5: ZENC: UNID British vessel 1724 SITOR-A w/end of QSO. QRT w/"24475 ZENC X+?" (MADX)
- 16718: UGQJ PTR Berillovyj 2306 ARQ log on and ship tfc to Vladivostok (ML)
- 16830: SVU: Olympia Radio 2058 CW w/channel mkr. (MADX)
- 16879: LZW: Varna, Bulgaria 14.50 FEC Varna Radio with traffic list. (PT)
- 16985.7: CTP: NATO Lisbon RTTY 75/850 1850Z NAWS de CTP etc (RH2)



17045.6: 9MG: Penang R ARQ Marker 1559Z (RH2)  
 17175.2: UFL: Vladivostok Radio 2335 FEC w/MIB. QRT at 2339 w/"NIL GB 73 DE UFL SK". (MADX)  
 17215.7: LOR: PNR Puerto Belgrano "Fm CEBA to BHPD info SIME" — "Avisos de Ventos Fuertes" RTTY 75/170 1145Z (RH2)  
 17314: SPO81: Szczecin Radio 1951 USB YL/Polish w/probable currency exchange rates. (MADX)  
 17421.7: UNID:FAPSI 5LG on Link 50035 RTTY 75/500 1755Z (RH2)  
 17430: UNID: FAPSI RTTY 75/500 0510Z 5LG on Link 30044 (RH2)  
 17441.5: 5YE: Nairobi Meteo RTTY 100/850 WX codes 0456Z (RH2)  
 18040.5: GXQ: London, England 11.33 Piccolo 6 Op chat to UNID station. (PT)  
 18064: UNID: MFA Warsaw Claris Msgs/Pol Pol-ARQ 100/240 1757Z (RH2)  
 18183.4: UNID: Ambalg Luanda Coq8 26.67 0815Z Admin Msg/FF to Algiers - followed by MAE to Kinshasa and Ouga, then MAE to N'Djamena & Niamey, then MAE to London, Antan, Libreville and Yaounde' the Ambalg Tripoli Msg/AA to MAE & Dakar ...and so on! (RH2)  
 18185.5: S73: Swedish Embassy Lagos 2023 MIL-STD 188-141A clg S00: Swedish MFA. No follow-on t/c noted. (MADX)  
 18220: JMH5: Tokyo Meteo 1650 FAX 120/576 w/weak, but recognizable chart. (MADX)  
 18220: JMH5: Tokyo Meteo FAX 120/576 0745Z Wind analysis chart. Clear! (RH2)  
 18249: UNID: 1700 UNID 11 "pips" each .9 seconds apart and .05 seconds duration followed by one "ping" one/second (MADX)  
 18308.5: RFGW: MFA Paris FEC-a 192/400 1815Z 5-6LG to Embassy (RH2)  
 18308.5: RFGW: MFA Paris FEC-a 192/400 1950Z 5-6LG with letter/subs — looked like Embassy Circular! (RH2)  
 18308.5: RFGW: MFA Paris FEC-a 192/400 1825Z Clg S5F/Brasilia then 5-6lg with letter sub. (RH2)  
 18444.5: RFFXL: Naqoura, Lebanon 16.00 ARQ-E 184.6/400 COMELEFRANCE LIBAN with t/c in French to RFFAAC/TRI-POST PARIS on XZL circuit. (PT)  
 18447.7: RFTPA: Ndjamena, Chad 16.41 ARQ-E3 200/400 COMELEF NDJAMENA with t/c in FF to RFFGC/HOPIARM METZ using FD? circuit (prob FDZ). (PT)  
 18447.7: RFQPTA: FF N'Djamena ARQ-E3 200/400 1745Z Idling for 20 mins! (RH2)  
 18553.7: RFTJWD: Dakar, Senegal 16.00 ARQ-E3 192/400 Service message to RFLIC, Fort de France on TJI circuit. WUN RF list shows RFTJWD as Navy at Cap Vert, near Dakar. (PT)  
 18663.5: GYU: Gibraltar 11.54 Piccolo 6 Op chat to UNID station. (PT)  
 18666: SU1: FBI Salt Lake City 1834 MIL-STD 188-141A w/sounding call (MADX)  
 18761.9: V5G: Bucharest, Roumania 11.03 CW/Rou-FEC 164.5/400 Op chat in CW to

UNID station then into Rou-FEC. (PT)  
 19031.7: Pakistani Embassy, Riyadh 1025 ARQ svc msg to Islamabad (ML)  
 19036.4: Kampala, Uganda 13.16 Coquelet 8 Algerian Embassy with SUPERFLASH message in FF to MAE, Algiers. (PT)  
 19067.7: Egyptian Embassy, Kuala Lumpur (JG WLKDKDJYLF) 1125 ARQ ATU-80 msg (ML)  
 19145.7: RFQP: Djibouti 14.00 ARQ-E3 200/400 Controle de Voie to self being returned on DKJ, Dakar - Djibouti, circuit. (PT)  
 19251.7: Egyptian Embassy, Pyongyang (FROM BOUSTAN PYONG YANG) 1120 ARQ 5LG msgs (ML)  
 19404: UNID: Romania? 09.20 Rou-FEC 164.5/400 CIRCULARA's in English re OSCE events. These headed "CIRCULARA/ALGER", so could they be coming from Roumanian Embassy in Algiers?. (PT)  
 19530.7: KAWN: Offutt AFB? RTTY 75/850 1525Z Endless foxes!! (RH2)  
 19675.1: UNID 1910 ARQ-M2 200/400 idle. RFFA reported here in the past. (MADX)  
 19697.5: SPB: Szczecin, Poland 11.00 FEC Szczecin Radio with traffic list. (PT)  
 19724.5: UIW: Kaliningrad, Russia 13.15 ITA2 50/170 Kaliningrad Radio with RY's and "DE UIW ANS 16621,5". (PT)  
 19971.8: UNID 1959 Minimum-FSK

100(?) /50. C3Gold reads 18.1 baud, but sounds more like 75 or 100. Signal was active for short periods. Anyone familiar with this signal? (MADX)  
 19986: CTP: NATO Lisbon RTTY 75/850 1958Z NAWS de CTP etc (RH2)  
 20141.2: Lagos, Nigeria 16.30 Coquelet 8 13.3 baud Algerian Embassy with t/c in FF to MAE and "MDN/DREC". (PT)  
 20631: LAJES/PLA 2156 USB wkg ANDREWS/ADW and MCCLELLAN/MCC in vx MIL-STD 188-141A radchecks. (MADX)  
 20633.7: RFV1: Le Port, Reunion 15.45 ARQ-E3 100/400 Controle de Voie to self on REI cct to Paris. (PT)  
 20856.7: RFQP: Djibouti 12.00 ARQ-E3 200/400 Controle de Voie to self on DJK circuit to Dakar. Also relaying RFTJ's CdeV. (PT)  
 20958: S12: Swedish Embassy Bogota 2055 2400bd QPSK wkg S84: Swedish Embassy Washington, D.C. Sign-off with MIL-STD 188-141A. (MADX)  
 21074.9: VE1YZ: UNID Ham Relay SailMail Station 1802 PACTOR 1 200/200 w/radio email to S/V. ID'd in TFC as SailMail in Halifax (MADX)  
 21865: UNID: MFA Warsaw 100/240 Long religious epistle in EE followed by Claris

## German Navy Callsigns — Part II

Call	Vessel Name	Type -Class
DRKU	FGS ODENWALD	AUXILIARY SHIP A-1436
DRLC	FGS FW-5	FRESH WATER SHIP Y-868
DRLE	FGS HELGOLAND	TUG A-1457
DRLF	FGS FEHMARN	TUG A-1458
DRLG	FGS EISVOGEL	TUG & ICE BREAKER A-1401
DRLH	FGS EISBAER	TUG & ICE BREAKER A-1402
DRLI	FGS WANGEROOGE	SALVAGE TUG A-1451
DRLJ	FGS SPIEKEROOG	RIVER TUG A-1452
DRLK	FGS NORDERNEY	RIVER TUG A-1455
DRLM	FGS LUETJE HOERN	HARBOR TUG Y-812
DRLN	FGS KNECHTSAND	HARBOR TUG Y-814
DRLO	FGS SCHARHOERN	HARBOR TUG Y-815
DRLP	FGS VOGELSAND	HARBOR TUG Y-816
DRLQ	FGS NORDSTRAND	HARBOR TUG Y-817
DRLS	FGS LANGENESS	HARBOR TUG Y-819
DRLW	FGS NEUWERK	HARBOR TUG Y-823
DRLX	FGS ELLERBEK	HARBOR TUG Y-???
DRLY	FGS HEPPEMS	HARBOR TUG Y-1681
DRLZ	FGS NEUENDE	HARBOR TUG Y-1680
DRMC	FGS HELMSAND	HILFSSCHIFF Y-862
DRME	FGS KRONSORT	HILFSSCHIFF Y-863
DRMF	FGS SCHWEDENECK	HILFSSCHIFF Y-864
DRMI	FGS BARBARA	TRIALS PLATFORM Y-844
DRML	FGS HOLNIS	TRIALS SHIP Y-836
DRMN	FGS WILHELM PULLWER	TRIALS SHIP Y-838
DRMO	FGS MUEHLHAUSEN	HILFSSCHIFF M-1052
DRMQ	FGS AM-6	Y-1674
DRMT	FGS PETER BACHMAN	AUXILIARY Y-1684

Msgs/Pol Pol-ARQ 1223Z (RH2)  
**21974:** TAD: MFA Ankara FEC-a 144/850  
 1551Z Idling (RH2)  
**22288.5:** UNID: 1943 SITOR-A 100/170 wkg  
 CBV: Valparaiso Radio w/SLGs. QRT at  
 1953 with no ID. (MADX)  
**22315.5:** UFML TH Kapitan Gnezdilov 1120  
 ARQ msg to Moscow (ML)  
**22383.5:** WLO: Mobile Radio 1941 CW w/ID  
 and SITOR free idle. (MADX)  
**22461:** FUJ: French Navy Noumea 1938  
 BAUDOT 75/800 w/test tape. (MADX)  
**22537:** FUF: French Navy Fort de France  
 1930 BAUDOT 75/850 w/test tape. (MADX)  
**22550.3:** MGJ: Royal Navy 1928 BAUDOT  
 75/311 w/CARB. Typically part of a 4-chan-  
 nel VFT. (MADX)  
**22583:** FUX/RFVIE: French Navy Le Port  
 1923 BAUDOT 75/810 w/ "OO FAAA DE  
 RFVIE ZNR UUUUU ZUI TESTING FUX"  
 then RYs and SGs. (MADX)  
**22610.5:** CLA: Havana Radio 1919 CW  
 w/call tape. (MADX)  
**22680:** UNID: 1917 UNID 150/800.  
 Encrypted? (MADX)  
**22744:** SVN73: Olympia Radio 1915 USB  
 OM AND YL in Greek. (MADX)  
**22786:** SVN76: Olympia Radio 1815 USB  
 wkg UNID MV w/pp tlc in RR. (MADX)  
**22857.7:** RFVI: Le Port, Reunion 13.25 ARQ-

E3 100/400 Controle de Voie to self on VII  
 cct to Noumea. (PT)  
**23190:** RFGW: Paris, France 09.30 FEC-A  
 192/400 MFA with 5-lg tlc to unknown sta-  
 tion. Using letter substitution, eg "A" sent as  
 "CF." (PT)  
**23316.5:** UGOX TH Kapitan Kurov 0738  
 ARQ svc msg to Vladivostok (ML)  
**23365.4:** HGX21: Budapest, Hungary 14.00  
 Dup-ARQ 125/170 MFA with 5-lg tlc to  
 HGX41, Damascus Embassy. (PT)  
**24370:** P6Z: MFA Paris FEC-a 192/400  
 1515Z Clg N2G (San'a) with Msg\FF using  
 Letter/substitution (RH2)  
**24537:** UNID: Maeroma? 228.6/170 looked  
 like online crypto using 5bit mode — nor-  
 mally EIGHT bit and 5LG!Rs-ARQ 1620Z  
 This freq, used by Rome and often heard up  
 to six months ago! (RH2)  
**25186.1:** ESA: Tallinn, Estonia 10.40 ARQ  
 "TALLINNRADIO" with marker tape and  
 ID. Later tlc list in FEC. Using wider than nor-  
 mal shift, about 220 Hz. (PT)  
**26241.7:** RFVI: Le Port, Reunion 15.56  
 ARQ-E3 100/400 COMAR LA REUNION  
 with "Retransmission Information Nautique"  
 in EE to RFVIFLR/AIG1946 (isn't  
 FLR the frigate Floreal?). copied to  
 RFVITT/DETMAR MAYOTTE on REI cct  
 to Paris. (PT)

**New!** The latest in  
 weather technology!



Our new Vantage Pro weather stations offer forecasting, on-screen graphing, and multiple alarm settings.

- Monitor temperature, wind, UV, rain, barometric pressure, humidity, and more.
- Quick-view icons and moving ticker tape display show the forecast.
- Over 80 graphs give instant analysis of highs & lows and historical data.
- Up to 70 alarms notify you of critical conditions.
- Optional data logger and PC software for even more analysis.

Wireless or cabled, starting at just \$495! Order now, or ask for your FREE catalog.

POC0107

**Davis Instruments**

3465 Diablo Ave, Hayward, CA 94545  
 800-678-3669 • www.davisnet.com

Call	Vessel Name	Type -Class
DRMU	FGS SP-1	AUXILIARY A-1408
DRMW	FGS STIER	AUXILIARY A-????
DRMX	FGS ALLIANCE	SUBMARINE DESTROYER
DRNA	FGS AK-4	AUXILIARY Y-1673
DRNB	FGS AK-6	AUXILIARY Y-1674
DRNE	FGS HIEV	AUXILIARY Y-875
DRNF	FGS GRIEP	AUXILIARY Y-876
DRNJ	FGS MA-1	AUXILIARY Y-1678
DRNL	FGS BALTRUM TAUCHERSCHULB	Y-1661, Diving School Boat
DRNM	FGS JUIST TAUCHERSCHULB	Y-1664
DRNN	FGS LANGEORG	TRAINING SHIP Y-1665
DRNO	FGS BUMS	HILFSSCHIFF
DRNR	FGS BOTSAND	AUXILIARY Y-1643
DRNS	FGS ASSCHAU	AUXILIARY Y-1685
DRNU	FGS AK-2	AUXILIARY Y-????
DRNV	FGS AK-1	AUXILIARY Y-1671
DRNW	FGS AK-3	AUXILIARY Y-1672
DRNX	FGS MA-2	AUXILAIRY Y-1676
DRNY	FGS MA-3	AUXILIARY Y-1677
DRNZ	FGS BORBY	AUXILIARY Y-1687
DROI	FGS EVERSAND	AUXILIARY Y-1644
DROK	FGS TF-1	TORPEDO RECOVERY SHIP Y-851
DROO	FGS TF-5	TORPEDO RECOVERY SHIP Y-855
DROP	FGS TF-6	TORPEDO RECOVERY SHIP Y-856
DROR	FGS TODENDORF	SAFETY CRAFT TV-1
DROS	FGS PUTLOS	SAFETY CRAFT TV-2
DRXP	FGS MITTELGRUND	AUXILIARY Y-864
DRXQ	FGS KALKGRUND	Y-865
DRXR	FGS BANT	AUXILIARY Y-867
DRXS	FGS BREITGRUND	AUXILIARY Y-866
DRXU	FGS STOLLERGRUND	AUXILIARY Y-863

**PowerPort** **Worldpouch for FT-817**

Belt pouch or fanny pack—padded and waterproof. Add 2.3 AH power kit & go anywhere!

**800-206-0115**  
 www.powerportstore.com

**Tune In PopComm Previews on "Spectrum"**

Get the goods on each upcoming issue of **Popular Communications**, direct from Editor Harold Ort, N2RL, the fourth weekend of each month on the "Spectrum" radio program, broadcast worldwide on shortwave over WWCR Radio, 5.070 MHz, Saturdays at 11:00 PM Eastern time.

Saturdays, 11 pm on WWCR Radio, 5.070MHz





*During the end of March, frequent UTE log contributor Roland McCormick took this picture of the German Navy frigates Koeln & Molders docked at Savannah, Georgia.*

26241.7: RFVIE: FF Le Port ARQ-E3  
100/400 0611Z 5LG to RFKA/Brest (RII2)

This month's log contributors:

Craig Rose (CR)  
Dwight Simpson (DS2)  
J.Hall (JH)  
Leroy Hogan (LH)  
Mid Atlantic (MADX)  
Murray Lehman (ML)  
Peter Thompson (PT)  
Robert Hall (RH2)

Thank you all very much for your efforts. It is appreciated!

### Next Month

Every year near the 25th of April Amateur Radio operators celebrate International Marconi day in order to celebrate the memory of that pioneer of radio (who did not invent the medium, but did exploit its commercial potential first).

This year amateur radio station K6KPH will be on the air for International Marconi Day (IMD) from the original transmitting and receiving stations of ex-RCA coast station KPH, which traces it's history back to the days of Marconi operation at the Bolinas transmitting site.

This station is significant, as it was one of the last commercial CW stations in operation. As a result the site is in excellent condition, including the original transmitter and antenna farm.

Next month's column will provide coverage of that event, and provide some excellent pictures of the building and site on that day. Along with that I will be providing some historical material on KPH, as well as background on the Maritime Radio Historical Society who maintain and operate the site.

So until next time, may all of your monitoring actives be rewarding, enjoyable, and most importantly — fun!

On pages 74 and 75 of this column is the continued list of German Navy vessel callsigns begun last month. These have been compiled from the logs of Ron Perron (aka Middle Atlantic Milcom) as well as listings in Jane's Fighting Ships; various websites; and research on international callsign allocations. The German Navy's website indicates that some of the vessels on this list are not active; however, their callsigns were still carried in the 1999 international ship listing. These vessels have been logged in both USB voice and RTTY traffic. If you have any questions please contact Ron at Rapbep@aol.com. ■

## readers' market

WANTED: AOR2002 scanner-contact Joseph at P.O. Box 268, Lynn, MA 01903.

**CB MODIFICATION SECRETS**, big new 200-page guide by Kevin Ross, author of "CB Radio Hacker's Guide." More great easy-to-do AM/SSB CB equipment upgrades and enhancements applicable to Cobra, Realistic, Uniden, President, etc. Freq. expansion, VFO, clarifier unlock, VOX, Roger Beep, anti-theft device, receive signal preamp, much more. Only \$21.95, plus \$5 s/h (\$6 to Canada) from CRB Research Books, P.O. Box 56, Commack, NY 11725. NY residents add \$2.22 tax. VISA/MC orders call: (631) 543-9169.

**SCANNER ANTENNAS:** VHF/UHF Discone base antennas \$29.95 + S&H, HF/VHF/UHF "Super" Discone \$45.95 + S&H, Super Scan Duck handheld antennas \$19.95 + S&H. Also antennas for amateur, CB, Cell, GMRS, MURS, SWL, TV. Antenna Warehouse, 811 9th Avenue, Camanche, IA 52730. MC/Visa toll free order line: 877-680-7818. [www.antennawarehouse.com](http://www.antennawarehouse.com)

WANTED: X-BAND RADAR AND MICROWAVE EQUIPMENT. CIVILIAN, MILITARY — ALSO PARTS TM'S PUBLICATIONS, ETC. RADAR, BOX 10215, PITTSBURGH, PA 15232.

**SAVE IMPORTANT RADIO TRANSMISSIONS WITH THE PROFESSIONAL FULLY AUTOMATIC VOICE ACTIVATED 12 HR RECORDER. SEND \$95 TO VAKIS, 2930 PINE AVE., NIAGARA FALLS, NY 14301.**

**SCANNER CRYSTALS FOR SALE.** Send a long SASE for list and price to G E Jones, P.O. Box 467, Buckeye Lake, OH 43008.

**CB MODIFICATIONS! 10M, frequencies, sliders, amplifiers, FM, books, plans, kits, high-performance accessories. The best since 1976. Find out why! Catalog \$3. CBCL, BOX 1898A, MONTEREY, CA 93942. <[www.cbintl.com](http://www.cbintl.com)>**

**CELLULAR IMAGE SCANNERS!! 10/11 METER RADIOS, MICROPHONES, POWER SUPPLIES, CB REPAIRS/MODS, BUYING CB AND SCANNERS!! QUOTE FOR SASE!! PRICE SHEETS \$1.00 (REFUNDABLE) GALAXY, BOX 1202, AKRON, OHIO 44309.**

**SATELLITE TV** — Large selection of items at reasonable prices. We specialize in Big Dish TVRO C & Ku Band equipment. Check us out at [www.daveswebshop.com](http://www.daveswebshop.com)

**vip**

# spotlight

## Congratulations To Johnny Bernays, Jr. Of Arkansas!

**P**opular Communications invites you to submit, in about 150 words, how you got started in the communications hobby. Entries should be typewritten, or otherwise easily readable. If possible, your photo (no Polaroids, please) should be included.

Each month, we'll select one entry and publish it here. Submit your entry only once; we'll keep it on file. All submissions become the property of *Popular Communications*, and none will be acknowledged or returned. Entries will be selected taking into consideration the story they relate, and if it is especially interesting, unusual, or even humorous. We reserve the right to edit all submitted material for length, grammar, and style.

The person whose entry is selected will receive a one-year gift subscription (or one-year subscription extension) to *Popular Communications*. Address all entries to: "How I Got Started," *Popular Communications*, 25 Newbridge Road, Hicksville, NY 11801 or E-mail your entry to [popularcom@aol.com](mailto:popularcom@aol.com), letting us know if you're sending photos. If you're E-mailing photos, please send them in a separate E-mail with your name in the "subject" line.

### Our July Winner, KD5MPM Says: Radio, A Rich Man's Hobby?

*Popular Communications* reader, Johnny Bernays, Jr. of Hot Springs, Arkansas, says, "I've been an avid SWLer, VHF public service monitor, and general radio 'nut' since I was five years old. In 1955 I started building Xtal sets, reading *Pop'Tronics* and was a Novice in 1958, but later in life fell on 'hard times,' became a 'hobo' and a traveling folk singer, traveling the lower 48 plus Canada and Mexico. I had very little time for the amateur radio hobby, except when I stayed in one city longer than three or four months, when I'd buy an SW receiver, scanner, and CB to enjoy radioing.

Now, in my 'old age' I have retired to my hometown, Hot Springs, where I live in a 1961 Chevy van with a collection of Boat Anchors and 'modern' 2-meter gear. Besides the equipment in the photo I have added a Heathkit HW 22 40-meter SSB Xcvr, a 1955 Hallicrafters S-85 SW receiver (in pristine condition!), a Realistic DX-398, and a Kenwood TM 231A 2-meter. I record many SW programs using two dual-deck cassette recorders, an Optimus SCT-57 Professional Series and a Soundesign. All of this equipment was purchased very reasonably or else rescued from dumpsters, the city dump, or given to me by other amateurs who know my economic situation. The FCC, in its infinite wisdom, gave me the perfect callsign for phonetics: KD5MPM, meaning Kilo Delta 5 Mighty Poor Man!

Oh, I also have a Bearcat BC-200XLT scanner and am an active storm spotter and emergency traffic handler. My application to the Army Military Affiliate Radio Service is pending. This old hobo now rides the airwaves, not the railways! (I don't have a picture of myself)."



*Johnny's 1961 Chevy van.*

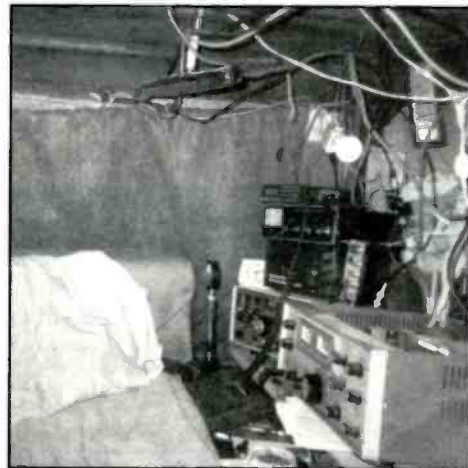

*Inside he's got tons of equipment.*

*A close up of Johnny's radio gear, most of which was procured from fellow hams and nearby dumpsters!*





## Resource Of The Month: RadioShack.Com



RadioShack estimates that 94 percent of all Americans live or work within five minutes of a RadioShack store or dealer. That being the case, you're probably quite familiar with your local store, receive their frequent mailings and think it strange I've chosen their website for "Resource of the month." Well, truth is, paying a visit to their website before going to your local store might just save you some money. Online you'll find: Web Specials, Items on Sale, printable Store Coupons and a downloadable "Online Specials" catalog featuring closeouts, clearance, discontinued and other limited quantity merchandise. Online ordering is also available. If you're going to make a RadioShack purchase, you'll find it well worth your time to explore their site first at <http://www.radioshack.com/>.

## Other Outstanding Resources:

Remember: ALL online resources and contacts appearing monthly in Pop'Comm are available at the Quick Links site: <http://www.dobe.com/ql/>

### CB RADIO

The Ultimate Guide to 11-Meter CB Antennas

[http://members.tripod.com/~cb\\_antennas/](http://members.tripod.com/~cb_antennas/)  
by Scott <2RP789@netscape.net>  
Recently Updated — Superb!

### AMATEUR RADIO

AC6V'S Amateur Radio & DX Guide by Rod Dinkins

<http://www.ac6v.com/>  
Over 700 Amateur Radio Topics — 6,000+ Links Updated Frequently

### PIRATE RADIO

KMUD Radio — 43 Meters by (Identity Withheld)

<http://www.qnet.com/~v1fradio/kmud.htm>  
KMUD Photos — Realm of Inyo (Thanks for the tip Van)

### MEDIUM WAVE DX

BCB DX LOGBOOK by Lee J Freshwater

<http://www.geocities.com/amlog-book/main1.htm>

North American AM and TV Databases  
New Site with Updated Listings

### CW SOFTWARE

CwGet Morse Decoder by UA9OSV

<http://www.dxsoft.com/>

Superb CW Decoder that works with your PC's sound card.

### MORSE CODE ABBREVIATIONS

Morse Code Abbreviations by AC6V

<http://ac6v.com/morseaids.htm#CW>

Nice reference for use with the CwGet Morse Decoder above.

### PROGRAMMING

RBASIC Programming Language by WiNRADIOÆ Communications

<http://www.rbasic.com/>

Free software that will run with The WiNRADIOÆ Demo program

### SCANNING FREQUENCIES

Scanner Frequency Guide by 911Scanner.8m.com

<http://www.911scanner.8m.com/>

Huge, no frills, frequency database. Lists seem dated, but appear OK.

### BCL CONTEST 2001

Selecting a Scanner Article At Dxing.com

<http://www.dxing.com/selectscan.htm>

Good information if you're about to Buy a scanner.

# ADVERTISERS' INDEX

Advertiser	Page Number	Website Address
ADI/Premier Communications	21	www.adi-radio.com
AOR USA, Inc.	13	www.aorusa.com
Alpha Delta Communications, Inc.	23	www.alphadeltacom.com
Antenna Supermarket	61	
Antique Radio Classified	21	www.antiqueradio.com
Atomic Time, Inc.	15	www.atomictime.com
Bill's CB & 2-Way Radio Service	38	www.bills2way.com
CQ Calendars	37	www.cq-amateur-radio.com
CQ Merchandise	31	www.cq-amateur-radio.com
CQ Videos	35	www.cq-amateur-radio.com
C. Crane Company	Cov. III	www.ccrane.com
C & S Sales, Inc.	27	www.cs-sales.com
CRB Research	21, 38, 75	www.crbbooks.com
Computer Aided Technologies	43	www.scancat.com
Cubex Co., Inc.	79	www.cubex.com
Cutting Edge Enterprises	75, 79	www.powerportstore.com
Davis Instruments	75	www.davisinstruments.com
ICOM America, Inc.	5	www.icomamerica.com
Jo Gunn Enterprises	37	www.jogunn.com
Lee Electronics Company	79	www.LeesElect.com
Lentini Communications, Inc.	1	www.lentinicomm.com
MACO Mfg. Div/Majestic Comm.	38	www.majestic-comm.com/maco
MFJ Enterprises, Inc.	39	www.mfjenterprises.com
Monitoring Times	57	www.grove-ent.com
Optoelectronics, Inc.	Cov. IV	www.optoelectronics.com
Phillips-Tech Electronics	79	www.phillips-tech.com
REACT International, Inc.	55	www.reactintl.org
Radioworld, Inc.	20	www.radioworld.ca
Ranger Communications, Inc.	29	www.rangerusa.com/PC
Signal Engineering, Inc.	20	www.signalengineering.com
Universal Radio, Inc.	3	www.universal-radio.com
Viking Systems International	27	www.vikingint.com
Yaesu USA	Cov. II	www.yaesu.com

Reach this dynamic audience with your advertising message, contact Don Allen, W9CW at 217-344-8653, FAX 217-344-8656, or e-mail: [PCAdvertising@aol.com](mailto:PCAdvertising@aol.com).

**Lee Electronics**  
 Scanners, SW, FRS and More:  

**AOR** & **Gbra** Bearcat **BayCom**  
**SANGEAN** **ICOM** **uniden**  
**1-800-578-6006**  
 Tech: (724) 275-5822  
[www.LeesElect.com](http://www.LeesElect.com)

**POWERPORT VX-5**  
 Leather pouch with pocket on back for antenna tip & sturdy clip. Many other pouches available. Call us!  
**800-206-0115**  
[www.powerportstore.com](http://www.powerportstore.com)



**Wireless Internet & TV**  
**WIRELESS CABLE - IFTS - MMDS**  
**ATV - INTERNATIONAL - DIGITAL**  
 Amplifiers • Antennas • Books • Components  
 • RF Frequency 2100-2700 Mhz  
 • SASE For "FREE" Catalog or Send \$1  
**PHILLIPS-TECH ELECTRONICS**  
 P.O. Box 737, 607 Parker St., Trinidad, CA 95570  
**CATALOG/INFO:** 707-677-0159  
**ORDER LINE:** 800-880-MMDS  
**FAX LINE:** 707-677-0934  
**WEBSITE:** [www.phillips-tech.com](http://www.phillips-tech.com)  
**E-MAIL:** [product@phillips.tech.com](mailto:product@phillips.tech.com)  
CHALLENGER SYSTEM 31 Channel Complete \$240 Other Systems Available 5 Year Warranty FREE SHIPPING Visa • MC • AmEx • Discovery • COD's • Quantity Price g

**CUBEX**  
 Quad Antennas  
**New- MAGNUM-CB Quads**  
 Full size 2 el. 4 el. & 6 el 27MHz Quad Arrays  
 Check our **WEBSITE** - [www.cubex.com](http://www.cubex.com)  
 write or call for Free Catalog  
 228 HIBISCUS ST. #9 - JUPITER, FL 33458  
 Phone (561) 748-2830 Fax (561) 748-2831

**WE'RE ON THE WEB**  
 Check out our Web site at:  
[www.popular-communications.com](http://www.popular-communications.com)





## Confessional Amnesty

Well, it's been a quite week in Cornfield County. My Internet service provider, DropNet, has moved up to 28.8kb service — if you're within 1/2 mile of their building, and if my 14.4 modem ever wears out, I'll be moving right up to a 28.8 to take full advantage of the advance.

Quite a few hams — radio amateurs, that is — have mentioned how the Internet has “siphoned off” many who would have been hams if Al Gore had never invented the 'net. Since I usually disagree with everyone, I was about to disagree with that too, but after some thought, I think it really has. Now for certain, there's no thrill in working someone from East Armpit, Bulgaria on a Usenet Newsgroup, but the difference is that you're both there because of a common interest, which is *not* the act of communicating, but instead it is the thing you're communicating about — from collecting dead bugs in amber, to one of the four harmonica groups where I can be found lurking. Even harmonica is broken up into two categories.

But it's not communicating. Well, it is, but with a computer, you're not communicating for the pure joy of, well, communicating. You buy your computer, plug it in, and sign up with a provider. With ham radio, your provider — besides the power company — is your antenna. Now I'm faced with making a joke as to whether an antenna is more reliable than an ISP or less, and the mere comparison is a joke no matter which way you look at it. Actually, the two are very similar. Just think of the way they respond to lightning, wind, and rainstorms. Yup, they're pretty much the same.

I've never put up an ISP. Wouldn't know how. Put up lots of antennas, though, and most of them worked after a fashion, and none ever cost me as much as one month with an ISP.

This lovely month of July has brought to mind one of the many ways I've used to string wire antennas waaaaay up in the air. My first solo attempt was by standing on a roof and tossing a rock with a “heaving line” attached, which I could retrieve on the ground, pull through the crotch of a tree, and eventually pull the wire into place. Dull, and uninteresting.

My friend John, whose code name here shall be Leroy, delighted in such antics. “Get a slingshot,” he said. “And a fishing reel — a spin casting reel.” The whole design unraveled before my eyes. There's even a commercial version of his gadget available today. The slingshot was good, but it was definitely a two-person job, and coordinating the twap of the slingshot with the release of the thumb lever on the reel proved to require more interaction than two of us could muster without laughing. It was a good try, Leroy went home, but as he drove away he stopped, backed up in the driveway and said, “What you need is a rocket!”

It so happened that I indeed had a rocket. I had several of them, actually. My son was a lot younger then, and we would fire a few into the ionosphere every now and then, just so we could do man-stuff and make a lot of smoke and sulphur smell

and talk about it to mom when we came home. It's like fishing, but you don't smell as bad afterward. I'd never launched much of a payload before, so I figured that four D-size engines would be about right to pull a length of 10# test monofilament fishing line up and over some tall trees. Actually, they were very tall trees — they seemed to go up forever — maybe 80 feet.

I should have enlisted the aid of my son, who already knew at least as much as I did about rockets, and I think ~~he'd~~ also memorized the safety pledge that you mail to the company to get a badge or membership with official rocket-brand burn ointment and bandages. Next time you're in a hobby shop, take a look at the rockets, and read the warnings about launching a rocket in any direction except straight up.

Of course I couldn't launch it straight up. How would it pull the wire over that enormous grove of trees? I knew the safety committee of the local rocket club would understand if they knew I was raising a longwire antenna.

Even from my catapult days, I remembered that 45 degrees gives the longest trajectory, so a 45-degree launch angle was calculated and set. We had long since run out of proper igniters, so a bit of magnesium wool from inside a press-25 flashbulb (I really hope someone knows what I'm talking about) twisted and stuffed inside the engine, and spun into about six inches of yarn would be my source of ignition.

When I touched the 9V battery to the wool, I expected it to burn slowly, just the way steel wool did in the same situation. It did not. Magnesium burns *much faster and much hotter* than steel. Shoulda known that, I guess.

I did escape from being burned — barely — but the flash startled me so much that I bumped the rocket as it left the ground. It seemed to go so far, I thought it'd pull all of the ten million or so feet of line I'd had spooled up for the event. I can't tell you how lucky I was that the people whose yard it hit were friends of mine. I could run in those days, and I ran pretty fast to see where it had hit, and it had hit their pool. I was glad, because it eliminated fire as one of the reasons they'd sue me, but it left an awful ash-slick on their pool. Their cookout was barely disturbed. I fished out the rocket, wondering if I could really pull several thousand feet of line through those trees.

It turns out I didn't have to. Monofilament line doesn't stand up well to flames, and there was about a four-inch stub of it dangling from the back of the rocket. Now I remember how I never heard or saw the line being pulled out of the reel.

My wife and son were safe, visiting neighbors when I did all this. They'll read of it the same time you do — sort of like how you tell your folks how you flipped a car when you were fourteen, but it's OK now because there's “confessional amnesty,” granted at all family gatherings to wayward offspring who've just repented.

Have a safe 4th of July, and don't embarrass your children.

# Radio Lovers' Radios

## Sangean ATS505



### Most Features & Best Performance For The Price!

- Continuous All Band SW Coverage
- SSB for Ham Radio Listening
- 45 Memory Channel with Auto Memory Preset
- AM/FM Stereo thru Headphones
- Dual Time Clock with Alarm
- Lighted LCD Display
- Carrying Case & Earbuds
- Size: 8-1/2" W x 5-1/4" H x 1-3/8" D

\$129<sup>95</sup>

## CCRadio



### The Best AM Radio Made Today!

- AM, FM, TV Audio, Weather Band + Alert
- Audio Tuned for Human Voice
- 5 Memory Buttons Per Band
- Rotary Tuning Knob with 1KHz Fine Tuning
- Lighted Digital Display
- 6V DC Input Jack, Charging Circuit and Light Jack
- Optional Solar Kit Available

\$159<sup>95</sup>

**FREE**  
U.S. Shipping  
On All Items

## Smart Accessories

### Portable SW Antenna



Improves All SW Radio Reception

\$14<sup>95</sup>

### Sangean Solar Panel

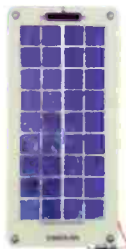

Powers All Sangean Radios, Except 606

\$59<sup>95</sup>

**NEW!**

### Soft Pillow Speaker



A New Level of Listening Comfort and Privacy

\$19<sup>95</sup>

### Radio Turntable



Orientate Your Radio For Best Signal Pickup

\$14<sup>95</sup>

**SANGEAN**  
sangean.com

**FREE CATALOG**  
**1-800-522-8863 (TUNE)**  
From C. Crane Company, Inc.

**C. CRANE**  
**COMPANY**  
ccrane.com



NEW NEW NEW NEW NEW NEW NEW NEW NEW NEW NEW NEW NEW NEW NEW

# Let's Get Digital



# \$529

TA100S antenna, AC90 charger, RS232 cable and download software are included.

## All New DS1000

FOR THE FIRST TIME EVER

a frequency counter that captures DIGITAL RF.

\*The NEW **DS1000** is the only frequency counter in the world capable of locking onto Digital modulations. TDMA, GSM, APCO 25, Tetrapol, On/Off Keying and other pulsed RF (Minimum 500uS pulse required for capture by the DS1000).

The **DS1000** also incorporates the \*patented Optoelectronics feature, Reaction Tune. Using the CI5 output, the DS1000 can automatically tune a compatible receiver to the frequency it captures (Analog signals only). The DS1000 also has an RS232 output for direct connection to a PC for downloading the 1000 internal memories (RS232 cable and download software are included).

- Frequency Range 10MHz-2.6GHz
- Captures Digital and Analog RF
- 1000 memories with a 65,000 hit counter
- Reaction Tune with ICOM IC R10, R7000 R7100, R8500 and R9000. AOR AR8000 and AR8200. Optoelectronics Optocom, OS456/Lite, OS535 and R11. BC245XLT.
- Download memory with built-in RS232(Cable and software included)
- Accurate .5ppm TCXO timebase

### Recommended Accessories

- N100 FM Broadcast Notch Filter \$99
- CBCI5 Reaction Cable for ICOM \$12
- RT8200 Reaction Cable for AR8200 \$39
- RT8000 Reaction Cable for AR8000 \$29
- DB32 Mini Antenna 150-1000MHz \$29

Order Factory Direct 800-327-5912

# OPTOELECTRONICS®

5821 NE 14th Avenue

Ft Lauderdale, FL 33334

Tel: 954-771-2050 Fax: 954-771-2052

[www.optoelectronics.com](http://www.optoelectronics.com)



ICOM and AOR are registered trademarks. DS1000 covered under Patent #5,471,402 and other \*Pat. Pending.

### SIGNAL STRENGTH

The DS1000 can also be used as a field strength meter. The DS1000 displays the power level of the nearfield RF in dBm, which is calibrated at the input of the DS1000. Signal levels can be measured from -45 to -5 dBm with accuracy of +/- 5dBm.

