

Fall  
1995

# **ELECTRONICS HOBBYISTS handbook**

# **PROJECTS**

YOU CAN

# **BUILD**

**WWV Receiver**

**PK Tester**

**Auto Stethoscope**

**Surface-Mount Technology**

**Auto Sprinkler**

**Solar-Powered**

**Model Airplane**



\$3.95 U.S.  
\$4.50 CAN.



# MIXED-MODE SIMULATION

## Design & Verify Faster with Electronics Workbench®

**New  
Version 4**

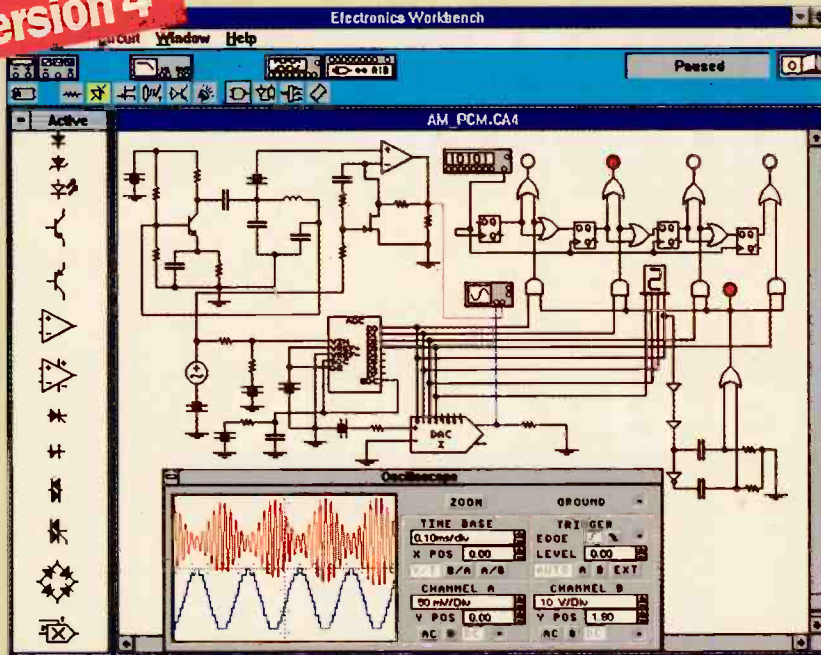

True mixed-mode simulation: Simultaneous AM transmission, digitization and pulse-code modulation of a signal.

### Analog, Digital & Mixed Circuits

Electronics Workbench® Version 4 is a fully integrated schematic capture, simulator and graphical waveform generator. It is simple to mix analog and digital parts in any combination.

### Design and Verify Circuits... Fast!

Electronics Workbench's simple, direct interface helps you build circuits in a fraction of the time. Try 'what if' scenarios and fine tune your designs painlessly.

Electronics Workbench delivers the power you need to design and verify analog, digital and true mixed mode circuits. Over 20,000 customers have already put Electronics Workbench to the test. The result: Better designs... Faster. And over 90% would recommend it to their colleagues.

Electronics Workbench will save you time and money. We guarantee it.\*

# Call Now: 800-263-5552

\*30 day money-back guarantee  
Free unlimited technical support

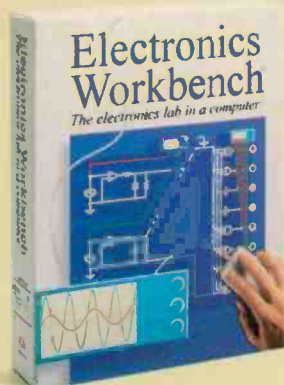

### Electronics Workbench \$299

- Includes:
- Schematic capture
  - Simulator
  - Graphical waveform generator
  - 350 models
- + 15 S/H

### Engineer's Pack \$599

- Includes:
- Electronics Workbench
  - 2,000 Extra Models
  - Export/Import to/from SPICE
  - Export to PCB packages
- + 15 S/H

Yes, I'm interested in  
Electronics Workbench.

Name: \_\_\_\_\_

Title: \_\_\_\_\_

Organization: \_\_\_\_\_

Address: \_\_\_\_\_

Phone: \_\_\_\_\_

I prefer to be contacted by e-mail/fax at:

9EA1FP5

INTERACTIVE IMAGE  
TECHNOLOGIES LTD.  
908 Niagara Falls Blvd. #068,  
North Tonawanda, NY 14120-2060  
Telephone: 416-977-5550  
FAX: 416-977-1818  
E-mail: ewb@interactiv.com  
CompuServe: 71333.3435  
BBS: 416-977-3540



Trademarks are property of their respective holders. Offer is in U.S. dollars and valid only in the United States and Canada.

Australia: 2519-9933 • Brazil: 11-5545988 • Cyprus: 2621098 • Czech Republic: 19-224308 • Denmark: 33-250109 • Finland: 02575093 • France: 149089000 • Germany: 711627740 • Greece: 15249981 • Hungary: 12150082  
India: 15684345 • Indonesia: 21-4721730 • Israel: 36175613 • Italy: 11-4375599 • Japan: 3-94823136 • Malaysia: 37742189 • Mexico: 55995260 • Netherlands: 18081-7666 • New Zealand: 9-2671756 • Norway: 22167045  
Portugal: 181-4669 • Singapore: 7772412 • Slovenia: 61-317890 • South Africa: 34168909 • South Korea: 22222441 • Spain: 15594234 • Sri Lanka: 186-970 • Sweden: 8740550 • Thailand: 662-886952 • UAE: 459596 • UK: 20823426

CIRCLE 126 ON FREE INFORMATION CARD

# CONTENTS

- 19 The "g" Machine** — A portable, digital readout, acceleration measurement gadget that measures the power impulse your car can deliver!
- 24 25-MHz Frequency Counter** — An inexpensive way to place a valuable testing tool on your workbench.
- 30 FM Transmitter** — As large as the law allows, this home-brew transmitter is ideal for budding disc jockeys.
- 35 Novel Nightlight** — The glow of a vacuum tube against a mirrored corner reflector brings nostalgia to the home.
- 37 WWV Receiver** — Pull in the government time station and get bonuses like weather, standard frequencies, and other scientific information.
- 41 Add a Switch to Your Serial Port** — Enable or disable serial ports with a flip of a switch.
- 42 Headphone Amplifier for Your Guitar** — Prepare for a rock-n-roll career or just practice without disturbing anyone.
- 46 Build a Solar-Powered Model Airplane** — A toy to gaze at that moves and never needs batteries.
- 49 Vacuum-Tube Audio Amplifier** — Hear the difference tubes make in sound without putting a dent in your wallet.
- 52 Build the PK Tester** — Discover and develop your latent mind-over-matter abilities.

*(Continued on next page)*

As a service to readers, *Popular Electronics Electronics Hobbyists Handbook* publishes available plans or information relating to newsworthy products, techniques and scientific and technological developments. Because of possible variances in the quality and condition of materials and workmanship used by readers, we disclaim any responsibility for the sale and proper functioning of reader-built projects based upon or from plans or information published in this magazine.

Since some of the equipment and circuitry described in *Popular Electronics Fall 1995 Electronics Hobbyists Handbook* may relate to or be covered by U.S. patents, we disclaim any liability for the infringement of such patents by the making, using, or selling of any such equipment or circuitry, and suggest that anyone interested in such projects consult a patent attorney.

*Popular Electronics Electronics Hobbyists Handbook* is published semi-annually by Gernsback Publications Inc. All rights reserved. Printed in U.S.A. Single copy price \$3.95. Canadian G.S.T. Registration No. 125166280. Canada \$4.50 ©Gernsback Publications Inc., 1994, 1995.

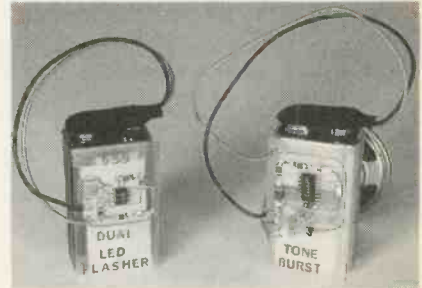

**Surface-Mount Technology**  
(See page 86)



**Auto Stethoscope**  
(See page 63)

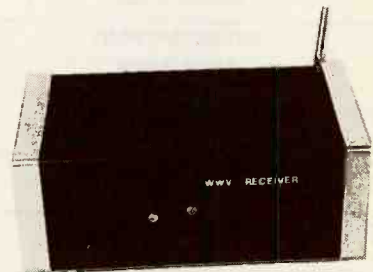

**WWV Receiver**  
(See page 37)

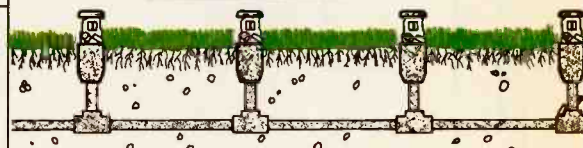
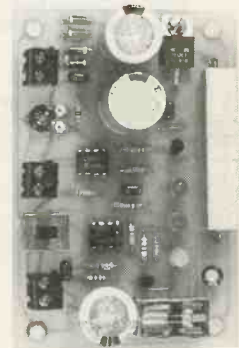

**Sprinkler Guardian**  
(See page 55)

**Popular  
Electronics®  
ELECTRONICS  
HOBBYISTS  
HANDBOOK™**

**Larry Steckler**

*EHF, CET  
Editor-in-Chief and Publisher*

**Julian S. Martin**

*Editor*

**POPULAR ELECTRONICS  
EDITORIAL DEPARTMENT**

**Carl Laron**

*Editor*

**Dan Karagiannis**

*Associate Editor*

**Teri Scaduto**

*Associate Editor*

**Evelyn Rose**

*Editorial Assistant*

**Marc Spiwak**

*Editorial Associate*

**PRODUCTION DEPARTMENT**

**Ruby M. Yee**

*Production Director*

**Karen S. Brown**

*Production Manager*

**Kathy Campbell**

*Production Assistant*

**ART DEPARTMENT**

**Andre Duzant**

*Art Director*

**Russell C. Truelson**

*Illustrator*

**Jacqueline P. Cheeseboro**

*Circulation Director*

**Michele Torrillo**

*P-E Bookstore*

**BUSINESS AND EDITORIAL OFFICES**

Gernsback Publications, Inc.

500-B Bi-County Blvd.

Farmingdale, NY 11735

1-516-293-3000

Fax: 1-516-293-3115

President: Larry Steckler

Advertising Sales Offices listed on page 112.

Cover by  
**Loewy Design**  
Oak Ridge, TN

Cover Illustration by  
**Jonathan Baron**

Composition by  
**Mates Graphics**  
Clifton, NJ



# CONTENTS

(Continued)

**55 Sprinkler Guardian** — Automatically shut off your programmed garden sprinklers at the first drop of rain and save money.

**58 Security in the Information Age** — All about codes in straight talk.

**63 Auto Stethoscope** — Go high-tech to discover those troublesome squeaks in the family chariot.

**66 The "LED-Tric" Christmas Tree** — Light up your holidays with this unusual and festive conversation piece.

**69 Telephone Line Simulator** — You can set up your own mini telephone system, or test telephone equipment.

**78 Frequency Response Tester** — You'll never again have to guess about the frequency response of an audio device.

**84 Variometer Radio** — A new version of a classic design.

**86 Getting Started in Surface Mount Technology** — Develop the skills required to make surface-mount components while building two useful projects.

**90 8-Channel A/D Converter** — Let your computer interface with the physical world.

**97 Making Square Waves at Home** — A cookbook of circuits that'll knock you off your block!

## And Other Things To Read and Do

- 4 New Products**
- 12 Electronics Library**
- 16 Free Information Card**
- 111 Classified Advertising**
- 111 Advertising Index**
- 112 Advertising Sales Office**

# How to stay cool without turning down the air conditioning...

*New device redirects air conditioning to rooms that need it most so you can be more comfortable without inflating your electric bill.*

by Charles Anton



**A**re you constantly adjusting the thermostat every time you're uncomfortable? Turning it down in the summer, up in the winter? Do you manually open or close vents just so air will be redirected to rooms that are too hot or too cold? Most homeowners who have central air conditioning and heating systems have the same recurring problem. High utility bills are the unfortunate result of manually adjusting your home's vents and thermostat.

**Forced air problem.** If you have rooms that never seem cool enough in the summer no matter how the thermostat is set, the problem isn't your air conditioner, it's your registers and ducts.

Some rooms have poor airflow because of bends in the ductwork or their distance from the blower. So if your home has central cooling and heating, you'll probably have at least one room that is always too hot or too cold.

**The better solution.** Now there's the Equalizer EQ<sup>2</sup> by Suncourt. Its built-in fan is designed to pull extra air out of poor-performing registers, helping equalize the temperature

in your home. Every time your cooling or heating system operates, it will pull twice as much air through the duct in half the time. This gives 80% more of the air you have already paid for—air that usually gets lost in the ductwork.

Air doesn't warm up because it spends less time getting to the vent. The Equalizer EQ<sup>2</sup> even continues to run after your system shuts off, making sure all the conditioned air is out of the air duct.

Air from the Equalizer EQ<sup>2</sup> is not diverted from other vents in your home. It is made up of air from the air conditioner instead. The effect on the other registers of your home is negligible. It installs in just seconds—simply place it on top of your existing floor or wall vent and plug it into a standard outlet.

**Intelligent thermostat.** This sophisticated electronic thermostat consists of dual solid-state sensors. When your cooling system starts, it measures the temperature of the register air and the room air and then calculates the temperature differential. It allows you to adjust the thermostat for the automatic on/off function best suited for the register air temperature.

When set on continuous running, it ventilates stuffy rooms. The fan is designed to increase airflow in several directions at once.

**Costs next to nothing.** The Equalizer EQ<sup>2</sup> has no cooling or heating elements, and it turns on and off automatically with your central system. It cost less than two cents a day to run. Compare this to the \$1.25-\$1.75 a day it costs to constantly adjust the thermostat by four degrees to make your rooms comfortable.

**Try it risk-free.** At Comtrad, we back all our products with a risk-free home trial. If you're not completely satisfied, return the Suncourt Equalizer EQ<sup>2</sup> within 30 days for a full "No Questions Asked" refund. It also comes with a full one-year manufacturer's limited warranty. Most orders are processed within 72 hours and shipped UPS.

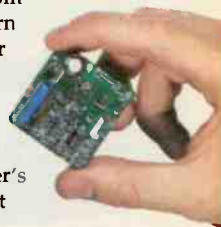

The Equalizer EQ's built-in microprocessor

### The perfect solution for problem cooling and heating

- **Uneven temperatures.** You have rooms that are always too hot or too cold.
- **Saving money.** You want to keep the thermostat turned up without sacrificing comfort.
- **Apartment.** You live in an apartment and want to increase fuel efficiency without making a permanent investment.
- **Convenience.** You don't want to bother with opening or closing off vents in the problem rooms.

Your vents are wasting your money. The Equalizer EQ<sup>2</sup> can cut your fuel bill down to size.



### HOW DOES THE EQUALIZER EQ<sup>2</sup> SAVE MONEY?

**W**hen a room is uncomfortable, you adjust the thermostat. But for every degree you turn it up or down you increase your fuel bill by at least 3%. Raising the thermostat just 4°

can add as much as \$1.25 to your daily energy costs. Turning the thermostat down is even more costly since air conditioners are notoriously inefficient. Even then, your home may not be comfortable.

A thermostat in a drafty hallway may stop

running even though an upstairs room is still boiling. The Equalizer EQ<sup>2</sup> maximizes your system by pulling 80% more air from your duct into the problem room—in half of the time.



lower thermostat 4



add a window unit

**Money-saving offer.** For a limited time, we're offering this breakthrough directly to you. For greatest efficiency, place several Equalizer EQ<sup>2</sup>s throughout your home. To enable you to do this, we're offering you this special offer. The first two Equalizer EQ<sup>2</sup>s you order are \$49 each, but when you order a third Equalizer EQ<sup>2</sup> or more, the price is reduced to just \$24.50 each!

Your third Equalizer EQ<sup>2</sup> is just \$24.50 \$4 S&H

Suncourt Equalizer EQ<sup>2</sup>.....\$49 \$4 S&H

Please mention promotional code 265-PL-6527.

For fastest service call toll-free 24 hours a day

**800-992-2966**



To order by mail, send check or money order for the total amount including S&H (VA residents add 4.5% sales tax.) Or charge it to your credit card by enclosing your account number and expiration date.

**COMTRAD INDUSTRIES**

2820 Waterford Lake Drive, Suite 106  
Midlothian, Virginia 23113

# NEW PRODUCTS

## Full-Spectrum Desktop Scanner



ACI's Trident TR4500 pulls in broadcast frequencies from the shortwave bands through the microwave-range public-service bands—from below AM broadcast to 1.300 GHz—and can be controlled via a personal computer. Users can tune in to practically every type of voice broadcast from around the world, including the broadcast, world-band, and civil and military aviation frequencies found in AM mode; police, fire, and emergency services in Narrow FM; radio and TV-audio broadcasts in Wide FM; and even single sideband for transoceanic aircraft and ship communications.

Desired frequencies can be selected directly using the keypad, or the unit can be set to search through all active channels. The user can store any interesting frequencies in any of 2016 permanent memory locations. Up to 16 different search ranges can be set into memory. Tuning increments can be selected in steps as low as 5000 cycles. The TR4500 will scan through memorized frequencies at up to 36 channels per second, and will lock on active calls to receive the broadcast. The user can listen through the built-in speaker or use the supplied headphone.

With the TR4500 connected to a PC's serial interface, the computer can be used to set the search ranges. The computer allows various frequencies to

be loaded and saved, and active frequencies to be stored. And, when used with a computer, the TR4500 effectively becomes a storage spectrum analyzer. An MS-DOS "comm" program is included.

The desktop scanner measures just 2¼ × 5½ × 6½ inches. It comes with a 12-volt DC cord, an AC adaptor, an earphone, a flexible antenna, software, and operating instructions that include a listing of allocated uses for all frequencies covered by the unit.

The TR4500 desktop scanner with computer interface has a suggested retail price of \$849; the street price is expected to be under \$500. For more information, contact ACI; Tel. 1-800-445-7717 or 317-849-2570; Fax: 1-800-448-1084 or 317-849-8794.

**CIRCLE 37 ON FREE INFORMATION CARD**

## MULTIMEDIA SPEAKERS

Although many of today's personal computers are equipped with a CD-ROM drive and sound card, the built-in speakers are usually inadequate. The *Media 3* and *Media 4* speakers from JBL Consumer Products address the needs of PC users seeking to enhance their multimedia experiences in learning, entertainment, and game-playing.

The *Media 3* powered speaker incorporates a 4-inch woofer and a 1.5-inch tweeter with a seven-watt-per-channel hi-fi amplifier. Subwoofer output allows the system to be further upgraded, dual inputs accommodate a second audio source, and a headphone jack provides private listening. The *Media 3* speakers also feature separate bass and treble controls and automatic power on/off.

The *Media 4* incorporates a five-inch woofer, a one-inch tweeter, and a 10-watt-per-chan-



nel hi-fi amplifier. Key features include switchable subwoofer output or headphone output, polyolefin cabinet material to dampen internal resonances, automatic turn on/off, and an acoustically efficient design for loud sound levels.

The *Media 3* (pictured here) and *Media 4* multimedia speakers have suggested retail prices of \$199/pair and \$299/pair, respectively. For more information, contact JBL Consumer Products, Multimedia Division, 80 Crossways Park West, Woodbury, NY 11797; Tel. 516-496-3400.

**CIRCLE 56 ON FREE INFORMATION CARD**

## FIELDPACK WITH "STICK" DMM

The *HS24K11 Fieldpack* from *Fieldpiece Instruments* consists of a leather holster that holds a heavy-duty *HS24* "stick" digital multimeter along with a 300-amp current clamp head, deluxe test leads, two short and two long probe tips, and one alligator ground clip. All the accessories are modular, using standard banana plugs and jacks for connections.

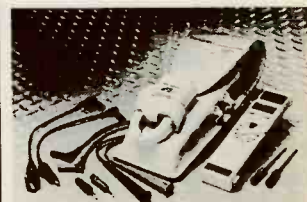

Specifically designed for field-service use, the leather holster holds the meter and test leads

**CALL TOLL FREE**  
1-800-292-7711  
1-800-445-3201 (Can)

# C&S SALES

EXCELLENCE IN SERVICE

**WRITE FOR  
FREE CATALOG**



**Line Tracker  
MV-963  
\$52.95**  
(Infra-red Sensor)  
The robot follows  
a black line  
on white paper  
Preassembled PCB



**Dual-Display  
LCR Meter  
w/ Stat Functions  
B+K Model 878  
\$239.95**  
Auto/manual range  
Many features  
with Q factor  
High Accuracy

**Electronic Tool Kit Model TK-1000**  
A professional organizer tool kit at affordable prices. No student should be without this unique tool kit that holds all the tools you need.

Including:  
Diagonal Cutter  
Long Nose Pliers  
6" Wire Stripper  
Solder 60/40  
6" Screwdriver  
6" Phillips Driver  
Safety Goggles  
IC Puller  
3pc Nut Drivers  
Iron 25W  
Iron Stand  
Solder Wick  
Desoldering Pump  
5 pc Solder Ease Kit  
6pc Precision Screwdrivers

**\$39.95**

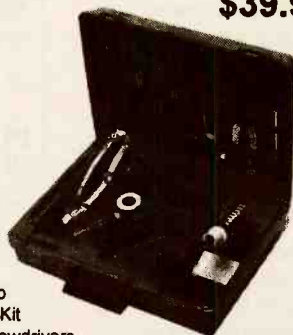

**Robotic Arm  
Y-01  
\$49.95**  
(Wired Control)  
Movement grabs  
& releases,  
lifts & lowers,  
pivots from side to side



**Stereo Cassette Player  
Kit  
Model  
TR-18K  
\$16.95**  
Headphones  
Included



**Digital  
Multimeter  
EDM-83B  
\$175.00**  
Almost every  
feature available  
Bargain of  
the decade



**Elenco  
LCR + DMM  
LCM-1960  
\$79**  
12 Functions  
Freq to 4MHz  
Inductance  
Capacitance



**Digital  
Capacitance  
Meter  
CM-1555  
\$49.95**  
Measures capacitors  
from .1pf to 20,000µf



**Digital  
LCR Meter  
LCR-680  
\$79.95**  
3-1/2 Digit  
LCD Display  
Inductance  
1uH to 20MΩ



**Function Generator  
GF-8026  
\$239**  
In/Ext  
Operation  
Sine, Square, Triangle, Pulse  
Ramp, .2 to 2MHz, Freq Ctrl



**3-3/4 Digit Multimeter  
BK-390  
\$139.00**  
0.1% DCV accy  
Analog bar graph  
Auto/manual ranging  
Capacitance meas  
Temperature probe



**Digital  
Multimeter Kit  
w/ Training Course  
M-2665K  
\$49.95**  
Full function 34 ranges  
Ideal school project  
M-2661 (Assembled) \$55.00



**Frequency Counter  
F-1225  
\$225.00**  
8 Digit LED display  
Wide meas range  
High sensitivity  
Data hold function  
Input impedance 1MΩ or 50Ω  
10:1 input attenuation function

**Fluke Multimeters  
(All Models Available Call)**

<b>Scopemeters</b>	<b>70 Series</b>
Model 97 \$1,795	Model 7011 \$69.95
<b>10 Series</b>	Model 7311 \$97.50
Model 10 \$62.95	Model 7711 \$149
Model 12 \$84.95	Model 7911 \$175
<b>20 Series</b>	<b>80 Series</b>
Model 2911 \$175	Model 87 \$289



**Triple Power  
Supply  
XP-620  
By Elenco  
\$75.00**  
3 fully regulated supplies; 1.5-15V @ 1A, -1.5 to -15V @ 1A or 3-30V @ 1A & 5V @ 3A Kit XP-620K \$49.95



**Quad Power  
Supply  
XP-581  
By Elenco  
\$79.95**  
Four supplies in one unit; 2-20V @ 2.5A, 5V @ 3A, -5V @ .5A and 12V @ 1A. All regulated and short protected



**High Current DC  
Power Supply  
BK-1686 \$169.95**  
3 to 14 VDC Output  
12A @ 13.8V  
For servicing high  
power car stereos,  
camcorders, ham radios, etc.  
Connect 2 or more in parallel



**Wide Band  
Signal  
Generators  
SG-9000  
\$124.95**  
RF Frequency 100K-450MHz  
AM modulation of 1KHz Variable  
SG-9500 150MHz \$239.00

**Telephone Kit  
PT-223K  
\$14.95**  
  
**Available  
Assembled  
PT-223  
\$15.95**



**Function Generator  
Blox  
#9600  
By  
Elenco  
\$29.95**



**Kit \$28.95**  
Sine, Triangle, Square Wave

**Learn to Build & Program  
Computers with this Kit**

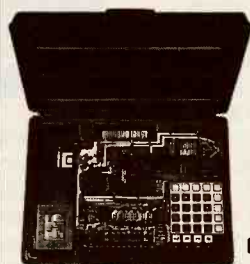

**MM-8000  
By Elenco  
\$129.00**

From scratch you build a complete system. Our Micro-Master trainer teaches you to write into RAMs, ROMs and run a 8085 microprocessor, which uses similar machine language as IBM PC.

**Digital/Analog Trainer  
Complete Mini-Lab For Building,  
Testing, Prototyping Analog and Digital**



**By Elenco  
in U.S.A.**

**XK-525  
\$159.95  
Kit  
XK-525K  
\$129.95**

Designed for school projects, with 5 built-in power supplies. Includes a function generator with continuously variable, sine, triangular, square wave forms. All power supplies are regulated and protected against shorts.

**AM/FM Transistor  
Radio Kit  
with Training Course  
Model AM/FM 108  
\$29.95**  
14 Transistor, 5 Diodes  
Easy to build because  
schematic is printed on the PCB  
Makes a great school project  
Model AM-550 AM Only \$17.95

**Telephone Line  
Analyzer**



**Kit TT-400K \$19.95  
Assembled TT-400 \$26.95**

**WE WILL NOT BE UNDERSOLD**  
UPS SHIPPING: 48 STATES 5%  
IL RES 7.5% TAX (\$3 min \$10 max)  
OTHERS CALL

## C&S SALES INC.

1245 ROSEWOOD, DEERFIELD, IL 60015  
FAX: 708-520-0085 (708) 541-0710



**15 DAY MONEY BACK  
GUARANTEE  
FULL FACTORY WARRANTY**

PRICES SUBJECT TO CHANGE WITHOUT NOTICE

## NEW PRODUCTS

on the inside and has loops for the current clamp head and long probe tips on the outside. A belt loop on the back allows easy carrying.

The HS24 meter offers the 12 most popular ranges for field service and will withstand steady-state voltages up to 1000-volts DC and 750-volts AC. It measures volts, ohms, continuity, capacitance, and AC current (with the included current clamp). A HOLD button freezes the display to make one-handed testing easy. Its Valox plastic case withstands drops up to 10 feet, "O"-ring seals protect against contaminants, and metal-oxide varistors (MOVs) protect against voltage transients. An audible beeper and a blinking red LED warn of voltages over 28 volts, even if the meter is set to the wrong range or function.

The heavy-duty HS24K11 Fieldpack costs \$159. For more information, contact Fieldpiece Instruments, 231 East Imperial Highway, Suite 250, Fullerton, CA 92635; Tel. 714-992-1239; Fax: 714-992-6541.

**CIRCLE 48 ON FREE INFORMATION CARD**

### PCMCIA MODEM

The *MT2834LT* PCMCIA modem features a patent-pending "CoolJax" duplex phone connector, eliminating the need for messy cables. The modem is compliant with the recently adopted ITU standard for 28.8-kilobyte per second, V.34 modems, and also supports all lower



speed standards. It is designed for use in standard Type II PCMCIA slots, and comes with MultiExpress fax and data communications software for Windows. The *MT2834LT* uses industry-standard "AT" commands for modem configuration and dialing, and includes a re-

mote configuration feature that allows the user to remotely change parameters and run diagnostics for troubleshooting, technical support, and system administration purposes.

The *MT2834LT* PCMCIA modem costs \$399. For additional information, contact Multi-Tech Systems, Inc., Tel. 800-328-9717 or 612-785-3500.

**CIRCLE 44 ON FREE INFORMATION CARD**

### PERSONAL POCKET DIGITAL MULTIMETERS

The *Model 380933* 3200-count, autoranging, digital multimeter from *Extech Instruments* offers high-resolution, bar-graph display, function indicators, data hold, diode test, and an audible continuity checker. It measures DC voltage from 300 mV to 450 volts, AC voltage from 3 to 450 volts, and resistance from 300 ohms to 30 megohms. The digital multimeter weighs just 3.4 ounces and measures 4.8 x 3 x 0.8 inches.



The *Model 380933* pocket-sized digital multimeter, complete with a wallet-style carrying case, test leads, 1.5-volt batteries, and a user's manual, costs \$39. A 2000-count, manual-ranging version (*Model 380929*), which features a larger display, 200-mA range, continuity indication, data hold, and diode test, costs \$25. For further information, contact *Extech Instruments*, 335 Bear Hill Road, Waltham, MA 02154-1020; Tel. 617-7440; Fax: 617-890-7864.

**CIRCLE 49 ON FREE INFORMATION CARD**

### DIGITAL STILL CAMERA

*Casio's QV-10* handheld digital still camera allows you to view images as they are shot, thanks to a high-resolution, active-matrix, 1.8-inch color LCD screen.

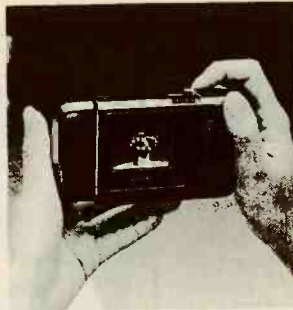

The images can then be transferred to a personal computer by using an optional transfer package, or to a TV or VCR using a video cable.

The camera's semiconductor memory can hold up to 96 color still images that can be added or deleted at any time. The fixed-focal-length lens with macro positioning allows point-and-shoot picture taking. The camera also features a high-speed (1/8 to 1/4000-second) shutter, 1/5-inch CCD element, and aperture-priority automatic exposure system.

The *QV-10* LCD digital camera has a suggested retail price of \$700. For further information, contact *Casio, Inc.*, 570 Mt. Pleasant Avenue, Dover, NJ 07801; Tel. 201-361-5400.

**CIRCLE 52 ON FREE INFORMATION CARD**

### EXTERNAL FAX/ MODEM

The *Bullet 100E* 28.8-kilobyte-per-second (Kbps) external modem with integrated fax from

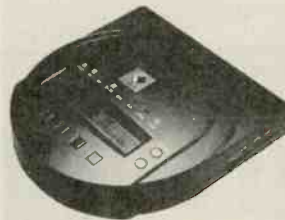

*E-Tech* complies with all the specifications of the recently adopted ITU V.34 standard. It is also V.23-compatible for European and other videotext users. A 16-bit CPU, along with an enhanced controller code, maximizes data throughput. The modem can operate at all conventional line speeds from 28.8 Kbps to 300 bps. The integrated fax operates at 14.4 Kbps and can communicate with Group 3 send and receive fax machines. Free fax software for DOS and

Windows is included; Mac software is available as an option.

The *Bullet's* sleek, attractive design resembles a CD-ROM player. Its LCD panel displays line conditions and throughput speeds so that the connection can be easily checked. The LCD and Smartkeys make it easy for users to set and change their modem configurations. Other high-end features include lease-lined operation with auto-dial backup, caller ID, distinctive ring, built-in Flash-ROM for easy upgrades, local and remote configuration, and password and callback security.

The *Bullet 100E* external fax/modem costs \$499. For additional information, contact *E-Tech Research Inc.*, 1800 Wyatt Drive, Suite 2, Santa Clara, CA 95054; Tel. 1-800-EBULLET; Fax: 408-988-8109.

**CIRCLE 35 ON FREE INFORMATION CARD**

### KEYBOARD-ENHANCED PERSONAL DIGITAL ASSISTANT

*Sharp's Zaurus ZR-5000* keyboard-enhanced personal digital assistant (K-PDA) is a handheld personal communications tool that offers speedy access to information, powerful integrated software, and months of battery life. Unlike PDA's that rely primarily on handwriting recognition for inputting information, *Zaurus* offers both the convenience of the pen for note-taking, drawing, and accessing information, and the productivity of a keyboard for text-intensive applications. The K-PDA has one megabyte of internal memory, 750K of which is available for user data and add-on software programs.

Aimed primarily at mobile professionals, *Zaurus* can send and receive e-mail, send faxes,





# AMAZING Electronic and Scientific Products

## Mystery Levitating Device!

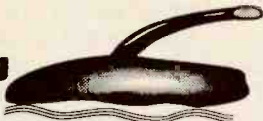

Remember War of the World? Objects float in air and move to the touch. Defies gravity, amazing gift, conversation piece, magic trick or great science project.

ANT1K Easy to Assemble Kit / Plans ..... \$19.50

## Laser Ray Gun

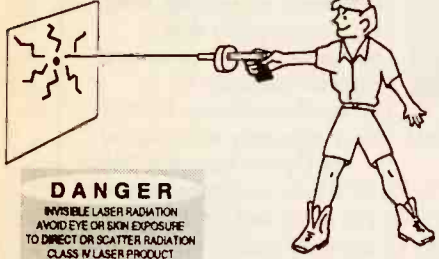

**DANGER**  
VISIBLE LASER RADIATION  
AVOID EYE OR SKIN EXPOSURE  
TO DIRECT OR SCATTER RADIATION  
CLASS IV LASER PRODUCT

Advanced project produces a burst of light energy capable of burning holes in most materials. Hand-held device uses rechargeable batteries. 500 joules of flash energy excite either a neodymium glass, yag or other suitable 3" laser rod. This is a dangerous CLASS IV project (individual parts/assemblies available). LAGUN1 Plans ..... \$20.00  
LAGUN1K Kit / Plans ..... Price on Request

## Extended Play Telephone Recording System

READY TO USE! Automatically controls and records on our X-4 extended play recorder, taping both sides of a telephone conversation. Intended for order entry verification. Check your local laws as some states may require an alerting beeper. TAP20X Ready to Use System ..... \$129.50



## Shocker Force Field / Vehicle Electrifier

Neat little device allows you to make hand and shock balls, shock wands and electrify objects, charge capacitors. Great payback for those wise guys who have wronged you! SHK1K Kit Easy to Assemble Electronic Kit ..... \$24.50



## Electric Charge Gun

All New Technology!

Stuns/immobilizes attackers up to 15 feet away! Legal in most state (not in NY, NJ, MA, WI) • More knock-down power than most handguns • No permanent injury • ID coded • Free 80KV stun gun with every purchase. ECG1 Data Packet, Creditable toward purchase ..... \$10.00  
ECG10 Charge Gun, Ready to Use, w/Free 80KV Gun \$249.50

## Homing / Tracking Transmitter

Beeper device, 3 mile range. HOD1 Plans ..... \$10.00 HOD1K Kit / Plans ..... \$49.50

## Listen Through Walls, Floors

Highly sensitive stethoscope mike. STETH1 Plans ..... \$8.00 STETH1K Kit/Plans ..... \$44.50



## Infinity Transmitter ++

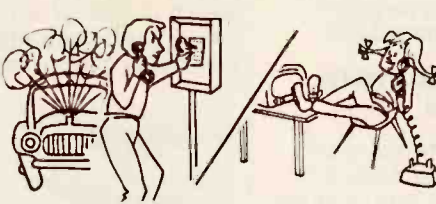

## Telephone Line Grabber / Room Monitor / Controller

All New - The Ultimate in Home/Office Security & Safety! Simple to use! Call your home or office, push a secret tone on your telephone keypad to access: • On premises sounds and voices • Ongoing phone conversation w/break-in capability • Up to 10 external electrical functions, lights, TV, alarms, coffee pots, heater, etc. CAUTION! Check legality with your state's attorney general's office before use for monitoring of voices. TELECOM2 Kit, Includes PC Board ..... \$149.50  
TELECOM2 Ready to Use ..... \$199.50

## Visible Beam Laser

Easy to build, RED Beam, visible for miles. Use for light shows, window bounce holography, cloud illumination and much more! LAS1KM Kit w/1mw Laser Tube, Class II ..... \$69.50  
LAS3KM Kit w/2.5mw Laser Tube, Class IIIA ..... \$99.50

## Life is Precious - Protect It!

Hard hitting 200,000 volts of crackling, sizzling plasma. Stuns and immobilizes most attackers STUN40 Ready to Use ..... \$69.50  
STUN10 Smaller Unit ..... \$39.00



## Ion Ray Gun

Projects charged ions that induce shocks in people and objects without any connection! Great science project as well as a high tech party prank. IOG3 Plans ..... \$8.00  
IOG3K Kit/Plans ..... \$69.50

## Invisible Pain Field Generator

Shirt pocket size electronic device produces time variant complex shock waves of intense directional acoustic energy, capable of warding off aggressive animals, etc. IPG7 Plans ..... \$8.00 IPG7K Kit/Plans ..... \$49.50  
IPG70 Assembled ..... \$74.50



## 1000 Ft++ Potato Cannon

NOT A TOY. Uses electronic or piezo ignition. CAUTION REQUIRED! POT1 Plans ..... \$10.00 (Dangerous Product)

## FireBall Gun

Shoots flaming ball - two shot capacity Great for special effects and remote fire starting. CAUTION REQUIRED! FIREBALL Plans (Dangerous Product) ..... \$10.00

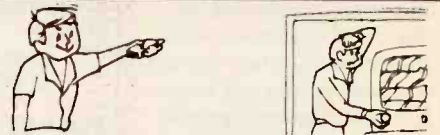

## TV & FM Joker / Jammer

Shirt pocket device allows you to totally control and remotely disrupt TV or radio reception. Great gag to play on family or friends. Discretion required. EJK1KM Easy to Assemble Electronic Kit ..... \$24.50

## ATTENTION: High Voltage Fans!

4,000 volts in the palm of your hand! Experiment with anti-gravity, hovercraft, ion guns, force fields, plasma guns, shock devices, wireless energy and electrical pyrotechnics. Input: 9-14VDC. MINIMAX4 Ready to Use ..... \$19.50



## "Laser Bounce" Listener System

NEW - Latest Technology! Allows you to hear sounds from a premises without gaining access. Aim at room window and listen to sounds from within via reflected laser light. Not for illegal use. Requires video tripods. LWB3K 5mw Laser and Receiver Kit ..... \$149.50  
LWB30 Ready to Use, includes Laser Gun Sight ..... \$199.50

## 5mw Visible Red Pocket Laser

Utilizes our touch power control! VRL5KM Kit / Plans ..... \$74.50



## Electronic Hypnotist

Puts subjects under control using highly effective electronic stimuli. Intended for parties and entertainment but must be used with caution. Includes valuable text book reference and plans. EH2 Plans and Text Book ..... \$19.50

## Automotive NEON!



Easy-to-Install 4-Tube Kit for Cars, Trucks, Vans! Available in Pink, Purple, Blue or Green - please specify color when ordering. RG4K (Specify Color) ..... \$129.50

Flash-To-Music Option for above kit FMU1 ..... \$29.50



## 3 Mi FM Wireless Microphone

Subminiature! Crystal clear, ultra sensitive pickup transmits voices and sounds to FM radio. Excellent for security, monitoring of children or invalids. Become the neighborhood disk jockey! FMV1 Plans ..... \$7.00 FMV1K Kit and Plans ..... \$39.50

## Telephone Transmitter - 3 Mi

Automatically transmits both sides of a telephone conversation to an FM radio. • Tunable Frequency • Undetectable on Phone • Easy to Build and Use • Up to 3 Mile Range • Only transmits during phone use. VWPM7K Plans ..... \$7.00  
VWPM7K Kit/Plans ..... \$39.50

Dept PEM18, Box 716, Amherst, NH 03031

Phone: 603-673-4730 FAX 603-672-5406

MC, VISA, COD, Checks accepted Please add \$5.00 Shipping & Handling

CATALOG With many more items! Free with Order or send \$1 P&H

Order by Mail or by 24 Hour Orders-Only Phone 800-221-1705

## NEW PRODUCTS

access on-line services, exchange information with local and remote PC's, take notes on an electronic note pad, create maps and drawings, generate documents with an intelligent word processor, and manage their time and information any time, anywhere. Adding to its communications capabilities, Sharp's optional Zaurus Mail system allows small work groups to exchange messages and data using a single Windows-based PC as an electronic post office. Employees of small companies, or individual departments within larger corporations, can keep in contact with each other and with the home office.

A PCMCIA Type II slot allows users to expand both the memory and the communications capabilities of the Zaurus. Users can add additional memory using up to 2-megabyte SRAM cards or 16-megabyte FLASH cards. The K-PDA also supports many PCMCIA Type II devices, including cellular-capable fax/modems and pager cards. To leave the PCMCIA slot open for other devices, Sharp's ultra-compact, low-power CE-FM4 9600/2400-bps fax/modem can be attached directly to the serial port of the Zaurus.

The Zaurus uses Sharp's proprietary 16-bit processor to provide both fast performance and low power consumption, with up to two months of battery life. The Synergy operating system is hidden from the user, freeing him or her from mundane system-management tasks. Synergy is "data-centric," with the ability to relate to different types of information. A graphical user interface provides elements that Windows and Macintosh users will find familiar, such as check boxes, radio buttons, scroll bars, and pop-up menus. In addition, pen-enabled features, such as text selection and drag-and-drop, provide fast and intuitive operation.

The Zaurus ZR-5000 has a suggested retail price of \$749. The ZR-5000FX, which includes the CE-FM4 fax/modem, has a suggested retail price of \$849.

For more information, contact Sharp Electronics Corporation, Sharp Plaza, Mahwah, NJ 07430-2135; Tel. 1-800-BE-SHARP.

**CIRCLE 57 ON FREE INFORMATION CARD**

### POCKET DMM WITH BARGRAPH

*B + K Precision's* first pocket digital multimeter, *Model 2700*, measures AC and DC volts and resistance, and offers data hold, range hold, audible continuity test, diode test, a bar-graph display, and a 3200-count LCD readout. Data hold freezes the display to hold a reading, while range hold allows users to defeat autoranging and select one specific voltage or resistance range for all their measurements.



The Model 2700 is aimed at electronic technicians, electricians, home handymen, college students, and hobbyists. The pocket DMM measures up to 450 DC volts in five ranges with 1.3% accuracy (0.7% on the 3-volt range). It measures AC volts to 450 volts in four ranges, and resistance to 30 megohms in six ranges.

The Model 2700 pocket digital multimeter, complete with test leads that store conveniently in its carrying case, an instruction manual, and two 2.5-volt button cells, has a suggested retail price of \$33. For additional information, contact B + K Precision, 6470 West Cortland Street, Chicago, IL 60635; Tel. 312-889-1448.

**CIRCLE 58 ON FREE INFORMATION CARD**

### AMPLIFIED TV/FM ANTENNA

*Recoton* recommends its *Bullseye* amplified TV/FM an-

tenna for general use as well as in homes equipped with the new Digital Satellite System (DSS), which does not deliver local broadcast channels 2 through 13. Bullseye can provide DSS subscribers who live a considerable distance from TV



transmitters with a cost-efficient way of receiving those programs.

The antenna's built-in, ultra-low-noise amplification circuitry improves reception of TV programs broadcast from up to 125 miles away, as well as enhancing AM and FM broadcasts. Using the antenna results in VHF signal gains of up to 24 decibels, UHF signal gains of up to 29 decibels, and up to 12-dB FM-signal gains.

Bullseye also features circuitry to reduce RFI, which causes signal interruptions from sources such as CB radio transmissions. The antenna's omnidirectional reception pattern, achieved through the use of a sophisticated quad-yagi circuit, eliminates the need to aim the antenna toward station transmitters.

With its circuitry enclosed in a sealed copolymer housing that is resistant to ultraviolet rays and hostile weather, the Bullseye is suited for outdoor mounting on rooftops or chimneys. It can also be tucked out of the way indoors in attics, closets, lofts, or garages.

The Bullseye omnidirectional TV/FM antenna has a suggested retail price of \$139.95. For further information, contact Recoton, 46-23 Crane Street, Long Island City, NY 11101; Tel. 800-742-3438 or 718-392-6442; Fax: 718-784-1080.

**CIRCLE 31 ON FREE INFORMATION CARD**

### CARBON MONOXIDE DETECTOR

A malfunctioning furnace or household appliance can fill a

poorly ventilated room with carbon monoxide, an odorless, colorless, and tasteless gas that can poison the air in a home without warning. The *Radio Shack Carbon Monoxide Detector* can warn your family of the potentially deadly fumes.

The detector continuously monitors the air in your home to warn of dangerously high concentrations of carbon monoxide, sounding an 85-dB alarm when high levels are reached. Meeting UL-approved safety standards, the device automatically compensates for temperature changes for maximum sensitivity and reliability.

The Carbon Monoxide Detector installs by simply plugging into an AC wall outlet. An optional DC adaptor allows it to be used in recreational vehicles, travel trailers, and boats. Detectors should be placed near appliances or equipment that use combustible fuel, including clothes dryers, stoves, fireplaces, and furnaces. The Federal Consumer Product Safety Commission recommends that multilevel homes should be equipped with a UL-listed detector on each level.

The Carbon Monoxide Detector is available for \$79.99 at Radio Shack stores nationwide. For more information, contact Radio Shack, 700 One Tandy Center, Fort Worth, TX 76102; Tel. 817-390-3300.

**CIRCLE 54 ON FREE INFORMATION CARD**

### "NEXT-GENERATION" HF TRANSCEIVER

DX'ers can work all the HF bands and receive 300 kHz to 29.995 MHz with *Icom's* "next-generation" *IC-738* transceiver. SSB, CW, AM, and FM are built in for a full 100-watts output (40 watts in FM). A heatsink with two large cooling fans ensures stable 100% duty-cycle operation even during DX'ing marathons. The IC-738 offers an analog feeling to the tuning, faster PLL lockup times, improved phase-noise blocking, and high dynamic range. Bringing the IC-738 into the "next-generation" are an automatic antenna tuner, frequency-management features, and CW-contest features.

# Be a high-paid computer service technician

Train With NRI — America's #1 Choice in Computer Training

Only NRI gets you inside a powerful 486DX2/66 MHz Intel-based computer system you keep—giving you the hands-on experience you need to work with, troubleshoot, and repair today's most widely used computer systems. There's no more affordable way to start a money-making career, even a business of your own, as a computer service technician.

## Rely on the original — NRI

Over a decade ago, NRI pioneered at-home training in computer servicing. Today, NRI offers the *only* computer servicing course with real-world experiments using state-of-the-art computer equipment and professional diagnostic tools.

There's no doubt about it: Working "hands-on" with all the most sought-after technology gives you practical skills and lasting confidence. Performing key tests and demonstrations, you're able to see for yourself how things work, what can go wrong, and how you can fix it.

## Train with and keep the most advanced computer in home study today

NRI's unique training has you explore a top-notch computer system and its peripherals, beginning with the 486DX2 Intel CPU and Pentium Overdrive-ready motherboard.

Your computer features 8 meg RAM, 420 meg hard drive, and fax/modem to store, receive, and send huge amounts of data.

You'll also appreciate the brilliant display of your Super VGA color monitor, the drama of your CD-ROM drive and 16-bit sound card, as well as the cutting-edge technology of Windows 95.

Plus learn to use Ultra-X professional diagnostic hardware and software to pinpoint problems on any IBM-compatible machine.

## No experience needed, NRI builds it in

Studies show that jobs for computer service technicians will be up by 38% in the next 10 years. Even if you've never worked with



## YOU GET EVERYTHING YOU NEED FOR SUCCESS

- **POWERFUL 486DX2/66 MHz INTEL-BASED COMPUTER**  
Features IBM compatibility, 8 meg RAM, Pentium Overdrive-ready motherboard, and math coprocessor
- **SUPER VGA COLOR MONITOR**  
With .28mm dot pitch for high-resolution graphics and tilt-swivel base
- **420 MEG HARD DRIVE**  
For greater data storage capacity and data access speed
- **EXCITING MULTIMEDIA PERIPHERALS**  
Double speed CD-ROM drive, 16-bit sound card with speakers, and reference CD
- **FAX/MODEM**  
Gives you access to a world of on-line information
- **ULTRA-X DIAGNOSTIC PACKAGE**  
R.A.C.E.R. plug-in card and QuickTech-PRO software help you detect problems on virtually all IBM-compatible machines, even if computer is 5% operational
- **NRI DISCOVERY LAB**  
Complete breadboarding system lets you design and modify circuits, diagnose and repair faults
- **DIGITAL MULTIMETER**  
Professional, hand-held test instrument for quick and easy measurements
- **WINDOWS 95**  
The time-saving operating system that everyone will be using tomorrow

computers before, NRI's interactive training builds such a solid foundation of know-how and practical experience that tomorrow's jobs can be yours.

Right from the start, hands-on experiments reinforce concepts presented in NRI's bite-sized lessons. And because your work is reviewed by your personal instructor, you know for certain that you can apply theory to real-world demands.

## FREE NRI catalog tells more

Send today for your free, full-color catalog describing every aspect of NRI's innovative computer training in the up-and-coming field of your choice.

If the coupon is missing, write to: NRI Schools, McGraw-Hill Continuing Education Center, 4401 Connecticut Avenue, NW, Washington, DC 20008.

IBM is a registered trademark of the IBM Corporation. R.A.C.E.R. and QuickTech-PRO are registered trademarks of Ultra-X, Inc.

## SEND TODAY FOR FREE NRI CATALOG!



McGraw-Hill Continuing Education Center  
4401 Connecticut Avenue, NW, Washington, DC 20008



Check one FREE catalog only

MICROCOMPUTER SERVICING

Computer Programming

TV/Video/Audio Servicing

Desktop Publishing & Design

LAN Specialist

Bookkeeping and Accounting

Programming in C++ with Windows

Check for details on career courses approved under GI Bill

Name (please print)

Age

Address

City

State

Zip

Accredited Member, National Home Study Council

0032-0895

## NEW PRODUCTS

The built-in antenna tuner has preset memories for each band (in 100-kHz steps), providing high-speed tuning on the HF



and six-meter bands. The transceiver's two antenna connectors are directed by an automatic antenna selector that switches to antenna one or antenna two when you change the operating band.

Frequency management is accomplished with the unit's quick-split function, which allows the offset frequency to be programmed in advance. Pressing the SPLIT button then automatically selects all the necessary settings for split-frequency operation. A split-lock function prevents users from accidentally changing the receive frequency while changing the transmit frequency, and a dial-lock function electronically locks the main dial.

CW contest features of the unit include a built-in electronic keyer with separate key jack, full break-in (QSK) operation, and separate jacks for an extended CW key or memory keyer. The CW enthusiast can use a memory keyer (or TNC with CW capability) to easily make contacts, then use the paddle for normal operation.

The IC-738 also features a double-band stacking register, which memorizes two frequencies and the mode in each band, allowing it to be used like two VFO's in one band. For contesting or DX'ing, up to 10 electronic memo pads are available to temporarily store the frequency and mode by pushing the memo-pad/write switch. Three scanning functions provide operating versatility: Programmed scan searches for signals over a specified range, memory scan searches all memories, and memory select scan searches only those memories specified by the user. Other features include pass-

band tuning, a notch filter, a set mode for adjusting infrequently changed values or conditions, a VOX function for convenient phone operation, fast/slow selectable AGC time constant, multiple metering, a keypad for direct frequency input, and compatibility with Icom's CI-V system for control from a personal computer.

The IC-738, including a handheld microphone, has a suggested retail price of \$1935. For more information on the unit, contact Icom America, Inc., 2380 116th Avenue N.E., Bellevue, WA 98004; Tel. 206-454-8155.

**CIRCLE 46 ON FREE INFORMATION CARD**

### 20-INCH MONITORS

Two high-resolution, color monitors from ViewSonic feature 20-inch screens and are compatible with PC, Mac, and Power Mac computer systems. Capable of displaying two pages of text and graphics, and offering a maximum resolution of 1600 x 1280, 0.28mm dot pitch, and a refresh rate of 77 Hz at 1280 x 1024, the monitors are ideal for CAD/CAM/CAE

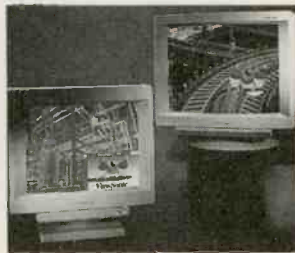

and desktop-publishing applications. Both offer the ViewMatch color-control system, which allows the user to adjust the screen image to match printer or plotter output. The monitors comply with the EPA's Energy Star program: by powering down to under 8 watts in off mode, and are MPR-11 certified for low radiation.

The ViewSonic 20 PS, part of the high-end professional series, offers an on-screen control system that permits the user to customize screen images, choosing from and adjusting more than 20 different functions, including trapezoid, parallax, moire, pincushioning, and ViewMatch color control. It

also includes a tilt-management system to counteract the effect of the earth's magnetic field, thereby ensuring precise screen alignment to the bezel. A special coating virtually eliminates screen glare and reflection, and a super-dark screen provides greater contrast and brilliance to colors.

The ViewSonic 20G, part of the midrange Graphics Series, features an Invar Shadow mask for sharply defined screen images and a digital control system for adjusting screen size, position, and geometry. It also offers tilt management.

The ViewSonic 20PS and 20G have suggested list prices of \$1695 and \$1495, respectively. For further information, contact ViewSonic Corporation, 20480 Business Parkway, Walnut, CA 91789; Tel. 909-869-7976 or 800-888-8583; Fax: 909-869-7958.

**CIRCLE 45 ON FREE INFORMATION CARD**

### FOUR-PORT SERIAL BOARD

B&B Electronics' Model 3PXCC4A serial card features four serial ports in a single slot, saving valuable space for other applications. Each of the ports can be independently configured for any I/O address and any IRQ, as well as RS-232, 422, or 485 data protocols, allowing it to fit any serial application.

TD, RD, RTS, CTS, DSR, DCD, and DTR port lines are supported by the RS-232 mode, with each port using a buffered, high-speed UART. In addition, the 3PXCC4A has interrupt-sharing capabilities and an interrupt-status register to increase throughput in shared

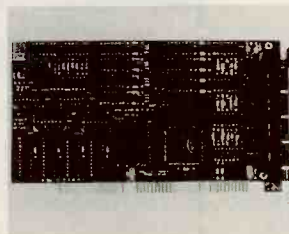

IRQ applications, and to increase the number of available interrupts in the system.

The 3PXCC4A uses eight-conductor RJ45 connectors.

Optional pre-wired adaptor kits allow the user to convert to DB-9 or DB-25 connectors, and various adaptors to configure the pinouts to fit any custom application are available.

The 3PXCC4A four-port serial card costs \$209.95. The optional adaptor kits, including seven feet of RJ45 cable, each cost \$10.95. For additional information, contact B&B Electronics Manufacturing Company, 707 Dayton Road, P. O. Box 1040, Ottawa, IL 61350; Tel. 818-434-0846; Fax: 815-434-7094; BBS: 815-434-2927.

**CIRCLE 55 ON FREE INFORMATION CARD**

### THERMOMETER-TIMER ALARM

Extech's Model 401362 thermometer-timer alarm provides instant, simultaneous readout of temperature, countdown time, and setpoints on a large (1.4-inch) LCD. When the temperature setting or countdown time is reached, an alarm sounds. A remote temperature probe measures from 32 to 392°F (0 to



200°C) with an accuracy of 2°C and a 1° resolution. The thermometer-timer alarm features an adjustable desktop stand as well as a magnetic wall-mounting device. It comes complete with a heat-resistant, six-inch stainless-steel probe and an "AAA" battery.

The Model 401362 thermometer-timer alarm costs \$29. For additional information, contact Extech Instruments, 335 Bear Hill Road, Waltham, MA 02154-1020; Tel. 617-890-7440; Fax: 617-890-7864.

**CIRCLE 39 ON FREE INFORMATION CARD**



## Breakthrough device repels pests... without chemicals or traps

*The new Transonic ESP generates ultrasonic and sonic noises to drive away annoying pests electronically.*

by Paige Clements Yasnowsky

**F**leas that torment your pet. Rats that spread dangerous diseases. Squirrels that nest in your attic. Spiders that spin webs endlessly. Are you waging a constant battle to get these pests out of your home?

If you're like me, you don't like the idea of using poisons or traps, especially if you have small children. Up until now, there wasn't another choice. But not anymore.

**Drive them away.** Now, thanks to modern technology, there's a better way to get rid of household pests—the Transonic ESP. This remarkable new electronic device uses high-frequency sound waves to repel common household pests.

Best of all, the Transonic ESP doesn't trap or kill pests, it simply drives them away. Pests are forced to flee the area to get away from the annoying and confusing sound waves. There are no dead bodies or messes to clean up.

### Tired of battling pests?



**Fleas and ticks.** Famous for causing skin discomfort, these pests also spread disease and parasites.



**Spiders.** Eliminate webs draped across your furniture and in the corners of your living room.



**Bats.** Dark places invite bats to roost. They can make a mess of your attic or storage building.



**Squirrels.** Gnawing squirrels in your walls or attic can cause structural and electrical damage.



**Mice and rats.** Well-known carriers of disease, rodents can be hard to get rid of once they have infested your home or office.



The Transonic ESP covers an area of up to 5,000 square feet.

**Ultrasonic/sonic repellent.** The key to the Transonic ESP is a patented electronic sound generator which broadcasts powerful ultrasonic and sonic noises in the five to 50 KHz range. These frequencies and pulse sequences

are extremely uncomfortable to insects and small rodents. Pests are forced to leave or they will die.

**Why It works.** Most wild creatures depend on their acute hearing abilities for survival. They rely on hearing mechanisms for communicating with each other, for establishing territorial boundaries and for locating available food sources.

When critical hearing frequencies are disrupted by high-frequency pulses, insects and small rodents feel threatened and confused. They are forced to leave. Remaining in the area causes apathy and immobility.

**Just plug it in.** The Transonic ESP comes with its own transformer which plugs

**Are poisons and traps endangering more than just household pests?**

**Traps.** In addition to the trouble of setting up a trap and the danger of accidentally stepping into it, you also face the unpleasant task of disposing of the animal once it is caught.



**Foggers.** Using a fogger is both time-consuming and inconvenient. You must cover up all of your belongings in order to shield them from the chemicals. You also must wait several hours for the fumes to disperse before re-entering the area.



**Pest sprays.** Exposing your carpet and furniture to chemicals can be potentially dangerous, especially if you have young children who are still crawling. Plus, chemical sprays are difficult to apply in a way that eliminates all the pests, especially the hidden ones.



into any standard outlet. To operate, simply press the appropriate button on the front panel. You can repel fleas, ticks, spiders, bats, mice, rats or squirrels, depending upon the sound frequency you select. (For optimum performance, follow proper pest control practices.)

### Factory-direct offer.

The Transonic ESP is an extremely cost-effective way to control pests. And through this special factory-direct offer, it's even more affordable. In order to introduce this product to the public, we're offering a \$25 discount off the retail price. You can purchase the new Transonic ESP for only \$99.



The versatile Transonic ESP is perfect for home, barn or storage shed.

**Try it risk-free.** The Transonic ESP is backed by Comtrad's exclusive risk-free home trial. Try it and if you're not completely satisfied, return it for a full "No Questions Asked" refund. The Transonic ESP is also backed by a two-year manufacturer's warranty. Most orders are processed within 72 hours and shipped UPS.

**Transonic ESP** ..... ~~\$124~~ \$124 S&H  
**With special factory-direct offer** ..... **\$99**

Please mention promotional code 532-PL-6628.

For fastest service call toll-free 24 hours a day

**800-992-2966**



To order by mail, send check or money order for the total amount including S&H (VA residents add 4.5% sales tax.) Or charge it to your credit card by enclosing your account number and expiration date.

**COMTRAD INDUSTRIES**

2820 Waterford Lake Drive, Suite 106  
 Midlothian, Virginia 23113

# ELECTRONICS LIBRARY

## Old-Time Telephones! Technology, Restoration, and Repair

by Ralph O. Meyer

Serious collectors of antique telephones, as well as casual hobbyists and museum curators, will be intrigued with the historical information on the past 120 years of telephones contained in this book. Much of the material, obtained from the author's painstaking research of patents and journal articles and his precise electrical measurements, has never been widely published before.

The book is divided into four sections covering the development of the telephone, types of telephones used in commercial service, electrical circuits used throughout the telephone's history, and a comprehensive

tique phones to use today, and FCC regulations on the restoration of antique instruments.

The book contains many photographs and drawings of antique phones, as well as unique schematic drawings. There is also an appendix of electronics fundamentals, conventions, and related physics principles.

*Old-Time Telephones! Technology, Restoration, and Repair costs \$19.95 and is published by Tab Books Inc., Blue Ridge Summit, PA 17294-0850; Tel. 1-800-233-1128.*

**CIRCLE 50 ON FREE INFORMATION CARD**

## INTRODUCTION TO RADIO FREQUENCY DESIGN

by Wes Hayward, W7ZO1

Aimed at engineers and advanced radio amateurs who are comfortable with digital hardware methods and basic analog design, this book-and-disk package presents basic RF-design concepts using mathematics as needed. Wherever possible, simple circuit models are used to prepare readers to actually design HF, VHF, and UHF equipment.

The book emphasizes the use of models and their application to both linear and nonlinear circuits. Traditional materials are reviewed from the viewpoint of the RF designer. The book presents system design using the communications receiver as an example, and further illustrates subject matter with numerical examples. A discussion of oscillator design covers oscillator noise, starting conditions, and limiting mechanisms. Two-port network methods are applied to the design of amplifiers and oscillators, including the use of S-parameters.

The 3½-inch disk (for IBM PC and compatible computers) in-

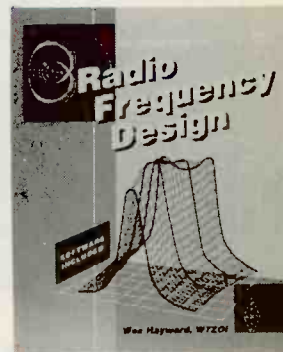

cludes programs that will design and analyze LC bandpass, low-pass, and high-pass filters; crystal ladder filters; feedback amplifiers; RF system dynamic range; phase-locked loops; and more. A user manual is included on the disk.

*Introduction to Radio Frequency Design costs \$30 and is published by The American Radio Relay League, 225 Main Street, Newington, CT 06111; Tel. 203-666-1541; Fax: 203-665-7531.*

**CIRCLE 43 ON FREE INFORMATION CARD**

## ELECTRONIC TEST ACCESSORIES CATALOG

from ITT Pomona Electronics

Although test accessories are a major market in their own right, many test-equipment directories and buyer's guide fail to include a separate test-accessory category. This catalog is intended to



guide to the restoration and repair of antique telephones. The fourth section covers mechanical and electrical repairs, testing, modifications to put an-

fill that gap by providing an easy-to-use source of accessories. Its 172 pages contain more than 3800 specialized products logically arranged and accompanied by helpful selection guides. All of the accessories are designed to optimize the performance of electronic test equipment and to guarantee consistently reliable test results. The catalog also includes short tutorial sections, such as "Selecting the Right Scope Probe" and "Extending Your DMM's Capability."

The *Electronic Test Accessories Catalog* is free upon request from ITT Pomona, Customer Service, 1500 East Ninth Street, Pomona, CA 91766-3835; Tel. 909-469-2900; Fax: 909-629-3317.

CIRCLE 30 ON FREE INFORMATION CARD

**MACINTOSH REVELATIONS: Customizing, Upgrading & Troubleshooting Using System 7.5**  
by Ken Maki

Macintosh computers are particularly easy to use. With a simple click of the mouse, Mac users can play games, write letters, enter a spreadsheet, or do almost anything else. But they are also powerful machines, and this book shows users how to unleash that power.

With an emphasis on the undocumented features of the Mac's latest operating platform, the book and its included CD-ROM provide practical advice and valuable hints that can make a System 7.5 run like a 10. It teaches readers how to customize their Macs, guides them through the upgrade process, and provides troubleshooting help for both software and hardware. The book also offers chapters on networking and system enhancements.

The CD-ROM contains more than 600-MB of System-7.5-compatible software. It contains software for games and entertainment; telecommunications; fonts, graphics, and sounds; educational programs; programming utilities; PowerPC utilities; and BMUG information.



Users can design their own icons, paint their desktop with interesting patterns, have Elvis drop by, or have Bullwinkle the Moose remind them to call home.

*Macintosh Revelations* costs \$32.95 and is published by John Wiley & Sons, Inc., 605 Third Avenue, New York, NY 10158-0012; Tel. 1-800-CALL-WILEY.

CIRCLE 34 ON FREE INFORMATION CARD

**WERNER VON SIEMENS: Inventor and International Entrepreneur**  
by Wilfried Feldekirchen

Although Werner Von Siemens is best known as an inventor and pioneering electrical engineer—he developed the electric dynamo and an improved pointer telegraph—this biography focuses on his life as a business-

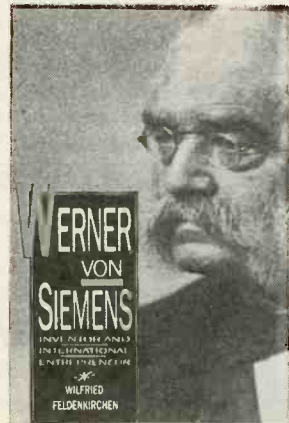

nessman. Siemens was also an entrepreneur with a broad and international business vision.

His firm, Siemens & Halske, built Germany's first important telegraph line and then built lines elsewhere in Europe and Asia. When he later turned his hand to electric technology, Si-

## Tube & General Purpose Projects

NEW



POTS & SOCKETS ALSO AVAILABLE

**LC SERIES**  
0.80" ANODIZED ALUMINUM  
TOP AND BOTTOM PANELS ARE FIELD REMOVABLE.  
FRONT, REAR 0.063" GOLD ANODIZED; OTHER PARTS  
BLACK ANODIZED VENTED CAGES AND OAK END  
PANELS AVAILABLE.

MENTION AD AND TAKE 5% OFF YOUR FIRST ORDER!

**LC Series**

MODEL	W	D	H	(mm)	PRICE \$
LC-1	100	100	50	45.00	47.50
LC-2	150	100	50	50.00	52.50
LC-3	200	100	50	55.00	57.50
LC-4	200	200	75	60.00	64.00
LC-5	150	150	75	50.00	54.00
LC-6	200	150	75	55.00	59.00
LC-7	300	150	75	60.00	64.00
LC-8	400	150	75	65.00	69.00
LC-9	200	200	75	60.00	64.00
LC-10	250	200	75	65.00	69.00
LC-11	300	200	75	70.00	74.00
LC-12	425	200	75	75.00	79.00
LC-13	250	250	100	70.00	76.00
LC-14	300	250	100	75.00	81.00
LC-15	350	200	100	80.00	86.00
LC-16	425	250	100	85.00	91.00

ALL HARDWARE SUPPLIED.

FOR MORE INFO REQUEST CATALOG TB-1 WRITE OR FAX FOR OTHER CATALOGS: AUDIO SOLUTIONS, CONSTRUCTOR'S HARDWARE, AUDIO SIPS AND AUDIO TRANSFORMERS

### Audio Transformers for Tube Construction

**Inputs - Line/Mic**

MODEL	PR	SEC	CASE	STYLE	WTS	PRICE \$
AT-1	150	6K	A	MC INPUT	4.50	45.50
AT-2	15K	15K	A	LINE INPUT	40.50	42.50
AT-3	15K	800	B	LINE OUTPUT	46.75	48.50

**Tube Outputs**

MODEL	SK	W	D	H	WATT	PRICE \$	
OT-1	5K	3	6	4.5	5 WATT	9.00	11.00
OT-2	6K	4.8	1.6	1.6	EL-10 WATT	12.00	16.00
OT-3	7K	4.8	1.6	1.6	EL-34 WATT	18.00	24.00

ULTRA LINEAR DESIGN

OUTPUT TRANSFORMERS DESIGNED FOR SIMPLE OUTPUT STAGES AND FEATURE FREQUENCY RESPONSE up to 40-150 KHz.

**Power Supply**

MODEL	#1	SEC	#2	STYLE	WTS	PRICE \$
PT-1	150	6K	15K	A	9.00	11.00
PT-2	250	300	300	B	18.00	24.00
PT-3	300	300	300	A	20.00	26.00
PT-4	400	300	300	A	20.00	30.00

NEW LARGER SIZES



METAL CABINET PANELS ARE .063" ALUMINUM; BLACK OR GOLD FRONT & REAR PANELS AVAILABLE FOR ADDITIONAL \$5.00

**Mini Project Boxes**

MODEL	W	D	H	(mm)	PRICE \$
MPB-1	1.2	2.1	1.5	25	2.95
MPB-2	1.4	4.1	2.40	27.5	2.95
MPB-3	1.6	4.1	2.95	32.5	2.95
MPB-4	1.5	2.1	1.5	25	2.95
MPB-5	1.5	4.1	1.5	25	2.95
MPB-6	1.5	4.1	2.25	25	2.95
MPB-7	1.5	2.3	2.25	25	2.95
MPB-8	1.5	4.3	2.75	31.5	2.95
MPB-9	1.5	4.3	4.00	43.0	2.95
MPB-10	1.5	2.5	2.50	30.0	2.95
MPB-11	1.5	4.4	3.50	35.5	2.95
MPB-12	1.5	6.5	4.25	50.5	2.95
MPB-13	2.2	4.1	2.25	28.0	2.95
MPB-14	2.4	4.2	2.65	31.5	2.95
MPB-15	2.6	4.2	4.40	50.0	2.95
MPB-16	2.8	4.2	6.85	73.5	2.95
MPB-17	3.2	4.2	2.45	29.5	2.95
MPB-18	3.2	4.1	2.90	33.0	2.95
MPB-19	3.6	4.3	4.20	49.0	2.95
MPB-20	3.8	4.3	4.65	54.5	2.95
MPB-21	4.8	4.3	4.55	51.5	2.95
MPB-22	4.1	10.3	4.75	54.5	2.95
MPB-23	4.1	12.3	5.70	63.0	2.95
MPB-24	4.1	14.3	6.10	68.0	2.95

PERFORATED OR PLEXIGLASS PANELS ALSO AVAILABLE.

GREAT LITTLE BOXES FOR LOW COST CONSTRUCTION DESIGNED TO GET THE JOB DONE WITHOUT THE FRILLS!

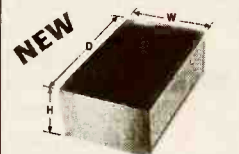

**MINI PROJECT BOX**  
NOT SPECIFICALLY DESIGNED FOR TUBE CONSTRUCTION, BUT THEY'RE SUPER FOR SMALL PROJECTS. 0.40" BARE ALUMINUM PANELS.

**Metal Cabinets**

MODEL	W	D	H	(mm)	PRICE \$
MC-1A	4	3	2	12	14.00
MC-2A	8	3	2	14	18.00
MC-3A	8	3	2	16	18.00
MC-4A	4	5	3	14	18.00
MC-5A	6	5	3	16	18.00
MC-6A	8	5	3	18	20.00
MC-7A	8	7	4	16	18.00
MC-8A	8	7	4	18	20.00
MC-9A	8	7	4	20	22.00
MC-10A	8	5	1.75	32	34.50
MC-11A	8	5	1.75	34	36.50
MC-12A	8	5	1.75	36	38.50
MC-13A	8	5	1.75	37	40.00
MC-14A	8	5	1.75	35	38.00
MC-15A	8	5	1.75	36	38.00
MC-16A	17	7	1.75	34	38.00
MC-17A	17	7	1.75	36	40.25
MC-18A	17	7	1.75	42	46.25
MC-19A	17	7	3.5	36	42.25
MC-20A	17	7	3.5	39	47.75
MC-21A	17	7	3.5	45	49.75

EXTRA PAIR FRONT/REAR PANELS 5.00 7.50  
FRONT/REAR PANELS CLEAR FINISH STANDARD

ORDER TODAY! (\$30.00 MINIMUM ORDER)  
ALL PRICES INCLUDE WORLDWIDE SHIPPING! A IS USA, CANADA & MEXICO, B IS REST OF WORLD

ORDERS (800) 634-3457 FAX (800) 551-2749  
OFFICE (702) 565-3400 FAX (702) 565-4828  
SESCOM, INC. 2100 WARD DRIVE, HENDERSON, NV 89015 U.S.A.  
SESCOM, INC. is not responsible for customer typographical errors and price and specifications are subject to change without notice

CIRCLE 16 ON FREE INFORMATION CARD

# From Not-Working to Networking!

**Troubleshooting Local-Area Networks!**  
Now, complete for the first time in one detailed booklet!

Gain a fuller knowledge of network fundamentals and how they developed from the early days of main frames, from XNS to Ethernet technology, the OSI stack for interconnecting different computers, basic and specialized test instruments, etc. Several tough LAN case histories brings you from theory to the practical side of troubleshooting.

ONLY \$5.00

CLAGGK Inc., Reprint Bookstore  
P.O. Box 4099, Farmingdale, NY 11735

Please rush my copy of "From Not-Working to Networking." I enclosed payment of \$5.50 which includes shipping charges.

Name \_\_\_\_\_  
Address \_\_\_\_\_  
City \_\_\_\_\_ State \_\_\_\_\_ ZIP \_\_\_\_\_

Sorry, no orders accepted outside of United States and Canada. All Payments must be in U.S. funds. Send check or money order payable to CLAGGK Inc.—do not send cash or stamps. New York State residents add applicable sales tax. Allow 6 to 8 weeks for delivery.

FALL 1995—ELECTRONICS HOBBYISTS HANDBOOK

## ELECTRONICS LIBRARY

emens was instrumental in creating the conditions for the advancement of electrical technology, helping to bring it from the experimental stage into the modern electrical industry.

*Werner Von Siemens: Inventor and International Entrepreneur is available for \$19.95 in hard cover and \$12.50 in paperback from Ohio State University Press, 180 Pressey Hall, 1070 Carmack Road, Columbus, OH 43210-1002; Tel. 614-292-6930; Fax: 614-292-2065.*

**CIRCLE 32 ON FREE INFORMATION CARD**

## PACKET: SPEED, MORE SPEED, AND APPLICATIONS

*compiled by Bob Schetgen, KU7G*

There have been a lot of exciting developments in packet radio recently, if you look beyond the local BBS and packet cluster. Hams are increasing



their speed, building high-speed LANs that span whole towns, using packet to report weather conditions automatically, mapping positions using Global Positioning receivers or LORAN-C, tracing the flow of messages through the packet network, and exchanging packet information via meteor scatter propagation. This book—actually a collection of articles from such publications as *QST* and *QEX*, and ARRL Conference Proceedings—shows you how to find the areas that interest you.

The book is divided into five sections. The first, "9600

Bits/s," shows readers how to increase their basic packet speed to 9600 bits per second. It includes basic information on high-speed packet, hands on advice for getting started, and a review of modems that work at both 1200 and 9600 bps.

*Packet: Speed, More Speed, and Applications costs \$15 and is published by The American Radio Relay League, 225 Main Street, Newington, CT 06111; Tel. 203-666-1541; Fax: 203-665-7531.*

**CIRCLE 28 ON FREE INFORMATION CARD**

## 1995 GENERAL CATALOG OF PRODUCTS FOR TESTING, REPAIRING & ASSEMBLING ELECTRONIC EQUIPMENT

*from Contact East*

The 144 pages of this full-line catalog are filled with hundreds of new test instruments and tools for engineers, technicians, hobbyists, and managers. Quality, brand-name products for

electronic testing, repair, and assembly are featured.

Highlights of the 1995 catalog include digital multimeters and accessories, soldering tools,

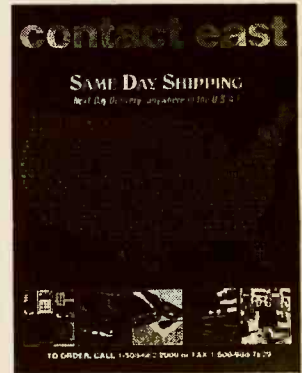

EPROM programmers, power supplies, custom tool kits, measuring tools, adhesives, data-communication tools and testers, heat guns, reference books, portable and bench-top digital storage oscilloscopes, ELF meters, precision hand tools, and breadboards. The catalog also offers full lines of communication test equipment, static-protection products, inspection equipment, soldering/desolder-

## Dual Channel DS Scope/Recorder

### 20 megasamples/sec Dual Channel PC Parallel Port Responsive Scope



**\$369** + ship & tax  
NJ residents  
VISA / Mastercard

Tel 201 837 8386  
Fax 201 837 6597

#### Features:

- Rear Connection to Parallel Port
- Windows 3.1 VGA based
- 1 M  $\Omega$  Input Resistance
- 8-bit Multiplexed Input
- Triggered with AC or DC Coupling
- Scope or Real Time Rec. Mode
- 16 freq. ranges in scope mode
- User definable timebase from 0.11 sec to as long as desired in rec. mode with buffer for up to 16,000 samples per channel
- 2 BNC Probes (1:1)
- Store results to Disk or Print
- Built-in DC, RMS, PK to PK and Frequency Meter
- 10 gain ranges: 5v/dv to 5mv/dv
- 16-bit user-defined output in response to input signal setpoints
- Auto ranging in scope mode
- 1MHz amplifier bandwidth
- Easy installation / Auto port detect.
- Made in USA



mission technology inc.  
P.O. Box 3016  
Teaneck, NJ 07666

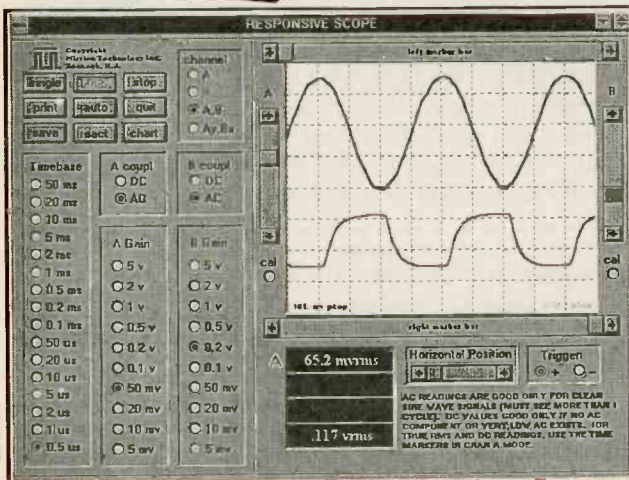

Actual scope screen for 500 KHz signals

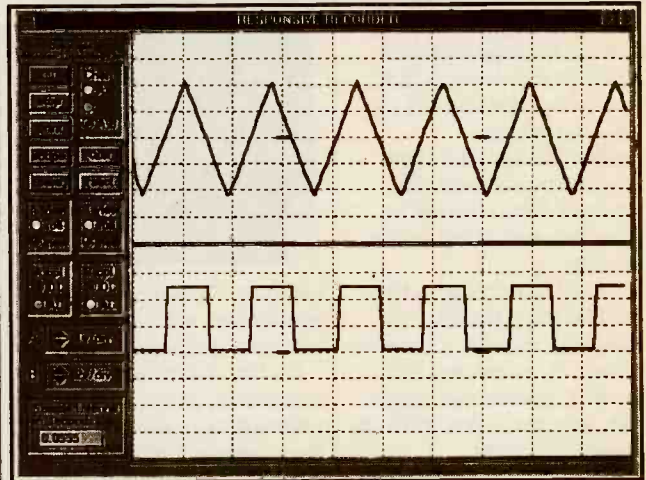

Actual recorder screen for 0.5 Hz signals



ing systems, ozone-safe cleaners, workbenches, and cases. All products are fully guaranteed, and orders placed by 4 PM will be shipped by 5 PM that same day.

*The 1995 Catalog of Products for Testing, Repairing & Assembling Electronic Equipment is free upon request from Contact East, 335 Willow Street South, North Andover, MA 01845-5995; Tel. 508-682-2000; Fax: 508-688-7829.*

**CIRCLE 51 ON FREE INFORMATION CARD**

### THE WHOLE SPY CATALOG

by Lee Lapin

This 440-page, hands-on encyclopedia of "secret sources" provides a wealth of professional secrets, tricks of the trade, "insider" phone numbers, and cutting-edge techniques for tracing, tracking, surveillance, and investigating anyone or anything.

The book shows how to locate and bug people, using the latest audio bugs and telephone taps. It shows where to buy exotic and inexpensive subcarriers, narrow-band, and burst bugs that are easy to hide and almost impossible to find; and how to turn a \$45 tape recorder



into a powerful room monitor. It also offers a look at the newest bugs, antennas, listening-post equipment, and intelligence kits from around the world, and lists sources for buying it all—even actual KGB surveillance equipment.

The book also shows readers how to locate and tap any telephone. It provides distribution

schemes, details the equipment needed, and shows how to use it. Photos, tips, and tricks from professionals are included, as are tests of cellular-phone interceptors (including how they work, and how to follow and intercept any nearby cellular calls). Also included is software that turns your PC into a cellular reader, as well as sources.

The book explains how to research a person's background and finances from the comfort of your living room, using mail forwarding, warranty-card information, magazine subscriptions, reverse directories, and credit information to find and build a dossier on anyone. It shows how to track down a person's real property, bank accounts, stocks, bonds, offshore accounts, and cars.

Other chapters cover Starlight night-vision technology, on-line resources, scrambling and encryption to protect your own personal information, high-tech countermeasures, and how to find and hire a good private detective.

*The Whole Spy Catalog costs \$44.95 and is published by Intelligence Incorporated, 2228 South El Camino Real #349, San Mateo, CA 94403; Tel. 415-851-3957 (1-800-805-5544 for credit-card orders); Fax: 415-851-5403.*

**CIRCLE 36 ON FREE INFORMATION CARD**

### USING PAGEMAKER 5 FOR WINDOWS

by Martin Matthews & Carole Matthews

Aimed at new or upgrading PageMaker users, this book-and-disk package provides all the information needed to create everything from simple forms and flyers to newsletters, catalogs, and annual reports. The book covers all the latest features of PageMaker 5 for Windows, including expert kerning and extensive color manipulation with four-color separations, spot color, and process color. Users will learn how to work with professional tools such as Aldus Additions, Control Palettes, and True Type fonts. The disk contains all the sample projects in the book, along with additional text and graphics files from Word for

# 51.092

## ELECTRONIC COMPONENTS

Whether you order 1 part or all 51,092...MOUSER stocks and...ships same day!!

CALL... (800) 992-9943

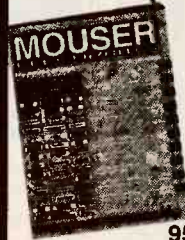

for your  
**FREE  
CATALOG**

958 North Main St.  
Mansfield, TX 76063

## MOUSER ELECTRONICS

Sales & Stocking Locations Nationwide

**CIRCLE 14 ON FREE INFORMATION CARD**

FULL- OR PART-TIME JOB/BUSINESS:

### Learn VCR repair!

Professional-level home study course. Master easy-to-learn, high-profit repairs without investing in costly high-tech instruments.

For free career literature, send or call 24 hours a day.

Call 800-223-4542



Name \_\_\_\_\_ Age \_\_\_\_\_

Address \_\_\_\_\_ Phone (\_\_\_\_) \_\_\_\_\_

City \_\_\_\_\_ State \_\_\_\_\_ Zip \_\_\_\_\_

**The School of VCR Repair, Dept. VRH351  
PCDI, 6065 Roswell Road, Atlanta, Georgia 30328**

### Learn to fix computers!

Home study course. Learn how to repair, troubleshoot, upgrade, and install PCs. Earn great money. For free career literature, call 800-223-4542.

Name \_\_\_\_\_ Age \_\_\_\_\_

Address \_\_\_\_\_

City \_\_\_\_\_ State \_\_\_\_\_ Zip \_\_\_\_\_

**The School of PC Repair, Dept. JH351  
PCDI, 6065 Roswell Road, Atlanta, Georgia 30328**

### BE AN ELECTRICIAN!

Home study. Make good money—maintain, install wiring in homes and businesses; electrical systems, cable, controls, utilities, phones, and more. Free career literature: call now 800-223-4542.

Name \_\_\_\_\_ Age \_\_\_\_\_

Address \_\_\_\_\_

City \_\_\_\_\_ State \_\_\_\_\_ Zip \_\_\_\_\_

**The Electrician School, Dept. TEH351, PCDI  
6065 Roswell Road, Atlanta, Georgia 30328**

### BE A MEDICAL TRANSCRIPTIONIST!

Home study. Experienced transcriptionists can make up to \$25,000—and more. Work in doctors' offices or at home. Free literature: 800-223-4542.

Name \_\_\_\_\_ Age \_\_\_\_\_

Address \_\_\_\_\_

City \_\_\_\_\_ State \_\_\_\_\_ Zip \_\_\_\_\_

**The School of Medical Transcription, PCDI  
Dept. YYH351, 6065 Roswell Rd., Atlanta, GA 30328**



**CIRCLE 15 ON FREE INFORMATION CARD**

**ELECTRONICS LIBRARY**

Windows, Word for DOS, WordPerfect, CorelDRAW!, Micrografx Designer, Excel, and dBASE that can be imported into PageMaker 5.

The book is divided into three distinct sections. The first provides an overview of desktop-publishing concepts, Windows, and basic PageMaker features. In the second section, readers

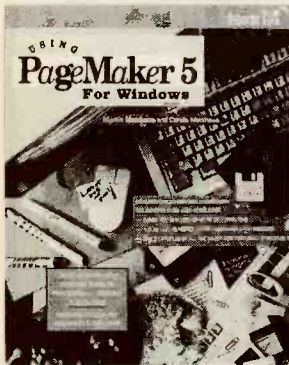

are guided through three common desktop-publishing projects: business forms using the Table Editor, an advertising brochure that introduces users to importing graphics, and an in-depth introduction to color concepts. The third section shows how to "dress up" multi-page documents, including a financial report, a catalog, and a newsletter, while learning how to import files found on the companion disk.

*Using PageMaker 5 for Windows costs \$39.95 and is published by Osborne McGraw-Hill, 2600 Tenth Street, Berkeley, CA 94710; Tel. 510-649-6600; Fax: 510-549-6603.*

**CIRCLE 47 ON FREE INFORMATION CARD**

**SIMPLIFIED DESIGN OF SWITCHING POWER SUPPLIES**

by John D. Lenk

This all-inclusive, one-stop guide to switching power-supply design describes the operation of each circuit in detail. Aimed at students and experimenters as well as design professionals, no previous design experience is required to use the tech-

niques presented in step-by-step instructions and detailed diagrams.

The book concentrates on the

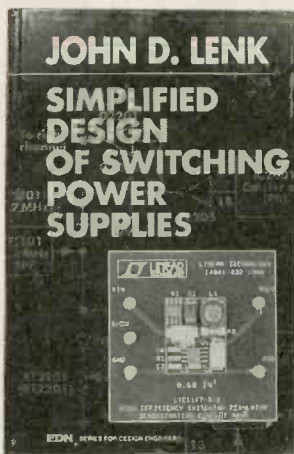

use of IC regulators and examines a selection of external components that modify the IC-package characteristics. All popular forms of switching supplies—including DC-DC converters, inverters, buck, boost, buck-boost, pulse-frequency modulation, pulse-width modulation, current-mode control, and pulse skipping—are covered. The design examples can be put to immediate use or can be modified to meet a specific design goal.

*Simplified Design of Switching Power Supplies costs \$39.95 and is published by Butterworth-Heinemann, 225 Wildwood Avenue, Woburn, MA 01801; Tel. 1-800-366-2665.*

**CIRCLE 59 ON FREE INFORMATION CARD**

**VOODOO UNIX: Mastery Tips & Masterful Tricks**

by Charlie Russel & Sharon Crawford

Filled with timesaving tricks and insider tips, and purposely devoid of unnecessary detail and technical jargon, this book is designed to help ordinary UNIX users become faster and more efficient at their work. It offers practical advice and solutions for a variety of challenging UNIX tasks. Beginning with the basics, it explains how to get going and get help, covering shells, security, and keeping track of your files. It goes on to cover moving around and mov-

**FREE**

- 1  Please send me 12 issues of POPULAR ELECTRONICS® for \$18.95 and bill me. (Canada \$25.63 U.S. FUNDS — Includes G.S.T.)
- 2  Please send me 12 issues of ELECTRONICS NOW® for \$17.97 and bill me. (Canada \$25.65 U.S. FUNDS — Includes G.S.T.)

Mail to: ELECTRONICS EXPERIMENTER'S HANDBOOK, Reader Service Management Dept., PO Box 5192, Pittsfield, MA 01203-9989

Name \_\_\_\_\_ Please Print  
 Company Name (if applicable) \_\_\_\_\_  
 Address \_\_\_\_\_  
 City \_\_\_\_\_ State \_\_\_\_\_ Zip +4 \_\_\_\_\_

Allow 6-8 weeks for delivery of first issue. OFFER VALID IN U.S. AND CANADA ONLY.

EHH Fall 1995

**FREE READERS SERVICE:** To receive more information about products and services mentioned in this issue, please circle the applicable Reader Service Number, and mail today!

1	16	31	46	61	76
2	17	32	47	62	77
3	18	33	48	63	78
4	19	34	49	64	79
5	20	35	50	65	80
6	21	36	51	66	81
7	22	37	52	67	82
8	23	38	53	68	83
9	24	39	54	69	84
10	25	40	55	70	85
11	26	41	56	71	86
12	27	42	57	72	87
13	28	43	58	73	88
14	29	44	59	74	89
15	30	45	60	75	90

**FREE**

## Just like these Fully Trained Electronics Professionals



"Thanks to CIE I have tripled my previous salary, and I am now in a challenging and rewarding new field where only the sky is the limit."

Daniel Wade Reynolds  
Industrial Electrician  
Ore-Ida Foods



"CIE was recommended to me by my boss. It was appealing since I could study at my own pace at home and during business travel."

Dan Parks  
Marketing Manager/Consumer Products  
Analog Devices, Inc.



"I loved the flexibility CIE offered. It was the only way I could continue both school and my demanding job."

Britt A. Hanks  
Director of Engineering  
Petroleum Helicopters, Inc.



"I liked the way the school was set up with laboratory assignments to enforce conceptual learning. The thing which impressed me the most about CIE's curriculum is the way they show application for all the theory that is presented."

Daniel N. Parkman  
Missile Electro-Mechanical Technician  
U.S. Air Force



"Completing the course gave me the ability to efficiently troubleshoot modern microprocessor based audio and video systems and enjoy a sense of job security."

Tony Reynolds  
Service Manager/Technician  
Threshold Audio & Video

# Graduate with an Associate Degree from CIE!

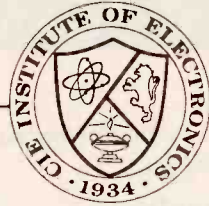

CIE is the best educational value you can receive if you want to learn about electronics, and earn a good income with that knowledge. CIE's reputation as the world leader in home study electronics is based solely on the success of our graduates. And we've earned our reputation with an unconditional commitment to provide our students with the very best electronics training.

Just ask any of the 150,000-plus graduates of the Cleveland Institute of Electronics who are working in high-paying positions with aerospace, computer, medical, automotive and communications firms throughout the world. They'll tell you success didn't come easy...but it did come...thanks to their CIE training. And today, a career in electronics offers more rewards than ever before.

### CIE IS COMMITTED TO BEING THE BEST...IN ONE AREA...ELECTRONICS.

CIE isn't another be-everything-to-everyone school. CIE teaches only one subject and we believe we're the best at what we do. Also, CIE is accredited by the National Home Study Council. And with more than 1,000 graduates each year, we're the largest home study school specializing exclusively in electronics. CIE has been training career-minded students for nearly sixty years and we're the best at our subject...  
**ELECTRONICS... IT'S THE ONLY SUBJECT WE TEACH!**

### CIE PROVIDES A LEARNING METHOD SO GOOD IT'S PATENTED.

CIE's AUTO-PROGRAMMED® lessons are a proven learning method for building valuable electronics

career skills. Each lesson is designed to take you step-by-step and principle-by-principle. And while all of CIE's lessons are designed for independent study, CIE's instructors are personally available to assist you with just a toll free call. The result is practical training... the kind of experience you can put to work in today's marketplace.

### LEARN BY DOING...WITH STATE-OF-THE-ART EQUIPMENT AND TRAINING.

CIE pioneered the first Electronics Laboratory

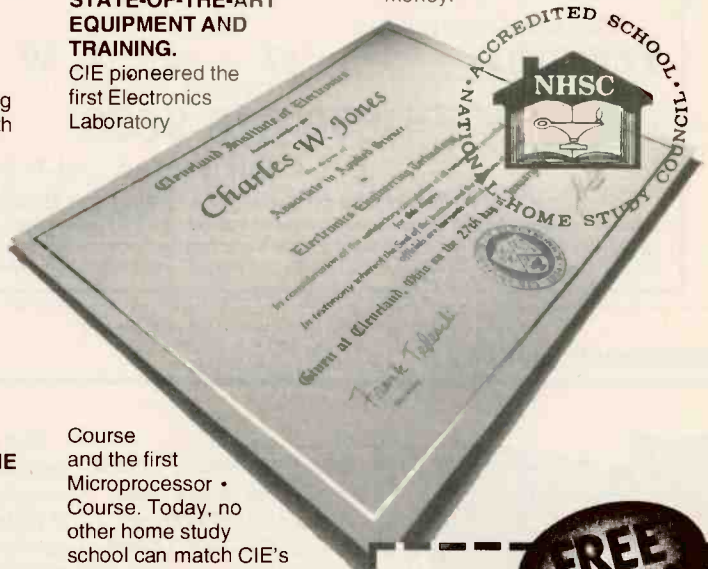

Course and the first Microprocessor • Course. Today, no other home study school can match CIE's state-of-the-art equipment and training. And all your laboratory equipment, books and lessons are included in your tuition. It's all yours to use while you study and for on-the-job after you graduate.

### PERSONALIZED TRAINING...TO MATCH YOUR BACKGROUND.

While some of our students have a working knowledge of electronics others are just starting out. That's why CIE has developed twelve career courses and an A.A.S. Degree program to choose from. So, even if you're not sure which electronics career is best for you, CIE can get you started with core lessons applicable to all areas in

electronics. And every CIE Course earns credit towards the completion of your Associate in Applied Science Degree. So you can work toward your degree in stages or as fast as you wish. In fact, CIE is the only school that actually rewards you for fast study, which can save you money.



## YES!

I want to get started. Send me my CIE course catalog including details about the Associate Degree Program. (For your convenience, CIE will have a representative contact you - there is no obligation.)

Please Print Clearly

Name \_\_\_\_\_

Address \_\_\_\_\_

City \_\_\_\_\_

State \_\_\_\_\_ Zip \_\_\_\_\_ Age \_\_\_\_\_

Phone No. \_\_\_\_\_

Check box for G.I. Bill Benefits.

Veteran  
Active Duty **AHOV4**

Cleveland Institute of Electronics, Inc.  
1776 East 17th Street  
Cleveland, OH 44114

A School of Thousands.  
A Class of One. Since 1934.

Send for CIE's FREE Course Catalog and See How We Can Help Your Career Too!

# CABLE TV DESCRAMBLERS

Best Wholesale Prices in the U.S.A.!

	1-4	5-9	10-19	20-49	50+
<i>For Jerrold Systems</i>					
TNT+	59	55	49	45	40
Stealth+	55	49	44	39	34
FTB3	49	39	35	32	30
<i>For Scientific Atlanta Systems</i>					
M80	69	62	55	45	40
SA3	55	45	40	36	33
<i>For Pioneer Systems</i>					
Super-PIO+	69	62	55	45	40
<i>Panasonic Converter</i>					
TZPC1003	75	67	62	59	57

**1-800-818-9688**

**U.S. Cable TV Inc. M-F: 9-6 EST**

**4100 N. Powerline Rd., Bldg. F4 Pompano Beach, FL 33073**

U.S. Cable will only sell the cable equipment to authorized cable subscribers. It is illegal to operate this equipment without paying for the basic and the premium services. U.S. Cable will not sell to anyone who will not comply with Federal and State laws. *No Florida Sales.*

lar Mac, the Quadra, and the PowerBook. It includes chapters on the Mac system, the use of binary numbers and transistors, the CPU, RAM, virtual memory,



disk storage, SCSI, the Apple desktop bus, NuBus, Mac sound and video elements, networks, printing, and publishing.

In *How Networks Work*, Frank J. Derfler, Jr. and Les Freed take an historical approach, using the development of modern communications to help explain and illustrate the underlying technology of modern networks.

telecommunications equipment and the network operating software that helps to integrate it. Individual chapters cover the use of computers as terminals, modems, cabling, interface cards, LAN types and topologies, linking, and workgroup applications.

For pricing and ordering information on the "How it Works" books, contact *Jensen Tools Inc.*, 7815 South 46th Street, Phoenix, AZ 85044; Tel. 800-426-1194.

**CIRCLE 38 ON FREE INFORMATION CARD**

## ELECTRONICS LIBRARY

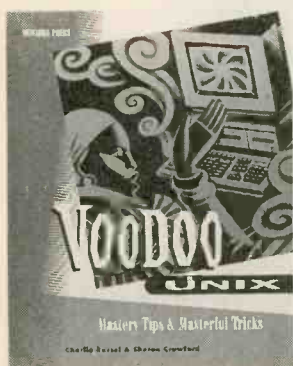

ing text, describes the differences between the command mode and the edit mode, and helps users master macros. X Windows is covered in detail, including opening windows, designing the desktop, using the mouse, and exploring existing X programs. The book shows readers how to use UNIX utilities, and how to avoid common UNIX pitfalls. It also explains communicating with non-UNIX computers, sharing files, logging in remotely, and using

network commands.

*Voodoo UNIX: Mastery Tips & Masterful Tricks* costs \$27.95 and is published by *Ventana Press*, P. O. Box 2468, Chapel Hill, NC 27515; Tel. 919-942-0220; Fax: 919-942-1140.

**CIRCLE 41 ON FREE INFORMATION CARD**

### "HOW IT WORKS" BOOKS

from *Jensen Tools*

The four volumes in the "How it Works" series of books for computer users are patterned after a technical-help column that debuted in *PC/Computing* magazine. *How Computers Work* and *How Software Works* are both written by Ron White, an original contributor to the magazine column. All four books aim to render the technology of computers, software, and networks understandable even to the non-technical user.

*How Computers Work* is organized by the six identifiable components and/or operations of IBM-compatible PC's—the boot-up process, the microchip, data-storage devices, input/output devices, networks, and printers. Other chapters in the book discuss transistors, microprocessors, keyboards, serial and parallel ports, scanners and OCR's, pen-based computers, LAN topologies, fonts, and printer types.

*How Software Works* takes the mystery out of computing, explaining in simple terms how hardware and software work together. The presentation is organized by types of software—database, spreadsheet, word-processing, graphics, communications, and Windows-based. An additional section covers programming languages.

*How Macs Work*, by John Rizzo and K. Daniel Clark, begins with a look inside the Macintosh, dealing separately with the Mac Classic, the Modu-



One tree can make  
3,000,000 matches.

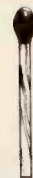

One match can burn  
3,000,000 trees.



A Public Service of This Magazine  
© The Advertising Council

# THE "g" MACHINE

BY ANTHONY J. CARISTI

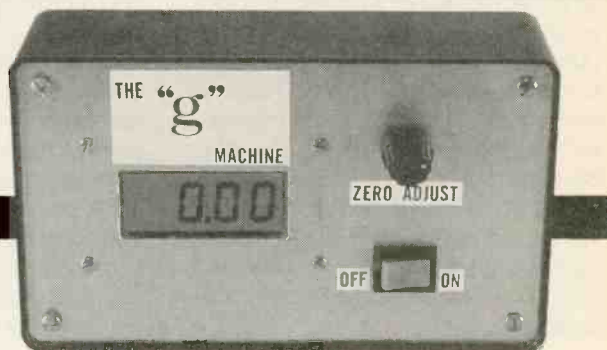

*Determine the "g" forces generated by your car with this portable, digital acceleration-measurement system.*

If you would like a high-tech way to measure the gravitational or "g" forces generated by your car, then this unusual project might be right for you. It's called the "g" Machine, and if you build it, you'll probably be the first one in your circle of friends to have a car equipped with a sophisticated g meter!

The "g" Machine measures acceleration and deceleration levels encountered in any moving vehicle, and displays those levels on an LCD. You can use it to compare the performance of your car's engine and braking system with that of other vehicles. The unit can also be used as a sophisticated electronic level by taking advantage of its sensitivity to the Earth's gravitational force.

**Velocity and Acceleration.** Before we get into how the "g" Machine works, let's quickly review how velocity and acceleration are measured. Velocity is the change in distance with respect to time, and can be specified as ft/s (feet per second). Acceleration is the change in velocity with respect to time and is specified as ft/s<sup>2</sup>. Sometimes, acceleration is referred to in terms of "g's," where 1 g is equal to the acceleration caused by Earth's gravitational field, or 32 ft/s<sup>2</sup>. Let's now look at an example:

An automobile traveling at a constant speed of 60 mi/hr (miles per hour) has an acceleration of zero, because there is no change in its velocity with respect to time. The velocity, 60 mi/hr, can also be spec-

ified in the unit of ft/s by using a simple algebraic equation that converts miles to feet and hours to seconds:

$$(60 \text{ mi/hr} \times 5280 \text{ ft/mi} \times 1 \text{ hr}) / 3600 \text{ s} = 88 \text{ ft/s}$$

Note that miles (mi) and hours (hr) are canceled out in the above equation to arrive at the desired units of ft/s.

Acceleration can easily be calculated using the equation

$$\text{acceleration} = \text{velocity}/\text{time}$$

Let's say that the automobile from the preceding example starts out at 0 ft/s and accelerates to 88 ft/s (60 mi/hr) in 8 seconds. That car has an average acceleration of

$$(88 \text{ ft/s}) / 8 \text{ s}$$

or 11 ft/s<sup>2</sup>. Because 1 g = 32 ft/s<sup>2</sup>, the automobile has an average acceleration of 11/32 or about 0.34 g's.

If the automobile was driven at a constant rate of acceleration as its speed increased from zero to 60 mi/hr, the "g" Machine would measure and display that automobile's performance with a display of about 0.34 g's. However, if the braking system could similarly stop the vehicle in 8 seconds, the deceleration would be displayed as -0.34 g's.

**The Accelerometer.** The "g" Machine uses the ADXL50 accelerometer, which is a monolithic integrated circuit designed by Analog Devices (the IC is available from the source in the Parts List or from an Analog Devices distributor). An accel-

erometer is a device that generates an electrical output signal that is proportional to any acceleration forces (changes in velocity) affecting it. The ADXL50 is used by at least one automobile manufacturer in airbag-deployment systems, and by other companies for different applications.

How does the accelerometer work? The ADXL50 IC is a completely self-contained measurement system that uses a change in capacitance to determine acceleration. Figures 1A and 1B are simplified diagrams of the sensor at rest and when subjected to the force of acceleration, respectively. The actual structure of the sensor consists of 42 unit cells, only one of which is shown in the figures. Its construction is such that each cell comprises a differential capacitor shown as C<sub>a</sub> and C<sub>b</sub>.

When the sensor is at rest, the values of C<sub>a</sub> and C<sub>b</sub> in each unit cell are identical. However, when the sensor experiences a change in velocity (acceleration), the center beam structure of the IC is deflected (as shown in Fig. 1B). That causes the capacitance value of C<sub>a</sub> to decrease while that of C<sub>b</sub> increases.

The fixed capacitor plates of the sensor are each driven by a 1-MHz square wave, and are 180 degrees out-of-phase with each other. With no acceleration force present, the voltages fed through the capacitors to the center plate cancel each other out, resulting in a voltage output at the center plate of zero.

When the force of acceleration is

present, the change in the capacitance of  $C_a$  and  $C_b$  causes an unbalance in the system, and a 1-MHz output signal is produced at the center plate. That signal is passed through a synchronous demodulator to produce a DC output voltage that is proportional to acceleration. Circuitry within the IC, if connected to the correct external components, provides an output voltage of 2.5 volts when the sensor is at rest. That voltage will increase or decrease in magnitude in accordance with the level of acceleration or deceleration affecting the sensor.

**Circuit Description.** Power for the "g" Machine (shown in Fig. 2) is taken from a 9-volt battery, B1. That battery's output voltage is regulated by U1, which supplies a constant 5 volts to drive the remainder of the circuit. Of course, the circuit can also run off of a car battery.

The heart of the circuit is U2, the ADXL50 accelerometer. The sensitivity of that chip is set to  $\pm 20$  g's in order to accommodate the full scale capability of LCD module DISP1 (19.99). Circuit gain is determined by the values of R4, R5, and R6, which control the gain of the internal buffer amplifier of the accelerometer. The series string composed of R1, potentiometer R2, and R3 provides a way to manually set the zero-g voltage-output level at pin 9 of U2 to half the supply voltage—2.5 volts. That output voltage will vary linearly by 0.1-volt-per-g of acceleration. Therefore, when sub-

ject to the maximum value of 20 g's, the output voltage will swing 2 volts from its zero-g level of 2.5 volts.

In order to achieve good circuit performance at low g levels, the bandwidth of the amplifier is limited to about 30 Hz by C6. That capacitor is externally connected across the feedback resistor of the internal op-amp of the accelerometer.

The digital-display section of the circuit is composed of DISP1 and U3. The latter is an analog-to-digital converter chip that contains all the necessary active components to drive DISP1, the 3½-digit LCD module. Included in U3 are the A/D converter, clock oscillator, storage registers and latches, 3½-digit seven-segment decoders, and backplane generator.

The differential analog input of U3 is applied between pins 30 and 31. The positive input, pin 31, is driven by output-pin 9 of U2 through R8, a buffer resistor, and the negative input, pin 30, is biased at a fixed voltage of 2.5 volts by a voltage-divider string composed of R9 and R10. That provides the desired display of 0.00 when the accelerometer is at rest.

A reference voltage is required by U3. That is applied between pins 35 and 36 to set the full-scale display range of the A/D converter. Full-scale display, 19.99, occurs when the differential, analog input voltage applied between pins 31 and 30 is equal to twice the reference voltage. Because the scale factor of U2 has been set to 2.0 volts for 20 g's, the reference voltage must be 1.0 volts. The voltage-

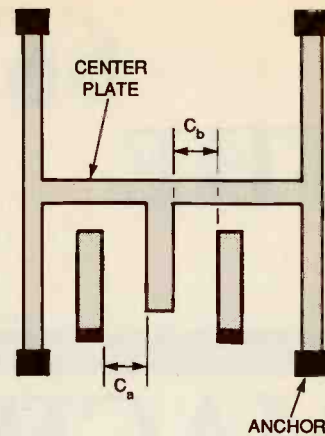

A

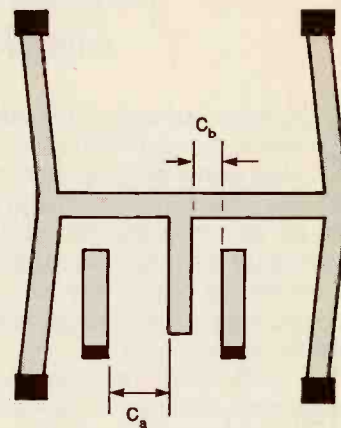

B

Fig. 1. When the accelerometer sensor is at rest (A), the capacitance of  $C_a$  is equal to that of  $C_b$ . However, when the sensor is accelerated to the left (B), the center plate shifts to the right, causing the capacitance of  $C_b$  to increase, and that of  $C_a$  to decrease.

## PARTS LIST FOR THE "g" MACHINE

### SEMICONDUCTORS

- U1—78L05 5-volt regulator, integrated circuit
- U2—ADXL50 accelerometer, integrated circuit (Analog Devices)
- U3—ICL7106 A/D converter, integrated circuit
- DISP1—3½-digit LCD module (Dig-Key LCD002VT-ND or similar)
- Q1—BS170 N-channel enhancement MOSFET

### RESISTORS

- (All fixed resistors are ¼-watt, 1%, metal-film units unless otherwise noted.)
- R1, R3—20,000-ohm
  - R2—10,000-ohm potentiometer, panel-mount

- R4—23,700-ohm
- R5—5000-ohm, cermet potentiometer, PC-mount
- R6—137,000-ohm
- R7, R9, R10, R11, R13—100,000-ohm
- R8—1-megohm, 5%, carbon
- R12—49,900-ohm
- R14, R16—100,000-ohm, 5%, carbon
- R15—470,000-ohm, 5%, carbon

### CAPACITORS

- C1—47- $\mu$ F, 25-WVDC, electrolytic
- C2, C3, C7, C9—0.1- $\mu$ F, metallized-film
- C4, C5—0.022- $\mu$ F, metallized-film
- C6, C10—0.047- $\mu$ F, metallized-film
- C8—100-pF, ceramic-disc
- C11—0.22- $\mu$ F, metallized-film

### ADDITIONAL PARTS AND MATERIALS

- S1—SPST toggle or slide switch
  - B1—9-volt battery
- Printed-circuit materials, project enclosure, 90-degree header (see text), 40-pin IC socket, battery snap with leads, spacers, machine screws and nuts, wire, solder, hardware, etc.

**Note:** The following parts are available from A. Caristi (69 White Pond Road, Waldwick, NJ 07463). Set of 3 PC boards: \$24.95; U1: \$2.00; U2: \$66.50; U3: \$14.95; Q1: \$2.00; set of 10 1% resistors: \$5.00. Please add \$5.00 postage/handling. New Jersey residents please add appropriate sales tax.

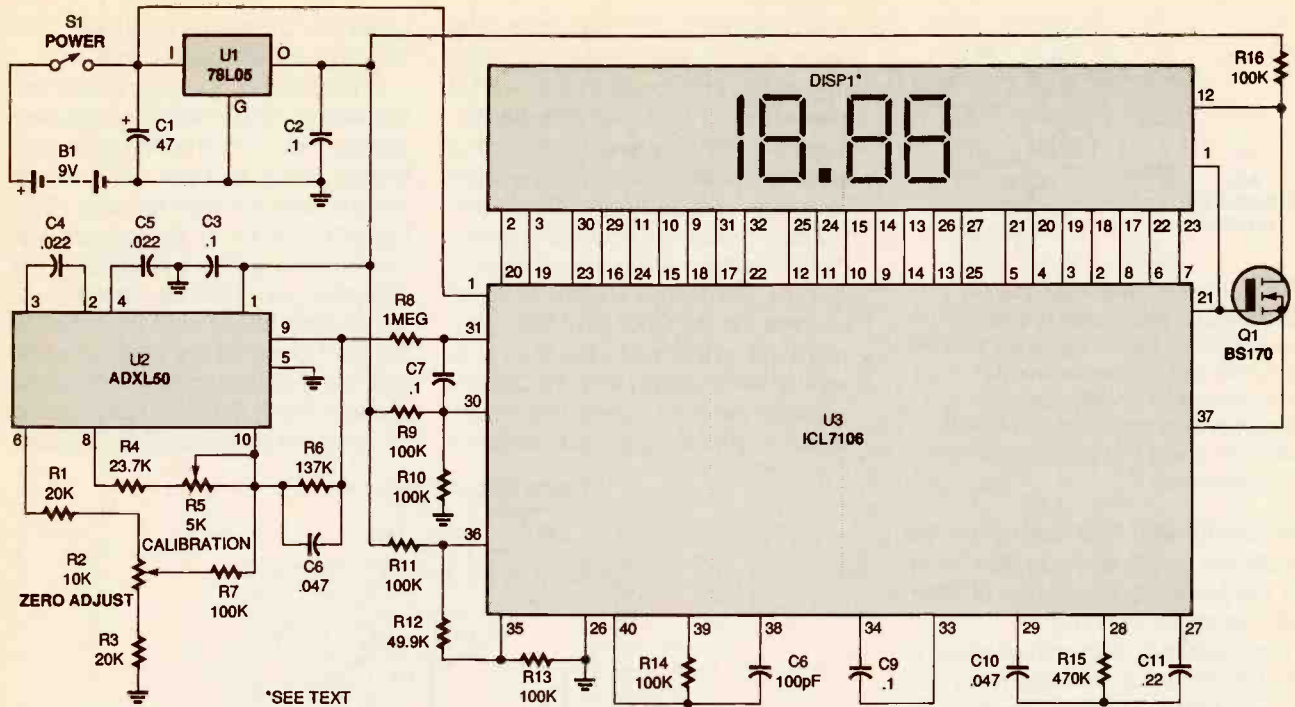

Fig. 2. As this schematic shows, the ADXL50 accelerometer, U2, interfaces with an A/D converter, U3, to drive a 3½-digit LCD module, DISP1. Because that module displays any number from -19.99 to +19.99, the circuit is designed to measure g's within that range.

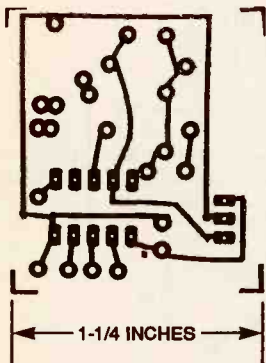

Fig. 3. Here is the template for the accelerometer printed-circuit board.

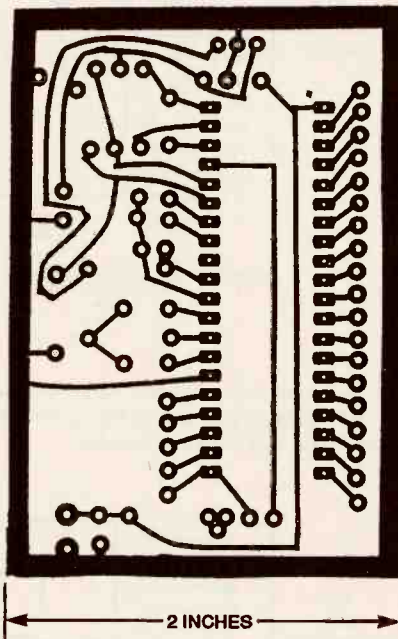

Fig. 4. This is the A/D-converter printed-circuit board.

divider string composed of R11, R12, and R13 provides that voltage.

The decimal point of the LCD has to be illuminated to display readings from 0.00 to 19.99. That is done by inverting the backplane square-wave drive signal appearing at pin 21 of U3, through MOSFET Q1, and applying the 180-degree out-of-phase signal to pin 12 of DISP1.

**Construction.** The author's prototype for the "g" Machine was assembled using three single-sided printed-circuit boards that are mounted within a small enclosure. Those are the accelerometer board (Fig. 3), the A/D-converter board (Fig.

4), and the display-module board (Fig. 5). The printed-circuit boards can be obtained from the source given in the Parts List, or you can etch and drill your own. Alternatively, the circuit can be hard-wired on one or more perfboards providing that proper orientation of the accelerometer is maintained, as explained later.

If you choose to build the project on PC boards, use Figs. 6, 7, and 8 as guides to ensure that you properly orient all polarized components. Install those parts first, then install the other capacitors and resistors. Next, install U3 using a 40-pin socket.

The accelerometer, U2, can be soldered directly onto the accelerometer board. Note the position of U2's tab shown in Fig. 6, and make sure that the orientation of the part matches. Then, gently bend the leads to fit into the ten holes on the board.

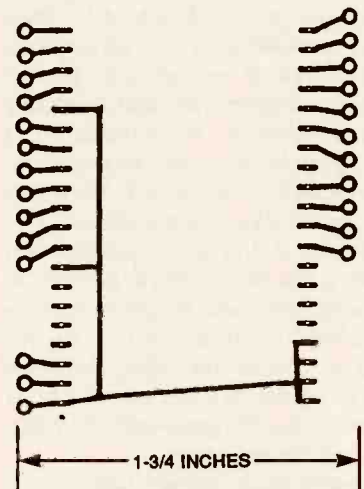

Fig. 5. The display board template is shown here.

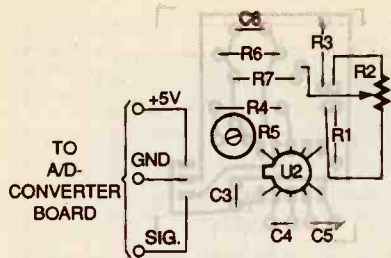

Fig. 6. Use this parts-placement diagram as a guide when assembling the accelerometer board. Check the position of the tab on U2 to make sure the accelerometer is oriented correctly. Also, note the connections to the A/D-converter board that can be made with a 3-pin header.

Be careful with that operation; the leads are fragile and you don't want to inadvertently break any of them with repeated bending.

The accuracy of the circuit relies on the stability of the accelerometer and A/D-converter voltage-reference-resistor values. For that reason, you should use only metal-film resistors for the resistors specified in the Parts List as 1% units. Ordinary carbon resistors are not temperature stable and should only be used where specified.

When you have completed assembly of the circuit boards, examine them very carefully for bad solder joints and/or incorrect orientation of parts. It is much easier to correct problems at this stage rather than after the boards are connected.

**Connecting the Boards.** Before you can connect the printed-circuit boards to the front panel of the enclosure, the A/D-converter board and display board must be wired together using light gauge (#22 to #26), insulated stranded wire (do not use solid wire—it has a tendency to break). Those connections include three sets of seven wires, each labeled a through g, for the seven-segment display digits, the half digit (1), the minus sign, and the backplane drive.

Use Figs. 2, 7, and 8 as guides when making the connections. Be sure to allow sufficient wire length to accommodate the final position of the boards. Check the wiring between the two boards carefully; an error there will result in garbled display digits, or no display at all.

A rectangular cutout measuring 2 by 7/8 inches should be made at the desired location in the front panel of

your enclosure. The two operating controls, S1 and R2, can be placed at any convenient location; they will be connected to the circuit boards later.

For the "g" Machine to provide a positive acceleration reading when it is facing the user, the accelerometer PC board must be oriented perpendicular to the front panel of the enclosure. The tab of U2 has to point towards the front panel of the instrument, as indicated in Fig. 9 (a side view of the assembly from the bottom edge of the front panel). Precise orientation of U2 is important to ensure a

balance between positive- and negative-acceleration forces.

One way to accomplish proper orientation of U2 is to mount the accelerometer board to the A/D-converter board using a 3-pin, 90-degree header with 0.1-inch spacing (Dig-Key S1112-3-ND or similar), as was done in the author's prototype. The assembly can then be stacked with the display board and mounted to the front panel of the enclosure with spacers, machine screws, and nuts (as shown in Fig. 9). If you are not planning on using the supplied PC-board tem-

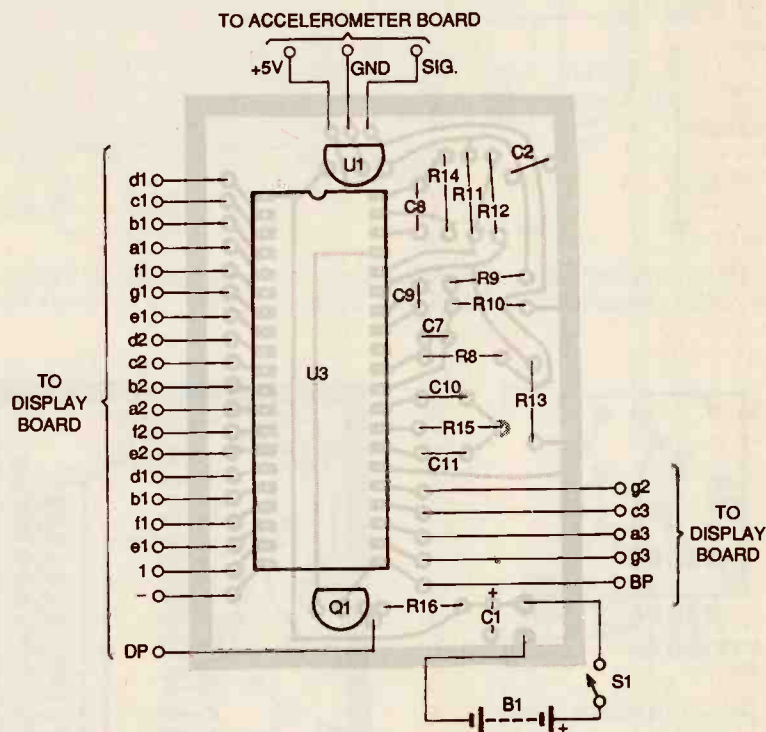

Fig. 7. On-board component placement on this A/D-converter board is pretty simple. Just be careful when making the off-board connections to the display board. Also, note the placement of the 3-pin header.

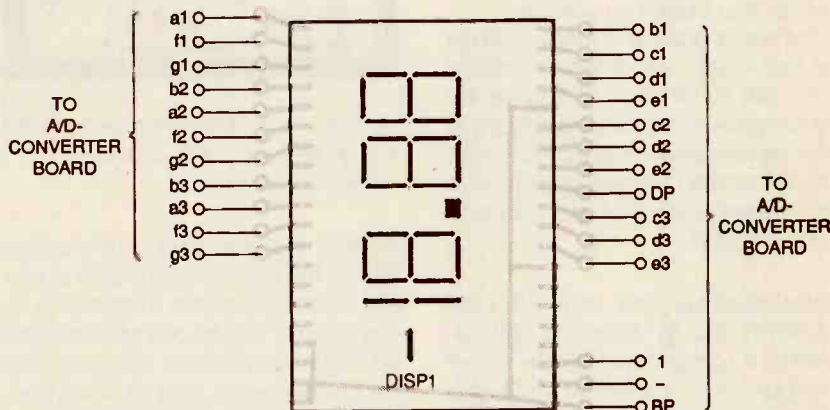

Fig. 8. The only component that mounts on this board is DISP1. However, watch those connections to the A/D converter board!



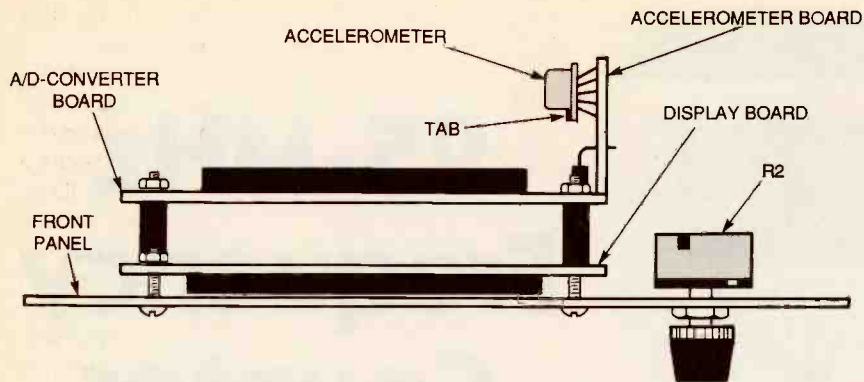

Fig. 9. This is a top-side view of the "g" Machine. Make sure U2 is placed so that its tab points towards the front panel, as shown. The boards are mounted with spacers and machine screws and nuts.

plates, and will use a different parts layout, make sure that the accelerometer is still aligned properly (with the tab pointing to the front panel).

Attach a battery clip, switch S1, and potentiometer R2 to the circuit using Figs. 6 and 7 as guides. Be sure to check polarity when wiring the clip to the circuit. The battery should be secured within the cabinet to keep it from moving around.

**Checkout.** The checkout procedure requires the use of a digital voltmeter or VOM. Set R2 and R5 to mid-position and connect a fresh 9-volt battery to the circuit. Turn the power on and measure the voltage at the output of U1 with respect to the circuit common (negative battery terminal). If all is well, it should measure between 4.75 to 5.25 volts.

Do not proceed with the checkout procedure if you do not obtain the correct voltage reading. Instead, check the orientation of C1 and U1. The next step in the procedure is to check the positive battery-terminal voltage and polarity under load to be sure it is delivering at least +7 volts to the circuit. If it's not, turn off the power and check the resistance between the 5-volt bus and circuit common to be sure that there is no short circuit. Locate and repair the fault before proceeding.

With the 5-volt regulator operating properly, apply power to the circuit and measure the voltage at pin 9 of U2 while adjusting potentiometer R2 over its range. A normal indication is about +2.3 to +2.7 volts. If necessary, a different-valued resistor can be used for R1 and/or R3 to obtain a swing that is centered about 2.5 volts.

If you do not obtain the correct voltage at pin 9 of U2, disconnect power and check the orientation of U2 on its board to be sure it is correct as shown in Fig. 6. Check the wiring to R2, and all the components on the accelerometer board. Check the voltage between pins 1 and 5 of U2 to be sure it is being powered by the +5-volt regulated supply.

With U2 operating properly, check the display as R2, the ZERO ADJUST control, is rotated over its range. You should obtain readings that cover the range of at least -1.00 to +1.00, or more. Of course, adjustment of R2 should allow the display to be set to 0.00.

If the display is blank, check the orientation of U3 and DISP1, and verify that all component values associated with U3 are correct. Check pin 21 of U3 with an oscilloscope to verify the presence of the 5-volt, peak-to-peak, 55-Hz, backplane square-wave signal.

If some of the digits are not properly formed, then there is either a wiring error, a short, or an open in one or more of the connections between the A/D-converter and display boards. Check the boards for solder bridges or poor connections. If the decimal point is not illuminated, check Q1 and its associated wiring, and if that is correct, try a new transistor.

**Calibration.** You will have to calibrate the "g" Machine against the force of gravity, which averages 1 g. To do that, set R5 to approximately mid-position first. Then, hold the enclosure so that the front panel is exactly vertical, and apply power. Carefully adjust R2, the ZERO ADJUST front-panel potentiometer, for a display of 0.00.

Now place the panel in a horizontal position with the display facing upward. The reading should be a negative number. Position the panel in a horizontal position so that the display faces down. The reading should be a positive number. Proper calibration is attained by adjusting R5 so that the readings in the last two positions are as close to -1.00 and +1.00 as possible. That will take several adjustments of R5. Before each adjustment, always hold the panel in an exact vertical position and re-zero the display to 0.00 with the front-panel potentiometer, R2.

Note: If there seems to be an imbalance in the positive and negative readings with the panel placed in each horizontal direction, the orientation of U2 is not exact. It will be possible to balance the readings by slightly adjusting the position of U2 on its board, rotating it either clockwise or counterclockwise as required. With careful calibration it should be possible to obtain positive and negative readings that are reasonably close to each other, within 0.1 g's or less.

**Using the "g" Machine.** The best way to check the operation of the "g" Machine is to take it for a test run in a vehicle. Be sure to have someone drive while you operate the instrument. Always hold the front panel in a vertical direction and zero the display while stopped, before taking a measurement.

Remember: acceleration is the rate of change of velocity or speed, so maximum acceleration readings occur when the vehicle is starting out. When a final speed is attained, the acceleration should become zero. For example, if the vehicle is driven so that its speed increases from zero to 55 MPH in as short a time as is practical, the g force will be about 0.3 to 0.5 when beginning the test and it will decrease to zero when speed becomes constant.

It should be noted that it is possible to attain much-higher g forces when braking. When that is done, the instrument will display a negative number, indicating deceleration.

The display will start to become erratic, and will eventually go blank, when the battery needs to be replaced. To extend battery life, shut off the unit when it's not in use. ■

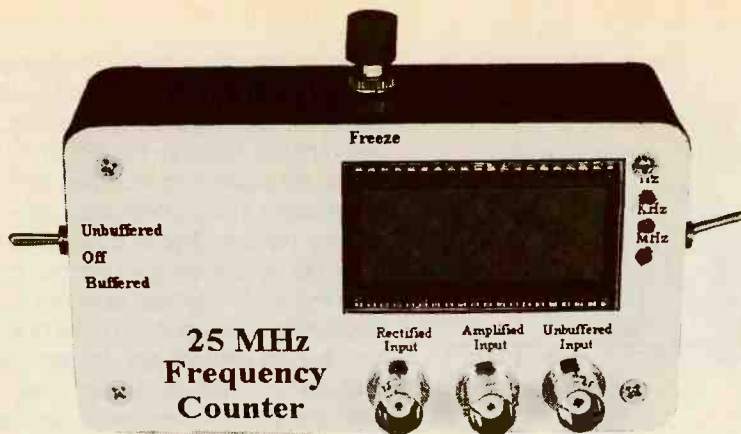

# 25-MHz Frequency Counter

*Here's an inexpensive way to gain a valuable test-gear addition to any hobbyist's workbench.*

BY MARK EMERY BOLLES

**W**ith the way that the electronics world has changed in the last twenty years, a frequency counter is no longer a luxury; it is a necessity. Unfortunately, like most of us, I walk a delicate line between what my test bench needs and what my budget can afford. A few years back, I spent nearly \$200 on a fancy signal-generator/frequency-counter unit; but, unfortunately, it only goes to 2 MHz. As even the simplest circuits these days have clock speeds that exceed that many, many times over, I constantly found myself perusing the catalogs, looking for something I could afford.

Then I came up with the 25-MHz Frequency Counter described in this article. It accurately counts frequencies to 25 MHz, is so small that it could fit in a coat pocket, and can be built for less than forty dollars.

The complete schematic for the frequency counter is shown in Fig. 1. Any frequency counter, including this one, can be broken down into five basic sections: counting, input conditioning, ranging, timing, and display. Let's look at each of those functions separately.

**Counting.** When building a frequency counter, it's hard to ignore the chips made by Intersil/Harris Semiconductor. Some of them are really complete frequency counters on a single chip; you just hook them up to a display, add some conditioning circuitry, throw it into a box, and *voilà*, you have a frequency counter.

That said, I didn't use one of those chips for a variety of reasons. To start with, they generally only count to 10 MHz; that isn't high enough for many applications. Secondly, the chips are quite pricey; some of them cost more than this whole project. And finally, it just feels like cheating to throw a single chip in a box and say: "Hey! Look what I made!" Part of the joy of electronics, whether as a hobby or a profession, is the chance to exercise your gray matter a little and come up with something innovative. The single-chip solution is lacking in challenge.

Having discarded the one-chip solution, there are still some extremely good Intersil chips that we can use. For the heart of the frequency counter, I chose the Intersil ICM7224IPL. It is a higher performance version of the CMOS family 74C946 counter/latch/display driver, but where the latter tops out at around 3 MHz, the former is guaranteed to count to 15 MHz, and typically counts to 25 MHz or better. Best of all, the ICM7224IPL costs less than \$10.

The ICM7224 directly drives a four digit LCD display; it has reset, clock, and enable inputs. The reset input sets all counters to zero. The enable input essentially disables the clock input. That means that we can connect the output of the counter's input-conditioning circuitry directly to the chip's clock line, and control when counting occurs with the enable input.

**Input Conditioning.** Input con-

ditioning is the area where most home-brew frequency counters fall down. The reason is simple enough: Designing a good input-conditioning circuit is usually difficult, expensive, or both. For this design, I wanted to be able to count frequencies from 0 to 25 MHz, using input signals from 0 to 50 volts, allowing both AC and DC signals of any wave shape. For use with the selected counter chip, the input-conditioning circuit must be able to change sine, triangle, or any other wave shape to a clean square wave of 0 to 5 volts, with fast rise and fall times. And, of course, the input-conditioning circuit had to be simple and cheap.

I am not above stooping to theft (although I prefer to call it "research"), so the first thing I did was to pull out all the old books and magazines and try a few front-end circuits from other frequency counters. Amazingly, I found that very few worked as claimed, and none would work for my design. All of the circuits I checked used op-amps for signal conditioning. I bread-boarded the designs, but found that the chips required were either too expensive, required a dual power supply, or weren't fast enough. I needed a new approach.

Most of you are probably familiar with the CMOS 4049 chip. That chip houses six inverters in a 16-pin DIP. It was designed for use in digital circuits for logic purposes, as well as for interfacing between TTL and CMOS. What many people don't know is that it can



the chip, and we can convert slow rise and fall times into fast ones. Lastly, as is typical with the HC family, high level outputs go all the way to  $V_{CC}$ .

By choosing input and feedback resistors that give a gain of 100, we can be assured that any significant input signal will drive the chip's output from rail to rail, ensuring a nice clean square wave for us to feed to the ICM7224IPL.

The one thing that the 74HC4049 does not like is a negative input voltage. The databooks say the minimum input voltage is 0 volts, but in reality, it will handle up to around  $-1$  volt without complaint. Also, although the chip is designed to handle up to 15 volts, it runs cooler if the maximum input does not exceed  $V_{CC}$  (5 volts in our design). Therefore, as part of our input conditioning, we need to be able to take signals that can range as far as  $-50$  to  $+50$  volts, and convert them so that they fit into a  $-1$  to  $+5$  volt range.

The obvious choice for that job is a Zener diode. The circuit uses a 1N751 5.1-volt Zener, along with a 47K resistor and capacitive coupling, so that a minimum load is put on the circuit under test.

When price is a factor, any circuit is a compromise. The one used here has two problems: The first is that the Zener diode has a relatively slow recovery time and starts to perform poorly at speeds above 8 MHz. The second problem is that the 74HC4049 uses a lot of supply current. So I chose to provide three different inputs to the frequency counter

Input-jack J1 is used when the signal needs to be amplified and conditioned for the ICM7224 chip. The Zener rejects all signals that fall outside the range of  $-0.7$  to  $+5.1$  volts. Therefore, that input is used for sine waves and AC signals up to about 50 volts; it works well to about 8 MHz or more, depending on signal symmetry.

Input-jack J2 is used when the input signal needs conditioning, but not rectification; a 0- to 15-volt DC triangular wave, for example. The input works up to the full 25-MHz limit of the frequency counter.

Input-jack J3 is used for an unconditioned signal; it goes directly to the ICM7224's clock input. If you are counting the frequency in a typical digital circuit, where you generally find only 0- to 5-volt square waves,

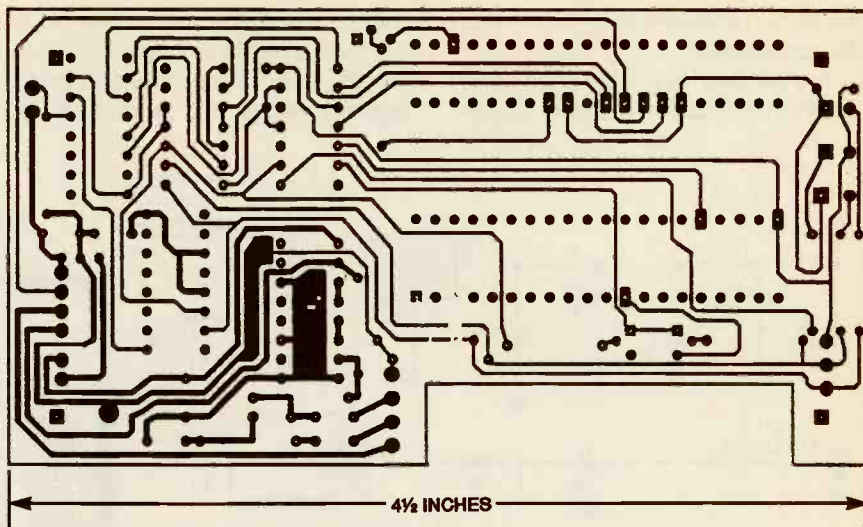

Fig 2. The counter is built on a compact double-sided PC-board. The artwork for the foil side of the board is shown here.

input conditioning is not required. When that input is used, switch S1 should be placed in position 3, the unbuffered position. Besides connecting the input directly to the counter chip's clock input, that removes supply power from the 74HC4049, which is not used in the unbuffered configuration. Since the input-conditioning circuitry consumes about 100 mA, that setting can extend battery life considerably.

**Ranging.** Since our design can display only 4 digits, some type of ranging is essential. The frequency counter has three ranges: 0000–9999 Hz; 000.0–999.9 kHz; and 00.00–99.99 MHz.

There are two different ways we could achieve the required ranging scheme: The first is to divide the incoming signal with counters so that the ICM7224 counts fewer pulses. The second method is to change the time period within which the input signal's pulses are counted. For the frequencies we will be dealing with, the second method is easier, cheaper, uses fewer chips, and is more accurate. All we need is a way of accurately controlling the timing period.

**Timing.** Actually, the term "frequency counter" is a misnomer; a frequency counter really doesn't count frequencies, it counts pulses. So when we design a frequency counter, we are really designing a piece of test equipment that shapes incoming pulses into a form it likes, counts them, and

displays the count. Of course, that sounds like the definition of an events counter; in order for it to be a frequency counter, it must count the pulses that occur within a specific time period. Therefore, we can think of a frequency counter as an events counter that contains accurate timing circuitry; that circuitry determines when the pulses (events) are counted.

It then becomes obvious that the accuracy of the frequency counter completely depends on the accuracy of the sampling period. If it is even a fraction of a second off, the ICM7224 will miss counts, or count more pulses than it should, giving an inaccurate readout.

As you can then see, next to the counter chip itself, the timing circuitry is the most critical part of an accurate frequency counter. For our design, we need a chip that will accurately define the three timing periods we require for the three different ranges.

The Statek PXO-1000 is a 16-pin DIP that contains a 1-MHz laser-trimmed crystal, along with internal logic and dividers that allow you to get 57 different frequencies from 1 MHz down to 0.0083 Hz, depending on the logic levels present at the chip's program pins. Also, the chip has good temperature stability (0.015% over its operating range), doesn't have start-up problems like crystal oscillators occasionally do, and runs on about 700  $\mu$ A of current. Epson America also makes a compatible chip, the SE3102 (available from Digi-Key, and elsewhere).

We can get the three frequencies

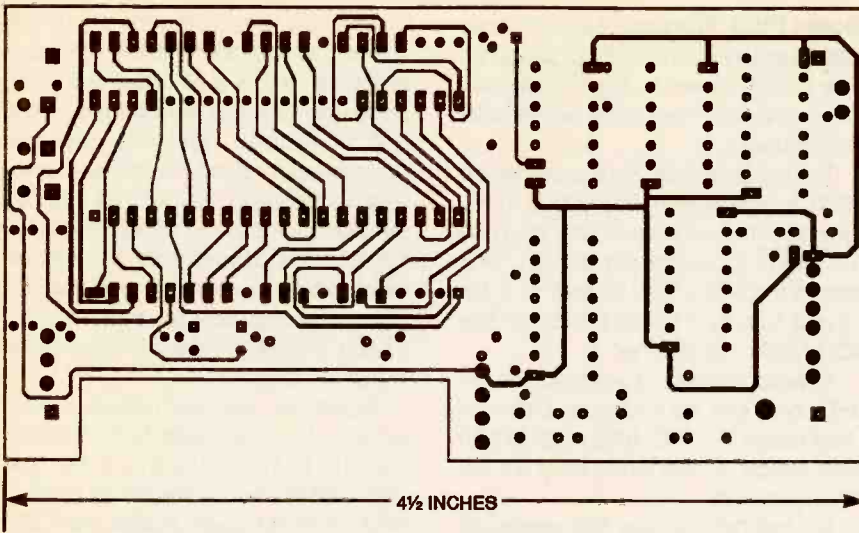

Fig. 3. Here is the component side of the project's PC-board. Like the foil side shown in Fig. 2, it appears full sized.

we need by changing the logic levels on just two of the chip's program pins. We can then take the frequencies that are output from the PXO-1000 and convert them into the timing periods that we need for the enable line.

Let's see how all of that works. The frequency from the PXO-1000 is fed to the clock input of the 74HC4017. As the clock counts, each of the 74HC4017's *Q* outputs goes high in succession. Two of the outputs are fed into an RS latch, the output of which is fed to the 74HC7224's enable input.

There are a couple of advantages to using that method. One is that the enable period becomes dependent only on the PXO-1000's output frequency, which in this case is easily controlled with just two logic pins. Secondly, we can use other outputs from the 74HC4017 to control the reset and latching inputs of the ICM7224. Lastly, and probably most important, is that the circuit, using the RS latch, is completely immune to propagation delays. Since the rise and fall propagation delays for the 74HC02 are exactly

the same, the delay in turning on the RS latch is exactly the same as the delay in turning off the latch; therefore, the enable period suffers no variations, and we can be confident that the ICM7224 is giving us an accurate count.

**Display.** Our frequency counter uses a 4-digit LCD display that is directly driven by the ICM7224. What the ICM7224 does not do is control the decimal points, nor does it directly control an overflow indicator; we must take care of that ourselves.

The ICM7224 generates a 150-Hz square wave for the display; that signal is called the backplane. When a segment of the LCD should be off, that segment is fed a square wave that is identical to, and in-phase with, the backplane. When a segment is to be on, the segment is fed a square wave that is 180° out-of-phase with the backplane, causing the segment to become visible.

Therefore, the easiest way to display the decimal points is to take the backplane signal, invert it, and gate it to the appropriate decimal point segments on the LCD with transistors. In strict theory, that isn't quite ideal. In our implementation we cause the decimal point segments to be on with a square wave 180° out-of-phase with

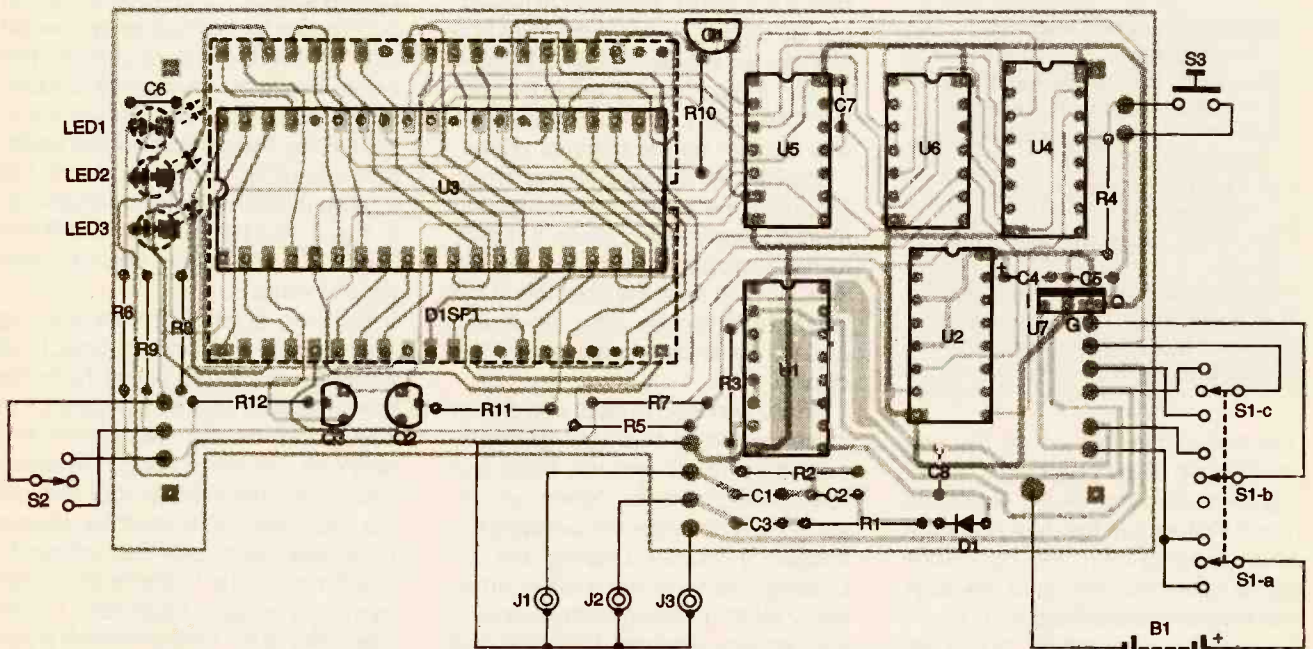

Fig. 4. Mount the components using this parts-placement diagram as a guide. Note that the LCD (DISP1) and the LED's mount on the foil side of the board. Be sure to solder all components on both sides of the board wherever pads are provided.

## PARTS LIST FOR THE 25 MHz FREQUENCY COUNTER

### SEMICONDUCTORS

- U1—74HC4049 high-speed CMOS hex inverter, integrated circuit
- U2—PXO-1000 or SE3102 programmable frequency source, integrated circuit (see text)
- U3—ICM7224IPL counter/latch/display-driver, integrated circuit
- U4—74HC4017 high-speed CMOS decade counter, integrated circuit
- U5—74HC04 high-speed CMOS hex inverter, integrated circuit
- U6—74HC02 high-speed CMOS quad 2-input NOR gate, integrated circuit
- U7—LM7805 5-volt regulator, integrated circuit
- DISP1—LCD003 4-digit liquid-crystal display, see text
- Q1—Q3—2N3904 NPN transistor
- D1—1N750 5.1-volt Zener diode
- LED1—LED3—20-mA light-emitting diode, 1/8-inch diameter

### RESISTORS

(All resistors are 1/8-watt, 5% units.)

- R1—47,000-ohm
- R2—100,000-ohm
- R3—10-megohm
- R4, R5, R7—2200-ohm
- R6, R8, R9—330-ohm
- R10—R12—10,000-ohm

### CAPACITORS

- C1—C3—0.022- $\mu$ F, Mylar
- C4—1- $\mu$ F, tantalum
- C5—C8—0.01- $\mu$ F, ceramic-disc

### ADDITIONAL PARTS AND

#### MATERIALS

- S1—3PDT, mini toggle, center off
- S2—SPDT, mini toggle, center off
- S3—SPST momentary push-button, normally off
- J1—J3—BNC connector, female, panel mount
- B1—9-volt battery, transistor-radio type
- PC-board and materials, enclosure (Radio Shack 270-222 or similar), 9-volt battery clip, hardware, solder, wire, etc.

the backplane, but cause the segment to be off by providing it with no signal at all. Strict theory would demand that we turn the decimal points off by feeding them the backplane signal, rather than no signal. However, that would increase the parts count of the circuit, and whatever "points" we lose by not adhering to strict theory, we gain back through our "admirable down-to-earth pragmatism!"

**Some Final Touches.** We have now described most of the major points of the circuit shown in Fig. 1. However, there are still a few points we need to touch upon.

The range switch, S2, is a center-off SPDT toggle switch. In position 1, we feed  $V_{CC}$  to a Hz LED indicator, and pull PXO-1000 program pin 4 high. That results in a PXO-1000 output of 5 Hz, and a 1-second timing period on the ICM7224's enable line.

In switch position 3, we feed the MHz LED, and pull no program pins low. That results in a PXO-1000 output of 50 kHz, which corresponds to a 0.1 ms timing period.

For the "kHz" range, the center-off position (position 2) of the range switch causes a NOR gate (U6-d) to generate an output; that output pulls PXO-1000 pin 5 high, and feeds the kHz LED through an inverter.

We also need an over-range indication to tell us when the input frequency exceeds the range we have selected. The ICM7224 has a carry line. Intended for cascading counters; it goes high whenever the count exceeds 9999, and remains high until a reset. While we don't need that line for its intended purpose, it is ideal for implementing an over-range indication.

The LCD display I used was originally intended for a variety of purposes, one of which was a digital-clock display. It has a "PM." indicator in the upper left display corner, in the form of a triangle; we will use that for our "over-range" indicator, and control it with the ICM7224's carry line in the same way we turn on the decimal points.

The 74HC4017 is used for more than just gating the enable line through the RS latch. Every timing cycle, just prior to the sampling period, we use the 74HC4017 to reset the counters in the ICM7224, and then after the timing period, we latch the count into the display.

Finally, we need to deal with one of those problems that you generally don't think about until you build and test a design like this. When we are using the MHz range, for example, the frequency counter is testing and displaying the frequency 5000 times every second. If the input frequency is, say, half way between 10.15 MHz and 10.16 MHz, then sometimes the last digit will be a "5", and sometimes it is a "6." The relatively slow recovery time

of the LCD, coupled with an effect called "persistence of vision" (the slow recovery time of the human eye) can cause that last digit to look like a 5 and a 6 combined, showing a weird character that looks like an 8 with one segment missing. It would be nice to be able to freeze the display for situations like this, as well as for those times when you are measuring a rapidly changing frequency, and want to take a "snapshot" of the frequency at a particular instant.

Therefore, you will notice in the schematic that there is a "freeze" switch (S3) hooked up to the 74HC4017's enable line. When closed, that normally open pushbutton disables the 745HC4017's clock input and stops the chip from cycling; the LCD display therefore becomes frozen.

That is not a perfect solution, though; although the display is frozen, if you press the freeze button during the sample period (statistically, the chances of that are 50%), then the counters will keep counting, even though that count will not be latched and displayed. What will be displayed is the over-range indicator. So, although the count displayed is accurate, you cannot expect an accurate over-range indication when the freeze button is pressed.

**Construction.** One of the design parameters for the frequency counter was portability; consequently, the whole circuit fits on a small double-sided board that measures just  $4\frac{1}{2} \times 2\frac{3}{8}$  inches. The artwork for the solder (foil) side of the board is shown in Fig. 2, while the component side is shown in Fig. 3. The board fits into a Radio Shack 270-222 project box, or a similar enclosure.

Start the construction by etching and drilling the board; check all traces for shorts and opens. Note the cut-out area; that area is necessary to allow room for the BNC connectors and can be made using a jeweler's saw or another suitable tool. Drill out the four areas indicated by square pads near the board's four corners to accommodate the project box's mounting screws; take care to not break any of the traces near the pads.

A parts-placement diagram is shown in Fig. 4. Note that DISP1 and the three LED's mount on the foil side

of the board. Begin assembly by mounting the IC's on the component side of the board. Note that most IC pins must be soldered on both the foil and component sides. To do that, begin by tacking the IC's in place by soldering a couple of pins on the board's foil side. Because of the small board size and relatively high circuit density, use the smallest soldering iron tip you have.

When all the IC's are in place, finish soldering all of the pins that need soldering on the board's foil side, and then turn the board over. You will see that all of the power and ground pins, as well as certain other pins, must be soldered on the component side. The IC pins that need to be soldered on the component side all have large pads to make the soldering go easier, and to identify which pins on the component side require soldering.

When all of the IC's are soldered, check each of the connections with a continuity tester, particularly the connections for the ICM7224 (U3); once the display is in place, you will not be able to correct any mistakes on the U3's foil-side connections.

Once you are sure that all the IC's are installed correctly, it is time to mount the display on the foil side of the board as indicated in Fig. 4. First solder all of the foil-side connections to the LCD, then turn the board over and solder all of the component-side connections.

The next step is to mount and solder all of the discrete components. All of those mount on the component side, with the exception of the three LED's, which, like the LCD, are mounted on the foil side. Be sure to note the orientation for all of the polarized components and the Zener. Note that to aid in assembly, the LED cathodes and the transistor emitters were given square pads. When installing the LED's, mount them so that they stick up about 3/8 of an inch, measured from the board surface to the LED's extreme top. Be sure to solder all parts on both sides of the board anywhere that pads are provided.

Once all parts are mounted, double check all soldered connections to ensure you have not only good electrical connections, but also that there are no shorts or solder bridges. The board is very compact, and mistakes are easy to make.

While the enclosure for the project is not critical, the one mentioned earlier is nearly ideal and was used by the author in his prototype; it does, however, require some minor modifications. Using a hand grinder (like a Dremel) and a miniature circular-saw blade, trim each of the mounting posts in the project box down by about 1/8-inch. Also, take a notch out of the upper left mounting post to make room for U4.

Regardless of the enclosure you select, you will need to drill holes for mounting the three switches and three BNC connectors. You will also need to drill openings for the display and the three LED's. Once that is done, mount the switches and connectors securely to the case and wire them to the appropriate points on the board using 5-inch lengths of stranded wire. Connect a 9V battery clip to the B1 terminals; be sure to observe proper polarity. Attach a battery to the battery clip, lay the board on the mounting posts, and put the face plate in place and screw it down. Label the switches, LED's, and connectors, and you are done. Now is the time to perform the final wiring inspection. Check it out carefully before you blow it out.

**Using the Frequency Counter.** The frequency counter is a cinch to use; the only thing you need to be careful of is which input you use. If you have any doubts about what kind of signal you are going to be testing, then use the rectifying input. The only time that you should use the unbuffered input is when you know you are working with TTL or 5-volt CMOS circuits. The ICM7224 has a certain degree of input-protection circuitry, but you can fry it if you try hard enough.

If you are using too low a range, then the over-range indicator will flash at you. Switch to a higher range.

Notice that although the display is only four digits, the ranging feature of the counter can give you up to eight digits of precision. Say, for example, the frequency you are measuring is 10.018763 MHz. In the "MHz" range, you will read "10.01" on the display; then switch to the "Hz" range, and you will read "8763", with an overflow indication. That way, you can achieve the same degree of precision as you would with an 8-digit display. ■

## You can Build Gadgets! Here are 3 reasons why!



### BP345—GETTING STARTED IN PRACTICAL ELECTRONICS \$5.95

If you are looking into launching an exciting hobby activity, this text provides minimum essentials for the builder and 30 easy-to-build fun projects every experimenter should toy with. Printed-circuit board designs are included to give your project a professional appearance.

### BP349—PRACTICAL OPTO-ELECTRONIC PROJECTS \$5.95

If you shun opto-electronic projects for lack of knowledge, this is the book for you. A bit of introductory theory comes first and then a number of practical projects which utilize a range of opto devices, from a filament bulb to modern infrared sensors and emitters—all are easy to build.



### BP363—PRACTICAL ELECTRONIC MUSIC PROJECTS \$5.95

The text contains a goodly number of practical music projects most often requested by musicians. All the projects are relatively low-in-cost to build and all use standard, readily-available components that you can buy. The project categories are guitar, general music and MIDI.



Mail to:  
**Electronic Technology Today, Inc.**  
P.O. Box 240  
Massapequa Park, NY 11762-0240

#### Shipping Charges in USA & Canada

\$0.01 to \$5.00.....	\$2.00	\$30.01 to \$40.00.....	\$6.00
\$5.01 to \$10.00.....	\$3.00	\$40.01 to \$50.00.....	\$7.00
\$10.01 to \$20.00.....	\$4.00	\$50.01 and above.....	\$8.50
\$20.01 to \$30.00.....	\$5.00		

Sorry, no orders accepted outside of USA and Canada. All payments must be in U.S. funds only.

Number of books ordered.

Total price of books.....	\$ _____
Shipping (see chart).....	\$ _____
Subtotal.....	\$ _____
Sales Tax (NYS only).....	\$ _____
Total enclosed.....	\$ _____

Name \_\_\_\_\_  
Address \_\_\_\_\_  
City \_\_\_\_\_ State \_\_\_\_\_ ZIP \_\_\_\_\_

Please allow 6-8 weeks for delivery.

# FM STEREO TRANSMITTER

BY  
FRED BLECHMAN

*Build this inexpensive gadget and become a local disc jockey, or just do away with excessive wiring around the house.*



**W**ould you like to be able to send good-audio-quality FM transmissions? Here is a device that will let you do just that. It is called the *FM Stereo Transmitter*, and it is definitely not a toy. With the proper choice of antenna, the Transmitter can broadcast up to a quarter of a mile, or more, with left and right-channel separation.

You can use the unit to transmit your tape-deck or CD-player output throughout your house or yard, or even to a nearby car. The transmission can then be received on any broadcast-band FM radio.

Because the Transmitter broadcasts in stereo, it can be used for two-channel experiments and demonstrations. It uses from 3- to 15-volts DC power, has a crystal-controlled subcarrier for frequency stability, and can be built to transmit anywhere in the standard 88–108 MHz, FM-broadcast band.

However, there is one caution you must observe: **You cannot interfere with anyone else's broadcast FM reception.** See the "Frequency Range Selection" box for more on that restriction.

**Circuit Description.** Figure 1 shows the schematic of the FM Stereo Transmitter. The heart of the unit is U1, a BA-1404 FM stereo-transmitter IC. A block diagram of the BA-1404 IC is shown in Fig. 2. Internally, the chip accepts separate left and right audio-

input signals, and contains all the circuitry needed to create and transmit a multiplexed FM-Stereo signal on the FM-broadcast band.

The aforementioned FM signal consists of a main audio channel, which contains the combined left- and right-channel (L + R) audio information; a 19-kHz pilot subcarrier; and the difference-signal (L - R) sidebands, which are centered around a suppressed 38-kHz stereo subcarrier. That complete signal can be processed and demodulated by any FM-broadcast receiver. Monaural FM receivers reproduce left- and right-audio signals together through a single speaker (no stereo). Stereo FM receivers separate left and right audio to individual speakers for the stereo effect, or to provide two "channels" on the same FM carrier.

Now, back to the Fig. 1 schematic. The left and right audio signals are fed

into jacks J1 and J2. Those signal levels can range from the type that feed small speakers or earphones, to the line-level outputs normally fed to amplifiers. If you wish to use a microphone, however, you'll need to boost its output voltage with a pre-amplifier.

Because the input voltages can cover a broad range, potentiometers R1 and R4, together with resistors R3 and R6, and capacitors C1, C2, C4, and C5, are used to control the voltages at pin 18 and pin 1 of U1. That prevents overloading. The pre-emphasis characteristic (U.S. or European) is set by the values of R3 and R6, as described later.

The 3 to 15 volts of required power can be provided by either a battery (B1 shown in Fig. 1 is a 9-volt battery) or a well-filtered power supply. Silicon diodes D1–D3 are forward-biased in series, with a voltage drop of about 0.7 volts each, to provide a stable voltage of about 2.1 volts to power U1.

Potentiometer R7 permits the adjustment of the stereo balance. Crystal XTAL1, together with C7, C10, and U1's internal components, provide the 38-kHz subcarrier oscillator needed to carry the (L - R) sideband signals. Tunable inductor L1 and capacitor C16 form a resonant circuit to determine the operating frequency of U1's oscillator section. The value of C16 determines the frequency adjustment range within the FM-broadcast band, as specified later.

#### WARNING!!

The publisher makes no representations as to the legality of constructing and/or using the FM Stereo Transmitter referred to in this article. The construction and/or use of the transmitter described in this article may violate federal and/or state law. Readers are advised to obtain independent advice as to the propriety of its construction and the use thereof based upon their individual circumstances and jurisdiction.



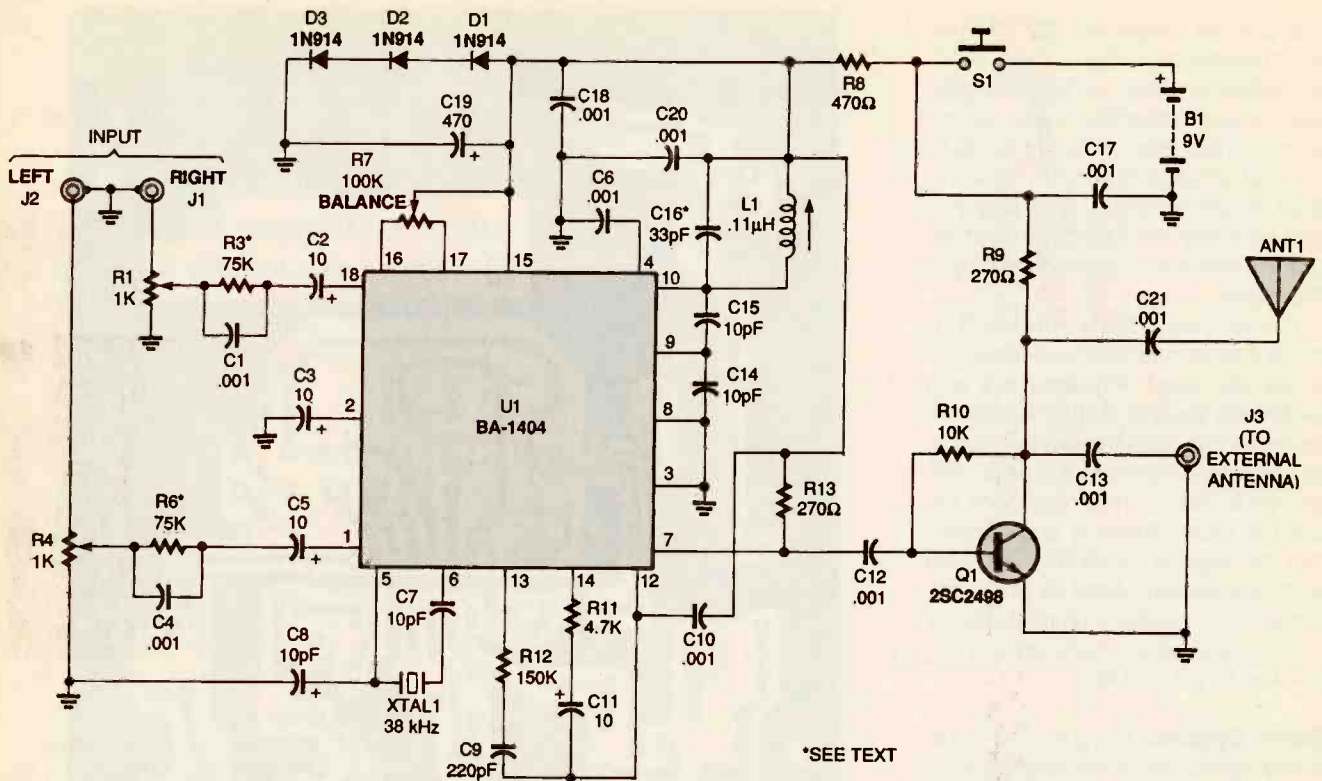

\*SEE TEXT

Fig. 1. At the heart of the schematic for the FM Stereo Transmitter is the BA-1404 FM stereo-transmitter IC. Note that there is no R2 or R5 in the circuit.

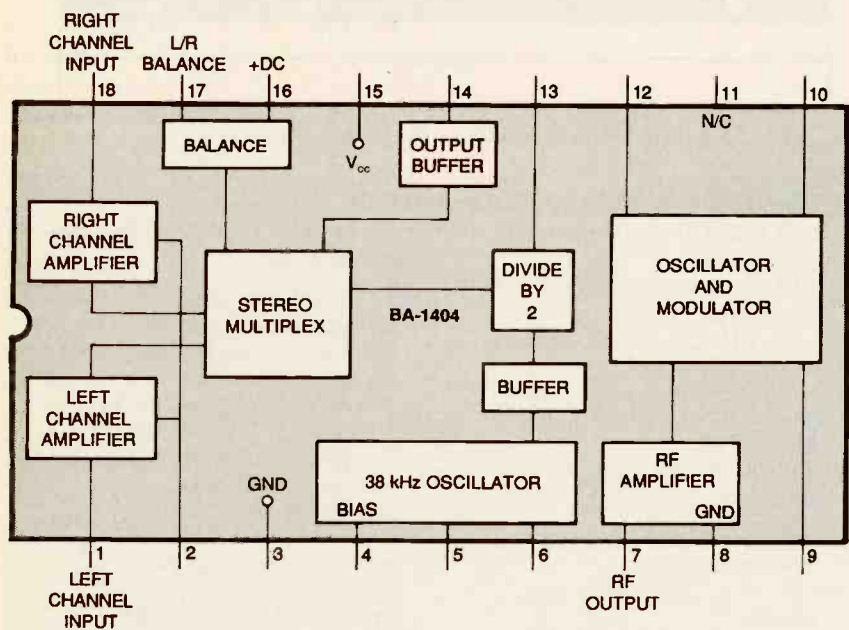

Fig. 2. The overall simplicity of the FM Stereo Transmitter is made possible by the many internal functions performed by the BA-1404 IC, which are shown in this block diagram.

VHF transistor Q1 and its associated components amplify the RF output at pin 7 of U1, feeding either telescoping antenna ANT1, or an external antenna jack at J3. That RF signal is modulated by three signals from U1: the stereo-

multiplex signal at pin 14, the 19-kHz pilot tone at pin 13, and the oscillator and modulator signal at pin 12.

**Construction.** Portions of the Transmitter circuit operate at a relatively

high frequency. Therefore, if you hand-wire the circuit, you could run into trouble with stray inductance and capacitance. To avoid that, use the printed-circuit template shown in Fig. 3 to etch your own board.

If you don't feel like making your own printed-circuit board, you could order an etched, drilled, and silk-screened PC-board from the source given in the Parts List. Other parts kits available for the Transmitter are also available from the same source, as detailed in the parts list.

The parts layout is shown in Fig. 4. Be careful to orient the diodes, transistor, and electrolytic capacitors as shown. The use of a socket for U1 is recommended.

You must make two choices along the way regarding certain capacitors and resistors. First, you must decide what portion of the FM-broadcast band you wish to use; that's because the Transmitter is only tunable over about one-third of the entire band. See the "Frequency Range Selection" box for help in making the proper selection.

Capacitor C16 sets the frequency range of the FM Stereo Transmitter. To transmit at approximately 88-95 MHz,

use a 33-pF capacitor for C16; for 95–102-MHz transmission, use a 27-pF capacitor; and for 102–108 MHz, use a 22-pF capacitor. If you are not sure in which part of the FM band to transmit, solder a “trial” C16 with some lead length to spare. That way you can desolder the capacitor and replace it with one of another appropriate value.

The second choice you need to make is to decide what pre-emphasis value you want. Pre-emphasis is a technique used in FM transmitters to increase the high-frequency signal-to-noise ratio. If you want the pre-emphasis to be 75 microseconds (as used in North America and Japan), use 75K resistors for R3 and R6. If you want the pre-emphasis to be 50 microseconds (as used in Europe, Russia, and in some other countries), use 47K resistors for R3 and R6.

**Some Options.** Because the Transmitter consumes power and emits RF whenever it is on, a visual “on the air” indicator is a useful addition. Simply connect an LED in series with a 1K resistor between one of the positive DC terminals of the switch and a ground point in the circuit; the cathode of the LED should be connected to the latter. When power switch S1 is on, the LED should light. If it doesn’t, you either

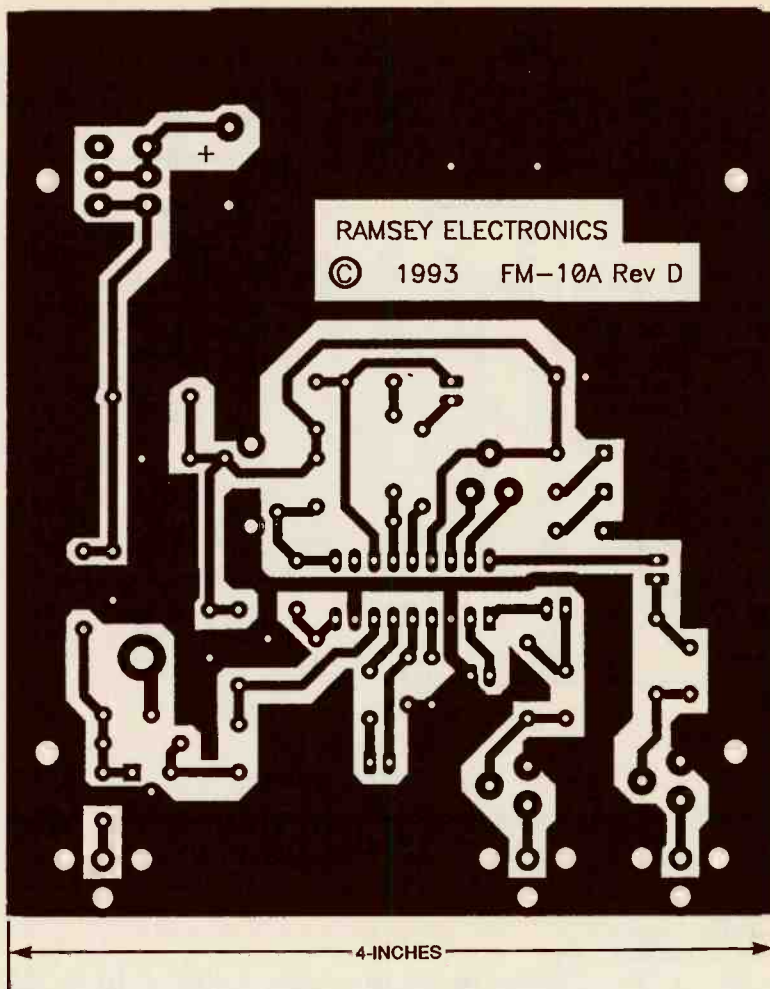

Fig. 3. The foil pattern for the Transmitter's PC-board is shown here.

### PARTS LIST FOR THE FM STEREO TRANSMITTER

#### SEMICONDUCTORS

- U1—BA-1404 FM stereo transmitter, integrated circuit\*
- Q1—2SC2498, 2SC2570, or 2N5179 low-noise VHF/UHF NPN transistor\*
- D1, D2, D3—1N914 or 1N4148 silicon diode

#### RESISTORS

(All fixed resistors are 1/4-watt, 5% units.)

- R1, R4—1000-ohm trimmer potentiometer\*
- R2, R5—not used
- R3, R6—75,000-ohm or 47,000-ohm (see text)
- R7—100,000-ohm trimmer potentiometer\*
- R8—470-ohm
- R9, R13—270-ohm
- R10—10,000-ohm
- R11—4700-ohm
- R12—150,000-ohm

#### CAPACITORS

- C1, C4, C6, C10, C12, C13, C17,

- C18, C20, C21—0.001- $\mu$ F, ceramic-disc
- C2, C3, C5, C11—10- $\mu$ F, 16-WVDC, electrolytic
- C7, C8, C14, C15—10-pF, ceramic-disc
- C9—220-pF, ceramic-disc
- C16—22-, 27-, or 33-pF, ceramic-disc (see text)
- C19—470- $\mu$ F, 16-WVDC, electrolytic

#### ADDITIONAL PARTS AND MATERIALS

- ANT1—4- to 19-inch telescoping antenna
- L1—0.11- $\mu$ H, shielded adjustable inductor\*
- XTAL1—38-kHz crystal, watch crystal package\*
- J1, J2, J3—RCA-type PC-mounted jacks\*
- B1—9-volt alkaline battery (or other 3–15-volt DC power source)
- S1—SPST pushbutton switch, normally open, PC-mounted\*
- Printed-circuit materials, enclosure,

18-pin socket for U1\*, solder, hardware, etc.

**Note:** The following items are available from Ramsey Electronics, Inc. (793 Canning Parkway, Victor, NY 14564, Order Tel. 800-446-2295, Information Tel. 716-924-4560, Fax: 716-924-4555): A complete kit for the FM Stereo Transmitter (FM-10ABP), including the printed-circuit board (but not the custom case or antenna)—\$34.95; an etched and drilled, silk-screened printed-circuit board (FM-10APCBP)—\$10.00; a “Special Parts Kit” (FM-10ASPKBP) containing all parts marked \* above—\$24.95; a custom case complete with knob and antenna (CFM-BP)—\$14.95; a 110VAC power adapter (FMAC-BP)—\$9.95. Postage/handling/insurance per order is \$4.95. Please add an additional \$3 for orders under \$20. New York residents please add 7% sales tax.

## ANTENNA CONSIDERATIONS

FCC Part-15 Rules specify a maximum field strength for an unlicensed, FM-broadcast device—250 microvolts at a one-meter-long receiving antenna located 3 meters (9.94 feet) from the transmitter. That field strength is inversely proportional to distance (at twice the distance, the field strength is halved). Therefore, at 384 meters (1260 feet—almost a quarter of a mile), the allowable signal is 1.95 microvolts, which is still strong enough to be picked up by an average stereo FM receiver. A “sensitive” receiver responds to a signal as small as 0.5 microvolts!

Note that the FCC Rules do not specify the power output of the transmitter—only the field strength at the receiving antenna. Because it is possible to couple an amplifier and high-gain antenna to your FM Stereo Transmitter, you could inadvertently exceed FCC limitations.

Unless you have a means of measuring field strength at those low levels, the best way to stay within the FCC-allowed field strength is to use the 19-inch telescoping antenna provided with the custom cabinet kit, or one like it. That antenna will give you a horizontally non-directional signal.

For a more directional signal, use a horizontally mounted dipole antenna (each half of the antenna should be about 30 inches), plugged into J3, instead of using a telescoping antenna. When mounted horizontally, the maximum radiated signal of a dipole is perpendicular to the direction of the wire; a north-south antenna will have maximum radiation to the east and west. ■

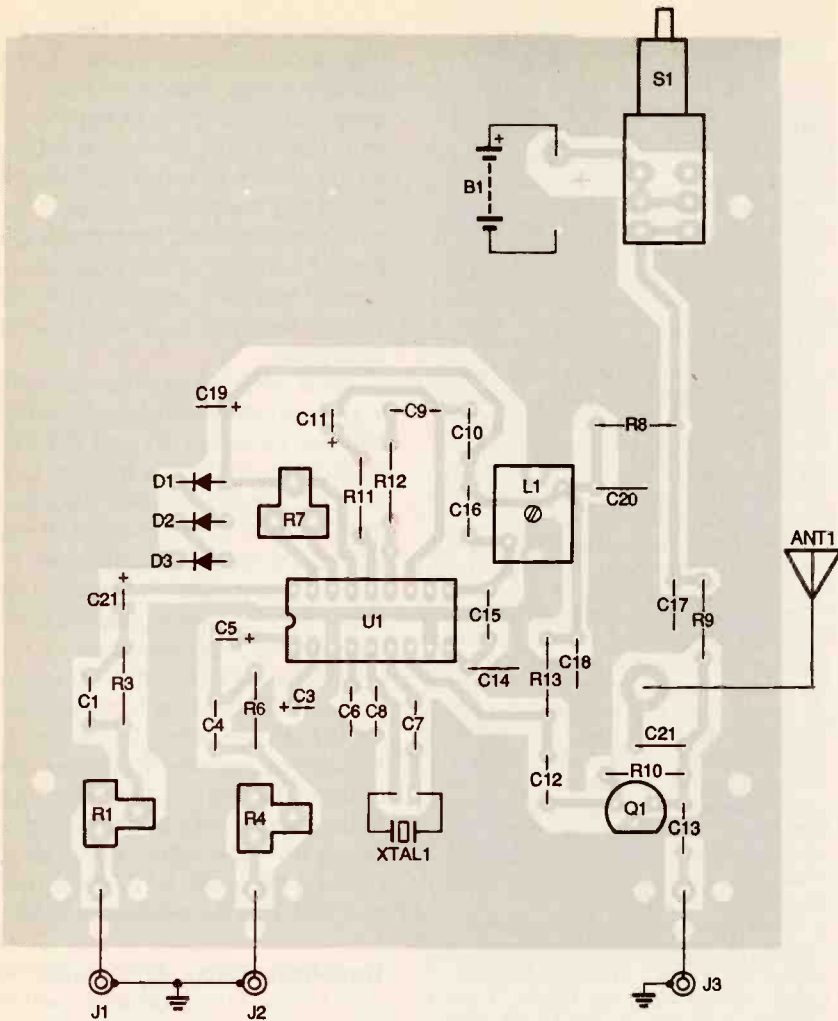

Fig. 4. Use this parts-placement diagram as a guide when mounting components on the board. Before soldering the polarized components, check to make sure their orientations match the ones shown here.



The assembled circuit board is shown here. Note the addition of an LED and a 1K resistor in series, which act as a power indicator (see text).

have the LED connected backwards, or to the wrong points in the circuit.

A custom, two-part plastic case, with front and back panels and a knob for the switch, is available from the source in the Parts List. Use of the custom cabinet enhances the appearance of your Transmitter, while protecting its circuitry.

The custom cabinet also comes with a telescoping “whip” antenna that opens to a length of 19 inches. Except for the antenna hole (and LED hole, if you use one), all other holes in the cabinet are drilled, and silk-screened with the appropriate legends. If you do not use the custom cabinet, you will still need to get some kind of antenna. See the “Antenna Considerations” box for suggestions.

**Audio Sources.** The FM Stereo Transmitter can accommodate a fairly broad range of audio sources at its J1 (right) and J2 (left) inputs, but the in-

put-voltage levels must fall within reasonable limits. For example, a microphone by itself does not put out enough voltage, so a pre-amplifier or an amplified mike mixer is necessary. The same applies to many record players.

The recommended inputs for the Transmitter are the line-level outputs of a stereo device, but many don't have those outputs. So instead, you can use the earphone or speaker output of a small radio, tape player, or CD player. However, be careful not to use the speaker output of a powerful Hi-Fi system as direct input to the Transmitter jacks. Using that output, or any other audio level that is too high, will result in a terribly distorted sound. If you suspect an audio source is too powerful, you can use an attenuating dubbing cord, an attenuating connector, or a similar device to drop the output to an appropriate level.

Shielded audio cables should be used for the interconnections. De-

## FREQUENCY RANGE SELECTION

When deciding what frequency to transmit on, choose one that is not being used by an FM-broadcast station that can be received in your location. In order to comply with Federal Communications Commission (FCC) Part 15 regulations, it is your responsibility to determine fully that your operation will not cause interference to broadcast reception.

It is not sufficient to search for an apparently open frequency using a simple FM portable radio. Many medium power, National Public Radio stations might be received by a neighbor with a good receiver and an outdoor antenna. Interfering with such reception is a direct violation of Federal law!

The most reliable way of finding a truly open frequency on the FM band is to check that band with a very good FM receiving system that uses an external antenna. If you don't have access to such a radio, most modern, FM car radios are also very sensitive.

When choosing an operating frequency, remember that most digital-tuned FM receivers—regardless of whether they are portable, mobile, or hi-fi—are designed to tune in 200-kHz increments. Therefore, they might not properly receive a signal operating between those pre-tuned, standard broadcasting frequencies.

Unlicensed operation of small transmitting devices is discussed in Part 15 of the FCC Rules. Licensed, FM-broadcast stations have the right to interference-free broadcasting, and their listeners have the right to interference-free reception. Make sure you are not interfering with those rights when you use your Transmitter. ■

frequency that will not interfere with any broadcast stations (see the "Frequency Range Selection" box). With either the telescoping or external antenna connected, turn on the FM Stereo Transmitter. Then use a plastic (not metal) alignment tool to adjust inductor L1 while listening for a quieting in the FM radio's normal background noise. Maximum quieting indicates you are transmitting on the receiver's frequency.

Adjust audio-level potentiometers R1 and R4 to their minimum level (fully counterclockwise) and set balance control R7 to the center position. Connect your audio sources to jacks J1 (right) and J2 (left). Advance R1 and R4 and you should begin to hear the audio on your stereo FM receiver. You might also have to increase the volume setting on your receiver.

When you have sufficient volume on each "channel" (left and right), adjust R7 all the way clockwise. You should only be able to receive one channel. Turning R7 all the way counterclockwise should enable you to receive only the other channel. To balance the audio, set R7 so that both channels can be received equally.

**Troubleshooting.** When operating with a fresh 9-volt alkaline battery, and without audio input, your Transmitter should draw about 32 milliamperes (about 37 milliamperes if you've added an LED power indicator). You can measure that with a milliammeter in series with the battery. If your Transmitter deviates more than 20% from that figure, you might have made an error in assembly.

If you think you have made an error, use Fig. 4 to double-check the placement and orientation of all components. Also, check all solder joints and cable connections.

If you can not get your Transmitter to transmit, check first to see if your audio sources are operating. If they are, then make sure you're tuning the correct portion of the broadcast band, based on the value you used for C16. That could be the problem, and you might end up unintentionally interfering with broadcast transmissions in another portion of the FM band. Frequency drift (caused by a weak battery or temperature extremes) can also cause you to broadcast out of the anticipated broadcast band. ■

## THE COLLECTED WORKS OF MOHAMMED ULLYES FIPS

#166—By Hugo Gernsback. Here is a collection of 21 April Fools Articles, reprinted from the pages of the magazines they appeared in, as a 74-page, 8½ × 11-inch book. The stories were written between 1933 and 1964. Some of the devices actually exist today. Others are just around the corner. All are fun and almost possible. Stories include the Cordless Radio Iron, The Visi-Talkie, Electronic Razor, 30-Day LP Record, Teleyglasses and even Electronic Brain Servicing. Get your copy today. Ask for book #166 and include \$16.00 (includes shipping and handling) in the US and Canada, and order from **CLAGGK Inc., P.O. Box 4099, Farmingdale, NY 11735-0793**. Payment in US funds by US bank check or International Money Order. Allow 6-8 weeks for delivery.



MA05

## THE TRANSDUCER PROJECT BOOK



1992T—From TAB Books. A unique collection of practical transducer devices that you can put together simply and inexpensively. You can build a seismic sensor, a temperature survey meter, an open-door annunciator, a moisture detector, an automatic night

light, and more. To order—ask for book 1992T, and include your check for \$11.95 (Includes s&h) in the US and Canada, and order from — **Electronic Technology Today Inc., P.O. Box 240, Massapequa Park, NY 11762-0240**. US funds only; use US bank check or international money order. Allow 6-8 weeks for delivery.

MA06

pending on the cable terminations, you might need adapters for the many types of plugs and jacks in common use. Those are readily available at Radio Shack and elsewhere.

Note that you can use two entirely different audio sources—such as the outputs of a tape player and a CD player—as inputs to the FM Stereo Transmitter. Remember, the Transmitter has both a left and right channel, and an FM receiver will receive them both. On a stereo FM receiver, one input is heard on the right speaker and the other on the left speaker. The stereo's balance control can be used to mix or separate them.

**Checkout and Use.** You'll need a nearby stereo FM radio to adjust your transmitting frequency and balance. Tune the radio to a suitable "open"

**G**lowing gas-discharge tubes were among the first electronic wonders. In the past, they were used as voltage regulators in tube circuits. However, even though gas-discharge tubes are still one of the easiest ways to regulate voltages higher than 75 volts, they are rarely applied to that task anymore.

What's a good use for a glowing tube? Well, because it is a source of faint light, a voltage-regulating gas-discharge tube makes a great nightlight. With just one of the tubes (which you can pick up on the antique-tube market for a buck or two), a couple of mirrors, and a few other components, you can build the *Novel Nightlight*, a truly unique project for the electronics-oriented household.

**Voltage-Regulator Tubes.** Voltage-regulator (VR) tubes are diodes; they have a plate and a cold cathode (*i.e.* one without a filament). During the manufacture of a VR tube, air is removed from the tube and the glass envelope is filled with small quantities of helium, neon, argon, or other gases at very low pressure. When enough voltage is placed between the plate

BY LARRY LISLE, K9KZT

## *Build this unusual nightlight in an evening or two, using an old, gas-filled voltage-regulator tube.*

and the cathode, the tube glows.

Let's take a look at how the tubes work. A typical circuit using a VR tube is shown in Fig. 1. As long as the current through the tube is kept within the manufacturer's ratings (typically 5 to 40 mA), the voltage at  $E_2$  will change very little, despite variations in supply voltage  $E_1$  or in the load current.

The above circuit only has one resistor, R1. To find the value of that resistor in ohms, use:

$$R1 = (E_1 - E_2)/I_{max}$$

where  $I_{max}$  is the maximum tube current.

As you can see, the operation of a VR tube is simple. However, for this

project we won't be using it to regulate voltages. We just want to make the tube glow!

**The Circuit.** Figure 2 shows the circuit of the Novel Nightlight. It's basically a transformerless, half-wave power supply that puts out enough voltage to keep  $\sqrt{1}$ , the OA3/VR75 VR tube, glowing. Because the circuit has no transformer, it's absolutely necessary for safety that all conductors be enclosed in insulated material!

In the event of component failure, fuse F1 will blow and interrupt the current flow. Resistor R1 limits the current through diode, D1, which rectifies the AC; capacitor C1 smoothes out the pulsations. The function of resistor R2 isn't immediately obvious but it is important. If R2 wasn't in the circuit, unplugging the nightlight would cause the voltage in C1 to discharge through R3 and V1. However, when the voltage dropped below 75 volts, V1 would go out and the 75 volts in the tube would just sit there waiting to zap someone. Even with a "bleeder" resistor like R2, it's always a good idea to short power-supply capacitors with an insulated screwdriver after unplug-

# Novel Nightlight

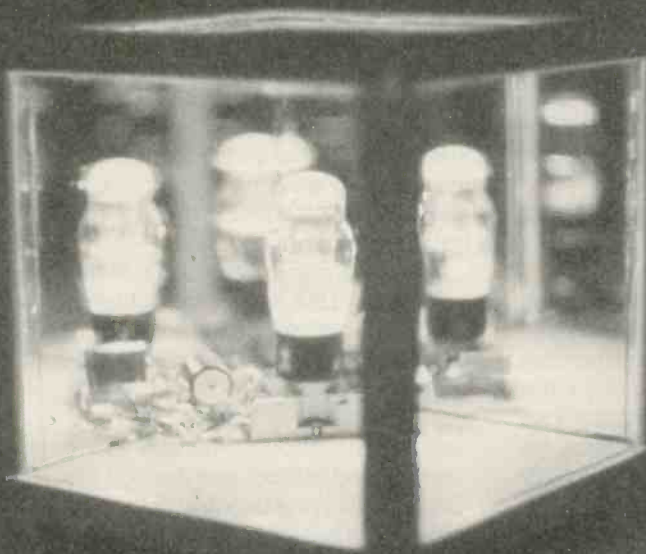

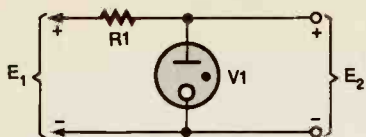

Fig. 1. This is the basic circuit for using a gas-discharge tube as a voltage regulator. In the nightlight project, however, we just want to make the tube glow!

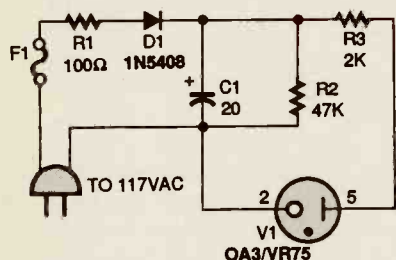

Fig. 2. The circuit for the Novel Nightlight is basically a transformerless, half-wave power supply that provides enough DC to light up V1, the voltage-regulator tube.

### PARTS LIST FOR THE NOVEL NIGHTLIGHT

- D1—1N5408 silicon rectifier diode
  - R1—100-ohm, 1-watt resistor
  - R2—47,000-ohm, 2-watt resistor
  - R3—2000-ohm, 5-watt resistor
  - C1—20- $\mu$ F, 250-WVDC, electrolytic capacitor
  - V1—OA3/VR75 voltage-regulator tube
  - F1— $\frac{1}{4}$ -amp, fast-acting fuse
- 7 $\frac{3}{4}$ -inch square baseboard, 7-inch square pieces of glass (2), 7-inch square pieces of mirror (2), 7 $\frac{1}{4}$ -inch square piece of glass, rubber mounting feet (4), molding strips (8), power cord and plug, octal relay socket for tube (Potter & Brumfield 27E122 or equiv.), Fahnestock clips, fuse holder, epoxy glue, wire, solder, etc.

ging the circuit and before touching anything.

**Construction.** The method of wiring used to build the nightlight isn't critical. For the prototype, Fahnestock clips and some of the unused tube-socket terminals were used to make connections. If you do the same, be aware that pins 7 and 3 of the OA3/VR75 are connected internally.

The circuit should be mounted on a wood baseboard. In the prototype, that measures 7 $\frac{3}{4}$   $\times$  7 $\frac{3}{4}$  inches. Drill a hole in one corner of the board for the power cord to go through, but make

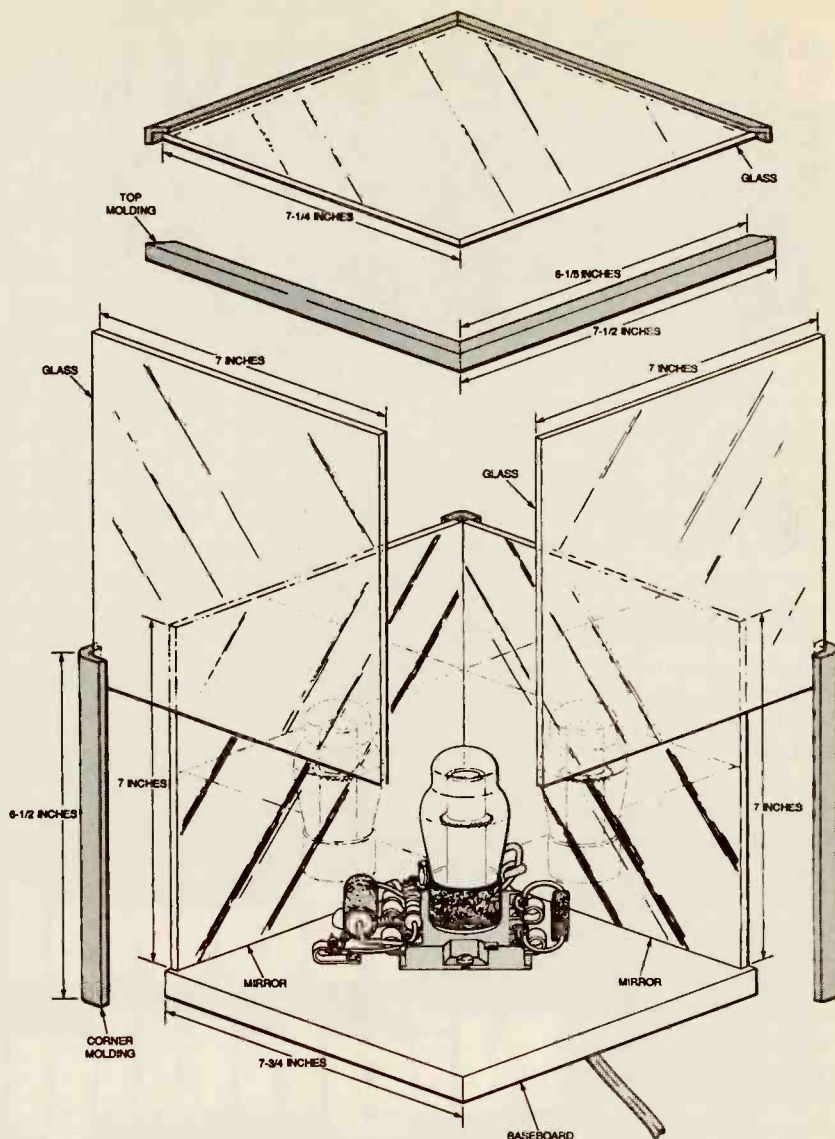

Fig. 3. Here is an exploded view of the nightlight-case assembly. The molding strips hold the pieces of glass and the mirrors together once they are glued. Note the 45° angles on the top molding which allow for a tight fit.

sure to tie a knot in the cord before inserting it, as that prevents strain on the wiring. To keep the unit from wobbling, attach four rubber feet on the bottom of the baseboard.

There are a few ways to adjust the brightness of the Novel Nightlight. First of all, you can change the value of R3. However, keep in mind that the current shouldn't exceed 40 mA (with the values shown in Fig. 2, it's about 31 mA). Also, other voltage-regulator tubes can be used instead, even though the OA3/VR75 was the brightest of the several that I tried. For a little variety, you could also add flashing neon bulbs with a capacitor and resistor for each, or an old mercury-vapor rectifier such as an 866.

Because of the high voltages present in the nightlight and the fact that the tube will get hot, once you have the circuit working, you should place it in some kind of enclosure or cover. An inverted food-preserving jar, an old aquarium, or a Plexiglas enclosure can be used. In the author's prototype, the enclosure was built as a 7-inch-on-a-side glass and mirror box (see Fig. 3). Two of the sides were made of mirror squares, so that when the unit is assembled and viewed at an angle, it looks as if there are four glowing tubes.

To duplicate the enclosure shown in Fig. 3, you will need two glass squares and two mirror squares, measuring 7 (Continued on page 104)



# WWV Receiver

*Get time, weather, frequency, and other information with this easy-to-build receiver.*

**N**ext to the crystal detector and super-regenerative receivers, the direct-conversion receiver is the simplest radio that any experimenter can build. Despite its being immune to spurious IF signals, which plague super-heterodyne receivers, the direct-conversion receiver has been shunned in the past because of component limitations that make first-try receivers sensitive to 60-Hz hum, microphonics, and low-frequency noise generated by active components. But ever-evolving electronics technology has produced low-noise/low-power amplifiers and mechanically stable components that promise to revive the direct-conversion receiver. Low-power active elements allow battery operation, significantly improving 60-Hz suppression.

The *WWV Receiver* described in this article (which contains only one tuned circuit) is comprised of readily available parts and its operating frequency can be easily modified, allowing you to monitor other signals.

**WWV/WWVH Broadcasts.** Radio stations WWV (Fort Collins, CO) and WWVH (Kauai, HI), operated by the National Institute of Standards and Technology (NIST), broadcast vast amounts of information 24 hours a day. The most obvious are the frequency standards of the carrier (2.5, 5, 10, 15, and 20 MHz), the 1-second time interval, and the standard audio tones (440, 500, and 600 Hz), which modulate the carrier at regular intervals.

Voice announcements, broadcast at one-minute intervals, give the time of day based on a cesium clock and expressed in "Coordinated Universal Time" (UTC). The radio stations are identified by voice on the half hour

BY BRIAN MCKEAN

and the hour, and continuously via audio tones. WWV transmits 500 Hz on even minutes while WWVH transmits 600 Hz on even minutes. The 5-, 10-, and 15-MHz carriers operate at 10 kW, making them easily audible throughout the continental US.

Special voice announcements, providing Global Positioning Satellite status, Geophysical data, OMEGA navigation system status, and Pacific and Atlantic storm warnings, are broadcast in regular time slots.

Those stations also broadcast the time of day, day of year, year, daylight saving's time status, leap second status, and UTC to UT1 conversion in a digital format. The digital code is transmitted at a rate of 1-bit-per-second on a 100-Hz subcarrier that is pulsed on and off, with the duration of the pulse representing the bit value "1" or "0" at the beginning of each second. The 100-Hz subcarrier is typically below the bandwidth provided by commercial shortwave receivers, so the pulses are not audible.

The direct conversion receiver does not have a high cutoff frequency on the HPF, so the 100-Hz pulses will be clearly audible on the direct-conversion receiver described in this article. Although intended for digital decoding, the low bit rate allows the BCD code to be decoded by ear with a little practice and a strong signal.

The most useful data transmitted by the NIST stations are the frequency standards. Those carriers allow worldwide frequency calibration to an accuracy of 1 ppm. The direct conversion receiver can serve in a secondary capacity as a 10-MHz, local-frequency standard since the local oscillator must be zero beat for

best reception. The voltage-stabilized crystal oscillator will allow the receiver to maintain its calibration under varying conditions.

Shortwave listeners will find the geophysical alert messages useful in correlating radio propagation conditions with solar activity and geomagnetic field disturbances. The NIST signals themselves provide direct information on band conditions. Poor reception in an otherwise good local-reception time period is usually indicative of some geophysical disturbance, which will be noted in the alert message. The geophysical bulletins (18 minutes after the hour for WWV and 45 minutes after the hour for WWVH) provide a daily summary of past 24-hour's solar and geomagnetic-field activity with 3-hour updates of current geomagnetic field conditions.

The solar-flux measurement is a measure of the solar emission at 2800 MHz, and is related to the solar constant, which is a measure of the total solar flux at the Earth. Solar flux is responsible for ionizing the upper atmosphere and, as such, affects long-distance high-frequency communications, which rely on ionosphere propagation modes.

The "A" and "K" indices in the message provide information on geomagnetic-field activity. The "K" index is measured at 3-hour intervals, and the "A" index is derived by taking the weighted average of the K index for a 24 hour period. From 0 UT to 2100 UT, the "A" index represents the previous day's measure. Between 2100 and 2400 UT, the "A" index is estimated from the 7 "K" indices for that day. The "A" index is finally produced at 2400 UT and remains unchanged until 2100 the following day.

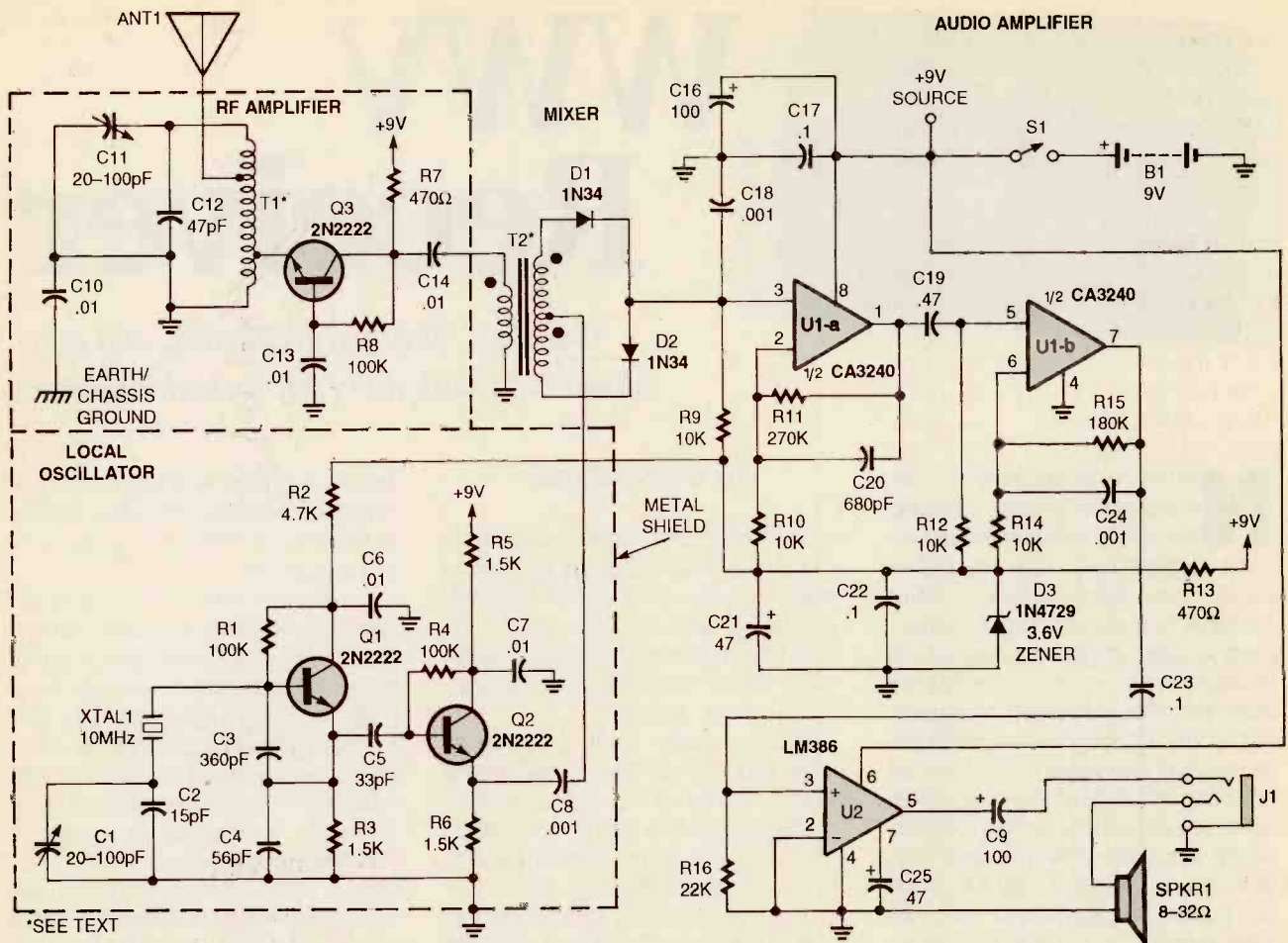

Fig. 1. The single balanced-diode mixer used in the WWV Receiver comprises T2, D1 and D2. The LO amplitude must be sufficient to forward bias the diodes.

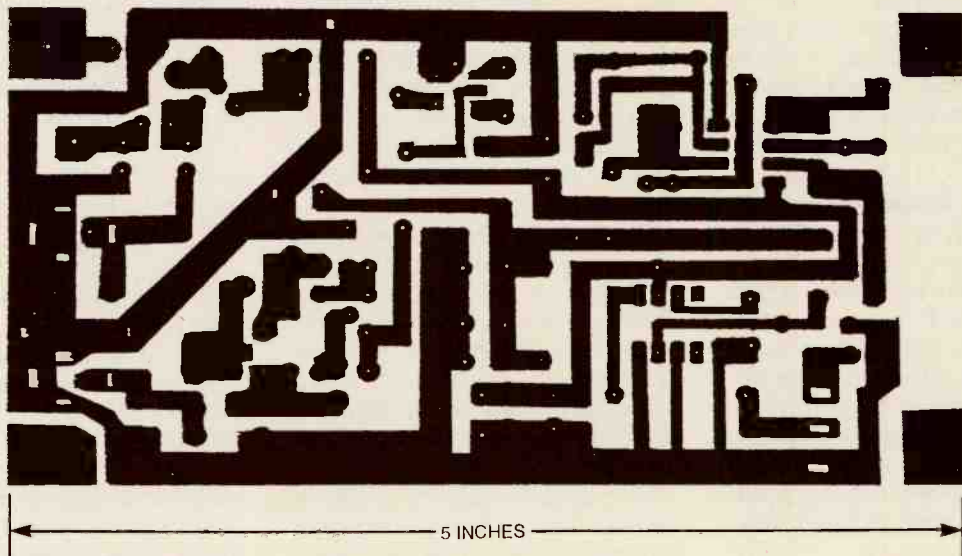

Fig. 2. The author's prototype was assembled on a small printed-circuit board, measuring about 5 by 2 1/2 inches, and is shown here on a 1:1 scale.

Geomagnetic-field activity is described in broad terms such as "quiet," "unsettled," "minor storm," etc., which

are selected based on the current "K" and "A" indices. Solar activity describes the solar-flare activity by mea-

surements of peak X-ray emissions from a flare event.

Note: Further information regarding



NIST broadcasts can be obtained by writing to: National Institute of Standards and Technology, Radio Station WWV, 2000 East County Road, Fort Collins, CO 80524. Ask for NIST publication SP 432.

**Circuit Detail.** Figure 1 shows a schematic diagram of the WWV Receiver. Incoming RF is picked by the antenna (ANT1) and is coupled via an auto-transformer to a grounded-base amplifier (Q3), before being applied to a diode-mixer network that is comprised of T2, D1, and D2. Best mixer performance is obtained when both secondary windings of T2 are identical, and D1 and D2 are matched.

The output of the local oscillator (LO)—a grounded-collector Colpitts oscillator (built around Q1)—is applied to emitter-follower/buffer Q2, which provides a low impedance drive signal for the mixer.

The demodulated signal is coupled to a pair of high gain op-amp stages (U1-a and U1-b). The op-amps provide a 50-dB gain and incorporate low-pass filter capacitors in the feedback path. Amplifier U2 provides a 20-dB gain, thereby producing sufficient output drive for an 8-ohm speaker, or 32-ohm headphones.

Note that our receiver lacks a volume control and AGC circuitry. That simplifies the circuit without introducing operational problems. The volume is controlled merely by adjusting the length of the whip antenna.

When driving 32-ohm headphones, the circuit consumes less than 25 mA; however, the current drain increases to 40 mA when driving an 8-ohm speaker. That current drain is close to the limit of 9-volt alkaline batteries, so headphone operation is preferred, especially under weak-signal conditions.

**Assembly.** The WWV Receiver was assembled on a printed-circuit board, measuring about 5 by 2½ inches. A template of the author's printed-circuit layout is shown in Fig. 2. The parts-placement diagram for the author's layout is shown in Fig. 3. All the parts except power switch S1, battery B1, speaker SPKR1, and antenna ANT1 are located on the board.

The crystal can be any of a number of physical sizes (note that the board layout is designed to accommodate

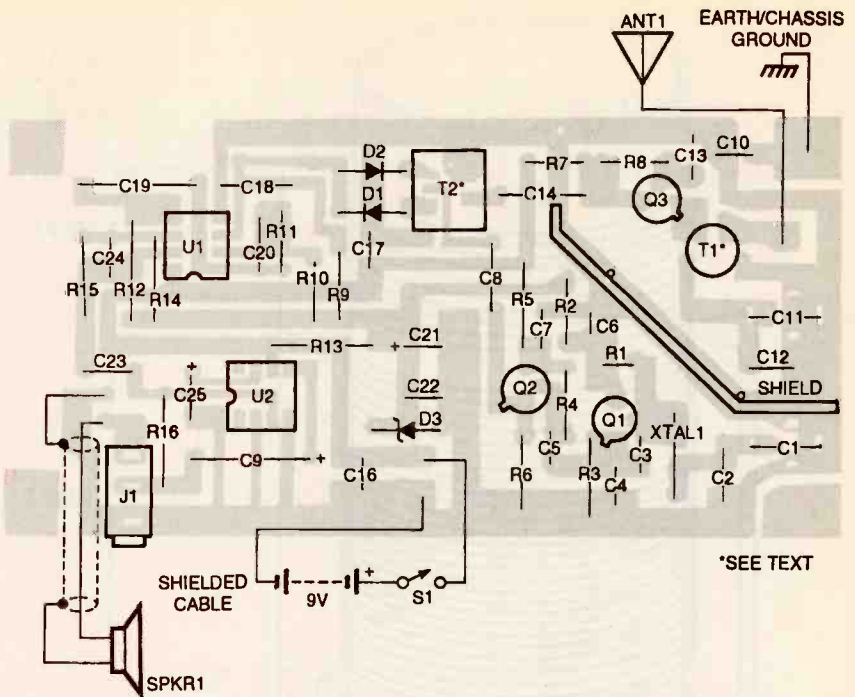

Fig. 3. All the parts that comprise the WWV Receiver (except the battery, the power switch, the antenna, and the headphone jack) are mounted directly to the circuit board. A metal shield (see text for details) is added to the board at the position shown to isolate the RF input section from the local oscillator.

## PARTS LIST FOR THE WWV RECEIVER

### SEMICONDUCTORS

- U1—CA3240, HA3-5152, HA7-5222, or similar, dual op-amp, integrated circuit
- U2—LM386 low-voltage, audio-power amplifier, integrated circuit
- Q1-Q3—2N2222, 2N3904, or similar general-purpose NPN silicon transistor
- D1, D2—1N34 germanium or NTE112 Schottky, small-signal diode
- D3—1N4729, or similar 3.6-volt, 1-watt Zener diode

### RESISTORS

- (All resistors are ¼-watt, 5% units, unless otherwise noted.)
- R1, R4, R8—100,000-ohm
  - R2—4700-ohm
  - R3, R5, R6—1500-ohm
  - R7, R13—470-ohm
  - R9, R10, R12, R14—10,000-ohm
  - R11—270,000-ohm
  - R15—180,000-ohm
  - R16—22,000-ohm

### CAPACITORS

- C1, C11—20- to 100-pF ceramic or mica trimmer (Mouser 242-3610-100 or equivalent)
- C2—15-pF mica or ceramic-disc
- C3—360-pF mica or ceramic-disc
- C4—56-pF mica or ceramic-disc

- C5—33-pF mica or ceramic-disc
- C6, C7, C10, C13, C14—0.01-μF, ceramic-disc
- C8, C18, C24—0.001-μF, ceramic-disc
- C9, C16—100-μF, 16-WVDC, electrolytic
- C12—47-pF mica or ceramic-disc
- C15—Not used
- C19—0.47-μF, polystyrene, mylar, or multilayer ceramic
- C17, C22, C23—0.1-μF, ceramic disc
- C20—680-pF mica or ceramic disc
- C21, C25—47-μF, 10-WVDC, electrolytic

### ADDITIONAL PARTS AND MATERIALS

- ANT1—50- to 100-cm telescoping antenna
  - J1—Closed circuit ¼-inch headphone jack
  - SPKR1—8- to 32-ohm, 0.5-watt or less, speaker
  - S1—SPST power switch
  - B1—9-volt alkaline, transistor-radio battery
  - T1, T2—See text
  - XTAL1—10-MHz, 30-pF crystal
- Printed-circuit materials, metal enclosure, metal shield material (see text), headphone (32 ohm), battery holder and connector, wire, solder, hardware, etc.

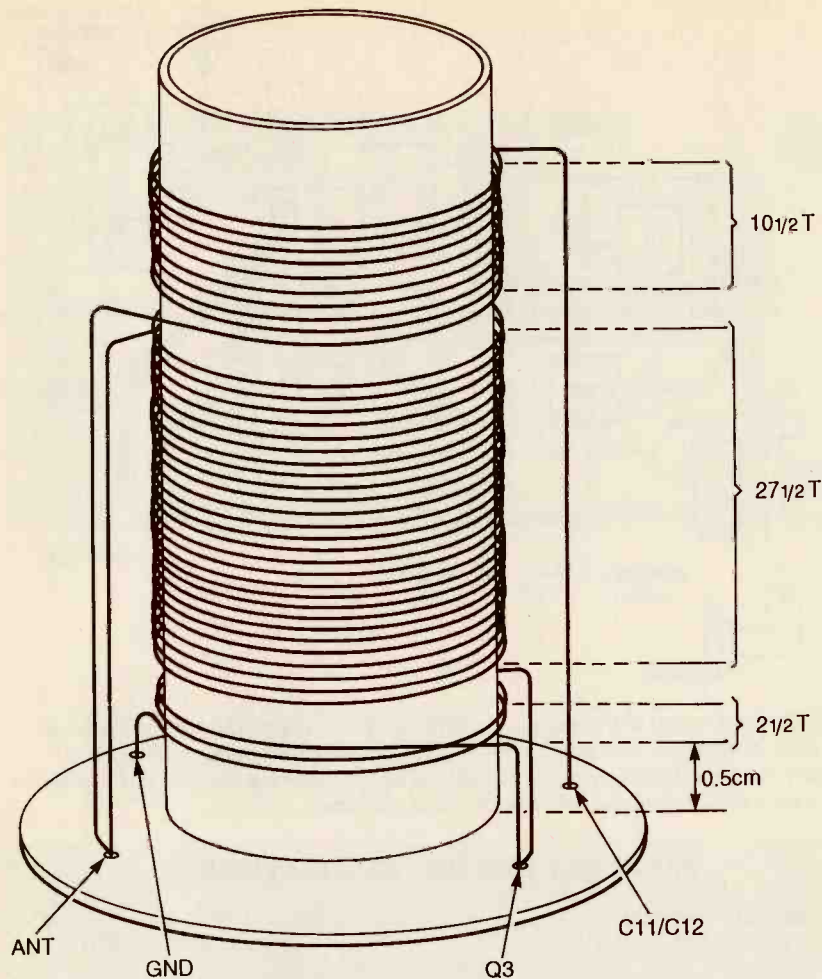

Fig. 4. Transformer T1 is a home-made unit comprised of 40 closely wound turns of #26 AWG enameled wire on a 1/4-inch diameter air-core form, with taps at 2 1/2 and 10 1/2 turns from each end; after each tap, the winding continues in the same direction.

the most common crystal-package sizes; the HC-49 and HC-33). To minimize microphonics—the generation of an electrical noise signal by mechanical motion (vibration) of parts within a device—after soldering XTAL1 in place, secure it to the board with RTV or similar silicone cement.

Tuning capacitors C1 and C11 should be installed with the tuning screw connected to ground to allow use of a metal tuning tool. The holes for T1 are arranged for use with a 1/4-inch diameter, plastic coil form with a molded base of the type commonly found in older TV sets. The holes for T2 are sized for a common subminiature IF can. The leads of T2 should be cut as short as possible and secured to minimize vibration.

Install a solderable-foil metal shield (approximately 1-inch high) between the local oscillator (Q1 and Q2) and RF amplifier (Q3), as shown in Fig. 3. Sol-

der the shield to the ground trace using short segments of stiff wire as supports. Once all of the board-mounted components have been installed, connect the off-board components to the printed-circuit board through short lengths of hook-up wire.

Mount the whip antenna on the proposed case for the unit; if the antenna that you choose for your unit has a pivoting base, the unit can be mounted in just about any convenient location on the enclosure using a low capacitance mounting method; or you can connect the antenna (vertically mounted) directly to the board. Many whip antennas are equipped with a threaded base that can be secured directly to the appropriate printed-circuit pads using a screw. If that arrangement is used, use a large grommet to isolate the whip from the metal case where the antenna passes through.

**Component Notes.** The crystal is used in its parallel (anti-resonant) mode in the Colpitts oscillator. Parallel-mode crystals are specified for a particular circuit load-capacitance—usually 20 to 40 pF—for the crystal to oscillate on frequency. Capacitors C1 and C2 provide series coupling to reduce the relatively large load capacitance of Q1 and

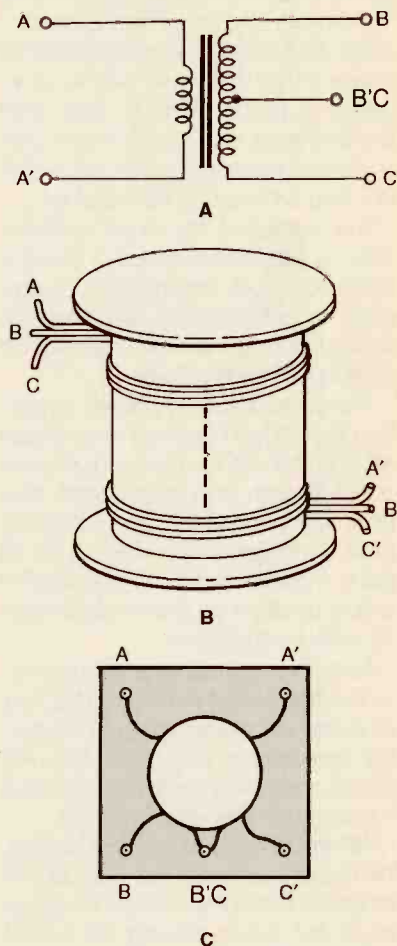

Fig. 5. Construction details for T2 (the mixer transformer) are shown here. The diagram in A is a schematic representation of the unit once completed; B illustrates how the three lengths of wire are wound as a set on the bobbin; and C shows how the bobbin is connected to the pinned base.

allow tuning the crystal frequency. The trimmer range specified for C1 should satisfy most crystals. If you have no information about your crystal, try it anyway. The oscillator's operation can be checked by any number of methods, but the easiest way is to listen to the receiver itself.

The mixer diodes should be small-  
(Continued on page 112)

# Add a Switch to your Serial Port

BY MARC SPIWAK

*Enable or disable serial ports with a simple flip of a switch!*

Sometimes a simple solution to an annoying problem is staring you right in the face, although you don't even know it. You see, at home, I have a pretty loaded 486 PC that's used not only as a day-to-day workhorse, but also as a test bed for various peripherals and accessories for review in this magazine and other purposes. While setting up the software for a computer-controlled construction set I was reviewing, I had a tough time getting the COM2 serial port to work peacefully with the set's interface. Using COM1 was out of the question, since it was used by my serial mouse. So here I was with this presumably easy-to-use interface unit that would not respond to COM2. What was going on? Could it be "the dreaded IRQ conflict?"

Now, I consider myself pretty good at setting up computers; I'm just not very good at remembering how things are set up (or at remembering where I put the piece of paper on which I jotted down the settings). Sometimes diagnostic software can be used to find a conflict, or a peripheral's setup program (if you are fortunate enough to have peripherals whose IRQ's are set via software) can give you the information you need. More often, however, you are left with one unpleasant task; opening the case. Of course, if you are like me, it's not that simple. First, all the junk piled on top of the case has to be moved. Then the case has to be opened. Then *lots* of cables have to be disconnected so that *lots* of cards can be removed so that *lots* of jumper settings can be noted.

After doing all of that, I found the problem. My internal modem was set on COM2, and so my machine's multi-I/O card was set to disable its own COM2—the one I was trying to use for the construction set's serial-interface unit. The first solution was to simply enable COM2 on the multi-I/O card; but the situation got worse. Now, not only wouldn't the serial interface respond, but the modem would no longer connect with any other modem—although it would dial out. Trying to get the modem and mouse to share an interrupt led to even more flakiness with both the modem and the mouse.

So I set the modem back to its original settings where it worked perfectly. "Try another interrupt" you say. Let's see: IRQ0 is reserved for the system timer, IRQ1 is for the keyboard, IRQ2 is a DOS system area, the

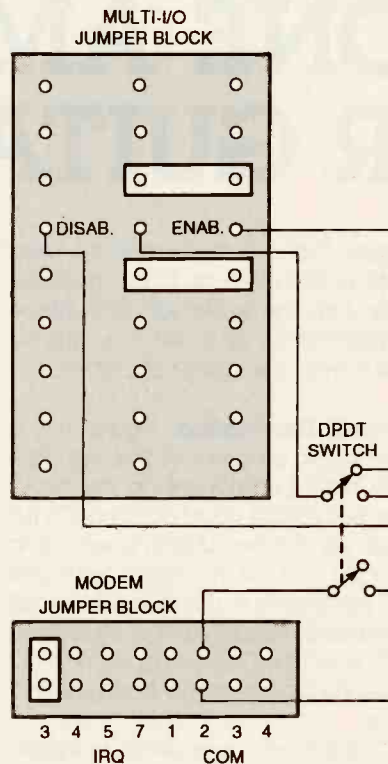
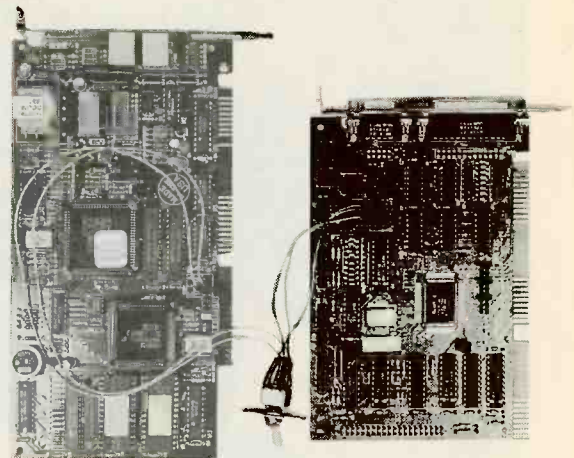

*Fig. 1. This switching scheme allowed an internal modem and COM2 on a multi I/O card to share the same interrupt (IRQ). While it won't work as shown for every set-up, it can be modified to handle similar problems.*

## MATERIALS LIST FOR THE PC SWITCH

DPDT switch  
Wire-crimp single-pin header sockets  
Wire, heat-shrink tubing, unused expansion slot cover, solder, hardware, etc.

modem (COM2) uses IRQ3, the mouse (COM1) uses IRQ4, my sound card uses IRQ5, diskette drives use IRQ6, and the printer (LPT1) uses IRQ7. These settings are pretty much standard—depending on your hardware and software, it is unlikely you'd be able to configure any of these devices to more obscure settings. Oh how I just love the flexibility of PC architecture!

That sort of problem has plagued PC users starting with the first IBM PC's right up to the present-day 486's. Even on the newer local-bus systems, where the COM ports are often set in CMOS, a modem's settings still have to be checked visually, or at least through hard-to-find setup menus—and changing settings usually requires that jumpers be moved manually. The odds are, in a loaded system, a game of musical jumpers usually forces you to return a card to its original settings because it worked properly that way in the first place. Another solution, although often not a very good one, is disabling the least-significant device that's conflicting with the most-significant device. That's what led me to having a disabled COM2 on the multi-I/O card.

**A Partial Solution.** As it seemed, after many hours of experimenting, the only way to get the serial interface to work was to enable COM2 on the multi-I/O card and to either remove the modem from the computer or to disable it—which meant removing it from the machine anyway! At least I could now work with the construction  
*(Continued on page 102)*

BY RODRICK SEELY

*With this headphone guitar amplifier you can practice your guitar playing and prepare for a rock n' roll career, all without waking up the neighbors.*

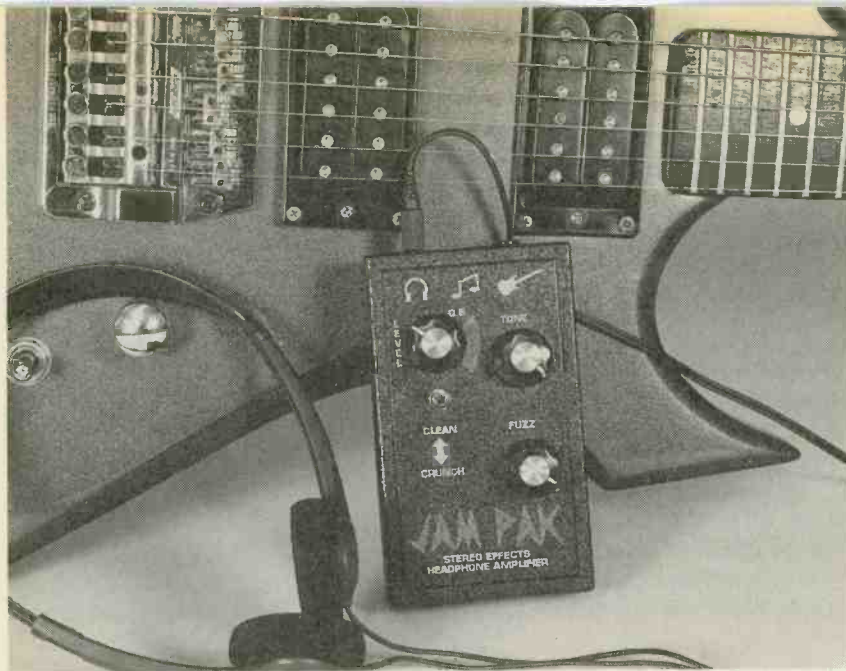

# HEADPHONE AMPLIFIER FOR YOUR GUITAR

**A**ny electric-guitar player knows about the high cost of musical equipment. To purchase a small practice amp, one or two effects pedals, associated patch cords, and batteries and other power-supplies can cost at least a few hundred dollars. Not only is that equipment bulky and expensive, but to make things worse for the budding musician, there's always someone who doesn't appreciate a killer overdrive sound rattling the windows!

It's not easy becoming a rock 'n' roll superstar. However, with the *Jam Pak* headphone guitar amplifier described in this article, you will find it easier to practice. Simply plug in your "ax," put on the headphones, and crank it up as loud as you like. You can jam anytime, anywhere, without disturbing your family or neighbors. Similar headphone amplifiers available through music stores typically cost around a hundred dollars, but you can build the *Jam Pak* for under \$50!

The *Jam Pak* is a personal-headphone guitar amplifier featuring a unique stereo-imaging effect, and adjustable distortion, overdrive, and tone controls. It also has an auxiliary input that allows you to plug in any walkman-style tape- or CD-player and play along with your favorite

songs. That input can also be used with a keyboard or drum machine. The *Jam Pak* works with any stereo headphones and will operate for hours from a single 9-volt battery.

**Circuit Description.** Figure 1 is a schematic diagram of the *Jam Pak*. The main components in the circuit are two LM324 quad op-amp IC's (U1 and U2) and two LM386 power-amp IC's (U3 and U4). The inputs to U1 and U2 are biased to a little less than half the power-supply voltage by resistors R10 and R11. Capacitors C1 and C2 filter the power-supply and bias voltages.

There is no power switch in the circuit. Input-jack J1 turns on the *Jam Pak* when the input plug is inserted. When an audio signal from an instrument is input through J1, the signal is fed through coupling-capacitor C3 to the tone-control circuit composed of U1-c, R2, R4, and C4. Frequencies above 1 kHz are amplified or attenuated depending on the position of potentiometer R4, which is the tone control. Resistor R2 and capacitor C4 filter unwanted high frequencies.

Audio level and overdrive are controlled by potentiometer R9; with that level-control adjusted to full volume, the circuit's final amplifiers are over-

driven to produce a soft distortion effect. To prevent any unwanted DC "swishing" noise, a coupling capacitor, C8, is used.

Switch S1 toggles between the clean and distorted signals. When S1 is on the CRUNCH setting, diodes D1 and D2, and U1-d produce a distortion effect by clipping the amplified signal at 0.7 volts. Frequencies below 160 Hz are attenuated by R5 and C6. The amount of gain or "fuzz" is controlled by R7 and potentiometer R6, and resistor R8 adjusts the distortion level to match the tone-control level.

One of the reasons that the *Jam Pak* sounds great through a pair of headphones is its unique stereo-imaging effect. That is produced by a phase-shift circuit, composed of U2-a through U2-d, R20-R23, and C9-C12. Each stage shifts 90 degrees at the same frequency. The frequency of the shift at U2-a is:

$$f = 1/(2\pi RC)$$

where  $f$  is the frequency in hertz,  $\pi$  is equal to 3.14159,  $R$  is the value of R20, and  $C$  is the value of C9. For the frequency of the shift at U2-b-U2-d, use the values of R21-R23 and C10-C12, respectively (as Fig. 1 shows, those values are all equal). The four stages provide 360 degrees of phase-shift at 330

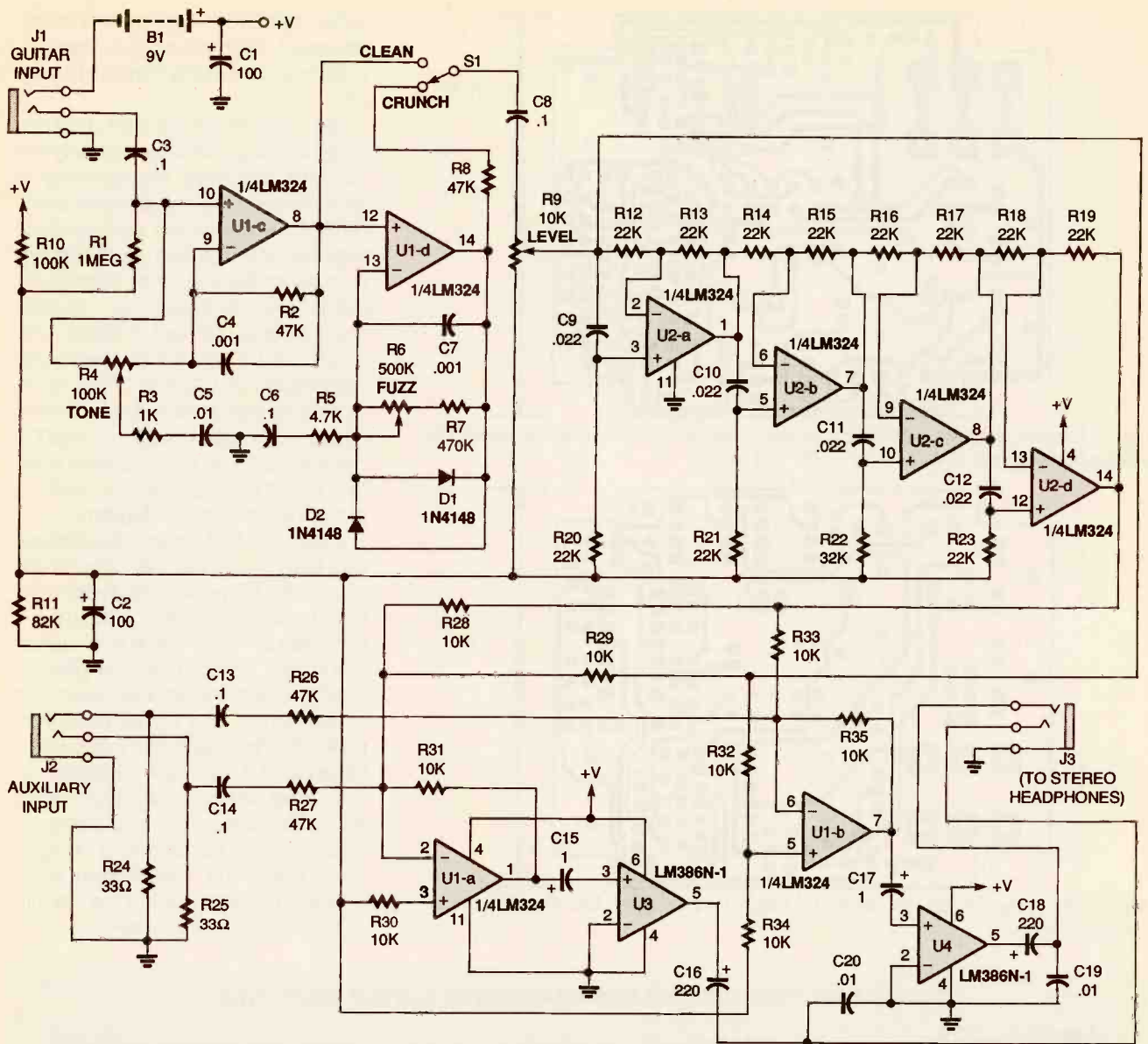

Fig. 1. From the hard distortion provided by U1-d and D1 and D2 to the stereo imaging accomplished by U2, the Jam Pak is a guitarist's dream come true. Note that there is no power switch in the circuit, as J1 turns on the unit whenever an instrument cable is plugged in.

Hz, which is about the center of the frequency range for guitars. At frequencies above and below 330 Hz, various degrees of phase shift occur. That phase-shifted signal is summed with the original signal for one channel (U1-a), and subtracted from the original signal for the other channel (U1-b). The result of all that is an interesting panning effect that is frequency dependent.

To play along with prerecorded music, or a keyboard or drum machine, you can feed the stereo signals from those sources into auxiliary-jack J2. Those signals are attenuated by R24 and R25, AC-coupled through C13 and C14, and mixed into the sum

and difference amplifiers through R26 and R27. Capacitors C15 and C17 provide AC-coupling of the sum and difference signals to U3 and U4, the final amplifiers.

Both U3 and U4 have a fixed gain of 20. With a supply voltage of 9 volts, they produce a power output of about 1/2 a watt into 8-ohm headphones. Capacitors C16 and C18 high-pass filter and couple the output to headphone-jack J3. Now, let's turn to building the amplifier.

**Construction.** The Jam Pak prototype was built on a double-sided printed-circuit board, which can be etched from the templates provided

in Figs. 2 and 3 or purchased from the source listed in the Parts List. There are a couple of good reasons why a PC-board is recommended for the project. One reason is to prevent the noise and self-oscillation problems that can occur in audio projects using other construction techniques. Also, using a PC-board simplifies construction and makes the finished product look neat and compact.

Most of the components listed in the Parts List are inexpensive and readily available from hobbyist sources and catalog distributors. Any enclosure of a suitable size can be used for housing the circuit board, jacks, and panel components. A pre-

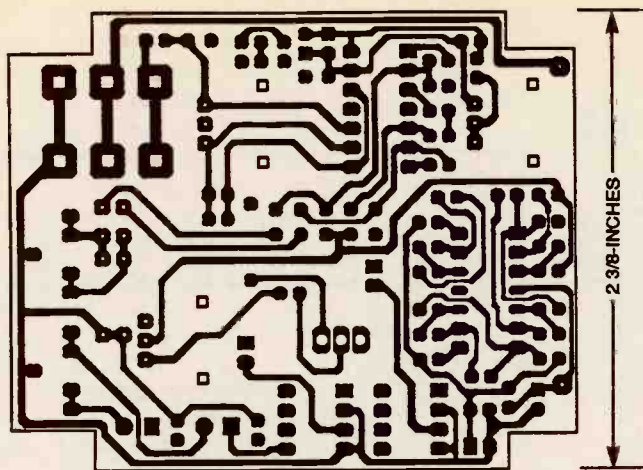

Fig. 2. Use this template to etch the component side of the printed-circuit board. The pattern is shown here in its full size of  $2\frac{3}{8} \times 3$  inches.

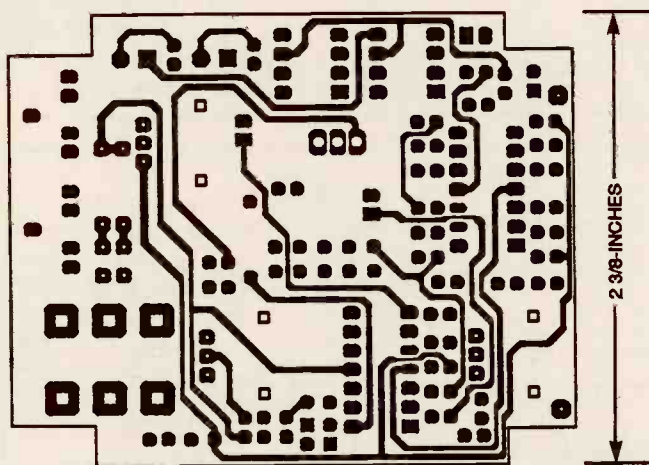

Fig. 3. This is the template for the solder side of the PC board. Like Fig. 2, it is also shown full size.

drilled enclosure with battery compartment, belt clip, and two-color silk-screening is available from the kit supplier.

Use the parts-placement diagram in Fig. 4 as a guide when building the Jam Pak, but keep the following in mind: To keep the circuit board small, most of the resistors are installed close together and standing up. To prevent a short, make sure that those part leads are not touching. Double-check your placement of integrated-circuits U1-U4 and the six electrolytic capacitors (C1, C2, and C15-C18) to make sure their polarities are correct. Also check to see if diodes D1 and D2 are installed with their banded ends facing in the directions indicated by the parts-placement diagram.

Install the IC's, jacks, capacitors, and fixed resistors on the component side of the PC board. The switch and the potentiometers should be mounted on the solder side of the circuit board (using PC-mount potentiometers eliminates the need for messy wiring, but panel-mounted units could be substituted if absolutely necessary). Make sure to solder on both sides of the circuit board wherever necessary. After you have installed all the circuit-board components, solder the 9-volt-battery snap in place, making sure that the polarity of the snap's leads is correct.

## PARTS LIST FOR THE JAM PAK HEADPHONE GUITAR AMPLIFIER

### SEMICONDUCTORS

U1, U2—LM324A quad operational amplifier, integrated circuit  
 U3, U4—LM386N-1 low-power amplifier, integrated circuit  
 D1, D2—1N4148, small-signal diode

### RESISTORS

(All fixed resistors are  $\frac{1}{4}$ -watt, 5% units)

R1—1-megohm  
 R2, R8, R26, R27—47,000-ohm  
 R3—1000-ohm  
 R4—100,000-ohm, linear-taper potentiometer  
 R5—4700-ohm  
 R6—500,000-ohm, linear-taper potentiometer  
 R7—470,000-ohm  
 R9—10,000-ohm, linear-taper potentiometer  
 R10—100,000-ohm  
 R11—82,000-ohm  
 R12—R23—22,000-ohm  
 R24, R25—33-ohm

R28—R35—10,000-ohm

### CAPACITORS

C1, C2—100- $\mu$ F, 10-WVDC, electrolytic  
 C3, C6, C8, C13, C14—0.1- $\mu$ F, ceramic-disc  
 C4, C7—0.001- $\mu$ F, ceramic-disc  
 C5, C19, C20—0.01- $\mu$ F, ceramic-disc  
 C9—C12—0.022- $\mu$ F, ceramic-disc  
 C15, C17—1- $\mu$ F, 35-WVDC, electrolytic  
 C16, C18—220- $\mu$ F, 10-WVDC, miniature electrolytic

### ADDITIONAL PARTS AND MATERIALS

J1— $\frac{1}{4}$ -inch stereo phone jack, circuit-board mount  
 J2, J3—3.5 mm stereo phone jack, circuit-board mount  
 S1—SPDT, micro-miniature toggle switch  
 B1—9-volt alkaline battery

Printed-circuit materials, enclosure, knobs, stereo headphones, 9-volt-battery snap with leads, wire, solder, hardware, etc.

**Note:** The following items are available from Lynn-Eren Electronics (17093 S.W. Lynnly Way, Sherwood, OR 97140; Tel. 503-625-2205): a complete kit of parts including an etched, drilled and plated-through PC-board with solder mask, and a pre-drilled enclosure with belt clip and two-color silk-screening, \$49; a fully assembled and tested unit, \$59; the PC-board only, \$15; stereo headphones only, \$10; a 72-inch auxiliary-input cable (3.5 mm stereo plug to 3.5 mm stereo plug), \$5. Please add 5% shipping and handling. Check or money order, VISA and MasterCard are accepted.

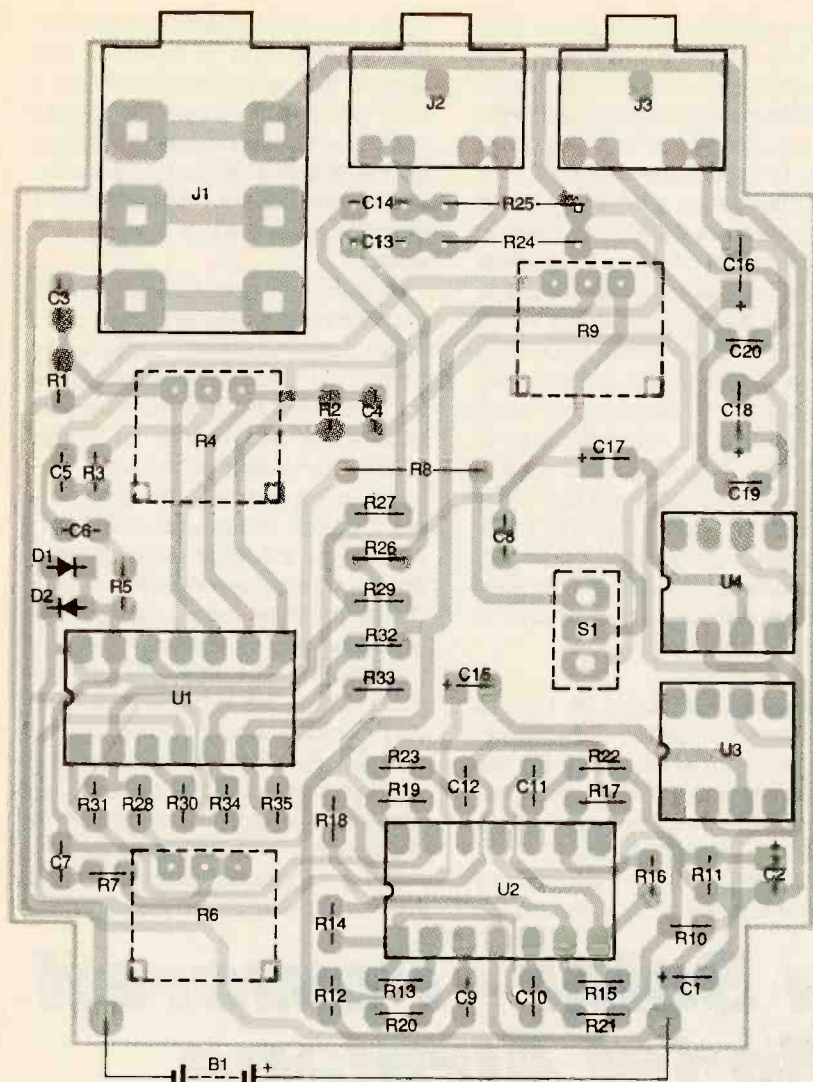

Fig. 4. Be sure to double-check the placement and polarity of your components with this diagram to avoid damaging any of them. Note that switch S1 and potentiometers R4, R6, and R9 mount on the solder side of the board.



This compact amplifier lets guitar players brush up on their skills without annoying others.

**Checkout and Use.** When the placement of all components has been thoroughly checked, you are ready to try out the Jam Pak. Plug a guitar, bass, or other unamplified musical instrument into input-jack J1, and plug stereo headphones into headphone-jack J3. Note, however, that the sound heard through the headphones might be surprisingly loud, so it is a good idea *not* to put them on just yet.

Connect a fresh, 9-volt alkaline battery to the unit. With switch S1 in the "clean" position and level-control R9 set at low to moderate volume, the amplifier should sound undistorted. Adjusting potentiometer R9 to a high volume setting should overdrive the amplifier and produce a soft distortion effect. Level controls on the guitar or other instrument might need to be turned up to achieve the overdrive effect.

With switch S1 in the "crunch" position, the amplifier should produce a hard distortion or fuzz sound, which can be adjusted using the "fuzz" control, R6. The tone control, R4, should adjust the treble of both the "clean" and "crunch" sounds.

Playing scales is a good way to hear how the Jam Pak amplifier's stereo effect works. As the frequency changes, the position or panning of the stereo channels also changes. The stereo effect will sound the fullest when playing chords or fast riffs with a wide frequency range.

To use the auxiliary input, connect any stereo walkman-type cassette- or CD-player, drum machine, or other amplified audio equipment to jack J2. That input has a low impedance, which is appropriate only for devices intended to drive headphones or speakers. Other high-impedance sources might be damaged if connected to J2.

The unit will operate for several hours on a good alkaline battery. Because the power switch is part of J1, it is a good idea to disconnect the plug from the input when the amplifier is not in use.

Once you get the Jam Pak working, you'll be able to practice any time of day or night you please, without irritating those around you. And who knows, with a bit of practice and some luck, rock n' roll stardom could be just around the corner!

**M**ost readers of this magazine probably tinkered with all kinds of unusual hardware—both electrical and mechanical—when they were kids. I'm assuming that because I certainly did, and we're all birds of the same feather—or at least we are all similarly feathered.

I've made robots out of clocks; strobe lights out of record-player motors and coffee cans; go-karts out of wood, wheels, and vacuum-cleaner motors; very dangerous "power saws" out of X-Acto blades and a DC motor; and a "wired" remote-control car out of various motors, gears, and other hardware. A motor—any motor—was always a good find. Any broken item that contained a motor was immediately ripped apart for its motor and anything else that was useful—switches, lights, and gearboxes were all pretty valuable (to me, at least).

Even though I'm over 30 years old now, I still find sometimes that I can't resist slapping together various items to make something unusual, or just plain fun. I can't help it—if I see some parts that beg to be assembled into one unit, I do just that. And believe me, since I started working for this magazine, mountains of assorted electronic parts have piled up.

One day, I was staring at some solar panels wondering if they could power a motor I had. To find out, I connected the panels to the motor and took the assembly out into bright sunlight. It worked well, and I soon after thought up the concept of the *Solar-Powered Airplane*—a toy that could perpetually fly in circles as long as bright light is available.

**The Airplane Concept.** Out of all the applications that a solar-powered motor could have, why did I decide to build a toy airplane? Well, for starters, the two solar panels I had looked like they would make perfect wings. Also, my low-voltage DC motor ran perfectly well from the low power produced by the solar panels (at least

well enough for an attached propeller to produce a little force). Let's just say that the two solar wing panels and the low-voltage motor screamed out to be assembled as an airplane. And so, to my workbench I went.

The only design problems I could think of were how to make a pivoting stand assembly and how to properly balance the plane. I realized that low friction on the pivoting stand would be essential for the plane to be able to move with the little force produced by the propeller. I decided that a ball bearing would be necessary to minimize friction as much as possible—nothing fancy, just any old ball bearing I could find. As for my other problem, balancing the plane could only be accomplished with the finished plane and stand assembly in hand, so that was left for later.

**Building the Plane.** Figure 1 shows the "schematic" of the airplane circuit, if you want to call it that. Do two solar panels plus one DC motor make a circuit?—technically I guess they do, albeit a very simple one!

Getting the solar panels is the easy part. The rest of the airplane and the

stand, however, have to be fabricated out of some kind of material, and wood is the best alternative. Wood is easy to come by—anyone can get it from a nearby source—and is probably the easiest material to work with. I also like the irony of a solar-powered, electric airplane that's made out of wood.

I had thought about using an actual airplane model—either a plastic or a tissue-paper-covered, balsa-wood type—and adding the solar panels and motor to it, but that would require extra work, extra money, and extra time to complete the project.

Figure 2 shows how the airplane is put together. To fasten everything in place, you will need hot-melt glue, double-sided tape, and a few screws. Due to the differences in weight between woods of various type and thickness, I will provide only approximate dimensions to follow in building your airplane. Also included are the procedures necessary to arrive at a well-balanced airplane, since an airplane that is poorly balanced will fly slow, wobble, or even topple over.

The solar panels specified in the Parts and Materials List come with a

## ***Build a Solar - Powered Model Airplane***



BY  
MARC SPIWAK

*Build this inexpensive toy airplane that flies nonstop and never needs batteries.*



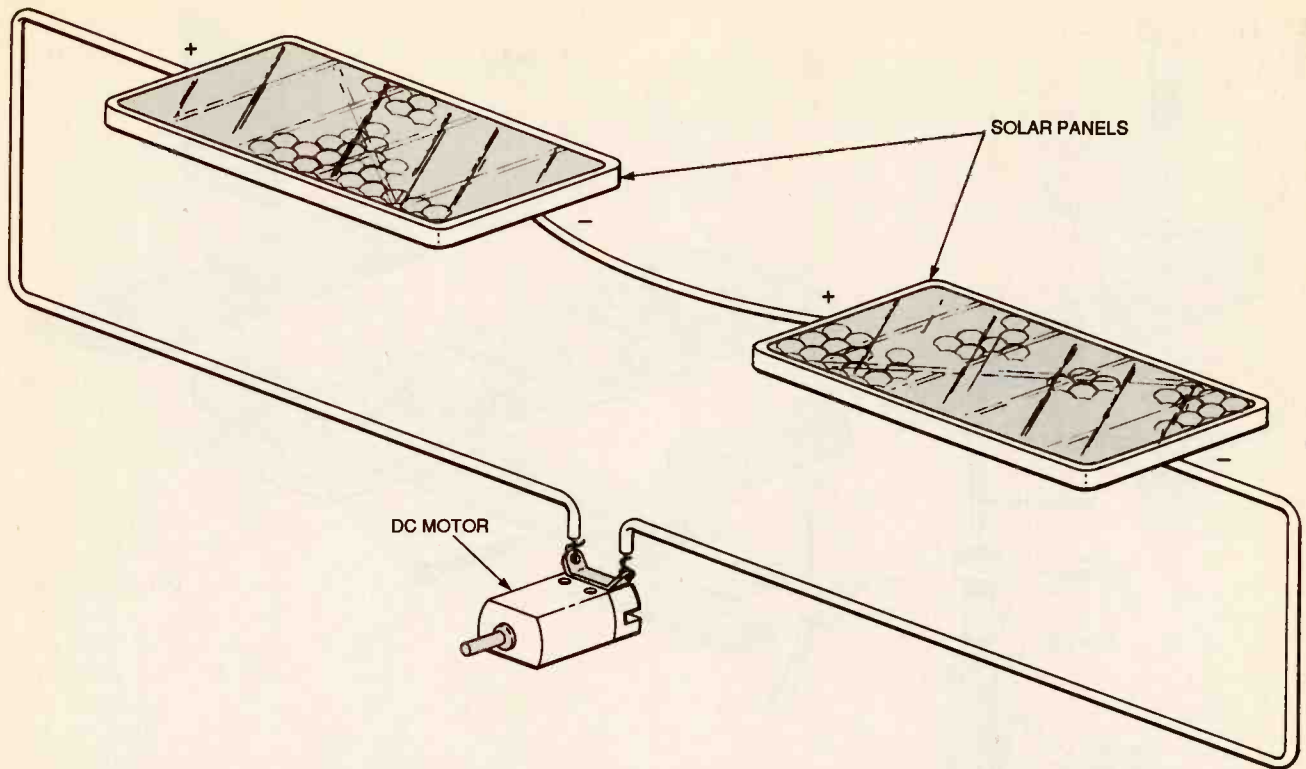

Fig. 1. As this "schematic" shows, two solar panels and one DC motor are the only components that make up the airplane's circuit.

metal strap, probably intended for connecting multiple panels together. On each panel, the positive and negative terminals on the bottom are threaded and come with a nut and lockwasher. Simply connect the two panels together—from the positive terminal of one to the negative of the other—with the metal strap and some hot-melt glue.

Next, cut a length of wood about 5½-inches long for the airplane fuselage. Also cut three pieces of wood for the tail, each approximately 2-inches long by 1½-inches wide, and secure them to the fuselage with hot-melt glue. Attach a small "shelf" for the motor, of the same width as the fuselage (probably about 2-inches long, and ¼ of an inch thick), to the underside of the fuselage at the front of the plane using hot-melt glue. Stick the motor to the top of the shelf with a piece of double-sided tape. The tape will hold because the weight of the motor presses down on it.

Make the pivot arm from another piece of wood about 13-inches long. Drill a hole vertically in the approximate center of the pivot arm to accept the bearing you will use. Make sure the hole provides a snug fit around the outside diameter of the bearing.

### PARTS AND MATERIALS LIST FOR THE SOLAR-POWERED AIRPLANE

- Solar panels (2), 0.45-volt, 1000-milliamp (Kelvin Electronics No. 260099 or equivalent)
- DC motor, low-voltage (Kelvin Electronics No. 852211 or equivalent)
- Plastic propeller, 3-blade (Kelvin Electronics No. 850590 or equivalent)
- Ball bearing, ½-inch outside-diameter, or similar unit
- Wood, screws, spacer, hot-melt glue, double-sided tape, paint, and assorted hardware.

**Note:** The solar panels (\$5.95 each), low-voltage motor (60 cents), and propeller (\$1.20) are available from Kelvin Electronics, 10 Hub Drive, Melville, NY 11747. Tel. 516-756-1750 or 800-645-9212.

Use another piece of wood, about 9-inches long, to form a support column. Then attach the base, a 7-inch square piece of plywood, to the column with a screw through the underside of the base and into the column. Countersink the hole in the plywood so that the head of the screw does not interfere with the base.

Mount the bearing on top of the column with a screw and a spacer. Make sure that the bearing rests on its inner race and that its outer race can spin freely (see Fig. 2). If you can't find a suitable spacer, one can be made from a piece of a ball-point pen's case.

At this point, the plane must be temporarily assembled so that it can be balanced. Everything must be in place to balance the plane—the motor, the propeller, the wings, and any hardware.

Place the pivot arm so that when it is connected the plane is balanced front-to-back (see Fig. 3). Then, attach the solar wings to the fuselage and to the pivot arm with double-sided tape, and fasten the plane in place with a screw going through the side of the fuselage and into the pivot arm. The pivot arm looks best if it's hidden under the wing of the plane. If you find that you can't balance your plane that way, simply add weight (or remove it if possible) to the front or back of the plane to balance the load.

Next, add a counterweight to the other end of the pivot arm to balance the entire assembly for rotational motion. Use something that closely matches the weight of your finished plane. I used a large bolt and two

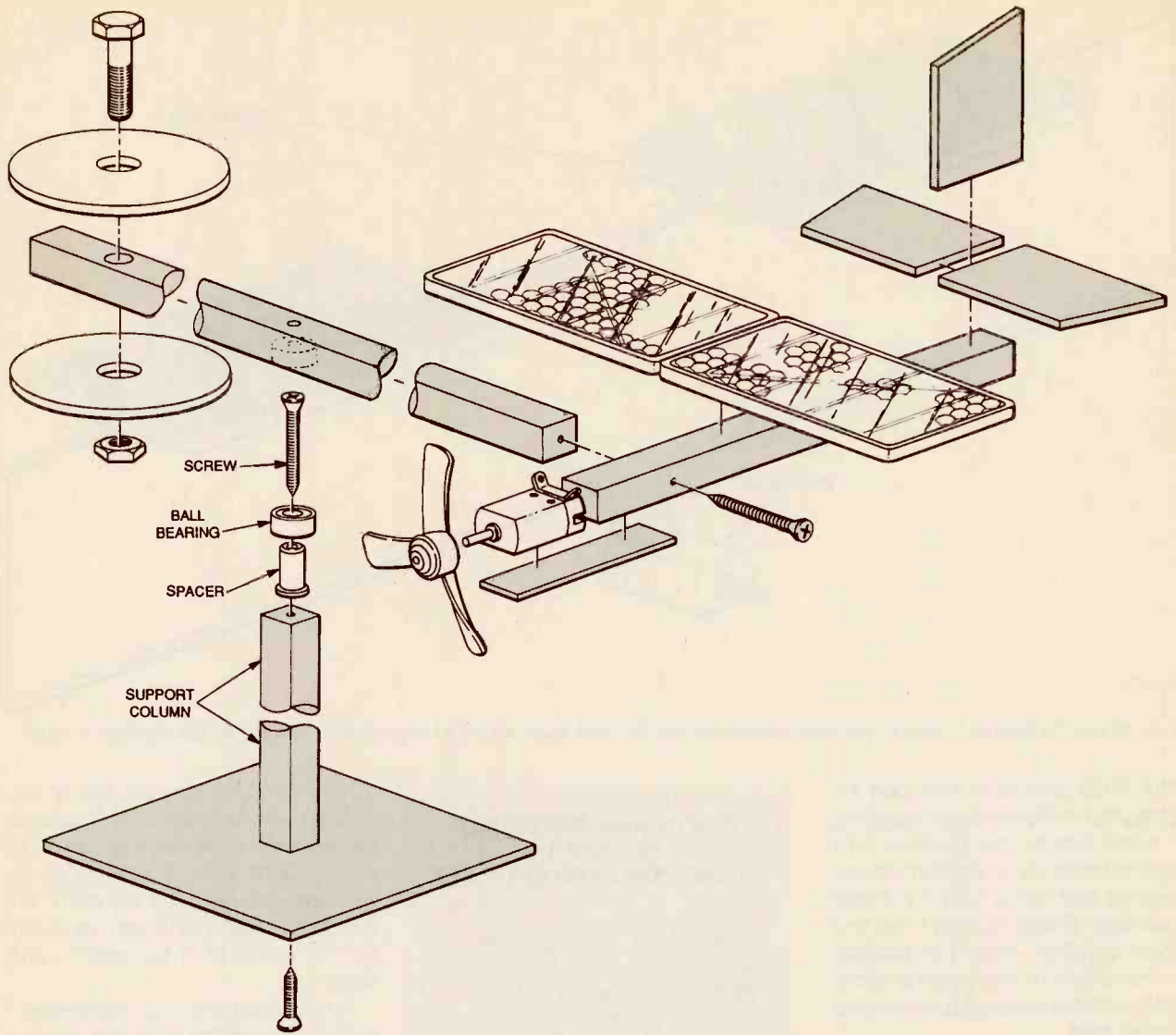

Fig. 2. This is the general assembly of the airplane and its stand. Hot-melt glue, double-sided tape, and a few screws hold everything together.

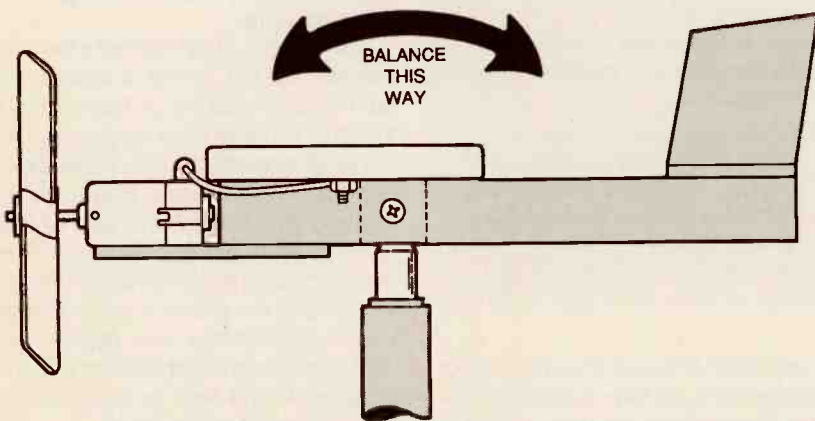

Fig. 3. The pivot arm must be connected so that the plane is balanced front-to-back.

gigantic washers. All together, that hardware was slightly heavier than the plane, so I mounted it about  $\frac{1}{4}$  of an inch from the end of the arm. Ex-

periment to find the perfect balance between the weight of your counterbalance, and its distance from the end of the arm.

Using a bolt and washers makes it easy to balance the arm. Temporarily tighten them on the edge of the arm to find the spot of balance, and drill a hole for the bolt. You might find it easier to balance the plane by drilling a hole for the bolt in a position where the counterweight is a little lighter than the plane. Then, you can fine-balance the arm by adding lighter washers to the counterweight.

After everything is balanced, you can disassemble the plane and paint it, or you can skip the paint and connect the power leads from the motor to the solar panels. Before you permanently attach the power leads, however, go outdoors and test for the polarity that will drive the propeller in the proper direction for forward movement. ■

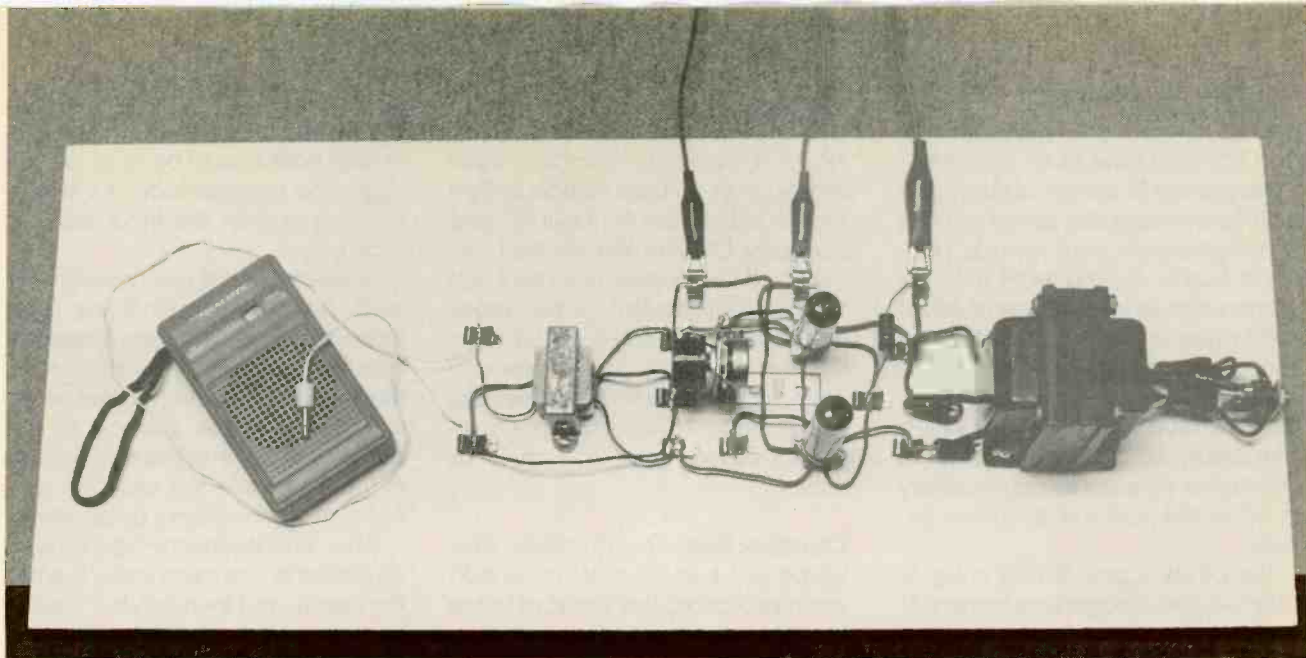

# Vacuum-Tube Audio Amplifier

*Build this audio amplifier and hear the difference tubes make in sound,  
without making a big difference in your wallet.*

BY LARRY LISLE

**V**acuum tubes seem to have a glowing future in expensive, high-end audio equipment. How come? What makes people shell out good money for amplifiers using devices that most thought were obsolete years ago?

Those who like them say that tubes sound better. They use words like "mellow" and "warm" to describe the tube sound. On the other hand, there are also those who don't like tube audio, or say that there's no difference in the sound at all.

How do you tell if you like the sound of tubes without making a big investment? Build the super-simple amplifier described below and hear what tube sound is like at a reasonable cost. That way, you can get some experience working with tubes while building a nice little amp you'll be proud to own.

**Circuit Description.** The circuit shown in Fig. 1 is the classic push-pull

tube amplifier used for generations. That amplifier is flat within  $\pm 1$  dB from 20 to 20,000 Hz into a resistive load, and is deceptively uncomplicated considering its performance. As explained below, the amplifier's design prevents hum and unwanted feedback—two of the toughest problems in the home construction of tube-audio systems.

Hum is minimized by balancing the two sides of the circuit via R1, located in the cathode circuit.

Unwanted feedback is avoided because the circuit is designed as a single-stage amplifier. The sensitivity of the 60FX5 vacuum tubes, V1 and V2, makes that possible.

The amplifier can be driven to full output with less than 3 volts of audio input on the grids, making it ideal for use with a battery-operated radio or tape player. At about 3 watts, the output of the amp is adequate for quiet listening on a 15-inch speaker, and is great for earphones. Of course, the

tubes can be pushed slightly beyond the linear portion of their operating curve (overdriven) to give a kind of distortion that some "tube-philies" like; more on that later.

The amplifier operates on a 120-volt power supply. That is low for tubes and was selected for safety reasons. The "60" in the designation of the 60FX5's indicates the filament voltage. Connecting the filaments of the two tubes in series permits them to be wired directly across the 120-volt DC output of the power supply. The filaments of audio tubes should be operated with DC whenever possible.

The 60FX5 is a sensitive, inexpensive tube (currently selling for under \$3) that works well in the circuit, but other tubes could also be used without changing the socket connections. If you want to substitute tubes with 50-volt filaments, the 50FK5, the 50EH5, and the very common 50C5 are good choices. However, a resistor will be needed in series with the filaments,

and the values of cathode resistors R2 and R3 might have to be changed.

Transformer T2 is a good quality, 10-watt, tube-type audio-output unit that is also available from Antique Electronic Supply (as model PT-1608). Its primary has an impedance of about 8000 ohms, center tapped, and the secondary has taps for 4, 8, and 16 ohms. The 220-ohm screen resistor, R4, is used to drop the screen voltage to a little below the plate voltage. Bypass capacitors were not found necessary in either the cathode or screen circuits.

The power supply, shown in Fig. 2, uses two low-voltage transformers, T1

and T2, connected back-to-back, although a conventional isolation transformer could be used instead. Bridge rectifier BR1 rectifies the input AC, and capacitor C1 filters the resultant DC. The filament voltage is taken from that 120-volt point. Resistor R1 then drops that voltage, and capacitor C2 filters it further. The plate and screen voltages are then taken from the resulting 92-volt output. For safety and for hum-control reasons, ground the circuit as shown.

**Construction.** The amplifier prototype was built on a 24- by 10-inch laminated board that is sold at home

improvement centers for shelving. A smaller board could be used, but the large one provides room for experimenting and for the input radio or tape player.

To wire the circuit, use insulated wire and make connections with fahnestock or similar clips; fasten the clips to the board with wood screws. Mount R1 on a corner bracket so it is raised above the surface of the board. That prevents you from coming into contact with the exposed connections when making adjustments.

When connecting the tube sockets, it is easiest to wire them, screw them to the board, and then trim the wires to an appropriate length. As for the leads of T1 and T2, don't trim them too short—you might want to use the transformers in other projects. The audio output from T2 can either be wired to fahnestock clips, or connected to an audio jack, depending on the nature of your speaker's leads.

The power-supply prototype was built on a separate 9- by 4-inch pine board so it could be physically separated from the amplifier. That is a good practice in audio work because hum might be radiated by the magnetic fields of the transformers and

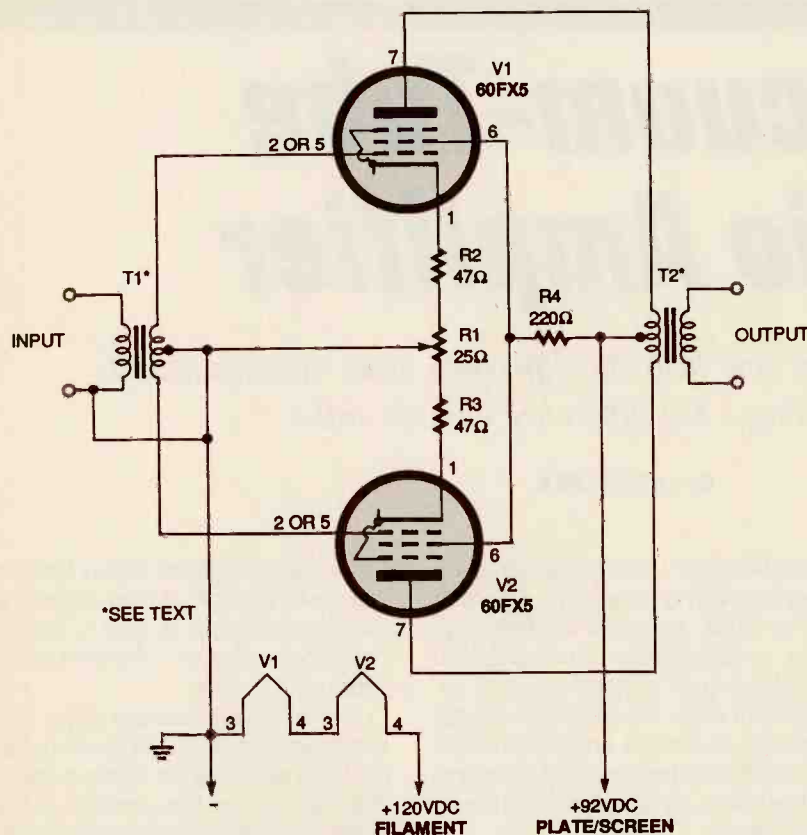

Fig. 1. Here is the schematic for the tube amplifier. Its single-stage design, which eliminates unwanted feedback, was made possible by the sensitive 60FX5 vacuum tubes.

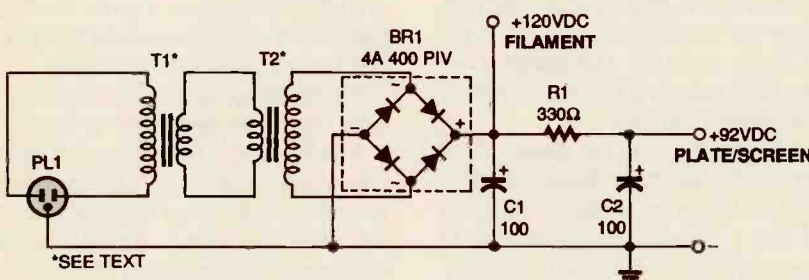

Fig. 2. The power supply for the amplifier uses two low-voltage transformers connected back-to-back. The full-wave bridge rectifier, BR1, provides DC for the filaments, plates, and screens.

## PARTS LIST FOR THE TUBE AMPLIFIER

### RESISTORS

(All fixed resistors are 5% units.)  
 R1—25-ohm, 2-watt, potentiometer  
 R2, R3—47-ohm, 1/2-watt  
 R4—220-ohm, 1-watt

### ADDITIONAL PARTS AND MATERIALS

T1—Tube interstage transformer, 1:1 to 1:3 turn ratio, Antique Electronic Supply PT-157 or equivalent  
 T2—Tube-type audio-output transformer, Antique Electronic Supply PT-1608 or equivalent (Available from Antique Electronic Supply, 6221 S. Maple Avenue, Tempe, AZ 85283, Telephone: 602-820-5411 or Fax: 602-820-4643.)  
 V1, V2—60FX5 vacuum tube  
 24- by 10-inch baseboard, corner bracket, knob for variable resistor, two 7-pin miniature tube sockets, fahnestock clips, audio-output jack (optional), speaker or headphones, alligator clips, screws, insulated wire, solder, hardware, etc.

hash (RF noise) might be given off by the rectifier.

Like the amplifier, you can wire the power supply using insulated wire and fahnestock clips. A small terminal strip can be used to mount BR1. To prevent strain on T1 and T2, use a couple of cable clamps on the power cord.

If you're new to tube voltages, be carefull **Do not touch any part of the amplifier except the knob of R1 while the power supply is plugged in.** After unplugging the amplifier, short the two positive-output fahnestock clips on the power supply to the negative clip to make sure the capacitors have discharged. If the amplifier and power supply are to be placed in regular service where others might come in contact with them, they should be enclosed. Exposed high voltages are not the only danger present—tubes get hot!

**Checkout and Use.** Double-check all wiring to make sure it is correct. Then, make the following connections between the amplifier and power-supply using insulated wires that have insulated alligator clips on both ends.

Begin with the power supply *unplugged*. Temporarily connect the plate/screen lead clip from the amplifier to the filament clip on the power supply. Properly connect the negative ground lead to the power supply. Then, short the input of the amplifier with a piece of wire, and connect a speaker to the output of T2.

Plug in the power supply and wait a minute or so for the tubes to warm up, then balance the circuit by adjusting R1 for minimum hum.

After the circuit is balanced, unplug the power supply. Connect the amplifier plate/screen lead clip to the proper clip on the power supply. Then, plug in the power supply and wait for the tubes to warm up again. When they do, the hum should be inaudible or nearly so. If it isn't, try moving the power supply away from the amplifier or change the physical orientation of the two circuits.

Unplug the power supply and remove the short from the input of the amplifier. Connect a battery-powered radio or tape player with an audio cable from its earphone jack to the amplifier input. Then, connect the filament-lead clip on the amplifier to the proper clip on the power supply.

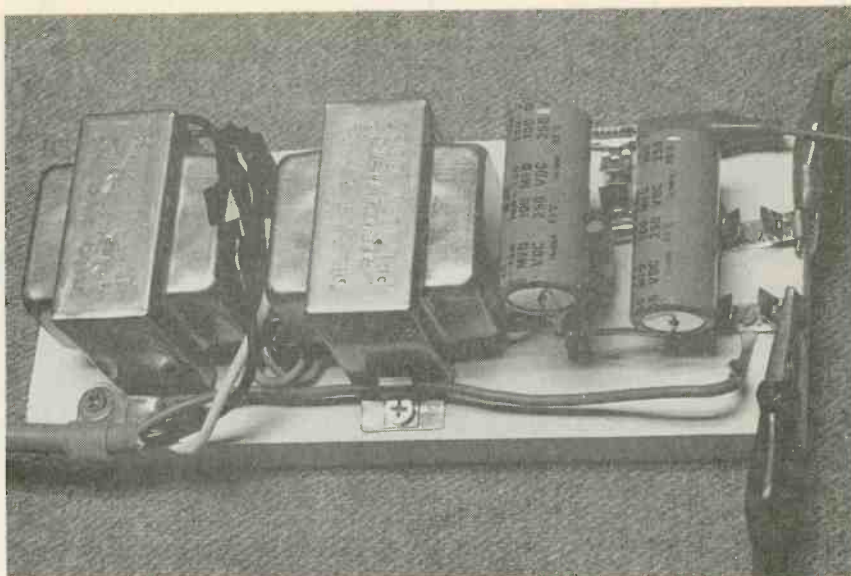

*This power-supply prototype was built on a separate board from the amplifier. It's usually wise to build audio power supplies as separate units to prevent unwanted noise.*

#### PARTS LIST FOR THE POWER SUPPLY

- BR1—4-amp, 400-PIV, full-wave bridge rectifier
- R1—330-ohm, 5-watt, 10% resistor
- C1, C2—100- $\mu$ F, 250-WVDC, electrolytic capacitor
- T1, T2—117 volt to 12.6 volt, 3-amp, power transformer
- PL1—3-conductor power cord and plug
- 9- by 4-inch pine board, terminal strip, fahnestock clips, screws, cable clamps, insulated wire, solder, hardware, etc.

would like to hear the difference, try Plug in the power supply, adjust the volume control on the radio, and enjoy the music.

Any distortion in the radio or tape player will, of course, be passed on to the amplifier (though "tube-philes" say tubes make it sound better!). Also, you'll find some music played over-the-air has built-in distortion—especially on "oldies" stations. Sound quality is also affected by sources that use bass boost, as they will sound "bassier" through the amplifier. So consider the above when making evaluations in the experiments that follow.

**Some Experiments.** There's long been a debate in tube-audio circles about pentodes vs. triodes. If you

reconfiguring the amplifier for triode operation. To do that, disconnect the screen of each tube from R4. Then, connect the screen of each tube to its own plate at the appropriate fahnestock clip. The output and distortion should be less in the triode mode. Try both modes to see which you like better.

The idea of pushing a tube slightly beyond the linear portion of its operating curve was mentioned earlier. Some authorities say that tubes sound best when slightly over-driven that way. That is easy enough to try, just turn up the volume!

The push-pull arrangement of the tubes tends to cancel the even harmonics. You can put the harmonics back in by disconnecting the plate and screen of one tube; however, hum might increase.

There is no "tone" control on the amplifier, but you can cut the highs and thereby boost the bass by connecting a 0.1- $\mu$ F capacitor across the secondary of the input transformer. A variable resistor can be placed in series with the capacitor to make the effect adjustable.

You can sometimes cause subtle variations in amp and speaker performance by connecting a small resistor between the output transformer and the speaker system. Also, resistors can be used to experiment with the various forms of negative feedback. The open construction of the amplifier makes it easy to try them all. ■

Discover and develop your latent mind-over-matter abilities.

# Build the PK Tester

BY LARRY A. DUARTE

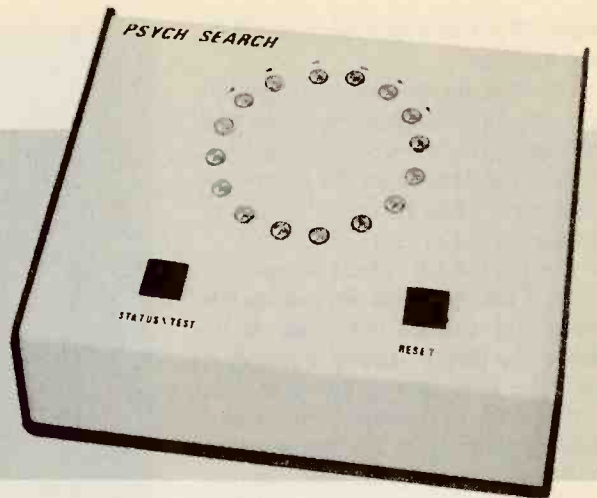

**P**sycho kinesis (PK) is the supposed ability of being able to move objects or influence events with one's mind. Over the years, many scientific investigations have gathered surprising evidence to support a belief in PK, but there is a continued skepticism among the general population. If you would like to settle that issue for yourself and your friends, build the *PK Tester* described in this article.

The project duplicates a device created by the German physicist Helmut Schmidt. In 1969, Schmidt was working for the Boeing Company, which allowed him time and resources to do PK and ESP research. With his traditional physics training, he believed psychic powers could not exist. However, being open minded, Schmidt decided to design an experiment that would scientifically attempt to resolve the mind-over-matter question.

**Schmidt's Experiment.** The heart of Schmidt's device was a random-number generator (RNG). To make that RNG, Schmidt used a radioactive substance called Strontium-90, which created a random strobe due to its erratic decay. That would cause a sample to be taken of a 50%-duty-cycle square wave at random intervals (see Fig. 1). The result was a totally random series of lows and highs (0's and 1's) that would cancel out over time.

Schmidt linked the output of his RNG to a box with 10 lights on it, arranged in a circle. Only one light would be lit at a time. Therefore, the light would give the appearance of

moving counterclockwise or clockwise depending on the RNG state. When the device was not being "influenced" by PK, it would drift in one direction or the other, but over time, its movement should be statistically neutral.

The person whose PK abilities were being tested was asked to "think" the lights in either a clockwise or counterclockwise direction. It is interesting to note that the people tested were not aware of the underlying method or electronics used to create the light's movement. Schmidt's results were startling: some people influenced the motion of the light by odds of over 10,000 to 1.

**A Modern Approach.** In his day, Schmidt used some very advanced equipment to carry out his experiments. However, Strontium-90 is a radioactive isotope that many scientists believe to be dangerous. For that reason, a different method is used to create the random strobe in this project (that is discussed later). However, developing an RNG is only part of the

process of recreating Schmidt's experiment. A method is also needed for translating the random output into directional movement, and for keeping track of the direction of that movement.

The solution to those problems is a Microchip Technology PIC16C55 microcontroller. The PIC's RISC-like architecture combined with its top clock of 20-MHz allows it to process 5-million-instructions-per-second (MIPS), making it one of the fastest microcontrollers around. The PIC used in the PK Tester is available preprogrammed from the source given in the Parts List. However, if you have the ability and equipment to program your own PIC, the firmware listing is available on the Gernsback BBS (516-293-2283).

**Circuit Description.** The schematic for the PK Tester is shown in Fig. 2. Power is provided by a 12-volt-DC wall adapter, which plugs into power-jack J1. That is used instead of batteries because, to guarantee the PK Tester's randomness, the circuit should be tested for many hours or even days at

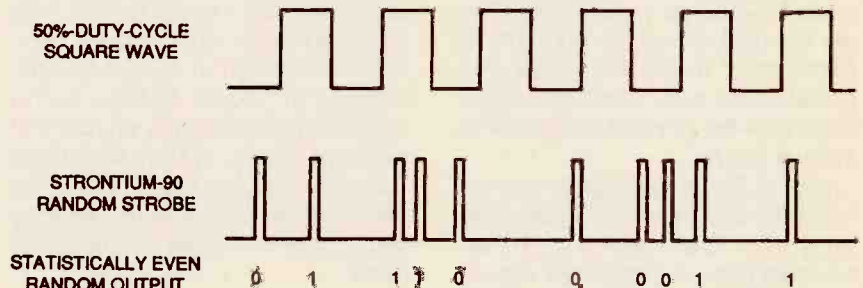

Fig. 1. Here's a sample of the statistically even output produced by Schmidt's random-number generator. A similar output is generated by the PK Tester using a non-radioactive method.

a stretch. A regulated 10 volts is needed by the noise circuit; that is provided by U4, an LM317 adjustable voltage regulator. High ripple rejection is accomplished by R11 and C10. The rest of the circuit runs off a regulated 5 volts produced by U5, a 7805.

Resistor R2 and capacitor C1 provide the RC timing for the PIC (U1), giving it a 78- $\mu$ s clock. The cathodes of LED1-LED16 are directly connected to the PIC. The anodes of the LED's are connected in common through R1, a 220-ohm resistor, to +5 volts. During

normal use, only one LED is on at a time, so that bypasses the need for separate current-limiting resistors on each LED. Two push-button switches, S1 and S2, are used to initiate the STATUS TEST and RESET functions described later.

The random strobe is produced this way: Transistor Q1's emitter-to-base junction is reverse-biased over the breakdown point. That type of configuration produces random noise that is then amplified by Q2. The resulting output is fed into U2, an LM311 comparator, and comes out as a clean, TTL-logic-level high or low signal.

The other signal that is needed to reproduce Schmidt's experiment is a square wave with a 50% duty cycle. That is created by U3, a 555 timer. Diodes D1 and D2 are used to generate the separate timing paths necessary for a precision 50% duty cycle. Also, to ensure that the square wave has a perfect 50% duty cycle, potentiometer R5 should be properly adjusted (more on that later). The combination of that square wave plus the random strobe equals a random but statistically neutral series of highs and lows.

The output of highs and lows is fed to pins 6 and 7 of U1. A section of the firmware then translates the signals into LED "movement." Each individual movement is also recorded by the PIC and the total number of movements are tabulated for display once the STATUS/TEST button is pressed.

**Construction.** The construction technique used is not critical, but if you would like to build the circuit on a PC board, a full-size pattern is shown in Fig. 3. An etched and drilled printed-circuit board (as well as a pre-programmed PIC) is available from the source given in the Parts List. The other parts for the PK Tester can be readily acquired from hobbyist sources like Radio Shack or Digi-Key.

If you decide to build the project on a PC board, use the parts-placement diagram in Fig. 4 as a guide. Mount all the resistors, capacitors, and IC sockets first; then insert the IC's in their sockets. Last, mount the LED's so that they stand on 3/4-inch leads. That will ensure that there is enough room for the other components when the circuit is placed in the case.

Wire the ground connection from power-jack J1 to the board as shown

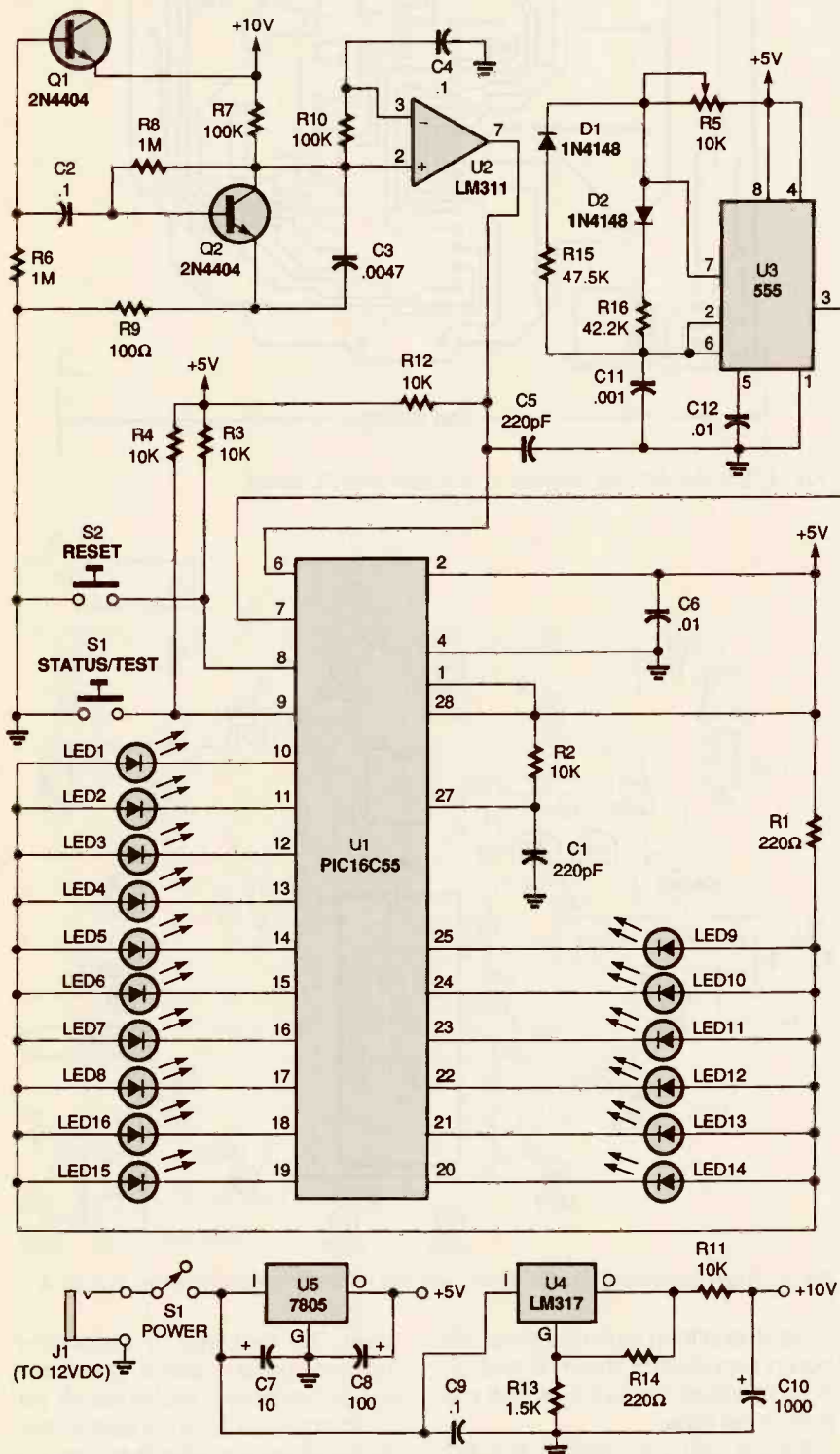

Fig. 2. This circuit generates a random output that is translated into LED "movement" by a preprogrammed PIC16C55 microcontroller, U1. That PIC also senses and records the bias of the LED's movement.

## PARTS LIST FOR THE PK TESTER

### SEMICONDUCTORS

- U1—PIC16C55 microcontroller, integrated circuit  
 U2—LM311 comparator, integrated circuit  
 U3—555 timer, integrated circuit  
 U4—LM317 adjustable voltage regulator, integrated circuit  
 U5—7805 5-volt regulator, integrated circuit  
 Q1, Q2—2N4404 general-purpose NPN transistor  
 D1, D2—1N4148 small-signal diode  
 LED1-LED16—Red light-emitting diode

### RESISTORS

- (All fixed resistors are 1/4-watt, 5% units, unless otherwise noted.)  
 R1, R14—220-ohm, 1/2 watt  
 R2, R3, R4, R11, R12—10,000-ohm potentiometer  
 R6, R8—1-megohm  
 R7, R10—100,000-ohm  
 R9—100-ohm  
 R13—1,500-ohm  
 R15—47,500-ohm, 1%  
 R16—42,200-ohm, 1%

### CAPACITORS

- C1, C5—220-pF, ceramic-disc  
 C2, C4, C9—0.1-μF, polyester  
 C3—0.0047-μF, polyester  
 C6, C12—0.01-μF, polyester  
 C7—10-μF, 25-WVDC, electrolytic  
 C8—100-μF, 16-WVDC, electrolytic  
 C10—1000-μF, 16-WVDC, electrolytic  
 C11—0.001-μF, polyester

### ADDITIONAL PARTS AND MATERIALS

- J1—Mono phone jack  
 S1, S2—Normally open SPST momentary pushbutton switch  
 S3—SPST switch  
 Printed-circuit materials, enclosure, IC sockets, lens caps for LED's, 12-volt AC adapter (with plug to match J1), wire, solder, hardware, etc.

**Note:** The following are available from Larry Duarte (P.O. Box 1232, Englewood, CO 80150): a pre-programmed PIC16C55: \$12.00; an etched and drilled PC board: \$12.00; add \$4.50 S&H to all orders. Colorado residents must add appropriate sales tax.

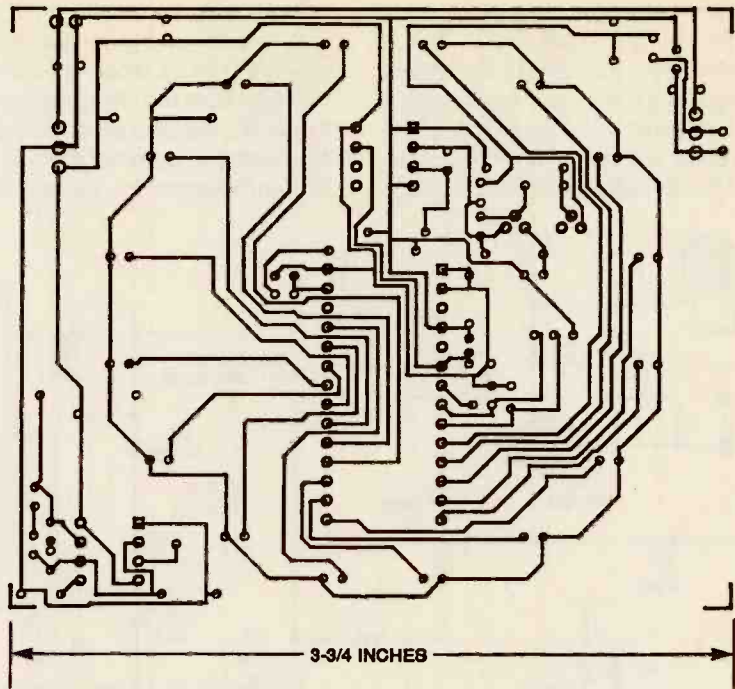

Fig. 3. Use this full-size template to etch your own PC board.

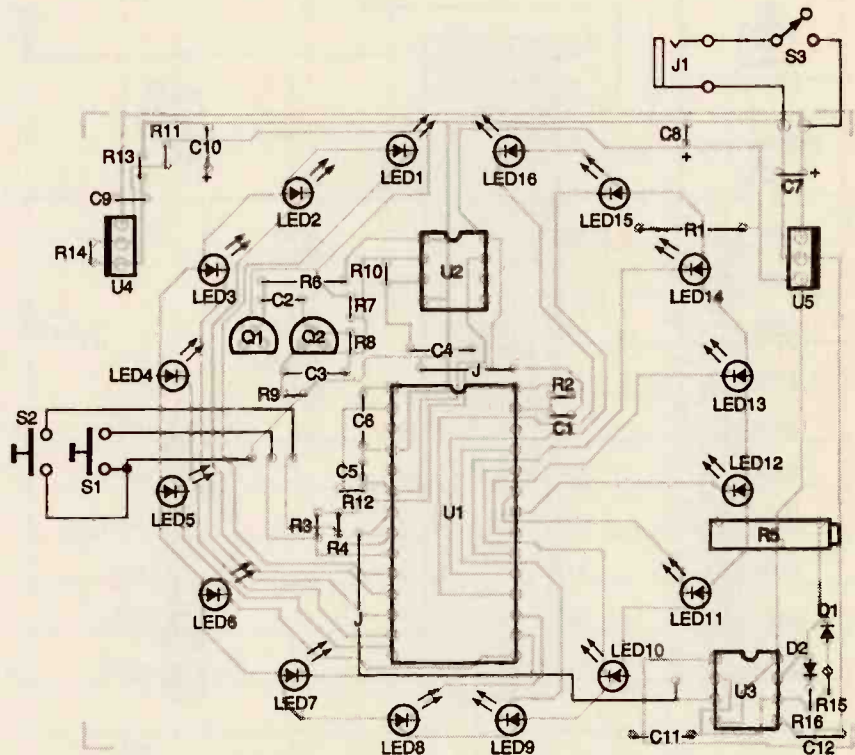

Fig. 4. When assembling the PK Tester, use this parts-placement diagram as a guide.

in Fig. 4, and then make the other off-board connections shown in that diagram. Mount the switches and the jack to the case.

Before you can mount the PC board in the case, you will have to adjust potentiometer R5 so that U3 produces a 50%-duty-cycle square

wave. The best way to accomplish that is by using a scope. However, if you do not have a scope handy, you could adjust R5 to an approximately "halfway" setting, and then use trial and error to determine if the output of the PK Tester is statistically neutral.

(Continued on page 108)



# Build the Sprinkler Guardian

BY  
W. SCHOPP

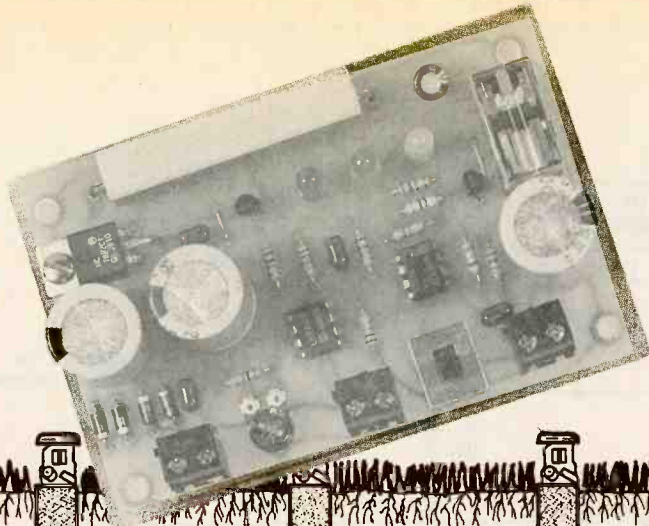

*Here is a rain shut-off for your automatic sprinkler-system that overcomes common problems, and can save dollars on your water bill.*

Ever drive by a yard during the height of a rain storm and wonder why the sprinkler system was working? The answer is simple: sprinkler systems are on timers, and don't know that it's raining. If you would like to keep your system from running in the rain, you can do one of two things: you can either turn off your sprinklers every time it looks like rain, or build the *Sprinkler Guardian* described in this article.

The Sprinkler Guardian is an add-on unit that works with your sprinkler controller and turns off your system when the ground is damp. Using it can significantly cut the watering bill for your lawn. The Guardian also solves some of the shortcomings with a few commercially available sensing units.

Some commercial units that detect lawn moisture have this problem to contend with: when the sprinklers turn on, the probes get wet, causing the unit to shut off the sprinklers (because the unit "thinks" it is raining). That problem is usually solved by telling the installer to bury the probes 4 to 6 inches below the ground. Doing so allows time for the water to soak down from the surface before it indicates that the ground is wet and the sprinklers should be off. There are a couple of drawbacks to that: For one thing, it solves the control problem by adding more work to the installation. In addition, that type of sensing does not detect dry soil at the surface where grass roots are, but waits for soil to dry clear

down to the depth of the sensors before calling for watering.

The above method also presents a problem with systems that have multiple branches. If the sensor probes are located in the first branch being watered, the probes might get wet and the second and remaining branches might never turn on. To avoid that, the probes must always be placed where they are in the last area watered.

Another type of sensing unit detects the resistance of water trapped in a small cup during a rain storm, and waits for that water to evaporate before it turns on the sprinklers. The obvious drawback to that type of sensor operation is that it has nothing to do with the amount of moisture in the ground.

**How It Works.** The Sprinkler Guardian can be used in conjunction with any sprinkler controller that uses standard, 24-volt AC valves. The add-on unit senses the moisture content at the ground surface, and if the ground is dry, the unit allows the controller to execute all the on-times preset by the controller clock. If there is enough moisture in the ground already, however, the Guardian will prevent the valves from opening.

The schematic for the Sprinkler Guardian is shown in Fig. 1. The unit obtains its power from the 24-volt AC power supply of the controller it is used with. That power is supplied to terminals 1 and 2 of terminal block TB1,

and the AC is then rectified by the bridge composed of diodes D1 through D4. Capacitors C1 and C2 act as supply filters, while C5 and C8 are bypass capacitors. The 10-watt resistor, R1, drops the supplied 24 volts down to about 14 volts, which is input to U1, the 12-volt regulator. The output of U1 supplies a regulated 12 volts to the rest of the circuit.

The ground probes are connected to terminals 1 and 2 of TB2. Resistor R2 is used to balance the resistance of the earth between the two probes so that op-amp U2, which is configured as a comparator, outputs a high when the ground is dry. When that happens, PNP transistor Q1 is turned off, K1 is not energized, and terminals 1 and 2 of TB3 are shorted. Under those conditions, if the controller calls for watering the lawn, watering will commence.

Now, let's assume that it rains, and that the ground is wet. The resistance between the probes drops, causing the output of U2 to go low, which turns on Q1. That energizes K1, causing its contacts to open. Under those conditions, even when the controller is programmed to water, the valves will not open. That covers the wet and dry conditions normally encountered.

Now let's assume the soil is dry. Relay K1 is off and all is ready for the needed watering-cycle. When the programmed watering time arrives, the water valve is opened, starting the timed watering-cycle. The probes are wetted immediately and U2 goes low.

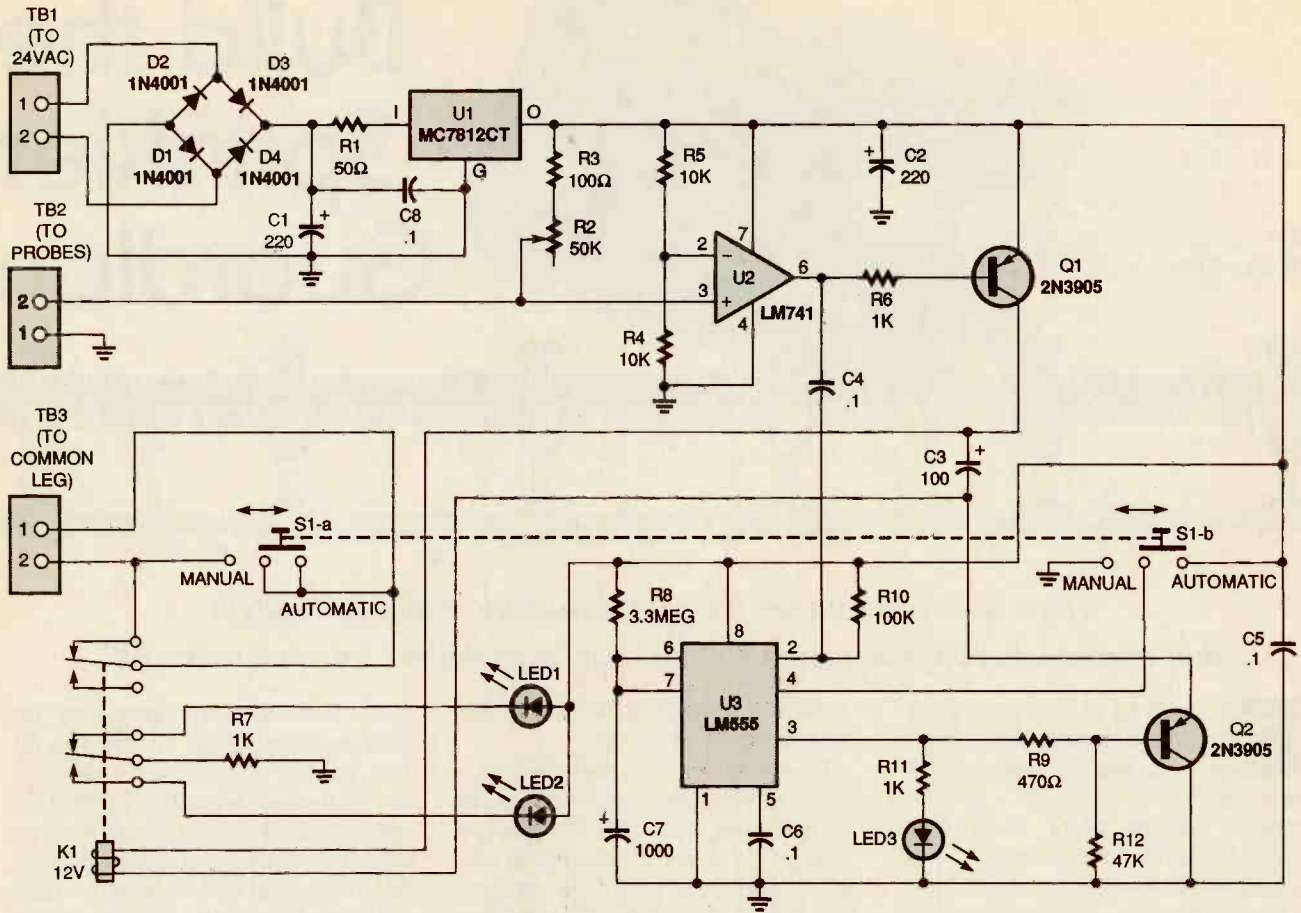

Fig. 1. The Sprinkler Guardian uses probes to sense the change in the ground's resistance when moist. If the moisture is caused by the sprinkler system, U3, a 555 timer, allows the sprinkler to run for about an hour with the values shown for R8 and C7.

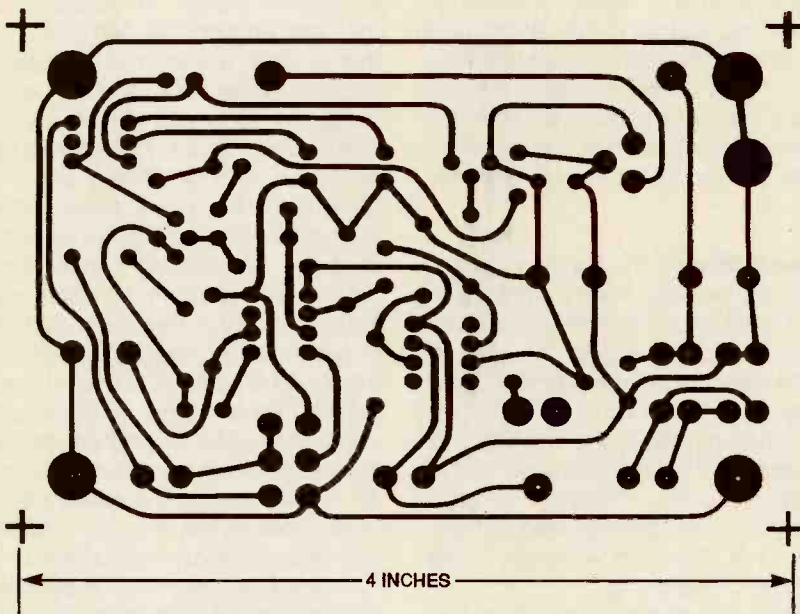

Fig. 2. The Sprinkler Guardian prototype was assembled on a printed-circuit board. A full-size template of it is shown here.

As the voltage output of U2 drops, a negative-going pulse is delivered through C4 to pin 2 of U3, a 555 timer, which triggers the timer into opera-

tion. The timer output from pin 3 turns Q2 off, which keeps K1 from closing during the time cycle determined by R8 and C7. That allows time for the sprinkler system to complete the watering cycle.

By the end of the U3 time period, the controller has most likely completed its on-time and has shut off. With the component values shown, the time period set on the Sprinkler Guardian is about one hour, after which the sensor becomes active again. If an hour is not long enough, the U3 period can be adjusted using the formula:

$$T = R \times C \times 1.1$$

where T is the time in seconds, R is the resistance of R8 in ohms, C is the capacitance of C7 in farads, and 1.1 is a constant.

A DPDT switch, S1, is used to place the circuit in either the "automatic" or "manual" modes. In the "automatic" mode, the circuit operates as previously described. In the "manual"

## PARTS LIST FOR THE SPRINKLER GUARDIAN

### SEMICONDUCTORS

- U1—MC7812CT, 12-volt regulator, integrated circuit  
 U2—LM741 op-amp, integrated circuit  
 U3—LM555 timer, integrated circuit  
 Q1, Q2—2N3905, general-purpose PNP transistor  
 D1-D4—1N4001, 1-amp, 50-PIV rectifier diode  
 LED1—Red light-emitting diode  
 LED2—Green light-emitting diode  
 LED3—Yellow light-emitting diode

### RESISTORS

- (All fixed resistors are 1/4-watt, 5% units, unless otherwise indicated.)  
 R1—50-ohm, 10-watt, 10%  
 R2—50,000-ohm, potentiometer, PC-mount (Digi-Key K4A54 or similar)  
 R3—100-ohm  
 R4, R5—10,000-ohm  
 R6, R7, R11—1000-ohm  
 R8—3.3-megohm  
 R9—470-ohm  
 R10—100,000-ohm  
 R12—47,000-ohm

### CAPACITORS

- C1, C2—220- $\mu$ F, 50-WVDC, electrolytic  
 C3—100- $\mu$ F, 16-WVDC, electrolytic  
 C4, C5, C6, C8—0.1- $\mu$ F, metallized-film  
 C7—1000- $\mu$ F, 25-WVDC, electrolytic

### ADDITIONAL PARTS AND MATERIALS

- K1—12-volt DC relay, AROMAT #HB2-DC12V (Jameco 18577 or equivalent)  
 TB1-TB3—2-terminal, terminal block, PC-mount  
 S1—DPDT slide switch  
 Printed-circuit materials, two 20D nails, insulated wire, solder, hardware, etc.

mode, the terminals of TB3 are shorted, effectively removing the Guardian from the system, and U3 is removed from the Guardian circuit, allowing R2 to be adjusted without worrying about the action of the timer. Note that R2 should always be adjusted with S1 in the "manual" position.

Two LEDs are used to indicate the condition of the relay. When green LED1 is on, it indicates that the relay is off and that all watering cycles will be completed. When the relay is ener-

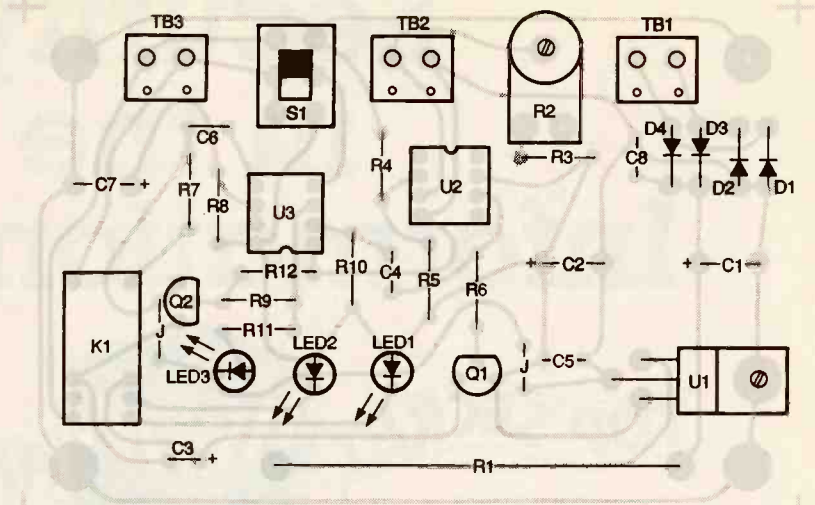

Fig. 3. Assemble your unit using this parts-placement diagram as a guide. Be sure to leave a 1/4-inch space between the PC board and R1 for ventilation.

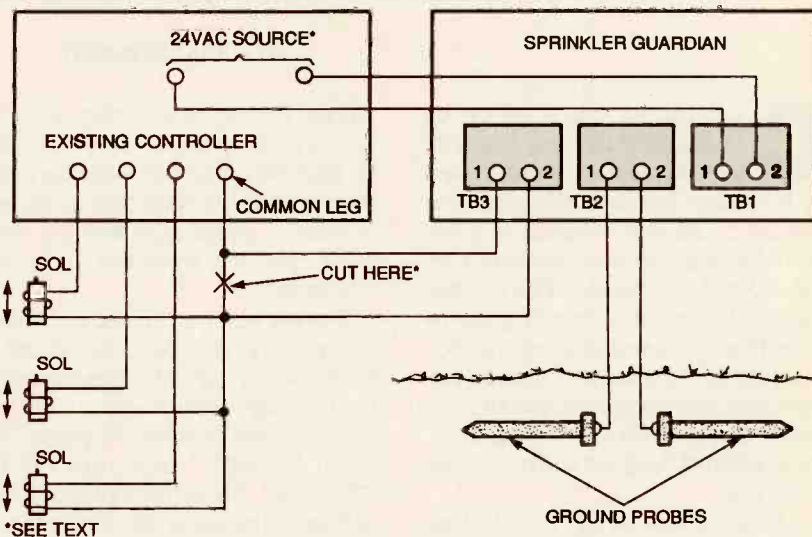

Fig. 4. This illustration shows how to properly connect the Sprinkler Guardian to your sprinkler-system controller and to the buried ground probes.

gized, red LED2 is on, indicating that the sensor is wet and that the demand for water by the controller will not be accommodated. Because the timer keeps the relay from being energized even if the probe is moist, it is essential to know if the timer is in its timing cycle or if it is off. Yellow LED3 is on when the timer is in its timing cycle.

**Construction.** The unit can be built on either perforated construction board or on a printed-circuit board. For those who want to use a PC board, a template is shown in Fig. 2, and the parts-placement diagram is shown in Fig. 3. Using the PC-board layout elimi-

nates wiring mistakes, but might limit parts substitutions, because of physical differences in part sizes.

All the components are mounted flush on the board except for R1. Leave about a 1/4-inch space between that high-wattage resistor and the surface of the PC board to allow better air-flow cooling. When installing capacitors C1, C2, C3, and C7, be sure to check that their polarity matches that shown in Fig. 3. Also, be sure to install the two jumper connections at the correct places.

The probes can be two 20D nails, with the needed length of insulated (Continued on page 102)

# Security in the Information Age

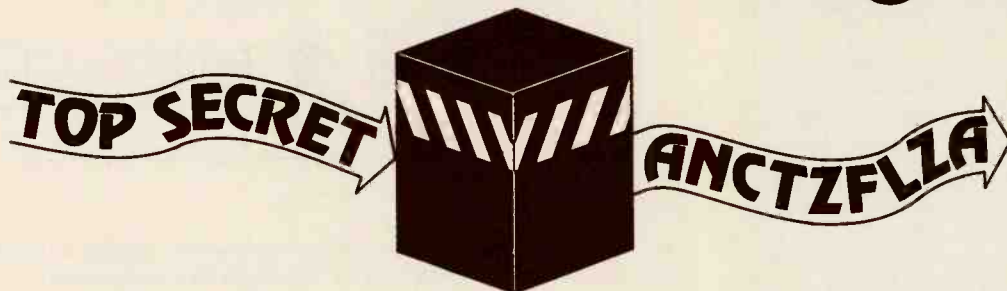

*How information is protected from falling into the wrong hands.*

BY CRAIG HOWARD

**C**ryptology, the science of codes and ciphers, has until fairly recently only been used by kings and generals. Because few people could read, illiteracy was the ultimate file protection. However, with the advent of universal literacy, the personal computer, and a government that can eavesdrop on a worldwide scale, cryptology has moved out from the back chambers and into the public domain. We can now protect information at the push of a computer RETURN key.

But how is that done? Well, before we can take a look at achieving true security in the information age, perhaps a little background material on codes and ciphers is in order.

**Codes and Ciphers.** Codes and ciphers are completely different entities, even though the two terms are often incorrectly used interchangeably. The first type, codes, changes the value of entire words, phrases, or sentences. For instance, the code phrase "CLIMB MOUNT NIITAKA" was used by the Japanese Navy to mean "ATTACK PEARL HARBOR."

Ciphers change the position or value of each individual character in the message. Ciphers are much easier to use than codes, which require large code books listing every word or group of words that will be used. A

cipher, on the other hand, requires only a mathematical formula, called an algorithm, that can often be easily memorized. The message to be encrypted is called *plaintext*; the message after it is encrypted is called *ciphertext*.

Ciphers can be divided into either *transposition* or *substitution* groups. A transposition cipher shuffles the plaintext message until it is unreadable. For example, the plaintext message "RETREAT AT ONCE" becomes "ETRNECTORA TE." Break the ciphertext into sequential blocks of five characters, in order to hide the placement of obvious words like "AT."

A substitution cipher changes the value of each character in the plaintext. Most substitution ciphers use a key, which can be a word that's easy to remember, a passage from a book, or even a piece of music. To use a key, convert the plaintext into numbers—"A" becomes 00, "B" becomes 01, and so on. Do the same with your key. Then add each plaintext number to its corresponding key number and you get the ciphertext.

For example, if you wanted to convert the plaintext word "ATTACK" into numbers, it would become: 00 19 19 00 02 10. To encrypt that word you would need a key; let's say that the key used was "BUSBUS." That key would become 01 20 18 01 20 18 when convert-

ed. To create the final ciphertext you would have to add those series of numbers, one series on top of the other, like this:

00	19	19	00	02	10
+01	20	18	01	20	18
01	39	27	01	22	28

Notice that noncarry addition was used; that reduces the number of errors. Because the key provides three different numbers, a plaintext number can be converted into three possible ciphertext numbers. For example, the first "T" in plaintext (19) is added to a "U" (20) in the key, and is turned into a ciphertext 39, but the second "T" is added to an "S" (18) in the key, which results in a ciphertext 27. That variation makes the cipher harder to crack.

**One-Time Pads.** Instead of using a key "word" that repeats, what if the key was a random string of numbers the length of the message? It would be unbreakable. Period. That unbreakable cipher is called a one-time pad, and is the favorite of spies everywhere. It requires only a pad of paper filled with random numbers on each page. That pad is the key.

Here is how to use the method. First of all, come up with a one-time pad of random numbers, and use them to encrypt your message, just like a substitution cipher. Then, tear off the

pages that were used and burn them, because they could never be used again. Your friend who receives the message can use a one-time pad, which is an exact duplicate of yours, to decrypt the message.

If that cipher is so secure, why don't banks and governments use it for all of their message traffic? Because the cipher requires that each sender and receiver have exactly the same one-time pads. Banks transmit and receive so many messages that they'd need millions of pads per day, all of which would have to be distributed in complete security to everyone communicating with the bank. Hence, the infallible one-time pad is used only by those who must communicate with bomb-proof security, such as a spy.

**Numbers Stations.** Occasionally, shortwave listeners will hear an announcer on an unlicensed station reading off a seemingly random string of numbers. The announcer is sending a message to a spy who's equipped with nothing more than a shortwave receiver and a one-time pad the size of a postage stamp. Shortwaves can reach halfway around the world, so the transmitter can be located on friendly soil.

Although most "numbers stations" transmit their messages in four- or five-digit blocks, occasionally you can hear a three-two station. On those stations, each block consists of three digits, a pause, then two digits. Those messages are using a dictionary-key system. The first three digits of each block are the page number of a book. The last two digits are the location of the word on the page. By looking up each word, the message is reconstructed. The dictionary-key system is safer than the one-time pad because being caught with a pad of random numbers is bad news, whereas being caught with a paperback novel is not.

Numbers stations can be found across the short-wave spectrum, but are especially active on 6840 kHz and 7415 kHz in the evening to morning hours. Brush up on your Spanish; it seems to be the language of choice for those types of stations in the western hemisphere. For more information, read *The Shortwave Listening Guidebook*, listed in the "Further Reading" box.

## MODULAR MATH CIPHERS

Modular math is easy; we use it every day. If the time is 10:00, what will it be in 6 hours? Well, 10 plus 6 equals 16, but a regular clock only goes up to 12 (it is a mod 12 system). Therefore, we have to also figure out that 16 mod 12 equals 4 (o'clock). To do that, simply divide the number by the modulus, keeping only the remainder. Subtraction could also work in that case, but not always. For example, if it's 10:00, and you want to know what time it will be in 34 hours, then you'd use 44 mod 12, which equals 8 ( $44/12 = 3$  remainder 8).

Modular math is good for locking up secrets in code. Even though finding 14 mod 12 is easy (the answer is 2), doing the reverse is difficult, even if you know the modulus. If the remainder is 2, then the original number can be 2, 14, 26, etc.

To use modular math for an RSA cipher, start by picking two prime numbers,  $p$  and  $q$ . For this example, we'll use 3 and 5, but in practice, the two numbers should be 100 digits long each. We'll also need a public key ( $r$ ), but first we have to come up with its modifier ( $n$ ), using:

$$n = pq$$

In this case,  $n$  equals 15. Next, you have to figure out the value of  $e$ , a number that determines the range of the public key ( $r$ ). To find  $e$ , use:

$$(p-1)(q-1)$$

which equals 8. So, in this case, the public key ( $r$ ) is any number between 1 and 8, which isn't a factor of 8 (that eliminates 2 and 4). Let's have  $r$  equal 3.

Then, find a number that when multiplied by  $r$  and divided by  $e$  leaves a remainder of 1. We'll use 11, which will be  $s$ , the private key. Now you're ready to give your friends the numbers  $n$  (15) and  $r$  (3).

If a friend wants to send you a message, say the number 12, he or she can use the public key to encrypt the message.  $12^r \text{ mod } n$ , or simplified,  $1728 \text{ mod } 15$ , which equals 3. The ciphertext message 3 can then be transmitted.

To decrypt to get the plaintext message, use  $3^s \text{ mod } n$ , or  $177147 \text{ mod } 15$ , which equals 12. With a little practice, it's not as complicated as it seems at first. ■

**Electronic One-Time Pads.** As we saw earlier, a one-time-pad cipher uses a random key that is the length of the plaintext message. The key is different for every message, and is added to the plaintext using noncarry addition. To make an electronic one-time pad, you can use the exclusive-OR gate (XOR) to perform the addition. That can be done either with

hardware—an XOR-gate chip (Fig. 1A), or with software—the XOR instruction in BASIC.

Looking at the truth table in Fig. 1B, we can see that the XOR gate is a binary adding machine. Input A is added to input B, and the sum is shown in the output column. Now, look at the last line. If  $A = 1$  and  $B = 1$  then  $1 + 1 = 10$ . Because the XOR uses noncarry addition, the 1 is dropped, leaving the output to equal 0.

The best source of random bits for the key is not the RND instruction in BASIC. That instruction doesn't grab a random number out of the air; instead, it generates a pseudo-random sequence that repeats after a long time. The sequence could be broken given enough ciphertext messages.

Instead, use random noise in the form of radio static. Fill a CD-ROM with static, and make a copy for the other one-time pad (see Fig. 2). Use a CD-ROM drive that has its laser power boosted. As the laser reads a bit, the bit is burned away. That makes it impossible to crack previous messages if the CD-ROM is captured.

**Encryption in Banking.** Every day the Clearinghouse Interbank Payment System electronically moves more than 1-trillion dollars. That data is encrypted with the Data Encryption Standard (DES), which is based on IBM's Lucifer algorithm. The original Lucifer used a 128-bit key, but the US government thought that a key that long would make the cipher too hard to break by their people at the NSA. So DES was given a 56-bit key, making the cipher too difficult to break by anyone except the government.

How weak is DES with a 56-bit key? A 56-bit binary key has  $2^{56}$  possible keys, which is equal to  $7.2 \times 10^{16}$  or 72,000,000,000,000,000 possible keys. A 128-bit key has  $2^{128}$  or  $3.4 \times 10^{38}$  possibilities (that's written as 34 followed by 37 zeros!). Double the size of the key, and you square the number of possible keys and the amount of work a codebreaker must put in.

DES encrypts a chunk of data by using a three-step cycle of substitution, transposition, and exclusive-OR'ing, which is repeated for a total of sixteen cycles. It has three modes: Electronic Codebook (ECB), Cipher Feedback (CFB), Cipher Block Chaining (CBC).

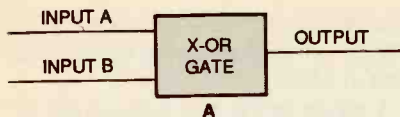

X-OR TRUTH TABLE

A	B	OUTPUT
0	0	0
0	1	1
1	0	1
1	1	0

B

Fig. 1. This is the block diagram of a XOR-gate chip (A). The truth table (B) shows that the XOR gate is really a binary adding machine.

The Electronic Codebook mode is so weak that even the government recommends not using it. Ironically, a number of commercial encryption programs use it anyway. For a complete description of DES, read *Security in Computing*, listed in the "Further Reading" box.

Can DES be broken? Michael Wiener of Bell Northern Research in Ottawa wrote a paper on how to do just that. He designed a chip that breaks DES keys by trying every combination until it finds the right one, the brute-force attack. The chip costs \$10.50 to manufacture. For \$1 million, you could build a machine that uses 57,000 of those chips to try every key in 7 hours, with the average time to solution being 3.5 hours. For \$10 million, you can get a solution in an average time of 21 minutes. Finally, for \$100 million, you can have a solution in 2 minutes! Wiener hasn't built the chip yet, but it is feasible.

DES will retire soon. Among its other flaws it uses a single key for encryption and decryption, just like the basic ciphers we looked at earlier. A single-key system, also called a conventional system, allows anyone who sends you an encrypted message to also decrypt your other messages. The solution: either use a separate key for each person with whom you communicate, or use the latest rage, the public-key cipher.

**Public-Key Ciphers.** Let's dust off some basic math terminology. Remember prime numbers? They're numbers that can be divided only by themselves and one. Three is a prime number; so is five. Take two prime

numbers, say 100 digits each, and multiply them together to get a 200-digit number, X. If a computer is given X, it will take years to find the original prime numbers again. Public-key ciphers use prime numbers for that very reason.

A public-key cipher is perfect for computers and E-mail. It uses two keys: a public key that can be given to anyone, and a private key that is kept secret. If someone wishes to send you a message, he or she would encrypt it with your public key. Once it has been turned into ciphertext, the public key cannot decrypt it: only the private key can do that. So you can distribute your

**Pretty Good Privacy.** In 1978, three researchers at the Massachusetts Institute of Technology introduced a public-key algorithm. They called it RSA after their names—Rivest, Shamir, and Adleman. The researchers published their algorithm before filing a patent, out of fear that the U.S. government would classify the patent a national secret, disallowing them to write about it. Because the rest of the world requires patenting before publication, RSA is patented only in the United States.

Enter Phillip Zimmermann, a computer consultant in Boulder, Colorado. He wrote an encryption program that

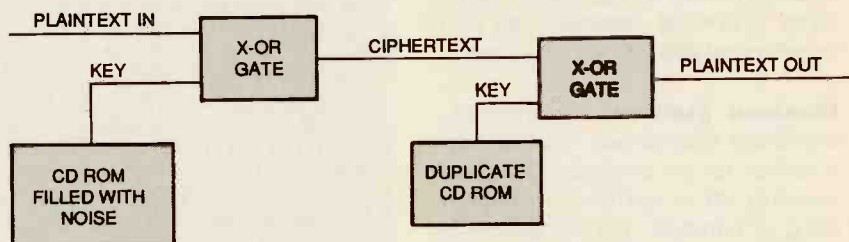

Fig. 2. To use an electronic one-time pad, fill a CD ROM with static, and make a copy for the other one-time pad. Use a CD ROM drive that has its laser power boosted. As it reads each bit, the laser burns the bit away, making it impossible to crack previous messages if the CD ROM is captured.

public key to the four winds, but no one can use it to decrypt any messages sent to you.

**Digital Signatures.** You get a call from Icepick: he wants the money you owe him. Now. The bank closes in a few minutes, and it's too far to drive. If you send a message to the bank to transfer money to the bank to transfer money to Icepick's account, how will the bank know that it's you?

We know that a public key encrypts; a private key decrypts. However a public-key system is commutative—that is, it can also encrypt with the private key and decrypt with the public one. Of course! You fire up the computer, and write a quick note to the bank. You encrypt the note with your private key and send it. The bank then looks up your public key and uses it to decrypt the message. Icepick gets his money, and your kneecaps feel great.

Using a private key to encrypt a message is called a digital signature, because it is unique, like your own handwriting. To make sure that no one but the bank can read your note, simply encrypt the note with your private key, then encrypt the ciphertext using the bank's public key.

uses the RSA algorithm and called it PGP, for Pretty Good Privacy. He posted it on a local computer bulletin board. Someone else downloaded PGP from the bulletin board, and posted it on the Internet. Copies of PGP multiplied exponentially, with thousands of people around the world downloading the program from one bulletin board, and posting it on another.

PGP is simple and free for the taking. It can encrypt personal files that you keep on disk, E-mail messages, or files to be sent to someone else. The best source for a clean, bug-free copy of the program is the bulletin board "The Catacombs," 303-772-1062. Grab the PGP Shell too, which has screen menus to make PGP easier to use.

When PGP first came out, the RSA patent holders claimed infringement. That is odd considering that RSA was created with public funds, and was published in widely read academic journals. Today, the infringement battle is over: the 2.6 version of PGP uses encryption algorithms that have no license fees for personal, non-commercial use.

**The Clipper Chip.** PGP has a distant cousin, the Clipper chip, which is the U.S. Government's replacement for DES. The chip is based on the Skipjack algorithm, which is classified.

But why look any further than RSA and PGP for use as our national encryption standard? If RSA is good enough for protecting our nation's nuclear weapons (and according to Ron Rivest, it is used for precisely that), why can't banks and phone companies use it? Because if everyone used an unbreakable encryption method, court-ordered wiretapping would be useless. The NSA, whose mission is to break codes and to eavesdrop on all forms of communication, would be defunct. Thus the Clipper was born. It allows the government to break any messages sent or received by that chip.

During the chip-manufacturing process, each chip is loaded with a serial number, a family key, and a unit key. The family key is the same for all Clipper chips; the serial number and unit key are unique to each chip. Two random, 80-bit binary numbers are factored (multiplied) together to form the unit key. A copy of the unit key is made, then split in half, each half being tagged with the chip's serial number. One half of the key is kept at the US Treasury Department, the other half at the National Institute of Standards and Technology (NIST).

If a law enforcement agency wishes to decrypt the messages of a specific Clipper-equipped phone, fax machine, or modem, it will need a court order for permission to place a wiretap. Every time a Clipper transmits a ciphertext message, it also sends its serial number in the clear, in a format called a LEAF—Law Enforcement Access Field. The police write down the serial number and fax it, along with the court order, to NIST and the Treasury Department. The two halves of the unit key are faxed to the wiretappers, who can then decrypt any messages sent by that Clipper.

If you design and manufacture secure phones or modems, must you use the Clipper? Only if you want to do business with the government, or plan on exporting your product. Though it's doubtful whether a worldwide market exists for encryption devices that can be broken by the US government.

Whenever two Clippers attempt to communicate with each other, a session key is created, which is used for only that communications session. A copy of the session key is encrypted with the Clipper's unit key, and is transmitted in the LEAF. The two Clippers exchange LEAF's, checking to see if they are valid. Thus if you possess the unit key, you can get the session key every time the chip communicates. The LEAF is 128 bits total, and contains the 80-bit session key, 32-bit serial number, and 16-bit checksum. The en-

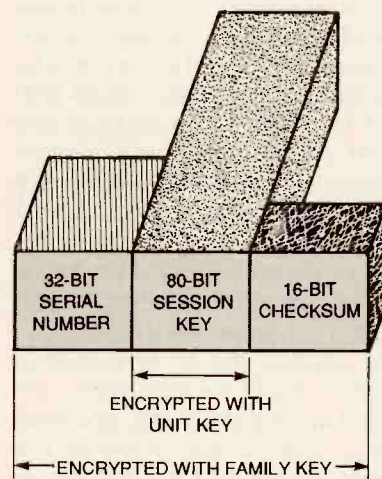

*Fig. 3. The Clipper chip's LEAF (Law Enforcement Access Field) is shown here. It is 128 bits total, and contains the 80-bit session key, 32-bit serial number, and 16-bit checksum. The entire LEAF is encrypted with the family key.*

tire LEAF is encrypted with the family key (see Fig. 3).

The Clipper is manufactured by Mykotronix in Torrance, California. It is also called an EES chip, for Escrowed Encryption Standard. There will be two EES chips: the Clipper or MYK-78, which will be used mainly in secure telephones, and the Capstone or MYK-80, which is a jazzed-up Clipper that can use public-key ciphers to encrypt computer files and E-mail. It will also have digital signature capability.

The Clipper chip itself is tamper-proof—anyone who tries to crack open the chip to examine its "guts" is wasting their time. However, the information entering and exiting the Clipper is not tamper-proof, as we shall see.

**The Clipper's Flaw.** When DES, RSA, and PGP were first devised, their

creators published full details of the systems and challenged the world's top math and code experts to "break it." That approach made it easy to find any flaws in the ciphers. Not so with the Clipper chip; the NSA allowed only five outside cryptologists to examine it, which was a big mistake.

The June 3, 1994 *Wall Street Journal* mentions an AT&T Bell Labs scientist who experimented with a prototype Clipper. Matthew Blaze found a way to make the chip generate a "bogus" LEAF, making it impossible for a wiretapper to get the right escrow key.

Simply removing the LEAF will not work; the receiving Clipper will not decrypt data unless the LEAF is present and its checksum appears to be valid. Generating the fake checksum is done by the brute-force attack. That takes a computer about 42 minutes, and it must be done each time the Clipper chip wants to connect with another, making that technique useless for a phone. It is quite useful for a fax machine or E-mail system, however.

You could speed up the process by using parallel-processing—a machine using 60 Clippers wired together could find a valid-looking LEAF in under 45 seconds. Also, the machine could precompute a list of session keys and fake LEAF's (if the number of possible recipients is small), but that will work only with fax and E-mail, not phones.

The government could counter that method by doubling the size of the checksum, which would square the number of possible checksums, making a brute-force attack too time-consuming. For that to work, however, the Clipper would have to be redesigned extensively.

**Do Citizens Need Encryption?** In the past, if the government wanted to read someone's paper mail, it required a lot of time and effort: opening, reading, copying, and resealing the letters. Today many letters are in the form of E-mail, which is nothing more than a stream of digits flowing from one computer to another.

It is possible to listen in on those messages and run them through a computer, which is programmed to copy any messages that contain trigger words such as "bomb," "assassinate," or "protest." That can be done

# VCR Cross Reference

**NOW Find the right Part  
for your VCR**

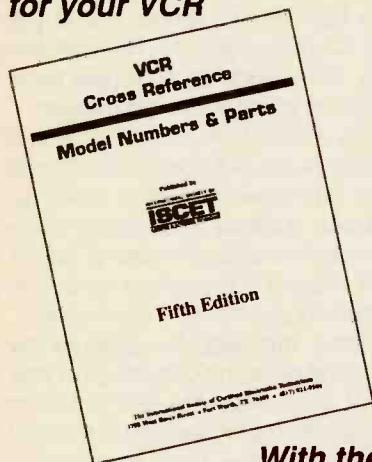

With the

## ISCET VCR CROSS REFERENCE

This 119-page reference contains both model and part-number cross-references updated to include 1994 units.

VCR's are made in a few factories from which hundreds of different brand names and model numbers identify cosmetically-changed identical and near-identical manufactured units. Interchangeable parts are very common. An exact replacement part may be available only a few minutes away from you even though the manufacturer supplier is out-of-stock. You may be able to cannibalize scrap units at no cost!

The ISCET VCR Cross Reference is pre-punched for standard loose-leaf binding. . . \$38.00 plus \$3.00 for shipping for each Reference.

**Clagck Inc.**  
**VCR CROSS REFERENCE OFFER**  
**P.O. Box 4099**  
**Farmingdale, New York 11735-0793**

Name \_\_\_\_\_  
 Business \_\_\_\_\_  
 Address \_\_\_\_\_  
 City \_\_\_\_\_  
 State \_\_\_\_\_ Zip \_\_\_\_\_  
 Phone \_\_\_\_\_  
 Enclose \$38.00 for the Fifth Edition of the ISCET VCR Cross Reference and \$3.00 for shipping for each Reference.  
 The total amount of my order is \$ \_\_\_\_\_  
 Check enclosed—do not send cash.  
 or please charge my credit card.  
 Visa  MasterCard Exp. Date \_\_\_\_\_  
 Card No. \_\_\_\_\_  
 Signature \_\_\_\_\_

New York State residents must add applicable local sales tax to total. U.S. funds only. Use U.S. bank check or International Money Order. CB02

quickly, automatically, and without detection. The listeners don't even have to put a tap on your phone, because most long-distance calls are transmitted via microwaves. An NSA listening post located in the microwave flow can intercept thousands of calls an hour.

**Storm on the Horizon.** Computer monitors are low-powered, radio-frequency (RF) transmitters. For about \$300, a receiver can be built to read the information displayed on a computer monitor from several-hundred feet away. In fact, the U.S. government takes that problem seriously enough to have devised a set of standards for low-emission computers called TEMPEST, for Transient ElectroMagnetic Pulse Emanation Standard. A computer product meets TEMPEST standards by using two methods: modifying the RF emissions by adding dummy signals, or by capturing the emissions. The first method is classified, but the second can be done by anyone.

To capture the RF emissions, a monitor should be completely enclosed with copper that is grounded, with a fine copper mesh on the monitor screen itself. The monitor cable and its junctions should be shielded also. The entire computer

room can be shielded with copper, but water pipes and heating ducts leading out of the shielded room can act like antennae, so that approach must be used carefully.

Using a laptop computer with a low-powered, LCD screen isn't foolproof. The computer processor, disk drive, and modem also generate RF signals. Even the phone cable running from the modem to the wall jack acts like an antenna. Other sources of RF leakage are: the printed-circuit board, internal wires, the power cable, switching transistors, and high-power amplifiers.

If the computer's wall outlet has a bad earth ground, it can also increase the amount of RF emissions. In fact, if even part of the earth ground has bad conduction, as from paint on a water pipe, it will increase the RF signal.

What about a roomful of computers, all using the same type of monitor? Wouldn't they emit RF signals all on the same frequency, making it impossible to sort through the signals? Not really. Even if two monitors are exactly the same model, they might have been manufactured at different times, using different components due to a change in the design. If so, they will not have the same RF signature. As a general rule, digital equipment emits RF signals in the form of pulses, which is easier to reconstruct than the non-pulse RF signals generated by analog equipment.

So, as you can see, there are ways to protect your private information from becoming a little too public. However, advances in computer technology will probably continue to make the ciphers of today obsolete tomorrow, which means cryptology will have to constantly strive to keep up. That should make the science worth watching in the future. ■

### FURTHER READING

*The Puzzle Palace.* by James Bamford, 1982, Houghton Mifflin Company, Boston. This is the story of the NSA.

*Protocol Failure in the Escrowed Encryption Standard.* by Matthew Blaze, June 1994. A paper on how to defeat the Clipper chip.

*Cryptologia.* Rose-Hulman Institute of Technology, Terre Haute, IN 47803; Tel. 812-877-1511. The quarterly journal on cryptology. Heavy math, but worth the struggle. \$34 per year.

*Shortwave Listening Guidebook.* by Harry Helms, 1993, High Text Publications, Solana Beach, CA.

*Kahn On Codes.* by David Kahn, 1983, Macmillan, NY. The history of cryptology.

*Security In Computing.* by Charles P. Pfleeger, 1989, Prentice Hall, Englewood Cliffs, NJ. An excellent textbook on encryption, computer and network security, copy protection, viruses and more. ■



"Oh, I cornered the market in 8-track tapes."



**H**unting down car noises is not easy because of the high background-noise level of the automobile. The cheapest method involves using a length of tubing or hose held up to one's ear to focus the noise, but that has a number of disadvantages. First of all, the tube acts as an audio filter that tends to resonate in a narrow frequency range determined by its length. Also, the limited bend radius of the tube restricts motion, and might not allow you to focus on the noise. Another option is to use an inexpensive mechanic's stethoscope, which is a metal probe connected to a metal or plastic diaphragm. However, that requires that you be in phys-

headphone amplifier, which is built around the other half of the dual op-amp. That audio output can be heard on any "Walkman-style" 32-ohm headphones.

Figure 1 is the schematic for the Electronic Auto Stethoscope. That circuit is powered by a 9-volt battery, B1, and power-supply filtered by capacitor C1. The NE5532 audio op-amp, U1, directly drives low impedances and can therefore drive the headphones without the need for a dedicated power-amplifier IC such as the LM386. A bipolar power supply has to be used with U1. So, to replace the bipolar-supply ground connection, two resistors, R1 and R2, are used to split the

through C6, to the tone-control circuit consisting of C7, C8, R7, R8, and R9. Tone-control potentiometer R8 allows the user to peak the amplifier response to the frequency of the noise being investigated. When R8 is centered, the frequency response is flat from 20 Hz to 15 kHz. When R8 is moved toward the bass or treble position, response in the rejected frequency range (i.e. bass is rejected in the treble position) is cut by as much as 12 dB.

The output of R8 is connected to volume-control potentiometer R10, and U1-b amplifies the signal at the wiper of R10. Gain is determined by R11 and R12. The output of U1-b is bi-

# Auto Stethoscope

*Find the source  
of those annoying car noises  
with this high-tech ear.*

BY CHARLES HANSEN

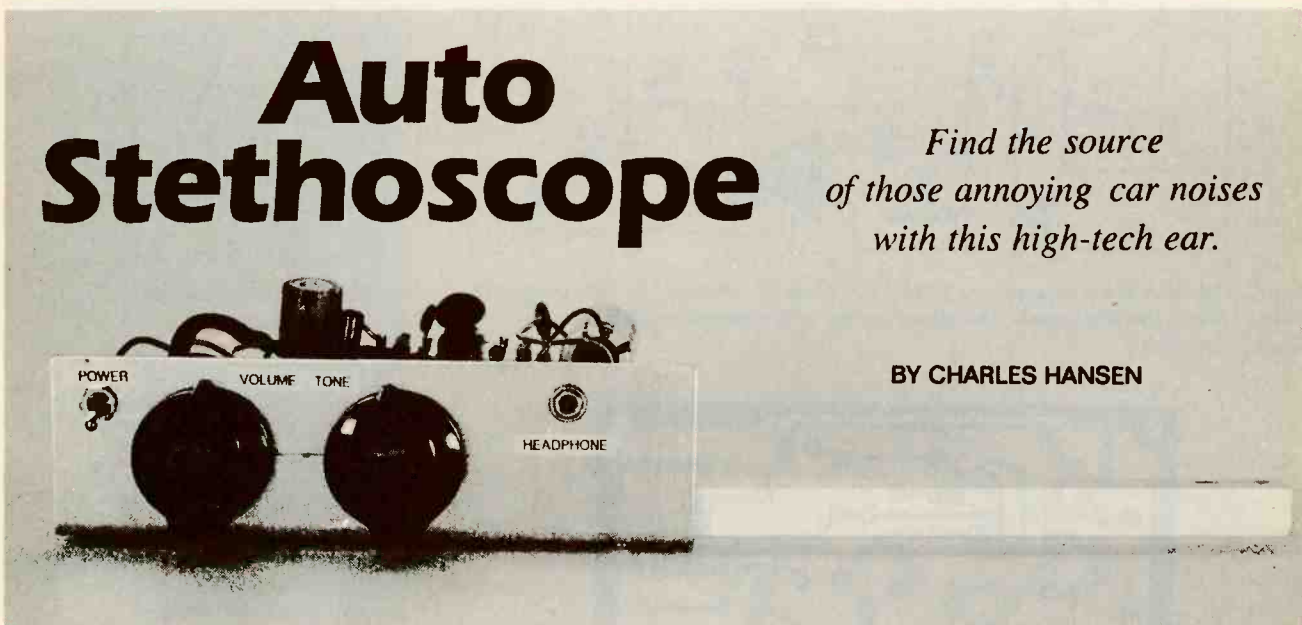

ical contact with the noise source.

The Electronic Auto Stethoscope presented in this article has a number of advantages over the previously mentioned mechanical ones. It has a built-in amplifier that amplifies low-level sounds, earphones to help block out other background noises, and a tone control that allows you to focus on the frequency range of the noise being investigated, whether it is low-frequency road noise or a high-pitched wind whistle or rattle.

**How it Works.** The Stethoscope uses an electret-microphone element, MIC1, which is amplified by 1/2 of U1, an NE5532, dual audio op-amp. The output of the op-amp is connected to the tone-control section and the volume control, where it is sent to the

9-volt, DC power supply and provide a "virtual ground." To provide balanced headroom for the audio signals, R1 and R2 are of an equal resistance. Capacitor C2 provides a bypass for audio signals and improves load regulation.

The 4.5-volt DC bias for the electret microphone, MIC1, is obtained from B1 through resistor R3. Capacitor C3 couples the audio output from MIC1 to U1-a, resistor R4 provides the virtual-ground connection, and resistors R5 and R6 determine the audio gain of U1-a. High-frequency roll-off above 15 kHz is provided by capacitor C4, and capacitor C5 rolls off the low-frequency response below 20 Hz. Capacitor C11 provides decoupling for the power-supply pins of U1.

The output of U1-a is coupled,

used to the virtual-ground voltage of 4.5 volts by R1 and R2. If that output were fed directly to the headphones, there would be a DC voltage continuously applied to them, which could limit battery life. For that reason, it was decided to isolate the headphones from the DC voltage.

To couple only the audio signal to the headphones, capacitor C10 is connected in series with the output. Large capacitive loads have a tendency to cause instability, peaking, and ringing in the output of a closed-loop op-amp circuit. To prevent that, R13 is connected in series to decouple the output of U1-b from C10. Feedback-capacitor C9 then provides a high-frequency feedback bypass, restoring stability to the amplifier.

The stereo headphones are con-

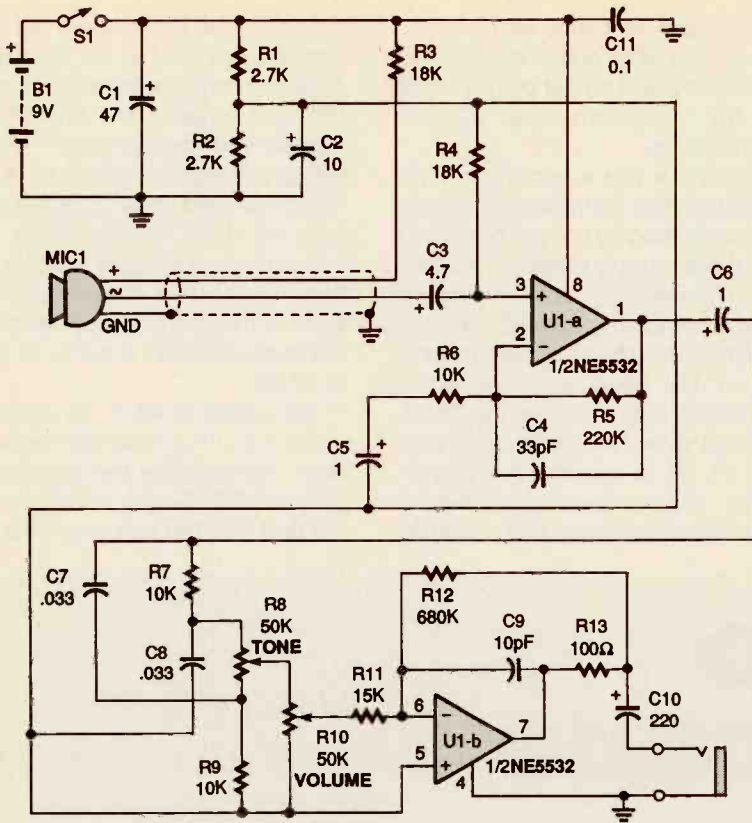

Fig. 1. The heart of the Stethoscope is the NE5532 audio op-amp, U1. That component directly drives low impedances and allows the use of headphones without adding another amplifier.

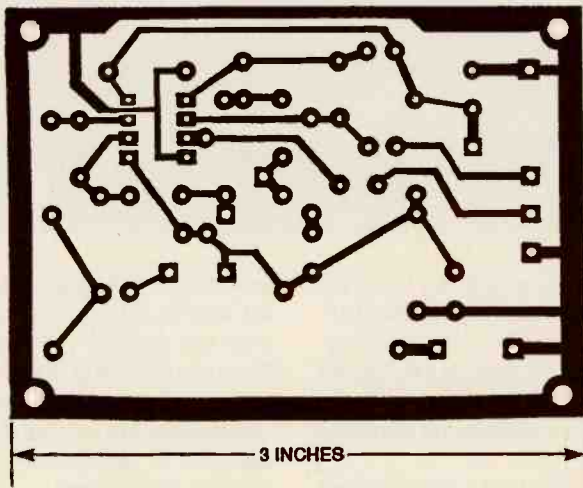

Fig. 2. If you would like to build the project on a PC board, use this full-size template to etch your own.

nected in series to make it easier for the op-amp to drive them to a useful volume. Because the microphone signal is monophonic, there is no need for stereo output.

**Construction.** The prototype Electronic Auto Stethoscope was built on a perforated board. Because of the high gain used, wire lengths were kept

short to prevent noise pickup and oscillation. For your convenience, a printed-circuit board template is provided in Fig. 2 if you prefer to etch and drill one. If that is the case, use the parts-placement diagram shown in Fig. 3 to make building the project easier. Select a project enclosure that has sufficient room for the perforated board or PC board and all chassis-

## PARTS LIST FOR THE ELECTRONIC AUTO STETHOSCOPE

### RESISTORS

(All fixed resistors are 1/4-watt, 5% units, unless otherwise noted.)

- R1, R2—2700-ohm
- R3, R4—18,000-ohm
- R5—220,000-ohm
- R6, R7, R9—10,000-ohm
- R8—50,000-ohm, linear potentiometer
- R10—50,000-ohm, audio-taper potentiometer
- R11—15,000-ohm
- R12—680,000-ohm
- R13—100-ohm

### CAPACITORS

- C1—47-µF, 35-WVDC, electrolytic
- C2—10-µF, 35-WVDC, electrolytic
- C3—4.7-µF, 35-WVDC, electrolytic
- C4—33-pF, mica or metallized-film
- C5, C6—1-µF, 35-WVDC, tantalum
- C7, C8—0.033-µF, metallized-film
- C9—10-pF, mica or metallized-film
- C10—220-µF, 35-WVDC, electrolytic
- C11—0.1-µF, ceramic-disc

### ADDITIONAL PARTS AND MATERIALS

- U1—NE5532N, low-noise dual op-amp, integrated circuit
- MIC1—electret microphone (Radio Shack #270-092 or equivalent)
- J1—3.5-mm phone jack
- S1—SPST toggle switch
- B1—9-volt alkaline battery
- Printed-circuit materials, project enclosure, 9-volt-battery snap with leads, 3/8-inch ID tubing (see text), two-conductor shielded microphone cable, control knobs, 32-ohm stereo headphones, standoffs, wire, solder, hardware, etc.

mounted components.

In keeping with good assembly practice, install the least-sensitive parts first, followed by the more-sensitive parts. Start by installing the battery connector and an IC socket at the position for U1. Next, connect the wiring to potentiometers R8 and R10, switch S1, and jack J1. Solder in the passive parts (resistors, then capacitors) and double check the orientation of the polarized components.

Before installing the last on-board component, U1, into its socket, and before attaching MIC1, test the power supply. Turn on S1 and measure the

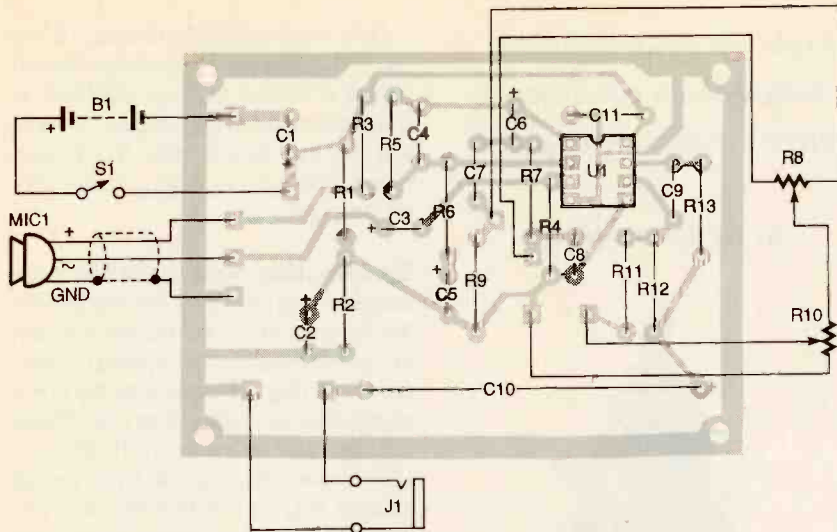

Fig. 3. Use this parts-placement diagram as a guide when assembling the Stethoscope. Be sure to double check the alignment of the polarized components.

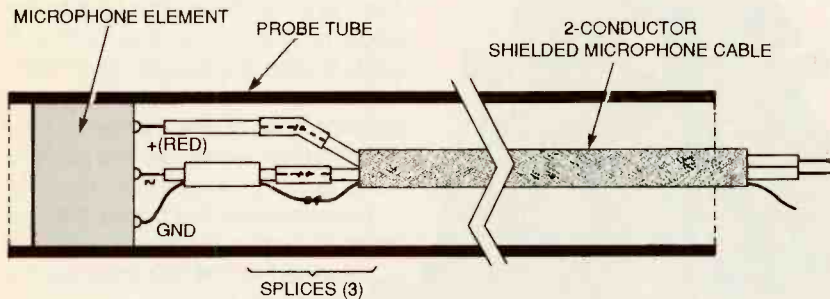

Fig. 4. The electret microphone element, MIC1, needs to be mounted in a tube assembly. Before doing that, extend the reach of MIC1's short leads by attaching them to a two-conductor, shielded microphone cable.

battery voltage across C1. Then check the virtual-ground voltage across C2; it should read half the battery voltage. If that is the case, turn off S1 and prepare the microphone assembly for attachment. If the voltage seems too high, check for wiring mistakes.

Microphone MIC1 can be mounted in a number of ways. The prototype has the microphone installed inside a six-inch-long, 3/8-inch diameter, plastic tube "wand," with the end of MIC1 just below flush with the open end of the tube. Because the leads on MIC1 are only a couple of inches long (as supplied by the vendor), they need to be extended (as shown in Fig. 4) before the microphone is mounted in the tube.

To extend the leads of MIC1, use two-conductor, shielded microphone cable; splice the red (+) microphone wire to the red wire in the cable, and then splice the white microphone-signal wire to the black wire in the cable.

Finally, splice the ground wire of the microphone to the shield of the cable. Use shrink sleeving over each of the splices, and then cover them all with one larger piece of shrink sleeve for ruggedness. You can then either directly connect the other end of the cable to the circuit board (as indicated in Fig. 1) or you can add another jack and plug to make the microphone detachable.

If you do mount the microphone probe directly to the case of the amplifier module, the tone and volume controls of the Stethoscope will be easier to use because the entire case can be aimed at the noise source. That is why a six-inch-long probe was recommended.

Once the microphone assembly is prepared and the leads are connected to the circuit board, turn on S1 again and measure the voltage across the red microphone lead to the shield. It should be 3.5- to 6-volts DC (4.5-volts DC nominal). If that is so,

turn off S1. You can then safely insert U1 into its socket.

If you want to use the Stethoscope in physical contact with engine noise sources (similar to a mechanical probe-diaphragm unit), mount MIC1 in a metal tube. That will provide the necessary rigidity to transmit mechanical sounds to the microphone. Be sure to electrically insulate the case of the microphone element from the metal tube. It is also a good idea to cover the metal tube with a non-conductive material such as shrink sleeving to prevent the tube from causing any electrical shorts under the hood.

**Checkout and Use.** Plug in the headphones and turn on the Stethoscope. Place the TONE control, R8, in the center of rotation and turn the VOLUME control, R10, all the way down (to the left). There should be no sound in the headphones. If you do not get any noise, proceed as follows.

Aim the microphone at a known low-volume audio source such as a radio speaker, and turn the VOLUME up until you can hear the audio source through the headphones. You should then be able to turn up the VOLUME high enough so that the sound in the headphones drowns out the source. Also, you should be able to greatly affect the tone of the audio source with the TONE control. That completes the check-out procedure.

When selecting headphones to use with the Stethoscope, keep in mind that the differences in sensitivity and frequency response between various Walkman-style headphones is surprising. Of course, the more expensive headphones have higher volume and fidelity; however, the Stethoscope can drive even the cheapest headphones to adequate volume. Watch out for small headphones, though. At high volume, acoustic feedback can occur between them and the microphone. Closed earpiece headphones are less prone to feedback than the smaller, open type.

The author originally built the Stethoscope to track down a rattle in the console of his car (which turned out to be a lost jeweler's screwdriver). Without the Stethoscope, that wouldn't have been possible, even with someone else driving. You should find it to be just as useful. ■

If you are looking for an unusual way to add some electronics fun to your Christmas, here's a project that you are sure to love. Called the *LED-Tric Christmas Tree*, it is a three-dimensional flashing Christmas-tree display that can help brighten up the holidays. To achieve its 3-D look, the tree is built using three identical boards connected together at the spine and spaced at 120 degrees apart. Each board sports six LED's, which are mounted to straddle the board edges so their light is directed outward. To complete the look, a single flashing LED is mounted at the tree's top

**How it Works.** The Tree consists of three essentially identical circuits. The basic schematic is shown in Fig. 1. As you can see, each circuit consists of an LM3909 LED flasher IC (U1), six LED's, and some support circuitry. However, note that the six LED's of each circuit are distributed equally over the three boards. That is done using interconnection pads located at the boards' spines. The pads on the component side are designated CP, while the pads on the foil side are designated SP. For the purposes of our discussion, the first of the three boards is identified as A, the second as B, and the third board as C.

Let's see how all of that works. The drive signal is taken from pin 8 of U1 on board A. It leaves that board via pad SP1 on board A and is fed to pad CP1 on board B, where it drives LED1 and LED4 on that board. That same drive signal then leaves board B at SP2 and goes on to connect with CP2 on board C, where it drives LED3 and LED6. Finally, the signal leaves board C via pad SP3 and is fed back to board A via CP3, where it drives LED2 and LED5. The result of all of that is to always move the drive signal one level higher as the signal rotates around the tree. To create a more random look, however, the value of the timing resistor, R8, is different on each board.

*Light up your holidays  
with this unusual and  
festive conversation piece*

BY RICHARD PANOSH



# The "LED-Tric" Christmas Tree

One independent blinking LED is placed at the very top of the Tree on board A. Power for that LED, LED7, is supplied by installing jumpers JU1 and JU2 on that board only. The power switch and battery also appear only on board A.

**Construction.** Building the Tree is relatively straightforward. The pattern for the foil side of the PC board is shown in Fig. 2; the component side's pattern is shown in Fig. 3. Remember, the complete tree requires three of these boards, and aside from S1, B1, and LED7, three sets of parts. If you prefer, boards, kits, and assembled units are also available from the source given in the Parts List.

The parts-placement diagram is shown in Fig. 4. Care should be exercised when soldering the LED's to the edge of the board. Cut both LED leads to about a quarter of an inch, but remember to leave the negative, cathode, lead a little shorter for easy identification. Make sure the positive, anode, lead is soldered to the component side of the board, and the cathode lead is soldered to the foil side so that the LED straddles the edge of the board.

Similarly, care should be exercised when mounting LED7. Again, its anode lead is soldered to the component side of board A, while the cathode is soldered to the foil side of that board. Be careful when selecting the unit used for LED7. Some blinking units require 5 volts or more of power for proper operation. The specified unit is rated to operate at 2.5 volts, and is extinguished at 2 volts.

Mounting the LED's on the board edge can get a little tricky. Fortunately, a technique used in assembling surface-mount components can be used here to good advantage. The technique involves the use of an epoxy such as Duro Depend II, available from most hardware stores. A drop of the part A epoxy is applied to the first surface to be joined, and a drop of part B epoxy is applied to

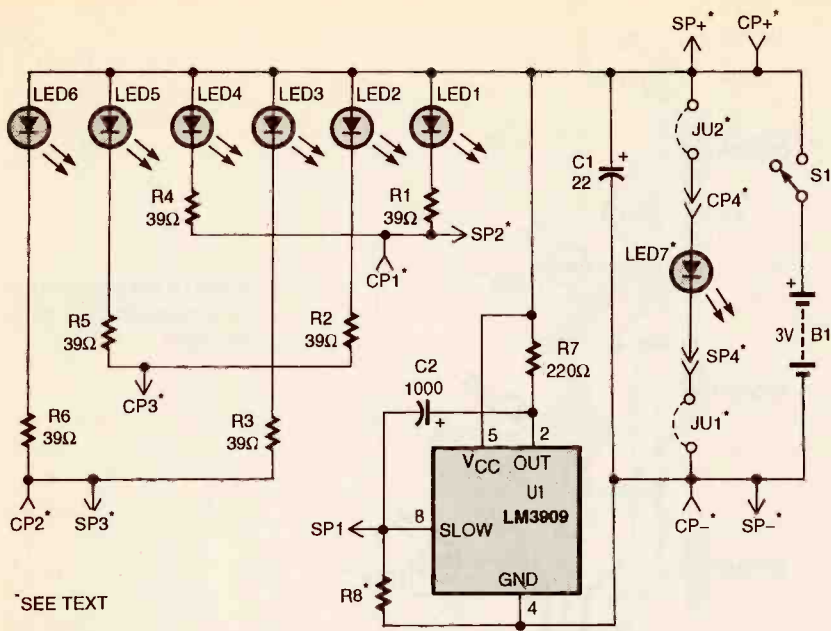

\*SEE TEXT

Fig. 1. The LED-Tric Christmas Tree consists of three essentially identical circuits. The schematic for the basic circuit is shown here.

the second surface. Then, when the two pieces are brought together, a bond is established in a few minutes.

To mount the LED's, place a small amount of the part A epoxy on the bottom surface of the LED and a small amount of the part B epoxy at the appropriate spot on the board edge. Once the bond has been formed, just solder the leads to the pads. Be sure to use as little epoxy as possible to avoid getting any on the leads or the pads.

The same technique can also be used to join the three boards at their spines. You may find it helpful to draw a template showing the proper angles (120°) and use it as a guide. Again, be careful to not get any epoxy on the interconnecting solder pads. Once the epoxy has set, bridge all adjoining interconnection pads on all boards with a healthy amount of solder. In addition to providing electrical

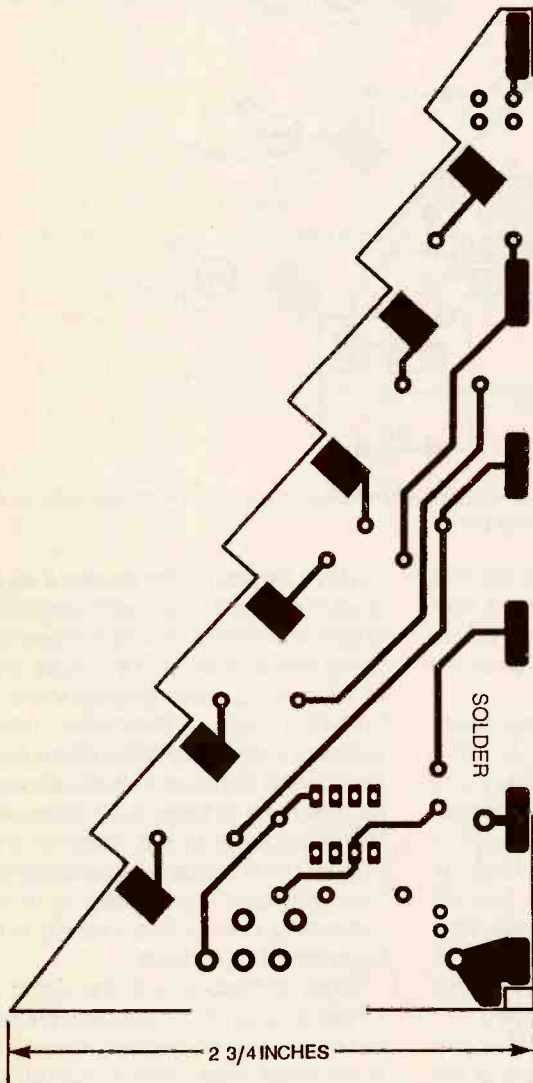

Fig. 2. Here's the foil side of the Tree's PC Pattern. It is shown here full size.

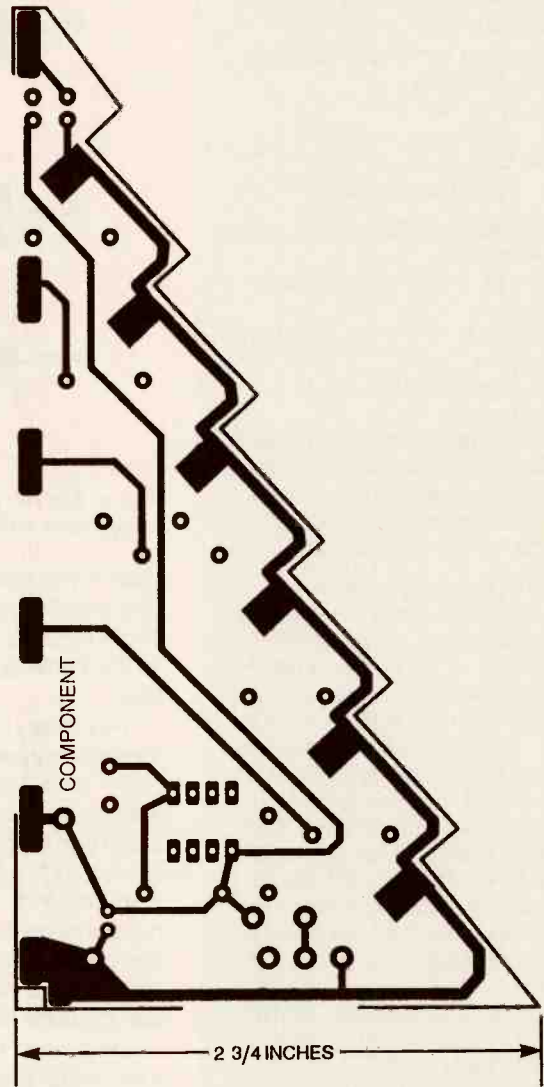

Fig. 3 Here's the component side of the board. Remember that you will need three boards to build the Tree.

connections, these pads are used to give mechanical strength to the assembly.

The power switch (S1) should be mounted on PC board A at the appropriate location. On boards B and C, a feedthrough should be installed at the rightmost pad at the S1 location as indicated in Fig. 4. A second feedthrough, near C2, should be installed on all boards.

Two jumpers are also installed on board A. The first, JU1, installs on the foil

## PARTS LIST FOR THE LED-TRIC CHRISTMAS TREE

### SEMICONDUCTORS

U1—LM3909 LED flasher, integrated circuit

LED1—LED6—T-1¼ superbright LED, assorted colors

LED7—Flashing LED, Radio Shack 276-036C or equivalent

### RESISTORS

(All resistors are ¼-watt, 5% units)

R1—R6—39-ohms

R7—220 ohms

R8-a—1000-ohms, see text

R8-b—1200-ohms, see text

R8-c—1500-ohms, see text

### ADDITIONAL PARTS AND MATERIALS

C1—22µF, 16 WVDC, electrolytic capacitor

C2—1000µF, 16 WVDC, electrolytic capacitor

B1—3 volts, 2 alkaline C-cell batteries

S1—SPST slide switch, PC mount  
Printed-circuit board, battery holder (twin C-cell size, see text), 6-32 × ¼ screw, nylon spacer, 6-32 brass nut, wire, solder, etc.

**Note:** The following items are available from Vista, PO Box 1425, Bolingbrook, IL, 60440, (708) 378-5534. A set of three printed circuit boards is available as XMASBRD at \$18.00. A kit of all parts including etched, drilled, and plated-through silk-screened PC boards and 2 alkaline batteries are available as XMASKIT at \$35.50. A fully assembled tree is available as XMASASSEM at \$45.50. Please add \$5.00 for shipping and handling in the U.S. and Canada. Illinois residents please add 7.5% sales tax. Check, money order, and credit cards are accepted. For fast check verification, please provide street address (no P.O. box), telephone number, and drivers license number and state of issue.

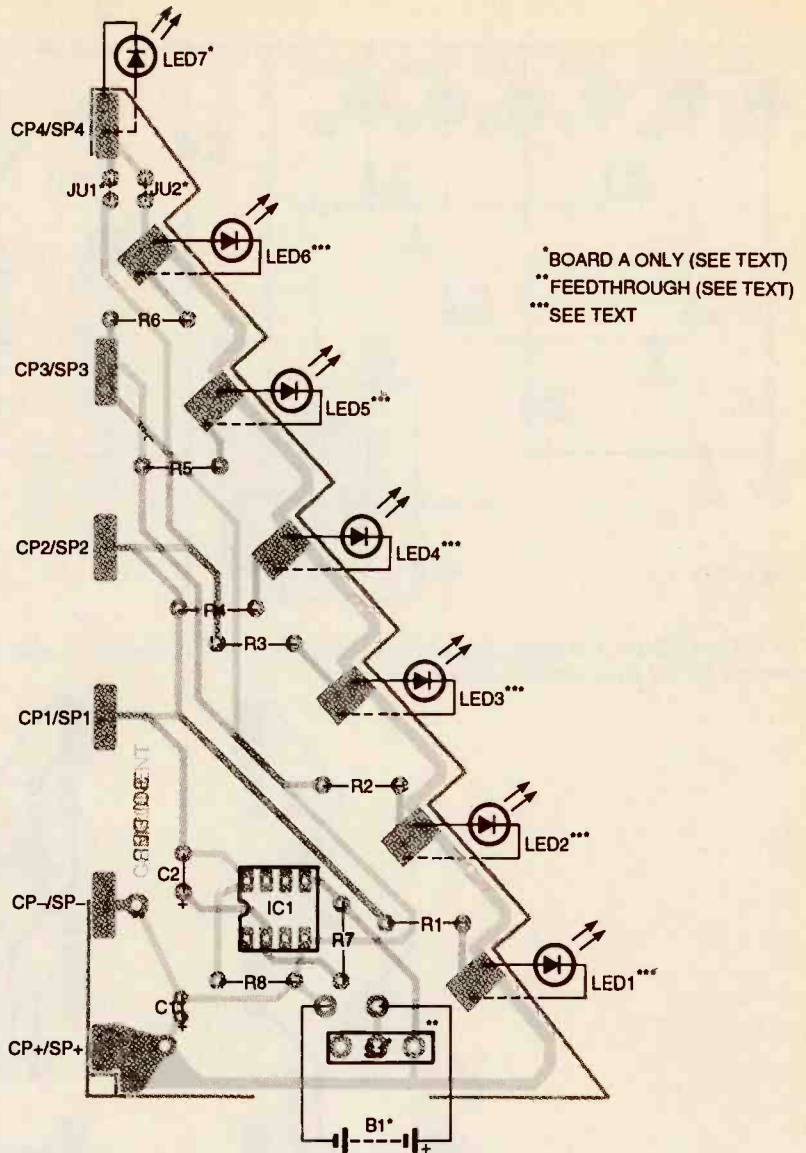

Fig. 4. Use this parts-placement diagram when building your unit. Note that some of the components mount on only one of the boards.

side of the board, while the second, JU2, installs on the component side. Those jumpers are used to get power to the blinking LED at the top of the tree.

The battery leads are connected to the appropriate positions on board A (BAT + and BAT -). Incidentally, if you wish to omit the switch, the battery leads can be connected to the CP + / SP + and CP - / SP - pads on board A. If you do that, however, the Tree will run continuously. On the positive side, the current draw of this project is so slight that a pair of alkaline C-cells can power it for about a month.

Speaking of the batteries, they and their holder make up the base of the Tree. The battery holder should be a twin plastic C-cell type with a mount-

ing hole located at the center; if yours does not have a hole, it will have to be drilled. The battery holder is mounted to the tree by means of that hole and a ¼-inch long, 6-32 machine screw. A half-inch long, unthreaded, nylon spacer is installed over the screw and the screw is fastened to the tree base by means of a large 6-32 brass nut that is soldered in the notch at the bottom of the tree spine. The length of the screw can be trimmed to fit, or, alternately, one or two washers can be installed as spacers.

That's all there is to it. The circuit is simple enough that it should work the first time power is applied. Once it is completed, your LED-Tric Christmas Tree is sure to brighten up your holidays.

# Telephone-Line Simulator

**M**r. Watson, come here; I want you. Ever since those famous words were spoken over the first telephone instrument by Alexander Bell, we've discovered unlimited uses for the telephone. Now we can communicate not only with our trusty telephone, but we can also use PC modems, Fax machines, answering machines, and the like.

But those gadgets have become complicated, and they occasionally break down. Testing them can be a real chore, unless you have access to multiple phone lines so that you can conveniently place test calls. Of course, there are commercial phone-line simulators that can be used instead of a phone line, but they can cost several hundred dollars.

Well, with *Ring-It!* you can now have a complete telephone system in a box. Forget about tying up your telephone line; simply plug in the telephone device that you want to check, and do your tests.

All of the standard telephone-system features that you need are supported. You can ring-up telephones, Fax machines, modems, and answering machines. Just about anything that you can connect to a standard phone line can be activated with *Ring-It!*

Because the standard telephone-call progress sounds are generated (dial tone, busy signal, ringing, etc.), you can even use *Ring-It!* to demonstrate telephone equipment. Don't ever tie up your home or business phone again while you show off your telephone products. In fact, with *Ring-It!*, it's almost impossible to tell that you aren't using a real phone line.

You can even connect a pair of standard phones and create a simple phone system. In that configuration,

BY THOMAS E. BLACK



*Use it to test or demonstrate telephone equipment, to set up your own mini telephone system, and more.*

the phone on line 2 automatically rings when the phone on line 1 is picked up. The lines are connected when both phones are in use, and the conversation ends by hanging up.

The flexibility of *Ring-It!* is provided by a single-chip microprocessor, which allows us to keep the component count to a minimum. An on-board ring generator provides the precise voltages required to activate the phone equipment, and a call-progress tone-generator IC creates the normal telephone-related sounds (busy signal, ring signal, etc.).

**Features.** *Ring-It!* has five different operational modes that can be invoked through one of the front-panel-mounted push switches. There is even an LED readout that displays the current mode that is in use.

The LED display is used to indicate mode, cycle time, and dialed-digit information. Its decimal point is illumi-

nated only when the mode or cycle time is shown; a decoded DTMF (Dual-Tone Multi-Frequency) digit is shown as a value without the decimal point.

The five modes can be invoked by pressing the Mode switch; the active mode is shown in the LED display. The modes are summarized as follows (the bracketed value indicates the corresponding LED display):

- [n.] Normal Ring Mode
- [A.] Automatic Ring Mode
- [b.] Beep Tone Mode
- [c.] Cycle Ring Test Mode
- [d.] Dumb Mode

The normal ring mode is used when you want standard telephone-system emulation. When you take the line-1 (main) phone off-hook, a dial tone is heard. If you do nothing for twenty seconds, a "reorder" sound is heard. If you tone dial any

seven-digit phone number, the line-2 (test) phone will start to ring. When line 2 answers, the front-panel connect LED will light up.

While you press the DTMF keys of your phone, the corresponding digit will appear in the LED display for up to two seconds. Because of limitations in our display, the \* tone is shown as "A" and the # key is shown as "P".

If you attempt to ring the test line and it is off-hook, then a busy signal will be heard. Please note that because it is a one-way device, line 2 can not be used to ring line 1.

There are some shortcuts in the normal mode that can be used to ring the test line. For example, pressing the main phone's DTMF \* key will immediately start the ring request. The front-panel Ring switch will also start the ring cycle, which can be used if the main line's phone is not DTMF compatible.

The normal mode is perfect for

demonstrating telephone equipment such as answering machines, Fax systems, voice mail, modems, and more. Because the standard call-progress audio tones are heard, your demonstration will appear more natural to your audience and equipment.

The automatic ring mode is similar to the normal ring mode, except that in the automatic mode, ringing begins immediately after the line-1 phone is picked up. That operation is sometimes called a "Ring-Down line" by phone-system manufacturers. If either line is off-hook when the other is picked up, the two lines will be automatically connected together.

The automatic mode, besides being used to test phone equipment, is also perfect for use as a front-entry intercom for home or office use. Place a phone near you and one near your entry. Be sure to post a note near the entry phone that instructs your visitors to "lift the receiver for assistance."

The beep tone mode is specially designed for cycle testing answering machines and other types of telephone equipment. That mode does not start until the Ring button or the DTMF \* key is pressed.

It is not necessary to have the line-1 phone off-hook during the beep mode. Whenever line 2 is taken off-hook the two lines will be automatically connected together and a series of repeating test tones will be generated.

During the beep mode, the test line automatically rings after a short adjustable delay (the delay is skipped on the first cycle). If the test line is answered, staggered beep tones are played. Those tones have been designed to keep a voice-controlled answering machine from hanging up. The ring-up cycle repeats (after the requested delay) until the mode is canceled by pressing the Mode switch.

For example, if the delay is set for thirty seconds, the device being tested will be rung-up thirty seconds after the last answer/disconnect cycle. The test tones will be played as long as the test line is off-hook. If the test line goes on-hook, the delay cycle starts up again.

The cycle ring-test mode provides most of the features of the beep mode, except that in the former, the beep tones are not played and a

TABLE 1—DTMF TONE PAIRS

Low Group	High Group		
	Column 0 1209 Hz	Column 1 1336 Hz	Column 2 1477 Hz
Row 0, 697 Hz	1	2	3
Row 1, 770 Hz	4	5	6
Row 2, 852 Hz	7	8	9
Row 3, 941 Hz	*	0	#

Note: In 16-digit DTMF, there is an eighth tone (1633 Hz, Column 3).

phone must be plugged into the main line. To start the cycle you must pick up the phone attached to line 1. Again, if either line is off-hook when the other is picked up, the two lines will be automatically connected together.

When line 2 answers, your conversation may begin. If line 2 hangs up and the main phone remains off-hook, the test line is automatically rung up after the delay time. That cycle repeats until the main phone is hung up.

The dumb mode provides a silent talk path and allows a manual ring. You will not hear any call progress tones; however, you can converse normally.

Line-2 ringing is controlled by using the Ring switch or the main phone's \* key. The ring signal will follow the key presses. Unlike the other modes, they do not continue to ring when the keys are released.

The dumb mode is perfect for testing the basic operation of equipment. And because you can control the duty cycle (cadence) of the ring signal, non-standard equipment can be tested for ring operation.

**How it Works.** A schematic diagram of the Ring-It! telephone-line simulator is shown in Fig. 1. The circuit's intelligence is provided by U9, a PIC16C57-XT/P microcontroller IC. That chip is a member of Microchip Technology's family of high-performance, low-cost 8-bit microcontrollers.

A microcontroller is a small, general-purpose computer chip that contains a microprocessor-type, Central Processing Unit (CPU), similar to the one found in your personal computer. However, it also incorporates Random-Access Memory (RAM), Read-

Only Memory (ROM), and digital Input/Output (I/O) lines. In other words, it's a complete computer system that is housed in one IC.

Because the PIC16C57-XT/P is a computer, it needs software to operate. The internal ROM holds the software program, which is called firmware. The firmware is permanently programmed and is non-volatile, which means that it isn't lost when power is turned off. The RAM is used by the program for storing temporary data variables and state conditions. Although there are only 72 bytes of RAM, it's more than enough for our application.

The firmware-controlled functions, such as ring generation, tone detection, LED and relay control, etc., are event-driven, so all features work seamlessly together. Unlike simple loop-controlled programs, our software design uses a time-based task scheduler to control the hardware operations.

Installing the firmware into ROM involves a process called prom burning, and special equipment is used to perform that task. For those without the required equipment or expertise, a preprogrammed microcontroller is available from the source given in the Parts List. On the other hand, for those of you who want to "roll-your-own," we have made the compiled object-code file, in Intel 8-bit merged (INHX8M) format, available on this magazine's BBS (516-293-2283, 8N1). Although the software is copyright protected, you are free to download a copy for your personal use. For other uses, consult the source given in the Parts List.

Getting back to the circuit, U9's RTCC input is used to emulate an adjustable-time-delay timer. The frequency of the oscillator formed by



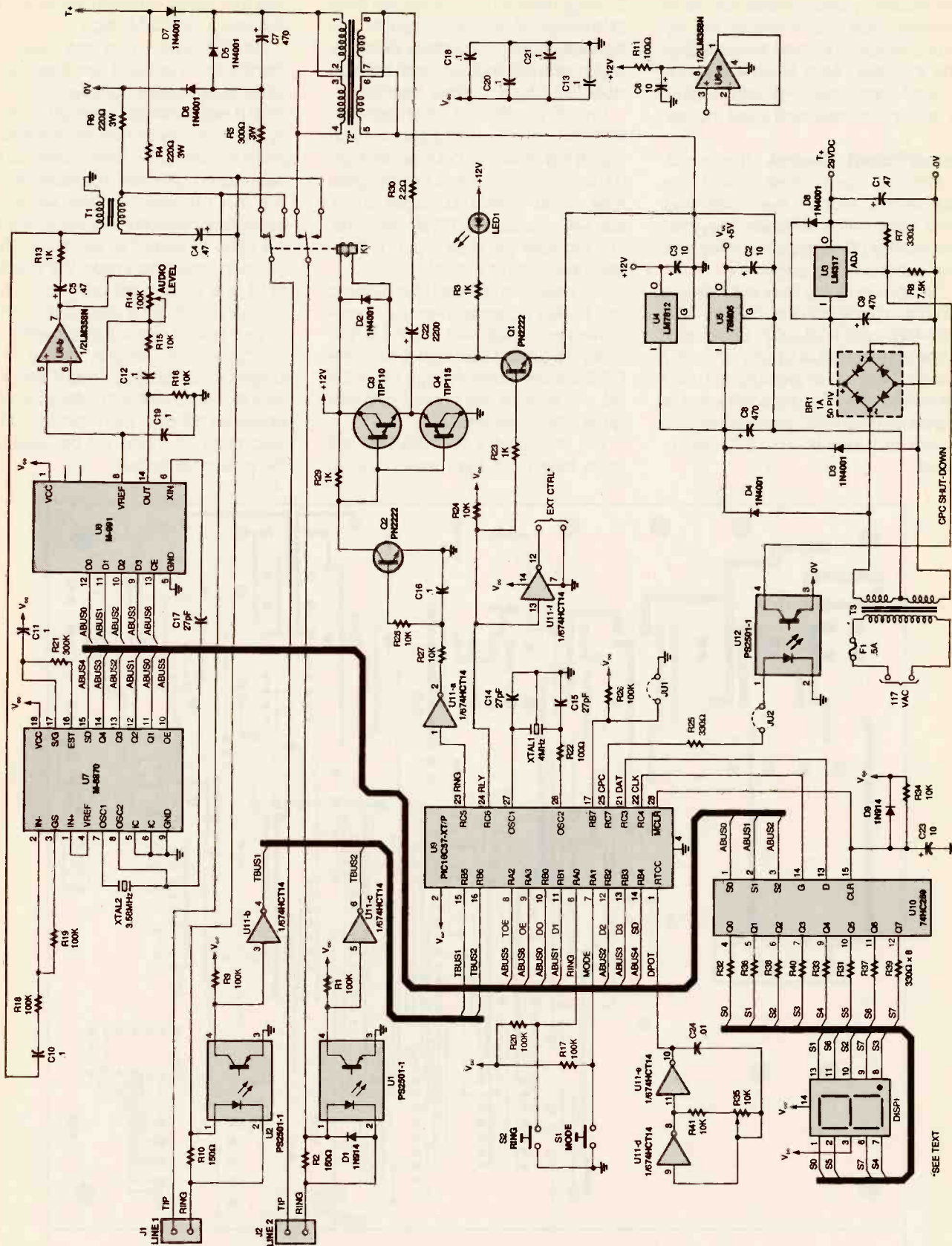

Fig. 1. Here's the complete schematic for the Ring-It! telephone-line simulator. The microcontroller (U9) gives the unit its sophistication but keeps circuit complexity to a minimum.

U11-d, U11-e, R41, and C24 can be varied using potentiometer R35. Its repetition cycle is sampled by the microcontroller and then translated by the software into a 10- to 90-second end-of-cycle timer. The delay feature is used in the beep and cycle modes.

**Input/Output Control.** The microcontroller's input/output control lines are used to monitor the mode, ring, and hook-switch switches. They also control the LED display, line relay, and call-progress tone generator.

Those twenty I/O lines are labeled on the microcontroller as RA0-RA3, RB0-RB7, and RC0-RC7. Under software control, RA2-RA3 and RC3-RC7 are configured as outputs, RA0-RA1 as well as RB4-RB7 are configured as inputs, and RB0-RB3 are used as both inputs and outputs; RC0-RC2 are unused.

Microcontroller-input RA0 monitors S2 (ring) and input RA1 is used to read S1 (mode). Software is used to debounce those momentary switches, which ensures that contact bounce does not cause multiple operations.

Under microcontroller control, RB0-RB3 can be configured to read (input) the decoded DTMF codes from U7. They can also output call-progress tone codes to U8 or LED codes to U10. We will discuss the DTMF decoder, call-progress generator, and LED interface in just a moment.

The direction of those four I/O data bits is also accompanied by microcontroller outputs RA2 and RA3. Normally low bit RA2 is set high to read the DTMF values. Normally high bit RA3 is set low to write the current call-progress tone code into U8.

The RB4 input is normally low, but goes to a logic high when a valid

DTMF is detected. The microcontroller uses that signal to determine when to decode a new DTMF digit.

The RB5-RB6 inputs are used to monitor the line 1 and line 2 optoisolated, loop-current hook switches (U2 and U1 respectively). Those act as normally open switches and detect when the attached telephones have been taken off-hook. For example, if line 2 is off-hook, current will flow through optoisolator U1's input, which will force its output at pin 4 low. The microcontroller can read the output of U1 and U2 and act appropriately.

The input at RB7 is used to read the circuit-board mounted, power-up configuration jumper, JU1. If the jumper is not installed, Ring-It! will default to the normal (n) mode upon AC power up. If the jumper is installed, the automatic (A) mode will be used as the power-up default.

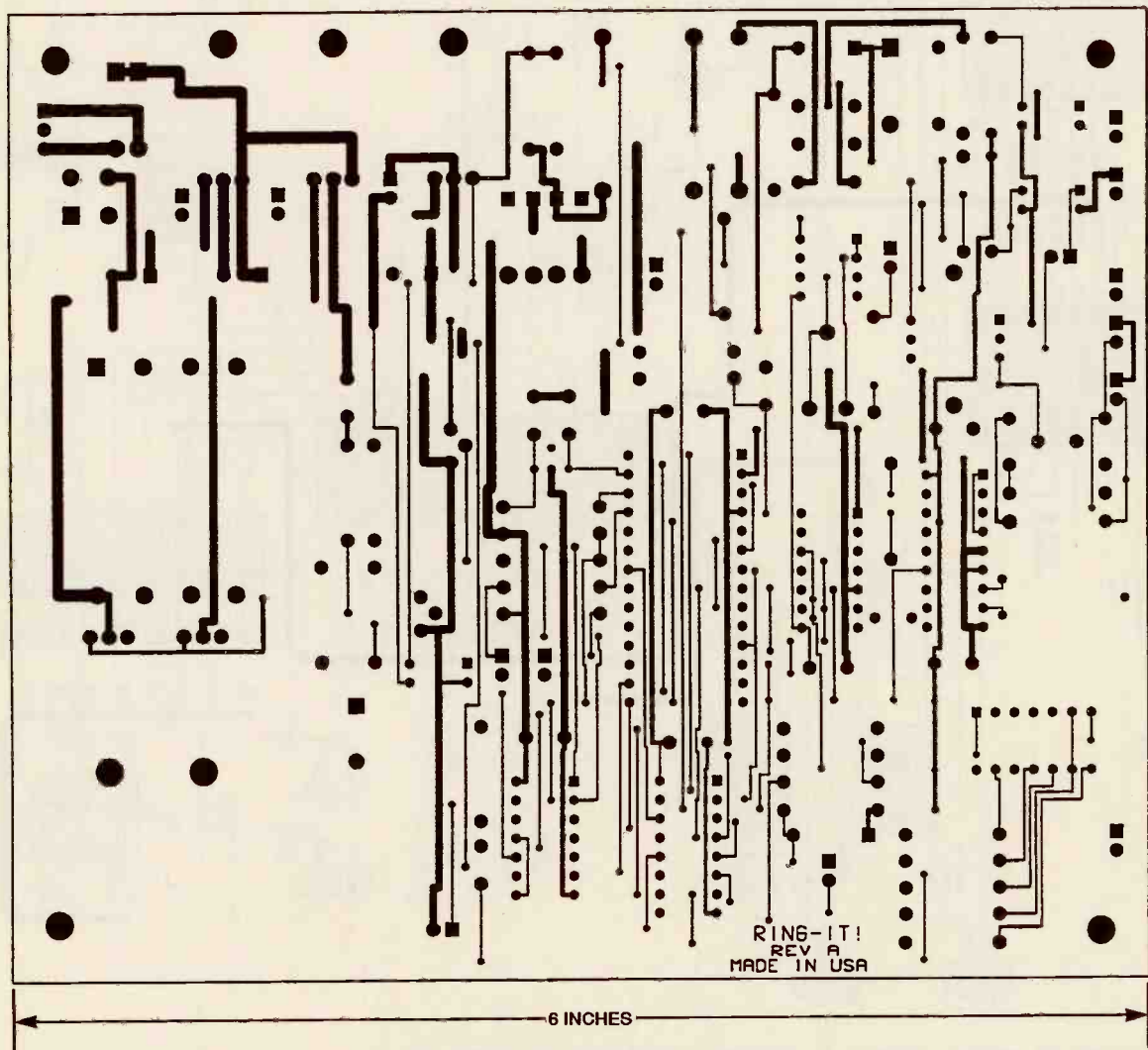

Fig. 2. The bulk of the circuitry is located on the main PC-board. The foil side of that board is shown here.

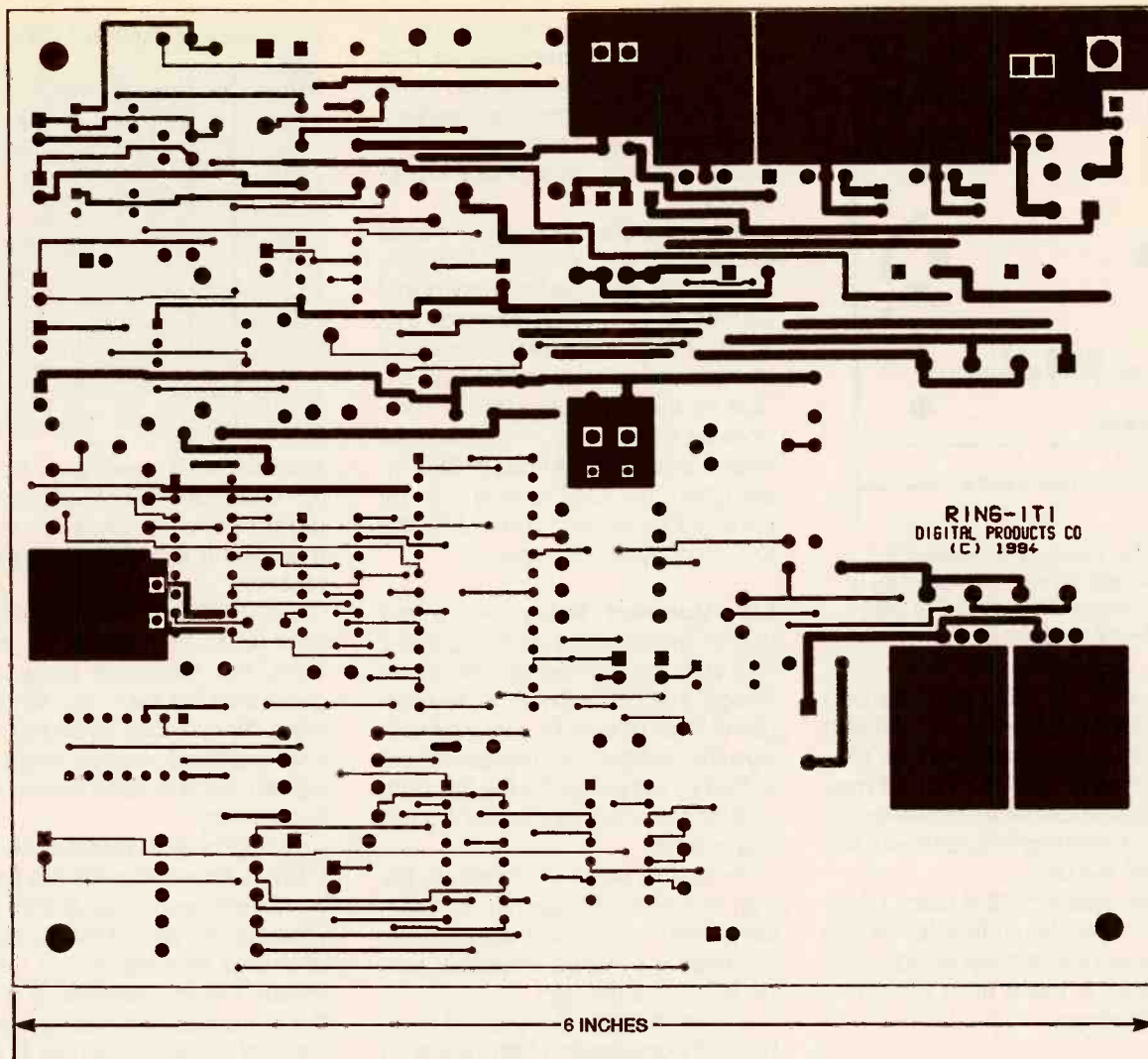

Fig. 3. Here is the foil-pattern for the main board's component side.

The RC0-RC2 port bits are unused. The RC3-RC7 bits are configured as outputs and are used to control the line relay, ring-voltage generator, and CPC pulse. When used in conjunction with the RB0-RB3 output bits, they can send new LED display values to U10, a 74HC259 8-bit addressable latch.

**LED Display.** Microcontroller output bits RB0-RB2 and RC3-RC4 are used to control the single-character, seven-segment LED display, DISP1. (Note that the display actually has eight segments if you count the decimal point.) Like most LED readouts, it was originally designed for displaying numbers 0-9. But by using a combination of upper and lowercase, and a little imagination, it is possible for us to get a limited number of alphabetic characters.

We use the alpha characters to dis-

play the current test mode and some of the DTMF tone values (\* and #). As mentioned earlier, the \* and # DTMF characters are not displayable, so we show them as "A" and "P".

The LED segments are enabled by the addressable latch, U10. The microcontroller uses RB0-RB2 to address which of eight LED segments are to be modified. The RC3 output selects how the LED segment will be illuminated (on/off) and RC4 latches the addressed value.

To update the display, the microcontroller must step through all eight bits of U10 and set or clear them as required. Of course, that is done so fast that it appears to happen as a single action. Eight 330-ohm series resistors are used to safely limit the current into each segment of the display.

**Ring Generator.** Microcontroller

output-bit RC5 is used to provide the 20-Hz frequency used by the step-up ring-voltage transformer, T2. Because American and many foreign phone companies use 20-Hz ring frequencies, we have provided the same in the Ring-It! design. Note that some low-end commercial telephone simulators use 60-Hz ring frequencies because they are easily derived from the AC power line. However, some phone equipment will not operate correctly with them. To maintain compatibility with all standard telephone equipment, a software-controlled, standard 90-volt AC, 20-Hz ring generator is used.

The 20-Hz generator provides reliable ring activation for at least two standard telephones. The high voltage (approximately 90 volts AC) is generated by T2, a step-up ring-voltage transformer, which is driven by

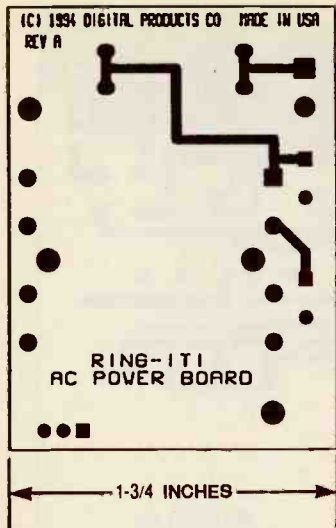

Fig. 4. For better performance, the power-supply circuitry is located on a separate board. The foil side of that power board is shown here.

push-pull power transistors Q3 and Q4. Because square-wave-derived ring voltages are used, some specialized telephone equipment may not respond correctly. However, all standard telephone equipment will work with the unit.

Please note that T2 is used "backwards" in this circuit. That is, the low voltage input is at its secondary and the output is taken from the transformer's primary.

**Calling-Party Control.** To help disconnect some telephone equipment, Ring-It uses a method called CPC (calling-party control). On most phone lines, the phone voltage is in-

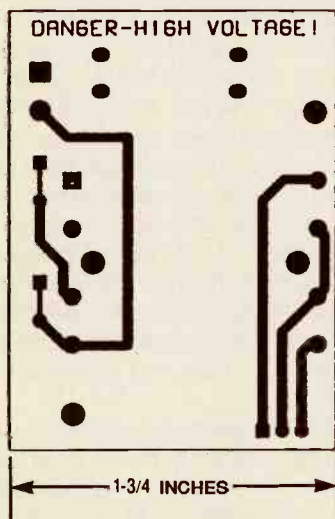

Fig. 5. The component side of the power board is shown here full size.

interrupted for a few hundred milliseconds after the phone call ends. That causes a current-interruption pulse that is sensed by some devices such as answering machines, which causes them to disconnect immediately.

Microcontroller port bit RC7 is used to control the CPC pulse. Normally low, that bit will be set high for about 500 ms to turn on optoisolator U12, which shuts down voltage regulator U3. Because U3 supplies the talk voltage to the phones, when it temporarily shuts down, the attached phone equipment senses a CPC interruption. The CPC feature can be disabled by removing the JU2, the CPC-configuration jumper.

**Line-Connect Relay.** While the phone lines are idle or during line-2 ringup, microcontroller port pin RC6 is a logic low and relay K1 is de-energized. That places T2, the high-voltage ring transformer, in series with line 2. That allows power for the talk path and/or microcontroller-controlled ring voltage.

Energizing relay K1 connects the two phone lines together and disables the ring-voltage signal path. The relay is switched whenever port pin RC6 is a logic high.

You can monitor pin 12 of U11 if you have an application that needs to know when the two lines are connected. That signal is available at the external-control output (labeled EXT CTRL on the schematic) and is a logic low when the relay is energized. It could be used to turn on an external audio source, relay, or whatever. It is a TTL-compatible signal and can sink or source about 10 mA.

**DTMF Decoder.** Decoding the dialed phone-number digits is a simple exercise because of the use of the industry-standard M-8870 DTMF tone-receiver for U7. That popular IC is made by the Teltone Corporation, Mitel Semiconductor, and others.

The receiver decodes only DTMF-type telephone digits; rotary-pulse-dialed digits are ignored. The DTMF feature allows you to conveniently test the tone dialing feature of your phone equipment.

As long as a DTMF tone is present the display will show its value; speed dialers may operate too quickly to al-

TABLE 2—FOUR-BIT CODE

DIGIT	D3	D2	D1	D0
1	0	0	0	1
2	0	0	1	0
3	0	0	1	1
4	0	1	0	0
5	0	1	0	1
6	0	1	1	0
7	0	1	1	1
8	1	0	0	0
9	1	0	0	1
0	1	0	1	0
*	1	0	1	1
#	1	1	0	0

low adequate viewing. To help see some very short DTMF digits, the microcontroller extends the viewing time of the last digit for about two seconds.

The DTMF encoding standard defines up to 16 dual-tone combinations, but standard phones only generate 12 of them. In a telephone, those 12 keys are arranged in four rows and three columns, and those in a given row or column have one tone in common.

For example, if you press the 3 digit, a 697-Hz tone and a 1477-Hz tone are combined. Seven frequencies are involved in standard DTMF generation and they are separated into two groups. The row information is called the low group and has the frequencies that range from 697 Hz to 941 Hz. The column information is called the high group and it covers frequencies from 1209 Hz to 1477 Hz. Table 1 shows the layout of the DTMF tone pairs.

DTMF Decoder U7 incorporates switch capacitor filtering to separate the low- and high-frequency tone groups. Qualified DTMF digits are decoded into a four bit code as shown in Table 2.

#### Call-Progress Tone Generator.

Phone-company generated sounds that are heard on the phone, such as dial tone, busy signals, telephone ringing, etc., are considered comfort tones. They are present only to confirm the progress of the telephone call. Although foreign countries use similar tones, they are slightly different than those heard in the U.S. In Ring-It, the comfort tones are largely produced using U8, a Teltone Corporation M-991 call-progress tone-generator chip.

Actually, Ring-It uses both software

## PARTS LIST FOR THE TELEPHONE-LINE SIMULATOR

### SEMICONDUCTORS

U1, U2, U12—PS2501-1 optoisolator (NEC), integrated circuit  
 U3—LM317T 1.2—37-volt adjustable regulator, integrated circuit  
 U4—LM7812 12-volt regulator, integrated circuit  
 U5—LM7805 5-volt regulator, integrated circuit  
 U6—LM358N low-power dual op-amp, integrated circuit  
 U7—M-8870, CMOS DTMF receiver (Telton Corporation), integrated circuit  
 U8—M-991, CMOS call-progress tone-generator (Telton), integrated circuit  
 U9—PIC16C57-XT/P CMOS 8-bit microcontroller (Microchip Technology), integrated circuit  
 U10—74HC259 or 74HCT259 CMOS addressable latch, integrated circuit  
 U11—74HCT14 CMOS hex inverter, integrated circuit  
 Q1, Q2—PN2222 NPN transistor  
 Q3—TIP110 NPN Darlington transistor  
 Q4—TIP115 PNP Darlington transistor  
 BR1—1 amp, 50 PIV, bridge rectifier  
 D1, D9—1N914 or 1N4148 general-purpose silicon diode  
 D2—D8—1N4001 silicon rectifier diode  
 DISP1—7-segment LED, 0.56-inch, common anode, RH decimal point  
 LED1—Green LED, T1¼ size

### RESISTORS

(All fixed resistors are ¼-watt, 5% units unless otherwise specified.)  
 R1, R9, R17—R20, R26—100,000-ohm  
 R2, R10—150-ohm  
 R3, R13, R23, R29—1000-ohm  
 R4, R6—220-ohm, 2-watt, metal oxide  
 R5—300-ohm, 2-watt, metal oxide  
 R7, R25, R31—R33, R36—R40—330-ohm  
 R8—7,500-ohm

R11, R22—100-ohm  
 R12—not used  
 R14—100,000-ohm, trimmer potentiometer, PC mount  
 R15, R16, R24, R27, R28, R34, R41—10,000-ohm  
 R21—300,000-ohm  
 R30—2.2-ohm  
 R35—10,000-ohm, potentiometer, panel-mount, linear-taper

### CAPACITORS

C1, C4, C5—0.47- $\mu$ F, 50-WVDC, radial-lead, electrolytic  
 C2, C3, C6, C23—10- $\mu$ F, 16-WVDC, radial-lead, electrolytic  
 C7, C8—470- $\mu$ F, 35-WVDC, radial-lead, electrolytic  
 C9—470- $\mu$ F, 50-WVDC, radial-lead, electrolytic  
 C10—C13, C16, C18—C21—0.1- $\mu$ F, 50-WVDC, radial-lead, monolithic-ceramic  
 C14, C15, C17—27-pF, ceramic-disc, see text  
 C22—2200- $\mu$ F, 16-WVDC, axial-lead, electrolytic  
 C24—0.01- $\mu$ F, radial-lead, polyester

### ADDITIONAL PARTS AND MATERIALS

K1—DPDT relay, 12-VDC coil, DIP Package, P&B T83S11D212-12, Aromat DS2YE-S-DC12V, or similar  
 S1, S2—SPST switch, normally open, momentary-contact pushbutton, panel mount  
 T1—Telephone-coupling transformer, 600-ohm:600-ohm, PREM Magnetics SPT130 or equivalent  
 T2—Ring transformer, split bobbin, dual 115-VAC primary to dual 6.3-VAC secondary, Magnetek/Triad FS12-200 or equivalent  
 T3—AC power transformer, split bobbin, dual 115-VAC primary to dual 14-VAC secondary, Magnetek/Triad FS28-200 or equivalent  
 XTAL1—4.00-MHz crystal, HC18 or HC49 package, or 4.00-MHz ceramic resonator, see text

XTAL2—3.5795-MHz crystal, HC18 or HC49 package J1, J2—RJ11 6/2 or 6/4 modular telephone jacks  
 F1—0.5-amp fuse, 5 × 20 mm  
 Printed-circuit boards, IC sockets, right-angle socket, fuse clips (Keystone 3521 or similar), AC line cord and plug, enclosure, heat sinks, wire, solder, etc.

The following parts are available from: Digital Products Company, 134 Windstar Circle, Folsom, CA 95630; Tel. 916-985-7219; FAX 916-985-8460. Complete Ring-It! kit, including pre-programmed microcontroller, PC-board set, relay, transformers, IC's, resistors, capacitors, seven-segment LED socket, documentation, etc. (case not included); \$145.00. Basic Ring-It! kit, including PC-board set, programmed microcontroller, complete documentation; \$53.95. Transformer/relay kit, including K1, T1, T2, and T3; \$38.95. Hard-to-get IC kit, including U1, U2, U7, U8, U10, U11, U12; \$24.50. Printed-circuit board set; \$34.95. Programmed PIC16C57-XT/P microcontroller (licensed copy); \$20.00. Seven-segment LED socket; \$3.75. Complete documentation package with schematic; \$6.00. Software disk, RI.OBJ object code, INHX8M format (disk provides single-use license; specify 3.5- or 5.25-inch size); \$8.00. Please add \$6.50 (\$14.00 Canada) to all kit orders and \$5.00 (\$9.50 Canada) to all component/documentation/software orders for shipping and handling. Other countries, please write/Fax for shipping information. California residents must add local sales tax. Checks, money orders, Visa, Master Card, and Discover accepted; checks must clear before shipping. Payment in U.S. funds only.

and hardware to create the call-progress tones. Under microcontroller control, U8 can simulate a number of the audio tones that are normally heard while using a phone. Some of the sounds are composed of two frequencies mixed together; others are simple single tones. Table 3 lists a few of the four bit codes that are sent to U8 to create the call progress sounds.

Because the tones may need to be

gated on and off, such as in a busy-signal pattern, the microcontroller must occasionally get involved. To create the cadence heard in the ring and busy tones, the microcontroller must set pin 13 of U8 to a logic high to mute the audio during the silent periods. Our task-based software program is used to schedule those time sensitive operations.

The progress tones are generated

whenever pin 13 of U8 is at a logic low. Because the four-bit code is latched at the falling edge of waveform presented to pin 13 of U8, the RB0—RB3 bits can be immediately freed for use by the DTMF receiver or the LED display latch.

**Power Supplies.** There are three different low-voltage, DC power supplies in the design. Common three-

**TABLE 3—CALL-PROGRESS-SOUND CODES**

Tone	Frequency	D3	D2	D1	D0
Dial	350/440	0	0	0	0
Special	400/off	0	0	0	1
Alert	440/off	0	0	1	0
Ring	440/480	0	0	1	1
Busy	480/620	0	1	1	0

terminal IC regulators are used to derive the required digital, analog, and talk-path power.

The digital logic and analog circuitry is powered by LM7805 (U5) and LM7812 (U4) fixed voltage regulators. Those popular devices provide excellent voltage regulation and have internal over-current and over-temperature protection.

The power supply uses a center-

tapped, full-wave rectifier design that begins with diodes D3 and D4. Capacitor C8 is used as a bulk filter to the raw DC (about 16–20 volts DC) before being applied to the IC regulators. Regulator U5 provides 5 volts DC for the digital logic and U4 provides 12 volts DC for the relay and analog circuitry.

We only need a few hundred milliamps of current to operate the circuit-

ry, so either the 0.5-amp (78Mxx) or 1-amp (78xx) type regulators can be used. Because they are series-pass-type regulators, they can run very warm while in operation. You must use a heatsink on U5 to maintain a comfortable operating temperature.

The simulated phone-line talk-path power ("battery" voltage) is provided by an LM317 IC (U3), another popular three-terminal regulator. Unlike the 78xx-series regulators, that device can provide an adjustable range of voltages as selected by resistors R7 and R8. The chosen resistor values set the output to about 29 volts DC. Although most phone lines use a 48-volt DC talk voltage, our 29-volt DC supply will work correctly with all standard telephone equipment.

The talk supply begins with rectifier

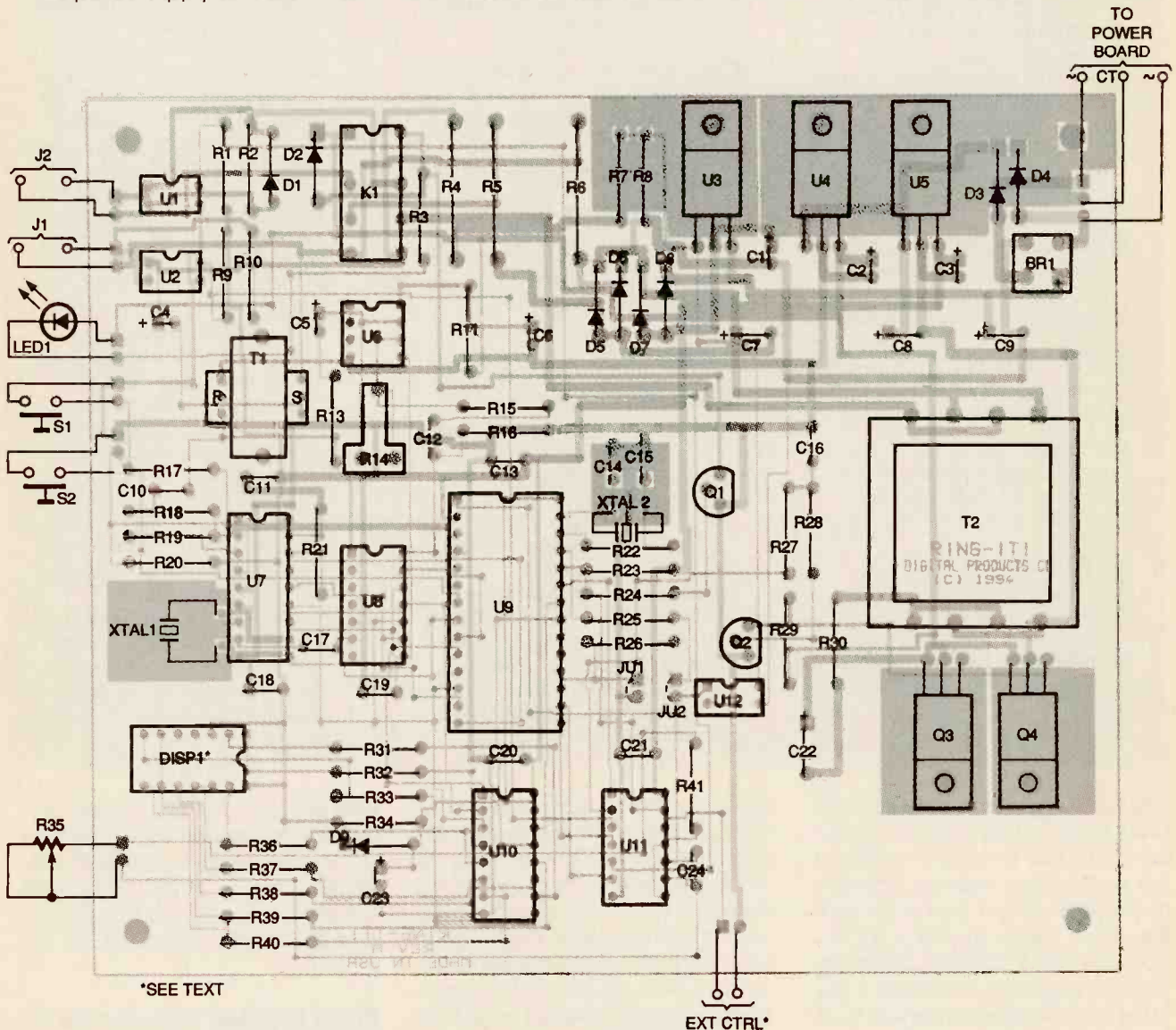

Fig. 6. Use this parts-placement diagram when mounting components on the unit's main board.

BR1, the full-wave bridge, which converts the incoming low-voltage AC to unregulated DC (about 36-volts DC). Capacitor C9 is used to bulk filter the raw DC voltage before it is applied to the regulator.

You may also notice that the regulator's ADJ terminal is connected to optoisolator U12. That optically isolated switch is used to shut off the voltage regulator during the CPC (calling-party control) pulse. When enabled by the microcontroller, U12 reduces the talk voltage to about 1.2-volts DC, which is low enough to simulate the CPC condition.

**Construction.** Although Ring-It! is a fun project to assemble, it certainly is *not* for beginning electronics-kit builders. If you don't have experience with CMOS IC's and PC-board assembly, please obtain help before starting.

We have provided PC foil patterns for the main board (Figs. 2 and 3) and the power board (Figs. 4 and 5) so that you can etch your own boards if you wish. You may find it more convenient to purchase a commercial-quality PC board from the source listed in the Parts List. If you do purchase the board, *do not* clean it before soldering; the boards available from the supplier have a special tin plate coating that prevents oxidation.

The parts-placement diagrams for the two boards are shown in Fig. 6 (main board) and Fig. 7 (power board). The AC transformer (T3) and fuse (F1) are installed on the power board; the bulk of the remaining components, including all of the digital circuitry, are installed on the main board. Among other things, the two board approach was used to promote safety. Always exercise caution when working near the power board's high voltages.

Use a 25–47-watt soldering-iron; temperature-controlled irons set to 700°–800° work best. Do not use a soldering gun! Use only rosin-core solder with a 60/40 tin/lead content.

Part substitutions are not recommended. Use the components shown in the Parts List and only substitute those that you know are exact replacements. For correct cycle-delay operation, do not substitute U11 with a non-HCT type IC.

Use care in handling the IC's; they are CMOS devices and are sensitive

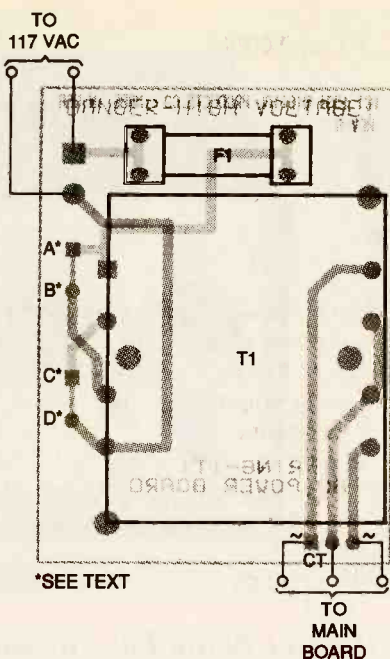

Fig. 7. The power board is set up for 117-volt operation, but can be modified for 220-volt use by cutting traces and adding jumpers as described in text.

to static. They can be damaged through mis-handling!

Component XTAL1 can be either a quartz-type crystal as specified, or a ceramic resonator. Delete capacitors C14 and C15 if using a ceramic resonator with built-in capacitors.

Use a socket to mount the microcontroller (U9). A special right-angle IC socket (made by Vertisocket and available from Digi-Key Electronics, 701 Brooks Ave. South, PO Box 677, Thief River Falls, MN 56701-0677; Tel. 800-344-4539) is used at DISP1 to vertically mount the seven segment LED for proper viewing. Sockets should be used for the other IC's, but are not absolutely required. Install two-pin headers with shorting blocks at the JU1 and JU2 positions.

Transistors Q3 and Q4 as well as the three voltage-regulators (U3–U5) should be anchored to the PCB with 4-40 × 1/4-inch machine screws and nuts. Use a heatsink and thermal grease (heatsink compound) on U5 the 7805 regulator. Please note that it's normal for that regulator to feel warm during operation.

Install and label LED1 as CONNECT on your enclosure's front panel. Wire it to the PC board using 5-inch-long pieces of 22–24 AWG stranded wire. Be sure to observe proper polarity.

Install and label S1 as MODE and S2 as RING on your enclosure's front panel. Again, connect them to the PC board using 5-inch-long pieces of 22–24 AWG stranded wire.

Install modular jacks at the J1 and J2 positions. Each jack's green wire is connected to the square pad on the board and the red wire is connected to the other pad. Cut off any extra wires that may be on the connector.

Install potentiometer R35 on the rear panel of your enclosure and label it as DELAY. Connect the potentiometer to the appropriate points on the PC board using stranded wire.

If after testing your finished project you find that the delay control works backwards, merely reverse the connection to the potentiometer's wiper. If installed correctly, the delay time should increase as the control is moved clockwise.

If you find that you can not achieve a 10–90 second delay range, then C24 or R35 are out of tolerance (check them). Although the software has been designed to allow correct operation over a wide range of component tolerances, it may be necessary to try different components at U11, C24, or R35 to get the desired range.

The power transformers, T2 and T3, are split bobbin types with dual 50/60Hz primaries and secondaries. Using standard power transformers is not recommended, especially at the T2 location. Such transformers are available from sources such as Microtran, Magnetek/Triad, Signal Transformer, PREM Magnetics Inc., and others.

Be sure to observe the orientation of the transformers. On T1, match the "P" and "S" references on the parts-placement diagram. It may be necessary to cut off the frame's mounting tabs on some transformer designs. Install T2 and T3 so that the transformer's pin 1 is in the square pad.

The power board layout is already set for 117-VAC operation. However, it can be converted to 230-VAC operation for use outside the U.S. For 230-VAC operation perform the following cuts and jumps: Cut the trace between the pads designated A and B in Fig. 7, cut the trace between the pads designated C and D, and add a jumper between pads B and C.

(Continued on page 110)

# FREQUENCY RESPONSE TESTER

BY RANDY CONSTAN



*With it, you'll never again have to guess about the frequency response of an audio device.*

Many off-the-shelf audio processors, such as equalizers, enhancers, and pre-amplifiers, alter audio signals even when in their so-called "pass-through" modes. The resulting frequency-spectrum losses often cause unwanted distortion, which can be very difficult to isolate if there are several components in an audio system. Therefore, a device that measures the frequency response of audio components should be a welcome addition to the toolbox of any audio-electronics enthusiast.

With the *Frequency-Response Tester* described in this article, you can directly view the frequency response of almost any audio gadget right on your oscilloscope screen, with a minimum of fuss. If any lumps and bumps appear in the signal of a device under test (DUT), the mystery of your sound troubles will be solved. Furthermore, the Tester will allow you to take corrective action, and quickly view the results.

The Tester works by generating two signals. The first is a linear-sawtooth sweep waveform that drives the horizontal input of your scope. Internally, that signal is transformed into a logarithmic waveform that spans three decades of voltage differential. That signal is applied to a function-generator IC to produce the second output, a sine-wave signal. The sine wave has a frequency that follows the log-

arithmic waveform, and has an amplitude that remains constant.

By connecting the DUT between the sine-wave sweep output and your scope's vertical input, the DUT's response to the entire frequency spectrum can be easily viewed. The logarithmic nature of the frequency sweep assures that the entire audio range appears as an ordered display, in which each  $\frac{1}{3}$  of your scope's horizontal range depicts one decade of frequency span. In other words, the ranges are: 20 to 200 Hz, 200 to 2,000 Hz, and finally 2,000 to 20,000 Hz, from left to right. Because the unit also generates your scope's horizontal sweep, the scaling remains stable and repeatable no matter how you vary the sweep rate.

Frequency-sweep generators are not a new or unique idea, but unfortunately their cost can be somewhat prohibitive for the average hobbyist. However, you can build the *Frequency-Response Tester* for under \$50, depending on your junk-box supplies. Even though this project will save you some money, keep the following in mind: The circuit requires an initial setup and occasional calibration; also, accuracy beyond two digits is impractical unless your scope uses sophisticated on-screen digital readouts for frequency and voltage levels.

A plain, vanilla scope will work fine with the Tester, as long as its time base

and vertical amplifiers provide reasonable accuracy. A frequency counter is also recommended, at least for the initial setup.

**Circuit Description.** The schematic for the *Frequency-Response Tester* is shown in Fig. 1. The two quad op-amp sections, U3-c and U3-d, are configured as a linear-ramp generator. With switch S2 in the SWEEP position as shown, the output of U3-d is low. Zener diodes D2 and D3 limit that output to about  $-7$  volts, which is the 6.2-volt reverse drop across D3, plus the forward drop of D2. The internal short-circuit protection of the op-amp limits the Zener current to several milliamperes.

Because the output of U3-d is negative, integrator U3-c generates a linear ramp in a positive direction, at a rate determined by the resistance of R4 and R29, and the capacitance of C5. A portion of that output is fed back to the noninverting input of U3-d via the voltage-divider network consisting of R2 and R3. Because U3-d is basically operating as a comparator with its inverting input grounded, its output will switch positive as soon as its noninverting input crosses zero volts. That will occur when the positive-going ramp reaches about  $+5.8$  volts.

Once U3-d switches to a high-output state, the operation is repeated with the opposite polarity except that



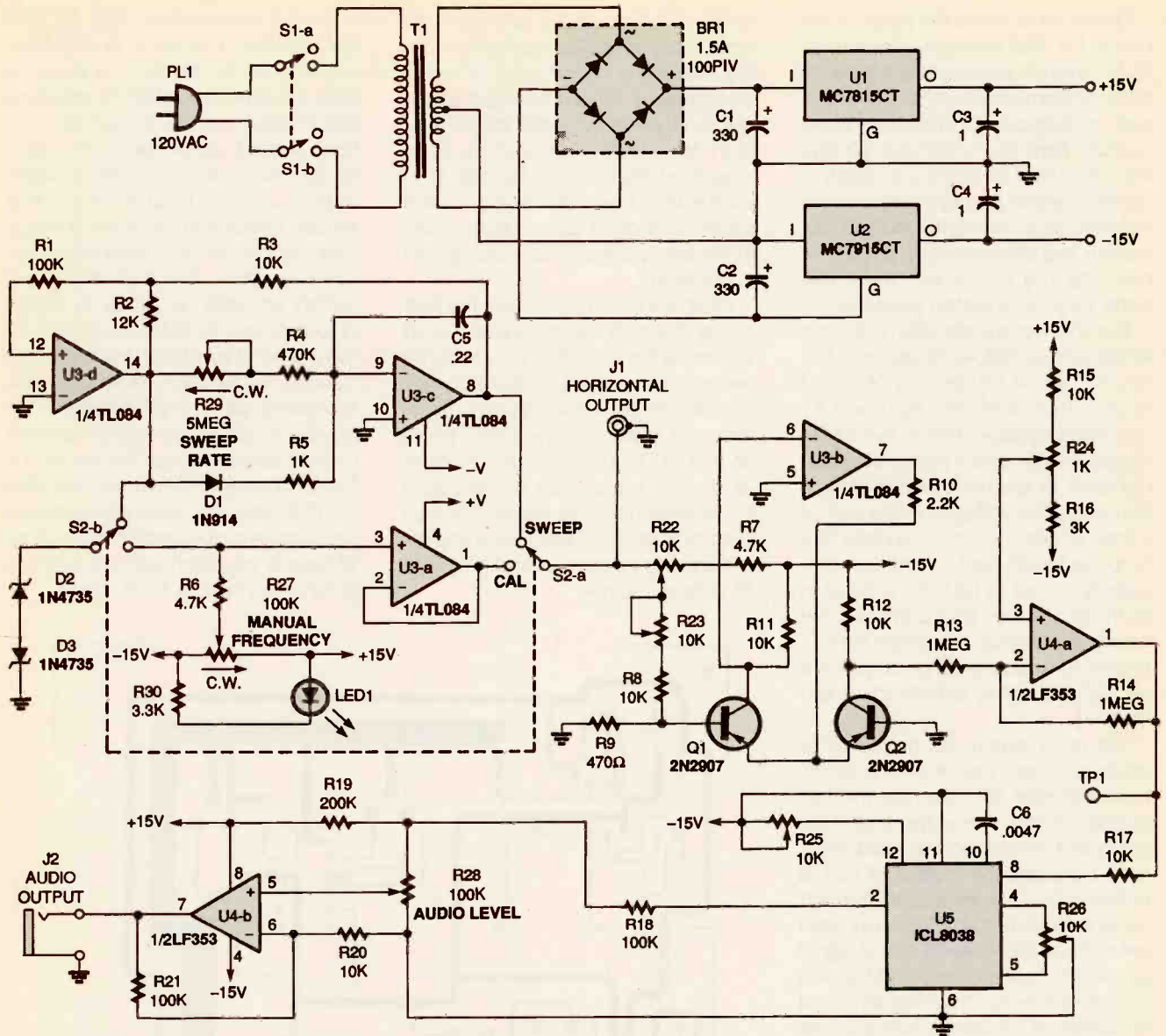

Fig. 1. As this schematic for the Frequency-Response Tester shows, there are five trimmer potentiometers, R22-R26, that are used for calibration. But don't worry, the process is not as hard as it might seem.

diode D1, now forward biased, allows an additional current path to U3-c via R5. Because the resistance of R5 is much less than the combined values of R4 and R29, the negative-going ramp time is almost negligible compared to the positive ramp, and the overall effect is to produce a sawtooth waveform with an amplitude of over 10-volts peak-to-peak. That is more than sufficient for just about any scope's horizontal input.

Next, the linear ramp undergoes a series of level and offset adjustments via resistors R7, R8, R9, R22, and R23, and is then applied to the base of Q1. The emitter-coupled transistors, Q1 and Q2, in combination with U3-b, produce an anti-log transfer function.

That means that when properly adjusted, the output at the collector of Q2 will be logarithmic with respect to the input, yielding a one-decade voltage differential for every few volts of input. To be more specific, if you divide the peak-to-peak voltage of the initial linear sweep by 3, the anti-log-generator output increases by a multiple of 10 each time the input voltage crosses another 1/3 milestone. That will all become much clearer when you see the logarithmic curve on your scope during the calibration phase discussed later in this article.

Next, U4-a inverts the polarity of the signal, so that it starts high and ends low. That is necessary because the output frequency of the 8038 function

generator, U5, is inversely proportional to its input voltage. In addition, U3-d's offset voltage is nominally set at about -7.5 volts by the combination of resistors R15 and R16, and can be trimmed precisely by the 15-turn trimmer potentiometer, R24. That shifts the logarithmic-sweep waveform to suit U5, which in our circuit receives its supply voltage from the ground and -15-volt source. Recall that our logarithmic sweep must span three decades of voltage differential, which means that if its final voltage were -5 volts, its initial voltage would be 1/1000 of that, or -.005 volts. Tiny voltages like that have to be carefully controlled, which is why R24 is used for that critical adjustment.

Finally, we come to the heart of the circuit, U5. That relatively inexpensive ICL8038 function generator produces constant-amplitude sine waves, as well as triangle- and square-wave outputs, from 20 Hz through 20 KHz. Also, its output frequency is nearly a perfect inverse proportional to its input voltage, so driving its input with our custom logarithmic-sweep circuit will produce the balanced, three-decade frequency sweep we desire.

The sine-wave output from U5 is fed to the voltage divider made up of R18 and R19, which restores the DC offset to zero. That eliminates the need for any coupling capacitors in the output stage, which makes it possible for output level to remain independent of frequency. The voltage-divider output is then applied to potentiometer R28 for output-level control, and is subsequently routed to U4-b for a boost in both amplitude- and current-drive capability. Output can range from 0- to over 10-volts peak to peak, which is enough for testing almost any audio device.

The DPDT switch, S2, has another position called "CAL." In that position, potentiometer R27 controls the frequency of the sine-wave output for setup and calibration purposes. However, because the output of R27 is buffered by U3-a and routed through the anti-log circuit, the Tester can also serve as a simple stand-alone signal generator. Potentiometer R27 is also indispensable for "homing in" on a troublesome frequency during actual response testing.

**Construction.** The method chosen to build the Frequency-Response Tester is not critical; however, the easiest method is to use the single-sided PC-board layout provided in Fig. 2. If you're looking for a good PC-board project to try, the Tester PCB is an excellent choice because it is both single-sided and reasonably low in component density. When cut to the size shown, the board fits comfortably within the widely available metal enclosure noted in the Parts List.

If you choose to use a PC board, a parts-placement diagram is provided in Fig. 3. If you choose not to use a PC board, a perf-board approach with point-to-point wiring will work fine. Just remember that an oversized zero-volt ground bus, or the use of a

single-point grounding scheme is always recommended in circuits involving op-amps. In any case, a metal enclosure is recommended to reduce noise and provide stable support for output connectors. One important layout consideration is to place R24 near the edge of the board, so that an access hole drilled in the enclosure will allow occasional calibration.

Most of the components in the Tester are of easy-to-obtain values, with a few exceptions; for that reason some reasonable parts substitutions can be made. For example, power-transformer T1 does not have to be a single 36-volt, 300mA center-tapped type as shown. Two smaller single-output transformers may be wired with their outputs in series to yield the same result, as long as each output is at least 18 volts at 200 mA.

On the more critical side, Q1 and Q2 must be a reasonably matched pair in order for the anti-log circuit to work properly. The 2N2907's specified are cheap, widely available, and have a lot of uses, so buy a few extra so you can look for a reasonable match. Using a DVM in diode-test mode, check the nominal voltage drop across the transistor's emitter-base junction. Two transistors that match up within or close to 3-digit accuracy are more than sufficient for the project. If your DVM does not have a diode-test function, make a temporary test jig with a 9-volt battery, a 10K resistor, and the base-emitter junction of the transistor. When the junction is forward biased (positive at the emitter for PNP devices), you can compare the voltage drops across the junctions of several transistors with an ordinary DVM set on its 0- to 1-volt range.

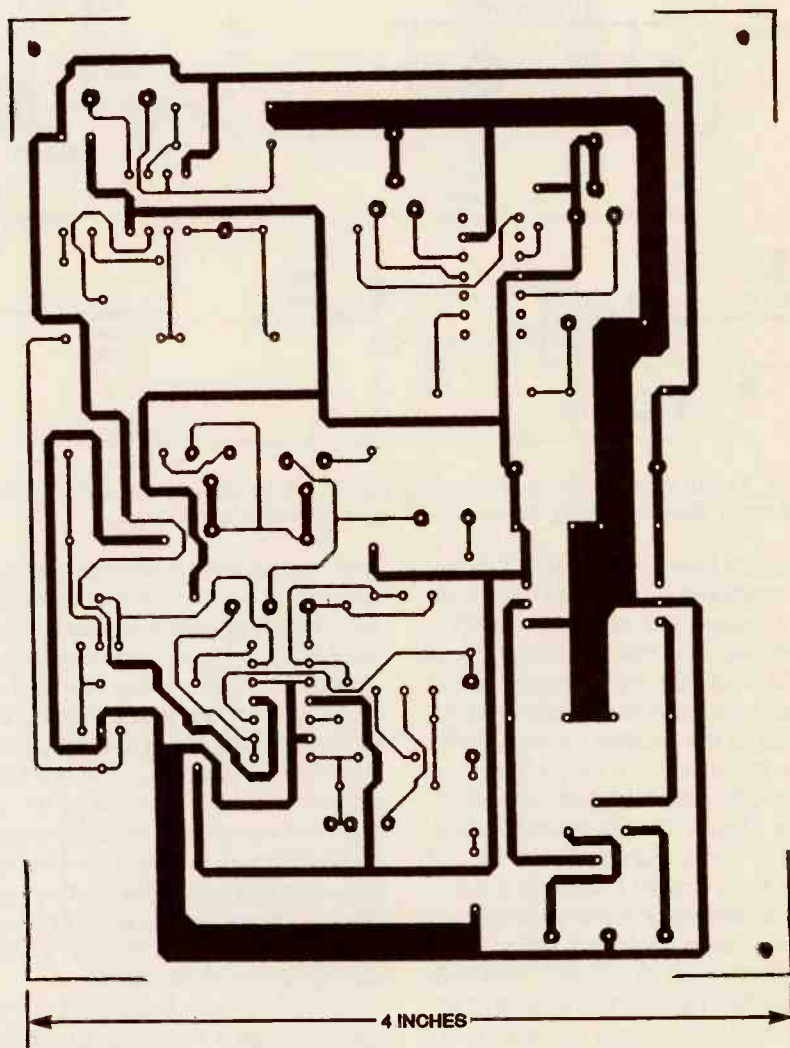

Fig. 2. The PC-board template for the Tester is shown here in its full size of 4 x 5 inches.

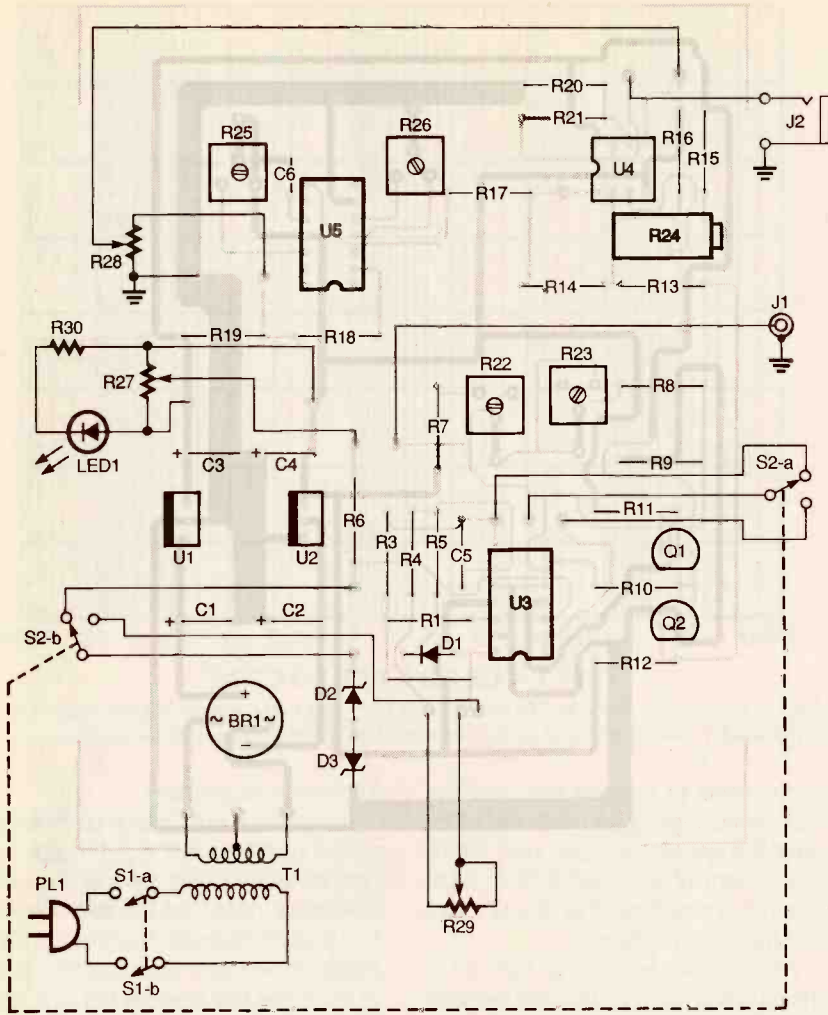

Fig. 3. Use this parts-placement diagram as a guide when making the various on- and off-board connections. Note that there is an off-board ground between a few of the components; connect those points and ground them to the metal chassis.

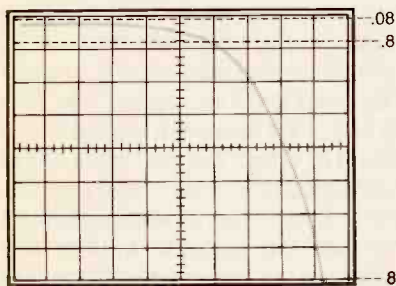

Fig. 4. Once calibrated, your Tester should display a three-decade logarithmic waveform that resembles this illustration.

Another critical item is R24, which must be a 15- or 20- turn trimmer potentiometer. It should also be obvious that even though normal component tolerances are not a problem, arbitrary substitution of seemingly "close" resistor values is unwise in the Tester circuit.

Here are a few things to watch for when using the parts-placement di-

agram in Fig. 3: Be careful when inserting Q1 and Q2, because the physical pinout of the transistors you obtain might not match the case style shown in Fig. 3. There, the emitter pad is closest to the edge of the board, and the base is the center pad. Also note that all pads that connect to off-board components such as potentiometers, switches, and outputs are slightly oversized for easy connection and identification. Some pads might not seem to be logically placed, which is a necessary sacrifice in maintaining a single-sided layout. Extra pads are provided for the center position of all trim pots except R24, to accommodate a wider physical variety of those parts. Socketing of all but the voltage-regulator IC's is recommended.

Potentiometers R27, R28, and R29 mount on the faceplate of the project case. Use insulated wires to connect them to the PC-board, as shown in Fig.

3. For best results, you might want to use coaxial cable for the connection to R28; if you do so, ground the cable and the off-board ground points shown in Fig. 3 to the metal chassis to provide shielding. Jacks J1 and J2, switches S1 and S2, resistor R20, LED1, and power-transformer T1 all mount off-board as well. Within the constraints of the enclosure, mount T1 as far from the board as possible.

Solder a small piece of stiff wire to the board at test point TP1. Make the wire just long enough to access later with your scope probe. Finally, when attaching the power cord to S1, use some kind of strain relief or grommet where the cord enters the case.

Check and re-check your connections before testing the project. The board itself can be mounted with some insulated stand-offs, but you might want to save that final mounting step until after initial checkout. In any case, plan to mount the board in such a way that a hole can be drilled to access R24 without opening the case. That is the only trim adjustment that you will occasionally need to touch up after initial calibration.

**Calibration and Set-up.** With all the trimmer potentiometers on the Tester's circuit board you might think that calibration is going to be a real nuisance, but that's not the case. The process is greatly simplified because you can use an oscilloscope to make almost all the adjustments visually. A separate frequency counter is also useful, but is not absolutely necessary. Another suggested tool to have on hand is a pair of walkman-type headphones. Hearing the frequency of the audio output is a good way of roughly gauging whether or not you're covering the entire audio range.

Start by centering all the trim pots, including R24. Before connecting any external equipment, power up the unit by itself to check that correct power-supply voltages are present in all the right places. Once you're confident that the circuit powers up correctly, you can proceed. Note that it is normal for the TL084 (U3) to run a little warm, and for both positive and negative regulators to become rather hot to the touch. If overheating becomes a concern, small heatsinks can be mounted on the regulators.

For your initial setup, connect the

horizontal output to the horizontal input on your scope, and the audio output to your headphones. If the headphones are stereo, it is possible to hear through both right and left with an appropriate adapter. In the absence of headphones, a stereo-system auxiliary input will do, but be careful to keep the volume level down to avoid speaker damage.

Connect a probe to your scope's vertical input. Power up the scope, set the horizontal time base for external, and set both the vertical and horizontal amplifiers for DC measurement. With S2 in the SWEEP position and both R28 and R29 set to minimum resistance, power up the Frequency-Response Tester. The scope should display a horizontal sweep, the speed of which you can adjust using R29. For calibration purposes, use the horizontal-gain and horizontal-position controls to produce a nine-division sweep deflection that is lined up with the left-most, vertical graticule line. Because nine divisions can easily be divided by three, setting up the three-decade logarithmic response we discussed earlier will be easy.

The next step is a bit tricky because it involves several coinciding adjustments. Connect the vertical input of your scope to the short wire you attached to TP1 earlier. If you turn up the AUDIO LEVEL control, R28, slightly, you should hear some kind of audio sweep that appears to follow the rate of the horizontal sweep (don't panic if that is not the case; the trim pots might just be too far out of adjustment). Flip S2 to the CAL position; the horizontal display will revert to a dot. Because the horizontal position of the dot is related to the audio-output frequency, refer to the screen display while using MANUAL FREQUENCY control R27 for calibration. Set R27 so that the dot once again lines up with the left-most, vertical graticule line on your scope. Then, adjust R24 to bring the audio-output frequency as low as possible. You will have to calibrate that more exactly later, but, for now, the lowest "bass note" you can hear without the audio dropping out is close enough.

Once the tone is established and set to the lowest frequency you can detect, re-adjust R27 so that the dot moves exactly nine divisions to the right on your scope screen. The frequency should audibly rise. Adjust R22

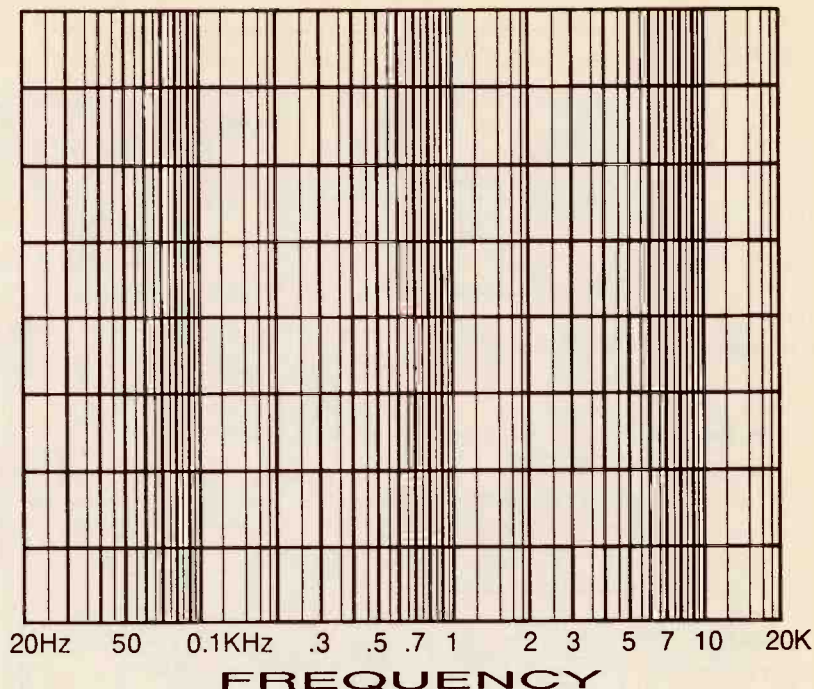

Fig. 5. By copying this scale to transparent film, you can create a custom reference graticule for your scope and greatly improve the visual accuracy of the display.

at this time to a point just past the highest frequency you can hear. Repeat the process of "low" and "high" adjustment of R24 and R22 at least one more time, and then flip S2 back into the SWEEP position.

With the SWEEP RATE control, R29, set to maximum speed, you should be able to adjust your scope's vertical sensitivity and position until you can see a curve starting high on the left, and sloping downward on the right. Continue to adjust the position and vertical sensitivity, abandoning the "calibrated" setting on your scope as needed, so that the vertical deflection exactly fills the screen, from the highest vertical division available, to the lowest. That resulting curve is a logarithmic progression.

The next step is to contour the curve so that every three horizontal divisions correspond to a  $1/10$  difference in vertical deflection. That is accomplished mainly with R23, which serves as a "decades/volt" adjustment for the anti-log network. Unfortunately, adjusting R23 is likely to affect the total vertical amplitude, so you might have to "see-saw" between R22 and R23 until the desired curve is obtained. Trim pot R24, which mainly affects the "top" portion of the vertical deflection, will probably not make much of a difference. In the end, your curve should resemble the one shown in Fig.

4 as much as possible.

The curve in Fig. 4 assumes that your scope graticule has eight major vertical divisions. Using the top line as a reference, note that the total deflection is eight divisions down at the right edge of the trace. Because the width of the trace has been set at nine divisions, you can easily divide the display into three sections. If you start at the right and move left, you'll see that the deflection from the top line is  $1/10$  less each time we cross  $1/3$  of the total width. So, the total deflection is 8, .8, and .08 vertical divisions at 9, 6, and 3 horizontal divisions respectively. Obviously,  $-.08$  divisions is not really visible, and in fact, the start point of the curve should really be  $-.008$  divisions, which is certainly not visible. Because the anti-log network defines the curve, we can assume that once one decade is correctly "tuned," the others will all fall into place. By continuing to adjust the decades-per-volt trim pot, R23, along with the high log-level trim pot, R22, you should be able to approximate that curve.

The two remaining trim pots, R25 and R26, adjust the purity of the sine-wave output, and should be set as necessary before final calibration. Potentiometer R25 adjusts the duty cycle so that the top portions of the sine wave equal the bottom half, while R26 is used to trim out distortion. Those

controls do not treat all frequencies equally, so waveform purity must be optimized at a specific frequency. The author recommends a mid frequency of about 1000 Hz. Using your scope in its normal internal-sweep mode, set the tester to CAL, and observe the audio-output waveform while making the above adjustments. In the end, both controls should be somewhere near their initial center position, or the frequency span might suffer.

The final step in calibration is simply to repeat the setups of R24, R23, and R22, this time with a frequency counter added to the audio output. Instead of using your ears for the low- and high-frequency adjustments, use the frequency counter to obtain values of 20 Hz and 20,000 Hz. For that final calibration, make sure the unit has been on for a few minutes to allow it to stabilize.

If no frequency counter is available,

you can use the scope as a frequency counter by switching it back to internal sweep, connecting the audio output to the vertical input, and making calculations based on time/division. That is a bit of a hassle because it means doing a lot of switching, and you must remember to restore the horizontal gain to the original nine-division setup in between each measurement. If you have a dual-trace scope, you can set up one channel to represent the nine-division span of the Tester's horizontal output, and the other to monitor the audio output. You will still have to go back to the original setup at least once more to touch up the log curve with R23. Remember, you've already set up the unit to span from the lowest to the highest frequency you can hear, which is all that really matters. The good news is that once the Tester is set up, only the low adjustment, R24, will need an occa-

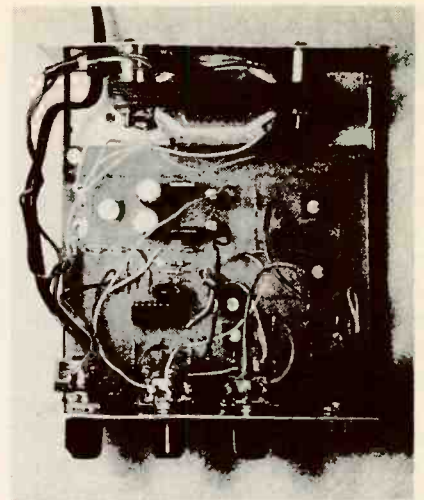

*As this internal view shows, the transformer in the Frequency-Response Tester should be mounted as far from the board as the project case allows.*

## PARTS LIST FOR THE FREQUENCY-RESPONSE TESTER

### SEMICONDUCTORS

- U1—MC7815CT 15-volt, positive-voltage regulator, integrated circuit
- U2—MC7915CT 15-volt, negative-voltage regulator, integrated circuit
- U3—TL084 quad op-amp, integrated circuit
- U4—LF353 dual op-amp, integrated circuit
- U5—ICL8038 function generator, integrated circuit
- Q1, Q2—2N2907, PNP transistor
- BR1—1.5-amp, 100-PIV, full-wave bridge rectifier
- D1—1N914 general-purpose silicon diode
- D2, D3—1N4735, 6.2-volt, Zener diode
- LED1—Red light-emitting diode

### RESISTORS

- (All fixed resistors are 1/4-watt, 5% units, unless otherwise indicated.)
- R1, R18, R21—100,000-ohm
  - R2—12,000-ohm
  - R3, R8, R11, R12, R15, R17, R20—10,000-ohm
  - R4—470,000-ohm
  - R5—1000-ohm
  - R6, R7—4700-ohm
  - R9—470-ohm
  - R10—2200-ohm
  - R13, R14—1-megohm
  - R16—3000-ohm
  - R19—200,000-ohm
  - R22, R23, R25, R26—10,000-ohm, trimmer potentiometer, PC mount
  - R24—1000-ohm, 15-turn, trimmer potentiometer, PC mount

- R27—100,000-ohm, linear potentiometer
- R28—100,000-ohm, logarithmic potentiometer
- R29—5-megohm, linear potentiometer (see text)
- R30—3300-ohm, 1/2-watt

### CAPACITORS

- C1, C2—330- $\mu$ F, 50-WVDC, radial-lead electrolytic
- C3, C4—1- $\mu$ F, 25-WVDC, radial-lead electrolytic
- C5—0.22- $\mu$ F, polyester
- C6—0.0047- $\mu$ F, ceramic-disc

### ADDITIONAL PARTS AND MATERIALS

- S1, S2—DPDT toggle switch
  - T1—AC power transformer, 115-VAC primary to 36-VAC secondary, 300-mA center-tapped (Stancor P-8612 or equivalent, see text)
  - J1—BNC jack
  - J2—Phone jack
  - PL1—2-conductor power cord and plug
- Printed-circuit materials, metal chassis (Radio Shack 270-253 or equivalent), insulated wire, solder, hardware, etc.

**Note:** A drilled and etched PC board is available postpaid from the author for \$20. Contact him on GENie at the E-mail address: R.CONSTAN for ordering information.

sional touch up.

If you wish, use a photocopier that has a scaling capability to make a copy of the log scale in Fig. 5. By making the copy on a transparent sheet, such as the ones used for overhead projectors, you can make a custom reference graticule for your scope and greatly aid the visual accuracy of the display.

**Using the Tester.** For accuracy at the low-frequency range, always allow the Frequency-Response Tester to remain powered-up for a few minutes prior to running response tests. As we've seen, the Tester's entire first decade from 20 to 200 Hz depends on the stability of a very small control voltage, which usually takes a little time to settle. To test the response of an audio device, simply connect the Tester's audio output to the DUT's input, and the DUT's output to the vertical input of your scope.

(A note of caution is in order here: Some power amplifiers have outputs that cannot be ground referenced. In such cases, a dual-channel scope used in differential mode via both inputs is the only safe way to monitor the amplifier. Also note that power amplifiers usually require output loading for proper operation.)

When your test set-up is complete, switch S2 to CAL mode, and select a middle frequency using the MANUAL FREQUENCY control, R27. Then, adjust the

*(Continued on page 102)*

I've always wanted to make a radio using a variometer. In the old radio books that I read as a kid, variometers were pictured as two coils connected in series, one inside the other. The inner coil could be rotated and would either cancel or add to the inductance of the outer coil, depending on how it was oriented. Variometers were used to tune radios before variable capacitors became common. Unfortunately, I couldn't figure out an easy way to build one.

The problem must have stuck in my subconscious, because forty years later I realized that the coils didn't have to rotate; one coil could be slid over another. When I realized that, I put together the *Variometer Radio* described in this article in a couple of hours, and it works great! Even though it doesn't use a variable capacitor, it can still be tuned "on the nose" to stations in the broadcast band.

**The Variometer Principle.** In the original variometer design, when the inner coil is rotated to a 90-degree position with respect to the outer coil, the mutual inductance of the coils is at its minimum. For the mutual inductance of the coils to be at its maximum, the coils have to be aligned.

Figure 1 is a schematic diagram of how the variometer principle was adapted to a linear design in the project. Three coils, L1-L3, are connected in series; L1 and L3 are fixed, while L2 can be slid over them. Unlike in the

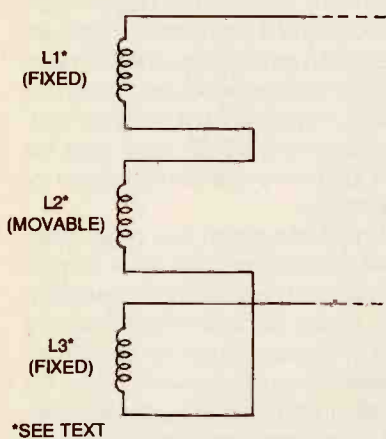
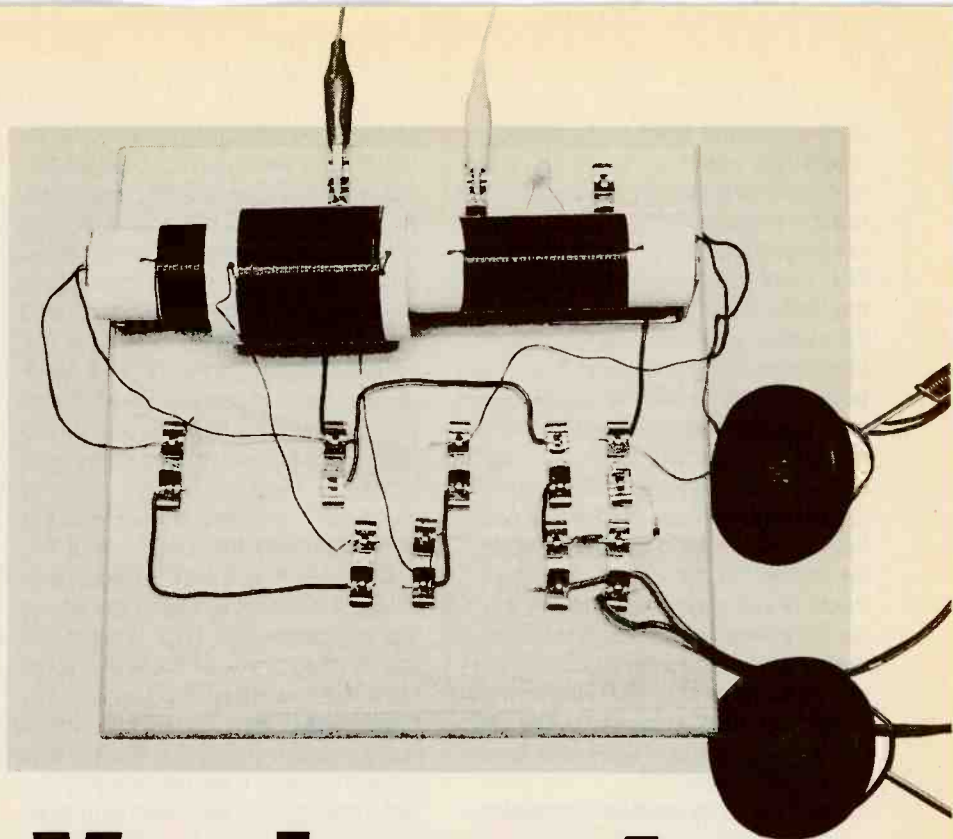

Fig. 1. This is the principle at work in the modern variometer. The middle coil, L2, can be slid over either of the other two. Because L1 and L3 are connected in opposite directions, the inductance of L2 will either add or cancel when it is moved over the other coils.



# Variometer Radio

*A new version of a classic design.*

BY LARRY LISLE

original variometer, it is the outer coil that moves over the inner coils. As L2 is moved over L1, their mutual inductance is increased to the maximum. But when L2 is moved over L3, their inductances cancel out because L3 is connected backwards (with respect to L2).

**The Circuit.** The schematic of the complete Variometer Radio is shown in Fig. 2. An antenna can be connected to the Radio through either of two points labeled ANT: either directly to the circuit or through a 100-pF capacitor. The ground connection can be made at any of the points marked GND. There is a reason for the preceding options: By varying the antenna capacitance, the ground connection, and the position of the sliding coil, the entire AM broadcast band can be tuned.

Depending on the antenna and ground connections, it might be necessary to add a small capacitor, C3, at

the point indicated in the schematic. If so, experiment with values between 25 and 200 pF (separately or in parallel) to find which gives the best result. If you build the Variometer using Fahnestock clips (as explained later), adding the capacitor(s) after the Radio is built should be easy, if the need arises.

When a signal is selected by adjusting the antenna, ground connection, and position of L2, the signal is passed on to the diode-detector part of the circuit, composed of D1, which demodulates the signal. That signal then goes through bypass capacitor C2 to the earphones. Only high-impedance earphones should be used with the Variometer.

**Construction.** The two fixed coils of the Variometer, L1 and L3, are wound on an 8½-inch-long piece of 1-inch-diameter plastic pipe (its outer diameter is about 1¼ inches). Each coil is 2¼-inches long. The number of turns is

not critical, but in the author's prototype, 86 tightly wound turns of number-22 enameled wire were used. When winding the coils, make sure you start at a point that will allow them to be placed 2 inches apart on the pipe. Drill holes in the pipe and run the leads of the coils out the end of the pipe that is closest to each.

The movable coil, L2, is wound on a piece of 1½-inch plastic pipe (its outer diameter is about 1⅞ inches). The winding is 2 inches long. Like L1 and L3, the actual number of windings of this coil are not critical, as long as the winding is approximately the right length. However, in the author's prototype, 74 tightly wound turns of number-22 enameled wire were used.

One final note on winding the coils: Plastic pipe was used in the author's prototype for durability. An alternative to that is to use cardboard tubes, especially if you only plan on experimenting with the Variometer Radio.

To support the smaller plastic pipe that contains L1 and L3, get an 8½-inch-long piece of 1-inch dowel rod. Using sandpaper or a knife, slightly flatten one side of the dowel. Then, insert the dowel rod into the pipe, and orient the flattened side of the rod so that the wires can run along it with some clearance. Mount the assembly

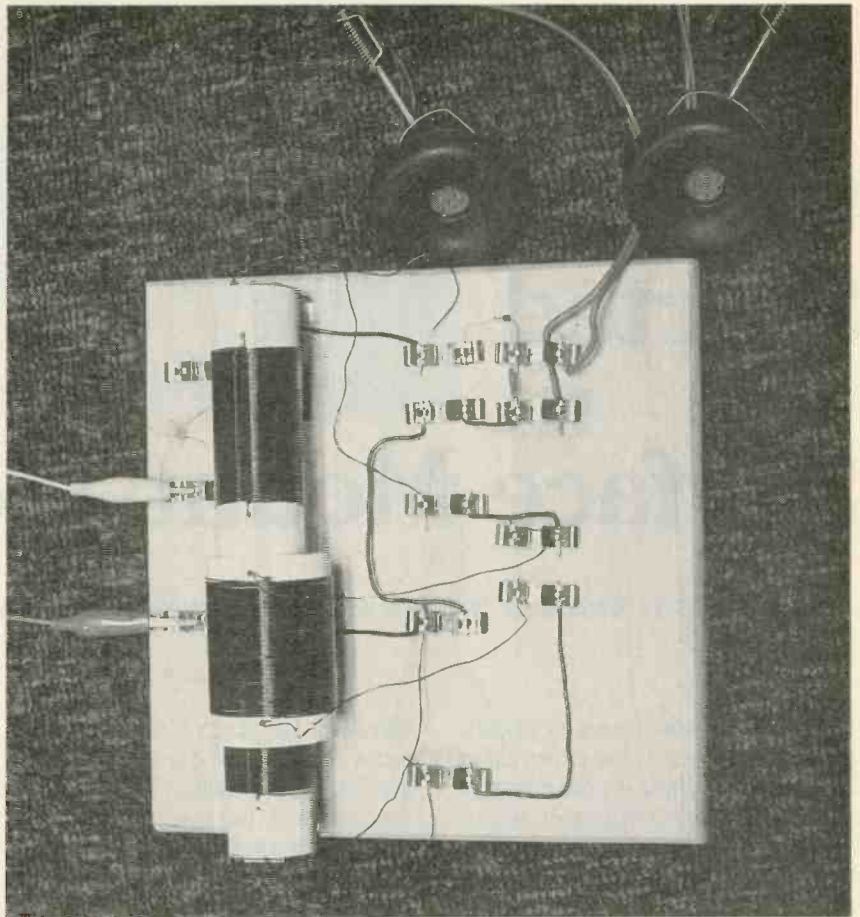

Here's the author's completed radio. For simplicity, it is laid out much like the schematic shown in Fig. 2.

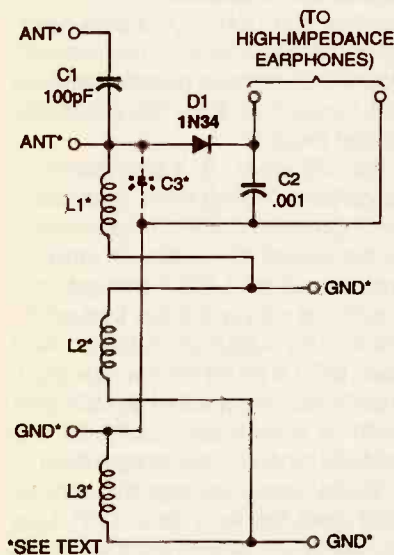

Fig. 2. Here is the modern variometer principle at use in a complete Variometer Radio. Even if you've never built a radio before, you can build this crystal set; the parts count is low, and the coil windings are not critical.

on a wooden baseboard (approximately 9-inches square) using a couple of corner brackets.

To make it easier to change ground and antenna connections, the prototype was built using Fahnestock clips. When laying out the placement of the parts on the baseboard, make sure to include adequate connection points for the possible use of capacitor C3 in the circuit. If you can't get Fahnestock clips, don't worry; an al-

ternative way to build the Radio is to use brass wood screws for the common points and simply wrap the wire around them.

**Other Uses.** Just by assembling your Variometer Radio and experimenting with tuning different stations, you might not realize that the variometer principle can be used in other applications as well. Some of those include uses in antenna loading coils, couplers, or matching devices.

Also, taps on one coil could give coarse adjustment, while a sliding coil can be used for fine tuning. With variable capacitors suitable for medium- or high-power ham transmitters becoming expensive and hard to find, the variometer principle might also find a use in the final output stage on the low-frequency bands.

The Variometer Radio is a modern version of an idea from radio past that's fun to play with in radio present. However, as you can see, the variometer principle might also become important in radio future. ■

### PARTS LIST FOR THE VARIOMETER RADIO

- D1—1N34 germanium diode
- C1—100-pF. ceramic-disc
- C2—0.001-μF. ceramic-disc
- C3—Optional, see text
- L1, L3—See text
- L2—See text
- Baseboard (about 9-inches square), 1-inch-diameter dowel rod, 2 pieces of plastic pipe (see text), Fahnestock clips, corner brackets, screws, wire, hardware, etc.

# Getting Started in Surface Mount Technology

*Two projects that will get you started in building with surface-mount components.*

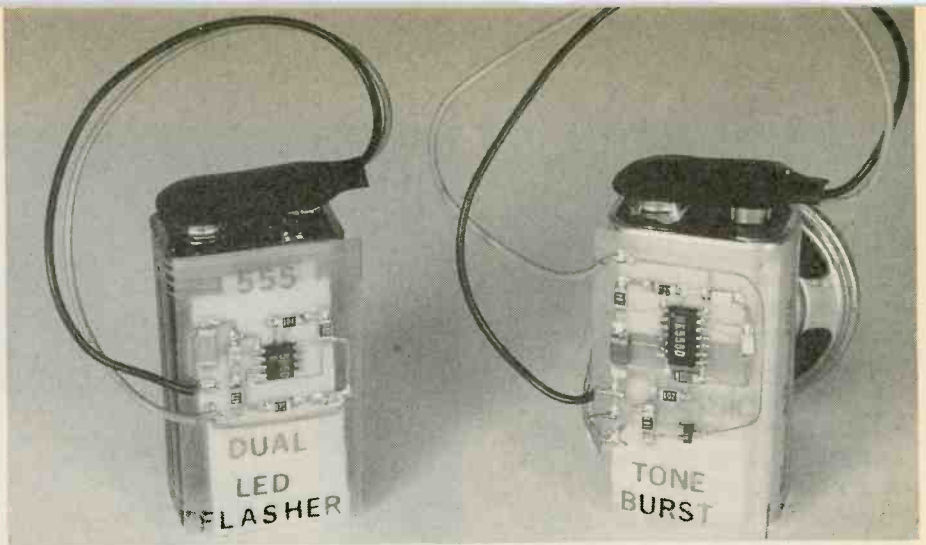

BY RONALD A. REIS

For most electronics hobbyists, the idea of hand-assembling surface-mount components (SMC's) into a working project seems ludicrous. After all, as most of us know, surface-mount technology (SMT) was developed with automatic assembly in mind. Finding, grasping, arranging, and somehow soldering those tiny, leadless SMT components by hand is ridiculous. Right? Wrong—delightfully wrong! Not only is it possible, but it can be accomplished easily, quickly, and, for the most part, with tools and materials you now have on your workbench.

As mentioned in the article "A Hobbyist's Guide to Surface-Mount Technology" (*Popular Electronics*, January 1995), SMT is a packaging revolution that attaches tiny, essentially "leadless" components to pads on the surface of a printed-circuit board (hence the name, "surface-mount technology"). That contrasts with traditional "insertion-mount technology" (IMT), which uses components with leads that are inserted through the PC board.

As you are about to discover, project-building with SMT is fascinating, fun, and, increasingly, inevitable. Even though today, for the most part, you still have a choice between traditional IMC's (insertion-mount components) and SMC's, tomorrow you might not; already, 50% of all the components in commercial electronic as-

semblies are SMC's. So, if you don't want to let a whole component-packaging revolution pass you by, learn to build the electronic projects of the near future, now.

**SMT Project Building.** To get you started in building tomorrow's electronic projects today, here are two fun, attention-getting, and, most important, easy-to-build SMT projects: the *555 Dual-LED Flasher* and the *Tone Burst*. Furthermore, to give you practice in fabricating SMT PC boards and soldering SMC's in place, a printed-circuit template for an SMT Practice Board is also included.

Both of the SMT projects presented here were chosen to give the begin-

ner the widest possible SMT project-building experience, using readily available, low-cost surface-mount components. Each project is built on a 1- x 1¾-inch PC board that is intended to be taped to the side of a 9-volt battery, its power source. The 9-volt-battery snap found in both projects, and the 8-ohm speaker in the *Tone Burst* are the only non-SMT components used.

**Circuit Descriptions.** The first project, the *555 Dual-LED Flasher*, alternately flashes a pair of tiny, surface-mount LED's at a rate of approximately 1 Hz. Figure 1 contains the schematic for that project.

The 555 timer, U1, is configured as an astable multivibrator (oscillator), the frequency of which is determined by the values of resistors R1 and R2 and capacitor C1. As C1 charges through R1 and R2, U1's output, pin 3, is high. As a result, LED2 is on (its anode is positive, its cathode, negative) while LED1 is off (both its anode and cathode are positive). When C1 discharges from ⅔ to ⅓ the supply voltage through R2, pin 3 goes low. As a result, LED1 turns on (now its cathode is negative and its anode is positive) and LED2 turns off (both its anode and cathode are negative). The duty cycle for the circuit is nearly 50 percent; therefore, each LED is on for close to an equal duration.

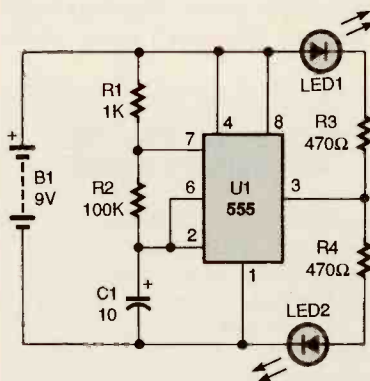

*Fig. 1. Here is the schematic for the 555 Dual-LED Flasher. The circuit alternately flashes LED1 and LED2, two surface-mount LED's, at a rate of approximately 1 Hz.*



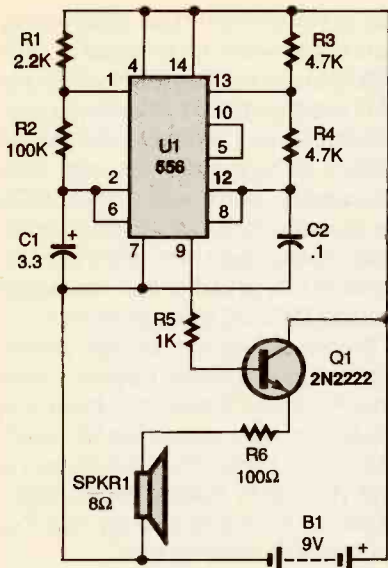

Fig. 2. The Tone Burst circuit puts out a 500-Hz tone, at a rate of 1 Hz, through an 8-ohm speaker, SPKR1. Besides the 9-volt battery and its connecting snap, SPKR1 is the only non-surface-mount component in the circuit.

The Tone Burst puts out a 500-Hz tone at a rate of 1 Hz. At the heart of the circuit is U1, a 556 IC, which is just two 555 IC's in one 14-pin package (see Fig. 2). Both "555's" are configured as astable multivibrators. The first, or low-frequency, oscillator, using resistors R1 and R2 and capacitor C1, turns on the second, or high-frequency, oscillator at a 1-Hz rate. The latter is alternately on and off for half a second. When it is on, it generates a 500-Hz signal, that value being determined by resistors R3 and R4 and capacitor C2. That signal is amplified by NPN transistor Q1, which drives the 8-ohm speaker.

**SMT PC-Board Fabrication.** The steps in fabricating an SMT printed-circuit board are identical to those used in etching a traditional, single-sided, IMT PC board. There are, however, two additional steps, or cautions, that should be observed when SMT boards are etched. We'll look at both in a moment, but first, here are the ten steps required to produce either an IMT or SMT PC board:

1. Clean the blank board with fine steel wool to get rid of contaminants and oily residue.
2. Spray a liquid photoresist onto the copper-clad board.
3. Dry the photoresist with a hair dryer.
4. Expose the sensitized board, with

the artwork negative on top, to ultraviolet light.

5. Let the image develop.
6. Rinse and drip-dry the board.
7. Immerse the board in acid (ferric chloride is often used).
8. When etching is complete, thoroughly wash the board and then dry it with a paper towel.
9. Remove the remaining photoresist layer by lightly rubbing the board with steel wool.
10. Drill all necessary holes in the PC board. In an SMT PC board, only mounting holes might be required.

The PC-board template for the 555 Dual-LED Flasher is shown in Fig. 3 and the one for the Tone Burst is shown in Fig. 4. Note the small component pads and the extremely thin traces—in some cases, a mere 0.015-inches wide. When fabricating those and other SMT boards, two cautions are worth observing:

First, because you are dealing with

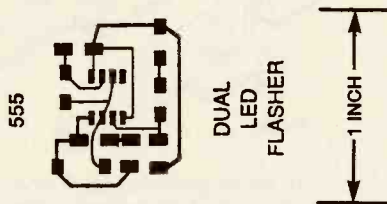

Fig. 3. This template for the 555 Dual-LED Flasher's PC board is shown in its actual size of only 1 × 1¼ inches! Note the small pads and extremely thin traces.

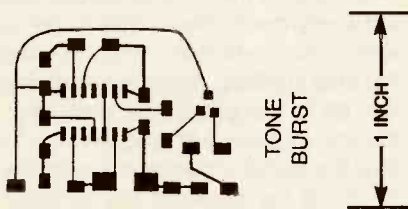

Fig. 4. The printed-circuit template for the Tone Burst is also shown here full size.

traces not much thicker than a line drawn with a pencil, it is a good idea to check the etching process frequently. Pull the board out of the acid bath often and examine it closely for acid undercuts. The narrow traces of an SMT board are delicate—leaving your board in the acid any longer than necessary to etch away unwanted copper might damage the traces.

Second, once the board is complete, check the PC-board pattern

with a magnifying glass. However, that might not be enough to locate any possible trace breaks, so you should check each trace (and pad) with a continuity checker (ohmmeter). That way you can be sure that the board is ready for the installation of surface-mount components.

Figure 5 is the template for an SMT practice board. By fabricating that board, you can gain experience in etching SMT PC boards with small pads and thin traces. Also, you can use the practice board to rehearse the SMC assembly techniques discussed later. For those reasons, etching the practice board before tackling either of the two SMT project boards is recommended.

**Tools and Materials.** In building either of the two projects presented here, you will need the right tools and materials. A full explanation of the items required was presented in "A Hobbyists Guide to Surface-Mount Technology" in the January 1995 issue of **Popular Electronics**. If you have a copy of that article, you might want to look it over.

Briefly, here are some tools you'll need: a soldering iron, a tweezers, a vise, and a magnifying glass. The soldering iron needs to be from 25 to 40 watts and should have a tinned tip with a conical shape, 1/16 of an inch or less in diameter. The tweezers should have forceps-style tips. A small vise is ideal for securing the PC board while components are being attached. Because SMC's are so tiny, no matter

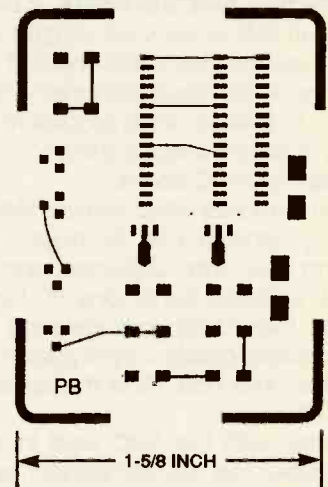

Fig. 5. Fabricating this SMT practice board will give you practice in etching an SMT PC Board, and in mounting SMC's. It is shown here full size.

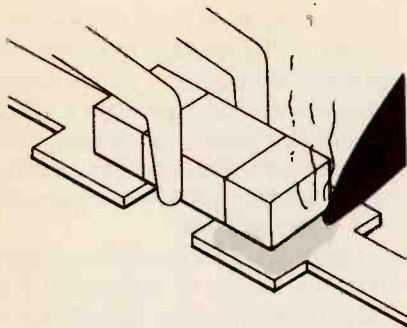

Fig. 6. To tag solder a two-terminal SMC in place, create a pool of solder on a pad, place the component above it, and reheat the solder so the SMC can "sink" close to the board surface.

how good your eyesight is, you'll want a magnifying glass close by. A desk-top illuminated magnifier, the kind that sells for around \$80, is ideal. At the very least, get yourself an inexpensive hand-held lens.

The materials you'll require are solder, liquid flux, a drop dispenser, a defluxer, and solder wick. The solder should have a 63/37 tin-lead mixture, and should be no greater than 0.020 inches in diameter. If you can find it, a 0.015-inch-diameter solder is even better. When purchasing a bottle of liquid flux, be sure it is of the noncorrosive type. To directly apply the flux where it is needed, you will want a drop dispenser. Also purchase a light-duty defluxer, in a spray can, which will be used to clean your assembled PC board of all contaminants. Finally, when choosing solder wick, select a width of 0.030 inches.

**Attaching SMC's to PCB's.** In building an SMT project, we suggest that you use the tag solder method discussed in the aforementioned article. Here is a review of the procedures for tag soldering various SMC's to a surface mount PC board:

To tag solder a two-terminal SMC to the surface of your PC board, first, using your drop dispenser, apply a dab of liquid flux to one PC-board pad. Then, using your soldering iron and solder, create a small pool of solder on that pad. Allow the solder to solidify.

Next, with the SMC held in your tweezers, rest the component on its PC-board pads and hold it in place. Then, using a soldering iron held in your other hand, reflow the solder so that the component "sinks" close to

the board surface (see Fig. 6). Remove the iron, allow the solder to cool again, and release the tweezers. With the component "held" in place, you're ready to solder the other terminal in a traditional manner.

To solder gull-wing leads on three- and four-lead components, proceed as above. Tag solder one lead and then solder the remaining leads in the conventional way (see Fig. 7).

When soldering DIP, gull-wing surface-mount IC's (SOIC's), first create a pool of solder on a corner pad in preparation for tag soldering. Then pick up the IC with a tweezers and

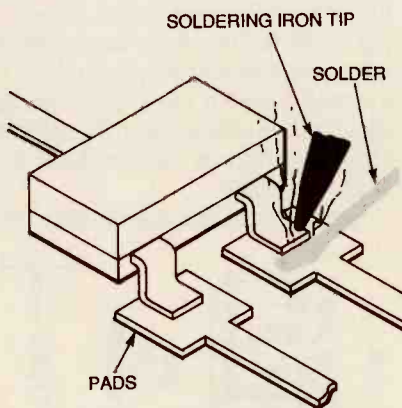

Fig. 7. To solder gull-wing leads to a PC board, use a 63/37 tin-lead solder that is 0.015 inches in diameter, and a conical soldering-iron tip that is 1/16 of an inch or less in diameter.

place it onto the copper pads, making sure to center the IC right-to-left as well as top-to-bottom. While holding the chip in place, apply the soldering iron tip to the pre-finned pad. Keep the iron in place just long enough to flow the solder. If necessary, pivot the IC about the soldered pin to again align all pins with their respective pads.

To ensure the IC doesn't pivot, solder a second pin "kitty-corner" to the first. When doing so, don't forget to apply a small amount of liquid flux. When the chip is secure, "bathe" one line of pins with liquid flux and solder each pin, moving quickly to avoid overheating the IC. Then repeat the above step with the opposite row of pins. Finally, inspect your work under the magnifying glass, looking in particular for solder bridges.

At this point, you could continue directly to the assembly of your chosen project. However, if the procedures

just outlined seem a bit intimidating, you might want to practice a little SMC-placement first. That's where the SMT practice board, mentioned earlier, comes in. If you have etched the board, as suggested, you can now proceed to "stuff it" with surplus SMC's. As you will notice, pads to accommodate various sized two- and three-terminal SMC's, as well as thin- and wide-bodied DIP SOIC's, are provided.

Before actual component-placement and assembly begins, clean your PC-board traces and pads with steel wool. Next, mount the PC board securely in a vise. If you don't have a vise, you can try holding the PC board down by taping its corners to a flat surface with masking tape.

If you are using a desk-top magnifier, swing it into place and turn on the light. Place the rest of your tools, materials, and components nearby, within easy reach, and get comfortable. Pretend you're a surgeon about to perform a delicate operation. Then, just pick out a component location on the PC board, take a deep breath, exhale, and give it a go. You'll be a pro at SMT hand assembly in no time. Now, let's build our projects!

**Construction.** The parts-placement diagram for the 555 Dual-LED Flasher is shown in Fig. 8, and the parts-placement for the Tone Burst is given in Fig. 9. Whichever project you build, begin by attaching the integrated circuit. Note that in both projects the IC is placed so that pin 1 is on the top-left pad. Next, install any polarized capacitors (the positive terminal is indicated by either a colored bar or a

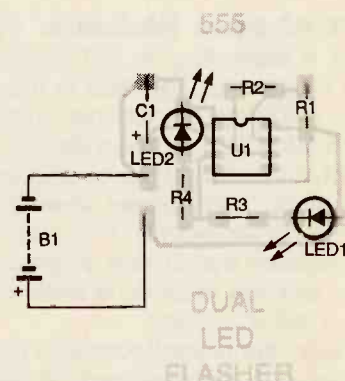

Fig. 8. Use this diagram as a guide when building the 555 Dual-LED Flasher. Because their markings are so small, polarized SMC's can be hard to work with, so be careful when aligning them.

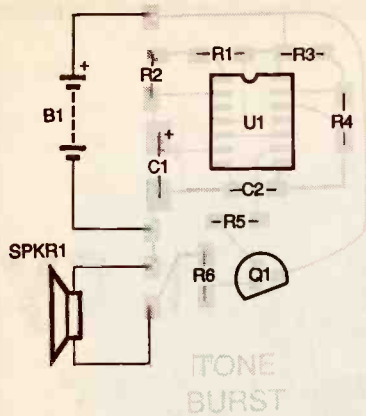

Fig. 9. This Tone Burst parts-placement diagram should make building the project a lot easier. Double check your battery- and speaker-wire connections to make sure they are correct.

### PARTS LIST FOR THE 555 DUAL-LED FLASHER

- U1—555 timer, surface-mount integrated circuit
- LED1, LED2—Green LED, surface mount
- R1—1000-ohm resistor, surface mount
- R2—100,000-ohm resistor, surface mount
- R3, R4—470-ohm resistor, surface mount
- C1—10- $\mu$ F, 10-volt, electrolytic capacitor, surface mount
- B1—9-volt alkaline battery
- Printed-circuit materials, 9-volt-battery snap with leads, wire, solder, hardware, etc.

### PARTS LIST FOR THE TONE BURST

- U1—555 dual timer, surface-mount integrated circuit
- Q1—2N2222 transistor or equivalent, surface mount
- R1—2200-ohm resistor, surface mount
- R2—100,000-ohm resistor, surface mount
- R3, R4—4700-ohm resistor, surface mount
- R5—1000-ohm resistor, surface mount
- R6—100-ohm resistor, surface mount
- C1—3.3- $\mu$ F, 10-volt, electrolytic capacitor, surface mount
- C2—0.1- $\mu$ F chip capacitor, surface mount
- B1—9-volt alkaline battery
- SPKR1—8-ohm speaker
- Printed-circuit materials, 9-volt-battery snap with leads, wire, solder, hardware, etc.

small marking). Proceed to install any non-polarized capacitors.

You can then place all the resistors. Because those components have no polarity, they can be installed in either direction. Do, however, solder them in place so that their resistance value is visible (for an explanation of how the values are read, once again refer to the previously mentioned article).

The 555 Dual-LED Flasher uses two LED's that are, of course, polarized. The cathode end is usually marked with a dot of green or red paint. If you're building the project, attach the LED's at this time.

The Tone Burst Project includes a three-terminal transistor. Because that tiny component can be placed on

"abuse," this is the time to find out. If your assembly techniques were good, the SMC's will hold.

Finally, attach a 9-volt battery. Your project should blink or beep, depending on which one you built. If the project fails to function correctly, make sure that you are using a fresh 9-volt battery. Then, check component placement and solder-joint integrity, and examine the project under your magnifier.

When your project is working, attach it to the battery with double-sided tape. For the Tone Burst, if you used a small enough speaker, you can affix the unit by taping it to the opposite side of the battery.

**How to Get SMC's.** You can purchase surface-mount components in single-lot (or "near-single-lot") quantities from a growing number of electronics distributors and retail outlets. First, check with your local electronics store. Second, look at the list of distributors presented in the aforementioned SMT article.

One of those sources, the Electronics Goldmine (P.O. Box 5408, Scottsdale, AZ 85261; Tel. 602-451-7454), has exactly what you need for either of the above two projects. In some cases you will have to purchase components in lots of anywhere from 5 to 20. That's practical, however, because you'll probably want to use the extras for solder practice or for building more projects.

**Conclusion.** Having built one or both of the SMT projects presented in this article, you have entered an entirely new realm of project building. In doing so, you have taken a leap not unlike that experienced by earlier electronics hobbyists when going from vacuum-tube-, to transistor-, to IC-based projects. You, too, are an electronics pioneer. But don't stop now.

SMT project kits are beginning to appear from a variety of sources. Purchase some of those kits and build them. Also, in the months to come, as you page through new issues of **Popular Electronics**, zero-in on the simpler IMT-based projects and try creating your own SMT versions of them. In no time at all, you will become an experienced pro at SMT project building.

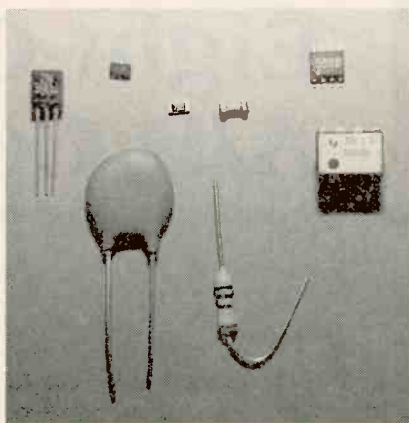

Surface-mount components are much smaller and lighter than their insertion-mount-component cousins.

the PC board in only one correct direction, you can't get its placement wrong. If you are building the Tone Burst, install the transistor now.

Tag solder the battery-snap wires directly to the appropriate PC board-pads. Be sure to observe correct polarity. Finally, if you are building the Tone Burst, attach speaker wires, approximately 2-inches long, to the correct pads on the PC board (see Fig. 9). Solder the other ends to SPKR1. For the sake of proportion, and to make an interesting assembly (more on that later), select a miniature unit for that speaker.

**Checkout and Use.** Before testing your project, spray it with the light-duty defluxer. Then take a nail brush and scrub vigorously to remove contaminants. Don't be afraid that you'll scrape off an SMC or two. If the components can't stand the rubbing

Every now and then, you come across an electronic component that is easy to use in an application. Such a device is National Semiconductor's ADC0831—a single-input, 8-Bit, Serial Input/Output (I/O), Analog-to-Digital (A/D) Converter. For standard 0- to 5-volt-input applications, all you need is the ADC0831 and a 5-volt power supply; no additional components are required! The ADC0831 output can connect directly to any of your PC's available parallel ports.

Many applications, however, use multiple inputs that don't span the complete 0- to 5-volt range. For instance, temperature sensors spanning the  $-40$  to  $+125^{\circ}\text{F}$  range will typically vary their input by only one volt or so. With the addition of two potentiometers, the ADC0831 can be adjusted to provide the full 255 steps inherent in an 8-Bit A/D converter over a smaller input-voltage range, without the need for op-amps or other analog scaling devices. That range can also be adjusted to begin at a voltage other than zero volts. Then, by adding a single, common multiplexer IC, up to eight input devices can be connected.

The result of those preceding additions is the *A/D Converter* described in this article. It is a circuit that has a non-critical layout, so it can be built on a low-cost prototyping board. Also, what's great about the project is that it can be built for under \$25. Even if you add eight temperature probes (as is done in an application that will be dealt with later), the cost can stay under \$50! Don't think that the low price means low performance, however. Depending on the speed of your PC, the circuit can capture 1000 or more samples per second.

**The ADC0831.** One useful feature of the ADC0831 is that its analog, zero-input-voltage value can be offset; the voltage-reference input can be adjusted to allow encoding any smaller, analog voltage span to the full 8 bits of resolution (with a  $\pm 1$  least-significant-bit error). As a result, it can operate ratiometrically or with a 5-volt-DC voltage reference; no zero or full-scale adjust is required. The ADC0831



# Eight-Channel A/D Converter

*Let your computer interface with the physical world.*

is TTL/MOS-I/O compatible. It operates from a single 5-volt power supply over a  $0^{\circ}\text{C}$  to  $70^{\circ}\text{C}$  temperature range, consuming only 15 milliwatts. The conversion time of the chip is 32 microseconds.

As shown in Fig. 1, the ADC0831 is an 8-pin IC. Operation is enabled by placing a logic low on pin 1, the chip select ( $\overline{\text{CS}}$ ). Data is sent out of pin 6 ( $\text{D}_{\text{out}}$ ), and the IC requires a clocking signal at pin 7 (CLK). Power is applied to pins 8 ( $\text{V}_{\text{cc}}$ ) and 4 (GND). The input signal is provided to  $\text{V}_{\text{in}+}$ , which is pin 2. The zero-conversion reference voltage is provided to  $\text{V}_{\text{in}-}$  (pin 3). Finally, the voltage representing the range of the 8-bit conversion is provided to  $\text{V}_{\text{ref}}$  (pin 5).

Figure 2 shows the timing diagram for the ADC0831. In our application, the CLK (clock) signal will be derived from the PC's parallel port, and the Data Out will be sent to the parallel port. To begin, a conversion is initiated by first pulling the CS line low. That line must be held low for the entire conversion. The ADC0831 then waits for a start bit. Next, the clock is provided to the CLK input. On the falling edge of

the first clock pulse, the Data Out ( $\text{D}_{\text{out}}$ ) line comes out of its high-impedance state and provides a leading zero for one clock period. Each bit of the converted voltage level (beginning with the most significant bit, and proceeding through the least significant bit) is made available on the  $\text{D}_{\text{out}}$  line, beginning with the falling edge of each succeeding clock period. After eight clock periods, the conversion is completed. The  $\text{D}_{\text{out}}$  line goes into the high-impedance state again when the CS line returns to the high state.

While the ADC0831 can be used in the standard 0- to 5-volt input mode,

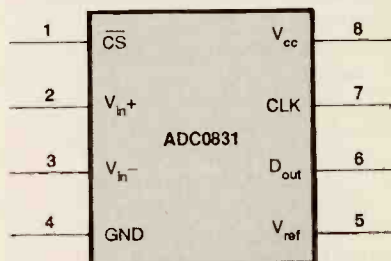

Fig. 1. This is the pinout of the ADC0831, which is the heart of the A/D Converter.

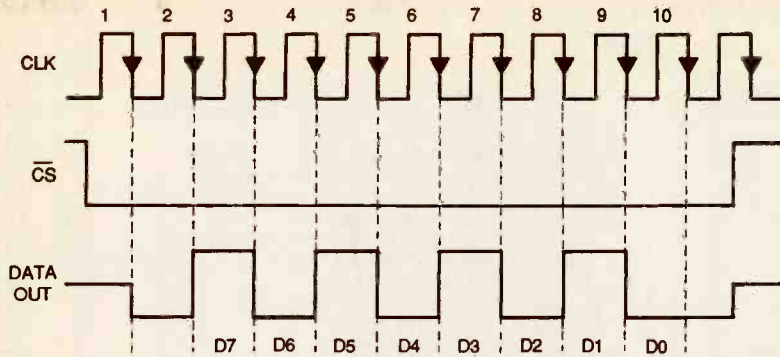
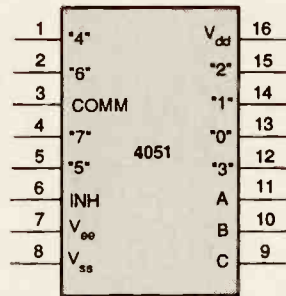

Fig. 2. Here's the timing diagram of the ADC0831. In the application discussed in the article, the CLK signal is derived from a PC's parallel port, and the Data Out is sent to the same parallel port.

both its minimum analog input-voltage and full-scale voltage values can be adjusted. When the  $V_{in-}$  pin is biased to other than ground, the converter will output a 0000 0000 digital code for that minimum input-voltage value. The voltage value applied to  $V_{ref}$  determines the analog input-voltage value that will produce the full-scale digital code (1111 1111). The sum of  $V_{in-}$  and  $V_{ref}$  must be less than or equal to 5 volts. For instance, by applying 2.3 volts to  $V_{in-}$ , and 1.28 volts to  $V_{ref}$ , an analog input voltage of 2.3 volts will produce a digital code of 0, and an input of 3.58 (2.3 + 1.28) will produce a digital code of 255. That provides an effective resolution of 1280 mV/256 counts, or 5 mV/count. That is four times the standard resolution of 19.53 mV/count (5000 mV/256 counts) that an 8-bit A/D converter would provide without the ratiometric capability.

**The 4051.** As mentioned earlier, for our application of the ADC0831, we will need to use an 8-channel multiplexer, the 4051. Figure 3A shows the pinout of that IC. Power is normally applied to  $V_{dd}$  (pin 16), and ground to  $V_{ss}$  (pin 8); however, in our application, we'll connect  $V_{ee}$  (pin 7) to ground also.

Three inputs—A, B, and C—form a binary counting scheme (as indicated in the truth table in Fig. 3B). The binary number input to the A-B-C inputs selects the same-numbered channel in the chip. That selected channel is connected to the COMM terminal (pin 3) through the 4051's internal circuitry, which adds a few-hundred ohms of resistance in series between the selected channel and



A

INH	C	B	A	"ON"
0	0	0	0	0
0	0	0	1	1
0	0	1	0	2
0	0	1	1	3
0	1	0	0	4
0	1	0	1	5
0	1	1	0	6
0	1	1	1	7
1	X	X	X	NONE

B

Fig. 3. The pinout of the 4051 8-channel multiplexer (A) shows all of its inputs and output channels. As the truth table (3B) shows, three inputs—A, B, and C—form a binary counting scheme. The binary number input to the A-B-C inputs selects the same-numbered channel in the chip.

pin 3. If the INH (inhibit) line (pin 6) is brought high, pin 3 is disconnected from all inputs, regardless of the A-B-C input.

**Temperature Sensors.** The A/D Converter described in this article will be put to use as a temperature measurer and data-logger. Let's take a look at the sensor that will make that possible: It is the LM335—a precision, easily calibrated, temperature-sensor

integrated-circuit. Shown in Fig. 4, that three-terminal device comes in a plastic TO-92 package. Operating as a 2-terminal Zener, the LM335 has a breakdown voltage directly proportional to absolute temperature at +10 mV/°K, with the extrapolated output of the sensor going to a zero-volt output at 0°K (-273.15°C).

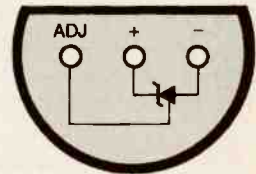

Fig. 4. This is a bottom view of the LM335 temperature sensor, showing the pinout configuration of its internal circuitry.

With less than a 1-ohm dynamic impedance, the device operates over a current range of 400  $\mu$ A to 5 mA, with virtually no change in performance. When calibrated at 25°C the LM335 typically has less than a 1°C error over a 100°C temperature range. Unlike other sensors, the LM335 has a linear output. The sensor operates over a range of -40°C to +125°C.

Errors in output voltage versus temperature are only slope or scale-factor errors, so a slope calibration at one temperature corrects all temperatures. The output voltage of the device (calibrated or uncalibrated) can be expressed as:

$$V(t) = V(t_0) \times t/t_0$$

where  $V(t)$  is the output-voltage reading at an unknown temperature,  $V(t_0)$  is the output voltage at the reference temperature,  $t$  is an unknown temperature in °K, and  $t_0$  is the reference temperature in °K. By knowing three of the preceding variables, the other one can be easily solved for.

Knowing that °K = °C - 273.15, and °C = (°F - 32)/1.8, it is possible to figure out the output voltage of an LM335 for any given Fahrenheit temperature. That voltage would be equal to:

$$[(x^{\circ}\text{F} - 32)/1.8 + 273.15] \times .01$$

where  $x$  is the Fahrenheit temperature. The first term  $[(x^{\circ}\text{F} - 32)/1.8]$  converts the Fahrenheit temperature to centigrade. The addition of 273.15 converts the centigrade temperature to Kelvin. Finally, the 0.01 multiplier (10 mV/°K) converts the temperature to

## LISTING 1

```

REM** ADC0831 with Up To 8 LM335 Temperature Probes
REM** V940126, c 1994 JJ Barbarello
REM*****
REM**  INITIALIZATION  **
REM*****
1      ON ERROR GOTO errortest
2      CLS : DEFINT A-S: DIM a(7), tempcorr(8)
3      FOR i = 0 TO 7: a(i) = 2 ^ i: NEXT
4      channel = 1
5      temp$ = "###" + CHR$(248) + "F"
'*****
'++++
'GET SETUP DATA FROM FILE (If no file, error occurs. +
' Then execution jumps to errortest subroutine). +
'*****
'++++
6      OPEN "ADC831.DAT" FOR INPUT AS #1
7      LINE INPUT #1, vinminus$: xsupply1 =
      VAL(vinminus$)
8      LINE INPUT #1, vinplus$: xsupply2 = VAL(vinplus$)
9      LINE INPUT #1, add$: add = VAL(add$)
10     LINE INPUT #1, numberchannels$: channels =
      VAL(numberchannels$)
11     LINE INPUT #1, delay$: delay! = VAL(delay$) /
      channels
12     FOR i = 1 TO channels
13         LINE INPUT #1, v$: tempcorr(i) = VAL(v$) - 2.732
14     NEXT i
15     datasource$ = "FILE ADC831.DAT"
16     jump.from.errortest.routine:
REM*****
REM**  SCREEN SETUP  **
REM*****
17     COLOR 15, 6: CLS : LOCATE 2, 15
18     PRINT "ADC-831 TEMPERATURE PROBE
      PROGRAM. Press ESC key to End.;"
19     COLOR 14, 6: LOCATE 3, 26: PRINT "Data Source:
      "; datasource$
20     VIEW PRINT 5 TO 24: COLOR 15, 1: CLS
21     LOCATE 6, 19
22     PRINT USING "Vin Range is ### to ###v";
      xsupply1; xsupply1 + xsupply2
23     LOCATE 6, 48: PRINT USING "(###mV/Step)";
      xsupply2 / 256
24     LOCATE 7, 10: PRINT USING "# Active Channels";
      channels
25     LOCATE 7, 28: PRINT USING "Using Parallel Port at
      #### Decimal"; add
26     LOCATE 7, 64: PRINT "("; HEX$(add); "H)"
27     LOCATE 8, 24
28     PRINT USING "Channel Scan Time is ###.#
      seconds"; delay! * channels
29     COLOR 3, 1
30     FOR i = 1 TO channels
31         LOCATE 10, i * 8 + 2
32         PRINT USING "###v"; tempcorr(i);
33     NEXT i
34     LOCATE 9, 23: PRINT "TEMPERATURE PROBE
      CORRECTION FACTORS"
35     COLOR 7, 0
'*****
'++++
'DRAW BOXES ON BLACK BACKGROUND FOR VOLTAGE &
TEMP DATA +
'*****
'++++
36     LOCATE 11, 8: PRINT CHR$(201);
37     FOR j = 1 TO 8: PRINT STRING$(7, 205);
      CHR$(209); : NEXT j
38     LOCATE 11, 72: PRINT CHR$(187)
39     FOR i = 12 TO 16: LOCATE i, 8: PRINT CHR$(186);
40     FOR j = 1 TO 8: PRINT SPACE$(7); CHR$(179); :
      NEXT j
41         LOCATE i, 72: PRINT CHR$(186)
42     NEXT i
43     LOCATE 13, 8: PRINT CHR$(204);
44     FOR j = 1 TO 8: PRINT STRING$(7, 205);
      CHR$(216); : NEXT j
45     LOCATE 13, 72: PRINT CHR$(185)
46     LOCATE 15, 8: PRINT CHR$(199);
47     FOR j = 1 TO 8: PRINT STRING$(7, 196);
      CHR$(197); : NEXT j
48     LOCATE 15, 72: PRINT CHR$(182)
49     LOCATE 17, 8: PRINT CHR$(200);
50     FOR j = 1 TO 8: PRINT STRING$(7, 205);
      CHR$(207); : NEXT j
51     LOCATE 17, 72: PRINT CHR$(188)
52     FOR i = 1 TO 8: LOCATE 12, i * 8 + 2: PRINT USING
      "CH #": i; : NEXT
REM*****
REM**  SAMPLING CODE  **
REM*****
53     start:
54     begin! = TIMER
55     WHILE (TIMER - begin!) < delay! * .95: WEND
56     LOCATE 12, channel * 8 + 2: COLOR 0, 7
57     PRINT USING "CH #"; channel; : COLOR 7, 0
58     WHILE (TIMER - begin!) < delay!: WEND
59     activech = (channel - 1) * 4
60     OUT add, activech + 2: REM: Select 4051 channel
      (1-8) which is input 0-7
61     FOR i = 1 TO 100: NEXT i
62     OUT add, activech + 0: REM: Set CS* low. CLK low.
63     OUT add, activech + 1: OUT add, activech + 0: REM:
      Pulse Clk Hi/low. keep CS* low
64     OUT add, activech + 1: REM: Pulse Clk High
65     j = 7
66     WHILE j > -1
67     OUT add, activech + 0: OUT add, activech + 1
68     jsum = jsum + (INP(add + 1) AND 64) * a(j): REM:
      Get Bit J. Result is 64 or 0.
69     j = j - 1
70     WEND
71     jsum = jsum / 64: REM: Divide by 64 once, not each
      time in jsum calc.
72     LOCATE 14, channel * 8 + 2
73     voltreading = xsupply1 + jsum * (xsupply2) / 255
74     PRINT USING "# ###v"; voltreading
75     LOCATE 16, channel * 8 + 1
76     tempreading = (voltreading + tempcorr(channel) -
      2.332) / (.01 / 1.8) - 40
'voltreading-tempcorr(channel)-2.332 is voltage diff. from -40F
'.01/1.8 is C to F conversion of 10mV/degC
77     IF tempreading < -40 THEN
78         PRINT CHR$(32); STRING$(5, 25);
79         ELSEIF tempreading > 125 THEN
80             PRINT CHR$(32); STRING$(5, 24);
81         ELSE
82             PRINT USING temp$; INT(tempreading + .9)
83         END IF
84     COLOR 7, 1
85     LOCATE 18, channel * 8 + 3: PRINT USING "###";
      jsum
86     COLOR 7, 0
87     jsum = 0: REM: Clear Jsum
88     LOCATE 12, channel * 8 + 2
89     PRINT USING "CH #"; channel;
90     channel = channel + 1: IF channel = channels + 1
      THEN channel = 1
91     a$ = INKEY$: IF a$ = "" THEN GOTO start
92     IF ASC(a$) <> 27 THEN BEEP: GOTO start
93     VIEW PRINT: CLS : LOCATE 18, 1: END
REM*****
REM**  ERROR HANDLER  **
REM*****
94     errortest:
95     IF ERR = 53 THEN
96         xsupply1 = 2.332
97         xsupply2 = 3.248
98         add = 888
99         channels = 8
100        FOR i = 1 TO 8: tempcorr(i) = 0: NEXT i
101        datasource$ = "DEFAULT VALUES"
102        RESUME jump.from.errortest.routine
103    END IF
104    LOCATE 12, 20: PRINT "UNDEFINED ERROR.
      Unable to continue"
105    LOCATE 18, 1: END

```

an output voltage. So, if we want to measure temperature between  $-40^{\circ}\text{F}$  and  $+125^{\circ}\text{F}$ , we would have to figure out the associated output-voltage range. The voltage associated with  $-40^{\circ}\text{F}$  is:

$$((-40 - 32)/1.8 + 273.15) \times .01$$

which equals 2.332 volts. The voltage associated with the upper end of the range,  $+125^{\circ}\text{F}$  is:

$$((125 - 32)/1.8 + 273.15) \times .01$$

which equals 3.248 volts.

If we set the ADC0831's  $V_{in}$  to 2.332 volts, and its  $V_{ref}$  to 0.916 volts (the difference between 3.248 volts and 2.332 volts), the ADC0831 will be able to sense a voltage difference as small as 3.58 mV (because  $0.916 \text{ V}/256 \text{ steps} = 3.58 \text{ mV/step}$ ). That will allow the chip to resolve between  $-40^{\circ}\text{F}$  and  $+125^{\circ}\text{F}$  (a  $165^{\circ}\text{F}$  temperature span) with at least a  $1^{\circ}\text{F}$  resolution, because a  $1^{\circ}\text{F}$  change will produce a voltage difference of  $0.916 \text{ V}/165^{\circ}\text{F}$  or  $5.5 \text{ mV}/^{\circ}\text{F}$ .

Further, if we limit the temperature span to a smaller range, the resolution will increase. For instance, if we limit the range to  $25^{\circ}\text{F}$ , the output-voltage range will be 0.139 volts. That will create an ADC0831 resolution of  $0.543 \text{ mV/step}$  ( $0.139 \text{ mV}/256 \text{ steps}$ ), which is more than ten times smaller than the  $5.5 \text{ mV}/^{\circ}\text{F}$  response of the LM335. Therefore, the ADC0831 will be able to resolve  $0.1^{\circ}\text{F}$  over that smaller range. As you can see, the ratiometric capability of the ADC0831 allows us to trade off range for greater resolution.

**Circuit Description.** The schematic of the A/D Converter is shown in Fig. 5. It is powered from a 9-volt battery, B1, the output of which is regulated by a 78L05, U1, to 5 volts. If a 5-volt source of regulated DC is available, U1, C1, and C2 can be eliminated.

The functions of the ADC0831 (U2) and 4051 (U3) IC's, were looked at earlier. Potentiometer R1 allows the user to set the minimum input voltage. The setting of potentiometer R2 deter-

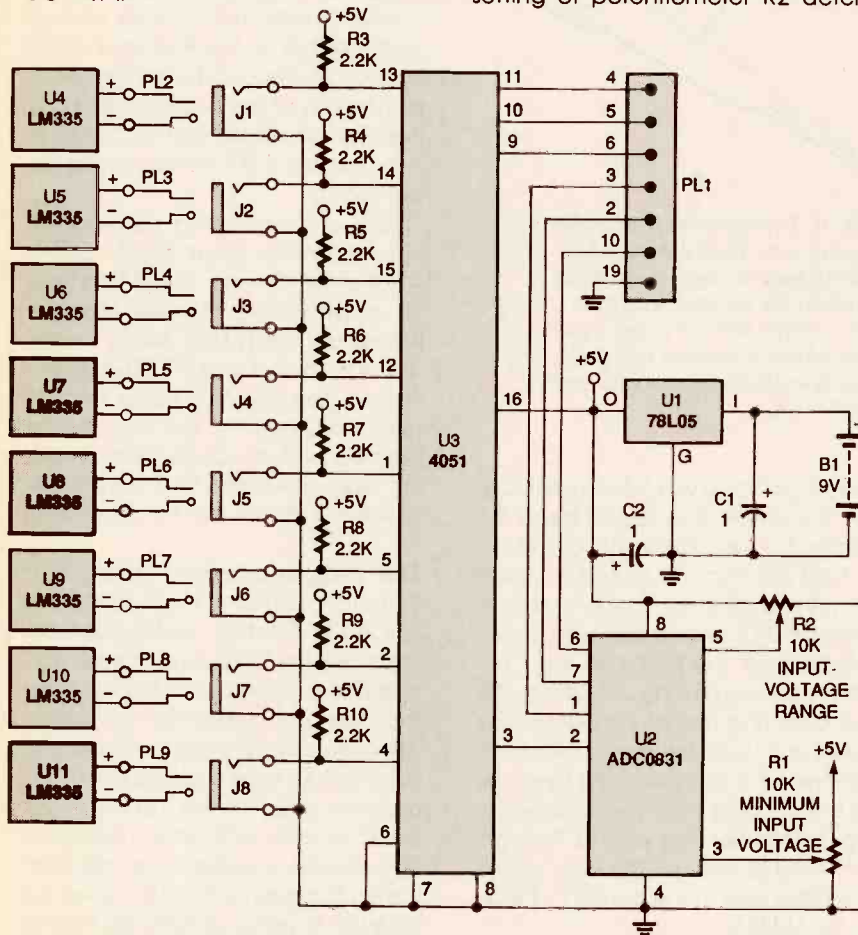

Fig. 5. The actual processing circuitry of this A/D Converter consists of only four parts: U2, U3, R1, and R2. As you can see, eight temperature probes are used with the circuit; however, they can be replaced with other types of sensors, as long as resistors R3-R10 are removed.

## PARTS LIST FOR THE A/D CONVERTER

### SEMICONDUCTORS

- U1—78L05 5-volt regulator, integrated circuit
- U2—ADC0831 8-bit serial I/O A/D converter, integrated circuit
- U3—4051 analog multiplexer, integrated circuit

### ADDITIONAL PARTS AND MATERIALS

- R1, R2—10,000-ohm,  $\frac{3}{4}$ -watt, 10- or 15-turn PC-mount potentiometer
- R3-R10—2200-ohm,  $\frac{1}{4}$ -watt, 5% resistor
- C1, C2—1- $\mu\text{F}$ , 15-WVDC (or greater), electrolytic capacitor
- PL1—DB25 male connector and hood
- J1-J8—phone jack (see text)
- B1—9-volt battery
- Perforated-board materials, project enclosure or wooden base, IC sockets, 22-gauge wire, 7-conductor wire, screws and nuts, solder, hardware, etc.

**Note:** The following are available from James J. Barbarello (817 Tennen Road, Manalapan, NJ, 07726). Daytime Fax is 908-532-0702. The A/D Converter Kit (ADC0831), consisting of all parts listed above less jacks with one temperature probe—\$25.00. Enhanced software (ADC0831S), containing source and executable code for temperature-sensing (and other) analog-input devices, and providing data logging, data storage, and data plotting—\$12.00

mines the desired voltage span (which effectively sets the maximum input voltage).

The A/D Converter interfaces with a PC through a DB25 plug, PL1. Note that the numbers shown in PL1 relate to the pin numbers of the DB25 plug, and of course, the parallel port of the computer. The Converter circuit contains eight phone jacks, J1-J8, to interface with eight temperature probes. Those probes each contain one LM335 (U4-U11) and a phone plug (PL2-PL9). Of course, in other applications, and with the appropriate external circuitry, J1-J6 can be used to interface with virtually any other type of analog sensor or signal.

**Construction.** The author's prototype was built on a perforated prototyping board. Any other appropri-

## PARTS LIST FOR THE TEMPERATURE PROBES (8)

U4-U11—LM335AZ temperature sensor, integrated circuit  
 PL2-PL9—phone plug (see text)  
 Twisted-pair wire (22-gauge), heat-shrink tubing ( $\frac{1}{16}$ -,  $\frac{1}{8}$ -, and  $\frac{3}{16}$ -inch diameter), solder, etc.

**Note:** The following are available from James J. Barbarello (817 Tennent Road, Manalapan, NJ, 07726). A kit of parts for a single temperature probe (TP831)—\$5.00. A four-probe kit (4TP831)—\$17.50; and eight-probe kit (8TP831)—\$32.50; are also available.

ate construction technique can, of course, be used. Regardless of the technique used, when installing the components in the circuit, be sure to check their orientation (except for R3 through R10, of course).

If you have difficulty finding either the ADC0831 or the 4051 locally, they are both available from Digi-Key (P.O. Box 677, Thief River Falls, MN 56701-0677; Tel. 800-344-4539). Use IC sockets for those IC's, and install them last.

As shown in the photo at the beginning of this article, the author's completed prototype board was attached to a block of wood using screws and nuts (as spacers). Any project enclosure can be used, however. Phone jacks J1-J8 can be of any size; just make sure you use matching plugs for the temperature probes. The jacks were mounted through holes in the wood base in the prototype, but if you use a project enclosure, the jacks can be mounted on its cover. Connect the jacks to the circuit with individual pieces of 22-gauge wire, and attach the ground points of the jacks together and to the common ground on the circuit.

Use a 7-conductor cable to make the connections between the circuit board and pins 2, 3, 4, 5, 6, 10, and 19 of the DB25 plug, PL1. To attach the battery to the circuit, use a battery connector with leads.

The next step is to build a temperature probe, or probes. Remember, the A/D Converter can accommodate up to eight probes. To begin, hold an LM335 with its flat side facing up and

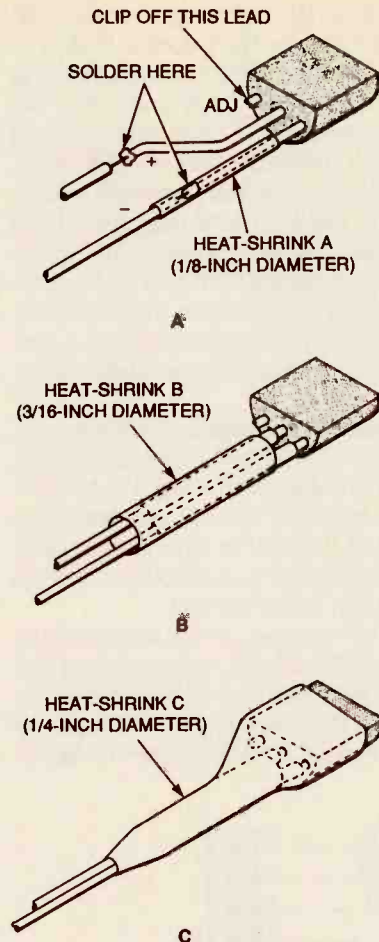

**Fig. 6.** To protect the temperature probe connections, three pieces of heat-shrink tubing must be used. Heat-shrink A prevents the negative lead from coming into contact with the positive one (A), heat-shrink B protects both leads (B), and heat-shrink C covers the entire probe (C).

the leads facing you (see Fig. 6A). Clip off the left (ADJ) lead and bend the center (+) lead to the left, as shown.

Next, strip about  $\frac{1}{4}$ -inch of insulation from the ends of both wires in a twisted pair. That twisted-pair wire, which will connect the probe to the Converter, can be as long as 50 feet without affecting the probe's accuracy. Insert a  $\frac{1}{2}$ -inch length of  $\frac{1}{8}$ -inch-diameter heat-shrink sleeving over one of the stripped wires (heat-shrink A in Fig. 6A). Solder that wire to the right (-) lead of the LM335. Then, solder the other wire to the center (+) lead of the LM335.

As an initial checkout, strip about  $\frac{1}{4}$ -inch of insulation from each of the wire's free ends. Connect the wire from the center lead of the LM335

through a 2200-ohm resistor to a 5-volt-DC source. Then, connect the wire from the right lead of the LM335 to the power source's ground. Using a digital multimeter, measure the voltage across the signal and ground leads. In a normal environment (around 70°F), the DMM should read around 2.95 volts. Place an ice cube in contact with the LM335. The voltage reading on the DMM should begin to decrease. If you don't obtain those results, check the probe's wiring and solder joints.

If the probe works, remove the power source and resistor. Push heat-shrink A over the solder joint and LM335 lead (see Fig. 6A). Using a portable hair dryer, or a match (be careful not to actually touch the tubing), heat the tubing until it shrinks around the joint and lead. Push the two LM335 leads together, making sure heat-shrink A keeps them from making contact.

Push a 1-inch-long piece of  $\frac{3}{16}$ -inch-diameter heat-shrink tubing, heat-shrink B, up the free end of the twisted pair wire, and push it as close to the body of the LM335 as possible (see Fig. 6B). Apply heat as before to heat-shrink B until it shrinks around the two leads.

Push a  $1\frac{1}{2}$ -inch-long piece of  $\frac{1}{4}$ -inch-diameter heat-shrink tubing (heat-shrink C) over the LM335 and down past the previously installed tubing on the LM335 leads. Leave about  $\frac{1}{16}$ -inch of the LM335 body protruding (see Fig. 6C). Apply heat to heat-shrink C. The last step in the preparation is to connect the wires to the plug. Make sure that the polarity matches that shown in the schematic.

**The Program.** Listing 1 presents a QBasic program that performs ADC0831 control, data-capture, data-display, and data-conversion operations. It also uses a text setup file that lets you customize operation without having to change the actual program. An enhanced version of the program, which makes it easier to use the Converter with other analog-input devices, is available on disk from the source given in the A/D Converter Parts List. To better understand how to use the Converter, let's examine the lines of the program.

Line 1 activates the error-trapping routine. That is used to define default



## LISTING 2

### LINE CONTENTS:

[Vin-	]	2.345
[Vref	]	3.567
[Parallel Port Address	]	888
[Number of Active Channels	]	4
[Total Scan Time (The time it takes to begin at channel 1, sample all active channels, and then come back to channel 1)	]	0.8
[Temp Correction for Channel 1	]	0.014
[Temp Correction for Channel 2	]	0
...		-0.005
[Temp Correction for highest active channel	]	0.03

### EXAMPLE:

(returning a 0). The results of the eight data reads are stored in `JSUM`. Because the actual value should be a 1 or 0 (not 64 or 0), line 71 divides the sum by 64 to arrive at a final value between 0 and 255. Line 72 positions the cursor at the correct area on the screen to display the data for the selected channel.

Line 73 converts the 0–255 value into the appropriate voltage using the  $V_{in} - (XSUPPLY1)$  and  $V_{ref} (XSUPPLY2)$  zero reference and voltage span. Line 76 converts the voltage reading to the appropriate temperature reading, using the temperature-correction factor for the selected temperature probe. Lines 77 through 83 format the temperature reading, printing up arrows if the reading is above the maximum allowed, and printing down arrows if the reading is below the minimum allowed, or printing the actual reading.

Line 90 increments the channel and resets it to 1 if the highest channel has just been read. Line 91 allows the operator to press any key to end the program (if so, line 93 ends the program). If no key is pressed, line 92 loops execution back to line 53.

**The Setup File.** Creating the setup file can be done with a word processor, from DOS, or better yet, from QBasic (which you'll use to `RUN` the program in Listing 1). The file contains a number of text lines, each ending with a line feed and carriage return. The contents of the lines are given in Listing 2.

Note that if you have more than one parallel port available in your PC (LPT2, LPT3, or LPT4), you can specify its address. That way you can still use your primary parallel port (LPT1) for regular printing.

**Calibration.** To calibrate the temperature probe, you have to compare the probe's output to a known temperature. If you have an existing, calibrated temperature-sensing device, place the probe next to that device's temperature-sensing element and record the probe's output voltage. Then, to determine the theoretical output voltage based on the temperature-sensing device's temperature reading, use the formula that was given earlier:

$$((x^{\circ}\text{F} - 32)/1.8 + 273.15) \times .01$$

values in case the setup data file is not present. Line 2 dimensions the `A` array, and the `TEMP CORR` array, which will hold the temperature-probe correction factors. In line 3, the `A` array is filled with the powers of 2 (which we'll use later). Lines 4 and 5 initialize variables.

Line 6 accesses the setup file and lines 7 through 14 retrieve the data. The variable `XSUPPLY1` corresponds to  $V_{in}$ , the zero offset, and `XSUPPLY2` corresponds to  $V_{ref}$ , the voltage span. The variable `ADD` is the address of the parallel port being used. `CHANNELS` is the number of channels to be used (between 1 and 8), `DELAY` is the delay-time-per-channel, and `TEMP CORR(I)` is the temperature-probe correction factor for the different probes. That value is used to correct for any small variations in the responses of individual LM335's. Lines 17 through 52 simply do housekeeping on the screen.

If the setup file is not available (we'll deal with that file later), an error in line 53 will result, and execution will proceed to line 94. In that instance, the variables needed for the program to execute are defined in lines 96 through 100, and execution returns to the main program from line 102. If an undefined error occurs, lines 104 and 105 identify that fact and end the program.

The heart of the program is between lines 53 and 93. Lines 54 and 55 create a delay loop that suspends execution until most of the time identified by `DELAY` has elapsed. Line 57 displays the active channel, and line 58 completes the delay processing.

The active channel is used to set a mask that will control U3, the 4051 multiplexer. For instance, if channel 4 is active, we want to access U3's "3" in-

put, because the channels are 1 to 8, and U3's inputs are 0 to 7 (channels 1 to 8 correspond to jacks J1–J8). Thus, the variable `ACTIVECH` is set to 12, or 00001100 binary (shown as bit 7 through bit 0). That value can then be used to send a 1 to pin 4 of PL1 (bit 2 to U3 "A"), a 1 to pin 5 of PL1 (bit 3 to U3 "B"), and a 0 to pin 6 of PL1 (bit 4 to U3 "C"). Referring back to Fig. 4, that bit pattern (or multiplex mask) selects U3's "3" input.

Line 60 uses the multiplex selection mask and adds 2 (binary 10) which also keeps pin 3 of PL1 (`CS`) high. Line 61 provides some settling time, and then line 62 brings the `CS` line low. Line 63 keeps `CS` low, and pulses the `CLK` line (pin 2 of PL1) high and then low again by bringing bit 0 high and then low. Line 64 brings the `CLK` line high again.

At that point in the program, we've selected the input channel, connected it through U3 to the input of U2, activated U2 by bringing its `CS` line low, and pulsed the `CLK` line one-and-a-half times. Referring back to Fig. 2, the next time the `CLK` line goes low, data bit D7 will be available at the `Dout` pin.

A counter is set to 7 in line 65. Line 66 and 70 form a `WHILE WEND` loop that will count back from 7 to 0, performing the commands in lines 67 through 69 each time through the loop (retrieving data bits D7 through D0 in the process). Line 67 pulses the `CLK` line low and then high again. Even though we could read the data when the `CLK` is brought low, pulsing it high again (the middle of the clock cycle) ensures the data has settled before we read it. Line 68 gets bit `j` and determines if it is high (returning a 64) or low

bands and frequencies adjacent to them:

The Bilal Isotrons are very small amateur-band HF antennas designed for portable and restricted-space applications where larger antennas are impractical. Some users mount them out in the open, such as on a chimney, since they are smaller than a TV antenna and really don't look like an antenna at all. Most of the Bilal antennas are small enough to fit in an attic.

Despite their small size, the antennas have reasonably large areas and are made electrically resonant using large coils in series with the antennas' capacitive plates. Six single-band versions cover the 160-, 80-, 40-, 20-, 15-, and 10-meter amateur bands. Other models cover various ranges in the regions from 1.8-7.3 MHz and 14.0-30.0 MHz. Prices range from \$32.95 to \$149.95.

The Spider antennas, from Multi-Band Antennas, are loaded amateur-mobile antennas that automatically

change bands without changing resonators; they don't need an antenna tuner. The four-band Spiders are good candidates for installation on vans, campers, motor homes, and freshwater boats. The antennas offer good operating bandwidth and low SWR. Three additional resonators can be installed for seven bands.

The Spiders also are suitable for use in mobile home parks, apartments, and condominiums; balcony-railing and vent-pipe mounting is popular. A special dipole version also is available, as are models tuned to commercial HF marine bands. A selection of resonators, mounts, and accessories is available. A complete Spider system typically costs \$150 or more, plus mount; dipoles are \$170 and up, depending on the number of bands covered.

### Antenna Tuners and Couplers.

Strictly speaking, you really don't use an antenna tuner to "tune" an antenna. Instead, tuners (sometimes known as couplers or transmatches) allow you to get the most from certain antennas by adjusting the impedance match between your receiver and antenna system.

While in amateur work tuners usually are adjusted using an SWR bridge, you can adjust them very simply by merely adjusting their controls for the strongest received signal. Another, more "high tech" way is to use an instrument such as an antenna bridge, dip meter, resistance analyzer, antenna noise bridge (ANB), or similar device that has a built-in signal source.

Those instruments let you determine antenna resistance, standing-wave ratio (SWR), resonant frequency, and other parameters without a transmitter. You can monitor changes as you tweak your antenna, lengthening or shortening it or adjusting its tuner to see the effect, without transmitting.

Antenna tuners also perform a second useful function by rejecting unwanted, out-of-band signals and preventing them from getting through to your radio. Many firms, including MFJ, Grove Enterprises, Palomar Engineers, and others, offer SWL tuners.

**Some Final Thoughts.** Just the fact that your antenna is physically smaller than usual does not exempt it from

any of the usual concerns that surround antennas. That is especially true of safety concerns.

If your antenna is outdoors, protect it from lightning. If it normally requires a parallel-conductor transmission line, consider placing a BALUN at the antenna to allow coax feeder to be used instead. The BALUN also connects both sides of the antenna to the cable shield (at DC and low AC frequencies). That reduces static-charge buildup on the antenna; charges flow to ground, not through your radio.

Also protect your vertical ground-plane antenna, even if it's at DC ground potential. When that type of antenna is elevated above ground, run a direct ground wire to its radial system. Don't rely on the coax feedline shield alone for grounding.

Get a good ground. The best way to do that is to have a good, short connection between your antenna system and ground, both for lightning protection and for good antenna performance. If you can, install outdoor ground rods, preferably several six-foot or longer rods connected together with heavy wire. Don't use hot-water pipes, gas lines, electrical conduit, or insulated plastic pipes.

You might have to settle for a wire run to a cold water pipe. Sometimes, even that's hard to find in homes and apartments built with plastic piping. Inside steel-frame buildings, a ground connection to the building's frame can be effective.

During an electrical storm, the only safe conductor is a grounded one, so ground or disconnect all antennas when a storm threatens. Use an antenna switch that automatically grounds all antennas except the one in use and that has enough positions so you can turn the antenna selector to an unused position when not using the equipment. Your best bet might be to remove all of your equipment from power and transmission lines during storms, or disconnect them whenever you're not using them.

We won't dwell further on antenna safety in this article. More information can be found in my article "Antenna Safety for Hams and SWLs," which appeared in the May 1995 issue of **Popular Electronics**. Also, there is an informative, four-page "Antenna Safety Advisory" pamphlet available free from Universal Radio. ■

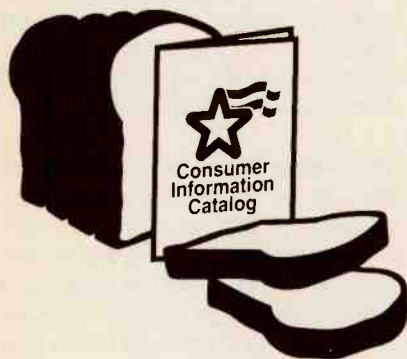

## The Greatest Thing Since Sliced Bread

No matter how you slice it, our free Consumer Information Catalog is great food for thought.

The Catalog dishes up more than 200 free and low-cost government booklets on subjects such as staying healthy, eating right, finding a job, getting federal benefits, using credit, buying a home, helping your kids, taking care of your car, and much, much more.

To get your free copy, send your name and address to:

**Consumer Information Center  
Department GT  
Pueblo, Colorado 81009**

U.S. General Services Administration

# MAKING SQUARE WAVES AT HOME

*Generating square waves is easy when you follow the simple "recipes" in this cookbook.*

BY JOSEPH J. CARR

**S**quare waves are among the most useful waveforms around. They are used to make qualitative tests of amplifier and passive-network circuits, and for radio troubleshooting. Square waves are even used as clocks in digital circuits.

Fortunately, square waves that are stable in both amplitude and frequency are relatively easy to generate using the following circuits. Let's take a look.

**Types of Square Waves.** Figure 1 shows five different types of square waves. For all five, the signal is inherently binary—it quickly jumps between two values ("high" and "low"). Because the square wave never permanently remains at just one level, it is said to be astable. For that reason, most square-wave generators are called "astable multivibrators."

A positive, monopolar square wave is shown in Fig. 1A. For that type of square wave, the two ideal voltage levels are zero volts and some positive voltage ( $V+$ ). In transistor-transistor logic (TTL), the low level is anything below 0.8 volts and the high level is anything from 2.4 to 5 volts. Non-TTL-based square waves of that type might use different voltage levels. For example, while CMOS chips can generate TTL-compatible voltage levels, they are often used in circuits with much larger high-level voltages.

Figure 1A also shows the time relationships of a positive, monopolar square wave. A total cycle consists of

one high and one low, each of equal length. The total period required for the square wave cycle is:

$$T = t_1 + t_2$$

while the frequency ( $f$ ) is:

$$f = 1/T$$

A negative, monopolar square wave is shown in Fig. 1B. The negative square wave is similar to the positive one shown in Fig. 1A, but in the negative square wave, a high is defined as 0 volts, while a low is some negative potential ( $-V$ ).

Another square wave is the symmetrical, bipolar square wave of Fig. 1C. In that type of square wave, the high and low voltages are equal potentials above and below the voltage axis. A variation on that is the offset, bipolar square wave of Fig. 1D. That wave has a DC offset voltage that prevents it from being symmetrical around the voltage axis. The square wave shown has a positive DC component added to it, but that offset voltage could be negative instead.

Figure 1E shows another asymmetrical square wave. In that case, however, the lack of symmetry is not across the voltage axis but in the relationship between  $t_1$  and  $t_2$ — $t_1$  does not equal  $t_2$ . The percentage of the time the wave is high, or:

$$100\% \times t_1/(t_1 + t_2)$$

is called the "duty cycle" of the square wave.

One of the things that make square

waves so useful for testing purposes is that they contain a large number of harmonics, or integer multiples of the fundamental frequency. Because the symmetrical, bipolar square wave has both baseline and time symmetry, it produces only even-order harmonics—harmonics with frequencies that are even multiples of the fundamental—as shown in Fig. 2. Theoretically, those harmonics extend to infinity, but in reality, a good, sharp, clean square wave has even-order harmonics out to about  $1000f$ .

Square waves can be generated by digital TTL and CMOS IC's, 555-timer-based circuits, and operational amplifier ("op-amp") circuits. Let's look at each in turn.

**TTL Generators.** TTL integrated circuits have a 74 or a 54 as the first two digits of their part numbers. They are powered by a 5-volt DC supply. Because a high level in TTL IC's is anything from 2.4 to 5 volts, a TTL signal is said to change state when it crosses a 2.4-volt threshold.

Normal TTL chips operate at speeds of up to 18 MHz, with some cooking along at 25 MHz. Special types go up to 80 MHz or more.

The inverter is a basic element in TTL-based square-wave generators.

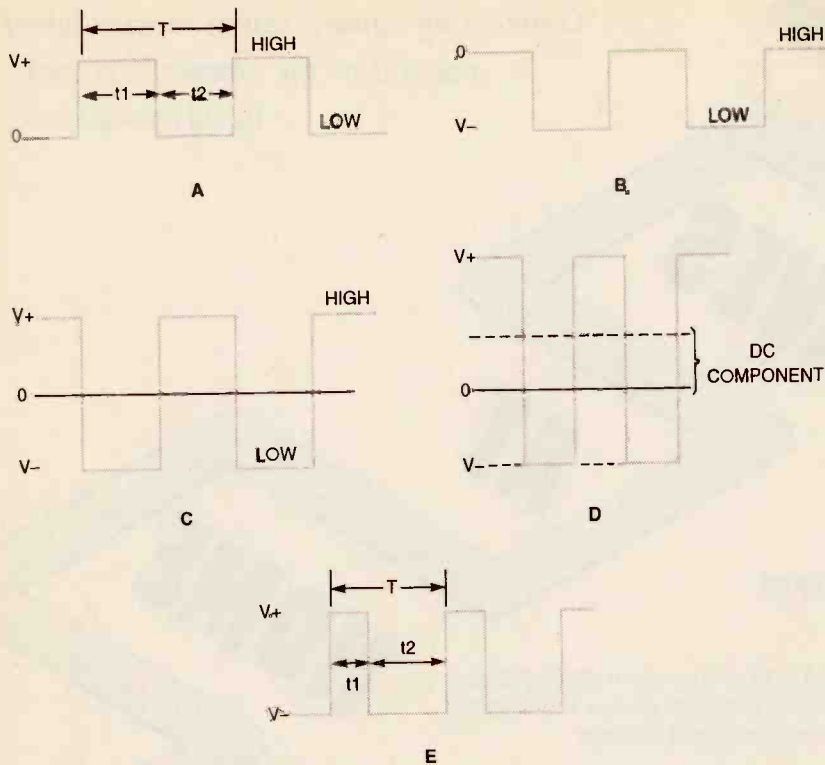

Fig. 1. Here are the five main types of square waves: positive monopolar (A), negative monopolar (B), symmetrical bipolar (C), asymmetrical bipolar (D), and time asymmetrical (E).

Those components can be either discrete inverters (such as the 7405), or NAND gates (like the 7400) or NOR gates (for example, the 7402) with their inputs tied together to form an inverter. Figure 3 shows a typical TTL ring oscillator that will produce square waves in the 500-kHz to 10-MHz range. In that form, it is made from three sections of a 7405 hex inverter chip.

The circuit's frequency is set by the values of C1 and R2. The value of C1 should be in the range of 390 pF to 0.005  $\mu$ F while R2 can vary from 1 to 3.9k ohms. It is common to use a circuit like the one in Fig. 3 to generate a frequency that is higher than the one needed, and to then divide the frequency with a series of TTL counter circuits cascaded together.

**CMOS Generator Circuits.** The CMOS family of digital integrated circuits operates at lower frequencies than the TTL family, but in return, CMOS IC's consume less power. While a typical TTL device might dissipate milliwatts of power, an equivalent CMOS device dissipates microwatts. Like TTL IC's, CMOS devices can also be powered from a 5-volt supply, and depending on the situation, might be TTL

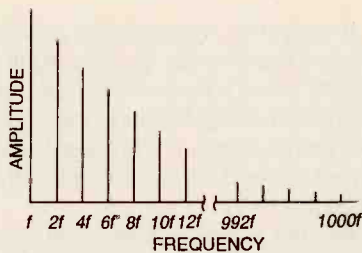

Fig. 2. The frequency spectrum of symmetrical square waves consists of the fundamental frequency and a large number of even harmonics.

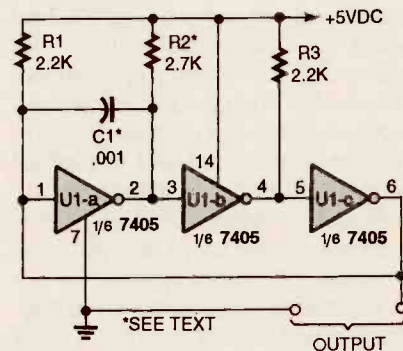

Fig. 3. A TTL ring-oscillator circuit uses an odd number of inverters in an astable configuration.

compatible. However, many CMOS devices can be powered at higher voltages.

For a typical CMOS chip, a signal is said to change state when it crosses the voltage half-way between the supply voltages. For example, when a +mi12-volt supply is used, the threshold is 0 volts, and when a single 12-volt supply is used, the threshold is 6 volts. The first digits in a CMOS-chip number are generally 4 or 45.

A Schmitt trigger is a special circuit that obeys slightly different rules than do other forms of digital gates. For example, when the 4584 hex inverting Schmitt-trigger IC is operated from a 5-volt power supply, the output state will change on positive-going input signals at 2.9 volts, and on negative-going input signals at 2.3 volts. The difference between the 2.9- and 2.3-volt signals is called the "hysteresis band."

Figure 4 shows a 4584 inverter ( $1/6$  of the total 4584) used in a very simple square-wave oscillator circuit. Because the 4584 is an inverter, a low at input pin 1 produces a high at output pin 2, and consequently, a high input produces a low output. When power is initially applied, capacitor C1 is discharged so the input sees zero volts (it is low); the output is therefore high, allowing C1 to charge from the output voltage at a rate limited by the time constant  $R1C1$ . When the voltage at the input reaches the Schmitt trigger's positive-going trip point, the 4584's input sees a high. That results in a low output, which causes C1 to discharge through R1 until the voltage drops below the negative-going threshold. The capacitor will continue to charge and discharge between those two levels at a frequency of approximately  $0.72R1C1$ .

Figure 5 shows a CMOS square-wave oscillator based on inverters (or NAND or NOR gates wired to act like inverters), which is similar to the ring oscillator shown previously. Unlike some CMOS inverter-based circuits, the one in Fig. 5 will produce a square wave

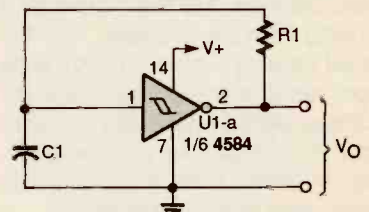

Fig. 4. A CMOS, inverting, Schmitt-trigger square-wave oscillator requires very few components to function.

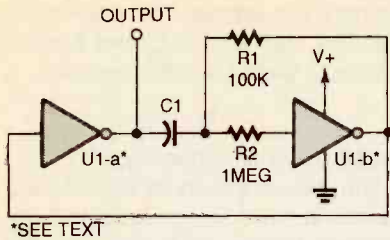

Fig. 5. This CMOS, inverting square-wave oscillator can be varied over a wide range. Note that R2 should be ten times the value of R1, as shown.

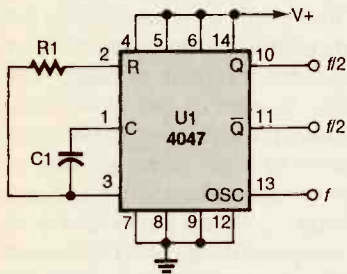

Fig. 6. This square-wave oscillator, based on the 4047 CMOS device, has complementary half-frequency outputs.

that has a 50% duty cycle. There are two resistors used in that circuit; R1 is used to set the operating frequency and R2 is approximately 10R1. Typical values for R1 and R2 are 100,000 ohms and 1 megohm, respectively. The value of C1 is less than 1000 pF. The operating frequency can be from 0.1 Hz to 1 MHz, depending on the values of R1 and C1, and is determined from:

$$f_o = 1/(2.2R1C1)$$

where  $f_o$  is in hertz, R1 is in ohms, and C1 is in farads.

Another CMOS square-wave generator is shown in Fig. 6. That circuit is based on the 4047 multivibrator circuit, which can be used for either monostable ("one-shot") or astable applications. In the configuration shown in Fig. 6, the 4047 is an astable multivibrator. There are three outputs from the 4047. The first is the oscillator (OSC) output, which is connected directly to the internal oscillator circuit. The other two outputs, Q and Q-bar, are complementary to each other and operate at one-half the frequency of the internal oscillator.

The output frequency is set by timing components R1 and C1, as in the last equation, but the Q and Q-bar outputs obey:

$$f_o = 1/(4.4R1C1)$$

The value of R1 should be between

10,000 ohms and 1 megohm, while the value of C1 should be 100 pF or more (the maximum capacitance is not limited theoretically, but a practical limit exists when the leakage resistance of C1 is of the same order of magnitude as R1).

**555-Timer Oscillators.** The 555 timer, with the possible exception of either the 741 operational amplifier or some microprocessors, is probably the most popular IC. That is because the 555 is versatile, low-cost, and behaves itself (which means that designing simple 555 projects is relatively easy).

The 555 is used to make monopolar square waves that can be either TTL compatible (V+ must be 5 volts DC), or CMOS compatible. Any power-supply voltage from 4.5- to 18-volts DC can be used, as the voltage sets the value of the high state.

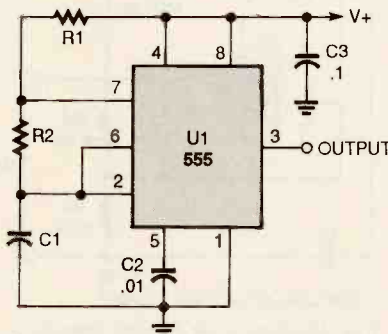

Fig. 7. Of course, the old 555 timer can be used as an astable multivibrator to generate square waves. However, for the circuit shown, they will not be symmetrical.

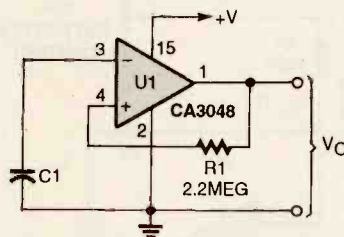

Fig. 8. An operational transconductance amplifier, square-wave generator circuit looks much simpler than it sounds.

The 555 can be connected in either monostable or astable configurations, but for continuous square waves, the astable version is used (see Fig. 7). The square-wave signal appears at pin 3 of the 555, while timing signals are processed at pins 2, 6, and 7. The output frequency of the 555 astable multivibrator is found from:

$$f_o = 1.44/((R1 + 2R2)C1)$$

The duty cycle of the 555's square-wave output is determined by the relationship between R1 and R2, and is given by:

$$\text{Duty Cycle} = (R1 + R2)/R2$$

**Linear IC Generators.** Several types of linear integrated circuits can be used to make square waves. The simplest of those is the operational transconductance amplifier (OTA). The only components in the simple circuit shown in Fig. 8 are a CA3048 OTA, a feedback resistor (R1), and a timing capacitor (C1). The output frequency is approximately given by:

$$f_o \approx 1/(2\pi R1C1)$$

Timing resistor R1 should be from 1 megohm to 3.9 megohms. When R1 is of a greater value, the circuit sometimes stops oscillating, depending upon the specific CA3048 used.

**Operational-Amplifier Generators.** The operational amplifier is one of the most useful linear IC's made. When introduced in the late 1940's (in vacuum-tube form), the op-amp was intended for performing mathematical operations in analog computers. Very rapidly, however, designers realized that the op-amp could be used for a wide variety of applications other than computing. The transistor soon introduced more people to the op-amp, but it wasn't until the advent of the integrated circuit that the complexity of the op-amp became an internal affair. The result was a simple amplifier in which the transfer function was set by manipulating the feedback.

Figure 9A shows a common op-amp square-wave generator circuit. It uses two feedback paths: one sets the DC level at the noninverting input (+), while the other is the RC timing network (R1C1). In general, if the feedback constant ( $\beta$ ) is:

$$\beta = R3/(R2 + R3)$$

the output frequency is set by:

$$f_o = 2R1C1 \ln((1 + \beta)/(1 - \beta))$$

But, as with many circuits, a simple assumption can simplify the equation quite a bit. If we assume R2 = R3, then the equation reduces to:

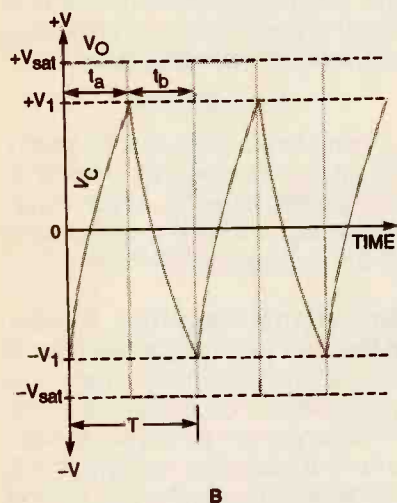
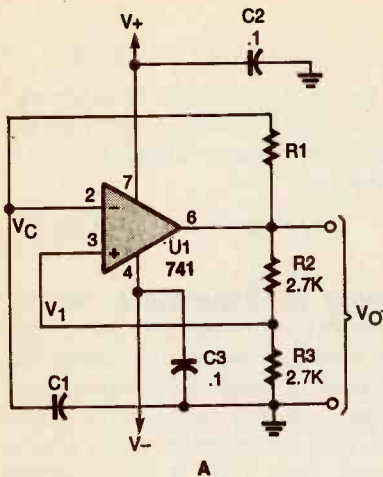

Fig. 9. This operational-amplifier square-wave generator (A) produces a 50-percent duty-cycle signal. That is because both the charge and discharge current for C1 flow through R1. The resulting charging and output waves are shown in B.

$$f_o = 1/(2.2R1C1)$$

Figure 9B shows the annotated timing waveform for the above circuit, with the capacitor charge/discharge curves superimposed on the output waveform. Because the op-amp is powered from a bipolar supply, output voltage  $V_o$  jumps between  $+V_{sat}$  and  $-V_{sat}$ . The noninverting input is biased to voltage  $V_1$ , which is a fraction of output voltage  $V_o$  according to:

$$V_1 = V_o \beta = V_o R3 / (R2 + R3)$$

Since  $R2 = R3$ :

$$V_1 = V_o / 2$$

The rules for the operational amplifiers used in the above nonlinear circuits are simple: If the inverting input is less positive than the noninverting input,

then the output is high; if the inverting input is more positive than the noninverting input, then the output is low; if the two inputs see the same potential, then the output is zero.

Assume on initial turn-on that the capacitor is discharged, so capacitor voltage  $V_c$  is zero. According to the rules for operational amplifiers, that forces a high output. Capacitor C1 can now charge under the influence of  $+V_{sat}$  and the  $R1C1$  time constant. After time  $t_a$  expires, the capacitor voltage  $V_c$  reaches  $+V_1$ , so the output snaps low to  $-V_{sat}$ . At that time, the low segment of the output waveform begins, and C1 begins to discharge under the influence of  $-V_{sat}$ . It then recharges under the opposite

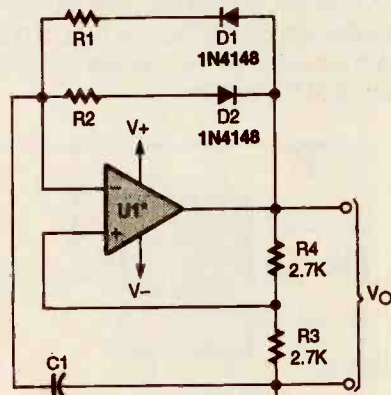

\*CHOOSE YOUR OWN OP-AMP

Fig. 10. Here is an op-amp-based square-wave generator that uses diode switching to produce a fixed duty cycle other than 50 percent.

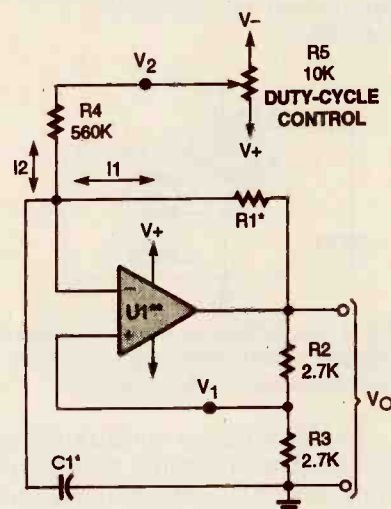

\*SEE TEXT

\*\*CHOOSE YOUR OWN OP-AMP

Fig. 11. Use R5 to adjust this variable-duty-cycle square-wave generator. That potentiometer controls  $I_2$  to vary the timing.

polarity. The process then repeats itself. The high time is  $t_a$  and the low time is  $t_b$ , while the total period is:

$$T = t_a + t_b$$

and the output frequency is  $1/T$ .

The circuit shown in Fig. 9A produces a time- and voltage-symmetrical square wave. We can alter that time symmetry by making either of the following two modifications to the circuit.

The first modification is shown in Fig. 10. That circuit uses two resistors in the timing network, and a pair of PN-junction diode switches to select which resistor is used at any given instant. Diodes D1 and D2 are backwards with respect to each other, so they conduct on alternate polarities of output voltage  $V_o$ . When the output is high, D1 is forward biased and D2 is reverse biased. As a result, R1 is used with C1 to time the circuit. When the output state changes to low, D1 is reverse biased and D2 is forward biased. In that case, R2 times the circuit. Because R1 and R2 are not equal to each other, their timing is different, so the output waveform's highs and lows are not equal.

A limitation on the circuit in Fig. 10 is that the duty cycle of the output square wave is fixed. The second modification to the circuit in Fig. 9A is the variable-duty-cycle square-wave generator shown in Fig. 11. That modification uses a DC-offset circuit (composed of R4 and R5) to inject a second current ( $I_2$ ). Because of that bias, the half cycle when  $I_1$  and  $I_2$  have the same polarity is shorter. When R5 is set to the mid-point, the value of  $V_2$  is zero, and the output waveform has the usual 50% duty cycle of the unmodified circuit.

The circuit shown in Fig. 11 can be modified to perform pulse-width modulation. For that, one end of R5 is grounded and the other end is connected to a source of triangle, sawtooth, or sinewaves that modulates the duty cycle of the square-wave signal. The modulating signal should vary over a substantial portion of the  $V+$  to  $V-$  voltage range (but not more than those values) in order to produce maximum duty-cycle variation.

Square-wave generator circuits are easy to design, easy to build, and are extremely useful for a wide variety of applications in electronics. ■

Enter A World Of Excitement with a Subscription to

# Popular Electronics®

Get the latest electronic technology and information monthly!

Now you can subscribe to the magazine that plugs you into the exciting world of electronics. With every issue of Popular Electronics you'll find a wide variety of electronics projects to build and enjoy, and feature articles that inform and entertain.

Popular Electronics brings you feature articles on technology, computers, test gear, and more—all designed to keep you tuned into the latest developments in electronics. So if you love to build fascinating projects, just fill out the subscription form below to subscribe to Popular Electronics. . . It's a power-house of fun for the electronics enthusiast.

### EXCITING MONTHLY FEATURES LIKE:

- CONSTRUCTION**—Exciting projects that range from simple radios to working robots
- FEATURES**—Learn about new technology, see how to troubleshoot all types of electronics gear, refresh your knowledge of basic electronics theory, see how components work and how to use them in your own designs, and much more
- PRODUCT REVIEWS**—Get in depth, hands-on reviews of all types of hobby gear, and learn about the latest and the greatest in consumer electronics in our no-holds-barred Gizmo section
- SPECIAL COLUMNS**—Think Tank, Circuit Circus, Computer Bits, DX Listening, Antique Radio, Scanner Scene, Amateur Radio, Multimedia Watch, and more

### PLUS: ALL OUR GREAT DEPARTMENTS!

You'll get 12 exciting and informative issues of Popular Electronics for only \$18.95. That's a savings of \$23.05 off the regular single copy price. Subscribe to Popular Electronics today! Just fill out the subscription order form below.



FOR FASTER SERVICE CALL TODAY

## 1-800-827-0383

(7:30AM-8:30PM) EASTERN STANDARD TIME

## Popular Electronics SUBSCRIPTION ORDER FORM

P.O. Box 338, Mt. Morris IL. 61054

AH395

**YES!** I want to subscribe to Popular Electronics for 1 Full year (12 Issues) for only \$18.95. That's a savings of \$23.05 off the newsstand price.

(Basic Subscription Rate—1 yr/\$21.95)

Payment Enclosed  Bill me later

Please charge my:  Visa  Mastercard

Acct. #

Signature

Exp. Date

PLEASE PRINT BELOW:

NAME

ADDRESS

CITY

STATE

ZIP

Allow 6 to 8 weeks for delivery of first issue. U.S. Funds only.  
In Canada add \$6.68 Postage (Includes G.S.T.).  
All Other Foreign add \$7.50 Postage.

## ADD A SWITCH

(Continued from page 41)

set, although after a day of jumper hunting I was somewhat less than enthusiastic.

The worst part in all this was that the PC could not be closed up until I was through playing with the construction set. As we all know, a PC with its cover removed is an accident just waiting to happen. If only there was a way to get both the construction set and the modem to work properly, at least using only one of them at a time, without having to reconfigure jumpers—and of course shutting down the computer—every time I switched between the two.

**A Total Solution.** Staring at my PC strewn across the floor, a total solution came to me: If a double-pole, double-throw switch could be connected to both the enable/disable-COM2 jumper on the I/O card and the COM2-enable jumper on the modem, all it would take to switch between the two would be a flip of the switch. The switch could easily be mounted on a spare expansion-slot cover or on a blank connector plate on the back of the computer case.

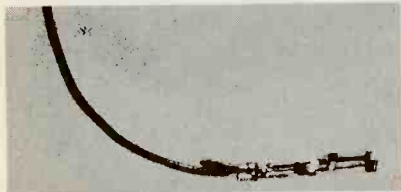

To avoid soldering to your computer peripherals, wire-crimp single-pin header sockets can be used to connect the switch to the cards.

The only problem I could foresee was how to connect switch leads to the male jumper-block pins on the two cards in question without soldering directly to them. The solution was to use five wire-crimp single-pin header sockets. Leads were crimped to each header socket and the metal body of each socket was covered with heat-shrink tubing. Figure 1 shows how the switch was connected to the jumper block on each card. With this addition to my PC, the modem works with the switch in one position and the serial port—along with the construction set—works in the other. ■

## SPRINKLER GUARDIAN

(Continued from page 57)

wire soldered to the nail heads. The probes should be buried horizontally, about 1 to 2 inches below the surface and about two feet apart.

**Installation.** Before you can use the Guardian, you have to know the resistance of the ground when it is dry. To find the resistance, bury your two probes as described before and wait a few days. Then, measure the resistance across the probes when the ground is dry and needs watering. The resistance value between the probes must fall within the range of R2 and R4, or between 10K and 40K ohms. If it falls out of that range, the distance between the probes might have to be adjusted.

The connections between the sprinkler controller and your Guardian are shown in Fig. 4. Three solenoids are shown in that system to show how the common leg connects to each; of course, there are probably more solenoids in your own system.

To install the Sprinkler Guardian, cut the common leg from the valves, and connect the leads to terminals 1 and 2 of TB3. Then, connect the buried probes to the terminals of TB2. Finally, pirate power from the supply of the controller using insulated wires, and connect the wires to terminals 1 and 2 of TB1.

**Checkout and Use.** Place S1 in the "manual" position; then turn R2 fully counter-clockwise. Relay K1 should be off and LED1 should be on. Slowly advance R2 clockwise until LED1 goes off and LED2 comes on indicating that K1 has closed. Now, slowly turn R2 counter-clockwise again until LED1 comes back on. Place S1 in the "automatic" position, and the unit is ready to use.

If adjusting R2 turns on LED1 but not LED2, the probe resistance is too high. On the other hand, if adjusting R2 turns on LED2 but not LED1, the probe resistance is too low. Decrease or increase the distance between the probes as needed to get the resistance in the proper range.

Once you get the Sprinkler Guardian up and running, you'll never have to worry about the costs of watering your lawn in the rain again. ■

## FREQUENCY-RESPONSE TESTER

(Continued from page 83)

AUDIO LEVEL control using your scope as a waveform monitor with internal sweep, to make sure no clipping occurs. Switch S2 into SWEEP mode, and set your scope to external sweep as you did during calibration. If you made your own log scale using Fig. 5, set your horizontal gain to match its width. By adjusting the vertical gain, you should be able to see the DUT's response over the entire frequency spectrum.

Here are a few hints: Although the response display seems most easily viewed with SWEEP RATE control R29 set to maximum, the low-frequency portion of the display (the left side) will not be very accurate with that setting. The Tester's lowest output frequency is about 20 Hz. Because that frequency is constantly being modulated, if the frequency increases significantly before a single 20 Hz-cycle is completed, then your test at 20 Hz is invalid. For that reason, the slowest sweep rate should be selected when seriously examining low-end response. A storage scope is of course ideal for that.

Note that the vertical display of your scope simply reads peak-to-peak voltage, which is very different from the decibel scale normally used for audio. To put things in perspective, a 50 percent dip in vertical deflection corresponds to a -3-dB drop when monitoring power amplifiers, and a -6-dB drop when testing almost any other audio device.

Finally, you might wish to occasionally touch up the low-frequency calibration via the access hole you drilled for R24. As before, leave the Tester powered-up for a few minutes before proceeding, and then perform the calibration procedure as previously described. ■





1990 was a Great Year for

# Popular Electronics®

The twelve 1990 issues of *Popular Electronics* reveal many fascinating articles. There's a bonanza of build-it project plans, informative theory articles and timeless feature stories. Check out the partial list of titles packed into the 1990 issues and you'll agree that 1990 was a banner year. If you see an article about a project, theory topic or newsworthy feature, you can have that article, with the entire issue for only \$6.50. To get your 1990 issue(s) of *Popular Electronics*, place a ✓ in the box that indicates the month you want and complete the coupon below. Note that ordering six or more copies reduces the price per issue! Tear out this page, or make a photo copy of it, and mail or FAX it today! Just follow the directions below.

## Popular Electronics 1990 Issues

### TOPICS FROM THE PAST

#### Selected Projects

Audio Ambiance Ditherizer, **April**  
 Bit Grabber for Parallel I/O Testing, **December**  
 Car-Radio Silencer, **October**  
 Cordless Test Probes, **January**  
 CW and SSB, Add to a SW Receiver, **May**  
 Digital Entry Switch, **November**  
 Economy Portable SW Receiver, **August**  
 Exhaust Monitor for Car, **June**  
 Experimental AC Hum Sniffer, **September**  
 Game Reaction Timer, **April**  
 Headphone Output for Your CD Player, **July**  
 Hot-Wire Glass Bottle Cutter, **December**  
 Indoor Burglar Alarm, **December**  
 IR-Triggered Sound-Effects Generator, **October**  
 Lie Detector, Simple, **January**  
 Microphone Preamp, Simplest, **March**  
 Mobile Battery Charger, **March**  
 NiCd Battery Tester, **August**  
 Plasma Display, Custom, **February**  
 Receiver Circuits You Can Build, **March**  
 Remote-Control FAX Switch, **August**  
 Serial Cable Tester, **January**  
 Telephone Toll Totalizer, **August**  
 Tesla's Lightning Generators, **September**  
 The Lepton Candle, **October**  
 Ultrasonic Morse-Code Transceivers, **July**  
 Universal 3-Terminal Power Supply, **November**  
 Video Titrer, Super Simple, **September**  
 Vision System for Robotic Toys, **March**  
 VLF Receiver and Transmitter, **July**  
 Water Leak Alarm, **January**

External Drive for Laptop, **June**  
 First Electric Motor Project, **October**  
 Ground Fault Technology, **November**  
 Keeping Up with Pacemakers, **July**  
 Living with Lightning, **October**  
 Make Your Own Iron-on PC Patterns, **July**  
 Old-time Radio Circuits, **March**  
 Oliver Lodge: Radio's Forgotten Pioneer, **July**  
 Restoring a Classic SW Receiver, **April**  
 Solar Power, Experimenting with, **June**  
 St. Elmo's Fire, **September**  
 Surface Mount Technology, **November**  
 Television Night, a Look Back, **July**  
 Tune-in to Satellite Radio, **May**  
 Using Appliances Overseas, **January**

#### Theory for Everyone

3-Terminal Voltage Regulators, **May**  
 200,000-volt van de Graaff Generator, **October**  
 All About Batteries, **August**  
 All About Thermistors, **December**  
 CCTV Installation Guide, **November**  
 Connect Anything to Your Computer, **August**  
 Designing Power-supply Circuits, **February**  
 Digital Electronics Introduction, **April**  
 Experiments in Electrophotography, **March**  
 Fiber-Optic Communications, **April**  
 Galvanometer, Build and Learn, **September**  
 Lasers, All About, **September**  
 Printer Technology, **October**  
 Signal Generator Circuits Cookbook, **November**  
 Stepping Motors Introduction, **March**  
 Troubleshooting Computer Disk Drives, **May**  
 Troubleshooting Your Printer, **December**  
 Typing Practice Program, **August**  
 Sideband Amplifiers, **January**  
 Wimshurst Machine, **December**  
 WW1 Long Island Spy Station, **December**

#### Special Features

Antenna Installation, **September**  
 Capacitors, Choosing and Using, **June**  
 Classic Amateur Receivers, **November**  
 Drying Out Flood-Damaged Equipment, **January**  
 Early Radio Transmitters, **May**

January	February	March	April	May	June	July	August	Sept.	Oct.	Nov.	Dec.
---------	----------	-------	-------	-----	------	------	--------	-------	------	------	------

✓ Check the issue(s) you want.  
**How to Determine Cost per Copy**

Quantity	Price per copy		
	United States	Canada	Foreign
1-5	\$6.75 US	\$7.75 US	
6-12	5.75	6.75	\$8.50 US

Prices include handling and shipping costs. Prices subject to change. All Canada and foreign orders payable in U.S.A. funds only, via international money order, check drawn on a U.S. bank, or acceptable credit card (Visa, MasterCard) in U.S.A. funds. Allow 6-8 weeks delivery. Minimum foreign order—6 issues. Foreign orders may take longer. PE7

Visa  MasterCard  USA Bank Check  US or International Money Order

Credit Card Number \_\_\_\_\_ Exp. Date \_\_\_\_/\_\_\_\_  
 (If used)

Signature \_\_\_\_\_ Total No. of Copies \_\_\_\_\_

Print Name \_\_\_\_\_ Total Amount \$ \_\_\_\_\_

Address \_\_\_\_\_

City \_\_\_\_\_ State \_\_\_\_\_ ZIP \_\_\_\_\_

Send orders to: CLAGGK, Inc. P.O. Box 4099, Farmingdale, NY 11735. No COD orders. Credit Card user may telephone or FAX order. Telephone 516-293-3751 or FAX 516-293-3115.

**PARTIAL LIST OF CONTENTS**

- Alternative Energy
- Amateur Television
- Antennas
- Antenna Duplexers
- Associations
- Auto Tags
- Award Plaques
- Badges, Balloons
- Batteries, Blimps
- BBS Listings
- Beam Headings
- Belt Buckles
- Books
- Books, Braille
- Books, Soviet
- Bumper Stickers
- Calendars
- Classified Ads
- Crystals
- Digital Frequency Display
- Digital Signal Processing
- Direction Finding
- Directories
- Duplexers
- DX Guides
- Embroidered Caps
- Emergency Supplies
- Filters
- Frequency Converters
- Frequency Counters
- Headphones
- Hurricane Tracking
- ID, Morse Code
- Interfaces:
- Computer-to-Rig
- Iron Powder and Ferrite
- Keyers, Kits, Lasers
- Linear Amplifiers
- Magazines, Manuals
- Meters
- Modifications, Mugs
- Newsletters
- Online Directories
- Software, Amiga
- Software, Apple
- Software, Commodore
- Software, PC
- Study Guides
- Surveillance
- Tools, Transverters
- TVI Filters
- Used Equipment
- Video Cams
- Weather Instruments

**Tune in the mail-order market for greater Ham Radio activity and enjoyment!**



Uncover the Undiscoverable

Eliminate Wasteful Search Time

Find the Better Buys

**Discover who's who in over 220 Amateur Radio activities!**

Introducing the one and only directory that will open the world of Amateur Radio mail-order bargains for you! Discover who's who in the world of amateur radio mail order! Find the part, antenna, test gear, gadget or gizmo you can't buy over the counter. Over 1700 listings! Over 220 categories! Plus, the huge Resource Directory includes the following: a list of 100 FREE catalogs you can order today; a list of 85 computer BBS's, 322 worldwide clubs; etc. Also included are mini-directories on Foreign Radio magazines, Amateur Radio satellites, Amateur Radio DX hotlines and helplines, detailed glossary, and the W6DDB Library of Tips for Hams! You'll find your copy of the 1994 *Amateur Radio Mail Order Catalog and Resource Directory* must reading!

**A "must have" Directory for Hams, SWL's, project builders, & electronics enthusiasts!**

I need to know who's who in the Amateur Radio mail-order business! Send me the latest edition of *The Amateur Radio Mail Order Catalog and Resource Directory* now!

Check one:

- \$9.98 which includes shipping and handling for postal *Book Rate* delivery to US and Canada
  - \$12.98 which includes shipping and handling for postal *First Class* delivery to US
  - \$14.48 which includes shipping and handling for postal *First Class* delivery to Canada
- Payment in US funds only.

VISA    MasterCard    USA Bank Check    US or International Money Order

Credit Card Number \_\_\_\_\_ Exp. Date \_\_\_\_/\_\_\_\_/\_\_\_\_

(If used)

Signature \_\_\_\_\_ Total No. of Copies \_\_\_\_\_

Print Name \_\_\_\_\_ Total Amount \$ \_\_\_\_\_

Address \_\_\_\_\_

City \_\_\_\_\_ State \_\_\_\_\_ ZIP \_\_\_\_\_

Send orders to CLAGGK, Inc., PO Box 4099, Farmingdale, NY 11735. No COD orders. Credit Card users may telephone or Fax Orders. Telephone 516-293-3751 or FAX 516-293-3115.

Prices subject to change. Allow 6 to 8 weeks delivery.

CB01

**NOVEL NIGHTLIGHT**

*(Continued from page 36)*

× 7 inches each, for the sides of the nightlight. The top is a 7¼-inch square of glass. You will also need to cut four pieces of top molding and four pieces of corner molding, using the dimensions given in Fig. 3.

To assemble the nightlight cover, apply epoxy glue to the inside edges of each piece of molding that you are ready to attach. Carefully fit together the pieces of glass and the mirrors that make up the sides of the box (the mirrors should be adjacent), and hold them firmly in place to allow the glue ample time to dry. When the sides are assembled, glue the top square of glass to the pieces of top molding. After that has fully dried, glue the assembly to the top of the glass box.

The glass cover should be secured to the baseboard, especially if the Novel Nightlight will be used by young children. That can be accomplished in a number of ways. On the prototype, a piece of wire is connected between two small screws on opposite corner moldings. Sliding the wire under the baseboard prevents the cover from being lifted. If you prefer, you can attach small latches on opposite sides of the project, instead.

With the case assembled, you can safely plug in and use the Novel Nightlight. So, put an antique VR tube to good use, and brighten up your evenings while you're at it. ■



**Earthquakes seem to move everyone closer together.**

Earthquakes. Floods. Hurricanes. Fires. Wherever tragedy strikes, The Salvation Army is among the first to arrive. Offering hope to those in need. Please give, so when we're needed we'll be ready to move.

**THE SALVATION ARMY**  
Changing the World One Life at a Time.





450P-XX \$36.95  
Counts as 2



3795P \$19.95

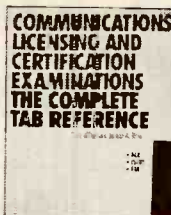

0708223-XX \$44.95  
Counts as 2/Hardcover



036432X \$27.95  
Hardcover

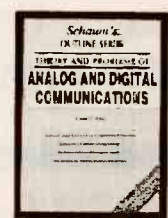

0306382 \$13.95



0304165 \$26.95  
Hardcover



0158778 \$44.95  
Hardcover



4112H-XX \$34.95  
Counts as 2/Hardcover

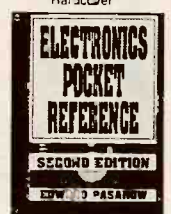

0487375 \$24.95



4179H \$28.95  
Hardcover



3258P \$15.95



0156697 \$44.95  
Hardcover

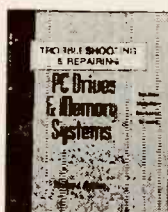

4491P \$24.95

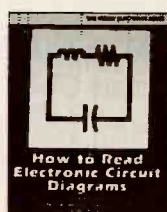

2880P \$15.95



0378514-XX \$44.95  
Counts as 2/Hardcover



2790P \$17.95

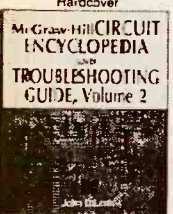

0376107 XX \$59.50  
Counts as 2/Hardcover



4227P \$15.95



3711P \$19.95



2613P \$19.95

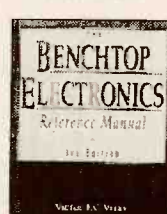

0673764 XX \$54.95  
Counts as 2/Hardcover



3627P \$19.95

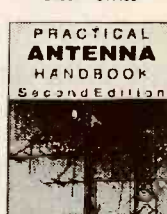

0111049-XX \$49.95  
Counts as 2/Hardcover



3700H-XX \$36.95  
Counts as 2/Hardcover



1122H \$36.95  
Hardcover

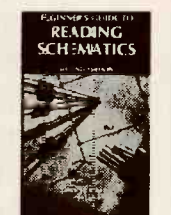

3632P \$10.95

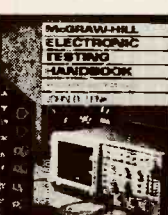

0376026 \$42.95  
hardcover



3279P \$26.95



0158751-XX \$55.00  
Counts as 2/Hardcover

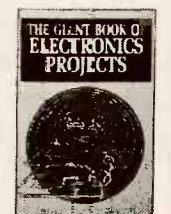

1367P \$29.95

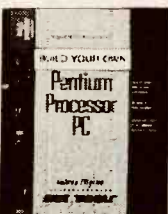

0501637 \$32.95  
Hardcover

# Select any 5 books

# for only \$4<sup>95</sup>

(values up to \$202.75)

## when you join the Electronics Book Club®



### As a member of the Electronics Book Club . . .

. . . you'll enjoy receiving Club bulletins every 3-4 weeks containing exciting offers on the latest books in the field at savings of up to 50% off of regular publishers' prices. If you want the Main Selection, do nothing and it will be shipped automatically. If you want another book, or no book at all, simply return the reply form to us by the date specified. If you ever receive a book you don't want due to late delivery of the bulletin, you can return it at our expense. You'll have at least 10 days to decide. And you'll be eligible for FREE BOOKS through the Bonus Book Program. Your only obligation is to purchase 3 more books during the next 12 months, after which you may cancel your membership at any time. A shipping/handling charge and sales tax will be added to all orders. All books are softcover unless otherwise noted. (Publishers' prices shown.) If you select a book that counts as 2 choices, write the book number in one box and XX in the next. ©1995 Electronics Book Club PEX785

If card is missing, write to: Electronics Book Club, A Division of McGraw-Hill, Inc., Blue Ridge Summit, PA 17294-0810

# The Electronics Industry is looking for a lot of good people!

Here is your chance to get in on the ground floor as an Associate CET. Is your job title "Electronics Service Technician?" Would you like to have that title? You can prove you qualify for the title with a CET Associate Certificate. It can be your career door-opener and begin your rapid advancement!

A technician or student of electronics with less than a total of four years of basic experience may take the Associate Level Exam. The exam is the basic electronics portion of the full-credit CET exam. The 75-question, multiple-choice test covers basic electronics, math, DC and AC circuits, transistors and semiconductors, instruments, measurements and troubleshooting. A successful Associate CET will receive a wall certificate valid for four years and is eligible to join ISCET as an Associate Member. ISCET is the International Society of Certified Electronics Technicians.

The ISCET Computer-Aided Associate-Level Study Guide prepares you for the Associate CET Certificate by randomly selecting sample questions with appropriate diagrams, provides multiple-choice answers, grades the test and provides a summary of your strong and weak points.

**CLAGGK INC. - CET Computer-Aided Study Guide Offer**  
**PO Box 4099, Farmingdale, New York 11735**

**Yes,** I want to step up to a career in servicing. Here is my order for the CET Computer-Aided Study Guide on a 3.5 diskette.

Bill my  VISA  MasterCard Expire Date   /  /    
 USA Bank Check  US or International Money Order

Card No. \_\_\_\_\_

Signature \_\_\_\_\_

Name (Please Print) \_\_\_\_\_

Address \_\_\_\_\_

City \_\_\_\_\_ State \_\_\_\_\_ Zip \_\_\_\_\_

New York residents add local sales taxes. Canadians add \$6.00 per order. No foreign orders. Do not send cash. Checks drawn on US Bank and International Money Orders in US funds only. Credit card users may telephone or FAX orders. Telephone 516-293-3751 or FAX 516-293-3115. Price subject to change. Allow 6 to 8 weeks for delivery.

CB05

## Proof Positive that you are a Certified Electronics Technician

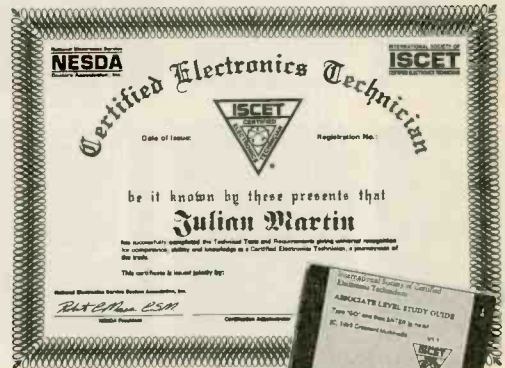

### A New Computer Software Program — ISCET Computer-Aided Associate-Level Study Guide

Prepare yourself for the 75-question CET Associate Examination. Model examinations provide the technician with a study program and introduction to the actual examinations. The model examinations are automatically graded in decimal numbers and bar graphs that can be outputted on your printer. The questions for each exam are selected randomly from a loaded data base—no two exams are exactly the same. When you answer a question, the correct answer is displayed and an explanation is given. From the printouts you will determine whether you need more practice and in which topic areas, or if you are ready to take the real test and continue to promote your electronics career today!

# YOU CAN \$ SAVE BIG \$ AT THE GROCERY STORE

## CUT YOUR GROCERY BILL



VEG SOUP	.89
BEAN SOUP	.98
POT CHIP	1.95
PEAS	.76
MILK 2X GAL	2.10
QJ GAL	2.99
6 PACK PEPSI	2.99
6 PACK PEPSI	1.55
SPAGHETTI	1.34
BANANAS	2.65
GRITS	.89
GRN BEANS	.89
GRN BEANS	3.50
CORN	2.20
CARROTS	1.95
APPLES	2.97
ORANGES	

RED PEPPER	1.10
MEAT DEPT	6.97
MEAT DEPT	4.95
COFFEE	4.98
EGGS	1.40
CHEESE	3.50
BUTTER	2.40
SALT	2.25
PAPER PLATES	3.49
FOAM CUPS	1.13
PAPER TOWEL	.98
SOAP	4.98
CUP CAKES	.99
QAT-R COOKIES	2.98
POP CORN	2.49
BAGELS	1.25
BREAD	1.39
MAGAZINE	3.50
NEWSPAPER	.50

## DOWN TO SIZE

Save up to 50% and More on over 1,000 National Name Brand Products.

SELECT THE COUPONS YOU WANT FOR THE GROCERIES YOU BUY!

Imagine having a coupon for almost every item that you buy at the grocery store! Think of the savings, especially on double and triple coupon days. By selecting the coupons for the groceries you buy, you will save from 20 to 50 percent and more on your grocery bill! It's Guaranteed!

**YOU GET TO SELECT FROM A LIST OF OVER 1000 NATIONAL NAME BRAND PRODUCTS.** Kraft, Frito Lay, Colgate, Folgers, Campbells, Nabisco, Oscar Mayer, Green Giant, Johnson's Gerber, Hunts, Kelloggs, Pillsbury, Dole, Heinz . . . And the list goes on!

These manufacturer's coupons can be used wherever you shop and as often as you like. When you use this Grocery Coupon Certificate Book Program, you are guaranteed to save money at the grocery store! You select the coupons you want from a list of over 1,000 national name brand products. Stretching your grocery shopping dollar has never been easier.

Grocery Coupon Certificate Books contain certificates valued at \$10.00 each. For example: the \$200.00 Grocery Coupon Certificate Book contains twenty \$10.00 certificates. Each certificate is redeemed for manufacturer's coupons through the Coupon Redemption Center. The number of \$10.00 Certificates that you redeem at one time depends upon your grocery buying needs. The coupons that you receive can be redeemed at your favorite grocery store. So now you can buy trusted name brand products at generic brand prices using manufacturer's coupons. Your savings are guaranteed when you use this money saving Grocery Coupon Certificate Book Program! You can't lose! Coupons valid in U.S. stores only!



**Order Your Grocery Coupon Certificate Book Today!**

**Yes.** I want to save big at the grocery store! Please send the *Grocery Coupon Certificate Book(s)* indicated at right.

Visa  MasterCard  USA Bank Check  US/International Money Order

Total Amount \$ \_\_\_\_\_ (NY State residents add local sales tax.)

Credit Card No. \_\_\_\_\_ Expire Date \_\_\_\_/\_\_\_\_/\_\_\_\_

Signature \_\_\_\_\_

Print Name \_\_\_\_\_

Address \_\_\_\_\_

City \_\_\_\_\_ State \_\_\_\_\_ ZIP \_\_\_\_\_

Send orders to **CLAGGK INC.**, PO Box 4099, Farmingdale, NY 11735-0793. Credit card users may FAX orders: 516-293-3115. US funds only. Prices subject to change. Allow 6-8 weeks delivery.

Please send Grocery Coupon Certificate Book(s) each good for *One Hundred Dollars* of face-value Grocery Coupons, at \$6.95 each. **Plus, receive a Ten Dollar Bonus!**

*To save even more money!*

Please send Grocery Coupon Certificate Books each good for *Two Hundred Dollars* of face-value Grocery Coupons, at \$12.95 each. **Plus, receive a Twenty Dollar Bonus!**

CB04

# NOW Find the Right Part for Your VCR!

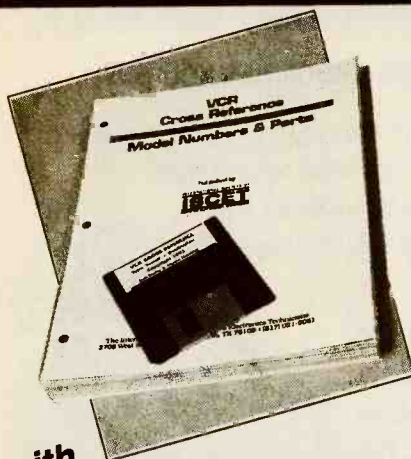

## with the **ISCET VCR CROSS REFERENCE**

**NEW!** The Fifth Edition is contained on a diskette for IBM PC AT/XT compatibles, DOS 2.1 or higher. The disk software allows technicians to search by manufacturer for model numbers and description of part numbers. A parts editing sequence gives an on-screen view of all substitutes for parts entered. With the diskette, the technician can update files by adding model and parts

The 119-page Fifth Edition of the VCR Cross Reference contains both model and part number cross references. Over 1300 new parts and 360 new models have been added.

VCR's are made in a few factories from which hundreds of different brand names and model numbers identify cosmetically-changed identical and near-identical manufactured units. Interchangeable parts are very common. An exact replacement part may be available only a few minutes away from you even though the original brand-name supplier is out of stock. Also, you may be able to cannibalize scrap units at no cost.

crosses of future models. The Fifth Edition can be printed on pages completely from the diskette.

The ISCET VCR Cross Reference, Fifth Edition, is on 8½ × 11-in., pre-punched pages and sell for \$38.00. The 3½ inch diskette sells for \$69.95 and you can view listings from a monitor or printed page.

**Only \$38.00 for pages  
\$69.95 diskette**

**Claggk Inc.  
VCR CROSS REFERENCE OFFER  
P.O. Box 4099  
Farmingdale, New York 11735**

Name \_\_\_\_\_  
Business \_\_\_\_\_  
Address \_\_\_\_\_  
City \_\_\_\_\_  
State \_\_\_\_\_ Zip \_\_\_\_\_  
Phone \_\_\_\_\_

Enclosed \$38.00 for the ISCET VCR Cross Reference, Fifth Edition.

Enclosed \$69.95 for the diskette containing the ISCET VCR Cross Reference, Ver. 6.0. Please specify:

5¼ Diskettes (2) 3½ Diskette (1)

Include \$3.00 for shipping each Cross Reference (Pages or Diskette)

The total amount of my order is \$ \_\_\_\_\_

Check enclosed—do not send cash.

Visa  MasterCard Exp. Date \_\_\_\_/\_\_\_\_/\_\_\_\_

Signature \_\_\_\_\_

New York State residents must add applicable local sales tax to total.

CB03

## PK TESTER

(Continued from page 54)

With R5 adjusted, you can complete the assembly of the unit. Drill 16 holes on the top panel of the project case to match the pattern of the LED's. Insert an LED lens cap into each of the holes, then lift the board and press the LED's into their respective caps. When that is done, the PC board will be held firmly under the panel.

**Using the Tester.** The finished unit has two pushbutton switches (S1 and S2). If the STATUS/TEST button (S1) is depressed when power-switch S3 is on, the Tester will go into a self-test mode. It will take 480 samples and see if the RNG is operating correctly. If it is, all the LED's will flash and the unit will then proceed into its normal-operation mode. If there is a problem with the circuit, all the LED's will continue flashing, indicating an error, until the unit is powered down. Check the calibration of R5 if that occurs.

Once in the normal-operation mode, the PIC keeps track of LED "movements" to the left or right. To find out if one direction has been coming up more frequently, hold down the STATUS/TEST button. If the top two LED's light up, then there is no excess movement. If one or more light to the left or right, then that means the unit is biased in the indicated direction. To determine the *maximum* number of moves that the unit is biased in that direction, use:

$$n \times 16$$

where n is the number of LED's lit. The system of LED's used in the PK Tester can only indicate the left or right bias in increments of 16 moves. For that reason, the *minimum* number of moves is 15 less than the maximum number. For example, if three LED's are lit to the right, then movement to the right exceeds normal by 33 to 48 moves. As a guide, a reading of seven LED's to the left or right indicates an extreme bias in that direction. When you have finished taking a reading,

you can either let go of the STATUS/TEST button and resume testing, or clear the "movement" counters and restart the PK Tester by pressing S2.

**An Experiment.** Leave the box on for 24 hours and verify its randomness by pressing STATUS/TEST. Then, have a test subject concentrate on the PK Tester. Have him or her "will" the movement of the LED either clockwise or counterclockwise. After about ten minutes, verify whether the LED movements are neutral by again pressing the STATUS/TEST button. Should the LED movement be biased in one direction, have the subject continue his or her "willing" so that you can see if the bias is coincidental. After another ten minutes the status response should show an even greater bias if the RNG actually is being influenced. Next, press the RESET button and ask the subject to concentrate in the reverse direction. If the bias follows the desired direction after several reversals, your subject most likely has a notable level of PK ability. ■

# Electronics Experimenters' Books



**PCP116—Introducing Digital Audio—CD, DAT and Sampling...\$10.00.** Digital audio involves methods and circuits that are totally alien to the technician or inquiring amateur who has previously worked with audio circuits. This book is intended to bridge the gap! The principles and methods are explained, but the mathematical background and theory are avoided when practical.



**BP325—A Concise User's Guide to Windows 3.1...\$7.95.** If you are having trouble with Windows 3.1, then discover how to manipulate Windows screens and how to run Windows and DOS applications under the Windows Graphic User Interface (GUI) environment. There's more: the word processor (Write), Program Manager, File Manager and Print Manager will be mastered by you. The text's scope is enormous.



**BP233—Electronic Hobbyists Handbook...\$9.95.** A collection of data for the amateur electronics enthusiast. The text includes data on a multitude of topics such as parts color codes, integrated circuit pin-outs, transistor lead-out diagrams and data, basic circuit building blocks, and much more. Where appropriate, detailed background information and explanatory notes are provided.



**BP278—Experimental Antenna Topics...\$5.95.** Contains 28 fascinating sections and includes many unusual practical antenna designs that use such outlandish materials as cardboard, aluminum foil, plastic bottles, cat-food cans, etc., even water!



**PCP104—Electronics—Build and Learn...\$9.95.** Construction details are given to build a circuit demonstrator that is used throughout the book to introduce common electronic components and how these components are built up to useful circuits.



**BP287—A Reference Guide to Practical Electronics Terms...\$8.95.** A companion volume to BP286. Covers the more practical and applied aspects of electronics. An essential reference work for the library of all those interested in electronics.

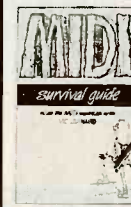

**PCP118—MIDI Survival Guide...\$7.75.** The book offers practical advice on starting up, setting up, and ending up with a practical MIDI system. Includes over 40 cabling diagrams and tips on connecting synths, sound modules, sequencers, etc.



**PCP117—Electronic Projects for Guitar...\$12.95.** If you are a guitarist, you'll find this collection of 16 guitar and general-purpose effects projects extremely useful at bargain do-it-yourself prices. Each project has an Introduction, an explanation of how it works, complete instruction on stripboard layout and assembly, as well as notes on setting it up and using. Written for the beginner project builder.



**BP256—Introduction to Loudspeakers and Enclosure Design...\$5.95.** All you need to know about the theory and operation of loudspeakers (drivers) and the various types of enclosures (boxes) into which they should be built. Crossover units are covered. Also includes the complete design and construction details of how to make an inexpensive but high-quality enclosure called the "Kapellmeister."



**BP195—An Introduction to Satellite Television...\$9.95.** As an introduction to satellite television this book is presented on two levels. For the absolute beginner with no previous knowledge, the story is told as simply as it can be in the main text. For the professional engineer, student or others with technical backgrounds, there are numerous appendices backing up the main text with additional technical and scientific details.



**BP275—Simple Shortwave Receiver Construction...\$6.95.** Contains practical designs for building a number of simple shortwave receivers. Comprehensive plans include diagrams and full coil-winding details where necessary.



**BP251—Computer Hobbyists Handbook...\$8.95.** Provides a single, quick reference source to bountiful data and information that the computer hobbyist will find useful. An absolutely essential addition to your bookshelf that will become a reference text.



**BP162—Counting on QL Abacus...\$4.95.** Shows the reader how to get the maximum use from the enormously powerful QL Abacus which is a practical spreadsheet-type program. Useful for presenting information and data.



**BP58—50 Circuits Using 7400 Series IC's...\$5.50.** Interesting and useful circuits and applications that cover many different aspects of electronics using this readily freely obtainable, inexpensive and fantastically versatile series of devices.

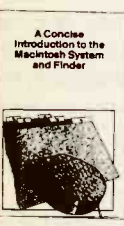

**BP298—A Concise Introduction to the Macintosh System and Finder...\$6.25.** If you have one of the popular Macintosh range of computers, this book is designed to help you get the most from it. Although the Mac's WIMP user interface is designed to be easy to use, much of it only becomes clear when it is explained in simple terms. All Macintosh computers are covered including the new "Classic" range.



**BP101—HOW TO IDENTIFY UNMARKED IC's...\$2.25.** A chart that shows the reader how, with just a multimeter, to go about recording the particular signature of an unmarked IC which should enable the IC to then be identified. By now you are probably wondering what an IC signature is. It is a specially plotted chart produced by measuring the resistances between all terminal pairs of an IC.



**PCP114—Advance MIDI User's Guide...\$14.95.** Although still regarded by many as nothing more than a way to get one instrument to follow the playing of another, MIDI actually has capabilities that go well beyond the simple slaving arrangement. This splendid book explains all the MIDI messages, routing MIDI in simple to advanced systems, explains how to troubleshoot when things go wrong, and much more.

## Bargain Table Best Buys for Experimenters and Computer Buffs

- |  |  |
|--|--|
| <input type="checkbox"/> BP106—Modern Opamp Projects .....\$5.75                     | <input type="checkbox"/> BP195—An Introduction to Satellite Television .....\$6.25   |
| <input type="checkbox"/> BP137—BASIC and FORTRAN in Parallel .....\$3.95             | <input type="checkbox"/> BP198—An Introduction to Antenna Theory .....\$6.95         |
| <input type="checkbox"/> BP138—BASIC and FORTH in Parallel .....\$3.95               | <input type="checkbox"/> BP248—Test Equipment Construction .....\$5.95               |
| <input type="checkbox"/> BP154—An Introduction to MSX BASIC .....\$4.95              | <input type="checkbox"/> BP249—More Advanced Test Equipment Construction .....\$6.95 |
| <input type="checkbox"/> BP169—Hot to Get Your Computer Programs Running .....\$5.95 | <input type="checkbox"/> BP260—A Concise Introduction to OS/2 .....\$4.95            |
| <input type="checkbox"/> BP194—Modern Opto Devices Projects .....\$6.25              | <input type="checkbox"/> BP263—A Concise Introduction to dBASE .....\$6.95           |

**ELECTRONIC TECHNOLOGY TODAY INC.**  
P.O. BOX 240, Massapequa, NY 11762-0240

Name \_\_\_\_\_  
Address \_\_\_\_\_  
City \_\_\_\_\_ State \_\_\_\_\_ Zip \_\_\_\_\_  
EN3 Allow 6-8 weeks for delivery

**SHIPPING CHARGES IN USA AND CANADA**

\$0.01 to \$5.00 .....	\$2.00
\$5.01 to \$10.00 .....	\$3.00
\$10.01 to 20.00 .....	\$4.00
\$20.01 to 30.00 .....	\$5.00
\$30.01 to 40.00 .....	\$6.00
\$40.01 to 50.00 .....	\$7.00
\$50.01 and above .....	\$8.50

**SORRY No orders accepted outside of USA & Canada**

Total price of merchandise ..... \$ \_\_\_\_\_  
Shipping (see chart) ..... \$ \_\_\_\_\_  
Subtotal ..... \$ \_\_\_\_\_  
Sales Tax (NYS only) ..... \$ \_\_\_\_\_  
**Total Enclosed** ..... \$ \_\_\_\_\_

Number of books ordered

**All payments must be in U.S. funds!**



## For years of easy rockin', make U.S. Savings Bonds part of your retirement savings program.

U.S. Savings Bonds are safe — they're backed by the full faith and credit of the United States. They're also guaranteed to earn interest. And they're both easy to buy — get them where you work or bank — and easy to afford. You can buy them for as little as \$25.

Ask your banker or your employer about including U.S. Savings Bonds in your retirement savings program.

For a recorded message of current rate information, call  
**1-800-4US BOND**  
**1-800-487-2663**



A public service of this magazine

### TELEPHONE-LINE SIMULATOR

(Continued from page 77)

A power switch was not used in the prototype. Although a power control is not necessary, you can add an SPST type toggle switch in series with the primary of T1.

Connect the main board to the power-supply board using short lengths of insulated wire. Wire the square pad to the square pad, the center-tap (ct) pad to the center-tap pad, and the remaining pad to the remaining pad.

Be sure to trim any long component leads. After assembly, clean the solder flux off the circuit boards. Commercial solvents are available that do a terrific job of removing the flux residue.

Mount the two circuit boards on short standoffs in an enclosure of your choice. Be careful when mounting the power board; do not allow it to come in contact with the conductive surfaces of your cabinet! Position the power board in your enclosure so that T3 is a minimum of two inches from T1 and T2. If they are placed too close together you may hear power-line AC hum on the telephone audio.

**Test and Check-Out.** Disconnect any telephone equipment plugged into the line-1 and line-2 phone jacks. Remove the JU1 power-up-mode configuration jumper. Install the JU2 CPC-configuration jumper. Adjust R14 (which sets the audio level) to about the middle of its range.

Turn on AC power and verify that the LED display shows "r." for a moment then shows "n." (normal mode). Press the mode switch and verify that it can be cycled through the five different modes (n, A, b, c, and d).

Remove power and install the JU1 configuration jumper. Turn on AC power and verify that the LED display shows "r." for a moment then shows "A." (automatic mode).

Set the unit to the normal mode ("n."). Connect a standard telephone to the line 1 (main) modular phone jack. Pick up line 1 and verify that a dial tone can be heard. If you are using a DTMF phone, dial a digit and verify that the dial tone stops and the digit is shown on the LED display.

Hang up the phone; then lift the handset again. Verify that you can

hear a dial tone again. Press the ring switch once and verify that a ringing sound can be heard in the telephone handset (it should sound like an authentic ring signal). Pressing the Ring switch again or hanging the phone up will terminate the ring sound and return the dial tone.

Plug a second telephone into the line 2 (test) jack. Pick up the line-1 phone and again press the ring switch. Verify that the line-2 phone's bell is activated. It should ring with a cadence similar to a standard ring pattern.

Try the remaining operational modes. For example, set the mode to "A" to have line 2 ring whenever line 1 is lifted off-hook.

#### Beep- and Cycle-Mode Operation.

To use the beep or cycle modes with the delay feature, connect an answering machine or telephone to line 2. If you are using the cycle mode, be sure to also install a phone in the line-1 jack. Start line-2 ringing by lifting the line-1 phone off-hook (cycle mode) or pressing the ring switch (beep mode).

While the test line is ringing, you can adjust the delay potentiometer from 10–90 seconds by viewing the LED display; the display will show a readout of 1 to 9. If the delay cycle has already started (as seen by the chasing LED pattern), you can press and hold the ring switch to review the delay-count setting.

When line 2 is answered, a series of beeps will be generated that will make most voice-operated (VOX) answering systems stay on the line (if they are operating correctly). If you want to force the answering system to periodically hang up, just use that unit's VOX time limit switch.

Keep line 1 off-hook if using the cycle mode. After the answering machine (or telephone) hangs up, it will be cycled on again every 10–90 seconds, depending on the R35's setting. At any time you can cancel the beep or cycle modes by pressing the Mode switch.

**Conclusion.** Using Ring-It! couldn't be easier. Plug the equipment to test or demonstrate into line 2 and use the line 1 telephone to place calls to it. Now that you're ready to use your Ring-It! project, reach out and touch someone. ■



# ELECTRONICS BUYER'S MART

## FOR SALE

**THE Case Against the Patents.** Thoroughly tested and proven alternatives that work in the real world. \$28.50. **SYNERGETICS PRESS**, Box 809-C, Thatcher, AZ 85552. (520) 428-4073. Visa/MC.

**300 Experimenters Circuits** — Complete in 6 practical books using diodes, relays, FET's, LED's, IC 555's, and IC CA3130's for building blocks. Only \$33.00 plus \$6.00 for shipping. USA and Canada only. US funds. **ETT, INC.**, PO Box 240, Massapequa Park, NY 11762-0240.

**SURVEILLANCE Privacy Security** protection. Catalog \$5.00. **SPY EMPORIUM**, 6065 Hillcroft, Suite 414, Houston, TX 77081. (713) 774-1000.

## PLANS AND KITS

**ALL-in-one catalog. AM/FM/ham/spy**, transmitters, amplifiers, receivers. Voice scramblers/disguisers, audio, TV, Tesla coils, plans, "secret" books, kits, imports, exports and more. Start your own licensed or unlicensed radio station, 60 full pages for \$1.00. **PAN-COM INTERNATIONAL**, PO Box 130-FH, Paradise, CA 95967.

**60 SOLDERLESS Breadboard Projects** in two easy-to-read pocket books. Complete with circuit descriptions, schematics, parts layouts, component listings, etc. Both books (BP107 & BP113) only \$11.90 plus \$4.00 for shipping. USA and Canada only. US funds. **ETT, INC.**, PO Box 240, Massapequa Park, NY 11762-0240.

**CRYSTAL set Handbook** — Visit antiquity by building the radios your grandfather built. Assemble a "Quaker Oats" rig, wind coils that work and make it look like the 1920's! Only \$10.95 plus \$4.00 for shipping and handling. **ELECTRONIC TECHNOLOGY TODAY, INC.**, PO Box 240, Massapequa Park, NY 11762-0240. US funds only! USA and Canada — no foreign orders.

## BUSINESS OPPORTUNITIES

**START** your own technical venture! Don Lancaster's newly updated **Incredible Secret Money Machine II** tells how. We now have autographed copies of the Guru's underground classic for \$18.50. **SYNERGETICS PRESS**, Box 809-C, Thatcher, AZ 85552. (520) 428-4073. Visa/MC.

## EDUCATION INSTRUCTION

**ELECTRICITY** Electronics training series used by US military. 24 volumes, other courses available. Free catalog; **FEDERAL TECHNICAL PUBLISHERS**, Box 1218 E., Glen Lake, MN 56345.

## CABLE TV

**UNIVERSAL descrambler**, \$129.95 + \$5.00 S&H. "Bullet" **Buster**, \$19.95 + \$3.00 S&H. Booklets, "Cable Unscrambled" and "Descrambler Schematics Revealed", \$10.00 each ... and much more! Visa/MC. **ELECTROMAN**, Box 24474, New Orleans, LA 70184. (504) 482-3017.

## BEST BY MAIL

Rates: Write National, Box 5, Sarasota, FL 34230

### BOOKS & CATALOGS

**PINBALL MACHINES BOOKS**, Parts, Supplies. Catalog \$1.00. **MARCO**, 2401-(EHH) Sunset, West Columbia, SC 29169-4717.

**PROFESSIONAL SECURITY SYSTEMS**. Free catalog. Security, PO Box 2933, West Monroe, LA 71294.

### COMPUTERS & SOFTWARE

**FOR THE LOWEST Priced Computers, Printers And Hardware** Call 800-540-2855.

**1000% PROFIT WITH** your computer! For complete details call: (419)-872-2792.

**PERSONAL COMPUTER OWNERS CAN EARN \$1000** to \$5000 monthly offering simple services part time. Free list of 100 best services. C.B.C.A.Z., P.O. Box 926168, Houston, TX 77292.

### OF INTEREST TO ALL

**LASER SAFETY LIGHT** has 2,500 feet of visibility for biking, camping, horseback riding, jogging, roller-blading or tending to auto emergencies. Send \$17.45 to: **BEACO Inc.**, P O Box 1168-(EHH), Glenside, PA 19038. **MUST SEE TO BELIEVE!** \$1,000+ POSSIBLE MONTHLY WRITE: MailOrder Express, 80550, Memphis, TN 38108.

**RADIO! ON THE Job** Training in Local Radio Stations. Part time, Nights, Weekends. No experience required. Free Brochure and Recording tells how. Toll free 1-800-858-4241.

**INVENTORS. HOW TO** Invent; Protect; Sell! Free Report. Randolph, Box 92972, Lakeland, FL 33804.

## SURVEILLANCE

& COUNTERSURVEILLANCE Electronic Devices

Hidden Video Cameras • Electronic Kits • Voice Changers  
Bug and Phone Tap Detectors • Shotgun Mics • Micro Recorders  
• Vehicle Tracking • Locksmithing • AND MORE!

Extra Long Play Telephone Recorders - Silently Tapes **\$125.00**  
Incoming/Outgoing Phone calls automatically... send up

**SPY FOR CATALOG SEND \$5.00 TO...** P.O. Box 337,  
**OUTLET** Buffalo, NY 14226 (716) 691-3476 - (716) 695-8660

## HOW FAR YOU GO DEPENDS ON WHERE YOU GET YOUR START.



## 1-800-854-CLUB



**BOYS & GIRLS CLUBS  
OF AMERICA**

*The Positive Place For Kids.*

## NEW TOOL

**Hot-A-Cro**  
Miniature Heatgun  
For Heat-Shrink Tubing

**For  
Equipment Repairmen  
Electronics Technicians  
Hobbyists & Modelers**

Uses most adjustable flame lighters  
Shrinks tubing in seconds; will not burn tubing  
Compact, shirt-pocket size for toolboxes  
Precision valve  
mouthpiece • Simple & easy to use • Completely portable • No moving parts • Patented air-injector nozzle turbocharges the flame, producing precise 1/8 inch diameter, super-hot air-stream and no carbon soot mess • Unbreakable & built to last a lifetime • Heats-up instantly & cools-down in seconds • Made with precision & top-quality materials; *Hardened stainless steel, Heat-resistant nylon, Polyurethane recoil tubing • Professional • Rugged • Limited lifetime warranty • Satisfaction guaranteed Limited Time, Introductory Price \$14.95*

Send check / money-order (\$3.00 S/H) to:  
**Rose Research & Development**  
P.O. Box 12212  
Santa Rosa, CA 95406

**1-800-606-9944**  
Free Color Brochure

## Prototype it..... FAST!

with ProtoQuick 8051 or 28

- Complete single board computers
- Up to 32K EPROMs and 8K RAM
- 12 sq. in. plated-through areas area
- RS232 C serial port w/ DB25 conn.
- On site in EPROMs w/ source code
- Assembled, ready to run - 5k only
- MS-DOS cross assembler included

**ProtoQuick 28 and 8051**  
**\$99.00** each

Run prototype applications or experimental hardware from the serial port - WITHOUT PROGRAMMING!

Browns Station  
2740 Pennsylvania Blvd  
Cleveland, OH 44134 USA  
(513) 581-2060

## ADVERTISING INDEX

**POPULAR ELECTRONICS** magazine does not assume any responsibility for errors that may appear in the index below.

RS #	Page
13	C&S Sales, Inc. .... 5
—	Cleveland Inst. of Electronics ... 17
—	CLAGGK ..... 13,104
—	CLAGGK ..... 34
—	CLAGGK ..... 108
—	Comtrad Industries ..... CV4
—	Comtrad Industries ..... 1
—	Comtrad Industries ..... 11
—	EDE - Spy Outlet ..... 111
—	ETT ..... CV3
—	ETT ..... 62
—	ETT ..... 109
—	Information Unlimited ..... 7
17	Interactive Image Technology CV2
18	Mission Technology ..... 14
14	Mouser Electronics ..... 15
—	NRI Schools ..... 9
—	Rose Research ..... 111
15	The School of VCR Repair ..... 15
16	Sescom ..... 13
—	Software Science ..... 111
—	Tab Books ..... 105
—	Zentek Corp. .... 18

## WWV RECEIVER

(Continued from page 40)

signal germanium or Schottky units. Selecting two diodes with matched forward-bias characteristics is not absolutely necessary; however, don't mix completely different types of diodes in the mixer!

The CA3240 op-amp was specified because of its low cost and moderately low, input-noise characteristic; the alternative HA series units listed in the Parts List are preferred for their lower noise figures. The MC1458 and other "741" derivatives should be avoided. With a single RF-amplifier stage, the receiver is noise limited by the op-amp, so lowest-noise units are beneficial to the overall operation of the receiver.

As for component replacement and substitution, most passive components are not critical and can be replaced with close values. If you can't find the Zener diode, it can be simulated by connecting five 1N914's in series.

**Transformer Winding.** Transformer T1 is a home-made unit, consisting of 40 closely wound turns of #26 AWG enameled wire on a 1/4-inch diameter air-core form, as shown in Fig. 4, with taps at 2 1/2 and 10 1/2 turns from each end; after each tap, the windings proceed in the same direction. Hot-melt glue can be used to secure the windings to the form. The coil does not require a screw-type tuning slug in the core.

Fig. 5 shows the assembly details for T2 (the mixer transformer). Shown electrically in Fig. 5A, T2 is wound on a ferrite bobbin taken from a sub-miniature 10.7-MHz IF transformer or detector coil universally used in older pocket, auto, and console FM radios. IF transformers are typically color-coded brown, green, or blue, and the detector coils are typically black or white. The 10.7-MHz detector coils are easily confused with 455-kHz transformers, which also use black and white as identifying codes. The internal arrangement of the detector coil differs from that of a 455-kHz transformer in that it has a single winding, while the 455-kHz unit has two.

Disassemble the transformer or coil, remove the tuning sleeve, the wind-

ings, and any tuning capacitor in the base. The bobbin is a dumb-bell shaped piece of ferrite material glued to the base. Lay out three 13 cm lengths of #32 to #38 AWG enameled wire in parallel. Wind the three wires 10 times around the bobbin as a set, as shown in Fig. 5B. Solder the wire ends to the base pins as shown in Fig. 5C.

The core permeability and the winding inductance are not critical as long as the winding acts as a transformer at 10 MHz with low inter-winding capacitance. The windings should not be glued within the bobbin.

**Test.** After completing the assembly, apply power to the circuit and check the voltage across Zener diode D3; the voltage across it should be between 3.0 and 3.6 volts. Connect a good earth ground to the receiver. Static should be heard through the speaker. Adjust trimmer capacitor C11 until a WWV signal is audible; then peak C11 for the best reception. The local-oscillator frequency will initially be offset from WWV, so you'll probably hear the beat note. Adjust trimmer capacitor C1 for zero beat.

If a WWV signal is not heard, verify that the audio circuit is functioning; check the input of U1 pin 3 to U2 pin 3 with an audio signal injector, while listening to the receiver output. Check the local oscillator's operation using an oscilloscope, dip meter/monitor, or other frequency-test device, or listen for the 10-MHz, local-oscillator signal on another 10-MHz receiver.

If the audio amplifiers are functioning, but no signal is heard, verify the winding polarity of T2 and the winding order on T1. If you have a dip meter, use it to verify and set the resonant frequency of C11/T1 to 10 MHz. Check the receiver with a marker generator calibrated for 25-, 50-, or 100-kHz increments. If a signal is still not heard, wait a few hours and try again. Verify your ground connection at both ends—the ground is essential for the short antenna.

After the initial circuit test, it may be necessary to re-trim capacitor C11 for optimum reception. If C11 does need re-trimming, re-examine your antenna attachment to the case and see if you can't reduce the stray capacitance by increasing insulation width or separation. ■

# ELECTRONICS HOBBYISTS HANDBOOK™

## ADVERTISING SALES OFFICE

**Gernsback Publications, Inc.**  
500-B Bi-County Blvd.  
Farmingdale, NY 11735  
1-(516) 293-3000

**Larry Steckler, EHF/CET**  
President

**Christina Estrada**  
Assistant to the President

**For Advertising ONLY**  
516-293-3000  
Fax 1-516-293-3115

**Larry Steckler**  
publisher

**Arline Fishman**  
advertising director

**Denise Mullen**  
advertising assistant

**Kelly Twist**  
credit manager

**Subscription/  
Customer Service/  
Order Entry**  
1-800-827-0383  
7:30 AM - 8:30 PM EST

## ADVERTISING SALES OFFICES EAST/SOUTHEAST

**Stanley Levitan**  
Eastern Sales  
1 Overlook Ave.  
Great Neck, NY 11021  
1-516-487-9357  
Fax 1-516-487-8402

**MIDWEST/Texas/Arkansas/  
Oklahoma, Colorado, Arizona**

**Ralph Bergen**  
Midwest Sales  
One Northfield Plaza, Suite 300  
Northfield, IL 60093-1214  
1-708-446-1444  
Fax 1-708-559-0562

## PACIFIC COAST/Mountain States

**Anita Bartman**  
Hutch Looney & Assoc., Inc.  
6310 San Vicente Blvd.  
Suite 360  
Los Angeles, CA 90048  
1-213-931-3444  
Fax 1-213-931-7309

# Electronics Paperback Books

## How to Use Op Amps



**BP88—How to Use Op Amps...\$5.95.** A designer's guide that covers operational amplifiers. Serving as both a source book of circuits and a reference book for design calculations. The text is non-mathematical and easy to understand by most readers.

## 30 Solderless Breadboard Projects



**BP113—30 Solderless Breadboard Projects-Book 2...\$5.95.** Companion to BP107. Presented in exactly the same style using "Verobloc" breadboards. All the breadboard projects in this book are based on CMOS logic integrated circuits.

## An Introduction to Computer Communications

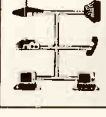

**BP177—Introduction to Computer Communications...\$5.95.** Details on types of modems and their suitability for specific application, plus details of connecting various computers to modems, and modems to the telephone system.

## Electronic Board Games



**BP350—Electronic Board Games...\$6.00.** Twenty novel electronic board games that you can build from the plans in this book. Some games are motor racing, searching for buried treasure or for gold in Fort Knox, — there is something for you to build and enjoy!

## Beginners Guide To Digital Techniques



**BP61—Beginners Guide to Digital Techniques...\$5.00.** Covers the basics of digital techniques—decimal, binary, octal and hexadecimal numbering systems are covered plus insights on weighted and non-weighted binary-coded-decimal codes and alphanumeric codes. The basic building blocks of circuit logic, the common AND, OR, NAND, NOR and EXCLUSIVE-OR gates and bi-stables are thoroughly covered.

## A Beginners Guide to Modern Electronic Components



**BP285—A Beginners Guide to Modern Electronic Components...\$6.50.** It is easy for newcomers to electronics to become confused. There are a great many different types of components available often with numerous variations of each type. This book presents the reader with a vast amount of invaluable parts information to enable the right component to be selected every time for repairs and projects.



**PCP103—Practical MIDI Handbook...\$9.95.** The Musical Instrument Digital Interface (MIDI) is surrounded by a great deal of misunderstanding. This book is aimed at musicians and technicians who want to explore the vast capabilities of MIDI. It covers MIDI-based equipment you can use: keyboards, drum machines, sequencers, effects units, mixers, drum pads guitars. There's also a section on computer music.



**PCP119—Electronic Music and MIDI Projects...\$14.95.** Save cash by building the MIDI gadgets you need. Want a MIDI Thru box, program change pedal, Metronome, analog echo unit? Over 16 practical and very useful music and MIDI projects.



**BP121—How to Design and Make Your Own PCBs...\$5.75.** Simple methods for copying printed-circuit board designs from magazines and books on to copper. Covers all aspects of simple PCB construction as comprehensively as possible.



**BP44—IC 555 Projects...\$5.95.** Every so often a device appears that is so useful that one wonders how life went on before without it. The 555 timer integrated-circuit chip is one such device. Included are basic and general circuits used by most hobbyists.



**PCP109—Everyday Electronics Data Book...\$10.00.** An invaluable source of electronics information—the text contains sections that deal with the underlying theory of electronic circuits and a wide range of practical electronic uses for everyone.



**BP301—Antennas for VHF and UHF...\$6.00.** From installing a TV or FM antenna to setting up a multi-antenna array for shortwave listening or amateur radio, this book explains the basics of VHF and UHF antenna operation and installation. The text describes in easy-to-understand terms the essential information about how antennas work, the advantages of different antenna types, and how to get the best performance.



**BP297—Loudspeakers for Musicians...\$6.25.** Contains all the information that a working musician needs to know about loudspeakers; the different types, how they work, the most suitable for different instruments, for cabaret work, and for vocals. It gives tips on constructing cabinets, wiring up, available fittings, finishing and how to connect multi-speaker arrays, etc. Includes ten enclosure designs with plans.



**PCP110—Electronic Power Supply Handbook...\$10.95.** All types of power supplies used for electronics purposes are covered in detail, starting with cells and batteries and extending by way of rectified supplies and linear stabilizers to modern switch-mode systems, IC switch-mode regulators, DC-converters and inverters. The devices, their operating principles and typical circuits, are dealt with in detail.



**BP254—From Atoms to Amperes...\$6.50.** Explains in crystal-clear terms the fundamentals behind the whole of electricity and electronics. Really helps you to understand the basis of the complex subject perhaps for the first time ever.



**PCP101—Practical Digital Electronics Handbook...\$9.95.** An introduction to digital circuits, logic gates, bi-stables, timers, micro-processors, memory and I/O devices. A special feature of the book is the section on digital test gear projects.



**BP315—Introduction to the Electromagnetic Wave...\$5.95.** A fundamental and easy-to-understand approach to a complicated theory topic. The beginner requires no more than elementary mathematics and basic knowledge of electronics.



**#228—Essential Theory for the Hobbyist...\$5.25.** Supplies to the hobbyist background knowledge tailored to the specific requirements of the hobbyist. Relevant material is presented in a readable manner with minimum mathematics.

## TEST EQUIPMENT SPECIALS

- BP239—Getting the Most from Your Multimeter...\$5.95**  
Covers analog and digital gear, component and gear testing.
- BP267—How to Use Oscilloscopes & Other Testing Equipment...\$6.95**  
Get with the next step to proficient troubleshooting.
- PCP111—Electronic Test Equipment Handbook...\$13.95**  
The all-purpose, all-pro handbook that covers basics to in-circuit testing.

## SUBSTITUTION GUIDES FOR HOBBYISTS

- BP85—International Transistor Equivalents Guide...\$7.50**  
The ultimate guide to replacing foreign and domestic transistors.
- BP108—International Diode Equivalents Guide...\$5.95**  
Rectifiers, Zeners, LEDs, OCIs, diacs, triacs...all hobby types.
- BP140—Digital Equivalents and Pin Connectors...\$12.50**  
A master reference for builders who design projects.

## ELECTRONIC TECHNOLOGY TODAY INC.

P.O. BOX 240, Massapequa, NY 11762-0240

Name \_\_\_\_\_  
Address \_\_\_\_\_  
City \_\_\_\_\_ State \_\_\_\_\_ Zip \_\_\_\_\_  
PE6

## SHIPPING CHARGES IN USA AND CANADA

\$0.01 to \$5.00 .....	\$2.00
\$5.01 to \$10.00 .....	\$3.00
\$10.01 to 20.00 .....	\$4.00
\$20.01 to 30.00 .....	\$5.00
\$30.01 to 40.00 .....	\$6.00
\$40.01 to 50.00 .....	\$7.00
\$50.01 and above .....	\$8.50

## SORRY No orders accepted outside of USA & Canada

Total price of merchandise .....	\$ _____
Shipping (see chart) .....	\$ _____
<b>Subtotal</b> .....	\$ _____
Sales Tax (NYS only) .....	\$ _____
<b>Total Enclosed</b> .....	\$ _____

Number of books ordered

**All payments must be in U.S. funds!**



# New microprocessor puts the brain of a \$50,000 car under your hood...

Breakthrough remote control lets you start your car, turn on its headlights, sound a panic alarm and unlock the doors and trunk...from up to 400 feet away.

by Charles Anton

**H**ow many times have you had to sit in a sticky, hot car and touch the blistering steering wheel to get your car started? Braving winter's freezing temperatures isn't any better! But what else can you do besides roast in the car's scorching heat or shiver in its cold until it warms up or cools down?

**A better way.** The new AutoCommand key chain transmitter gives you the power to start your car from the comfort of your home or office. Simply press a button to start cooling off or warming up your car from up to 400 feet away. You can turn on the air conditioner, heater or defroster without leaving your seat.

The powerful microprocessor brain learns your car's starting pattern. It adjusts the starting routine based on the outside temperature,

### Why AutoCommand is better...

- **Range.** Most remotes only work up to 100 feet away. AutoCommand gives you a range of up to 400 feet.
- **Self-diagnostics.** The unique feedback lights on AutoCommand confirm proper wire connections during and after installation, just like a car's on-board computer.
- **Total security and convenience.** AutoCommand gives your car the capability of remote car starting, keyless entry, panic alarm and car security. It also has built-in low temperature and low battery voltage start options.

battery voltage and the amount of time since your car was last run to guarantee starting every time.

**Give your car a brain.** AutoCommand gives your car the same features as luxury cars, and even some they don't have, by adding this microprocessor brain. In addition to remote car starting, your car will have features such as keyless entry and built-in car security.

You can call for help or scare someone away with the panic alarm; locate your car with car finder; and have your car automatical-

ly turn on its headlights when it gets dark or turn them off 20 seconds after leaving your car. You can even leave your car running with the doors locked and no key in the ignition. If you forget your car is running, it will automatically shut off after 10 or 15 minutes, you choose.

**Intelligent benefits.** With AutoCommand, your car can't be driven until a key is put into the ignition. AutoCommand immediately cuts off the engine if your vehicle's hood is raised, brake pedal is pressed or the vehicle is shifted out of gear without the key in the ignition, preventing theft or tampering.

AutoCommand also monitors your car while you are away. The built-in Vacation Option will automatically start and run your car for 10 minutes every four to six hours when the temperature drops below zero. On hot summer days, AutoCommand will also start your car when the interior reaches 140 degrees. If your battery drops below 11 volts, AutoCommand will start your car to recharge it.

**Try it risk-free.** At Comtrad, we back all our products with a risk-free home trial. Try AutoCommand in your car and if you're not completely satisfied with its value and performance, return it within 90 days for a full refund, "No Questions Asked."

AutoCommand is also backed by a two-year manufacturer's limited warranty. Most orders are processed within 72 hours and shipped UPS.

### UPGRADE OPTIONS.

You can replace your existing garage door remote control with the Garage Door Remote Control replacement system. This system can be added to any garage door that has an existing electrical garage lift unit. It will share the same transmitter as the AutoCommand, eliminating extra key chain remotes! You can also add the Shock Sensor option to the built-in car security system. It detects any impact on your car, giving you added protection.



The key chain transmitter works with all the available features.

### Exclusive \$50 installation discount

AutoCommand comes with an installation video and has patented self-diagnostic feedback lights which confirm wire connections step-by-step during installation. But for those who prefer to have AutoCommand professionally installed, we offer a \$50 installation discount. Use the money for professional installation, or install it yourself and keep the money. Either way, AutoCommand makes it easy and affordable to add luxury car features to your automobile.

**AutoCommand** ..... ~~\$249~~ \$14 S&H  
with installation discount ..... \$299 \$14 S&H

**AutoCommand Upgrade Features**  
Garage Door Opener ..... \$79 \$8 S&H  
add Shock Sensor to alarm ..... \$49 \$4 S&H

### AUTOCOMMAND FEATURES

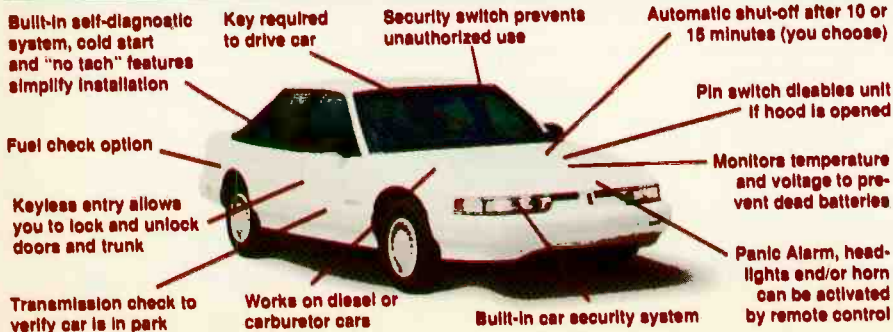

Please mention promotional code 692-PL-6626. For fastest service call toll-free 24 hours a day

**800-992-2966**



To order by mail, send check or money order for the total amount including S&H (VA residents add 4.5% sales tax.) Or charge it to your credit card by enclosing your account number and expiration date.

**CONTRAD INDUSTRIES**

2820 Waterford Lake Drive, Suite 106  
Midlothian, Virginia 23113