

Projects you can build!

GERNSBACK SPECIALTY SERIES 49604

SPRING
1994

ELECTRONICS HOBBYISTS handbook™

Popular
Electronics®

COMMUNICATIONS

- Aviation-Band Receiver
- 4-Element, 2-Meter Quad
- Receiver Preamplifiers
- Active Antenna

AUTOMOTIVE

- Smarter Gas Gauge
- Turn Signal Reminder

FUN PROJECTS

- Electronic Gong
- Beverage Cooler
- Digital Bowl Box
- Non-Serious Circuit

SPECIAL SECTION ON...



PLUS—

Wire Tracer ● Fuel Miser ● Configurable Power Supply ● Audio Water Tap ● Solar Power Supplies ● Battery Butler ● Ion Detector ● Freeze Fighter Thermostat ● and more!



A
GERNSBACK
PUBLICATION

\$3.95 U.S.
\$4.50 CANADA

What Do These Prestigious Companies Have In Common?

Aerovox
DC Film and RFI Suppression Capacitors,
AC Oil Capacitors, EMI Filters

AMP
Electrical/Electronic Connectors,
IC Sockets, PCB Switches

AVX CORPORATION
A KYOCERA GROUP COMPANY

MLC, Tantalum and Thin Film
Capacitors, Resistors,
Networks, Trimmers,
Oscillators, Resonators, Filters
and Piezo Devices

BERG
ELECTRONICS
High Density and Industry Standard
Connectors/Subsystems

BURNDY
an FCI Company
Electronic Connectors

CAROL

CAROL CABLE COMPANY INC
Electronic and Electrical Wire and Cable
and Power Supply Cords

COLE FLEX

Tubing, Conduits, Hose, Sleeveings, Splices,
Insulation and Cable Harness Products

Communications Instruments, Inc.
Relays and Solenoid Relays

COOPER
Belden

Multi Conductor, Paired, Coaxial, Flat,
Fiber Optic, Instrumentation/Process
Control, LAN, Special Application Cables,
Power Supply Cords & Molded Cable
Assemblies

COOPER
Bussmann
Fuses, Fuseholders, Fuse Blocks,
and Fuse Accessories

CORNELL DUBILIER

Capacitors-Aluminum
Electrolytics, Mica, AC Oil, Film,
MICA Paper and Relays

A COMPANY OF
DALE

Dale Electronics, Inc.
Resistors, Networks, Oscillators, Displays,
Inductors & Thermistors

DI DANTONA INDUSTRIES, INC.

BATTERIES: Computer, Cordless
Phone, Scanner & R/C.
ANTENNAS: Cordless Phone (metal &
rubber), Scanner Bumpers,
Grommets and Stik-On Feet

DEARBORN
WIRE AND CABLE L.P.

EATON
Eaton Corporation, Commercial
& Military Controls Operation
Switches, Relays, Displays and Keyboards

A
GERNSBACK
PUBLICATION
Popular Electronics
Electronics Now Magazine

KOA SPEER ELECTRONICS, INC.
Resistors, SMT Tantalum Capacitors Inductors,
Resistor Networks, SMT Thermistors

MALLORY

North American Capacitor Company
Tantalums, Alumalums, Sonalerts®
Ceramics, Films and AC's

M-tron
Quartz Crystal Clock Oscillators
and Special Hybrid Products

muRata ERE
MURATA ERIE NORTH AMERICA

Monolithics, Discs, Variable Capacitors,
Oscillators, Potentiometers, RFI/EMI Filters,
Microwave, Surface Mount Capacitors

NTE
NTE ELECTRONICS, INC.
A WORLDWIDE REPUTATION FOR QUALITY, SERVICE AND VALUE
Semiconductors, Resistors,
Capacitors, Relays

Philips ECG
A North American Philips Company
Semiconductors, Test Equipment,
Relays, A/V Parts and
Chemicals

Quam
Loudspeakers and Commercial Sound
Products

ROHM

Rohm Electronics Division
Resistors, Ceramic Capacitors,
Transistors/Diodes,
Opto Components and IC's

SELECTA
Electrical/Electronic Products

Switches, Relays, Terminals,
Indicator/Pilot Lights, LED Indicators,
Test Clips, Test Leads, Cable Ties and
Heat Shrinkable Tubing

A COMPANY OF
SPRAGUE

Tantalum Capacitors, Wet & Foil
Capacitors, Resistor Networks,
Resistor Capacitors Networks, Filters

Switchcraft
A Raytheon Company
Switches, Connectors, Jacks, Plugs,
Jackfields & Audio Accessories

TECH SPRAY

Non-CFC Cleaners/Degreasers,
UV Cured Compounds, Swabs, Wipes,
Brushes, Wick, Cleanroom Supplies, and
Static Control Products.

They sell through distributors.
They belong to the E.I.A.
They belong on your vendor list.

Leadership in electronics is not just a matter of designing products better and manufacturing them better, but also of marketing them better. And the sponsors of this message understand that better service to customers requires effectively involving distributors as part of their marketing teams.

Distributor involvement means lower prices, quicker deliveries, better service over-all. The Buyer wins. . . the Seller wins.

Distributors help achieve marketing leadership. So does the manufacturer's involvement in the Components Group of the Electronic Industries Association. EIA fosters better industry relations, coherent industry standards, and the sharing of ideas, which helps one another *and* serves customers better.

In choosing your component supplier, look for the marks of leadership —

- availability through distribution
- membership in the E.I.A.



Electronic Industries
Association/Components Group
2001 Pennsylvania Avenue, N.W. 11th Floor
Washington, D.C. 20006
Phone: (202) 457-4930 Fax: (202) 457-4985

Committed to the competitiveness of the
American electronics producer

AMAZING Electronic and Scientific Products

Mystery Levitating Device!



Remember War of the World? Objects float in air and move to the touch. Defies gravity, amazing gift, conversation piece, magic trick or great science project.

ANT1K Easy to Assemble Kit / Plans \$19.50

Laser Ray Gun

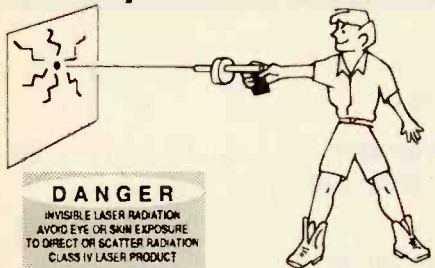

DANGER

INVISIBLE LASER RADIATION
AVOID EYE OR SKIN EXPOSURE
TO DIRECT OR SCATTERED RADIATION
CLASS IV LASER PRODUCT

Advanced project. produces a burst of light energy capable of burning holes in most materials. Hand-held device uses rechargeable batteries. 500 joules of flash energy excite either a neodymium glass, yag or other suitable 3" laser rod. This is a dangerous CLASS IV project (individual parts/assemblies available).

LAGUN1 Plans \$20.00

LAGUN1K Kit / Plans Price on Request

Extended Play Telephone Recording System



READY TO USE! Automatically controls and records on our X-4 extended play recorder, taping both sides of a telephone conversation. Intended for order entry verification. Check your local laws as some states may require an alerting beeper.

TAP20X Ready to Use System \$129.50



Shocker Force Field/ Vehicle Electrifier

Neat little device allows you to make hand and shock balls, shock wands and electrify objects, charge capacitors. Great payback for those wise guys who have wronged you!

SHK1KM Easy to Assemble Electronic Kit \$24.50



Blaster Pulsar

Pocket-sized wand produces 100,000 watts of power for personal defense, field and lab use, etc. BLS3 Plans \$10.00
BLS3K Kit / Plans \$69.50

Homing / Tracking Transmitter

Beeper device, 3 mile range.
HOD1 Plans \$10.00 HOD1K Kit / Plans \$49.50

Listen Through Walls, Floors

Highly sensitive stethoscope mike.
STETH1 Plans \$8.00 STETH1K Kit/Plans \$44.50



NEW!

Telephone Line Grabber / Room Monitor

ALL NEW! The Ultimate in Home or Office Security & Safety! Simple to Use! Call your home or office phone, push a secret tone on your telephone keypad to access either: A. On premises sounds and voices; or B. Existing telephone conversation with break in capability for emergency messages. CAUTION: Before assembly or use, check legalities with your state Attorney General's office as you may require "beepers" or other 3rd party alerts.

TELEGRAB1 Plans Only \$10.00

TELEGRAB1K Kit / Plans \$99.50

Ultrasonic Blaster

Laboratory source of acoustical shock waves. Blow holes in metal, produce "cold" steam, atomize liquids. Many cleaning uses for PC boards, jewelry, coins, small parts, etc.

ULB1 Plans \$10.00 ULB1K Kit/Plans \$69.50

100,000V Intimidator / Shock Wand Module

Build an electrical device that is effective up to 20 feet. May be enclosed for handheld, portable field or laboratory applications.

ITM2KM Easy-to-Assemble Electronics Kit \$49.50

ITM2 Plans only, credit-able to kit \$10.00



Ion Ray Gun

Projects charged ions that induce shocks in people and objects without any connection! Great science project as well as a high tech party prank. IOG3 Plans \$8.00

IOG3K Kit/Plans \$69.50

Invisible Pain Field Generator

Shirt pocket size electronic device produces time variant complex shock waves of intense directional acoustic energy, capable of warding off aggressive animals, etc.

IPG7 Plans \$8.00 IPG7K Kit/Plans \$49.50

IPG70 Assembled \$74.50

SUPER GIANT SMOKE ASSORTMENT

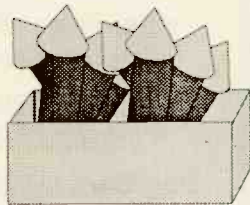

SPECIAL INTRODUCTORY OFFER! WOW! Over 500 items - the largest smoke assortment we have! Each super giant assortment contains at least 500 pieces - enough to last you a long time. All this at a special price - less than 12 cents per item. Guaranteed value at least 50 percent more than you pay! SMOKE 25 \$59.50



TV & FM Joker / Jammer

Shirt pocket device allows you to totally control and remotely disrupt TV or radio reception. Great gag to play on family or friends. Discretion required. EJ1KM Easy to Assemble Electronic Kit \$24.50

Visible Beam Laser

High brightness red HeNe laser visible for miles. Produce your own light show! Projects a visible beam of red light clearly visible in most circumstances. Can be used to intimidate by projection of a red dot on target subject. Also may be used to "listen in" using our laser window bounce method #LLIS1 below. Easy to build module makes A working visible laser!

LAS1KM Kit w/1mw Laser Tube, Class II \$69.50

LAS3KM Kit w/2.5mw Laser Tube, Class IIIA \$99.50



"Laser Bounce" Listener System

Allows you to hear sounds from an area via a lite beam reflected from a window or other similar objects. System uses our ready-to-use LATR1 Laser Terminator gun site as the transmitter. The receiver section is supplied as an easy-to-build kit, including our cushioned HS10 headsets. LLIS2 Plans \$20.00

LLIS1K Kit of Both Transmitter and Receiver \$199.50

LLIS20 Assemble with Laser Gun Site \$299.50

5mw Visible Red Pocket Laser

Utilizes our touch power control!
VRL5KMX Kit / Plans \$119.50



Whirly Wheels!

Fantastic ALL NEW pinwheel effect for auto, motorcycle, bicycle, etc. Use one per wheel. SIMPLE TO USE! LWMIRLY \$9.50

Pocket Sized Night Viewer

Uses Low Level Starlight to See in the Dark!

- Low Cost
- Ultra-Hi Lite Amplification!
- Auto Brightness Control
- Limited Amount Available
- Made in USA • Night surveillance • Animal studies, etc.

Can be used to fly an airplane or drive a car!

PKV7 Plans \$15.00

PKV7K Easy to Assemble Kit \$1,295.00

PKV70 Ready to Use \$1,595.00

3 Mile FM Wireless Microphone



Subminiature! Crystal clear, ultra sensitive pickup transmits voices and sounds to FM radio. Excellent for security, monitoring of children or invalids. Become the neighborhood disk jockey, or go "under cover" using our sunglasses FM radio (see catalog). FMV1 Plans ... \$7.00
FMV1K Kit and Plans \$39.50
SUGL10 Sunglasses with built in FM Radio \$29.50

Telephone Transmitter - 3 Mi

Automatically transmits both sides of a telephone conversation to an FM radio. • Tunable Frequency • Undetectable on Phone • Easy to Build and Use • Up to 3 Mile Range • Only transmits during phone use.

VWPM7 Plans \$7.00

VWPM7K Kit/Plans \$39.50

INFORMATION UNLIMITED

Dept PEM14, Box 716, Amherst, NH 03031

Phone: 603-673-4730 FAX 603-672-5406

MC, VISA, COD, Checks accepted Please add \$5.00 Shipping & Handling

CATALOG
With many more items!
Free with Order or send \$1 P&H

Order by Mail or by 24 Hour Orders-Only Phone
800-221-1705



Peltier Effect Beverage Cooler
(See page 43)

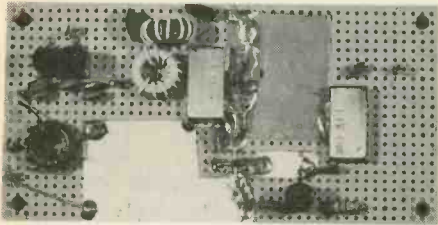

Receiver Preamplifiers
(See page 34)



Battery Butler
(See page 93)

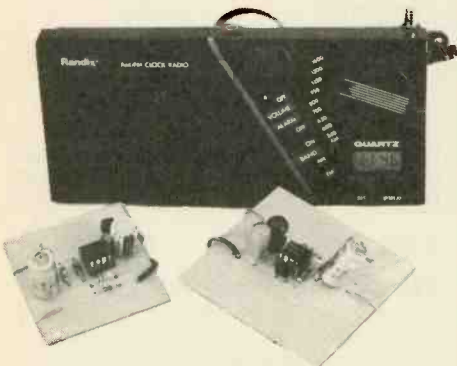

Solar Power Supplies
(See page 89)



Reduce Home Heating Costs
(See page 25)

Popular Electronics[®]

SPRING 1994

Contents

HIGH-VOLTAGE ELECTRONICS

- 200,000-Volt Van de Graaff Generator** 58
Enjoy hours of high-voltage experimenting
- Solid-State Tesla Coil** 61
An updated version to spark-a-mania!
- Jacob's Ladder** 65
You see it in "crazy scientist" movies

FABULOUS PROJECTS

- Build a Smarter Gas Gauge** 14
Build intelligence into your car's gas-measuring system
- Turn-Signal Reminder** 23
A musical reminder to hit the lever when you forget!
- Reduce Heating Costs with the Fuel Miser** 25
Tame home-heating cost and keep warm, too!
- Wire Tracer** 30
Follow out-of-sight wires hidden in walls and ceilings
- Configurable Power Supply** 32
Delivers 1.2 to 33 volts DC up to 1.5 amps
- Receiver Preamplifiers that You Can Build** 34
Design a front-end for your SW/VHF/UHF receiver
- An Electronic Gong** 38
A civilized way to signal
- Build a Four-Element, Two-Meter Quad** 41
Inexpensive to build and has great performance
- Peltier Effect Beverage Cooler** 43
Keep your soda cool and taste buds happy
- Digital Bowl Box** 47
A must project for "College Bowl" players
- Dog Bark Inhibitor** 52
A humane way to de-bark a woofers

As a service to readers, *Popular Electronics Spring 1994 Electronics Hobbyists Handbook* publishes available plans or information relating to newsworthy products, techniques and scientific and technological developments. Because of possible variances in the quality and condition of materials and workmanship used by readers, we disclaim any responsibility for the safe and proper functioning of reader-built projects based upon or from plans or information published in this magazine.

ELECTRONICS HOBBYISTS handbook TM

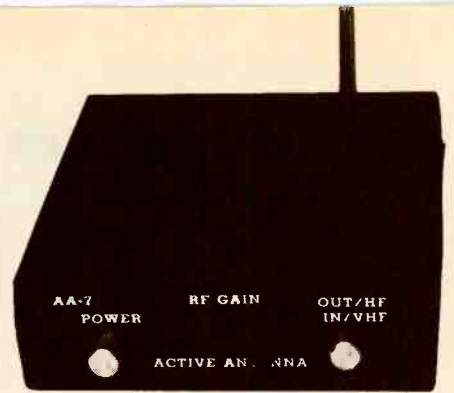

Active Antenna
(See page 72)



Aviation-Band Receiver
(See page 80)



A Non-Serious Circuit
(See page 55)



Wire Tracer
(See page 30)

A Non-Serious Circuit	55
<i>A lot of fun and it's educational</i>	
Freeze Fighter	68
<i>Power control in sync with the weather</i>	
Active Antenna	72
<i>Boost those hard to hear 3-3000 MHz signals</i>	
Build an Ion Detector	75
<i>Zero in on high-voltage leakage and static build-up</i>	
Build the Water Tap	78
<i>Who knows—maybe fish can talk?</i>	
Aviation-Band Receiver	80
<i>Tune in the chit-chat from the high flyers</i>	
Experimenting with Shaped Memory Alloys	85
<i>Discover a new hobbyist project adventure</i>	
Solar Power Supplies for Portable Radios	89
<i>Cut down on battery expense</i>	
Battery Butler	93
<i>Restore and charge Ni-Cd batteries as never before!</i>	
Making the Connection	99
<i>Cut antenna losses with the correct connection</i>	
DEPARTMENTS	
Editorial—About this issue	4
New Products	6
Literature Library	12
Free Information Card	56A
Classified Advertising	111
Advertisers' Index	111
Advertising Sales Offices	112

Since some of the equipment and circuitry described in *Popular Electronics Spring 1994 Electronics Hobbyists Handbook* may relate to or be covered by U.S. patents, we disclaim any liability for the infringement of such patents by the making, using, or selling of any such equipment or circuitry, and suggests that anyone interested in such projects consult a patent attorney.
Popular Electronics Spring 1994 Electronics Hobbyists Handbook is published semi-annually by Gernsback Publications Inc. All rights reserved. Printed in U.S.A. Single copy price \$3.95. Canadian G.S.T. Registration No. 125166280. Canada \$4.50. ©Gernsback Publications Inc., 1994.

Larry Steckler
EHF, CET

Editor-In-Chief and Publisher

Julian S. Martin
Handbook Editor

POPULAR ELECTRONICS EDITORIAL DEPARTMENT

Carl Laron
Editor

Robert A. Young
Associate Editor

John J. Yacono
Associate Editor

Teri Scaduto
Associate Editor

Evelyn Rose
Editorial Assistant

Marc Spiwak
Editorial Associate

PRODUCTION DEPARTMENT

Ruby M. Yee
Production Director

Karen S. Brown
Production Manager

Kathy Campbell
Production Assistant

Lisa Rachowitz
Editorial Production

ART DEPARTMENT

Andre Duzant
Art Director

Injae Lee
Illustrator

Russell C. Truelson
Illustrator

Jacqueline P. Cheeseboro
Circulation Director

Michele Torrillo
P-E Bookstore

BUSINESS AND EDITORIAL OFFICES

Gernsback Publications, Inc.
500-B Bi-County Blvd.
Farmingdale, NY 11735
1-516-293-3000
Fax: 1-516-293-3115

President: **Larry Steckler**

Advertising Sales Offices listed on page 112

Cover photography by
Ruth Carey
Oak Ridge, TN

Composition by
Mates Graphics



Since some of the equipment and circuitry described in 1994 ELECTRONICS HOBBYIST HANDBOOK may relate to or be covered by U.S. patents, 1994 ELECTRONICS HOBBYIST HANDBOOK disclaims any liability for the infringement of such patents by the making, using, or selling of any such equipment or circuitry, and suggests that anyone interested in such projects consult a patent attorney.



Editorial

There's a name missing from our masthead this issue. We've lost a good editor and a longtime friend—Byron G. Wels. Byron was a very unusual friend and co-worker. This brief editorial cannot hope to unveil his glorious character or even the humorous adventures that life gave to him and he gave to us.

I met Byron in September, 1958, when I was the Managing Editor of Popular Electronics (then a Ziff-Davis publication) and Byron was an author specializing in audio-stereo stories at that time. He had a knack for opening doors to the big audio mavens at H. H. Scott, Fisher, EICO, Heath, Arkay, Marantz, Garrard, Rek-o-kut, Knight and many others. Names like Pioneer, Sony, Sansui and others were not household names then.

Byron's fame came from the many diverse free-lance jobs he held. I remember he undertook a feature story for a famous house organ. He reported on an indoor ski training technique that used a sloping, moving-carpet machine. Yep, Byron tried it and broke his leg. He sky dived for a story long before many of our readers were born.

That was no feat, because earlier he bailed out over the Burma Road during WWII. That was a true story, but each time he told it the derring-do and the rescue follow-up got better and better.

Most of all, Byron loved to write and talk. His office here at

Gernsback Publications was a meeting place for the staff. That's where everyone took a coffee break. He loved people and people loved him. He retired to Florida and continued to work for the company. His phone calls were welcome breaks in the workday.

Finally, the Grim Reaper came and took Byron. I can't help but think that Byron put a smile on that apparition's face. God bless you, Byron, for being a part of my life.

However, life and editorials continue on!

We find it difficult to repeat an editorial, but portions of the last editorial are repeated here to describe the function of the "Project Time Evening" ratings. We found the ratings for projects to be a confidence builder for novice project builders. Many readers' letters said that the ratings for two or three evening projects should have been reduced. Most of the letters were from first-time or novice builders. That was heartening.

Many editors are involved in the generation of Electronics Hobbyist Handbook articles, so when the editorial "we" is used, believe me when I say that I speak for a crowd of dedicated editors, who, by the way, are accomplished project builders. Here are their views on the project rating system.

We consider the project's

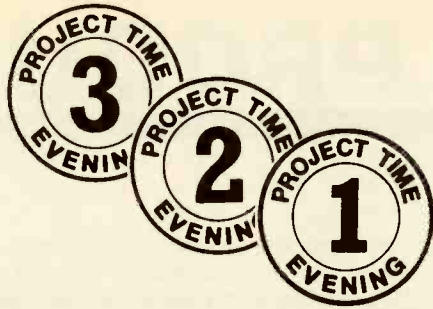

construction time to begin after all the parts are available, and that includes the printed-circuit board. Although there are modern methods for adding resist patterns to the copper-clad surface of a board, even that time is an indeterminate quantity. So, the gun fires to start the clock when all the parts are on the workbench and you plug in the soldering iron.

Projects that require tuning, alignment or adjustment have the time interval thus required added to the total time. The making of simple boxes, cabinets, etc., and other minimal cosmetic tasks such as nameplates, dial markings, paint jobs, etc., are included in the total time. As previously stated for the parts, materials and equipment necessary for the task to be completed must be on the workbench or available nearby so as not to interrupt the flow of work.

We assume that most of the work will be done in the evenings after your normal work day, so that a typical one-evening project takes about three hours. Expect a give-or-take of one hour depending upon your skill and the quality and availability of tools and equipment on your workbench. For example, we consider that at least one solder connection must be redone for whatever reason. If you have a "suction-tip" desoldering iron, add 30 seconds to the task. If you use a copper braid to sap off the solder, add two minutes. If you let the tip of the iron do the job, add five

minutes. (Of course, the latter technique should not be used!)

A small drill press, power jig saw, desk-top illuminated magnifying lens, electric screw-nut driver, and other convenient hand tools speed up most hobbyist's projects. Also, what many readers fail to do is study the text carefully before they begin to build a project. Know what you have to do, then do it. Don't look for short cuts or redesigning efforts as you assemble the project. It's best to stop all work and seriously think out and plot out what you want to do and how to do it. In most cases, it is wiser to complete the project, get it working, then redesign for a specific purpose.

Now you know the time-evaluation system, look for the "Project Time" label for each article. (See above.) The editors would like to know if this system was of value to you, so drop us a line and tell us what you think and what you experienced. Remember, your reports are our eyes. Happy project building.

Confidence in building projects builds confidence to undertake bigger and larger projects. If so, you may be interested in Electronics Experimenters handbook, Summer 1994 issue on sale April 6, 1994.

Julian S. Martin
Handbook Editor

FREE

Electronics & Computer Software
Education Catalog

- *Fast-Track Individual Learning Programs
- *State-of-the-Art Classroom Courses
- *The Best Values in Electronics Education

New

Career-Level Courses
Personal Computer Servicing
TV and VCR Servicing

New

Computer-Aided Instruction

DC & AC Electronics
Semiconductors
Electronic Circuits

*The stunning animations, hypertext
glossary, and easy-to-understand text make
learning electronics a breeze...and fun!*

Learn the easy and affordable way from the
Masters in Electronics Training - **Heathkit**.
From Basic Electricity to Advanced Microproces-
sor Applications and more, Heathkit will provide
you with an unparalleled learning experience at a
fraction of the cost of other programs.

Heathkit[®]

Educational Systems

For your FREE Catalog, call

Toll-Free 1-800-44-HEATH

please mention this code when calling 107-031

CIRCLE 16 ON FREE INFORMATION CARD

CABLE TV DESCRAMBLERS

Best Prices in the U.S.A!
Guaranteed to Work!

QUANTITY DISCOUNTS



JERROLD PANASONIC
SCIENTIFIC ATLANTA PIONEER

The Newest & the Latest

- DMTB-A - all Jerrold Impulse & Starcom series
- SA3-DFA - all Scientific Atlantas including 8536, 8536+, 8580, Drop-field
- PN-3A - all Pioneer systems

ALSO

FTB3, SA3, TZPC145G

24 HOUR SHIPMENTS
30 DAY MONEY BACK GUARANTEE
FREE CATALOG & INFORMATION

1-800-772-6244

M-F 9-6 EST

U.S. Cable TV, Inc. Dept.: KEE034
4100 N. Powerline Rd. Bldg. F-4 Pompano Beach FL 33073
NO FLORIDA SALES!

CIRCLE 18 ON FREE INFORMATION CARD

NEW PRODUCTS

Nine-Range Battery Tester

A compact battery tester from *L-com*, the *DX20BT*, accepts any standard carbon-zinc, alkaline, mercury, silver-oxide, lithium, or nickel-cadmium battery. When the selector switch is set to the desired battery type, the meter will provide a true test of its condition with an actual load imposed. Test results are shown on three colored meter scales for regular, lithium, and nickel-cadmium cells.



The *DX20BT* features permanent, built-in test leads to prevent signal loss. A special adjustable clamp holds all types of button cells, making the test fast and simple. Dual contact buttons on the top panel accept 9-volt batteries, eliminating the need for test leads in 9-volt tests. The tester also features a "neg" contact button to test any size single cell, so that only the red test lead is required for those tests. The case is elevated for easy reading.

The *DX20BT* nine-range battery tester costs \$18.50 in single units; quantity discounts are available. For further information, contact *L-com, Inc.*, 1755 Osgood Street, North Andover, MA 01845; Tel: 800-343-1455 or 508-682-6936; Fax: 508-689-9484.

CIRCLE 114 ON FREE INFORMATION CARD

PC-BASED CALLER ID

Most products designed to provide security against intrusion into telecommunications equipment automatically answer

incoming calls and wait for the caller to enter an access code or password. Such systems are easily thwarted by hackers and inconvenient for authorized users. According to *Pewee Valley Innovations*, however, their *PC Receptionist*, a PC-based Caller ID accessory, eliminates any chance for a hacker to gain access to the system, while allowing the user to completely block calls from unauthorized, "privatized," or unknown numbers, or to pass only calls from particular numbers. The device is transparent to outgoing calls.

The *PC Receptionist* uses Caller ID to determine whether to pass or block the ring signal. When a call comes in, foreground computer activity is temporarily suspended and a display pops up on the screen, showing the phone number of the caller and, if previously entered into the system, the caller's name. The user can enter a one-line memo regarding the call. Previous consumer activity is restored with a single keystroke, or after a user-specified time period. At the end of the call, the device saves the call record and memo along with a date and time stamp and the length of the call. The call

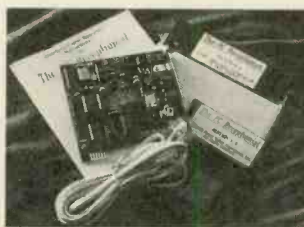

record can be called up at any time, and can be imported into many popular databases. With the included software for managing a digital pager, you needn't give out your pager number. Incoming calls can be routed to an answering machine, with only calls from pre-specified numbers forwarded to your pager.

The package includes an easily configured, 8-bit adapter

card for IBM PC-compatible computers, a DOS-based software package on 3.5 and 5.25-inch diskettes, a modular extension cord, and a user's manual. The user must subscribe to Caller ID from the local telephone company.

The *PC Receptionist* package costs \$149.95; for Windows software, add \$30. For more information, contact *Pewee Valley Innovations, Inc.*, 6601 Old Zaring Road, Crestwood, KY 40014; Tel: 502-241-4295.

CIRCLE 107 ON FREE INFORMATION CARD

DIGITAL AC-LINE MONITOR

Well suited for such applications as high-end consumer electronics, laboratory instrumentation, and other products requiring accurate AC-line monitoring, *Datel's DMS-20PC-1-LM* is a self-contained, 3-digit LED display that measures AC-line voltages from 85-265 VAC (47-63 Hz). No external components or auxiliary power are needed. When the device is plugged into any wall outlet or PC board, it instantly measures line voltages. Using half-wave sinusoidal averaging techniques, typical accuracies of ± 1 VAC are achieved over the full input span of the meter. The AC-line monitor is packaged in a 0.88 x 1.38 x 1.00-inch red filter case with an integrated bezel. The 0.37-inch high LED is easy

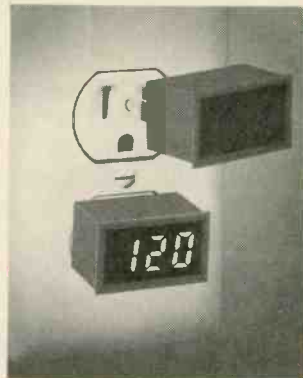

24 HOUR SHIPPING

ELENCO • HITACHI • B&K PRODUCTS
GUARANTEED LOWEST PRICES

TO ORDER
 CALL TOLL FREE
 1-800-292-7711
 1-800-445-3201 (Can.)

AFFORDABLE - HIGH QUALITY
2 YEAR WARRANTY

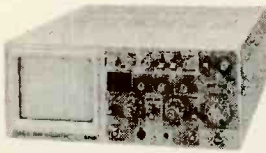

STANDARD SERIES
 S-1325 25MHz \$349
 S-1340 40MHz \$495
 S-1365 60MHz \$849

Features:

- High Luminance 6" CRT
- 1mV Sensitivity
- X-Y Operation
- Voltage, Time, + Frequency differences displayed on CRT thru the use of cursors (S-1365 only)
- Plus much, much more
- TV Sync
- 2 - x1, x10 Probes
- Complete Schematic

ELENCO OSCILLOSCOPES

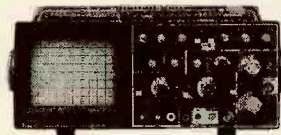

DELUXE SERIES
 S-1330 25MHz \$449
 S-1345 40MHz \$575
 S-1360 60MHz \$775

Features:

- Delayed Sweep
- Automatic Beam Finder
- Z Axis Modulation
- Built-in Component Test
- Plus all the features of the "affordable" series
- Dual time base
- Illuminated internal gradicule

Hitachi Compact Series Scopes

V-212 - 20MHz Dual Trace	\$399
V-525 - 50MHz, Cursors	\$995
V-523 - 50MHz, Delayed Sweep	\$949
V-522 - 50MHz, DC Offset	\$895
V-422 - 40MHz, DC Offset	\$795
V-222 - 20MHz, DC Offset	\$649
V-660 - 60MHz, Dual Trace	\$1,149
V-665A - 60MHz, DT, w/cursor	\$1,325
V-1060 - 100MHz, Dual Trace	\$1,395
V-1065A - 100MHz, DT, w/cursor	\$1,649
V-1085 - 100MHz, QT, w/cursor	\$1,995
V-1100A - 100MHz, Quad Trace	\$2,495
V-1150 - 150MHz, Quad Trace	\$2,395

B&K OSCILLOSCOPES

2120 - 20MHz Dual Trace	\$389
2125 - 20MHz Delayed Sweep	\$539
1541B - 40MHz Dual Trace	\$695
2160 - 60MHz Dual Trace, Delayed Sweep, Dual Time Base	\$949
2190 - 100MHz Three Trace Dual Time Base, Delayed Sweep	\$1,395
2522A - 20MHz / 20MS/s Storage	\$875

Digital Capacitance Meter



CM-1550B
 by Elenco
\$58.95
 9 Ranges
 .1pF-20,000uFd
 .5% basic accy.
 Big 1" Display Zero control w/ Case

Digital LCR Meter



LC-1801
\$125
 Measures:
 Coils 1uH-200H
 Caps .1pF-200uF
 Res. 0.1-20M
 by Elenco

Digital Multimeter



DVM-638
\$39.95
 11 Functions with Case

FLUKE MULTIMETERS

Scopemeters (All Models Available Call)	
Model 93	\$1,225.00
Model 95	\$1,549.00
Model 97	\$1,795.00
10 Series	
Model 10	\$62.95
Model 12	\$79.95
70 Series	
Model 70II	\$65.00
Model 77II	\$149.00
Model 79II	\$169.00
80 Series	
Model 87	\$289.00

12A DC Power Supply



B+K 1686
\$169.95
 3-14V @ 12A

Fully regulated & protected
 Separate volt & current meters
 with current limiting, low ripple

Quad Power Supply XP-580



\$79.95 2-20V @ 2A 5V @ 3A
 12V @ 1A -5V @ .5A
 Fully regulated and short circuit protected



B&K 390
\$139
 3-3/4 Digit DMM
 Bargraph
 9 Functions including
 Temp, Freq
 Rubber Boot



Dual-Display LCR Meter
 w/ Stat Functions
B+K 878
\$239.95
 Auto/Manual Range
 Many Features
 w/ Q Factor
 High Accuracy

Sweep/Function Generator



with Freq. Counter
\$239
 Elenco
GF-8026
 Int/Ext operation
 Sine, Square, Triangle, Pulse, Ramp
 .2 to 2MHz, Freq Counter .1-10MHz

Audio Generator



Elenco **GF-800**
\$59
 20Hz-150KHz
 Sine/Square
 Waves
 Handheld

2MHz Function Generator



B+K 3011B **\$219.95**
 LED Display, Sine, Square, Triangle, Ramp
 & Pulse Waves. TTL & CMOS

Digital Multimeter Kit



with Training Course
 Elenco
M-2665K
\$49.95
 Fun & Easy
 to Build

Learn to Build and Program Computers with this Kit

Includes: All Parts, Assembly and Lesson Manual



Model
MM-8000
\$129.00
 by Elenco

Starting from scratch you build a complete system. Our Micro-Master trainer teaches you to write into RAMs, ROMs and run a 8085 microprocessor, which uses similar machine language as IBM PC.

Elenco Wide Band Signal Generators



SG-9000 **\$119**
 RF Freq 100K-450MHz AM Modulation of 1KHz Variable RF output
SG-9500 w/ Digital Display & 150MHz built-in counter \$239

TELEPHONE PRODUCT TESTER



B+K 1045A **\$499.95**
 Provides basic operation tests for corded & cordless telephones, answering machines and automatic dialers.

Multi-Function Counter



Elenco **F-1200**
 1.2GHz
\$229
 Measures Frequency, Period, Totalize
 8 LED digits, Crystal oven oscillator,
 .5ppm accuracy

WE WILL NOT BE UNDERSOLD

UPS SHIPPING: 48 STATES 5% OTHERS CALL
 IL RES add 7.75% TAX
PROBES INCL ALL SCOPES & METERS

C&S SALES INC.

1245 ROSEWOOD, DEERFIELD, IL 60015
 FAX: 708-520-0085 • (708) 541-0710



15 DAY MONEY BACK GUARANTEE

FULL FACTORY WARRANTY
WRITE FOR FREE CATALOG

SPRING 1994 ELECTRONICS HOBBYISTS HANDBOOK

FUN WITH ELECTRONICS



◀ **160—COIL DESIGN & CONSTRUCTION MANUAL** \$5.95. How to make RF, IF, audio and power coils; chokes and transformers. Practically every possible type is discussed.

▶ **PCP113—THE PC MUSIC HANDBOOK** \$13.95. Learn the basics of computer music systems. For the professional musician, gifted amateur or just plain curious.



◀ **BP297—LOUDSPEAKERS FOR MUSICIANS** \$6.25. Loudspeaker design from the musician's point of view! All you need to know, and you should be able to design your own after reading this.



▶ **BP277—HIGH POWER AUDIO AMPLIFIER CONSTRUCTION** \$6.25. Here's background and practical design information on high power audio amplifiers capable of 300 ± 400 watts r.m.s. You'll find MOSFET and bipolar output transistors in inverting and non-inverting circuits.



◀ **BP302—A CONCISE USER'S GUIDE TO LOTUS 1-2-3 RELEASE 3.1** \$6.25. If you are a PC user and want to upgrade to Lotus 1-2-3 release 3.1, this book can teach you how to do that in the shortest and most effective way.

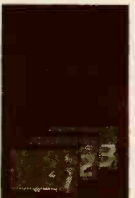

▶ **BP298—A CONCISE INTRODUCTION TO THE MACINTOSH SYSTEM AND FINDER** \$6.25. This introduction for those new to the Mac, this book also serves as a quick refresher for experienced owners that have not used the machine in some time.



MAIL TO: **Electronic Technology Today, Inc.**
P.O. Box 240
Massapequa Park, NY 11762-0240

SHIPPING CHARGES IN USA AND CANADA

\$0.01 to \$5.00	\$1.50	\$30.01 to \$40.00	\$5.50
\$5.01 to \$10.00	\$2.50	\$40.01 to \$50.00	\$6.50
\$10.01 to \$20.00	\$3.50	\$50.01 and above	\$8.00
\$20.01 to \$30.00	\$4.50		

SORRY, No orders accepted outside of USA and Canada

Total price of merchandise	\$ _____
Shipping (see chart)	\$ _____
Subtotal	\$ _____
Sales Tax (NYS only)	\$ _____
Total Enclosed	\$ _____

Name _____
Address _____
City _____ State _____ Zip _____

to read under virtually any lighting conditions.

The DMS-20PC-1-LM digital AC-line monitor costs \$45. For additional information, contact Datel, Inc., 11 Cabot Boulevard, Mansfield, MA 02048; Tel: 508-339-3000; Fax: 508-339-6356.

CIRCLE 117 ON FREE INFORMATION CARD

RANGEMASTER MULTIMETER

Extech's 380280 Rangemaster multimeter has nine functions for monitoring and testing, and a large 3½-digit LCD readout for easy viewing. The rotary range-selector switch lets you monitor DC and AC amps in four (ranges from 2 mA to 20 A), DC



volts in five ranges (from 200 mV to 1000 V), AC volts in five ranges (from 200 mV to 750 V), resistance in six ranges (from 200 ohms to 20 megohms), capacitance in five ranges (from 2 nF to 20 µF), and frequency in four ranges (200 Hz to 200 kHz). Other functions include a transistor test, diode check, and continuity tester with buzzer. Ideal for field work, the rugged Rangemaster features full overload protection and low-battery and over-range indicators. It comes complete with built-in tilt stand, a rubber holster, test leads, and a 9-volt battery.

The 380280 Rangemaster multimeter costs \$79. For additional information, contact Extech Instruments Corporation, 335 Bear Hill Road, Waltham, MA 02154; Tel: 617-890-7440; Fax: 617-890-7864.

CIRCLE 109 ON FREE INFORMATION CARD

DIGITAL SPECIAL-EFFECTS GENERATOR

Although it is targeted primarily at the semi-professional "prosumer" market, small production facilities and home-video enthusiasts can use Sony's XV-



D1000 digital special-effects generator to obtain professional-like results. The easy-to-use component lets you combine multiple video and audio sources, create dramatic scene transitions, add spectacular video effects, and quickly program effects sequences. Designed to work with professional editing decks, the effects generator features VISCS and GPI interfaces for use with computerized editing systems, three A/V inputs and two A/V outputs for multiple-source editing and post-production effects sessions, and an S-Video input/output.

The XV-D1000 features a digital frame synchronizer for precise combination of two distinct video sources, a double-frame memory for high-resolution images, and 77 different wipe patterns. It allows you to size and insert one image into another, fade to white or black, zoom in on a particular area, divide the screen into nine picture areas, stop the action at successive points and display each point in a nine-image matrix, and freeze the full-screen image without ghosting or tracking lines. A ten-program memory lets you store effects.

The XV-D1000 digital special-effects generator has a suggested retail price of \$2600. For more information, contact Sony Electronics Inc., One Sony Drive, Park Ridge, NJ 07656.

CIRCLE 103 ON FREE INFORMATION CARD

(More on page 10)

5 sure steps to a fast start as a high-paid computer service technician

1. Choose a complete training program for a secure tomorrow

Jobs for computer service technicians will almost double in the next 10 years, according to the latest Department of Labor projections. For you, that means unlimited opportunities for advancement, a new career, or even a computer service business of your own.

But to succeed in computer service today, you need training—complete, practical training that gives you the confidence to service any brand of computer. You need NRI training.

Only NRI—the leader in career-building, at-home electronics training for 80 years—gives you useful knowledge, hands-on skill, and real-world experience with a powerful 486sx computer you keep. NRI is all you need to succeed in this growing, profitable field.

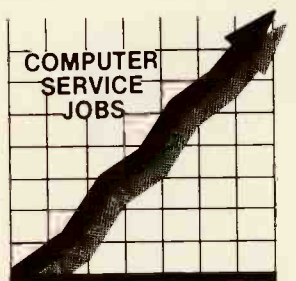

1994 Good pay, too! 2004

Plus, now you train with and keep the latest in diagnostic hardware and software: the R.A.C.E.R. plug-in card and QuickTech software program, both from Ultra-X. Using these state-of-the-art diagnostic tools, you learn to quickly identify and service virtually any computer problem on IBM-compatible machines.

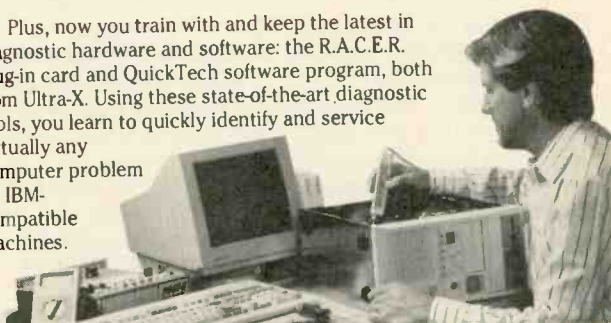

4. Make sure you've always got someone to turn to for help

Throughout your NRI training, you've got the full support of your personal NRI instructor and the entire NRI technical staff. Always ready to answer your questions and help you if you should hit a snag, your instructors will make you feel as if you're in a classroom of



one, giving you as much time and personal attention as you need.

2. Move beyond "book learning" to try things for yourself

NRI knows you learn better by doing. So NRI training works overtime to give you that

invaluable practical experience. You first read about the subject, studying diagrams, schematics, and photos that make the subject even clearer. Then you do. You build, examine, remove, test, repair, replace. You discover for yourself the feel of the real thing, the confidence gained only with experience.

3. Get inside a 486sx computer system

If you really want to get ahead in computer service, you have to get inside a state-of-the-art computer system. That's why NRI now includes a high-speed 486sx mini-tower computer as the centerpiece of your hands-on training.

As you build this 1 meg RAM, 32-bit CPU from the keyboard up, you actually see for yourself how each section of your computer works. You assemble and test your computer's "intelligent" keyboard, then interface the power supply and high-density floppy disk drive. But that's not all.

You go on to install a powerful new 200 meg hard disk drive and Super VGA Color Monitor, today's most wanted computer peripherals. Now not only will you dramatically increase your computer's storage capacity, but you'll get to enjoy the drama and impact of a full-color display!

Now with 200 meg hard drive, Super VGA color monitor!



5. Start a bright new future by sending for your FREE catalog today!

Discover for yourself how easy it is to succeed in computer service. Return the coupon to get NRI's big, full-color catalog describing every aspect of NRI's incomparable computer training, as well as training in TV/video/audio servicing, telecommunications, industrial electronics, and other growing high-tech career fields. Find out more about how step-by-step training the NRI way will help get you where you want to go!

If the coupon is missing, write to: NRI Schools, McGraw-Hill Continuing Education, 4401 Connecticut Avenue NW, Washington, DC 20008.

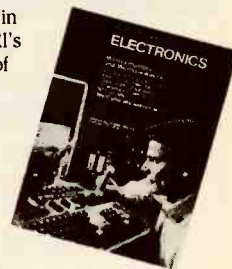

NRI Schools

McGraw-Hill Continuing Education Center
4401 Connecticut Avenue, NW, Washington, DC 20008

CHECK ONE CATALOG ONLY

- | | |
|--|--|
| <input type="checkbox"/> Microcomputer Servicing | <input type="checkbox"/> Computer Programming |
| <input type="checkbox"/> TV/Video/Audio Servicing | <input type="checkbox"/> PC Applications Specialist |
| <input type="checkbox"/> Telecommunications | <input type="checkbox"/> Multimedia Specialist |
| <input type="checkbox"/> Industrial Electronics/Robotics | <input type="checkbox"/> Programming in C++ with Windows |
| <input type="checkbox"/> Basic Electronics | <input type="checkbox"/> Bookkeeping & Accounting |

For career courses approved under GI Bill
 check for details.

Name _____

Address _____

City _____ State _____ Zip _____

Accredited Member, National Home Study Council

32-0294

NEW PRODUCTS

PC WEATHER STATION

WeatherPort's WS-12 WindStation is a data-acquisition system for measuring and logging wind speed, wind direction, and temperature on a personal computer. The device interfaces via the parallel port of an MS-DOS-based computer. Measurement data can be displayed on screen, stored as disk files,



and accessed by other real-time DOS programs. An alarm function sounds the audible annunciator in the computer whenever the peak wind speed

(Continued from page 8)

exceeds the value set by the user. An optional relay can also activate an external device whenever the wind speed alarm limit is exceeded.

The WS-12 WindStation has a suggested retail price of \$295. For additional information, contact WeatherPort, P. O. Box 240, Grass Valley, CA 95945-0240; Tel: 916-477-5226; Fax: 916-477-8339.

CIRCLE 112 ON FREE INFORMATION CARD

MULTI-PURPOSE TESTER

If you're worried about electromagnetic radiation, poor antenna performance, or EMI/RFI, I.C. Engineering's Digi-Field field-strength meter can help put you at ease. With its frequency response of DC up to 12 GHz, it readily detects potential electromagnetic radiation hazards. Digi-Field can easily find 60-Hz AC-line interference,



as well as RFI/EMI instrumentation-disrupting setups. The handheld instrument can also be used to check antenna gain/loss and polarization patterns. All measurements are displayed on the unit's 3½-digit LCD readout, allowing the user to make quick visual checks of radiation gain or loss, antenna patterns, garage-door opener transmitters, microwave oven leakage, and cellular and portable phones, and to locate transmit-

ters. The battery-powered meter also has a detector output jack for AM monitoring. The Digi-Field can be used with its own telescoping antenna or with an external one with a PL 259 connector. Typical calibration curves in dBm are available.

The Digi-Field field-strength meter costs \$119.95 plus \$4.50 shipping and handling. For more information, contact I.C. Engineering, 16350 Ventura Blvd., Suite 125, Encino, CA 91436; Tel: 800-FIELD58 (3435358) for orders, 818-345-1692 for information; Fax: 818-345-0517.

CIRCLE 101 ON FREE INFORMATION CARD

BENCH-STYLE DIGITAL MULTIMETER

The 4000-count, bench-style Model 2835 from B + K Precision is a full-featured multimeter/capacitance meter/frequency counter with a basic DC voltage accuracy of 0.5%. Multimeter functions include the measurement of resistance and AC/DC voltage and current, and

Toner Cartridge Recharge

& Laser Printer Supplies

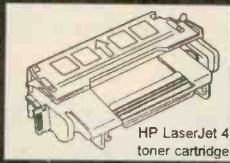

HP LaserJet 4 toner cartridge

Start Your Own Recharge Business!

Recharge your customers' toner cartridges. Two profitable methods:

You Do It

Learn how to recharge toner cartridges used in the most popular laser printers.

Free Instructions Free Technical Support

- Supplies cost from \$5.70 per recharge
- Starter Kit with supplies, tools & chemicals
- Initial investment approximately \$650.00, including toner vacuum
- Dial Document# 2040

We Do It For You

Send us your customer's toner cartridges and we will professionally recharge them for you.

Prices as low as \$19.95

We support all popular laser printers including all HP LaserJets (II, III, IIp, IIIsi, 4, 4si, 4L), IBM, NEC, Epson, Apple, QMS, Panasonic, etc.

- Just mail your cartridges to us and we will do the rest.
- Dial Document# 3710

For detailed information, Call us, or dial our

FAX-ON-DEMAND SYSTEM

Call from any Fax machine equipped with a touch-tone phone.

516-467-0772



Chenesko Products Inc.
2221 Fifth Avenue, #4, Ronkonkoma, NY 11779
Fax: 516-467-3223 Tech. Support: 516-467-3205
Orders: 800-221-3516

CIRCLE 17 ON FREE INFORMATION CARD

From Not-Working to Networking!

Troubleshooting Local-Area Networks!

Now, complete for the first time in one detailed booklet!

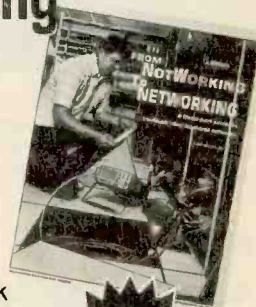

**ONLY
\$5.00**

Gain a fuller knowledge of network fundamentals and how they developed from the early days of main frames, from XNS to Ethernet technology, the OSI stack for interconnecting different computers, basic and specialized test instruments, etc. Several tough LAN case histories bring from theory to the practical side of troubleshooting.

CLAGGK Inc., Reprint Bookstore
P.O. Box 4099, Farmingdale, NY 11735

Please rush my copy of "From Not-Working to Networking." I enclosed payment of \$5.00 which includes shipping charges.

Name _____

Address _____

City _____ State _____ ZIP _____

Sorry, no orders excepted outside of United States and Canada. All Payments must be in U.S. funds. Send check or money order payable to CLAGGK Inc.—do not send cash or stamps. New York State residents add applicable sales tax.

diode and continuity checks. Frequency measurement extends to 1 MHz, with up to 1-Hz resolution, and capacitance measurement is to 40 μ F with up to 1-pF resolution. The Model 2835 features autoranging or manual ranging operation and a high-contrast back-lit LCD readout with 42-segment bar-graph.



Designed for bench or field use, the instrument offers AC or battery operation, with battery life rated at 1800 hours. The compact unit has convenient built-in storage for test leads and AC power cord. High-energy fusing, overvoltage protection, and an impact-resistant case provide protection against accidental misuse. The DMM comes with test leads, power cord, hand and neck straps, and user's manual.

The Model 2835 digital multimeter costs \$270. For further information, contact B + K Precision, Maxtec International Corporation, 6470 West Cortland Street, Chicago, IL 60635; Tel: 312-889-9087; Fax: 312-794-9740.

CIRCLE 105 ON FREE INFORMATION CARD

SURGE SUPPRESSOR

Tripp Lite's Spike Bar Super 7 surge suppressor features three diagnostic indicators that light to show the presence of wiring faults, status of protection circuitry, and loss of AC power. The indicators warn of any abnormalities before equipment is turned on, assuring complete protection of connected equipment. The UL-listed Spike Bar Super 7 also has seven spike-and noise-filtered AC outlets, a seven-foot AC line cord, and a safety circuit breaker. In addition, "Ultimate Lifetime Insurance" protects both the surge suppressor and any con-

nected equipment from surge damage, including direct lightning strikes, for up to \$5000.

The Spike Bar Super 7 has a suggested retail price of \$49.95.

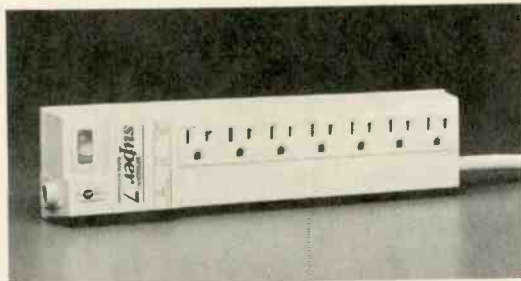

For additional information, contact Tripp Lite, 500 North Orleans, Chicago, IL 60610-4188; Tel: 312-329-1777; Fax: 312-644-6505.

CIRCLE 104 ON FREE INFORMATION CARD

HIDDEN WIRE TAPE

Today's speakers are getting smaller and less conspicuous, but there's still the problem of unsightly wire runs between the speakers and the audio or video components. *Wire Tape*, designed to replace any 18-gauge wire for speakers or burglar alarms, is just ten thousandths of an inch thick. Its resemblance to a strip of tape is compounded by its pre-applied adhesive backing that allows you to sim-



ply "peel-and-stick" Wire Tape to drywall or plaster walls. Covered with a coat of paint or wallpaper, the Wire Tape is virtually invisible, particularly when installed in room corners.

Wire Tape has a suggested price of \$19.95. For further information, contact Wire Tape, 640 North Cypress, Orange, CA 92667; Tel: 714-771-4063. ■

CIRCLE 108 ON FREE INFORMATION CARD

43,216

ELECTRONIC COMPONENTS

Whether you order 1 part or all 43,216...MOUSER stocks and...ships same day!!

CALL...

(800) 992-9943

for your
FREE CATALOG

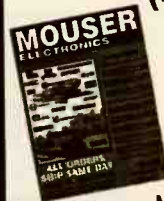

2401 Hwy. 287 N.
Mansfield, TX 76063

MOUSER[®] ELECTRONICS

Sales & Stocking Locations Nationwide

CIRCLE 23 ON FREE INFORMATION CARD

Learn VCR repair at home!

MAKE GOOD MONEY IN YOUR OWN FULL- OR PART-TIME JOB



Professional-level home study course. You will master easy-to-learn, high-profit repairs *without* investing in high-tech instruments or a costly workshop.

Want more independence and higher income? Send or call today!

Free career literature:
800-223-4542

Name _____ Age _____
Address _____ Phone (____) _____
City _____ State _____ Zip _____

The School of VCR Repair
6065 Roswell Road
Dept. VA351, Atlanta, Georgia 30328

CIRCLE 21 ON FREE INFORMATION CARD

ELECTRONICS LIBRARY

INSIDE YOUR SHORTWAVE RADIO

by Ted Benson, WA6BEJ

Written in a clearly understandable style, this book explains how your shortwave radio works, beginning with radio reception and taking readers through the inner workings of a typical superhet shortwave receiver.

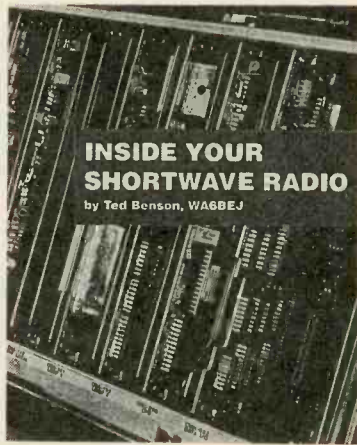

It goes beyond the information that is typical in your receiver's manual, expanding upon what the manual leaves unclear, or leaves out altogether. Throughout the book, the emphasis is placed on helping you get the most from your shortwave radio.

The book discusses receiver tuning, passband tuning, and receiver displays. It explains CW, SSB, Fax, and RRTY signals, and shows you how to tune them in. Shortwave accessories are also covered. The book explains phase-locked loops, IF filters, IF notches, exalted-carrier single sideband, panoramic adaptors, preselectors, antenna tuners, antenna connections, feedlines, and grounds. A wealth of illustrations accompany the text. There is also a handy glossary of receiver terms, and a section that answers many of the most commonly asked questions

about shortwave receivers and their use.

Inside Your Shortwave Radio is available for \$14.95 plus \$2.00 shipping and handling (\$3.00 outside the U.S.) from *Tiare Publications, P. O. Box 493, Lake Geneva, WI 53147.*

CIRCLE 100 ON FREE INFORMATION CARD

VOODOO WINDOWS: Tips & Tricks With an Attitude

by Kay Yarborough Nelson

Although the appeal of Microsoft Windows, with its intuitive interface and friendly flexibility, is obvious, many Windows manuals obscure the programs attributes with excess information and technical language. This book helps remove the confusion by reducing each Windows function to its simplest ingredients, and limiting those functions to the most accessi-

EASY TO FABRICATE
DESIGNED FOR SMALL LOT PRODUCTION

SHEET METAL BOXES FOR CONSTRUCTION

ALL ITEMS STOCKED FOR QUICK DELIVERY
SHEET METAL BOXES SHIPPED FLAT

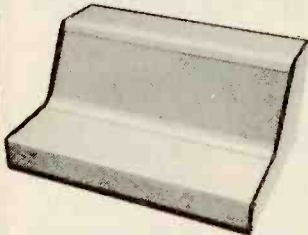

DUAL SLOPE METAL CABINETS

MODEL	DESCRIPTION MAJOR DIM. SECONDARY DIM. W x D x H (inches)	PRICE \$
DS-1	4 x 6 x 4 x 12 x 1.9 x 2.4 x 1.6	59.00
DS-2	6 x 6 x 4 x 12 x 1.9 x 2.4 x 1.6	63.25
DS-3	8 x 6 x 4 x 12 x 1.9 x 2.4 x 1.6	67.50
DS-4	10 x 6 x 4 x 12 x 1.9 x 2.4 x 1.6	71.50
DS-5	12 x 6 x 4 x 12 x 1.9 x 2.4 x 1.6	76.00
DS-6	18 x 6 x 4 x 12 x 1.9 x 2.4 x 1.6	81.00
DS-7	4 x 8 x 6 x 2 x 3.1 x 3.5 x 1.9	69.00
DS-8	6 x 8 x 6 x 2 x 3.1 x 3.5 x 1.9	73.00
DS-9	8 x 8 x 6 x 2 x 3.1 x 3.5 x 1.9	78.00
DS-10	10 x 8 x 6 x 2 x 3.1 x 3.5 x 1.9	82.75
DS-11	12 x 8 x 6 x 2 x 3.1 x 3.5 x 1.9	87.75
DS-12	18 x 8 x 6 x 2 x 3.1 x 3.5 x 1.9	100.75

EXTRUDED SERIES

MODEL	DESCRIPTION W x D x H (inches)	PRICE \$
ET-1	4.52 x 4.35 x 1.57	10.00
ET-1B	4.52 x 4.35 x 1.57	10.00
ET-2	4.52 x 6.00 x 1.57	24.00
ET-2B	4.52 x 6.00 x 1.57	24.00
CCET	PLASTIC CARRYING CASE	18.00

PANELS ARE .063" ALUMINUM

RACK CHASSIS

MODEL	DESCRIPTION W x D x H (inches)	PRICE \$
1RU5	19 x 5 x 1.75	30.85
1RU7	19 x 7 x 1.75	33.10
1RU10	19 x 10 x 1.75	35.25
2RU5	19 x 5 x 3.5	33.10
2RU7	19 x 7 x 3.5	35.25
2RU10	19 x 10 x 3.5	37.50
3RU5	19 x 5 x 5.25	41.90
3RU7	19 x 7 x 5.25	44.10
3RU10	19 x 10 x 5.25	46.30

SHEET METAL PUNCHES

MODEL	HOLE SIZE & SHAPE	PRICE \$
PUNCH 1	3/8" ROUND	9.95
PUNCH 2	7/16" ROUND	9.95
PUNCH 3	1/2" ROUND	9.95
PUNCH 4	9/16" ROUND	12.95
PUNCH 5	5/8" ROUND	12.95
PUNCH 6	11/16" ROUND	12.95
PUNCH 7	3/4" ROUND	12.95
PUNCH 8	13/16" ROUND	12.95
PUNCH 9	7/8" ROUND	12.95
PUNCH 10	1" ROUND	13.95
PUNCH 11	1-1/16" ROUND	13.95
PUNCH 12	1-1/8" ROUND	13.95
PUNCH 13	1-3/16" ROUND	14.95
PUNCH 14	1-1/4" ROUND	14.95
PUNCH 15	1-3/8" ROUND	14.95
PUNCH 16	1-1/2" ROUND	16.95
PUNCH 17	1-5/8" ROUND	21.95
PUNCH 18	1-3/4" ROUND	24.95
PUNCH 19	2-5/8" ROUND	61.95
PUNCH 20	1 1/16" SQUARE	32.95
PUNCH 21	3/4" SQUARE	36.95
PUNCH 22	1" SQUARE	46.95
PUNCH 23	2 1/32" x 1 1/16" RECT.	46.95
*PUNCH 24	*THURST PAGES	10.95

PANELS ARE .063" ALUMINUM

METAL CABINETS

MODEL	DESCRIPTION W x D x H (inches)	PRICE \$
MC-1A	4 x 3 x 2	16.50
MC-2A	6 x 3 x 2	18.75
MC-3A	8 x 3 x 2	20.95
MC-4A	4 x 4 x 3	18.75
MC-5A	6 x 4 x 3	20.95
MC-6A	8 x 4 x 3	23.15
MC-7A	4 x 7 x 4	20.95
MC-8A	6 x 7 x 4	23.15
MC-9A	8 x 7 x 4	25.75

PANELS ARE .060" ALUMINUM AND ARE FIELD REMOVABLE

HEAVY DUTY RACK CHASSIS

MODEL	DESCRIPTION W x D x H (inches)	PRICE \$
3RU7 HD	19 x 7 x 5.25	115.00
3RU10 HD	19 x 10 x 5.25	121.00
3RU14 HD	19 x 14 x 5.25	134.00
4RU7 HD	19 x 7 x 7.0	121.00
4RU10 HD	19 x 10 x 7.0	129.00
4RU14 HD	19 x 14 x 7.0	134.00
5RU7 HD	19 x 7 x 8.75	126.00
5RU10 HD	19 x 10 x 8.75	133.00
5RU14 HD	19 x 14 x 8.75	143.00

HAND TOOLS

MODEL	DESCRIPTION	RANGE (mm)	PRICE \$
MD-1	MICRO REAMER	1.0-5.5	16.50
MD-2	REGULAR REAMER	3.0-12.0	26.00
MD-3	LARGE REAMER	10.0-25.0	48.00
RT-1	RETHREADER	3.0 x 0.5	10.50
AD-1	DRILL BIT ADAPTER FOR POWER SCREWDRIVER		6.50

NEW FOR 1994

RACKEM 'N' STACKEM™ SERIES
A NEW 1/2" RACK SYSTEM WITH ITS OWN TABLE-TOP RACK AVAILABLE IN CLEAR, BLACK AND GOLD FOR A GREAT PRESENTATION

ORDERS (800) 634-3457
FAX ORDERS (800) 551-2749

TECH LINE (702) 565-3993 M - Th 8 am TO 4 pm (Pacific Time)

Line will only be answered by our technician;

If no answer, please try at another time

OFFICE (702) 565-3400

FAX (702) 565-4828



SESCOM, INC.
2100 WARD DRIVE
HENDERSON, NV 89015 USA



CALL OR WRITE FOR YOUR **FREE 24 PAGE CONSTRUCTOR'S CATALOG!**
PREPAID ORDERS SHIPPED GROUND AT NO CHARGE (48 STATES)



ble, quickest, and easiest. The book demonstrates techniques for teaching your mouse new tricks, customizing Windows for fun and productivity, and avoiding common pitfalls. It provides tips on starting, switching, and exiting Windows; and on copying and pasting. It reveals Program Manager secrets for installation, creating new groups, and multitasking, along with File Manager hints for selecting, moving, copying, and renaming files; deleting files and directories; and using the View menu. The book also covers printing pointers; accessories including Calendar, Calculator, Notepad, Paintbrush, Cardfile,

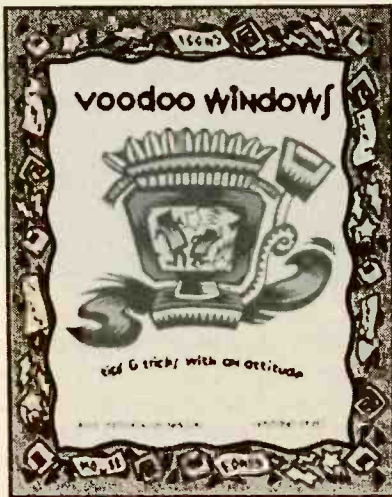

and Clock; and various ways to customize and optimize Windows.

Voodoo Windows: Tips & Tricks With an Attitude costs \$19.95 and is published by Ventana Press, P. O. Box 2468, Chapel Hill, NC 27515; Tel: 919-942-0220; Fax: 919-942-1140.

CIRCLE 92 ON FREE INFORMATION CARD

THE ELECTRICITY BOOK:
The Junior Technician's Discovery Guide to How Electricity Works
 by Gene McWhorter

This book aims to "spark" the young reader's imagination and interest in electricity—for a hobby, a science-fair project, or even a future career in electrical engineering. With easy-to-read text and clearly illustrated ex-

(Continued on page 77)



*From the Lab
 to your
 Living Room!*

Does your VCR have a "Head Cold?"

Probably not! However, through constant playing and using of degrading dry or wet cleaners, the output of your video tapes has slowly diminished to an unacceptable level and the VCR plays as if it has a head cold! The culprit is most likely clogged and dirty video and/or audio heads.

The **3M Black Watch™ Head Cleaner Videocassette** uses a patented magnetic tape-based cleaning formation to remove head clogging debris. No foreign substances such as cloth, plastics or messy liquids and no harsh abrasive materials are present. The cleaner's usable life is 400 cleanings or more!

It's easy to use. Place the **3M Black Watch™ Head Cleaner Videocassette** in the VCR and press the Play button. A pre-recorded message appears clearly on your screen and an audible tone is heard, telling you that the cleaning process is now completed. No guess work, you never over clean!

3M Black Watch™ Head Cleaner Videocassette SVHS VHS.....\$19.95

Once your VCR's head cold is cured, and the unit plays like new, consider using the finest videocassette you can buy—the **3M Black Watch™ T120 Hi Pro VHS 4410 Videocassette**. The 4410 is the highest performing videocassette available today for use with all standard format VHS recording hardware!

Here's what you hear and see....A sharp, clear picture—brightest colors—freedom from streaks, flashes and snow—outstanding high-fidelity audio reproduction—optimum camcorder performance—maintains recording integrity. **3M Black Watch™** video tape is 100% laser inspected to guarantee surface smoothness and drop-out free performance.

3M Black Watch™ T120 Hi Pro VHS 4410 Videocassette VHS.....\$8.00

CLAGGK INC. — 3M VHS Special Offer
 P.O. Box 4099, Farmingdale, New York 11735

Yes, I like your offer and here is my order for 3M Black Watch™ products!

___ 3M Black Watch™ Head Cleaner Videocassette	(\$19.95 each)	___ \$
___ 3M Black Watch™ T120 Hi Pro VHS 4410 Videocassette	(\$8.00 each)	\$ ___
Shipping and handling per order		\$ 4.00
Total Amount in U.S. Funds only		\$ ___

New York State residents add local sales tax. Canadians add \$6.00 per order. No foreign orders. Do not send cash.

Bill my VISA MasterCard Expire Date ___/___/___

Card No. _____

Signature _____

Name (Please print) _____

Address _____

City _____ State _____ ZIP _____



Build intelligence into your car's fuel-measuring system by installing an indicator lamp that flashes when your fuel supply falls to a user-defined level.

BUILD A SMARTER GAS GAUGE

BY JONATHAN GORDON

Whether you have a 1930–1950's vintage car, a 1960–1970's stock car that's been rebuilt into a musclecar, or a modern 1980–1990's car that has an engine computer, the *Smarter Gas Gauge* described in this article will accurately monitor the changing gas level in the tank—without affecting the operation of your factory installed gas-gauge in any way. Although your car may already be equipped with an in-dash low-fuel indicator, sometimes called an *idiot light* (which uses a factory preset, gas-level-sensing switch), such switches offer no manual control over the fuel level at which the idiot-light illuminates.

But, that's not the case with the Smarter Gas-Gauge. The Smarter Gas Gauge lets you electronically set the fuel-level trip point to $\frac{3}{4}$, $\frac{1}{2}$, $\frac{1}{4}$ full, almost empty, or any level in between. And the trip point that you set remains valid, even during periods of extreme agitation like when you quickly accelerate or take a tight turn. When the gas level reaches your preset trip-point, the low-fuel indicator illuminates.

But before we get into the operation of the circuit, a quick discussion of fuel-level indicators is in order.

Fuel-Gauge Systems. There are three types of fuel gauges found on automobiles: The magnetic, balanced-coil fuel gauge, the bi-metallic, heated-coil fuel gauge, and an electronic fuel-level bargraph or digital display.

Figure 1 shows the magnetic fuel-gauge system that's used in a 1972 Olds Cutlass convertible, which, incidentally, acted as the test platform for this project. The car's original gas-gauge was working fine but had become blocked from the driver's view by a modified steering-wheel column.

Inside the magnetic gauge is a set of balancing coils labeled L1 and L2, which are electromagnetic inductors that are wound around a plastic core at right angles to each other. The gauge needle is attached to a metal armature on which the two electromagnetic coils act. A series DC current flows through limiting-coil L1, then through operating-coil L2, and finally to ground.

Limiting-coil L1 exerts a constant

magnetic pressure on the gas-gauge needle that pulls it toward the empty-tank position; while operating-coil, L2 exerts a variable magnetic pressure that pulls the gauge needle toward the full-tank position. In such systems, the direction of the needle's movement depends on how much current is shunted away from L2 to ground via tank-rheostat R1 (which is usually called a sender).

Because coil L2 has more windings than coil L1, a small resistor, R2, is added to the winding resistance of L1 so that the resistance between the two coils is balanced.

Now let's suppose that ignition-switch S1 is turned on and sender R1 is in the full-tank position. Most of the current flows to ground through the gas gauge via coils L1 and L2; minimal shunt current flows to ground through the high-resistance path of sender R1, which is in parallel with coil L2. Operating-coil L2 builds up a stronger magnetic field than limiting-coil L1, and the pointer is pulled to the full position.

Now suppose that sender R1 is in the empty-tank position. Most of the current flows through the gas gauge via coils L1, and the low-resistance path



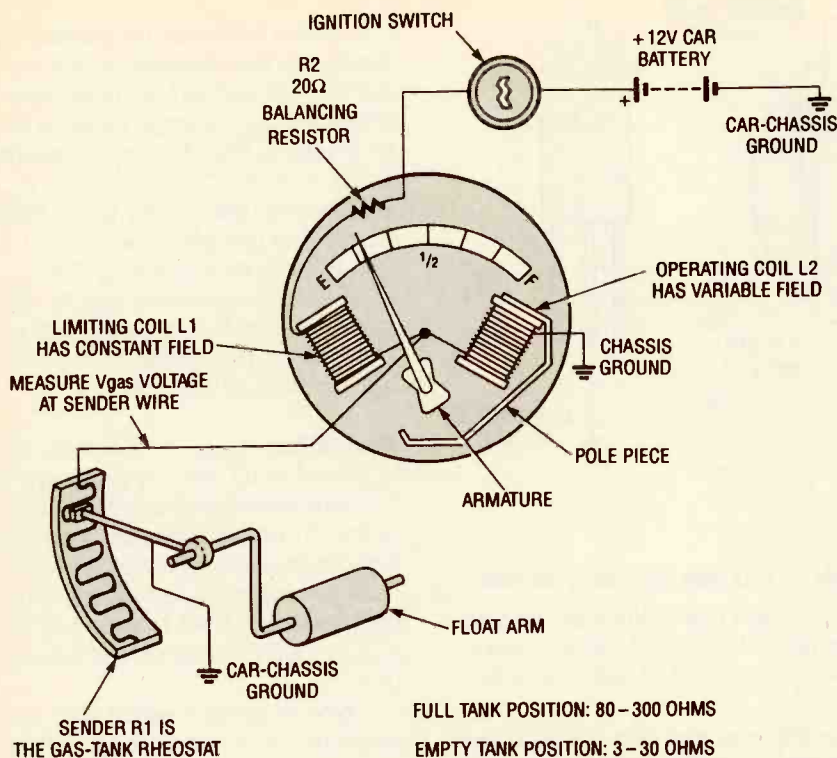

Fig. 1. There are two types of magnetic balanced-coil gauge systems; the one shown here uses a set of electromagnetic coils, L1 and L2, and a sender, R1, that shunt's coil L2.

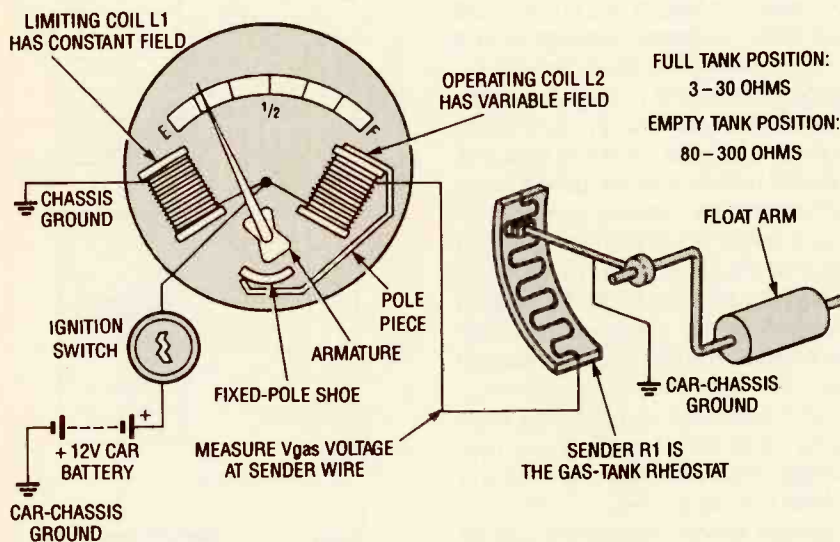

Fig. 2. Here is the second type of magnetic balanced-coil gauge system; this one uses a set of electro-magnetic coils L1 and L2, and a sender R1, as with the previous one. But, instead of the sender shunting L2, the sender is in series with coil L2.

to ground through sender R1, which shunts current around coil L2. Limiting-coil L1 builds up a stronger magnetic field than operating-coil L2, and the pointer is pulled to the empty position.

Figure 2 shows another version of the magnetic, balanced-coil, fuel-gauge system. In this version, limiting-coil L1 exerts a constant magnetic

pressure that pulls the gauge needle toward the empty position. Operating-coil L2 exerts a steady magnetic pressure that pulls the gauge needle toward the full position, but the magnetic strength depends upon the amount of current flowing through the series circuit formed by coil L2 and sender R1. When R1 is in the empty

position, the resistance is high, which reduces the series current, so that the magnetic pull developed by coil L2 is weak. When sender R1 is in the full position, the resistance is low, which increases series current, so that the magnetic pull developed by coil L2 is strong.

The magnetic fuel-gauge systems in Figs. 1 and 2 work differently. The gauge in Fig. 1 uses a shunt circuit, consisting of operating-coil L2 and sender R1, while the one in Fig. 2 uses a series circuit of operating-coil L2 and sender R1. In addition, sender R1 in Fig. 1 has a low resistance in the empty position and a high resistance in the full position; while sender R1 in Fig. 2 has just the opposite, a high resistance in the empty position and a low resistance in the full position.

Figure 3 shows another type of fuel-gauge system; a bi-metallic, heated-coil type. In that system, sender R1 influences the series current flow by way of a coiled heating element that's wound around a bi-metallic bar in the gauge. When the tank is full, sender R1 has a low resistance, allowing maximum current to flow through the coiled heating element, which causes it to heat. As the bi-metallic bar heats, it begins to bend because

A BRIGHT IDEA

The author wishes to thank Bob Manfred of SK Technologies, Inc., Boca Raton, FL, who is an expert on 1972 Cutlass convertibles in particular, and musclecars in general. It all started when Bob asked the author to design an instrument that would flash a light when his car was in need of fuel. The author admits that the whole idea sounded a lot like the idiot light (that most cars already had in abundance) that flash to signal everything from an alternator malfunction, low fuel, battery problems, door ajar, you name it. But Bob wanted no ordinary idiot light; what he wanted was a smarter light. The old fashioned idiot light that just illuminates when the gas gauge reads near empty wasn't good enough. Bob wanted to manually set the light's trip point for any gas needle position, from empty to full. And the light had to be an extremely bright incandescent lamp, an LED just wouldn't do. That's how the brighter idea for the Smarter Gas Gauge got started, and one week later the author's prototype was installed in Bob's 1972 Olds Cutlass. The Smarter Gas Gauge has since become a fool-proof warning system and a conversation piece for everyone who comes along for a ride.

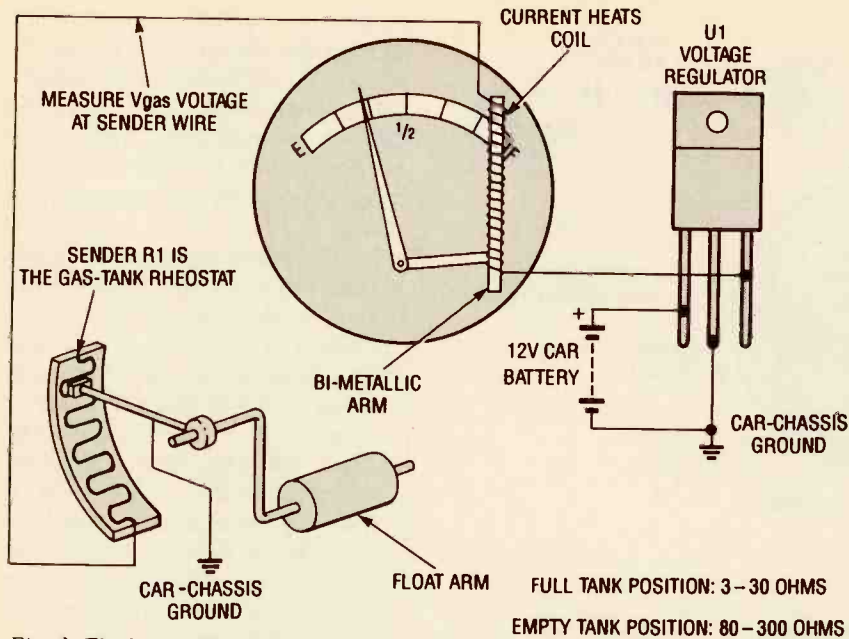

Fig. 3. The bi-metallic heated-coil gauge system uses a heating coil wound around a bi-metal bar, and a sender (R1) that's connected in series with the heating-coil wire.

of the difference in temperature expansion properties between the two bonded metals. Consequently, the gauge needle moves to the full position. When the tank is empty, sender R1 has a high resistance so minimum current flows through the coiled heating element. The bi-metallic bar cools, bending back to the original position, and the gauge needle moves to the empty position.

Voltage regulator U1 assures that any changes in current through the coiled heating element is caused by changes in resistance originating at the sender. Because the bi-metallic strip heats and cools slowly, sudden fuel-level changes caused by fuel sloshing in the tank are dampened so that a steady reading of the average fuel level in the tank is indicated. That is in contrast to the magnetic, balanced-coil gauge, which responds to sloshing fuel and gives a noticeable swing to the gauge needle.

Figure 4 shows an electronic fuel-level gauge that uses a bargraph display (digital readout). Notice that the gas-tank rheostat R1 (sending unit) is the same as that used by the electromechanical needle-type gauges. The sender consists of a float arm and variable resistor. As the fuel level changes, the sender's resistance also changes, which, in turn, places a varying voltage across the sender.

The electronic control module (or ECM) senses the voltage across the

sender and converts it into a bargraph or digital readout that indicates fuel-gallons remaining. For example, a typical General Motors sender has 90 ohms when the tank is full and 0 ohms when empty. Therefore, every decrease of 6 ohms would decrease the display one segment if it is equipped with a 16-segment bargraph gauge and a 16-gallon tank.

Figure 5 shows how a typical sending-unit is situated in the fuel tank. The rheostat assembly works just like a potentiometer. The resistive element is inside a metal housing that is lowered into the tank. The float arm is attached to a brush that contacts the resistive element. As the fuel level changes, the float arm moves and the rheostat then converts that linear up-and-down motion into a changing resistance. That varies the current flow through the fuel gauge so that the pointer needle moves.

Typical sender-resistance values are: 0-ohm empty to 90-ohms full for most GM vehicles; 73-ohms empty to 8-12-ohms full for Ford and Chrysler; 240-ohms empty to 33-ohms full for AMC, Stewart Warner senders, and marine applications.

Now that we've established that the sender resistance depends on the fuel level in the tank, it stands to reason that by measuring the voltage across sender R1 a unique voltage is recorded for each fuel level in the tank from empty-to-full.

In fact, a table can be created by measuring the voltages—which we'll call V_{gas} —at various fuel levels. Table 1 shows the V_{gas} voltage rising as the tank is being filled for the fuel gauge in Fig. 1. Tables 2 and 3 show V_{gas} levels falling as the tank is being filled for the fuel gauges in Figs. 2 and 3, respectively. By monitoring the V_{gas} level, we'll always know exactly how much fuel is in the tank. Now let's go through the procedure to measure V_{gas} and record the data.

Measuring V_{gas} . To measure the V_{gas} level, you'll need to perform the following steps: Turn the ignition switch to the on position (powering up the fuel-gauge system); disassemble the dash to locate the fuel-gauge plug; and hookup a DVM to measure the V_{gas} voltage that's across the sending unit.

A typical ignition switch with four positions—LOCK, ACC, ON, and START—is

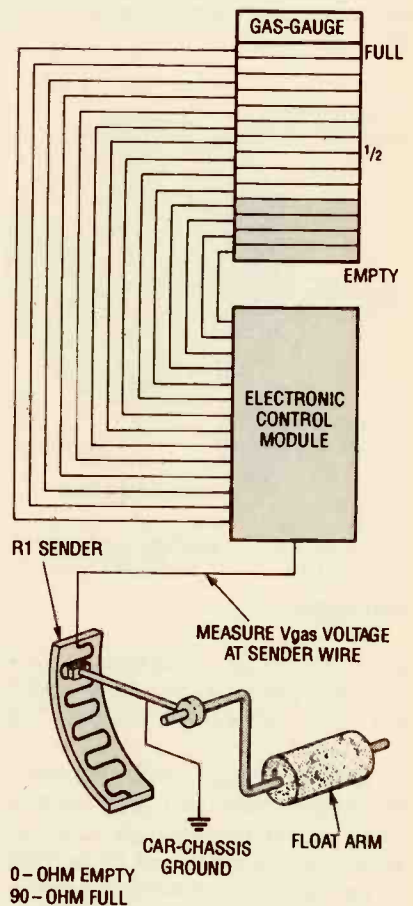

Fig. 4. This electronic, fuel-level, bargraph-display system uses an Electronic Control Module (ECM), a 16-segment LED display, and a sender R1.

Just like these Fully Trained Electronics Professionals



"Thanks to CIE I have tripled my previous salary, and I am now in a challenging and rewarding new field where only the sky is the limit."

Daniel Wade Reynolds
Industrial Electrician
Ore-ida Foods



"CIE was recommended to me by my boss. It was appealing since I could study at my own pace at home and during business travel."

Dan Parks
Marketing Manager/Consumer Products
Analog Devices, Inc.



"I loved the flexibility CIE offered. It was the only way I could continue both school and my demanding job."

Britt A. Hanks
Director of Engineering
Petroleum Helicopters, Inc.



"I liked the way the school was set up with laboratory assignments to enforce conceptual learning. The thing which impressed me the most about CIE's curriculum is the way they show application for all the theory that is presented."

Daniel N. Parkman
Missile Electro-Mechanical Technician
U.S. Air Force



"Completing the course gave me the ability to efficiently troubleshoot modern microprocessor based audio and video systems and enjoy a sense of job security."

Tony Reynolds
Service Manager/Technician
Threshold Audio & Video

Graduate with an Associate Degree from CIE!

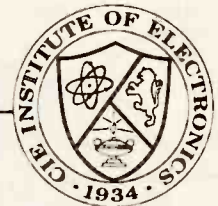

CIE is the best educational value you can receive if you want to learn about electronics, and earn a good income with that knowledge. CIE's reputation as the world leader in home study electronics is based solely on the success of our graduates. And we've earned our reputation with an unconditional commitment to provide our students with the very best electronics training.

Just ask any of the 150,000-plus graduates of the Cleveland Institute of Electronics who are working in high-paying positions with aerospace, computer, medical, automotive and communications firms throughout the world. They'll tell you success didn't come easy...but it did come...thanks to their CIE training. And today, a career in electronics offers more rewards than ever before.

CIE'S COMMITTED TO BEING THE BEST...IN ONE AREA...ELECTRONICS.

CIE isn't another everything-to-everyone school. CIE teaches only one subject and we believe we're the best at what we do. Also, CIE is accredited by the National Home Study Council. And with more than 1,000 graduates each year, we're the largest home study school specializing exclusively in electronics. CIE has been training career-minded students for nearly sixty years and we're the best at our subject...
ELECTRONICS... IT'S THE ONLY SUBJECT WE TEACH!

CIE PROVIDES A LEARNING METHOD SO GOOD IT'S PATENTED.

CIE's AUTO-PRO-GRAMMED® lessons are a proven learning method for building valuable electronics

career skills. Each lesson is designed to take you step-by-step and principle-by-principle. And while all of CIE's lessons are designed for independent study, CIE's instructors are personally available to assist you with just a toll free call. The result is practical training... the kind of experience you can put to work in today's marketplace.

LEARN BY DOING...WITH STATE-OF-THE-ART EQUIPMENT AND TRAINING.

CIE pioneered the first Electronics Laboratory

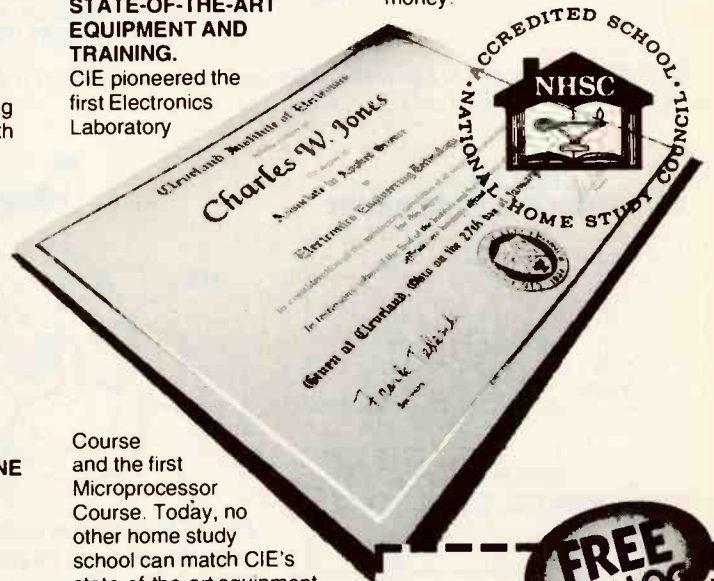

Course and the first Microprocessor Course. Today, no other home study school can match CIE's state-of-the-art equipment and training. And all your laboratory equipment, books and lessons are included in your tuition. It's all yours to use while you study and for on-the-job after you graduate.

PERSONALIZED TRAINING...TO MATCH YOUR BACKGROUND.

While some of our students have a working knowledge of electronics others are just starting out. That's why CIE has developed twelve career courses and an A.A.S. Degree program to choose from. So, even if you're not sure which electronics career is best for you, CIE can get you started with core lessons applicable to all areas in

electronics. And every CIE Course earns credit towards the completion of your Associate in Applied Science Degree. So you can work toward your degree in stages or as fast as you wish. In fact, CIE is the only school that actually rewards you for fast study, which can save you money.



YES! I want to get started.

Send me my CIE course catalog including details about the Associate Degree Program. (For your convenience, CIE will have a representative contact you - there is no obligation.)

Please Print Clearly

AGZ01

Name _____

Address _____

City _____

State _____ Zip _____ Age _____

Phone No. _____

Check box for G.I. Bill Benefits.

Veteran

Active Duty

Cleveland Institute of Electronics, Inc.
1776 East 17th Street
Cleveland, OH 44114

*A School of Thousands.
A Class of One. Since 1934.*

Send for CIE's FREE Course Catalog and See How We Can Help Your Career Too!

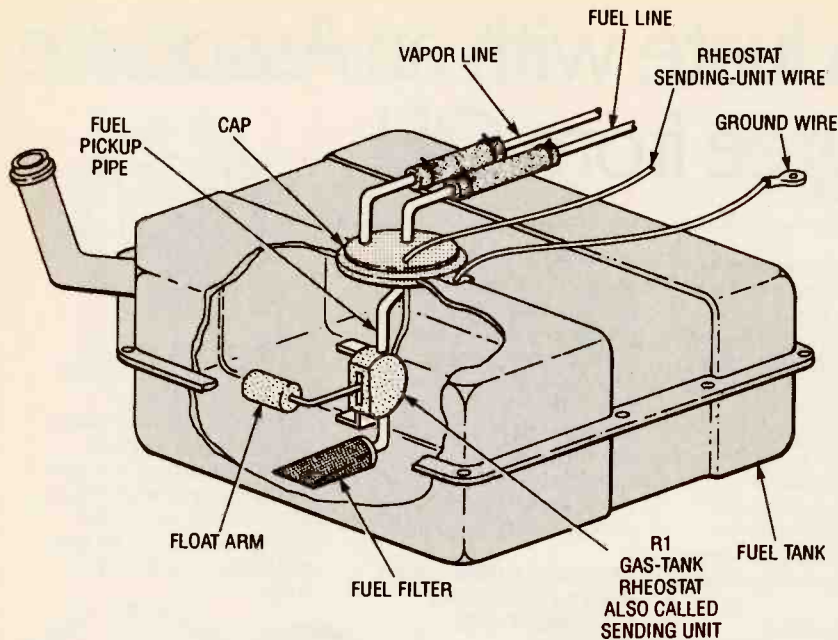

Fig. 5. The sending unit is effectively a rheostat that is controlled by a float arm, which senses the gas level in the fuel tank.

TABLE 1—
DATA FROM FIG. 1 GAS GAUGE

Fuel Level	V_{gas}
Full	7.7
¾	6.7
½	6.2
¼	5.2
Empty	4.5

TABLE 2—
DATA FROM FIG. 2 GAS GAUGE

Fuel Level	V_{gas}
Full	4.1
¾	5.2
½	6.0
¼	6.7
Empty	7.5

TABLE 3—
DATA FROM FIG. 3 GAS GAUGE

Fuel Level	V_{gas}
Full	1.5
¾	2.8
½	3.9
¼	5.3
Empty	6.4

shown in Fig. 6. The first step is to start the engine by turning the ignition switch to the START position. Release the key when the engine turns over. With the engine running, the alternator and DC regulator supply the electrical power necessary to operate the

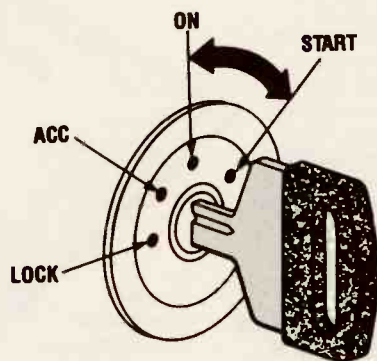

Fig. 6. Most ignition switches have four positions: LOCK, ACC (accessory), ON, and START, as shown here.

fuel gauge and other instrumentation.

The ignition switch may also be turned to the ON position without starting the engine. In that case, all the high-current electrical systems (like the fuel gauge, heater, and windshield wipers) will function normally except the battery will be supplying all the power. If left in the ON position for a lengthy period, the battery can become discharged.

When the ignition switch is in the ACC position, only the low-current devices (such as the radio and some of the warning buzzers, like door ajar will function), but the high-current devices (like the fuel gauge) will not be supplied with power.

For now, it's important to understand the ignition switch so that you can

take V_{gas} voltage measurements with confidence. Begin by turning the ignition switch to the ON position to power the fuel-gauge system. The next step is to disassemble the dash and remove the instrument cluster to get to the fuel gauge plug. In the 1972 Olds Cutlass, that means that the fuel-oil-gen-temp cluster gauge must be removed. Connected into the back of the cluster gauge is the fuel-gauge plug.

The third step is the most difficult because you'll have to locate the sending wire that is surely among several dozen other wires that all look alike. Turn on the ignition-switch and hook a voltmeter's positive lead to the wire coming from the sender, and the voltmeter's ground lead to the car chassis. If you don't know which wire in the fuel-gauge plug comes from the sender, don't be intimidated. Take a good look at the back of the cluster gauge: locating the fuel-gauge plug will be obvious.

Just study the plug and take an educated guess as to which wire comes from the sender. The wire is often color-coded green, brown, or striped. Now stick the voltmeter probe into the terminal (wire) you've picked. The probe's tip should be ground to a pointy spike that can be jabbed into the insulation of a harness wire.

There are just so many wires in the plug and sooner or later you'll hit on the right one. Make a splice into the sending wire and you're ready to take some measurements. Be advised, however (if you don't already know), that even shop manuals (like Chilton, etc.) are poor references when it comes to plug-connector diagrams.

A fool-proof method for locating the sending wire is to assemble a jabbing test-probe like that in Fig. 7. You'll need a sharp sewing needle or hat pin, a 10-watt, 10-ohm resistor, some hook-up wire, and an alligator clip. The probe's lead length should be several feet. The idea is quite simple. Hook the alligator clip to ground, turn the ignition switch to the ON position, and start jabbing the sewing pin into one wire at a time while watching the fuel gauge. When you hit the sending wire, the gas-tank rheostat (sender) will now be shunted by a 10-ohm resistor. Because any two resistors in parallel will reduce the total resistance, the fuel gauge thinks the rheostat resistance has changed and the gauge

needle will swing. It's fast, it's simple, and it works every time.

When your tank is about empty, drive to a gas station and have the attendant fill up your car. While the attendant goes for the gas hose, you should turn the ignition-switch to the

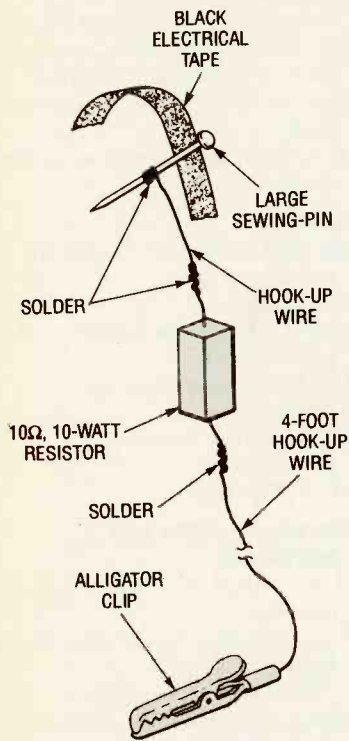

Fig. 7. A home-made test probe—like this one made from a 10-ohm, 10-watt resistor, a large sewing needle, an alligator clip, and some hook-up wire—can be used to locate the lone sending wire amongst the jumble of wires behind the dashboard.

on position to power up the instrument gauges; but do not start the engine. As the tank is being filled, watch the fuel-gauge pointer move toward the full position, and record the voltage measured for each ¼ tank of gas.

There are three reasons why you might not get a V_{gas} voltage reading; two of which are bad news. One bad reason could be that the fuel gauge is completely inoperative and burnt out—no current can flow through the gauge to get to the sender. The other bad reason might be that the sender is broken, or maybe the connecting wire is broken or intermittent. In either event, you'll have to do some electrical checking to diagnose why there's no V_{gas} voltage.

The third reason isn't so bad and may even surprise you. When the gauge is lifted out of the dash on some musclecars, the electrical ground is lost and the gauge becomes inoperative; the V_{gas} voltage may also be lost. The fix for that is simple: Use hook-up wire to jump the gauge's ground wire or terminal to the car chassis.

Circuit Theory. A schematic diagram for the Smarter Gas Gauge is shown in Fig. 8. In that circuit, a single op-amp, U1-a—¼ of an LM324N quad op-amp, configured as a comparator—is used to compare the V_{gas} input to a reference voltage (V_{ref}). Switch S1 is used to reverse the V_{gas} and V_{ref} inputs to U1-a, depending on whether V_{gas} rises from empty-to-full

as in Table 1, or falls from an empty-to-full as in Tables 2 and 3.

Let's take a look at two examples: Suppose V_{gas} rises in the manner indicated in Table 1. In that instance, V_{gas} goes to pin 2 (the inverting input) and V_{ref} goes to pin 3 (the non-inverting input). Let's set the indicator lamp to illuminate when the tank is ¼ full.

According to Table 1, V_{gas} is 5.2 volts, so V_{ref} —which serves as the trip point—should be manually set to 5.2 volts via potentiometer R2. When the tank is more than ¼ full, the V_{gas} level will be above 5.2 volts, causing U1-a's output at pin 1 to be driven to ground. The output of U1-a, which is fed through S2, reverse biases transistor Q1, causing lamp I1 to stay off. However, when the tank is less than ¼ full, the V_{gas} dips below 5.2 volts, causing U1-a's output at pin 1 to swing to the positive rail, forward biasing Q1 and turning I1 on.

Now let's suppose that V_{gas} falls as indicated in either Tables 2 or 3; in that case, the V_{gas} level is fed to U1-a's non-inverting input at pin 3 and V_{ref} is routed to U1-a's inverting input at pin 2. Let's set the indicator lamp to illuminate when the tank is ¼ full. According to Table 2, V_{gas} is 6.7 volts, so V_{ref} should be manually set to 6.7 volts (the trip point for this example) via potentiometer R2.

When the tank is more than ¼ full, V_{gas} will be below 6.7 volts and U1-a's output at pin 1 will be driven to ground, which reverse biases transistor Q1, causing I1 to stay off. How-

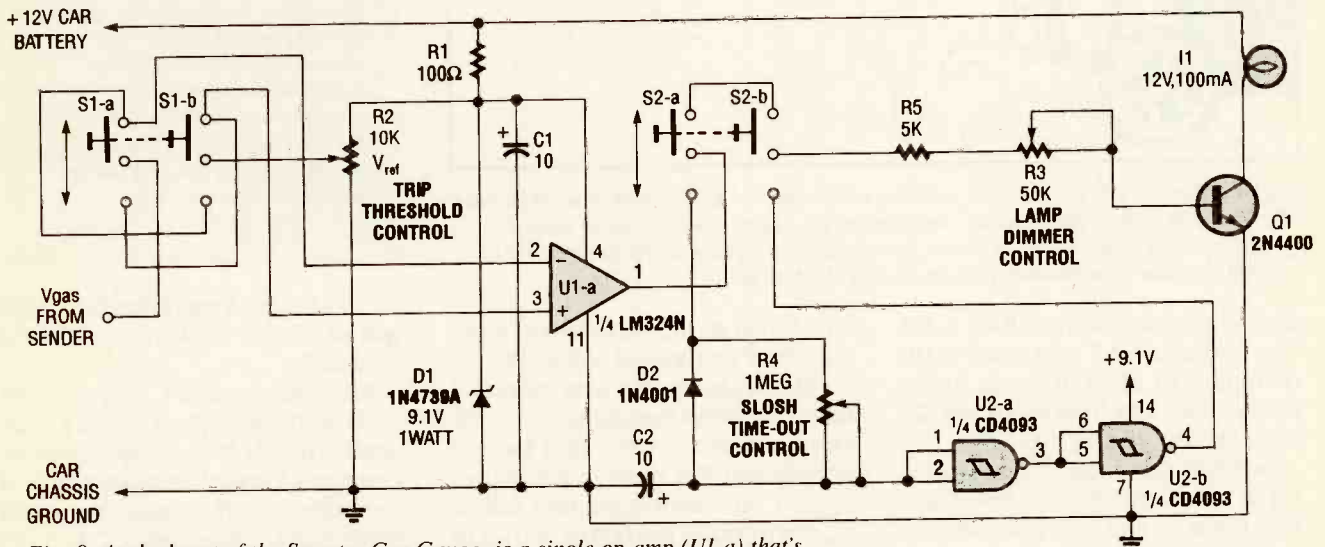

Fig. 8. At the heart of the Smarter Gas Gauge, is a single op-amp (U1-a) that's configured as a comparator. The output of the op-amp toggles high when the gas tank needs to be refilled, which forward-biases transistor Q1, causing I1 to light.

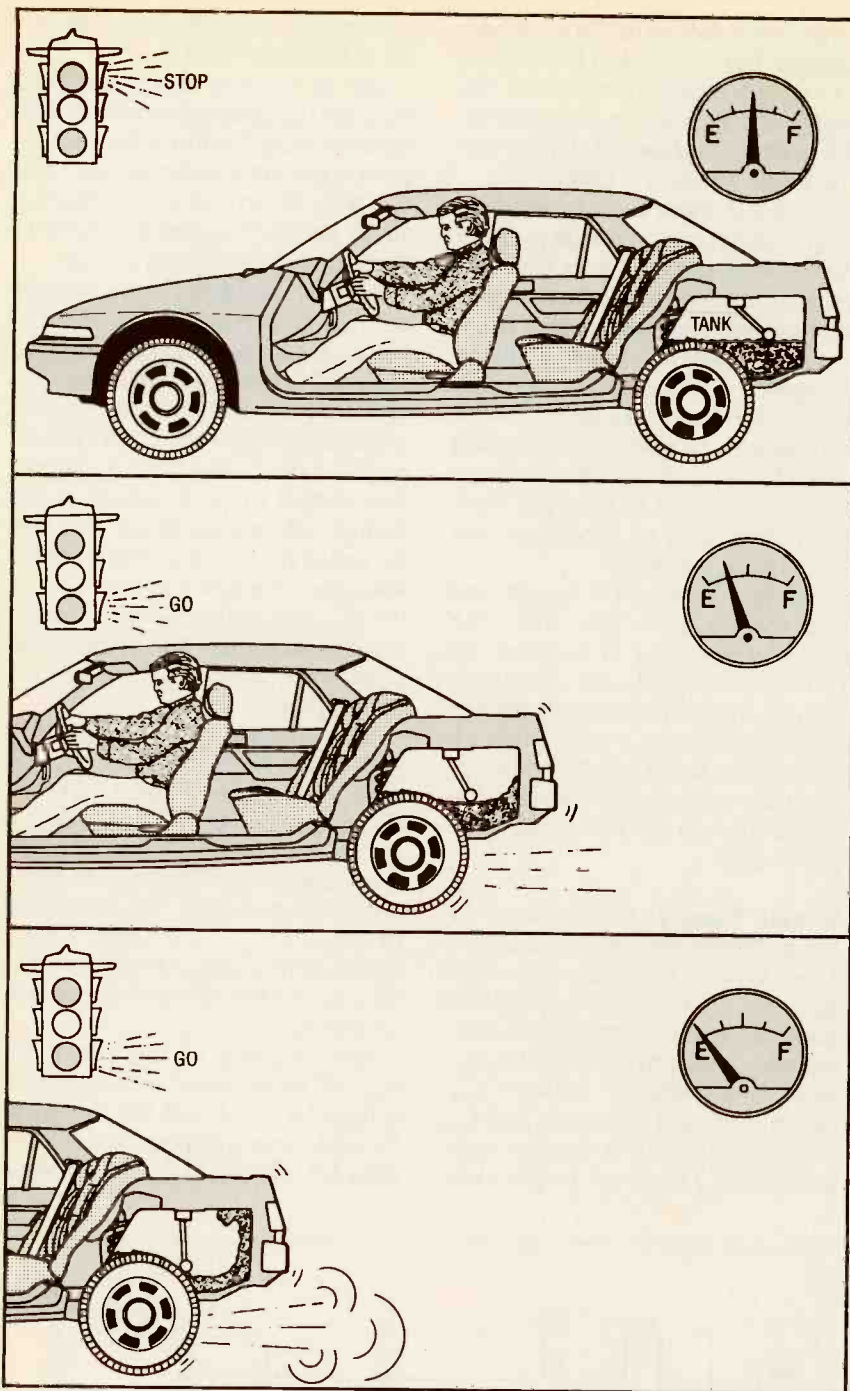

Fig. 9. When the car accelerates, gasoline within the fuel tank begins to slosh around. The float arm follows the gasoline, causing the gas-gauge needle to move toward empty, giving a false indication. Some float arms have a calibrated friction brake to prevent gasoline wave-motion from oscillating the float arm.

ever, when the tank is less than $\frac{1}{4}$ full, V_{gas} rises above 6.7 volts, causing U1-a's output at pin 1 to swing to the positive rail. That forward biases Q1, which, in turn, causes I1 to light.

Switch S2 can route U1-a's output in either of two directions. In one direction, the output of U1-a is fed straight to the base of Q1 (as we've just seen). In the other direction, the output of U1

is routed to an RC, gas-sloshing, time-out circuit (comprised of R4/C2).

Let's discuss how the time-out circuit functions. When the gas level is at the comparator's trip point and the car accelerates, the sloshing gas causes V_{gas} to oscillate above and below V_{ref} . That causes the output of U1-a at pin 1 to also oscillate high and low. When the output goes high, capaci-

PARTS LIST FOR THE SMARTER GAS GAUGE

SEMICONDUCTORS

- U1—LM324N quad, low-power op-amp, integrated circuit
- U2—CD4093, quad 2-input NAND Schmitt-trigger, integrated circuit
- Q1—2N4400 small-signal, general-purpose NPN silicon transistor
- D1—1N4739A 9.1-volt, 1-watt, Zener diode
- D2—1N4001 general-purpose silicon rectifier diode

RESISTORS

- (All fixed resistors are $\frac{1}{2}$ -watt, 5% units.)
- R1—100-ohms
 - R2—10,000-ohm linear-taper potentiometer
 - R3—50,000-ohm linear-taper potentiometer
 - R4—1 megohm linear-taper potentiometer
 - R5—5,000-ohm

ADDITIONAL PARTS AND MATERIALS

- C1, C2—10- μ F, 35-WVDC, tantalum capacitor
- I1—12-volt, 60-175-mA incandescent lamp
- S1, S2—DPDT slide switch
- Printed-circuit materials, enclosure (optional), 2-amp 3GA-type fuse, crimping tool and connectors, in-line fuse holder, hookup wire, wire ties, solder, hardware, etc.

Note: The following items are available from Jonathan Gordon, 74 Berkshire, Apt. C, West Palm Beach, FL 33417; a kit of parts containing the printed-circuit board and all components (except an enclosure) for \$49.95; the fully assembled and tested Smarter Gas Gauge for \$69.96. Please add \$4.00 to all orders for shipping and handling. Florida residents please add 6% sales tax.

for C2 charges through resistor R4 (together R4 and C2 form an RC time constant).

The voltage across C2 rises only for the time that the output of U1-a is high, which is usually for less than a second. Eventually, the slosh reverses itself and the output of U1-a goes low, which immediately discharges C2 through diode D2. The C2 charging-cycle must now start all over again. Notice

that V_{gas} can now swing above and below V_{ref} , yet the indicator lamp remains off. When C2 has charged enough to trigger U2-a ($1/4$ of a 4093 quad CMOS NAND Schmitt-trigger), I1 illuminates.

There are two reasons for using a CMOS Schmitt-trigger for U2: CMOS gates offer a high input-impedance that won't interfere with the charging rate of C2, and because the voltage across C2 is slow-rising voltage, that's far too long a time for most digital gates. Digital gates like fast rise-time inputs (at the least a few milliseconds) or they'll get confused and the output will oscillate while trying to figure out if the input voltage is actually rising or falling past the gate's trip-point.

A Schmitt trigger has two separate trigger points—one for rising voltages and another for falling voltages—and can, therefore, toggle on the slowly-rising voltage across C2 without oscillating.

The circuit is powered from a 12-volt source that is tapped off the vehicle's battery. The 9.1-volt power source for the IC's is provided through a conventional Zener-regulator circuit consisting of D1 and its current-limiting resistor, R1.

Slosh Time-Out. When the 1972 Olds Cutlass (mentioned earlier) accelerates from a stop, the gas-gauge needle swings toward empty. In Fig. 9, when the tank is about $1/2$ full and the car lurches forward, there's plenty of room in the tank for the gas to slosh back-and-forth like an ocean surf. When the float arm that's attached to the rheostat rides the surf to the tank's bottom, the rheostat thinks the tank is empty and the gauge needle swings all the way to "E" (empty).

The V_{gas} voltage will vary with the rocking gas-tank sender every time that the car accelerates quickly, takes a tight turn, or hits a road bump. That presents no problem until V_{gas} approaches the comparator's trigger point (the V_{ref} voltage). Points a and b in Fig. 10 show that every time V_{gas} oscillates above and below V_{ref} , U1-a's output toggles (as shown in Fig. 10 at point c), which causes the lamp to flash (see point d).

If U1-a's output is routed to the slosh time-out circuit, C2 charges on the positive pulse (see Fig. 10, point e). Because there is not insufficient time

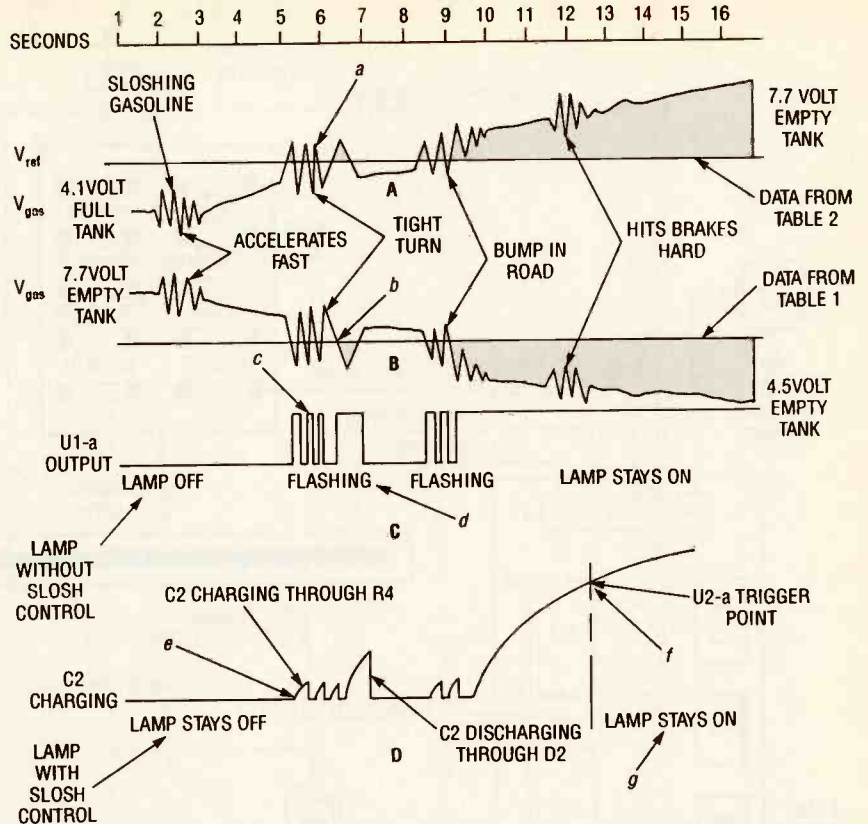

Fig. 10. The low-fuel indicator flashes when gasoline within the tank sloshes around the threshold trip-point. The RC circuit ($R4/C2$ in Fig. 8), operating in much the same manner as a switch-debouncer, prevents the lamp from flashing as gas sloshes about the fuel tank.

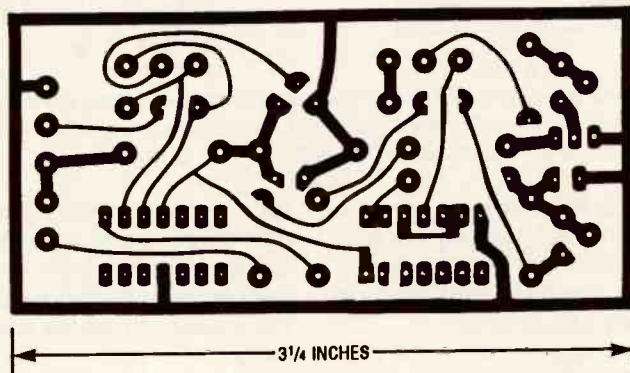

Fig. 11. The author's prototype was assembled on a small printed-circuit board that measures about $3/4$ by $1\frac{1}{16}$ inches. A full-size template of that printed-circuit pattern is shown here.

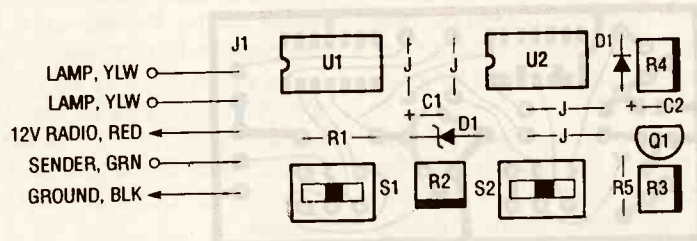

Fig. 12. Here's the printed-circuit board's parts-placement diagram. Careful attention should be paid to component orientation, which will prevent most construction errors.

to charge C2 to U2-a's trigger point, the lamp remains off. Ultimately, after

driving for some time, the tank gets so low that the float arm cannot swing

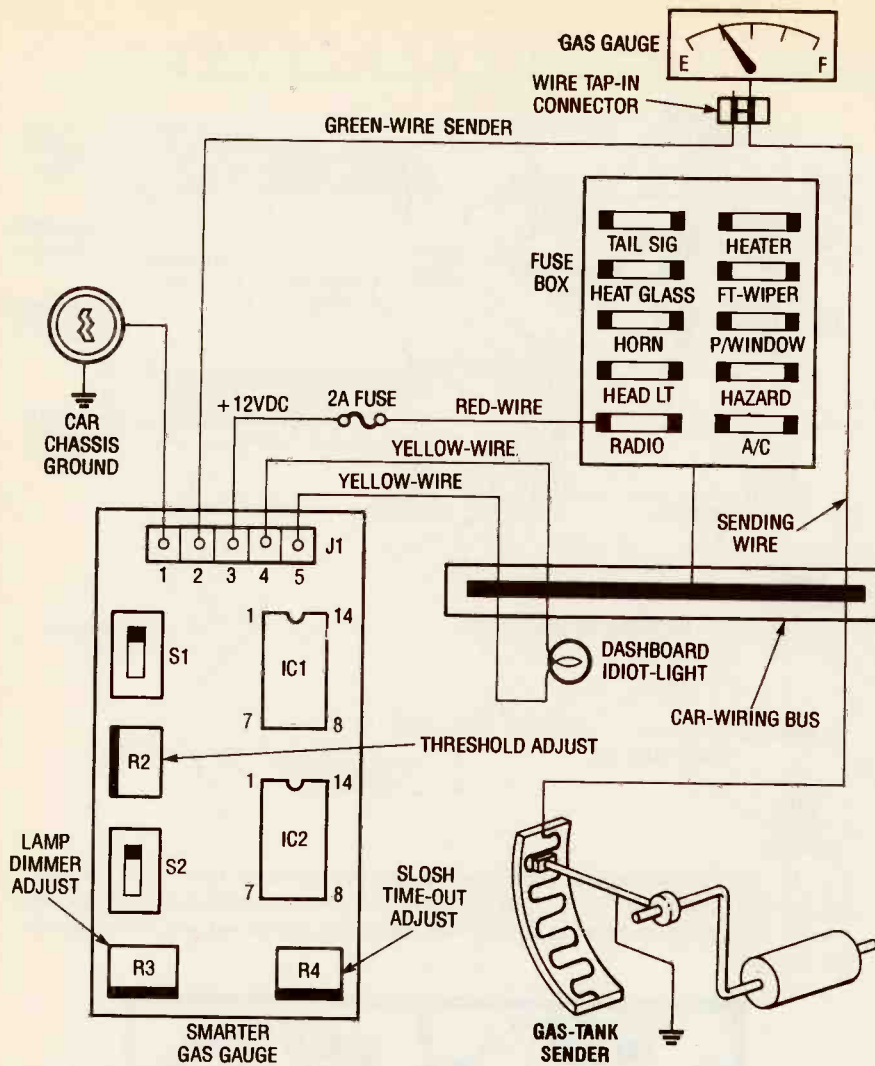

Fig. 13. Here's the musclecar hook-up diagram. To make installing the Smarter Gas Gauge a bit easier, use a different color wire for each connection: It's also a good idea to plan your installation carefully before starting.

high enough to oscillate V_{gas} around V_{ref} . When that happens, C2 has time to charge (see Fig. 10 point f), and trigger U2-a, which causes I1 to turn on continuously (see point g).

There is, of course, always the possibility that a wild screeching turn will rock the float arm enough to push V_{gas} to the V_{ref} level. That causes U1-a's output to go low, discharging C2. When that happens, I1 turns off, and requires another 5 seconds or so before turning on again. But the lamp will not flicker or flash.

A flashing lamp sure gets your attention though, possibly because the flash rate is somewhat non-repetitive—sometimes flashing quickly and at other times quite slowly—depending on how the gas sloshes in the tank. Although for many, a flashing light that goes crazy when the car accelerates is a perfect attraction,

not everyone loves a flashing light. And if you prefer a lamp that just comes on and stays on when the gas level exceeds the trip threshold, then the answer is to use the slosh time-out circuit.

Construction. The Smarter Gas Gauge was assembled on a small printed-circuit board that measures about 3¼ by 1½ inches. A full-size template of that printed-circuit pattern is shown in Fig. 11, with the corresponding parts-placement diagram appearing in Fig. 12. The electronic components are simple and should tolerate all but the most severe abuses.

There are no delicate oscillators or touchy amplifier feedback loops to worry about, no ultra-fast computer clocks that wreak havoc with every wire that comes near them, and no

delicate transistor betas to worry about when the temperature gets too hot or too cold.

What you should do, however, is to make absolutely sure that U1 and U2, D1 and D2, Q1, and C1 and C2 are installed with the proper orientation. If Zener diode D1 is put in backwards, the 9.1-volt power source used to operate U1 and U2 just won't be available. Remember, reverse-biased Zener diodes act like regular rectifier diodes. The means that if D2 is installed backwards, R4 will be shorted out and the R4/C2 time constant won't function at all—C2 will charge and the lamp will be lit continually.

If the voltage at U1-a pin-1 is high and the lamp isn't lit, check Q1, make sure that R3 is wired correctly, and check the continuity through switch S2.

Once assembly is complete, carefully inspect your work for solder shorts (bridges) between pads and lands, cold solder joints (characterized by dull blobs of solder). Finally, label all wires going to the car as either G for ground, S for sender, or +12V for battery.

Installation. First we'll take a look at the original prototype installation in the aforementioned 1972 Olds Cutlass. For a proper installation, you'll need the right tools and the know how to do the following: disassemble the dash; drill a hole here or there; run a wiring harness up and around corners; find the sending wire in the back of the dash at the fuel-gauge plug; make good splice connections using a crimping tool or soldering iron; know how to take voltage measurements using any DVM or VOM; and use metal brackets and other hardware for a secure installation. Also, be prepared to treat minor cuts and scrapes should you be careless and thrust your fingers in blind corners under the dash.

Before beginning your installation, study the car's dash and decide what kind of installation you want. If your dash has a low-fuel "idiot" light, you'll have to disconnect the two wires from the lamp's socket. That usually means cutting the wires unless there's a simple crimp terminal to pull off. Just tuck those wires away. Now wire the in-dash light to the appropriate pads on the Smarter Gas Gauge's printed-cir-

(Continued on page 103)

Have you ever merged onto an interstate highway from an on ramp and several miles down the road realized that your turn signal never went off as you entered traffic? Suddenly, you realize that there are 16 cars slightly behind you in the left lane that have been refusing to pass for several miles, fearing that you may really intend to change lanes. You turn off the signal, and as those vehicles fly past you, their drivers give you a look that, as they say, could kill!

Well, the *Tune-Signal* described in this article—which is designed to set off a musical chime—will prevent that from happening by alerting you when your signal has been left on a little too long. The circuit uses a small, inexpensive, pleasant-sounding, musical chime, rather than an irritating buzzer; you probably already have enough irritation while drive without adding more irritation to it.

About the Circuit. A schematic diagram of the Tune Signal is shown in Fig. 1. The circuit consists of U1 and U2 (a 4093 quad two-input NAND Schmitt trigger and a 4040 12-stage ripple-carry counter/divider, respectively), Q1 (a TIP42 PNP silicon power transistor), BZ1 (the aforementioned chime module), and a handful of support components.

The input to the circuit—a series of pulses plucked from the load (or output) wire of the auto's flasher module—immediately divides along two signal paths. In one path, the signal is applied to gate U1-d, which is configured as an inverter. The output of that gate is fed through diode D1 and used to charge C2, a 470- μ F capacitor. The charge on C2 is applied to both inputs of U1-c (also set up as an inverter), pulling its output low, in effect, enabling U2.

In the second path, the signal is fed to U1-a, which squares the applied signal in preparation for its application to the clock input of counter U2. The squared-up pulses applied to U2's

TURN~SIGNAL REMINDER

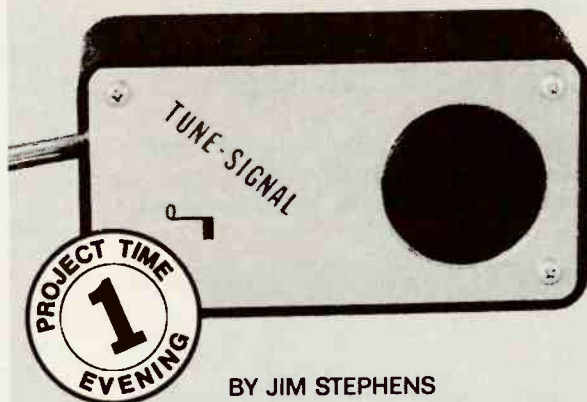

BY JIM STEPHENS

If you often neglect to turn off your car's turn signal, then perhaps this easy-to-build reminder is just what you need!

clock input cause the counter to advance one count for each clock pulse received. When both pins 3 and 4 (the Q5 and Q7 outputs, respectively) are high at the same time, the output of U1-b is pulled low. That low is applied to the base of Q1, causing the transistor to turn on. With Q1 turned on, power is applied to the chime module (BZ1), causing it to sound. The chime module—which puts out enough volume to be heard over the road noise—will chime twice, wait a few seconds and chime again if the circuit is not reset.

After the chime has sounded, and the turn signal is switched off, the charge stored in C2 is bled off through R3. With C2 no longer charged, the output of U1-c goes high, resetting U2. When U2 is reset, its outputs (at pins 3 and 4) go low. That low, which is applied to the base of the transistor, causes Q1 to turn off, removing power from the chime module.

The number of flashes that the circuit counts depends on which two of U2's outputs are connected to U1-b. With the circuit wired as shown in Fig. 1, about 70 flashes are allowed to occur

before the chime sounds. The number of flashes that the counter counts before triggering the chime can be altered by connecting pin 6 of U1-c to another of U2's outputs. For example, connecting pin 13 (the Q7 output) of U2 to pin 6 of U1-b, rather than to pin 4, directs the circuit to count 144 flashes before sounding the chime. Even greater counts can be achieved by connecting to the higher Q outputs (say, the Q11 and Q12 outputs, at pins 15 and 1, respectively) of U2 to pins 5 and 6 of U1-b.

Power for the circuit is taken from any keyed (switched) power line at the vehicle's fuse panel, so that the circuit receives power only when the ignition key is in the on position. Fuse F1 is included in the circuit in case of a wiring error or short.

Circuit Assembly. The author's prototype of the Tune Signal was hard-wired on a

small section of perfboard. Use Fig. 1 as a guide when assembling your unit. It is recommended that sockets be provided for the two integrated circuits (U1 and U2). That will prevent thermal damage to the IC in the event that a component is misconnected to an IC pin. The IC's, being CMOS units, are highly susceptible to damage due to heat and electrostatic discharge.

The chime module (BZ1) was not mounted to the perfboard along with the other components, but was instead mounted to the front panel of the enclosure in which the circuit was housed. You could, however, mount the chime module remotely in some other position that allows it to be heard. The circuit was housed in a small plastic enclosure with a metal lid. The only enclosure preparation required is to make a hole (or slot) in the enclosure for the wires that connect the circuit to a keyed (switched) 12-volt power source, ground, and the flasher's load wire, and (as appropriate) a cutout for the chime module or a second hole for the connecting wires between the circuit and a re-

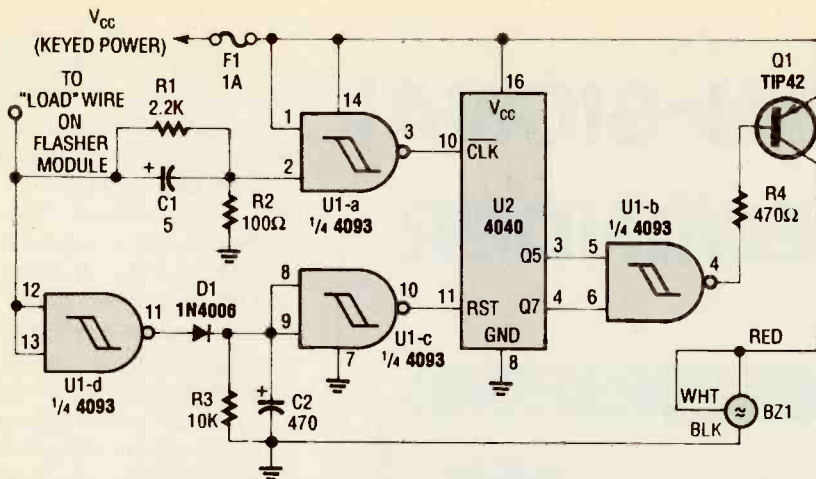
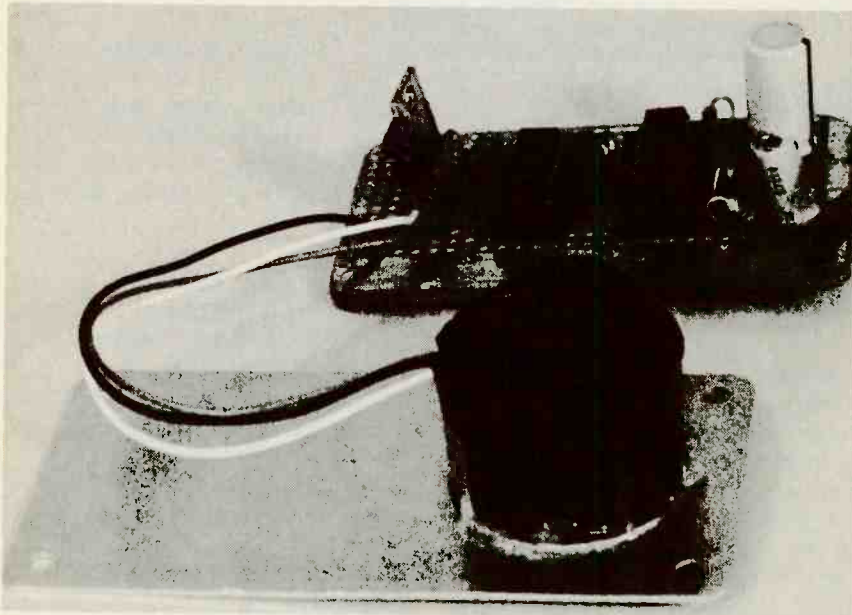
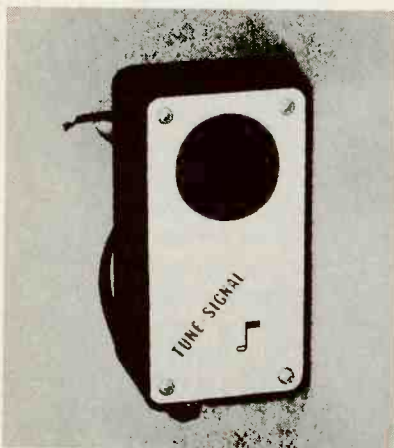

Fig. 1. As shown by this schematic diagram, the circuit consists of U1 and U2 (a 4093 quad two-input NAND Schmitt trigger and a 4040 12-stage ripple-carry counter/divider, respectively), Q1 (a TIP42 PNP silicon power transistor), BZ1 (the chime module), and a handful of support components.



Here is the author's perfboard assembly. The chime module can be installed in a cutout in the front panel of the enclosure, and secured in place with silicon cement, as shown here, or mounted remotely in some other convenient location within earshot.



Here's the completed unit just prior to installation.

remotely located module.

Note that fuse F1 (a fast-blow unit) is not mounted to the circuit board, but is instead an in-line unit that should be connected to the far end of the circuit's power-supply line (near the +V feed point) to minimize the chance that a short could occur between the fuse and the connection.

Installation. The first step in installing the circuit is to locate the vehicle's flasher module. Connect the project's positive-supply line to a switched power source (the 12-volt power line that feeds the flasher module is ideal) and the negative line to ground (pref-

PARTS LIST FOR THE TUNE-SIGNAL

SEMICONDUCTORS

- U1—4093 quad 2-input NAND Schmitt Trigger, integrated circuit
- U2—4040 12-stage, ripple-carry, binary counter/divider, integrated circuit
- Q1—TIP42 PNP silicon, power transistor
- D1—1N4006 1-amp, 800-PIV, rectifier diode

RESISTORS

- (All resistors are 1/8-watt, 5% units.)
- R1—2200-ohm
 - R2—100-ohm
 - R3—10,000-ohm
 - R4—470-ohm

CAPACITORS

- C1—5-μF, 25-WVDC, electrolytic
- C2—470-μF, 25-WVDC, radial lead electrolytic

ADDITIONAL PARTS AND MATERIALS

- F1—1-amp, fast-blow fuse
 - BZ1—Chime module (Radio Shack 270-071)
- Perfboard materials, enclosure, in-line fuse holder, snap-on connectors, wire, solder, hardware, etc.

erably somewhere on the chassis). Then connect the Tune Signal's input wire to the load (or output) of the vehicle's turn-signal flasher module. The signal and power connections can be simplified by using small "self tap" snap connectors.

To test the operation of the circuit simply turn the vehicle ignition on, and activate the turn signal (any direction will do). After a predetermined number of flashes, the circuit should activate the chime. Let the turn signal remain on for a while. The module will chime, wait a few seconds, and the unit should chime again if the circuit is not reset. If the circuit works as outlined, you can turn off the turn signal, and mount the unit near the bottom of the dash so that sound will be directed into the car and not up into the dashboard. The author used Velcro fasteners to attach the unit to the underside of the dash. That allows the project to easily be removed should it become necessary to service the unit.

That's all there is to it. Once the Tune-Signal is installed, you and your fellow drivers should enjoy safer and saner motoring. ■

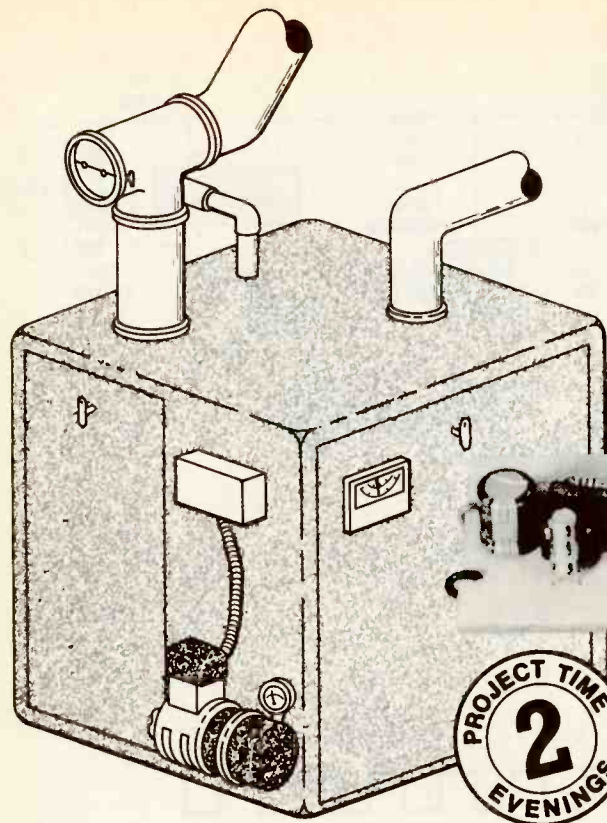

Reduce Heating Costs with the Fuel Miser

BY ANTHONY J. CARISTI

Tame home-heating costs by installing our super-efficient furnace controller

The price of everything is steadily going up these days. And one of the major drags on most household budgets is home heating costs; be it gas, oil, or electric. That's because a properly designed heating system operates with a 100% duty cycle, meaning that the burner is either 100% on—producing possibly 80,000 to 120,000 BTU's of heat energy for each hour of operation—or 100% off at any given time. Unfortunately, there is a flaw in that type of operation; the thermostat knows nothing of the amount of heat that has built up in the heat exchanger, which can transfer just so many BTU's of heat. Thus, the burner can run and run until the temperature set-point is reached, and so a great amount of heat is simply wasted. Not a very efficient method of operation, to say the least.

Some thermostats have a "heat anticipator" feature that shuts off the burner before the thermostat set-point temperature is reached. That helps somewhat; but a significant amount of heat (fuel) is still wasted. Of course, there are other ways to reduce heating-fuel consumption, installing better insulation and/or lowering the thermostat settings, for instance. But what can be done after those measures have been taken?

That's where the *Fuel Miser* described in this article comes into play. The *Fuel Miser*, which is designed to be connected to the thermostat circuit of a heating system, takes control of the system and meters out a selected amount of fuel, as we'll soon see.

How It Works. The *Fuel Miser*, a solid-state, optically isolated, duty-cycle controller, is connected in series with the thermostat wiring of a heating system. Without regard to the thermostat setting, the *Fuel Miser* allows the furnace burner to operate at selectable duty cycle increments of 10% of up to 100%. There is no apparent loss of comfort level because the *Fuel Miser*, while keeping the burner cut off, allows the heat normally trapped and wasted in the exchanger to be distributed, thereby enhancing fuel efficiency.

Gas- and electric-heating systems respond well to short bursts of fuel demand. For gas- and electric-heating systems, the *Fuel Miser* is designed so that each 10% of duty-cycle time is just 45 seconds, and a complete on-off cycle takes 450 seconds or 7½ minutes. Oil systems are more restrictive in their cycling requirements because the system must be allowed time to cool down before it can be

restarted. For oil systems, the *Fuel Miser's* duty cycle is 3½ minutes for each 10% increment of duty cycle, thus a full on-off cycle (100% duty cycle) takes 35 minutes.

The *Fuel Miser's* duty cycle is set by a specific value of timing capacitor—one value for gas and electric systems and another for oil-fired systems. The circuit's duty cycle is instantly adjustable at any time by means of a 10-position rotary switch. An optoisolator/Triac circuit is used to interface the *Fuel Miser* to the heating system.

About the Circuit. Refer to the schematic and timing diagrams in Fig. 1. In the schematic diagram (Fig. 1A), U1 (a 555 oscillator/timer) is configured as an astable multivibrator (or free-running oscillator), whose operating frequency is determined by R1, R2, and C2. The value of C2 (the timing capacitor) must be selected for the type of fuel used by the system; gas, electric, or oil. For gas and electric systems, U1's operating frequency should be 0.02 Hz; for oil systems, it should be set to 0.005 Hz.

The output of U1 at pin 3 is fed to the clock input of U2 (a CD4017B decade counter/divider with 10 decoded outputs) at pin 14. That causes U2 to advance one count for each low-to-

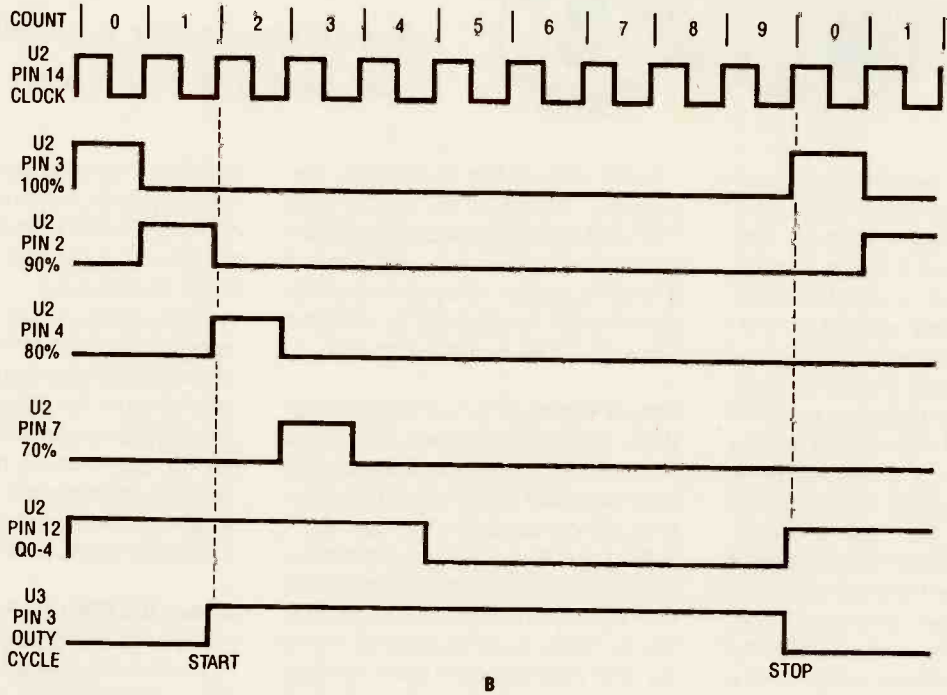
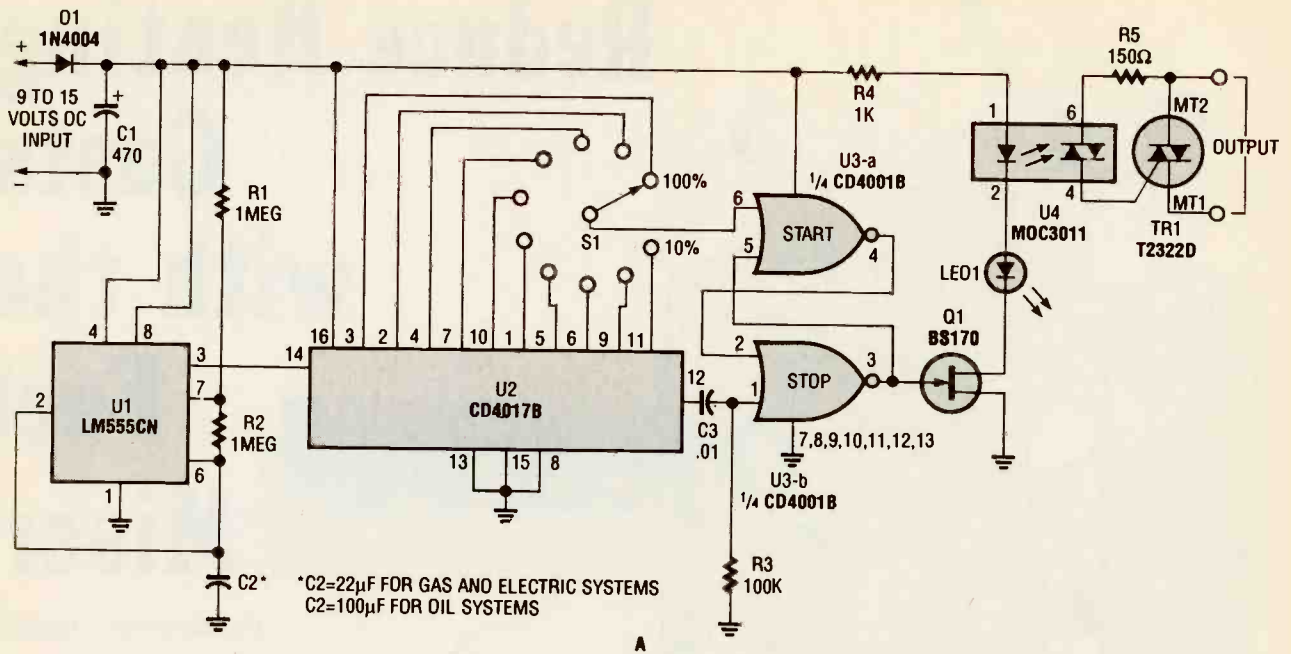

Fig. 1. Here are the schematic and timing diagrams for the Fuel Miser. The Fuel Miser is comprised of a 555 oscillator/timer (U1), a CD4017B decade counter/divider (U2), half of a CD4001 quad two-input NOR gate (U3), an MOC3011 optoisolator/coupler (U4), a BS170 N-channel, enhancement, TMOS field-effect transistor (Q1), a T2322D Triac, and a handful of support components.

high transition of the clock input, sequentially forcing one of U2's ten outputs high, as illustrated in Fig. 1B.

An eleventh output at pin 12 (the carry output) goes high when output pins 3, 2, 4, 7, and 10 (the 0, 1, 2, 3, and 4 counts, respectively) go high. When U2's outputs at pins 1, 5, 6, 9, and 11 (which correspond to counts 5-9, re-

spectively) go high, pin 12 goes low. The output of U2 at pin 12 is fed to one input (pin 1) of a bistable latch, comprised of U3-a and U3-b (½ of a CD4001 quad two-input NAND gate). The U2 output selected via S1 is fed to the other input of the latch at pin 6. Together, those two U2 outputs are used to start (set) and stop (reset) the

latch, which in turn determines the duty cycle of the circuit.

Now, let's assume that S2 is set to the 80% duty-cycle (U2 pin 4). When pin 4 (which corresponds to a count of 2) goes high, the latch sets, causing its output at pin 3 to go high and pin 4 to go low. The latch remains in that state until U2 goes from count 9 to count 0.

At that point, a positive-going signal appears at pin 12 of U2 and is applied to pin 1 of U3, causing the latch to reset. The latch remains in the reset state until U2 again reaches a count of 2, and the cycle repeats.

Note that the output signal appearing at U3 pin 3 has a duty cycle of 80%, which is the setting selected by S1. One can see that if S1 is set to any of the other nine decoded outputs of U2, the resulting duty cycle at U3 pin 3 will respond accordingly.

The signal appearing at U3 pin 3 is used to bias Q1 (a BS170 N-channel, enhancement, TMOS field-effect transistor) on and off. The drain of Q1 is connected through LED1 to the cathode end of U4's internal LED. When Q1 turns on, current flows through U4 (an MOC3011 optoisolator/coupler), causing LED1 to light and U4's Triac-driver output stage to turn on. With U4 activated, the Triac-driver applies gate current to TR1 (a T2322D), causing it to conduct. At that point, operating power is fed through the thermostat wiring of the heating system, permitting the burner to operate (provided that the thermostat is calling for heat).

When the signal at U3 pin 3 is low, Q1 is cut off and no current flows into U4, so TR1 remains off and the heating-system burner is prevented from operating during the off-time of the Fuel Miser. However, heat continues to flow from the heat exchanger into the system, maintaining the comfort level, without consuming fuel.

The Fuel Miser can be set to 100% duty cycle at any time; that restores the heating system to its normal operating state. When S1 is set to any of the other positions, the circuit provides a fuel savings that depends on the selected duty cycle.

The Fuel Miser can be powered from any 9–15-volt DC power source (although the author's unit was powered from a common wall adapter). Any ripple voltage generated by the power source is filtered out by C1. Diode D1 is included in the circuit to protect against accidental reverse polarity connections.

Construction. There is nothing critical about the construction of the Fuel Miser. In fact, if you choose, the circuit can be built on perfboard using point-to-point wiring techniques.

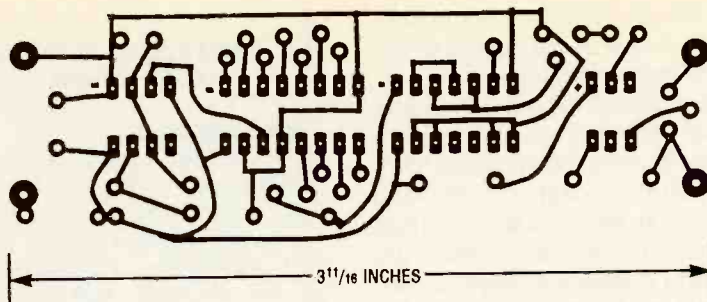

Fig. 2. The author's prototype was built on a small printed-circuit board, measuring about 3¹/₁₆ by 1³/₄ inches; a full-size template of that printed-circuit pattern is shown here. You can etch your own board from the pattern shown or purchase one from the supplier listed in the Parts List.

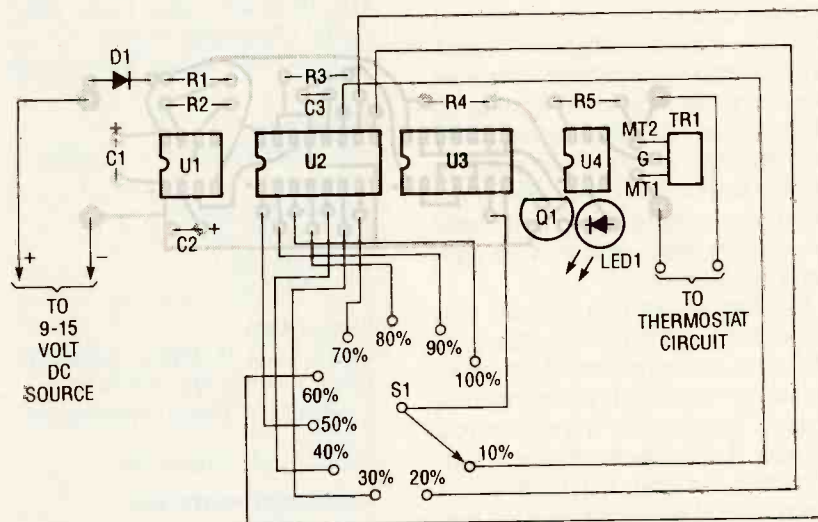

Fig. 3. Assemble the printed-circuit board using this parts-placement diagram as a guide. Note: It is recommended that sockets be provided for all of the IC's.

However, the author's prototype was built on a small printed-circuit board, measuring about 3¹/₁₆ by 1³/₄ inches; a full-size template of that printed-circuit pattern is shown in Fig. 2. You can etch your own board from the pattern shown or purchase one from the supplier listed in the Parts List.

Once you've obtained all the necessary parts and the printed-circuit board, construction can begin. Assemble the printed-circuit board using Fig. 3 as a guide. It is recommended that sockets be provided for all of the IC's. The use of sockets allows for ease of troubleshooting and servicing of the circuit should it ever become necessary. If you do not have 6- or 8-pin sockets on hand (for U4 and U1, respectively), they can be simultaneously fabricated by carefully cutting a 14 pin socket into two pieces with a small hacksaw.

After the sockets are installed, place and solder all the passive com-

ponents (resistors, capacitors), except the timing capacitor (C2). Follow the passive components with the active components. Be sure that all of the polarized components (electrolytic capacitors and all semiconductor devices) are properly oriented; all it takes is one misoriented polarized part to render the circuit inoperative. That error can also cause parts to be damaged.

Timing-Capacitor Selection. As mentioned earlier, the Fuel Miser's timing circuit (U1) must be set for the type of fuel—gas and electric or oil—that is used by the heating system. It does not matter what kind of heat is produced by the system . . . hot water, warm air, or steam . . . the Fuel Miser will operate properly when the correct value of timing capacitor (C2) is installed. For gas (either propane or natural gas) and electric systems, make C2 a 22- μ F unit. For oil burners,

use a 100- μ F unit. Low-leakage electrolytic capacitors are a must to ensure timing accuracy.

Note: If an oscilloscope is available, the Fuel Miser can be put through a rapid test by temporarily using a 1000-pF (0.001- μ F) 50-volt, ceramic-disc capacitor in place of the specified C2 values to temporarily increase U1's oscillating frequency. (We'll discuss the rapid test procedure later.)

Final Assembly. When the board is fully populated (excluding C2), inspect it carefully for any possible shorts, especially between closely spaced conductors. All solder joints must be shiny, smooth, and filleted. Any that appear as dull blobs of solder (known as cold solder joints) must be corrected by removing the old solder and redoing the joint. It is far easier to correct such faults at this stage of the game than attempting to do so later after you've discovered that the project is inoperative.

The Fuel Miser's circuit board can be housed in the furnace enclosure or placed in a small plastic enclosure of its own, and installed next to the thermostat, furnace, or anywhere you choose. A suitable enclosure is suggested in the Parts List. LED1, which provides a visual indication of the Fuel Miser's operation may optionally be placed on the front of the cabinet or furnace where it can be seen.

The rotary switch may be installed in any convenient location near the circuit board, with the positions marked 10%, 20%, etc., (in 10% increments) up to 100%. That allows you to instantly change the Fuel Miser's duty cycle at any time. When wiring S1 refer to Fig. 3, which illustrates the location of the connections.

Power for the author's prototype was provided by a 9-15-volt DC wall adapter (but any power supply with an output voltage within the specified range will do just fine). Be sure to check your power source with a DC voltmeter to be sure that its output voltage is within the specified range. Connections between the power supply and the Fuel Miser can be hard wired, or made through a miniature plug and jack arrangement. In any case, be sure to observe proper polarity.

When installing the Fuel Miser in a cabinet, a pair of binding posts or a

PARTS LIST FOR THE FUEL MISER

SEMICONDUCTORS

- U1—LM555CN oscillator/timer, integrated circuit
- U2—CD4017B decade counter/divider, integrated circuit
- U3—CD4001B quad 2-input NOR gate, integrated circuit
- U4—MOC3011 optoisolator/coupler with Triac-driver output, integrated circuit
- Q1—BS170 N-channel, TMOS enhancement-mode FET
- TR1—T2322D 4-amp, 400-PIV Triac
- D1—1N4004 or similar 1-amp, 400-PIV silicon rectifier diode
- LED1—2-volt, 20-mA, light-emitting diode

RESISTORS

- (All fixed resistors are 1/4-watt, 5% units.)
- R1, R2—1-megohm
 - R3—100,000-ohm
 - R4—1000-ohm
 - R5—150-ohm

CAPACITORS

- C1—470- μ F, 25-WVDC, electrolytic
- C2—22- or 100- μ F, 25-WVDC, electrolytic (timing capacitor, see text)
- C3—0.01- μ F, ceramic-disc

ADDITIONAL PARTS AND MATERIALS

- S1—SP10T rotary switch (RS 275-1385 or similar)
- Printed-circuit board materials, enclosure (RS 270-231 or similar), IC sockets, binding posts, 9- to 15-volt DC, 20 mA or more, wall adapter (RS 273-1431 or similar) wire, solder, hardware, etc.

Note: The following parts are available from A. Caristi, 69 White Pond Rd., Waldwick, NJ 07463: PC board for \$10.95; U1, U2, U3, U4 for \$2.25 each; Q1 for \$2.00; Q2 for \$3.50; C2 low-leakage capacitor (specify value) for \$1.50. Please add \$3.00 postage/handling to all orders.

two-wire connector should be used to bring TR1's MT1 and MT2 terminal connections out to the heating system. The polarity of those wires does not matter. Once those terminals are installed, **do not** connect the Fuel Miser to the heating system until instructed to do so, which will come later, after the checkout procedure.

Checkout. Since the Fuel Miser's timing circuit operates at a very low frequency (0.02 Hz for gas and electric systems and 0.005 Hz for oil systems), a DMM or VOM with an input impedance of 1 megohm or more and a clock or stopwatch can be used to checkout the circuit. If, on the other hand, an oscilloscope is available, a more rapid checkout procedure can be performed by temporarily substituting, as mentioned previously, a 1000-pF capacitor for C2 and observing the output waveform's duty cycle. In addition, if a 24-volt step-down transformer is available, it can be used to check the Triac output of the circuit.

Begin the checkout procedure by connecting a 9-15-volt DC power source to the circuit, and after making sure that the source voltage is properly polarized, apply power. Check the signal at pin 3 of U1. A normal indication is about a 67% duty cycle (high level 2/3 of the time and low level 1/3 of the time). The period of the signal should be about 45 seconds (gas/electric systems) or 3 1/2 minutes (oil systems) with the specified value of C2 installed. With a 1000-pF unit installed, the period (as observed on the oscilloscope) should be about 2 milliseconds.

If you do not obtain the correct signal at U1 pin 3, troubleshoot the circuit before proceeding. Check the power supply voltage and its polarity. Check the orientation of D1, U1, U2, and C2. Check the values of R1, R2, and C2. If everything looks correct, try a new 555 oscillator/timer (U1).

Set S1 to the 50% position, and observe LED1 or examine the scope display of the signal at pin 3 of U3. After the circuit has gone through one on-off cycle, the duty cycle should, thereafter, be 50%. With the specified value of C2 for gas and electric or oil systems in place, the off and on times of the LED should be either 3 3/4 minutes or 17 1/2 minutes each, depending upon which timing capacitor has been installed in the circuit. With the 1000-pF test capacitor installed, the off/on times should be 10 milliseconds each.

Try different positions of S1, and verify that the duty cycle can be set from 10% to 100% (in increments of 10%) by observing LED1 and/or the scope display of the signal at U3 pin 3. If the LED

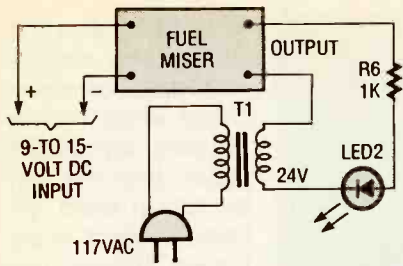

Fig. 4. When the circuit is working properly, the output circuitry can be checked using a 24-volt step-down transformer, a 1k resistor, and an LED. Together those components simulate the load that the Fuel Miser sees during normal operation.

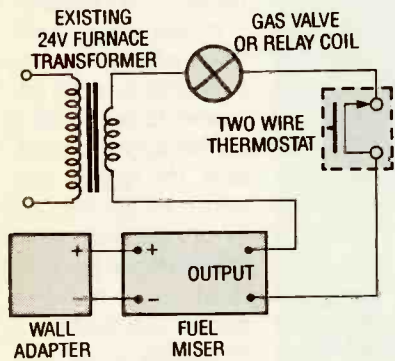

Fig. 5. This drawing shows the Fuel Miser connected in series with the thermostat of a two-wire gas furnace that's powered by a 24-volt transformer.

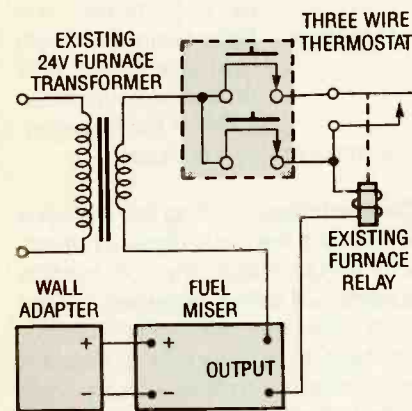

Fig. 6. Some oil-fired systems use three-wire thermostats to control the operation of the burner motor and ignition system by activating a relay. This is a typical installation for such systems.

does not flash on and off as indicated or the duty cycle is incorrect, check the orientation of U2, U3, U4, Q1, and LED1. Check C3, R3, and R4. Check the wiring to S1. Examine the circuit board carefully for any possible shorts, opens, or cold solder joints. Try new chips for U2, U3, and U4.

When the circuit is working properly,

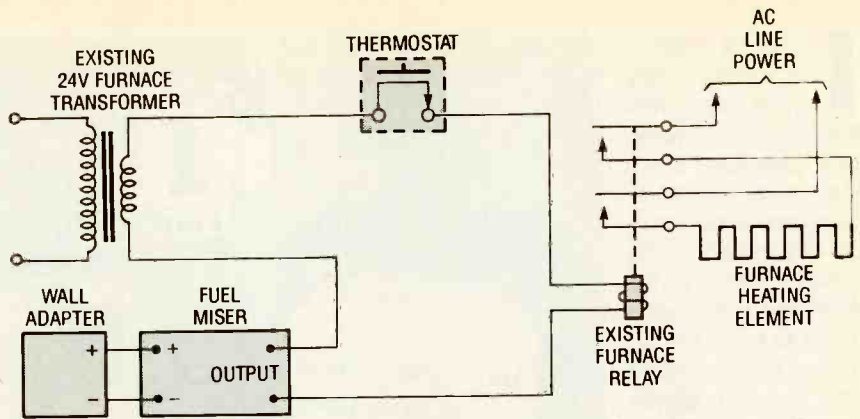

Fig. 7. Electric-heating systems may or may not use a relay in the thermostat circuit. Those that do have a relay can be controlled by the Fuel Miser by wiring its output circuit in series with the relay coil connections as shown here.

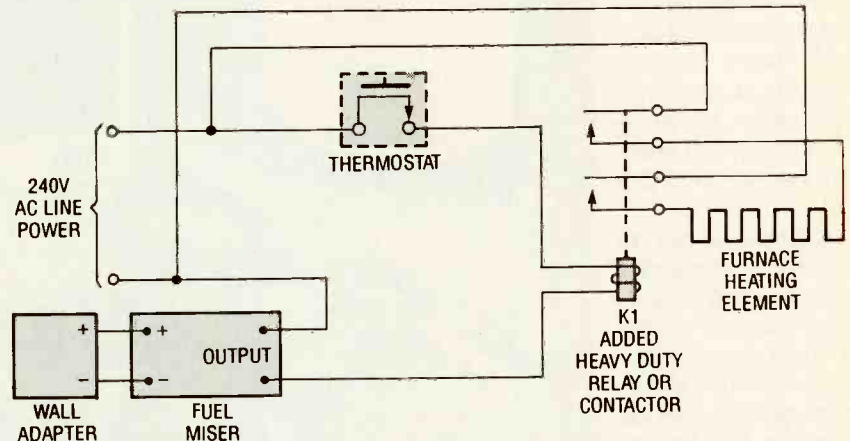

Fig. 8. Electric-heating systems that do not contain a low-current thermostat (as in the previous installation), use a heavy-duty thermostat that directly feeds current to the heating element. For such systems, it will be necessary to install a heavy-duty relay (K1 in this example) to control the heavy heating-element current.

the output circuitry can be checked using a 24-volt step-down transformer, a 1k resistor, and an LED as illustrated in Fig. 4. Together those components simulate the load that the Fuel Miser sees during normal operation. Before making this test, however, install the correct C2 value (assuming that the rapid test was performed).

With power applied to the circuit and the 24-volt transformer energized, allow the Fuel Miser one on-off cycle to initialize itself. Then verify that the test LED flashes off and on at the duty cycle set by S1, and that it's synchronized with LED1. Check that the total time for one complete cycle (off and on) of the test LED is either 7½ minutes for gas and electric systems, or 35 minutes for oil systems for any setting of S1.

If the test LED does not light, check the orientation of TR1 and the wiring associated with it. Also check R5 and/or try another optoisolator/coupler for U4 and/or another Triac for TR1.

Installation. As previously stated, the Fuel Miser can be installed directly into the furnace enclosure, on the wall next to the thermostat, or in any desired location where the thermostat wiring is accessible. Be sure to turn off power to the furnace before attempting the installation.

Figure 5 shows the Fuel Miser connected in series with the thermostat of a two-wire gas furnace that's powered by a 24-volt transformer that is located inside the furnace enclosure. The polarity of the connections from the Fuel Miser to the furnace circuit is not important. The thermostat directly controls the gas valve, which operates at 24-volts AC and draws about 1-ampere of current. The Triac in the Fuel Miser switches current off and on in the thermostat circuit.

Three-wire thermostats are used in some oil-burner systems to control the operation of the burner motor and ignition system (by activating a relay).

(Continued on page 110)

In these difficult economic times, many home owners are opting, whenever possible, to do their own home repairs and remodeling. Do-it-yourself home repairs often entail spending many hours trying to trace the AC wiring through walls and junction boxes. Remodeling, such as adding a new window or door to your home, often requires that you cut a section out of a wall. When hacking through a wall, you had better know the location of the electrical wiring or it's lights out.

A simple solution to those and other similar wire-tracing dilemmas—such as tracing a signal through your automobile's electrical system—can be found in the *McTrak* wire-tracing circuit described in this article. The *McTrak* can turn a job that might otherwise require hours of cutting, whacking, and pulling into child's play (well almost), cutting your work time from a few hours to only a few minutes.

The *McTrak* is easy and inexpensive to build, and best of all, there is nothing difficult about using the unit. All you have to do is connect the *McTrak* to the wire of interest and, using a portable AM receiver, trace a signal (put out by the *McTrak*) to its final destination.

How It Works. A schematic diagram of the *McTrak* is shown in Fig. 1. At the heart of the circuit is a 567 tone decoder. The tone decoder (U1) is configured as a simple astable, square-wave oscillator, operating at about 250 Hz. The 250-Hz output of the squarewave oscillator, at pin 5, is fed to the base of Q1 (a 2N3904 general-purpose NPN transistor), which in this application, functions as a buffer stage. The alternating output of U1

causes Q1 to switch on and off in time with the drive signal.

The output of Q1, taken from its collector, is fed through capacitor C2 to Q2 and Q3—a second 2N3904 NPN unit and its companion 2N3906 PNP transistor, respectively—which form a complementary pair. Together, those transistors alternately amplify both halves of the applied signal; e.g., when one transistor is off the other one is on. That pair of transistors provides a low output-impedance signal source that can be used to drive either an open- or closed-loop circuit.

The output of the complementary pair (Q2 and Q3) splits along two paths; in one path, the output of the complementary pair is applied to C5, causing the 250-Hz output of the complementary pair to be induced into the AC wiring and radiated

throughout the wiring system. The circuit's 250-Hz squarewave output, which is rich in harmonic signals that reach into the AM broadcast band, allows the signal to be traced through the house or other wiring with an inexpensive AM transistor radio. The radiated signal, when detected by an AM receiver, produces a buzzsaw-like sound in the receiver's speaker.

In the other path, the signal goes through C4 and is delivered to output jack J1 (the open-loop output); the signal also continues on through 47-ohm current-limiting resistor R6 (which is used to protect the tracker's output from overload) to J2 (the closed-loop output). Those output jacks, along with J3 (common), are used when conditions are less than optimum. (We'll give examples of how and when to use those jacks at the appropriate time later in this article.)

Construction. Building the *McTrak* is simple and the parts layout is not critical, so just about any construction scheme will suffice. However, the author's prototype of the circuit was assembled on a printed-circuit board. A template for that printed-circuit layout is shown in Fig. 2. If you opt to go the printed-circuit route, follow the parts-placement diagram shown in Fig. 3.

As usual, start by installing the passive components (resistors, capacitors, etc.) followed by the semiconductors, double-checking all part locations and their orientations as they are installed on the board. Once the electronic components have been installed, connect a 9-volt battery connector to the board at the points indicated in Fig. 3. Be sure that the proper polarity is observed.



Cut those seemingly insurmountable wire-tracing jobs down to size

BY CHARLES D. RAKES

ate time later in this article.)

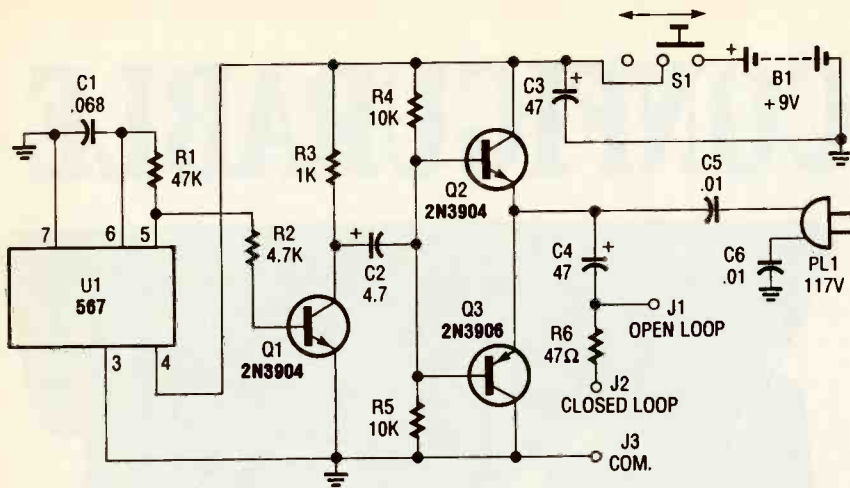

Fig. 1. At the heart of the McTrak is a 567 tone decoder, configured as a simple squarewave oscillator, operating at about 250 Hz.

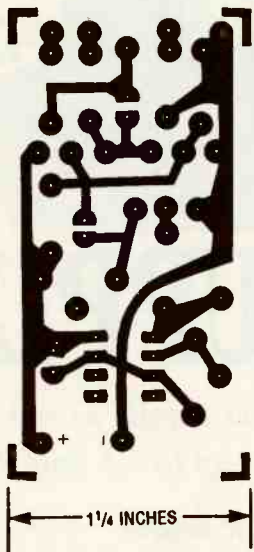

Fig. 2. The author's prototype of the circuit was assembled on a printed-circuit board, the template for that printed-circuit layout is shown here full size.

PARTS LIST FOR THE MCTRAK

SEMICONDUCTORS

- U1—LM567 tone-decoder, integrated circuit
- Q1, Q2—2N3904 general-purpose NPN silicon transistor
- Q3—2N3906 general-purpose PNP silicon transistor

RESISTORS

- (All fixed resistors are 1/4-watt, 5% units.)
- R1—47,000-ohm
 - R2—4700-ohm
 - R3—1000-ohm
 - R4, R5—10,000-ohm
 - R6—47-ohm

CAPACITORS

- C1—0.068- μ F, 100-volt Mylar
- C2—4.7- μ F, 16-WVDC, electrolytic
- C3, C4—47- μ F, 16-WVDC,

side and prepare the enclosure.

The author's prototype was housed in a 4 $\frac{5}{8}$ x 2 $\frac{9}{16}$ x 1 $\frac{1}{16}$ -inch plastic project box (available from Radio Shack and other sources) that is slotted to hold small circuit boards in place. The circuit board was sized to fit the case's internal slots.

It will be necessary to drill holes in the enclosure for the off-board components: S1 (along with its mounting hardware), J1-J3, and PL1. Note that although the author used a slide switch for S1, there is no reason that a toggle or even a locking pushbutton (push on/push off) switch could not be substituted. Mount switch S1 to one side of the cabinet, and the three output jacks on the opposite side. Then

electrolytic

- C5, C6—0.01- μ F, 500-1000-WVDC, ceramic-disc

ADDITIONAL PARTS AND MATERIALS

- B1—9-volt transistor-radio battery
- S1—SPST slide switch
- J1-J3—See text
- Printed-circuit materials, enclosure (Radio Shack #270-222), molded AC power plug with line cord, 9-volt battery holder and connector, wire, solder, hardware, etc.

Note: The circuit board and all of the parts that mount on it are available for \$14.95, plus \$1.00 shipping and handling from: Krystal Kits, P.O. Box 445, Bentonville, AR 72712. Arkansas residents please add appropriate sales tax.

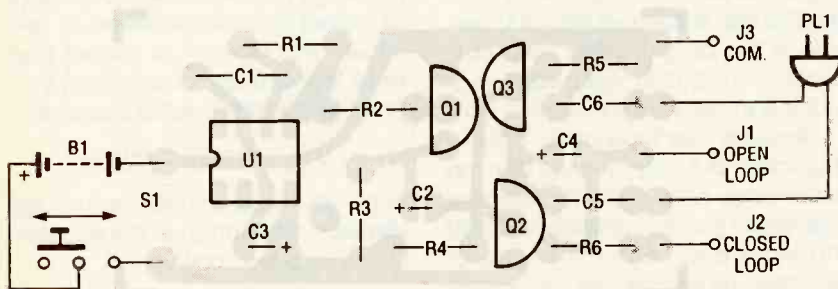

Fig. 3. Follow this parts-placement diagram when assembling McTrak's printed-circuit board. As usual, start with the passive components, followed by the semiconductors, double-checking the part's location and orientation as it is installed.

After all of the on-board components have been installed, check your work for potential problems—solder bridges, cold solder joints, and so on.

When you are satisfied that the circuit board contains no errors (of the nature usually associated with hobbyist projects), place the board to the

using hook-up wire, connect the switch and the three jacks to the circuit board at the appropriate points.

Once that is done, mount an AC plug with line cord to one end of the enclosure. That can be accomplished by first passing the plug's line cord through a 1/8-inch hole in one end of the enclosure, and then clipping off the excess cord length and connecting the line cord to the circuit board as shown in Fig. 3. After that is done, the plug can be secured to the enclosure using hot-melt glue.

Check Out and Use. To check the operation of the McTrak, first install a
(Continued on page 109)

Power supplies are not something that we think about often—we usually take them for granted. But when you think about it, where would electronic projects be without them? And for that matter, where would this magazine be without them? The fact is, we don't usually think about power supplies until we need one.

Usually a power supply is built specifically for a certain project, and incorporated right into the project itself. However, general-purpose power supplies can be even more useful, lending themselves to all sorts of applications. So, what we've got here is a very basic power supply that can be adapted to almost any project. The 12-volt power supply that we came up with was actually built for powering car radios indoors, but it is useful for any 12-volt accessory. With just a few part substitutions, the supply can have an output of from 1.2 to 33 volts—which should be good for nearly anything you can think of. If you'd like to build one of these no-nonsense power supplies, then read on.

Adjustable Voltage Regulators.

The adjustable voltage regulators that are readily available today are a great boost to hobbyists building power supplies. Unlike fixed regulators, adjustable units can be programmed to output any voltage within their operating range. (The minimum and maximum output voltage varies from model to model and manufacturer to manufacturer.) Furthermore, the devices come in positive and negative "flavors" to suit any reasonable application.

Our power supply uses an LM317 positive-voltage adjustable regulator. It can produce an output voltage ranging from around 1.25 to 33 volts. We buy these units in place of standard regulators (5-volts, 9-volts, 12-volts, etc.) simply because they can provide any voltage required to suit most needs. As long as one or two of those devices are around, there's nothing to stop us from building any project we desire.

As regulators go, adjustable units provide excellent ripple rejection and have a neat short-circuit shut-off feature: If you short the regulator's output, it shuts down and automatically turns back on when the short is removed.

CONFIGURABLE

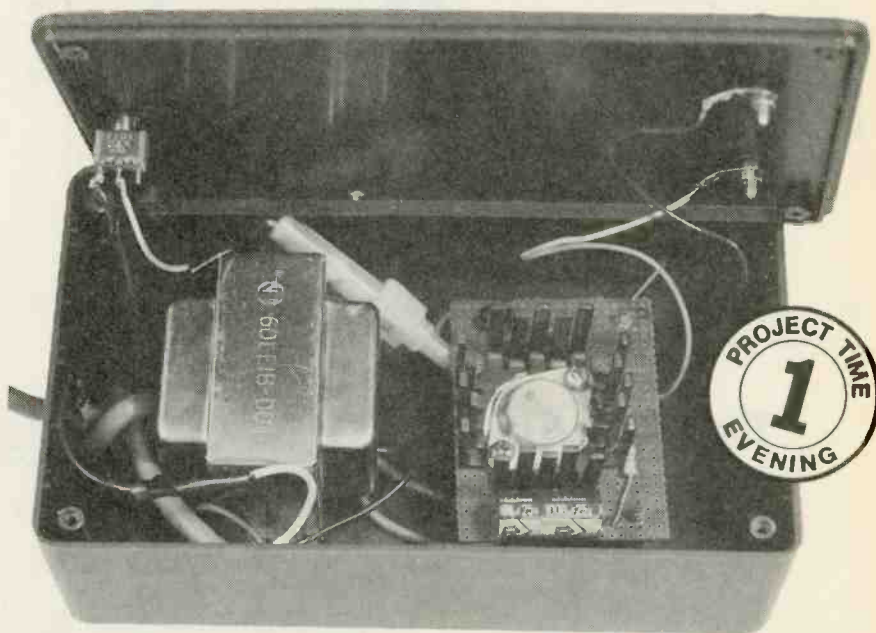

POWER SUPPLY

An inexpensive, configurable power supply to suit any device in need of 1.2 to 33 volts at up to 1.5 amps!

BY JOHN YACONO AND MARC SPIWAK

They also shut down if they become too hot.

To add to their value, adjustable regulators are easy to use. In Fig. 1A, a positive adjustable regulator is shown with its two programming resistors in place. A negative adjustable regulator is shown in Fig. 1B. For the sake of discussion, we'll talk about positive regulators, but keep in mind that the exact same rules apply for negative regulators; the only difference is that the input and output voltages for negative regulators are, of course, negative.

Resistor R1 is usually chosen to be around 240 ohms to provide optimal performance, but we often use 220-ohm resistors without the least bit of trouble. While the value of R1 is pretty standard, the value of R2 determines the output voltage of the regulator

according to the relation:

$$V_{\text{Out}} = 1.25(1 + R2/R1) + R2 \cdot I_{\text{adj}}$$

where I_{adj} (the adjustment current, as it's called) is usually between 40 and 50 μA . That amount of current is so small that you can often disregard it and use this abbreviated equation:

$$V_{\text{Out}} = 1.25(1 + R2/R1)$$

Since you usually know the voltage you want, let's rearrange the equation to find R2 based on V_{Out} :

$$R2 = R1(V_{\text{Out}}/1.25 - 1)$$

There are just three restrictions that you should bear in mind when using an LM317. First, the supply to the regulator should be filtered to supply at least 3-volts rms more than the desired V_{Out} . That fact will help you to determine the secondary voltage of the

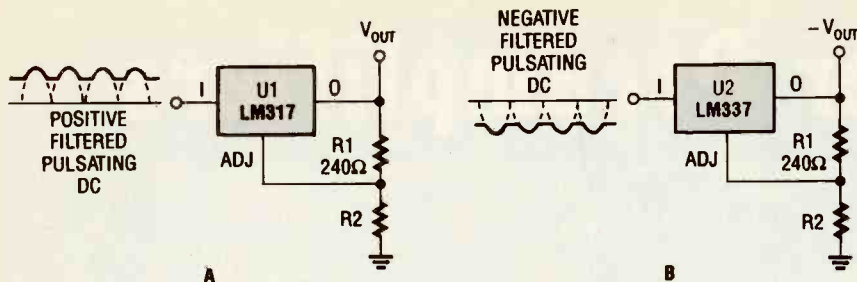

Fig. 1. Adjustable regulators are easy to use. Whether you need a positive (A) or a negative (B) output voltage, you just have to add two resistors and a filtered source of pulsating DC.

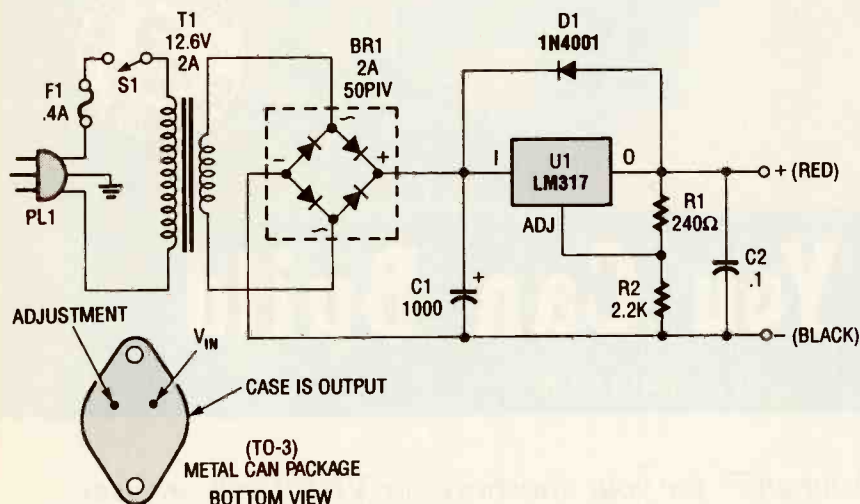
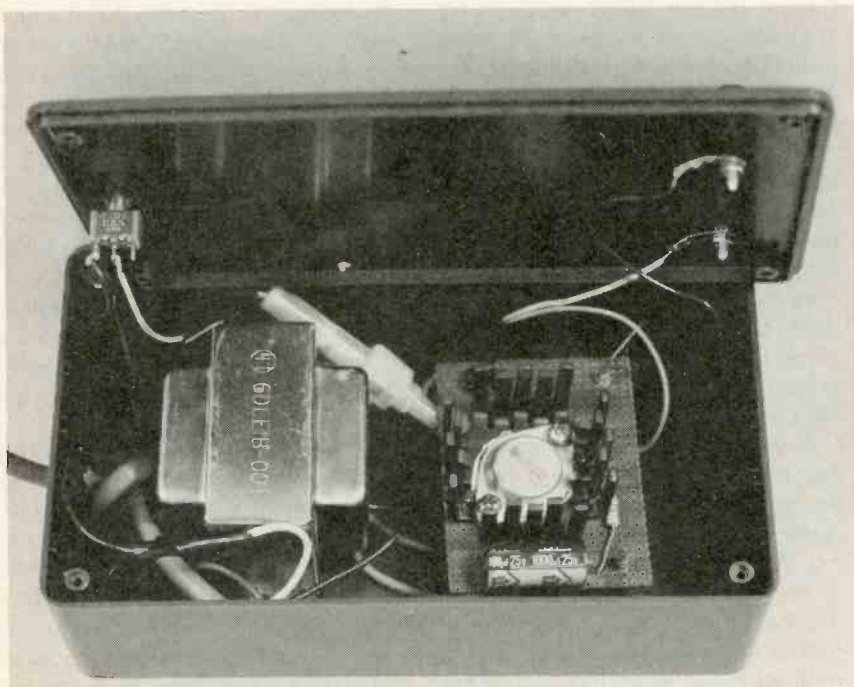

Fig. 2. The adjustable supply can easily be reconfigured by altering the value of R2 and beefing up some other components as necessary.



Because the case size was chosen for the size of the transformer, there's plenty of room inside for the board.

PARTS LIST FOR THE CONFIGURABLE POWER SUPPLY

SEMICONDUCTORS

U1—LM317 adjustable positive-voltage regulator, integrated circuit
 BR1—2-amp, 50-PIV, full-wave bridge rectifier (see text)
 D1—1N4001 1-amp, 50-PIV rectifier diode

RESISTORS

(All fixed resistors are ¼-watt, 5% units.)

R1—240-ohm

R2—2200-ohm

CAPACITORS

C1—1000-μF, 50-WVDC electrolytic

C2—0.1-μF, ceramic-disc

ADDITIONAL PARTS AND MATERIALS

F1—0.4-amp fast-blow fuse

PL1—3-terminal molded AC power plug with line cord

S1—SPST toggle switch

T1—125-volt primary, 12.6-volt, 2-amp secondary, power transformer (see text)

Perfboard, case, rubber grommets, heat sinks, fuse holder, wire, solder, hardware, etc.

transformer that you should use to supply the LM317 in your design. Second, make sure the the difference between the input voltage to the regulator and the output voltage from the regulator is less than 12 volts rms. That will guarantee at least a 1.5-amp output at the rated voltage, with a possible maximum current of 3.4-amps with good heatsinking. Third, if substantial current (more than ¼-amp) is to be drawn from the regulator, use a heat sink.

One last thing to be aware of is the fact that adjustable regulators have different pinouts than constant-voltage models. In a similar vein, positive and negative adjustable regulators don't have the same pinouts as one another. That's enough theory for now, let's get to the real circuit.

The Circuit. The transformer's primary in the power supply (see Fig. 2) is connected to the AC line via S1 and F1. The value of F1 has been selected to prevent the secondary (yes, the secondary) from experiencing too much current.

(Continued on page 108)

Receiver Preamplifiers

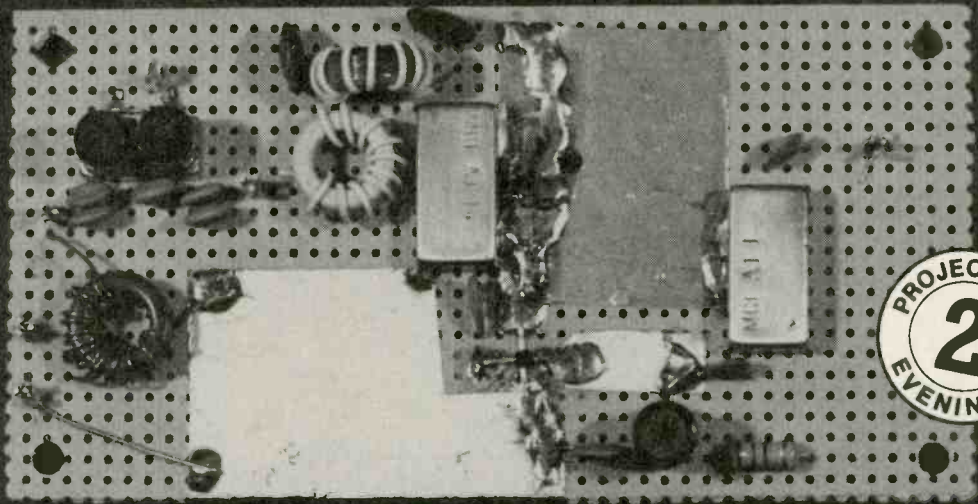

That You Can Build

BY JOSEPH J. CARR

Design and build a "front end" for your shortwave or VHF/UHF receiver

Receiver preamplifiers, which are used to boost weak signals before they are applied to a receiver's input terminal, come in two basic forms: tuned and untuned. The tuned version, also called a preselector, passes only one frequency at a time. The untuned version, on the other hand, is designed to pass a wide range of frequencies at the same time.

Until very recently, the task of designing and building very wideband amplifiers was daunting. Stray inductances and capacitances, as well as the limitations of the active devices (usually transistors) in the circuit, conspired to thwart success. While there were a lot of circuits laid out in print, it wasn't until monolithic microwave integrated circuit's (MMIC's) came on the scene that very wideband preamplifiers became easy for electronic hobbyists to build.

Although MMIC's had been around for a while, they were previously limited by price to high-cost equipment. Today, however, hobbyists can easily

obtain MMIC's at low cost. The MAR-x series of MMIC's (available from Mini-Circuits, P.O. Box 350166, Brooklyn, NY, 11235-0003) are some of the most useful for projects like the preamplifier circuits that will be discussed in this article.

MMIC. Figure 1 shows the MAR-x package outline. On the surface, it looks like any UHF/microwave transistor. The leads (radiating outward from the body of the unit) are not wires, as with other devices, but flat strips that reduce inductance (a prime limiting factor in VHF and higher frequency amplifiers).

As shown, MAR-x devices have only four leads, two of which are grounds (leads 2 and 4) terminals. The reason for two grounds is to distribute grounding, thereby reducing the inductance of the leads. The other two terminals are the RF input (lead 1) and the RF output (lead 3). Note that lead 1 is marked in two ways: the end of the lead is beveled, and there is a color dot next to it.

MAR-x's come in several varieties (which are designated by a number replacing the "x" in the dummy type number above). The MAR-1 can operate from DC to 1000 MHz (1 GHz), and provide gains of up to 18.5 dB, while providing a noise figure of 5 dB. Other devices (carrying suffixes 2, 3, 4, 6, 7, or 8) operate to 2,000 MHz, with noise figures as low as 2.8 dB. Thus, the MAR-x series can fulfill the requirements of a large number of applications.

Table 1 lists several MAR-x devices along with their capabilities and the unique color dot that indicates the RF-input terminal; the color of the dot indicates the MAR-x version.

An interesting aspect of the MAR-x series is that the input and output impedances of the device are inherently 50 ohms. There is no need to match impedances if the source and load impedances are 50 ohms. That single fact makes MAR-x devices extremely interesting to use, because much of the complex and finicky circuitry associated with RF amplifiers is for impedance transformation.

TABLE 1—MAR-X CAPABILITIES

DEVICE	MAX. FREQ. (MHz)	GAIN (100/50/1000 MHz)	N.F.	COLOR
MAR-1	1,000	18.5/17.5/15.5	5	Brown
MAR-2	2,000	13/12.8/12.5	6.5	Red
MAR-3	2,000	13/12.8/12.5	6	Orange
MAR-4	1,000	8.2/8.2/8	7	Yellow
MAR-6	2,000	20/19/16	2.8	White
MAR-7	2,000	13.5/13.1/12.5	5	Violet
MAR-8	1,000	33/28/23	3.5	Blue

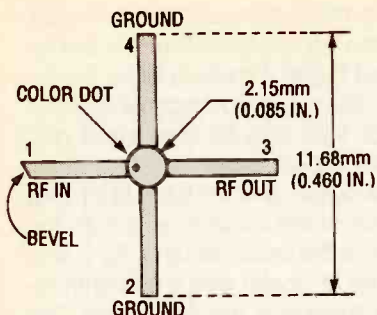

Fig. 1. The package outline of MAR-x series MMIC looks, on the surface, like any UHF microwave transistor, with its flat leads radiating outward from the body of the unit. The leads (flat strips) help to reduce inductance, a prime limiting factor in VHF and higher frequency amplifiers.

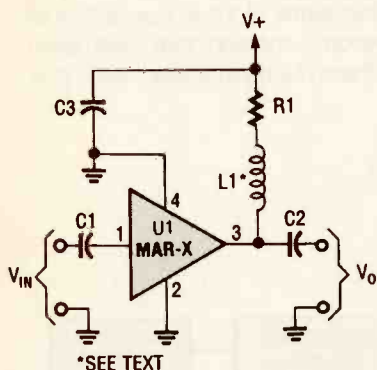

Fig. 2. In the basic MAR-x-based circuit, shown here, both the input and output are comprised of a single DC-blocking capacitor (C1 and C2 for the input and output, respectively). The DC power-supply network (comprised of L1 and R1) is attached to the MAR-x via the RF-output terminal (lead 3).

Basic MAR-x Circuit. Figure 2 shows a bare bones, MAR-x-based circuit that works well in nearly all cases. Note that both the input and output of that circuit consist of a single DC blocking capacitor (C1 for the input and C2 for the output). For frequencies up to 100 MHz or a little higher, C1 and C2 can be ceramic-disc units, but above 100 MHz, they should be chip capacitors. (Digi-Key—P.O. Box 677, Thief River Falls, MN, 56701-0677; Tel. 1-800-344-4539—sells Panasonic-brand, type 0805 and 1206 chip capacitors in 100-unit quantities.) In most cases, C1 and C2 should be 0.001- μ F units, although for HF (below 30 MHz) circuits, 0.01- μ F units are more suitable. For projects that are strictly for above 100 MHz, 100-pF or smaller capacitors are used.

There is also a DC power-supply network, comprised of L1 and R1. The DC power-supply network is attached to the MAR-x via the RF-output terminal (lead 3). The basic component needed in that network is current-limiting resistor R1, with an RF choke (L1) being used in some cases. The resistor is used to limit current to a designed optimum value, which for the MAR-1 is 15 mA. The value of the resistor depends on the value of the V+ and the desired current level, as follows:

$$R1 = (V+) - (V)/I$$

where V+ is the power-supply voltage, V is the voltage at the RF-output terminal of the MAR-x device, and I is the current. Consider this example for the MAR-1 operating from a 12-volt DC supply, and providing +5 volts DC for V.

$$R = (+12) - (5)/0.015$$

$$R = 7/0.015 = 467 \text{ ohms}$$

Because the standard value of 470 ohms is close to 467 ohms, that value is selected instead. (Note: A 5% tolerance 470-ohm resistor may well have an actual resistance of 467 ohms, anyway!) The power dissipation of the resistor is 0.105 watts, so a quarter-watt resistor is sufficient. The resistor selected for R1 should be a non-inductive type such as carbon composition or metal film. No form of wire-wound resistor should be used in the circuit, not even those touted as non-inductive because they are non-inductive only in the audio-frequency range.

The optional RF choke (L1, which is used in many practical circuits) has two purposes: Choke L1 is used to prevent the RF output of the MAR-x from getting into the power-supply circuit or vice versa. The choke's other purpose is to act as a peaking coil to improve the circuit's upper-frequency response. The latter purpose is fulfilled because the load impedance seen

by the MAR-x is the combination of the inductive reactance of L1 and the resistance of R1. Because L1's reactance increases with frequency, the load impedance is also higher at higher frequencies.

Now that we've got the basic circuit, let's put it together and make a workable project. I selected two projects. The first is a shortwave-band (high-frequency) preamplifier, and the other is a VHF/UHF preamplifier for monitors and scanner receivers.

HF SW Receiver Preamplifier.

Figure 3 is an HF preamplifier that is designed to be used in front of shortwave receivers. It can be used to boost weak signals or to form a basic kind of active-antenna circuit (more on that later).

The input to the circuit consists of a broadband toroidal transformer that was made by winding 3 turns of #26 enameled wire on an Amidon Associates (P.O. Box 956, Torrance, CA 90508) T-50-2 (red) core for L1-a, and then winding 10 turns of #26 enameled wire on the same core for L1-b.

From there, the signal is fed to a complex LC network comprised of a 1600-kHz, high-pass filter and a 32-MHz, low-pass filter. Those filters are used to limit out-of-band signals. AM broadcast-band signals (less than 1600 kHz) are usually very strong at most locations, and can easily drive the preamplifier into saturation, causing big problems. The high-pass pi-filter (which is comprised of C1-C3, L2, and L3) is designed to attenuate signals below the 1600-kHz point, reducing their effect on the amplifier.

Inductors L2 and L3 can be made by winding 26 turns of #26 enameled wire over an Amidon Associates T-50-2 (red) toroidal core. However, I used a Toko adjustable core (available from Digi-Key). The Toko 332PN-T1018Z (Digi-Key part no. TK5136) is a good bet (I actually used a retuned 5.6 μ H version

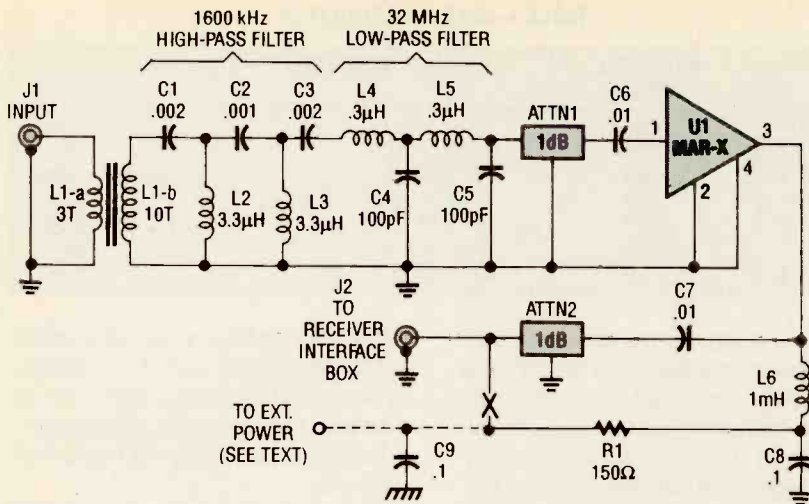

Fig. 3. The HF SW Receiver Preamplifier is comprised of a broadband toroidal transformer (L1-a and L1-b), a complex LC network (comprised of a 1600-kHz, high-pass filter and a 32-MHz, low-pass filter), L2 and L3 (26 turns of #26 enameled wire wound on an Amidon Associates T-50-2, red, toroidal core), a pair of resistive attenuators (ATTN1 and ATTN2), and of course, the MAR-x device.

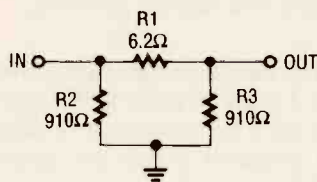

Fig. 4. Shown here is the composition of the basic 1-dB pi-network resistor attenuator used in the circuit of Fig. 3.

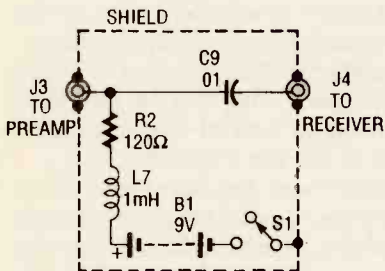

Fig. 5. The purpose of this receiver-interface circuit is to pass RF to the receiver through capacitor C9, while adding DC power to the feedline through R2 and RF choke L7.

of the same coil in the model I built and tested for this article, but that is not an optimum choice). The capacitors are NPO ceramic-disc units.

The two-section 32-MHz low-pass filter is designed to attenuate local VHF/UHF signals, but pass HF-shortwave signals. The capacitors can be NPO ceramic-disc or silvered-mica (the former are preferred) units. Inductors L4 and L5 (0.3- μ H units) were made by winding 9 turns of #26 enameled wire on Amidon T-50-6 (yellow) cores.

make them from ordinary 1/4-watt, carbon-composition or metal-film resistors.) Figure 4 shows a basic pi-network attenuator pad that will drop the signal 1-dB with 50-ohm input and output impedances.

The output of ATTN1 is fed to U1. That portion of the circuit is essentially the same as the basic circuit of Fig. 2, with a 1-mH RF choke and a 150-ohm resistor supplying the DC power. The power supply end of the resistor is connected to the coaxial connector that carries signal to the receiver. The MAR-x's input and output capacitors (C6 and C7) are 0.01- μ F ceramic-disc units.

In order to improve performance at higher frequencies, it is necessary to strip the leads of those capacitors of the ceramic material that flows down onto them during manufacture. A pair

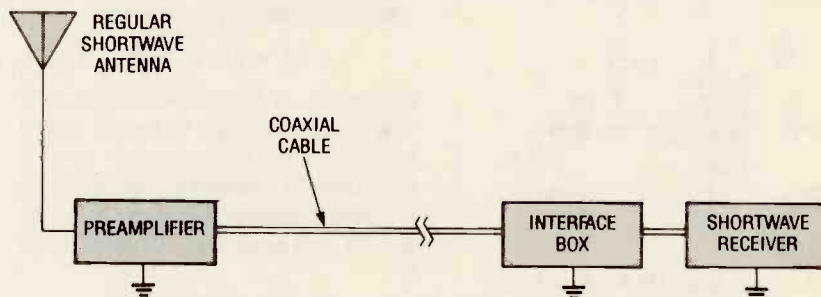

Fig. 6. In this set up, the preamplifier is used with an ordinary SW antenna (such as a random-length wire, vertical, or dipole) in the conventional manner.

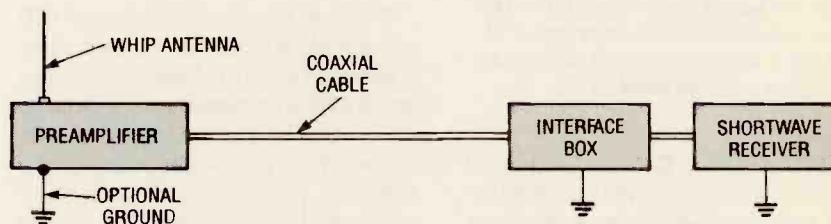

Fig. 7. In the active antenna setup shown here, the SW antenna from the previous setup is replaced by an 18-to 30-inch whip antenna.

From the 32-MHz filter, the signal is fed to the first of two 1-dB, 50-ohm resistive attenuators (ATTN1 and ATTN2) used in the signal line at the RF input and output of the MAR-x. Those attenuators are used to swamp out impedance variations in the source and load. Those impedances can vary considerably, and the attenuators help level them out as far as the MAR-x device is concerned. (I used Mini-Circuit's AT-1 1-dB shielded attenuators for the project. But if you don't want to purchase those parts, or cannot for some reason, then you can

of long-nose pliers will crush the ceramic overflow so that it can be removed.

The preamplifier circuit can be placed remote from the receiver; i.e., mounted on the antenna mast or other support structure. That remote capability is possible because the circuit sends DC power up the same coaxial-cable feedline that's used by the RF signals. Sometimes, a decoupling capacitor is used at the junction of L6 and R1 to limit the load impedance to the reactance of L6 (a 1-mH Toko choke, Digi-Key part #TK4312).

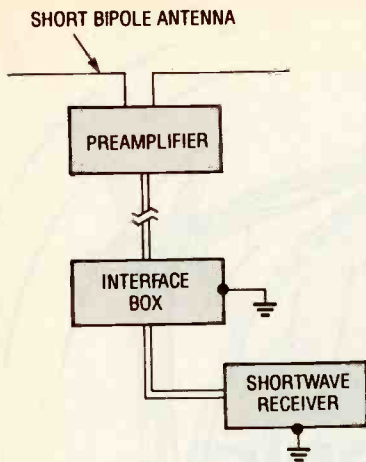

Fig. 8. Here the preamplifier is modified to unground the input coil (L1-a in Fig. 3) so that a bipole (a small, two-element) antenna can be connected.

route it to the external power source. A 0.01- μ F decoupling capacitor is needed in that case.

The preamplifier should be built into a shielded metal box, either die-cast type, or a sheet-metal box with overlapped edges between the top and bottom covers. That type of box prevents RF leakage into or out of the box. Flush-fit boxes are not well shielded and should be shunned for RF projects.

Receiver Interface. A receiver interface for the preamplifier is shown in Fig. 5. The purpose of the interface is to pass the RF signal to the receiver through capacitor C9, and to add the DC power to the feedline through R2 and RF choke L7. The DC power sup-

is used to turn the preamplifier on and off.

The project can be built on a section of perfboard. There is some point-to-point wiring on the bottom side of the board, although the MAR-x connections are on the component side. Large ground-plane areas are made from adhesive-backed copper foil. (The foil material is sold in electronic parts stores for those who want to make pseudo-PCB's.)

Figures 6-8 show three different ways that the preamplifier can be used in shortwave-receiver systems. Figure 6 shows the conventional manner, in which the preamplifier is used with an ordinary SW antenna (such as a random-length wire, vertical, or dipole).

An active antenna setup is shown in Fig. 7. In that setup, the SW antenna from the previous setup is replaced by an 18- to 30-inch whip antenna. In testing that setup, I had good shortwave reception from my dining room table, using a 20-inch telescoping whip antenna that was soldered to the center conductor of a coaxial connector. The original antenna was intended as a portable radio replacement type.

Another active antenna setup is shown in Fig. 8. In that setup, the preamplifier is modified to unground the input coil (L1-a in Fig. 3) so that a bipole antenna can be connected to it. So what's a bipole antenna? I coined that word for a small two element antenna, similar to a dipole. It is not a dipole because the antenna is of similar size to the whip used in Fig. 7. A regular dipole for shortwave bands would be at least 16-feet long for ten meters, and as much as 150-feet long at the lower bands.

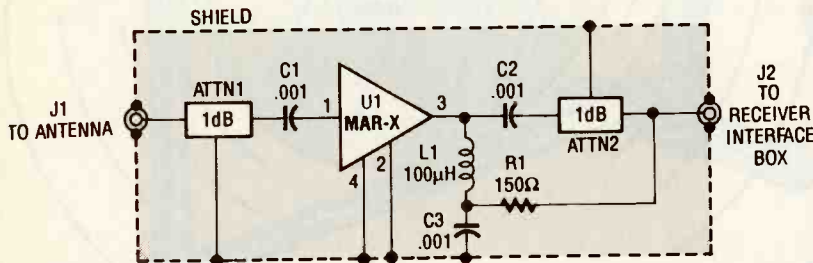

Fig. 9. Here's a VHF/UHF version of the preamplifier. The VHF/UHF preamplifier is similar to the basic configuration shown Fig. 2, while using the DC power-supply, feed system used in Fig. 3.

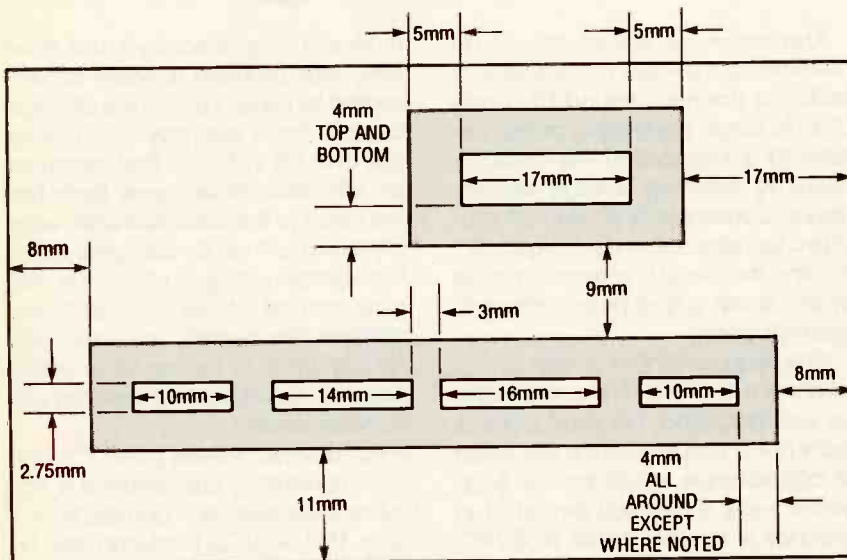

Fig. 10. The circuit can be assembled on perfboard, using adhesive backed copper foil and following the pattern shown here. The back of the board is a solid copper foil ground plane.

If you wish to use the preamplifier closer to the receiver, with a DC power source that is not fed through the coaxial cable, then break the DC power line at point X in Fig. 3 and

ply is a 9-volt transistor-radio battery. As a precaution, an AC-derived power source is not recommended because the preamplifier is often used outdoors. Switch S1 (an SPST unit)

VHF/UHF Preamplifier. Figure 9 shows the schematic diagram of a VHF/UHF version of the preamplifier. The VHF/UHF preamplifier is similar to the basic configuration shown Fig. 2, while using the DC power-supply, feed system shown in Fig. 3. The capacitors for the RF input and output must be 100-pF or 0.001- μ F chip capacitors. In this circuit, the RF choke (used in Fig. 3) has been replaced by an Amidon Associate FB-43-101 ferrite bead, which is more suitable for VHF/UHF applications.

(Continued on page 108)

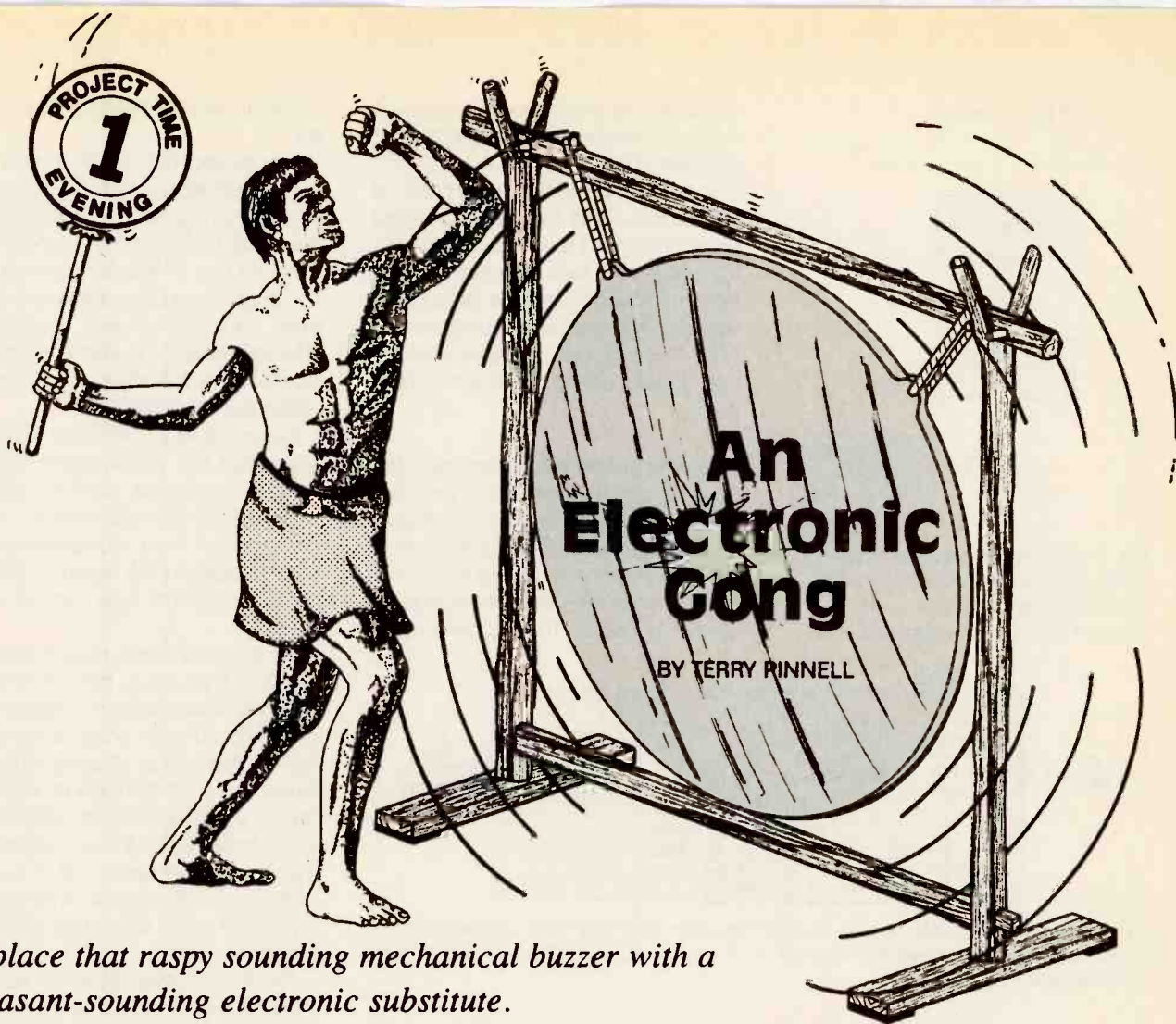

Replace that raspy sounding mechanical buzzer with a pleasant-sounding electronic substitute.

I was awakened one morning for the umpteenth time by the loud rasping noise produced by our bedside tea-making machine. My wife and I would hate to be without our morning resuscitator. However, I thought that it deserved a more civilized sounding device than an electro-mechanical buzzer. So, I decided to replace it with a less crude alternative—the *Electronic Gong* described in this article.

Circuit Operation. Figure 1 shows a block diagram of the Electronic Gong, which is comprised of a power supply, an oscillator, an active filter, and an audio-output amplifier.

Figure 2 shows a full blown schematic diagram of the Electronic Gong. Power for the circuit is provided by a 12-volt stepdown transformer (T1) coupled with a fullwave bridge rectifier (BR1). The power supply provides a non-critical DC voltage, which is filtered by capacitor C1, and is used to power the rest of the circuit.

Application of power causes an asymmetrical astable multivibrator or oscillator (formed around U1-a and U1-b) to begin generating pulses. Resistor R1 is included in the oscillator circuit to minimize voltage dependency. Components R2 and D1 provide a fast alternative discharge path, causing the circuit to produce a series of very sharp output pulses, about 12 seconds apart.

One requirement of simple CMOS astables is that the timing capacitor be non-polarized. For short periods that's not a problem, since the value of capacitance would be low (e.g., below 1 μ F). The timing period (T) in seconds is roughly equal to $0.7RC$, where R is resistance in megohms and C is capacitance in microfarads. That means that the capacitance would have to be about $1.4T/R$.

Unfortunately, for periods of more than, say, 5 seconds, with the value of R kept below 5 megohms, the value of the timing capacitor would have to be greater than 1.4 μ F. That would nor-

mally call for an electrolytic unit. However, that problem is easily circumvented by using a pair of equal value, back-to-back electrolytics in series (C2 and C3 in Fig. 2). That produces an effective capacitance that's half the value of the individual units, while at the same time, doubling the effective voltage rating; in effect, the voltage ratings of the two units are additive. (Incidentally, the capacitors do not have to be equal in value, however, equal values make the calculation simple.)

For any two values given C2 and C3, the resulting capacitance is calculated like resistors in parallel, from $1/C = 1/C1 + 1/C2$. (That can also be quite a handy dodge when you have no capacitor on hand with a high enough voltage rating; just use two back-to-back units and treat the result as having twice the rating.)

The output of the oscillator (at pin 4 of U1-b) is coupled via C4 to the base of Q1 (a BC108 NPN silicon transistor), causing it to briefly conduct. With Q1

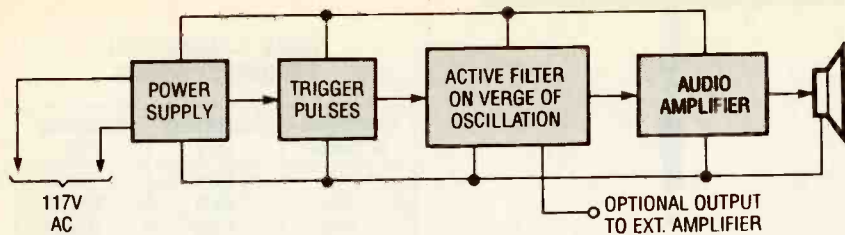

Fig. 1. This block diagram shows the various subassemblies that combine to form the Electronic Gong.

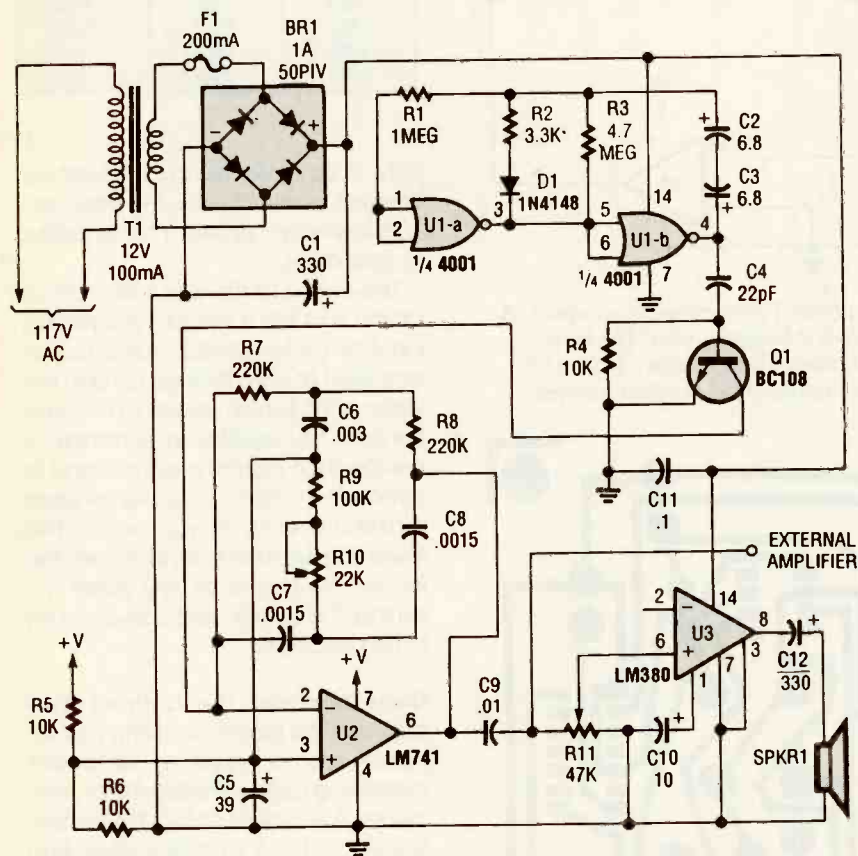

Fig. 2. The Electronic Gong is comprised of a power supply (made up of a 12-volt stepdown transformer coupled with a fullwave bridge rectifier), an oscillator (built around half of a 4001 quad 2-input NOR gate), an active twin-T filter (built around an LM741), and an audio-output amplifier (consisting of an LM380 low-voltage audio-power amplifier).

conducting, pin 2 of U2—a 741 general-purpose op-amp, which forms the heart of the active twin-T filter circuit—is pulled close to ground which is all that is needed to strike the gong.

The twin-T filter configuration, see Fig. 3, is normally used as the basis for notch filters (or sometimes as a sine-wave generator). In our application, however, the filter is set up to be on the threshold of oscillation. In the twin-T circuit, two separate T-filter elements—lowpass (Fig. 3A) and high-pass (Fig. 3B) filters—combine to produce a bandpass filter. Figure 3C

shows the basic configuration for the twin-T filter used in the Electronic Gong. Also shown in that figure is the relationship between the components values of the two filter elements. The bandpass frequency of the circuit is given by:

$$f = \frac{1}{2\pi RC}$$

where f is frequency in Hz, R is resistance in ohms, and C is capacitance in farads.

Table 1 gives the bandpass frequency of the filter network base on a fixed capacitance (in our case, 1500

PARTS LIST FOR THE ELECTRONIC GONG

SEMICONDUCTORS

- U1—4001 quad 2-input, NOR gate, integrated circuit
- U2—LM741 general-purpose op-amp, integrated circuit
- U3—LM380 low-voltage, audio-power amplifier, integrated circuit
- D1—1N4148 general-purpose, small-signal, silicon diode
- BR1—1-amp, 50-PIV, fullwave-bridge rectifier

RESISTORS

(All fixed resistors are 1/4-watt, 5% units.)

- R1—1-megohm
- R2—3300-ohm
- R3—4.7-megohm
- R4—R6—10,000-ohm
- R7, R8—220,000-ohm
- R9—100,000-ohm
- R10—22,000-ohm, potentiometer
- R11—47,000-ohm, potentiometer

CAPACITORS

- C1—330- μ F, 16-WVDC, radial-lead electrolytic
- C2, C3—6.8- μ F, 10-WVDC, radial-lead electrolytic
- C4—22-pF, ceramic-disc
- C5—39- μ F, 10-WVDC, radial-lead, electrolytic
- C6—0.003- μ F, polystyrene
- C7, C8—0.0015- μ F, polystyrene
- C9—0.01- μ F, ceramic-disc
- C10—10- μ F, 16-WVDC, radial-lead electrolytic
- C11—0.1- μ F, ceramic-disc
- C12—330- μ F, 16-WVDC, electrolytic

ADDITIONAL PARTS AND MATERIALS

- T1—12-volt, 100-mA, stepdown transformer
- F1—200-mA PC-mount fuse
- SPKR1—Speaker, see text
- Perfboard materials, enclosure, AC power source, IC sockets, grommet, stand-offs, wire, solder, hardware, etc.

pF) and various resistor values. For example, if you want to try for a bass-drum sound, you might try replacing R7 and R8 (220k, respectively) with 1-megohm (1000k) resistors. You would additionally have to alter the values of R9 and R10 so that their combined resistance could be adjusted to about 500k; that could probably be best achieved by making R9 a fixed 470k unit and presetting R10 to 47k. (Natu-

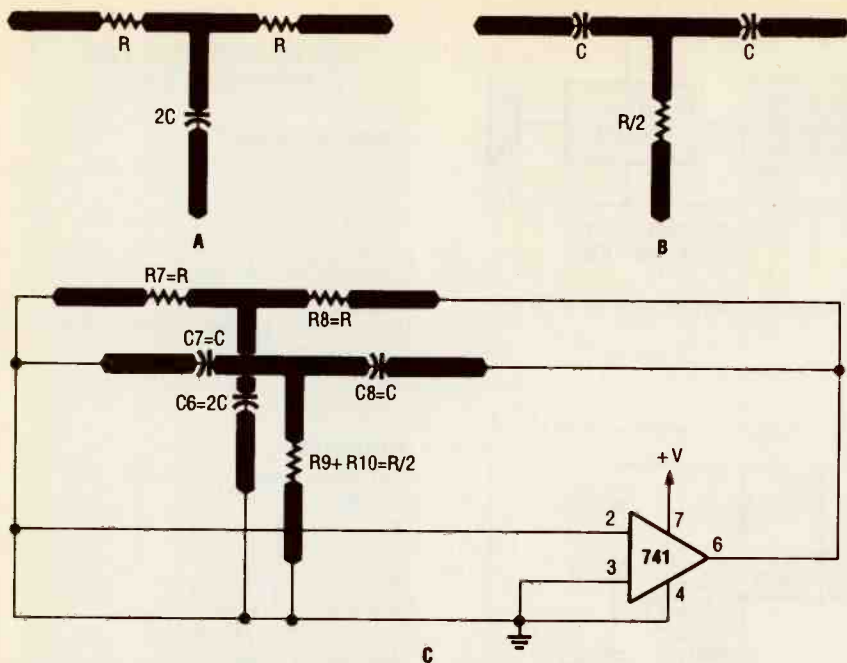

Fig. 3. The filter network is comprised of two separate T-filter elements—lowpass, A, and highpass, B, filters—which combine to produce a bandpass filter. The basic configuration for the twin-T filter used in the Electronic Gong is shown in C. Also shown is the relationship between the components values of the two filter elements.

TABLE 1—BANDPASS FREQUENCY RANGE

Resistance (k ohms)	Capacitance (pF)	Frequency (Hz)
47	1500	2260
56	1500	1890
100	1500	1060
180	1500	590
220	1500	480
390	1500	270
470	1500	230
560	1500	190
680	1500	160
1000	1500	110
1200	1500	90

rally, if you are using a miniature speaker as specified in the basic circuit, then don't expect it to do justice to your drum.)

The output of the twin T-filter circuit (at pin 6 of U2) is fed to the inverting input of U3 (an LM380 audio power amplifier) at pin 6 through C9 and the wiper of R11 (which serves as a volume control). Any speaker impedance of greater than 8 ohms is suitable and its selection is mainly a question of what maximum volume you need; the lower the speaker's impedance, the louder the output at any given R11 setting. The author used a 64-ohm unit in his prototype.

Construction. The author's prototype of the Electronic Gong was assembled on a printed-circuit board, measuring approximately $4\frac{1}{4}$ by $4\frac{10}{16}$ inches. A template of that foil pattern in shown in Fig. 4. Once you've etched your printed-circuit board and gathered the parts construction can begin.

A parts-placement diagram for the author's printed-circuit layout is shown in Fig. 5. It is recommended that sockets be provided for the IC's. For the most part, the component values are not critical; the only exception is that the twin-T resistors (R7 and R8) and capacitors (C7 and C8) are within at least 5% of each other. Note that in the area of C2 and C3, the author has provided extra pads to accommodate capacitors slightly larger than the subminiature units used in the prototype.

Begin construction by first installing the IC sockets, followed by the passive components. Afterwards, install all

(Continued on page 106)

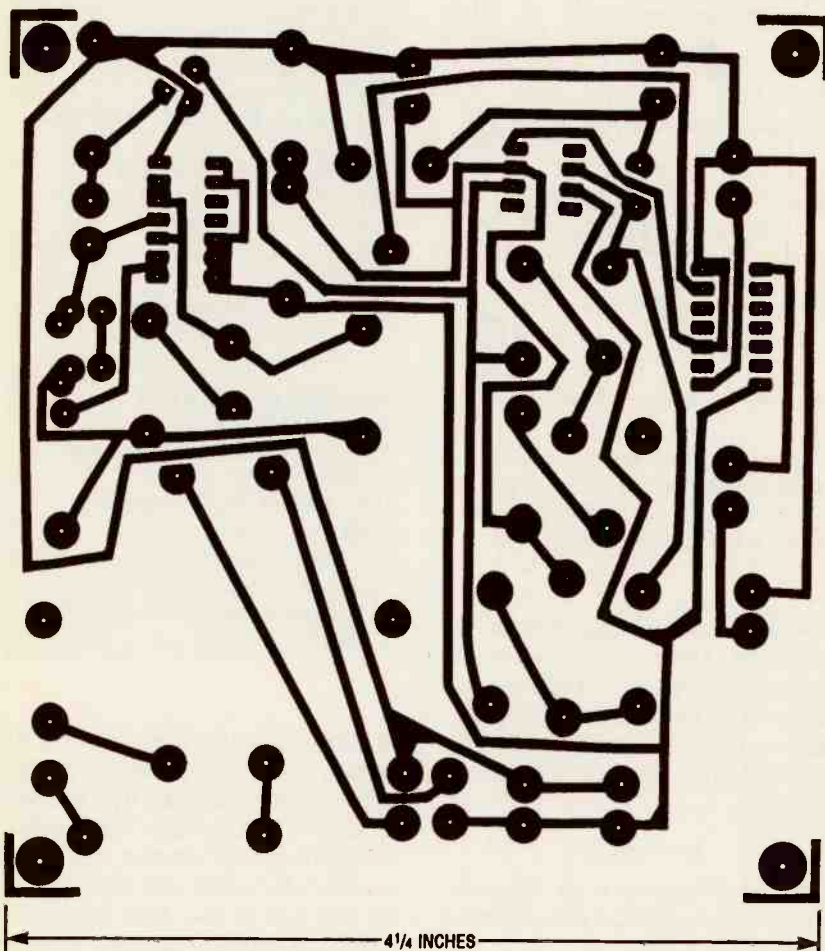
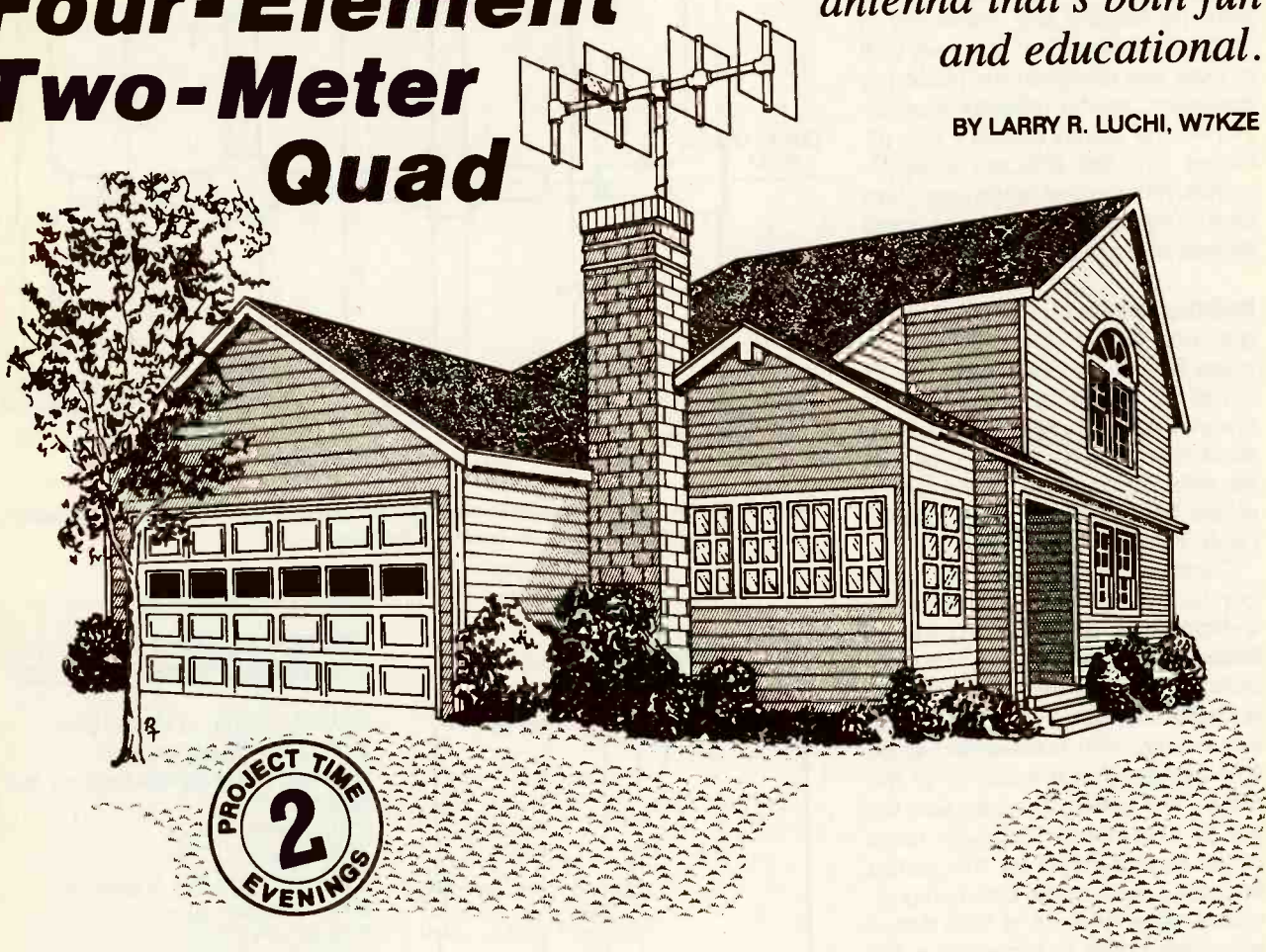

Fig. 4. The prototype of the Electronic Gong was assembled on a printed-circuit board, measuring approximately $4\frac{1}{4}$ by $4\frac{10}{16}$ inches. Here's a template of that foil pattern.

Build a Four-Element Two-Meter Quad

You can easily build an inexpensive transceiver antenna that's both fun and educational.

BY LARRY R. LUCHI, W7KZE



I really enjoy my work in the Electronics Technology Program at the Sno-Isle Skills Center where I teach. The Center is a vocational high school with twenty-two programs of instruction. During the second semester of each year, I teach amateur radio to junior and senior high school students. As part of their instruction, I have each of my students build an AM/FM superheterodyne receiver.

Of course, we also cover antenna design. So as a group, we had also constructed a half-wave dipole for two-meters. Two-meters gave us the compact size and also allowed me to demonstrate vertical and horizontal polarization.

As I explained the half-wave dipole antenna to my students, they appeared puzzled as if to ask "how can that work?" After the demonstration, some of these bright young minds came to life and started to ask ques-

tions out loud: "How can a full wave fit into a half-wave length of wire?" "If a gallon of milk is a gallon of milk and we drink a glass is it still a gallon?" My excitement increased with each question; they were obviously very intrigued by antennas.

So it Started. Since antennas were obviously a point of interest to the class, I searched for my *ARRL Antenna Book* (my personal favorite) and started to look for a two-meter quad antenna that could be easily constructed with little cost to the students. With the book in hand, I went to the faculty lounge to discuss my quad-antenna project with some of the staff.

I showed our welding instructor the drawings of a portable 144-MHz, 4-element quad. It turned out that he was the right man to speak to as he had a large quantity of 1/8-inch braz-

ing rods that we could use for the loops. (For your information, No. 8 aluminum ground wire will work just as well, but using the brazing rods kept student cost to a minimum.) Our plastics instructor had the needed PVC supports (spreaders) and a PVC boom. Our machine-trades instructor suggested he have his students drill all of the holes needed in the PVC supports and boom.

Now I would have to do some number crunching before we went further. The element spacing for quad antennas found in literature ranges from 0.14λ to 0.25λ (where λ is the wavelength). Factors such as the number of elements in the array and the parameters to be optimized (front/back ratio, forward gain bandwidth, etc.), determine the optimum element spacing within this range.

The other characteristics obey these relations:

$$\begin{aligned} \text{Reflector length} &= 1046.8/f_{\text{MHz}} \\ \text{Driven element} &= 985.5/f_{\text{MHz}} \\ \text{Directors} &= 937.3/f_{\text{MHz}} \end{aligned}$$

where f_{MHz} is the frequency of interest and the lengths are measured in inches. The 4-element quad we built in class was designed for 146.58-kHz operation, so the reflector was 86-inches, the driven element was 81-inches, and the directors were 77-inches. With that out of the way, it was time for the students and I to roll up our sleeves and get to it.

Building the Quad. Construction began with two, 10-foot, 1/2-inch PVC pipes. From that stock, the boom was cut to 42 inches in length with allowances given for two PVC tees to be fitted at each end (see Fig. 1); one for the reflector and one for the first director. Those tees were not permanently installed at that time.

Construction of the elements began by cutting the PVC stock for the spreaders and drilling 1/8-inch holes in the ends of each piece to accommodate the brazing rods. The reflector spreader was initially cut to be 22 1/2 inches long, with holes drilled to be 10 3/4 inches from the center of the boom. The driven spreader was first cut to 21 1/4 inches long with holes drilled so that they'd be 10 1/8 inches from the center of the boom. The directors were then cut to 20 1/4 inches with holes drilled to place them 9 5/8 inches from the center of the boom.

At this point, each spreader was cut

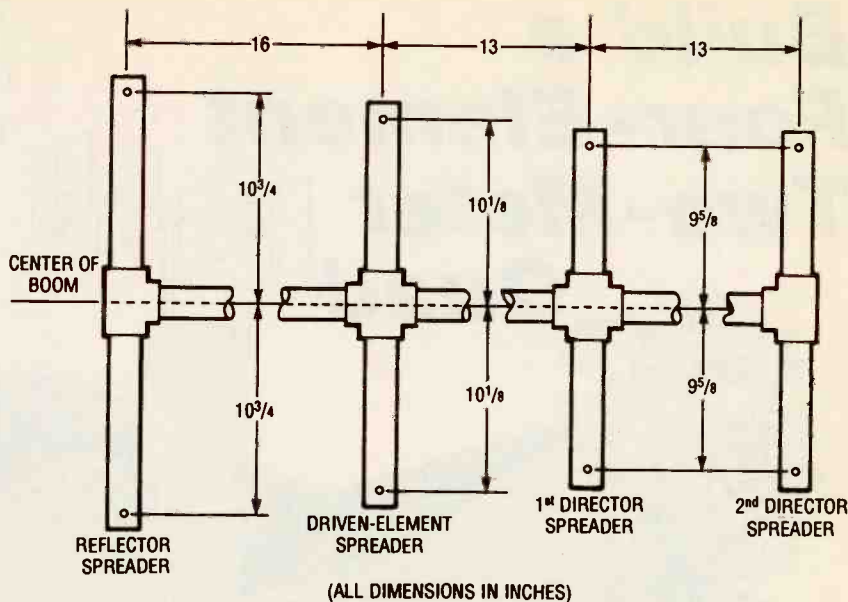

Fig. 1. This is the boom/spreader assembly for the quad antenna. Note that the locations of the holes are measured from the center of the boom.

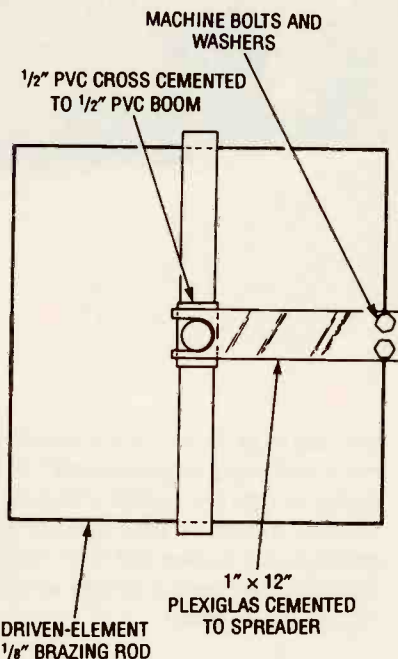

Fig. 2. A Plexiglass strip was used as a support for the feed point. It was cemented to the driven-element spreader.

in half (i.e., the reflector was cut at 11 1/4 inches). Then the reflector and first-director spreaders were glued (using Nova Weld P cement) to their tees, which were in-turn glued to the ends of the boom. The driven-element and the middle-director spreaders were glued into two PVC crosses that had been cut in half and glued to their measured places on the boom.

The driven element required extra preparation as the coax feed-point

MATERIALS LIST FOR THE 4-ELEMENT 2-METER QUAD

- 2 10-foot lengths of 1/2-inch PVC
- 1 x 12-inch Plexiglass plate
- 2 pounds of 1/8-inch oxy-acetylene brazing rods
- PVC cement
- RTV cement
- 2 Solder lugs for No. 8 hardware
- 2 No. 8 nut/bolt pairs
- 2 1/2-inch PVC tees
- 5 1/2-inch PVC crosses
- A length of 52-ohm feedline

needs to be adequately supported. We used a 1 x 12-inch Plexiglass plate to support the coax feed line, as shown in Fig. 2. One end of the Plexiglass plate was cut to fit around the boom, where it was epoxied. At the other end of the Plexiglass plate we drilled two holes 3/4 of an inch apart.

To begin making the feed-point connections, a 52-ohm coax feedline was terminated in solder lugs. Then two brazing rods were taken and a loop was formed in one end of each. A bolt was passed through each loop, solder lug, and hole in the Plexiglass and secured with a nut. The junctions were then soldered and sealed with RTV cement. From there, the cable was routed directly to the mast and down.

Three more brazing rods (two of
(Continued on page 107)

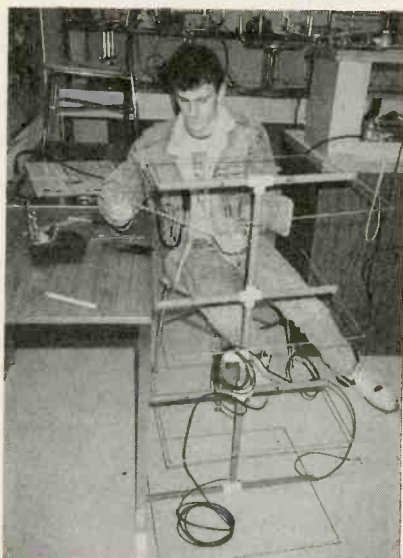

As each brazing rod was added to a given loop, its ends were simply soldered to those already in place.

Peltier Effect Beverage Cooler



BY JAMES MELTON

Keep your soft drinks cool, even during a sweltering summer heat wave!

There are several reasons why electronics hobbyist elect to build projects; for example, it can be fun as well as educational. However, there is a practical side to the hobby; hobbyist often must build things that they cannot afford to buy, or those that are simply not commercially available. The *Peltier Effect Beverage Cooler* described in this article falls into the latter category. The Solid-State Beverage Cooler, as its name implies, is a project that is designed to keep a soft drink or other beverage cold. That is, if a canned drink is placed in the cooling chamber, it will be kept cool indefinitely.

About the Project. The Solid-State Beverage Cooler is built around a cooling module that makes use of the "Peltier effect," which is similar to the effect used in thermocouples; however, the effect is applied in reverse. What that means is that instead of a temperature difference between two junctions causing a current to flow, a current flow is used to cause a flow of heat.

A thermocouple is formed when two different metals are joined together. You can make your own thermocouple for experimental purposes by screwing two pieces of copper wire on either end of an aluminum standoff, as shown in Fig 1. If a voltmeter is attached to the copper wires,

and one of the copper/aluminum junctions is placed in proximity to a heat source (such as a candle flame), the meter will register small amount of voltage. The hotter the heat source, the higher the voltage. Similarly, the cooler the cold end gets, the greater the voltage.

With a crude thermocouple like the one shown in Fig. 1, of course, you'll not be able to power any equipment—it does, however, demonstrate the thermoelectric effect. It also simulates the Peltier effect. If a current is passed through the copper/aluminum junctions, one of the two junctions will experience a temperature rise, while the other junction will experience a temperature decrease. But that effect will be so slight on this crude model so as to be virtually undetectable.

Modern solid-state Peltier junctions are formed from various metals, which are doped like semiconductors. Depending on the doping, the metal will either have an excess of electrons (P-type material) or holes (N-type material) in its atomic structure. The metal junctions formed from the two types of doped material act kind of like a thermocouple, but are much more efficient.

Figure 2 illustrates the make up of a commercial Peltier cooler junction. In a commercial junction device (cooling module), more than 50 junctions

are series-connected electrically and parallel-connected thermally. That results in a device with an impedance that's high enough so that the cooling modules can be connected directly to a 12-volt power supply.

The Cooler. The cooler itself was built using almost every available means to make it easy, fast, and fun. The cooling module was bought commercially. (I have included the addresses of two places that sell cooling modules in case you have trouble locating one; see the Materials List.) Most of the construction of the cooling module/heat-sink combination was done with epoxy adhesive. That leaves the top of the unit clean in appearance, and helps a little more with the heat transfer efficiency.

The power for the circuit is provided by a commercial (surplus) 12-volt DC, 3-amp power supply that was originally intended for computers. Such a regulated power supply is required because a "brute force" supply will have too much ripple, which will produce excessive heat that must be dissipated somehow. For the convenience of using the cooler in my car, I attached a 12-volt cigarette-lighter power adapter to the unit's cord.

The heat sink has two major requirements: it must be big (far larger than you might think) and it should not

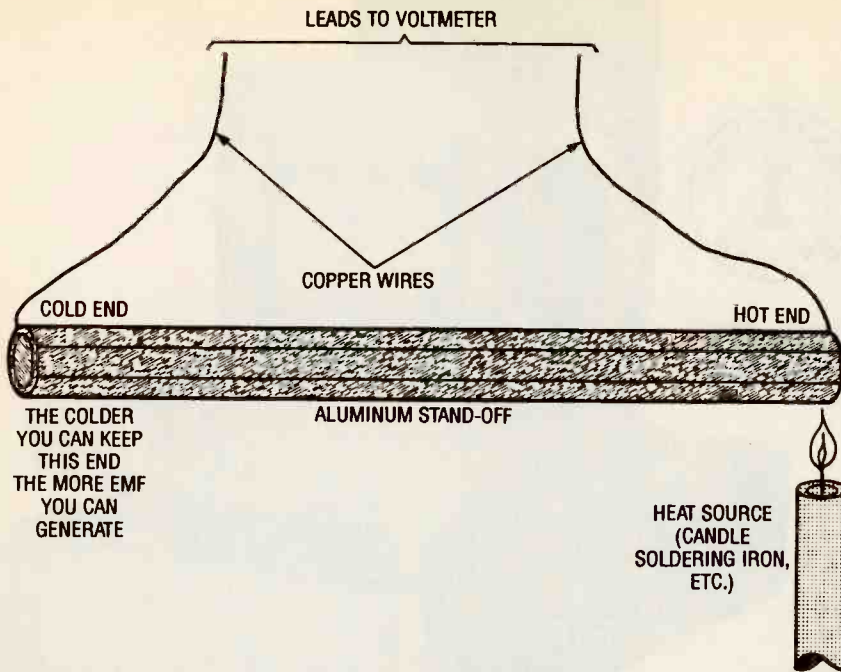

Fig. 1. Modern solid-state Peltier devices are formed by joining two dissimilar metals, which are doped in the same vein as semiconductors to form junctions. Depending on the direction of the applied current, one junction will experience a temperature increase, while the other will experience a temperature decrease.

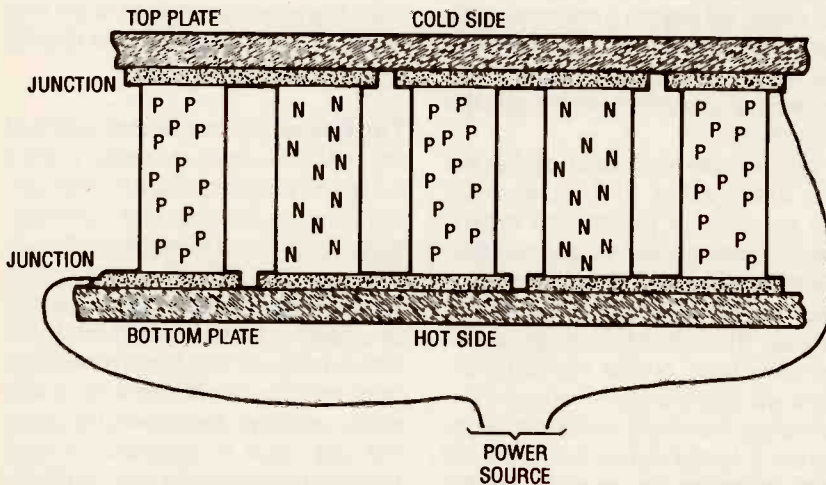

Fig. 2. This illustration shows the make up of the commercial Peltier cooler junction. In a commercial junction device (cooling module), more than 50 junctions are series-connected electrically and parallel-connected thermally.

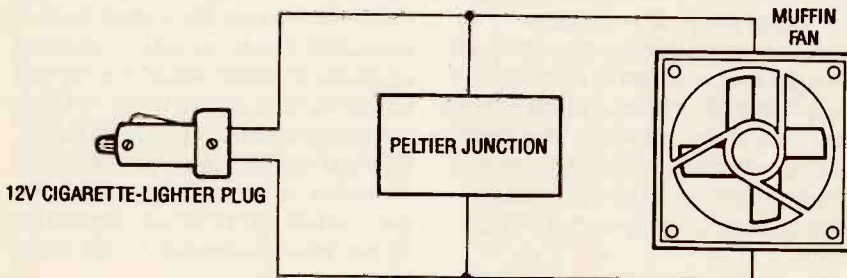

Fig. 3. A small muffin fan is connected in parallel with the cooling module, and in series with the power supply so as to increase the amount of cooling available from the heat sink by several degrees.

MATERIALS LIST FOR THE PELTIER EFFECT BEVERAGE COOLER

- Thermoelectric cooling module (Melcour CP1.4-71-06L or equivalent)
- 12-volt DC miniature muffin fan
- 12-volt DC power source (see text)
- Large heat sink
- Double-walled soft drink container
- Power supply (see text)
- Enclosure, wire, solder, epoxy, hardware, etc.

Note: Cooling modules can be obtained from Melcour, 1040 Spruce Street, Trenton, NJ 08648 Tel. 609-393-4178; and American Science and Surplus, 601 Linden Place, Evanston, IL 60202. Contact the companies directly for current pricing, shipping, etc.

have any holes at all in the area where the cooling module is to be mounted. That last requirement might be a little hard to meet with general junkbox materials, however, it is essential that you have the best heat transfer to the heat sink obtainable.

As shown in Fig. 3, a small muffin fan is included in the project so as to increase the amount of cooling available from the heat sink by several degrees. The lowest temperature of the cooling module, after the excess heat of the soft drink has been removed, depends on the lowest temperature that can be obtained on the heat sink. In the design presented here, the lowest possible obtainable temperature is approximately 30°F below the ambient temperature.

You need a soft-drink container of the type typically sold in gas stations. Such containers are double walled and are ideal for the cooling chamber of this project.

Construction. Begin construction of your cooler with the base (or enclosure), which will hold the cooling module/heat-sink combination and the muffin fan. Obviously, there is nothing critical about the dimensions or layout of the base—it merely has to have sufficient room to accommodate the cooler components.

The cooling module by itself is very ineffective, so you have to help it out every step of the way. To that end, a hole, about 2 inches in diameter, must

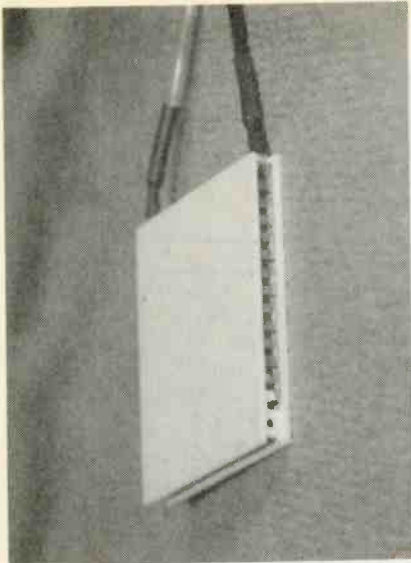

Fig. 4. Here is the cooling module prior to installation in the project. Unmarked units can be tested by attaching a D-cell battery to the cooling module's two leads to determine the hot and cold sides of the device. Under power, one side of the module will be hot while the other will be cool.



Fig. 5. Using the pieces of aluminum left over from the holes in the base, make a platform (which consists of two pieces) for the soda can. A rectangular aluminum piece, which rests against cooling module, lifts the top circular platform piece into the chamber where it can contact the beverage can.

be made in the top of the base to expose the heat sink. Cut the hole carefully; the cut-away portion of the hole will be used later. Then flip the base over, cut another circular hole in the bottom of the base for the fan. The material from this cut-out will also be used.

After cutting the holes, mount the heat sink inside the enclosure, centered under the 2-inch top hole and flush to the inside surface of the base, using epoxy—the epoxy makes for the best heat transfer possible and also leaves the top of the box smooth.

Figure 4 shows the cooling module. While it's free of its enclosure, attach a D-cell battery to its leads—red to positive and black to negative. Feel both sides of the cooling module to determine the hot and cold side; then mark the hot side with an "H" using a soft pencil. That helps to orient the device in the cooler later.

After the epoxy holding the heat sink has cured, place the cooling module on top of the heat sink, and mark appropriate holes in the heat sink for the leads of the cooling module to go through. Then drill and deburr the holes. Next mount the muffin fan. The muffin fan should be mounted so that it blows out of the bottom (as the author did) or the side of the base. However you mount the



Fig. 6. With the top plate and insulation in place, allow the epoxy to cure, before moving on to the final phase of the cooling chamber construction.

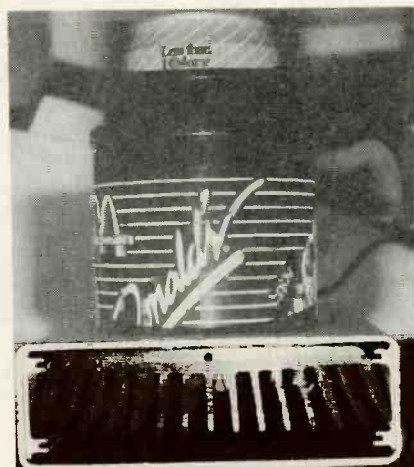

Fig. 7. Here is the business end of the Solid-State Beverage Cooler.

fan, make sure that the flow of air is unobstructed. (I cannot stress enough that the amount of air flow and the size of the heat sink will have a major effect on the final temperature of the cooler.)

Place the cooling module back on top of the heat sink and pre-form the leads so that there is no strain when the cooling module is epoxied in place. After forming the leads, epoxy the cooling module to the smooth top surface of the heat sink. Pass the leads through the heat-sink holes. While the epoxy is curing, clamp or weight the cooling module to ensure that there will be a good strong bond.

Using the pieces of aluminum that you saved when making the holes in the top and bottom of the base, make a piece that will serve as a platform for beverage cans. The platform, which consists of two pieces, is shown in Fig 5. The rectangular piece, which rests against cooling module, lifts the top circular piece into the chamber where it can contact the beverage can. The rectangular piece also leaves room for some foam insulation between the cool top plate and the hot bottom plate. I used the bottom from a foam drink keeper for the insulation.

(Continued on page 108)

computers...



"That's very odd, Mr. Stitch, your monitor reads, 'Viewer Discretion Advised!'"



"We're confident, Larry, that this new model will help kids become computer literate."



"You know, Mr. Mark, this PC gadget has definite possibilities!"

NASA MISSION CONTROL



"Oh shoot! My computer is down, Neil, can I borrow your pencil?"

COMPUTER DATING NETWORK



"But enough about me—how about you?"

they're turning the world upside down!

By
Ernie
Brown

COMPUTER MART



Karl Young has finally found his niche in life!

DIGITAL BOWL BOX

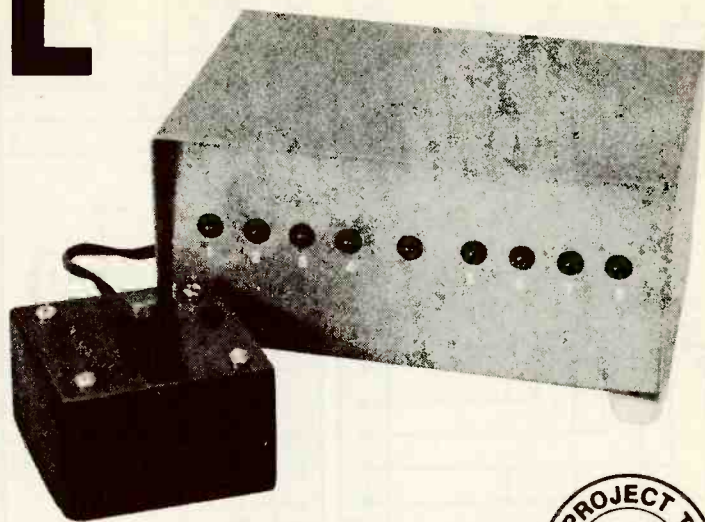

BY WILLIAM L. CALL

This circuit brings the old "College Bowl" concept of first-response answers to a moderator's questions into the '90's.

Many contests and game shows are based on the old "College Bowl" concept of first-response answers to a moderator's questions. Usually two teams are assembled, typically with four contestants each; a question is read, and the first person to respond gets the opportunity to answer the question. Middle and High Schools have gotten into the action with Math Bowls and Academic Bowls; even churches have gotten into the act with "Bible Bowls." In individual classrooms, many teachers have used the Contest Bowl idea to build excitement into classroom activities.

A key component of the Contest Bowl is an impartial judge to determine which participant responded first. Usually each contestant is given a pushbutton switch that is connected to an electronic device that determines which button was pushed first. Such a system can be quite elaborate (incorporating large and colorful displays, impressive sound effects, etc.) and complex. The system presented here, on the other hand, was designed to be compact and inexpensive. Since the heart of the electronic system is a digital IC often used in computer circuits, the unit has been dubbed the *Digital Bowl Box*.

Circuit Description. Figure 1 shows

a schematic diagram of the Digital Bowl Box. At the heart of the circuit is a 74LS373 low-power Schottky octal (or eight-input) transparent latch, U1. At power up, U1's output-enable (\overline{OE}) terminal at pin 1 is held low via pull-down resistor R2 and the latch-enable (\overline{LE}) terminal at pin 11 is high, via pull-up resistor R1-i (part of a 9-resistor network). That allows any signal presented to U1's data-input (D_0 - D_7) terminals to be passed to its respective output. Since all of the data inputs of U1 are held high via pull-up resistors (R1-a-R1-h), each output of U1 is high. That reverse biases LED1-LED8 so all of them remain dark; only LED9 is illuminated.

Let's say that S1 is the first switch to close. That low pulls U1 pin 3 low, causing its corresponding output (pin 2) to go low. The low output on pin 2 forward biases LED1, causing it to light. At the same time, a voltage drop developed across R8 (as a result of current flow through LED1), turns Q1 on, which then causes Q2 and Q3 to turn on.

When transistor Q2 turns on, pin 11 (\overline{LE}) of U1 is pulled low, latching U1 in its present state, keeping LED1 on, identifying the contestant who responded first, while locking out all subsequent respondent signals. With Q3 turned on BZ1 sounds. The 74LS373 and transistors have a response time of a few

nanoseconds, making it highly unlikely (though not impossible) that a "tie" could occur.

After noting which contestant responded first, the moderator momentarily presses RESET (S9), which pulls pin 1 (\overline{OE}) high, clearing U1. That causes the highs presented to the data inputs of U1 (as a result of the pull-up resistors) to once again be passed to their corresponding outputs. As before, the LEDs are now reverse biased, so no voltage drop develops across R8. That removes the bias from Q1, which causes Q2 and Q3 to turn off, turning off BZ1 and deactivating the latch.

Power for the circuit is provided by a traditional transformer, rectifier, and voltage-regulator system. As designed, the Digital Bowl Box supports up to eight contestants. An expansion jack (J3) is included in the circuit, allowing you to daisy-chain two Digital Bowl Boxes together for up to 16 contestants (eight for each team). The expansion jack parallels the \overline{LE} control signals of the two Boxes. Only one LED will light, corresponding to the first switch depressed; full lockout of all other switches remains in affect. The expansion jack could be omitted if that option is not desired.

Construction. The majority of the Digital Bowl Box's circuitry was assembled on a printed-circuit board,

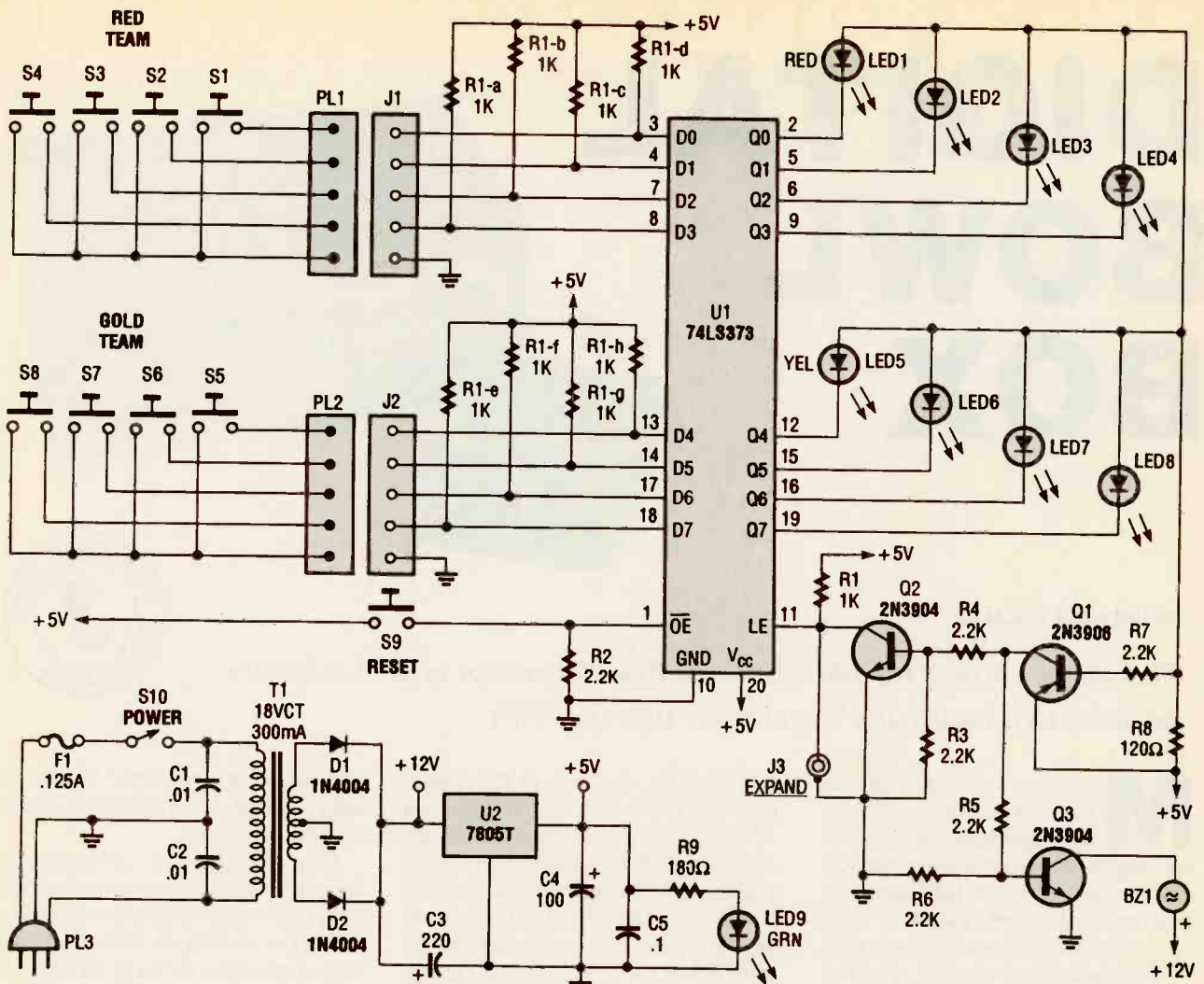

Fig. 1. At the heart of the Digital Bowl Box is a 74LS373 low-power Schottky octal (or eight-input) transparent latch, U1. Note that instead of 9 individual 1k resistors, the circuit uses a 10-pin 1k × 9 SIP bus-type resistor network.

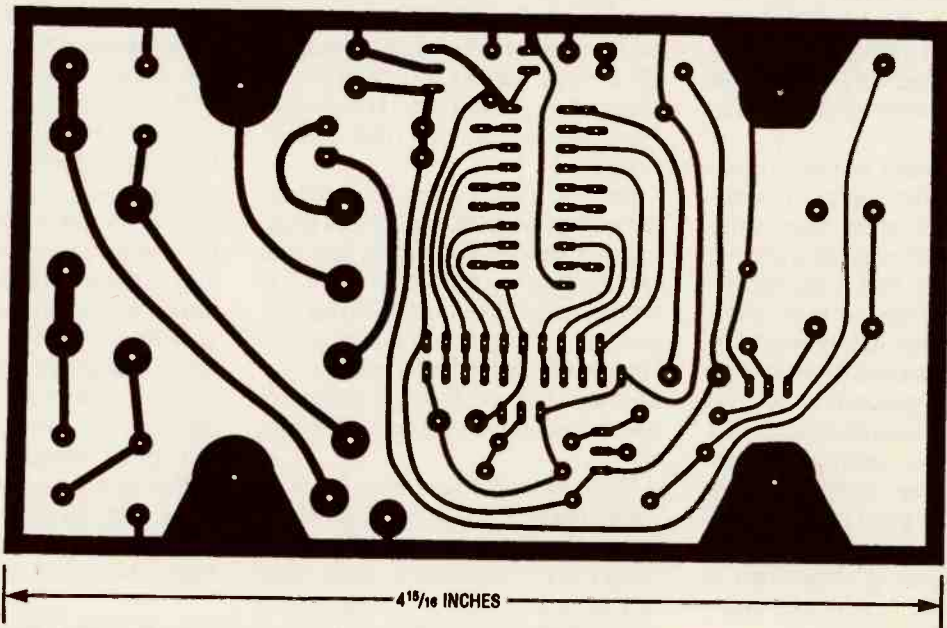

Fig. 2. Most of the Digital Bowl Box's circuitry was assembled on a printed-circuit board, measuring approximately 4¹/₁₆ by 2⁷/₈ inches. A template for that printed-circuit layout is shown here full scale.

PARTS LIST FOR THE DIGITAL BOWL BOX

SEMICONDUCTORS

- U1—74LS373 low-power Schottky, octal D-type latch, integrated circuit
 U2—7805T 5-volt, 1-amp voltage regulator, integrated circuit
 Q1—2N3906 general-purpose PNP silicon transistor
 Q2, Q3—2N3904 general-purpose NPN silicon transistor
 LED1—LED4—Red light-emitting diode
 LED5—LED8—Yellow light-emitting diode
 LED9—Green light-emitting diode
 D1, D2—1N4004 1-amp, 400-PIV rectifier diode

RESISTORS

- (All fixed resistors are 1/4-watt, 5% units, unless otherwise noted.)
 R1—1000-ohm × 9 SIP bus-type resistor network
 R2—R7—2200-ohm
 R8—120-ohm
 R9—180-ohm

CAPACITORS

- C1, C2—0.01-μF, 1000-WVDC, ceramic-disc
 C3—220-μF, 25-WVDC, radial-lead electrolytic
 C4—100-μF, 10-WVDC, radial-lead electrolytic
 C5—0.1-μF, ceramic-disc

SWITCHES

- S1—S9—SPST momentary-contact, pushbutton switches
 S10—SPST toggle switch

ADDITIONAL PARTS AND MATERIALS

- BZ1—12-volt buzzer (Mouser 251-0012)
 F1—0.125-amp fuse
 J1, J2—Panel-mount 5-conductor, DIN jack
 J3—Panel mount, RCA phono jack
 PL1, PL2—5-conductor DIN plug
 PL3—3-conductor, molded AC power plug with line cord
 T1—18-volt, center-tapped, 300-mA, transformer (Mouser 41WJ300)
 Printed-circuit board materials, enclosure, strain reliefs, fuse holder, LED mounting clips, #6 × 1/2-inch sheet-metal screws, #6-32 × 1/4-inch BH machine screws, 20-pin IC socket, 2 × 6-inch pine wood (see text), aluminum sheet metal, threaded aluminum #6-32 × 1/2-inch standoffs, #24 4-conductor shielded cable, wire, solder, hardware, etc.

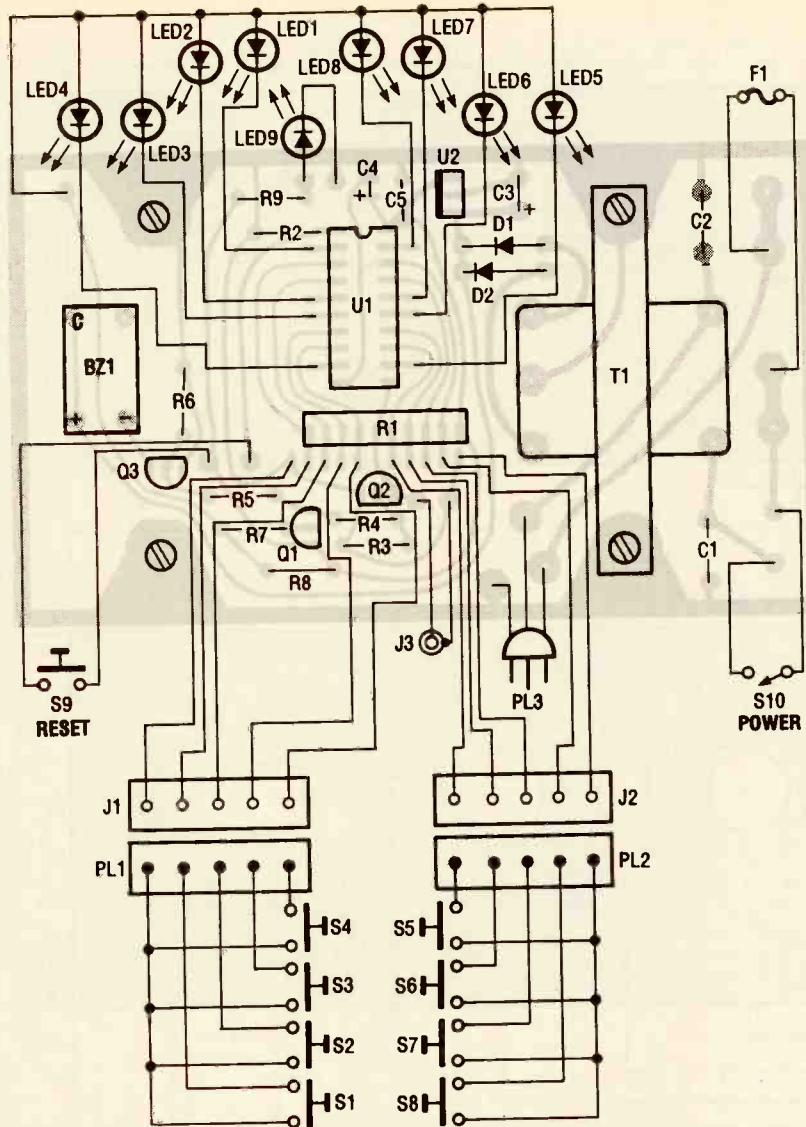

Fig. 3. In this parts-placement diagram for the printed-circuit board, note that the power transformer (T1) and the buzzer (BZ1) are mounted directly to the board. That means that due to physical space tolerances, the vendor-referenced components specified in the Parts List are required.

measuring approximately 4¹/₁₆ by 2⁷/₁₆ inches. A template for that printed-circuit layout is shown in Fig. 2. A parts-placement diagram for the printed-circuit board is shown in Fig. 3.

Note that the power transformer (T1) and the buzzer (BZ1) are mounted directly to the board, eliminating interconnecting wires. Although that simplifies construction, it also requires (due to space tolerances) that the vendor-referenced components specified in the Parts List be used. Non-vendor-referenced parts are not critical. The switches, cabinet, switch wiring, and switch housings should be rugged enough to withstand the rigors of constant use.

Start by mounting a socket where

U1 is indicated. Follow that by installing the passive components. Note that R1 is a 10-pin SIP bus-type resistor network, which is available from Digi-Key Electronics (701 Brooks Ave., PO Box 677, Thief River Falls, MN 56701-0677; Tel. 800-344-4539) as well as other sources.

After the passive components, mount and solder the active components to the board as indicated in Fig. 3. Once that's done, attach the transformer to the board with #6-32 × 1/4-inch screws and 1/2-inch threaded metal standoffs; the transformer mounting holes double as the board-mounting holes. Install screws and standoffs at the other mounting holes. After first tightening the mounting

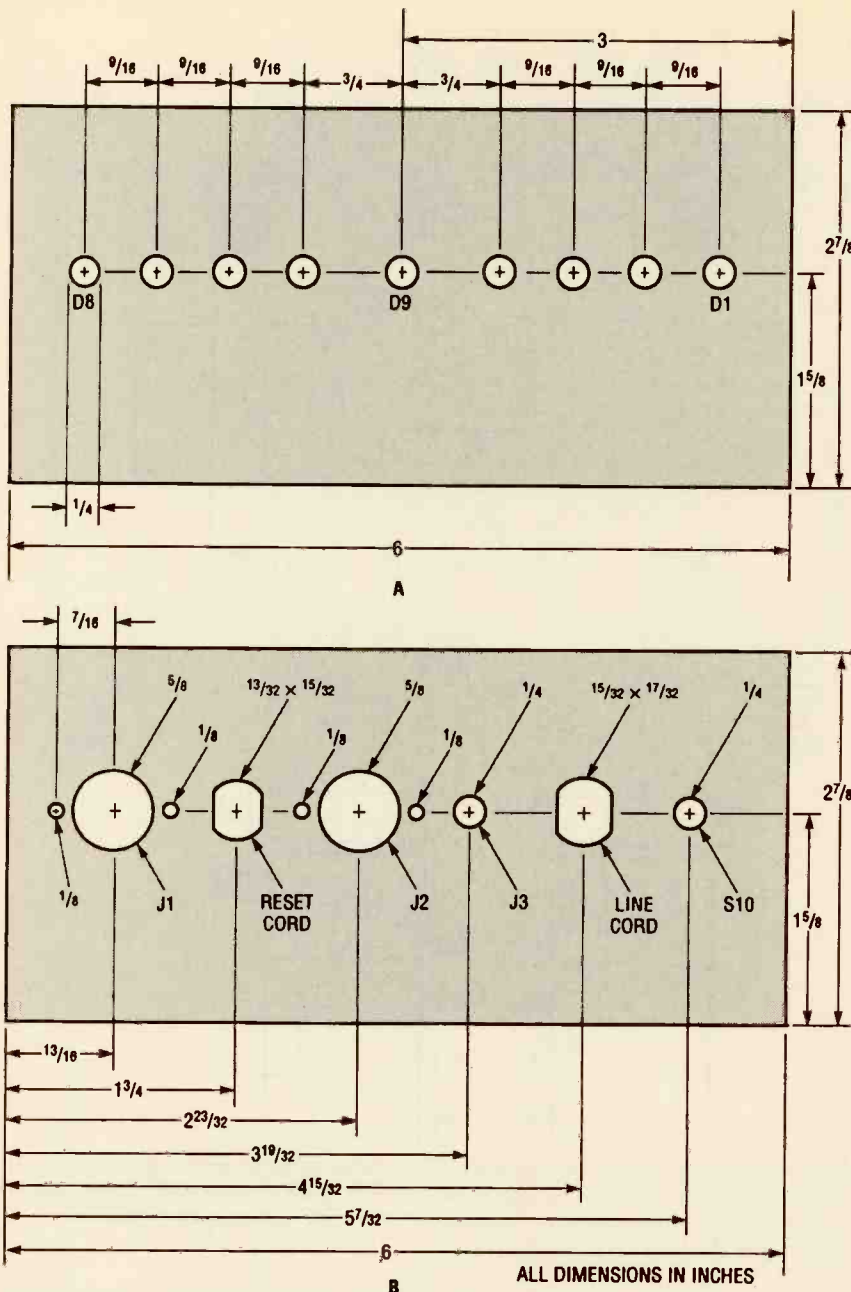

Fig. 4. Holes must be drilled in the front and rear panels of the enclosure to accommodate the off-board components; A shows the front panel layout while B shows the rear panel layout. You can layout your enclosure's front and rear panels in a similar manner, or follow any scheme that you choose.

screws to the stand-offs, solder the transformer terminals to the appropriate circuit-board pads. After that solder 4-inch lengths of pre-stripped hookup wire for the LED's, jacks, and power switch to the board.

The printed-circuit board assembly is now complete.

PCB Enclosure. Before the board can be mounted in its enclosure, it will be necessary to do a little preparatory work; e.g., holes must be drilled in the front- and rear-panels of the en-

closure to accommodate the off-board components. Figure 4 shows the front and rear panel layouts for the author's unit. You can layout your enclosure's front and rear panels in a similar manner, or follow any scheme that you choose.

In any event, prepare the enclosure by punching or drilling nine 1/4-inch holes in the front panel for the LED's. To promote the team concept, red LED's were used for one group of four outputs, and yellow for the other. (The corresponding switches, which we'll

get to shortly, were mounted on plates that were painted red or yellow.) The LED's and switches can be labeled 1-8 or red 1 through red 4 and gold 1 through gold 4. If the application is for individual contestants rather than teams, like-colored LED's and plates might be preferable. The cabinet was labeled with embossed tape labels.

Mount the LED's into the front panel using plastic LED-mounting clips, and connect the anodes of all but LED9 (the power indicator) together with bare bus wire. Run the reset and power cords loosely through their cabinet holes and solder their ends to the board. Maneuver the board into position in the cabinet, and install the bottom mounting screws into the other end of the standoffs. Install clamp-in strain-relief bushings on the reset and power cords, and then install a pair of DIN jacks and the power switch.

Now the final soldering can be completed. The easiest way to solder to the LED's is to first melt some solder onto the end of the connecting wire and then separately to the LED lead. After that, reflow-solder them together. The switch jack terminals work well with this method too. Once the printed-circuit board has been mounted, and the connections between the circuit board and the off-board components have been completed, move on to the final phase of the project's construction.

Contestant Switches. Figure 5 shows one unit of the four-contestant switch arrangement used in the author's prototype. The contestant switches were housed in wood blocks (approximately 2 1/2 inches square) that were cut from 2- x 6-inch pine lumber using a table saw. However, if you happen to have some scrap 2-by-4 lying around, that can be used as well. The blocks were then drilled out using a drill press. A router with a 0.25-inch veining bit was used to cut a groove into the wood to hold the switch wiring snugly clamped under a metal, switch-mounting plate.

The switch-mounting plates were fabricated from 1/16-inch sheet aluminum, and cut just slightly smaller than the wood blocks. A hole was then punched in the center of each mounting plate for the switches, and smaller holes in each corner for the

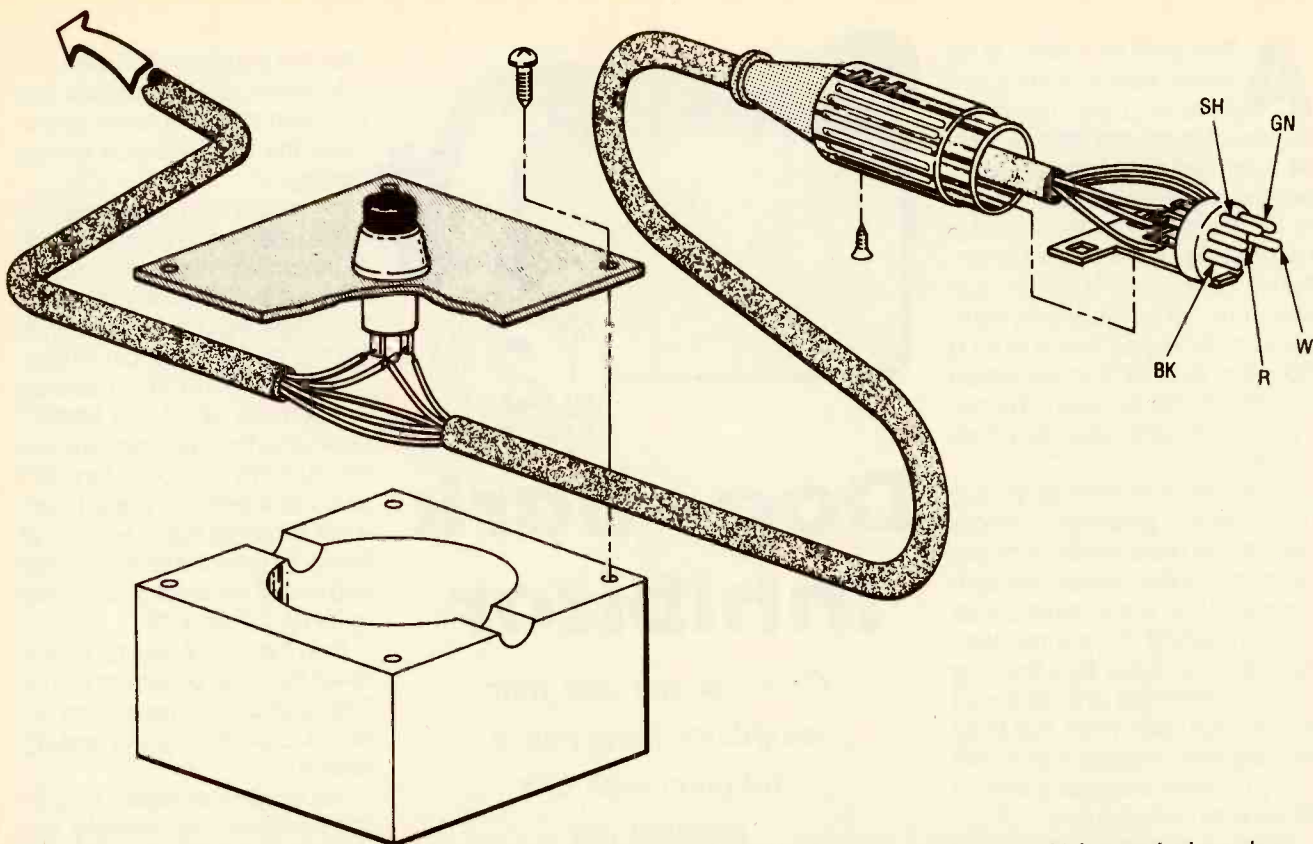
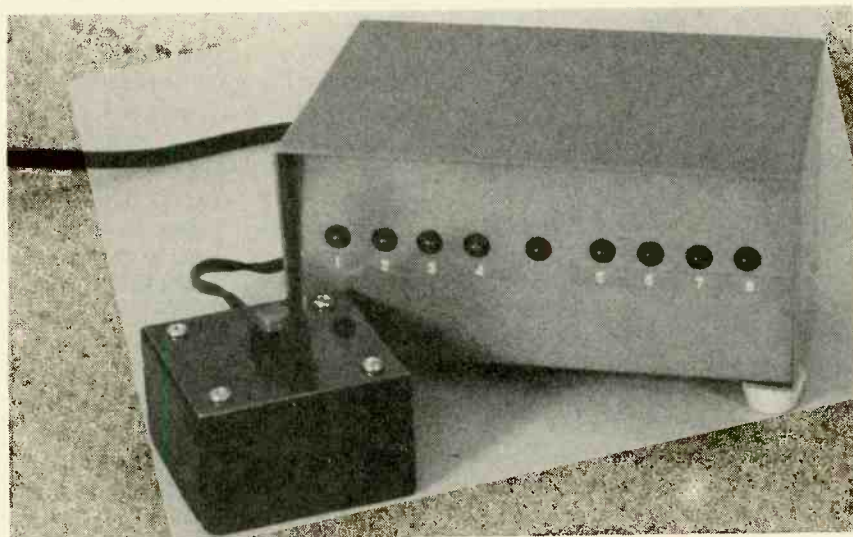

Fig. 5. Shown here is one unit of the four-contestant switch arrangement used in the author's prototype, which was wired together using an approximately 14-foot length of 4-conductor shielded cable for each team. Each switch within that arrangement has one terminal connected to one of the color-coded inner wires of the cable. The other switch terminal is connected to the cable shielding. After connecting the contestant switches to the cable, a heavy-duty DIN plug was connected to the free end of the cable.

plate's mounting hardware. Once the mounting plates are complete, mount the switches in position. Note that the recommended switches require a small notch in their mounting plate. If desired, small plastic enclosures could be substituted for the homemade switch boxes, using suitable strain reliefs on the wires.

The four-contestant switch arrangement (see Fig. 5) was wired together using an approximately 14-foot length of 4-conductor shielded cable for each team; that arrangement is less prone to tangling than individual switch cables. Shielded cable was used to lessen the chances of static discharges causing false triggering.

Prepare the cable by removing about 1.5-inch of insulation at three locations (each switch should be about 24 inches apart) along the multi-conductor cable. The fourth switch connects to the very end of the multi-conductor cable. Strip one color-coded inner wire for each switch. The color-coded wire is then soldered to one switch contact, and the bare shield wire is looped out and soldered to the other contact. A



Here's the author's completed prototype shown along with one unit of the four-contestant switch arrangement.

heavy-duty DIN plug was then connected to the other end of the cable.

Conclusion. The design that has been described is the result of many successive improvements over the years. The Digital Bowl Box was developed in response to requests by local school systems for an afford-

able, compact, easy-to-use quiz-bowl apparatus, and nearly 100 similar systems are now in use in our area. Needing to build so many in a part-time operation, considerable attention was given to easy assembly methods. The unit reportedly has met its need well, and helps make contesting very exciting. ■

Although it may seem quite distant now, summer is approaching with the anticipation of backyard games, barbecues, and the dog next door barking incessantly. If you happen to be the owner of the irritating, barking dog next door, then neighborhood harmony is at risk. But, worry not... for in this article, we're going to show you how to build a *Dog Bark Inhibitor* that will restore neighborhood harmony by humanely stopping your dog from barking.

Commercially available dog bark inhibitors (electronic devices built into a dog's collar) that are currently on the market are both expensive and can in some circles be considered inhumane. With such devices, every time the dog barks an electrical charge is sent to the dog's neck. While that stops the dog from barking, it can also turn a dog into a cowering animal afraid of its own shadow.

However, the Dog Bark Inhibitor described here is inexpensive and humanely stops the dog from barking by actuating a buzzer every time the barking begins. The buzzing is used to give the dog negative feedback that he'll associate with his barking, causing him to refrain from that annoying tendency.

Circuit Description. Figure 1 shows a schematic diagram of the Dog Bark Inhibitor. At power up, a one-shot multivibrator, consisting of one-third of a 40106 hex Schmitt trigger (U4-c and U4-d), resets U2 and U3, keeping the buzzer (BZ1) cut off. At the same time, resistors R1 and R2 set the trigger level of U1-a, U1-c, and U1-d (¾ of an LP324 quad op-amp) to 2.5 volts. Op-amps U1-a and U1-d are configured as inverting comparators with hysteresis, while U1-c is configured as a voltage follower.

The voltage follower (U1-c) provides a standing DC bias voltage for an electret microphone (MIC1). When MIC1 picks up the dog's barking (see the waveform diagram in Fig. 2A), the bias voltage applied to MIC1 fluctuates, and the output of U1-c follows. Fluctuations in the microphone's bias voltage are applied to U1-d, which amplifies the signal and feeds its output to U1-a. The overall sensitivity of



Dog-Bark Inhibitor

Give yourself and your neighbors some peace and quiet with this training aid

BY ROBERT J. GAFFIGAN JR.

the circuit is determined by the gains provided by U1-a and U1-d. The hysteresis provided by those two op-amps helps to keep background noise out of the signal applied to U1-b, which is setup as a low-pass filter. That low-pass filter is used to remove frequencies from the signal that are not in the range of a dog's bark.

From the filter, the signal (see Fig. 2B) is made compatible with digital circuitry by U4-a (¼ of a 40106 hex inverting Schmitt trigger), which also inverts the input signal. That signal is again inverted by U4-f and output to the following circuitry as a train of negative-going pulses. Those pulses are produced each time that the sound picked up by the microphone falls within the low-pass range of the filter (see the waveform in Fig. 2C).

The output of U4-f divides along two signal paths: in one path, the signal is fed to the clock input of U2 (a 4040 12-stage ripple carry binary counter); in the other path, the signal is applied to the trigger input of U3-a (½ of a 556 dual oscillator/timer). The negative pulses trigger U3-a, whose output, in turn, enables U2, causing it to count the number of times that the sound falls within the low-pass range of the

filter. The purpose of U2 and U3-a is to reject spurious sounds that fall within the filter's range and to allow the dog a period of free barking.

If the counter (U2) counts 256 bark pulses within eight seconds, its output goes high. That high is inverted by U4-b and applied to the trigger input of U3-b at pin 8, forcing its output at pin 9 high. The high output of U3-b is applied to the base of Q1 (an MPSA12 Darlington transistor), causing it to conduct. With Q1 conducting, BZ1 (a 6-volt electronic buzzer) activates for about half a second. At the same time, the ripple counter (U2) is reset via an OR gate, made up of D1, D2, and R11.

If, on the other hand, U2 counts fewer than 256 pulses within that 8-second period, the counter resets, and awaits the next barking session.

The circuit is powered by a 9-volt transistor-radio battery. Because of that, the semiconductors used for this circuit were chosen for their low-current re-

quirements—the circuit draws approximately 0.9 microamps of quiescent current, and 15 mA with the buzzer on—and should not be substituted unless swapped for lower-power components.

Construction. Although the author's prototype was built on a section of perfboard, using point-to-point wiring to interconnect the circuit elements, the final version was assembled on a printed-circuit board, measuring about 3 × 2 inches. A template of the printed-circuit layout is shown in Fig. 3. You can etch your own printed-circuit board from the template shown in Fig. 3, or you can order a printed-circuit board and the parts (separately) to populate it from the supplier listed in the Parts List.

Once you have obtained the board and the parts that go with it, construction can begin. Figure 4 shows the parts-placement diagram for the author's printed-circuit layout. It is recommended that IC sockets be provided for all of the DIP units (U1-U4). The regulator, U5, is housed in a TO-92 style package. Begin construction by installing the DIP sockets and the jumper wires. Once that is done, install

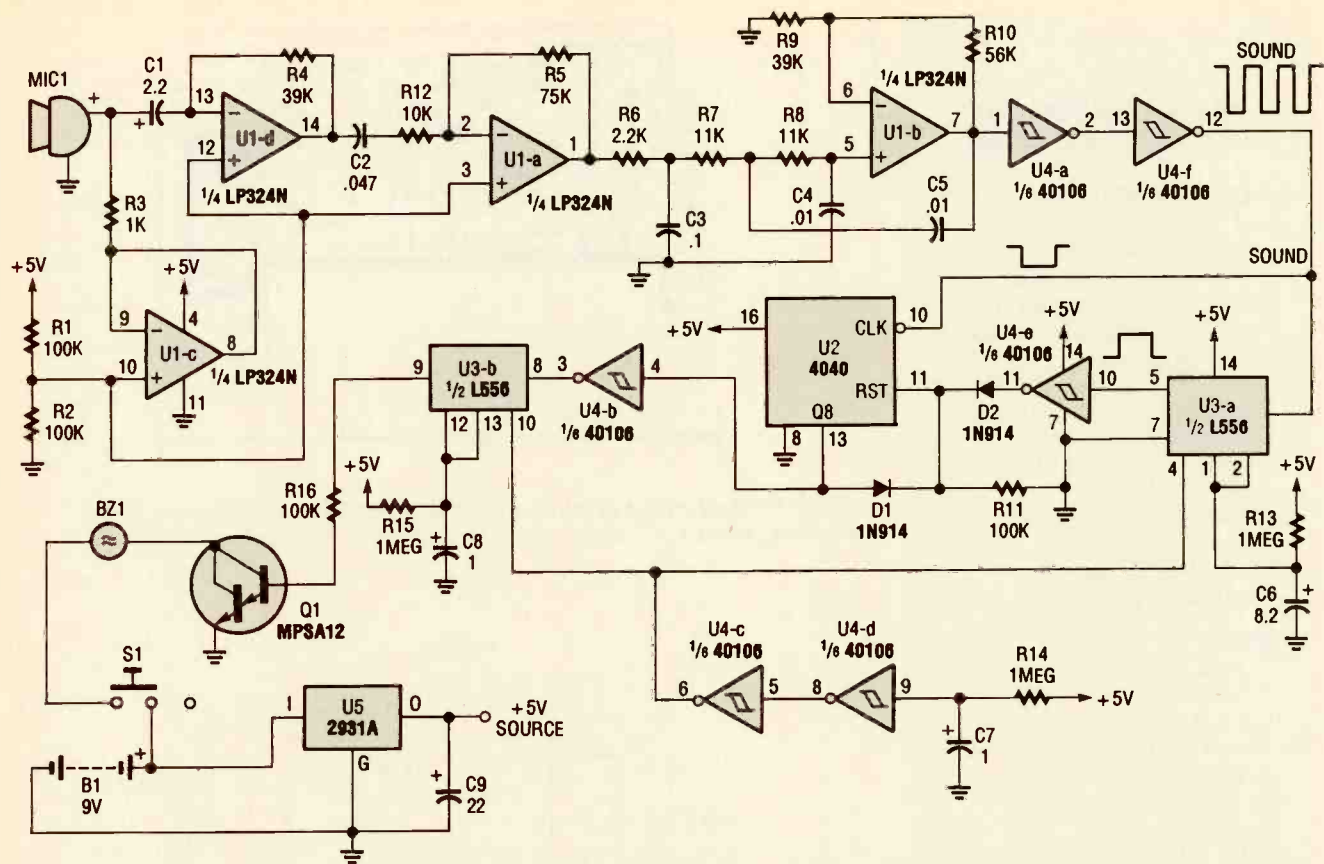

Fig. 1. The Dog Bark Inhibitor is comprised of an LP324 quad op-amp (U1), a 4040 12-stage ripple carry binary counter (U2), an LM556 dual oscillator/timer (U3), a CD40106 hex inverting Schmitt trigger (U4), an LM2931A 5-volt series, low-dropout, voltage regulator (U5), an MPSA12 Darlington transistor (Q1), two 1N914 general-purpose, small-signal silicon diodes (D1 and D2) and a handful of additional components.

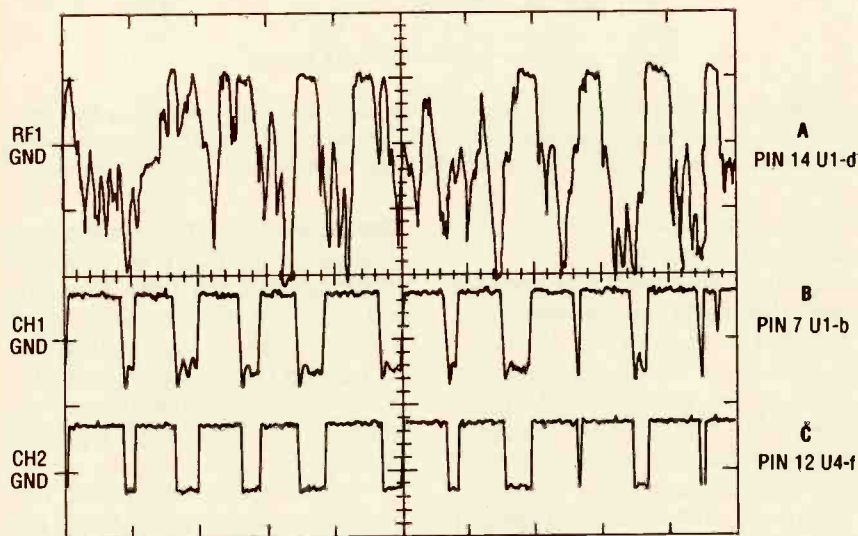

Fig. 2. Shown in A is the waveform produced at the output of U1-d when the dog barks; B shows the same waveform after it has undergone filtering; and C shows how the waveform looks after being processed for application to the digital circuitry that follows.

the passive components (resistors and capacitors).

After the passive components have been installed, mount the active components (excluding the DIP IC's,

they will be installed in their respective sockets later), and connect a 9-volt battery connector to the appropriate points on the board. In the author's prototype unit, the microphone

(MIC1) was mounted directly to the circuit board, although it might appear otherwise in the parts-placement diagram.

It will be necessary to prepare the enclosure that is to house the circuit board and the off-board components. The author's unit was housed in a plastic project box with a metal lid, measuring about 3¼ x 2½ x 1 inches. Begin preparing the enclosure by first placing the circuit board into the enclosure to determine where the microphone will be located when it is permanently mounted. Mark that position on the wall of the enclosure, and drill several tiny holes at that location.

Next, on the same side of the enclosure, drill two holes (one near each end), which will be used to mount a nylon web strap (dog collar) to the project box. Then make two cutouts at opposite ends of the enclosure for the buzzer (BZ1) and the slide switch (S1); the cutouts should be approximately ⅞ x ⅝ inches for the buzzer, and the

PARTS LIST FOR THE DOG BARK INHIBITOR

SEMICONDUCTORS

- U1—LP324 micropower quad op-amp (National), integrated circuit
 U2—CD4040 12-stage ripple carry binary counter, integrated circuit
 U3—LM555 dual oscillator/timer, integrated circuit
 U4—CD40106 hex inverting Schmitt-trigger, integrated circuit
 U5—LM2931A 5-volt series, low-dropout, voltage regulator, integrated circuit
 Q1—MPSA12 Darlington NPN silicon transistor
 D1, D2—1N914 general-purpose, small-signal silicon diode

RESISTORS

(All fixed resistors are 1/4-watt, 5% units.)

- R1, R2, R11, R16—100,000-ohm
 R3—1000-ohm
 R4, R9—39,000-ohm
 R5—75,000-ohm
 R6—2200-ohm
 R7, R8—11,000-ohm
 R10—56,000-ohm
 R12—10,000-ohm
 R13—R15—1-megohm

CAPACITORS

- C1—2.2- μ F, 16-WVDC, tantalum
 C2—0.047- μ F, monolithic
 C3—0.1- μ F, monolithic
 C4, C5—0.01- μ F, monolithic
 C6—8.2- μ F, 16-WVDC, tantalum
 C7, C8—1- μ F, 16-WVDC, tantalum
 C9—22- μ F, 16-WVDC, miniature electrolytic

ADDITIONAL PARTS AND MATERIALS

- S1—SPST slide switch
 MIC1—Electret microphone
 BZ1—6-volt electronic buzzer (RS #273-054)
 B1—9-volt transistor-radio battery
 Printed-circuit materials, enclosure, 3/4 \times 24-inch web strap, adhesive backed cushion feet, battery holder and connector, wire, solder, hardware, etc.

Note: The following items are available from Futronics, 22524 Millenbach, St. Clair Shores, MI 48081. A complete kit of parts, \$29.95; printed-circuit board only, \$9.95. Please add \$3.00 for shipping and handling. Michigan residents please add appropriate sales tax.

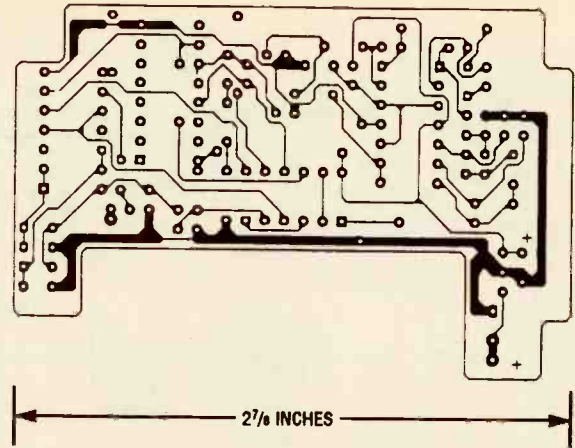

Fig. 3. The final version of the circuit was assembled on a printed-circuit board, measuring about 3 \times 2 inches. A template of that layout is shown here full size.

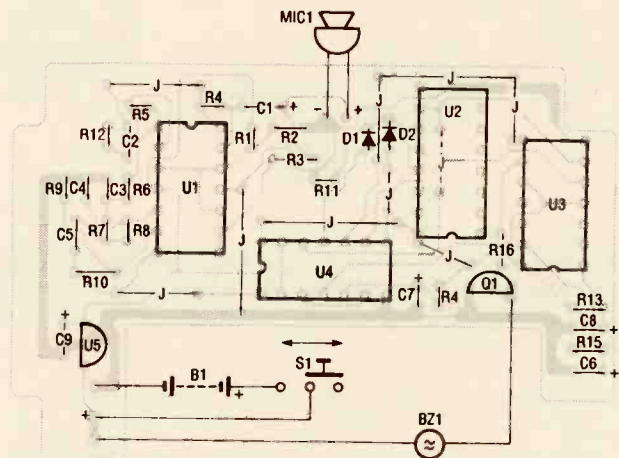

Fig. 4. Once you've obtained the board and the parts that will populate it (either on your own or by ordering them from the supplier listed in the Parts List), use this parts-placement diagram to locate and install the components in their proper positions.

other approximately 5/16 \times 1/4 inches for the slide switch.

Connect short lengths of hook-up wire to the buzzer and the switch, connect the wires from the off-board components to the appropriate points on the printed-circuit board. Mount the printed-circuit board, switch, and buzzer to the enclosure, and then secure the nylon web strap to the side of the enclosure using a pair of 4/40 screws and nuts. The strapping used to secure the project to the dog's neck is available at most sports and army surplus stores.

Cut off any excess strap length after sizing it to the dog's neck; the free end of the strap should be melted to avoid fraying. Finally, install the IC's in their respective sockets, install a 9-volt battery, and close up the project box.

Operation. Using the circuit is easy. Simply strap the Dog Bark Inhibitor to your dog's neck (be sure to orient the unit so that the microphone is up), turn the unit on using S1. Any long duration or repeated barking by the dog will cause the buzzer to sound for one half second. If greater sensitivity is desired, increase the value of R5.

A longer free-barking period can be achieved by increasing the number of counts U4 allows before turning on the buzzer (that can be done by cutting the trace to pin 13 of U2 and moving the wire to the Q9 output pin 12 or the Q10 output pin 14). The project has been used on the author's dog for more than a year and has stopped the dog's nuisance barking and has restored neighborhood harmony. ■

A NON-SERIOUS CIRCUIT

BY D. DEREK VERNER



Is it a parallel circuit or is it a series circuit? You'll have loads of fun watching your friends try to figure it out for themselves.

haven't yet, don't feel too bad, this circuit has been known to confuse and mystify electronically sophisticated engineers. I built the first version of it when my son was studying parallel and series circuits in a technology class in junior high school. He brought it into class and asked his teacher why it didn't work properly. Believe me, the teacher almost went crazy trying to explain it. The secret is that each lamp and switch contains a concealed component.

How it Works. As can be seen in Fig. 2, the concealed components are rectifier diodes connected as shown. With both switches open there can be no current flow because the diodes wired across them block current in both directions.

Let's suppose we close S1. Let's also assume that during the first half-cycle of the power line's waveform current flows in a clockwise direction around the circuit. At I1 the current encounters D1, which blocks it so it travels through the lamp (I1) instead, lighting it (at half power). Next the current approaches I2, where D2 effectively shorts out the lamp. At S2 the current passes readily through D4 and on through S1, which is closed.

On the next half cycle when the current attempts to travel counterclockwise through the circuit it is simply blocked by D4. The overall effect is that lamp I1 appears lit and I2 is out. When S2 is closed as well, the current

is AC and each lamp lights during the appropriate half cycle.

Parts Selection. You probably have all the parts necessary to build the Non-Serious Circuit in your junkbox. Any clear plastic box large enough to house the components will serve for the enclosure. The lamps can be any low-wattage AC bulbs with an intermediate-size brass base. Most American-made bulbs these days are made with aluminum bases that are not suitable for this project because it is hard to solder to the shell. If you use Christmas-tree bulbs, as I did, choose red and yellow ones as they light with more apparent brightness than blue or green when fed half-wave AC.

Although your hardware store probably also stocks a large selection of intermediate-size lamp sockets, the best choice is the brass shell removed from a composition-type Christmas-light string. That is because the shells cannot be "gimmicked" in any way that wouldn't be readily apparent.

The toggle switches must be of a type that can be easily disassembled. The ones shown are held together with two small screws. Although no longer listed in their current catalog, it might be possible that your local Radio Shack has them still on the shelf as item 275-602 or in their toggle-switch assortment as item 275-322. However, any SPST switch that can be neatly disassembled and re-assembled will do.

The diodes can be 1N4002's or any

Every reader of this magazine is familiar with the difference between a parallel circuit and a series circuit. The parallel circuit shown in Fig. 1A allows independent control over each lamp: S1 turns I1 on or off independent of S2, while S2 operates I2 without regard to the position of S1. In the series circuit shown in Fig. 1B both switches must be closed in order to light the lamps, and if either is opened, both lamps go out. There is no independent control of the lamps.

That's where the Non-Serious Circuit comes in. The unit consists of two color-coded switches (one yellow, one red), and two bulbs of corresponding color. Since the components and wiring are clearly visible through the clear plastic box they are in, you can see that the switches and lamps are wired in series.

However, if you plug the unit in and flip a switch, only its like-colored lamp is affected! Flip the other switch and the other lamp goes off. At this point you'd be wondering what's going on here? As an experiment you might try switching the bulbs, but to no avail; the red switch still operates the red bulb, and the yellow switch controls the yellow bulb.

Very astute readers may have already figured out the circuit. If you

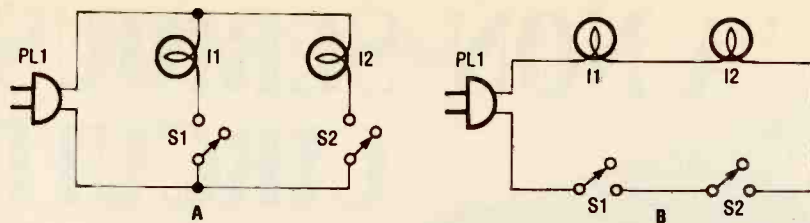

Fig. 1. The operation of a normal parallel circuit (A) or straightforward series circuit (B) is easy to figure out if you have a little knowledge of electronics.

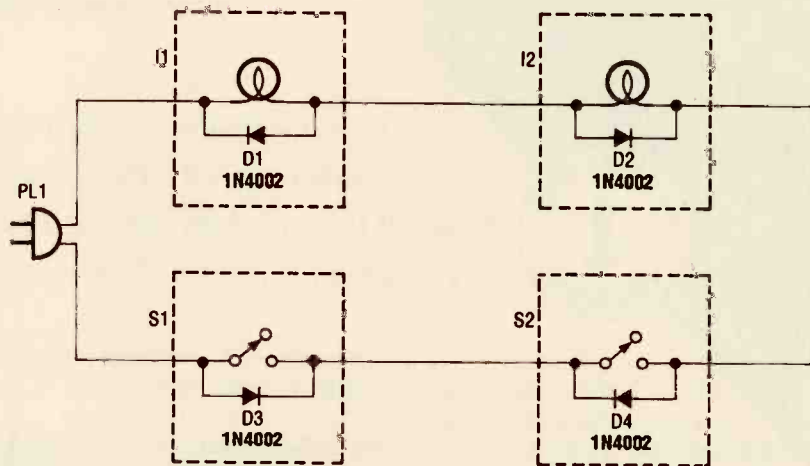
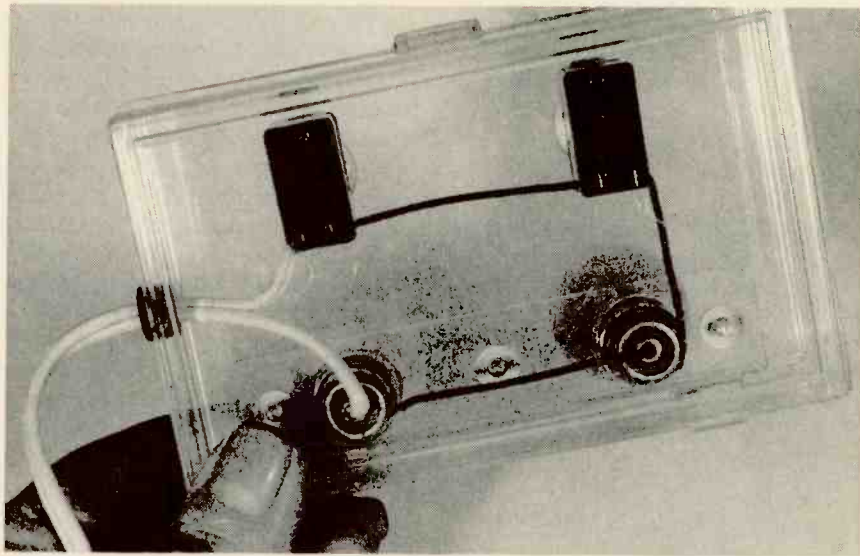

Fig. 2. This is the Non-Serious Circuit. If you follow each alternation of the AC line current around the loop for various settings of S1 and S2 you'll soon see how confusing the circuit would appear to the unsuspecting.



The components of the circuit can be clearly seen through the transparent enclosure. Note the clear-plastic strip holding the socket shells in place beneath the box's cover.

others rated at least 1 amp at 100 PIV. These are generally available in the DO-14 size, which is less than a quarter-inch long. The smaller size makes it easier to conceal the diodes in the switches and lamp bases.

If you opt for the brass shells from some Christmas lights, you will have to devise a way to mount them so that the shell is not exposed (presenting a shock hazard). I epoxied mine into

suitably countersunk holes in a small strip of acrylic plastic mounted inside the box by means of 6-32 screws. Slightly smaller holes in the top of the box allow the bulbs to be inserted, but prevent the shells from protruding outside the box.

To remove the bases from the lamps, you will need a propane torch and a pair of gas pliers. Wrap the bulb in a cloth with the base exposed and

PARTS LIST FOR THE NON-SERIOUS CIRCUIT

SEMICONDUCTORS

D1-D4—1N4002 1-amp, 100-PIV, rectifying diode (see text)

ADDITIONAL PARTS AND MATERIALS

I1, I2—Christmas-light bulb

S1, S2—SPST power switch (see text)

PL1—AC linecord and plug

Clear-plastic case, two Christmas-light sockets, wire, solder, etc.

put on a pair of goggles. (Although I have never had a bulb break during this operation, it is always better to be safe than sorry.) Heat the base of the lamp in the flame of the torch, and with the pliers keep testing the bond by twisting it slightly. It shouldn't take much heat before the base loosens. As soon as it is free, turn off the torch and set the bulb down to cool. If the base and the bulb are still connected by wires soldered to the center contact and to the shell, carefully unsolder the connections.

With a penknife, scrape out the remnants of the composition material from the base of the lamp and from the interior of the shell. The material is brittle and can be easily removed. Clean the two exposed copper wires carefully by scraping or using fine sandpaper. Tinning the wires will make the next operation easier.

Clip the cathode lead of the diode (usually marked with a band), leaving about 1/4 inch of lead. Wrap one of the wires from the lamp around the shortened lead close to the body of the component. Also wrap the lead with a short length of bare, tinned, solid hookup wire. Using a heat sink on the diode, solder the connection. Insert the stubby length of lead into the space between the evacuation tube and the remainder of the bulb. Take care not to fracture the fragile glass evacuation tube. Slip a small piece of spaghetti over the other wire from the lamp and solder it to the anode of the diode.

Examine the brass shell and locate the point on its rim where the wire was previously soldered. File a small notch in the rim large enough to clear the piece of hook-up wire installed in the previous step. Check the center contact and make sure that no solder is

blocking the small hole in it.

Apply a liberal coating of epoxy to the inside of the shell and install it on the base. The uncut lead from the diode goes through the hole in the end contact and the short length of hook-up wire through the small notch in the shell. Clamp the assembly together and allow the epoxy to set with the bulb in a base-up position.

When the adhesive has cured, solder the diode lead to the end contact and cut it off flush. With your goggles on, clip off the other lead so that about $\frac{1}{16}$ of an inch is exposed, bend it over, and solder it to the shell. Repeat the operation with the other lamp, but this time the cathode end of the diode should be left long for connection to the end contact.

Open up the toggle switches and, by pushing them out from the back, remove the contacts. If you use the same switches the author did, drill a small hole in the left-hand contact for one lead of the diode, and fin the area of the right-hand contact where the other lead will go. Reassemble the contacts into the switch housing and, with its leads cut short, solder the diode to the contacts. In one switch, the cathode should face to the left, in the other, to the right.

If you are using a different type of switch or you cannot locate any diodes small enough to fit, you can probably find some space for the diode somewhere else in the switch housing. A motor tool with a small burr bit can be used to rout out space at the end of the housing opposite the contacts. Small wires can be used to connect the diode to the contacts.

Reassemble the switches, making sure that the slot in the mounting bushing is on the side opposite the contacts. This assures that the on-off nameplates will read correctly.

Mount the components in the box back in Fig. 2. Install the lamps and paint the switch handles to correspond to the colors of the bulbs.

Using the Unit. The best way to present the Non-Serious Circuit to a friend is to pretend to be confused. Explain that you'd like his help—it seems that you wired up this circuit and it is operating in a very strange manner. You can probably build the unit in one evening with parts already on hand, so I hope you'll give it a try. ■

BONUS SECTION

High-Voltage Electronics

Having fun . . .

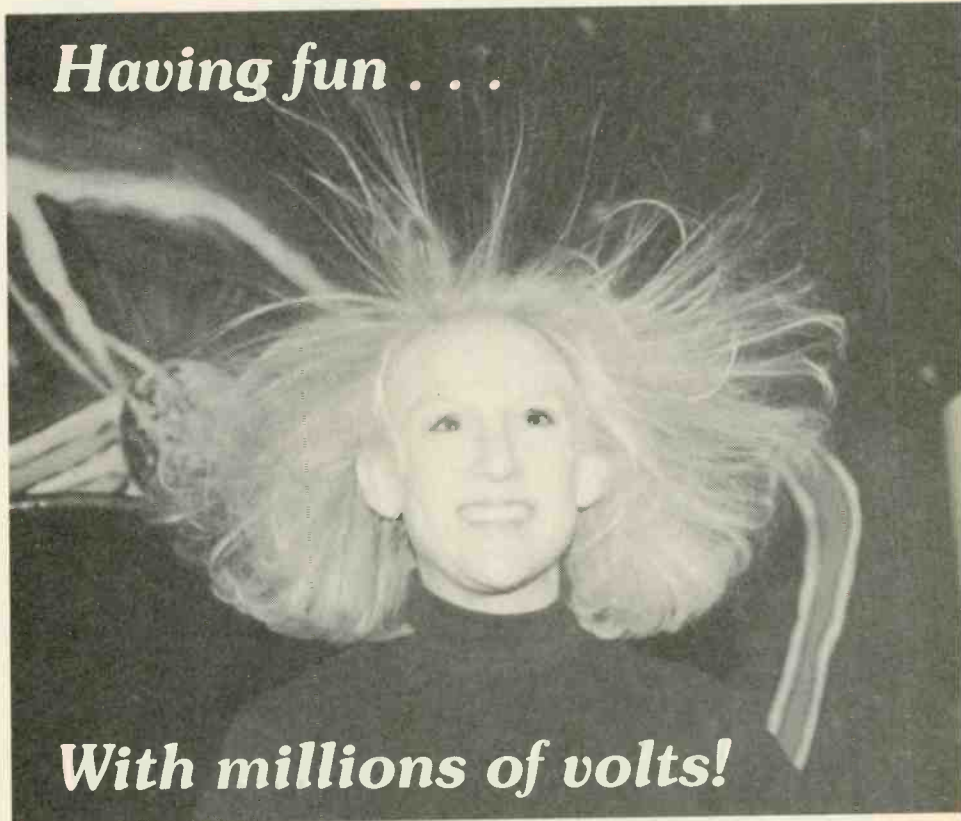

With millions of volts!

- **200,000-volt Van de Graaff Generator**
- **Solid-State Tesla Coil**
- **Easy to build Jacob's Ladder**

**Just turn the page
to High Voltage Excitement**

200,000-Volt Van de Graaff Generator

The first known electrical generator was built in 1660 by the German experimenter, Otto von Guericke (also known to historians as the inventor of the air pump). Though Guericke's generator consisted of little more than a revolving ball of sulfur, that frictional device was capable of developing a very strong charge of static electricity.

The generator's ball was made by pouring molten sulfur into a spherical glass container "about the size of a child's head." When the sulfur cooled, the glass was broken open, and the globe removed and equipped with an iron axle. The assembly was then mounted on a wooden frame that allowed the ball to spin freely. When a dry hand was applied to the rotating sulfur sphere, the ball would become electrified, attract small objects, make a crackling sound, and glow faintly in the dark.

Van de Graaff's Generator. Otto von Guericke's machine quickly became obsolete, but the *triboelectric* principles that allowed that generator to operate did not. It is an elementary physical fact that extremely high voltages can be generated by the repeated contact and separation of dissimilar substances, a process that is otherwise known as friction.

In 1927, New Zealand physicist Ernest Rutherford voiced the need for "a copious supply of atoms and electrons ... transcending in energy the alpha and beta particles from radioactive substances." He was talking about an accelerator. Rutherford's wish inspired a young American scholar by the name of Robert J. Van de Graaff.

Van de Graaff knew that charged particles could be moved to high speeds by high voltages. He also knew that conventional methods of electrical transformation might not provide the necessary energy. But the electrostatic characteristics of the atomic nucleus gave him an idea. Van de

Graaff decided to find some way of generating high electrostatic voltages in order to, as he phrased it, "meet the atom on its own terms."

The first Van de Graaff generator was built at Princeton University in the fall of 1929. Van de Graaff built the machine from scrap: a silk ribbon, a small motor, and a tin can. The silk had to be pure; there is a story about how Van de Graaff would visit local fabric shops and set fire to silk samples to see if the cloth was tainted. Van de Graaff's primitive static device developed about 80,000 volts. The high-voltage output was restricted by corona discharge from the edges of the can.

The public became aware of Van de Graaff's new technology in 1931. That's when he demonstrated the creation of over 1,000,000 volts between the spherical terminals of two belt-driven generators. Following that, general interest in these magnificent machines grew very quickly.

Giant Generators. The early success of Van de Graaff's creations was encouraging. Immediately, researchers began making plans for a much, much bigger generator. The size of the machine was to be limited only by the size of the building found to keep it in. A suitable structure was located on the estate of Colonel E.H. Green at South Dartmouth, Massachusetts. It was the biggest enclosure anyone could find. It was a hangar built originally to house a dirigible, or blimp.

Engineers built two separate machines: one for the positive charge, and one for the negative. The spherical terminals, about 15 feet in diameter, were made of welded aluminum and mounted on two large tubular insulators, each 24 feet high and 6 feet across. The generators were carried on railway track. That allowed technicians to vary the distance between the electrodes. The giant Van de Graaff system was capable of generating nearly ten-million volts.



*Have hours of high-voltage
fun when you experiment
with this working high-
voltage generator.*

BY STANLEY A. CZARNIK

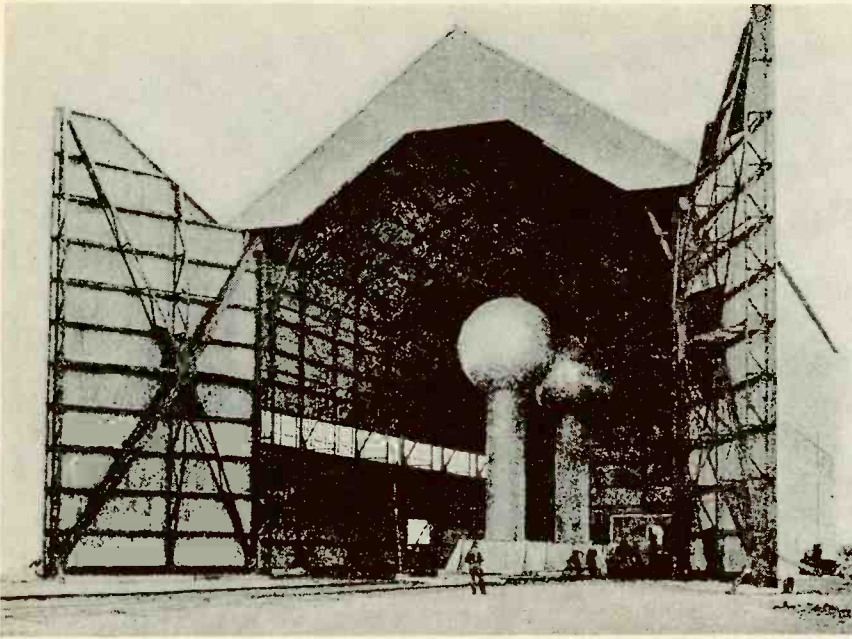

This giant Van de Graaff generator system was built in Dartmouth, Massachusetts in the early 1930's. The machine was capable of developing nearly ten million volts. The very large structure in the background was, originally, a hangar built for a blimp.

A Working Model. With a kit of parts from Analytical Scientific, a laboratory supply company in Texas, you can build your own 200,000-volt Van de Graaff static generator in about one hour. (See the Parts List for ordering information.)

The fully assembled machine is about 18 inches high. The spherical aluminum terminal, mounted on top of a heavy plastic tube (PVC pipe), is about 7 inches in diameter. The generator runs on 117 VAC and comes complete with a small electric motor and all the necessary hardware; there's even a spare rubber belt. It's a classic design and an excellent addition to any home-experimenter's workshop.

Building your Model. Once you've obtained the kit, begin by attaching the three rubber feet to the round metal base. Now locate the L-shaped

motor bracket and the lower brush, which is the short-length of stranded wire that's connected to a soldering lug. Push three small screws (8-32 x 1/2-inch) up through the bottom of the base and the motor bracket. Place lock washers on the screws and secure the assembly with three 8-32 hex nuts. The lower brush goes on the screw furthest away from the 90-degree bend in the motor bracket. The brush should point

towards the vertical section of the bracket. Handle the brush carefully as it is delicate.

The next step is to find the electric motor and mount it by passing the two threaded studs plus the armature shaft through the three remaining holes in the motor bracket. Place lock washers on the threaded studs and secure the motor with a couple of hex nuts.

Now look for the white plastic pulley. Push the pulley over the armature shaft. If you have trouble, tap the end of the pulley very gently with a small hammer or the handle of a screwdriver. The pulley should not come into contact with the motor bracket.

The plastic pipe is held against the upper portion of the motor bracket with a large U-bolt, a metal strip, and two large hex nuts. One end of the pipe has a couple of semi-circular notches cut into it. That end of the pipe should be up; the plain end should be down. The lower end of the pipe should extend about 5/8 inch below the U-bolt. The notches on top should line up with the pulley at the bottom. To check the alignment, simply look straight down through the center of the pipe.

Next, locate the rubber belt and slip it over the metal pulley. Place the pulley into the two notches on top of the insulator and allow the belt to fall through the tube. Pull the lower end of the belt down and place it over the lower pulley. Try to avoid handling the belt too

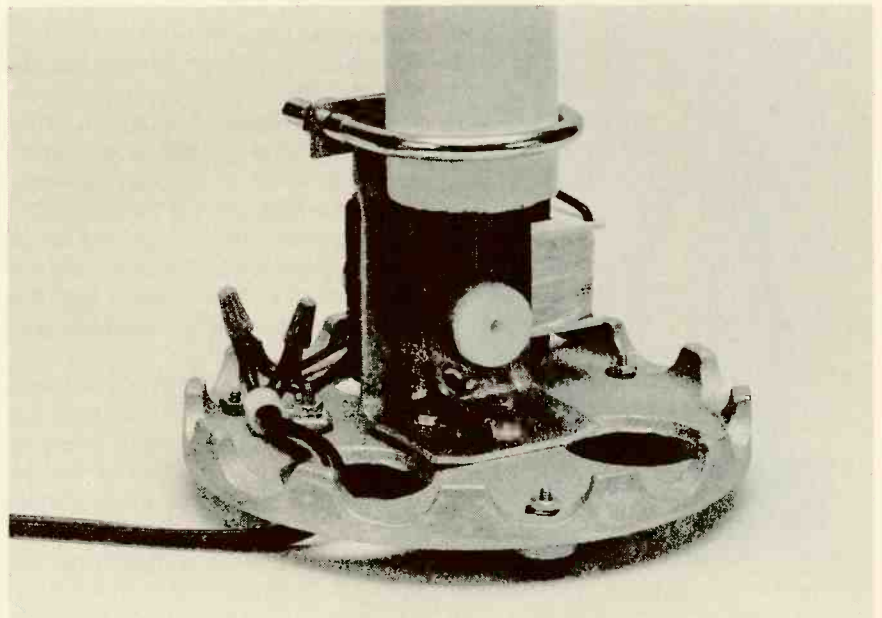

This is how the inside of your Van de Graaff generator will look just before the lower aluminum shell is placed over the round metal base. Note the arrangement of the stranded wire brush, the rubber belt, and the pulley assembly.

WARNING!! This article deals with and involves subject matter and the use of materials and substances that may be hazardous to health and life. Do not attempt to implement or use the information contained herein unless you are experienced and skilled with respect to such subject matter, materials, and substances. Neither the publisher nor the author make any representations as to the accuracy of the information contained herein and disclaim any liability for damages or injuries, whether caused by inaccuracies of the information, misinterpretations of the directions, misapplication of the information, or otherwise.

much as skin oils can reduce its effectiveness.

Now, very carefully, adjust the lower brush so that it just barely touches the rubber belt. Spread the strands of wire gently so that as many of them as possible are touching the rubber.

Find the collector support and upper-brush assembly. That's the short length of stranded wire soldered to a V-shaped piece of stiff wire. Push the V-shaped wire into the two small holes at the upper end of the insulator (PVC pipe). And here again, adjust the stranded wire brush so that it just barely touches the rubber belt.

Return to the bottom of the generator and hook up the 117-VAC line cord. Use the wire nuts provided with the kit. The line cord is held in place with a plastic strain relief. Don't forget to connect the little green ground wire. Both the strain relief and the ground wire are attached to the base of the generator with a small screw and a hex nut.

Finally, lower the cylindrical aluminum shell over the plastic tube and push it down over the base. Then place the spherical terminal over the collector support. It should balance perfectly. Now stand back and admire your new Van de Graaff generator. It's a work of electromechanical art!

Testing. Plug your generator in and

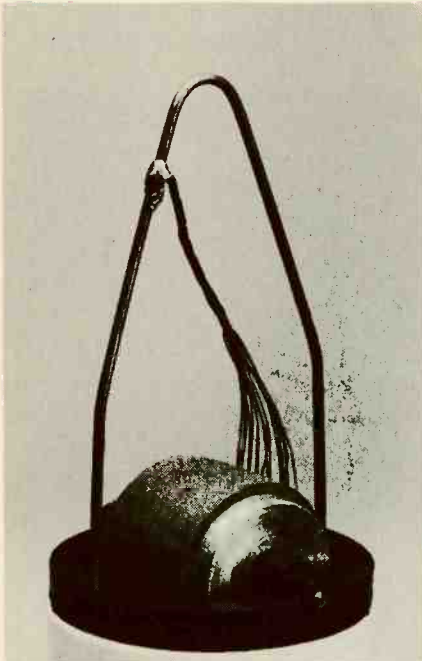

The upper brush and upper terminal support fit into the upper end of the tubular insulator. Note how the wire brush is positioned to make contact with the rubber drive belt.

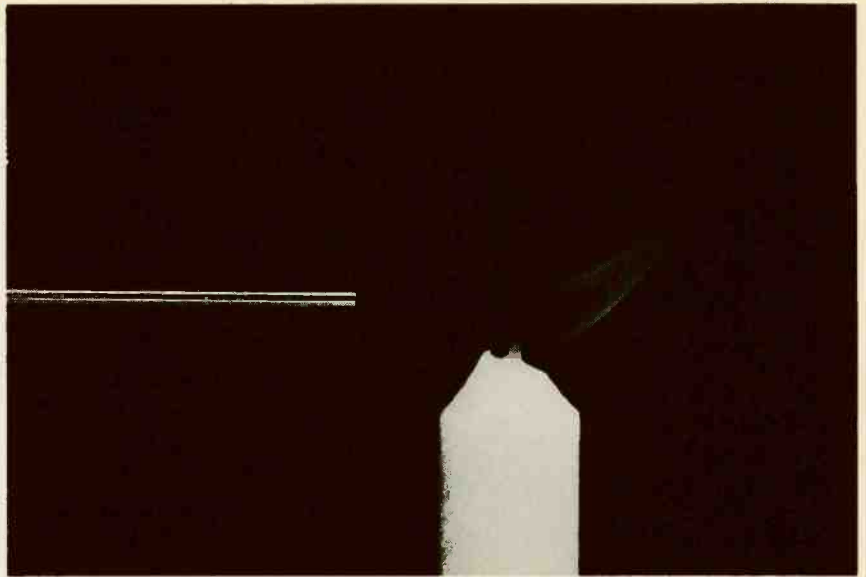

This photograph illustrates the creation of what is sometimes called an "electric wind." Tape one end of a narrow metal rod to the top of your Van de Graaff generator. Turn on the machine and light an ordinary household candle. Now bring the candle close to the free end of the rod. As molecules of ionized air rush from the metal tip, the flame is blown to one side.

the motor should turn. If it doesn't, remove the upper spherical terminal and give the pulley a little spin in the right direction. That should start the generator. Replace the aluminum sphere immediately.

Wait a few moments for a charge to build up on the terminal. Now approach the sphere with a large fluorescent tube. When the tube is three or four inches away from the sphere, the machine will discharge, and the tube will flash. If that doesn't happen, or if the flash isn't very bright, your generator is not working properly.

Unplug the unit and remove the upper terminal and the lower shell. (Please be careful. A small static charge may be waiting for you when you touch the aluminum sphere.) Check the belt and the pulleys for dirt and moisture. They should be clean and dry. Then check the brushes. If the wire strands are too far away from the belt, the generator will operate very poorly, or not at all.

Finally, check both the upper terminal and lower shell for dust and lint. They, too, must be very clean. I was able to improve the performance of my own Van de Graaff generator by cleaning both the shell and the terminal with a bit of good quality metal polish and a soft cloth. That seemed to make a big difference in the machine's operation. In fact, it might be a good idea to polish the aluminum sections before putting the machine together.

MATERIALS LIST FOR THE VAN DE GRAAFF GENERATOR EXPERIMENT

Van de Graaff generator kit
Aluminum-foil strips, very thin
Candle
Fluorescent tube
Foam plastic packing material
Metal polish
Metal rod, 8 to 10 inches long
Tape

The Van de Graaff generator kit is available from Analytical Scientific, Post Box 198, Helotes, TX 78023, Tel. 210-684-7373. The catalog number is MLE-10-065 and the price is \$137.75. Include \$5.00 for shipping and handling within the continental U.S. The Analytical catalog is \$3.00, which is refundable with first order. TX orders must include appropriate sales tax.

Theory of Operation. Here's how your Van de Graaff generator works: The electric charge originates with the friction of the rubber belt moving over the lower plastic pulley. The plastic pulley acquires a negative charge that appears on the outside of the belt while a positive charge appears on the inside. The negative charge is picked up by the ionized air around the lower brush. The positive charge is carried to the upper brush by the belt where it is transferred to the aluminum sphere.

(Continued on page 67)

SOLID-STATE TESLA COIL

Build an updated version of Nikola Tesla's most-famous experiment.

By Charles D. Rakes

NIKOLA TESLA IS CONSIDERED BY SOME TO BE THE greatest inventor of our modern electrical age, and many experts consider him to be the true father of radio. However, today he is best remembered for his fascinating wireless power-transmission experiments, using his famous Tesla coil.

The high-frequency air-core, oscillating Tesla coil is just as exciting today as it was back in 1899, when he used it to successfully transmit electrical energy over 25 miles, without wires, to light a large number of incandescent lamps. The Tesla coil is ideal for demonstrating and exploring the unusual phenomena that occur with high-frequency high-voltage energy.

Most Tesla coils designed for educational and experimental purposes use a line-operated, step-up transformer—in setups like that shown in Fig. 1—to generate the high voltage needed for the coil's primary circuit. While there's nothing technically wrong with that approach, it can place the operator in harm's way if the coil's primary circuit is accidentally touched. A shock from the high-voltage winding could prove extremely dangerous and may be fatal.

Our version, the *Solid-State Tesla Coil* (see photos), eliminates the line-operated, high-voltage transformer, making it a safer project to build and to experiment with. Even so, wise operators will keep their digits out of the wiring while the coil is under power.

Solid-State Tesla Coil

The schematic diagram for the Solid-State Tesla Coil is shown in Fig. 2. In that updated version of the Tesla experiment, an 18-volt, 2-ampere transformer (T1), a bridge rec-

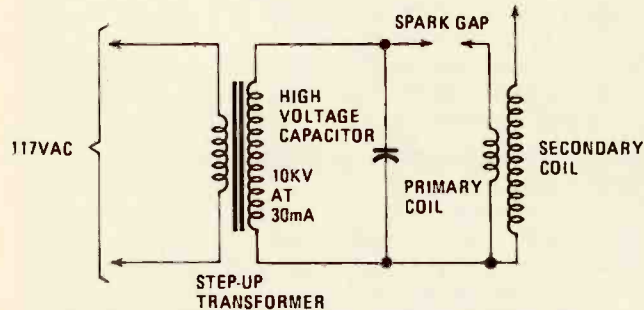
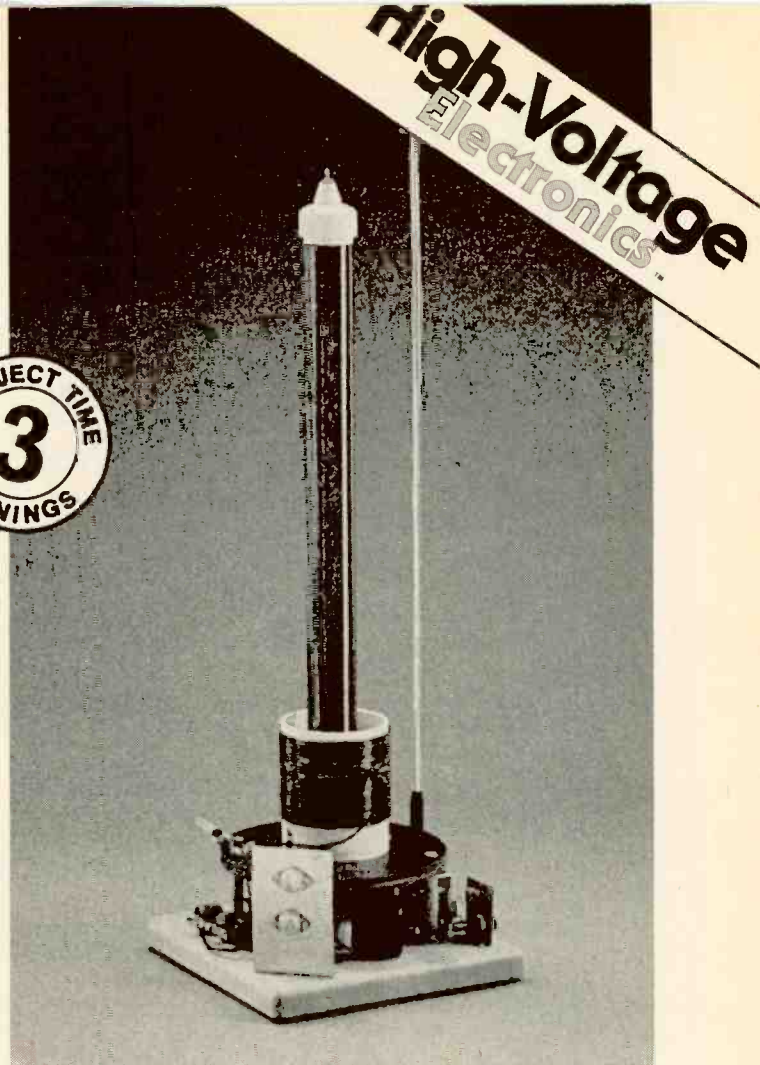
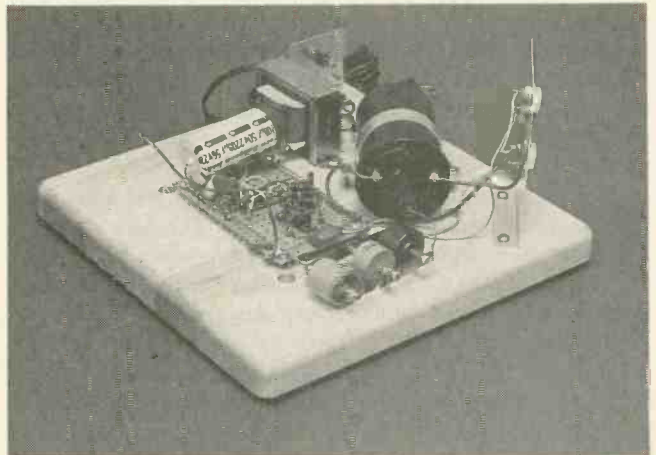

Fig. 1—Shown here is a basic design for a Tesla Coil circuit, using a line-operated, step-up transformer to generate the high voltage needed for the coil's primary.



tifier circuit (consisting of D1-D4), and filter capacitors (C1 and C3) supply operating power for the coil circuitry.

A 555 oscillator/timer (U1) is configured as a self-oscillating pulse-generator circuit. Resistors R1 and R2 make up a voltage-divider network, which is used to lower the 24-volt DC output of the power supply to a safe operating level for U1. The 555's narrow output pulse at pin 3 supplies drive current to the base of Q1. Transistor Q2 supplies sufficient



Here is the author's prototype of the Solid-State Tesla Coil with the 9-inch circular deck removed. The two heavy wires running the length of the top and bottom of the board serve as the ground and +V bus.

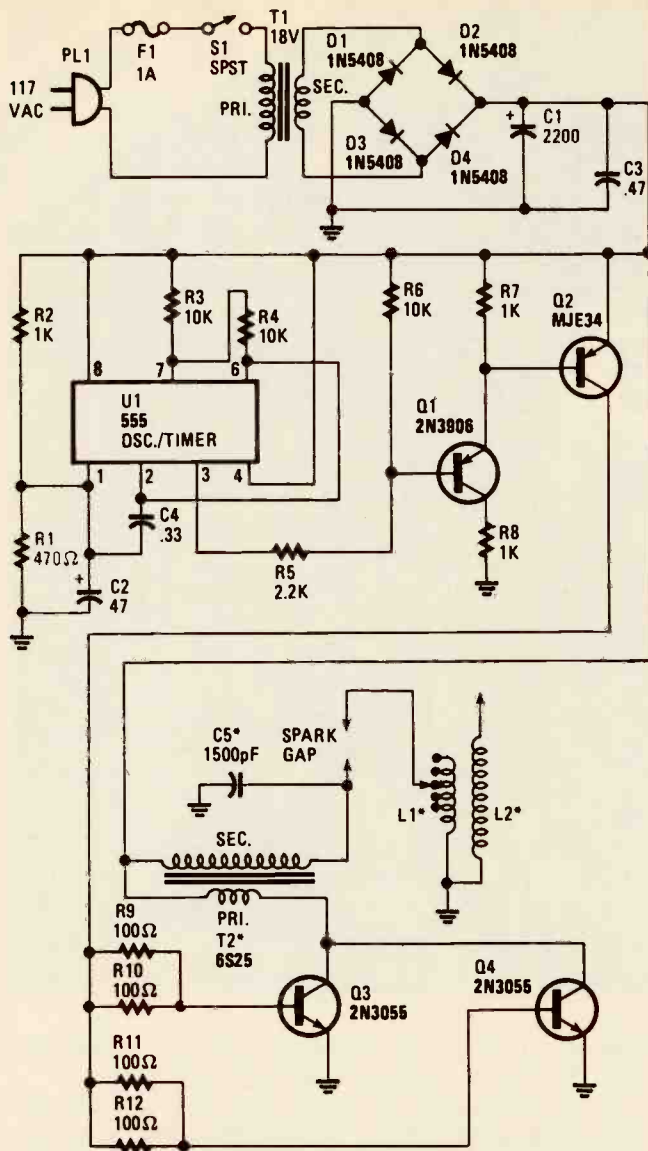

Fig. 2—Our updated version of the Tesla experiment uses an 18-volt, 2-ampere transformer (T1), a full-wave bridge rectifier (consisting of D1-D4), and filter capacitors (C1 and C3) to supply operating power for the Coil's circuitry.

current to transistors Q3 and Q4 to drive those components into full saturation.

The primary winding of T2 (an automobile-ignition coil) is connected in series with Q3 and Q4, and across the power supply. Transistors Q3 and Q4 operate like a toggle switch, connecting the coil across the power source at the rate and on-time set by U1.

That high-current pulse generates a rising and collapsing field across the primary winding of T2. The field causes a current to be induced in the secondary winding of T2. The secondary output of T2 is fed across three 500-pF, 10-kilovolt doorknob capacitors (collectively designated C5) that are parallel connected and tied across the high-voltage output of T2 as an energy-storage device. Those capacitors charge up to T1's secondary voltage and are then discharged through the spark gap and the primary (L1) of the Tesla coil, producing higher voltage in the secondary of the coil (L2).

The secret of producing a successful Tesla coil is in the tuning of the primary coil to the natural resonance frequency of the secondary coil. Because variable 10-kilovolt capacitors

are about as common as Condor eggs, some other means must be used to tune L1. The simplest method is to tap the primary coil on every turn and select the tap that produces the greatest voltage at the hot end of L2.

Perfboard Assembly

The author's prototype was built breadboard style on an 11 × 11 × 1-inch wooden cutting board (see photos), but any similar non-conducting material (perhaps plastic) will do. The majority of the small components, as shown in the photos, were mounted on a 3 × 5-inch section of perfboard, and point-to-point wiring techniques were used to complete the connections. Refer to the schematic diagram (in Fig. 2) and the photos for wiring and general parts-layout details. Note: Components T1 and T2, C5, Q3 and Q4, F1, and S1 are not mounted to the perfboard (see photos).

Figure 3 shows the positioning of the perfboard and off-board components on the baseboard. Mount the fully-populated perfboard assembly to the baseboard using four ¼-inch plastic spacers and wood screws. The location of the sub-assemblies on the baseboard isn't too critical, so long as the general layout is followed. Keep all wire leads as short as possible, especially around the high-voltage circuitry.

A 2½ × 2-inch piece of aluminum is formed into an "L" bracket, which is used to hold S1 and F1 (see photo), and is mounted on one corner of the baseboard. A 5 × 3-inch piece of aluminum mounts to the opposite corner and functions as the heat sink for the two power transistors (Q3 and Q4). A simple band is formed from aluminum to hold T2 in place.

Recall that C5 is really three 500-µF doorknob capacitors.

PARTS LIST FOR THE SOLID-STATE TESLA COIL

SEMICONDUCTORS

- U1—555 oscillator/timer, integrated circuit
- Q1—2N3906 general-purpose PNP silicon transistor
- Q2—MJE34, ECG197 (or similar) audio-frequency PNP silicon power transistor
- Q3, Q4—2N3055 NPN silicon power transistor
- D1-D4—1N5408 3A, 100-PIV silicon rectifier diode

RESISTORS

(All resistors are ½-watt, 5% units, unless otherwise noted.)

- R1—470-ohm
- R2, R7, R8—1000-ohm
- R3, R4, R6—10,000-ohm
- R5—2200-ohm
- R9-R12—100-ohm, 1-watt resistor

CAPACITORS

- C1—2200-µF, 50-WVDC electrolytic
- C2—47-µF, 25-WVDC electrolytic
- C3—0.47-µF, 100-WVDC mylar
- C4—0.33-µF, 100-WVDC mylar
- C5—1500-pF, 10K-WVDC (three parallel-connected 500-pF doorknob capacitors, see text)

ADDITIONAL PARTS AND MATERIALS

- F1—1-ampere fuse, 3AG
- L1, L2—see text
- S1—SPST miniature toggle switch
- T1—117-volt primary, 18-volt 2-ampere secondary stepdown transformer
- T2—Automobile-ignition coil (Ford #6S25, or similar)
- Perfboard, #12 wire, #26 wire, aluminum, Fahnestock clips, spacers, solder, hardware, etc.

Q3 & Q4
ON ALUMINUM
HEAT SINK

MOUNTING
STRAP

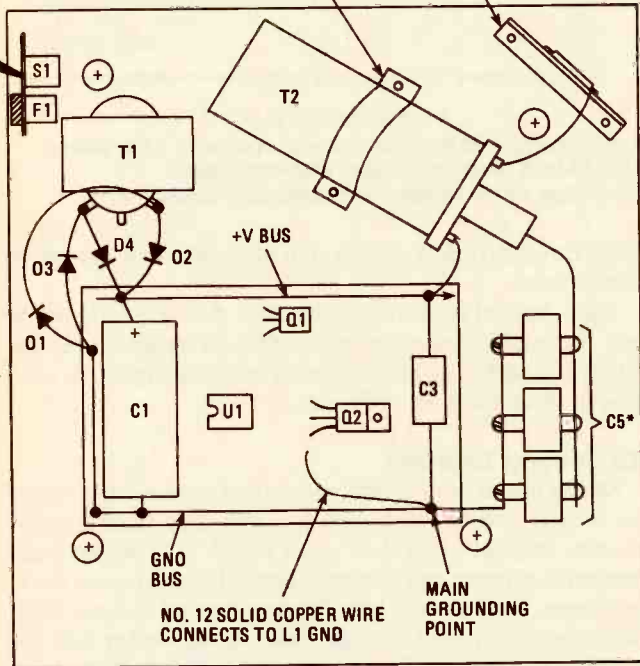
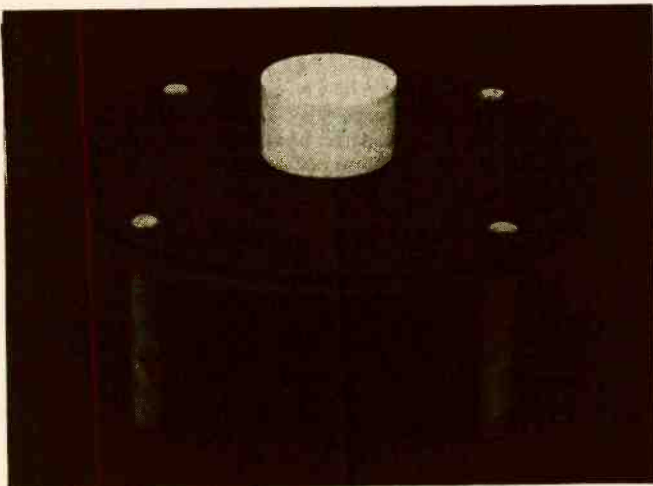

Fig. 3—The author's prototype was built breadboard style on an 11 × 11 × 1-inch wooden cutting board, and most of the components were mounted on a 3 × 5-inch piece of perfboard.

Two brass strips, about 3/8-inch wide by 3-inches long, are used to tie the three high-voltage capacitors together. If doorknob capacitors cannot be located (often they can be salvaged from older black-and-white TV's), a substitute can be made from window glass and aluminum foil.

To fabricate C5, take a 10-inch square piece of glass, like that of a picture frame, and glue a 9-inch square piece of aluminum foil to the center of the glass on both sides, leaving an equal border around each aluminum plate. Cut two 6-inch lengths of #22 insulated stranded wire. Strip about 3-inches of insulation from one end of each wire and tape the stripped end to each of the aluminum plates.



Shown here is the 9-inch circular deck supported by four dowel rods, and an end cap positioned at its center.

The Deck

Figure 4 and the photos show the top deck of the author's prototype, where the two air-core coils (L1 and L2) are mounted. The top deck consists of a 9-inch diameter circle cut from 1/2-inch thick fiber board. Four 3 3/4-inch lengths of 3/8-inch dowel hold the 9-inch coil base above the perfboard.

Select a drill bit slightly smaller than the dowel rod's diameter and drill the four mounting holes in the 9-inch circle on the baseboard at about the center, and mark the location of each hole. Drill each location on the baseboard with the same bit to a depth of about 1/2-inch.

If the two-layer Tesla coil seems like too much bother to

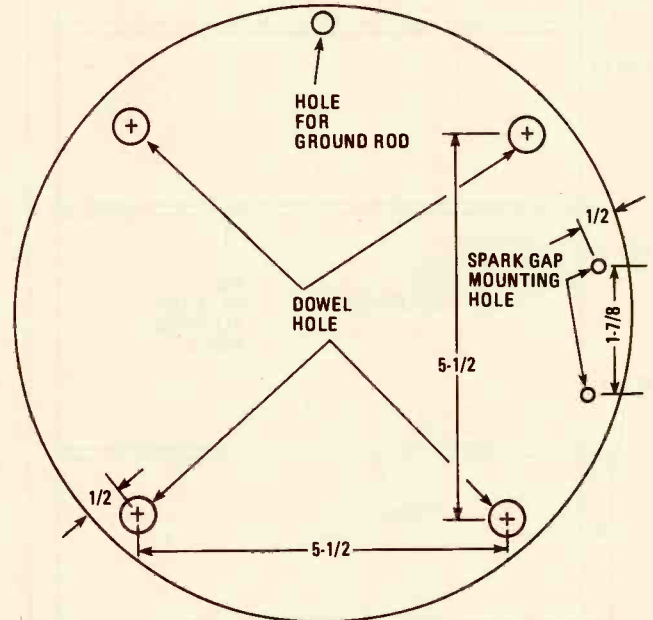

9-INCH DIAMETER, 1/2-INCH THICK
FIBER OR WOOD CIRCLE
ALL DIMENSIONS IN INCHES

Fig. 4—Shown here is the general layout of the top deck of the author's prototype, which supports coils L1 and L2. Four 3 3/4 × 3/8-inch wooden dowel rods hold the 9-inch circular base above the perfboard and other components.

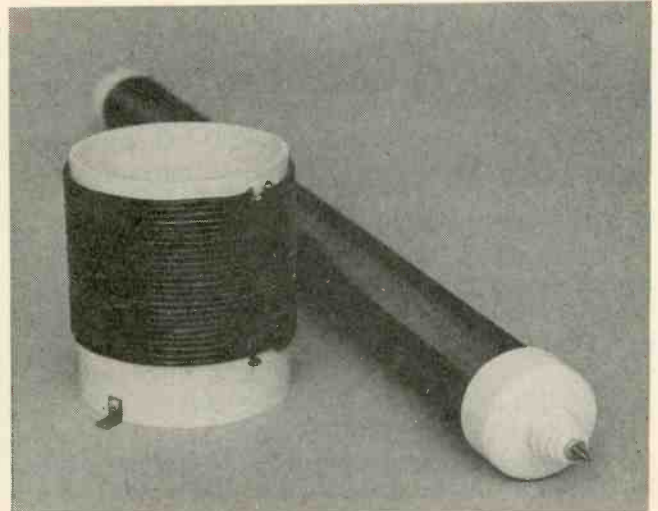

Here is what L1 (left) and L2 (right) should look like once completed. Although winding L2 may appear difficult, it can be done in an hour by hand or in 15 minutes by lathe.

duplicate, then build a single-level unit on a larger wooden base to suit your own needs. Actually, any good layout scheme that respects the dangers of high voltage should do quite well.

Winding the Primary Coil

The primary-coil (L1) is wound on a form cut from a 4-inch diameter, plastic sewer pipe to a length of five inches (see Fig. 5). Take a 27-foot piece of #12 insulated solid-copper wire and strip away a 1/8-inch section of insulation at about every 12 inches, continuing for one-half the length of the wire (12 times total). Those stripped areas serve as tap points for tuning the coil.

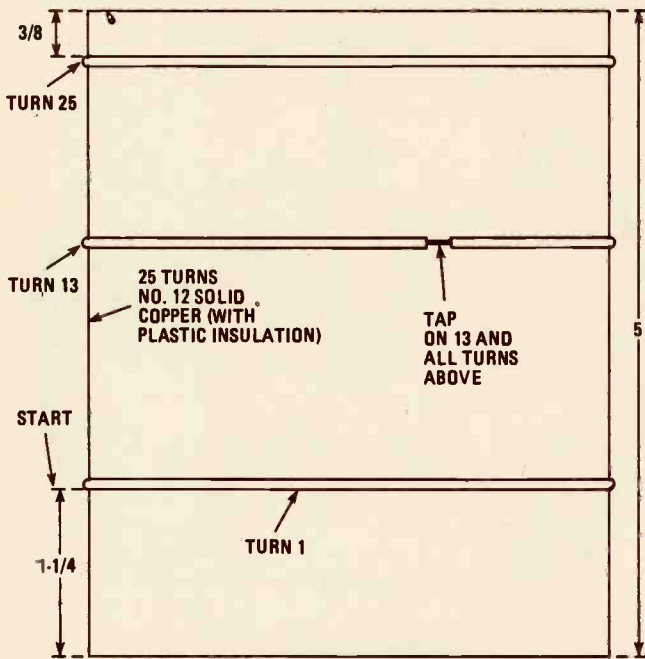

COIL FORM (4-INCH DIAMETER PLASTIC SEWER PIPE)
ALL DIMENSIONS IN INCHES

Fig. 5—The form on which L1 is wound is a five-inch length of four-inch diameter, plastic sewer pipe. A 27-foot length of #12 insulated solid copper wire (with 12 quarter-inch sections of insulation stripped away at intervals of about every 12-inches) is then wound onto the form.

Wind the coil starting at the top of the coil form (see Fig. 5) with the end that has the 12 tap points. In other words, turn 25 is the first winding to be made. That gives a tap on every turn from turn number 13 to turn number 25. Drill two small holes in the coil form where the winding starts and ends. Those holes are used to secure the ends of the windings (see photos).

Winding the Secondary Coil

The secondary coil form (see Fig. 6) is cut from a section of 1 1/2-inch diameter, plastic water pipe (which actually measures 1 7/8-inches in diameter). So when selecting your secondary coil form, take a ruler with you and be sure to come home with the correct-diameter pipe. You'll also need two plastic end caps that snugly fit the ends of the tubing.

Make a mark on the coil form about one inch from each end. That sets the starting and ending points for the winding. Fill the space between marks with a neat solenoidal winding of #26 enamel-covered copper wire. Winding the coil by hand shouldn't take over an hour, and if a lathe is handy, you should be able to complete the job in about 15 minutes. Leave

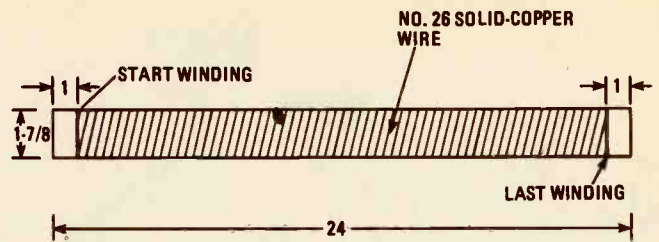

ALL DIMENSIONS IN INCHES

Fig. 6—Using #26 enamel-coated copper wire, L2 is wound on a 24-inch length of 1 1/2-inch diameter, plastic water pipe, either by hand or (if available) using a lathe.

about 6-inches of wire at both ends of the winding for making connections.

Spray several coats of Krylon clear #1301 acrylic on the coil for added insulation and protection against moisture. Always let each coat dry completely before applying the next. Two or three coats are sufficient.

It's Coming Together

Mount one of the 1 1/2-inch, plastic end caps to the center of the 9-inch circular deck with a 1-inch long #8-32 screw, washer, and nut. Take two small metal "L" brackets and mount the primary coil centered around the end cap on the 9-inch base. Drill a small hole through the end cap and base-board near the rim of the cap. Take the secondary coil and push one end of the coil's lead through the hole in the end cap, and then set the coil in the end cap.

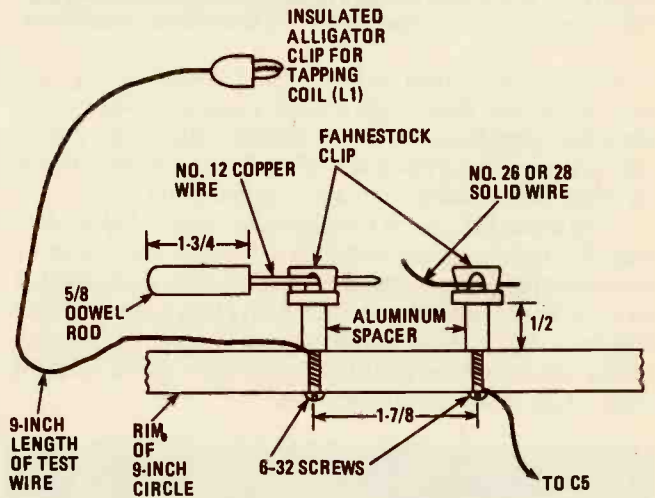

ALL DIMENSIONS IN INCHES

Fig. 7—The spark gap is formed by mounting two fahnestock clips to the 9-inch circular deck; one tied to the main grounding point, and the other connected to an alligator clip, which is used to change taps on L1.

Take the other end cap and drill a hole in the center to clear a #8-32 screw, and mount a feed-through insulator (see photo) on top. Select a #8-32 screw long enough to stick through the top of the insulator by about 1/2-inch, and grind the end to a nice sharp point. Connect the top end of the secondary coil to the bottom of the #8-32 screw with a small solder lug and tighten in place. Place the cap on top of the coil.

The spark gap is shown in Fig. 7. Two holes are drilled to clear a #6-32 screw to match the drawing in Fig. 4. Two

(Continued on page 67)

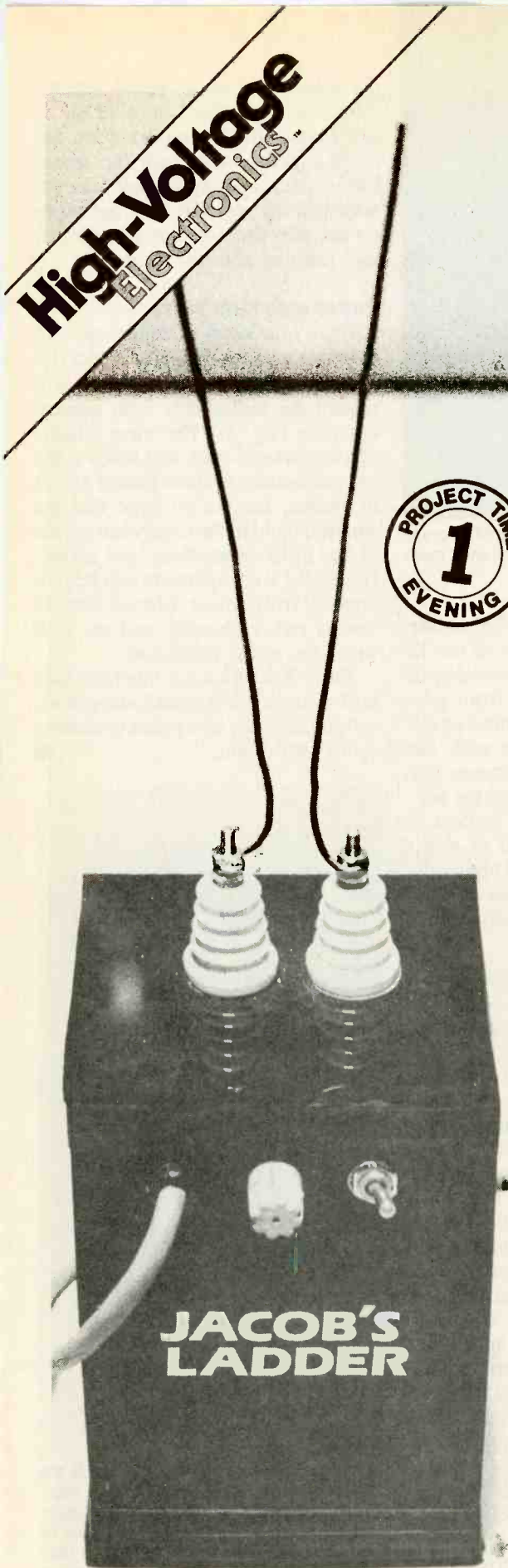

JACOB'S LADDER

A climbing electric arc has held the imagination of science-fiction fans as the symbol for an eerie laboratory!

JAMES, NICOLE, and DWIGHT PATRICK, Jr.

IN MANY SCI-FI AND HORROR FLICKS, ESPECIALLY THE STOCK "FRANKENSTEIN" variety, along with weird sound effects and the like, movie producers always feature the fantastic visual effects produced by Tesla coils, van de Graaff generators, and Jacob's Ladders. Of those three devices, the Jacob's Ladder is the easiest to build. With a low-current neon-sign transformer, a converted flyback transformer, converted auto spark coil, or other similar transformer, you can whip together your own Jacob's Ladder in less than an hour. Because the ladder is so simple, there's no need for a detailed parts list or a schematic. We tell you how to build one as we reveal the theory of operation.

Getting started

As we can see in Fig. 1, a Jacob's Ladder provides a fantastic visual effect. A beautiful electric arc hisses its way up two diverging wires, providing a fascinating and downright scary effect. The arc starts at the smallest distance between the vee electrodes (Fig. 1-a), and "walks" up the widening gap toward the top of the electrodes (Fig. 1-b).

Why does the arc walk up the vee electrodes? You would expect that when the arc starts to jump across the narrow gap at the bottom of the electrodes, that it would stay there where the electrical resistance between the electrodes is lowest. What actually happens is that the arc heats the air it passes through, causing it to rise. Because the heated air is ionized by the high-voltage arc, it provides a very low-resistance path, so the current path (the arc) rises with the warm air.

Eventually the arc reaches the top of the ladder (the electrodes) and bows upward creating an electrical path that gets longer and longer. At the point where the resistance at the bottom of the electrodes is less than that of the arc-path, the upper arc stops, and a new arc begins at the bottom of the ladder. Thus, what is seen is a continuous climbing arc that disappears at the top of the ladder and reappears at the bottom. It's all a lot of fun to watch, providing that you don't poke your finger between the electrodes or get your nose too close.

To build a Jacob's Ladder, you need a high-voltage source that

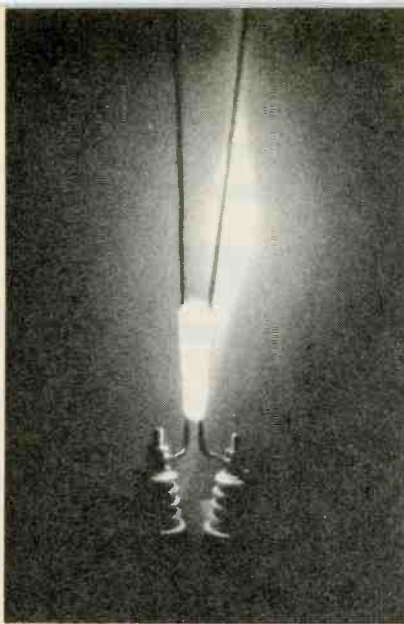
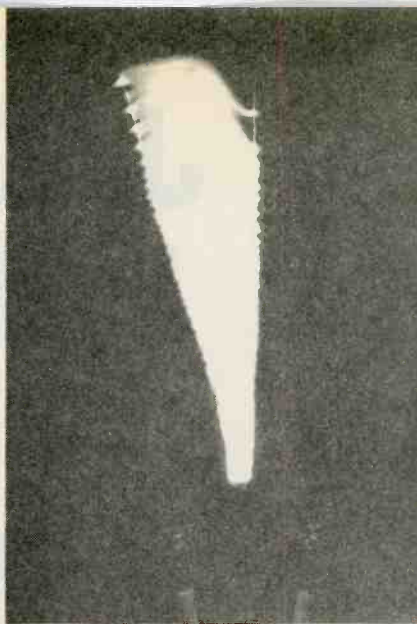

FIG. 1—HERE IS A TIME-EXPOSED PHOTOGRAPH showing the development of an arc at the bottom of the ladder as it climbs to the top. Display Jacob's Ladder in a darkened room for best viewing.



the ladder arcs at the initial setting, move the wires apart until an arc is just sustained. Placing the wires too close together will ruin the transformer over time. When you have established the arc, if it does not move up between the two diverging wires, they must be adjusted in or out.

Better safe than sorry

Once your Jacob's Ladder is up and running, a clear Plexiglas or acrylic cylinder around the entire unit will prevent the unthinkable from happening (see Fig. 3). The clear plastic housing should have vent holes at the top and bottom to allow heated gasses to escape, but not so large that the smallest child in the family can get his or her mitts or anything else inside. Generally, such cylinders can be purchased from most plastic-supply houses rather cheaply, and are well worth the added protection.

You do have to keep in mind that such high voltages are extremely dangerous, and you certainly don't want to come in contact with them. ■

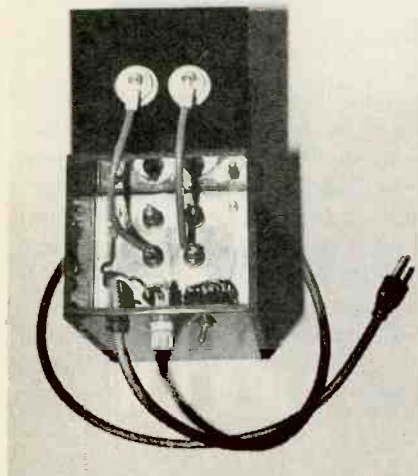

FIG. 2—NOTICE HOW NEAT THE WIRING IS. RTV cement is used around the high-voltage connection points. The line cord's third lead is used to ground the case.

ected via high-voltage TV anode hook-up wire to two pieces of no. 12 copper wire used for the vee-shaped electrodes that protrude from porcelain insulators. When removing the insulation, be sure not to nick the wire. The connections between the transformer's secondary and the bottom of the insulators must be kept as short as possible and void of sharp bends (see Fig. 2). Exposed high-voltage points were given a coat of RTV silicon rubber to prevent any arcing inside the enclosure.

Adjustment and operation

The last step in getting your Jacob's Ladder to work is the adjustment of the vee electrodes. **DO NOT MAKE ANY ADJUSTMENTS WHEN THE UNIT IS TURNED ON.** The unit should be turned off and unplugged when making adjustments, to prevent accidental electrical shocks.

The electrodes must be close enough at the bottom to establish the spark or arc-over, with the wires gently angling away from one another to form the "V." The initial distance at the base to start the spark will vary with the voltage applied, humidity, altitude, etc.; so, it's pretty much done by trial and error. Start with the wires at the base about an inch apart when using 10 kilovolts or more, and move them closer in small increments until an arc is established. But remember to kill the power before each adjustment.

When the distance is correct, the arc should start. On the other hand, if

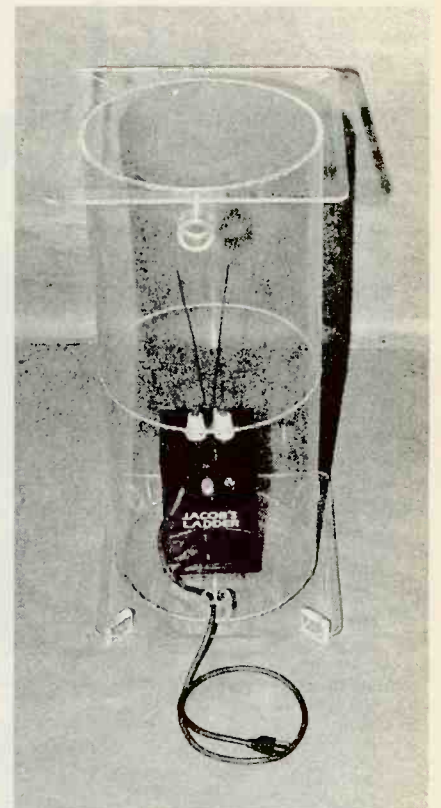

FIG. 3—A PLASTIC SHIELD SHOULD BE USED to prevent inquisitive people from accidentally touching the arc or the electrodes. Be sure to include a vent hole at the top and bottom of the shield so that gasses produced by the arc are allowed to escape.

can deliver around 10 kilovolts at 30 milliamperes or more—such as a neon-sign transformer or high-voltage power-supply transformer. The lower the current output, the less chance there is for building a fatal shock hazard. The higher the voltage, the larger the separation you'll be able to make at the top of the ladder's electrodes.

The high-voltage source should be placed in a well-insulated case or cabinet. If the case is metal, it should be adequately grounded. In the photograph in the opening of this article, a 7-kilovolt transformer was placed in a 1/4-inch Plexiglas case with the primary winding connected via fuse and switch to the 117-volt AC input. The output of the transformer was con-

SOLID-STATE TESLA COIL

(Continued from page 64)

fahnestock clips are mounted to the board on 1/2-inch aluminum spacers, using #6-32 hardware. A 1 3/4-inch length of #12 solid-copper wire is fitted in one end of a 1 3/4-inch piece of dowel rod to produce the adjustable terminal of the spark gap. The other gap wire must be made from a #26 or smaller wire for the gap to perform properly.

Place the four dowel rods in the baseboard, position the 9-inch deck on top, and press down until all four dowel rods are even with the top of the circle. Connect the bottom of L1, using a short length of #12 wire, to the main grounding point (see Fig. 3). Also connect the bottom end of L2 to the same point.

A separate vertical ground rod can be positioned on the deck (see photos) for additional experimenting. The vertical ground was made from a 29-inch length of 1/4-inch threaded rod, and covered with a section of aluminum tubing to give a neat appearance. At the top, a binding post was mounted for versatility. That allows the ground rod to accept a number of different experimental items.

Checking It Out

Before we start this stage of construction, a word of warn-

ing is in order:

Do not touch or make any adjustments while power is applied to the Solid-State Tesla Coil. Remember that you'll be dealing with high voltages, so caution is the watchword.

With the power off, set the spark gap for a 1/8-inch gap and connect the tap clip to turn 15 or 16. Plug in the power cord and turn S1 on. A loud electrical discharge should be heard, and a blue brush discharge should be seen at the top of the pointed screw that's connected to L2.

Turn the power off and move the tap wire (that's connected to L1) up or down one turn at a time until the greatest blue discharge is obtained at the top of L2. Form a 1 1/2 to a 2-inch vertical gap between the ground rod and the top of the coil to aid in tuning up the coil. When the Tesla coil is properly adjusted, it should produce a 2-inch arc between the top of L2 and the ground terminal.

The coil discharge is most dramatic in a darkened room, and you should be able to light a fluorescent lamp at a distance of about two feet from the secondary coil. A clear incandescent lamp moved to within a few inches of the secondary coil will produce a beautiful blue lightning array from the lamp's filament to the outer edge of the glass envelope. Neon lamps glow around the coil without wires. Experimenting with the coil can be an almost endless adventure. But remember, always put safety first!

VAN DE GRAAFF

(Continued from page 60)

A powerful static charge builds up on the spherical terminal. In a dark room, you will be able to see long, thin, bluish bolts of artificial lightning jump between the upper terminal and the base. It's a fantastic sight!

Experiments. Gaseous tube illumination and spark production are only two of the many interesting things you can do with your Van de Graaff generator. Here are just a few of the others:

- Obtain some foam plastic packing material and break it up into small pieces. Turn on your generator and allow it to run for a few moments. Now, drop the plastic bits, one by one, on top of the spherical terminal. They land on the aluminum, sit there for a second, and then shoot off! Some of the plastic may fly for a distance of one or two feet. When the material makes contact with the terminal, it picks up an electric charge. Since like charges repel, the plastic is thrown off the surface.

- Find some very thin aluminum foil and carefully cut it into strips about 1/4- to 1/2-inch wide and about 8 inches long. Tape the strips to the top of the terminal. Make sure the foil is making good electrical contact with the alumi-

num sphere. Turn on the generator. The strips will be repelled from the terminal and from each other. Now approach the sphere slowly with the palm of your hand. The strips will be attracted magically to your fingers!

- You can also use your generator to create what is sometimes called an "electric wind." Locate a narrow metal rod about 9- or 10-inches long. Tape one end of the rod to the top of the spherical terminal. Make sure that this end of the rod is entirely covered with tape, and, once again, check for a good electrical contact. Turn on the machine. Next, light a household candle and approach the free end of the rod with the candle flame. As molecules of ionized air rush from the metal tip, the flame will be blown to one side.

These experiments just scratch the surface of what you can do with your generator. The book, *Nature's Electricity* by C.K. Adams (Tab Books, Blue Ridge Summit, PA 17294) contains many other interesting experiments that can be performed with your Van de Graaff generator, as well as other static-electricity experiments.

A word of CAUTION: When you work or play with high voltages, you can be injured or killed. Always proceed with caution. If you are a minor, obtain the assistance of an adult.

Be a computer repair expert!

CAREER-LEVEL HOME STUDY



Learn PC repairs, troubleshooting, servicing, upgrading, installation. Increase your value as an employee or open your own business.

No expensive instruments, no high-tech electronics. Over 90% of PC repairs and service involve easy mechanical procedures or parts replacements. Send or call for free literature.

800-223-4542

Name _____ Age _____

Address _____ Phone () _____

City _____ State _____ Zip _____

The School of PC Repair

6065 Roswell Road
Dept. JA351, Atlanta, Georgia 30328

CIRCLE 22 ON FREE INFORMATION CARD

A broken water pipe can be an expensive repair job. The repair leaves you with walls torn apart, floors ripped up, and we haven't even mentioned the water and construction damage to rugs and furniture. In Texas where I live, the number of times during the winter it freezes hard enough to break pipes can be counted on the fingers of one hand. However, only one mishap is enough to cost significant money. Also, since freezing weather is something we Texans normally let the folks up north deal with, most of our houses (and the plumbing in them) are not really designed to withstand the week-long plunges below 20 degrees. For example, I have a few outside faucets that insist on freezing at every opportunity. Putting covers over them works for a short time, but in extended freezes, they freeze-up solid. Letting them drip is often a sure cure, but after a week of dripping, a lot of water is wasted and some mighty respectable ice cones have built up.

While there are many things you can do to winterize your house in general (see the boxed text entitled "A Winter Arsenal") I wanted a solution to this yearly nuisance in particular. The solution had to be simple, reliable, and able to work totally unattended. My solution was to build a circuit called the Freeze Fighter that automatically warms outdoor faucets once the temperature drops to the freezing point.

The Design Process. I wanted to go on vacation, leave the house, and let the system handle any "blue norther" that might blow in. Therefore I needed a device to sense temperature and take appropriate action. Fortunately, National Semiconductor makes an integrated circuit that is designed to sense temperatures and turn devices on or off with changing temperatures. This IC is the LM3911; an 8-pin device containing a voltage reference, a temperature sensor, and an op-amp. With the addition of a few resistors, this IC can be configured into a complete temperature controller that will switch an external load with rising or falling temperatures. Now I had to figure out how to take the on/off signal generated by the controller and use it to keep the faucets warm.

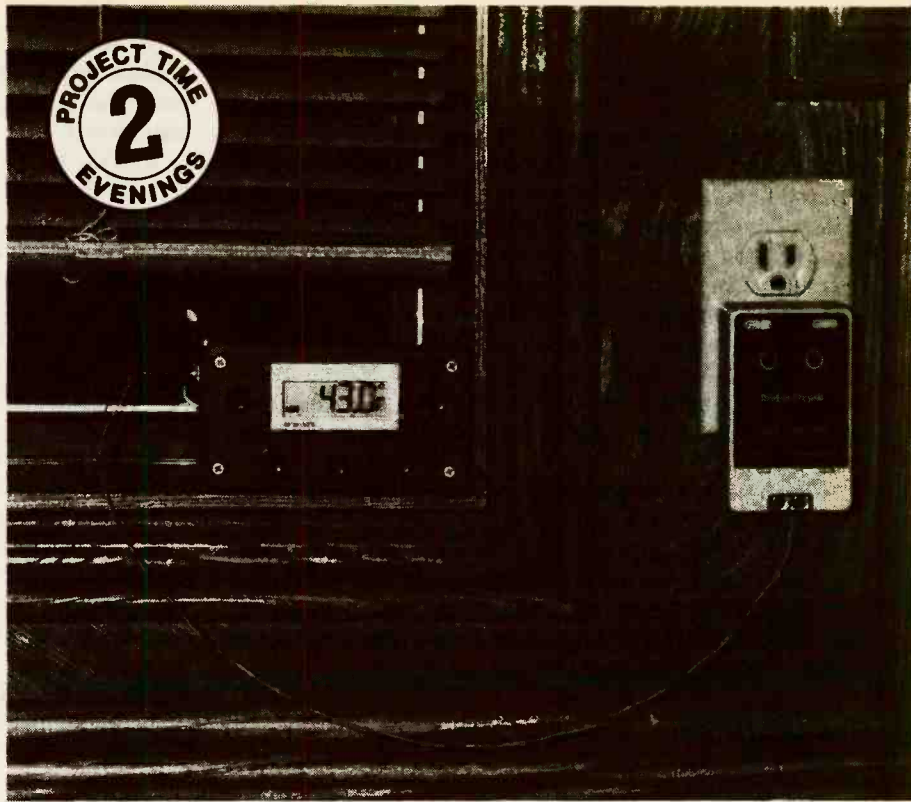

FREEZE FIGHTER

Keep your outdoor faucets warm in cold weather, and control your air conditioner in the summer.

BY DAVID H. PENROSE

Luckily, very little energy is needed to keep a faucet from freezing. A few watts of power should keep most faucets cheerfully warm. I decided to strap a 50-ohm, 10-watt resistor to the faucet using a hose clamp, and then apply enough voltage to produce about five watts of heat. I determined that a 13-volt, AC-to-AC adaptor, which will result in about 4 watts when terminated in the 50-ohm resistor, would be adequate. A 50-ohm resistor with 13 volts across it is going to pull about 300 milliamps. The adaptor is rated at 800 milliamps so the adapter was chosen with that current rating. I do not recommend using a DC adaptor for any extended period, since in a wet environment, a plating effect could occur which would eventually destroy the connections at the resistor.

The only problem left to solve was how to take the small control voltage available from the controller, and use it to turn the 13-volt supply on and off.

The application notes on the LM3911 show a method of controlling a relay or similar device using a transistor switch. This would work fine if there was just a single faucet to protect, but my house has three that are vulnerable to freezing. I didn't want to string wire from one to another and use multiple control relays, nor did I want to produce three copies of the control circuit.

Radio Shack's universal interface for their "Plug'n Power" home controllers provided a solution. The interface will accept almost any kind of signal on its input, and will activate any number of remote modules through the house wiring when the signal is received. Adding a matching remote-controlled appliance module or a special wall outlet (both available from the same source) completes the system. Figure 1 illustrates the major components of the system and how they might be used to protect two faucets. Note that both a controlled outlet and

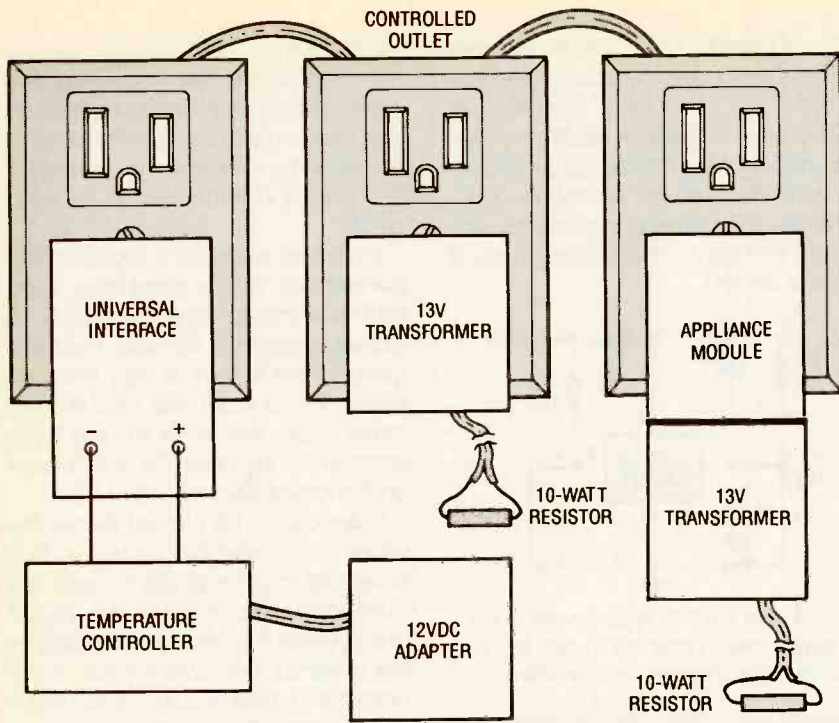

Fig. 1. A few components must be added to the temperature controller to complete the Freeze Fighter. This illustration shows two options for the remote devices: a remote-controlled outlet and a plug-in controller.

an appliance module are shown to indicate how both are connected. Before discussing the Freeze Fighter control circuit, it would be wise to explain a little about the operation of the LM3911 and the interface modules, so I'll deal with them next.

All-in-One Temperature Controller.

As mentioned, the heart of the Freeze Fighter is an LM3911 Temperature Controller IC. As you can see in Fig. 2, this clever IC incorporates a voltage reference, a temperature sensor, and an op-amp all in one 8-pin package. The voltage reference allows this chip to operate over a wide temperature range and also allows the unit work with accuracy over a wide power-supply range. The reference is a 6.8-volt active shunt regulator connected between pins 1 and 4 of the IC. In order to operate properly, this reference must be wired in series with an external current-limiting resistor. The selection of this resistor and the input voltage determines in part how much power is dissipated by the package. The application information on the LM3911 recommends values ranging from 3.5k to 12k depending on the application.

The sensor incorporated in the IC produces an output voltage that is di-

rectly proportional to temperature in degrees Kelvin at $10\text{mV}/^\circ\text{K}$. The sensor is powered by the internal reference and feeds the positive input of the on-board op-amp. If the output of this op-amp is tied back to the feedback input on the package, the $10\text{mV}/^\circ\text{K}$ will be available for external use.

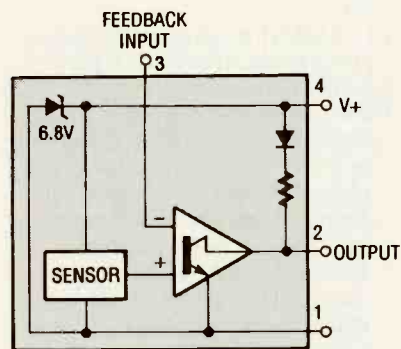

Fig. 2. There are only a few building blocks inside the LM3911: a voltage reference, a sensor, a comparator, and a pull-up network.

The internal op-amp can also be configured as a comparator. This is the mode used for the Freeze Fighter. To use this mode, the feedback input pin is supplied a voltage that corresponds to the desired temperature setting. The internal op-amp then compares this voltage to the voltage

being generated by the sensor and switches high or low if the temperature is lower or higher than the set point. The passive output of the op-amp is pulled high by an internal resistor and series diode.

Remote-Control Using House Wiring.

The universal interface controller and the remote-controlled outlet or appliance module used in the Freeze Fighter are only a few selections from a wide array of different home-automation devices available from Radio Shack, Heathkit, and other suppliers. The devices all use an interface adhering to the X-10 standard to send control signals over a home's AC-power lines. These devices have existed for a number of years and have gone through a number of refinements to make them more reliable and flexible.

The universal interface controller is a remarkable device in that it allows almost any type of control input to generate command signals to other devices in the house. The controller can accept a switch closure, or a low-level AC or DC signal at its input. It can then turn on one or more devices that match the address set through switches on its faceplate. The control inputs can be momentary or continuous, and the controlled devices can be turned on or flashed.

This device was obviously designed as an interface for alarm circuits, but it is also perfect for computer control. A computer can easily generate the output signals required to control remote devices. Granted, the device can only address devices corresponding to its switch settings, but this is usually not a major limitation. For the purposes of the Freeze Fighter, the Controller works perfectly.

The remote-control devices come in a number of different packages with a variety of functions. The devices recommended in this article are designed to be used to turn an appliance on and off. Other units that are designed for incandescent lights can vary the brightness of the light over a number of steps. These devices are not appropriate for the Freeze Fighter, and can cause the user significant problems if accidentally connected to fluorescent lights or other devices that allow only on/off control.

Little difficulty should be encoun-

tered in using the devices, since most of them just plug in. In some cases, devices plugged into different legs of the house's power line may not be able to communicate with each other. However, some means do exist to correct this problem. One method is to place capacitors across the different legs of the power line at the house's junction box. If you encounter this problem, I would recommend that you search around for outlets that do share a common supply leg, rather than paying an electrician to install the capacitors. I would never recommend attempting to install these capacitors yourself.

Winterizing.

The Freeze Fighter is only one weapon in the war against winter. A homeowner should be prepared with both active and passive defenses against freezing temperatures.

One of the best passive tools is pipe insulation. Sections of foam tubes can be bought that easily wrap around exposed pipes. This wrap helps trap the heat of the water and thus prevent freezing during mild freezes. A properly designed house will have all exposed pipes covered with this tubing or some other form of pipe insulation. Houses designed to withstand the killer freezes of the northern climates will have all the pipes protected within the warm core of the house. Faucet extensions allow the water carrying pipes to be inside the insulated walls while the controls and outlets are on extensions that are accessible from outside the house. An ideal configuration has a separate system for pipes that are in danger of freezing so that this system can be turned off and drained during winter. In milder climates, these precautions are overkill, and most of the time a foam bonnet on the exposed faucets prevents disaster.

Active defense systems consist of the Freeze Fighter described in this article and the electrical heating tape that can be wrapped around pipes. This tape is powered by house current and can be purchased in a number of different lengths, with or without built-in thermostats. This tape is an excellent defensive measure for those houses with exposed pipes that are prone to freezing. This tape should be used in accordance with all the instructions that come with it. Tape which is improperly used can destroy plastic pipes or even cause fires. The tape should not be placed in walls or other enclosed spaces, nor should it be overlapped on itself. Power consumption is minimal—the cost of warming pipes is considerably less than that of replacing them after they break. ■

The Circuit. The LM3911 requires very few external components to implement a full-function temperature controller. Figure 3 illustrates the simplicity of the Freeze Fighter circuit. The resistor network consisting of R1, R2, and R3 is used to provide the set-point voltage for the feedback input of the LM3911.

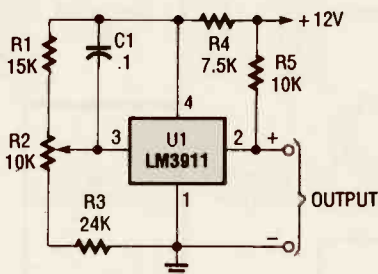

Fig. 3. The LM3911 requires only a few resistors and a capacitor to turn into a full-function temperature controller.

PARTS LIST FOR THE FREEZE FIGHTER

RESISTORS

(All fixed resistors are 1/4-watt, 5% units.)

- R1—15,000-ohm
- R2—10,000-ohm miniature trimmer potentiometer
- R3—24,000-ohm
- R4—7,500-ohm
- R5—10,000-ohm

ADDITIONAL PARTS AND MATERIALS

- C1—0.1μF, ceramic or Mylar capacitor
- U1—LM3911 temperature controller, integrated circuit (Digi-Key LM3911N)
- Universal interface module (Radio Shack 61-2687), a 12-volt DC adaptor, a case with perfboard, jacks and plugs if desired, wire, solder, etc.
- For each faucet you'll also need a 13-volt, 800-mA power transformer, a 50-ohm, 10-watt resistor, a hose clamp, and an appliance controller (Radio Shack 61-2681 or 61-2684) or remote-controlled outlet (Radio Shack 61-2685).

Resistor R4 limits the current through the internal voltage reference of the LM3911 and can be selected from a wide range of values. I chose 7.5k, which is specified in most of the application notes.

Resistor R5 pulls the output of the IC high when the temperature is below the set-point. The internal 50k resistor probably would have been sufficient

for this project, but I included the external 10k resistor just to be safe. The internal resistor is in series with a diode that allows a switching voltage up to 35 volts to be used with the device. For the Freeze Fighter, 12 volts is adequate.

If ultimate reliability is required, dispensing with R2 is a good idea. To do that you should wire the circuit as shown, calibrate R2 with the procedure that follows a little later, remove R1–R3 from the circuit, and install larger values for R1 and R3 to account for the absence of R2 based on the calibration setting of R2.

Capacitor C1 is placed across the wiper of the variable resistor to limit noise that may be present. These few components complete the circuit and provide the interface required by the universal interface module. If the application had required switching a voltage on with a rising temperature, an additional transistor would have been required on pin 2 of the IC to invert the output.

Construction. Any typical method of construction (point-to-point wiring, wire-wrapping, or PC-board mounting) is suitable for this project. I chose to use point-to-point wiring on a perfboard that comes with its own plastic case. If you choose to do the same, clean the perfboard well with some steel wool or other cleansing agent to insure that the copper pads are free of all oxidation. I soldered the IC directly to the board rather than using a socket to avoid the potential corrosion problems that may develop when the circuit is used outside over extended periods.

One additional caution when working with this IC: the positive voltage is attached to the bottom leg of the package (pin 4) where most other IC's have the ground attached. The ground on this IC is attached to pin 1 which is the top pin. Confuse these pins and the temperature-controller IC becomes a fuse.

Once you have your own temperature controller mostly built, you must decide on a power source. I powered my circuit from an AC adaptor I had available. If you don't have one in your junkbox, purchase a small 12–15 volt DC unit. The circuit draws very little current, so any adaptor rated at a suitable voltage will do.

I mounted the perfboard in the case with the components facing the plastic rather than the aluminum face plate, and drilled a number of holes in the side of the box to insure that the sensor was exposed to ambient air. Use caution when drilling these holes so as to not drill through the supports for the PC board, which are at the corners of the box. Power is supplied through a DC coaxial jack and the output is terminated in a 2-conductor miniature phone jack. These jacks are not necessary and could be replaced with direct connections. I included them because it makes it easier to string the power and signal connections through small openings.

Calibration. Now it's time for calibration. The relationship between the voltage at pin 3 of U1 and the desired temperature set-point is $10\text{mV}/^\circ\text{K}$. Since absolute zero Kelvin is equal to -273.4°C , a temperature of 0°C will result in an output voltage from the sensor of 2.734 volts. The resistor network values were chosen so that the same amount of voltage is obtained with the wiper of variable resistor R2 near its mid-point, so start by setting R2 to its middle position.

You will be required to check the voltage set by R2 shortly. However, be careful when measuring this value because the IC is not looking for a voltage referenced to ground, but instead is looking at the difference between the voltage at pin 4 and this set-point voltage. That seems simple enough until you fall back on old habits of connecting the black lead of the multimeter to ground and then measuring the voltage at pin 3. It took me a few minutes to realize that the circuit was working properly but that I wasn't.

That said, connect the black probe of your meter to pin 3 and the red probe to pin 4. Apply power and adjust R2. As you adjust the voltage you should find a point at which the circuit just switches on or off. At normal room temperature that should happen at about 2.98 volts, which is 250 millivolts above the zero point of 2.73 volts. The presence of 250 millivolts at $10\text{mV}/^\circ\text{K}$ would indicate a room temperature of about 25°C . Now adjust R2 until you get as close as possible to 2.734 volts. This should calibrate the unit for the freezing point.

You can verify the calibration with

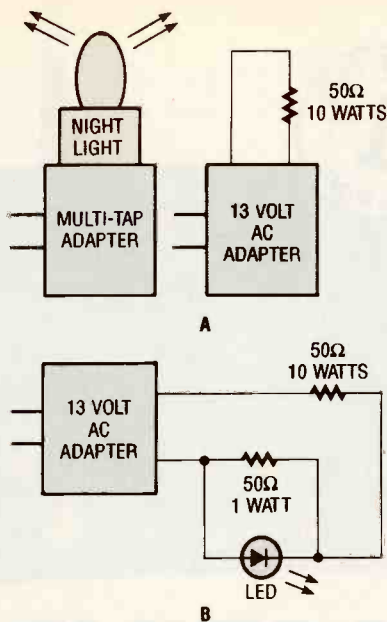

Fig. 4. If you want to monitor the operation of one of the faucet stations you could augment it with a cube adapter and a night light (A), or a resistor and LED (B).

just a little extra work. First place the sensor in your refrigerator and verify that it does not switch on, move it to your freezer and in a few minutes it should switch on.

Set Up. On the Plug'n Power interface connect the terminal labeled "+" to the output from pin 2 on the temperature controller. Connect the "-" terminal to the ground connection of the temperature controller. Make sure you have set the mode switches on the interface for an on/off control of the addressed device ("input select" to 1 and "mode select" to 3), then select the house code and unit code settings you wish to use for all the devices. The remote units must be set to the same house and unit codes.

I placed the controller outside near a window and ran the wire between the window and the frame. The seals on my windows allowed this. If this won't work on your window, you'll have to find some other way of exposing the controller to the outdoor temperature. If you must drill through the wall, plug the opening with caulk to keep the bugs out, and put a loop in the portion of wire that is outside to keep the rain from following it in.

Plug a 13-volt transformer into each remote module and run its leads out-

side as you did for the temperature controller. Use common sense in placing the resistor's transformers (and thus the remote modules); they can get warm when operating and should not have any drapes or flammable material near them. Connect each transformer output to its intended high-wattage resistor and cover the joints with high-temperature tubing. Avoid plastic that could melt at the elevated temperature. Physically attach each 10-watt resistor to its faucet with a hose clamp and you are done.

Improvements. I put foam covers over the faucets and taped a temperature sensor from an electronic thermometer (Radio Shack 63-842) to the faucet to monitor the effect of the heater until I was comfortable with it. You might do the same, and then adjust R2 until the desired effect is achieved. If you wish to have an operation indicator for each faucet station, you can put a multi-tap adaptor on the remote unit and include a small night light to indicate when the unit is activated (see Fig. 4A). An even more fool-proof device is illustrated in Fig. 4B. There, the current flowing through the load resistor induces a voltage drop in a monitoring resistor. The voltage drop can be used to power an LED. Make sure the wattage of the monitoring resistor is large enough so if the load resistor shorts-out, the full load current will not cause any damage.

Summertime. This same controller with minor modifications can be used in the summertime to help control the air conditioner in your house. To use the controller in that way, rewire it to include an inverting transistor on the output lead. Mount the heating resistor under the air conditioner's thermostat and set the thermostat to a high temperature. Now when the outside temperature exceeds the maximum you program via R2, the heating effect of the resistor will turn on the air conditioner. This will take some careful adjustment of the resistor because eventually you want the air conditioner to turn off.

The Freeze Fighter can be used in many more applications around the home and in the car. Let your imagination work, and see what you can come up with. ■

If you have a shortwave or high-frequency receiver or scanner that is struggling to capture signals with a short, whip antenna, and you'd like the kind of performance that a 60-foot long-wire antenna can provide but lack the space to put one up, consider building the AA-7 HF/VHF/UHF Active Antenna described in this article.

The AA-7 is a relatively simple antenna that is designed to amplify signals from 3 to 3000 megahertz (MHz), including three recognized ranges: 3–30 MHz high-frequency (HF) signals; 30–300 MHz very-high frequency (VHF) signals; 300–3000 MHz ultra-high frequency (UHF) signals. Those bands are typically occupied by shortwave, ham, government, and commercial radio signals.

Active Antennas. In its simplest form, an active antenna uses a small whip antenna that feeds incoming RF to a preamplifier, whose output is then connected to the antenna input of a receiver. Unless specifically designed otherwise, all active antennas are intended for receive-only operation, and thus should not be used with transceivers; transmitting into an active antenna will probably destroy its active components.

A well-designed broadband active antenna considers field strength of the desired signal (measured in microvolts per meter of antenna length), atmospheric and other noise, diameter of the antenna, radiation resistance, and antenna reactance at various frequencies, plus the efficiency and noise figure of the amplifier circuit itself.

Circuit Description. Figure 1 shows a schematic diagram of the AA-7, which contains only two active elements; Q1 (an MFE201 N-channel dual-gate MOSFET) and Q2 (a 2SC2570 NPN VHF silicon transistor). Those transistors provide the basis of two independent, switchable RF preamplifiers. Two double-pole double-throw (DPDT) switches play a major

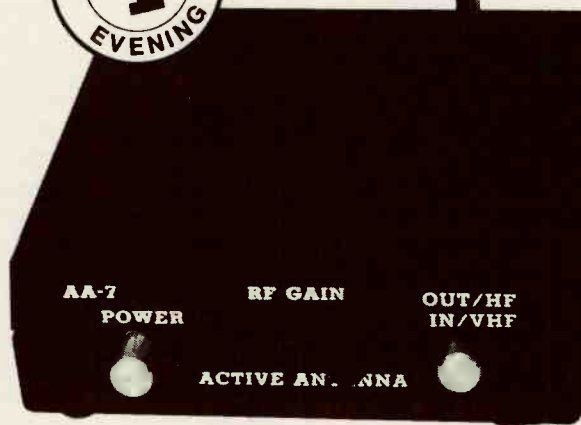

ACTIVE ANTENNA

*Lift hard-to-hear signals
out of the mud with
this handy receiver accessory.*

BY FRED BLECHMAN

role in the operation of the AA-7. Switch S1 is used to select one of the two preamplifier circuits (either HF or VHF/UHF). Switch S2 is used to turn off the power to the circuit, while coupling the incoming RF directly to the input of the receiver. That gives the receiver non-amplified access to the auxiliary antenna jack, at J1, as well as the on-board telescoping whip antenna.

With switch S2 in its power-on position, the input and output jacks are disconnected and B1 (a 9-volt transistor-radio battery) is connected to the circuit. With switch S1 in the position shown in the schematic, incoming RF is directed to the HF preamp circuit built around Q1 (an MFE201 N-channel dual-gate MOSFET). The HF preamp operates with an exceptionally low noise level, and is ideal for copying weak CW and single-sideband signals.

When S1 is switched to the other position, the captured signal is cou-

pled to the VHF/UHF preamp built around Q2 (a 2SC2570 NPN VHF silicon transistor), which has excellent VHF through microwave characteristics. With the on-board whip antenna adjustable to resonance through much of the VHF-UHF region (length in feet = 234 divided by the frequency in MHz), the VHF/UHF mode is ideal for indoor and portable use with VHF scanners and other receivers.

Either mode can be used when tuning 3–30-MHz HF signals. The VHF/UHF preamp offers higher gain than the HF preamp, but also has a higher noise level. You can easily choose either amplifier for copying any signal of interest—just try both S1 positions. The RF gain control (R5) can be used to trim the output of either amplifier.

Caution: The AA-7 is not intended for transmitting operations (be it ham, maritime, or CB); if it is used with a transceiver of any kind, make sure it is not possible to transmit by accidentally pressing a mike button or CW keyer. Transmitting RF into the AA-7 is likely to ruin one or both of the transistors in the circuit.

Construction. The AA-7, which can be built from scratch or purchased in kit form from the supplier listed in the Parts List, was assembled on a printed-circuit board, measuring about 4 by 4 $\frac{1}{8}$ inches. A template for the printed-circuit board is shown in Fig. 2. You can either etch your own board from that template, or purchase the circuit board or a complete kit of parts (which includes a printed-circuit board and all parts).

The kit comes with a 16-page kit assembly and instruction manual that gives step-by-step assembly instructions and contains additional information not covered in this article. Kit assembly time, working slowly and carefully, should take less than an hour.

Most of the parts specified in the Parts List are standard components and can be procured through conventional hobby electronics suppliers.

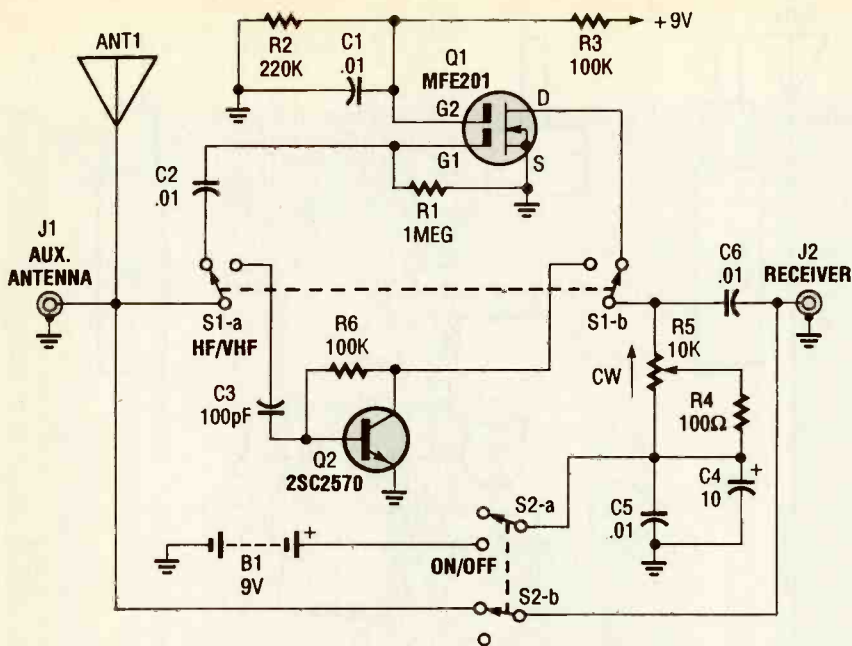

Fig. 1. The AA-7 Active Antenna contains only two active elements; Q1 (an MFE201 N-channel dual-gate FET) and Q2 (a 2SC2570 NPN VHF silicon transistor), which provide the basis of two independent, switchable RF preamplifiers.

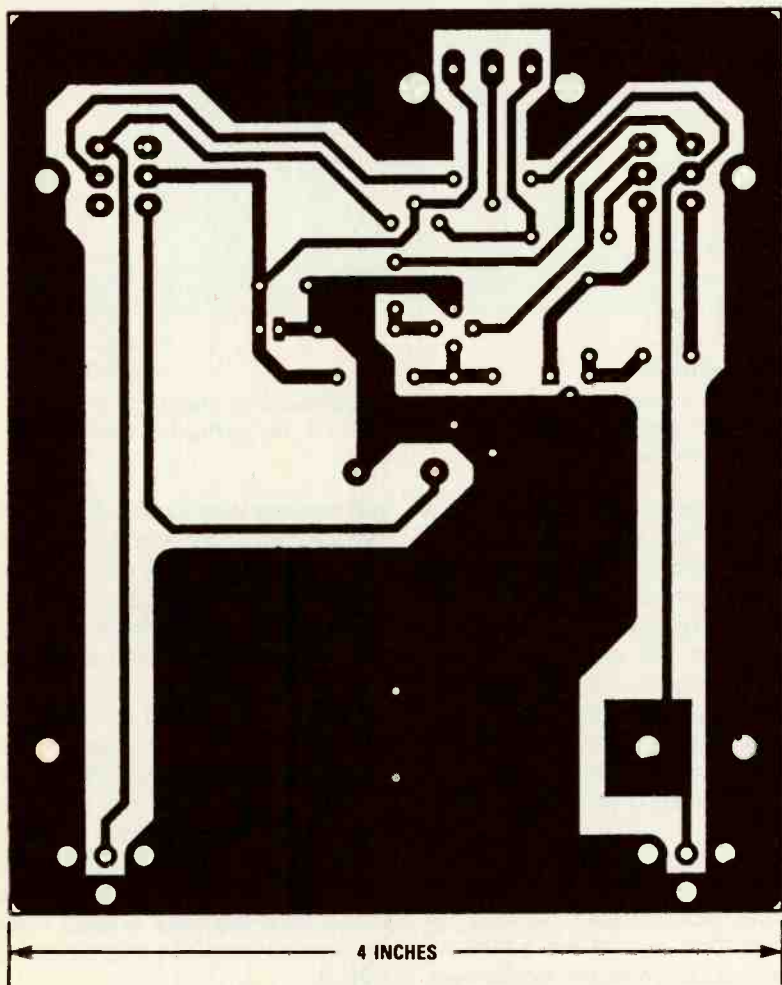

Fig. 2. The AA-7 was assembled on a printed-circuit board, measuring about 4 by 4¹¹/₁₆ inches. A template for the printed-circuit board is shown here.

PARTS LIST FOR THE AA-7 ACTIVE ANTENNA

SEMICONDUCTORS

Q1—MFE201, 3N204, or SK3991 N-channel, dual-gate MOSFET (see text)*

Q2—2SC2570, 2N5179, or SK9139 NPN VHF silicon transistor (see text)*

RESISTORS

(All fixed resistors are 1/4-watt, 5% carbon units.)

R1—1-megohm

R2—220,000-ohm

R3, R6—100,000-ohm

R4—100-ohm

R5—10,000-ohm potentiometer*

CAPACITORS

C1, C2, C5, C6—0.01- μ F, ceramic-disc

C3—100-pF ceramic-disc

C4—4.7- to 10- μ F, 16-WVDC, radial-lead electrolytic

ADDITIONAL PARTS AND MATERIALS

MATERIALS

B1—9-volt transistor-radio battery

S1, S2—DPDT PC-mount

pushbutton switch*

J1, J2—PC-mount RCA jack*

ANT1—Telescoping whip antenna (screw mount)*

Printed-circuit materials, enclosure, battery holder and connector, wire, solder, hardware, etc.

Note: The following items are available from Ramsey Electronics, Inc. (793 Canning Parkway, Victor, NY 14564; Tel. 716-924-4560): A complete kit of parts (order #AA-7BP), including printed-circuit board, \$24.95; and drilled printed-circuit board only (order #AA-7PCBP), \$10.00; special parts kit, containing all items marked with an asterisk (*) in the Parts List (order #AA-7SPKBP), \$14.50; custom case and knob set (order #CAA-BP), \$12.95. Please add \$3 for orders under \$20, and \$3.75 for postage/handling. New York residents, please add appropriate sales tax.

However, some parts—J1, J2, S1, S2, and R5—have particular physical mounting dimensions; the board is designed to accept those parts. In addition, Q1 and Q2 can be hard to find; however, it is possible to make substitutions provided that you can find a supplier. Suitable replacements

for Q1 and Q2 are given in the Parts List.

The telescoping whip antenna screw-mounts to the board; the screw provides contact between the printed-circuit board traces and the antenna. To save time and trouble locating and ordering hard-to-find parts, a Special Parts Kit is also offered by the supplier listed in the Parts List.

A parts-placement diagram for the AA-7's printed-circuit board is shown in Fig. 3. When assembling the circuit, be especially careful that transistors Q1 and Q2, and electrolytic capacitor C4, are oriented as shown.

Although not shown in the schematic (Fig. 1) or the parts-placement (Fig. 3) diagrams, an optional LED power indicator can be added to the circuit. Adding a power indicator to the circuit allows you to tell at a glance if the circuit is on; leaving the circuit on, even though the AA-7 draws only about 0.7 mA, will eventually discharge the battery. Of course, adding an LED will increase the current drain by about 7 mA, but the red glow makes it obvious when the unit is on.

If you decide to include the indicator in your project, power for the indicator can be easily taken from the switched 9-volt DC terminal of S2 (center terminal, right side, looking at the top of S2). Simply connect the positive voltage to the anode (longer wire) of the LED and connect the cathode lead through a current-limiting resistor of about 1000 ohms to a ground point on the printed-circuit board, or as the author did from the frame of R5. Mount the LED at any

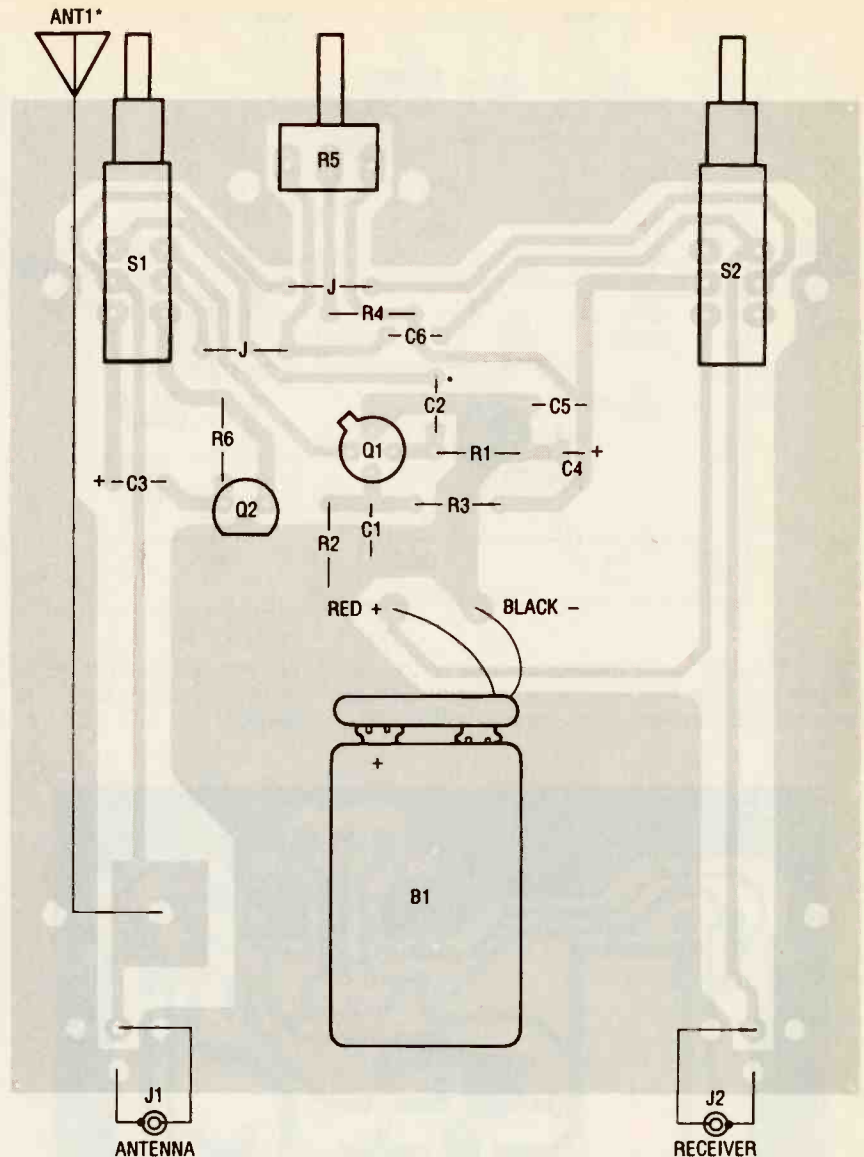

Fig. 3. When assembling the AA-7's printed-circuit board, be especially careful that transistors Q1, and Q2, and electrolytic capacitor C4, are oriented as shown in this parts-placement diagram.

TYPES OF ACTIVE ANTENNAS

The RF preamplifier section of an active antenna may be of several different styles. A fixed-tuned preamplifier has the greatest gain for the specific frequency of operation, but is limited to only that frequency. A variable-tuned amplifier can be peaked within a range of frequencies, but the circuitry is more complex and expensive, and tuning requires constant resetting whenever the receiver frequency is changed. A broadband preamplifier doesn't require any tuning, making it very versatile and easy to use, but has less gain at any specific frequency. The AA-7 described here, for simplicity and low cost, is of a dual broadband design.

convenient point near the switch.

Although not supplied with the kit, a custom plastic enclosure (with front and back panels, and knobs for the switches and gain control) is offered in the Parts List. The enclosure comes pre-drilled and silk-screened with the appropriate legends for all the circuit controls and connectors, but is not equipped with holes for the whip antenna or the LED (if you include one).

Use. Prepare a coaxial cable to connect the RF output of the AA-7 to the antenna input of your receiver or scanner. One end of the interconnecting cable must be terminated with an RCA phono plug; the other end connector depends on the tar-

get receiver. With some receivers, the only practical connection is to clip the output of the AA-7 to the receiver's antenna, although that connection method won't be as effective as conventional (ground-return type) coupling.

To increase signal strength, especially for the lower frequencies, you can connect a simple supplementary portable antenna of any design (a dipole, a random-length wire with Earth ground, a bigger vertical whip of some kind, etc.) to the circuit. Just use a small-diameter coaxial cable terminated in an RCA plug for mating with J1.

No alignment is required. If you're
(Continued on page 112)

Ions are defined as electrically charged atoms. Positively charged ions have a deficiency of electrons, and negatively charged ions have a surplus of electrons. An ion can also be classified as an atom or molecule with an electrostatic charge. Another classification of an ion is a charged particle that is formed when one or more electrons are taken from or added to a previously neutral atom or molecule.

The *Ion Detector* described in this article can be used to detect the presence, and indicate the relative amount, of free ions in the air. The Ion

Detector, a handheld unit about the size of a pack of cigarettes, is designed to indicate ion emissions from ion generators, high-voltage leakage points, static-electricity sources, electric-field gradients, and in other situations where the presence of ions or a measurement of their relative flux density is required.

The front cover features, a sensitivity control with on-off switch, a high-flux indicator lamp, and a panel meter. An antenna, mounted on the top of the unit, serves an external ion collector. A strip of metallic foil on the outside of the plastic enclosure touches the users hand and is used to ground the unit. For fixed applications, the strip can be replaced by a wire connected to ground.

Circuit Description. Figure 1 shows a schematic diagram of the Ion Detector—a rather simple circuit consisting of three transistors, (two PN2907 PNP units, and a single PN2222 NPN unit), three resistors, an antenna, and an LED.

In that circuit, a telescoping antenna is used as the pickup. In the presence an ion field, ions accumulate on the antenna, causing a minute negative current to flow to the base of Q1. Capacitor C1 and resistor R1 form an RC network, whose function is to eliminate any rapid fluctuations. Once the negative current becomes large enough, it causes Q1 to turn on, connecting the negative terminal of battery B1 to the base of Q2. That forward biases Q2, causing it to turn on. That, in turn, couples the base of Q3 to the positive terminal of the battery, for-

ward biases Q3—whose collector is in series with current-limiting resistor R2 and meter-sensitivity control R3—causing it to conduct.

With Q3 turned on, meter M1 indicates (in a non-linear manner) the relative level of ion flux, while LED1 (which is connected in series with Q3's emitter) lights to give a visual indication of strong ion fields. It should be noted that in order for the unit to operate properly, some sort of ground is usually required.

Metallic tape is used in the prototype to provide a convenient contact for the users hand, thereby providing a partial ground. If possible, such as when the unit is used as a monitor at a permanent location, the detector should be grounded to a water pipe, or some other convenient grounding point.

The detector is set up to detect negative ions. It can be made to detect positive ions by simply reversing the polarity of the transistors that comprise the circuit; *i.e.*, PNP units become NPN units, and the NPN transistor is replaced by a PNP unit. It should note that the performance of the detector is seriously affected by high humidity. Damp or moist air tends to impair the circuit's ability to detect ion flux.

The Ion Detector can be used to give a quick indication of the presence of a negative ion field, aid in identifying its source, and indicate its relative strength, but it is not designed to provide an absolute measurement of flux intensity. The circuit can also be used to aid in making adjustments to ion sources, by noting the meter's needle deflection as you attempt to increase or decrease ion emissions. The Ion Detector can also be used to ferret out residual ion fields, check for ion leakage (in shielding tests, for example), or to test for static charges (in people's clothes, fluorescent lighting,

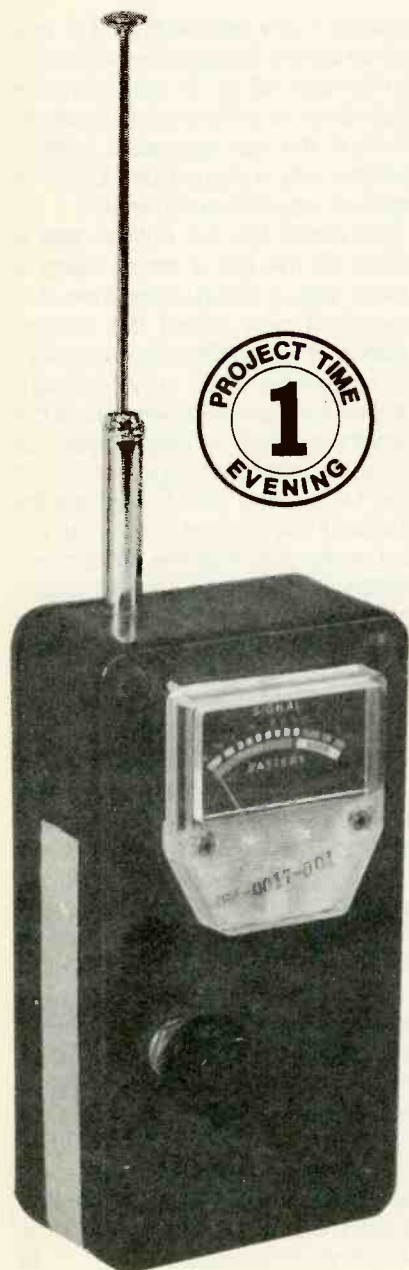

Build an Ion Detector

BY VINCENT VOLLONO

This simple circuit lets you track down sources of high-voltage leakage, static build-up, and more.



The author's prototype of the Ion Detector was housed in a small plastic enclosure, measuring about 4 $\frac{3}{8}$ by 2 $\frac{1}{8}$ by 1 $\frac{1}{16}$ inches. Note the strip of tape running along the side of the enclosure, which is used to ground the circuit via the user's hand contact. The strip can be supplemented or replaced by a wire connected to the same point in the circuit and terminated at the other end with an alligator clip.

plastic containers, certain winds, etc.), along with a host of other applications.

Construction. The author's prototype of the Ion Detector was assembled on a section of perfboard, using point-to-point wiring for inter-component connections. Pay close attention to the orientation of the polarized components (diodes, transistors, electrolytic capacitors, etc.), as well as the polarization of the DC source that will power the circuit, when assembling the circuit. It is very important that you verify all your inter-connecting wiring.

It is highly recommended that the circuit be enclosed in a plastic project box. Once the circuit is completed, a $\frac{1}{2}$ -inch wide strip of aluminum is attached to the side of the enclosure, and is then connected to the circuit

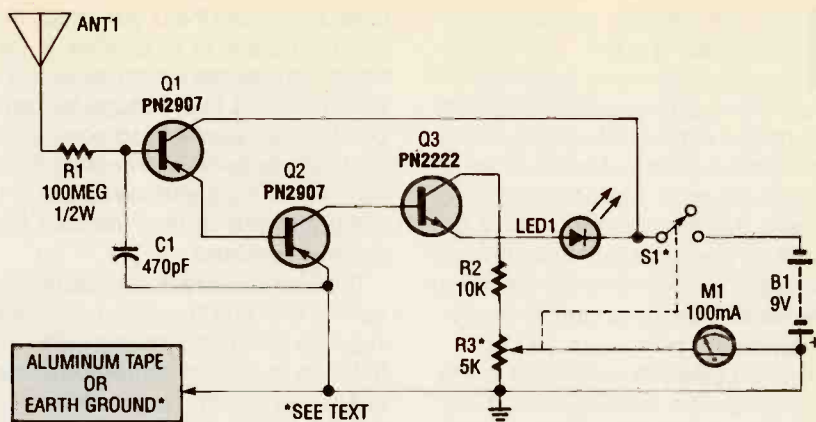

Fig. 1. The Ion Detector is a rather simple circuit consisting of three transistors, (two PN2907 PNP units, and a single PN2222 NPN unit), three resistors, a telescoping antenna (which is used as the ion pickup), and an LED.

PARTS LIST FOR THE ION DETECTOR

- Q1, Q2—PN2907 general-purpose PNP silicon transistor
- Q3—PN2222 general-purpose NPN silicon transistor
- LED1—Light-emitting diode
- R1—100-megohm, $\frac{1}{2}$ -watt, 5% resistor
- R2—10,000-ohm, $\frac{1}{4}$ -watt, 5% resistors
- R3—5000-ohm potentiometer (see text)
- C1—470-pF, ceramic-disc capacitor
- M1—100-mA panel meter
- B1—9-volt transistor-radio battery
- S1—see text

ADDITIONAL PARTS AND MATERIALS

- Perfboard materials, plastic enclosure, 9-volt battery holder and connector, wire, solder, hardware, etc.

board (at the junction of C1, the positive lead of the panel meter, and the positive terminal of the battery) as shown in Fig. 1. The aluminum strip serves as the circuit's grounding point. That grounding strip can be replaced or supplemented by a wired alligator clip for connection to a "true" earth ground (a water pipe, for instance).

The author used a telescoping antenna as the ion pickup in his prototype unit; however, a piece of stiff wire (a wire hanger, for example) would also work. In either case, the antenna must be electrically isolated; i.e., it should not be connected to

ground in any way. Note that S1 (the on-off switch) is piggy-backed to potentiometer R3 (a 5k potentiometer that serves as the meter's sensitivity control). You can also use a potentiometer with a piggy-back switch or use two separate components.

For meter M1, the author used a small 100-mA panel meter; using a meter with a rating other than that specified may effect the performance of the unit. It is also important to remember that any leakage around the input of Q1 will reduce the circuit's sensitivity. To help prevent (or at least reduce) leakage, the circuit can be coated with a high-quality varnish. If you decide to coat the circuit, make sure that the unit is completely clean and dry before applying the varnish.

Use. To demonstrate the unit's sensitivity, run a plastic comb through your hair, and place it near the antenna of the Ion Detector. Making sure that the unit is grounded (either by the user touching the aluminum strip or by connecting an earth ground to the circuit), bring the comb near the antenna. As the comb is brought near the antenna, you'll note a needle deflection on the meter (indicating the presence of ions), and LED1 lights. As the detector is brought closer to the ion source, the meter needle should deflect harder. If the needle deflects too hard (pegs), R3 can be adjusted to bring the meter reading on scale.

That's all there is to it. While the Ion Detector is not a precision instrument, it can come in handy in your workshop or laboratory. ■

ELECTRONICS LIBRARY

(Continued from page 13)

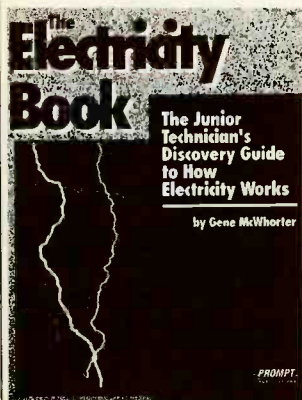

amples, the book guides junior-high and older students through the principles of electricity. Topics covered include atoms, protons, electrons, and neutrons and how their charges attract or repel one another; motor action and how it is produced; voltage, current, and resistance; and magnetic fields. Each chapter includes applications for various projects and experiments, and ends with a self-test for what the student has learned about electricity. Bold two-color graphics are used in the book and are designed to hold a the young reader's interest.

The Electricity Book costs \$14.95 and is published by Prompt Publications, Howard W. Sams & Company, 2645 Waterfront Parkway, East Dr., Indianapolis, IN 46214; Tel: 317-298-5710; Fax: 317-298-5604.

CIRCLE 85 ON FREE INFORMATION CARD

THE MODERN CONVERTER AND FILTER CIRCUIT ENCYCLOPEDIA

by Rudolf F. Graf

This book contains a large assortment of ready-to-use circuits sure to meet the converter and filter needs of engineers, technicians, students, and hobbyists. Representing state-of-the-art technology, the circuits include analog-to-digital and digital-to-

analog converters; current-to-voltage and frequency-to-voltage converters; temperature-to-frequency converters; frequency converters; and band-pass, high-pass, low-pass, notch, noise, and state-variable filters. For easy reference, the circuits are arranged alphabetically by application. Each entry includes a schematic and a brief explanation of how the circuit works.

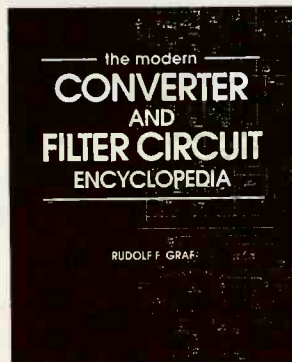

The Modern Converter and Filter Circuit Encyclopedia costs \$12.95 and is published by Tab Books Inc., Blue Ridge Summit, PA 17294-0850; Tel: 800-233-1128.

CIRCLE 98 ON FREE INFORMATION CARD

1994 CATALOG

from Radio Shack

Radio Shack calls its largest catalog ever an "encyclopedia of electronics." Within its close-to-200 pages, are featured more than 75 electronic "Buzz Words," brief definitions of terms. In several product categories, helpful hints for smart shopping also are included, and charts make it easy to make feature-by-feature comparisons of each product offered. A page of money-saving coupons is also included.

The full-color, perfect-bound catalog features more than 3000 performance-tested products that fall into such categories as audio, video, computers, telephones, do-it-yourself, automotive, communications, and home and family. New products include such in-



novative items as America's first Digital Compact Cassette (DCC) recorder and the Tandy Z-PDA Personal Digital Assistant, as well as the Optimus Professional Series of audio gear, Optimus home-theater equipment, two stereo satellite systems, a mobile CB radio with digital signal processing, and two multimedia personal computers (MPC).

The 1994 Catalog is available for \$2.95 at more than 6600 participating Radio Shack stores nationwide. For more information, contact Radio Shack, 700 One Tandy Center, Fort Worth, TX 76102.

CIRCLE 91 ON FREE INFORMATION CARD

REPAIRING IBM PCs AND COMPATIBLES: An Illustrated Guide

by Michael F. Hordeski

Written for anyone who uses, manages, maintains, or repairs PC's, this book is based on the philosophy that the better your understanding of your computer's design and operation, the easier it is to discover when and why they are not working correctly. With that aim in mind, the book thoroughly explains the architecture of the IBM-PC families and compatible computers, defines common buzzwords

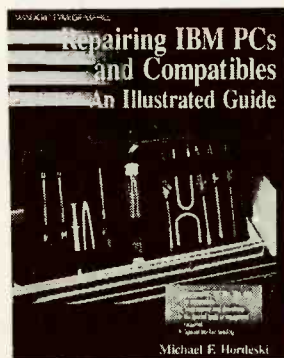

and acronyms, and details effective troubleshooting techniques.

By learning how to maintain your system, you can reduce downtime and its inherent costs. Packed with time- and money-saving diagnostic and repair tips, the book explains the many ways that a PC can fail, how to detect those failures, and how to make the appropriate repairs. Data disasters as well as hard-drive difficulties are covered.

Repairing IBM PCs and Compatibles: An Illustrated Guide costs \$19.95 and is published by Windcrest/McGraw-Hill, Blue Ridge Summit, PA 17294-0850; Tel: 1-800-233-1128; Fax: 717-794-2103.

CIRCLE 96 ON FREE INFORMATION CARD

RIDING THE AIRWAVES WITH ALPHA & ZULU

by John Abbot

If you'd like your children to get their Amateur Radio Novice or No-Code license but couldn't get them to finish reading a license manual, this book could be the answer. Taking a fresh approach to teaching the amateur-radio question pool, it uses a family of "Phonetic" cartoon characters that review every question contained in the pool. Graphics and drawings are used in place of endless pages of text.

Each cartoon episode is one or two pages long and is followed by a mini exam designed to test reader comprehension. Additional teaching tools provided in the book include word searches, crosswords, and other fun puzzles. Each Phonetic character is named after a letter in the Phonetic alphabet, and their bodies are made up of the appropriate Morse code dits and dahs for that letter. Youngsters and adults alike will enjoy following the Phonetics' adventures as they explore and discuss the exciting world of amateur radio.

Riding the Airwaves with Alpha & Zulu costs \$14.95 and is published by Artsci Inc., P. O. Box 1428, Burbank, CA 91507; Tel: 818-843-4080; Fax: 818-846-2298.

CIRCLE 90 ON FREE INFORMATION CARD

THE AUDIO WATER TAP

Add the dimension of sound to your fish tank with this one-evening project.

BY MARC SPIWAK

Ideas for projects don't grow on trees—usually they're the result of wanting to do something that can't be done without some unique gadget. That's exactly how the idea for this project came about. You see, I have a rather large freshwater fish from the Cichlid family known as a "Jack Dempsey" (in Latin it's called *Ciclasoma octofasciatum*). The fish is of a rather violent nature, even more so than most Cichlids (hence the name Jack Dempsey). He can't be kept in a community aquarium among peaceful fish, so he has his own tank.

Besides being able to swallow smaller fish whole, the Jack Dempsey can also swallow whole food pellets. These food pellets are "crunchy" when dry, and "Jack" swallows them as soon as they hit the water. One day while feeding him, I could swear I heard a sort of "crunch, crunch" sound just after he swallowed a pellet. Now although the pellets seem like they would be hard for a fish with no teeth to pulverize, apparently he can do just that.

Thinking about the faint yet strange sounds, I wished that I could somehow amplify them. I had an amplifier circuit with an electret microphone attached to it, but electret microphones shouldn't be placed underwater. If only there were some easy way to waterproof the microphone, then it would be easy to amplify the underwater sounds—or to at least to test the idea.

So I wrapped the microphone in



cellophane, plunked it into the fish tank, and powered up the amp. It worked, but at first all I heard was the filter bubbling away—although much louder than usual. After shutting off the filter, it sounded very much like what you hear when you swim underwater. So then I dropped in a food pellet, and there was that crunching sound, loud and clear.

After listening for a while, static started to replace the nautical theme. The problem was that the cellophane had somehow leaked, and the microphone was actually exposed to water.

Clearly the microphone would need better waterproofing. Let's discuss the method I used to protect the microphone, and the amplifier circuit in greater depth so you can build your own.

The Water Tap. The amplifier circuit is shown in Fig. 1. It's based on a 2-watt TBA820M op-amp, but as you can see from the Parts List, there are a few other chips that are pin-for-pin compatible replacements for it. The circuit is powered from a 9-volt battery. Instead of making a PC board for the

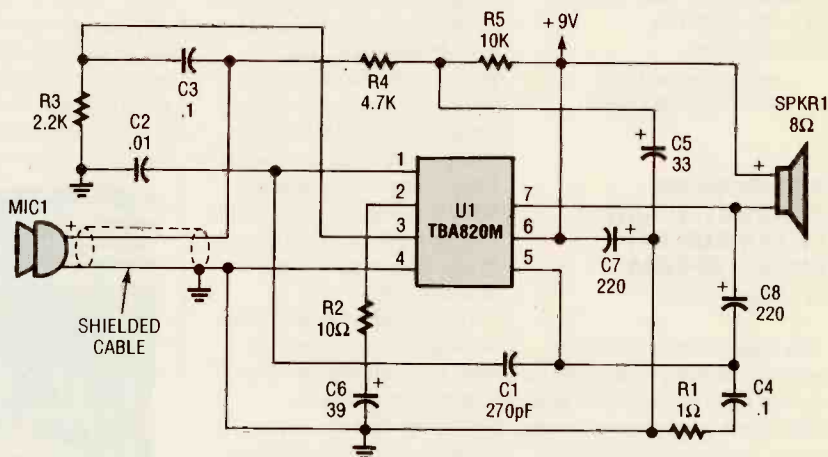

Fig. 1. The amplifier circuit is based on a 2-watt audio op-amp, and powered from a 9-volt battery. Perfboard and point-to-point wiring was used to make the circuit.

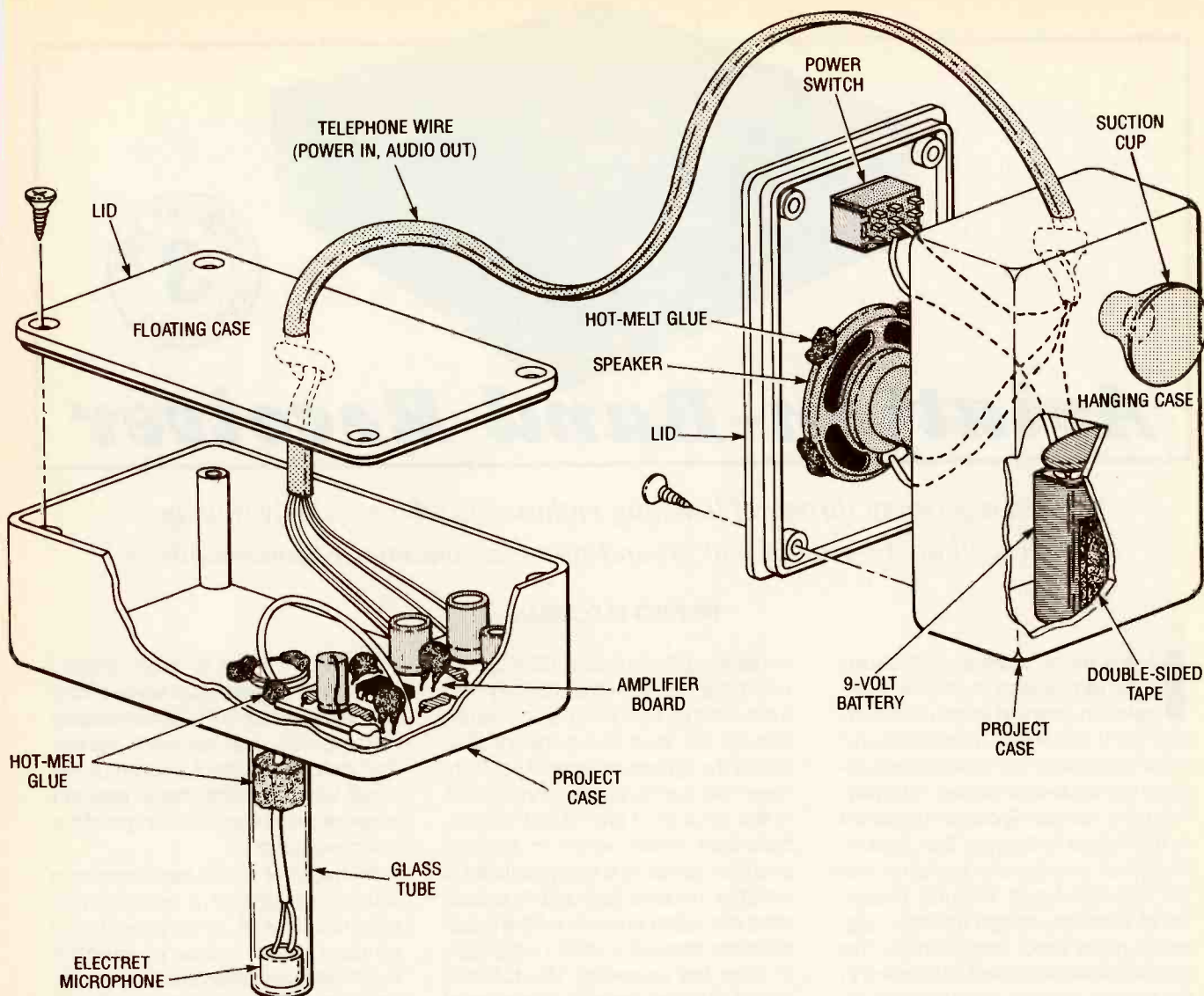

Fig. 2. The microphone and amplifier board are mounted in one floating project case, and the battery, speaker, and on/off switch are mounted in another case.

project, simple perfboard and point-to-point wiring was used.

The microphone was connected to the circuit with a 3-inch shielded cable. The amplifier is so sensitive that, during the initial tests, the speaker had to be attached to the cable via a 2-foot wire—otherwise the circuit squealed uncontrollably with feedback. Fortunately the wire can be shortened for the final Water Tap design.

It was decided that the microphone and amplifier board would be mounted in one floating project case (since the microphone's shielded cable shouldn't be too long), and that the battery, speaker, and on/off switch would be mounted in another project case that could be stuck to the side of the fish tank with a suction cup.

Figure 2 shows how the two sections

are interconnected. Since four wires are needed to connect the two sections together, a piece of 4-conductor telephone wire a little over a foot long was used. You can use four separate wires twisted together, but telephone wire has a neat finished appearance.

A glass test tube was used as a waterproof case for the microphone. It was reasoned that glass would probably result in better sound pickup than plastic, but you can experiment on different microphone covers if you like. The test tube was included in a fish-tank ammonia test kit. If you can't find a suitable test tube, or something similar, buy a cheap test kit (they should only cost two or three dollars) from an aquarium-supply store and use the one that comes with it.

The figure also shows how the floating case is laid out. A hole exactly the

same size as the test tube must be drilled in the bottom of the case. The tube then hangs out of the bottom of the case, making a tight fit in the hole. The joint between the case and the test tube must then be sealed with hot-melt glue or RTV (room-temperature vulcanizing) silicone to ensure a completely watertight seal. The microphone then slides down to the bottom of the tube, and more hot-melt glue or RTV silicone plugs up the top of the tube to further isolate the microphone from the outside air. Another hole is drilled in what is now the top of the case for the telephone wire to pass through. Make the hole as small as possible—seal the hole if it's much wider than the wire to help prevent water from getting inside the case. The circuit board is then centered
(Continued on page 107)



Aviation-Band Receiver

Join a growing throng of listening enthusiasts who regularly tune in commercial air-to-ground and ground-to-air aeronautics communications.

BY FRED BLECHMAN

If, like many scanner enthusiasts and ham operators, you are interested in listening in on all the excitement manifest in aeronautic communication, but lack the equipment to pursue your interest, then perhaps the *Aviation Receiver* described in this article is for you. The Aviation Receiver, designed to tune the 118–135-MHz band, features exceptional sensitivity, image rejection, signal-to-noise ratio, and stability. The receiver is ideally suited to listening in on ground and air communications associated with commercial airlines and general aviation.

Powered from a 9-volt transistor-radio battery, it can be taken along with you to local airports so that you won't miss a moment of the action. And even if you're nowhere near an airport, this little receiver will pick-up the air-to-ground and ground-to-air communications of any plane or ground facility within about 100 miles!

Circuit Description. Figure 1 shows a schematic diagram of the Aviation Receiver—a superhetrodyne AM (amplitude modulated) unit built around four IC's: an NE602 double-balanced mixer (U1), an MC1350 linear IF amplifier (U2), an LM324 quad op-amp (U3), and an LM386 audio amplifier (U4).

In operation, an antenna that plugs into J1 picks up the AM signal. That signal is then coupled through C1 to a three-section, tuned-filter network,

consisting of L1–L5 and C2–C6. Signals in the 118–135-MHz VHF (very high frequency) range are coupled through C7 to a VHF transistor (Q1), where the signals are amplified. From there, the signals are fed through C8 to the input of U1 (the NE602 double-balanced mixer), which in this application serves as a local oscillator. A variable inductor (L6) and its associated capacitor network set the local-oscillator frequency at 10.7-MHz higher than the incoming 118–135-MHz signals. A tuning network, consisting of varactor diode D1 and potentiometer R1, allows the local-oscillator frequency to be tuned across about 15 MHz.

The 10.7-MHz difference between the received signal and the local-oscillator frequency (*i.e.*, the intermediate frequency or IF) is output at pin 4 of U1 to a 10.7-MHz ceramic filter (FIL1). The filter is used to ensure a narrow pass band and sharp signal selectivity.

The output of FIL1 is amplified by Q2 and then fed through C16 to U2 (an MC1350 IF amplifier), which, as configured, also offers automatic gain control (AGC), as we'll see shortly. The amplified 10.7-MHz IF signal is peaked using variable transformer T1. The AM audio is then demodulated by diode D2. After that, the audio is fed in sequence through the four sections of U3 (an LM324 quad op-amp).

Note that a portion of U3-a's output signal is fed back through resistor R25 to the AGC-control input of U2 at pin 5.

That signal is used to automatically decrease the gain of U2 when strong signals are present or to automatically increase U2's gain for weak signals. That keeps the output volume of the circuit within a comfortable listening range regardless of the strength of the incoming signals.

The receiver circuit also contains a squelch circuit that is controlled by potentiometer R3, which is used to kill random noise below a selected threshold level. When properly set, the squelch control virtually eliminates background noise, so that all you hear are incoming signals that can be brought up to a usable level. Potentiometer R2 controls the overall volume fed through C26 to U4, an LM386 low-voltage audio-power amplifier. Due to the overall design and squelch control, the audio output is quite low in background noise, and yet it's capable of driving simple communications speakers or earphones to excellent volume levels.

Construction. The Aviation Receiver was assembled on a printed-circuit board, measuring about 4 × 4¾ inches. Figure 2 shows a full-size template of that printed-circuit board's layout. A kit of parts (which includes an etched and pre-drilled, printed-circuit board, but no case) is offered by the supplier listed in the Parts List.

Although most of the parts for this project are commonly available through conventional electronic-

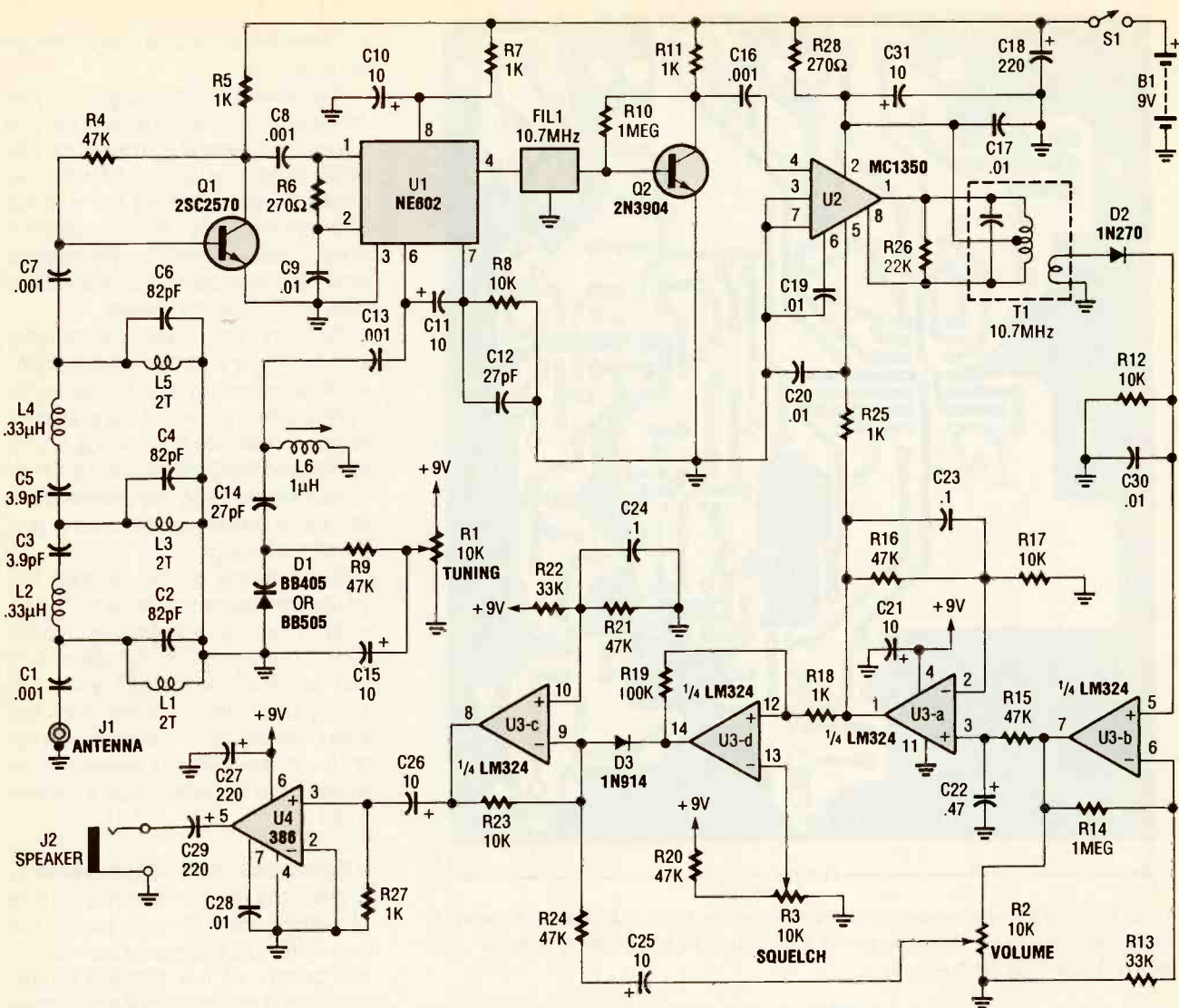
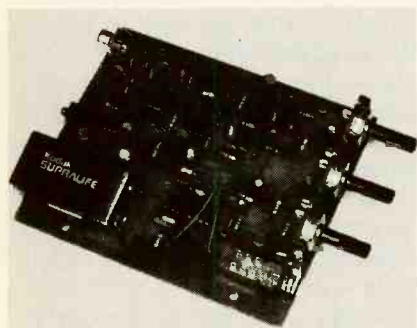

Fig. 1. The Aviation Receiver—a superheterodyne unit, built around four IC's—is designed to receive AM signals in the 118–135-MHz frequency range.



All of the components for the Aviation Receiver (including the 9-volt transistor-radio battery that powers the circuit) mount on a single printed-circuit board.

components suppliers, a source for some of the more difficult to find parts is given in the Parts List for those who prefer to do their own shopping. If you opt to gather your own parts or you

plan to use what you have on hand, keep in mind that the circuit-board layout was designed to accommodate components of specific dimensions in some cases; jacks J1 and J2, switch S1, transformer T1, and all three potentiometers, for example. To ease the pain of obtaining those parts, a "Special Parts Kit" is also available from the listed source.

Also note that either of the Siemens parts specified in the Parts List for varactor diode D1 will work, but both may be difficult to find from hobbyist sources. However, the second unit (BB505) is available from Allied Electronics.

However you go about collecting the parts for this project, don't even think about building the receiver circuit without the printed-circuit board.

At the frequencies involved, the placement of every wire and part, and every part value is critical for trouble-free performance.

Once you've obtained all of the components and the board for the Aviation Receiver, construction can begin. A parts-placement diagram is shown in Fig. 3. When assembling the project, take special care that polarity-sensitive components (electrolytic capacitors, diodes, and transistors) are installed properly. Just one part installed *backwards* can cause grievous harm!

Begin by installing the passive components (jumper wires, resistors, capacitors, and inductors). Follow that by installing the active components; diodes, transistors, and IC's. Once the active components have been in-

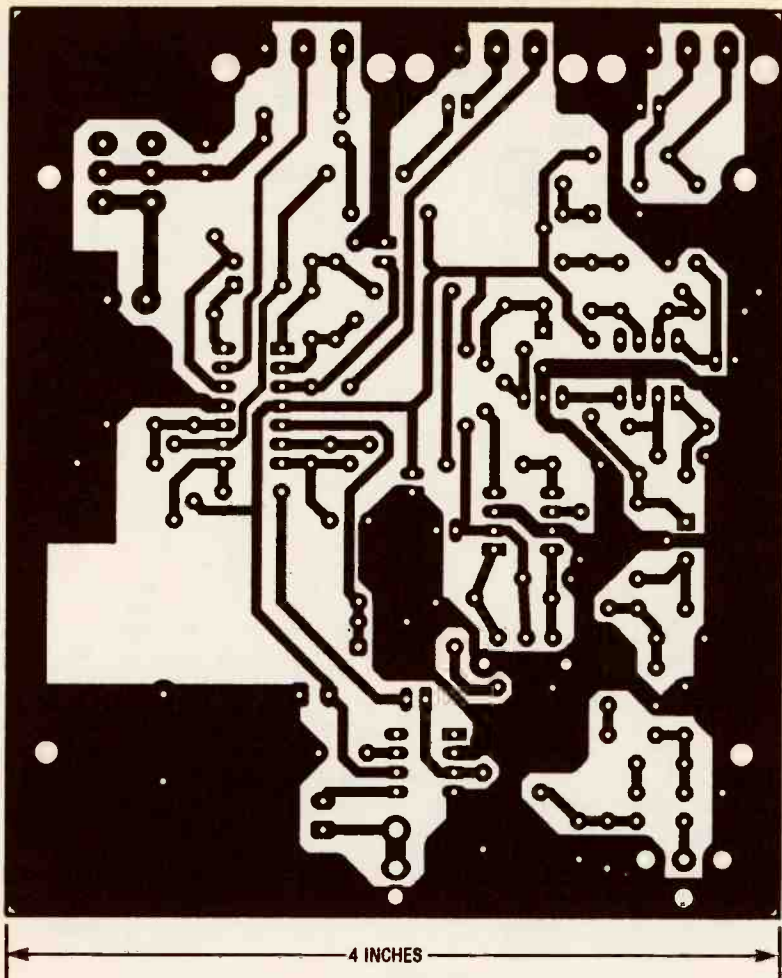
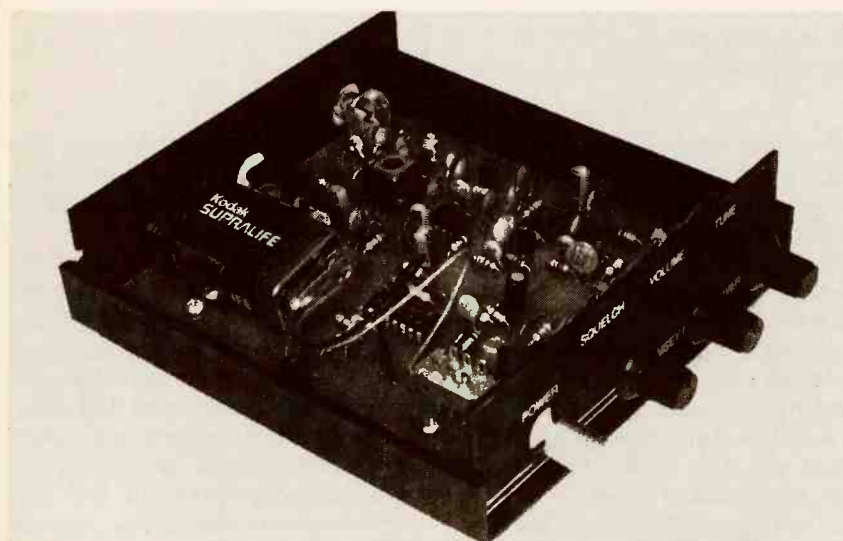

Fig. 2. Here's a full-size printed-circuit pattern for the Aviation Receiver. The printed-circuit board can be purchased as part of a full-blown kit or separately from the supplier listed in the Parts List.



The Aviation Receiver's printed-circuit board fits neatly into this optional 5.25 × 5.25- × 1.5-inch custom cabinet (which comes with knobs, hardware, silk-screened front and back panels, as well as rubber mounting feet).

stalled, check your work for the usual construction errors: cold solder joints, misplaced or misoriented compo-

nents, solder bridges, etc. Once you've determined that the circuit has been correctly assembled, it's time to

consider the enclosure that will house your receiver.

The receiver's circuit board can be housed in any enclosure that you choose. However, if you prefer, an optional case and knob kit for the receiver is available from the supplier listed in the Parts List. The optional case is supplied with neatly lettered front and rear panels, knobs, rubber feet, and mounting screws.

If you choose a case other than the one available from the listed supplier, it will be necessary to drill holes in the front and rear panels of the enclosure to accommodate the controls (S1, R1, R2, R3) and the jacks (J1 and J2). Once drilled, the front and rear panels of the enclosure can be labeled using dry-transfer lettering.

The antenna for the Aviation Receiver can be as simple as a 21-inch length of wire, or you can get a fancy roof-mounted aviation antenna. If you are near an airport, you'll get plenty of on-the-air action from the wire antenna, but if you're more than a few miles away, a decent roof-mount antenna offers a big improvement.

Alignment and Adjustment.

Aligning the Aviation Receiver consists of nothing more than adjusting the slug in the local-oscillator coil (L6) for the center of the desired tuning range, and peaking the IF transformer (T1). The receiver can be calibrated using a VHF RF signal generator, frequency counter, or another VHF receiver by setting R1 to its mid-position; remember that you want to set the local-oscillator frequency 10.7-MHz higher than the desired signal or range to be received. Then, using a non-metallic alignment tool—a metal tool of any kind will drastically detune the coil, making alignment almost impossible—adjust L6 (the LO coil) until you hear aircraft or airport communications.

Once you are receiving aircraft or airport frequencies, adjust T1 for the best reception. Typically, T1 is adjusted 2–3 turns from the top of the shield can. If you don't have any signal-reference equipment for alignment, and are not yet hearing airplanes, your best bet is to pack up the receiver and the necessary alignment tools, and head for the nearest airport! If the airport has no control tower, visit a gen-

WHAT YOU CAN EXPECT TO HEAR

No matter where you live, you will be able to receive at least the airborne side of many air-traffic communications. If you know where to tune, you can hear any aircraft that you can see, plus planes a hundred miles away and more, since VHF signals travel "line of sight." An airliner at an altitude of 35,000 feet and in the next state is probably still line-of-sight to your antenna.

Similarly, whatever ground stations you may hear are also determined by the line-of-sight character of VHF communication. If there are no major obstacles (tall buildings, hills, etc.) between your antenna and an airport, you'll be able to hear both sides of many kinds of aviation communication. Be prepared for them to be fast and to the point, and for the same airplane to move to several different frequencies in the span of a few minutes!

At most metropolitan airports, pilots communicate with the FAA on a "Clearance Delivery" frequency to obtain approval or clearance of the intended

flight plan, which is done before contacting ground control for taxi instructions.

From the control tower, ground movements on ramps and taxiways are handled on the Ground Control Frequency, while runway and in-flight maneuvers near the airport (takeoffs, local-traffic patterns, final approaches, and landings) are on the Tower Frequency. ATIS, or "Automatic Terminal Information System," is a repeated broadcast about basic weather information, runways in use, and any special information such as closed taxiways or runways. Such a broadcast offers an excellent steady signal source for initial adjustment of your receiver, if you are close enough to the airport to receive ATIS.

Approach Control and Departure Control are air-traffic radar controllers that coordinate all flight operations in the vicinity of busy metropolitan-airport areas. When you hear a pilot talking with "Jacksonville Center" or "Indianapolis Center," these are regional ATC (Air Traf-

fic Control) centers. The aircraft is really en route on a flight, rather than just leaving or approaching a destination. A pilot will be in touch with several different Regional Centers during a cross-country flight.

Airports without control towers rely on the local Unicom frequency for strictly advisory communications between pilots and ground personnel, such as fuel service operators. The people on the ground can advise the pilot what they know about incoming or outgoing aircraft, but the pilot remains responsible for landing and takeoff decisions. Typical Unicom frequencies are 122.8 and 123.0 MHz.

The FAA's network of FSS (Flight Service Stations) keeps track of flight plans, provides weather briefings and other services to pilots. Some advisory radio communication takes place between pilots and a regional FSS. If there is an FSS in your local area, but no airport control towers, the FSS radio frequency will stay interesting. ■

PARTS LIST FOR THE AVIATION RECEIVER

SEMICONDUCTORS

- U1—NE602 double-balanced mixer, integrated circuit (Digi-Key)
- U2—MC1350 linear IF amplifier, integrated circuit (Allied 858-3011)
- U3—LM324 quad op-amp, integrated circuit (Digi-Key)
- U4—LM386 low-voltage audio-power amplifier, integrated circuit (Digi-Key)
- Q1—2SC2570 or 2N5179 NPN UHF transistor (Allied 858-1041)
- Q2—2N3904 general-purpose NPN silicon transistor (Digi-Key)
- D1—BB405 or BB505 varactor diode (Siemens, Allied 586-0610)
- D2—1N270, 1N34, or similar germanium diode
- D3—1N914 silicon diode

RESISTORS

- (All fixed resistors are 1/4-watt, 5% units.)
- R1—R3—10,000-ohm PC-mount potentiometer
 - R4, R9, R15, R16, R20, R21, R24—47,000-ohm
 - R5, R7, R11, R18, R25, R27—1000-ohm
 - R6, R28—270-ohm
 - R8, R12, R17, R23—10,000-ohm
 - R10, R14—1-megohm
 - R13, R22—33,000-ohm

R19—100,000-ohm

R26—22,000-ohm

CAPACITORS

- C1, C7, C8, C13, C16—0.001- μ F, ceramic-disc
- C2, C4, C6—82-pF, ceramic-disc
- C3, C5—3.9-pF, ceramic-disc
- C9, C17, C19, C20, C28, C30—0.01- μ F, ceramic-disc
- C10, C15, C21, C25, C26, C31—4.7- to 10- μ F, 16-WVDC, electrolytic
- C11—10-pF, ceramic-disc
- C12, C14—27-pF, NPO ceramic-disc
- C18, C27, C29—100- to 220- μ F, 16-WVDC, electrolytic
- C22—0.47- μ F, 16-WVDC, electrolytic
- C23, C24—0.1- μ F, ceramic-disc

INDUCTORS

- L1, L3, L5—1/2-turns #24 to #30 gauge wire
- L2, L4—0.33- μ H, inductor (Digi-Key M9R33-ND)
- L6—0.1- μ H, 3/2-turn, slug-tuned coil (Digi-Key TK2816)
- T1—10.7-MHz, shielded transformer (Mouser 42IF123)

ADDITIONAL PARTS AND MATERIALS

- FL1—10.7-MHz ceramic filter (Digi-

Key TK-2306)

S1—SPST switch, PC mount

J1—RCA jack, PC mount

J2—Subminiature phone jack, PC mount

B1—9-volt transistor-radio battery
Perfboard materials, enclosure, AC molded power plug with line cord, battery(s), battery holder and connector, wire, solder, hardware, etc.

Note: The following items are available from Ramsey Electronics, Inc., 793 Canning Parkway, Victor, NY 14564; Tel. 716-924-4560: A complete kit of parts (AR-1BP), including printed-circuit board (but not the case or control knobs), \$24.95; an etched and drilled printed-circuit board only (AR-1PCBP), \$10.00; a Special Parts Kit (AR-1SPKBP) containing all semiconductors, R1—R3, all inductors, S1, J1 and J2, and FL1, \$14.50; Custom case and knob set (C-AR-1BP), \$12.95. Please add \$3 for orders under \$20. All orders are subject to \$3.95 postage/handling charge. New York State residents, please add appropriate sales tax.

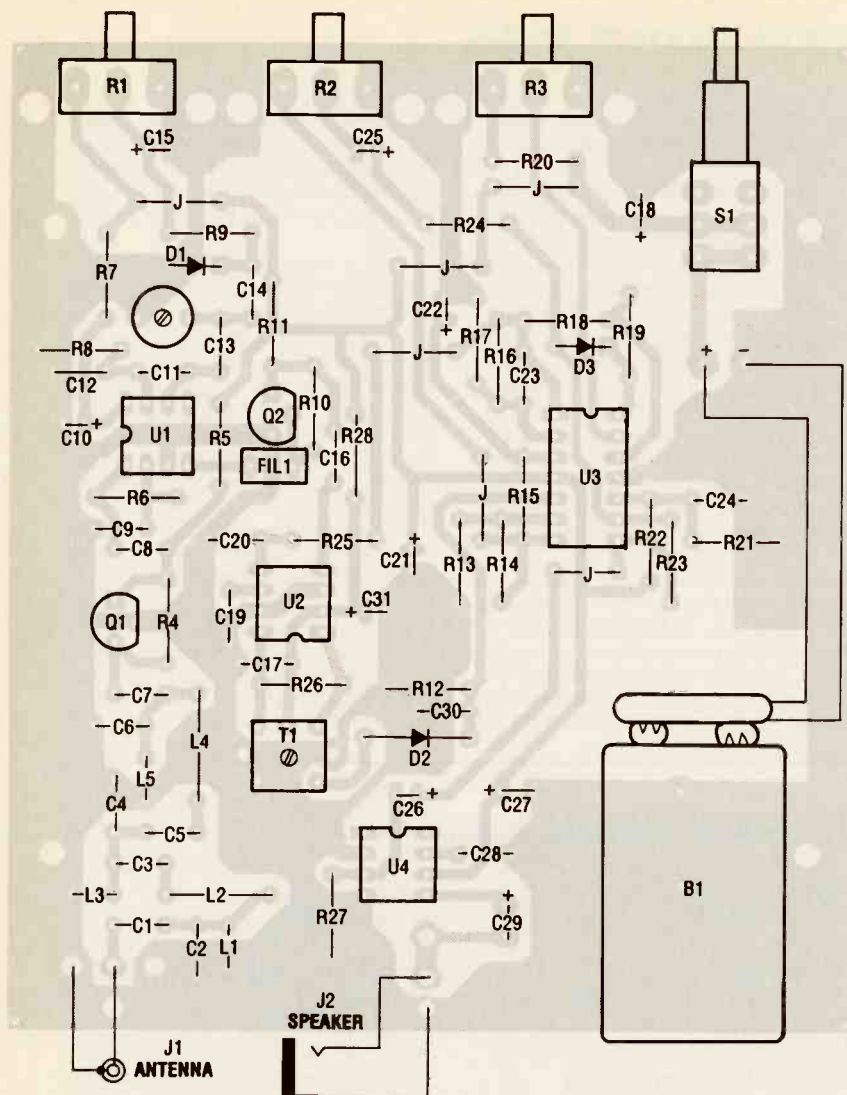

Fig. 3. Use this parts-placement diagram as a guide when assembling the printed-circuit board

eral aviation service center on the airport grounds, and ask which are the most active frequencies. Then adjust L6 and R1 until you hear the action.

A ground-service operator or private pilot may be willing to give you a brief test transmission on the 122.8 Unicom frequency. Remember, also, that if your airport has ATIS transmissions, you can get a steady test signal as soon as you are within line-of-sight of its antenna. (See the sidebar for explanation of Unicom and ATIS.)

Use. Plug an antenna into J1 and a 4-to 8-ohm speaker or earphone into J2. Turn on the Aviation Receiver by closing S1. You may or may not hear background noise. Turn R2 (the SQUELCH control) fully counterclockwise. Then rotate R2 clockwise until you hear a "pop" and some background noise;

then back it off slightly (counterclockwise) past the pop. You are now in squelch mode.

With pilots and controllers talking so briefly, you will need to get used to tuning your receiver. As you sweep across the band (via R1), listen for a sound, then rock back and forth slightly to tune it in clearly.

Troubleshooting Suggestions. If the receiver does not work at all, carefully check the obvious things first; battery polarity, soldering of the battery wires and switch, and the connections to the speaker jack. Also, be sure to check that you've correctly installed all of the jumpers. If the circuit's operation is erratic, a solder connection is usually the culprit, or there could be a break in the antenna or speaker wire. Pay special attention to the orienta-

PILOT AND CONTROLLER TALK

Don't blame the Aviation Receiver if all you hear are short bursts of words that don't make a lot of sense at first. Aviation communication is necessarily quick and brief, but clear and full of meaning. Generally, pilots repeat exactly what they hear from a controller, so that both know the message or instructions were correctly interpreted. If you are listening in, it's hard to track everything said from a cockpit, particularly in big city areas. Just to taxi, takeoff, and fly a few miles, a pilot may talk with 6 or 8 different air-traffic-control operations within a few minutes, all on different frequencies.

Here's the meaning of just a few typical communications:

"Miami Center, Delta 545 heavy out of three-zero for two-five." Delta Flight 545 acknowledges Miami Center's clearance to descend from 30,000 feet to 25,000 feet. The word "heavy" means that the plane is a jumbo jet, perhaps a 747, DC-10, or L-1011.

"Seneca 432 Lima cleared to outer marker. Contact tower 118.7." The local Approach Control is saying that the Piper Seneca with the N-number, or "tail number" ending in "432L" is cleared to continue flying an instrument approach to the outer marker (a precision radio beacon located near the airport), and should immediately call the airport radio control tower on 118.7 MHz. That message also implies that the controller does not expect to talk again with that aircraft.

"Cessna 723, squawk 6750, climb and maintain five thousand." A controller is telling the Cessna pilot to set the airplane's radar transponder to code "6750," climb to and level off at the altitude of "5000 feet."

"United 330, traffic at 9 o'clock, 4 miles, altitude unknown." The controller alerts the United Airlines flight of radar contact with some other aircraft off to the pilot's left at a "9 o'clock" position. Since the unknown plane's altitude is also unknown, both controller and pilot realize that it is a smaller private plane not equipped with altitude-reporting equipment. ■

tion of all IC's, transistors, diodes, and electrolytic capacitors. Also, be sure that C11 and C12 in U1's oscillator circuit are of the right values. Local-oscillator operation can be verified with a simple VHF receiver or frequency counter. Remember that the local oscillator should be set to a frequency 10.7 MHz above the desired listening range. If the oscillator works, only a defective or incorrectly installed part can prevent the rest of the receiver circuit from functioning. ■

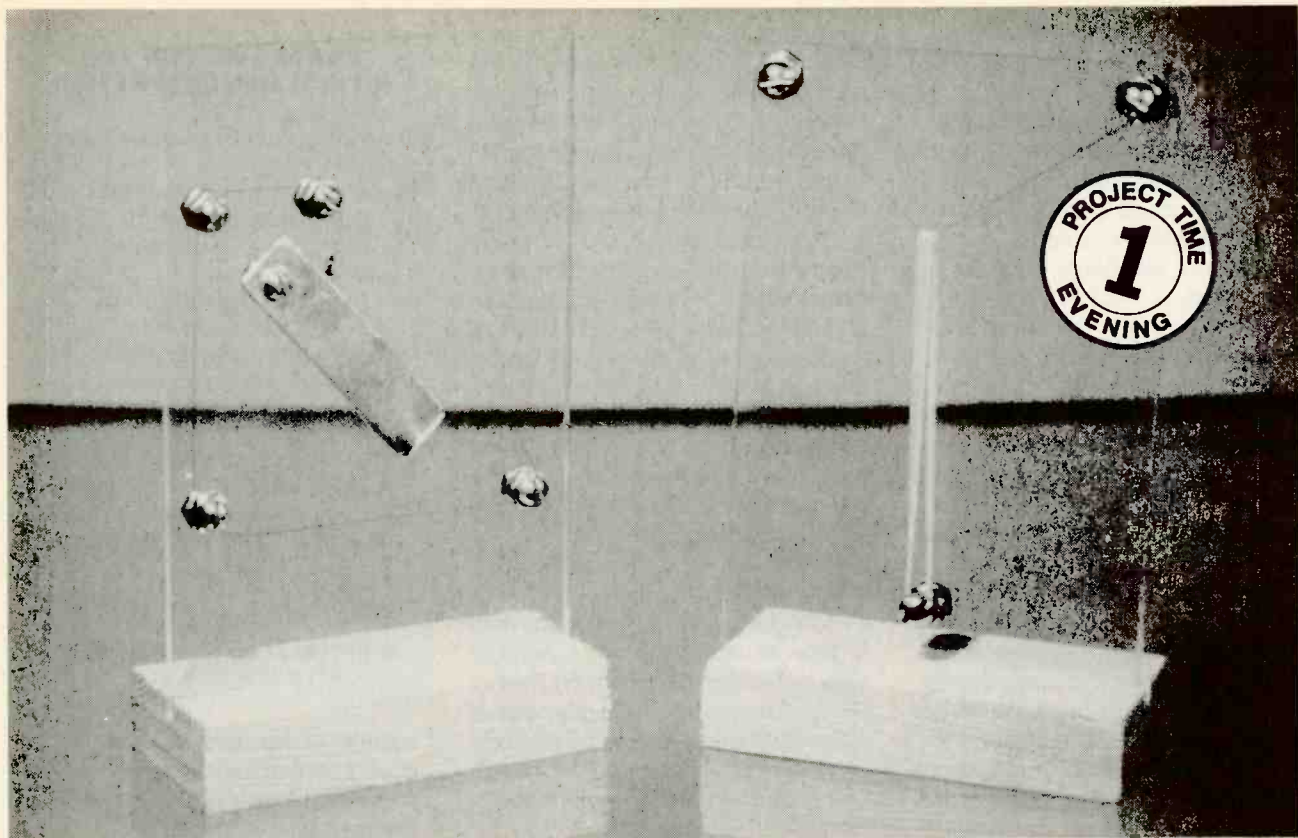

Experimenting With Shaped Memory Alloys

Learn about Shaped Memory Alloys and how they work, then perform some hands-on experiments with these fascinating materials

BY JOHN IOVINE

Shaped Memory Alloys (SMA) are alloys of two or more metals that have some interesting properties. One property of the material is that it contracts when heated. This is analogous to the contraction of muscle tissue; note that this effect is the opposite of standard metals, which expand when heated and contract when cooled.

Another property of these alloys is called the Shaped Memory Effect (SME). Simply put, this material will, when heated to a critical temperature, return to a shape that it has been trained to "remember." In short, this material could be twisted, bent, and folded, but when heated it will return to its original shape.

History. In 1932, Arne Olander, a Swedish researcher, discovered the Shaped Memory Effect in a gold-cadmium (AuCd) alloy. In 1951, two researchers, L.C. Chang and T.H. Read, analyzed the crystal structure and changes of the Shaped Memory Effect in the AuCd alloy, and in 1958 those two researchers made a cyclic weight-lifting device to be displayed at the Brussels World Fair.

In 1961, William Beuhler working at U.S. Naval Labs discovered SME in an alloy of titanium-nickel. At the time, Beuhler and his team were looking to develop a heat and corrosion resistant alloy. In any case, the alloy they discovered was, by far, cheaper and safer to work with than any SME alloy

to date. The team named the new alloy Nitinol, pronounced night-in-all. The material's name is representative of its elemental components and place of origin. The "Ni" and "Ti" are the chemical abbreviations for nickel and titanium, and "NOL" stands for the "Naval Ordnance Laboratory" where it was discovered.

In later years, other alloys were discovered that exhibited SME. In 1985, Dr. Dai Homma of Japan's Toki Corporation announced an improved version of Nitinol. That improved version of Nitinol is sold in this country under the name trade name BioMetal. A California company, Mondo-Tronics, sells Nitinol wire under the trade name of Flexinol.

There are many interesting applications for this material. NASA has proposed using Nitinol to make space craft antennas that would deploy when heated by the sun, or a secondary heating unit. More down to earth ventures are its use in eyeglass frames, dental-alignment material, pumps, blood filters, solenoids, and an artificial heart.

How it Works. The properties of Nitinol rely upon the crystal structure of the material. That structure is sensitive to both external stress and temperature. Before we discuss the actual mechanics involved, we must define the temperature phases of the material.

Parent Phase refers to a state that exists above the transition temperature, the temperature where the wire contracts or returns to a previously defined shape. In this phase, the crystal structure is cubic. The transition temperature depends upon the exact composition of the material. For the Nitinol wire we will be working with later on in this article, the transition temperature is 100–130°C (190–260°F).

Martensitic Phase refers to state that is below the transition temperature. The crystal structure is needle-like and is collected in small domains. Within each domain, the crystals are aligned. The material is cool and can be bent or formed into other shapes. That external stress transforms the crystal structure of the material. It is sometimes called stress-induced martensite.

The Annealing Phase occurs at a temperature where the material will reorient its crystal structure to remember its current shape. The annealing phase for the material we are working with occurs at a temperature of 540°C.

With those definitions under our belt, we can discuss how the material works: When a cooled wire is bent or twisted, the crystal structure is transformed. If the wire is then heated above its transition temperature (Parent Phase), the crystal structure changes from needle-like to cubic. Since the cubic crystals don't fit into the same space as the needle-like crystals, they are formed under strain. To relieve this strain they move and change their positions to relieve the

strain. This "least strain" position happens to be the original shape (or the annealed shape) of the material.

Where the wire hasn't any stress-induced transformations, the crystal structure still changes, but that change results in no net movement.

Properties. Nitinol metal can generate a shape-resuming force of about 22,000-pounds-per-square-inch. In our experiments later on, we will be using a 6-mil wire. Even so, a 6-mil wire (.006 inch diameter) can generate a contractive force of 11 ounces. If you want more pull, simply multiply the wires till you reach the contractive force you require.

Nitinol wire, as stated previously, is sold under the trade name of Flexinol by Mondo-Tronics. The wire diameter is given in micrometers as a number suffix of the name Flexinol. So Flexinol 150 is a Nitinol wire with a diameter of 150 micrometers. To convert micrometers to inches multiply by .0003937. Doing that, we find the diameter of Flexinol 150 is 6 mils (.006 inch).

The wire can contract up to 10% of its length. To extend the life of a given sample (greater than 1,000,000 cycles), you should restrict the contraction to only 6% of its length.

Reaction time can be quite short, measured in milliseconds. In addition, full strength is developed at the beginning of the cycle.

The Nitinol material is stronger than many steels. The 6 mil wire has a breaking strength of about 6 pounds.

Activating Nitinol Wire. The easiest way to heat the wire is by passing an electric current through it. The wire's resistance to the current heats the wire and causes it to contract. The

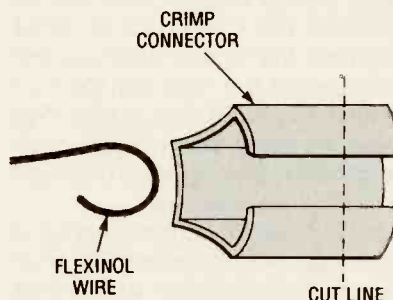

Fig. 1. Soldering directly to the Nitinol wire could adversely affect it. The supplier mentioned in the article supplies crimp terminals that get around that problem.

PARTS LIST FOR THE NITINOL DEMONSTRATION

- U1—4011 quad NAND gate, integrated circuit
 - Q1—IRF511 MOSFET transistor
 - R1—15,000-ohm, ¼-watt, 10% resistor
 - C1—1-μF, 35-WVDC, tantalum capacitor
 - B1—9-volt transistor-radio battery
 - S1, S2—SPST toggle switch
 - Nitinol wire, perfboard or plastic, hardware, rubber band, enclosure, etc.
- The following are available from Mondo-Tronics, 524 San Anselmo Ave., #107, San Anselmo, CA 94960; Tel. 415-455-9330, 800-374-5764; Shape Memory Wire Guidebook and Sample Kit (part no. 3-074), \$29.90; 40 inches of Flexinol 150 (part no. 3-072), \$14.95. Please add \$4.00 for shipping in the U.S.; international orders add \$9.00. California residents must add 8.25% sales tax.

volume of the wire doesn't change during contraction, so as the wire decreases in length, its diameter increases by a proportional amount, keeping the volume the same. The activation temperature of the wire is 100 to 130°C (or 190–260°F).

Care should be taken not to overheat the wire or its properties will degrade. The wire has an electrical resistance of a little less than 1-ohm-per-inch. Flexinol wire is supplied with crimp terminals (see Fig. 1). These terminals are used to make connections to the material because the Nitinol wire should not be heated to the temperature that would be required for soldering.

Direct Electric Heating. Nitinol wire can be activated using low voltage, such as a 9-volt transistor-radio battery. A simple circuit can be built using a battery, switch, and a small length of Nitinol (see Fig. 2).

Again, care must be taken not to overheat the wire. In addition, connections to the Nitinol will draw heat away from the ends of the wire. That results in the center of the wire heating faster than the ends. So although direct electric heating works, a better method is pulse-width modulation.

Pulse-Width Modulation Heating. In this technique, a squarewave from a simple circuit is used to turn the electric current on and off. Depend-

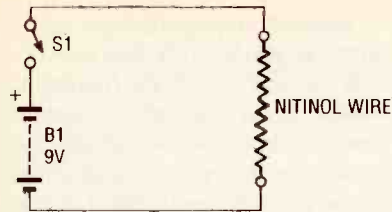

Fig 2. While this is the simplest way to activate Nitinol wire, it has some important limitations.

ing upon the frequency and duty cycle of the squarewave, we can adjust the amount of contraction and maintain the wire in a contracted condition for a longer period of time. Because of the rapid on and off action of the waveform, the wire has time to distribute the heat, which results in a more uniform heating. That is the method that we shall use in our experiments.

The Circuit. The circuit we shall use (see Fig. 3) is designed around a 4011 quad NAND gate. The NAND gate is configured as a squarewave generator. The circuit can be operated manually using a switch (S1), or it can be interfaced to any computer by deleting the switch and connecting the circuit (via pin 1 of U1) to a port line that can be brought high and low under program control. The 4011 can't handle the current requirements of the Nitinol wire, so the wire is interfaced to the rest of the circuit via an IRF511 MOSFET.

Nitinol Demonstrations. To demonstrate the potential of this material, we need to build a small mechanical device. If you're like me, you'll want the simplest unit to start with. To make our electric "muscle," the materials you'll need are 3 machine screws with six nuts, a piece of perfboard or plastic, a small rubber band, and, of course, a length of Nitinol material.

Look at Fig. 4. Three machine screws are arranged in a triangular pattern in the perfboard or plastic as shown. The Nitinol wire is connected to the two top screws. The rubber band is looped around the bottom machine screw, with the Nitinol wire looped through the top of the rubber band. Begin by drilling two holes to accommodate the top two screws. To determine the location of the third (bottom) machine screw, stretch the rubber band from a position that is parallel with the top screws and

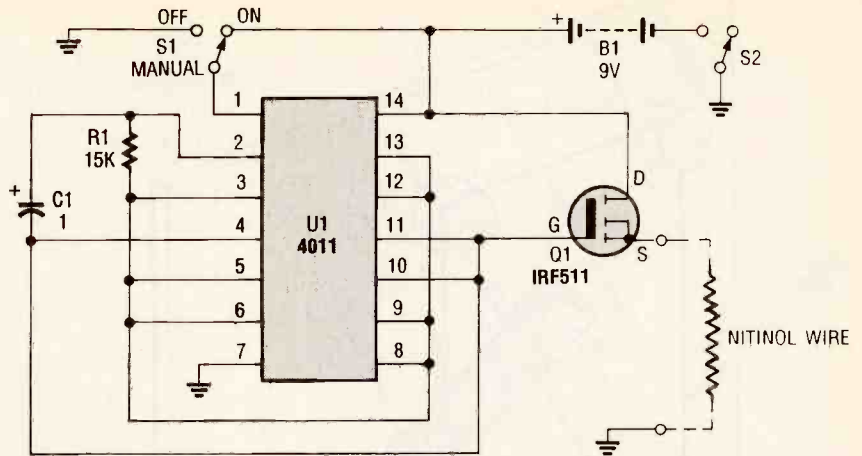

Fig. 3. This circuit produces a squarewave output and provides a much better way to activate the wire. It can be manually controlled as shown, or, with some simple modifications, can be interfaced to a computer.

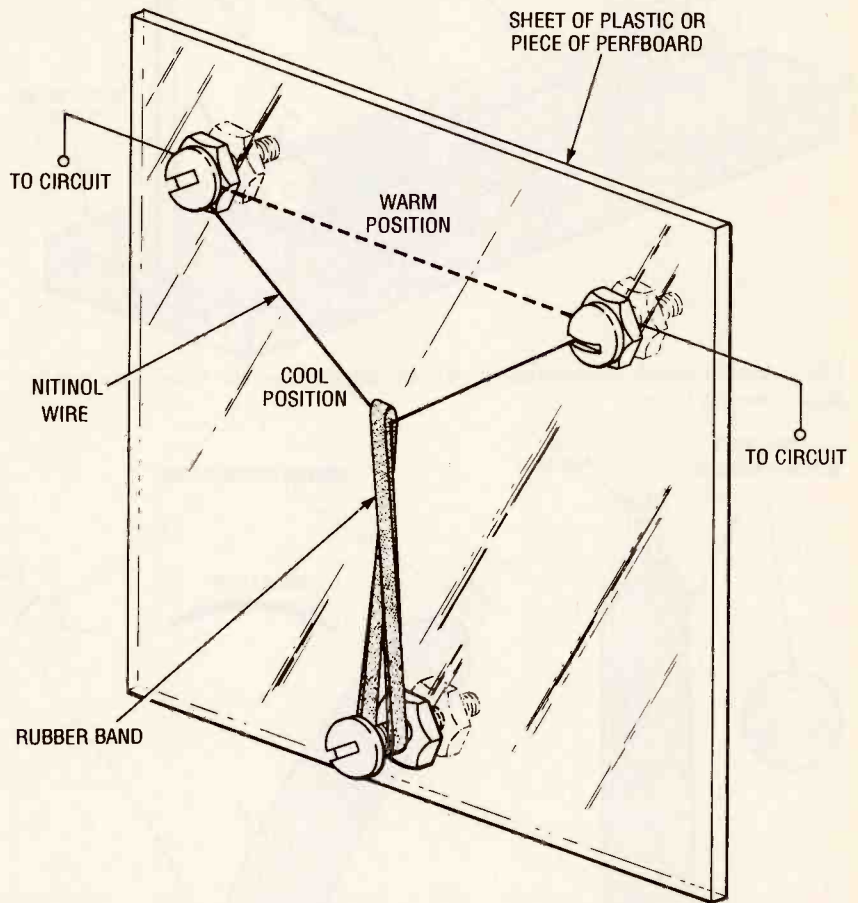

Fig 4. This simple demonstration is easy to build, and shows off the basic properties of the Niitinol wire.

down. Remember the Nitinol has a pull of about 11 ounces so don't make the rubber band so tight that the Nitinol isn't able to contract and move upwards, although it should be tight enough for it to take up the slack of the Nitinol wire when it is relaxed. Drill the third hole and build the assembly

as shown. Finish up by connecting the Nitinol wire to the circuit of Fig. 2.

When the unit is activated, the wire gets hot, contracts, and pulls up the rubber band. When the unit is deactivated the wire cools, elongates, and lowers the rubber band into its resting position.

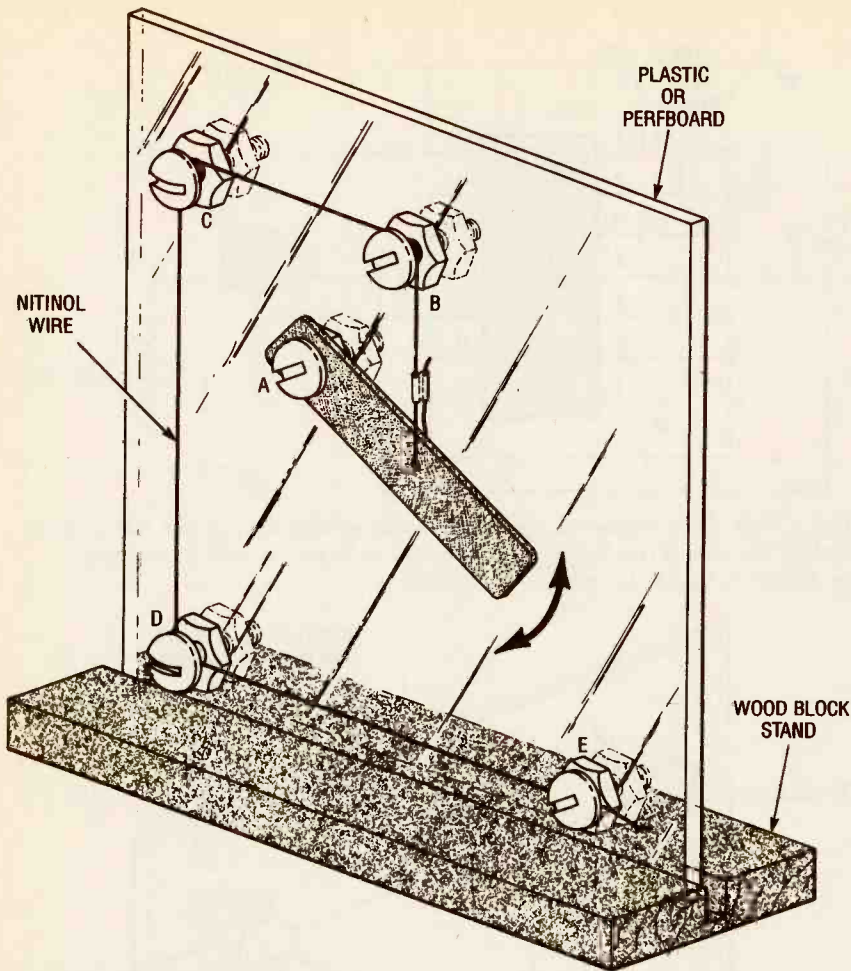

Fig 5. Another simple demonstration, this time showing how the Nitinol wire can be used to move a lever.

I also built a second Nitinol demonstrator, shown in Fig. 5. That unit shows how you can amplify the mechanical motion of the wire using a lever. The lever pivots on screw A. The Nitinol wire is attached to the lever and screw E. The wire is threaded around screws B, C and D. When activated, the lever rises.

The lever can be made from wood, plastic, or metal. If you use a metal lever, you can make the electrical connections to the wire through screws A and E. If the lever is made from a non-conductive material, use screws B and E for the electrical connections.

Going Further. We have just scratched the surface of the potential of this material. It is quite possible to build a realistic android hand. As an example, consider the simple single-digit flexor that is illustrated in Fig. 6A. That unit is built using a three-hole soft-rubber or silicone tube. The Nitinol wire is threaded in a loop through the two outer holes. A copper wire is threaded up through the center hole. The loop of Nitinol wire and the end of the copper wire is crimped in a small terminal. By applying current between the copper wire and one end of the Nitinol you can make the tube flex right (A-C) or left (B-C), as shown in Fig. 6B. Or by applying power to the two ends of the Nitinol wire the tube will flex backwards.

Heat engines are another fertile field for experimentation and development. One company sells a toy boat powered by Nitinol wire. The boat has a small cargo bay for ice. The difference in temperature between the ice and the water the boat rests in powers the toy boat.

You may want to attempt to train a piece of Nitinol wire to a particular shape. You can do this by bending the wire to the shape you want, clamping it in position and heating it to about 540°C. You also might want to try direct electric heating of the wire to reach the annealing temperature.

Mondo-Tronics sells a book titled *Working with Shaped Memory Wires*, which shows various actuators and uses of this material. Several Nitinol-wire samples with various diameters are included with the book. It is a worthwhile investment if you plan on doing any experimentation.

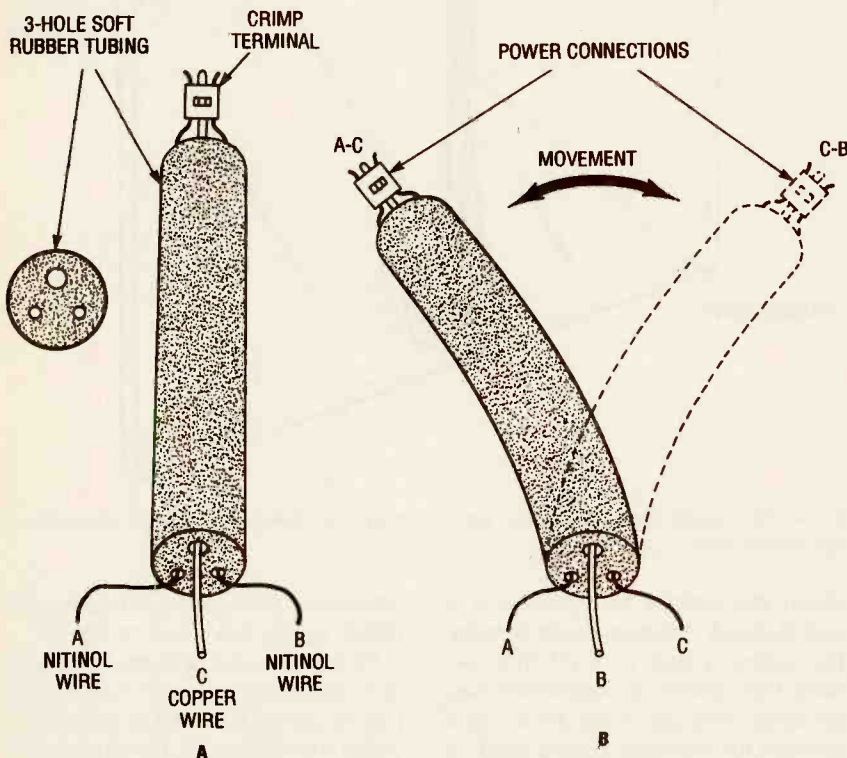
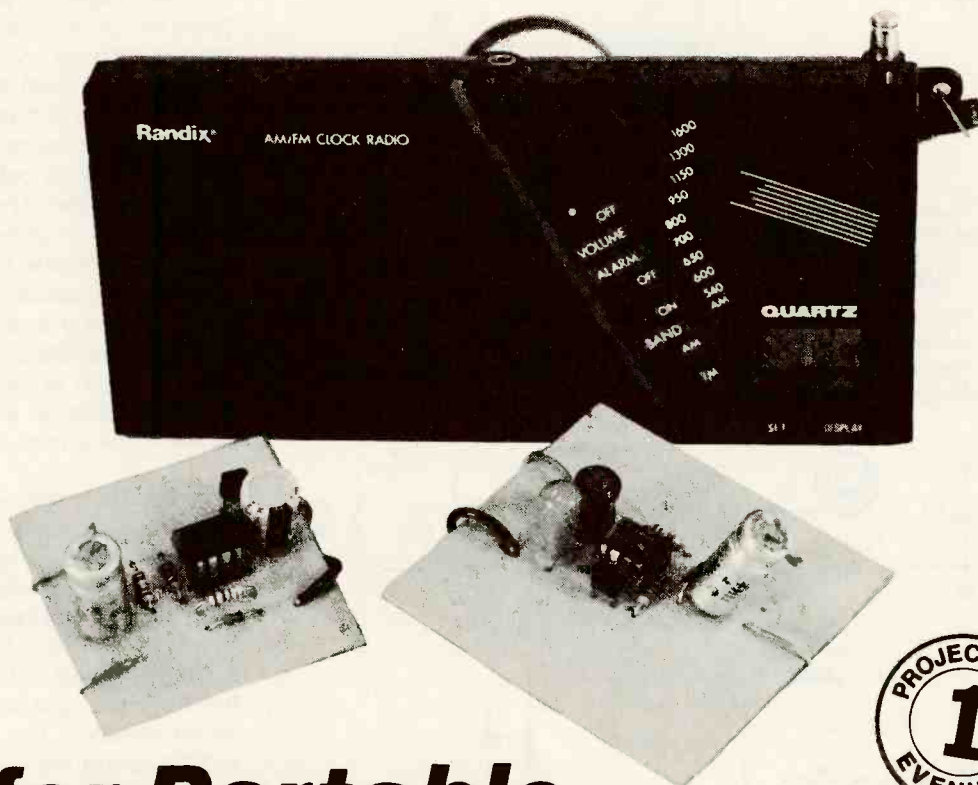

Fig. 6. This simple one-digit flexor can be bent to the left or the right depending on how power is applied to the three leads.

Solar Power Supplies



for Portable Radios & Cassette Players

If you make extensive use of portable radios or cassette players, you are well aware of the high cost of replacement batteries. Besides being expensive, batteries tend to expire right in the middle of your favorite music. The *Solar Power Supply* described in this article is designed to address that problem by providing a low-cost alternative to purchasing batteries, assuming that much of your listening is done during the daylight hours and in places where sunlight is available.

To accommodate different types of portable electronic equipment, two systems will be described; a switching (step-up) regulator and a linear (step-down) regulator. Each of the regulator circuits is used in conjunction with a solar-cell array, which converts light into electrical energy. The outputs of the circuits remain constant even with varying degrees of light intensity.

For special low-light operation, the builder can add more cells in series

BY ANTHONY J. CARISTI

Build an environment-friendly, money-saving power supply for radios, cassette players, and more!

with the solar-cell array to compensate for that condition. For night-time or indoor use, if the solar array is placed close to bright lighting, the Solar Power Supply will be able to provide sufficient power to operate most portable devices.

Switching Regulator. Figure 1 shows the schematic diagram of the switching regulator, which can be configured to output 7.2 or 4.8 volts of regulated DC, depending on the resistor value selected for R1. By making

R1 453k, which produces an output of 7.2 volts, the circuit can be used to operate radios that are normally powered from a 9-volt battery. By making R1 274k, which produces an output of 4.8-volts, the circuit can be used to operate devices that are normally powered from a 6-volt source (i.e., two AA or C cells).

At the heart of the switching-regulator circuit is an MAX630CPA (Harris) micropower switching regulator (U1), which is designed to deliver 7.2 volts at 15 mA with an input of 3 volts. The switching regulator is fed from a solar-array, consisting of eight, 0.5-volt photovoltaic or solar cells, which output 4 volts. The 8-cell solar-array ensures that the circuit can provide sufficient power to operate the connected device when less than full Sun intensity is available.

With a typical load current of 15 mA at 7.2 volts, the power output of the circuit is 108 mW. Assuming that the

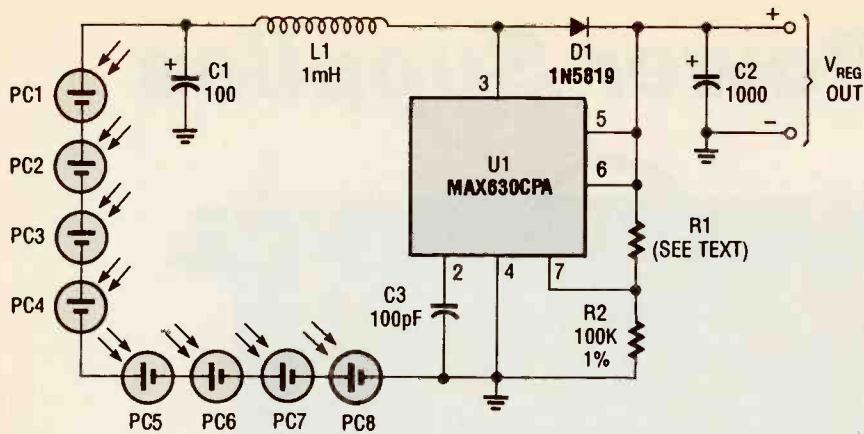

Fig. 1. Powered from an 8-cell solar array, the switching regulator can be configured to deliver 7.2 or 4.8 volts of regulated DC. At the heart of the circuit is an MAX630CPA micropower switching regulator (U1), a chip that's designed to deliver 7.2 volts at 15 mA with an input of 3 volts.

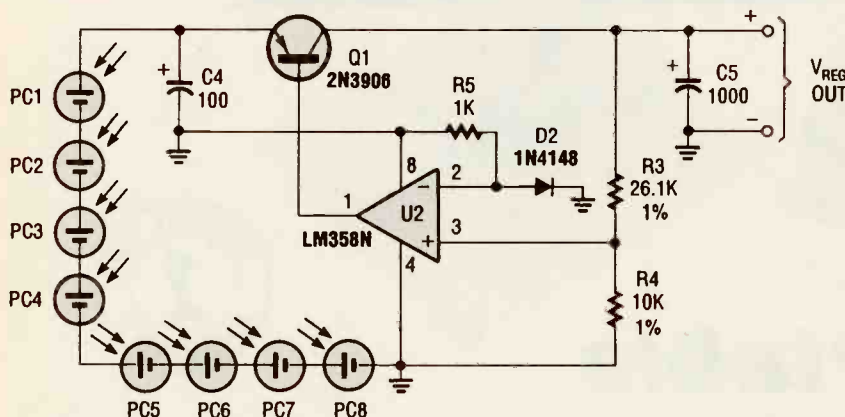

Fig. 2. This linear regulator circuit has at its heart a low-power op-amp, which controls a PNP transistor that's connected as a high-side switch between the array and the load.

circuit has an operating efficiency of 70%, power input is 154 mW. With an input of 3 volts, the solar-cell array must be able to deliver 51 mA to power the regulator circuit. With the specified resistor value, the circuit can provide 4.8 volts at 115 mA with an input of as little as 3.3 volts.

The calculations for a typical load driven by the circuit are as follows: A cassette player that draws 115 mA of current at 4.8 volts requires an input power of 552 mW. Using a conservative figure of 70% efficiency for the switching regulator, the current required from the solar-cell array is 239 mA. For this application 250- or 300-mA cells would be a good choice. If necessary, one way to attain greater current ratings than can be obtained from one solar cell is to connect two or more in parallel.

Linear Regulator. Some portable cassette players use two AA cells as

the power source, and require an operating current of typically less than 125 mA. Although a step-down switching regulator can be designed for this application, a linear circuit is more efficient. Such a circuit is illustrated in Fig. 2. The heart of that regulator is a low-power op-amp, which controls a PNP transistor that's connected as a high-side switch between the cell array and load. The circuit's input/output voltage differential just 0.3 volt, which is lower than most fixed linear-regulator chips.

In the linear circuit, the negative input of the op-amp is biased at a reference voltage of 0.7 volts by means of R5 and D2. A voltage divider, composed of R3 and R4 and connected to the positive input of the op-amp, monitors the output voltage of the regulator. The output of the op-amp acts as a current sink for the base of Q1, and draws sufficient base current to maintain a relatively constant out-

put voltage with variations in solar-cell voltage and load current.

As the output voltage of the solar-cell array changes with varying degrees of Sun intensity, the voltage at pin 1 of U2 moves up and down accordingly. As a result, the output of the supply remains at or close to 2.4 volts.

As discussed earlier, the current supplied by the solar-cell array is essentially equal to the current demanded by the radio or cassette player. For most 3-volt portable cassette players, the current is usually in the 125-mA range. One way to obtain a solar cell with that capacity is to parallel 100-mA cells with 50-mA cells, which would provide an extra margin of power to the system.

Construction. Both of the regulator circuits are extremely simple to build and can easily be hardwired on a small section of perfboard. But for a more professional look, you may wish to use printed-circuit construction. The board(s) can either be etched from the full-sized, printed-circuit templates shown in Figs. 3 and 4 (the switching and the linear regulators, respectively), or purchased from the source given in the Parts List.

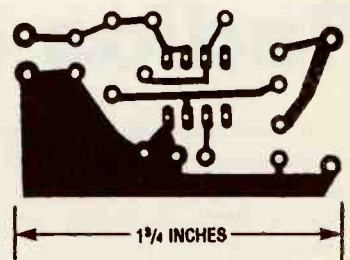

Fig. 3. The switching regulator was assembled on a small printed-circuit board. This full-sized, printed-circuit template can be used to etch your own board.

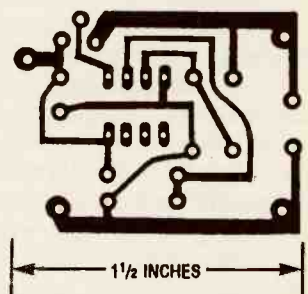

Fig. 4. The linear regulator was also assembled on a small section of printed-circuit board. Here is a template of that foil pattern.

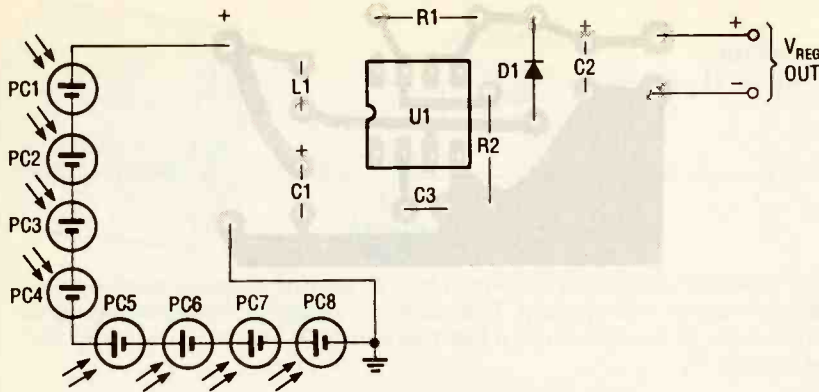

Fig. 5. When gathering the components for the switching-regulator board, be sure to use the parts specified in the Parts List, including the use of metal-film resistors where called for, and a Schottky diode.

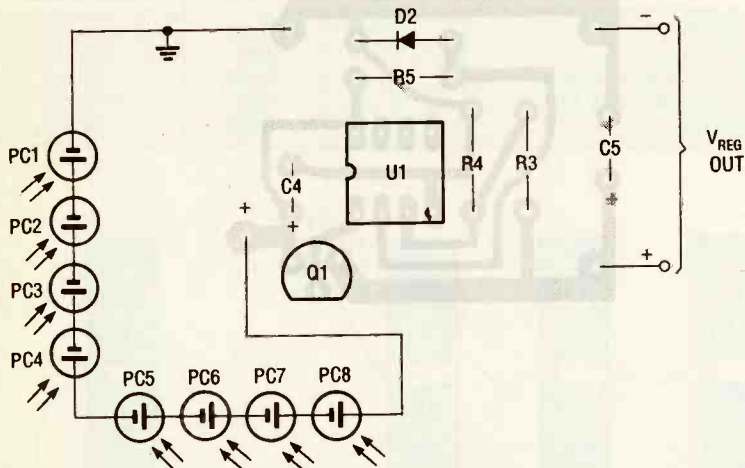

Fig. 6. Here is the parts-placement diagram for the linear-regulator circuit. When assembling this, as well as any other electronic project, make absolutely sure that all of the polarized components are properly oriented.

When gathering the necessary components, be sure to use the parts specified in the Parts List. That includes using 1% metal-film resistors where called for, and a Schottky diode in the switching regulator. The inductor must be rated for twice the load current of the supply, and have a resistance of less than 5 ohms. The use of alternate components will result in less than optimum operation. Be very careful to orient all polarized components properly; just one part placed backwards on the board will render the circuit inoperative and may cause component damage.

Once you've obtained the specified parts, construction can be begun. Parts-placement diagrams for Figs. 3 and 4 are shown in Figs. 5 and 6, respectively. It is recommended that a socket be used for the DIP IC in each circuit. The use of sockets makes troubleshooting or servicing much easier should either ever be necessary.

When the circuit is completely assembled and wired, inspect it very carefully for shorts, opens, and cold solder joints (which may appear as dull blobs of solder). Any suspect joint should be redone by removing the old solder and applying new solder. It is far easier to correct construction problems at this stage than it is to do so later on should you discover that your project does not work.

Solar Cell Selection. In order to select the correct-size solar cells for the desired application, the current draw of the device to be operated must be known. That can be determined by actually measuring the current drawn by the device to be powered, with a DMM set to read DC milliamps, while the radio or cassette player is operated from a set of batteries or an AC adapter.

Using batteries as the power source is the preferred method for determin-

PARTS LIST FOR THE SWITCHING REGULATOR

SEMICONDUCTORS

U1—MAX630CPA switching regulator (Harris Semiconductors), integrated circuit
D1—1N5819 Schottky diode

RESISTORS

(All fixed resistors are 1/4-watt, 1% units, unless otherwise specified.)
R1—453,000-ohm or 274,000-ohm, metal-film (see text)
R2—100,000-ohm, carbon, 5%

CAPACITORS

C1—100- μ F, 10-WVDC, radial-lead electrolytic
C2—1000- μ F, 10-WVDC, radial-lead electrolytic
C3—100-pF, 50-WVDC, ceramic-disc

ADDITIONAL PARTS AND MATERIALS

PC1-PC8—0.5-volt photocell (see text)
L1—1-mH, 200-mA choke. DC resistance 5 ohms or less
Printed-circuit materials, enclosure, wire, solder, hardware, etc.

ing load current since it will provide a more accurate reading. While making the measurement, play the unit with the highest volume that you intend to use.

The easiest way to make this measurement is to obtain a power-adaptor plug that fits the external power jack of the unit to be powered, and use an external power source (batteries or AC adapter) to operate the unit. A DMM connected in series (as illustrated in Fig. 7) with one of the power leads and set to 200 mA DC will indicate the current drawn by the unit.

Because there is no standard power-supply connection scheme from one manufacturer to another, one must be very careful about power-supply polarity when performing this test. One way to check polarity of the jack on some units is to connect a pair of wires to the adapter plug, insert the plug into the jack, and use a DC voltmeter to check the polarity of the battery voltage appearing across the wires. That test requires batteries to be in the unit to provide voltage at the power jack, and will work if the plug does not automatically disconnect the batteries.

PARTS LIST FOR THE LINEAR REGULATOR

SEMICONDUCTORS

U2—LM358N dual low-power op-amp, integrated circuit
 Q1—2N3906 general-purpose PNP silicon transistor
 D2—1N4148 general-purpose silicon diode

RESISTORS

(All fixed resistors are 1/4-watt, 1% units, unless otherwise specified.)
 R3—26,100-ohm, metal-film
 R4—10,000-ohm, metal-film
 R5—1000-ohm, carbon, 5%

CAPACITORS

C4—100- μ F, 10-WVDC, radial-lead electrolytic
 C5—1000- μ F, 10-WVDC, radial-lead electrolytic

ADDITIONAL PARTS AND MATERIALS

PC1-PC8—0.5-volt photocell (see text)
 Printed-circuit materials, enclosure, wire, solder, hardware, etc.

Note: The following parts are available from A. Caristi, 69 White Pond Road, Waldwick, NJ 07463: PC board (specify linear or switching regulator), \$5.00; U1, \$11.50; U2, \$2.75; L1, \$5.50; D1, \$2.00; metal-film-resistor kit (specify values), \$2.00. Please add \$3.00 postage/handling. New Jersey residents please add applicable sales tax.

Another way to verify polarity (if an AC adapter for the unit in question is available) is to plug the unit into a 117-volt AC receptacle and check the DC voltage at the output of the plug with a DC voltmeter.

Table 1 gives the approximate current drawn by several types of common portable radio and cassette equipment. Note that "radio only" operation requires significantly less current than cassette operation. That because the motor does not run when simply playing the radio. For 3-volt devices, the linear regulator circuit is the best candidate. For that type of circuit, the solar-cell array's output current should equal that of the unit to be powered.

For 6- and 9-volt devices, the step-up switching regulator in Fig. 4 is the preferred circuit. In that case, the required solar-cell current capacity

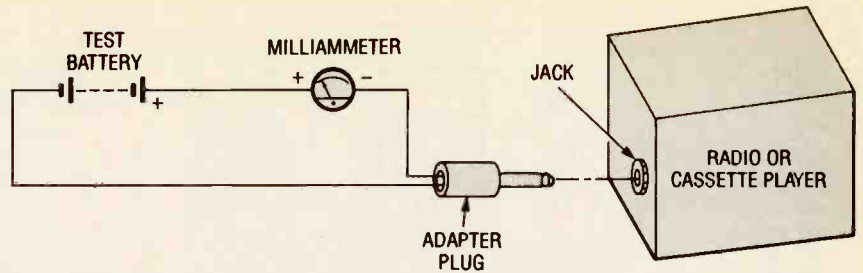

Fig. 7. The solar cell used in this project must be selected according to the current draw of the device to be operated. That can be determined by actually measuring the current drawn by the device using a DMM set to read DC milliamps, in a setup like that shown here.

TABLE 1—TYPICAL CURRENT REQUIREMENT FOR PORTABLE RADIO AND CASSETTE PLAYERS

Power Source/Drive	Volts	Mode	Load Current
2 AA cells/Walkman	3	Radio	25 mA
2 AA cells/Walkman	3	Tape	125 mA
4 AA/C cells/Radio & cassette	6	Radio	25 mA
4 AA/C cells/Radio & cassette	6	Tape	115 mA
9-volt battery	9	Radio	15 mA

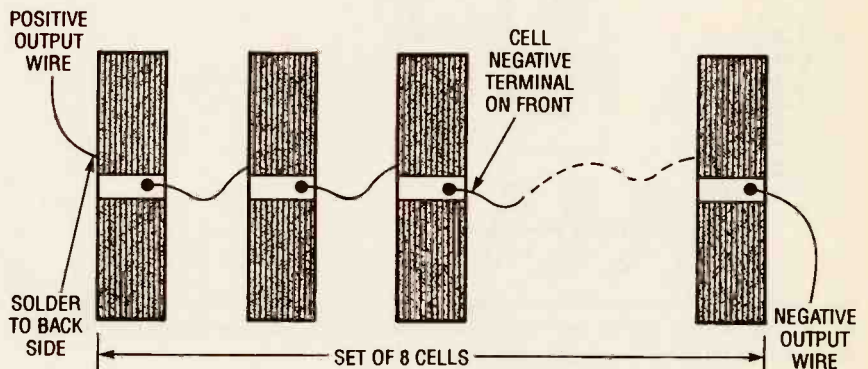

Fig. 8. This illustration shows the proper way to wire solar cells in series. The connections are made from the back of the cell (positive terminal) to the silver colored band on the front of the cell (negative terminal). The free ends of the 8-cell string is the connected to the circuit as shown in the schematic diagram.

must be calculated, using two simple equations. First calculate the radio/tape player power input in milliwatts:

$$\text{mW} = \text{V} \times \text{mA}$$

where V is the nominal regulated supply voltage (4.8 or 7.2 volts) and mA is the device's load current, which was measured previously.

Next calculate solar-cell current using a conservative estimate of 70% (0.7) for switching-regulator efficiency, and a minimum solar-array output voltage of 3 volts under hazy sunlight:

$$\text{Solar-array current} = \text{mW}/(0.7 \times 3)$$

where mW is the power input previously calculated. For example, for a typical cassette player that is powered by 4 AA cells and draws 115-mA load current:

$$\text{mW} = 4.8\text{V} \times 115\text{ mA} = 552$$

and:

$$\text{Solar-array current} = 552/(0.7 \times 3) = 263\text{ mA}$$

For the above example, a set of eight solar cells (rated at 300 mA) connected in series will be ideal for this application.

Solar-Cell Assembly. Solar cells may be obtained individually, or in groups connected in series to form an array. A typical solar cell, rated at 300 mA, is available from Radio Shack (part number 276-124). Another good source for solar cells is Edmund Scientific Co. (101 E. Gloucester Pike, Barrington, NJ 08007).

(Continued on page 104)

PROJECT TIME
2
EVENINGS

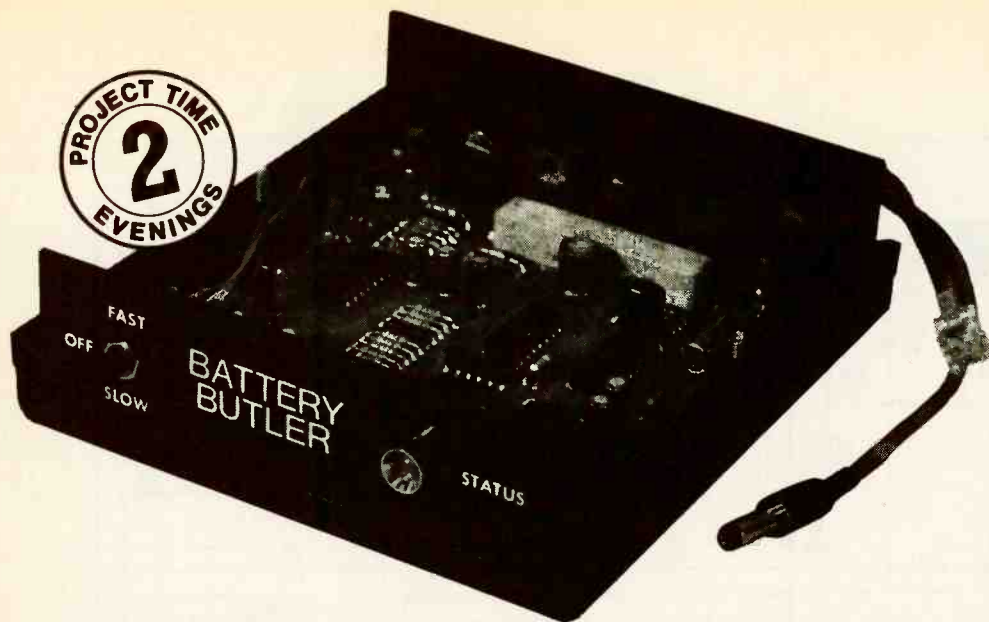

Eliminate frequent rechargeable Ni-Cd battery replacement with a charging circuit that can also restore batteries that have developed a "memory"

BATTERY BUTLER

BY LARRY LANPHER

With the widespread use of fast-charging, nickel-cadmium (Ni-Cd) battery chargers supplied with many consumer products, many consumers have found that the convenience of rapid charging has not offset the high cost of replacing destroyed batteries in their telephones, handheld transceivers, remote-control model cars, and planes. The replacement cost of the batteries that power such portable and cordless gadgets can range from 25 to 75 dollars. On top of that, with regular use, some types of fast chargers can reduce the useful life of a rechargeable battery to 20% to 50% of its normal life.

Further reducing the useful life of their Ni-Cd batteries, consumers, especially portable cellular telephone users, fail to let their batteries fully discharge before recharging them. That can cause the battery to develop what is known as a "memory"—which is caused by repeated partial discharge of the Ni-Cd battery. Each time the battery is partially discharged, prior to a normal recharge cycle, the battery demonstrates an apparent loss of capacity. However, most of the incurred loss is recoverable by subjecting the battery to a few deep-discharge cycles.

Operating and charging Ni-Cd batteries at elevated temperatures also reduces their useful life. Most Ni-Cd batteries give their best perfor-

mance at temperatures between 18°C and 30°C. The high internal temperatures of Ni-Cd batteries during fast charging, often near 50°C, accelerates cell electrolyte-seal and separator deterioration and increases the probability of internal shorting. Electrolyte venting, due to high internal pressures, occurs more often at elevated temperatures. The loss of cell electrolyte, due to continuous cell venting, results in a net loss of cell capacity.

The *Battery-Butler*, described in this article, solves the common problems associated with the maintenance and operation of Ni-Cd batteries. The Battery-Butler, by initially discharging a Ni-Cd battery to a preset point, reduces the possibility of the "memory" effect occurring. Once discharged, a battery is then usually charged at 25% or less of the fast-charge rate. Charging at a lower rate will typically reduce the internal cell temperature rise by 25% and reduce the internal cell pressure increase by 40% or more. Once the battery is fully charged, a trickle charge is provided to maintain the battery in a fully charged state. The Battery-Butler circuit can be bypassed, and the existing fast-charger used, if needed.

Circuit Description. A schematic diagram of the Battery-Butler is shown in Fig. 1. When power is first applied to the circuit and S1 is in the off position,

C2 is held discharged. At the same time, pin 14 of U3-f is held low via R2, forcing U3-f's output at pin 15 high. The high output of U3-f divides along two paths. In one path, U3-f's output is fed to U3-b at pin 5 through D3, causing the output of U3-b at pin 4 to go low. The logical-low output of U3-b is fed to the base of Q4, keeping it turned off.

In the other path, the high output of U3-f is applied to the input of U3-c at pin 7, forcing its output low, which in turn holds C1 in a discharged state through R4 and D2. That keeps the output of U1-b (at pin 9) high, which keeps LED1 dark. The reset signal (taken from pin 6 of U3-c), being low, forces both R/S latches (comprised of U4-a/U4-b and U4-c/U4-d) to return to their respective reset states. Once in a reset state, pin 4 of U4-b and 10 of U4-c go high, and pin 11 of U4-d remains low, indicating a discharge cycle. The low output of U4-d at pin 11 forces pin 2 of U3-a high, turning Q2 on. That pulls the \overline{ADJ} pin of U7 low, which holds the output off.

When S1 is flipped to the slow position, pin 15 of U3-f goes low, forcing pin 6 of U3-c high, while at the same time reverse biasing D3, so no current flows through that unit. With D3 reverse biased and pin 11 of U4-d low, pin 4 of U3-b goes high, turning on Q4. The battery then starts to discharge into R39 through Q4. Zener diode D7 provides overvoltage and reverse-voltage protection for Q4.

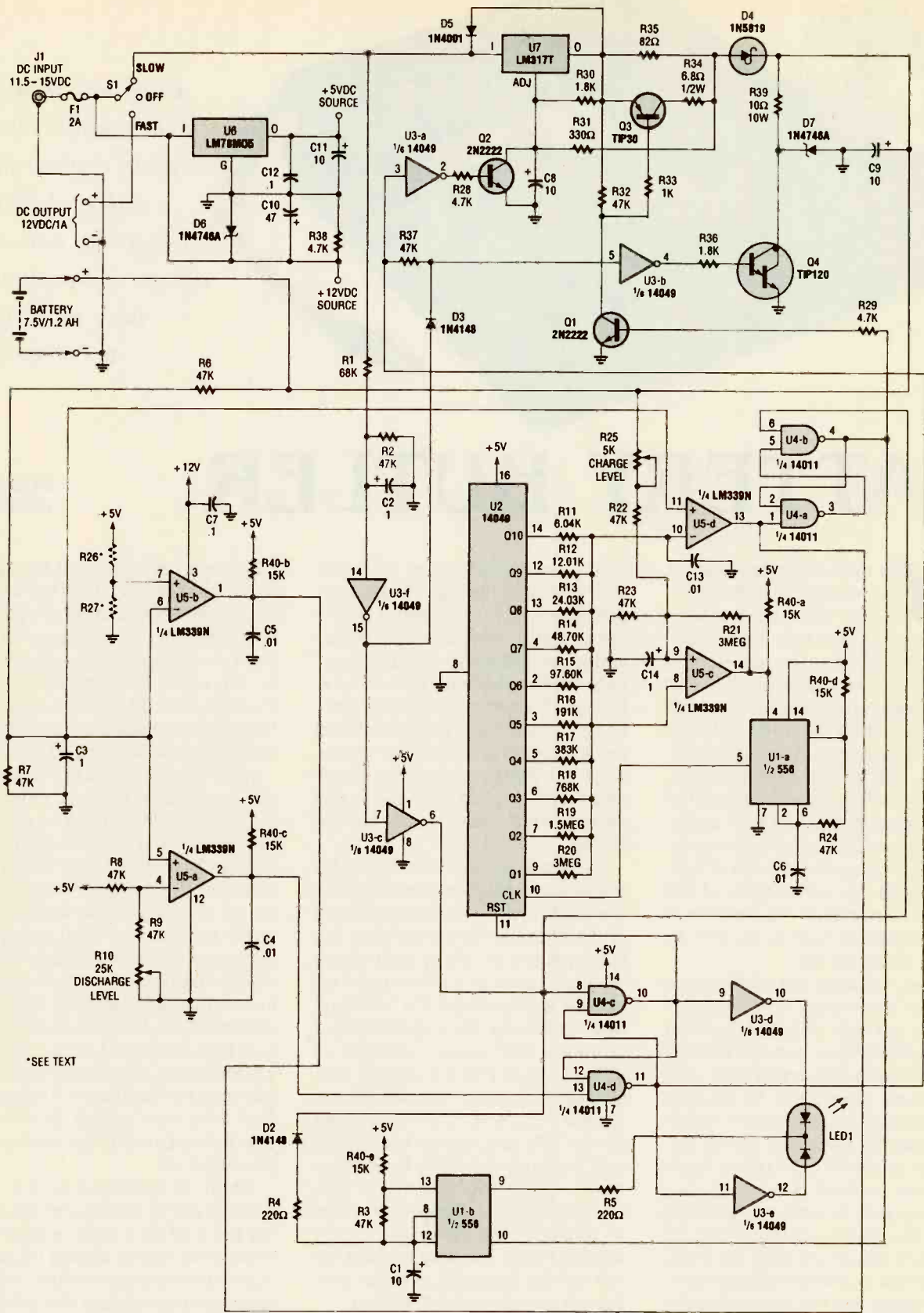

*SEE TEXT

Fig. 1. The Battery-Butler is comprised seven IC's—an LM555 dual oscillator/timer, an MC14040 CMOS 12-stage binary counter, an MC14049 CMOS hex inverting buffer, an MC14011 quad CMOS NAND gate, an LM339N quad comparator, an LM78M05 5-volt, 500-mA, voltage regulator, and LM317T 1-amp, adjustable voltage regulator—along with their support components.

Pin 6 of U3-c, which is now high, allows C1 to begin charging. The charge on C1 is applied to the threshold input of U1-b at pin 12. The high output of U4-b at pin 4 is applied to the reset input of U1-b at pin 10. Those two signals, being high, cause U1-b to begin oscillating, which in turn flashes LED1. The displayed color of LED1 is selected by the state of pin 10 of U4-c and 11 of U4-d. With pin 11 of U4-d low, LED1 flashes red.

The Ni-Cd battery's voltage is applied to the circuit and divided by R6 and R7, and is monitored by U5-a. When the voltage at a pin 5 of U5-a dips lower than the reference voltage at pin 4 of U5-a, pin 2 of U5-a goes low, indicating that the battery has been discharged. Note that the discharge cycle can last from seconds to hours, depending upon the type and condition of the battery. The low output of U5-a is fed to one input of an R/S latch (consisting of U4-c and U4-d), forcing pin 10 low and 11 high, which, in turn, causes the red section of LED1 to turn off and the green section to turn on, indicating that a charge cycle has begun. The high output of U4-d at pin 11 forces the output of U3-a at pin 2 low, turning Q2 off. That allows the ADJ terminal of U7 to float high, which turns the output pin on and allows current to flow to the Ni-Cd battery.

Since the initial reset cycle, pin 4 of U4-b has been high, generating the hi-rate signal. The hi-rate signal (in a high-logic state) turns Q1 on, which turns Q3 on. With Q3 conducting, R34 sets the regulator's constant-current output at the higher charging rate.

The Ni-Cd battery's charge voltage is divided by a resistor network comprised of R22, R23, and R25, and applied to a track-and-hold circuit, which is used to monitor the charge voltage. The track-and-hold action is initiated when the reset input of U2 at pin 11 drops low at the start of the charge cycle. That allows U2, clocked by U1-a, to begin counting. Once counting, U2, combined with R11-R20, produces a ramp voltage at pins 8 and 10 of U5-c and U5-d, respectively. That voltage continually increases until the voltage at pin 8 of U5-c is greater than that at pin 9, at which time, the reset input of U1-a at pin 4 goes low, inhibiting the clock.

As the battery continues to charge, the voltage at pin 9 of U5-c increases

PARTS LIST FOR THE BATTERY BUTLER

SEMICONDUCTORS

U1—LM556 dual oscillator/timer, integrated circuit
 U2—MC14040 CMOS 12-stage binary counter, integrated circuit
 U3—MC14049 CMOS hex inverting buffer, integrated circuit
 U4—MC14011 quad CMOS NAND gate, integrated circuit
 U5—LM339N quad comparator, integrated circuit
 U6—LM78M05 5-volt, 500-mA, voltage regulator, integrated circuit
 U7—LM317T 1-amp, adjustable voltage regulator, integrated circuit
 Q1, Q2—2N2222 general-purpose NPN silicon transistor
 Q3—TIP30 PNP Darlington power transistor
 Q4—TIP120 NPN Darlington power transistor
 DI—Not used
 D2, D3—1N4148 or 1N914 general-purpose silicon, switching diode
 D4—1N5819 or equivalent Schottky diode
 D5—1N4001 1-amp, 50-PIV rectifier diode
 D6, D7—1N4746A 18-volt, 1-watt, Zener diode
 LED1—Bi-color (3 lead) light-emitting diode

RESISTORS
 (All fixed resistors are 1/4-watt, 5% units, unless otherwise noted.)
 R1—68,000-ohm
 R2, R3, R6-R9, R22-R24, R32, R37—47,000-ohm
 R4, R5—220-ohm
 R10—25,000-ohm, cermet trimmer potentiometer (Bourns 3386P)
 R11—6040-ohm, 1/4-watt, 2%
 R12—12010-ohm, 1/4-watt, 2%
 R13—24030-ohm, 1/4-watt, 2%
 R14—48700-ohm, 1/4-watt, 2%
 R15—97600-ohm 1/4-watt, 2%
 R16—191,000-ohm, 1/4-watt, 2%
 R17—383,000-ohm, 1/4-watt, 2%
 R18—768,000-ohm, 1/4-watt, 2%
 R19—1.5-megohm
 R20, R21—3-megohm
 R25—5000-ohm cermet trimmer potentiometer (Bourns 3386P)
 R26—Jumper wire, see text
 R27—No connection, see text
 R28, R29, R38—4700-ohm
 R30, R36—1800-ohm
 R31—330-ohm
 R33—1000-ohm
 R34—6.8-ohm 1/2-watt, 5%
 R35—82-ohm
 R39—10-ohm 10-watt, 5% ceramic
 R40—15,000-ohm × 5 SIP resistor network

CAPACITORS
 C1, C8, C9, C11—10-μF, 25-WVDC, electrolytic
 C2, C3, C14—1-μF, 25-WVDC, electrolytic
 C4-C6, C13—0.01-μF, ceramic-disc
 C7, C12—0.1-μF, ceramic-disc
 C10—47-μF, 25-WVDC, electrolytic

ADDITIONAL PARTS AND MATERIALS
 FI—2-amp, 125-volt, 5-mm × 20-mm fuse
 J1—5.5-mm × 2.1-mm DC power jack
 S1—SPDT center-off toggle switch
 Printed-circuit board materials, 5/2 × 5- X 1 1/2-inch plastic enclosure, battery-output cable, DC-output cable, LED bezel, grommets, TO-220 heat-sink, fuse holder, wire, hardware, etc.

Note: A kit containing a PC board, plastic enclosure, and all parts for the Battery-Butler is available from Peripheral Products (P.O. Box 19278, Tampa FL, 33686-9278; Tel. 813-835-8088) for \$49.95, plus \$4.50 shipping and handling. Florida residents please add appropriate sales tax.

proportionately with the increase in battery voltage. When the voltage at pin 9 of U5-c is greater than that pin 8, the reset input of U1-a at pin 4 pulled high, causing it to oscillate. The output of U1-a at pin 3 is fed to the clock input of U2 at pin 10. As the charge cycle continues, the track-and-hold circuit tracks the battery's reference voltage at pin 9 of U5-c, which is slightly less than the $V_{BATT/2}$ voltage at pin 11 of U5-d. That difference can be adjusted via R25.

As the Ni-Cd battery approaches full charge, the voltage across the battery terminals begins to decrease. Since the voltage at pin 8 of U5-c and pin 10 of U5-d is held slightly below the peak $V_{BATT/2}$ voltage, the circuit can detect when the decreasing voltage crosses the lower limit, and hence detect that the battery is approaching full charge.

Once $V_{BATT/2}$ falls below the voltage at pin 10 of U5-d, pin 13 drops low, causing the high-rate signal at pin 4

of U4-b to go low. That signal turns Q1 off, which, in turn, turns Q3 off. With Q3 turned off, R35 sets the regulator's constant-current output at the lower charging rate. The high-rate signal brings pin 10 of U1-b low, inhibiting LED1 from flashing; LED1 remains a steady green until S1 is returned to the OFF position or DC power is lost.

If the battery is disconnected during discharging or charging, the leakage current through U7 will cause $V_{BATT/2}$ to exceed the threshold voltage at pin 7 of U5-b, causing pin 1 of U5-b to go low. That low signal, which indicates a high level at the battery terminals, sets pin 1 of U4-a low, forcing the ready state as previously described. That function also detects overcharging conditions and functions as a safety feature.

Construction. The authors prototype was assembled on a double-sided, printed-circuit board. The foil patterns for the two sides of the board are shown in Figs. 2 and 3 for those who wish to etch their own board. The board is also available separately or as part of a complete kit from the supplier listed in the Parts List. Note that, in any event, it will be necessary to solder the circuit elements to both sides of the board.

Once you have the board and all the components, construction can begin. A parts-placement diagram for the project's double-sided board is shown in Fig. 4. It is wise to socket all of the DIP IC's, as some are CMOS devices and as such are static sensitive. Note: To make socket installation simpler, it is recommended that you use wire-wrap DIP sockets, elevating them slightly so that the leads can be soldered to the top, as well as the bottom, of the board. Once the sockets are in place, install the passive components (resistors, capacitors, fuse, etc.), followed by the active components (diodes, and non-socketed IC's). Be sure and use heat sinks on both U7 and Q4.

The Battery-Butler may be built with an internal DC power supply, allowing operation directly from the 117-volt AC line, or an external adapter may be used. The circuit, as described, requires 11.5–15.0 volts DC at 250 mA during charging, and less than 80 mA during discharging and when in the ready state.

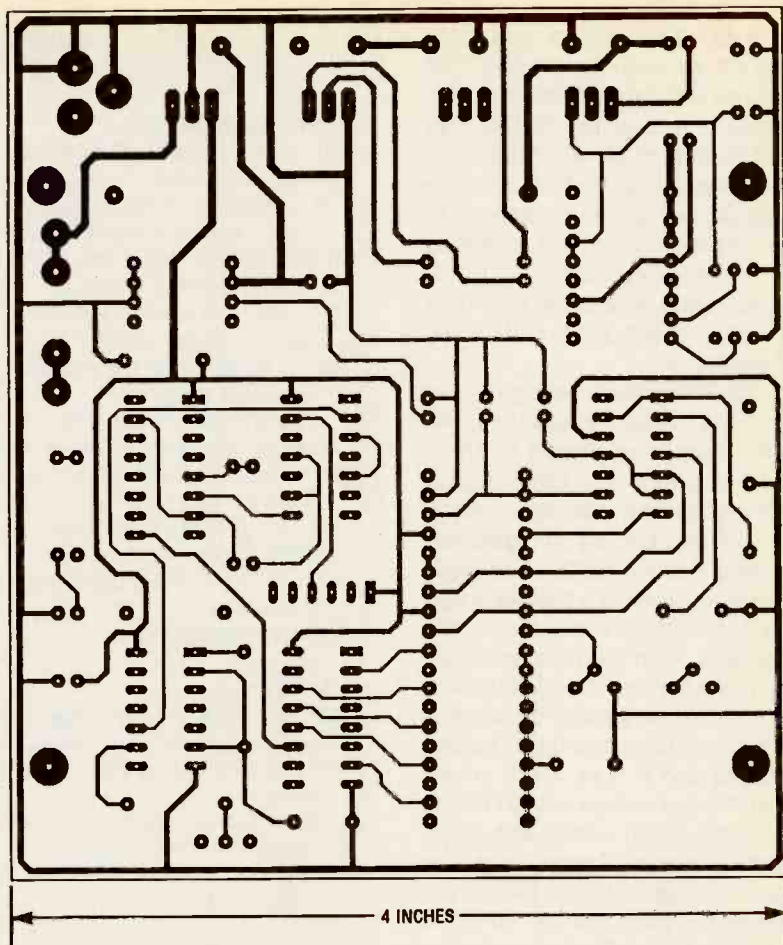
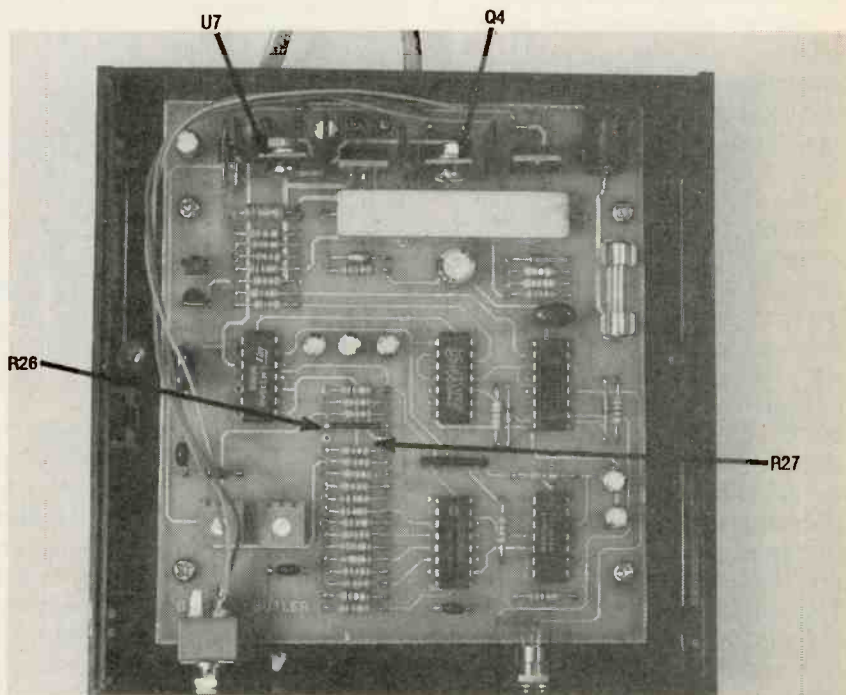

Fig. 2. The author's prototype of the Battery-Butler was assembled on a double-sided, printed-circuit board, measuring about 4 by 4½ inches. The foil pattern for copper side of the board is shown here full-scale.



Note that in the author's prototype, a jumper wire has been placed in the R26 position and R27 (just below it) has been omitted. Also note that U7 and Q4 have heat sinks mounted to them.

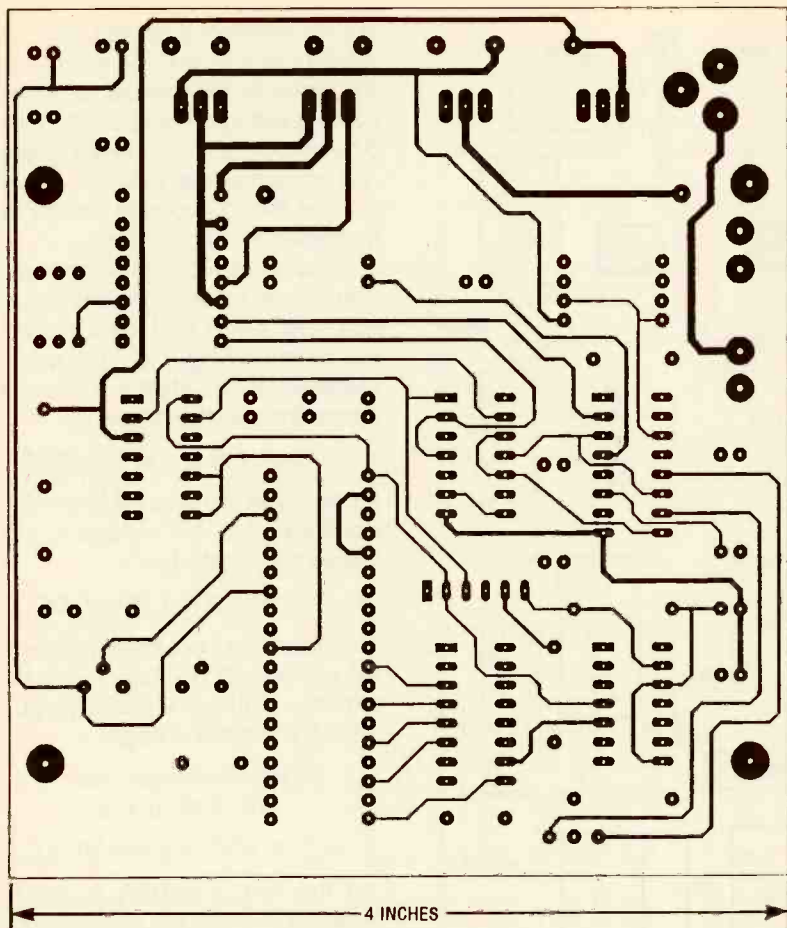

Fig. 3. This full-size template shows the circuit board traces for the components side of the Battery-Butler's double-sided, printed-circuit board. If you decide to etch your own board, be very sure that the two traces are properly aligned before the etching process is begun.

Modifications and Limitations. As described, the circuit has been designed to operate a six-cell—a 7.5-volt DC, 1.2 amp/hr Ni-Cd battery, commonly used in several models of portable cellular telephones. In the unit used by the author, access to the battery is provided through the hands-free interface modular telephone jack on the rear of the charging stand. When using a standard RJ-11 plug and four conductor wire, the red wire is the battery's negative lead, the black lead is the battery's positive lead, and the yellow and green wires are not used.

The charging stand may be used with the 12-volt DC auxiliary output of the Battery-Butler. By connecting that output to a 5.5 mm × 2.1 mm DC power plug (polarized for positive tip) and inserting the plug into the DC power jack on the charging stand, the fast charger can be used normally by placing S1 in the FAST position. Some users have reported good success

even with occasional use of the fast charging mode.

The circuit may be adapted for use with any Ni-Cd battery within the range of from 4.8 to 8.8 volts at 500 mA with a capacity of up to 2 amp/hrs. The charge and discharge characteristics can be easily adjusted to suit the battery. The rate of discharge is set by the value of R39. The discharge level is set by the combination of R8–R10. The high-rate charge current is set by R34 and the low-rate charge current is set by R35. The output over-voltage limiter threshold is set by R26 and R27. (Note that in the version for the 7.5-volt DC/1.2-amp/hr battery described in this article, those resistors are replaced by a jumper and an open circuit, respectively; *i.e.*, the overvoltage limiter threshold is equal to 5 volts.)

The infinite range of battery types, voltages, and current ratings make it difficult to address all possible configurations, but by experimenting and



Shown here is the wiring interface between the battery-charging stand and the Battery-Butler.

using simple calculations, the proper setting for those resistance values can be determined.

Table 1 lists modifications to the circuit for various battery voltages and number of cells. For example, for a battery with two cells and a voltage ranging from 2.40 to 2.50 volts, R6 should be replaced by a jumper wire, R7 is not installed, R9 goes from 47k to 12k, R22 is replaced by a jumper wire, R23 goes from 47k to 82k, R26 (which, in the author's configuration, is a jumper wire) becomes 47k, and R27 (which is omitted altogether in the author's unit) is now 68k. In addition, the voltage measured at pin 4 of U5 should be around 1.80 volts, with no more than a 0.06-volt deviation.

The discharge rate can be controlled by changing the value of R39. If the battery's rated full-charge voltage and the desired discharge rate are known, the new value for R39 (in ohms) can be determined using the following formula:

$$R39 = (V_{\text{batt}} - 0.7) / I_{\text{discharge}}$$

where V_{batt} is the battery voltage, and $I_{\text{discharge}}$ is the discharge current in amperes. For example, if V_{batt} is 7.5 volts and $I_{\text{discharge}}$ is .68-amps (680 mA), then:

$$\begin{aligned} R39 &= 7.5 - .7 / .68 \\ &= 6.8 / .68 = 10 \text{ ohms} \end{aligned}$$

which is the R39 value used in the author's prototype unit.

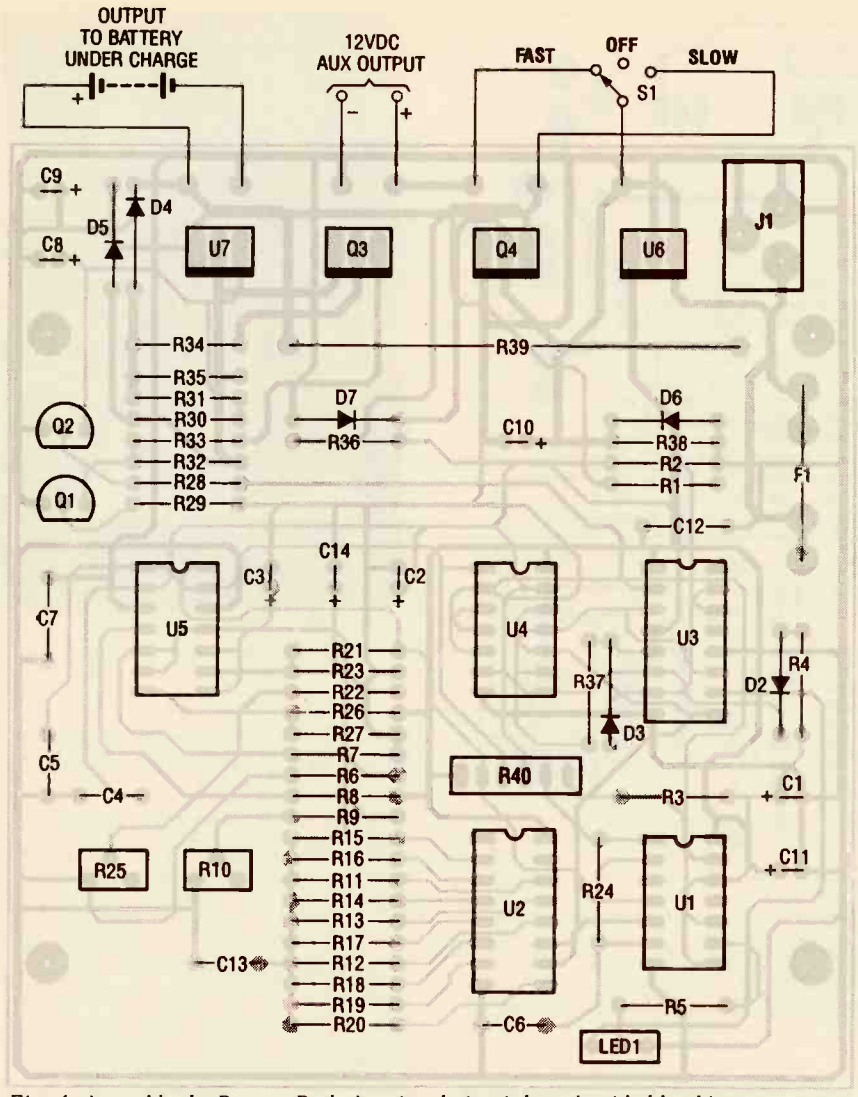

Fig. 4. Assemble the Battery-Butler's printed-circuit board guided by this parts-placement diagram. Note that whether you purchase a board or kit from the supplier listed in the Parts List or etch your own board, it will be necessary to solder the circuit elements to both sides of the board. It is also wise to socket all of the DIP IC's, as some are CMOS devices, and as such are static sensitive.

TABLE 1—RESISTOR VALUE CHANGES AND VOLTAGE ADJUSTMENTS

No. of Cells	Battery (V)	R6	R7	R9	R22	R23	R26	R27	Pin 4 U5 (V)	-dV
2	2.40 - 2.50	JW	NI	12K	JW	82K	47K	68K	1.80	0.06
3	3.60 - 3.75	JW	NI	43K	JW	82K	JW	NI	2.70	0.08
4	4.80 - 5.00	15K	47K	47K	15K	47K	JW	NI	2.70	0.08
5	6.00 - 6.25	33K	47K	47K	33K	47K	JW	NI	2.60	0.08
6	7.20 - 7.50	47K	47K	47K	47K	47K	JW	NI	2.70	0.10
7	8.40 - 8.75	68K	47K	47K	68K	47K	JW	NI	2.60	0.10
8	9.60 - 10.0	82K	47K	47K	82K	47K	JW	NI	2.60	0.10

JW = Jumper Wire NI = Not Installed

To charge seven- and eight-cell (8.40 - 10.0 volt) batteries, the circuit must be supplied from a 16-18-volt DC power source. That voltage must be regulated (via an LM317 or equivalent device). Resistor R34—which normally ranges from 2 to 47 ohms at

½ watt—sets the high-rate charge current. Resistor R35—which normally ranges from 47 to 120 ohms at ¼ watt—sets the low-rate (trickle) charge current.

Testing and Adjustments. Set S1 to

the off position. Connect the completed circuit to a 12-15-volt DC supply. Measure the voltage at pin 3 of U5. That voltage should be at, or near, 5.0 volts DC. If either of those voltages are not within the specified ranges, remove the DC voltage source and recheck the connections.

Measure the voltage at pin 4 of U5 with a high input-impedance digital voltmeter (DVM). That voltage can be set by adjusting R10. The recommended voltage at pin 4 of U5 can be determined by the following:

$$0.90(V) \times (\text{number of cells})/2$$

For example, if a 6 cell, 7.5-volt Ni-Cd battery is used, the voltage at pin 4 should be adjusted to:

$$0.90 \times 6/2 = 2.70 \text{ volts DC}$$

That adjustment sets the level to which the battery will be discharged. Note that the battery will discharge to twice this present voltage:

$$\begin{aligned} \text{Battery Discharge Level} &= \text{pin 4 of U5} \times 2 \\ &= 2.70 \text{ VDC} \times 2 = 5.40 \text{ VDC} \end{aligned}$$

If the Ni-Cd battery is not discharged low enough, the battery will lose its ability to hold a full charge. If the Ni-Cd battery is discharged too low, it is possible that the cells within the battery may reverse and the battery will lose its ability to take a charge.

Connect a fully charged 7.5-volt, 1.2 amp/hr Ni-Cd battery to the proper terminals on the Battery-Butler. Be aware that reversing the battery connection will cause the battery to immediately begin discharging through D7 and R39; that should not damage the Battery-Butler.

Again using a high input-impedance DVM, measure and record the voltage at pin 5 of U5. Measure the voltage at pin 9 of U5. The recommended voltage at that point can be determined by subtracting 0.10 volt DC from the voltage noted earlier at pin 4 of U5. The proper voltage can be set by adjusting R25.

If the voltage at pin 9 of U5 is within .02 volts, or greater than the voltage at pin 5 of U5, the circuit will return to the ready state too soon, and the Ni-Cd battery will not reach a full charge. Note: If the voltage at pin 9 of U5 is 0.30 volts less than the voltage at

(Continued on page 110)

Making The Connection

Make the right connection between a wire antenna and your rig.

There is large amount of information on wire antennas available to receiver users. However, two related topics that seem lacking in coverage, or at least jumbled up with other material, are antenna-construction and termination. In this article, we will take a look at both topics. As we proceed, keep in mind that the information applies to nearly all wire antennas, not just the types mentioned.

Types of Wire Antennas. The variety of wire antennas around is mind boggling, but they fall into two basic categories. One group is like the Marconi-style antenna, shown in Fig. 1A, consisting of a single-wire radiator, usually made of insulated or uninsulated No. 14 or No. 12 wire placed high in the air. The antenna is typically supported by a set of end insulators and rope supports. One end of the antenna is connected to a piece of insulated wire (called the "downlead"), which is connected to the rig (receiver, transmitter, or transceiver).

Related antennas include the random-length wire antenna, long-wire antenna (both resonant and nonresonant types), windoms, Tee-antennas, and top-hat antennas to name a few. They are all different, but have one similarity: they consist of a single radiator element connected to a single-wire downlead that is connected to the radio rig.

Someplace before the downlead enters the house, a protective lightning arrester is connected to the circuit. The lightning arrester is used to bypass as much of a lightning strike as possible to ground. The ground wire connected to the lightning arrester is made of heavy wire or braid cut as short as possible, and is connected at the other end to a ground rod driven into the ground. Always follow local electrical and safety codes for the

BY JOSEPH J. CARR

ground rod, which in most cases means you should use an 8-foot copper-clad steel rod. Those little 4-foot ground rods are not terribly good for lightning protection, so don't depend on them.

The downlead is connected directly to the rig's antenna terminal. A second ground, which may go to the same ground lead as the lightning arrester ground, is used to improve the RF performance of the radio antenna.

The other basic type of antenna is shown in Fig. 1B. That antenna is a dipole. Such antennas consist of two wire radiators fed by a two-conductor cable such as twin-lead, twisted-pair or, most commonly, coaxial cable. When coaxial cable is used, the center feed point may be either a special center insulator or a BALUN (BALanced UNbalanced) transformer. Again, end insulators and rope supports hold the antenna in the air. As with all antennas, a lightning arrester is used to protect the house and rig.

End and Center Insulators. End insulators are used to electrically isolate

the wire radiator from the support rope. In addition, they provide a certain amount of mechanical strength in the connection between the radiator wire and the rope supports. They may be made of glass, glazed ceramic, or a synthetic material such as nylon or Teflon.

Figure 2 shows one popular shape of the classic ceramic end insulator. Most of those sold in stores today are made of synthetic material, although used ceramic and glass insulators can be frequently seen at hamfests.

Two synthetic end insulators are shown in Fig. 3. The larger one shown can be used for high-power ham-radio transmitter antennas as well as general-receiver antenna use. It provides a much larger degree of isolation between the wire and the supports (which presumably reduces end effects). The smaller unit is used for smaller transmitter antennas, and general shortwave-receiver antennas.

A pair of popular center insulators are shown in Figs. 4 and 5. The type shown in Fig. 4 has an SO-239 UHF



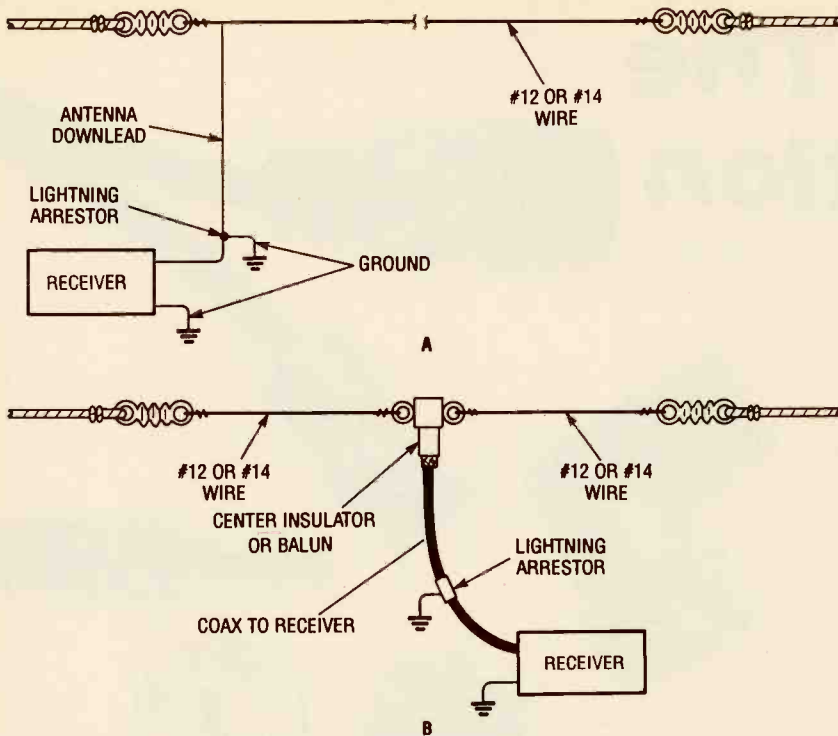

Fig. 1. The two most common antenna types—the Marconi-style antenna (A) and the Hertzian “balanced” antenna (B)—are shown here. Note the additional radiator in B.

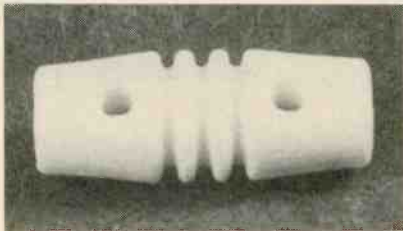

Fig. 2. End insulators come in different styles. Here is a “classic” end insulator made of glazed ceramic. Some can still be found at ham shows today.

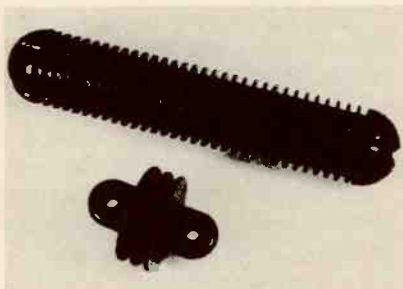

Fig. 3. The modern end insulators are typically made of a synthetic material such as nylon. That makes them fairly resilient

coaxial connector, that can mate directly with the PL-259 coaxial connectors used on many antenna feedlines. The radiator elements are connected to heavy-duty, solid-copper wire “pigtailed” protruding out each

end of the center insulator. (Connections for this type of center insulator will be discussed later.) A different form of center insulator is shown in Fig. 5. In that type of insulator, a hollow body of PVC-like plastic material contains connections for the SO-239 coaxial cable. The wires are connected to, and supported by, a pair of screw/eye terminals on either side.

Some center insulators contain BALUN transformers. For ordinary dipoles use 1:1 BALUN transformers; for folded dipoles use 4:1 BALUN's.

Using Insulators. There are two goals to keep in mind when making connections to either end insulators or center insulators. First, you want a strong, reliable mechanical connection that won't come loose under the buffeting the antenna will receive. Winds and weather can take a terrible toll on wire antennas, so a good, reliable connection is mandatory. The second goal is to make a good electrical connection—after all is said and done, the antenna is still an electrical device connected to an electronic circuit.

A minor point to make is to avoid kinks. Radiator wire is either hard-drawn copper wire or copper-clad steel wire (e.g., Copperweld), so keep

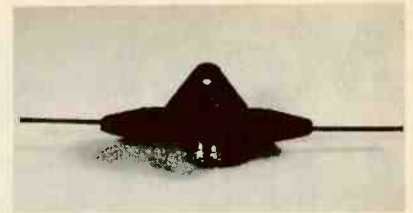

Fig. 4. Some center insulators have “pigtailed” radiators on each side that the antenna's downlead attaches to the connector at the bottom of the insulator.

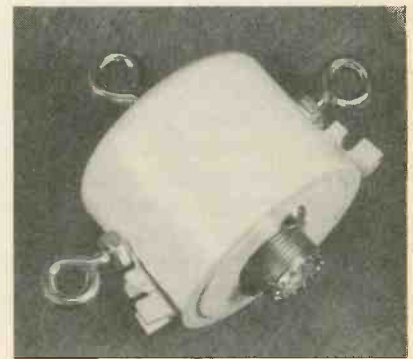

Fig. 5. This type of center insulator has crimp-on lugs for a good electrical connection. These center insulators sometimes contain BALUN transformers.

in mind that it kinks up very easily. In fact, experienced antenna erectors claim that gremlins or RF demons exist whose main function in the universe is to put permanent kinks in wire. When the wire kinks, it is nearly impossible to get the kink out of the wire so that it looks good again. The antenna will still perform well, but the spot where the kink occurred will always remain.

Let's deal with end insulators first. Figure 6 shows how to make a connection to an end insulator. Although only one style insulator is shown here, the method for the other styles shown earlier is identical.

The first step in connecting the antenna wire to the insulator is to pass the wire through one of the holes in the insulator. Leave 6 to 8 inches of free wire. Next, double the free end of the wire back on itself, and wrap it around the main body of the wire six to eight times; leave about 3/4- to 1-inch of loop to permit the insulator to move freely. If a downlead is required, as it will be on one end of a Marconi-style antenna, then strip away about 2 inches of its insulation, and then wrap the bare downlead wire around the main antenna wire four to eight times.

The final step is to solder all the con-

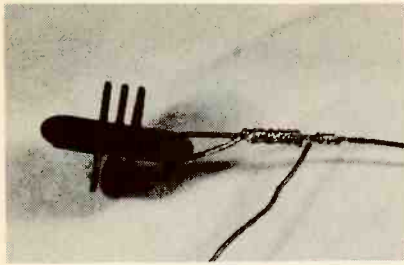

Fig. 6. To make a connection to an end insulator, you first insert some wire into an eyelet, twist it over on itself 6-8 turns, and then solder.

nections. The purpose of the solder is not to add mechanical strength, but to ensure the electrical connection in the face of potential corrosion. Use either 50/50 or 60/40 lead/tin resin-core solder. Use solder marked "resin core," "radio/TV," or "electronic" solder. Under no circumstances use acid-core solder! That solder will eat the antenna wire away. It is marked "plumber's" solder, or something similar. Also avoid coreless solder. It can only be used with separate acid-core flux, and is useless to wire-antenna constructors.

Use at least a 150-watt soldering iron or soldering gun. A small pencil-type iron (typically less than 75 watts) is not suitable for this purpose. Heat the joint thoroughly, and then apply the solder so it completely coats the wire of the support splice and the downlead splice. You may find that the area where you apply the iron will turn out well coated with solder, but other areas aren't wetted at all, so be sure to turn the wire over and solder all surfaces.

Apply caution when soldering.

Solder must be very hot to melt, and the wire junction and its vicinity (even the insulator) will try to "sink" the heat, so don't touch it with your bare hands! It can cause painful first- and second-degree burns. Handle the wire and the insulator with insulated pliers, or some other heat-handling tool.

The procedure for connecting a center insulator depends on the type of center insulator that is used. Figure 7 shows the use of an ordinary end insulator as a center insulator for a dipole or other balanced antenna. The two wire radiators are spliced onto the insulator in the normal manner for end insulators. The coaxial cable is stripped such that its center insulator and conductor are each

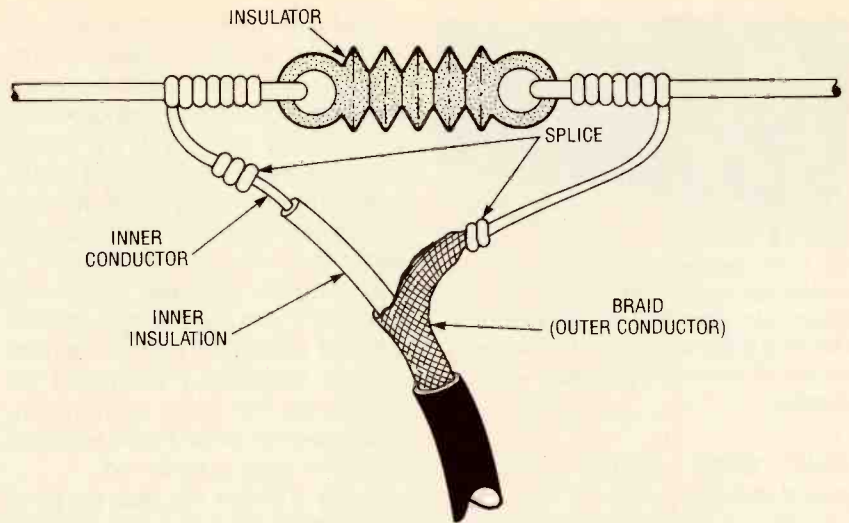

Fig. 7. The split-coax method of making center connections shown here is not advisable, as the connection is prone to corrosion.

routed to one of the antenna radiators, while the braid (outer conductor) is routed to the other. Both are spliced to their respective radiator elements. One popular method is to use the pigtailed left over from making the two support splices as electrical connections for the coaxial cable.

In some cases, the body of the coaxial cable is wrapped around the center insulator and tied off with string, cord, or fishing line in order to provide mechanical support for the connections. If you use the "split coax" method, then a strain relief is essential.

The method shown in Fig. 7 is not recommended. It is mechanically weak, and open to the weather. It is common to find water infiltration into the coaxial cable, which deteriorates its performance. It is better to use a regular center insulator or a BALUN transformer.

The type of center insulator shown back in Fig. 4 has heavy, solid copper-wire pigtailed protruding from inside the insulator. Before beginning the splice, you must tin the pigtailed. That is, heat up each one with a soldering iron and spread a thin coating of solder over them. They should look silver plated and smooth after they are tinned.

The antenna wire is laid alongside each copper pigtail, and in contact with it, and is then passed through the hole in the insulator, doubled back on itself, and then wrapped around both the pigtail and its own main body six to eight times. It thus resembles an ordinary end insulator support splice, except for the pigtail in the core. Fi-

nally, using a soldering iron or gun, solder the splice thoroughly in the same manner as for support splices.

The method for connecting the other type of center insulator (shown back in Fig. 5) is similar to the technique for an end insulator. You pass the antenna wire through an eyelet, and leave about 8 to 10 inches of wire free when you pass it through. Then wrap the wire back on itself until you have about 5-inches of the free end left. The end left over is then connected to the terminal lugs fastened to the eyelet. It is prudent to pull the lug away from the body of the insulator so it can be later crimped and soldered without melting the plastic body. Pass the end of the wire all the way into the terminal past both sets of flanges, and then crimp the flanges over the wire with long-nose pliers in order to form a good mechanical joint. Next, solder the terminal and wire together.

The Rig End. There are a variety of connectors used for connecting antennas to receivers and transmitters. If the connector on your antenna complements the one on your receiver, you just have to plug them together. If the two connectors do not mate, you could just buy an adapter to bridge the connection.

Some receivers are equipped with a two- or three-station screw terminal instead of a connector. On a two-screw terminal block, one screw (often labeled "ANT" or "A") is for the antenna and the other (labeled



Fig. 8. The rear panel of this shortwave receiver can accept coax, lug-terminal, or bare-wire download terminations. In a pinch, a banana plug could be pushed into the 50-ohm socket for single-wire antennas.

"GND," "GRND," or "G") is for the ground connection.

The screws on units equipped with three-terminal antenna blocks are typically labelled "A1," "A2," and "G." Those sets can use a balanced transmission line, such as twin-lead, parallel line or twisted pair line, but are most often connected to a single-wire line. When a single line is used, the input can be converted into an unbalanced one by connecting a wire jumper between terminals A2 and G (i.e., by strapping one side of the antenna connector to ground).

The method of choice for connecting any such wires is through the use of neat cable-ends, or spade lugs. However, if you must use just the ex-

posed wire, take the time to strip the end of the download about 3/8 inch, and then form it into a loop that has a diameter slightly larger than the body of the screw terminal. If the wire is stranded, then tin the stripped end to prevent it from fraying and shorting to the adjacent terminal. Place the loop under the screw in the direction of tightening for the screw (clockwise). The idea is to cause the loop to close on itself under the screw when the screw is tightened. If you place the loop under the screw in the counterclockwise manner, then it will open when the screw is tightened.

Figure 8 shows the rear panel of one of my shortwave receivers. There are three connections present: 50-ohm antenna, "Hi-Z" antenna, and ground. The 50-ohm antenna input is an SO-239 UHF connector for coaxial-cable fed antennas, while the Hi-Z input is for single-wire downloads. In many cases, it is found that the two are connected together inside the receiver, so which one to use is a moot point. However, if needed, it is possible to connect a single-wire antenna directly to an SO-239 coaxial connector by placing a banana plug on the end of its download. If the "Hi-Z" terminal is used, then use a spade lug on the end of the download.

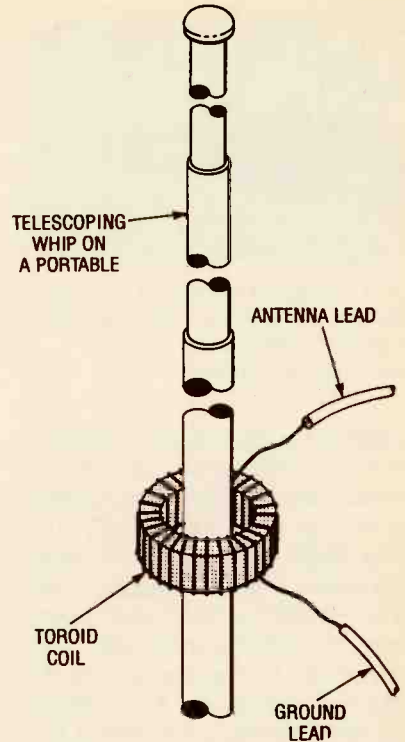
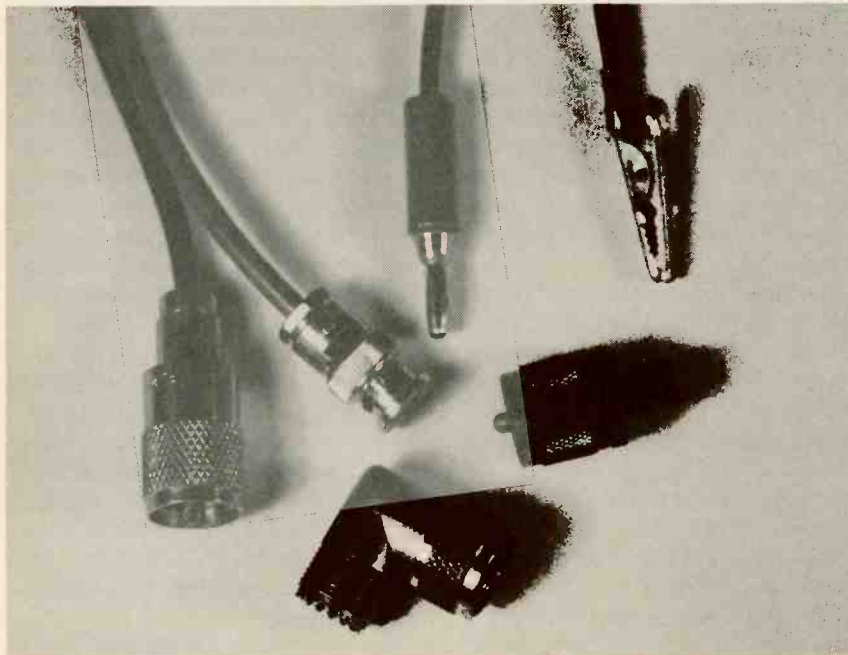

Fig. 9. This method of coupling a single-wire antenna to a portable shortwave radio equipped with a telescoping-whip antenna sometimes works. Other times, it just overloads the receiver

A means for connecting a single-wire antenna to a portable shortwave radio is shown in Fig. 9. Of course, you could use an alligator clip on the end of the download, and connect it directly to the whip antenna of the radio. But that may cause damage to the radio if static charges build up on the antenna. The method shown uses inductive coupling to avoid that.

The coil is wound on a toroidal core that has an inside diameter that will just fit loosely over the bottom portion of the whip antenna when the coil is wound. That usually means a T37 or T50 core. For low bands (less than 7 MHz), use about 20 turns of No.-26 enameled wire over the core; for higher bands (greater than 7 MHz), use 8 to 10 turns of No.-26 enameled wire. Connect one end of the coil to the download, and the other to the ground lead.

Be careful when adding an external antenna to a portable shortwave radio. Some of them already provide compensation for their small telescoping whip antennas. If an external antenna is used, then signal levels may prove excessive causing the radio to overload. ■



These connectors are commonly used to link the download to a receiver or transmitter. From left to right they are the PL-259 UHF coaxial connector, the BNC coaxial connector, the banana plug, and the alligator clip. The coaxial adapters in the foreground are a PL-259-to-SO-239 male-to-female right-angle adapter (left) and an SO-239-to-BNC adapter (right).

SMARTER GAS GAUGE

(Continued from page 22)

cuit board. An incandescent lamp can be connected directly to the circuit board. If, however, the in-dash idiot light is an LED, it will be necessary to use a 1000-ohm current-limiting resistor in series with driver transistor Q1 and the LED. (Check to see if there isn't already a limiting resistor.)

If your car is an early model, then you might not have an idiot light that was factory installed and integral to the instrument cluster. In that case, you'll want to install your own idiot light.

Although you could mount all three potentiometers (trip threshold, lamp dimmer, and slosh control) in the dash, the trip-threshold potentiometer is the one that you'll be adjusting the most. The other two controls can be left on the circuit board, adjusted once, then left alone.

The grounding wire should be terminated with an eyelet (ring lug) and attached to the car chassis anywhere under the dash using a sheet-metal screw or rivet. It's better to ground the circuit directly to the car chassis rather than to another wire that seems to be grounded. Very often, wires that seem to be grounded are actually disconnected when the ignition switch is in one position or another; going directly to the chassis ground takes most of the guess work out of the installation procedure.

The 12-volt wire should go to the radio fuse in the car's fuse box, either solder the joint or use a mechanical twist connector. Also, don't forget to place a 2-amp, in-line fuse in series with the positive supply lead of the Smarter Gas Gauge. If you're in a rush, just jam the Gas Gauge's positive lead wire against the radio fuse and push them both into the fuse box. The fuse clip will hold the wire pretty tightly. It's fast and it works.

Lastly, the V_{gas} lead wire should be connected at the gas gauge to the sending wire using a wire tap-in connector.

Quick connect, snap-n-splice, or wire tap-ins are trade names for a connector that's designed to make an electrical connection between two wires without having to cut, twist, or solder them together. First select

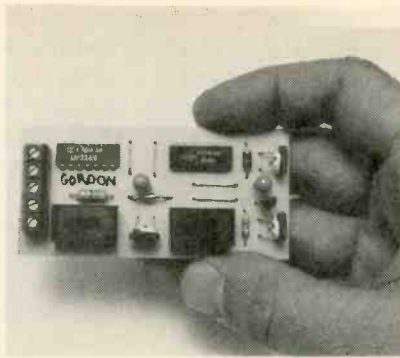

The author's finished prototype of the Smarter Gas Gauge, though small, is uncluttered.

the wire-tapping connector of the appropriate wire gauge for your installation. Place the sending wire and connecting wire into the wire-tap connector, then fold and squeeze with pliers until the metal insert bottoms out; that will force the metal insert to pierce the insulation of both wires thereby making electrical contact without cutting the conductors.

What if your gas gauge is broken? Maybe the gas needle is stuck in the full or empty position. If so you can still use our Smart Gas-Gauge, but you'll have to bypass your broken gauge. That's because series current must flow from the battery through the gas gauge then through the sender to ground. Any broken wire internal to the gauge will open the series circuit and no current will be able to reach the sender.

The idea is to disconnect the gauge wiring and install a 100-ohm, 10-watt, bypass resistor (such as Radio Shack's P/N 271-135 wire-wound resistor). You can leave the gauge in place to retain the dash aesthetics.

Calibration. Here's one method to calibrate the threshold at which the gas level in the tank turns I1 on. Drive your car until the gas tank is well below $\frac{1}{4}$ tank and pull up to a gas pump at any gas station. Turn the ignition key to the ON position, which will leave the fuel-gauge system on, but the engine off. For the calibration to work you'll need to watch the gas-tank needle move as the tank is being filled. When the gas-station attendant starts the pump, adjust R2 (the TRIP-THRESHOLD CONTROL) so that the lamp is illuminated. The second the gas gauge shows exactly $\frac{1}{4}$ tank, back off on the trip threshold until the lamp extinguishes.

That's all there is to it. Now you've set the lamp to come on when your tank is $\frac{1}{4}$ full. Then adjust R3 (LAMP-DIMMER CONTROL) to achieve the desired lamp brightness.

You could also fill up the tank yourself to the exact gas-gauge indication, say $\frac{1}{2}$ full, then go back into your car and adjust the trip-threshold potentiometer so that the lamp just turns on. Any additional gas pumped into the tank will immediately turn the lamp off, as the tank fills up.

The bi-metal, heated-coil, fuel gauge requires a minute or so to accurately reflect the gas level in the tank. That's because the bi-metal takes that long to heat up and bend to the correct position. So give the gauge a minute to stabilize before adjusting the trip threshold. Magnetic-type gauges, which display the correct gas level in the tank right away, don't have that problem.

Even though bi-metal gauges take their time to respond to the correct gas-level reading, the Smarter Gas-Gauge reads the sender voltage immediately and is therefore immediately accurate.

Calibrating the trip threshold while driving on the open road is easy, too. When the gas tank reads about $\frac{1}{4}$ full, adjust the trip-threshold potentiometer so that the lamp just comes on. When you adjust the trip threshold, you're actually adjusting V_{ref} . As the gas sloshes in the tank, V_{gas} varies above and below V_{ref} and that will cause the lamp to flash while you're driving. You, therefore, might want to re-adjust the trip threshold several times until you get a feeling for the lamp's flashing rate.

Accelerating quickly by stepping down hard on the gas peddle or turning tight corners at screeching speeds may also light the lamp, again, because the gas is rolling in the tank. A steep hill or incline may also turn on the lamp. Stopping the lamp from flashing is easy: Adjust potentiometer R4 (the SLOSH TIME-OUT CONTROL) until the lamp stops flashing, then tweak R4 a little more in the same direction for good measure.

Of course, the beauty of the Smarter Gas-Gauge is that you can adjust the lamp to illuminate at any gas level in the tank; whether $\frac{3}{4}$ full, $\frac{1}{2}$ full, $\frac{1}{4}$ full, almost empty, or anywhere in between.

SOLAR POWER SUPPLIES

(Continued from page 92)

A solar cell will deliver about 1/2 volt into its rated load when exposed to full sunlight; a set of eight connected in series will deliver 4 volts for use with this project. The current capability of a cell may be estimated by noting its area. A rule of thumb for solar-cell current rating is 40 mA for each square centimeter of cell area, when exposed to full sunlight.

Refer to Fig. 8, illustrating the proper way to connect solar cells in series. The connections are made to the back of the cell (positive terminal), and the silver colored band on the front of the cell (negative terminal). One must be extremely careful when soldering wires to the cells, which are extremely fragile and will break if subjected to excessive force. Use a low-power soldering iron and very fine flexible wire to make the connections.

The assembly of cells should be placed into a frame that's made of wood or some other suitable insulat-

ing material. The cells can be held in place by sandwiching them between a piece of glass or clear rigid plastic and the frame. A 1/8 or 1/4-inch thick piece of flat foam rubber makes a good cushion to prevent excessive force on the fragile parts.

The regulator circuit itself may be placed into the frame, or a pair of flexible wires can be brought out of the solar panel to allow connection to the circuit.

Checkout. The regulator circuits can be checked out using either the solar-cell array placed in full sunlight as the power source or using a well-filtered adjustable DC supply that can provide 3 to 4 volts at 250 mA. Using a power supply is the preferred method as it will demonstrate that the regulator circuit will operate properly with the minimum specified input voltage.

The radio or cassette player that you intend to power from the circuit can be used as the load, but it would be more convenient to calculate its representative load resistance and use a fixed resistor instead. The load resistance (R_L) is equal to the regulated output voltage ($V_{reg out}$) of the supply divided by the required load current (I_{load}) in amperes. Be sure to use a resistor with a sufficient power rating; about 1 watt should do.

Testing the circuit will require a DC voltmeter with an input resistance of 1 megohm or more. A typical DVM or VOM is satisfactory. Before applying power to the circuit, check the polarity of the input and output connections to be sure they are correct. If a current-limited power supply is used for power, set it to limit the current to slightly more than the circuit requirement.

Apply about 3.5 volts to the regulator circuit while measuring the regulated output voltage. It should be within 0.1 volt of the nominal rating, 2.4 (for the linear circuit), 4.8, or 7.2 volts (for the switching circuits). Vary the input voltage to the circuit by partially shielding the solar cells from the Sun or adjusting the DC power source. Note that the output voltage of the regulator circuit remains relatively constant as the input voltage varies from about 3 to 4 1/2 volts.

If the supply is operating as described, remove the load resistor and

connect the radio or tape player to the output of the regulator. Verify that the circuit will properly drive the unit, delivering a minimum of 2.4, 4.8, or 7.2 volts DC (depending of the type and regulator configuration you've chosen to build. Replace the power supply (if one was used) with the solar-cell array; place solar cell in full sunlight, and verify radio or cassette operation. That completes the checkout.

If the circuit does not work as described, examine it very carefully for proper component values, and correct orientation of the IC, electrolytic capacitors, and diodes. Inspect the wiring for inadvertent short circuits, open circuits, and bad solder joints. Check the input and output connections of the supply to be sure the polarity is correct.

Check the output voltage of the solar-cell array to be sure it is delivering 4 volts in full sunlight. If the output voltage of the regulator is not within 0.1 volt of nominal, check the values of R1/R2, or R3/R4 to be sure they are correct.

Using the Solar Power Supply.

When using the Solar Power Supply, the batteries should be removed from the radio or tape player. The easiest way to connect the power supply to the unit to be powered is via that unit's external power supply (AC-adapter) jack. Units that do not have an external power jack can easily be modified by connecting a pair of wires to the positive and negative contacts in the battery compartment and bringing the wires out to the output terminals of the Solar Power Supply.

The solar panel should be exposed to direct sunlight for best performance. If the sun is very bright, the panel may simply be placed in a horizontal position during most of daylight hours. On hazy or cloudy days, it may be necessary to position the panel so that it is perpendicular to the rays of the Sun to achieve maximum performance.

If the switching Solar Power Supply is to be used for AM radio reception, some interference from the radiated switching-frequency harmonics may be experienced. That may be counteracted by placing the supply some distance from the radio, and using additional filtering and/or shielding to minimize interference. ■

Invest a stamp



Save a bundle

For the price of a stamp, you can get the latest edition of the federal government's free **Consumer Information Catalog**. It lists more than 200 free or low-cost publications on federal benefits, jobs, health, housing, education, cars, and more, to help you save money, make money, and spend it a little more wisely.

So stamp out ignorance with our free **Catalog**. Send your name and address to:

**Consumer Information Center
Department SB
Pueblo, Colorado 81009**

TURN A FAULTY VCR INTO A PROFIT!

“... gives all the necessary information for learning the art of troubleshooting popular brands.”

—Electronics For You

“... fully explains the mechanical systems and electronic circuitry... also details servicing data on all popular brands of VCRs.”

—VIDEO Magazine

Newly revised, MAINTAINING AND REPAIRING VCRs is the ONE book no electronics activist should be without. It gives you the operational specifications, testing how-tos, repair procedures, and troubleshooting techniques used by top professionals in the field. This is the information you need to quickly pinpoint any malfunction and fix it right down to the component level.

Packed with hundreds of helpful pinout diagrams and exploded-view illustrations, MAINTAINING AND REPAIRING VCRs gives you the how-tos needed to tackle even the trickiest VCR, Beta, or camcorder repairs. Now, there's no need to spend hours looking through service literature, and using trial and error. Everything you need to turn a broken VCR into cash in your pocket is here in MAINTAINING AND REPAIRING VCRs.

Turn to Bob Goodman for expert advice

Bob Goodman explains the test equipment you need, the procedures you follow, what circuits work best where, and the various repair options you have. He walks you through every service, maintenance and repair you make, giving you actual case problems, symptoms to watch for, and solutions for each. See for yourself how easy it is to make successful VCR repairs, and profit from that success.

FREE UNIVERSAL TEST LEAD KIT WITH EVERY ORDER!

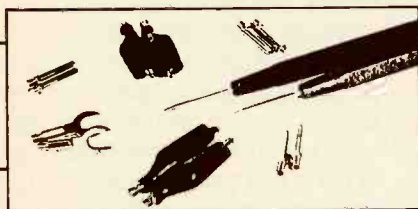

Includes 14 electronic tools that you can use to test and measure equipment. Use this kit to • screw on alligator clips for grounding • use probes to check for defects • find where your current is coming from • measure voltage • and more.

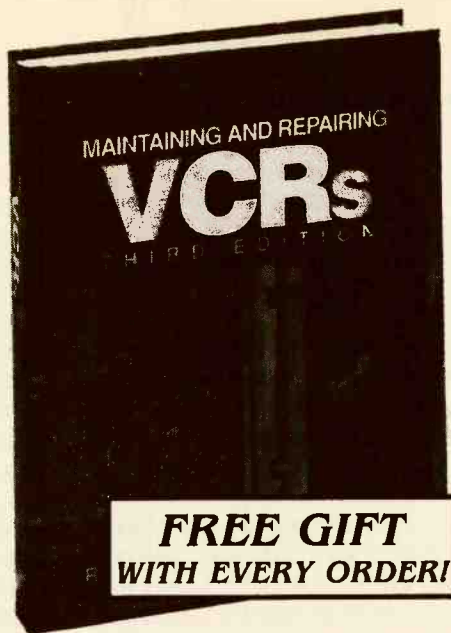

• 520 pages • 457 illustrations
• #023969-XH • \$39.95

Step-by-step, MAINTAINING AND REPAIRING VCRs will help you master maintenance and repair procedures, including how to:

- Adjust belt and drive wheels
- Replace audio and video heads
- Fix damaged or weak control functions
- Minimize damage caused by contaminants
- Repair and replace dirty switch contacts
- Troubleshoot electronic or mechanical servo malfunctions
- Identify and correct video head sticking and friction
- Turn a snowy, weak picture into a crisp, strong picture
- Adjust an improperly running tape path
- And much more.

3 Easy Ways to Order:

1. Call 

1-800-822-8158

(24 hours a day, 7 days a week)

2. FAX  1-717-794-2080

3. Or mail this coupon to:

TAB/McGraw-Hill Inc.
Blue Ridge Summit, PA
17294-0840



YES, send me MAINTAINING AND REPAIRING VCRs—3rd Ed. (#023969-XH) to examine FREE for 30 days. After 30 days, I will pay \$39.95 plus postage, handling, and applicable state and local sales tax. If I am not completely satisfied, I can return the guide and owe nothing.

Name _____

Address _____

City _____ State _____ Zip _____

Telephone _____

Signature _____

Order invalid without signature

Order subject to credit approval and acceptance by McGraw-Hill. Prices subject to change. Orders made outside the U.S. and Canada must be prepaid in U.S. dollars drawn on U.S. banks, and include an additional \$5.00 postage and handling.

SP14PV1

AN ELECTRONIC GONG

(Continued from page 40)

semiconductors (BR1, D1, and Q1) except the IC's. Follow that with transformer T1. In the prototype, T1 was mounted to the board using a couple of nuts and bolts. Next, you must decide on a location for SPKR1. The mounting location for the speaker depends on the circuit's intended use and housing. (In the author's case, the speaker was fastened inside the base of the tea-maker using a self-tapping screw.)

Once you've mounted SPKR1, connect short lengths of hook-up wire between the circuit board and the speaker. Finally connect a 117-volt AC source to the appropriate points on the circuit. In the author's prototype installation, the AC source was tapped directly from the tea machine's internal wiring.

Check Out. Before applying power to the circuit, it is wise check the as-

sembly for construction errors, such as solder bridges (shorts) between traces, cold solder joints, misplaced and misoriented components, etc. Once you are satisfied that the circuit contains no errors, it time to put the circuit through its paces. Install the IC's in their sockets, making sure that they are properly oriented.

With a project that's powered by the AC line, it is often a good idea to first test the circuit using a regulated, low-voltage DC power supply. The circuit is in no way fussy about the supply voltage, and will operate on any voltage from about 9 volts (below which the LM380 does not perform reliably) to 15 volts (above which CMOS IC's like the 4001 tend to get zapped).

With power applied, adjust R10 until the twin-T network is just about to oscillate; working from there, decrease R10's resistance until the circuit oscillates steadily. After that, increase R10's resistance until the oscillations fade to silence (as shown in Fig. 6). If R10 is set to its maximum resistance, there will be fast decay, or perhaps even no

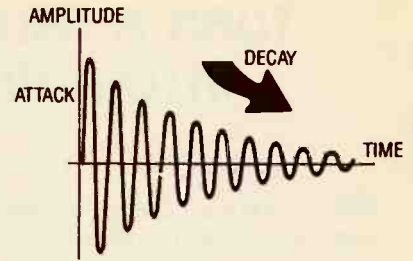

Fig. 6. With power applied, adjust R10 until the twin-T network is just about to oscillate; working from there, decrease R10's resistance until the circuit oscillates steadily. After that, increase R10's resistance until the oscillations fade to silence, as shown here.

oscillation. With R10 at the other end of its rotation, oscillation should be constant, i.e., no decay.

The preferred setting will be influenced by the triggering period. With the RC component values used in the oscillator circuit (U1-a and U1-b), the delay between pulses was about 12 seconds. With R10 set very critically, for maximum decay and reverberation, the sound may not have completely disappeared when the next trigger pulse arrives. Finally, R11 should be adjusted to give the required volume level.

Other Uses. I have used essentially the same circuit in a car-alarm unit to provide a repetitive warning alert during the exit and re-entry periods. It is also triggered to give between one and four chimes on detecting various conditions such as low fuel, low washer fluid, and icy temperatures.

I've also built a little electronic-percussion unit with 11 switchable sounds across the frequency spectrum, which was fun to make and play with. Lots of other possibilities come to mind, such as using it in a prowler alarm, a proximity detector, or (with some challenging logic circuitry) as a clock chimer.

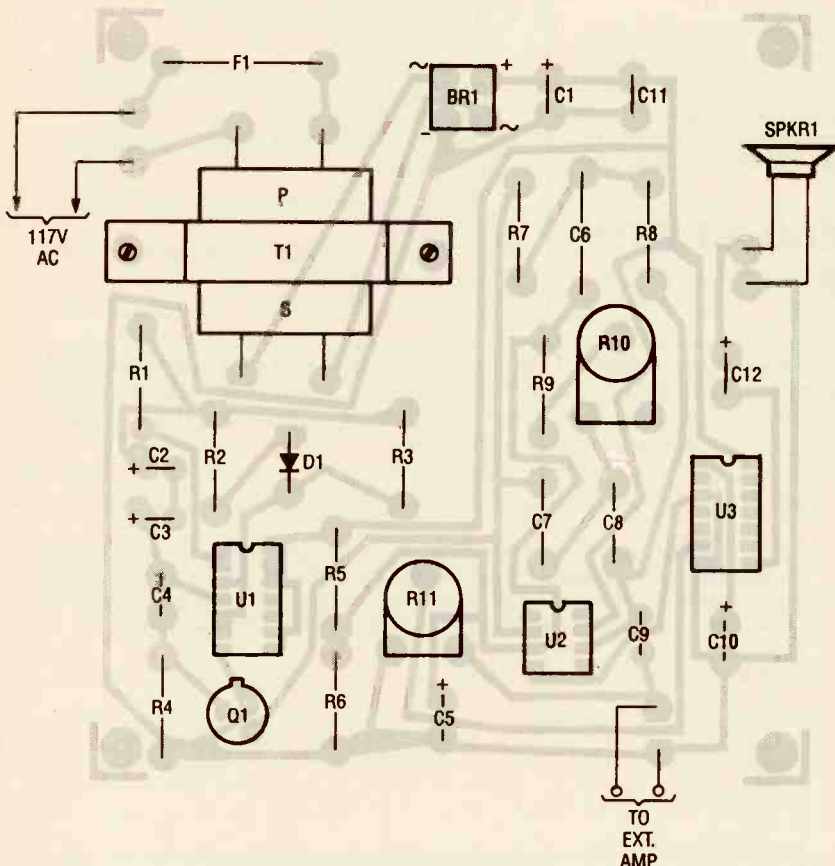
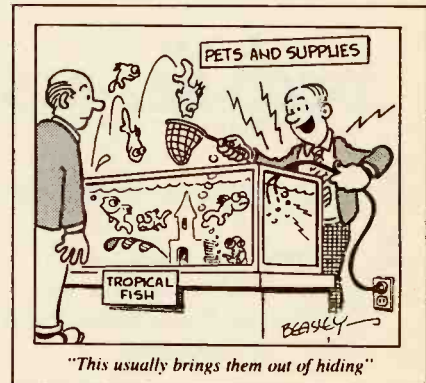

Fig. 5. This diagram shows the component locations for all of the circuit elements, both on-board and off-board. It is recommended that sockets be provided for the IC's; two 14-pin units for U1 and U3, and an 8-pin unit for U2.



QUAD ANTENNA

(Continued from page 42)

which were snaked through the spreader holes) were used to complete the driven-element loop and soldered together. The other loops were assembled in the same fashion, feedpoint not withstanding.

An electrician's copper-wire clamp placed on the reflector was used to tune the quad. We pointed the reflector toward a handheld two-watt transceiver and tuned for minimum signal into the transceiver.

The antenna provided very good performance, with a reasonable SWR over the entire 144-MHz band. We used a watt meter to measure the reflected power, and found that with 100 watts of output, less than a 1/2 watt was reflected.

So my students now know the difference between a full-wave and half-wave antenna. Our next classroom project is to build a PVC-based ten-meter quad. Hope to work you on ten meters. ■

BUILD THE WATER TAP

(Continued from page 79)

over the tube so that the assembly floats as level as possible.

The other section contains the 9-volt battery with the power switch in series, which supplies power to the floating section via two strands of the telephone wire. The battery is held in place inside the case with a piece of double-sided tape. Holes are drilled in the lid of the case for the speaker sound to pass through. The speaker is then secured to the lid with hot-melt glue. The speaker is connected to the amplifier board with the two remaining telephone wires. The telephone wire exits the top of the case. A suction cup is mounted on the back of the case to hang it on the outside of the fish tank.

When the adhesive (hot melt glue or RTV silicone) is completely dry, the Water Tap is ready to listen in on your fish. You can probably think of many other unusual uses for this bizarre gadget. ■

PARTS LIST FOR THE WATER TAP

RESISTORS

(All resistors are 1/4-watt, 5% units.)

- R1—1-ohm
- R2—10-ohm
- R3—2200-ohm
- R4—4700-ohm
- R5—10,000-ohm

CAPACITORS

- C1—270-pF, ceramic-disc
- C2—0.01- μ F, ceramic-disc
- C3, C4—0.1- μ F, ceramic-disc
- C5—33- μ F, 10-WVDC, electrolytic
- C6—39- μ F, 10-WVDC, electrolytic
- C7, C8—220- μ F, 10-WVDC, electrolytic

ADDITIONAL PARTS AND MATERIALS

- U1—TBA820M audio-amplifier integrated circuit, (SN76001, MCE820, NTE1294, or equivalent)
- MIC1—Electret microphone
- SPKR1—8-ohm speaker

Shielded cable, telephone wire, 9-volt battery and clip, glass test tube, two project cases, suction cup, hot-melt glue or RTV silicone, double-sided tape, wire solder, etc.

FACTCARDS



■ ALL YOU NEED to know about electronics from transistor packaging to substitution and replacement guides. FACTCARDS numbers 34 through 66 are now available. These beautifully-printed cards measure a full three-by-five inches and are printed in two colors. They cover a wide range of subjects from Triac circuit/replacement guides to flip-flops, Schmitt triggers, Thyristor circuits, Opto-Isolator/Coupler selection and replacement. All are clearly explained with typical circuit applications.

■ WANT TO EXPAND your knowledge of electronics? Do it the easy way

by studying the Electronics Fact Cards. Do you travel to and from your job each day? Drop a handful of cards in your pocket before you leave, and the bus becomes a schoolroom! At home, you can build some of the projects and not only have fun building and using them, but learn how they work at the same time.

■ YOU'LL BE AMAZED both at how rapidly you learn with these cards, and how easy it is to understand. These new cards are available right now. Don't miss out. Send your check or money order today.

FACTCARDS—Facts at your fingertips for Experimenters and Project Builders!

- Please send one copy of FACTCARDS at \$3.50. Shipping \$1.00 (U.S. and Canada only).
- Please send _____ copies of FACTCARDS. Total cost is sum of copy price and First Class postage and handling cost multiplied by number of card sets ordered.

New York residents add sales tax to total cost of each order.

Please print

Allow 6-8 weeks for the material to arrive.

(Name)

(Street Address)

(City) (State) (Zip)

Detach and mail today:
CLAGGK Inc.
P.O. Box 4099
Farmingdale, NY 11735

All Payment must be in U.S. Funds!

Jampacked with information at your fingertips

POWER SUPPLY

(Continued from page 33)

If you choose to use a transformer with a different current rating than the 2-amp unit we used, then you will have to compute the value of the fuse to suit your needs. Most transformers are rated by their primary voltage, secondary voltage, and secondary current. You will need to know the maximum current to permit in the primary that will not damage the secondary. Here is a simple relation you can use to determine that maximum:

$$I_p = I_s(V_s/V_p)$$

where I_p is the primary current, I_s is the secondary current, V_p is the primary voltage, and V_s is the secondary voltage.

You may wish to select a slightly lower value for added safety. However, since some of the power produced by the primary is lost in the transformer's iron core, not all of it reaches the secondary. Opinions may

vary, but that provides a margin of safety that has proven itself sufficient over the years.

The bridge rectifier BR1 is used to turn the secondary's AC into full-wave rectified, pulsating DC. While we used a 2-amp bridge, you should use one that will handle the maximum current that you expect to draw, plus a 25% safety margin.

Capacitor C1 filters the pulsating DC of the rectifier into a more manageable form for the adjustable regulator. The capacitor at the regulator's output (C2) helps to eliminate destructive transients or other noise that may occur on the power leads.

Of course, R1 and R2 program the regulator for the desired 12-volt output in the fashion mentioned earlier. Note that a diode (D1) has been added to the circuit. It steers any current that might be coming from the device under power around the regulator to prevent the regulator from being damaged. Such reverse currents usually occur when devices are powered down.

Construction. Building the power supply is easy since so few components are required. We mounted the parts on a piece of perfboard and used point-to-point wiring to complete the interconnections. The size of the cabinet was chosen mainly for the size of the transformer, which wouldn't fit in a smaller cabinet. The transformer and circuit board are mounted to the bottom of the case using some drywall screws and scraps of perfboard as "nuts." While standard hardware could also be used, drywall screws cost much less and perfboard scraps are essentially free. To use the drywall screws, all you have to do is countersink the holes on the bottom side of the case and drill a starter hole in the perfboard "nuts." To make the power supply as versatile as possible, we put simple binding posts on the top of the case for the output. We also put the on/off switch there.

The power supply should only take a couple of hours to build. However, we're sure you'll find uses for it for many years to come. ■

BEVERAGE COOLER

(Continued from page 45)

Figure 6 shows the top plate, insulation, and a soda can all in place while the epoxy cures. The last part of the cooling chamber construction is the chamber itself. My chamber is made from a doubled-walled drink container, which are available virtually everywhere. If you buy one specifically for this project (rather than using one you have on hand), try to find one that is insulated. That prevents you from having to stuff insulation into void of the double-walled container (cooling chamber).

Prepare the cooling chamber by cutting off the bottom 2 inches or so of the drink container. If you are fortunate, you'll find insulation between the walls. Obviously, the one I used in the prototype only had air between the walls, so I had to stuff it with the insulation from the soft-drink keeper mentioned earlier. You absolutely need to insulate the chamber for satisfactory results.

Once the drink container has been prepared, epoxy it in place over the cooling module assembly. Just put a

decent layer of epoxy all around the bottom, and press it into place. Let the epoxy cure with a weight on top of it.

To finish the chamber, put a single layer of weather stripping around the top of the cooler, on the inside. That seals the chamber from outside air as much as possible. Your soda can should just fit inside the chamber, with about one inch of can sticking out the top. Figure 7 shows the business end of the cooler.

The Hookup. As shown in Fig. 3, the cooling module is wired in parallel with the fan, and both are connected to a 12-volt DC power source. If you are not comfortable soldering the connections, you can use wire nuts. Your car's battery works well as a source of DC to test the unit. (I now use the power supply from my ham-radio equipment to power the cooler.) Remember, the power source must be clean (free of ripple) and capable of delivering a full 3 amps without overheating.

That all there is to it. I hope you have as much fun building and using the cooler as I did. And don't be surprised if you are asked to build several for friends! ■

RECEIVER PREAMPLIFIERS

(Continued from page 37)

The circuit can be assembled on perfboard, using adhesive-backed copper foil and following the pattern shown in Fig. 10. The back of the board is a solid copper foil ground plane. The preamplifier works better if the perfboard is replaced with the G-10 epoxy fiberglass type of board, and even better yet (to 2000 MHz) with PTFE woven fiberglass board.

Conclusion. Monolithic microwave integrated circuits, like the MAR-x, make it possible to build well behaved receiver-preamplifier circuits that will operate to 1000 MHz in some varieties, and up to 2000 MHz in some others.

Note: For a limited time after publication of this article, I am prepared to sell an MAR-1 MMIC chip and two 0.001- μ F or 100-pF chip capacitors for \$6.00, postpaid. You can get them cheaper from Mini-Circuits, but may run into a minimum order problem. If you are interested, contact me, Joe Carr directly (at P.O. Box 1099, Falls Church, VA 22041). ■

BUILD A WIRE TRACER

(Continued from page 31)

9-volt battery, then connect a clip lead to the closed-loop output, J2, and power up the circuit. Turn on a small AM receiver and position it close to the clip lead. Tune the radio until you hear a buzzsaw-like sound, and then adjust the tuning for maximum signal strength. (The maximum transfer of energy occurs when the radio's internal ferrite loop is positioned perpendicular to the wire).

Once that is done, connect the opposite end of the clip lead to the common output, J3, and note the increase in signal strength. The increase in signal strength is due to circulating current within the closed loop. (Anytime a closed loop can be used, the signal will be greater and, in most cases, easier to track.)

Now plug the McTrak into a 117-volt AC outlet and try to trace the McTrak signal through the AC wiring using the AM receiver. If the wiring happens to go behind a metal panel in the wall or is run through a metal conduit, the metal will attenuate the signal, possibly making it too weak to follow. When that happens (or if the signal is diminished for some other reason), try connecting the open-loop output (J1) to the conduit and see if the signal can be traced along the conduit.

Using McTrak to trace your auto's electrical wiring is just as easy. With all of the electronics in today's cars, it's almost impossible to visually trace a wire from one location to another without going through a maze of cables, and possibly becoming side-tracked. But McTrak can handle that task as well.

To trace your auto's wiring, connect the McTrak's J2 output to the wire you want to follow. Then track the signal by moving the radio along the path that produces the strongest signal. If the receiver's signal is too weak, connect the common lead (J3) to the car's ground system (negative battery terminal or chassis in most vehicles) to increase the signal strength. Since there are some circuits in a car's electrical system that could be effected by the full output of the Tracker, it would be better to always use the closed-loop output when working with automotive electronics. ■

For your Heart's sake get **PULSE STICK II**

Your very own sophisticated pocket health monitor, PULSE STICK II, checks your pulse rate quickly and accurately anywhere. Regular monitoring of your pulse rate during exercise will enable you to plan an exercise regimen suitable for your stage of fitness. PULSE STICK II provides an early warning that you may be exceeding your own capabilities.

PULSE STICK II photoelectrically measures the changes

in the pulsed intensity of infrared radiation emitted by superficial blood vessels below the skin of the thumb. The time intervals between pulses are automatically measured and analogued by the micro-processor based circuitry and displayed in a liquid-crystal display (LCD).

Before attempting any exercise program, consult your doctor. Ask for guidance regarding the recommended safe pulse ranges for your exercise program. Follow your doctor's instructions carefully.

Only
\$39⁹⁵



Uses three AA dry cells
supplied with PULSE STICK II



Ideal for running, walking and
aerobic training programs!

PSII-2

YES! Please send me _____ PULSE STICK II at \$39.95 each. Price includes shipping and handling charges.

Total amount of order \$ _____

Check or Money Order enclosed. Make check payable to **CLAGGK Inc. PULSE STICK II Offer**

Charge my Visa MasterCard

Account No. _____

Exp. Date _____ / _____

Credit Card

Signature _____

Print Name _____

Address _____

City _____ State _____ Zip _____

No telephone orders or C.O.D. Signature required on credit card orders. All prices include postage and handling. Payments in U.S.A. funds only. New York residents must include local applicable sales taxes. No foreign orders.

Mail orders to CLAGGK Inc. Pulse Stick II Offer, P.O. Box 4099, Farmingdale, NY 11735.

FAX orders to 1-516-293-3115.

THE BATTERY BUTLER

(Continued from page 98)

pin 5 of U5, the circuit will never return the ready state and the battery will be overcharged. The total amount of charge that the Ni-Cd battery receives can be adjusted by R25. The maximum charge level can be determined by starting with the voltage at pin 9 of U5 near the level of voltage at pin 5 of U5 and adjusting R25 to obtain a greater voltage difference each time the battery is cycled, but still allowing the circuit to come to the ready state. Note that as a Ni-Cd battery ages, its ability to hold a complete charge will decrease and R25 may have to be reset to compensate for the aging battery.

Set S1 to the *slow* position. LED1 should begin flashing red, indicating that the battery is being discharged via R39. In a few minutes, transistor Q4 and resistor R39 should be warm to the touch; that's normal. Connect the DVM across the battery terminals, and

note that the voltage should begin decreasing towards the present discharge limit. Once the voltage across the battery is at the discharge level, LED1 should begin flashing green and the voltage across the battery should rapidly start moving up.

Depending on the type of battery, the circuit will reach the ready state, which is indicated by LED1 being in a steady green state, in 4 to 5 hours. If it does not, adjust R25 to bring the voltage at pin 9 of U5 closer to the voltage at pin 5 of U5.

The battery can remain connected to the Battery-Butler for prolonged periods without damage to the battery. A 20-mA trickle charge is maintained across the battery after the unit returns to the ready state. However, it is recommended that the battery, once charged, be removed from the circuit if the charger is to be turned off. The input circuit load will drain a small amount of current from the battery over extended periods.

The Battery-Butler can hold a battery on a trickle charge to offset the

internal losses of Ni-Cd batteries incurred during storage. To use that feature, apply power to the circuit without a battery connected. Place S1 in the *slow* position. LED1 should immediately go to a steady green state. The Ni-Cd battery may now be connected. A 20-mA trickle charge will be maintained across the battery until the circuit is reset.

Operating Tips. Avoid making or disconnecting DVM connections to the circuit or the battery once a charge/discharge cycle has started. The circuit detects very small changes in voltage in the comparator section, and DVM connections and other external noise sources can cause erratic circuit operation. Operate and charge your Ni-Cd batteries at normal room temperatures. Avoid extreme heat and cold. Ni-Cd batteries will recover from occasional dips to near-freezing temperatures. However, extreme heat (above 40°C) will dry out the seals of most Ni-Cd batteries, resulting in electrolyte loss. ■

FUEL MISER

(Continued from page 29)

Such thermostats have two sets of contacts that close at slightly different temperatures, and are wired so that the burner can start only when both sets of contacts are closed. That type of system is shown in Fig. 6. To install Fuel Miser in such systems, simply connect the Fuel Miser's output terminals in series with one of the relay coil connections, as shown.

Electric-heating systems may or may not use a relay in the thermostat circuit. Those that do have a relay can be controlled by Fuel Miser by wiring its output circuit in series with the relay coil connections as shown in Fig. 7. Electric-heating systems that do not contain a low-current thermostat (as in the previous installation examples), use a heavy-duty thermostat that directly feeds current (as shown in Fig. 8) to the heating element, without the use of a relay or contactor. For such systems, it will be necessary to install a heavy duty relay (as shown in Fig. 8) to control the heavy heating-element current. The voltage and current rating of the relay must be equal to or

greater than the electrical requirement of the furnace.

Final Test. After installing the Fuel Miser, apply power to both the heating system and the Fuel Miser. Set the duty cycle (via S1) to 100%, and check the furnace for normal operation when heat is called for by the thermostat. At the 100% duty cycle setting, the heating system should operate normally—as it did prior to the installation of the Fuel Miser.

If all is well, set S1 to 10% and turn the thermostat up as high as it will go to force the system to call for constant burner operation. Time the operation of the burner for at least two complete Fuel Miser cycles. For gas systems the valve should be powered for about 45 seconds and be off for about 7 minutes. (The gas flame may start and stop after a time lag). For oil systems, the burner should operate for 3½ minutes and be off for 31½ minutes.

That completes the checkout of the Fuel Miser, and it is ready to control your heating costs. A good starting point for the Fuel Miser's operation is at the 70% duty-cycle setting; try that setting for a day or two. Remember, try

to keep a constant thermostat setting during the test period to see how the Fuel Miser operates in your system.

With some experimenting, you'll be able to determine which duty cycle is best. Remember, the lowest duty cycle that still provides sufficient comfort will provide the greatest savings. ■

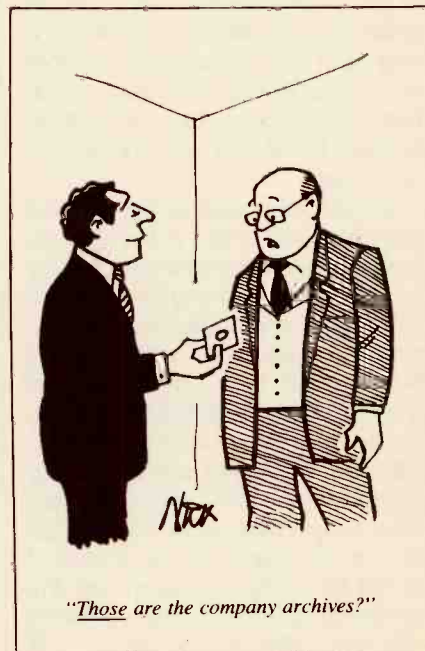

CLASSIFIED AD ORDER FORM

To run your own classified ad, put one word on each of the lines below and send this form along with your check to:

Gernsback Handbooks Classified Ads, 500-B Bi-County Boulevard, Farmingdale, N.Y. 11735

Please check Magazine(s) selected.

- Summer 1994 Electronics Experimenter Handbook
(Copy due on Feb. 8, 1994)
- Fall Electronics Hobbyist Handbook (Copy due May 4, 1994)

Rates given below are for one issue only!

PLEASE INDICATE in which category of classified advertising you wish your ad to appear. For special headings, there is a surcharge of **\$12.00**.

- Plans/Kits Business Opportunities For Sale
 Education/Instruction Wanted Satellite Television

Special Category: \$12.00

PLEASE PRINT EACH WORD SEPARATELY, IN BLOCK LETTERS.

(No refunds or credits for typesetting errors can be made unless you clearly print or type your copy.) Rates indicated are for standard style classified ads only. See below for additional charges for special ads. **Minimum: 15 words.**

1	2	3	4	5
6	7	8	9	10
11	12	13	14	15 (\$25.50)
16 (\$27.20)	17 (\$28.90)	18 (\$30.60)	19 (\$32.30)	20 (\$34.00)
21 (\$35.70)	22 (\$37.40)	23 (\$39.10)	24 (\$40.80)	25 (\$42.50)
26 (\$44.20)	27 (\$45.90)	28 (\$47.60)	29 (\$49.30)	30 (\$51.00)
31 (\$52.70)	32 (\$54.40)	33 (\$56.10)	34 (\$57.80)	35 (\$59.50)
36 (\$61.20)	37 (\$62.90)	38 (\$64.60)	39 (\$66.30)	40 (\$68.00)

We accept MasterCard and Visa for payment of orders. If you wish to use your credit card to pay for your ad fill in the following additional information (Sorry, no telephone orders can be accepted.):

Card Number _____ / _____ Expiration Date _____

PRINT NAME _____

SIGNATURE _____

IF YOU USE A BOX NUMBER YOU MUST INCLUDE YOUR PERMANENT ADDRESS AND PHONE NUMBER FOR OUR FILES. ADS SUBMITTED WITHOUT THIS INFORMATION WILL NOT BE ACCEPTED.

CLASSIFIED COMMERCIAL RATE: (for firms or individuals offering commercial products or services) \$1.70 per word prepaid (no charge for ZIP code)...**MINIMUM 15 WORDS. NON-COMMERCIAL RATE:** (for individuals who want to buy or sell a personal item) \$1.35 per word. **ONLY FIRST WORD AND NAME** set in bold caps at no extra charge. Additional bold face **40¢ per word additional**. Entire ad in boldface. \$2.10 per word. **TINT SCREEN BEHIND ENTIRE AD:** 25% premium to total price. **TINT SCREEN BEHIND ENTIRE AD PLUS ALL BOLD FACE AD:** 45% premium to total price. **EXPANDED TYPE AD:** \$2.25 per word prepaid. **TINT SCREEN BEHIND ENTIRE EXPANDED TYPE AD:** 25% premium to total price. **TINT SCREEN BEHIND ENTIRE EXPANDED TYPE AD PLUS ALL BOLD FACE AD:** 45% premium to total price. **DISPLAY ADS:** 1" x 2 1/8"—\$75.00; 2" x 2 1/8"—\$150.00; 3" x 2 1/8"—\$225.00. **General Information:** **ALL COPY SUBJECT TO PUBLISHERS APPROVAL. ADVERTISEMENTS USING P.O. BOX ADDRESS WILL NOT BE ACCEPTED UNTIL ADVERTISER SUPPLIES PUBLISHER WITH PERMANENT ADDRESS AND PHONE NUMBER.** Send for the classified brochure. Circle Number 49 on the Free Information Card.

FOR SALE

300 Experimenters Circuits — Complete in 6 practical books using diodes, relays, FET's, LED's, IC 555's, and IC CA3130's for building blocks. Only \$33.00 plus \$5.50 for shipping. USA and Canada only. US funds. **ETT, INC.**, PO Box 240, Massapequa Park, NY 11762-0240.

THE Case Against Patents. Thoroughly tested and proven alternatives that work in the real world. \$24.50. **SYNERGETICS PRESS**, Box 809-C, Thatcher, AZ 85552. (602) 428-4073. Visa/MC.

Prototype it..... FAST!

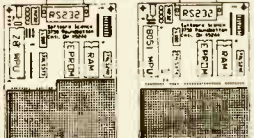

with ProtoQuick 8051 or Z8

- Complete single board computers
- Up to 32K EPROM and 64K RAM
- 1/2 sq. in. photo-through probe area
- RS232 C serial port w/ DTR/CTS conn.
- Up to 3rd. in EPROM or source code
- Assembled, ready to run - 5v only
- MS-DOS cross-assembler included

ProtoQuick Z8 and 8081

\$99.00 each

Software Included:
2708 Random Access
Control, 01, 02, 03, 04, 05, 06, 07, 08, 09, 10, 11, 12, 13, 14, 15, 16, 17, 18, 19, 20, 21, 22, 23, 24, 25, 26, 27, 28, 29, 30, 31, 32, 33, 34, 35, 36, 37, 38, 39, 40, 41, 42, 43, 44, 45, 46, 47, 48, 49, 50, 51, 52, 53, 54, 55, 56, 57, 58, 59, 60, 61, 62, 63, 64, 65, 66, 67, 68, 69, 70, 71, 72, 73, 74, 75, 76, 77, 78, 79, 80, 81, 82, 83, 84, 85, 86, 87, 88, 89, 90, 91, 92, 93, 94, 95, 96, 97, 98, 99, 100

Run prototype applications or experimental hardware from the serial port - WITHOUT PROGRAMMING!

PLANS AND KITS

ALL-in-One catalog. AM/FM/Ham/Spy transmitters/amplifiers, voice disguisers, descramblers, audio/TV/science projects. Start your own licensed/unlicensed radio station, books/plans/kits for import and export. 60 mouth-watering pages for \$1.00. **PAN-COM INTERNATIONAL**, PO Box 130-FV, Paradise, CA 95967.

60 SOLDERLESS Breadboard Projects in two easy-to-read pocket books. Complete with circuit descriptions, schematics, parts layouts, component listings, etc. Both books (BP107 & BP113) only \$11.90 plus \$3.50 for shipping. USA and Canada only. US funds. **ETT, INC.**, PO Box 240, Massapequa Park, NY 11762-0240.



RECEIVING TUBES

OVER 3000 TYPES IN STOCK!

Also hard-to-find transformers, capacitors and parts for tube equipment.

Send \$2.00 for our 32 page catalog.

ANTIQUE ELECTRONIC SUPPLY
6221 S. Maple Ave. • Tempe, AZ 85283 • 602-820-5411

EDUCATION & INSTRUCTION

JOIN TESLA COIL BUILDERS' ASSOC. High voltage / historical quarterly newsletter. SASE to 3 Amy Lane, Queensbury, NY 12804.

BUSINESS OPPORTUNITIES

START your own technical ad! Don Lancaster's newly updated **Incredible Secret Money Machine II** tells how. We now have autographed copies of the Guru's underground classic for \$18.50. **SYNERGETICS PRESS**, PO Box 809-C, Thatcher, AZ 85552. (602) 428-4073. Visa/MC.

SURVEILLANCE

& COUNTERSURVEILLANCE Electronic Devices

Bugging/Phone Tapping Detectors • Caller IDs • Covert Video
• Phone Scramblers • Voice Changers • Shotgun Mics
Vehicle Tracking • Transmitter Kits • Locksmithing • AND MORE!

NEW! Telephone Recording Systems Disguise Video Cameras

FOR CATALOG SEND \$5.00 TO...
P.O. Box 337, Buffalo, NY 14226 (716) 691-3476

MICROCOMPUTER BASED LAB

MEASURE/study/explore real forces, light, temperature, sound,...with your microcomputer. Hardware, software, sensors, manuals: \$159.00. Laptop version: \$209.00. Kit: \$109.00. **MICROPHYSICS**, 99 Bennoch, Orono, ME 04473. (207) 866-3527.

ADVERTISING SALES OFFICE

Gernsback Publications, Inc.
500-B BI-County Blvd.
Farmingdale, NY 11735
1-(516) 293-3000

Larry Steckler, EHF/CET
President

Christina Estrada
Assistant to the President

For Advertising ONLY
516-293-3000
Fax 1-516-293-3115

Larry Steckler
publisher

Arline Fishman
advertising director

Denise Mullen
advertising assistant

Kelly Twist
credit manager

ADVERTISING SALES OFFICES

EAST/SOUTHEAST

Stanley Levitan
Eastern Sales
1 Overlook Ave.
Great Neck, NY 11021
1-516-487-9357, 1-516-293-3000
Fax 1-516-487-8402

MIDWEST/Texas/Arkansas/ Oklahoma, Colorado, Arizona

Ralph Bergen
Midwest Sales
One Northfield Plaza, Suite 300
Northfield, IL 60093-1214
1-708-446-1444
Fax 1-708-559-0562

PACIFIC COAST/Mountain States

Mike Brooks
Pattis/3M
1800 North Highland Avenue
Suite 717
Hollywood, CA 90028
1-213-462-2700
Fax 1-213-463-0544

ADVERTISING INDEX

POPULAR ELECTRONICS magazine does not assume any responsibility for errors that may appear in the index below.

Free Information No.	Page
— Antique Electronics	111
17 Chenesko Products	10
— CIE	17
— CLAGGK Video	CV4
— C & S Sales	7
— EDE	111
— EIA	CV2
16 Heath	5
— Information Unlimited	1
20 Kelvin Electronics	CV3
23 Mouser Electronics	11
— NRI Schools	9
19 Sescor	12
— TAB Books	105
20 The School of PC Repair	7
21 The School of VCR Repair	11
— Software Science	111
18 Zentek	5

BUILD AN ACTIVE ANTENNA

(Continued from page 74)

using the whip antenna, simply connect the output of the AA-7 to your receiver, with the unit turned off (that's the bypass position) and the RF gain control (R5) turned fully counter-clockwise. Turn on the receiver and tune-in a weak station. Switch S2 on, and adjust the gain control clockwise to increase the output signal. Toggle S1 back and forth to see which setting gives you the best results. Don't be surprised if the gain control overloads the receiver; if so, back it off.

There are other characteristics or phenomena associated with preamplifiers and active antennas that does not mean that your the circuit is malfunctioning. For example, if you have strong AC hum in the HF setting, the antenna is too close to an AC cord or power line. HF signals may be clearer at the VHF/UHF setting than at the HF setting. Why? Although either preamp may be used for HF, the signal strength will be greater with the VHF/UHF preamp. However, the HF signal-to-noise ratio is better with the dual-gate-MOSFET-based preamp. Try both and use the best for your particular receiving conditions.

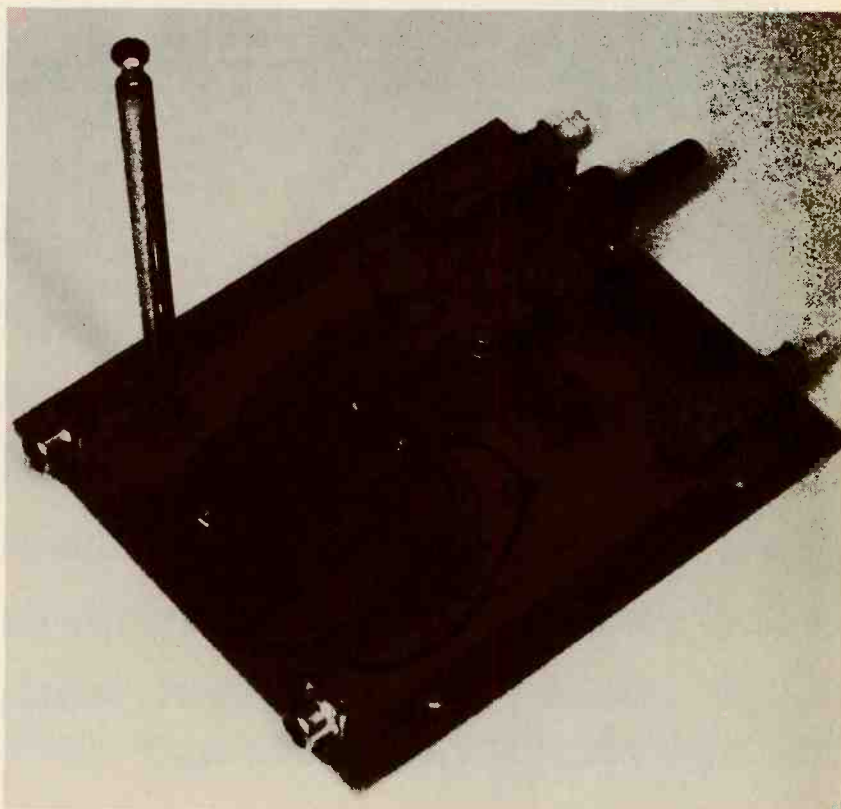

Although not shown in the schematic or the parts-placement diagrams, an LED can be added to the circuit so that you can tell at a glance if the circuit is on. In his own unit, the author accomplished that by connecting the LED (with a series-connected current-limiting resistor) between a terminal on the power switch and the grounded frame of the gain control (R5).

Troubleshooting. The fact that there are two independent preamplifiers in the AA-7 makes faults easier to diagnose than with many other devices. If a problem occurs, only at one setting of S1, concentrate on that part of the circuit. If the problem is common to both settings, the components and connections common to both preamps should be checked. Make sure the jumper wires are in place.

Some portable receivers not enclosed in metal cases may break into oscillation when connected to any RF preamplifier. Try reducing the AA-7's gain and make sure that good grounds are provided with the interconnecting coax cables. A preamplifier will intensify any problems due to poor receiver design: overloading, images, or any problems with selectivity and image rejection. ■

KELVIN

ELECTRONICS

10 HUB DRIVE, MELVILLE, NY 11747

RE-ENGINEERED & DESIGNED FOR 1994



150 LE - Student 200 LE - Technician 400 LE - Engineer

Standard Features -

- AC & DC VOLTAGES
- DC CURRENT
- RESISTANCE
- TRANSISTOR
- CONTINUITY TEST - Buzzer
- DIODE TEST
- 3 1/2 Digit LCD
- 10M ohm INPUT IMPEDANCE

BATTERY TEST
TRANSISTOR
DC CURRENT
10 Amp

FREQ COUNTER
up to 20MHz
TRANSISTOR
CAPACITANCE
from 1pF to 20uF

INDUCTANCE
Resolution 1uH
FREQ COUNTER
up to 20MHz
CAPACITANCE
from 1pF to 200uF

AC/DC CURRENT
10 Amp

AC/DC CURRENT
20 Amp

150 LE
Stock # 990122
\$29.95

200 LE
Stock # 990123
\$49.95

400 LE
Stock # 990124
\$79.95

Designed to meet IEC-348 & UL-1244 safety specifications
2 Year Warranty (Parts & Labor)



"Not only does the Kelvin 94 boast alot of features... the features go the extra distance."

"If we had to run into a burning building to do some emergency trouble-shooting and could carry in only one piece of equipment, the Kelvin 94 would be it!"

Popular Electronics
Reviewed - May 1993

KELVIN 94 The Ultimate Meter

LCR Hz dBm True RMS Logic Probe

The only meter with 0.1% Accuracy on DC Voltages, built-in True RMS, Freq Counter to 20MHz Res: 10 uH, LCR-Inductance Tester Res: 10 uH, DC/AC Voltages Res: 0.1mV, Ohm Meter Res: 0.1 ohms

TRUE RMS PLUS

12 INSTRUMENTS IN ONE - AC & DC VOLT METERS, AC & DC CURRENT, dBm, OHM METER, DIODE TESTER, AUDIBLE CONTINUITY TEST, 20 MHz FREQ COUNTER, CAPACITANCE METER, INDUCTANCE METER, LOGIC PROBE

Model 94

#990111
\$199.95

*See Standard Features Listed below

ENGINE ANALYZER PLUS

Model 95 #990112
\$199.95

A Must For Auto Mechanics

Standard Features - Models 94 & 95

- DC/AC VOLT METERS
- AC/DC CURRENT
- OHM METER
- DATA HOLD
- RELATIVE MODE
- FREQ COUNTER to 4 MHz (Model 95)
- AUDIBLE CONTINUITY TEST
- DIODE TEST
- MAX/MIN AVERAGE MEMORY RECORD
- 10A HIGH-ENERGY FUSE PROTECTION
- AUTO SLEEP & AUTO POWER OFF

(800) 645-9212
(516) 756-1750
(516) 756-1763/FAX

Established 1945

M/C & VISA \$20 Minimum Order

KELVIN CATALOG \$3
Stock No. 650412

KELVIN 100 Basic
990087
\$19.95



- AC & DC VOLTAGES
- DC CURRENT
- RESISTANCE
- CONTINUITY TEST - Buzzer
- 3 1/2 Digit LCD
- LOW BATTERY INDICATOR
- DIODE TEST
- BATTERY TEST

CAPACITANCE METER

KELVIN 250 LE
990126
\$59.95



- ACCURACY: 0.5%
- RANGES: 20mF, 2000uF, 200uF, 20uF, 2uF, 200nF, 20nF, 2000pF, 200pF
- Zero Adjust
- Safety Test Leads
- Test Socket for Plug-in Components

AUTO-RANGE METER

KELVIN 300 LE
990125
\$49.95
AUTO-RANGE



- ACV & DCV
- DC CURRENT
- RESISTANCE
- CONTINUITY TEST
- DIODE TEST
- 3 1/2 Digit LCD
- 10M ohm INPUT IMPEDANCE

INSTRUMENTS

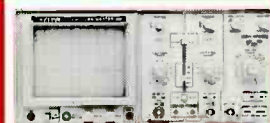

20 MHz SCOPE
Dual Trace 2 Yr Warranty-Parts & Labor
Stock No. 740085 \$385

40 MHz SCOPE 2 Yr Warranty
Dual Trace with Delayed Sweep
Stock No. 740086 \$655

TEST ACCESSORIES

SCOPE PROBES

60 MHz, X1 & X10 SPECIAL

700072 \$18.95

150 MHz, X10

700073 \$39.95

IC CLIPS

SOLDER TYPE SPRING LOADED

Stock No. COLOR COST 25+ Qty

990104 BLACK \$.65 ea. \$.50 ea

990105 RED \$.65 ea. \$.50 ea

DC TOY MOTORS

DC Toy Motor

Stock No. 850647

\$.80 ea

\$.75 ea / 50+ Qty 6V DC High Speed

Solar Motor Stock No. 850646

\$.60 ea 1.5V DC

\$.55 ea / 50+ Qty

Solar Cells 3 3/4" L x 2 9/16" W

Stock No. 260099 1000mA .45V

\$.95 ea

\$.55 ea / 3+ Qty

DIGITAL TRAINER



Laptop Digital Trainer comes with 100 page instruction manual, power supply, built-in 1 digit true hexadecimial display, two independent clocks with user adjustable freq & duty cycles, 4 data bit switches and 4 LED displays. Assembled Stock No. 840460 \$99.95

BINARY QUARTZ CLOCK w/Alarm



ORIGINAL DESIGN - 24 Hr. Binary Quartz Accurate Clock with 2 color LED's. Built-in Alarm and Alarm Display in binary code. DESIGNED FOR LEARNING about digital circuitry & binary code. Built with individual IC components. Battery Memory Loss Prevention. Comes with rechargeable battery, DC wall transformer and detailed instruction manual. Advanced Level Kit
Stock No. 840589 \$79.95

Electronic VOICE PAD

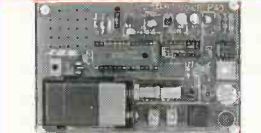

An electronic note pad, able to record your message & replay it later. It has a built-in photo cell & as soon as it senses your presence, it will automatically playback the message left for you. The components are PC mounted. The IC can record a message up to 20 seconds & no mechanical parts or tape - only a digital integrated circuit.
Intermediate Level Kit
Stock No. 840606 \$49.95

BREADBOARDS



Stock No. Post Contacts YOUR COST

680093 0 500 \$ 4.25

680097 0 840 \$ 5.95

680098 2 1390 \$11.75

680100 4 2390 \$22.95

WIRE JUMPER KIT

Pre-cut, Pre-Stripped

330289 140 Piece Set \$ 4.95

330290 350 Piece Set \$ 8.95

COMPONENTS

WHOLESALE PRICES!



Stock No.	TYPE	(10 Pcs. Min.) YOUR COST
600021	555 TIMER	\$.29 ea
600029	556 DUAL TIMER	\$.40 ea
600039	LM566 PPL FUNCTION GENERATOR	\$.60 ea
600018	741C OP-AMP INTERNALLY COMPENSATED	\$.30 ea
600026	1458 OP-AMP DUAL 741C OP-AMP	\$.35 ea
630041	2N2222	\$.20 ea
630383	PN2222	\$.08 ea
600023	7805 Voltage Reg	\$.36 ea
SILICON CONTROLLED RECTIFIER (Similar to GE C106C1) 4.0 amp, 100PIV		
600014		\$.89 ea \$.79 ea/10+

THERMISTOR - 100 ohm		
110097	\$.1.35 ea	\$.1.00 ea/20+
THERMISTOR - 10K ohm		
110097	\$.1.35 ea	\$.1.00 ea/20+

PROJECT PARTS

Project Speaker
2" 8 Ohm, 1 Watt
Stock No. 350009
59¢



Project BUZZER
3 - 9 Volt DC, 80 db
Stock No. 680089
\$1.59 ea



\$1.39 ea / 10+ Qty

Soldering IRON
with STAND
LONG LIFE TIP
Stock No. 990098
\$3.95 ea



LED T1 3/4

Stock No.	Color	100+ Qty	1000+ Qty
260020	RED	\$.05 ea	\$.045 ea
260027	GREEN	\$.08 ea	\$.07 ea
260026	YELLOW	\$.08 ea	\$.07 ea
260078	2 COLOR RED/GREEN	\$.32 ea	\$.29 ea

XENON STROBE TUBE

Stock No. 260050
\$3.25 ea
\$2.95 ea / 20+ Qty



TRIGGER COIL
for Xenon Strobe Tube
Stock No. 320037
\$1.25 ea
\$.89 ea / 20+ Qty



INFRARED LED

IR Pair, LED Infrared transmitter and receiver
Stock No. 260061
\$1.95 ea



NEON LAMP

NE2, 2" Lead
Stock No. 260003
\$.15 ea
\$.12 ea / 100+ Qty



PHOTO CELL

Photo Cell - 450 ohm
Stock No. 260017
\$.65 ea **\$.45 ea / 20+ Qty**



Photo Cell - 1.5K ohm
Stock No. 260018
\$.65 ea **\$.45 ea / 20+ Qty**

PUSH-BUTTON SWITCH

PUSH-ON, PUSH-OFF
Stock No. 270021
\$.55 ea
\$.49 ea / 100+ Qty



SUB-MINIATURE MOMENTARY SWITCH

Stock No. 990002
\$.35 ea
\$.28 ea / 100+ Qty



MINIATURE TOGGLE SWITCH

Stock No. 270034
\$.90 ea Type-SPST
\$.79 ea / 50+ Qty



Countersurveillance

Never before has so much professional information on the art of detecting and eliminating electronic snooping devices—and how to defend against experienced information thieves—been placed in one VHS video. If you are a Fortune 500 CEO, an executive in any hi-tech industry, or a novice seeking entry into an honorable, rewarding field of work in countersurveillance, you must view this video presentation again and again.

Wake up! You may be the victim of stolen words—precious ideas that would have made you very wealthy! Yes, professionals, even rank amateurs, may be listening to your most private conversations.

Wake up! If you are not the victim, then you are surrounded by countless victims who need your help if you know how to discover telephone taps, locate bugs, or “sweep” a room clean.

There is a thriving professional service steeped in high-tech techniques that you can become a part of! But first, you must know and understand Countersurveillance Technology. Your very first insight into this highly rewarding field is made possible by a video VHS presentation that you cannot view on broadcast television, satellite, or cable. It presents an informative program prepared by professionals in the field who know their industry, its techniques, kinks and loopholes. Men who can tell you more in 45 minutes in a straightforward, exclusive talk than was ever attempted before.

Foiling Information Thieves

Discover the targets professional snoopers seek out! The prey are stock brokers, arbitrage firms, manufacturers, high-tech companies, any competitive industry, or even small businesses in the same community. The valuable information they filch may be marketing strategies, customer lists, product formulas, manufacturing techniques, even advertising plans. Information thieves eavesdrop on court decisions, bidding information, financial data. The list is unlimited in the mind of man—especially if he is a thief!

You know that the Russians secretly installed countless microphones in the concrete work of the American Embassy building in Moscow. They converted



**CALL
NOW!**

1-516-293-3751

**HAVE YOUR
VISA or MC CARD
AVAILABLE**

what was to be an embassy and private residence into the most sophisticated recording studio the world had ever known. The building had to be torn down in order to remove all the bugs.

Stolen Information

The open taps from where the information pours out may be from FAX's, computer communications, telephone calls, and everyday business meetings and lunchtime encounters. Businessmen need counselling on how to eliminate this information drain. Basic telephone use coupled with the user's understanding that someone may be listening or recording vital data and information greatly reduces the opportunity for others to purloin meaningful information.

The professional discussions seen on the TV screen in your home reveals how to detect and disable wiretaps, midget radio-frequency transmitters, and other bugs, plus when to use disinformation to confuse the unwanted listener, and the technique of voice scrambling telephone communications. In fact, do you know how to look for a bug, where to look for a bug, and what to do when you find it?

Bugs of a very small size are easy to build and they can be placed quickly in a matter of seconds, in any object or room. Today you may have used a telephone handset that was bugged. It probably contained three bugs. One was a phony bug to fool you into believing you found a bug and secured the telephone. The second bug placates the investigator when he finds the real thing! And the third bug is found only by the professional, who continued to search just in case there were more bugs.

The professional is not without his tools. Special equipment has been designed so that the professional can sweep a room so that he can detect voice-activated (VOX) and remote-activated bugs. Some of this equipment can be operated by novices, others require a trained countersurveillance professional.

The professionals viewed on your television screen reveal information on the latest technological advances like laser-beam snoopers that are installed hundreds of feet away from the room they snoop on. The professionals disclose that computers yield information too easily.

This advertisement was not written by a countersurveillance professional, but by a beginner whose only experience came from viewing the video tape in the privacy of his home. After you review the video carefully and understand its contents, you have taken the first important step in either acquiring professional help with your surveillance problems, or you may very well consider a career as a countersurveillance professional.

The Dollars You Save

To obtain the information contained in the video VHS cassette, you would attend a professional seminar costing \$350-750 and possibly pay hundreds of dollars more if you had to travel to a distant city to attend. Now, for only \$49.95 (plus \$4.00 P&H) you can view *Countersurveillance Techniques* at home and take refresher views often. To obtain your copy, complete the coupon or call.

CLAGGK INC. HHS
P.O. Box 4099 • Farmingdale, NY 11735

Please rush my copy of the Countersurveillance Techniques Video VHS Cassette for a total cost of \$53.95 each (which includes \$4.00 postage and handling).

No. of Cassettes ordered _____

Amount of payment \$ _____

Sales tax (N.Y.S. only) _____

Total enclosed _____

Bill my VISA MasterCard

Card No. _____

Expire Date ____ / ____

Signature _____

Name _____

Address _____

City _____ State _____ ZIP _____

All payments in U.S.A. funds. Canadians add \$4.00 per VHS cassette. No foreign orders.