

LASER HOLOGRAMS ON A BUDGET

OCTOBER 1999

Popular Electronics®

PLUS!
Descrambling
Scanner Channels

Plasma Saber

Banish the force of darkness
and learn about high voltage
with this glowing light foil

Designing and Building

PC Boards

Your computer and a few tools are
all you need for perfect results

Gizmo®

Affordable GPS Navigation
Dual CD Recorder Deck
Free Energy Radio
And much more



A GERNSBACK
PUBLICATION

Also Inside:

- Voice Recording and Recognition
- Controlling Robots, Part II
- How Most Anything Works
- Tweaking Monitors

\$4.99 U.S.
\$5.99 CAN.

#BXBDCCH CAR-RT SORT** C-012
 #35802YUN711GR004# JUN00 P09
 |||||
 STEPHEN R YOUNG RESP
 167
 7118 GARTH RD SE
 HUNTSVILLE AL 35802-1947

www.gernsback.com

High-end features. Low-end price.



\$299

CircuitMaker 6:
Schematic design
and simulation
software

\$299

TraxMaker 3:
Printed circuit
board layout
software

CircuitMaker Version 6 and TraxMaker Version 3 give you the features of professional, high-end software at a fraction of the cost. Plus, with exceptional ease-of-use, you'll spend less time learning to use the software and more time designing. Both applications are compatible with your existing design software, and feature outstanding technical support. Call now for your free functional demo.

CircuitMaker 6 is a powerful schematic design and simulation program featuring:

- Professional schematic features including printout borders, title block and barred pin names
- Symbol editor and Macro feature for custom devices
- Fast, accurate SPICE3f5/XSPICE-based simulation
- Complete array of analysis types, including Fourier, AC, DC Parameter Sweep, Transient and more
- Virtual instruments including a digital oscilloscope, multimeter, Bode plotter, curve tracer and more
- Extensive library of over 4,000 devices
- Tight integration with TraxMaker® for quick PCB layout
- Output PCB netlists in Protel®, Tango®, and TraxMaker®, formats for use in a variety of PCB layout programs
- Windows 3.1, 95, 98 and NT

TraxMaker 3 is a powerful printed circuit board layout program featuring:

- Over 2,000 component footprints in a fully-documented, indexed library. Documentation shows footprints actual size
- Built-in autorouter and Design Rules Check
- Supports up to 6 signal layers plus power and ground planes, silk screen overlays and solder and paste masks
- Board sizes up to 32" x 32", with no pin limitations
- Intelligent manual routing with unroutable capabilities
- Import any PCB netlist in CircuitMaker®, Protel® or Tango® format
- Output RS274X Gerber files, Excellon N/C drill files and Bill of materials
- Print to any Windows compatible printer or plotter
- Windows 3.1, 95, 98 and NT

CircuitMaker For free demo software, or to order, call **1-800-419-4242**
CUSTOMER SERVICE CENTER 5252 N. Edgewood Dr #175 • Provo, UT 84604 • Tel 801.224.0433 • Fax 801.224.0545 • www.microcode.com

©1999 Protel International Pty Ltd. All rights reserved. CircuitMaker, TraxMaker and SimCode are registered trademarks of Protel International Pty Ltd. All other brand and product names are trademarks or registered trademarks of their respective companies.

CIRCLE 175 ON FREE INFORMATION CARD

Popular Electronics®

THE MAGAZINE FOR THE ELECTRONICS ACTIVIST!

FEATURES AND CONSTRUCTION

PLASMA SABER	Paul Mauhaideeb	29
<i>Banish the force of darkness and learn about high-voltage supplies with this glowing light foil</i>		
DESIGNING AND BUILDING PRINTED-CIRCUIT BOARDS	James Edwards	35
<i>Your computer and a few tools are all you need to create perfect PC boards every time</i>		
POCKET METRONOME	Dean F. Poeth II	73
<i>Keep better time with this simple, one-evening project</i>		

PRODUCT REVIEWS

HANDS-ON REPORT		9
<i>NuvoMedia Rocket eBook</i>		
GIZMO®		20
<i>Affordable GPS navigation, dual CD recorder deck, free energy radio, and more</i>		

COLUMNS

PEAK COMPUTING	Andrew T. Angelopoulos	3
<i>Choosing and Tweaking Monitors</i>		
NET WATCH	Konstantinos Karagiannis	7
<i>How Stuff Works</i>		
MULTIMEDIA WATCH	Marc Spiwak	10
<i>A Digital Voice Recorder and Fast Peripherals</i>		
COMPUTER BITS	Ted Needleman	13
<i>Full-Motion Video Capture</i>		
SCANNER SCENE	Marc Saxon	18
<i>Descrambling Channels</i>		
AMAZING SCIENCE	John Iovine	41
<i>Laser-Diode Holography, Part 1</i>		
ROBOTICS WORKSHOP	Gordon McComb	45
<i>Parallel Port Control, Part 2</i>		
COMM LINKS	Joseph J. Carr	75
<i>Spurious Transmitter Outputs</i>		
CIRCUIT CIRCUS	Charles D. Rakes	78
<i>Electronic-Ignition Systems</i>		

DEPARTMENTS

EDITORIAL		2
LETTERS		16
ELECTRONICS LIBRARY		28
POPULAR ELECTRONICS MARKET CENTER		49
NEW PRODUCTS		83
ADVERTISING INDEX		88
FREE INFORMATION CARD		88A

Popular Electronics (ISSN 1042-170-X) Published monthly by Gernsback Publications, Inc. 500 Bi-County Boulevard, Farmingdale, NY 11735. Second-Class postage paid at Farmingdale, NY and at additional mailing offices. One-year, twelve issues, subscription rate U.S. and possessions \$24.99, Canada \$33.15 (includes G.S.T. Canadian Goods and Services Tax Registration No. R125166280), all other countries \$33.99. Subscription orders payable in U.S. funds only, International Postal Money Order or check drawn on a U.S. bank. U.S. single copy price \$4.99. Copyright 1999 by Gernsback Publications, Inc. All rights reserved. Hands-on Electronics and Gizmo trademarks are registered in U.S. and Canada by Gernsback Publications, Inc. Popular Electronics trademark is registered in U.S. and Canada by Electronics Technology Today, Inc. and is licensed to Gernsback Publications, Inc. Printed in U.S.A. Postmaster: Please send address changes to Popular Electronics, Subscription Dept., P.O. Box 338, Mount Morris, IL 61054-9932

A stamped self-addressed envelope must accompany all submitted manuscripts and/or artwork or photographs if their return is desired should they be rejected. We disclaim any responsibility for the loss or damage of manuscripts and/or artwork or photographs while in our possession or otherwise.

As a service to readers, Popular Electronics publishes available plans or information relating to newsworthy products, techniques, and scientific and technological developments. Because of possible variances in the quality and condition of materials and workmanship used by readers, Popular Electronics disclaims any responsibility for the safe and proper functioning of reader-built projects based upon or from plans or information published in this magazine.

Larry Steckler, EHF, CET,
editor-in-chief and publisher

EDITORIAL DEPARTMENT

Konstantinos Karagiannis, editor
Robert Young, technical editor
Evelyn Rose, assistant editor
Teri Scaduto, assistant editor
Janine Abitabile, editorial assistant
Andrew T. Angelopoulos,
contributing editor

Joseph J. Carr, K4IPV, contributing editor
John Iovine, contributing editor
Gordon McComb, contributing editor
Ted Needleman, contributing editor
Charles D. Rokes, contributing editor
Marc Saxon, contributing editor
Marc Spiwak, contributing editor

PRODUCTION DEPARTMENT

Ken Coren, production director
Kathy Campbell, production assistant
Michele Musé, production assistant

ART DEPARTMENT

Andre Duzant, art director
Russell C. Truelson, illustrator

CIRCULATION DEPARTMENT

Gina L. Gallo, circulation manager
Christina M. Estrada, circulation assistant

REPRINT DEPARTMENT

Janine Abitabile, Reprint Bookstore

BUSINESS AND EDITORIAL OFFICES

Gernsback Publications, Inc.
500 B-County Blvd.
Farmingdale, NY 11735
516-293-3000
Fax: 516-293-3115
President: Larry Steckler
Vice-President: Adria Coren
Vice-President: Ken Coren

**SUBSCRIPTION
CUSTOMER SERVICE/
ORDER ENTRY**

800-827-0383
7:30 AM - 8:30 PM EST

**Advertising Sales Offices
listed on page 88**

Composition by Mates Graphics
Cover by Loewy Design

VISIT US ON THE INTERNET AT:
www.gernsback.com

Since some of the equipment and circuitry described in POPULAR ELECTRONICS may relate to or be covered by U.S. patents, POPULAR ELECTRONICS disclaims any liability for the infringement of such patents by the making, using, or selling of such equipment or circuitry, and suggests that anyone interested in such projects consult a patent attorney.

EDITORIAL

The Power of Light

From its use as a metaphor in the mythological battle between good and evil to scientific applications, light has vast appeal to humankind. Obviously, we rely on it every day to see what we're doing, but its uses are much more numerous than that. As hobbyists we take advantage of electronic indicators that are often visual, be they simple LEDs or advanced LCD panels—some such indicators can even warn us of danger. Further, we may have either been helped by fiber optics or laser procedures in medicine, or we may know someone who has. Light is a powerful force for good, indeed.

It can also be a source of fun. That's why in this month's issue we chose to provide a couple of really fascinating and entertaining applications for light.

As you no doubt noticed on our cover, one of these illuminating projects is the Plasma Saber. While our prototype contained a green one, your Saber neon-tube "blade" can be one of a number of different colors, including red or blue. Imagine the envy of everyone around as you slice through the air with this bright light sword. While it won't transport you to another galaxy filled with interplanetary turmoil (and would you really want to be in such a dangerous place, anyway?), it will provide you with hours of fun. Just turn out the lights or step outside at night and dispel the darkness around you. Best of all, you'll learn a thing or two about simple yet efficient high-voltage power supplies while building the device. For more on the Plasma Saber, turn to page 29.

Then move on to the world of lasers. Ever hear of holograms? Sure you have. You've seen moving versions of them in more than one sci-fi flick and may have read about their real-world counterparts, but did you know that you can build your own holography setup using an inexpensive laser pointer? Once again, columnist John Iovine has put together a fascinating experiment that you can duplicate at home—this time with 3-dimensional, eye-popping results. *Amazing Science* begins on page 41.

Add these neat construction projects to the other hands-on coverage you'll find this and every month in **Popular Electronics**, and you should keep quite busy for some time. However, we hope you free up your schedule a bit by next month. You won't want to miss our special issue covering the life and work of Nikola Tesla, complete with a tremendously powerful Tesla coil that you can build. It's hands-on high voltage—see you in 30.



Konstantinos Karagiannis
Editor

CHOOSING AND TWEAKING MONITORS

Cathode-ray-tube (CRT) monitors are sold in the millions nowadays. In fact, according to a study issued by the Microelectronics and Computer Technology Corporation (MCC), a semiconductor and electronics trade group, 100 million monitors will be sold in 2002 alone. There is also something else inferred in the document: Competition has been good for the consumer. Larger displays, shorter "necks" or depths, lighter weight, more features, and lower prices are the direct result of the number of manufacturers available and the broad demand for product (according to the *Computer Display Industry and Technology Profile*, updated February 1999). The price ranges for monitors vary; but 15-inch models can be found between \$130–\$200, 17-inch ones between \$230–\$400, and 19-inch from \$450–\$650. Higher prices than these represent models with enhanced features.

Buying a monitor can be a tricky process, whether you're choosing one as part of an initial PC purchase or as an upgrade. To many users, all monitors look the same, but they're actually so varied under their covers that shopping for one is difficult. We hope to help you with this task this month.

MAKING PICTURES

All CRTs make pictures pretty much the same way, whether the tubes are in a TV, an EKG monitor, or a desktop computer's display. In a CRT, a stream of focused electrons rapidly paints specially coated glass. When the coating is struck by the particles, it glows to form a dot or pixel. As this beam scans across line by line, it creates an image. Because of the speed of this scanning

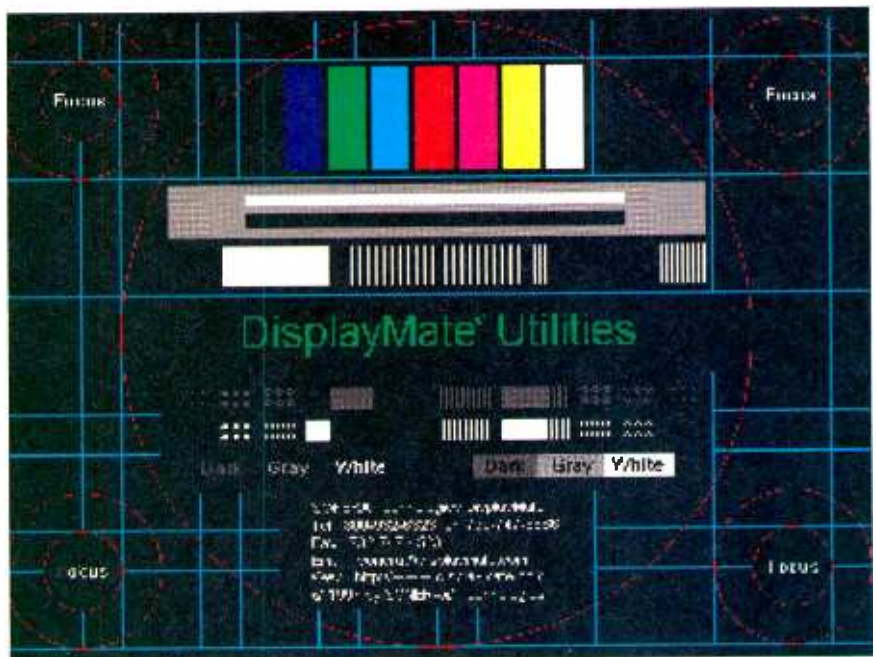

When adjusting your monitor's settings, use a test pattern like the ones found in DisplayMate by Sonera Technologies. It will help you correct for oddities with precision.

process and our brains' persistence of vision, we are fooled into thinking that the resulting image is a solid one.

To create color, manufacturers build each dot or pixel out of three phosphors: red, green, and blue (RGB). Color is derived by how intensely each is excited. The phosphors don't overlap, but are packed so closely together that your brain thinks they are. Hence, each pixel is actually a combination of these three color elements. The vertical distance between each pixel is called dot pitch.

There are two popular technologies for creating the aforementioned dot-by-dot images on a display: shadow mask and aperture grille. Many prefer

aperture grille, and it usually comes at a premium. Let me explain:

With shadow-mask, there is another layer between the pixel coating on the inside of your monitor and your eyes—a layer that fits over each pixel and uniformly "masks" them. It ensures that the electron stream strikes the right target and helps to keep the image consistent and even. Dots or pixels are an equal distance from each other, and though dot pitch has gotten tiny, it's often not as tight as the resolution of aperture grille.

The aperture grille is better explained as consisting of continuous vertical stripping instead of dots. The vertical dots are practically connected,

Accredited B.S. Degree in Computers or Electronics

by studying at Home

Grantham College of Engineering
offers 3 distance education programs:

- B.S.E.T. emphasis in Electronics
- B.S.E.T. emphasis in Computers
- B.S. in Computer Science

NEW! Electronics Workbench Professional 5.0
included in our B.S.E.T. curriculums
-Approved by more than 200 Companies,
VA and Dantes, (tuition assistance avail.)

For your free catalog of our programs dial

1-800-955-2527

<http://www.grantham.edu>

GCE

Your first step
to help yourself
better your future!



Grantham College of Engineering
34641 Grantham College Road
Slidell, LA 70460-6815

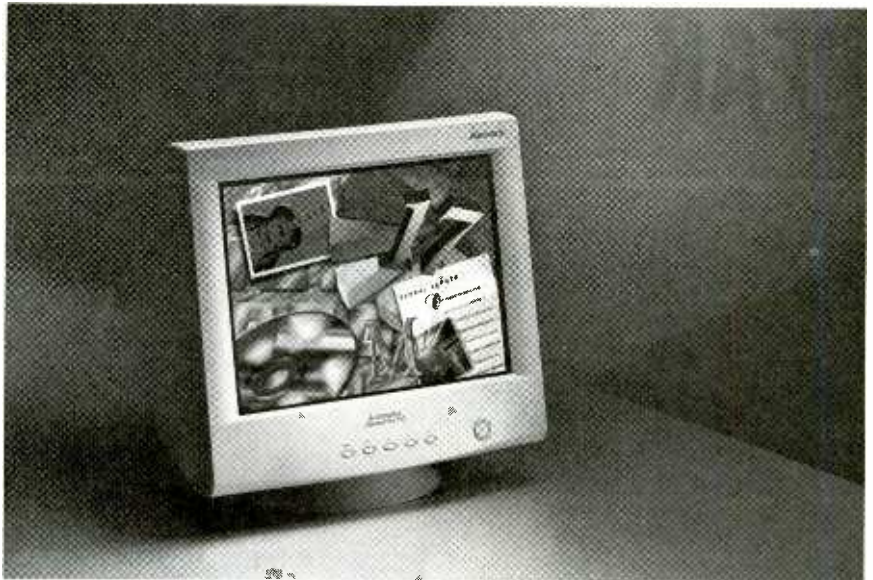

Combining flat-face technology with an aperture-grille, Mitsubishi's 17-inch (16-inch viewable) Diamond Pro 710 is a premium-quality display in every way. At about \$450, it costs more than a bargain monitor, but is worth every penny.

making for a sharper picture. The horizontal rows are pretty close, too. To keep the rows in place, there are two stabilization wires (seen as faint, almost invisible gray lines running horizontally on the screen).

"Dot pitch" isn't an accurate phrase when it comes to aperture grilles, because you can only measure the distance between the rows and not the dots. For this reason, aperture-grille monitors use a measurement called aperture-grille pitch.

A popular type of aperture-grille monitor is the Trinitron from Sony. There are also many Trinitron-licensed brands from other manufacturers (the products usually have a "-tron" in their name). Buying a Trinitron-type display ensures the sharpest picture.

SPECS TO CHECK

One problem with shopping for a monitor is all the variables that affect display quality. Each computer and video card generates an image with different characteristics. Some cards have better digital-to-analog converters (DACs) than others, resulting in brighter images, for instance. Also, video-card resolution and color-depth settings will affect a display's appearance. Be certain when replacing your monitor because of some annoying defect that it is actually a monitor defect. A cheap video card will present a dull picture on both an old and new monitor, for example.

With that said, let's look at monitors themselves. Whenever possible, it pays to physically look at a monitor before purchasing it. Despite the video-card influences we just described, some monitors can present a crisper or brighter image. But when you can't do that, you'll have to base your shopping decision on specifications alone.

The dot or aperture-grille pitch mentioned previously is a good start for your specification checklist. Remember, the smaller the gap or pitch, the finer the detail. Try to get a .27-mm or, even better, a .26-mm dot or aperture-grille pitch. You may even find a .25-mm unit, but these are likely to be pricey. In any case, be wary of some of the "steals" seen in local papers. Many of these "bargains" are .28-mm or worse monitors that one shouldn't buy at the turn of the millennium.

The next spec to look for is the maximum supported resolution (*i.e.* 1280 × 1024). Ideally, you want a monitor that can achieve a level of resolution higher than the one at which you like to operate. For instance, if you find 1024 × 768 to be a comfortable setting for a 17-inch monitor (at least, I do), make sure the max setting on your monitor is at least 1152 × 864 (though it will most likely be 1280 × 1024). This gives you some room to go up if you need to.

Refresh rate is a spec expressed in Hz. The number indicates the number of times a screen is "refreshed" or re-

Some Say Watching Tropical
Fish Lowers Blood Pressure
& Relieves Stress...



They Could Be On To
Something.



Discover the Caribbean aboard a Tall Ship.
6 & 13 day adventures from \$650.
For more information call your travel agent
or 1-800-327-2601.

Windjammer
Barefoot Cruises LTD

P.O. Box 190120, Dept. 5568, Miami Beach, FL 33119

CIRCLE 172 ON FREE INFORMATION CARD

painted each second. Anything lower than 70 Hz, and you'll begin to notice a flicker. Less than 60 will drive you nuts and give you a headache. Note that the monitor's maximum resolution will result in the monitor's lowest or worst refresh. This is another reason to make sure you buy a monitor capable of higher resolution settings than you plan on using. At your rung or two down in the resolution-setting ladder, you should be able to get a good, maybe 75- to 85-Hz refresh rate. The maximum resolution settings of many monitors only provide 60 Hz, which is cutting it close.

When it comes to monitors, display size matters in a confusing way. Measured in diagonal inches (corner-to-corner), display size is often less than advertised. Manufacturers measure the part of the CRT hidden by the case, though it can't provide you with any use or pleasure. It's like buying meat and paying for bone.

A 17-inch monitor usually has only 15.6 to 16.0 viewable inches, depending on the model, and a 15-inch monitor has approximately 13.8 viewable inches. More and more manufacturers are listing the viewable size in their consumer specs, so you can compare actual screen real estate.

Keep in mind that the larger the monitor class (e.g. 17-inch, 19-inch), the wider and deeper the monitor's footprint and the more it weighs, unless the monitor uses some form of short-neck technology. Monitors with the latter can save a lot of space on your desk. I've seen short-neck 19 inchers that take up less space (depth-wise) than a 17-inch display. Of course, short-neck units cost more as a result—make sure you need the luxury of small surface area.

FOR MORE INFORMATION

Mitsubishi Electronics America, Inc.
Display Products
5665 Plaza Drive
P.O. Box 6007
Cypress, CA 90630-0007
800-843-2515
www.mitsubishi-display.com

Sonera Technologies
PO Box 550
Amherst, NH 03031
800-932-6323
www.displaymate.com

Popular Electronics

REPRINT BOOKSTORE

- | | |
|---|---|
| <input type="checkbox"/> 229 Popular Electronics (1999 back issues) \$5.00
Write in Issues desired _____ | <input type="checkbox"/> 218 Electronics Now (1998 back issues) ..\$5.00
Write in Issues desired _____ |
| <input type="checkbox"/> 228 Popular Electronics (1998 back issues) \$5.00
Write in Issues desired _____ | <input type="checkbox"/> 217 Electronics Now (1997 back issues) ..\$5.00
Write in Issues desired _____ |
| <input type="checkbox"/> 227 Popular Electronics (1997 back issues) \$5.00
Write in Issues desired _____ | <input type="checkbox"/> 216 Electronics Now (1996 back issues) ..\$5.00
Write in Issues desired _____ |
| <input type="checkbox"/> 226 Popular Electronics (1996 back issues) \$5.00
Write in Issues desired _____ | <input type="checkbox"/> 215 Electronics Now (1995 back issues) ..\$5.00
Write in Issues desired _____ |
| <input type="checkbox"/> 225 Popular Electronics (1995 back issues) \$5.00
Write in Issues desired _____ | |
- | REPRINTS | REPRINTS |
|---|---|
| <input type="checkbox"/> EH96 Experimenters Handbook (1996) .. \$5.00 | <input type="checkbox"/> 174 Electronics Cartoons (The Best of) ..\$1.99 |
| <input type="checkbox"/> EH95S Experimenters Handbook
Summer Edition (1995) .. \$5.00 | <input type="checkbox"/> 173 From Not-Working to Networking
Troubleshooting Local-Area Networks ..\$2.99 |
| <input type="checkbox"/> EH94S Experimenters Handbook
Summer Edition (1994) .. \$5.00 | <input type="checkbox"/> 172 33 Bench-Tested Circuits ..\$1.99 |
| <input type="checkbox"/> EH94W Experimenters Handbook
Winter Edition (1994) .. \$5.00 | <input type="checkbox"/> 171 36 Time Tested Circuits ..\$1.99 |
| <input type="checkbox"/> EH94 Experimenters Handbook (1994) .. \$5.00 | <input type="checkbox"/> 170 High-Voltage Project for Fun and
Science Book 1 ..\$2.99 |
| <input type="checkbox"/> EH93 Experimenters Handbook (1993) .. \$5.00 | <input type="checkbox"/> 170A High-Voltage Projects for Fun and
Science Book 2 ..\$2.99 |
| <input type="checkbox"/> HH95S Hobbyists Handbook
Spring Edition (1995) .. \$5.00 | <input type="checkbox"/> 169 Think Tank (133 Circuits) ..\$1.99 |
| <input type="checkbox"/> HH95F Hobbyists Handbook
Fall Edition (1995) .. \$5.00 | <input type="checkbox"/> 169A Think Tank Vol. 2 ..\$1.99 |
| <input type="checkbox"/> HH94S Hobbyists Handbook
Spring Edition (1994) .. \$5.00 | <input type="checkbox"/> 168 Fact Cards (#34-66) ..\$1.99 |
| <input type="checkbox"/> HH94F Hobbyists Handbook
Fall Edition (1994) .. \$5.00 | <input type="checkbox"/> 168C Fact Cards (#67-99) ..\$1.99 |
| <input type="checkbox"/> HH93 Hobbyists Handbook (1993) .. \$5.00 | <input type="checkbox"/> 168D Fact Cards (#100-132) ..\$1.99 |
| <input type="checkbox"/> HISTORY Crystal Radio History, Fundamentals
& Design ..\$10.95 | <input type="checkbox"/> 167 Designing With IC's ..\$2.99 |
| <input type="checkbox"/> XTAL Crystal Set Handbook ..\$10.95 | <input type="checkbox"/> 166 Collected Works of Mohammed Ulyses
Fips (62 pages, April Fools Collection) ..\$6.99 |
| <input type="checkbox"/> XTALPRO Crystal Set Projects ..\$14.95 | <input type="checkbox"/> 165 How to Repair CD Disc Players ..\$2.99 |
| <input type="checkbox"/> XTALBLD Crystal Set Building ..\$15.95 | <input type="checkbox"/> 164 Modern Electronics (April 1908) ..\$1.99 |
| <input type="checkbox"/> POP96 POPtronix Hobbyist Handbook (1996)\$5.00 | <input type="checkbox"/> 160 New Ideas - 42 Circuits ..\$1.99 |
| <input type="checkbox"/> POP97 POPtronix Exper Handbook (1997) \$5.00 | <input type="checkbox"/> 159 Low Frequency Receiving Techniques
Building and Using VLF Antennas ..\$2.99 |
| <input type="checkbox"/> Radiocraft 1993 Projects for Hobbyists .. \$5.00 | <input type="checkbox"/> 158 Electro Importing Co. Catalog
(Circa 1918) ..\$2.99 |
| <input type="checkbox"/> 219 Electronics Now (1999 back issues) ..\$5.00
Write in Issues desired _____ | <input type="checkbox"/> 157 All About Kits ..\$1.99 |
| | <input type="checkbox"/> 156 How To Make PC Boards ..\$1.99 |
| | <input type="checkbox"/> 154 How To Repair VCR's ..\$1.99 |

To order any of the items indicated above, check off the ones you want. Complete the order form below, include your payment, check or money order (DO NOT SEND CASH), payable to and mail to Claggk Inc., Reprint Department, P.O. Box 4099, Farmingdale, NY 11735.

Please allow 4-6 weeks for delivery. No COD's!

To place a credit card by phone, Visa Mastercard or Discover only. You can also order and pay by e-mail. Contact Claggk@gernsback.com for details.

CALL: 516-293-3751.

To use your Visa, Mastercard or Discover, complete the following:

Bill my Visa Mastercard Discover

Card No. _____

Exp. Date _____

Signature _____

MAIL TO: Claggk Inc.

Reprint Bookstore, P.O. Box 4099, Farmingdale, NY 11735

All payments must be in U.S. funds

SHIPPING CHARGES IN USA & CANADA

Up to \$5.00	\$2.00	\$30.01 to 40.00	\$6.00
\$5.01 to \$10.00	\$3.00	\$40.01 to 50.00	\$7.00
\$10.01 to 20.00	\$4.00	\$50.01 and above	\$8.50
\$20.01 to 30.00	\$5.00		

Overseas Orders must contact
CLAGGK for shipping charges.

Total price of merchandise

Shipping Charge (see chart)

Subtotal

Sales Tax (New York State Residents only)

Name

Total Enclosed

Address

City

State

Zip

Another feature you can expect to pay more for (maybe about \$100 more) is the use of flat-face technology. By this I don't mean LCD, which is an animal to discuss in another column. Rather, flat-face technology makes certain that the glass face of the CRT you view is totally flat. This is expensive to implement, because engineers have to overcome the distortion that would result due to the beam bending that occurs at the edge of a flat CRT screen. They've gotten good at wiping this out, and the result is some beautiful and pricey flat monitors. For example, Mitsubishi's 17-inch (16-inch viewable) Diamond Pro 710 combines flat-face technology with an aperture grille. It costs more than a bargain monitor (about \$450), but it's worth it. Most people can do without the luxury, but once you see the crispness of these new goodies it's hard to pass them up.

In today's environment, virtually all monitors are multisynch (also called multiscan, multifrequency, or autoscans) units, but look for this feature especially if you're getting a second-hand display. This feature automatically detects the setting of your video card and

adjusts the monitor's horizontal scan frequency, expressed as a range in kHz, to match. Make sure the latter range is as large as possible.

Lastly, buy a monitor with as many controls as you can find. The more controls you have on your monitor, the more control you will have over its display quality. For example, an obscure control like pincushion adjustment could help you avoid frustration from looking at a skewed image day after day. Let's now look at adjustments, including those related to geometry.

ADJUSTING DISPLAYS

All monitors can do with a tweak or two, but for some reason most go untweaked. Millions of monitors are underutilized, and their display quality is unnecessarily poor. There is a simple fix: Learn how to use the monitor adjustment controls.

The factors and geometry that affect monitor quality are common to all monitors, but not all monitors can control all factors. Again, the more controls available in the onscreen menu or on the monitor's faceplate, the better. Some monitor controls display numbers as they are adjusted. Write these numbers down for reference before making adjustments.

Sonera Technologies sells an intensive PC display test-pattern program that can assist you with monitor adjustments and help identify imperfections in your monitor (with your eye being the judge). In most cases, the free demo of *DisplayMate* (\$79) available from the Sonera Web site is enough. In some instances, video cards provide a set of secondary adjustment controls as well. Use the monitor's controls first for maximum quality.

Horizontal and vertical size and position are the most underutilized, yet easiest to use, display adjustments. These control the actual width and height of the screen being displayed, with the position control allowing you to center your screen so that the image covers a monitor's entire display area. Some people have spent money on a 17-inch monitor only to live with what looks like a 15-incher. Make sure the image on your display goes from edge to edge.

Adjusting monitor or color temperature (measured in degrees Kelvin) affects how white the white is and how vivid other colors look. A higher tem-

perature provides a stronger, cleaner white. A lower temperature usually makes the white look yellow. Other colors take on similarly duller appearances with low color temperature.

Pincushion, trapezoid, and parallel-ogram adjustments refer directly to screen geometry or shape, and represent the figures they are named after. If the image displayed is anything but rectangular, then the control named after the figure that most closely represents the anomaly will help bring the screen back into shape. Rotation or tilt control can be used if your display image looks like it came from an episode of the 60's *Batman* TV show and is rotated either to the left or right. Get the displayed image as close to aligned as possible, as rotation might affect how you perceive other corrections, like pincushion or trapezoid.

Brightness and contrast ought to be checked, as well. These two simple controls can greatly enhance a display's appearance. As odd as it may sound, most computer monitors look great with both settings maxed.

Degaussing is used to demagnetize a computer monitor's screen and interior components. Over time, as the magnetic charge builds, image quality deteriorates. The electron stream responsible for the image is influenced by this light magnetic charge (you've seen the effect in old-style predegauss button monitors and TV screens with rainbow corners). Newer monitors degauss automatically at start-up. Most older ones are manually operated—degauss these regularly, maybe every two or three days.

Moiré-pattern control helps minimize the impact of these inherent and annoying screen patterns. These patterns are present in most displays to one degree or another, manifesting themselves as colored bands or portions of the screen where the image seems slightly off. The larger screen, the more likely moiré patterns are to manifest. Make sure your monitor has this control, or forever stare at weird swirls in fields of what should be a solid color or consistent pattern.

In the end, there's no substitute hardware or program that can make your new monitor look its best. You are the brains behind the machine here, so be sure to take full advantage of all the tweaking options you have. Your eyes will thank you. ■

ATTENTION!

ELECTRONICS
TECHNICIANS

EARN YOUR

B.S.E.E.

DEGREE

THROUGH HOME STUDY

Our Highly Effective Advanced-Placement Program for experienced Electronic Technicians grants credit for previous Schooling and Professional Experience, and can greatly reduce the time required to complete the program and reach graduation. No residence schooling required for qualified Electronic Technicians. Through our Special Program you can pull all of the loose ends of your electronics background together and earn your B.S.E.E. Degree. Upgrade your status and pay to the engineering level. Advance rapidly! Many finish in 12 months or less! Students and graduates in all 50 states and throughout the world! Established Over 50 Years! Write or call for free Descriptive Literature. (601) 371-1351



COOK'S INSTITUTE
OF ELECTRONICS ENGINEERING



4251 CYPRESS DRIVE
JACKSON, MISSISSIPPI 39212

CIRCLE 173 ON FREE INFORMATION CARD

How Stuff Works

The Internet is being used for a myriad of applications nowadays. Even if you're not online yet, you might have caught on to the aforementioned fact just by perusing the topics of this column for, say, the past four issues, if not the past four years (yes, this is the 48th installment of *Net Watch!*). But despite its use for shopping, audio/video entertainment, gaming, and more than a little time wasting, the Net is still primarily used for what it was created for:

To share information.

This month we're going to take a look at a site that does just that, yet does so in a way of particular interest to electronics hobbyists and do-it-yourselfers. What do folks like these, possibly you included, have in common?

An interest in how things work.

Think about it; without such knowledge, it's not possible to create a very thrilling project or repair a gadget that's not working up to par (or at all). And without being able to do either of those things, you won't find much use for that workbench and set of tools.

There's a lot of technology out there—some of it new, some of it old but enduring. Why not use some tech to keep abreast of just how other tech works? Actually, you can even use the site we're covering this month to learn more about how the Web and Internet sites themselves operate. How's that for a well-rounded spot to visit online?

SO HOW DOES IT?

How Stuff Works is a terrific site that houses a lot more information than it appears to at first glance. While the first teaser page greets you with a list of just a couple dozen articles—divided into Engines and Motors, Electronics, and Around the House

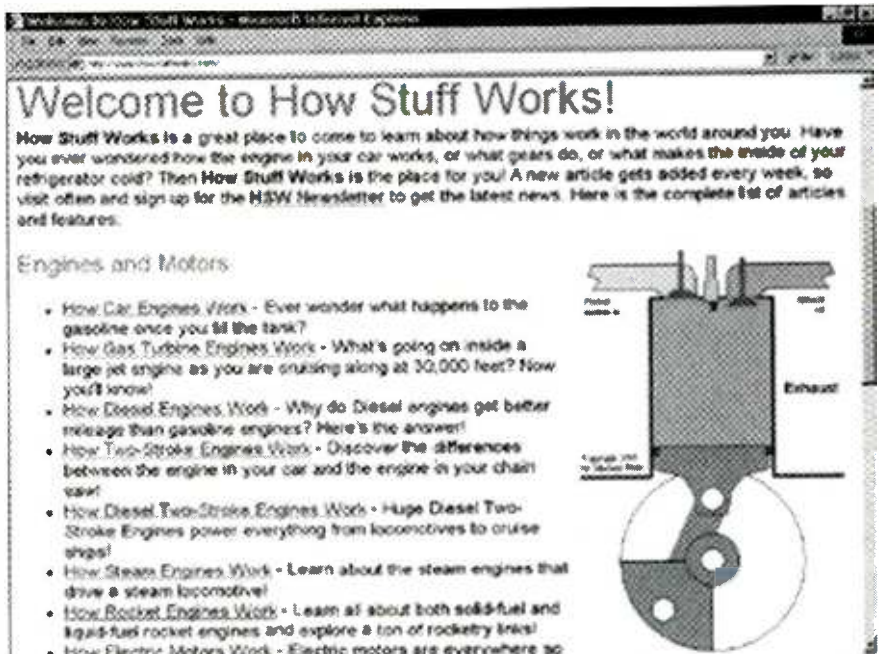

Even the first page of *How Stuff Works* makes it clear that it's a site devoted to making complex concepts easier to understand. The simple diagram of an engine is only a hint of the detail waiting in each article.

categories—these are only a few samples. Clicking on the PowerPanel at the top of the page lets you into a site that's a veritable techie wonderland.

Once at the PowerPanel site, you find, among other links, one to an expanded Table of Contents. Select that link and get ready for some visual scanning. Added to the three categories from the teaser page are Things You See in Public, Basic Technologies, The Internet, Computers, Understanding Digital Technology, Automotive, In the News, Food, Your Body, Question of the Day, and Miscellaneous. It would be impossible to list all the articles contained in each of the aforementioned categories, but I can give some examples.

Under Electronics, for instance, you'll find *How Television Works*, *How a VCR Works*, *How a Cell Phone Works*, and other such selections. Check out the VCR article for a good example of the site's quality. I was impressed to find not only well-drawn diagrams, but actual internal photographs of some of the mechanisms inside a VCR. Laid out in an easy-to-follow manner, the pages mix information and illuminating artwork quite nicely, and they have the feel of a high-quality manual. Make that an unusually high-quality manual, as most images are in full color.

I mentioned earlier that the site teaches visitors about the Internet. As a test of this content, I decided to

How Stuff Works
www.howstuffworks.com

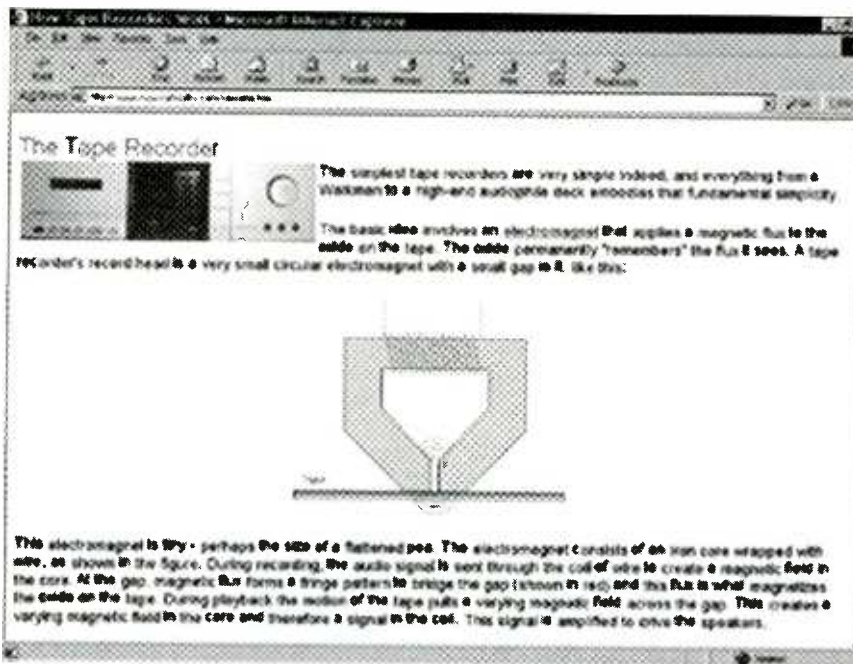

Mixing real photos and well-drawn diagrams, articles at How Stuff Works are well illustrated, which only adds to the enjoyable experience of reading the concise text.

peruse some of the offerings about how Web sites work. The HTML information was not only sound, but presented in such a way that I'm sure a beginner would be inspired to craft his or her own site by hand (that is, without a Web-page designer product). There are examples of coding and how resulting pages from such code would look. If printed out and stapled together, the article would make an excellent desktop reference for budding web designers.

Reading through all the entries, you'll be amazed to find just how many articles there are if you visit How Stuff Works—then check back a few days later and find new additions. This is a living site in every way.

Another feature enhances the feeling that you're dealing with something in a constant state of change. I'm referring to the site's Question of the Day. Here you can post a query about some technical matter and see if an answer is available. These questions can be quite diverse, too. On one day that I visited the site, someone had asked about plywood types! And he got an answer. You can also check through past Questions of the Day and their answers. Things others wanted to know about can be helpful to you, after all.

On the topic of searching, the PowerPanel gives you access to a search engine that covers not only past questions and answers, but every article at the site, too. This is helpful if you're not sure where to look for information on some obscure term you've come across.

TRUSTING IT

Here's some advice that applies not only to How Stuff Works but to most anything you read online: Chances are it's been fact-checked by the person who wrote it. Actually, that's a best-

case scenario—most data you find online hasn't been checked for accuracy at all. That's not to say it isn't true, but it just might be remembered or interpreted incorrectly by the person who wrote it (if it wasn't outright fabricated in the first place).

Fortunately, the creator of How Stuff Works can be trusted more than your average Web author. Read his bio, and you'll learn that he's the author of ten books on a variety of computing-related topics, as well as a former university teacher.

Still, no one is an expert at everything. This is part of the reason that How Stuff Works is such a great site—we can all use overviews on many different topics—and also why you can't use the information you find at the site as your only avenue of research. Many of the articles found there, as factually correct as they may be, can only act as springboards for further reading. Don't count on the information at How Stuff Works to be your complete technical bible, but do plan on getting the gist of anything covered there. How you expand on such information is up to you to decide.

Incidentally, How Stuff Works even makes finding extra information easy. At the bottom of most articles are two to four links to other sites and resources on the particular topic you've been reading about. A nice touch.

That's all the time and space we have this month. Until next time, when we kick off our fifth year, I'd love to hear your comments and suggestions. Please feel free to contact me via snail-mail at *Net Watch*, **Popular Electronics**, 500 Bi-County Blvd., Farmingdale, NY 11735, or e-mail me at netwatch@gernsback.com. ■

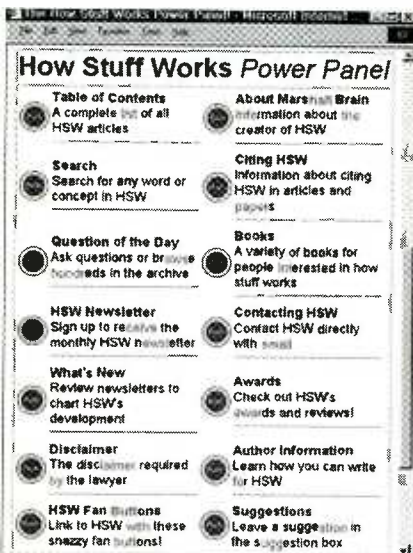

To get the most out of the site, access its PowerPanel, which gives you more navigation options than the teaser opening page.

LynX-10
HOME AUTOMATION KIT

- Software Included
- Use Existing Wiring
- Simple Inexpensive

1-800-928-5299 www.marrickltd.com



NuvoMedia Rocket eBook

Carry a small library in a high-resolution electronic reader that weighs about as much as a hardcover.

If you like buying books online, but could do without the wait and costs associated with shipping, consider getting those titles in electronic form. The *Rocket eBook* from NuvoMedia may be just the way to save some trees and the soaring costs of printing and paper.

The Reader. Weighing 22 ounces, the *Rocket eBook* may not be as light as a paperback, but considering that it can hold about ten novels (4000 pages), you won't mind that its weight is comparable to that of a hardcover. It's comfortable to hold for hours and a joy to use.

Because it's supposed to be replacing something that requires no technical know-how (to read a book you turn its pages), the eBook has few controls. Besides its on/off switch, which if you tap quickly acts as a backlight power switch, the only buttons on the unit are arrow keys for moving a page up or down—all you need while reading. To set up your eBook, you can take advantage of the screen's four touch-sensitive icons, using the included stylus or a finger to tap them.

The icon that looks like a rocket lets you switch between large and small fonts. Using the *RocketLibrarian* software that comes with the device, you can choose what each of these will be—when the eBook is connected to your computer with its docking cradle. We found the default font and sizes to be easy to read and only changed them for testing purposes.

Press the icon of a page with arrows surrounding it to change the orientation of the display. This makes it easy for both left and right-handed users to get cozy with

the eBook.

The opened-book icon lets you search for text, make a note, or jump to a particular part of a book. Don't worry about setting bookmarks, though. The

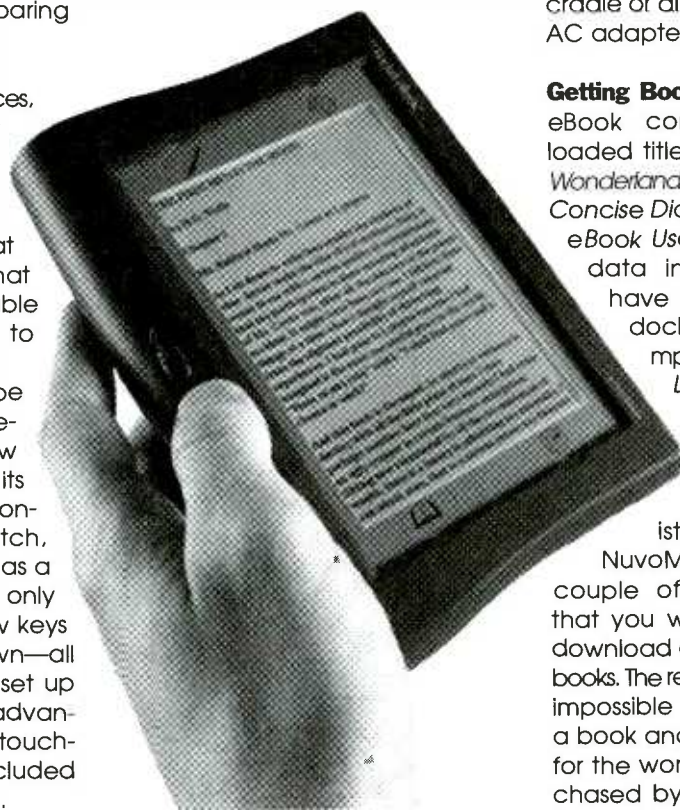

eBook remembers where you were when you shut it off last and will be on that same page next time you turn it on.

The last icon is a little image of books on a shelf. This one presents you with a list of loaded titles (more on how to load titles into the eBook in a moment), making it possible to access a book with a touch of the screen.

We liked the backlit screen a lot. It makes it possible to read in poor light conditions without eyestrain and isn't too hard on the built-in

rechargeable battery. The latter provides 17 hours of fully lighted reading, and as much as 33 hours if you seldom or never use the light. Fortunately, it only takes 90 minutes to charge in either the docking cradle or directly connected to the AC adapter.

Getting Books in There. The *Rocket eBook* comes with three pre-loaded titles: *Alice's Adventures in Wonderland*, *Random House Webster's Concise Dictionary*, and the *Rocket eBook User's Guide*. To get other data into the device, you'll have to install the included docking cradle to your computer and load the *RocketLibrarian* software that comes on a CD-ROM.

Once your computer setup is complete, you need to register the device with NuvoMedia. This only takes a couple of minutes and ensures that you will be able to buy and download e-versions of your favorite books. The registration process makes it impossible for people to download a book and then post it on the Net for the world to share. A book purchased by you can only be read on your eBook, in other words.

At the time of this writing, there aren't that many e-titles available, but the list is growing all the time. Popular modern fiction and nonfiction as well as classics are out there, with even more obscure books being transferred to the medium. Prices are comparable to print versions, but, as mentioned, you don't have to pay any shipping costs or wait for delivery.

When you buy an e-title, you download it to your computer and store it in the *RocketLibrarian*

(Continued on page 19)

A Digital Voice Recorder AND FAST PERIPHERALS

Most people are probably familiar with those micro-cassette recorders that people use for recording interviews, dictating, and so on. But today there's a better way to record audio notes, one that eliminates the need to transcribe the audio later on.

Olympus' new *D1000 Digital Voice Recorder* with IBM *ViaVoice Transcription* lets you automatically convert digitally recorded speech to text on a PC. The compact D1000 fits in a shirt pocket. It records anywhere, anytime.

Audio is stored on an Intel Flash Memory Miniature Card. To turn this audio into text, you remove the card, insert it into the D1000's PC Card adapter, and then plug the latter into a notebook computer's PCMCIA slot. An optional card reader is available for desktop computers.

Using a 2MB card, you can get a little over a half hour of recording time; but for voice recognition you'll have to use the high-quality mode which will only get about 8 minutes per megabyte. A 4MB card is available, allowing for about 33 minutes of voice-recognition-quality recording. Soon 8MB cards will be commonplace that will offer more than an hour of recording time. Neat, huh?

If you've always used a tape recorder for dictation and then had to spend hours listening to the recording and typing in the text, you will certainly appreciate what a timesaver the D1000 Digital Voice Recorder can be. The device costs \$299, which includes IBM's *ViaVoice Transcription* software.

USB SMARTMEDIA READER

I don't have to mention—again—how good digital cameras are becoming. Image resolution is way up, and prices are coming down. You can now buy a two-million-pixel camera for under \$1000. However, I'm not about to introduce another camera. Instead, I've got a handy new accessory.

While I don't often need more storage space than most digital cameras provide, I am tired of using the slow serial link to transfer pictures. Hagiwara Sys-Com's new *FlashGate* makes the task quick and easy, provided that your camera uses SmartMedia memory cards.

FlashGate is a USB-based peripheral that trans-

(Mbps). *FlashGate* supports SmartMedia cards up to 128MB in capacity, and in both 5- and 3.3-volt forms. The reader's compatible with SmartMedia cards used in digital cameras, personal digital assistants (PDAs), voice recorders, and more.

Since it's a USB peripheral, *FlashGate* does not require an external power supply—it simply pulls power from the computer's USB port, for use in the field with notebook computers. *FlashGate* is Plug and Play compatible with Windows 98 and the upcoming Windows NT Version 5.0. It will also work with Mac OS 8.1 or higher. *FlashGate* costs \$99.

PERFECTION 636U SCANNER

The popularity of the USB interface is starting to snowball. All new computers, both desktop and notebook models, feature USB ports, so it makes sense to use them. USB is well-suited for peripherals such as scanners. One reason is because the Universal Serial Bus interface has more than enough bandwidth for scanners, and another is that computers don't need to have a SCSI adapter installed to take advantage of high speeds.

Epson's new *Perfection 636U* is a USB-compatible flatbed scanner with a maximum hardware resolution of 600-dpi optical, which produces 600 × 2400 dpi with Epson Micro Step Drive technology. Use



The Olympus *D1000 Digital Voice Recorder* lets you dictate and then have it transcribed with IBM's *ViaVoice* software. Just think, no more typing!

fers data from SmartMedia directly to USB-equipped desktop and notebook computers. Images are transferred at speeds up to 12 megabits per second

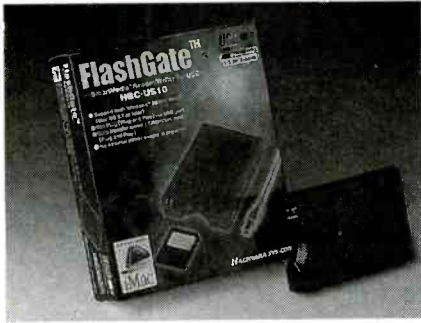

FlashGate transfers data from SmartMedia directly to USB-equipped desktop and notebook computers at speeds up to 12 Mbps per second.

interpolation, and you can simulate 9600 × 9600 dpi. Maximum scan size is 8.5 × 11 inches. Each 36-bit scan recognizes more than 68 billion colors for accurate color reproduction. When scanning documents to convert to text, the Perfection 636U uses advanced technology to separate background colors from text. The 636U is compatible with iMac, G3, or Windows 98 computers. A 20-page document feeder is standard.

Bundled with the scanner is Adobe PhotoDeluxe for easy retouching of photos and adding special effects. Also

included is document management software with one-button scanning, OCR (Optical Character Recognition) software for converting scanned documents to text, and desktop-publishing software complete with page templates. The scanner measures just 11.3 by 16.75 by 3.47 inches (WDH), so it doesn't take up much desk space—perfect for small offices. Epson's 636U scanner has a street price of about \$229.

LEXMARK E310 LASER PRINTER

Lexmark's new E310 business-class laser printer is the perfect laser printer for small offices—it is fast and small in size, and it offers crisp output. The Lexmark E310 is a true 600-dpi laser printer with a software-enhanced mode for even sharper printing. The E310 comes standard with a parallel interface and a USB port, and PostScript Level 2 and PCL 6 emulation are standard as well.

The E310 measures 13.6 by 14.4 by 8.8 inches (WDH), and it weighs 16.5 pounds. Powered by a 67-MHz Toshiba RISC processor, the E310 can

print up to eight pages per minute, with the time to first print being less than 17 seconds. It comes standard with 2MB of memory, which can be upgraded to as much as 66MB. The printer will accept almost any stock up to 8.5 inches wide or less, and its automatic paper feeder holds 150 sheets. It sells for under \$400.

IMAGE MASSTER SOLO

Bringing a computer back to life after a hard drive crashes or setting up a new computer from scratch requires more than just a passing knowledge of computers, and usually at least half an hour or so of effort. People that have to deal with new and dead systems for a living need a faster way to do it. The fastest way to get a new or refurbished PC up and running is to install a pre-loaded hard drive. Then the system will boot up immediately with an exact configuration.

One portable and affordable drive-duplication solution is Intelligent Computer Solutions' handheld Image MASter SOLO. The Image MASter SOLO can copy or restore hard drives that are still installed in a system by work-

SENCORE "LITE"

High Quality Test Equipment At Affordable Prices



OSCILLOSCOPE

- 150 MHz CRT readout
- CRT readout of frequency, time, voltage
- 10 on-screen memory settings
- Dual channel
- Built-in component analyzer

- 3-year limited warranty

\$1,799

DM500 METER

- AC/DC voltage and current
- Resistance to 30 MΩ
- Beep Guard™ Input Protection
- Continuity/Diode Test
- Shockproof
- 1-year limited warranty



\$99

DM501 METER

- True RMS
- AC/DC voltage and current
- Resistance to 30 MΩ
- Data hold
- Water resistant
- Beep Guard™
- Current to 20A (limited)
- 1-year limited warranty



\$199

CALL TODAY
1-800-SENCORE
or e-mail
sales@sencore.com



\$529



\$269

\$299

POWER SUPPLIES

- Low ripple
- Constant current and voltage
- Master slave operation
- 1-year limited warranty

SENCORE

3200 Sencore Drive Sioux Falls, SD 57107
1-800-SENCORE • www.sencore.com

CIRCLE 40 ON FREE INFORMATION CARD

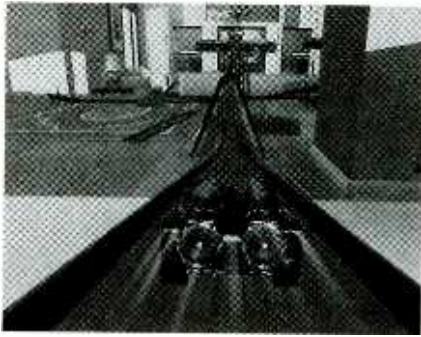

Stunt Track Driver lets you blast through different areas of a house in your favorite Hot Wheels car. It's fun for all ages.

ing through the parallel port at speeds over 300MB per minute. It can copy both IDE and SCSI drives in this manner. It works with any operating system and application software, too. The master and target drives can even be different sizes and models.

IDE drives can be copied much faster using the SOLO's direct IDE interface. Unfortunately the drives must be removed from a system before they can be cloned using that method. Direct IDE copying works at speeds up to 400MB per minute, depending on the speed of the hard drives used. With the addition of optional software, the Image MASter SOLO can store up to ten different hard-disk images on a single master hard drive. It costs \$795.

NEW SOFTWARE

New from LucasArts comes *X-Wing Alliance*, the latest installment in the *X-Wing* series. *X-Wing Alliance* features story-driven single-player gameplay and multiplayer options as well. The game also offers the first opportunity for players to pilot the Millennium Falcon in the assault on the second Death Star in the Battle of Endor. The game's main story focuses on the Rebel Alliance's struggle to survive after being defeated by the Galactic Empire in the Battle of Hoth. *X-Wing Alliance* lets players pilot many new craft, including the Corellian transport ships, the X-wing, A-wing, B-wing, Y-wing, and Z-95. It retails for \$49.

Even newer from LucasArts is *Episode I The Phantom Menace* for PCs. I guess I wasn't surprised to see the new Star Wars software titles get delivered to me the same week that the movie opened in theaters—all the Star Wars toys were in stores the week

Epson America, Inc.
20770 Madrona Avenue
Mail Stop C2-02
Torrance, CA 90509
800-GO-EPSON
www.epson.com

CIRCLE 60 ON FREE INFORMATION CARD

Hagiwara Sys-Com
5375 Mira Sorrento Place, Suite 201
San Diego, CA 92121
800-358-7267
www.hscus.com

CIRCLE 61 ON FREE INFORMATION CARD

Hasbro Interactive
50 Dunham Road
Beverly, MA 01915
978-921-3700
www.hasbro.com

CIRCLE 62 ON FREE INFORMATION CARD

Intelligent Computer Solutions
9350 Eton Avenue
Chatsworth, CA 91311
800-545-5447
www.ics-iq.com

CIRCLE 63 ON FREE INFORMATION CARD

WHERE TO GET IT

Lexmark International, Inc.
740 New Circle Road N.W.
Lexington, KY 40550
800-LEXMARK
www.lexmark.com

CIRCLE 64 ON FREE INFORMATION CARD

LucasArts Entertainment Company
PO Box 10307
San Rafael, CA 94912
415-472-3400
www.lucasarts.com

CIRCLE 65 ON FREE INFORMATION CARD

Mattel Media
333 Continental Boulevard
El Segundo, CA 90245
310-252-2000
www.mattelmedia.com

CIRCLE 66 ON FREE INFORMATION CARD

Olympus America
Digital & Imaging Systems Group
Two Corporate Center Drive
Melville, NY 11747
800-347-4027
www.olympus.com/digital

CIRCLE 67 ON FREE INFORMATION CARD

before the movie opened. Now, normally I put new software into a holding bin and cover it in the order I receive it. But with all the hype surrounding the new Star Wars movie, I figured I'd cover it now. Even so, you won't read this until the middle of August, which is about three months after the release of the movie.

Based on the narrative of the new movie, the *Phantom Menace* game places the fate of the Star Wars galaxy in your hands. Of course, you'll have to enlist the help of the Force if you want to win. The game features Jedi Knight Obi-Wan Kenobi, Jedi Master Qui-Gon Jinn, Queen Amidala, and Captain Panaka. Obi-Wan and Qui-Gon are trying to negotiate a settlement to a threatened trade route blockade when a trap puts their fates in jeopardy. You'll have to figure out the rest yourself. Pick up a copy for \$49.

Another new Phantom Menace game from LucasArts is *Star Wars: Episode I Racer*. This game sticks you right in the middle of the action in the pod-racing scene from the *Phantom Menace* movie. You must take control

of super-fast Podracers in a series of dangerous races. Podracers are powered by two big jet engines and controlled from a cockpit that hovers behind the jets. You'll reach simulated speeds of 600 miles per hour, while skimming just four feet above the ground. With over 20 race courses in eight different worlds, *Star Wars: Episode I Racer* is one game you'll definitely want to check out. Like the other LucasArts titles covered this month, it retails for \$49.

I've mentioned before that I collect Hot Wheels. Normally it's an inexpensive hobby where I get to own as many different cars as I like—of course, I'd rather own a fleet of real cars, but I can't afford that. Hot Wheels are still about a buck apiece, but only for the regular ones sold in stores. You can pay hundreds, or even thousands, of dollars for a Hot Wheels car that's old, rare, or customized.

Anyway, I recently learned about a CD-ROM from Mattel Media that makes collecting Hot Wheels easier and more fun. The *Hot Wheels*

(Continued on page 15)

COMPUTER *BITS*

Full-Motion Video Capture

Last time, we took a look at capturing still video frames from a source of moving video. That was pretty easy, though you do have to develop a sense of timing and manual dexterity to capture the desired frames, especially when you have a choice of 30 frames of video every second.

Grabbing the whole shebang—all 30 of those frames per second (fps), every second—is both easier and more difficult. That is, it's easier to do, yet more difficult to work with what you capture. So here's a warning right up front. I don't want to discourage you from playing with full-motion video, but you shouldn't believe a word when the vendors tell you that their video-editing software is both easy to use and capable of providing professional-looking results. Capturing full-motion video is easy, and minor editing on the captured video is also pretty easy. But while you can get some pretty sophisticated transitions and effects using the software that comes with most capture hardware, or even third-party software such as *VideoWave II* from MGI Software, getting a really professional-looking finished product takes a lot more than a few simple clicks of your mouse.

Still, the aforementioned pessimism is not meant to imply that playing with video isn't worth doing. You can have a lot of fun for fairly little outlay of cash and time. And while you may not think your results are all that terrific, your audience may have a better opinion.

THE HARD AND SOFT OF IT

Just exactly how you capture video doesn't change regardless of the use you make of it. You'll need a device that continually captures frames of



Dazzle's DVC is a compact and attractive unit. Don't let the tangle of cables mislead you—setting it up is a breeze.

video, rather than the single-frame device like the Snappy we used last month. Before you run out to buy a full-motion video capture device, take a moment to look at your current PC. Many PCs already have a video-capture input jack, especially those computers with certain ATI video cards, such as the All-In-Wonder. If your PC is equipped with this or comparable hardware, you may have to install a videocapture driver from the vendor's original diskettes or CD-ROM or download it from the hardware manufacturer's Web site. You'll also need video-editing software, such as *VideoWave II* or Ulead Software's *VideoStudio*, and a really large hard-disk drive. Captured video takes up a lot of room!

Just how much room depends on the video file format you are using. The native Windows 95/98/NT video file format is AVI, for Audio Video Inter-

leave. The AVI format produces good results, and even inexpensive hardware is able to capture 320 × 240, 30-fps video. Playback of captured video is usually accomplished by using the standard Media Player utility included as part of the Windows operating system. The biggest limitation with AVI files, though, is their very large size. Capturing 30-fps video, even at relatively low 320 × 240 resolution, can easily eat up 100MB of hard disk space per minute of saved video. Ten minutes of captured video can therefore occupy a gigabyte of storage. As large as that size is, it's not usually a problem if you have a large hard disk and want to play with and show the video from the PC it has been captured on. But sending any length of video attached to an e-mail or distributing a half-hour of AVI video is a major pain.

To alleviate the problem of dealing with huge AVI files, the PC world has turned to the same family of technology that allows two hours of high-resolution video to reside on a silver DVD platter. Called MPEG, after the Motion Pictures Expert Group that developed the technique, it is a method of capturing only the information that changes from frame to frame between a specified number of full frames that are captured. Called keystone frames, these frames are captured in their entirety. Generally, keystone frames are captured every 15 frames, though many encoders allow you to specify this frequency. Then, in the frames that follow the keystone frame, only the objects that actually change position, color, or brightness are captured. MPEG encoding cuts down on the file size considerably.

For DVD, an encoding scheme called MPEG-2 is used. However, this



Dazzle's interface is easy to use and provides self-explanatory icons to guide you through the capture and initial editing stages.

high-quality format results in the largest of MPEG files and requires special hardware or software decoders to play back the video. Most amateur video-capture systems use MPEG-1, a scheme which produces VHS-like quality and smaller file sizes than MPEG-2. With MPEG-1's 200X compression, about an hour and ten minutes of video can easily fit on a CD-R (which offers 650MB of storage).

DAZZLE 'EM

There are a number of MPEG-1-capable video grabbers on the market.

I like Dazzle Multimedia's Dazzle Video Creator (DVC), a \$250 external unit that comes with either a parallel port or USB interface. I've been playing with the parallel-port model. This is a very attractive looking unit that stands up on a small plastic base. Of course, when you're done plugging in the audio and video feeds from the VCR or other video source, as well as the cable that goes from the DVC to the PC's sound card input, it's a little difficult to see the unit through all of the cables.

Setting up everything takes about

ten minutes. The DVC plugs into the parallel printer port, or if you opt for the USB model, into a USB port. If you use the parallel model, you'll need to set the port (in the BIOS or CMOS setup) to EPP for best performance. Also, when doing full-motion video capture, having a fast PC also makes a difference in the number of frames actually captured and those that are dropped. My test system at the moment is a very fast machine, a Compaq Presario 5600s with a 450-MHz AMD K6-III processor. This system is about as fast as a similar-clock Pentium III, has a huge 13GB hard disk, and can take just about anything I throw at it. It's a loaner from Compaq, and I really think I'm going to cry when it has to be returned.

Anyway, back to using the DVC on your PC. After you plug the VCR's video and audio outputs into the appropriate DVC inputs, you need to feed the audio from the DVC into the PC's sound card so that the audio can

WHERE TO FIND IT

Dazzle Multimedia
45778 Northport Loop West
Fremont, CA 94538
510-360-2300
www.dazzle.com

MGI Software Corp.
50 West Pearce St.
Richmond Hill, Ontario
Canada L4B 1E3
888-MGISOFT
www.mgisoft.com

Ulead Systems, Inc.
970 West 190th Street
Suite 520
Torrance, CA 90502
310-523-9393
www.ulead.com

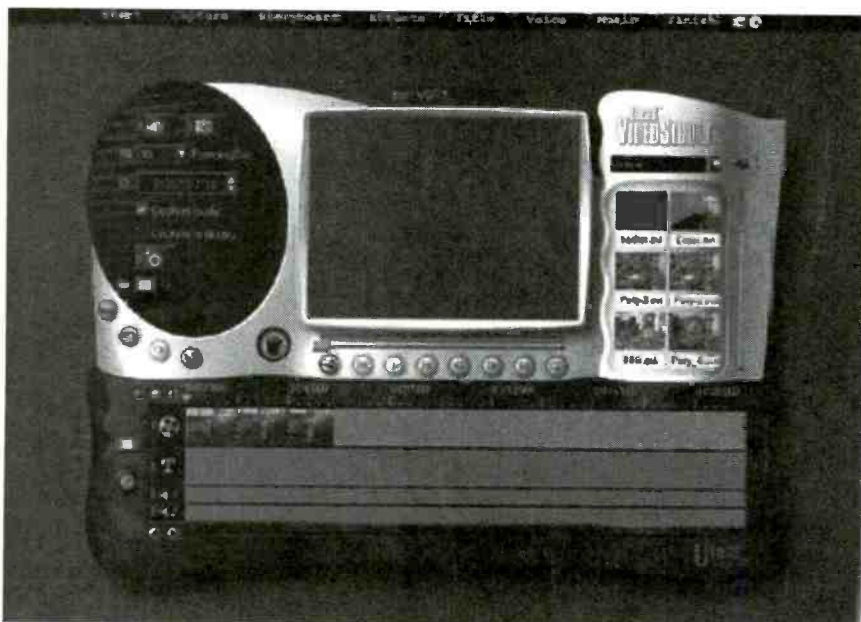

Also included with the DVC is Ulead Software's VideoStudio, which provides more robust editing functions than the Dazzle interface.

be captured as well as the video. Plug in the power supply, install the software, and you're ready to rumble.

The Dazzle DVC comes with a nice software bundle. First there's the attractive and easy-to-use Dazzle capture interface. Help bubbles pop up when you place the cursor on a button for a few seconds, making everything user friendly. Slide-out control panels let you adjust the resolution, quality, and frequency of the frames captured (incidentally, the DVC can also capture individual frames of video as BMP files, so if you have a DVC, you don't need a Snappy or similar frame grabber). Once you've made any settings

or adjustments in the Dazzle interface, just click on the icon of the video camera on the right side of the "control panel" to start recording.

You can do simple video editing with the interface, but Dazzle wisely includes a separate editing package for this purpose—the aforementioned Ulead *VideoStudio*. This editing package also lets you perform video capture, but I prefer the Dazzle interface for this task. Once you start working with the captured video, *VideoStudio* excels. It lets you "mark" sections of the captured video so you can string clips together with simple transition effects and eliminate sections that you don't want. You can even output the video through the DVC back to the VCR or camcorder to re-record the edited video.

If you've ever wanted to produce your own short videos, the Dazzle DVC is a must-have gizmo. You can also publish the captured video to the Web in RealVideo format or MPEG-1 and can even package the latter with an MPEG player (if you suspect its recipient can't otherwise play the file).

Adaptec's *CD-Creator* software is also included on one of the CD-ROMs, but if you have a CD-R/RW burner, you probably already have a copy. In any event, putting an MPEG video file on a CD is a great way to transport or distribute your work.

And, when you've gotten a bit of video capture and editing experience under your belt, the files that you capture with Dazzle's DVC can be used with more sophisticated editing software such as Adobe's *Premier* or Ulead's *MediaStudio Pro*. But for getting started with digital video, the Dazzle Digital Video Creator package is a terrific and affordable first step.

Until next time, feel free to send any comments or suggestions to me at tneedleman@aol.com. ■

HEAD

(continued from page 12)

Collector Guide contains over 5000 photos of Hot Wheels vehicles from the past 30 years, plus general information about the vehicles. Advanced search functions help you find the information you need; and you enter the cars you own in a database that will detail the history, values, and grading of the Hot Wheels in your collec-

tion. A Shopping List feature lets you print out information on a car to take to stores or swap meets. This CD costs about \$35 and comes with a special Hot Wheels racing bus.

Another great Hot Wheels title from Mattel Media is *Stunt Track Driver*. This game lets you pick your favorite car, and there are 12 different cars to choose from. Of course, not all of them are available to you until you have mastered parts of the game. Not only does this game let you do amazing stunts from inside the car you choose, you can race the cars in many unusual settings. You can speed down a steep staircase

and through the main area of the house, jump across an open fish bowl, race around a dusty old attic, and drive in a greenhouse that seems like a deep jungle. You can get in on the action for about \$30.

Hasbro's new two-player *Em@il Games* let you play games via e-mail. Favorite games such as *Scrabble*, *Chess*, and *Battleship* are just a few of the offerings. All you need is a Windows-based e-mail account and a CD-ROM drive. Games are sent as standard e-mail attachments and are simple to open up and play (on a colorful screen). These *Em@il Games* for Windows 95/98 cost about \$15 each. ■

Get our Freeware version
and you will know
why more and more PC-boards
are designed with EAGLE.



EAGLE 3.5

Schematic Capture • Board Layout
Autorouter

for Windows[®] 95/NT

Windows 95 and Windows NT are registered
trademarks of Microsoft Corporation.

EAGLE Professional offers the full EAGLE power: 99 schematic sheets, pc-boards up to 64 x 64 inches, 16 signal layers.
With **EAGLE Standard** you can use 4 signal layers and place components on an area of 6.4 x 4 inches.
EAGLE Light is limited to 1 schematic sheet (of any size) and to 2-layer boards. Components can be placed on an area of 4 x 3.2 inches. All other features are equivalent to EAGLE Professional and Standard.

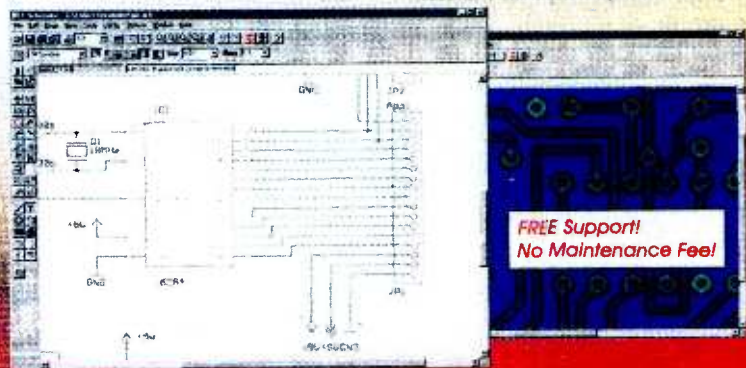

FREE Support!
No Maintenance Fee!

EAGLE 3.5 Light is Freeware!

EAGLE Light is now available free for non-profit and evaluation use! Download it from our Internet Site or order our free CD. Registered users (49 \$ for the complete package) get the commercial license, the reference manual, and free hotline support.

<http://www.CadSoftUSA.com>

800-858-8355

CadSoft Computer, Inc., 801 S. Federal Highway, Delray Beach, FL 33483
Hotline (561) 274-8355, Fax (561) 274-8218, E-Mail: info@cadsoftusa.com

Prices	Light	Standard	Professional
Layout		199\$	399\$
Layout + Schematic		398\$	798\$
Layout + Autorouter		398\$	798\$
Layout + Schematic + Autorouter	49\$	597\$	1197\$

Pay the difference for Upgrades

CIRCLE 174 ON FREE INFORMATION CARD

LETTERS

APPLAUSE FOR ROBOTICS

I am pleased with the addition of the *Robotics Workshop* column to **Popular Electronics**. Robotics is not given enough credit within electronics. It is hard to find any magazine that deals with the subject at all. I applaud your magazine for dedicating a column to robotics.

I feel that robotics will be the next big technology in the 21st century. Robotics is now where computers were about 20 to 30 years ago. In 20 years or so, you will see people with their own personal robots. Every household will have a robot, just like almost every household has a computer today.

I am studying Electronics Engineering Technology at Arizona State University, with the goal of entering the field of Robotics and Control Systems. By doing so, I hope to become the "Bill Gates" of robotics.

We are now seeing robotics being taken more seriously by the amateur and professional electronics experimenter, as evidenced by your magazine. There are more and more companies dedicated to robotics. As a matter of fact, I saw at least three ads for such companies in the August issue.

Thanks again for the new column; I am going to subscribe to the magazine because of it. Please keep up the excellent work.

Who knows? Maybe someday Gernsback will have a magazine totally dedicated to robotics.

J.H.
Tempe, AZ

AMAZING SCIENCE CORRECTION

I wanted to point out an error occurring in the *Amazing Science* column: "Space Horticulture" (**Popular Electronics**, August 1999). On page 71, when talking of the inverse square law as it applies to artificial light, the author states, "So doubling of distance reduces the intensity by a quarter ($1/4$)."
This should be $3/4$: What remains is $1/4$ of the original. The author should have said "reduces ...to $1/4$ of the original amount." For example, if you have an area four square something-or-other

and reduce by $1/4$, you have $3/4$ remaining, or in this case 1 watt is reduced to .25 watt, or by $3/4$ to $1/4$ watt.

Normally, I wouldn't take the time to mention this; however, I can only assume that school children will be reading this otherwise wonderful article. Given the problem our kids seem to be having with math these days in the U.S., I felt this error shouldn't slip by unremarked.

D.S.O.
via e-mail

ARTICLE ADDITION

I would like to add one suggestion for my article "Guitar Distortion Pedal" (**Popular Electronics**, September 1999).

KEEP IN TOUCH

We appreciate letters from our readers. Comments, suggestions, questions, bouquets, or brickbats... we want to hear from you and find out what you like and what you dislike. If there are projects you want to see or articles you want to submit—we want to know about them. And now there are more ways than ever to contact us at **Popular Electronics**.

You can write via snail mail to:

Letters
Popular Electronics
500 Bi-County Blvd.
Farmingdale, NY 11735

Please note the above address is the snail-mail way to get the quickest response. Some readers send letters to our subscription address, and although the mail is forwarded to our editorial offices, it does increase the time it takes to answer or publish your letters.

Send e-mail to:

peeditor@gernsback.com

Of course, e-mail is fast.

Check the end of your favorite columns, too. Many of them list individual e-mail addresses for their respective authors.

And don't forget to visit our Web site: www.gernsback.com.

Try replacing diodes D1 and D2 with LEDs. They have a more gradual clipping characteristic than diodes and can make for a softer distortion. Different-color LEDs have different forward voltages, from 1.2V for infrared to 2.7V for blue, so you get different ratios of signal to clipping voltage.

Chuck Hansen
via e-mail

MISSING DOT

An error crept into the schematic in my article: "Universal Sensor Interface" (**Popular Electronics**, June 1999). A junction dot is missing in the schematic. IC4 should receive its supply from the output of IC3, which places C11 (the decoupling capacitor for IC4) in parallel with C12 (the decoupling capacitor for IC5), C7, and C8 (the output filter capacitors for IC3).

Also, please note that IC3 has no reference to its orientation: input should be to the right; reference pin to ground; and +5V regulated output at the left.

I'm sorry for any inconvenience that these omissions may have caused.

David Prutchi
via e-mail

HAVES & NEEDS

I need information on how to hook up a "Rustrak" Model 288 Strip Chart Recorder. It seems to be operational, but I don't know how to input a signal to it. A current address for this company (a division of Gulton Industries) would be appreciated, too.

Thanks for your help.

Richard Flaws
212 Mondovi Drive
Oswego, IL 60543-8408

I'm requesting help from fellow readers. I had put a project away for lack of a special IC, Part # uaa170, a Matrix encoded LED driver. I am asking anyone who has one or knows where to get one to please let me know.

Thank you in advance.

Don Westenberger
2814 Arsenal St.
St. Louis, MO 63118
e-mail: djw39@juno.com



Give a Friend a Year of Electronics Fun this Christmas...

Does fighting the crowds at Christmas short-circuit your holiday fun? Don't blow a fuse this year...for the friend who shares your love of project-oriented electronics — or a youngster who may need only a spark to ignite a life-long interest — give a gift subscription to Popular Electronics.

Popular Electronics readers get the know how they need to build exciting, educational, and useful projects like these...a professional-quality home-security system...an autoranging frequency counter...a nine-band shortwave receiver...a radio-controlled car...a telephone scrambler...an aviation receiver...and even a robot!

PLUS...Gizmo, our honest and straight-shooting review of the latest consumer-electronics gear...Market Center, featuring mail-order merchants that are ready to help you in all your hobby activities...articles and columns covering every aspect of the electronics hobby — including antique radio, shortwave listening, ham radio, computers, scanners, circuit design, and more!

SAVE MONEY... A great gift to receive, Popular Electronics is also a great gift for *you* to give! The Special Holiday Rate saves you \$41.89* off the newsstand price on each gift. You can save another \$41.89* when you start or extend your own subscription at the same time. It's our "thank-you" for sharing Popular Electronics with a friend at Christmas.

Send no money, unless you prefer. We'll be glad to bill you in January, 2000. Just take a brief moment to go over your gift list and make sure you haven't forgotten anyone who might appreciate the many benefits of Popular Electronics. Then write the names on the attached Gift Certificate and mail it back in the postage-paid reply envelope...we'll take it from there!

Your friends will receive a handsome gift announcement card signed with your name just before Christmas. And all through the new year they'll remember and appreciate your thoughtful gift! So don't blow a fuse...take it easy and enjoy the holidays. Give Christmas gifts of Popular Electronics!

Popular Electronics[®]

*Basic sub rate — 1 yr/\$24.99

SCANNER SCENE

Descrambling Channels

MARC SAXON

By now, you have encountered digital scanning if you've tuned across certain channels used by some federal agencies. Nothing being said is understandable, nor does it even sound like anyone is speaking—just bursts of white noise or basic hiss. Well, even if listeners could copy the digital mode, digital federal traffic is all encrypted, anyway. Sensitive communications on FBI, DEA, Secret Service, and Customs Service frequencies are often sent using digital (properly called DVP, for digital voice processing) scrambling—or what the Feds refer to as the bubble machine. Non-sensitive communications, however, are often sent in clear-voice mode.

In addition, there is analog voice scrambling. This decades-old technology was once called speech inversion. It's very simple. At a specially equipped transmitting station, the modulation's high frequencies are reversed with its low frequencies. To casual listeners, such transmissions are unintelligible gibberish. At properly equipped receiving stations, the process is reversed; and the voice sounds completely normal.

This unsophisticated and relatively inexpensive method achieves a useful degree of communications privacy. It's popular with public service and industrial licensees. Scrambled 46/49-MHz cordless telephones all use analog methods. I have monitored analog systems on VHF-FM commercial maritime channels and also on some TV newscrew assignment desks.

It's possible to understand scrambled channels—as well as to scramble channels oneself. CTP offers a nifty combination speech scrambler and descrambler—the Model DS49. It does a fine job of descrambling standard frequency-inversion schemes using 3300-, 3500-, and 3750-Hz pilot tones, as well as all non-standard split-band schemes using pilot tones be-

tween 2.4 to 4.7 Hz. Capable of providing analog scrambling, the unit is compatible with most cordless phones and two-way communications systems. If hooked to a scanner, it will also descramble such signals. Be sure to check communications laws and regulations in advance to see if they relate to your intended usage.

The DS49 is available in several versions. For instance, the DS49-CU is a stand-alone self-contained unit with a built-in speaker and an AC adapter. It plugs into the extension speaker or earphone jack and costs \$89.95. Other models require four easy solder

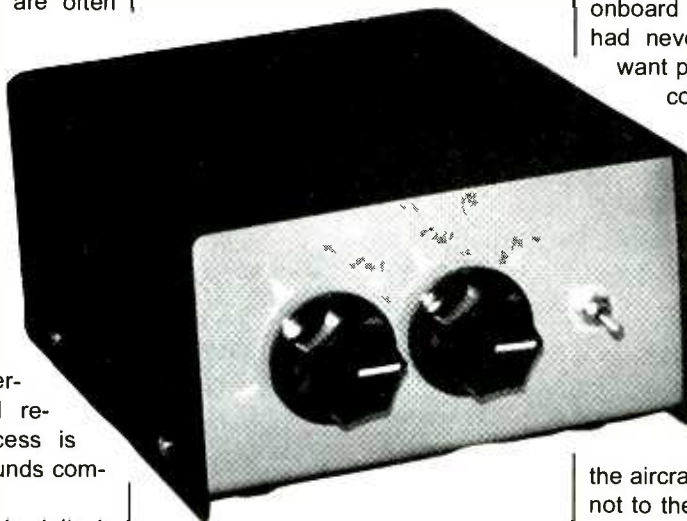

The nifty CTP Model DS49-CU, which is a combination analog speech scrambler and descrambler, does a fine job of descrambling standard frequency-inversion schemes, as well as all non-standard split-band schemes using pilot tones.

connections to fit any receiver and a +12VDC power source inside the radio. The basic DS49 kit is priced at \$39.95; with external controls, \$46.95; or wired and tested, it's \$59.95; or this tested kit with external controls is \$69.95.

For information/orders, contact CTP, 517 Lower Terrace, Huntington, WV 25705; Tel./Fax: 304-525-1761; Web: members.aol.com/ctpds49. VISA, MC, AMEX, and Discover cards are all accepted.

CAN'T WIN 'EM ALL

In the May column, I told the story of not being allowed to use a scanner aboard an airliner, on the basis that passengers are not permitted to monitor company communications. Another time, I brought along a tunable AM/FM and airband receiver and easily got permission to use it during the flight.

That story brought a negative response from reader Bob Birdsong, KB4A, of PA. Bob retired from a major airline and claims that certain electronic equipment can't be used on board, not only since it's against regulations but also because it interferes with onboard navigational equipment. He had never heard that airlines didn't

want passengers to monitor cockpit communications; in fact, they used to pipe them into the cabin through the PA system (which stopped when passengers complained).

On the other hand, we heard from Trevor, in Canada, who currently works for a major airline. He notes that his airline has an audio channel that lets passengers listen in on communications between

the aircraft and ground controllers, but not to the juicy company communications. He adds that nobody has yet proven a passenger's electronic gadget has actually caused a plane to go out of control. However, he's aware that cellphones and laptops can affect some of the sensors through long cable runs. Trevor reports that aircraft manufacturers design today's systems not to malfunction in the presence of virtually all consumer electronics equipment. So, take your choice of stories.

ORDER WIRE

Except for military satellite links, communications in the 225–400-MHz VHF military aeronautical band are normally in AM mode. However, there has always been hobby interest and curiosity in the WBFM mode communi-

cations observed nationwide in this band. The WBFM communications belong to a full duplex (two channel) air/ground, so-called "Order Wire," system operated by the U.S. Air Force, whose interesting transmissions have been reported by hobbyists for more than 30 years.

Originally designed for use by the Post Attack Command Control System (PACCS), the WBFM mode now also includes communications from Air Force 1. PACCS was created during the Cold War, designating certain EC-135 aircraft that could act as airborne control centers for nuclear-missile submarines in case of war. Strategically located ground-station facilities are able to maintain constant communications with these aircraft no matter where they are flying above the continental U.S.

The communications system is multiplex (MUX), combining a central WBFM carrier with multiple SSB (upper sideband) links carrying telephone calls and other traffic imposed on the WBFM frequency at closely spaced increments, offset above and below its center. At times, NFM has also been reported, and 100-wpm encrypted teletype links can also be monitored. Hobbyists can use NFM to take advantage of their scanner's higher sensitivity in that mode, which will help bring in the weaker signals when the aircraft is far away. The voice may be a bit distorted, but when the aircraft gets closer and increases its 1-kilowatt signal, switching over to WBFM makes it clearer. All call signs are tactical, meaning that the stations use various code names like Messkit or Gladiolus.

Channels appear to be in standardized pairs designated for air and ground station use, though the air and ground stations often reverse their usage of the frequencies in a given pair. Little is known about which frequencies pair with what others, and these frequencies may be referred to by code numbers beginning with the letters RF. Frequency assignments are at 50-kHz spacing. Over the years, more than 100 frequencies have turned up. You could scan/search the entire range for these frequencies; but, to make it easier, we are providing a listing of those that have been reported as the most active during 1998 to 1999.

Known and suspected frequency pairs are indicated as one, joined by a slash bar (e.g. 230.65/305.55).

Here are Order Wire frequencies to check: 228.3, 228.35, 228.55, 230.65/305.55, 232.75/357.7, 234.95, 235.85, 236.55, 266.05, 267.6/355.0, 271.0, 273.0, 273.85, 276.5, 276.9, 277.5, 284.2/359.95, 288.85, 291.95, 326.0/359.75, 336.8/366, 337.55, 337.85, 339.55, 344.0, 344.9, 345.4, 351.0, 351.35, 356.35, 359.0, 366.0, 366.65, 366.75/397.05, 369.5/398.5, 379.5, 382.35, 385.1, 385.15, 389.15, 391.15, and 391.5 MHz. Note that 366.0 MHz has been particularly active.

BIG APPLE, BIG DOINGS

Major changes in the New York City Police Department's patrol division during recent months have trickled down through many areas of the agency, not the least of which has been that division's communications system. Where four precincts formerly shared a single frequency, now there are only two or three precincts to a frequency. There are numerous other changes, too.

At our deadline, here's the latest information we have, although this data is still subject to change. Precincts 1, 5, and 7 are now on 476.4375 MHz; Pcts. 10-13 on 476.3375 MHz; Pcts. 19-23 on 476.3875 MHz; Pcts. 20-24 & Central Park on 476.3125 MHz; Pcts. 25, 28, and 32 on 476.6375 MHz; Pcts. 26, 27, 29, and 30 on 476.3625 MHz; Pcts. 33 and 34 on 476.8875 MHz; Pct. 120 on 482.8875; Pcts. 122 and 123 on 482.5875 MHz; Man. N. & S. on 476.5875 MHz; Patrol Boro/Man. S. on 471.0875 MHz; Patrol Boro/Man. N. on 471.0625 MHz; Patrol Boro/Staten I. No. on 482.8625 MHz; and Patrol Boro/Staten I. So. on 482.5625 MHz. As it turns out some of the precincts' former PIL tones have been changed.

There are also 24 NYPD low-power simplex tactical channels, code-named TAC-A through TAC-X. Channels TAC-A through TAC-E, respectively, are for Patrol purposes: 485.6125, 485.5875, 485.5625, 485.4875, and 485.4625 MHz. TAC-F (the Task Force) is 485.4375 MHz. TAC-G and TAC-H are Traffic Control and Special Operations Division on 473.4875 and 473.7125 MHz. TAC-I is the SP Command on 485.4125 MHz. TAC-V is the Communications Division on 485.5375

MHz. The designated uses for TAC-J through TAC-U are not yet known here, but the frequencies are: 465.1125, 465.1875, 465.2375, 465.3125, 465.4625, 465.4875, 460.1125, 460.1875, 460.2375, 460.3125, 460.4625, and 460.4875 MHz. TAC-W and TAC-X are for special use. We have not yet learned their frequencies (maybe one of our readers has?).

Readers with additional information on the revamped NYPD system are invited to share their data here with other listeners.

But, hey, this column is always looking for reader input relating to all scanning matters. This is your column, and we want it to reflect those things that most interest you.

So keep us in mind with your new frequencies, loggings, questions, and suggestions. Our mailing address is: *Scanner Scene*, **Popular Electronics**, 500 Bi-County Blvd., Farmingdale, NY 11735. Our direct e-mail address is: sigintt@aol.com. ■

HANDS-ON REPORT

(continued from page 9)

Bookshelf. You can then load it to your eBook at will. What we really like about the software is that it lets you load *any* text to your eBook, using the RocketWriter feature. This program feature converts text or HTML documents into the eBook format, so you can bring the day's news, company information, or just about anything else that you find online with you for reading at a later time.

Also, if you feel like doing some Web browsing, you'll find a remarkable selection of free, public-domain electronic books in TXT-file form. Most of these are classics, which for many is a good thing. If you're an avid reader of great works of literature, the cost of the eBook might be all you pay for books for quite a while.

The NuvoMedia Rocket eBook retails for \$499, but can be found on sale for as low as \$299. Contact NuvoMedia, Inc., 310 Villa Street, Mountain View, CA 94041; Tel. 650-314-1210; visit the company's Web site at www.rocket-ebook.com; or circle 50 on the Free Information Card. ■

GIZMO®

Lifestyle Home Theater

The Bose *Lifestyle 30 Series II* home-theater system (\$3000) uses a unique combination of proprietary Bose technology and conventional digital decoding to create a system that is easy to use, easy to live with, and easy on the ears. Dolby Digital decoding delivers 5.1 discrete audio channels from a DVD player, satellite system, or HDTV, while Bose Video-stage 5 decoding technology ensures that the listener will hear five independent channels of audio from five speakers, even if the source material contains only mono or stereo programming.



speakers, that option can be selected via the remote control.

The system consists of a sleek-looking music center, five tiny (4 × 2 × 3-inch) Jewel Cube speakers, an Acoustimass-powered bass module that can be hidden from view, and a remote control. The music center includes a six-disc magazine-style CD changer and provides multi-room, multi-source capability. The Acoustimass module has two 5/8-inch woofers, six amplifiers, active electronic equalization, and Bose patented signal processing. Because the Lifestyle 30 is precalibrated, it requires no additional adjustment in the home.

Flippin' Out

Blaupunkt's *X Line* car stereo CD receivers includes the *Key West CD 169* (\$249.95), the *Boston CD 189* (\$289.95), and the *Houston DM 199* with CD changer control (\$329.95, shown here). The Houston and Boston have 4 × 47-watt power amplifiers with high-voltage, low-impedance, four-channel preamp outputs. The Key West has a 4 × 42-watt amplifier and a two-channel preamp output. All three models have faceplates that flip open to allow the user to exchange individual CDs without interrupting the radio. The faceplate also detaches for security.

The front panel features a large, multi-color display designed to provide the driver with easy-to-read information. The display simultane-

ously shows the time and the name of the CD or radio station being played. The peak/average VU meter has four different formats, ranging from small to almost full-panel.

The CD mechanism uses a three-beam CD pickup and rugged suspension for resistance to road shock. The Blaupunkt ORC V tuner provides 18 FM and 12 AM presets and station access via call letters. Users can enter the name or call letters of their favorite stations, and then locate individual stations with a scrolling menu. All three models also have a proprietary bass-equalization circuit that provides four levels of bass extension.

Digital Camera and Display Frame

Sony's *Cyber-shot* (\$999) is a compact, 10-ounce digital camera that offers exceptional picture quality (1600 × 1200), a professional-quality Carl Zeiss lens system, and an MPEG movie mode to capture audio and full-motion video on a Memory Stick for instant playback on the desktop *Digital Photo Frame* (\$999).

Memory Stick is a tiny, integrated-circuit digital storage media designed to share content, such as images, between electronic products. It is available in 4-, 8-, and 32MB storage capacities, and a PC card adapter is also offered. In the future, larger capacity versions will add copyright protection features, primarily for audio applications.



Videostage allows surround-encoded VHS tapes, stereo CDs, and even mono TV broadcasts to be enjoyed in full five-speaker surround sound. Intelligent software selects the appropriate decoder by searching for a digital bitstream. If one is available, the digital decoder is engaged. If not, or if the bitstream is two-channel, the Videostage 5 decoder is engaged. If you prefer to hear music through two

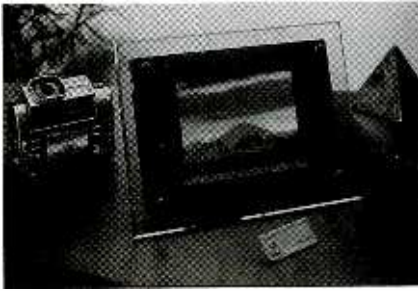

Acting like an electronic photo album and tabletop frame all in one, the Digital Photo Frame (Model PHD-A55) has a 5¹/₂-inch display that “brings photographic memories to life.” You can view mini MPEG movies of a vacation or JPEG scenic digital shots played back in slide-show mode, programmed to change every few seconds, every 15 minutes, or once a day. A touchless sensor allows you to turn on the frame with the wave of a hand. It turns off automatically with a sleep timer. The frame has a built-in speaker with volume control for presentations or for voice memos. An automatic angle detector can differentiate between portrait and landscape orientation and adjust the photo accordingly.

The Cyber-shot’s two-inch display uses a new hybrid LCD technology that combines transmissive and reflective LCD technologies to reduce LCD power consumption by up to 20%. The camera has a 180-degree rotating lens and a “crop-and-save” feature to allow in-camera editing, zooming, and saving of images. The Cyber-shot also features audio/video out for connection to a TV.

Home-Theater Speakers

Atlantic Technology’s System 170 (\$1396) features two-way D’Appolito-configured left, center, and right

Gizmo® is published by Gernsback Publications, Inc., 500 Bi-County Blvd., Farmingdale, NY 11735. Senior Writers: Christopher Scott and Teri Scaduto. Copyright 1999 by Gernsback Publications, Inc. Gizmo is a registered trademark. All rights reserved.

satellites, and two-way full-range dipole surrounds. A 12-inch, 150-watt Class G subwoofer rounds out the compact home-theater speaker system. The speakers come in a black-oak finish and include keyhole mounting brackets for easy placement. The surround speakers are also available with a matte white finish and have an optional in-wall mounting kit.

The *Model 171 LR* satellites feature dual 4-inch-long throw woofers with coated composite molded graphite cones, rubber composite surrounds, and high-temperature



voice coils. They also have one-inch Ferrofluid-cooled silk dome tweeters, and they are magnetically shielded to allow placement near a TV. The *Model 174 SR* dipole surrounds use the same drivers and add a ³/₄-inch modified dome tweeter. Their “Frequency Enhance” design is said to eliminate the inherent tendency of dipoles to cancel their own bass response, making the speakers ideal for all types of surround systems. The *Model 173 C* center channel features an “aim-able” base design and a high-frequency level control for precise timbre matching. The *Model 172 PBM* subwoofer includes a 12-inch composite cone woofer in a sealed enclosure. The built-in 150-watt RMS amplifier has an adjustable crossover, a phase reversal switch, and high-level/low-level inputs with pass-through connectors.

Bit by Bit

On any list of the top ten consumer-electronics items of the 20th century, the compact disc is sure to be

near the top. This is the format that brought us greater fidelity, longevity, and convenience than its audio predecessors—records and audio tape. It also generated an acceptance of digital technology that helped pave the way for DVD and other new formats.

Until recently, however, compact discs failed to offer one major feature that endeared audio tape to millions—recordability. The problem wasn’t that no one could figure out how to make a CD recorder that could dub perfect digital recordings of a compact disc. The problem was that, with such a machine, consumers *could* make a perfect duplicate of a compact disc, a nightmare scenario for the recording industry.

It took a long time, and a lot of compromises, but the consumer electronics industry and the Recording Industry Association of America (RIAA) worked out a set of solutions acceptable to all parties. The result was a new audio product category: the Audio CD-Recorder (ACD-R).

Under the terms of the agreement with the RIAA, consumer ACD-Rs can record only on certain blank discs, the sale of which includes a small royalty payment to the RIAA. In addition, manufacturers must make royalty payments on each CD recorder sold. Those recording decks must include two built-in copyright protection technologies. First, the Serial Copy Management System (SCMS) prevents users from making a digital copy of a digital copy. Second, a Recorder Unique Identifier, or RUI, is an ID code burned into each copy recorded using the ACD-R, allowing pirated CDs to be tracked to a specific recording unit.

Philips, which is aggressively trying to grow the CD-recorder market, is the first company to get to market with the digital equivalent of that old favorite, the dual-well cassette recorder. Their *CDR765* (\$649) features dual independent disc trays and offers double-speed disc-to-disc dubbing.

A standard-sized component, the *CDR765* features a center display with a CD drawer on each side. Each CD tray has its own set of the usual

OPEN/CLOSE, PLAY, PAUSE, STOP, PREVIOUS-TRACK, and NEXT-TRACK buttons. The front panel also provides controls, such as RECORD, ERASE, DUB, CD-SYNC, RECORDING LEVEL, and SOURCE, never before seen on standard CD players.

Those recording-control buttons, along with the full range of rear-panel connections, hint at the CDR765's versatility. Not only does it offer automatic synchronized recording and manual recording from one CD compartment to the other, it also allows you to digitally dub discs from other CD players or MiniDisc players, using its digital coaxial or optical inputs. Or you can record from tape or record players using the CDR765's analog inputs.

The CDR765 records on blank CD-Recordable (CD-R) discs, which can be recorded once, and CD-ReWritable (CD-RW) discs, which can be re-recorded over 1000 times. Although the ability to erase and re-record a disc is certainly attractive, CD-RW discs cost quite a bit more than CD-Rs (\$15 compared to \$4), and not every CD player is compatible with the CD-RW format. (All future Philips CD players will be CD-RW compatible, however.)

It might be a good idea to use a CD-RW for your first recording attempt. While making digital recordings is at least as easy as recording to cassette, mistakes are likely, until you're accustomed to the controls. After recording, you must finalize a disc to make it playable; once a CD-R disc is finalized, it can't be changed. That means you can't audibly "preview" your disc to make sure you like the way it sounds.

When dubbing from the CDR765's player deck to its recorder deck, you can copy an entire disc or a pre-selected program of tracks at double the normal playback speed, or you can copy single tracks or programs at normal speed. While the high-speed option is convenient (and quick!), be warned: The CDR765 inserts short pauses between tracks

on the recording, which can be disconcerting (or downright annoying) with some albums whose tracks run into one another. In normal speed, no pauses are added.

There are also several recording options when using external sources. With manual digital recording from a CD player, you can have track numbers inserted automatically, as they appear on the source material, or you can insert them manually. When using CD-Sync, track numbers are automatically input. Analog recordings from either cassette decks or record players also allow you to opt for manual or automatic track numbering.

The simplest operation of the CDR765 is to duplicate an entire disc—it can be done essentially with the push of a button. But why would you want

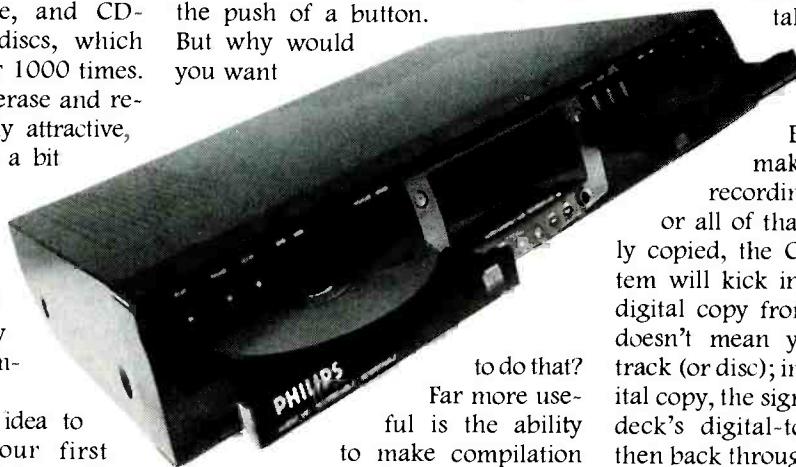

to do that? Far more useful is the ability to make compilation discs of favorite tracks from your CDs—it can almost obviate the need for a CD changer in your car, and it's great for mixing party music.

We must admit, though, that the CDR765 really proved its worth in making copies of some of our cherished LPs. Not just some of our Zappa or Janice Joplin records (which we could get on CD at retail, anyway) but some old Charlie Parker and Errol Garner LPs that are no longer available. Vinyl wears out. The CD copies should last through our lifetimes, and their fidelity should never diminish.

Before a newly recorded disc can be played, it must be finalized. With the completed disc in the CD recorder well, press FINALIZE and then RECORD. The display will indicate the

approximate time required for finalization (two minutes minimum). Although CD-Rs cannot be changed, CD-RW discs can be "unfinalized" to add more tracks or erase existing tracks.

The finalized results are, well, perfect—bit-for-bit, exact duplicates of the original recordings. It's not a matter of the listener's ear not being able to discern the difference; there is no difference. The CDR765 creates perfect digital clones via digital recording. That's because it has no sampling-rate converter. So, although it can't be used to make digital copies of MiniDisc or digital audio tape, it can make bit-perfect copies of CDs in all its digital dubbing modes.

In its analog recording mode, the CDR765's analog-to-digital converter makes excellent copies of LPs, tapes, and radio broadcasts.

By the way, if you're making a digital recording of a CD, and part or all of that disc was previously copied, the CDR765's SCMS system will kick in to prevent another digital copy from being made. That doesn't mean you can't copy that track (or disc); instead of a direct digital copy, the signal is fed through the deck's digital-to-analog converter, then back through its analog-to-digital converter. The resulting recording is not bit-perfect, but the imperfections caused by the dual conversions are barely, if at all, audible.

As a CD player, the CDR765 functions, in Philips' words, as a "dual-deck CD changer." You can listen to disc one followed by disc two, create programs of tunes from the two discs, or use random-play mode using the tracks on one or both discs. When used independently in the "dual-on" mode, you can route each individual output to a separate amplifier—for use in a second room, for example.

We enjoyed the speed and convenience of making duplicate discs using high-speed dubbing from deck one to deck two. It's a great way to add a favorite disc to your car CD changer, without removing it from

your home collection. But most of all, we liked being able to create our own digital mixes—something we used to do all the time in the heyday of audio cassettes and had truly missed in recent years.

As well as the CDR765 performed in its numerous dubbing modes, it really excelled in manual, track-by-track recordings. The process is a bit more time-consuming than automatic or CD-sync recordings. But you never had to deal with unwanted pauses between tracks—and, of course, there was no need to calculate time remaining per side like we used to do when making audio-cassette mixes.

Despite its popularity, we've always hated the cassette as much as we loved making our own compilation tapes. But now, with the CDR-765, we can make high-quality recordings with convenience. Home recording isn't dead—now, it's a whole new world.

Where in the World?

Hansel and Gretel found out the hard way that leaving a trail of bread crumbs behind them was not a reliable method of trail-marking. If only they'd had Magellan Corporation's *GPS 315* handheld navigator (\$150), they might never have had that unpleasant run-in with the witch.

The *GPS 315* is a pocket-sized device that can do a lot more than just lead you safely out of the woods. It uses the U.S. Government's Global Positioning System (GPS) to pinpoint your current location and provide directions to specified destinations.

The Global Positioning System is made up of 24 Navstar GPS satellites that continually transmit the precise time (using on-board atomic clocks) and their position in space as they orbit 12,000 miles above Earth. An Earth-based GPS receiver uses the information transmitted by several (at least three and as many as 12) satellites within their range to determine the precise location of the receiver. GPS triangulates signals from the satellites; knowing the location of those satellites and the time it takes a

radio signal to travel from the satellite, the receiver can calculate its position relative to the satellites, as well as how fast and in what direction the receiver is moving.

So, in its most basic configuration, a GPS receiver can reveal your position (latitude and longitude), serve as a compass, and act as a speedometer. Add to the *GPS 315* navigator Magellan's *DataSend* software (\$40) and interface cable (\$40), and the device can pull double duty as a handheld travel information device. Leave the travel guides at home; you can download right to the *GPS 315* information about points of interest on the way to, and at, your vacation spot.

We'll come back to those accessories later. Because even as a stand-alone unit, the *GPS 315* can provide a wealth of information. It can guide you to approximately 20,000 cities worldwide, as well as up to 500 locations that you input.

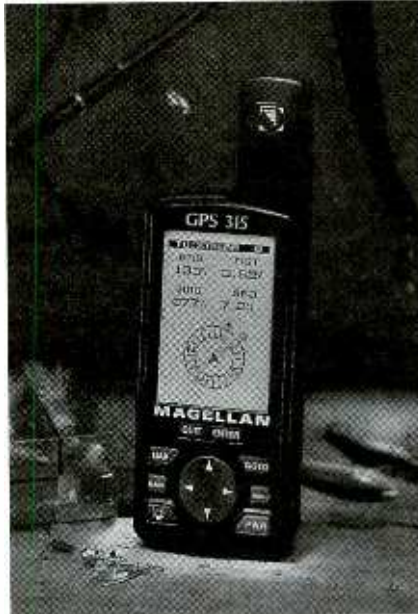

The *GPS 315* measures approximately $4\frac{1}{2} \times 2 \times 1\frac{1}{4}$ inches; a $\frac{7}{8}$ - \times $1\frac{1}{2}$ -inch rectangular quadrifilar antenna protrudes from the top of the unit. Most of the unit's face is taken up by its large LCD readout. The controls arrayed below the LCD include a four-direction cursor pad button surrounded by eight buttons

used to power up and down, activate the backlight, and "navigate" through the myriads of options provided by the receiver.

It takes some time to learn the back roads and trails within the *GPS 315* itself. The device offers so many different menu options and navigation screens, and it displays so much information on such a small readout (using plenty of abbreviations), that you can't simply pick it up and start using it. The manual contains almost 70 pages of instructions—"Getting Started" and "Basic Operation" fill more than 20 pages and are required reading. Scanning the glossary helps, too, unless you're already familiar with terms such as VMG ("Velocity made good; the component of the velocity that is in the direction of the destination") and COG ("Course over ground; the direction the receiver is moving, reported in true or magnetic north values"). Without learning the meaning of close to a dozen such cryptic abbreviations, you won't have a clue as to what is being displayed.

Before using the *GPS 315* for the first time, you must initialize it so that the unit can determine its location. The initialize screen automatically appears the first time the unit is powered up. You are prompted to enter the region, area, elevation, time, and date, and to select land or marine mode. (If your travels are mainly by sea, however, you'd be better served by the *GPS 320*, a nautical version of the *315*.) Then you must take the receiver outside to a spot where its antenna has a clear view of the sky. Heavy foliage or tall buildings can obstruct its line of sight to the satellites it seeks. You can watch the *315*'s progress on the status screen as it begins to gather information from the satellites. When it has computed a fixed position, the position screen comes up.

At this point, you have the option of creating your first landmark or "waypoint," which is simply a location stored in memory that can be used to create routes. Two presses of the MARK button store the waypoint with a name assigned by the receiver. It takes just a bit more time to assign

it a name of your choice.

Next, press the **GO TO** button, select a destination and a waypoint, and you're ready to begin using the GPS 315's navigation screens to plot your course. Nine different screens can be viewed by pressing the **NAV** button. You can scroll through them by pressing **QUIT**.

The status screen lets you know what's going on with the GPS 315. It displays an orbital map of the satellites whose signals are being received, has a chart depicting the signal strength and satellite numbers, and provides a battery-life indicator. The position screen shows the coordinates (latitude and longitude) of your last computed position, along with elevation, date, time, speed, distance traveled, and course. A compass is also provided. **Nav 1** shows your destination, a graphical compass, and your choice of four navigational fields—with options such as bearing, distance, course over ground, course to steer, estimated time of arrival, cross-track error, and velocity made good. **Nav 2** is similar, but leaves off the compass.

The compass screen shows a traditional, round pointer compass with a steering indicator showing the direction of travel. When the steering indicator and the **COG** (course over ground) indicator are aligned, you know you're on the right track. **Sun** and **Moon** indicators can also be used to chart your course, and four different navigational fields of your choice are displayed.

You can plot your course using the plot screen, a mini-map that shows where you have been and where you want to go. It allows you to view the active route, your current position, other waypoints along the course, and your destination. The **Pan-n-Scan** feature lets you look ahead or see a track history—view an electronic trail of bread crumbs, if you will.

The road screen, with an image resembling a road stretching out toward the horizon, displays your choice of four navigation fields and shows your position along the route chosen. The speed screen lets you

view a graphical speedometer, an odometer, and a trip odometer, along with the numerical bearing and speed over ground. A small round icon on the speedometer indicates average speed. Finally, the time screen depicts the current time (by the way, you must manually reset the clock for Daylight Savings changes), estimated time en route, time of arrival, and elapsed time.

Once you become accustomed to the various icons, terms, and abbreviations, it isn't too difficult to use the GPS 315 to find your way. Whether you're in the wilderness, on the highway, or in the suburbs, the basic technique is the same. Tell the device where you want to go (give it a destination waypoint), and each of its screens, in its own unique way, will help point the way there. To help you recall the finer points of handheld navigation, Magellan enclosed a handy little reference card detailing how to create a waypoint or route, reverse a route, and activate a **GoTo**.

You can add as many as 500 of your own waypoints, in addition to the thousands of cities already programmed. The GPS 315 can be further customized using *DataSend* software. Say you're headed for a camping/hiking trip in the Smoky Mountains. You can use your PC to upload waypoints—here they're called **Points of Interest** or **POIs**—within that geographical area. The program includes more than 500,000 **POIs** arranged in 37 different categories. The GPS 315 can hold up to 19,820 **POIs** from ten different categories at one time. Categories are geared toward travelers and outdoor activities, and include airports, campgrounds, sports arenas, diving and snorkeling, car repair, marinas, hotels and lodging, **ATMs**, parks, museums, and tourist attractions. It's nice to know that after emerging filthy, hungry, and tired from a week in the wilderness, you can quickly find a place to wash up, a restaurant, a clean bed—and an **ATM** to pay for it all. After your trip, you can delete the customized **POIs** to clear the memory for your next vacation.

Once you've got the hang of the

GPS 315's basic functions (all that we've been describing so far), if you're feeling exceptionally ambitious you might want to learn some of its intricacies. Here's where you begin to create multi-leg or back-track routes, or change a leg of a trip.

The GPS also offers a couple of neat, not-very-complex auxiliary functions—**Sun/Moon** and **Fish/Hunt**. **Sun/Moon** provides the solar and lunar information including time of sunrise and sunset, and moonrise and moonset, for the present location. It also shows a graphic depiction of the current phase of the moon. The **Fish/Hunt** shows the best times of day and night for fishing and hunting in your location (never mind that here in the suburbs the closest we get to "game" are squirrels and geese!)

The GPS 315 offers an interesting assortment of features. The device is definitely targeted primarily at the combination outdoor enthusiast/high-tech geek (an ever-increasing segment of the gadgetry market). But the addition of the *DataSend* CD-ROM means that the 315 can work for the back-seat driver, too. You might want to find your way back to that favorite fishing spot from last summer's camping trip. Your significant other might prefer finding the nearest **ATM** on the way to the mall. If you're willing to take the time to learn how to use it, Magellan's GPS 315 can do it all.

People Power!

We make a concerted effort to keep a supply of batteries in the house in case of emergency. If the power goes out during a hurricane, for instance, we want to be able to listen to storm reports on the battery-operated radio and have a couple of working flashlights on hand to supplement the flickering light cast by candles.

Perhaps it's due to our line of work, or maybe we have an inherent streak of unpreparedness (despite all those years of scouting). But, whatever the reason, we never can find a battery when we really need one.

So you can imagine our delight in

Clock + Radio = Model 88



disk. Turning the handle activates the Freeplay's Personal Power Generation technology, which according to BayGen, "is based upon energizing a textured carbon steel spring by winding it from one spool to the other. As the spring returns to its original position, the spring releases energy and applies a rotational torque into a transmission. The transmission consists of

a gearbox that drives a direct current generator to provide the energy for the radio receiver."

As the radio plays, you can watch the gears spinning around inside. When it runs out of steam, the signal stops abruptly. That's your cue to give the handle a few more cranks and get the radio powered up again.

Do you like to listen to the ball game while you're washing the car or weeding the garden? You might not even have to turn the crank—the solar panel mounted on the top of the radio should supply enough power to keep it operational. And if you're out camping or boating, you never need to remember to pack extra batteries. (Although we wouldn't choose to take along the Freeplay on any backwoods camping trips—its size and weight limit it to car-camping.)

This is not a radio you'll choose for discriminating music listening. It doesn't provide hi-fi stereo sound. But it's great for casual outdoor listening, and, in an emergency, who cares about hi-fi sound?

Of course, the ideal situation for using the Freeplay radio is during a power failure. You won't have to search through junk drawers in the dark for your spare batteries. You'll know that your radio will work, any time, any place.

We find that sort of self-sufficiency quite appealing. In fact, we're thinking of getting BayGen's people-powered lantern, as well as the Freeplay radio, to keep us in the light and in the know during next hurricane season!

finding a radio that is not dependent upon either batteries or AC power. The *Freeplay Solar Assisted Radio* (\$79.95) from BayGen Power USA runs, instead, on people power—with, as its name suggests, a healthy assist from the sun.

The Freeplay *Model FPR2SC* is a portable radio in the somewhat hefty old-fashioned sense. It measures 8 inches high by 11.5 inches long by 8 inches deep, and weighs in at 5½ pounds (without batteries, of course!). It doesn't offer stereo sound, let alone simulated surround sound or any other processed modes. It doesn't even offer digital tuning.

Half of its front panel is covered by a large speaker grille, the other side is home to the radio dial, on/off switch, and tuning and volume knobs. There's an AM/FM slide selector on the side, and that's it as far as controls go.

Further setting the Freeplay apart from other portable radios, old fashioned or modern, is its transparent plastic case. You can see all the inner workings of the radio, including its built-in Freeplay Generator.

That generator is what truly puts the Freeplay in a class of its own. The spring-powered mechanism transforms 30 seconds of turning a handle into up to an hour of listening time. Remember (or perhaps you've only seen pictures of) those old wind-up Victrolas? Well, here's a way to get cranking into the new century!

The crank is found on the back of the unit. A handle flips out from a 3fi-inch diameter, 1-inch deep black

When we auditioned the Model 88 table radio from Cambridge Sound-Works, (*Gizmo*, April 1999), we were quite pleased with its performance. We did find it a bit odd, however, that although the unit looked like a clock radio, it did not actually include a clock. There was a "sound" reason for the omission: Designer Henry Kloss intended the Model 88 to be placed across the room from the listener, not off to the side on a night table. We mentioned that the company planned to sell a combination remote control/clock as an accessory to the radio—well, it's arrived.

Dubbed the *Control Clock 88* (49.99), the device (like the Model 88 itself) is a fine example of function over form. The 3½" × 2¾" × 1¾" inch box has a digital clock on its front panel and an array of dual-alarm and radio control buttons on its top. A small cylinder, looking like a tank turret protruding from the top, houses the infrared remote-control emitter. The cylinder swivels almost 360 degrees, allowing you to aim the IR signals. The Control Clock runs on AC power; a 9-volt battery (included) protects time and memory settings in the event of a power outage.

Because the Model 88, on its own, does not serve as an alarm clock, our unit has been as residing in our "hobby room." We placed it, as directed, across the room from our worktable; the tiny remote rests safely on a shelf above all the clutter of the table. Although the addition of the Control Clock 88 effectively transforms the Model 88 into a clock radio for use in the bedroom, we chose to leave the radio in its place and just replace the remote with the Control Clock 88.

Basic setup consisted of plugging in the clock, inserting the battery, and setting the time by holding down the set button and scrolling through the displayed time until we reached the current time.

We immediately discovered that we had mixed feelings about having a clock over our worktable. Yes, it's



Clock 88 to bring us back to the real world. We could set one of its dual alarms to ring when it was time to pick up our son at school, for instance. We also discovered how handy the radio-wakeup function could be even when we were awake. We could set the radio to come on to WABC at game time and never missed the first inning of the Yankees games, as we tend to do

immediately apparent. It allows you to keep the clock facing the bed and to have the emitter facing the radio placed atop a dresser or shelf located anywhere else in the room.

The dual alarms are more than a convenience to any dual-career couples with different work hours. The sleep delay allows you to fall asleep listening to your favorite station and have the radio turn off after a specified period of time. You can opt to be awakened by a tone, by your choice of radio station, or both. You can even program each alarm to tune in a different station. Here, the Model 88 plus clock got put to everyday use as a clock, a radio, and a clock-radio.

Just as the Model 88 “does just what it’s supposed to do and does it well,” so does the Control Clock 88.

good to have some idea of how much time passes when we’re engrossed in a project. On the other hand, bursts of creativity do not appreciate reminders of the hours that are ticking away.

Knowing that we tend to lose track of time when we’re in the midst of a project, we soon relied on the Control

ordinarily—a great feature.

Other than those two circumstances, however, we found ourselves using the little handheld remote more often than the box-top controls on the clock. So we decided to try out the Control Clock in its intended environs—the bedroom. The reason for the swiveling IR emitter became

GIZMO NEWS

Home Networking Approaches

The Home Radio Frequency (HomeRF) Working Group—consisting of more than 90 companies spanning the PC and peripheral, consumer-electronic, networking, communications, software, retail-channel, home-control, and semiconductor industries—announced in June that several member companies expect to have products based on the Shared Wireless Access Protocol (SWAP) on the market by this winter.

The SWAP specification provides an open platform that enables a broad range of interoperable consumer devices for wireless voice and data communications in the home. “The broad industry support that the HomeRF Group has garnered has allowed us to rapidly move the SWAP specifications to the point where these companies can begin delivering end-user products,” said Intel’s Ben Manny, chairman of the HomeRF Working Group. “We envision that these first products are simply the initial step in enabling the flexibility and mobility that consumers expect,

MANUFACTURERS

Atlantic Technology
343 Vanderbilt Avenue
Norwood, MA 02062
781-762-6300

www.atlantictchnology.com

CIRCLE 100 ON FREE INFORMATION CARD

BayGen Power Group
80 Amity Road
Warwick, NY 10990
800-WIND-234

www.freeplay.net

CIRCLE 101 ON FREE INFORMATION CARD

Blaupunkt
Robert Bosch Corporation
2800 South 25th Avenue
Broadview, IL 60153
800-950-BLAU

www.blaupunkt.com

CIRCLE 102 ON FREE INFORMATION CARD

Bose Corporation
The Mountain
Framingham, MA 01701-9168
800-444-BOSE

www.bose.com

CIRCLE 103 ON FREE INFORMATION CARD

Cambridge SoundWorks Inc.
311 Needham Street
Newton, MA 02164
800-367-4434

www.hifi.com

CIRCLE 104 ON FREE INFORMATION CARD

Magellan Corporation
960 Overland Court
San Dimas, CA 91773
909-394-5000

www.magellangps.com

CIRCLE 105 ON FREE INFORMATION CARD

Phillips Electronics
64 Perimeter Center E
Atlanta, GA 30346
800-531-0039

www.philips.com

CIRCLE 106 ON FREE INFORMATION CARD

Sony Electronics Inc.
1 Sony Drive
Park Ridge, NJ 07656-8002
800-222-SONY

www.sony.com/electronics

CIRCLE 107 ON FREE INFORMATION CARD

and demand, for delivering Internet access and next-generation cordless telephony service anywhere in the home or yard."

Proxim, which had earlier announced a technology relationship with Intel to develop wireless home-networking products based on the SWAP specification, recently announced a partnership with Motorola to produce integrated wireless networking products for high-speed Internet access in the home or small office. Proxim was the first company to announce specific SWAP product plans. At PC Expo, the company exhibited prototypes of the new Symphony Cordless Networking Suite, including a cordless USB adapter for desktop computers, a new cordless PC card for notebook computers, and a cordless miniature module for integrating radio into products such as broadband Internet gateways. The new SWAP 1.1-based products will carry the moniker "Harmony" and will be compatible with the company's current Symphony product family and other OpenAir wireless LAN devices.

SWAP-compliant products operate in the license-free 2.4-GHz frequency band and use frequency-hopping spread-spectrum RF technology for secure and robust wireless communications. The SWAP 1.1 update was implemented by the HomeRF Group in an effort to reduce production costs and speed product availability. Several low-level technical changes were made that allow companies to take advantage of existing technologies.

"Reducing or eliminating standards conflicts is very important in the home-networking market," noted Van Baker, director of Consumer Market Research at Gartner Group. "This strategy will allow the home-networking market to grow faster, without interruption, and will keep consumers confident that the products they buy today will continue to be viable solutions for the future, as they can interoperate with next-generation products."

Through SWAP, consumer electronics and home appliances in and around

the home will contain wireless technology that allows them to "talk" to each other and share the resources of the connected PC without being tethered to the existing wiring and wall outlets in the home. For instance, a mobile display pad linked to the Internet could access recipe information in the kitchen, be taken out to the yard to provide gardening tips, and be used in the garage to assist in do-it-yourself auto maintenance.

All-Digital Phantom Menace

As lucky *Star Wars* fans at four select theaters were treated to fully digital screenings of *Episode I: The Phantom Menace* in mid-June, debates raged in the industry over the very future of movies as we know them. Digital Cinema could change the entire film industry by, well, getting rid of the film part. Movies that are shot and stored in a digital format could then be shipped to theaters via satellite, phone lines, fiber optics, or the Internet. Although digital movies would offer consistent quality; last longer than film; and be immune to the scratches, marks, and faded colors that plague today's films; there are several obstacles on the road to digital cinema. There is no consensus on projection, compression, and encryption technologies; and no one can predict the ways in which digital technology might change the artistry of cinema. No one has determined who will cover the cost of switching to digital cinema, and standards have not been created.

The collaboration between Lucasfilm, CineComm Digital Cinema, and Texas Instruments (TI), and the use of the popular *Star Wars* prequel puts the digital debate out in the public arena. Lucasfilm has created a new, digital version of its THX cinema specification, and George Lucas hopes to implement the technology in *Episodes II* and *III*. TI and CineComm are working separately; each company will supply two theaters with its own projectors.

Texas Instruments' digital light projection (DLP) technology uses digital micromirror devices (DMDs). There are 1,300,000 tiny mirrors embedded on a silicon chip that uses electrical current to turn each mirror on or off. Three such chips—for red, green, and blue—will display an image with SXGA resolution (1280 × 1024 pixels).

CineComm is working with Hughes and JVC and their Image-Light Amplifier (ILA) technology. ILA uses a 0.9-inch CMOS device consisting of silicon transistors and a reflective surface. CineComm plans to provide satellite delivery of digital films to theaters. It claims that ILA-based projectors can deliver 1365 × 1024-pixel resolution and generate 1000 lumens of light intensity.

May the Force be with them.

Grammy-Winning Game Soundtracks?

Do you find yourself humming a song all day long, and finally you can identify it as the soundtrack to your favorite videogame? Well, you're not the only one who finds some of those tunes catchy. The folks at the National Academy of Recording Arts & Sciences have decided to open the doors a little wider on Grammy night 2000, allowing "other visual media" to compete in the same category as movies and television. That means music written for video games, be they console or PC based, will achieve a higher level of mainstream acceptance—as long as the music is also out on an audio CD. (Just think how happy parents will be to hear those songs coming from the stereo as well as the Nintendo!) 

Don't lose sight of Glaucoma.

IE NATIONAL EYE HEALTH EDUCATION PROGRAM

National Eye Institute, National Institutes of Health, Public Health Service, U.S. Department of Health and Human Services

ELECTRONICS LIBRARY

UNDERSTANDING AUTOMOTIVE ELECTRONICS: FIFTH EDITION

by William B. Ribbens

In today's cars, the electronic systems are more complex than simple electrical wiring. This extensive revision of the popular fourth edition provides an overview of basic automotive and electronic systems.

Suitable for automotive technicians, students, or enthusiasts, this practical text helps readers understand how automobile electronics really work. The most recent technological advances in operation and troubleshooting of electronic systems and components are covered, including onboard diagnostics and communications, digital instrumentation, and digital engine control, as well as a discussion of the ultra-low emission vehicle regulations.

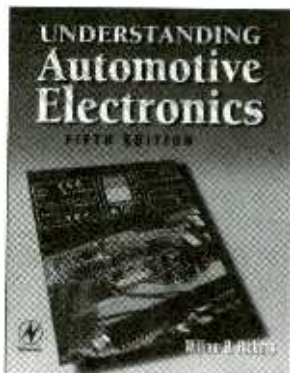

Understanding Automotive Electronics: Fifth Edition costs \$29.95 and is published by Newnes, Butterworth Heinemann, 225 Wildwood Avenue, Woburn, MA 01801; Tel. 800-366-2665 or 781-904 2500; Web: www.bh.com/newnes.

STICHT PURCHASING GUIDE from Herman H. Sticht Co. Inc.

This 80-page black and white catalog covers tachometers, insulation testers, electrical testers, and repair and calibration service. It briefly describes the more popular models that are offered. Brand names include AEMC, A. W. Sperry, Amprobe Instrument, B&K

Precision, Fluke, Simpson, Standco, Sticht, TIF Instruments, Triplett, Wavetek, and Yokogawa.



The products, all arranged by manufacturer, are each accompanied by a photograph and complete specs. Featured products include the Fluke Scopemeter B Test Tool, Sticht surface-speed indicators and 4¹/₂-inch contactless meter controllers, and AEMC megohmmeters and ground resistance testers.

The Sticht Purchasing Guide is free upon request from Herman H. Sticht Co. Inc., 57 Front Street, Brooklyn, NY 11201; Tel. 800-221-3203 or 718-852-7602; Web: www.sticht.com.

ARRL's TECH Q&A: YOUR QUICK & EASY PATH TO A TECHNICIAN HAM LICENSE by Larry Wolfgang

This quick and easy-to-use study guide helps novice hams earn their Technician Amateur Radio licenses. Every question in the Novice (Element 2) and Technician (Element 3A) question pools—everything needed to pass the license tests—is covered in this handbook. The

BooksNow To order books in this magazine or, any book in print. Please call anytime day or night: (800) BOOKS-NOW (266-5766) or (801) 261-1187 ask for ext. 1456 or visit on the web at <http://www.BooksNow.com/popular-electronics.htm>.

Free catalogs are *not* available.

Element 2 exam consists of 35 questions and Element 3A consists of 30 questions—all about Amateur Radio rules, theory, and practice.



For each of these exam elements, novices have to know some basic electronics theory and Amateur Radio operating practices and procedures. In addition, those taking the test will need to learn some of the rules and regulations governing the Amateur Service, as contained in Part 97 of Title 47 of the Code of Federal Regulations (CFR)—the FCC rules. Brief explanations help readers understand the correct answer to each question.

The ARRL's Tech Q&A: Your Quick & Easy Path to a Technician Ham License costs \$12.95 and is published by American Radio Relay League, 225 Main Street, Newington, CT 06111-1494; Tel. 888-277-5289 or 860-594-0200; Web: www.arrl.org.

TROUBLESHOOTING & REPAIRING VCRs: 3rd EDITION by Gordon McComb

VCRs contain a lot of high-tech circuitry and moving parts, but it's possible to keep the equipment in top-notch condition without being an electronics whiz. Most problems can be fixed by hobbyists. This hands-on VCR repair manual shows readers how to fix such things as dirty switch contacts, old and worn rubber belts and rollers, broken

(Continued on page 87)

Plasma Saber

Banish the force of darkness with this glowing-light foil and learn about portable high-voltage power sources.

At any given moment, half our planet is engulfed in the dark side. While there may not be any evil forces trying to conquer or take us over by force, here's a fun and exciting way to defeat the darkness ... a way to wave cohesive light before you as you move through the night.

While it may not turn you into a mystical warrior, the *Plasma Saber* described in this article is an educational and enjoyable project. As you build this handheld high-voltage source, you'll be learning by doing. As you swing the glowing neon blade of your Saber, you'll be the envy of everyone on your block, be they sci-fi fans or not.

Circuit Operation. A schematic diagram of the Plasma Saber is shown in Fig. 1. The circuit is comprised of three transistors (Q1-Q3), a custom-wound transformer (T1), and a few support components. Together those components form a high-frequency, high-voltage power supply that's capable of driving a neon-plasma display, discharge tube (NE1).

Note that the circuit contains four batteries: A pair of parallel-connected 9-volt batteries (B1 and B2) are wired in series with a couple of series-connected 1.5-volt AA batteries (B3 and B4). Batteries B3 and B4 are required only when a red neon tube is used for NE1; otherwise, those batteries must be eliminated during construction. Power from the batteries is applied directly to the collector of Q2 and, via the R1/C1 parallel combination, to the base of Q1. As long as the touch contacts remain unbridged, a positive voltage is applied to the base of Q1, a PN2907 PNP bipolar

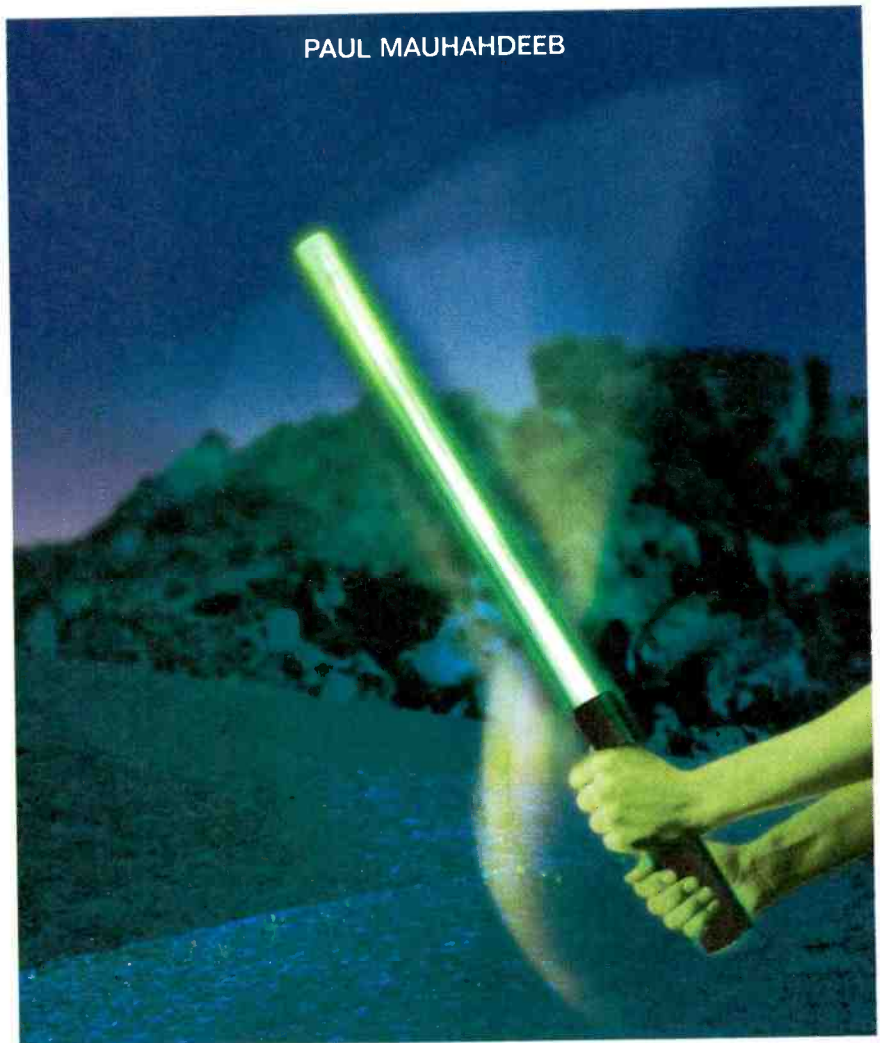

PAUL MAUHAIDEEB

transistor, keeping Q1 biased at cutoff.

However, when the two touch contacts are bridged (by the user through hand contact), the bias voltage appearing at the base of Q1 is pulled low. (Recall that in order for a bipolar PNP transistor to conduct, its collector must be more negative than its base, and its base more negative than its emitter.) **Note:** The amount of bias applied to the base of Q1 depends on the user's skin resistance.

With Q1's base pulled low, it begins to conduct, feeding a variable current ramp to the base of Q2 (an NPN unit whose turn-on cri-

teria is the opposite to that of the PNP unit). That causes Q2 to turn on, feeding a ramp current to the collector of Q3—which is configured as a modified Hartley oscillator—through the primary winding of transformer T1.

The Hartley oscillator—used rather extensively in AM and FM radio receivers—is a form of variable-frequency oscillator (VFO), whose operating frequency is usually determined by a parallel combination of inductance and capacitance (tank circuit) in the feedback loop. However, our version of the Hartley oscillator uses an auxiliary winding of T1 in conjunction

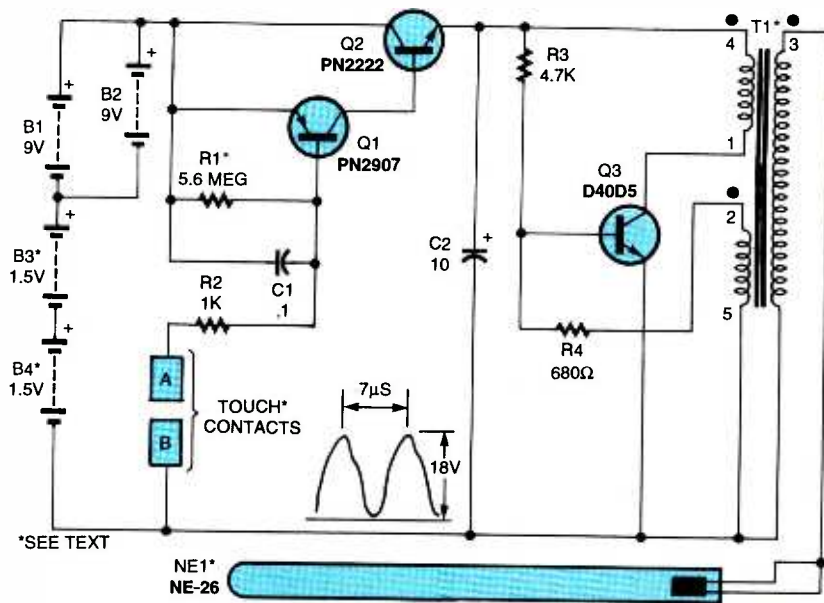

Fig. 1. The Plasma Saber is a rather simple circuit comprised of three transistors (Q1-Q3), a custom-wound transformer (T1), and a few support components—which form a high-frequency, high-voltage plasma-power source—coupled with a neon plasma-display discharge tube (NE1).

ment values may vary from that specified. That is acceptable, since all of the components used in the Saber have a tolerance of 10 to 20%, unless otherwise noted.

Begin board assembly by installing all the passive components (with the exception of the transformer) on the printed-circuit board first, followed by the solid-state devices. **Note:** All board-mounted components should be mounted slightly elevated (about 1/8 to 1/4 inch) above the board surface. Be sure to observe the proper orientation of the polarized components—C2 and Q1-Q3. After each component is soldered in place, cut away any excess lead length.

Now we come to the installation of T1. If you've purchased a kit of parts or the transformer (only) from the kit supplier listed in the Parts List, install the unit as outlined in this paragraph. If, on the other hand, you intend to wind your own transformer, follow the coil-winding instructions given in the next paragraph and mount the unit as outlined here. Secure the body of T1 (a tubular custom-made high-frequency unit) to the board with tape, and then connect the transformer to the appropriate circuit board pads using short lengths of buss wire, as shown in Fig. 3. Note from the pinout diagram (shown below T1 in the parts-placement diagram) that T1 is mounted with pins 1 and 5 toward the surface of the board.

Figure 4 gives details for custom winding your own transformer. The transformer was fabricated by bifilar winding 10 turns of 26 AWG and 10 turns of 28 AWG wire on a tubular type TC75D-I coil form, leaving a little extra wire length for connection to the terminal pins of the coil form. After winding them, secure the coils in place with a piece of

with R4 to form a properly phased feedback network, through which a drive signal is delivered to the base of Q3. That signal causes the Hartley to oscillate at a frequency—determined by the resonant frequency of the inductance (the auxiliary winding of T1) in the feedback loop—of approximately 200 kHz. The rising and collapsing field created in the primary windings of T1 generates an alternating high-voltage output (approximately 6kV) in T1's secondary winding that is fed to NE1, causing it to glow.

No on/off switch is necessary since total power is controlled by the user's skin contact. **Note:** A dry hand may require a tighter grip where a damp hand requires only a light touch to achieve full plasma ignition. Capacitor C1 is included in the circuit to bypass any external signals that could potentially cause premature operation, while R2 sets the sensitivity range of the circuit.

Electronic Construction. The majority of the electronic components for the Plasma Saber were assembled on a small printed-circuit board, measuring 2 3/4 by 5/8 inches. A full-size template of that printed-circuit foil pattern is shown in Fig. 2 for those who prefer to etch their own printed-circuit boards. For those not

so inclined, a complete kit of parts, as well as selected Plasma Saber components and pre-assembled units, is available from the supplier listed in the Parts List. Table 1 lists kit, selected components, and assembled unit prices (contact the supplier for further information).

For ease of construction, the Plasma Saber was assembled in two parts—the display and power sections. The Saber was assembled so that should the plasma discharge tube become broken or damaged, it can easily be replaced. The two-section assembly scheme also allows the plasma tube to be replaced should the builder decide to change the display colors (recall the need for batteries B3 and B4 if a red tube is used). The display section of the device can consist of a 12- to 36-inch length of small-diameter neon or other gas tube.

Regardless of which route you take, once you've obtained all of the parts listed in the Parts List, construction can begin. Assemble the project guided by the parts-placement diagram shown in Fig. 3. Note that if you are building the unit from a kit, some of the compo-

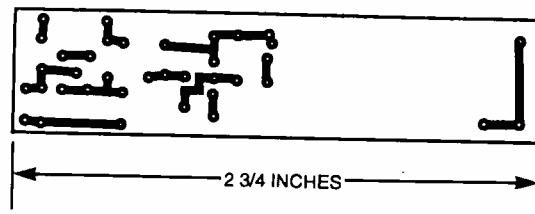

Fig. 2. The majority of the electronic components for the Saber were assembled on a small printed-circuit board, measuring 2 3/4 by 5/8 inches. A full-size template of the printed-circuit foil pattern is shown here for those who prefer to "roll their own."

TABLE 1—PRICE LIST FOR SINGLE AND MULTIPLE PLASMA TUBE PURCHASES

PART	LIST	10-24	25-99	100-249	250-499	500-999	1000+
26-inch Plasma Tubes NE26B Photon Blue NE26R Neon Red NE26P Starfire Purple NE26G Phaser Green	\$24.95	\$12.95	\$11.95	\$10.95	\$9.95	\$8.96	Large Volume Pricing Available
36-inch Plasma Tubes NE36B Photon blue NE36R Neon Red NE36P Starfire Purple NE36G Phaser Green	\$39.95	\$19.96	\$16.95	\$15.95	\$14.95	\$13.95	Ditto
Assembled and Tested Control Module PFS3E	\$24.95	\$20.96	\$16.95	\$13.95	\$12.95	\$11.95	Ditto
Assembled Units PFS360 36-inch Discharge PFS260 26-inch Discharge PFS120 16-inch Dagger!	\$149.95 \$99.95 \$59.95						
Kit and Plans PFS36K 36-inch Discharge PFS26K 26-inch Discharge PFS12K 16-inch Dagger!	\$79.95 \$69.96 \$29.95						
Above Kits with Assembled Electronics PFS36EK 36-inch Discharge PFS26EK 26-inch Discharge PFS12EK 16-inch Dagger!	\$99.95 \$79.95 \$49.95						

electrical tape. Using a multimeter, identify the ends of the 26 AWG wire and connect them to the coil form (which has numbered terminal pins), as shown in Fig. 4. Follow that by winding 1350 turns of 38

AWG wire for the secondary winding on top of the bifilar-wound coils. Connect the bottom end of the secondary winding to pin 5 of the coil form, mating it with the lower end of the second (auxiliary) pri-

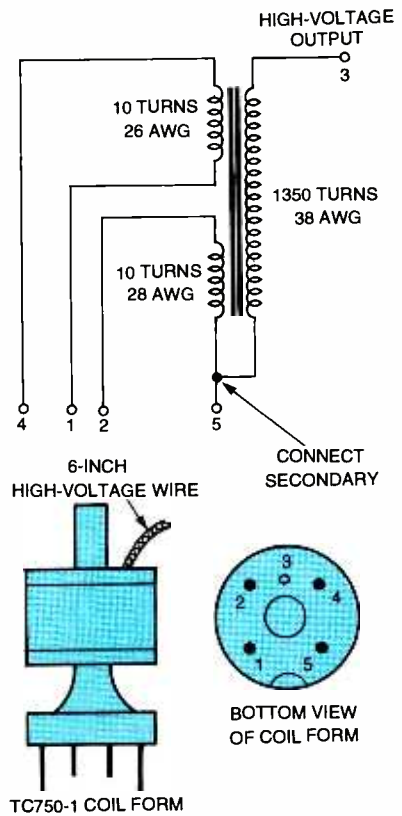

Fig. 4. Details for custom winding your own transformer are given here. The primary windings of the transformer was fabricated by bifilar winding 10 turns of 26 AWG and 10 turns of 28 AWG wire on a tubular type TC750-D coil form and securing the coils in place with a piece of electrical tape. The secondary is comprised of 1350 turn of 38 AWG wire wound on top of the bifilar-wound coils.

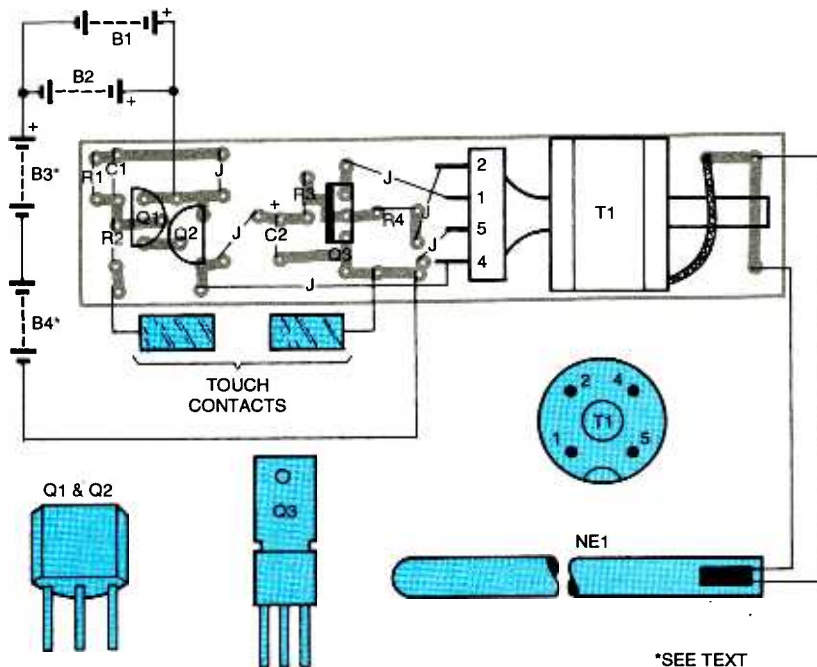

Fig. 3. Assemble the Plasma Saber guided by this parts-placement diagram. Note that if you are building the unit from a kit, the actual value of some parts may deviate somewhat from their specified values. That is acceptable since all the components used in the Saber have a tolerance of 10 to 20%, unless otherwise noted.

mary winding. **Note:** The other end of the secondary winding does not connect to a coil-form pin, but instead connects to an insulated wire lead that is brought out through the rear (stud) end of the coil. Cover the entire assembly in tape to hold the assembly together.

Attach leads for the batteries (B1 and B2)—the leads are more easily attached to the actual foil runs on the foil side of board. Solder 11-inch lengths of wire to the appropriate pads on the printed-circuit board for connection to the touch terminals on the handle. Check for accuracy, quality of solder joints, potential shorts, etc. Once you are satisfied that the printed-circuit portion of the project contains no construction defects, put the assembly to the side and begin preparing the display portion of the circuit.

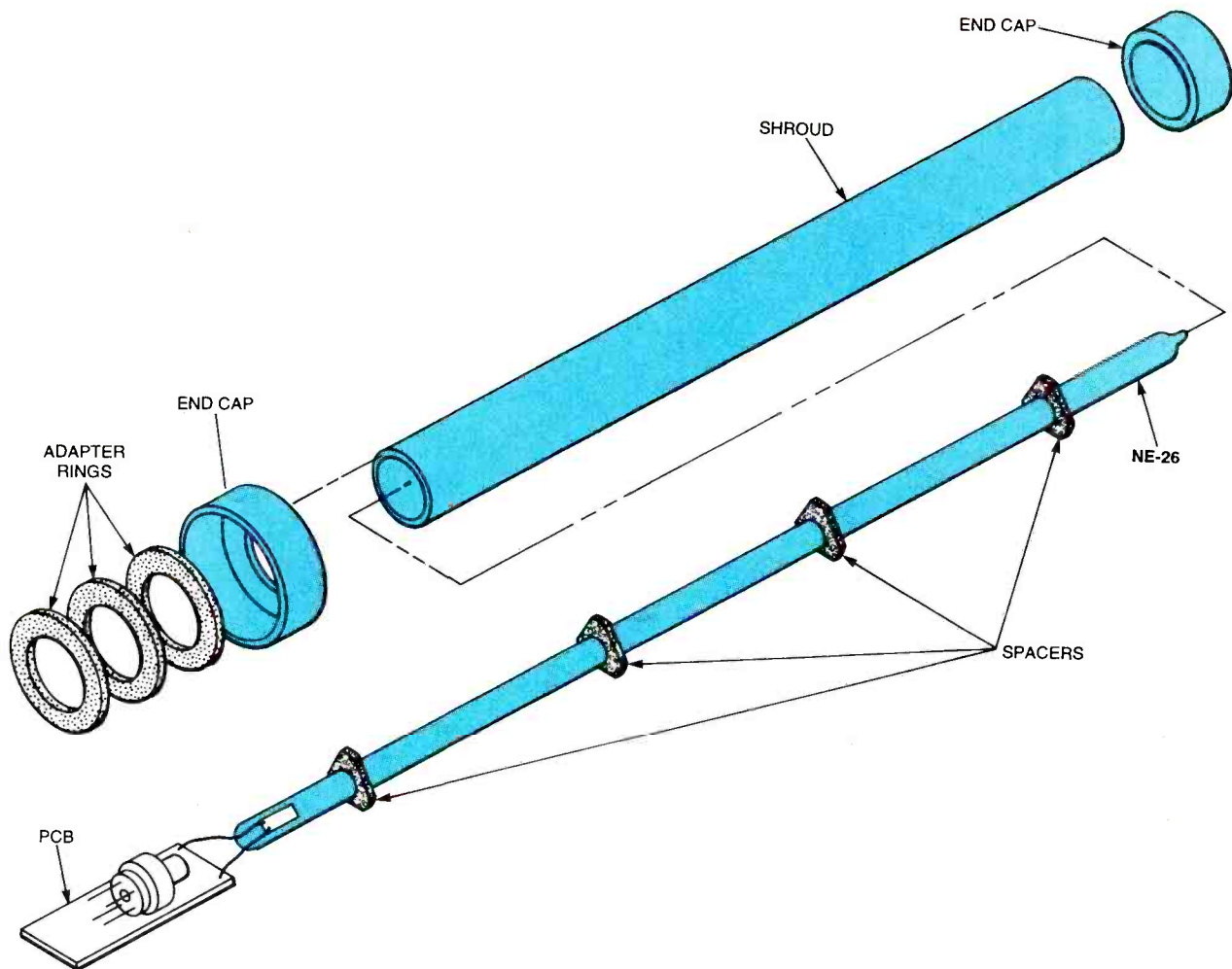

Fig. 5. If building the Saber from scratch, cut some 1-inch diameter, clear, ridged plastic tubing—which will serve as a shroud—to a length of 29½-inches as shown here. Then fabricate four spacer rings from a sheet of clear flexible ⅛-inch vinyl and three adapter rings from ⅛-inch thick Lexan.

Mechanical Assembly. The display portion of the Plasma Saber is comprised of the neon display tube and a clear plastic shroud, with a few additional items thrown in for good measure. Although the following instructions assume you are building the 26-inch version, all procedures described herein also relate to the other Saber display sizes. In any event, begin construction by cutting a 29½-inch length of 1-inch clear plastic tube, which will serve as a shroud (see Fig. 5), and then flush up and debur the ends.

After that, fabricate four spacer rings from a sheet of clear flexible ⅛-inch vinyl as shown. The spacers were manufactured by cutting ⅞-inch diameter circles, punching ⅜-inch holes in their centers, and then cutting them to a triangular shape, as shown in Fig. 5. The center holes

of the spacers should fit snugly onto the neon tube, while the outer diameter of the spacers should provide reasonable friction to the inner walls of the shroud tube. The spacers—which should be mounted to the NE-26 display tube as shown in Fig. 5—help to center and hold the neon tube inside the plastic shroud, while simultaneously offering some small degree of shock protection in case the unit is mishandled. Note that other materials can be used to manufacture the shroud.

Next, fabricate three adapter rings, as shown in Fig. 5, from ⅛-inch thick Lexan by cutting three 1½-inch circles and punching a 1-inch hole in the center of each circular piece of Lexan. The outside diameter of the spacers must fit snugly into the handle of the Saber. The

adapter rings should be positioned and glued to the shroud tube as shown in Fig. 5. Prepare a plastic end cap by drilling a centered 1-inch hole in it, and then put it in position on the shroud assembly.

Follow that by fabricating a handle from a 10-inch length of 1½-inch (diameter) × ⅛-inch (wall thickness) rigid PVC tubing or equivalent material. Start this operation by drilling two small ⅛-inch holes in the handle (as shown in Fig. 6), through which the contact terminals that will mount directly to the printed-circuit board are connected to the neon tube assembly with spacer rings. **Note:** The positioning of the contact terminals isn't critical and should be placed to suit user preference.

Final Assembly. Insert the NE-26 tube assembly with spacer rings

Times Are Tough...



Today's headlines scream of the lack of qualified individuals to fill new and existing high-tech job openings. If you feel the robust economy is passing you by, there is something you can do about it. **Become CIE Qualified.** Since 1934, The Cleveland Institute of Electronics has been providing its students with the necessary technical and academic credentials employers are seeking. In fact, CIE was started in 1934 to fill a similar void in the radio/television industry.

Since then, CIE boasts of over 150,000 worldwide graduates who have benefited from a patented, independent-study program that lets the student complete a Career Course, Associate Degree program, or through our affiliate school

World College, a Bachelor Degree program.

If you are currently "under-employed" and want to increase your level of income, the most proven method is an education. With CIE's independent-study program you study when and where you wish with no time constraints on how quickly you can proceed. And though it is an independent-study program you have the full support of the faculty and staff at CIE's Cleveland Campus.

To discover all the Benefits, Career Courses and Degree Programs available from CIE send for your Free Course Catalog Today!

The Cleveland Institute of Electronics has been approved for the training of eligible veterans and active duty military service members, under the G.I. Bill. Military tuition assistance (Up-Front and Basic) is also available under the DANTES Distance Learning Program.

...For Employers



BUSINESS NEWS
Employers Searching For
Qualified Candidates

F R E E C A T A L O G



Cleveland Institute of Electronics
1776 E. 17th Street
Cleveland, Ohio 44114-3679
Visit Our Web-Site: www.cie-wc.edu

*A School of Thousands.
A Class of One. Since 1934.*

YES! Please send me a catalog. AH142

Name: _____

Address: _____

City: _____ State: _____ Zip: _____

Phone Number: _____

Check Box for a Bulletin on Military Education Benefits:

VA Benefits DANTES Benefits

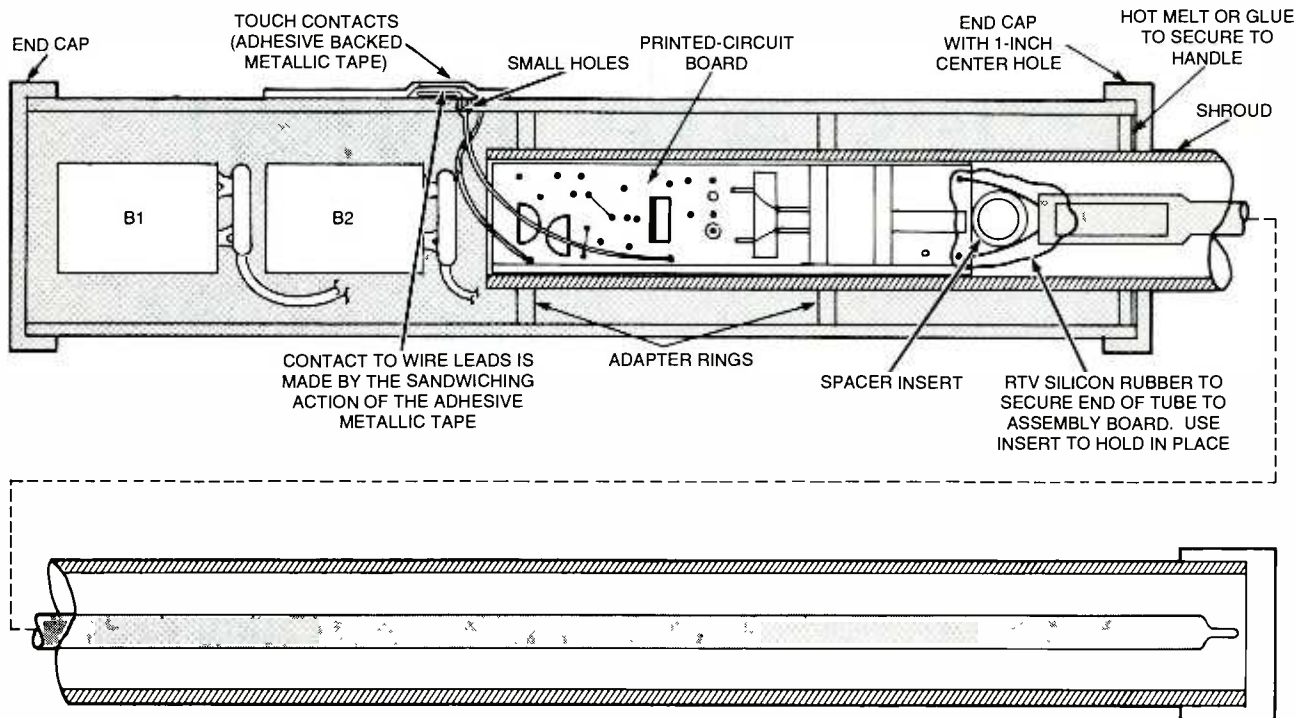

Fig. 6. The handle for the Saber was fabricated from a 10-inch length of 1½-inch (diameter) × ⅛-inch (wall thickness) rigid PVC tubing. After cutting the handle to length, two ⅛-inch holes were drilled in the handle tubing through which the contact terminals are connected to the printed-circuit board.

and assembled printed-circuit board into the shroud as shown in Fig 7. **Note:** It may help to moisten the inner walls of the shroud by deeply exhaling into one end and quickly inserting the neon tube assembly to form the "blade" portion of the Saber.

Insert the blade portion of the Saber into the handle with the forward adapter ring (the one closest to blade end) recessed approximately ¼ inch into the handle, as shown in Fig 6. Liberally apply hot-melt adhesive or other suitable glue to secure the assembly in place. Allow the glue to cure and then slide the prepared end cap into place as shown. Summoning all the patience and ingenuity that you can muster, thread the touch-contact wires through the two small holes that were previously drilled in the handle, as illustrated. Then sandwich the stripped ends of the wires to the handle using small pieces of metallic tape as shown. Cut pads to shape for appearance using an X-acto knife.

34 Connect a pair of fresh standard 9-volt alkaline or lithium batteries

PARTS LIST FOR THE PLASMA SABER

SEMICONDUCTORS

- Q1—PN2907 general-purpose, silicon PNP transistor
- Q2—PN2222 general-purpose, silicon NPN transistor
- Q3—D40D5 NPN silicon power transistor

RESISTORS

- (All resistors are ¼-watt, 5% units.)
- R1—5.6-megohm
 - R2—1000-ohm
 - R3—4700-ohm
 - R4—680-ohm

CAPACITORS

- C1—0.1-µF, ceramic-disc
- C2—10-µF, 25-WVDC, radial-lead, aluminum electrolytic

ADDITIONAL PARTS AND MATERIALS

- T1—High-frequency oscillator transformer (see text)
- NE1—NE-26 glass neon tube (see

Table 1)

- B1, B2—9-volt transistor-radio battery
- B3, B4—1.5-volt AA alkaline battery (optional, see text)

Printed-circuit materials, battery connectors, adapter rings (1½-inch OD × 1-inch ID × ⅛-inch thick Lexan washers, see text), shroud (29½-inch length of 1-inch OD × ⅞-inch ID Acrylic/Plexiglas tubing), spacers (4¾-inch OD × ⅞-inch ID × ⅛-inch Flexi Clear PVC, see text), #22 buss wire, #24 stranded wire, 4-inch tie wraps, 1-inch clear plastic cap, 1½-inch plastic cap (see text), adhesive-backed metallic tape, 10½-inch × 1½-inch black plastic handle (see text), wire solder, hardware, etc.

Note: A complete kit of parts is available from Information Unlimited, contact them by snail mail at PO Box 716, Amherst, NH 03031; Tel. 603-673-6493; e-mail: wako2@xtll.com; Web: www.amazing1.com.

into the battery snaps and insert them into the handle. After that, pack pieces of foam rubber into

the handle to hold the batteries in place. Place a final end cap on the

(Continued on page 86)

Designing and Building Printed-Circuit Boards

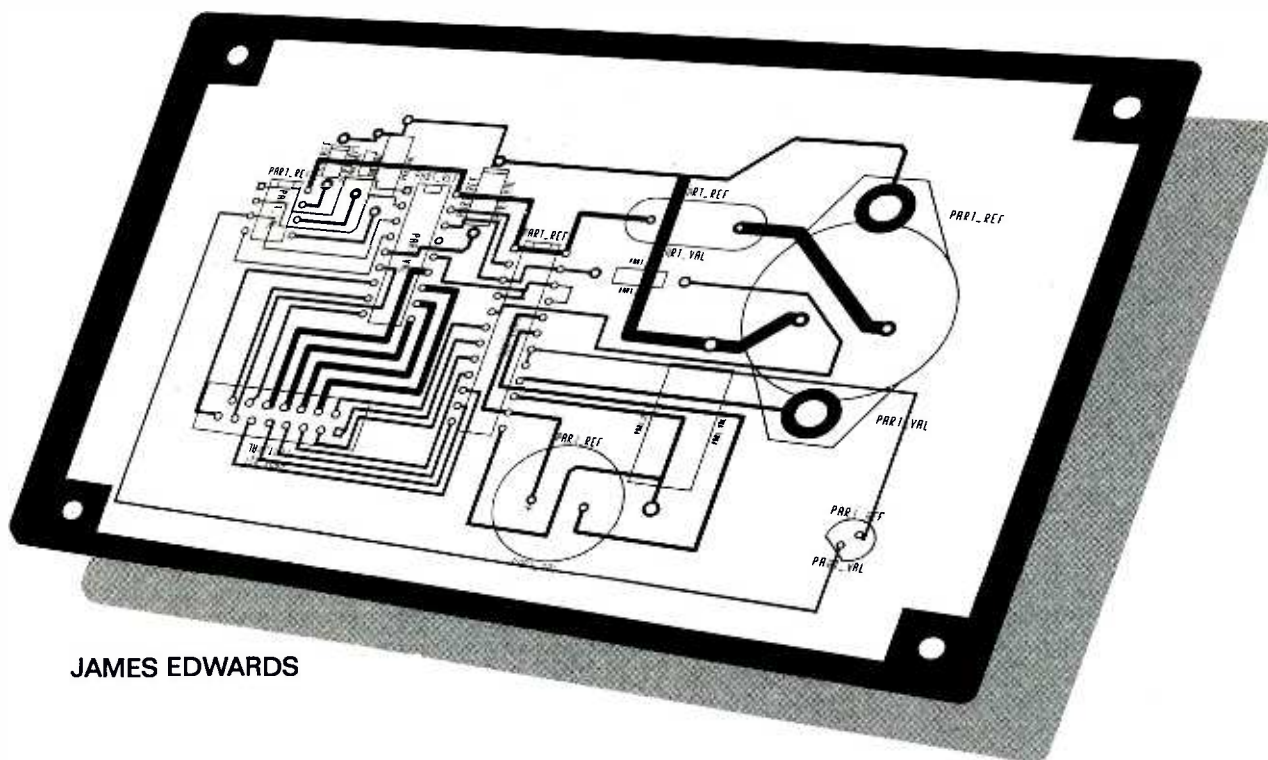

JAMES EDWARDS

In the past ten years, the software packages used to lay out printed-circuit boards (PCBs) have dramatically come down in price, while their usefulness has skyrocketed. Because of that, very few hobbyists design boards by hand anymore. They've made the transition from designing boards using rub-on transfers on sheets of Mylar to designing with mouse clicks on a computer screen.

As with any other such transition, however, going from hand-taped to computer-created artwork requires that you change your thinking somewhat. There are some things that can be done, or even should be done, differently. The author has

It's hard to do anything for over five years and not learn a few tricks. Here, the author shares several practical tips for designing printed-circuit boards on a computer.

learned a few tricks in the five years or so that he's been using a layout program that he'd like to share to help smooth the transition to computer-based PCB layouts.

Think. As always, the most powerful tool at your disposal is your brain. You should always start a project by considering how it will be implemented once it is completed. For

example, suppose you were designing a weather station. The first thing to look at would be where the station would physically reside. If all the electronics go on the roof, the enclosure should be weather resistant or weatherproof to keep out rain and snow. If only the sensors are to be mounted on your roof and the rest of the electronics is to be tucked safely inside the house, then a completely different enclosure should be selected.

Enclosure selection, in turn, influences the size of the board. It might also sway your decisions on what components to use. For example, conventional switches can be relatively expensive parts, but weather-

proof switches are even more costly. Decide up front how the finished project is to be configured, so you can select the correct parts, enclosure, and circuit-board size.

Except as stated above, try not to select a board size until you've made an initial layout and gotten a rough idea of how much printed-circuit "real estate" is required. Once you've done that, be sure to select either a standard PCB size or the size of a remnant you have on hand. If you design a board with a final size of 3.1 × 5.1 inches, you'll end up buying a 4- × 6-inch board and then having the hassle of trimming it to size. A better approach would be to start designing to a 3- × 5-inch board and then *sticking with it*. It seems as if there are always methods of shaving a few fractions of a square-inch off a design. Can the resistors be mounted upright? Do you really need 0.4 inches between integrated circuits?, etc.

If possible, stick with single-sided boards—they are much easier to build and somewhat less expensive to produce than double-sided boards. Then, after you are well into the design process, you can always switch back to a double-sided board if there are too many intersecting traces. It's surprising how many traces can fit on a single-sided board. That's especially true if your layout program contains a decent "auto-route" algorithm.

Another point to keep in mind is that there is nothing wrong with a few jumper wires on a *one-of-a-kind* printed-circuit board. Just remember to keep the jumpers short and avoid allowing them to cross over any board-mounted components. The goal should be to minimize jumper wires, not necessarily to eliminate them.

Most layout programs measure distances in tenths of an inch. Unfortunately, very few rulers have tenth-of-an-inch increments. That becomes a problem for mounting holes. On the computer, you can easily place the mounting holes 1.3 inches apart. However, it would be hard to measure 1.3 inches on the enclosure where the board will be mounted. The best thing to do is get in the habit of placing the mounting

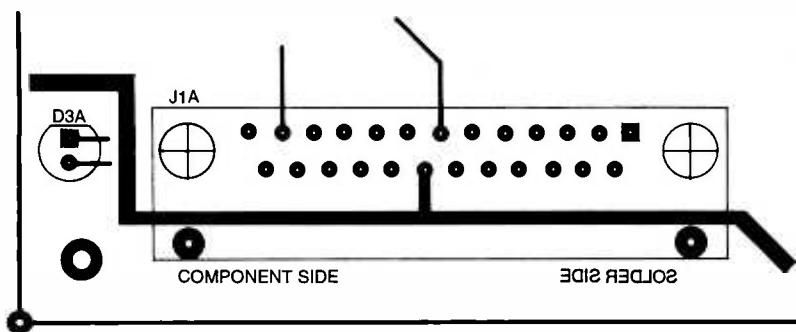

Fig. 1. Many a printed-circuit board has been ruined because the foil pattern was flopped (artwork positioned backwards), so it is wise to label both sides of the template as illustrated here.

holes at half-inch increments. That way, when you drill the mounting holes in the project case, you'll find that it's much easier to mark off half-inch distances than some strange number of 0.1-inch increments.

When preparing the enclosure, use a full-scale printout of the board layout as a drilling guide. That guarantees that the enclosure and board mate correctly when the time comes. If the circuit includes panel-mounted components—switches, LEDs, or any other components that must be secured to the enclosure—be sure to include them on the printout.

Clearly label the foil patterns for two-sided boards (either SOLDER SIDE or COMPONENT SIDE on the layout) and make sure that they are flipped appropriately so they read correctly on the computer display. Get in the habit of always doing that, even for single-sided boards. Doing so helps later on when you have to determine the orientation of the clear artwork (surface on which to mount and mechanically connect components—using point-to-point wiring techniques). More than one board has been wrecked because the artwork was positioned backwards (see Fig. 1).

Once you have a "first pass" design of a board layout, be sure to print out a full-sized copy of it. Then, take all of the actual components and set them on the printout. Make certain that all the components fit

into their allotted space. Sometimes the silk-screen layer of the program's parts library does not exactly match the part, and that can result in multiple parts all competing for the same board real estate. Work all those details out in the "paper phase," before the design is committed to copper and fiberglass.

It's also a good idea to write the date and a version number (as shown in Fig. 2) right on the artwork—preferably on both sides of the board. That helps to keep track of multiple versions of the same project. The author was once hit by that very dilemma; it took nearly an hour to figure out that he'd accidentally used an old version of the PC artwork on the bottom side of the board. Only one trace was missing, but it was an important one!

Most hobbyists do not place a silk-screen layer on their boards, so some important information that might be displayed on the comput-

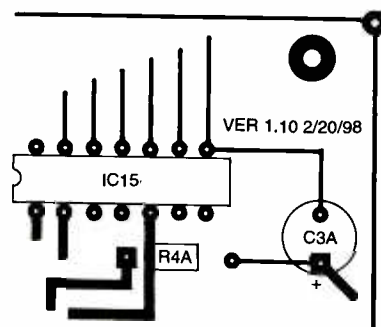

Fig. 2. If, during the development process, you find it necessary to alter the layout, be sure that subsequent versions of the layout are labeled with the date and a version number (as shown here) right on the artwork—preferably on both sides of the board.

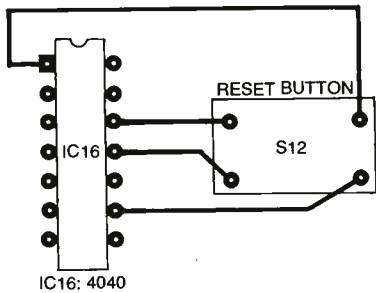

Fig. 3. If space allows, component designations and/or values (as here) or even component symbols revealing component orientation can be included in the foil-pattern template.

er's monitor can be lost when the screen display is output in hard copy. To remedy that situation, consider putting important information right on either the top or bottom copper layers. As a minimum, you'll want to include orientation markings for items—such as diodes, electrolytic capacitors, and integrated circuits—that might accidentally be misoriented (placed in the board backwards).

If space allows, component names and/or values can be added to the foil side(s) of the boards as illustrated in Fig. 3. That helps speed things up in the construction phase and also helps when you get to the debug stage.

It is good design practice to orient all IC packages in the same direction, unless that violates one of the other suggestions previously mentioned. Doing so helps "error-proof" your board, making it just a little harder to misorient compo-

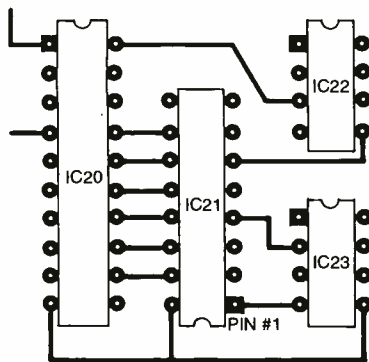

Fig. 4. It is good design practice to orient all IC packages in the same direction. Doing so helps "error-proof" the board, making it a little harder to misorient the ICs. If, as shown here, an IC is oriented differently from the rest, make certain that pin 1 is clearly marked on both copper sides of the board.

nents. If you are forced to mount one of your ICs with a different orientation, make certain that pin 1 is clearly marked on both copper sides of the board (see Fig. 4).

Always remember that a schematic diagram is not set in stone. It's amazing how many people seem to think otherwise when they reach the board-layout phase of a construction project. The ability to redefine various aspects—e.g., changing connector pin numbers or using one IC gate in place of another—of a PCB template very often makes laying out the board easier. If portions of the layout are altered, be sure to update the schematic diagram so it accurately reflects the changes. The Windows operating environment is great for that, since it permits you to easily toggle between the schematic-capture and the board-layout programs, between two schematic diagrams, or between two board layouts (as shown in Fig. 5) to make the changes.

Component-pad size is also not fixed. If there is sufficient room, it's wise to make the pads as big as possible to facilitate construction. Remember, most layout programs assume you will be having boards professionally manufactured, and hence the default pad sizes are generally very small. When etching such board designs, the small traces tend to get eaten through very quickly. It's much better to make the pads larger than the defaults (where possible) to reduce the risk of over-etching. Also, greater pad area makes hand soldering components to the board much easier and less problematic (small pads are notorious for pulling away from the substrate when soldering-iron heat is applied).

The next bit of advice is nearly the opposite of the last tip: Make some component pads smaller than the others when it makes sense. All of the PC-board pads, even those for a single component, needn't be the same size. Some pads can be made smaller so that your final design can be optimized. For example, if a little extra room is needed in order to feed in a high-current trace between two pins of an IC, the IC pads can be made a

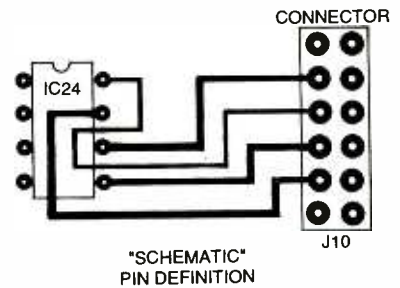

"SCHEMATIC" PIN DEFINITION

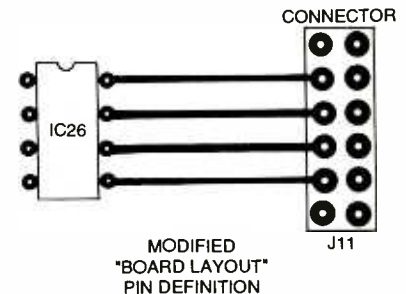

MODIFIED "BOARD LAYOUT" PIN DEFINITION

Fig. 5. If portions of a layout are altered, be sure to update the schematic diagram so that they agree. Operating in the Windows environment provides a convenient method of toggling between schematic-capture and board-layout programs, between two schematic diagrams, or between two board layouts (as shown here) to make the changes.

bit smaller than the others, as shown in Fig. 6.

Does the design include an IC or two that has unused pins? If so, why waste precious board real estate by including pads that serve no useful purpose? Where board space is at a premium, it makes sense to eliminate unused pads from the artwork. Then, when it comes time to "stuff" the board, simply cut off the appropriate pins on the IC's socket and install it as usual. Doing so allows the unaltered IC to be placed in the socket without making electrical contact to the foil side of the board. That frees up a little extra space beneath the IC wherein a trace or two can be routed.

Don't wait until the layout is complete to actually print out the artwork. At least once or twice before the design is complete, it's a good idea to print out an exact-sized copy of the layout, making sure to include the silk-screen layers even if they aren't being used. You can then place the actual components on the printout to make cer-

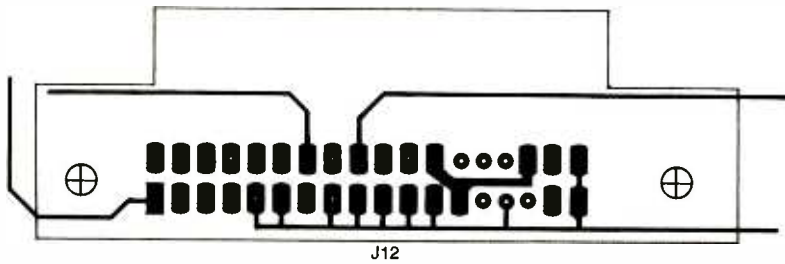

Fig. 6. Component-pad size is also not fixed. If there is sufficient room, it's wise to increase pad size as much as possible to facilitate construction.

tain that there is adequate space for everything. Items to watch out for are large capacitors, mounting holes for connectors, and any components whose templates you've created yourself.

Also, be sure connector pin numbers line up correctly. If the board is designed for a male DB-25 connector, but the layout software accidentally configures the pattern for a female DB-25, the pin definitions won't be as expected.

If there is sufficient room, place extra pads (see Fig. 7) on unused connector pins or IC gates. Initially, there may not be a need for them, but if your design doesn't work, the extra pads make it much easier to modify the board further down the line if, for example, one gate of an IC turns out to be defective. You might also consider including pads or component spacing for any upgrades that might be wired into the circuit at a later time.

Few hobbyists use plate-through holes on their two-sided boards. Because of that, it's necessary to take extra precautions with any

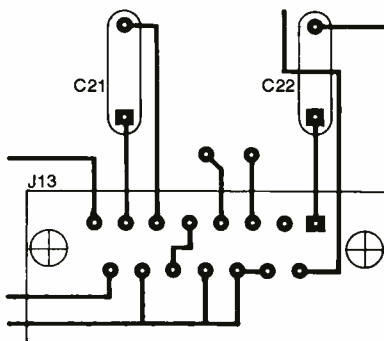

Fig. 7. When space allows, placing extra pads on the board and connecting them to unused connector pins or IC gates permits substitutions should a connector pin or IC terminal or gate become defective.

hole that connects to traces on both sides (top and bottom) of the board because it may be necessary to solder to both sides of the board to make a good electrical connection. For example, straight PCB-mounted connectors are frequently encased in plastic in such a way that they can only be soldered from the bottom side of the board—the tops of the pins are inaccessible to a soldering iron. If a trace for such a connector is placed on the top copper side of the board, there'll be no way to solder it! Hence, there *won't* be an electrical connection between its pins and the top traces.

If that causes design problems, there are two things that can be done: either mount the component a few millimeters above the board so that you slip the iron beneath the obstruction, or create a "poor-man's via" near the problem pad. A poor-man's via is simply a small hole with pads on both sides of the board, in which you solder a small piece of wire (see Fig. 8).

If you use an auto-routing accessory to your layout program, set it up to minimize the number of vias it uses. That's recommended because otherwise you'll have to install poor-man's vias for every normal via that the program designs in, which is a pain in the neck. That's a fairly major annoyance for hobbyists using an auto-routing routine: they tend to use vias as if they are going out of style.

Create a personalized checklist of things you want to examine before you are "finished" with a layout. Before generating a comprehensive list, it's wise to check the sizes of mounting holes or to run an automatic check routine to verify

all trace routings.

Be sure to adhere to all the good design rules that you've learned during years of laying out circuit boards by hand! You should still keep the analog and digital sections of the board separated. Use grounding planes where necessary. Don't make the traces too small for the expected maximum current loads. Even though layout software has improved a lot in the past ten years, it still doesn't check for things like that. All those tasks remain the domain of the human brain—the best computers on the planet.

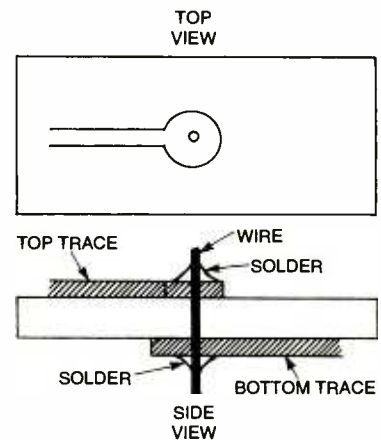

Fig. 8. A poor-man's via is simply a small hole with pads on both sides of the board, in which a small piece of wire is inserted and soldered to both sides of the board.

Once the printed-circuit layout is complete, you are still left with the task of etching the board. Many recent entrants to the electronics hobby and even some seasoned hobbyists tend to shy away from printed-circuit construction because of the perceived complexity of producing their own printed-circuit boards. One of the most frightening aspects of the hobby, particularly to the newcomer, is how to transfer the printed-circuit pattern from the printed page, original drawing, or tape and donut-pad, or computer-generated layout to a copper-clad slug (unetched printed-circuit media). Although there are several methods by which that task can be accomplished, here we'll present only one of the techniques; the most popular amongst hobbyists—the *photoresist* method.



There are several permutations of the photoresist method of printed-circuit production, each of which requires certain "universal" supplies, such as an exposure frame (a homebrew unit is shown here), an ultraviolet light source and light stand, a developing tray (glass or metal), and an etching tray (glass or plastic).

Supplies. Aside from the supplies that may be specific to a particular method, there are some "universal" items that are required regardless of the method selected. Among the items that can be considered universal is an **exposure frame**—a jig that holds the foil pattern against the PC slug. Exposure frames are commercially available from many sources. However, you can obtain comparable results using a homebrew jig comprised of little more than a flat board and a piece of glass weighted or clamped (if necessary) to the board to hold the pattern flat to the copper-clad slug. Aside from saving a few bucks, making your own jig also allows you to decide how large or small your unit should be in order to handle any size board you might decide to make.

You'll also need an **ultraviolet light source** and a **light stand**. Although an ultraviolet lamp is the light source of choice, many have achieved a lot of success using a photo-flood lamp. In addition, you'll need a **developing tray** (glass or metal) and an **etching tray** (glass or plastic). Both developing and etching trays are commercially

available, but if you are into cutting corners without compromising quality, a large Pyrex (or similar) baking dish can be used to handle both jobs.

You'll need a few chemicals; **etching solution**, **developing solution** (to prepare the board for etching), and a **solvent**. And, of course, you need a **drill** and **drill bits**.

Preparing the Board. The photoresist method of printed-circuit production involves the use of pre-photosensitized slugs (unetched copper-clad printed-circuit material, coated with a photo-chemical resist) and intense light to transfer the printed-circuit pattern from film to the slug.

The slug is coated with a light-sensitive chemical and allowed to dry. The film imprinted with printed-circuit pattern is placed on a pre-sensitized slug and exposed to ultraviolet or high-intensity light. Under the light, the board's coating undergoes a chemical change, causing the unmasked (for the positive photoresist method) areas to become susceptible to a chemical developer. Ordinary light-bulbs and slide-projector lamps don't put out a whole lot of energy in the ultravi-

olet part of the spectrum, but sun-lamps do. If you don't have a sun-lamp, you can use a fluorescent lamp or photographic flood (photo-flood) lamp; exposure times will vary depending on the light source. You'll have to experiment with the exposure time to obtain the best results for the type of light source being used.

Once the exposure phase is complete, the next step is to develop the board; that must also be done while working under a safe light. Make sure the developer selected is made for the type sensitizer with which the board is coated; e.g., if you are preparing a copper-clad slug that is coated with a positive photoresist, then the developer should be the positive type.

Fill a glass or metal tray with developer to a depth of about $\frac{1}{2}$ inch. **Warning:** Do not place the developer in a plastic tray; its solvent action will eat right through most plastics. Lay the exposed board on the bottom of the tray containing the developing solution with the pattern side up. Gently agitate the solution. As the developing solution begins to react with the board's photo-chemical coating, areas that were *not* masked from the light during the exposure procedure will begin to chemically break down, leaving behind the desired pattern (the traces). You can check to see how things are proceeding by removing the board from the solution. Handle the board by the edges *only*, and keep the pattern from touching anything. Also, be sure to hold the board so that any developer that remains on the board when it's removed can drain back into the tray. If the pattern appears clearly on the board, let the developer drain off and then dunk the board repeatedly in water.

Do not let running water hit the board for the first twenty seconds or so because the resist is still very soft and easy to ruin, and there is a risk of smearing it. With the resist still swollen with developer, the pattern will be easy to see. The best time to tell if the board will etch well or not is when it's in the water and still full of developer. As the developer



In addition to the items already discussed you'll need a few chemicals; etching solution, developing solution (to prepare the board for etching), and a solvent.

evaporates or is washed away, however, the pattern will disappear. If necessary, re-immerses the board in the developer and give it another 30 or 40 seconds of gentle agitation and then wash it again as above.

After you've washed the developer off, blow and shake the excess water off the board (**do not** wipe it off). Stand the board on end and allow it to dry thoroughly. An ordinary fan can be used to help speed the drying time considerably. Once the board is completely dry, it is ready for etching.

Etching the Board. Fill a glass or plastic tray with etching solution (ferric chloride is readily available from many electronic-supply sources) to about $\frac{1}{2}$ inch. Do not allow the etching solution to come in contact with any metal object; the solution will corrode metallic objects. Immerse the developed board in the solution, copper-side up, and agitate periodically by gently rocking the tray back and forth.

The etching time can vary from about 20 to 60 minutes, depending on how often you agitate the tray and the temperature of the solution. The time required for etching can be reduced by heating the solution to between 90 and 120°F. If you decide to warm the solution, be sure that there is sufficient ventilation, as the solution gives off toxic

fumes. Agitation also helps to speed the etching process. Many hobbyists use a simple technique involving an aquarium air pump to speed etching time: Simply connect a plastic air hose to the pump and immerse the other end of the hose in the etching tank. The air bubbles provide constant agitation to the etchant; ergo, speeding the etching process.

The board can be removed from the solution and rinsed under tap water from time to time to check on the etching process. Once you are satisfied that all the unwanted copper has been removed, thoroughly rinse the board under tap water, and allow to dry.

The next step is to remove the etch-resist coating from the etched board. There are several methods by which that can be accomplished: a stripping solvent (acetone), fine steel wool, or even re-exposing the board to ultraviolet light for about 10 minutes and again immersing it in developing solution (assuming that you have not discarded the solution).

Drilling the Board. Once the board has been etched, the next step (assuming that you plan to use *through-the-hole* construction) is to drill holes in the appropriate positions. You will need a couple of small bits, as lead diameter of components can vary somewhat. Three bit sizes—0.20, 0.30, and 0.40 inch—should take care of most lead diameters. It is important that when drilling the board that the drill bit be kept perpendicular to the board, as any bending of the bit (no matter how slight) has the potential to snap the small-diameter bit in two. To that end, it is recommended that a drill press capable of speeds of about 20–30,000 rpm be used for this procedure. A Dremel Motor Tool and a miniature drill-press attachment is ideal for the hobbyist PCB production setup.

The etched, undrilled board should be placed on a block of wood on a press table. The wood block serves two purposes: Doing so prevents damage to the drill bits as they pass through the PC board substrate and contact the metal drill-press table. It also prevents the

drill bit from marring the drill-press table surface. A marred table surface makes it difficult to move that board as it is positioned for drilling.

Once all the holes have been drilled, mount the components flush to the board and in their proper positions; then, bend the component leads slightly so that the parts are gently held in place for soldering. Another way of accomplishing the same end is to *populate* the board, and then cover the tops of the components with a sheet of $\frac{1}{2}$ -inch or so foam rubber backed up by a piece of cardboard. The assembly can be temporarily held together with rubber bands, tape, or what have you. Flip the board over so that the copper side of the board is facing upward, and solder the components in place, being careful not to bridge closely spaced traces. Also make sure that the PC board traces are not overheated during the soldering process. Too much heat can cause the copper foils to separate from the substrate.

When you've completed the soldering process, the board can be sprayed with an electronic lacquer to help prevent the copper from tarnishing or oxidizing.

Nasty Problems. Most electronic hobbyist circuits that fail to function properly don't contain design flaws—circuit failure can most often be traced to poor solder connections, improperly placed or misoriented components (call it *cockpit error*), etc. The biggest problems arise from poor soldering techniques, resulting either in cold, ineffective solder joints or massive blobs of solder running across contacts and terminals shorting them out. Many such problems can be traced to not applying the right amount of heat to a joint, moving it too soon, using too much solder and not watching where it flows, applying the soldering iron tip to the solder rather than to the joint, and working with dirty soldering tools.

Problems due to cold solder joints are difficult to diagnose. They tend to blend into regular electronic malfunctions, making them diffi-

(Continued on page 86)

AMAZING SCIENCE

Laser-Diode Holography, Part I

JOHN IOVINE

Holograms are true three-dimensional (3-D) pictures. Because holograms produce true 3-D pictures, viewers can tilt a holographic image to get a better look at the sides. On the other hand, when standard two-dimensional pictures are tilted, it just creates a foreshortening of the picture. Interested in making a 3-D picture?

One of the major drawbacks to learning holography has been the need of a HeNe laser, which also represents the single greatest cost in setting up a home holography workshop. While a laser is still needed to shoot holograms, inexpensive laser diodes have been used to successfully shoot first-rate holograms. At the same time, experimenters have used inexpensive \$15 laser pointers to shoot pretty good holograms. In this article, we'll show you how to shoot 3-D holograms using an inexpensive laser diode or laser pointer.

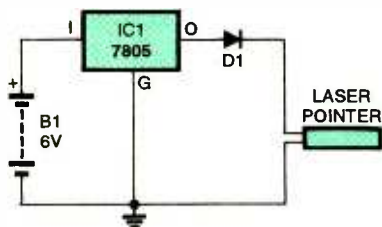

Fig. 1. A 7805 fixed-voltage regulator (rather than an LM317 adjustable-voltage regulator) was used in conjunction with a silicon diode to power the laser from a 6-volt battery pack, comprised of four C-cell batteries.

LASER-DIODE HOLOGRAPHY HISTORY

In 1989, while writing my first book on holography, *Homemade Holograms* (McGraw-Hill), I experimented using (then quite expensive) laser diodes to create holograms. I was disappointed with the results, because the profile of the beam emitted by the diode was choppy and broken up. During that time, however, there were other holographers working with even more expensive laser diodes who had achieved

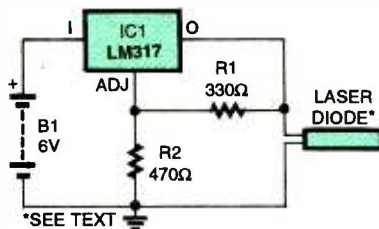

Fig. 2. Fed from another 6-volt (four C-cell) battery pack, this circuit was used to power the 665-nm laser diode, which required only a 3-volt DC source. The resistors in the circuit were selected to provide the proper voltage to power the laser diode.

much greater success.

Over the last ten years, the price of laser diodes has dropped considerably, while their quality has steadily improved. Today's inexpensive laser

diodes have a better output beam profile and shorter (635–650nm) wavelength than the expensive laser diodes of ten years ago.

I became reacquainted with laser-diode holography with a phone call from an experimenter (in February of this year) inquiring if it were possible to use a laser diode to create holograms. I said, while it may be possible, the quality of the resulting holograms wouldn't be worth the effort. That's when I was informed that Frank Defreitas of The Internet Webseum of Holography has been using laser diodes in his teaching workshops. I said I hadn't heard anything about it, but I'd check it out with Frank directly. With my interest piqued, I gave him a call. To my surprise, Frank told me that

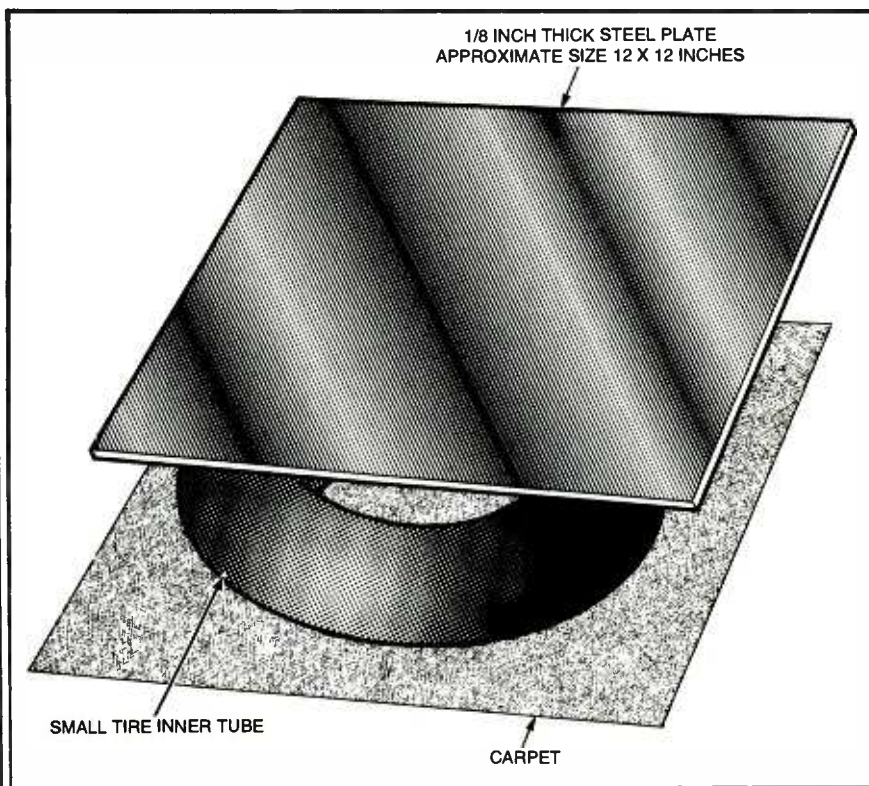
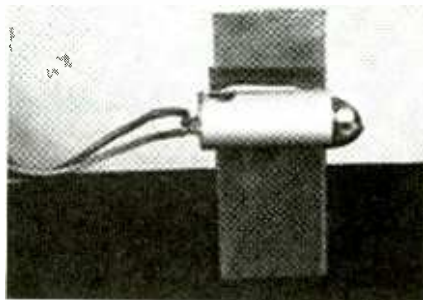

Fig. 3. When shooting holograms, holographers use an isolation table to eliminate as much vibration as possible. A simple isolation table (like the extremely simply contraption shown here) can be assembled from a piece of carpet (thick pile, if available), a small (12-inch diameter) inner tube, and a 12- x 12-inch steel plate.



With some minor modifications, many inexpensive laser pointers and diodes can be used to create holographic images.

it was true and that he was achieving extraordinary results with laser diodes.

He went on to say that it was Steve Michael of Three Dimensional Imagery who first told him that laser pointers could be used to create holograms. Since then, Frank has "evangelized" on the use of laser diodes in holography. Numerous small bite-size articles on laser-pointer holography can be found on his interesting Web site (www.3dimagery.com/pointer2.html).

LASER DIODES

There are many manufacturers of laser pointers and laser diodes. No

one can insure the suitability of any particular laser diode or laser pointer for holography. There's even an in-group variance among diodes (pointers) of the same make and manufacturer that needs to be taken into account. So far, it appears that many laser pointers do work. So if you have a spare laser pointer lying around the house, try it before buying another one. Laser diodes sold by Images Company (PO Box 140742, Staten Island, NY 10314; Tel. 718-698-8305 or 982-6145; Web: www.imagesco.com) have been used successfully.

MODIFYING THE POINTER

Since I had a few inexpensive laser pointers lying around, I decided to try one. Before it could be used, however, it was necessary to make some minor modifications. Because I felt that the three small batteries that came with the pointer would wear out at the most inappropriate time, I decided to replace them. I used a hacksaw to remove the battery section of the pointer. Two wires were then soldered to the unit—one to the negative *inside* terminal and the other to the case (which serves as the positive power terminal).

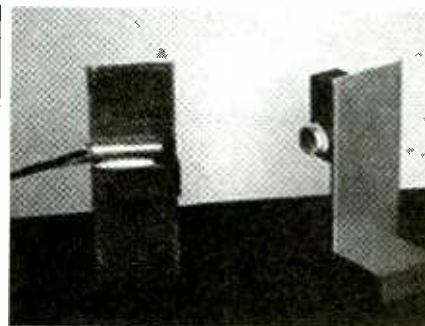

As shown here, the radius mirror can be mounted to a bar magnet using an epoxy or hot glue. If using epoxy, mix only a small amount, and apply it to the magnet using a toothpick. Be extra careful not to get any on the radius-mirror surface.

The original unit was powered from a source of approximately 4.5 volts. (I say approximately because the measured voltage across fresh batteries will be greater than their rated capacity, while used batteries will exhibit a less-than specified voltage.)

Rather than use an LM317 adjustable-voltage regulator, I opted to use a 7805 fixed-voltage regulator in conjunction with a voltage-dropping silicon diode, see Fig. 1. Since I didn't want to lose the portability of battery power, but I did want to ensure that the laser-light source wouldn't quit prematurely in the middle of a holographic session, I decided to power the unit from a 6-volt battery pack, comprised of four C-cell batteries. With fresh batteries, the laser diode should easily last for at least ten hours of continuous operation. The 7805 fixed-voltage regulator and diode were mounted on a small piece of protoboard. Double-sided foam tape was used to adhere the board assembly to the battery pack. You may want to add a small switch (I just pop one of the batteries in and out to turn the unit on and off).

The only other modification to the pointer was to secure a small piece of cardboard over the on/off button to keep it depressed. Hot glue was then used to secure the laser pointer to a bar magnet so that it could be mounted like any other optical component on my table.

LASER DIODE

While the beam from the pointer worked, I wasn't thrilled with the quality of the beam spread—there were many imperfections. The beam spread from a 650-nm laser diode was much

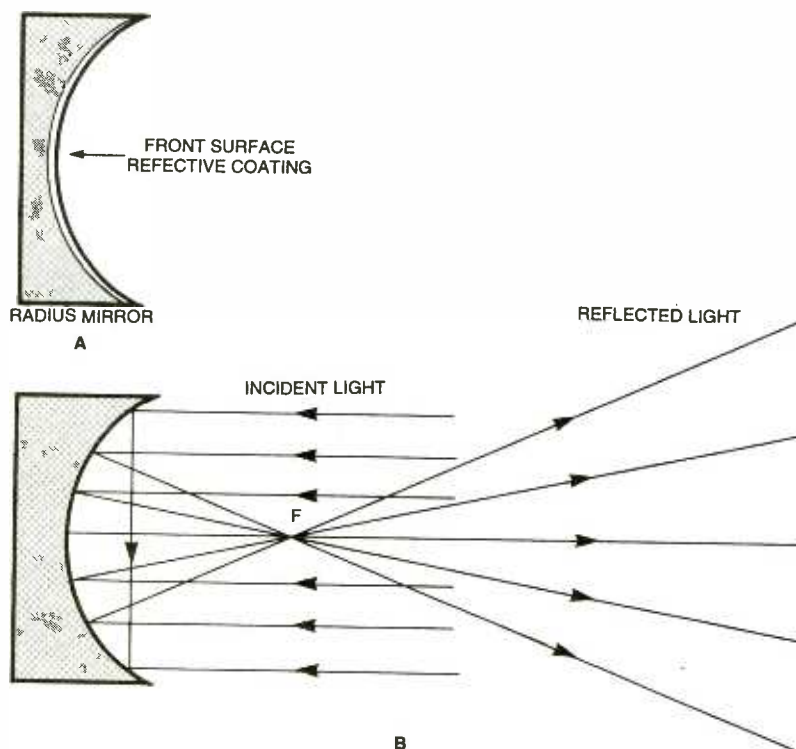

Fig. 4. Only one optical component—a tiny front-surface radius mirror—is needed for this basic single-beam setup. The radius mirror, which is mounted on a small bar magnet, reflects and quickly spreads a laser beam.

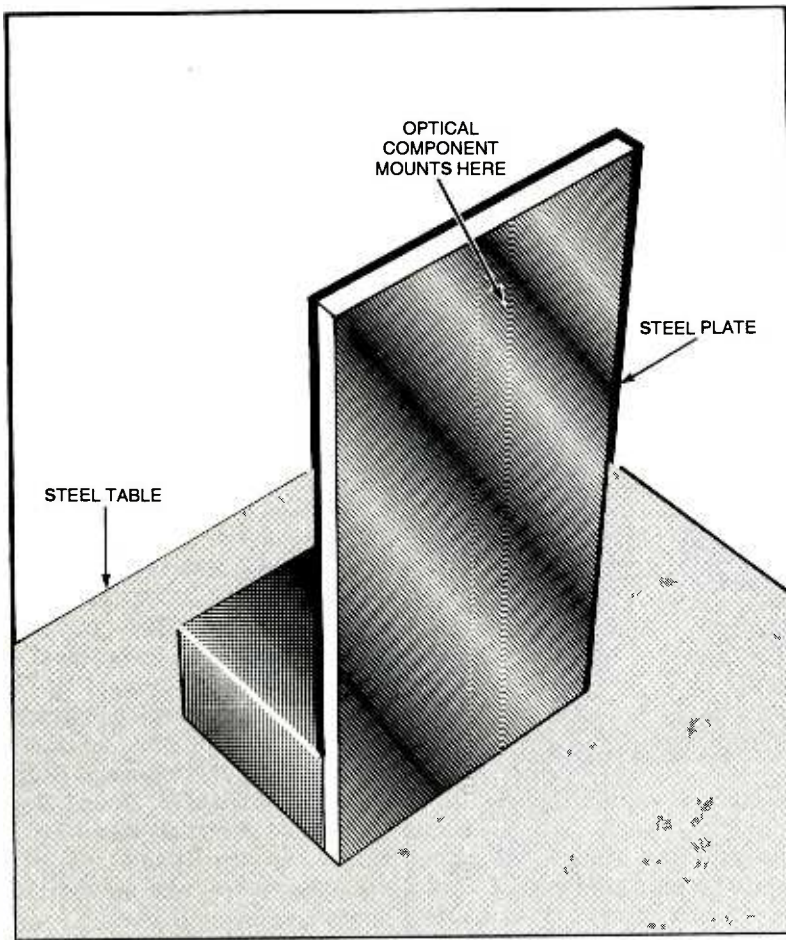

Fig. 5. An optical component mount, which was fashioned from a small steel plate (measuring $1 \times 2\frac{1}{2} \times \frac{1}{16}$ inches), was secured to the top surface of a steel table using a $0.9 \times 0.9 \times 0.4$ -inch ceramic magnet.

cleaner. So I decided to build another power supply for the 665-nm laser diode, which required a 3-volt DC source. At that point, I decided to press an LM317 adjustable-voltage regulator into service, see Fig. 2, that was fed from another 6-volt (four C-cell) battery pack.

The LM317 along with the two resistors were soldered to a small piece of protoboard. The board was attached to the battery case with double-sided foam tape. This laser-diode module was also glued to a bar magnet to make for easy mounting.

VIBRATION

When shooting holograms, vibration must be eliminated as much as possible. Vibrations so subtle that you can't feel them can prevent a hologram from forming as the film is exposed. Because of that, holographers shoot holograms on an isolation table—which is designed to “shield” the holographic setup from as much

vibration as possible. Construction details for a simple, easy-to-build and-use isolation table, consisting of a piece of carpet (thick pile if available), a small 12-inch diameter inner tube, and a 12×12 -inch steel plate, are shown in Fig. 3.

The carpet should be large enough to accommodate the inner tube without any overhang. If a piece of thick-pile carpet isn't readily available, a folded towel can be used. The inner tube should be filled to less than full capacity—with just enough air to make it feel firm but still remain very soft, so that you can easily squeeze the sides together. The steel plate, which lies on the inner tube, serves as a working surface. The steel plate should be thick enough to support itself and a few lightweight components without flexing or bending. Anything around $\frac{1}{8}$ -inch thick should do the trick. The plate must be comprised of ferrous material, so that a magnet can adhere to it. Many stainless steels are non-magnet-

ic and therefore are unsuitable.

Paint the steel table top flat black to help cut down on unwanted laser reflection and to generally improve the quality of the holograms made on the table.

WHERE TO SHOOT

The problem of where to shoot is alleviated somewhat by the portability of our equipment. You need to find a place that can be made dark; for example, a photographic darkroom. The room should also be quiet, meaning little or no vibration. In some cases, a bathroom floor can be used. **Do not** play music or run a fan while exposing a holographic plate—shooting the hologram(s). Any form of molecular movement (due to sound energy or the rapid movement of air) can generate vibrations in the holographic plate and table that'll prevent a hologram from forming.

While setting up the isolation table for a shoot or during the development of the holographic plates, music and fans are definitely allowed.

OPTICAL MOUNTS AND COMPONENTS

For a basic, single-beam set up, only one optical component—a tiny front-surface radius mirror—is required. The radius mirror reflects and quickly spreads a laser beam, see Fig. 4. The mirror is mounted to a small bar magnet, using epoxy or hot glue to secure the radius mirror in place. If using epoxy, mix only a small amount and apply it to the magnet using a toothpick. Be extra careful that you don't get any of the stuff on the radius mirror's surface.

PARTS AND MATERIALS LIST

Laser pointer or diode, radius mirror (spreading optic), isolation table, film, BB640 $2\frac{1}{2}$ -inch square holographic plates (2), $\frac{3}{8} \times \frac{3}{8} \times 1$ -inch bar magnets (4), $0.9 \times 0.9 \times 0.4$ -inch rectangular magnets (2), $2\frac{1}{2} \times 1 \times \frac{1}{16}$ -inch steel plates, green safelight, developing chemicals (jd3 kit), medium-size binding clips, 2×2 -inch black card, $2\frac{1}{2} \times 2\frac{1}{2}$ -inch white card, glue, small piece of carpet (or towel), small inner tube, three trays, quiet dark area.

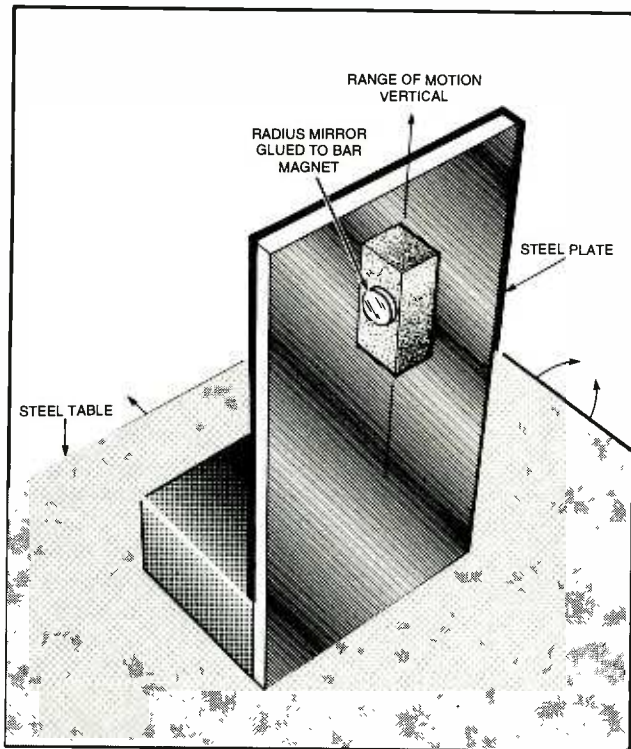

Fig. 6. The radius-mirror/bar-magnet combination was attached to the upright steel plate.

Optical mounts can be fabricated using the steel table surface and a small steel plate, measuring $1 \times 2\frac{1}{2} \times$

$\frac{1}{16}$ inches. The small steel plate mounts to the steel table using a $0.9 \times 0.9 \times 0.4$ -inch ceramic magnet, see

Fig. 5. The radius-mirror/bar-magnet combination attaches to the side of the upright $2\frac{1}{2}$ -inch steel plate. The radius-mirror magnet is usually placed on the side of the upright opposite from the table-mounted magnet to prevent any magnetic interaction. That gives a good deal of flexibility, allowing the mirror to be adjusted through a full range of motion (see Fig. 6), making aligning and directing the laser light easy.

Although only one optical component is used in this holography example, other optical components, such as front-surface mirrors, beam splitters, light blocks, etc., can just as easily be incorporated into the setup.

Well, that's about all the space allotted to us for this month. But be sure to join us next time around when we'll continue our holographic discussion, looking at type of film, exposure and developing techniques, additional equipment, as well as other aspects of holography. Until the appointed time rolls around, try to absorb the material presented this month so that you'll be better equipped to deal with the remainder of this fascinating pastime. ■

FACTCARDS

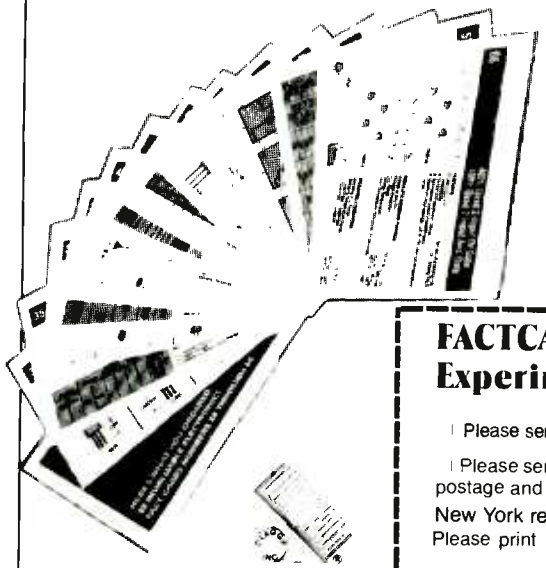

■ ALL YOU NEED to know about electronics from transistor packaging to substitution and replacement guides. FACTCARDS numbers 34 through 66 are now available. These beautifully-printed cards measure a full three-by-five inches and are printed in two colors. They cover a wide range of subjects from Triac circuit/replacement guides to flip-flops, Schmitt triggers, Thyristor circuits, Opto-Isolator/Coupler selection and replacement. All are clearly explained with typical circuit applications.

■ WANT TO EXPAND your knowledge of electronics? Do it the easy way

by studying the Electronics Fact Cards. Do you travel to and from your job each day? Drop a handful of cards in your pocket before you leave, and the bus becomes a schoolroom! At home, you can build some of the projects and not only have fun building and using them, but learn how they work at the same time.

■ YOU'LL BE AMAZED both at how rapidly you learn with these cards, and how easy it is to understand. These new cards are available right now. Don't miss out. Send your check or money order today.

FACTCARDS—Facts at your fingertips for Experimenters and Project Builders!

Please send one copy of FACTCARDS \$1.99. Shipping \$2.00 (U.S. and Canada only).

Please send _____ copies of FACTCARDS. Total cost is sum of copy price and First Class postage and handling cost multiplied by number of card sets ordered.

New York residents add sales tax to total cost of each order.

Please print

Allow 6-8 weeks for the material to arrive.

(Name)

(Street Address)

(City)

(State)

(Zip)

Detach and mail today:

CLAGGK Inc.

P.O. Box 4099

Farmingdale, NY 11735

All Payment must be in U.S.

Funds!

BS168

Robotics Workshop

Parallel Port Control, Part 2

GORDON MCCOMB

In last month's column, I introduced the parallel-port experimenter's interface, a simple buffering device for use between an ordinary PC parallel port and a robot. That column described the interface and its construction. This time around, however, we'll talk about how to use the interface to control robotic functions, such as drive motors.

INTERFACING THE PORT

The parallel-port experimenter's interface is ideally suited to controlling your robot. But since the 74367 hex buffer/driver used in the interface circuit (see last month's column) is incapable of sinking or sourcing very much current, the circuit is unable to drive a motor directly. However, last month's circuit can drive a low-power relay or a power transistor.

Figure 1 shows a simple circuit in which a 2N2222 general-purpose transistor is used to drive a single-pole, double-throw (SPDT) relay. When a positive voltage (logical 1) is applied to the input of the circuit, Q1 turns on. Turning Q1 on provides a ground path through Q1 for the relay's coil, causing RY1 to turn on, feeding power to MOT1 (a small DC motor), which in turn causes it to rotate.

That circuit can easily be modified, allowing it to control the motor's direction of rotation in addition to the circuit's on/off operation by adding a second relay, as shown in Fig. 2. In the Fig. 2 circuit, RY1 is used to turn the motor on and off, while RY2 is used to change the motor's direction of rotation by reversing the polarity of the power applied to its terminals. (Obviously, that application requires a reversible DC motor. Most, but not all, DC motors are reversible. Make sure the one you select is fully reversible.)

Two such relay circuits connected to four data lines on the experimenter's interface can control two motors on your robot, providing full

motion. By activating the four lines in special sequence, you can control the motors and their direction. A robot with two drive wheels mounted on each side of the unit can efficiently provide full stop, full forward, full reverse, and turning actions (see Fig. 3).

Note: There are a number of ways to connect motors to robot-control circuitry, and relays are but one method. Other methods include using discrete transistors, power MOSFETs, and full-bridge ICs. Unfortunately, those alternative methods are not within the scope of this column, so they won't be

fully explored here. But rest assured that those and other methods of robot-motor control will be discussed in future columns.

PC CONTROL

Let's say that you have two motors connected to the experimenter interface, controlling both their on/off states and their direction. For that, you might use, for example, data lines 0, 1, 2, and 3 (pins 2, 3, 4, and 5, respectively) of the interface. MOT1 can be turned on by activating the bit for line 0; i.e., make it high. To do that, the PC

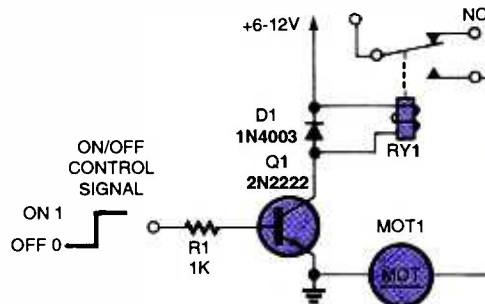

Fig. 1. This simple circuit, in conjunction with the experimenter's interface presented in last month's column, allows a motor to be turned on and off via signals originating from your PC.

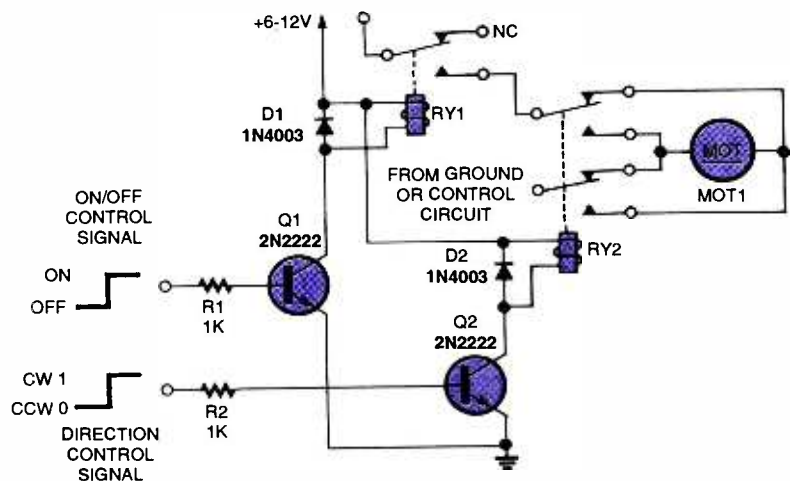

Fig. 2. With the addition of the driver/relay circuit shown here, the circuit in Fig. 1 can be made to control on/off operations, as well as the direction of the connected robot motor.

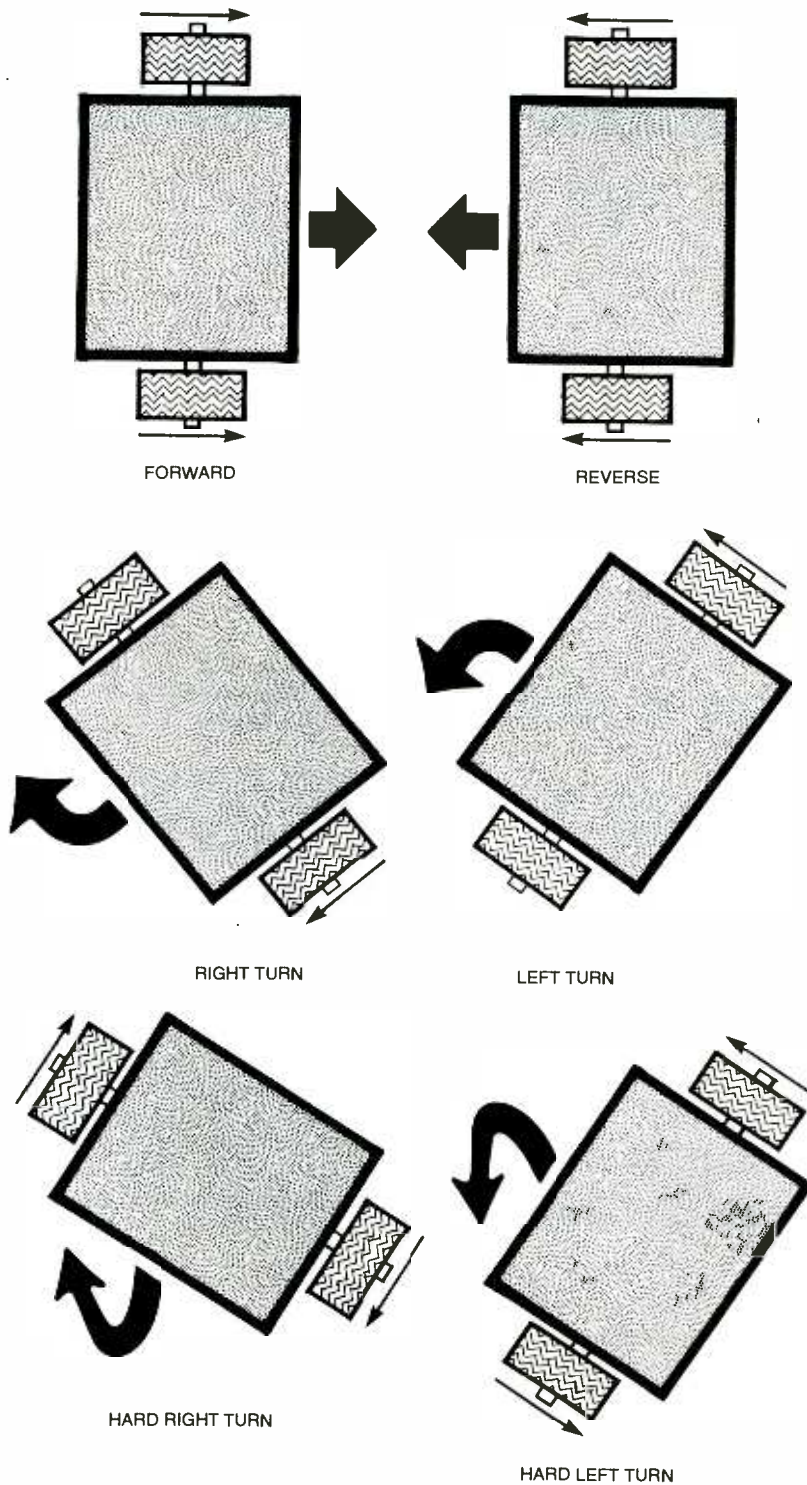

Fig. 3. A robot can be endowed with full mobility through the use of two motors and two wheels, as illustrated here. In such an arrangement, each motor controls the rotation of a single wheel, making the operation of each independent of one another.

must output a *bit pattern* number to the port using the BASIC OUT command. (The BASIC OUT command is used to send data to an I/O port.) The command consists of just two variables—the port address and value, which are separated by a comma. Assuming that

the interface is connected to the standard LPT1: parallel port of a PC, type the following to send data to the data-output line:

OUT 888, x

where x is the decimal value of the binary bit pattern you wish to use.

Table 1 lists all the possible bit patterns for data lines 0–3. Although the motor relays can be connected to the pins in any order, the table assumes the following:

- Data line 0 (bit 1) controls the On/Off relay for motor 1
- Data line 1 (bit 2) controls the On/Off relay for motor 2
- Data line 2 (bit 3) controls the Direction relay for motor 1
- Data line 3 (bit 4) controls the Direction relay for motor 2

It's a good idea to get into the habit of initializing the port at the beginning of the program by outputting a decimal 0. That way the relays are **not** energized at random. The line of code to accomplish that is:

OUT 888, 0

To activate MOT1, choose a decimal number wherein only the first bit changes. There is only one number that meets that criteria: decimal 1 or 0001 (we will ignore bits 5–8 for this discussion, since they are not in use). So type:

OUT 888, 1

Running that program causes MOT1 to turn on. To turn MOT1 off, send a decimal 0 to the port, as described above. The same technique is used to turn on MOT2, or both MOT1 and MOT2 at the same time. To turn on both motors at the same time, for example, look for the binary bit pattern where the first and second bits are 1 (in this case, decimal 3) and output that value to the port.

CONTROLLING A TWO-WHEEL ROBOT

Figure 4 shows a typical two-wheel-drive, robot-platform arrangement. The wheels are attached to motors mounted on either side of the platform (you can use metal, wood, or plastic for the platform). On the front and back of the platform are casters for balance. For best results, only one caster wheel should touch the ground at any time; otherwise, the robot may not travel in a straight line.

Table 2 shows the seven primary

TABLE 1—BIT PATTERNS

Binary	Value	MOT1 Control (Bit 1)	MOT1 Direction (Bit 3)	MOT2 Control (Bit 2)	MOT2 Direction (Bit 4)
0000	0	Off	Forward	Off	Forward
0001	1	On	Forward	Off	Forward
0010	2	Off	Forward	On	Forward
0011	3	On	Forward	On	Forward
0100	4	Off	Reverse	Off	Forward
0101	5	On	Reverse	Off	Forward
0110	6	Off	Reverse	On	Forward
0111	7	On	Reverse	On	Forward
1000	8	Off	Forward	Off	Reverse
1001	9	On	Forward	Off	Reverse
1010	10	Off	Forward	On	Reverse
1011	11	On	Forward	On	Reverse
1100	12	Off	Reverse	Off	Reverse
1101	13	On	Reverse	Off	Reverse
1110	14	Off	Reverse	On	Reverse
1111	15	On	Reverse	On	Reverse

motor-control sequences required to operate a two-wheel-drive robot. Note that binary 0000 (decimal 0) turns off both motors, causing the robot to stop. Changing the binary bit pattern activates the right or left motor (depending on the data transmitted to the experimenter's interface), thereby controlling the motor's direction of rotation. For example, sending binary 0111 (decimal 7) to the interface turns on both

motors, but causes MOT1 (say, the right motor in our test robot) to run in reverse and MOT2 (the left motor) to go forward. Under that condition, the robot spins about its center axis in a clockwise direction.

When writing the control program for the robot, it may be necessary to insert short pauses between each state change (MOT1 forward and reverse, for example). You can create

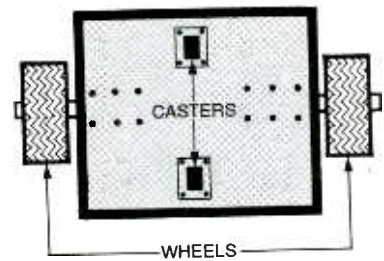

Fig. 4. Shown here is the typical wheel arrangement for a small two-wheel-drive robot. Note that casters are attached to the bottom of the robot platform to help balance the robot.

simple pauses in BASIC with "do nothing" FOR-NEXT loops as shown in Listing 1 (a testing program). Such do nothing FOR-NEXT loops are processor-speed dependent, and therefore, it may be necessary to adjust the value of one or both loops to control the actual delay for your computer. You can also use the SLEEP statement, which inserts a delay for the number of seconds you specify. Other versions of BASIC provide for additional time-delay commands.

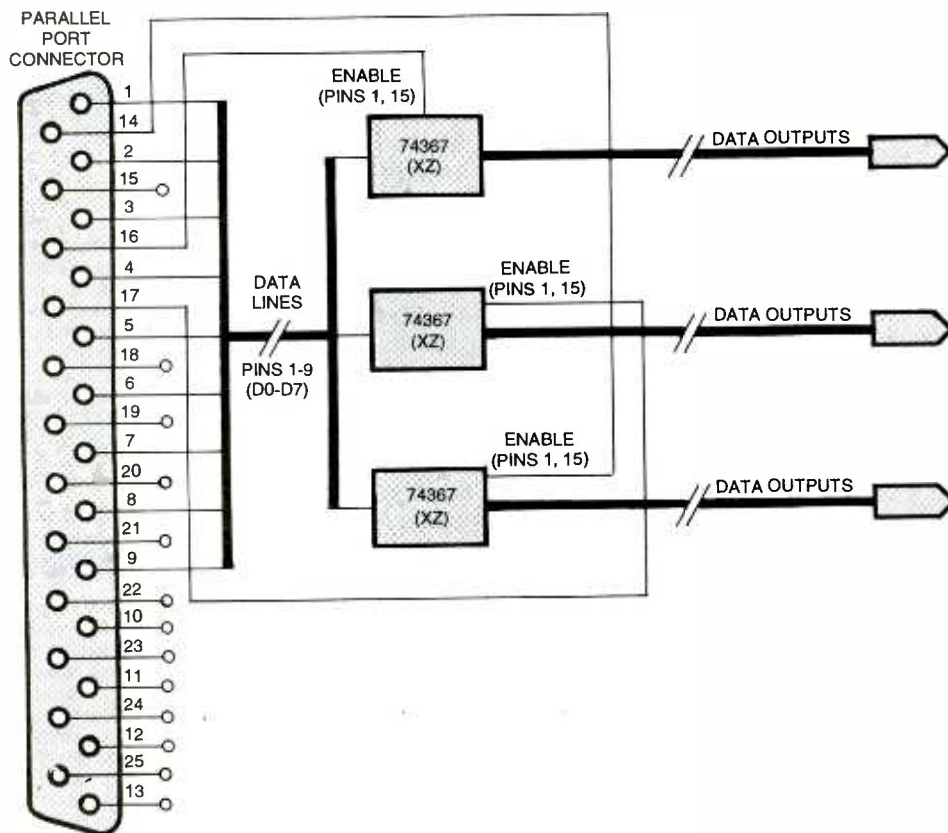

Fig. 5. By connecting the ENABLE lines of the 74367 to the control terminals of the parallel port, three separate devices, each with eight data lines, can be independently controlled. Because the 74367 contains only six buffers, you need two ICs for each data output set.

LISTING 1

```

DECLARE SUB DELAY
SUB ()PORTADDRESS
= 888 'LPT1 for
non-mono card ports
OUT PORTADDRESS, 0'
DELAYSUB
OUT PORTADDRESS, 3'
DELAYSUB
OUT PORTADDRESS, 15
DELAYSUB
OUT PORTADDRESS,
0$SUB DELAYSUBFOR
X = 0 TO 500
FOR DELAY = 1 TO 100:
NEXT DELAYNEXT XEND
SUB
    
```

CONTROL EXPANSION

As shown in the above examples, each motor requires two bits. Therefore, one parallel port can control the action and direction of four motors. However, you can actually control more motors (or other devices), using a number of simple schemes, without resorting to using additional ports.

The most straightforward method of expanding a single parallel port is to make use of some or all of the control lines. Bits are sent to the control lines in exactly the same way as was done for the data-output lines, except that a different address is used. For LPT1: (expansion board), the decimal address for the control lines is 890. Only the first five bits of the address are used in the port, which means the decimal numbers used fall between 0 and 31; bit 0 should be considered as reserved, because that bit controls the STROBE line.

Let's say you're using bit 2 of the control address. (In a printer application, bit 2 is used to initialize the printer.) That bit (and no others) is turned on by entering the following program

TABLE 2—PRIMARY MOTOR-CONTROL SEQUENCES

Binary	Decimal	Function
0000	0	All stop
0011	3	Forward
1111	15	Reverse
0010	2	Right turn
0001	1	Left turn
0111	7	Hard right turn (clockwise spin)
1011	11	Hard left turn (counter-clockwise spin)

line into BASIC:

```
OUT 890, 4
```

Note that a binary pattern can be output to address 890 without affecting the data-output lines.

A second method that might be used is a "sub-address" scheme, which allows a single parallel port to fully control a large number of 8-bit devices. The output lines of the 74367 used in the experimenter's interface can be disabled. In the experimenter's interface, the ENABLE lines of the chip (pins 1 and 15) are always held low, so data is passed from the inputs to the outputs. When the ENABLE pins are brought high, the outputs are driven to a high-impedance state, and no longer pass digital data. In that way, the 74367 acts as a kind of valve. The two ENABLE lines control different input/output pairs. The high-impedance disabled state is engineered so that multiple 74367 chips can be paralleled on the same data lines, without loading the rest of the circuit.

The ENABLE pins of the 74367 and a few of the unused control lines of the parallel port can be used to make an electronic data selector switch. In operation, the data selector places a binary word onto the data-output lines, which is then sent to the desired device by addressing it with the control lines.

For example, suppose you've connected three sub-address ports to the parallel port, as shown in Fig. 5. Control lines 1, 2, and 3 (pins 14, 16, and 17) are connected to the ENABLE inputs of the 74367 (pins 1 and 15). The inputs of the 74367s are connected together. The outputs of each 74367 feeds a specific device. As an example, to turn on bits 0 and 1 on device 2, enter the following lines into BASIC and run the program:

```
OUT 888, 3
OUT 890, 5
```

The first line of the program outputs a decimal 3 to the data-output lines. That places the binary bit pattern 00000011 on the parallel-port data output lines. The second line enables device 2 by turning on the second 74367 (the bit pattern is 00000101, so when the data line goes low, the 74367 attached to it is enabled). Note that the

74367 is a buffer and not a latch. If you want to latch the data (keep it present on the output until specifically removed), you can substitute a latching buffer such as a 74373 for the 74367s currently used.

INPUTTING DATA

Most parallel ports provide for up to five status lines, which can be used to send data back into the computer. To read data from the port, the BASIC command statement INP (for input) is used. The input command is:

```
Y=INP(x)
```

where x is the decimal address of the port you want to read. In the case of the LPT1: expansion-board parallel port, that address is 889. Use any valid variable name for Y; in this variable is placed the instantaneous value of the port when the program is run.

Practical examples of using the status lines can be demonstrated through the robot's various sensors, like touch switches, "whiskers," light detectors, and so forth. The simple on/off nature of these sensors make them ideal for the parallel port.

THE TRANSDUCER PROJECT BOOK



1992T—From TAB Books. A unique collection of practical transducer devices that you can put together simply and inexpensively. You can build a seismic sensor, a temperature survey meter, an open-door annunciator, a moisture detector, an automatic night light, and more. To order—ask for book **1992T**, and include your check for **\$6.99 - clearance (includes s&h)** in the US and Canada, and order from —**Electronic Technology Today Inc., P.O. Box 240, Massapequa Park, NY 11762-0240**. US funds only; use US bank check or International money order. Allow 6-8 weeks for delivery. **MA06**

ELECTRONIC GAMES

BP69—A number of interesting electronic game projects using IC's are presented. Includes 19 different projects ranging from a simple coin flipper, to a competitive reaction game, to electronic roulette, a combination lock game, a game timer and more. To order **BP69** send **\$4.99 clearance (includes s&h)** in the US and Canada to **Electronic Technology Today Inc., P.O. Box 240, Massapequa Park, NY 11762-0240**. US funds only. Use US bank check or International Money Order. Allow 6-8 weeks for delivery. **MA07**



Market Center™

SURVEILLANCE

The Latest High Tech Professional Electronic Devices

Our latest catalog offers a HUGE selection of surveillance, countersurveillance - privacy devices: *spy* pinhole camera \$99⁰⁰, hidden video, "realtime" 15-Hour telephone recorder \$149⁰⁰, 12 hour VOX recorder, phone call register, bug detectors, phone tap detectors, voice disguisers, locksmithing tools, wireless video, vehicle tracking via the internet and much more. Wholesale/retail.

We will not be undersold.

Catalog \$5.00 or

www.spyoutlet.com

SPY OUTLET

PO Box 337, Buffalo NY 14226
(716) 691-3476/(716) 695-8660

FREE
SAMPLE COPY!

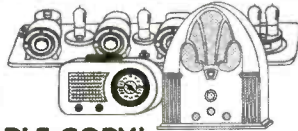

ANTIQUE RADIO CLASSIFIED

Antique Radio's Leading Monthly Magazine

Classifieds - Ads for Parts & Services
Articles - Auction Prices - Flea Market Info.
Early Radio & TV - Hi-Fi - Ham Equip.
Art Deco - Telegraph - 40s & 50s Radios
Also the source for Books & Price Guides
1-Year: \$39.49 (\$57.95 by 1st Class)
6-Month Trial - \$19.95. Foreign - Write.
Call: 978-371-0512 - Fax: 978-371-7129
A.R.C., P.O. Box 802-L23
Carlisle, MA 01741



Web: www.antiqueradio.com

NetSurf PRO™

wireless keyboard™

100 feet range

Power indicator



Integrated Touch pad

104-key functionality

\$99
only

- 900MHz Wireless RF Technology
- No Line of Sight Requirement
- Encrypted Data Transmission
- Long Battery Life

Ultima Associates, Inc. 45645 Northport Loop East Fremont, CA 94538
Tel: 510-623-8988 ext 101 • Fax: 510-623-8989 • Email: Sales@RTDevices.com • URL: www.RTDevices.com

MAY THE SOURCE BE WITH YOU

Don't let the dark forces of ignorance defeat you. Tap into the source of free or low-cost government publications—the free CONSUMER INFORMATION CATALOG.

Call toll-free 1-888-8 PUEBLO.

Or set your coordinates for our web site:

www.pueblo.gsa.gov

Weeder Technologies



Visit our
ON-LINE
CATALOG



Pro-Kit

PO Box 2426, Ft. Walton Beach, FL 32549

www.weedtech.com

Voice/Fax 850-863-5723

Stackable RS-232 Kits

Digital I/O - 12 I/O pins Individually configurable for input or output. DIP switch addressable; stack up to 16 modules on same port for 192 I/O points. Turn on/off relays. Sense switch transitions, button presses, 4x4 matrix decoding using auto-debounce and repeat. **\$32**

Analog Input - 8 input pins. 12-bit plus sign self-calibrating ADC. Returns results in 1mV steps from 0 to 4095. Software programmable alarm trip-points for each input. DIP switch addressable; stack up to 18 modules on same port for 128 single-ended or 64 differential inputs. **\$48**

Home Automation (X-10) - Connects between a TW523 and your serial port. Receive and transmit all X-10 commands with your home-brewed programs. Full collision detection with auto re-transmission. **\$39**

Caller ID - Decodes the caller ID data and sends it to your serial port in a pre-formatted ascii character string. Example: *12/31 08:45 850-863-5723 Weeder, Terry <CR>. Keep a log of all Incoming calls. Block out unwanted callers to your BBS or other modem applications. **\$35**

Touch-Tone Input - Decodes DTMF tones used to dial telephones and sends them to your serial port. Keep a log of all outgoing calls. Use with the Caller ID kit for a complete in/out logging system. Send commands to the Home Automation or Digital I/O kits using a remote telephone. **\$34**

Telephone Call Restrictors

Two modes of operation: either prevent receiving or placing telephone calls (or call prefixes) which have been entered into memory, or prevent those calls (or call prefixes) which have not been entered.

Block out selected outgoing calls. Bypass at any time using your password. **\$35**

Block out selected Incoming calls. Calls identified using Caller ID data. **\$48**

Phone Line Transponder

7 individual output pins are controlled with buttons 1-7 on your touch-tone phone. Automatically answers telephone and waits for commands. Monitor room noises with built in mic. "Dial-Out" pin instructs unit to pick up phone and dial user entered number(s). Password protected. **\$49**

IR Remote Control Receiver

Learns and responds to the data patterns emitted by standard infrared remote controls used by TVs, VCRs, Stereos, etc. Lets you control all your electronic projects with your TV remote. 7 individual output pins can be assigned to any button on your remote, and can be configured for either "toggle" or "momentary" action. **\$32**

DTMF Decoder/Logger

Keep track of all numbers dialed or entered from any phone on your line. Decodes all touch-tones and displays them on a 18 character LCD. Holds the last 240 digits in a non-volatile memory which can be scrolled through. Connect directly to radio receiver's speaker terminals for off-air decoding of repeater codes, or numbers dialed on a radio program. **\$55**

EARN MORE MONEY!

Be an FCC LICENSED ELECTRONIC TECHNICIAN!



No costly school. No commuting to class. The Original Home-Study course prepares you for the "FCC Commercial Radio-telephone License." This valuable license is your professional "ticket" to thousands of exciting jobs in Communications, Radio-TV, Microwave, Maritime, Radar, Avionics and more...even start your own business! You don't need a college degree to qualify, but you do need an FCC License.

No Need to Quit Your Job or Go To School
This proven course is easy, fast and low cost! **GUARANTEED PASS**—You get your FCC License or money refunded. **Send for FREE facts now. MAIL COUPON TODAY!**

Or, Call 1-800-932-4268 Ext. 210

COMMAND PRODUCTIONS

FCC LICENSE TRAINING, Dept. 210
P.O. Box 2824, San Francisco, CA 94126
Please rush FREE details immediately!

NAME _____
ADDRESS _____
CITY _____ STATE _____ ZIP _____

DATA ACQUISITION & CONTROL

AFFORDABLE PLUG-IN BOARDS FOR PC's ISA BUS

ANA100 Analog I/O \$ 99



- * 8 Channel 8-Bit 0 to 5 Volt Input
- * 14 TTL I/O lines
- * Analog Output
- * 400KHz Sampling

DIG100 Digital I/O \$ 39



- * 82C55 PPI
- * 24 or 48 TTL I/O Lines option
- * Selectable Base Address

ANA150 Analog/Counter... \$ 89



- * 8 Channel 8-Bit 0 to 5 Volt input
- * 3 16-Bit Counters
- * 400KHz Sampling

DIG200 Counter I/O \$ 79



- * 3 16-Bit Counters
- * 8 TTL Input lines
- * 8 TTL Output lines
- * Selectable Clock Frequency input

ANA200 Analog I/O \$ 79



- * 1 Channel 12-Bit 0 to 5 Volt Input optional bi-polar
- * 100KHz / 300KHz Sampling rate
- * 24 TTL I/O lines

ANA201 Analog \$ 119



- * 8 Channel 12-Bit * x1, x5, x10, x50 Programmable Channel gain
- * 100KHz Sampling rate

On-Line Product Catalog at Our Web Site

<http://www.Bsof.com>

E-Mail: Sales@Bsof.com

BSOFT Software, Inc.

444 COLTON ROAD * COLUMBUS, OH 43207
PHONE 614-491-0832 * FAX 614-497-9971

CONTROL MEASUREMENT

RELAYS • LIGHTS • MOTORS

TEMPERATURE • PRESSURE • LIGHT LEVELS • HUMIDITY

INPUT

SWITCH POSITIONS • THERMOSTATS • LIQUID LEVELS

MODEL 30 \$79



- * PLUGS INTO PC BUS
- * 24 LINES DIGITAL I/O
- * 8 CHANNEL, 8 BIT A/D/ IN
- * 12 BIT COUNTER
- * UP TO 14K SMP/SEC

MODEL 45 \$189



- * RS-232 INTERFACE
- * 8 DIGITAL I/O
- * 8 ANALOG INPUTS
- * 2 ANALOG OUTPUTS
- * 2 COUNTERS-24 BIT

MODEL 100 \$279



- * 12 BIT 100 KHZ A/D
- * 4 ANALOG OUTPUTS
- * 3 TIMER COUNTERS
- * 24 DIGITAL I/O

MODEL 150-02 ... \$179



- * RS-232 INTERFACE
- * TRMS, 20 AMPS
- * 12 BIT A/D
- * OPTO-ISOLATED
- * COMPLETE DMM

MODEL 40 \$109



- * RS-232 INTERFACE
- * 28 LINES DIGITAL I/O
- * 8 ANALOG INPUTS
- * PWM OUTPUT

MODEL 70 \$239



- * RS-232 INTERFACE
- * 18 BIT A/D
- * 8.5 DIGIT
- * UP TO 60 SMP/SEC

Prairie Digital, Inc.

PHONE 608-643-8599 • FAX 608-643-6754

920 SEVENTEENTH STREET • PRAIRIE DU SAC, WISCONSIN 53678

CIRCLE 150 ON FREE INFORMATION CARD

Electronic Training Videos



Learn electronics quickly and easily with UCANDO's computer-animated training videos. Students can learn at their own pace and professionals will find the UCANDO videos to be a valuable source of reference material. If these videos aren't the best learning tools you've ever seen, return them within 30 days for a

complete refund. These videos are being used by Tech-Schools, CET's, Military Branches, Ham Operators, Industries, and more, across the United States and around the world. Order today and see how UCANDO is ...

"Changing The Way The World Learns Electronics."

VCR Maintenance & Repair ... \$29.98 All others ... \$44.95 each
 • Intro to VCR Repair • Direct Current • Alternating Current • Semiconductors • Power Supplies • Amplifiers • Oscillators • Digital 1 • Digital 2 • Digital 3 • Digital 4 • Digital 5 • Digital 6 • AM Radio • FM Radio Part 1 • FM Radio Part 2 • TV Part 1 • Intro to TV • TV Part 2 • The Front End • TV Part 3 • Audio • Fiber Optics • Laser Technology •

SAVE!!! 6 videos for only \$240 or 12 videos for only \$450



1-800-678-6113

or mail check or money order to:

UCANDO Videos

P.O. Box 928

Greenville, OH 45331



FREE Shipping ... FREE Catalog

RS232/RS422/RS485 Converters



RS232 TO RS485 2 wire

- Makes your RS232 port an RS485 port
- Supports up to 40 RS485 devices
- Automatically determines data direction.
- Signal powered version available

CMC's low cost converters adapt any RS232 port for RS422 or RS485 operation. These converters provide your RS232 device with all the advantages of RS422 or RS485 including reliable high speed operation (up to 200kbaud) and data transmission distances up to 5000 feet. Two AD422s can be used to extend any RS232 link up to 5000 feet. Completely transparent to the system: no software changes of any type are necessary.

ADA485 (requires 9VDC) \$79.00
 ADA485-1 for 110VAC 89.00
 ADA485L signal powered 84.00

RS232 TO RS485 4 wire

- Converts an RS232 port for use with RS422 or RS485 devices
- Supports up to 40 RS485 or RS422 multidrop devices
- Adds multidrop capability to RS232 devices
- Automatically determines data direction.

RS232 TO RS422

- Converts bi-directionally between RS232 and RS422
- Use as a short haul modem
- Plug in and go. No software changes required

AD422 (Requires 9VDC) \$79.00 ADA425 (requires 9VDC) \$89.00
 AD422-1 for 110VAC 89.00 ADA425-1 for 110VAC 99.00

Mention this ad when you order and deduct 5%
 Use Visa, Mastercard or company purchase order

code P9H



Connecticut microComputer, Inc.
 PO BOX 186, Brookfield, CT 06804 (203)740-9890

WWW.2CMC.COM

Fax: (203)775-4595

Kenwood CS-4125 Sale!!!

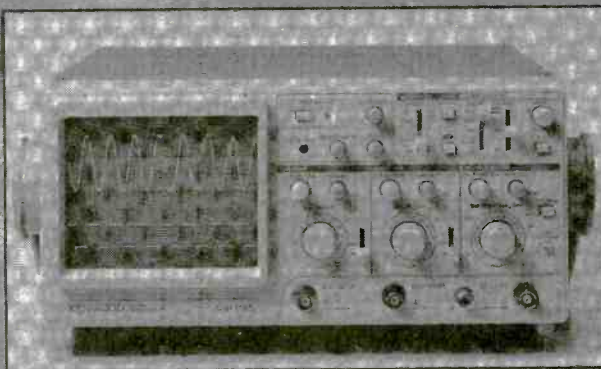

Free KENWOOD t-shirt with purchase of CS-4125 oscilloscope!!!



KENWOOD

MODEL CS-4125

20 MHz, 2 Channel, includes probes
 Suggested Price \$595.00

SPECIAL SPECIAL \$395.00!!!

PRINT™

Products International



8931 Brookville Rd * Silver Spring, MD, 20910 * 800-638-2020 * Fx 800-545-0058

www.prodintl.com

SPARE SCOPE PROBE SPECIAL:

Kenwood PC-35 - 10:1, DC to 50 MHz

Regular \$62.00

SALE \$29.95

Kenwood PC-41 - 10:1/1:1, DC to 50 MHz

Regular \$62.00

SALE \$29.95

Call today for your free 84 page test & measurement instrument catalog!

High Energy Pulsers

Experiment with and Construct Rail Guns, Magnetic Launchers, Coil and Sleeve Guns, Super High Gravity Pulses, Explode Wires and Water, Antigravity, Levitation, Mass Warping, Magnetic Can Crushing, Plasma Propulsion, High Energy Radio Frequency Guns (Herg), EIMP, Lattice Snapping, and all Types of Electrical Pyrotechnics, Plus Much More!!

Features:

Lossless Induction Charging
Programmable Energy Charging to 16 KJ
Triggered Spark Switch

12vdc/115vac Input
1 to 10KV Output*
Optional Designs Available

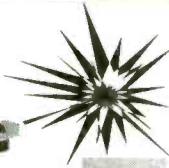

HEP3 Plans for 1 to 2KV @1 KJ	\$15.00
HEP3K Kit with 500J	\$349.95
HEP3K Assbled Above	\$449.95
HEP9 Plans Higher Energy 1 to 10 KV @ 16 KJ	\$20.00

Custom Designs Available on Request

Complete System Projects

PPR01 Plasma Gun Plans With Above HEP3 Plans	\$20.00
MASS1 Mass Driver/Magnetic Cannon Plans With HEP3 Plans	\$20.00

Jacobs Ladder

Observe a pyrotechnical display of "Traveling" fiery plasma. Starts off as 1/2" arc and expands to over 3" before evaporating into space. This is an excellent attention getting display as well as a winning science project!! With arc control.



JACK1 Plans	\$8.00
JACK1K Kit Minus Case	\$129.95
JACK10 Ready to Use	\$249.95

3 Mile Voice Xmitter

Listen to Children or Invalids in Hazardous Areas, Pools, Ponds etc. Great Security Intrusion Alert!! Uses FM Table Top Radio. Become the local neighborhood D.J.



FMV1K Kit/Plans	\$39.95
-----------------	---------

Cybernetic Ear!

Enhances Normal Hearing 3 to 4 Times. Provides That Extra "Edge" Hunters Trackers Nature Enthusiasts

Adjustable Volume Control
Fits Into Either Ear
Built In Long Lasting Batteries



CYBEREAR	\$19.95
----------	---------

Micro Tesla Coil

Lights up a 4 ft Fluorescent Tube Without Contact!!! Yet Only 3" Tall!

Super Magic Trick
Low Cost Science Project
12 VDC/115 VAC Operation



MTC1K Kit/Plans	\$24.95
MTC10 Assembled	\$34.95

Burning Laser Ray Gun

Blasts thru the Hardest of Metals



We Stock all Individual Parts

LAGUN2 Plans	\$20.00
--------------	---------

Poor Mans CO2 Burning Laser

Build a relatively high powered laser from homemade parts. Eliminates glass blowing and complicated machining. Shows many low cost alternatives and approaches. Generates over 10 watts of burning energy. Great science project. Build for less than \$100.00.

LC3 Plans	\$15.00
-----------	---------

Phaser Pain Field Pistol

CAUTION! Do Not Aim at People!

Blast out rats and other rodents with high powered ultrasonics



Handheld and battery operated with all controls

Rental units available

PPP1 Plans	\$8.00
PPP1K Kit/Plans	\$49.95
PPP10 Ready to Us	\$79.95

Hover Boards

28 Pages of "how to" build a magnetic force field capable of containing a column of ionized air up to several psi! Includes theory on how to build a HOVERBOARD prototype capable of lifting 200 lbs.



HOVER Plans and Data	\$25.00
----------------------	---------

Electronic Hypnosis/Mind Machines! TAKE CONTROL!!

Electronic Circuitry Induces Hypnotic as Well as ALPHA Relaxed States of the Mind. Place Subjects "Under Your Control. Enhances Hidden PSYCHIC Ability in Many People!!



MIND2 Plans	\$15.00
MIND2K Kit/Plans	\$49.95
MIND20 Ready to Use	\$79.95

Intended For Hypnosis

HYP2 Plans	\$10.00
HYP2K Kit/Plans	\$49.95
HYP20 Ready to Use	\$69.95

Telephone Taping System

Extends Taping Time by X4, Automatically tapes both sides of phone conversation-Check Laws!



TAPE30X Ready to Use	\$84.95
BEEP10 Beeper Alert	\$29.95

Transistorized TESLA Coil

Amazing and Bizzare Effects Turn a Normal Light Bulb into a Spectacular Plasma Display!! Excellent Science Project



- Transmits Wireless Energy
- Noiseless Operation
- Pyrotechnic Effect
- 12 VDC/5 Amps or Battery
- Adjustable Frequency
- Control For Effect

TCL5. Plans	\$8.00	TCL5K. Kit/Plans	\$59.95
TCL50. Assembled and Tested	\$99.95		
12DC/7. 12VDC@7Amps Supply	\$39.95		

1 800 221 1705 Orders Only! Fax 1 603 672 5406 Information 1 603 673 6493 Free Catalog on Request
Pay by MC,VISA,Cash, Check, MO, COD. Please Add \$5.00 S&H plus \$5.00 if COD. Overseas Please Contact for Proforma

New and Pre-Owned Test Equipment

Goldstar



Model OS-5100 → \$899.00
Full 100 MHz Bandwidth!

- Dual-Channel, High Sensitivity
- TV Synchronization Trigger
- Calibrated Delayed Sweep
- Includes Two Probes, 2 Year Warranty

Spectrum Analyzer

Avcom PSA-37D

Satellite Downlink
Installation
Maintenance & Service

- Band 1 10 - 1750 MHz
 - Band 2 3.7 - 4.2 GHz
 - Built-in DC Block & Power for LNA/LNB's
 - Line or Battery Powered
- Only \$2,475.00!

We Buy Surplus Test Equipment

Leader CATV Signal Level Meter Model LF 941

- ✓ TV/CATV Coverage from 46 - 870 MHz
- ✓ Video/Audio Carrier Measurements \$695.00!

Just Released! → "Series III" Multimeters

Fluke Model 87III \$319.00 III

SIMCHECK® II PLUS Module Tester

- * Tests SIMMs/168 p DIMMs
 - * Stand alone/portable
 - * Identifies Module properties
 - * Advanced Setup Capabilities
- Only \$2750.00!

(1-800-996-3837)

Pre-Owned Oscilloscope Specials

Tektronix 2213	60 MHz	\$549.00
Tektronix 2215	60 MHz	\$649.00
Tektronix 465	100 MHz	\$599.00
Tektronix 465B	100 MHz	\$729.00
Tektronix 475	200 MHz	\$829.00
Tektronix 475A	250 MHz	\$999.00

- Professionally Refurbished
- Aligned & Calibrated to Original Specifications
- The Industry Standard of Oscilloscopes
- 1 Year Warranty - The Longest Available!!!

See us on the Web!
www.fotronic.com

Test Equipment Depot

A FOTRONIC CORPORATION COMPANY

99 Washington St. Melrose, MA 02176

(781) 665-1400 • FAX (781) 665-0780

email: sales@fotronic.com



TOLL FREE 1-800-99-METER

"I Got The Career I Wanted And The Pay I Deserve. You Can Too!"

*Earn up to \$20/Hour and
more as a PC Specialist*

Were you passed up for the promotion because someone had the computer skills you didn't? Are you entering the job market again? Or, do you want your business to run more efficiently?

A lot of ambitious people, like you, have been asking these same questions. Foley-Belsaw has the



answer. The Personal Computer Repair Course.

With Foley-Belsaw's Computer Repair Course, you'll get the computer skills to land a better job or start a business of your own. Trained Computer Repair Technicians can

earn \$25 to \$40 an hour and that's just a start. In a business of your own you can charge \$75 to \$125 an hour for many repair jobs.

The Computer Repair Course is complete. You'll learn using basic step by step easy to understand language. Soon you'll be proficient at all types of advanced repair procedures. With your new skills you can earn a good living and start living better - regardless of your previous computer experience. It's just that simple.

Get The Foley-Belsaw Training Advantage

Since 1926, Foley-Belsaw has been helping people build a better future. We provide you the training, technical support and resources to succeed. You set your own study pace and train at home. Our SkillPak lessons teach a variety of computer

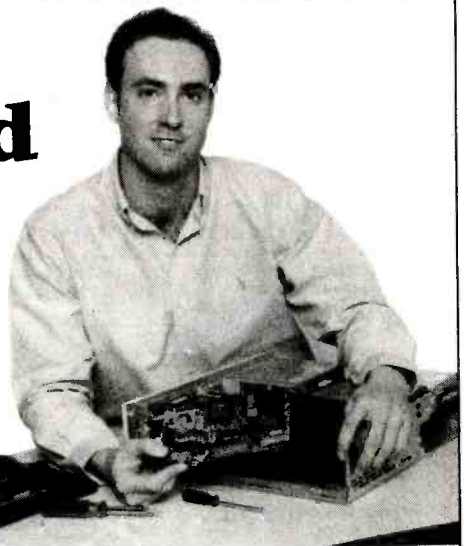

operations. You practice as much as you want. There aren't any deadlines and most students complete the course in a few months - at home and in your spare time.

Turn your doubts into dreams. Get the career you want and the pay you deserve. Call or send for your free opportunity kit for the Computer Repair Course or in the electronics field that interests you. Opportunities await you. The information is free and there is no obligation.

*Fill in and
mail coupon below or
Call Toll-Free
1-800-487-2100 Ext. 22
to receive full
information and details
free by return mail.*

DO IT TODAY!

1. Computer Repair, Maintenance & Upgrade: (NEW) Service the information superhighway as a skilled computer technician. The computerization of America can mean big money to you.

2. Computer Programming: Skilled programmers are in demand and technology is the wave of the future. Secure your future. Learn computer languages and programming skills.

3. TV/Satellite Dish: Entertainment is big business. Here's your lucky break. Earn top dollar as a skilled satellite dish technician.

4. Electrician: The opportunities are endless. As a trained commercial or residential electrician your

future is sure to be bright. Earn while you learn in this fast-growing field.

5. VCR/DVD Cleaning, Maintenance & Repair: Learn troubleshooting skills for repairing and servicing VCRs and earn up to \$50 an hour.

6. Networking Specialist: Fast-paced America depends on

efficiency. Networking specialists can earn great money tying personal computers together to make efficient operating systems.

7. PC Specialist: Learn word processing, spreadsheet and database applications.



Foley-Belsaw Institute

6301 Equitable Road • Kansas City, MO 64120
Please Check Only ONE of the Following:

YES! Rush me a free information kit on the Computer Repair Course right away. 321

- VCR/DVD Repair, 320
- Computer Specialist, 325
- Computer Programmer, 323

- TV/Satellite Dish, 322
- Electrician, 326
- Networking Specialist, 324

Name _____
Street _____
City _____ State _____ Zip _____

Or Call Toll-FREE 1-800-487-2100 Ext. 22

"Even before I finished my course, I got my first raise. Thank you Foley-Belsaw."

John O., Chicago, IL

CALL TOLL FREE
(800) 292-7711
Orders Only
 Se Habla Español

C&S Sales

Look For Other
Monthly Specials
On Our Website

Excellence in Service

www.cs-sales.com

Power Supplies

Elenco Quad Power Supply
 Model XP-581
\$79.95



4 Fully Regulated DC Power Supplies in One Unit

4 DC voltages: 3 fixed - +5V @ 3A, +12V @ 1A, -12V @ 1A
 1 Variable - 2.5 - 20V @ 2A

Elenco Power Supply Kit
 Model XP-720K
\$54.95



- 1.5VDC - 15VDC @ 1A
- -1.5VDC - -15VDC @ 1A
- 5VDC @ 3A
- 6.3VAC @ 1A & 12.6VAC center tapped @ 1A

XP-720 Fully Assembled **\$85**

Elenco DC Power Supply
 Model SPL-603
3A 0-30VDC \$79.95

The SPL-603 is a solid-state DC power supply providing the exact output voltage no matter what current you use. It contains one fully regulated power supply. The variable voltage is capable of delivering 0-30V at up to 3A. The output is precisely held at the desired output voltage by a special regulating circuit. Output fully protected from overload.



Miscellaneous

Elenco Model EP-50
 Electronic Playground and Learning Center
 Contains Over 50 Experiments
\$19.95



Elenco Model XK-150
 Digital/Analog Trainer
\$89.95



Ideal for Schools

Elenco Model MX-9300

Four Functions in One



\$450

Features:

- One instrument with four test and measuring systems:
- 1.3GHz Frequency Counter
- 2MHz Sweep Function Generator
- Digital Multimeter
- Digital Triple Power Supply - 0-30V @ 3A, 15V @ 1A, 5V @ 2A

Generators & Counters

Elenco Sweep Function Generator
 w/ built-in frequency counter Model GF-8036
\$225



This sweep function generator with counter is an instrument capable of generating square, triangle, and sine waveforms, and TTL CMOS pulse over a frequency range from 0.2Hz to 2MHz.

10 Function 1.3GHz Universal Counter
 Elenco Model F-1300
\$225



- Frequency .05Hz - 1.3GHz 3 Ranges
- Period - Can read 80Hz to 80.000000 F=1/T
- Totalize - Counts to 999,999,999
- RPM - 3 to 20999994 RPM
- Duty Cycle
- Max/Min/AVG with Time
- Stop-watch set 2 sec. to 100 hrs.
- Math Functions
- Timer - 2 sec. to 99 days
- Pulse Width - 0.1ms to 66666.6ms

Multifunction Counter
 B&K Model
\$189



Elenco Handheld Universal Counter
 Model F-2800
\$99



Elenco RF Generator with Counter
 (100kHz - 150kHz) Model SG-9500
\$225



Features internal AM mod. of 1kHz, RF output 100MV - 35MHz. Audio output 1kHz @ 1V RMS.

SG-9000 \$119.95 (analog, w/o counter)

B&K 20MHz Sweep/Function Generator with Frequency Counter
 Model 4040
\$445



- 0.2Hz to 20MHz
- AM & FM modulation
- Burst Operation
- External Frequency counter to 30MHz
- Linear and Log sweep

10MHz Model 4017 \$319
 5MHz Model 4011 \$249

BK PRECISION

Measures Frequency, Period, Data Hold, Relative, Memory (min., max., average). High Sensitivity, Microprocessor Controlled.

Features 10 digit display, 16 segment and RF signal strength bargraph. Includes antenna, NiCad battery, and AC adapter.

Kit Corner

over 100 kits available

Model AK-870
 Radio Control Car Kit
\$24.95



- Solderless
- 7 Functions
- Radio Control Transmitter Included

Model AM/FM-108K
 AM/FM Transistor Radio Kit w/ Stand
\$29.95

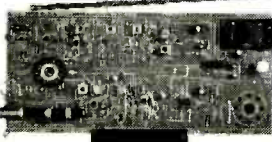

Model AK-700
 Pulse/Tone Telephone Kit
\$15.95



Ideal School Project

Elenco Digital / Analog Trainer

Model XK-700

Elenco's newest advanced Digital / Analog Trainer is specially designed for school projects. It is built on a single PC board for maximum reliability. It includes 5 built-in power supplies, a function generator w/ continuously sine, triangular and square waveforms, 1,560 tie point breadboard area. Tools and meter shown optional. (Mounted in a professional tool case made of reinforced metal).

XK-700 Assembled & Tested **\$189.95**
 XK-700K - Kit **\$159.95**



Made in USA

Guaranteed Lowest Prices

UPS SHIPPING: 48 STATES 5%
 OTHERS CALL FOR DETAILS
 IL Residents add 8.25% Sales Tax

C&S SALES, INC.

150 W. CARPENTER AVENUE
 WHEELING, IL 60090
 FAX: (847) 541-9904 (847) 541-0710

15 DAY MONEY BACK GUARANTEE
2 YEAR FACTORY WARRANTY

PRICES SUBJECT TO CHANGE WITHOUT NOTICE

CIRCLE 32 ON FREE INFORMATION CARD

SAME DAY SHIPPING C&S Sales

Excellence in Service

CALL OR WRITE FOR OUR FREE 64 PAGE CATALOG! (800) 445-3201

Digital Multimeters

Elenco LCR & DMM Model LCM-1950



12 Functions
Freq. to 4MHz
Inductance
Capacitance
and Much More

\$69

Elenco Model M-1740 \$39.95



11 Functions:
• Freq. to 20MHz
• Cap. to 20µF
• AC/DC Voltage
• AC/DC Current
• Beeper
• Diode Test
• Transistor Test
• Meets UL-1244 safety specs.
Model M-2760 - \$24.95 (9 functions)

Fluke 79III \$185



• Capacitance ranges from 99.99nF to 9999µF.
• Built-in frequency counter of voltage input from 1Hz to over 20kHz.
• Lo-Ohms range, a 40Ω range with Fluke's proprietary Zero Calibration, offers 0.01 resolution with increased noise rejection.
Series II (limited qty.) **\$179**

Fluke 87III \$299



Features high performance AC/DC voltage and current measurement, frequency, duty cycle, resistance, conductance, and capacitance measurement.
Series II (limited qty.) **\$289**

Elenco Model LCR-1810 \$99.95



• Capacitance .1pF to 20µF
• Inductance 1µH to 20H
• Resistance .01Ω to 2000MΩ
• Temperature to 750°C
• DC Volts 0 - 20V
• Frequency up to 15MHz
• Diode/Audible Continuity Test
• Signal Output Function
• 3 1/2 Digit Display

Elenco Model M-1005K \$14.95



Digital Multimeter Kit
• 18 Ranges
• 3 1/2 Digit LCD
• Transistor Test
• Diode Test

M-1000B (Assembled) \$14.95

Dual-Display LCR Meter w/ Stat Functions B&K Model 878 \$219.95



Auto/manual range
Many features with Q factor
High Accuracy

Elenco Model 6100 \$99.95



• True RMS of high speed signals
• Computer Interface and software
• Frequency to 200kHz
• Capacitance to 40µF
• Large 3 3/4 LCD display
• Captures and displays max, min, & avg.
• Relative % to reference
• Three hold system
• Analog bar graph and pointer
• Audible continuity
• Auto power off
• Unit Indicator
• Diode test

Oscilloscopes

Free Dust Cover and 2 Probes



S-1325	25MHz	Dual Trace	\$325
S-1330	25MHz	Delayed Sweep	\$439
S-1340	40MHz	Dual Trace	\$475
S-1345	40MHz	Delayed Sweep	\$569
S-1360	60MHz	Delayed Sweep	\$749
S-1390	100MHz	Delayed Sweep	\$995

DIGITAL SCOPE SUPER SPECIALS

DS-203	20MHz/10Ms/s Analog/Digital	\$695
DS-303	40MHz/20Ms/s Analog/Digital	\$995
DS-603	60MHz/20Ms/s Analog/Digital	\$1295

TEKK Radios

Both Models Available In Yellow, Blue & Black

Pro-Sport FRS Two-Way Radio Model PRO-SPORT+

Talk up to 2 miles!

Model PRO-SPORT

• 1/2 Watt Output, 14 Channels.
• TX LED Indicator.
• Removable Belt Clip.
• Highly Water Resistant.
• Economy Type
• No License Required!

\$68.00 each or 2 for \$109.95



No License Required

Model PRO-SPORT +

• 1/2 Watt Output, 14 Channels.
• TX & RX LED/LCD Indicators.
• Large LCD Display.
• 38 Privacy (CTCSS) Tones.
• Plus All Features of Pro-Sport Model.

\$79.00 each or 2 for \$149.95



Elenco Technician Tool Kit

Model TK-1500 \$49.95

28 tools plus a DMM (M-1000B) contained in a large flexible tool case with a handle ideal for everyone on the go.



Guaranteed Lowest Prices

C&S SALES, INC.

15 DAY MONEY BACK GUARANTEE
2 YEAR FACTORY WARRANTY

UPS SHIPPING: 48 STATES 5%
OTHERS CALL FOR DETAILS
IL Residents add 8.25% Sales Tax
SEE US ON THE WEB

150 W. CARPENTER AVENUE
WHEELING, IL 60090
FAX: (847) 541-9904 (847) 541-0710
▶ www.cs-sales.com



PRICES SUBJECT TO CHANGE WITHOUT NOTICE

Any waveform you want!



New Features:

- ✓ 21.5 MHz
- ✓ .01 Hz steps
- ✓ multi-unit phaselock

Telulex Inc. model SG-100A

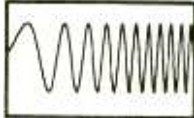

DC to 21.5 MHz linear and log sweeps

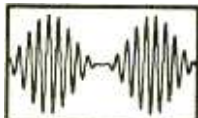

Int/Ext AM, SSB, Dualtone Gen.



Int/Ext FM, PM, BPSK, Burst

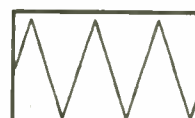

Ramps, Triangles, Exponentials



Pulse Generator

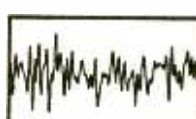

Noise

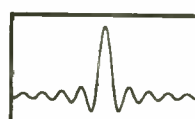

Arbitrary Waveforms

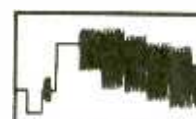

Unlimited Possibilities!

● Synthesized Signal Generator

Clean sinewaves DC-21.5 MHz, .001% accuracy! .01 Hz steps. DC Offset. RS232 remote control.

● Arbitrary Waveform Generator

40 Megasamples/Second. 32,768 points. 12 bit DAC

● Function Generator

Ramps, Triangles, Exponentials & more to 2 MHz!

● Pulse Generator

Digital waveforms with adjustable duty cycle

Telulex Inc.

2455 Old Middlefield Way S Tel (650) 938-0240 <http://www.Telulex.com>

Mountain View, CA 94043 Fax (650) 938-0241 Email: sales@Telulex.com

CIRCLE 137 ON FREE INFORMATION CARD

ELECTRONIC COMPONENTS



Visit our web site!
www.mouser.com

Subscribe, download, or
view catalog online!

- Over 90,000 Products
- More than 200 Suppliers
- Same Day Shipping
- No Minimum Order

800-992-9943

817-483-6828 Fax: 817-483-6899
catalog@mouser.com

958 North Main St., Mansfield, TX 76063

CIRCLE 165 ON FREE INFORMATION CARD

COPY RENTAL TAPES

WITH OUR VIDEO STABILIZERS

BEFORE



AFTER



The clearest picture possible
playing back movies.
GUARANTEED
to eliminate copy protection.

- No Rolls/Jitters/Flickers/Fading
- Works on all TV's, VCR's Beta & Cable
- Gold Video Connectors & Cables Included
- 1 Year Warranty
- Money Back Guarantee

VISION ELECTRONICS
1-800-562-2252

2609 S. 156TH CIRCLE • OMAHA, NE 68130
<http://www.modernelectronics.com>

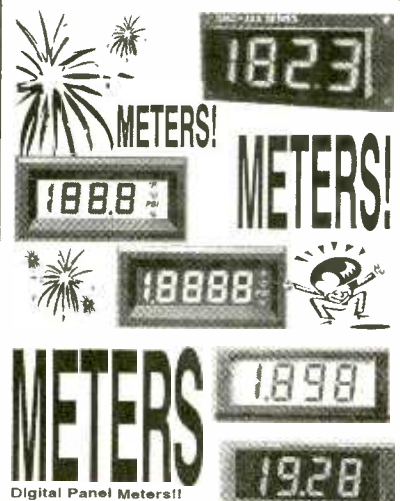

Digital Panel Meters!
LCDs • LEDs • 3 1/2 digits
• 4 1/2 digits • loop powered • adjustable voltage
input • bezel mount • surface mount • miniatures •
big digits • black • red • amber • green • negative
backlighting • positive backlighting • RF resistant •
EMI resistant • displayed engineering units • snap-in •

For the best selection...
800-356-4920

Visit our catalog on the web
www.knsinstruments.com

KNS Instruments
PO Box 10158
Bedford, NH 03110-0158
Fax 800-356-1250

velleman Remote Control Kits

K6700 2-WIRE REMOTE CONTROL TRANSMITTER

\$14.95

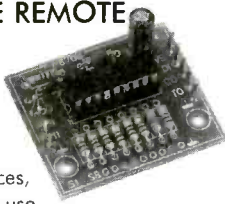

Control up to 16 devices, with only 2 wires! For use with K6701 kit

Remotely control 8 (*16 with 2 units) devices up to 160 feet away. Transmitter is powered over the data wires. Simple operation by means of switches (not included). Transmitter can drive multiple receivers

K6701 2-WIRE REMOTE CONTROL RECEIVER

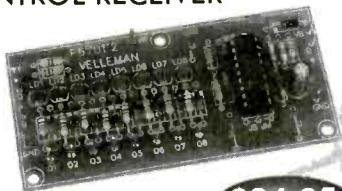

\$24.95

8 open collector outputs (max 200mA)

LED output status indication. Doisy chain 2 units for 16 outputs. Power supply: 6-16V DC

K6708 IR REMOTE CONTROL KEY CHAIN TRANSMITTER KIT

\$14.95



Transmitter for use with K6709 kit.

Range: Up to 24 feet. LED operation indicators. Over 8000 different code settings. Power supply: 12V battery type V23GA or GP23GA (not included)

K6709 IR REMOTE RECEIVER

\$24.95

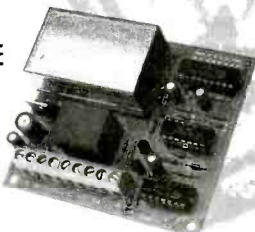

For K6708 kit.

The easy way to add a remote control 5A relay with momentary or pulse changeover contact. Allows control of alarm systems, garage doors, outdoor lighting, garden pumps, etc. LED reception indicator. Accepts multiple transmitters K6708. Power supply 2x9VAC or 12 to 16VDC

K6706A TWO CHANNEL RF KEY CHAIN TRANSMITTER KIT

\$19.95



For use with K6707 kit

Very handy key chain size. LED operation and battery indicator. Over 8000 code settings for your security. Transmitter does not need to 'see' the receiver. 433MHz operation. Max. open field range: 30m / 98'. Needs 12V battery type V23GA or GP23A (not included)

K6707 ONE CHANNEL RF REMOTE RECEIVER KIT

\$24.95

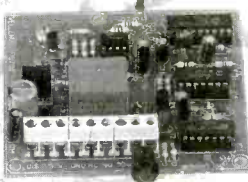

Operate lighting, arm alarm systems, open carports, etc from a comfortable distance

Goes with the K6706A key chain transmitter. Control appliances up to 5A. Easy to assemble, no coils to wind. Over 8000 code settings for your security. Receiver does not need to 'see' the transmitter. 433MHz operation. Power supply: 2x9VAC or 12 to 16VDC. 100mA max.

K6714 UNIVERSAL RELAY CARD KIT

\$69.95



Allows power switching of appliances with K6701/K6711/K8000 kits

Eight 5A relays with switch over contact (extendible to 16). Transformer included (also powers K6701 / K6711). Optional manual or TTL-level switching possibility. Power supply: 110-125VAC 60Hz

K6710 15-CHANNEL INFRARED TRANSMITTER KIT

\$69.95



For use with K6711 and K6712

15 independent channels. 2 preset memories. Very attractive aluminum enclosure and tactile keyboard. Max. range: 7m/23'. Power supply: 9V battery (not included)

K6711 15-CHANNEL INFRARED RECEIVER KIT

\$49.95

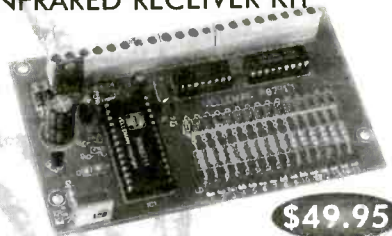

For use with K6710 15-channel IR transmitter kit

15 independent output channels with LED indication. Toggle/pulse selection of each channel. Single channel on mode (all others off). Microprocessor controlled. Load: up to 100mA/50V per channel. Power supply: 8-14VDC or 2x12VAC / 150mA

K6712 IR REMOTE CONTROLLED DIMMER KIT

\$59.95

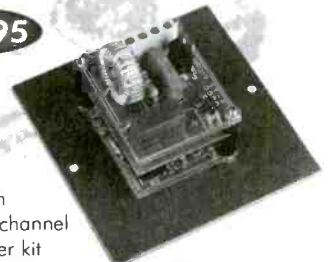

For use with K6710 15-channel IR transmitter kit

Up to 15 units can be controlled with one remote. Manual operation possible. With attractive front panel. Fits in most light switch spaces. Max. load: 2A (4A with heatsink). Power supply: 110-125VAC 60Hz

Available at:

Tech America

Tel: (800) 877-0072

velleman

7415 Whitehall Street Suite 119

Fort Worth, TX 76118

(817) 284-7785 F: (817) 284-7712

www.velleman.be email: velleman@earthlink.net

Questions? Contact us for a list of US distributors or to get your FREE catalogue

CIRCLE 163 ON FREE INFORMATION CARD

Turn Your Multimedia PC into a Powerful Real-Time Audio Spectrum Analyzer

Features

- 20 kHz real-time bandwidth
- Fast 32 bit executable
- Dual channel analysis
- High Resolution FFT
- Octave Analysis
- THD, THD+N, SNR measurements
- Signal Generation
- Triggering, Decimation
- Transfer Functions, Coherence
- Time Series, Spectrum Phase, and 3-D Surface plots
- Real-Time Recording and Post-Processing modes

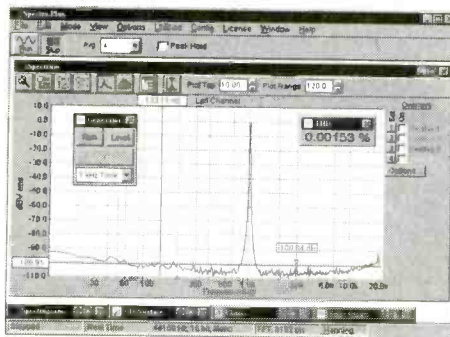

Applications

- Distortion Analysis
- Frequency Response Testing
- Vibration Measurements
- Acoustic Research

System Requirements

- 486 CPU or greater
- 8 MB RAM minimum
- Win. 95, NT, or Win. 3.1 + Win.32s
- Mouse and Math coprocessor
- 16 bit sound card

Priced from \$299

(U.S. sales only – not for export/resale)

DOWNLOAD FREE 30 DAY TRIAL!

www.spectraplus.com

PHS Pioneer Hill Software
24460 Mason Rd.
Poulsbo, WA 98370
a subsidiary of Sound Technology, Inc.



Spectra Plus
FFT Spectral Analysis System

Sales: (360) 697-3472

Fax: (360) 697-7717

e-mail: pioneer@telebyte.com

BEST DEALER PRICING!
CABLE DIRECT
CONVERTERS • FILTERS
DESCRAMBLERS

IMPROVE YOUR IMAGE WITH
VIDEO STABILIZERS

FREE CABLE TV CATALOG!

100% MONEY BACK GUARANTEE!

30 DAY FREE TRIAL!

Now you can tune-in your favorite cable TV programming and **SAVE \$100'S - EVEN \$1000'S** on premium **CABLE TV EQUIPMENT.**



MODERN ELECTRONICS
1-800-906-6664

2609 S. 156TH CIRCLE • OMAHA, NE 68130
<http://www.modernelectronics.com>

FREE! (a \$20.00 VALUE)

CONSTRUCT THOSE SIMPLE AUDIO PROJECTS FROM SESCOM SIPs

JUST APPLY SIGNAL, POWER AND OUTPUT CONNECTIONS AND YOU ARE READY TO GO. SIMPLE CONSTRUCTION. PINS ARE ON 0.1" CENTERS.

GET YOUR SIP-1 AUDIO MODULE TODAY
ONLY \$2.00 FOR SHIPPING AND HANDLING. EXPERIMENT FOR YOURSELF TO SEE THE BENEFITS OF THESE DEVICES. THERE ARE 25 DIFFERENT DEVICES IN THE SIP PRODUCT LINE.

OFFER GOOD ONLY IN THE 48 STATES. OFFER ENDS DECEMBER 20, 1999. LIMIT ONE REQUEST PER CUSTOMER. MUST BE PREPAID BY CREDIT CARD OR CHECK. MAILED 1ST CLASS. ALLOW 1-2 WEEKS FOR DELIVERY.

ORDERS 800-634-3457 • FAX 800-551-2749
OFFICE: 702-565-3400 • FAX 702-565-4828
www.sescom.com • info@sescom.com
SES.COM, INC. 2100 WARD DR. HENDERSON, NV 89015
SES.COM, INC. is not responsible for inadvertent typographical errors and prices and specifications are subject to change without notice.

VIDEO SYNC GENERATOR

Restores Horizontal and Vertical Sync Lines from Distorted Video

Lost Sync

Restored Sync with VSG

For Free Information Package and Pricing

Call (219) 233-3053
www.south-bend.net/rcd

R.C. Distributing, PO Box 552, South Bend, IN 46624

PROGRAMMERS OVER 50 MODELS

ADVANTECH EETTOOLS NEEDHAM'S DATA I/O ICE TECHNOLOGY HILO SYSTEM GENERAL CHROMA MODULAR CIRCUIT TECHNOLOGY XELTEK

PROMAX EMP-20 MEGAMAX MEGAMAX-4 SIMM/SIP TESTER EMU/PA

CALL ADVANTECH LABTOOL	599 EETTOOLS SIMMAX
629 ICE TECH MICROLV	795 CHROMA SIMM/SIP
650 EETTOOLS ALLMAX -	359 MOD-MCT-EMU/PA/R
409 EETTOOLS MEGAMAX	279 MOD-MCT-EMUP/R
509 EETTOOLS MEGAMAX4	49 EPROM 1G TO 512K
369 XELTEK SUPERPRO II	69 EPROM 1G TO 1MEG
409 XELTEK SUPERPRO II P	99 EPROM 4G TO 1MEG
249 XELTEK SUPERPRO L	199 EPROM 16G TO 1 MEG
165 XELTEK ROMMASTER II	89 EPROM 1G TO 8MEG
479 MOD-MCT-EMUPA	129 EPROM 4G TO 8MEG
739 STAG ORBIT-32	250 EPROM 8G TO 8MEG

LABTOOL48 MICROMASTER SUPERPRO ALLMAX PLUS ROMMASTER2

General Device Instruments
Sales 916-393-1655 Fax 916-393-4949 BBS 983-1234
www.generaldevice.com E-Mail icdevice@best.com

YOU CAN WIND YOUR OWN COILS?

There's no trick to it except knowing what you are doing. In a unique, 106-page book you can become expert in winding RF, IF, audio and power coils, chokes and transformers. Practically every type of coil is discussed and necessary calculations are given with the mathematical data simplified for use by anyone. Get your copy today!

Coil Design and Construction Manual

Mail coupon to:

Electronics Technology Today, Inc.
P.O. Box 240
Massapequa Park, NY 11762-0240

Please send me my copy of *Coil Design and Construction Manual* (BP160). I enclose a check or money order for \$8.99 to cover the book's cost and shipping-and-handling expenses. NY state residents must add local sales tax.

Name _____

Address _____

City _____ State _____ ZIP _____

All orders must be paid in U.S. funds only. Sorry, no orders accepted outside of USA and Canada. Please allow 6-8 weeks for delivery. ET07

CABLE TV BOXES

Hablamos Español!!

We'll Beat Any Price!

30 Day Trial • 1yr. Wrnty • Free Catalog • Qty. Discounts • Dealers Welcome!

1-800-538-2225

Galaxy Electronics Inc.
www.Galaxydescramblers.com

MCM ELECTRONICS®

The Source For All Of Your Electronics Needs

When ordering, please provide this code: **SOURCE CODE: POP69**

Prices effective Aug. 17, 1999 through Oct 29, 1999



ONLY \$29.50

Order #22-3875

•Constructed with durable lightweight aluminum

•Adjustable dividers •Tool palate with 17 tool pockets •Dimensions: 18" x 13" x 6½"

•Regular price \$39.95



ONLY \$14.95

Order #29-1335

12 volt, 4.5 Amp/hour battery is ideal for security and other power backup applications. 0.25" tabs accept standard quick-disconnects. Dimensions 3½" x 2½" x 4". **Regular price \$26.95**

ONLY \$69.95

Order #82-3890



•Measures only 1½" square •3.6mm lens •92° viewing angle •Requires 12VDC, 100mA •NTSC composite video output •75ohm •**Regular price \$79.95**

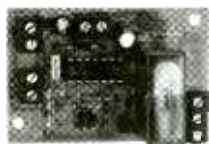

As Low As \$5.99

Ideal for repairing old equipment, prototype work or your latest project. These well constructed PCBs are fully assembled, tested and ready to use. Supplied with application instructions and technical specifications. All operate from a single 12VDC source. Call your MCM Sales Representative for more information on over 120 available modules.

Order #	Description	Reg.	Sale
28-4795	1W audio amplifier	\$7.49	\$5.99
28-4796	5W audio amplifier	13.95	11.15
28-4800	5W x 2 stereo amplifier	24.95	19.96
28-4801	15W x 2 stereo amplifier	39.95	31.96
28-4851	88-108MHz FM transmitter	24.95	19.96
28-5115	Flip-flop relay	16.50	11.96
28-4825	VOX relay	17.95	14.36
28-4815	Electric guitar preamplifier	8.95	7.16



ONLY \$39.95

Order #72-4025

3½ digit DMM measures AC/DC voltage from 200mV-600V, resistance to 2000Mohm, capacitance to 20µF, transistor h_{FE} gain and audible continuity test. Requires 9V battery (#290-080) not included. Dimensions: 2½" (W) x 5½" (H) x 1½" (D). **Regular price \$65.95.**



As Low As \$29.95

Choose the size that best suits your needs. All models have binding post connections, 4A, 7A and 10A versions include a cigarette lighter receptacle. Ripple voltage: <50mV, full load.

Order #	Continuous/Surge Current	(ea.)
72-6621	4A/6A	\$29.95
72-6622	7A/10A	49.95
72-6623	10A/14A	64.95
72-6624	15A/20A	84.95
72-6625	20A/25A	99.95

NEW ONLY \$69.95

Order #50-6270



Ideal for anyone interested in building their own powered subwoofer. •Isolated left/right speaker level inputs •Single line level input •40W/50W RMS/peak output. •Auto turn-on •Continuously variable 40Hz-180Hz crossover •Adjustable level control

Order #111-2974

ONLY \$39.95



Great for use with any benchtop power supply. Allows easy connection and disconnection of multiple accessories. •DC voltage meter •15A fuse •Power switch •Eight pairs of RF bypassed binding posts •**Regular price \$44.95**



Secured Ordering at: www.mcmelectronics.com

Hours: M-F 7 a.m.-9 p.m., Sat. 9 a.m.-6 p.m., EST.



MCM ELECTRONICS®
650 CONGRESS PARK DR.
CENTERVILLE, OH 45459
A PREMIER FARNELL Company

SOURCE CODE: POP69

CIRCLE 161 ON FREE INFORMATION CARD

Learn MICROCONTROLLERS EMBEDDED SYSTEMS and PROGRAMMING...

...with the AES learning system/ embedded control system. Extensive manuals guide you through your development project. All programming and hardware details explained. Complete schematics. Learn to program the LCD, keypad digital, analog, and serial I/O for your applications.



THREE MODELS AVAILABLE. Choose from an Intel 8051, Intel 8088, or Motorola 68HC11 based system. All models come with:

- 32K Byte ROM, 32K Byte RAM • 2 by 16 Liquid Crystal Display • 4 by 5 Keypad • Digital, Analog, and Serial I/O • Interrupts, timers, chip-selects • 26 pin expansion connector • Built-in Logic Probe • Power Supply (can also be battery operated) • Powerful ROM MONITOR to help you program • Connects to your PC for programming or data logging (cable included) • Assembly, BASIC, and C programming (varies with model) • Program disks with Cross Assembler and many, well documented, program examples • User's Manuals: cover all details (over 500 pages) • Completely assembled and ready to use • Source code for all drivers and MONITOR • Optional Text Book

Everything you need. From \$279. Money Back Guarantee

Call for Free Info Pack, or see WEB at <http://www.aesmicro.com> 714-979-1091, FAX 714-979-1093



Call 1-800-730-3232

AES MICRO, INC., 2110 S. LYON ST., SUITE C, SANTA ANA, CA 92705, USA

www.unbound-tech.com **UTI 1-877-UNBOUND**

Development Boards, Microcontrollers, Kits, Control and Measurement

Development, Prototype and Testing

- JCM Vulcan Logic Trainer: Design and test digital circuits in minutes with this trainer and a breadboard. \$32
- JCM Advanced dig daughterboard \$39
- JCM Analog Trainer: Use on its own, or to complement to the logic trainer. test analog circuits in minutes. \$45
- UTI PIC-Micro Trainer: This system gives you the flexibility to test and experiment with micro based designs. includes a 64K-bit non-volatile E² mem. and RS-232 and RS-485 drivers. \$129
- UTI Control Trainer: Real world interface for the trainer series, with inputs and outputs for measurement and control, analog cond., relays, buffered dig I/O, and more. \$69
- JCM Cybug1 kit: a great little robot kit for the hobbyist \$32
- Prototyping breadboard to fit the above

Serial Control and Measurement

- UTI-XX-232:485 Series: measure Inputs and trigger events over serial. uses simple ASCII protocol \$99-\$299
 - UTI-05-XXX: 0-5VDC 4 channel 8 bit A/D
 - UTI-DI-XXX: 0-30VDC 4 channel digital Input. adjustable trigger level
 - UTI-OC-XXX: 8 channel open collector outputs. opt SV pull-up, drive relays or solenoids
 - UTI-RE-XXX: 4 SPDT relays w/ 2A contacts
 - UTI-PM-XXX: 2 channel PWM output with two buffered digital outputs, good for motor control apps. opt H-bridge version.
 - UTI-WM-XXX: ambient temperature and relative humidity. 8 bit resolution - More available....
- UTI-232-485: Speak to an RS-485 device with your PC, extend 500' to other serial devices, or chain several UTI-XX-485 devices. \$129

Microcontroller Boards and Interfaces

These boards include voltage regulation. 64K-bit serial E². RS-232 and RS-485 drivers. interface with screw terminals and/or stackable expansion headers.

- UTI-P76F: A flash PIC micro dev board \$169
- UTI-11A1: A 68HC11 based SBC \$189
- Some interfaces available: \$49-\$99
 - 4 and 8 channel analog zero and span cct
 - 8 SPDT relays with 2A contacts
 - 2A dual H-bridge for motors and solenoids
 - Audio capture. 2-4 min of audio
 - Micro modem rates @ 2400 - 28.8
 - LCD. 2 line x 16 char, and 4 line x 20 char
 - Ambient temperature and relative humidity
- UTI-12CM-XXX-X: Non-volatile PC memory boards (up to 512Kb per board!) \$39

Other Exciting Products

- UTI-WC1: Serial CCD Camera. Board level. takes serial commands through RS-232 at up to 115K Baud, returns CCD data in various res. Great for pics and experimenting. PC SW incl. \$249
- UTI-SCL: WinCam.Live. Serial port based webcam system for your PC. \$499
- UTI-SCP: SecureCam Pro. Remote access surveillance camera, event trigger, motion detection, outdoor encl. available \$599
- UTI-ACC: Capture and play 2-4 min of audio. line level input. dry contact trigger \$129
- UTI-MP-XXX: serial RS232 radios. 900MHz narrow band RF. ch selectable. 1000' range outdoor. combine with our control and measurement products for a telemetry system. \$519

* All prices in US\$

**Shipping and handling not included

We also provide affordable electronic design, consulting, assembly, and product development.



#25-1725 30 Ave NE Calgary, Alberta, CANADA T2E 7P6

Tel: 403-291-0054 Fax: 403-291-0017

Payment by Cash, Chk, MO, COD

Call us to receive details via fax, mail or email.

Do You Repair Electronics?

- Repair Databases for TV, VCR, Monitor, UL Audio, FCC, and more.
- Over 76,000 records
- Private user forums
- Live on-line chat rooms

RepairWorld.com

Electronics Corp - Herald Sq. Fairborn, OH 45324 (937) 878-9878

Website www.j-tron.com

Visit us online and enter our contest for a test meter. Call J-Tron today!

- Components
 - Kits
 - Meters
- 888-595-8766**

BUGGED??

EAVESDROPPING is unbelievably widespread! Electronic Devices with amazing capabilities can be monitoring your telephone and room conversations RIGHT NOW! Are you sure you're safe? **FREE CATALOG** tells you fast! Includes Free Bonus details on fantastic opportunities now open in Counter-Surveillance field. Exciting, immensely interesting and EXTREMELY profitable (up to \$250/hr) full/part-time income. Call Now! **1-800-732-5000**

CABLE BOXES
BEST PRICES
Ship Any where
In U.S.A.

1-800-637-4615
www.xxbox.com

The Pocket Programmer

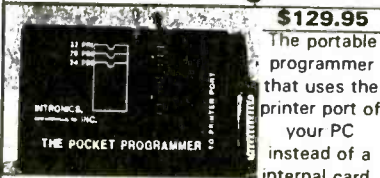

\$129.95

The portable programmer that uses the printer port of your PC instead of an internal card.

Easy to use software that programs E(P)rom, Flash & Dallas Ram. 27(C)/28(C)(F)/29(C)(F)/25 series from 16K to 8 Megabit with a 32 pin socket. Adapters available for MCU's 874X, 875X, Pic, 40-Pin X 16 & Serial Eprom's, PLCC, 5-Gang and Eprom Emulator to 32K X 8.

Same Name, Address & Phone # for 13 Years.... Isn't it Amazing ?

Intronics, Inc.
Box 13723 / 612 Newton St.
Edwardsville, KS 66113 Add \$4.75 COD
Tel. (913) 422-2094 Add \$4.00 Shipping
Fax (913) 441-1623 Visa / Master Charge

Max '99' \$459.90

Used world wide for research!



- * Three 12 inch diameter decks
- * 30 lbs payload capacity
- * HC11 microprocessor w/ 32k ram
- * Basic, Forth and 'C' programming lang.

Zagros Robotics
PO Box 460342
St. Louis, MO 63146-7342
(314) 768-1328
<http://www.zagrosrobotics.com>
info@zagrosrobotics.com

World Passing You By?

Are you interested in Microprocessors & Embedded Control Systems? If not you should be! Look around, just about everything these days has an embedded microprocessor in it. TVs, cars, radios, traffic lights & even toys have embedded computers controlling their actions. The Primer Trainer is the tool that can not only teach you how these devices operate but give you the opportunity to program these types of systems yourself. Examples & exercises in the Self Instruction manual take you from writing simple programs to controlling motors. Start out in Machine language, then move on to Assembler, & then continue on with optional C, Basic, or Forth Compilers. So don't be left behind; this is information you need to know!

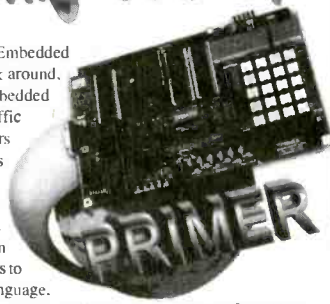

Examples Include:

- Measuring Temperature
- Using a Photocell to Detect Light Levels
- Making a Waveform Generator
- Constructing a Capacitance Meter
- Motor Speed Control Using Back EMF
- Interfacing and Controlling Stepper Motors
- Scanning Keypads and Writing to LCD/LED Displays
- Bus Interfacing an 8255 PPI
- Using the Primer as an EPROM Programmer
- DTMF Autodialer & Remote Controller (New!)

The PRIMER is only \$119.95 in kit form. The PRIMER Assembled & Tested is \$169.95. This trainer can be used stand alone via the keypad and display or connected to a PC with the optional upgrade (\$49.95). The Upgrade includes: an RS232 serial port & cable, 32K of battery backed RAM, & Assembler/Terminal software. Please add \$5.00 for shipping within the U.S. Picture shown with upgrade option and optional heavy-duty keypad (\$29.95) installed. Satisfaction guaranteed.

EMAC, inc.

11 EMAC WAY, CARBONDALE, IL 62901
618-529-4525 Fax 457-0110 BBS 529-5708
World Wide Web: <http://www.emacinc.com>

1985 - 1998
OVER
12
YEARS
OF SERVICE

Oscilloscopes

And Much More From \$99



O-Scope II turns your PC into a DSO, Spectrum Analyzer, Freq. Counter, Logger, DVM and DC-500KHz. Uses standard scope probes. Made in U.S.A.

Pico Technology Ltd.

Resolutions 8 to 16 bits

Sampling rates to 100 msp/s

Loggers to 22 channels

Environmental Monitoring Systems



Order Yours Today!

800-980-9806

MC/Visa/Amex

Allison Technology Corporation

2006 Finney Vallet Rd. Rosenberg, TX 77471 U.S.A.

Phone: 281-239-8500 Fax: 281-239-8006

[Http://www.atcweb.com](http://www.atcweb.com) atc@accesscomm.net

LEADER

For Professionals Who Know The Difference

- Oscilloscopes
- Video Sync/Test Generators
- Waveform Monitors/Vectorscopes
- EFP/ENG Instruments
- RF Signal Level Meters
- Audio Generators & Meters
- Frequency Counters
- Meters & Bridges
- Power Supplies
- Function Generators
- RF Generators

PRINT™

Products International



Call, fax or email for your free test and measurement instrument catalog today!
800-638-2020 / Fax 800-545-0058
www.printintl.com

Test Instruments, Equipment, Tools & Supplies For Electronic Production, Maintenance & Service
8931 Brookville Road, Silver Spring, MD, 20910 * 800-638-2020 * Fax 800-545-0058

CIRCLE 143 ON FREE INFORMATION CARD

USE ELECTRONICS NOW CLASSIFIEDS

READ BY ELECTRONIC BUYERS AND SELLERS AND TRADERS

INSTRUCTIONS FOR PLACING YOUR AD!

HOW TO WRITE YOUR AD

TYPE or PRINT your classified ad copy **CLEARLY** (not in all capitals) using the form below. If you wish to place more than one ad, use a separate sheet for each additional one (a photo copy of this form will work as well). Place a category number in the space at the top of the order form (special categories are available). If you do not specify a category, we will place your ad under miscellaneous or whatever section we deem most appropriate.

We cannot bill for classified ads. **PAYMENT IN FULL MUST ACCOMPANY YOUR ORDER.** We do permit repeat ads or multiple ads in the same issue, but in all cases, full payment must accompany your order.

WHAT WE DO

The first word and company name of each ad are set in bold caps at no extra charge. No special positioning, centering, dots, extra space, etc. can be accommodated.

RATES

Our classified ad rate is \$2.50 per word. Minimum charge is \$37.50 per ad per insertion (15 words). Any words that you want set in bold are each .40 extra. Indicate bold words by underlining. Words normally written in all caps and accepted abbreviations are not charged anything additional. State abbreviations must be post office 2-letter abbreviations. A phone number is one word.

If you use a **Box** number you must include your permanent address and phone number for our files. **ADS SUBMITTED WITHOUT THIS INFORMATION WILL NOT BE ACCEPTED.**

For firms or individuals offering Commercial products or Services. **Minimum 15 Words.** 5% discount for same ad in 6 issues within one year; 10% discount for same ad in 12 issues. **Boldface** (not available as all caps), add .40 per word additional. **Entire ad in boldface**, add 20%. **Tint screen behind entire ad**, add 25%. **Tint screen plus all boldface ad**, add 45%. **Expanded type ad**, add \$4.00 per word.

General Information: A copy of your ad must be in our hands by the 13th of the fourth month preceding the date of issue (i.e. Sept issue copy must be received by May 13th). When normal closing date falls on Saturday, Sunday or Holiday, issue closes on preceding work day. Send for the classified brochure.

DEADLINES

Ads not received by our closing date will run in the next issue. For example, ads received by November 13 will appear in the March issue that is on sale January 17. **ELECTRONICS NOW** is published monthly. No cancellations permitted after the closing date. No copy changes can be made after we have typeset your ad. **NO REFUNDS**, advertising credit only. No phone orders.

CONTENT

All classified advertising in **ELECTRONICS NOW** is limited to electronics items only. All ads are subject to the publishers' approval. **WE RESERVE THE RIGHT TO REJECT OR EDIT ALL ADS.**

AD RATES: \$2.50 per word. Minimum \$37.50

Send you ad payments to:

ELECTRONICS NOW 500 Bi-County Blvd, Farmingdale, NY 11735-3931

CATEGORIES

100 -- Antique Electronics	270 -- Computer Equipment Wanted	450 -- Ham Gear Wanted	630 -- Repairs-Services
130 -- Audio-Video Lasers	300 -- Computer Hardware	480 -- Miscellaneous Electronics For Sale	660 -- Satellite Equipment
160 -- Business Opportunities	330 -- Computer Software	510 -- Miscellaneous Electronics Wanted	690 -- Security
190 -- Cable TV	360 -- Education	540 -- Music & Accessories	710 -- Telephone
210 -- CB-Scanners	390 -- FAX	570 -- Plans-Kits-Schematics	720 -- Test Equipment
240 -- Components	420 -- Ham Gear For Sale	600 -- Publications	730 -- Wanted

CLASSIFIED AD COPY ORDER FORM

Place this ad in Category # _____

Special Category \$30.00 Additional _____

1 - \$37.50	2 - \$37.50	3 - \$37.50	4 - \$37.50
5 - \$37.50	6 - \$37.50	7 - \$37.50	8 - \$37.50
9 - \$37.50	10 - \$37.50	11 - \$37.50	12 - \$37.50
13 - \$37.50	14 - \$37.50	15 - \$37.50	16 - \$40.00
17 - \$42.50	18 - \$45.00	19 - \$47.50	20 - \$50.00
21 - \$52.50	22 - \$55.00	23 - \$57.50	24 - \$60.00
25 - \$62.50	26 - \$65.00	27 - \$67.50	28 - \$70.00

29 - \$72.50	30 - \$75.00	31 - \$77.50	32 - \$80.00
33 - \$82.50	34 - \$85.00	35 - \$87.50	36 - \$90.00
37 - \$92.50	38 - \$95.00	39 - \$97.50	40 - \$100.00

Total words _____ \$2.50 per word = \$ _____

Bold Face _____ \$0.40 per word = \$ _____

Special Heading _____ \$30.00 = \$ _____

Other _____ = \$ _____

Total classified ad payment \$ _____ enclosed

TOTAL COST OF AD \$ _____

Check Mastercard Visa Discover Card # _____ Expiration Date ____/____

Signature _____

Name _____ Phone _____

Address _____ City State Zip _____

Fantastic DMM Offer!

Don't let this price fool you. This meter is a digital multimeter designed for engineers and hobbyists. Equipped with 5 functions and 19 ranges. Each test position is quickly and easily selected with a simple turn of the FUNCTION/RANGE selector rotary switch. Rubber Boot Included!
 Display: 3-1/2 Digit LCD, 21mm Figure Height with Automatic Polarity
 Overrange Indication: 3 Least Significant Digits Blank
 Temperature for Guaranteed Accuracy: 23°C
 ±5°C RH ±7.5%
 Temperature Ranges:
 Operating: 0°C to 40°C (32°F to 104°F)
 Storage: -10°C to 50°C (14°F to 122°F)
 Power: 9V Alkaline or Carbon-Zinc Battery (NEDA 1604)
 Low Battery Indication: BAT on Left of LCD Display
 Dimensions: 188mm(L) x 87mm(W) x 33mm(thick)
 Net Weight: 400g



ONLY \$19

#9300G

7 1/2" Pro Modular Crimping Tool Kit



ONLY \$64.95
 Includes:
 • Heavy Duty Ratchet Crimp Tool
 • 5 Die Sets!
Details on our Web Site

True RMS DMM

ONLY \$69
 CSI-980 DMM
 • Full Sized, 4 1/2 Digit
 • Frequency Range to 20 KHz
 • Capacitance Ranges from 2000 pF to 20 uF
 • I/Fc, Audible Continuity, max & 700VAC max
 • 20k max 1000VDC/20kA
 • Selectable Data Hold Function

Removable Hard Drive Rack For IDE/Ultra DMA Hard Drives

We Sold Over 14,000 in 1998!
 This product can be used with any 3-1/2 IDE hard drive up to 1" high. It includes an electronic keylock for safe removal and insertion. Made of ABS 707 fireproof plastic. Use this product to protect sensitive hard drive data, take your hard drive between work and home or even set up different users with their own hard drives that they physically insert every time they use a PC. Other models available from C.S.I. include RH10 series and RH20 series, which are interchangeable within the same interface design (IDE or SCSI). Other Models are Available. See www.web-tronics.com under "hard drive and accessories" for more details and pictures.



ONLY \$14.95

RH-10C-IDE

Auto-Temp Solder Station with Ceramic Element

ONLY \$39

• With Ceramic Heating Element for More Accurate Temp Adjustment
 • 3 Conductor Grounded Power Cord
 • 250°C-480°C (470°F-900°F)
 • Fast Heating Feature
SR-976
 Extra Tip Options Available. See Web!



www.web-tronics.com
 CTRL - D to bookmark this site
 Don't forget the dash
Circuit Specialists Inc.
 Easy to Navigate • Includes a Search Engine • That Really Works • New Items Added Constantly
 In Business Since 1971

CCD B&W Board Cameras

• ASIC CCD Area Image Sensor
 • Extremely Low Power Consumption
 • 0.5 Lux Min Illumination
 • Built-In Electronic Auto Iris for Auto Light Compensation
Detailed Specs on the Web

VM1030PA
 30mmx30mmx25mm
 Pinhole lens with audio, 12V
\$59.00 \$49.00
 5 or more

Infra-Red! VMCB21
 44mmx38.5mmx28mm with 6 infra-red LEDs, 12V
ON SALE \$59.00
 any qty. Reg. \$69.00

VM1030A
 30mmx30mmx26mm
 Standard lens with audio, 12V
\$59.00 \$49.00
 5 or more

VM1035A
 42mmx42mmx25mm
 Standard lens with audio, 12V with back light compensation
\$77.00 \$68.00
 5 or more

VM1036A
 32mmx32mmx25mm
 Standard lens with audio, 12V, reverse mirror image feature
\$69.00 \$63.00
 5 or more

COLOR CCD Mini Board Cameras

• Low Power Consumption
 • 1 Lux Illumination
 • Built-In Electronic Auto Iris for Auto Light Compensation
 • Internal Synchronization
 • 12Volts
 • 400 TV Lines
VM3010PA
 33mmx33mmx18mm
 Pinhole lens with audio
\$149.00 \$137.00
 5 or more
VM3010-A
 45mmx40mmx24mm
 Standard lens with audio, single board
\$147.00 \$139.00
 5 or more
VM3010-A
 33mmx33mmx32mm
 Standard lens with audio
\$144.00 \$129.00
 5 or more
Detailed Specs on the Web

Bullet CCD Cameras B&W and Color

• Smart Rugged Metal Housing
 • Extremely Low Power Consumption
 • 12 Volt
 • CCD Area Image Sensor for Long Camera Life
 • Built-In Electronic Auto Iris for Auto Light Compensation
 • No Blooming, No Burning
 • 0.1 Min Lux Illumination (B&W), 1 Lux Min Lux Illumination (color)

VMBLT3025W
 Digital Color, Weatherproof
 20mm(D)x33mm(L)
\$219.00 \$199.00
 5 or more

VMBLT1020W
 B&W Weatherproof
 21mm(D)x38.5mm(L)
\$96.00 \$89.00
 5 or more

VMBLT1020A
 B&W with audio
 21mm(D)x35mm(L)
\$85.95 \$77.00
 5 or more

Detailed Specs on the Web

Prottek Amazing Test Equipment Offers

Series 6500 Deluxe 20MHz/40MHz/60MHz/100MHz Dual-Trace Oscilloscopes
 • Alternate Trigger
 • Internal Sync Separator Circuit
 • Alt-Mag Sweep
 • Delay Sweep (6510)
LATEST DESIGNS!
 Asia's currencies are devalued against U.S. dollars. Take advantage of **GREAT** prices while they last!

#6502 - 20MHz \$289
#6504 - 40MHz \$569
#6506 - 60MHz \$689
#6510 - 100MHz \$799

For More Information See www.web-tronics.com

Part No.	6510	6506	6504	6502
Bandwidth	100MHz	60MHz	40MHz	20MHz
Vert. Sensitivity	1mV/Div to 5V/Div	1mV/Div to 5V/Div	1mV/Div to 5V/Div	1mV/Div to 5V/Div
Max Sweep Rate	2nS/Div to 0.2S/Div	0.1uS/Div to 0.2S/Div	0.1uS/Div to 0.2S/Div	0.2uS/Div to 0.5S/Div
Delay Sweep	YES	YES	YES	YES
Vert. Mode Trig.	YES	NO	NO	NO
Cursor Readout	NO	NO	NO	NO
CRT Volts	12KV	10KV	10KV	2KV

These deluxe HC Prottek oscilloscopes provide the features and accuracy that serious technicians and engineers need at prices well below what you may have expected. These dual-trace, dual-channel, scopes have Alt-Mag sweeps and provide simultaneous display of normal and magnified traces. An internal sync separator circuit provides stable triggering of video signals. TVH (TV line synchronizing feature) and TV.V (TV free waveform measurements) are automatically switched by the Time/Div front-panel control. The user can view parallax-free waveform measurements on the large 6" rectangular CRT that includes an illuminated internal 8x10 Div graticule.

Amazing Test Equipment Offers

1GHz Multifunction Counter
 • Frequency, Period, Totalize Measurements
 • Low Pass Filter
 • 2 Channel Input (100MHz, 1GHz)
 • 8 Digit Gate
 • Time Control
 • 1/20 Input Attenuator
B-818 \$209
Prottek
 See the web site for details

2GHz Universal Counter
 • Frequency, Period Totalize Ratio Measurements
 • Low Pass Filter
 • 3 Channel Input (CH A, CH B, CH C)
 • Variable Trigger Level
 • 8 Digit LED Display
 • 4 Step Gate Time Control
 • FI/10 Input Attenuator
 • Self Test
U2000A \$319
Prottek
 See the web site for details

10MHz Sweep Function Generator
 • Sine, Triangle, Square, Ramp, Pulse Waveform
 • Gate & Trigger Output
 • Burst Waveform Output
 • Sweep Function (Linear/Logarithmic)
 • VCG Input
 • GCV Function
 • AM Modulation
 • Variable Symmetry
 • Output Attenuator
 • DC Offset
 • Frequency Counter
B-810 \$559
Prottek
 See the web site for details

Digital Multimeter
 • AC/DC Voltage, AC/DC Current, Resistance Measurement
 • 4 1/2 Digit Display
 • Over Range Indication
 • 7 Functions
 • Data Hold Function
9902A \$189
Prottek
 See the web site for details

2MHz Sweep Function Generator
 • Sine, Triangle, Square, Pulse, Ramp, Slew Sine Waveform
 • Sync. Output (TTL Square Waveform)
 • Sweep Function
 • VCG Input
 • DC Offset
 • Variable Symmetry
9205C \$279
Prottek
 See the web site for details

2MHz Sweep Function Generator
 • Sweep Function Width: 1:1 to 1000:1
 • Sweep Rate: 0.5Hz to 50Hz
 • Attenuation: -20dB
 • Frequency Range: 0.02Hz to 2MHz in 7 Ranges
 • Outputs: Sine, Triangle, Square Wave, Pulse, Ramp, Slew Sine Wave
 • Sync. Out: TTL Square Wave
9205 \$219
Prottek
 See the web site for details

20 Amp Switching Power Supply
 With Overvoltage Protection and Variable DC Output
ONLY \$99

#SPS-1020G
 Specifications
 Input Voltage: AC 110V ±15%, 50Hz/60Hz
 Output Voltage: DC 9V - 15V variable
 Polarity: Negative ground Current (13.8V): 25A peak, 20A continuous
 Overvoltage Protection
 Cooling fan inside chassis
See the web site for details

HDD Heat Sink & Fan Heat Reduction System
 • The Ultimate Heat Reduction System for Hard Drives
 • Huge Aluminum Heat Sink, Plus Two Cooling Fans
 • Heat Terminator Mounts in Any 3.5" FDD, Bay
 • For All 3.5 Drives up to 1" High Hard Drive Heat Reduction up to 33%
HEAT TERMINATOR \$39.00 \$35.00
 10 or more
See the web site for details

2GHz RF Field Strength Analyzer
 • Frequency Range: 100KHz to 2.060MHz
 • Narrow Band FM (NFM), Wide Band FM (WBFM), AM and Single Side Band (SSB) Modulated Signals May Be Measured
 • PLL Tuning System for Precise Frequency Measurement and Tuning
 • LED Backlight LCD (192x192 dots)
 • Built-In Frequency Counter
 • Hand Held and Battery Operated
 • All Functions are Menu Selected
 • RS232C for PC Interface and Printer
Prottek #3201 ONLY \$1529
 See the web site for details

October 1999, Popular Electronics

Direct from Manufacturer
We will beat any competitor's price

World's Smallest Wireless Video Camera!

- Transmits video up to 1000 ft.
- Runs on 9V battery for 12 hrs.
- Can be built into just about anything (beeper, clock, etc.)

We also carry:
• Color micro video cameras
• B&W micro video cameras
• Hidden cameras
• Custom video systems
• Countersurveillance & More

World's smallest plug & play system about 1" x 1"



Looking for Distributors

Call for a free catalog (305) 667-4545
SECURETEK Fax (305) 667-1744
7175 SW 47 St. #205 • Miami, FL 33155

PIC PROJECTS Book & CD-ROM

Many PIC Projects for Beginners & Experts!
Includes Software, Documentation, and PCB Layout



Book & CD Only \$24.95

- LCDs
- X10 - Home Automation
- Keypads
- Serial Port Interface
- On-Screen Displays
- Robotics
- Data Logging
- Serial-Parallel
- And Many More!

PIC Programmer

Programs all PIC16C550/6x/7x/8x/9x, PIC16F8x, and PIC12C devices. Optional ZIP adapters for SOIC & PLCC. Includes all necessary software. Only \$39.95



Buy Both for \$59

We accept:

VISA • MasterCard • American Express
To order, call Worldwyde @ 1-800-773-6698
21365 Randall Street • Farmington Hills, MI 48336
Visit us on the web at www.worldwyde.com/plc

PIC Programmer Kits

Super Value! Program all 8, 18, 28 & 40 pin PICs in the 12C5xx, 14000 and 16Cxx series (except 16C54-58). All components, PCB and Instructions included. Parallel port of PC is used with straight through (25 pin) cable (not supplied). Kit uses the P16PRO shareware which is downloaded from the web and registered for \$20. Can program 64 pin PICs with adapter (not supplied). For more info and other PIC programmers visit www.electronics123.com

\$19.95 +S&H \$4.95

Miniature Camera Code:BB004

Sugar Cube CMOS Camera Module, Black & White, Size: only 0.63"x0.63"x0.59"H. Low cost, low power and very small! Lens: f4.9, F2.8 FOV 56 deg x 42 deg. EIA 320Hx240. Scan: 2:1 interlace, 5 pins. Pin 3 is 1V p-p composite video (75 ohm) to standard video monitor. Power Supply, 5V +/- 0.5V. Current 10mA. Needs regulated power supply. *S&H to Canada is \$7.95

\$39.95 +S&H \$4.95

Toll Free: 1-888-549-3749 (USA & Canada)
Tel: (330) 549-3726. Request a FREE catalog or visit us at: www.electronics123.com for more products. Amazon Electronics, Box 21 Columbiana OH 44408

CABLE SECRETS!!!

Build your OWN cable box "test" devices!

Why pay \$100.00 or more for a "test" device that someone else made? Make your own! Includes complete source code and plans for the most commonly used cable boxes. Unlock all of the channels on your box!

Or start your own lucrative business!

Complete source code \$79.95
Code for individual boxes \$29.95

DSS SECRETS - Vol. 2

Step-by-step instructions on programming your own DSS access card. Unlock all channels on your own card! This is the most current information on the market! Includes software, plans, and hardware sources. Book & CD-ROM.

DSS Secrets Vol. 2 \$49.95

VISA • MasterCard • American Express
To order, call Worldwyde @ 1-800-773-6698
21365 Randall Street • Farmington Hills, MI 48336
Visit us on the web at www.worldwyde.com

OWN A MACHINE SHOP!

Do your own machining and shop work with a Smithy 3-in-1 Lathe•Mill•Drill

Do it yourself!

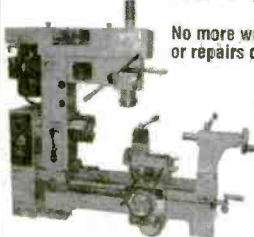

No more waiting to have parts or repairs done.

- Easy to use—Free training. You'll be doing quality work right away.
- Affordable—Four models starting at \$995.
- Versatile—Work metal—and wood or plastic.
- CNC adaptable



"I can fix most anything. Now I don't know how I lived without it. It paid for itself in no time."

CALL TODAY!

1-800-345-6342

or visit: **Smithy**
Dept. PE PE Box 1517
Ann Arbor, MI 48106-1517

Guaranteed to pay its own way

The Hack & Crack Bible on CD-ROM

Includes all Software, Documentation, Plans, and PCB Layouts!

Unlock the secrets of:

- DSS & Smart Cards
- Programming & Schematics
- Cable Test Devices
- Sony Playstation
- Mod Chip/CD Backups/Emulation
- Backup Sega & SNES Console Cartridges
- Sega & SNES Emulation on your PC or Mac
- Ware - where to find them on the internet
- Cellular Hack/Phreak/Mod
- And Much More!



Only \$29.95

PC & Mac Compatible CD-ROM

We accept:

VISA • MasterCard • American Express
To order, call Worldwyde @ 1-800-773-6698
21365 Randall Street • Farmington Hills, MI 48336
Visit us on the web at www.worldwyde.com/hack

PCB LAYOUT Software For Windows - FREE

- 1 Download our board layout software
- 2 Design your 2 sided plated-through PCB
- 3 Send us your layout over the Internet
- 4 In 2-3 business days, UPS delivers your boards, often under \$100

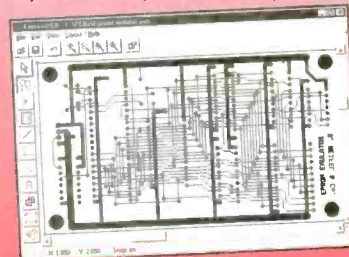

www.expresspcb.com

SINGERS! REMOVE VOCALS
Unlimited, Low Cost, Instantly Available Background Music from Original Standard Recordings! Does Everything Karaoke does... Better and gives you the Thompson Vocal Eliminator Free Brochure CD Demo tape. 11 Sound Dept PE 7888 LI Parkway, Lithonia, GA 30058 Internet: <http://www.LTSound.com> 24 Hour Demo/Info Request Line (770) 482-2485 Ext 49 When You Want Something Better Than Karaoke!

CABLE TV BOXES



(WE'LL BEAT ANY PRICE!)
30 DAY TRIAL* 1YR. WRNTY. *FREE CATALOG
QTY. DISCOUNTS * DEALERS WELCOME!

1-800-785-1145

HABLAMOS ESPANOL



PRIVATE CABLE SYSTEMS

FCC License Preparation

RADIOTELEPHONE LICENSE

Electronics Tech, Avionics, Marine & Radar
Homestudy—Fast-Easy & inexpensive.
Manuals-Audio-Video-podisks-Q&As
Guarantee Pass-see at www.wptfcc.com
Details-800-800-7555. WPT Publications
4701 NE 47ST, Vancouver, WA, 98661

GREAT FOR TEST FIXTURE BUILDING



LAB-1 (1.5" x 2.0" x 0.75")

FREE!

PHONE, FAX, WRITE OR E-MAIL WITH YOUR MAILING ADDRESS MUST MENTION OFFER "LAB199"

PRE-PUNCHED END PANELS ALSO AVAILABLE
9 BOX SIZES
25 PREPUNCHED END PANELS

ALSO IN STOCK AT:
JENSEN TOOLS: 800-438-1194
MCM ELECTRONICS: 800-543-4390
TECH AMERICA: 800-442-7771

ALL ALUMINUM CONSTRUCTION LOW COST
OFFER GOOD ONLY IN THE 48 STATES. ENDS DECEMBER 20, 1999. LIMIT ONE REQUEST PER CUSTOMER. MAILED 1ST CLASS. ALLOW 1-2 WEEKS FOR DELIVERY

ORDERS 800-634-3457 • FAX 800-551-2749
OFFICE 702-565-3400 • FAX 702-565-4828
www.sescom.com • info@sescom.com
SES.COM, INC. 2100 WARD DR. HENDERSON, NV 89015
SES.COM, INC. is not responsible for inadvertent typographical errors and prices and specifications are subject to change without notice.

ALL ELECTRONICS

C O R P O R A T I O N

QUALITY PARTS

FAST SHIPPING

DISCOUNT PRICING

CALL, WRITE, FAX
or E-MAIL For A
Free 96 Page
CATALOG.
Outside the U.S.A.
send \$3.00 postage.

MINI-RIGHT ANGLE GEARHEAD MOTOR WITH CIRCUIT CONTROL

Omron # R2DG-41 Built-in control circuits allow this motor to be used in a continuous or a pulsed mode. In continuous mode the final drive gear turns at 22-45 RPM (3-6 Vdc). In the pulsed mode the final drive gear turns one revolution each time the controller is momentarily pulsed. The motor assembly is 1.75" x 1.25" x 0.5" overall. The nylon final gear is 0.62 diameter and has a little nipple slightly off-center to which a small push-rod could be attached. Motors are in good condition, removed from equipment. Hook-up instructions included.



CAT# DCM-110 **\$7⁵⁰** each

10 for \$60.00

ENCLOSED SWITCHING POWER SUPPLY

Voltek Corp # SPEC7188B
Input: 100 - 240 Vac
Outputs: + 5 Vdc @ 3.70 A,
+12 Vdc @ 0.60 A,
-5 Vdc @ 0.05 A,
+5 Vdc Trickle @
0.1 A. Metal
encased switching
supply. Standard three-prong IEC socket
power input. 7 conductor, Molex-type connec-
tor output. 9" x 2.1" x 1.36". UL recognized.
Removed from new equipment.

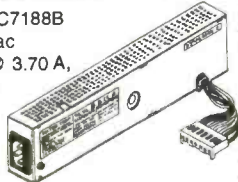

CAT # PS-27 **\$3⁵⁰** each

3000 MCD ULTRA-BRIGHT RED LED

Everlight # 383URC-2/TR1-C(R)
Red, "Ultra-bright" T 1 3/4 LEDs
"Tape-and-reel" parts. These are
5 mm diameter water-clear LEDs
that light bright red at 20 ma.



CAT# LED-50

2 for \$1⁰⁰

100 for \$35.00
1000 for \$250.00

INCREDIBLY LOW PRICE! Sony Color Video Camera with Audio

Sony# CCX-Z11/S1.
Brand new color video
camera with audio.
Ideal for surveillance
or video con-
ferencing.
Good-looking,
compact design,
only 3.5" X 2.33" X 1.05".
Adjustable lens. On-off
power switch. RCA jacks for
video and audio outputs. Includes
4.5 Vdc power supply, output cables and
adjustable desktop camera stand which can
easily be used as a wall or ceiling mount
bracket. Get one now...at this price they won't
last.

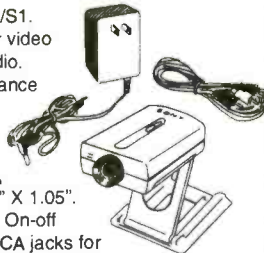

CAT# VC-1100 **\$90⁰⁰** each

3 or more \$85.00 each

12 Volt Lamp and Socket

A great lamp assembly
for display or special
effects lighting.
Consists of a remov-
able 12 volt wedge base
bulb # 921, 12C21CP
wedge base lamp that draws
1.2 Amps. Assembly is 2.6" X
0.95" X 0.75". 19" pigtail leads.
Large quantity available.



CAT# LMP-7 **\$1²⁵** each

10 for \$10.00 • 100 for \$70.00

"HI-8" Video Cassette

SONY Hi-8 Top quality,
metal particle 120 minute
video cassettes. *Used
for a short time, then
bulk-erased.* Each
cassette has its own
plastic storage box.



CAT # VCU-8 **\$3⁰⁰** each

10 for \$28.00 • 100 for \$250.00

20 Character X 4 Line LCD

Optrex # DMC 20434-CEM
(PWB 20434-CEM)
5 x 8 dot format.
3" x 1" viewing area.
3.88" x 2.38" module.
Removed from new
equipment. May have felt padding on metal
bezel. 14 pin single row header is pre-attached.
Spec/hook-up sheet included.

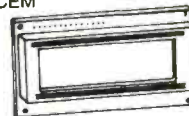

CAT# LCD-46 **\$7⁰⁰** each
10 for \$60.00

Microphone For Fish

Consists of a dart-shaped underwater trans-
ducer on a 21' wire and a small
amplifier. According to the man-
ufacturer, it enables
you to hear the fish strik-
ing your bait, thus
allowing you to
catch more fish. We
don't have the instruc-
tions, and you will need some head-
phones with a 3.5 mm phone plug. Also
requires 4 AAA batteries (not included).
Transducer is 3.3" long. Amplifier
assembly is 3.5" x 2.4" x 1".



CAT # AQS-1 **\$5⁰⁰** each

Padded Carrying Case

Good looking pro-
tective carrying
case for Zip
drives or
Walkman
players, tools,
guns, photo-
graphic or electronic
equipment. This well-built black
canvas bag has 0.5" thick high density padding
all around and nylon inner liner. 1.5" wide
webbed handle and detachable shoulder
strap. Heavy duty zipper. Interior pocket and
adjustable velcro compartment. Interior area:
16" X 6" X 2.5". These are new bags with a
company logo (Interactive Network) on a patch
on one side.



CAT # CSE-10 **\$5⁰⁰** each

ORDER TOLL FREE

1-800-826-5432

MAIL ORDERS TO:
ALL ELECTRONICS CORP.
P.O. BOX 567
VAN NUYS, CA 91408-0567

FAX (818) 781-2653 • INFO (818) 904-0524
INTERNET <http://www.allcorp.com/>
E-MAIL allcorp@allcorp.com

NO MINIMUM ORDER • All Orders Can Be Charged to Visa, Mastercard, American Express or Discover • Checks and Money Orders Accepted by Mail •
Orders Delivered in the State of California must include California State Sales Tax • NO C.O.D • Shipping and Handling \$5.00 for the 48 Continental United
States - ALL OTHERS including Alaska, Hawaii, P.R. and Canada Must Pay Full Shipping • Quantities Limited • Prices Subject to change without notice.

MANUFACTURERS - We Purchase EXCESS INVENTORIES... Call, Write, E-MAIL or Fax YOUR LIST.



BUY FOUR AND GET ONE FREE *



Hyper Peppy

OWI-969K: \$24.95
Fast, 3 wheeled robot with a touch/sound sensor



Line Tracker

OWI-963K: \$49.95
Follows a black line with its infrared sensor



Triple Action Solar Car

OWI-685: \$39.95
High powered 1.4V - 350mA solar cell included

*** While supplies last, purchase any four of the robotic kits shown at left, and receive a Moon Walker Robotic Kit absolutely FREE!**



Moon Walker

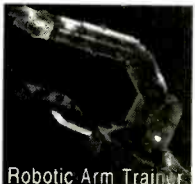

Robotic Arm Trainer

OWI-007: \$69.95
Highly acclaimed award winner

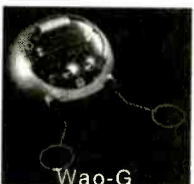

Wao-G

OWI-968K: \$89.95
48 fuzzy logic programming steps and drawing capabilities

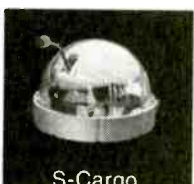

S-Cargo

OWI-936K: \$36.95
Sound sensor controls it to spin, stop, and go forward

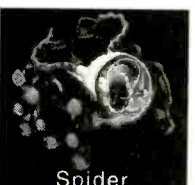

Spider

OWI-962K: \$49.95
Infrared sensor detects solid obstacles in its path

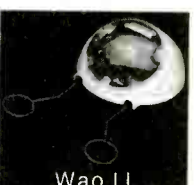

Wao II

OWI-961K: \$69.95
Learn how to program in simple Basic language

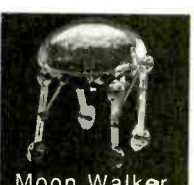

Moon Walker

OWI-989K: \$34.95
Will walk when it detects a change in light



ROBOTIKITS™
DIRECT



Order M - F:
8a.m. - 4p.m. PST

17141 Kingsview Ave. Suite B, Carson, CA 90746
Phone: (310) 515-6800
Fax: (310) 515-0927
E-mail: owi@ix.netcom.com
Web Page: www.owirobot.com

ALFA ELECTRONICS

HIGH QUALITY TEST EQUIPMENT

Visit www.alfaelectronics.com for complete info
Call 1-800-526-2532 for Order and Free Catalog

DMM	FOR/COUNTER	FLUKE	SPECIALTY
<p>DMM-899 (\$179.00): true rms, AC/DC (V,A), Ω, bar graph, freq, capac, dBm, logic, diode</p> <p>DMM-23T (\$99.95): 4 1/2 digit, true rms, high resol. (10μV, 10nA, 10mΩ), hFE, diode, contin.</p> <p>DMM-20 (\$74.95): AC/DC (V, A), Freq, cont., Capac, Induct, Ω, hFE, diode, duty cycle</p> <p>DMM-122 (\$59.95): DC/AC(V,A), Ω, hFE, diode, capacitance, freq, logic, continuity</p> <p>DMM-123 (\$44.95): DMM + capacitance, DC/AC(V,A), Ω, hFE, diode, continuity</p> <p>DMM-10 (\$19.95): 3 1/2 digit, DC/AC V, Ω, hFE, diode, signal output(+3V,-0.5Vsq, 50% duty)</p>	<p>CAP-15 (\$49.95): 3 1/2 digit, 0.1pF-20mF, 9 Ranges, 0.1pF resolution, zero adjustment.</p> <p>LCR-24 (\$119.95): 0.1μH-200H, 0.1pF-2000μF, 0.01Ω-20MΩ, diode test. <i>New Model</i></p> <p>LCR-131D (\$219.95): autorange, 0.1μH-10kH, 0.1pF-10mF, 1mΩ-10MΩ, Q Factor, serial/parallel, 120Hz/1kHz testing mode.</p> <p>FC-1200 (\$129.95): 1.25GHz Handheld, 8 digits display, 10ppm accuracy, sensitivity 5mV (130-350MHz), 30mV (440MHz)</p>	<p>12B \$ 94.95</p> <p>70-III \$ 99.00</p> <p>73-III \$125.00</p> <p>75-III \$155.00</p> <p>77-III \$173.00</p> <p>79-III \$195.00</p> <p>87-III \$325.00</p> <p>92B-III \$1,445</p> <p>96B-II \$1,695</p> <p>99B-III \$2,095</p> <p>105B \$2,495</p> <p>123-III \$1,130</p> <p>863E \$555</p> <p>867B \$740</p>	<ul style="list-style-type: none"> AC Current Probe \$34.95 DC/AC Current Probe \$79.95 Mini AC Clamp \$59.95 AC Clamp w/temp \$89.95 DC/AC Clamp \$109.95 Thermometer \$69.95-\$89.95 IR Thermometer \$189.95 Sound Level Meter \$169.95 Tachometer \$169.95-\$219.95 EMF Tester \$69.95 Pressure Meter \$299.95 Watt Meter \$129.95 High Voltage Probe \$59.95 pH Meter \$79.95 Light Meter \$79.95-\$89.95

Single Output DC Power Supplies	Triple Output	AUDIO/RF/FUNCT. GEN.
<ul style="list-style-type: none"> Constant current, constant voltage mode Short Circuit and overload protected <p>Analog Meters Display</p> <p>PS-303 (\$159.00) 30V/3A</p> <p>PS-305 (\$219.95) 30V/5A</p> <p>PS-812 (\$399.95) 60V/5A</p> <p>PS-1610 (\$289.00) 16V/10A</p> <p>PS-8107 (\$399.95) 30V/10A</p> <p>Digital Volt, Analog Current</p> <p>PS-8200 (\$179.95) 30V/3A</p> <p>PS-8201 (\$239.95) 30V/5A</p> <p>Digital Volt & Current Display</p> <p>PS-8300 (\$199.95) 30V/3A</p> <p>PS-8301 (\$259.95) 30V/5A</p>	<ul style="list-style-type: none"> Independence of Tracking operation Parallel to double current output (PS-8102 & PS-8103 only) <p>Triple Output (Analog displays)</p> <p>PS-8102 (\$399.95) 30V/3A/30V/3A</p> <p>PS-8103 (\$489.95) 30V/5A/30V/5A</p> <p>Digital Displays</p> <p>PS-8202 (\$499.95) 30V/3A/30V/3A</p> <p>PS-8203 (\$549.95) 30V/5A/30V/5A</p>	<p>RF Generator • SG-4160 (\$124.95) 100kHz-150MHz sinewaves in 8 ranges</p> <p>• SG-4162AD (\$229.95) with 6 digit counter</p> <p>Audio Generator • AG-2601 (\$124.95) 10Hz-1MHz, 0-8Vpp sine, 0-10Vpp squarewave</p> <p>• AG-2603AD (\$229.95) with 6 digit counter</p> <p>Function Generator • FG-2100A (\$154.95) 0.2Hz-2MHz, 5mV-20Vpp</p> <p>• FG-2103 (\$329.95) Sweep 0.5Hz-5MHz</p>

DC POWER SUPPLIES				FUNCTION GENERATOR	BENCHTOP DMM
20 MHz Scope	Cursor Readout	Triple Output	Single Output Programmable		
<p>OS-620 \$324.95</p> <ul style="list-style-type: none"> Most economical scope Dual CH/X-Y operation 1 mV/div sensitivity Z-axis input, CH1 output TV syn, ALT trigger 2 probes (x1, x10) 	<p>OS-626G \$599.95</p> <ul style="list-style-type: none"> Readout & Cursor meas Dual CH / Delay sweep Built-in delay line ALT trigger, Hold-Off Z-axis input, CH1 output 2 probes (x1, x10) 	<ul style="list-style-type: none"> 2 variable out 0-30V, 0-3A One fixed 5V, 3A output Auto track, serial, parallel Const volt, current mode 4 analog or 2 digital display <p>PC-3030 (\$499.95)</p> <p>PC-3030D (\$549.95) digital</p>	<ul style="list-style-type: none"> Const voltage, current mode Voltage regulation ≤ 0.01% Current regulation ≤ 0.2% <p>PS-1830 (\$198.95) 18V/3A</p> <p>PS-1850 (\$214.95) 18V/5A</p> <p>PS-1830D (\$214.95) 18V/3A</p> <p>PS-1850D (\$244.95) 18V/5A</p>	<p>FG-8020G (\$209.95)</p> <ul style="list-style-type: none"> 0.02Hz-2MHz w/counter Sine/Squ/Tri/pulse/Ramp FG-8020G (\$209.95) 0.02Hz-2MHz w/counter FG-8050 (\$449.95) Sweep 0.05Hz-5MHz w/counter INT/EXT AM/FM mod 	<p>DM-8034 (\$179.95) 3 1/2 dgt</p> <ul style="list-style-type: none"> AC/DC(V,A), C, Ω, diode DM-8040 (\$339.95) 3 1/2 dgt ACV to 50kHz, true rms DM-8055G (\$889.95) 5 1/2 dgt 0.06% accuracy, GPIB dBm, auto, REL, min/max

ALFA ELECTRONICS P.O. BOX 8089 PRINCETON, NJ 08543-8089
TEL: (800)526-2532 / (609) 897-1135
FAX: 609-897-0206
E-mail: sales@alfaelectronics.com

Call / Write / Fax / Email for **FREE CATALOG**
 Visa, MC, AMEX, COD, PO Accepted. OEM Welcome.
1 Year Warranty (2 Years for GW/Instek)

PARTS EXPRESS

ELECTRONICS & MORE

6-1/2" Two Way System

This is our most popular in-wall. You won't believe how good these really sound. Big enough to produce great home theatre sound and still fit everyone's budget. Put a pair in every room of your house. Great for front or rear speakers in your surround system. The 6-1/2" polypropylene woofer and 1" textile dome tweeter were specially designed with home theatre in mind. The crossover network utilizes a mylar capacitor for crisp clean highs. 3 piece design make installation in new or existing walls a snap.

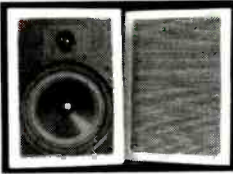

Specifications: 6-1/2" polypropylene cone woofer with poly foam surround 1" textile dome tweeter/midrange 8 ohm impedance 3 component L/C crossover network Frequency response: 50-20,000 Hz Power handling capability: 60 watts RMS/85 watts max Sensitivity: 89 dB 1W/1m Overall dimensions: 6-1/2" W x 12" L x 3-1/2" D Hole size: 7-1/4" x 10-3/4" Fits into standard 2" x 4" wall Net weight: 12 lbs. per pair.

#300-036 \$89.90 (1-3 PRS) \$79.50 (4 PRS-UP)

Satellite Speaker Stands

These quality speaker stands are perfect for mini or rear surround speakers. The heavy die cast base provides stability. Textured black satin finish blends in well with any decor. The height is adjustable from 26-1/2" to 47-1/2" and the speaker wire can be run inside the pole for a better appearance. The top base is adjustable from 4-1/8" to 7-1/2" to accommodate most mini speakers. Includes foam pads to prevent marring of speaker cabinet. Sold in pairs. Net weight: 12 lbs.



#240-762 \$39.80 (1-3 PRS) \$35.50 (4 PRS-UP)

5 Function Remote

Operates five devices (TV, VCR, Cable, Satellite, A/V Receiver) Lighted component keys which indicate what device is currently being used Preprogrammed, 621 codes that work over 6,400 models New ergonomic design features a contoured case, index finger grooves, and keys grouped in clusters for easy operation Satellite cursor control is tailored for use with a Home Theatre system, keypad design allows movement through menus with ease Retains codes when replacing batteries New flat back design for easy operation Money back guarantee ensures customer satisfaction Toll free customer service number provides the customer with friendly, knowledgeable assistance Requires 2 AAA batteries (#140-150 not included)



#180-806 \$29.95 (1-3) \$26.35 (4-UP)

3M 3/4" Temflex™ 1700 Vinyl Electrical Tape

General purpose 7 mil electrical tape. UL listed and CSA approved. 3/4" x 60' rolls.



#350-052 75¢ (1-9) 59¢ (10-UP)

Gold Plated A/V Cables

A super quality, "siamesed" type cable. Two RCA cables for stereo (audio) signal from VCR to receiver/stereo TV and one low noise coaxial type cable for video.



Part #	Length	Price (1-9)	Price (10-UP)
180-120	3 ft.	\$4.25	\$3.95
180-118	6 ft.	4.90	4.50
180-121	12 ft.	8.95	7.95
180-124	20 ft.	12.75	11.50

If you haven't received a copy of our current 260 page catalog ... have one added to your order or give us a call and we will send one out to you immediately.



6-1/2" Round Coaxial System

Designed for the home and office, these 6-1/2" round in-walls are ideal for ceiling installations, or for use as rear channel surround speakers. Adding music to the kitchen, den, bath, or patio has never been easier! System features a weather resistant 6-1/2" treated paper cone with poly foam surround, coaxially mounted 1/2" polymer dome tweeter, and built-in crossover with a mylar capacitor in the tweeter feed. Retrofit design allows installation in both new and existing construction in just minutes. System includes removable steel mesh grills, built-in mounting bracket, hardware, and installation instructions.



Specifications: Impedance: 8 ohms Frequency response: 60-20,000 Hz Power handling capability: 30 watts RMS/45 watts max Sensitivity: 89 dB 1W/1m Dimensions: 9" round x 2-7/8" deep Net weight: 5 lbs. per pair.

#300-408 \$69.95 (1-3 PRS) \$62.75 (4 PRS-UP)

3 Amp Power Supply

This fully regulated power supply is perfect for powering CBs, car radios, and other 12 VDC devices that draw up to 3 amps. Heavy duty steel housing with front mounted switch and binding posts. Short circuit and overload protection!



Specifications: Output Voltage: 13.8 VDC (fixed) Output Current: 3A (cont), 5 amps (surge) Ripple Voltage: Less than 3mV at rated output Input Voltage: 120 VAC, 60Hz Dimensions: 5-1/2" x 3-1/2" x 6-1/2" Weight: 5 lbs.

#120-530 \$19.95 (1-3) \$18.50 (4-UP)

DMM and LCR Meter

In addition to functions found in regular DMM's, this meter can also measure inductance in 5 ranges (4mH, 40mH, 400mH, 4H, 40H), capacitance in 5 ranges (4nF, 40nF, 400nF, 4uF, 400uF), frequency in 4 ranges (4KHz, 40KHz, 400KHz, 4MHz), TTL logic test, diode test and transistor hFE test. 5 AC/DC ranges up to 1000V (AC750V), 3 AC/DC current ranges up to 20A and 7 resistance ranges up to 4000 M ohms. Includes test leads, battery, spare fuse, and manual. Net weight: 1 lb.



#390-513 \$85.90 EACH

2.5W Mini Audio Amplifier

This amp contains both pre-amplifier and power amplifier on a super small board measuring only 1-5/8" x 1-1/4". Maximum output power is 2.5W into 4 ohms with 12VDC input power. No adjustments required. Short circuit protected.



#320-215 \$9.95 EACH

Weller WLC100 Soldering Station

The Weller WLC100 solder station is ideal for the professional, serious hobbyist, or kit builder who demands higher performance than usual of a standard iron, but without the high cost of an industrial unit. Power is adjustable from 5 to 40 watts. Includes 40 watt pencil iron. UL approved. Net weight: 1-3/4 lbs. Replacement sponge #372-119.



#372-120 \$39.95 EACH

"44" Solder

Kester "44" rosin core solder is designed for electronic and electrical work. It uses a fast acting, instant wetting, non-corrosive, and non-conductive flux for faster soldering and a strong, long lasting bond.



Part #	Alloy	Lead/Tin	Spool	Dia.	Price (1-3)	Price (4-UP)
370-080	60/40	1 lb.	.031"		\$8.50	\$7.95
370-090	60/40	1 lb.	.050"		8.50	7.95
370-098	60/40	4 lb.	.031"		33.90	31.80
370-088	60/40	1/2 lb.	.020"		6.95	5.75
370-072	63/37	1 lb.	.020"		14.90	13.50
370-086	63/37	1/2 lb.	.031"		9.95	8.50
370-074	63/37	1 lb.	.031"		12.50	11.50
370-087	36/37	1/2 lb.	.031"		7.95	6.75

Pro Wick

Pro Wick's advanced fine braid design provides wicking action that is second to none.



Part #	TS #	Size	Length	Price (1-9)	Price (10-UP)
341-415	1802-5	.06"	5'	\$1.40	\$1.25
341-416	1803-5	.08"	5'	1.45	1.30
341-417	1804-5	.10"	5'	1.60	1.45
341-424	1802-10	.06"	10'	2.75	2.50
341-425	1803-10	.08"	10'	2.80	2.55
341-426	1804-10	.10"	10'	2.95	2.70
341-440	1802-25F	.06"	25'	6.80	6.30
341-441	1803-25F	.08"	25'	6.85	6.35
341-442	1804-25F	.10"	25'	7.60	7.00
341-418	1802-100	.06"	100'	21.90	20.50
341-419	1803-100	.08"	100'	21.90	20.50
341-423	1804-100	.10"	100'	23.90	22.50

725 Pleasant Valley Dr., Springboro, OH 45066-1158
Phone: 513-743-3000 Fax: 513-743-1677
E-mail: sales@parts-express.com

KEY CODE: POM

LARGEST SELECTION OF SPEAKER DRIVERS IN THE COUNTRY!

VISIT OUR WEB SITE AT www.parts-express.com

OR CALL TOLL FREE **1-800-338-0531**

CIRCLE 156 ON FREE INFORMATION CARD

Building a Micro Robot ?

MicroCore-11™

- tiny 2" x 2" stackable 68HC11 microcontroller module
 - plugs into solderless breadboard like a chip
 - download programs via you PC serial port
 - use assembler or BASIC (both included)
 - 32K SRAM plus 8K or 32K EEPROM
 - RS232, 5V regulator, 8MHz xtal
- 8K Starter Package #MC11SP8K.....US\$75.00
 32K Starter Package #MC11SP32K.....US\$89.00
 Motor driver board and accessories available.



26 Scollard Street
 Toronto, Ontario
 Canada M5R 1E9
 Phone: (416) 963-8996
 Fax: (416) 963-9179

www.technologicalarts.com

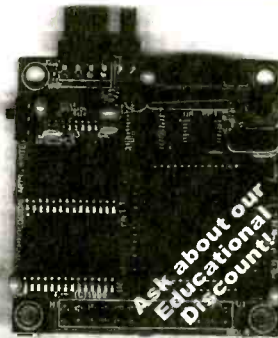

Ask about our Educational Discount!

Call Today And **SAVE!** **Unbeatable PRICES!**

CABLE TV

**DESCRAMBLERS
 CONVERTERS · FILTERS
 VIDEO STABILIZERS**

- FREE** ➤ 30 Day Trial
FREE ➤ Product Catalog
FREE ➤ 1 Year Warranty

100% MONEY BACK GUARANTEE

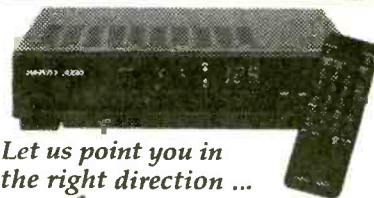

Let us point you in the right direction ...



**TOLL FREE
 888-554-ARROW
 888-554-2776**



Hexapod Walker Kit \$150.00 Plus S&H

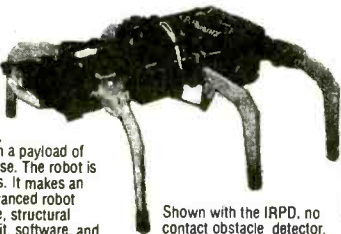

You can build this Hexapod Robot

This easy to build robot really walks using an alternating tripod gait. It can walk forward, reverse, and turn on a dime, left or right. With a payload of more than 12 oz., this robot is a real workhorse. The robot is programmed using simple BASIC instructions. It makes an excellent foundation for many simple and advanced robot experiments. The kit includes all the hardware, structural components, Hitec servos, First Step Micro kit, software, and an illustrated assembly manual. The Lynxmotion Hexapod Walker is a lot of fun to build and even more fun to operate.

Shown with the IRPD, no contact obstacle detector.

We have many more cool robots, check out our web page or ask for our free catalog!

Lynxmotion, Inc.
 104 Partridge Road
 Pekin, IL 61554-1403
www.lynxmotion.com



Tel: 309-382-1816
 Fax: 309-382-1254
sales@lynxmotion.com
tech@lynxmotion.com



One tree can make 3,000,000 matches.



One match can burn 3,000,000 trees.

PicC C Compiler \$59

for Microchip's PIC microcontrollers

Supports PIC16C55x, 16C6x, 16C62x, 16C8x, 16C92x PIC families

SnXC C Compiler \$59

Supports SncmX 8x18ac and 8x28ac microcontrollers

Both compilers based on ANSI C standard. Arrays, unions, structures, pointers, strings, function calls, if, for, switch, while, interrupt vectors, in-line assembler code, 8 & 16 bit variables, etc. Outputs Intel Hex format and assembly code. Code optimizer included. Excellent development tools!

DebugIDE Debugger \$79

C source level debugger for PicC and SnXC compilers. Integrated Development Environment. Step, Run, Stop, Reset. Variable monitoring and modification. Oscillator/Cable kit (\$39)

732-873-1519 fax: 732-873-1582 e: grichre@aol.com

Grich RC Inc. 120 Cedar Grove Ln, Ste 340, Somerset NJ USA 08873

URL: <http://members.aol.com/piccompile>

LEARN ELECTRONICS REPAIR

Home study. Learn to repair, service, and install stereos, TVs, VCRs, camcorders, sound/lighting systems. Free literature: send or call now.

CALL 800-223-4542

The School of Electronics
 430 Technology, Dept. ELL341
 PCDI, Norcross, GA 30092

GALEP-III Pocket Multiprogrammer

This size fits all!



- ◆ Programs 8-bit and 16-bit EPROMs, EEPROMs, Zero Power RAMs, Flash, serial EEPROMs ◆ GAL, PALCE, ATF ◆ 87xxx, 89xxx, PIC12/16/17Cxx ◆ All DIL devices without adaptor ◆ Lightning fast parallel data transfer (e.g. 27C512 read/compare 2 sec!) ◆ Power supply independent due to rechargeable battery ◆ Uses PC printer port ◆ Hex, JEDEC, and binary file formats ◆ Hex and fusemap buffer editor ◆ Split & shuffle for 8-bit, 16-bit and 32-bit targets ◆ Runs under Win3.1, 95, 98 ◆ Remote control by DDE scripts ◆ Designed for the future due to flexible pin driver technology - new devices will be added every month ◆ Device list, demo software and lifetime free updates from our website www.conitec.com!

GALEP-III Set with cable, battery, recharger \$389.00

PLCC Adaptor for 8-bit EPROMs / 16-bit EPROMs / GALS each \$149.00

1951 4th Ave. Ste 301 • San Diego, CA 92101
 Tel: (619) 702-4420 • <http://www.conitec.com>

MECI

340 East First Street
 Dayton, Ohio 45402

Tons of Electronics

Get your FREE catalog today and discover some of the best deals in electronics. We have thousands of items ranging from unique hard-to-find parts to standard production components. Call, write or fax today to start your subscription to one of the most unique catalogs in the industry, filled with super values on surplus electronic and hobbyist type items.



Checkout our 10,000 item on-line catalog <http://www.meci.com>

Order Toll Free Why pay more?
1-800-344-4465 Call today!
 Fax Order Line
 1-800-344-6324

CIRCLE 139 ON FREE INFORMATION CARD

Cable T.V. Converters & Equipment

- Lower Prices
- Dealer Discounts
- 30-Day Money back
- 1-year warranty
- MC, Visa, AE, COD



www.cable4you.com

1-(800) 888-5585

SUPPORTS DEVICES TO 32 MEG

EPROM+

A device programming system for design, repair and experimentation

- ◆ EXCEPTIONAL POWER FOR THE PRO
- ◆ EASY-TO-USE FOR THE NOVICE
- ◆ INCLUDES STEP-BY-STEP TUTORIAL

Here's what you get: A rugged, portable programming unit including the power pack and printer port cable both of which store inside the case. A real printed user and technical manual which includes schematic diagrams for the programming unit plus diagrams for all technology family adapters. * Comprehensive, easy-to-use software which is specifically designed to run under DOS. Windows 3.1, 95 and 98 on any speed machine. The software has features which let you READ, PROGRAM, COPY and COMPARE plus much more. You have full access to your system's disk including LOADING and SAVING chip data plus automatic processing of INTEL HEX, MOTOROLA S-RECORD and BINARY files. For detailed work the system software provides a full screen buffer editor including a comprehensive bit and byte tool kit with more than 20 functions.

Broad device support: FIRST GENERATION EPROMS (2708, TMS2716*, 25XX) SECOND GENERATION EPROMS (2716-28C080), 40 AND 42 PIN EPROMS* (27C1024-27C160) FLASH EPROMS (28F190C, 29EE, 29F), EEPROMS (2816-28C010), NVRAMS (12XX, X221012) 8 PIN SERIAL EPROMS* (24, 25, 85, 93, 95, 8001A) PLUS ERI400/M58657* AND ER5901 BIPOLAR PROMS* (72S/82S), FPGA CONFIGURATORS (17CXXX) MICROCONTROLLERS* (874X, 875X, 87C5X, 87C75X, 89C5X) ATMEL MICROS* (8-40) PIN 89C051, 89SXXX (AVR) 90SXXX PIC MICROS* 8, 18, 28, 40 PIN (12CXXX-16CXXX, 16CXX, 17C) MOTOROLA MICROS* (68705P3/U3/R3, 68HC705, 68HC711)

\$289

*REQUIRES SNAP-IN ADAPTER (ORDER FACTORY DIRECT OR BUILD YOURSELF) \$5.00 SHIPPING • \$5.00 C.O.D. 1 YEAR WARRANTY - 30 DAY MONEY BACK GUARANTEE VISA • MASTERCARD • AMEX
ANDROMEDA RESEARCH, P.O. BOX 222, MILFORD, OH 45150
 (513) 831-9708 FAX (513) 831-7562 website - www.arlabs.com

Home Automation

- World's Largest Selection!
- Best Customer Service
- Top Technical Support

Take a step into the future -- discover the latest in innovative home technology, from remote controls to high-tech toys to voice-activated systems. We will show you the *smart* (and easy!) way to automate your home.

Lowest Prices Guaranteed!

call **800-SMART-HOME**
800-762-7846

or visit us on the web @ **smarhome.com**
to order your **FREE** catalog today!

Order 24 Hours • 7 Days

FREE
128 page full color catalog!

Dealers/Resellers ask about our SmartHome PRO Dealer Program 800-949-6255

SMARTHOME.COM

Wireless Internet & TV

WIRELESS CABLE • IFTS • MMDS • ATV • INTERNATIONAL • DIGITAL
 Amplifiers • Antennas • Books • Components

- RF Frequency: 2100-2700 MHz
- SASE For "FREE" Catalog or Send \$1

PHILLIPS-TECH ELECTRONICS
 P.O. Box 13074 • Scottsdale, AZ 85267-3074
 CATALOG/INFO: 800-947-7700
 ORDER LINE: 800-880-MMDS
 FAX LINE: 480-947-7799
 WEBSITE: www.phillips-tech.com
 E-MAIL: product@phillips-tech.com

CHALLENGER SYSTEM
 31 Channel Complete \$749
 Other Systems Available
 5 Year Warranty
FREE SHIPPING
 Visa • MC • AmEx • Discover • C.O.D. • Quantity Pricing

SURVEILLANCE HIDDEN CAMERAS

DIRECT FROM MANUFACTURER—BEST PRICE IN THE MARKET

Ultra miniature hidden camera, in dome, smoke or motion detector w/ mic, B/W or Color. Wide view angle. Low light sensitivity w/ super sharp images, plus video and audio output, from \$159.00. Also 1/2" B/W board Camera w/mic, starts at \$79.00 USD. Wireless hidden camera, start at only \$249.00 USD. Plus \$5.95 for SHL. Wholesale/Retail Welcome. C.O.D., Check, Money Order or Visa/MC.

BOLIDE INTERNATIONAL CORPORATION
 PH: (800) 355-8895 or (626) 575-8178
 9660 Flair Drive, #218, El Monte, CA 91731
 h.t.p://www.bolideamazingproducts.com/

BROADCAST EQUIPMENT !!!

We manufacture & carry Stereo FM Transmitters, RF Amplifiers, Low Pass Filters, Antennas, DJ Mixing Boards & Consoles, Mics, Compressor/Limiters, Digital Reverbs, Automation Software, RF Test Equipment, RF Parts including BGY133's, and much more! Call For Free Catalog!

Progressive Concepts
 BOX 586 S TREMWOOD, IL 60187
 (630) 726-8825 FAX (630) 726-2383

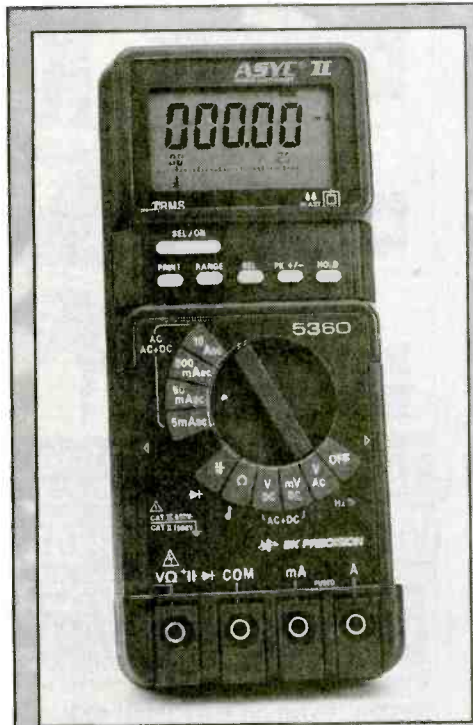

BK PRECISION®

The 5300 Series, one of the world's finest digital multimeters. The best of the ASYC II Series, it has the best accuracy, a built-in counter, and displays AC voltage as resistive power or dB (impedance selectable), saving you the time of making the calculation. A careful examination of the performance features and user-conscious design will tell you that you hold a superior DMM in your hand, designed with measurement capability needed by users who demand the best.

MFG	MODEL	ACC'Y	LIST	SPECIAL PRICE
B&K	5360/MX53B	0.1%	\$229.00	\$129.00
B&K	5380/MX55	0.025%	\$309.00	\$139.00
B&K	5390/MX56B	0.025%	\$325.00	\$149.00

(resistive power on model #5390/MX56B)

- meters made in France by Metrix for B&K, feature 50,000 count capability, bargraph, true RMS, mains disturbance indication, good transient protection, a wide temperature range, conform to IEC 1010 class 2 safety compliance and feature a 3 year warranty

Call, fax or email today for complete specs, a free B&K Precision catalog, and a copy of our 84 page test and measurement instrument catalog

PRINT™
 Products International
 8931 Brookville Rd * Silver Spring, MD, 20910
 800-638-2020 * Fx 800-545-0058 * www.prodintl.com * sales@prodintl.com

CIRCLE 153 ON FREE INFORMATION CARD

CLASSIFIEDS

BUSINESS OPPORTUNITIES

\$400 Weekly Assembling electronic circuit boards/products from home. For free information send SASE: **Home Assembly-PE** Box 216 New Britain, CT 06050-0216

TOO MANY BILLS? Free, Easy Debt Consolidation. One monthly payment-reduced up to 50%! **Genus Credit Management-Nonprofit** 1-800-299-6778 (1265).

CABLE TV

Cable TV Descramblers. One-piece units. Scientific Atlanta, Jerrold, Pioneer, and others. Lowest Prices Around. **Precision Electronics** Houston, TX., anytime 1-888-691-4610.

ALL CABLE TV BOXES. WE'LL BEAT ANY PRICE. 30 DAY TRIAL 1 YEAR WARRANTY. FREE CATALOG! www.galaxydescramblers.com 1-800-538-CABLE(2225).

Descramblers, Converters, Activators, Rft's, Ftg's, Bullet Snoopers, All Options Explained, Best Prices, Services, 2yr. Warranty, Free Catalog 1-800-854-1674 www.resourceleader.com/aapc Bewildered about descramblers? Call for your options. Same day shipping, M-F, 9-8 Saturday 12-5. **Global Electronics** 1-888-221-8365.

FREE TV Cable Catalog. New full viewing boxes, works everywhere! 1-800-676-6342.

WHOLESALE PRICES, SUPERIOR QUALITY, INTERNAL AND EXTERNAL ACTIVATORS.

1ST TIME DISCOUNT. \$200.00 MIN, COD ONLY. 24/7 MESSAGE SERVICE SALES OPEN M-F 8:00 TO 4:30 PM. CALL LUNAR INDUSTRIES 1-800-289-9566.

CABLE DESCRAMBLERS, including activators for all Jerrold Dp-5-CFT22xx's and SP'S. Lowest single or lot prices. Also, **RFT-Dams ZENITH, SCIENTIFIC ATLANTA, and PIONEER.** Se habla en español. Call 888-684-9277.

CABLE TV DESCRAMBLERS/CONVERTERS. LOWEST PRICES. 30 DAY MONEY BACK GUARANTEE. 1 YEAR WARRANTY - 1-800-785-1145

Awesome Cable Descrambling guides for all systems (TEST TUBES, STEALTH BOX, VHS, UNIVERSAL) and more! \$10 Gift Certificate included. Call 1-877-880-0197. Cable Boxes all makes and models. Call 1-877-539-9896. Dealers Welcome. www.melectronics.com

DESCRAMBLER BLOWOUT Scientific Atlanta 8580. Original one piece. 99 channels. Guaranteed. Single \$160, (5) 140, (10) 120. **NOVICOR ELECTRONICS** 412-833-0773

CABLE DESCRAMBLER PLANS!!! Plus two free bonuses, Radar Jammer Plans and Cable Manual \$14.00. 1-888-367-9972

CB-SCANNERS

CB Radio Modifications! Frequencies, kits, high-performance accessories, books, plans, repairs, amps, 10-Meter conversions. The best since 1976! Catalog \$3.00. **CBCI** Box 1898PE, Monterey, CA 93942. www.cbciintl.com

COMPUTER HARDWARE

Robot Module. Security Robot Kit. Free catalog. www.actionrobotics.com. **Action Robotics** Box 138, Boston, NY 14025.

COMPUTER SOFTWARE

Mother of all CD-ROMS! Everything you need to start your home business! Free Details: **PARADIGM-CD** 1516 E. Fountain Mesa, AZ. 85203

PLANS-KITS-SCHEMATICS

AWESOME KITS: Voice Changers, Levitators, Lasers, Solar Robots and more! Catalog \$1.00. **LNS Technologies**, PO Box 67243, Scotts Valley, CA 95067. www.techkits.com

ELECTRONIC PROJECT KITS: \$3.00 catalog. 49 McMichael St. Kingston, ON., K7M 1M8. www.qkits.com - **QUALITY KITS**

"HEATHKIT COMPANY is selling photocopies of most Heathkit manuals. Only authorized source for copyright manuals. Phone: 616-925-5899, 8-4 ET."

Commodore 128/64: Turn your c128 or c64 into an advanced automated video security system. Programmable: #cameras (1-4), date, time, calendar, display time. Stop on any camera. Four cameras to one screen. Color, video plus audio. Output to VCR, TV, monitor. Plans, video tape, program diskette. \$129.00. Send money order. **CAMUX**, 12407 Wagner St. #209, Los Angeles, CA 90066. Order Today!!

BEST BY MAIL

Rates: Write National, Box 5, Sarasota, FL 34230
WIN AT HORSE RACING. INCREDIBLE! Free audio tape. WB, Box 1540, Minden, NV 89423.

PUBLICATIONS

Mind Blowing Plans! 196 + Publications, impossible to find underground info! Hacking, revenge, moneymaking and lots more. Very shocking stuff. Free catalog. **TIC** PO Box 876PE Hurst, TX 76053. www.theinformationcenter.com

SATELLITE EQUIPMENT

DSS Test card. Authorizes all channels for information, plus free bonus. Call toll free 1-888-416-7296. **FREE Satellite TV Buyer's Guide.** Best Products - Lowest Prices - Fastest Service! Dish Network, Direct TV, C/Ku-band, including 4DTV, Parts-Upgrades-Accessories! **SKYVISION** 1-800-543-3025. International 218-739-5231. www.skyvision.com

FREE DTV & DISH NETWORK test card information. \$10 gift certificate included. 1-877-856-0923. www.melectronics.com

ROBOTICS

AROBOT Kit from **ARRICK ROBOTICS** uses the BASIC Stamp II. Quality metal construction. Easy to assemble and very expandable. \$235.00. <http://www.robotics.com/arobot>.

INVENTORS

INVENTORS: Free information package/initial consultation. 800-876-6670. Direct office: 301-990-9393. **John Halvonik**, Patent Attorney. **Inventions/new** products. ISC, America's leading invention firm, helps submit to companies. Patent Services 1-888-439-IDEA.

MONDO • TRONICS

ROBOT STORE

* KITS *

Your

* BOOKS *

Mailorder

* PARTS *

Source

* VIDEOS *

For

* MODELS *

Robots!

* MORE! *

(REQUEST OUR FREE CATALOG)

www.robotstore.com

800-374-5764

Or write to us:

4286 Redwood Hwy PMB #226
San Rafael CA 94903

Phone 415-491-4600 • Fax 415-491-4696

Email info@mondo.com

Dalbani

www.dalbani.com

Computer Cases

Lexon®

\$15.00

Nickel Chassis with built in 250 power supplies
7 ATX Slots
7 AT Slots

FCC Approved

Item # 95-4025



Amplifiers

\$19.99

120 Watt
Separate
Bass/Treble Switch
Item # 89-3470



Soldering Station

\$14.95

Variable Power Control (5-40W)
Interchangeable Tip & Heating Element

Item# 51-1505



RCA

Video Tapes

\$1.25

Min. 10 pieces

6 Hours
Hi-Fi Sound

Item # 50-1005

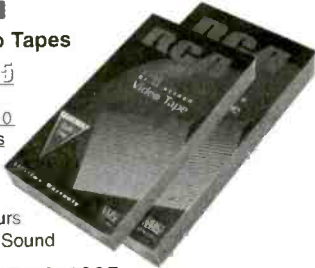

F-Quick Cable

\$7.95

Gold Plated
3ft.,
75Ω

Item # 17-7395

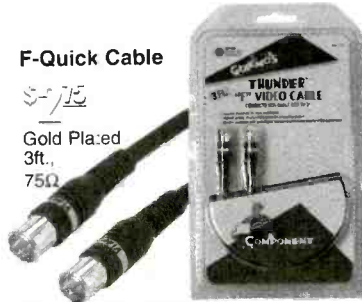

SONY PlayStation

\$24.95

Minimum
3 pieces

Laser Pickup

Original Sony# KSM-440ACM

Item # 46-4720



MAGNAVOX

Remote Control

\$5.95

Min. 5 pieces
Controls
3 Units
TV, VCR,
Cable Box

Item # 82-1380



GEMINI II Power Strip

\$9.95

25 Joules
6 Outlets

Item # 40-1755



Multimeters

\$19.95

6 Functions
19 Ranges
9V Battery
Included

Item #
50-2895



Clearance

\$21.95

Aluminum frame
Tool Case

Item# 50-1890 Black



CALL TOLL FREE

e-mail: savings@dalbani.com

1-800-325-2264

SPECIAL SHIPPING RATE

\$20.00
Minimum Order
not including shipping & handling

ups
2ND DAY AIR®

\$3.95 plus shipping and handling

U.S. only and U.S.A. including Alaska, Hawaii & Puerto Rico.

CIRCLE 164 ON FREE INFORMATION CARD

RETAILERS THAT SELL OUR MAGAZINE EVERY MONTH

Arizona

Circuit Specialists, Inc.
220 S. Country Club Dr.
Bldg 2
Mesa, AZ 85210

Elliott Elec. Supply
1251 S. Tyndell Ave.
Tucson, AZ 85713

California

All Electronics
14928 Oxnard Street
Van Nuys, CA 91411

California Electronics
221 N. Johnson Ave.
El Cajon, CA 90202

Electronics Plus, Inc.
823 4th St.
San Rafael, CA 94901

Electronics Warehouse
2691 Main Street
Riverside, CA 92501

Ford Electronics
8431 Commonwealth Ave
Buena Park, CA 90621

HCS Electronics
6819 S. Redwood Drive
Cotati, CA 94931

HSC Electronics
4837 Amber Lane
Sacramento, CA 95841

Halted Specialties Co.
3500 Ryder Street
Santa Clara, CA 95051

Inland Electronic Suppliers
1012 N. Carpenter Rd.
Modesto, CA 95351

JK Electronics
6395 Westminster Blvd.
Westminster, CA 92683

Kandarian Electronics
1101 19th Street
Bakersfield, CA 93301

Metro Electronics
1831 J Street
Sacramento, CA 95814

Minute Man Electronics
37111 Post St., Suite 1
Fremont, CA 94536

Orvac Electronics
1645 E Orangethorpe Ave.
Fullerton, CA 92631

San Mateo Elec. Supply
16 W. 42nd Ave.
San Mateo, CA 94403

Sav-On Electronics
13225 Harbor Blvd.
Garden Grove, CA 92643

Colorado

Centennial Elec. Inc.
2324 E. Bijon
Colorado Springs, CO
80909

Connecticut

Cables & Connectors
2198 Berlin Turnpike
Newington, CT 06111

Electronic Service Prod.
437 Washington Avenue
North Haven, CT 06473

Delaware

Wholesale Electronics
77 McCullough Dr., Ste. 10
New Castle, DE 19720

Illinois

BB&W Inc.
2137 S. Euclid Ave.
Berwyn, IL 60402

Tri State Elex
200 W. Northwest Hwy.
Mt. Prospect, IL 60056

Indiana

Hutch & Son, Inc.
300 N. Main St.
Evansville, IN 47711

King of the Road Elec.
409 E. Center Rd.
Kokomo, IN 46902

Maryland

Mark Elec. Supply Inc.
11215 Old Baltimore Pike
Beltsville, MD 20705

Michigan

Purchase Radio Supply
327 East Hoover Avenue
Ann Arbor, MI 48104

The Elec. Connection
37387 Ford Road
Westland, MI 48185

Minnesota

Acme Electronics
224 Washington Avenue N.
Minneapolis, MN 55401

New Jersey

Lashen Electronics Inc.
21 Broadway
Denville, NJ 07834

New York

LNL Distributing Corp.
235 Robbins Lane
Syosset, NY 11791

Unicorn Electronics
Valley Plaza
Johnson City, NY 13790

Ohio

Philcap Electronic Suppliers
275 E. Market Street
Akron, OH 44308

Oregon

Norvac Electronics
7940 SW Nimbus Avenue
Beaverton, OR 97005

Texas

Tanner Electronics
1301 W Beltline
Carrollton, TX 75006

Electronic Parts Outlet
3753 B Fondren
Houston, TX 77063

Computers Electronics Etc.
110 E. Medical Center Blvd.
Webster, TX 77598

**If you'd like to sell our magazine in your
store, please circle 180 on free information card
or Contact**

Christina Estrada at (516) 293-3000 ext 223

Get the rhythm right with THE POCKET METRONOME

DEAN F. POETH II

Have you ever heard what music sounds like when one instrument or voice is off tempo? It's akin to choirs where a few singers are just a little off key. After listening to a performance recently where a couple of the performers were just a bit off beat, a few of the (nicer) words that came to mind were chaos, disorder, confusion, turmoil, discord, anarchy, pandemonium, etc. Fortunately, there is a simple solution for this—practice, practice, practice.

A metronome can help you keep time while practicing or performing music. Unfortunately, it is easy to spend \$40 or more on a commercial version! The *Pocket Metronome* described in this article is small, portable, very inexpensive, and fun to build. It makes an easy one-evening project and also makes a great gift to that musically inclined friend or child!

The *Pocket Metronome*, as its name implies, is small enough to fit in a shirt pocket or purse. Powered by four AAA-cell batteries, which can last for several years with moderate use, the Metronome has two speed ranges, plus both an audio and a visual beat indicator. The performer can select between visual only or both audio and visual "time keeping" via a slide switch. That versatility allows the Metronome to be used not only for practice, but also for performances where an audible beat would be undesirable.

You will be able to keep better time when you build this simple one-evening project!

A Look at the Circuit. A schematic diagram of the *Pocket Metronome* is shown in Fig. 1. At the heart of the circuit is an NE556 dual oscillator/timer, IC1, which contains two highly stable oscillators that are

in or out of the circuit. A third switch (S3, a miniature slide unit) is used to select one of two speed ranges; the lower range is variable from 30 to 50 beats per minute (BPM), while the upper range is variable from 50 to 208 BPM.

Construction. There is nothing particularly critical about the construction of the *Pocket Metronome*. In fact, the author's unit was assembled on a small section of perfboard, and point-to-point wiring was used to accomplish intercomponent connections. The first step in assembling the project is to cut the perfboard to fit inside an audio-cassette case (approximately 4 by 2½ inches) using a small saw. Once the perfboard is cut to size, begin mounting the com-

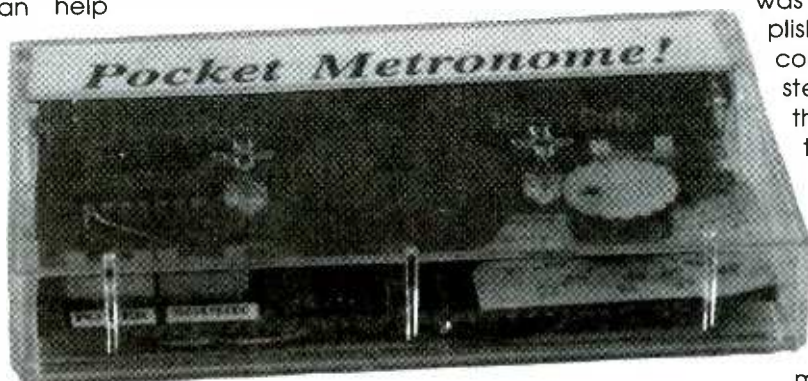

ponents to the perfboard substrate. Start by deciding where on the board IC1 will be located and place a 14-pin IC socket in that position, bending two diagonally located pins (for example, pins 1 and 8 or 7 and 14 on a 14-pin socket) to hold the socket in place. The purpose of the socket is twofold: First, using a socket helps to ensure that the IC doesn't suffer thermal damage during circuit assembly; and second, it makes IC replacement a simple "swap" operation should it ever become necessary.

In any event, once the socket is secured in place, begin installing the rest of the components one at a time (guided by the schematic

capable of producing accurate time delays. Each oscillator operates independently, sharing only power and ground connections. One oscillator is used to generate timing pulses (that aid in maintaining rhythm), while the other is used as a tone generator. Each timer's output circuit can sink up to 200 mA, so they can drive a speaker or light-emitting diode (LED1, in this case) directly.

The number of beats per minute can be varied via a linear trimmer potentiometer, R4, which functions as a miniature speed control. Component S1 (a miniature slide switch) serves as the unit's power switch, while S2 is used to switch BZ1

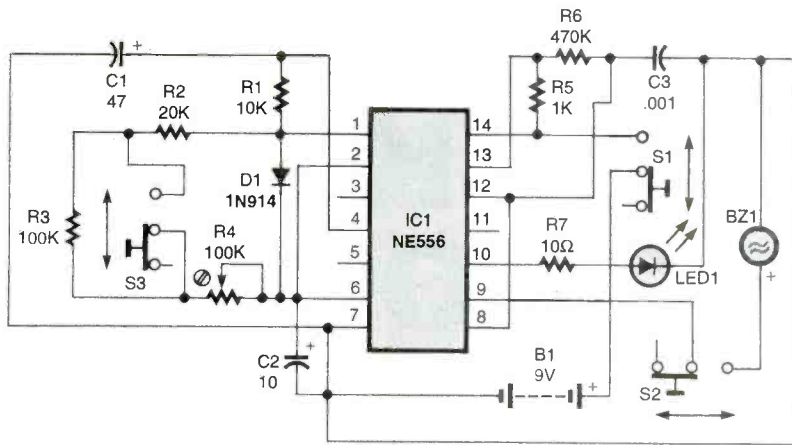
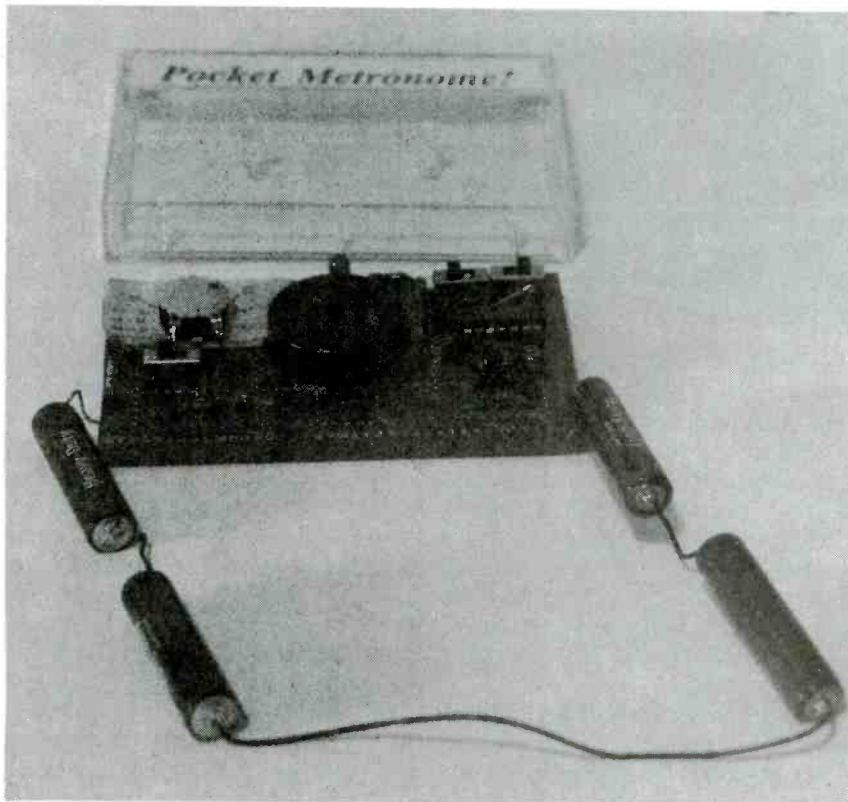

Fig. 1. At the heart of the Pocket Metronome, as revealed by this schematic diagram, is IC1—an NE556 dual oscillator/timer—which contains two independently configurable, highly stable oscillators that share only their power and ground connections.

diagram in Fig. 1), connecting each as required (or possible at this point) before moving to the next part. Carefully make all intercomponent connections using a low-temperature (600°F) pencil-type soldering iron. Note: Components S1–S3, R4, and BZ1 should all be epoxied to the perfboard for support—five-minute epoxy works fine

for this operation.

Power for the circuit is provided by four AAA-cell batteries that were meticulously directly wired in series with one another: AAA cells were used because they are small enough to fit into the small plastic audio-cassette case. Interconnections between the batteries can be accomplished in sev-



The Pocket Metronome was assembled on a small section of perfboard (approximately 4 by 2½ inches) with point-to-point wiring used for intercomponent connections. The completed project was then fitted into an audio-cassette case.

PARTS LIST FOR THE POCKET METRONOME

SEMICONDUCTORS

IC1—NE556 dual oscillator/timer, integrated circuit (RadioShack 276-1728 or equivalent)

D1—1N914 or equivalent, general-purpose, small-signal, silicon switching diode

LED1—Red light-emitting diode (RadioShack 276-066A or equivalent)

RESISTORS

(All fixed resistors are ¼-watt, 5% units.)

R1—10,000-ohm

R2—20,000-ohm

R3—100,000-ohm

R4—100,000-ohm, thumb-knob trimmer potentiometer

R5—1000-ohm

R6—470,000-ohm

R7—10-ohm

CAPACITORS

C1—47-μF, 16-WVDC, electrolytic capacitor

C2—10-μF, 16-WVDC, electrolytic capacitor

C3—0.001-μF, ceramic-disc

ADDITIONAL PARTS AND MATERIALS

B1—6-volt battery (see text)

S1–S3—SPDT miniature slide switch (RadioShack 275-409 or equivalent)

BZ1—1500- to 3000-Hz piezoelectric transducer (RadioShack 273-073 or equivalent)

eral ways—direct soldering (a tedious and extremely dangerous method that is not recommended), using a conductive epoxy to bond connecting wires to the battery terminals, or using a battery connector. The choice is yours.

In the author's prototype, the batteries were interconnected using the conductive epoxy: Once the batteries are wired into the circuit, they can be glued in place using only a small amount of silicon RTV adhesive.

Checkout and Operation. Carefully check all connections before proceeding. It's a good idea to set the completed project aside for several hours or more, and then come back to it and check the wiring one last time. If everything looks OK,

(Continued on page 86)

Comm Links

Spurious Transmitter Outputs

JOSEPH J. CARR

When a radio transmitter is operated legally, the user is expected to transmit only on the assigned frequency, and none other. Ideally, when a transmitter produces a radio-frequency (RF) signal, only that frequency is created. Likewise, when the "ideal-but-never-achieved" signal is modulated, the only new signals that are generated are those created by the modulation sidebands. But, in the real world, things never seem to gravitate toward the ideal—things can, and usually do, get a bit nastier. Let's take a look at some of the different forms of output signal normally emanating from a transmitter.

Figure 1 shows an amplitude-vs-frequency plot of a hypothetical transmitter, as displayed by a *spectrum analyzer* (i.e., a frequency swept receiver with its output connected to an oscilloscope that is swept with the same sawtooth as the receiver's local oscillator).

The main signal is the carrier, F , which is the highest amplitude "spike" in the display. We'll consider only an unkeyed continuous wave signal because modulation sidebands would make a mess out of our clean little picture. All of the amplitudes in Fig. 1 are normally measured in dBc (decibels below the carrier). A signal that is -3 dBc, for example, would be 3 dB lower than the carrier or about half the power of the carrier. For spurious outputs, the lower the level the better, so look for high negative dBc values (e.g., -60 dBc or more).

DIRECT INSTABILITY

If both the input and output ends of an RF amplifier are tuned (often the case) or there is unexpected coupling between input and output, causing feedback of the output signal, then the amplifier may oscillate on either the transmitter's operating frequency or on a nearby frequency. If the transmitter's "on-frequency" output level does not drop to zero when the drive signal is reduced to zero, then suspect direct

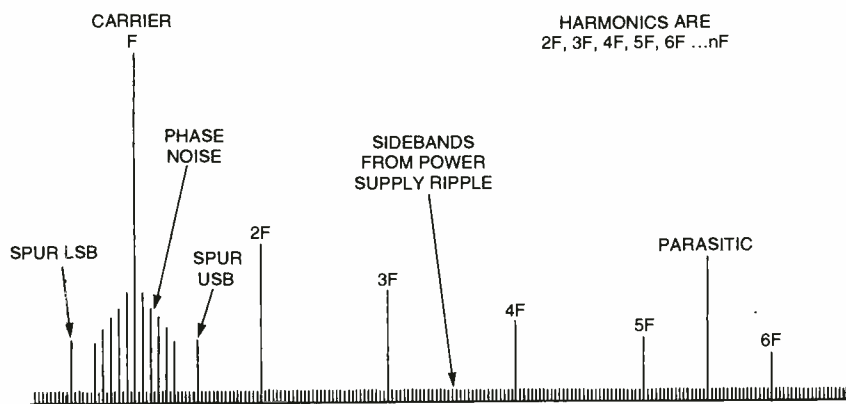

Fig. 1. Shown here is an amplitude-vs-frequency plot of a hypothetical transmitter, as displayed by a spectrum analyzer.

instability as a cause of the oscillation. That's especially likely if the input and output are tuned to the same frequency, giving rise to what used to be called "tuned-grid-tuned-plate (TGTP) oscillations."

PHASE NOISE

Because the process of generating a single frequency (F) is not a perfect and precise operation—there's normally a certain amount of noise energy surrounding the carrier. Some of the signals are caused by thermal noise in the circuit, as well as other sources. The signals tend to modulate the carrier, creating the phase-noise sidebands shown in Fig. 1.

HARMONICS

Any complex waveform can be represented by a series of sine and cosine waves that make up its *Fourier series* or *Fourier spectrum*. If a transmitter produces a pure sinewave output signal, then only the carrier frequency (F) appears in the spectrum. But if the signal is distorted in any way, no matter how slightly, harmonics appear. Those signal components are integer multiples of the harmonic and so they manifest themselves at $2F$, $3F$, $4F$. . . nF . For example, a 780-kHz, AM broadcast-band transmitter can generate harmonics at 1560 kHz, 2340

kHz, 3120 kHz, 3900 kHz, and so forth. The specific harmonics and their relative amplitude differ from case to case, depending on the circuit and the cause of the distortion.

Like all spurious emissions, the harmonics must be suppressed so that they do not interfere with some other services.

VHF/UHF PARASITICS

A transmitter can be designed to operate at a relatively low frequency (in the medium-wave or high-frequency bands), but in operation produce large output signals in the VHF or UHF bands. The problem is caused by stray capacitances and inductances in the circuit. Although the problem can manifest itself in transistor-based RF-power amplifiers, it is most commonly associated with vacuum-tube-based RF amplifiers. Unfortunately, the really high-power amplifiers used in today's broadcast transmitters are vacuum-tube based . . . making the problem even more pronounced due to the power levels involved.

Barkhausen's criteria for oscillation are: 1) a phase shift of 360 degrees at the frequency of oscillation, and 2) a loop gain of one or more at that frequency. If the phase inversion of the amplifier plus the frequency selective phase shifts caused by the stray

capacitances and inductances (including those inside components) add up to 360 degrees at any frequency where there is gain, then oscillation takes place. Because strays are typically small, the oscillating frequency tends to be in the VHF and higher-frequency ranges of the radio spectrum.

POWER-SUPPLY RIPPLE

Like most electronic devices, transmitters are powered by direct current (DC), while the utility company supplies alternating current (AC) at a frequency of 60 Hz (some countries use 50 Hz). Therefore, the AC voltage must be fed through a converter circuit (DC power supply) that produces an impure form of DC called pulsating DC. That form of DC, which is produced at the output of the rectifier, contains a ripple-factor impurity at a frequency equal to the AC line frequency (60 Hz) in half-wave rectifiers or twice the AC line frequency (120 Hz) for full-wave rectifiers. The ripple factor represents a small amplitude variation that tends to amplitude modulate the carrier. That produces a low-level "comb" spectrum with RF signals spaced every 120 Hz up and down the band.

Normally, that power supply by-product isn't a problem; but if the DC power-supply ripple filtering is ineffective or if the application is particularly sensitive, then it'll be heard. In some cases, such as the 400-Hz power supplies used in aircraft systems or transmitters that use 5- to 100-kHz switching power supplies, the problem can be much more pronounced.

LOW-FREQUENCY SPURS

When an amplifier is misadjusted or when an RF feedback path exists through the DC power supply (or other circuits), then there is a strong possibility of the amplifier oscillating at a low frequency (perhaps audio or below). The oscillations amplitude modulate the RF signal, giving rise to spurious emissions. I've seen solid-state VHF RF power amplifiers break into low-frequency oscillation when either mistuned or incorrectly biased. If the low-frequency oscillation is caused by DC power-supply coupling, then both a high-value electrolytic and low-value ceramic-disc (or similar) capacitor can be used in parallel for decoupling.

One peculiar form of low-frequency

oscillation occurs in supposedly broadband solid-state power amplifiers. In some units, a broadband toroid transformer is used to couple the input and output to the transistors of the power amplifier. In such circuits, a DC blocking capacitor is used to prevent bias from being shorted out through the transformer. Unfortunately, the inductance of the transformer and the capacitance of the coupling capacitor form a tuned resonant circuit. If both input and output are tuned to the same frequency, then a species of TGTP-like oscillations are produced. Such oscillations tend to occur in the 10- to 200-kHz range, generating spurious RF sidebands (SPUR LSB and USB in Fig. 1) spaced at that frequency from the carrier, F.

FREQUENCY HALVING

Solid-state, bipolar-transistor, RF-power amplifiers sometimes show an odd spurious emission in which a signal is produced at half of the carrier frequency. That phenomenon is evident when the input and output load and/or tuning conditions are such that the transistor's operating parameters vary over cyclic excursions of the signal. Unfortunately, that effect is seen in non-linear situations, so odd multiples of the halving frequency occur. Suspect that to be the problem when a spurious emission occurs at 1.5F because it could be the third-harmonic of a halving situation.

AUDIO (AND OTHER) STAGE OSCILLATION

Few transmitters produce a single frequency with no modulation, so Fig. 1 is rather simplistic in order to illustrate the actual case. When the transmitter is modulated (AM, PM, FM *etc.*), sidebands appear. Let's consider only the AM case for simplicity's sake. Let's say we have a 1-kHz audio-sinewave tone modulating a 1000-kHz (1-MHz) RF carrier. When the modulation occurs, a new set of sideband signals appear: The lower sideband (LSB) will appear at $1000 \text{ kHz} - 1 \text{ kHz} = 999 \text{ kHz}$, while the upper sideband (USB) will appear at $1000 \text{ kHz} + 1 \text{ kHz} = 1001 \text{ kHz}$. In the case of a voice amplifier, the nominal range of audio frequencies is about 300 Hz to 3 kHz, so the normal speech sidebands will appear at $\pm 3 \text{ kHz}$ from the carrier, or in our 1000-kHz case, from 997 kHz to 1003 kHz.

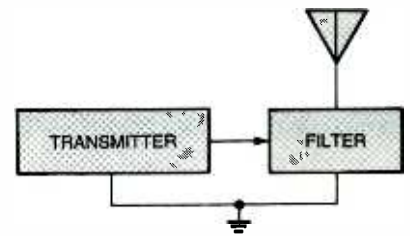

Fig. 2. In order to prevent their rigs from interfering with other RF services (particularly those in the VHF/UHF bands, especially TV channels), ham operators place filters in series with the outputs of their HF transmitters.

But what happens if the audio stages oscillate at a frequency higher than the audio range? The LSB/USB pairs appear at those frequencies as well. I can recall a VHF FM transmitter, used in the 2-meter amateur radio band (144-148 MHz), that produced signals every 260 kHz up and down the band from the transmitter's nominal output frequency. The cause turned out to be "ultrasonic" oscillation of the FM reactance modulator stage. The manufacturer supplied a retrofit kit that provided better decoupling (capacitors and ferrite beads) and grounding of the circuit. Once the oscillation ceased, the RF output was cleaned up.

Keep Barkhausen's criteria for oscillation in mind: Any time there is a frequency at which the loop gain is greater than unity and the overall phase shift is 360 degrees, there will be oscillation. That's true regardless of whether the sub-assembly is an audio amplifier, reactance modulator, or RF stage.

WHAT TO DO?

There are three basic strategies to reducing emissions to the level required by the Federal Communications Commission: 1) adjust (or repair) the transmitter correctly, 2) use shielding, and 3) filter the output of the transmitter.

The adjustment issue should go without saying, but apparently it is a problem. One trick that many transmitter operators pull is to either increase the drive to a final RF power amplifier to increase the output power or peak the tuning for maximum output. That isn't always the smartest thing to do. Never operate the transmitter at levels above the manufacturer's recommendations. There are cases where tuning up the amplifier using a spectrum analyzer as well as an RF power meter will

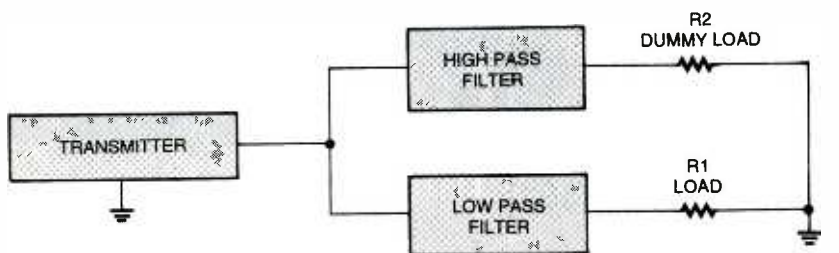

A

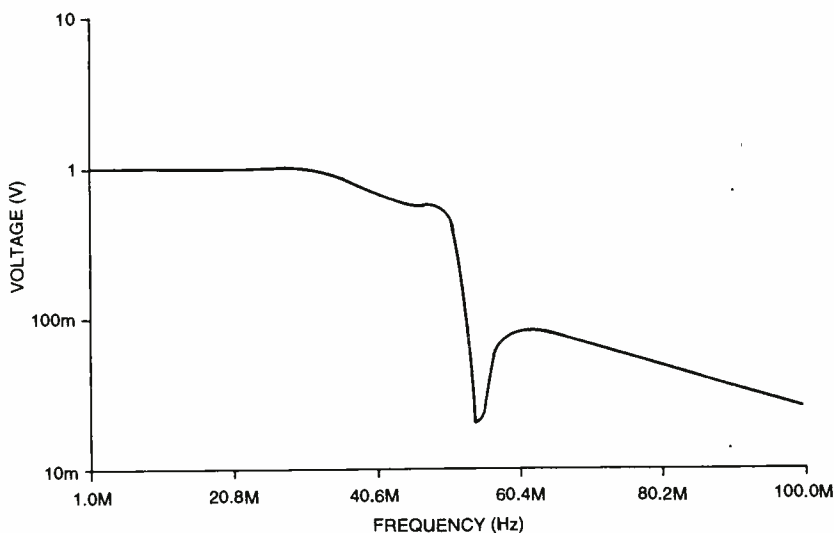

B

Fig. 3. One of the best approaches to filtering is to use an absorptive filter (shown in A), which is comprised of two separate filters—one high-pass and one low-pass—with the same cut-off frequency. In one variation of that configuration, a 40-MHz absorptive filter coupled to a 56-MHz notch filter produced the frequency response shown in B.

show that the increased power level apparent on the meter is due to the production of harmonics or other spurs and not the carrier.

At one time, it was relatively common to see illegal operation of citizens-band (CB) transmitters. In the tube days, it was relatively easy to increase the RF-output power from 4 watts, on average, to about 8 watts. Consider this situation: A 2:1 increase is only 3 dB, which is about half an S-unit on a distant receiver . . . or about half as much as the minimum discernible change. Yet, operating the transmitter that way not only doesn't produce the desired end result, it creates a distinct possibility of high harmonic or other spurious emissions!

When repairing a transmitter, use only parts that are recommended. That's especially true of capacitors and semiconductors. All capacitors exhibit a bit of stray inductance, as well as capacitance, and so they'll have a self-resonant frequency. If that

frequency meets Barkhausen's rules, then oscillation will occur. In general, the problem comes from using a cheaper capacitor, or different type of capacitor, from the one used originally. Also, be very wary of *replacement transistors* that are *not* really and truly "exact" replacements. Such components frequently cause either UHF or low-frequency oscillations.

Shielding is an absolute *must* in transmitters, especially higher-power transmitters. Even low-power transmitters can cause sufficient spurious-emission levels so as to interfere with other services. Transmitters operated outside their cases, or with critical shields removed, are candidates for high radiation of spurs.

Even small shields are important. I recall one transmitter that had a large amount of AM splatter, and a very broad signal, as well as output components appearing up and down the band. The rig was a 300-watt AM HF band transmitter. The thing looked nor-

mal, but a photo of the transmitter in a service manual revealed a missing bit of metal on the master oscillator's shielded housing. Someone had removed that little bit of sheet metal and allowed a slot to appear that admitted RF from the final into the oscillator housing. That feedback path proved critical. Restoring the shielding fixed the problem.

FILTERING

Ham operators use low-pass filters in the outputs of their HF transmitters in the transmission line to the antenna to protect VHF/UHF bands (especially TV channels), as shown in Fig. 2. In other cases, a high-pass filter or band-pass filter may be used, depending on the frequencies that need protecting.

One of the best approaches to filtering is to use an absorptive filter as shown in Fig. 3A. The absorptive filter is comprised of two separate filters—one high-pass and one low-pass—with the same cut-off frequency. Either filter can be used for the output, depending on the case. Let's consider a ham-radio situation wherein the VHF band TV channels must be protected from the high-frequency emissions of the transmitter. In that case, as shown in Fig. 3A, the low-pass filter is used to feed the load (R1, which can be an antenna), and the high-pass filter feeds a non-radiating dummy load. The harmonics and parasitics, therefore, are absorbed in the dummy load, while the desired signal is output to the load.

In other cases, where the protected frequencies are below the transmitter frequency, then the roles of the high-pass and low-pass filters are reversed—R2 becomes the load and R1 becomes the dummy load.

Some absorptive filters also place a wavetrapp across the load in order to protect specific frequencies. In one version, there is a 40-MHz absorptive filter with a 56-MHz notch filter (*i.e.*, a series-tuned LC circuit across the load). The design was published in *The ARRL RFI Book* for ham transmitters. I modeled the circuit on *Electronics Workbench* and produced the frequency response shown in Fig. 3B. Note that the gain of the filter drops off starting just before 40 MHz (which is the -3 dB point), and there is a deep notch at the 56-MHz point. The design

(Continued on page 81)

Circuit Circus

Electronic-Ignition Systems

CHARLES D. RAKES

Hello, circuiters. This visit we're going on an electromechanical adventure that, hopefully, will illustrate how electronics can be used to simplify the design and operation of a typical mechanically operated device. Actually, this odyssey started some time ago, when I was visiting an antique "Gas and Steam Engine" show, where I spotted a very old and interesting inverted open-crank air compressor in the flea market area. At first glance, I thought I'd found a rare and valuable turn-of-the-century inverted gas engine, but a closer look confirmed that it was indeed an air compressor. Since the price was only about five percent of what a similar-looking inverted engine would cost, I purchased the compressor with the intent of converting it into an operating inverted gas engine. The following is the result of some of those efforts.

FOUR-STROKE ENGINES

The drawing in Fig. 1 illustrates the relationship between the flywheel and piston in all four positions of a typical single-cylinder, four-stroke gasoline engine. (Note the position of the harmonic balancer, also called a vibration dampener, on the flywheel for each quarter cycle of the four-stroke engine.) Figure 1A represents the intake stroke—the time in which gas and air are "sucked" into the cylinder during the first half turn of the flywheel. Following that stroke comes the compression stroke (as illustrated in Fig. 1B)—the period during which the air/fuel mixture is squeezed into an increasingly smaller area as the piston travels up the cylinder and the flywheel completes one full revolution. When the piston reaches the point of maximum compression (top dead center or TDC), a spark is introduced into the cylinder, igniting the air/fuel mixture. That, in turn, forces the piston downward (i.e., creating the power stroke) and moves the flywheel forward another one-half turn, as shown in Fig. 1C.

The final half-turn of the flywheel, shown in Fig. 1D, moves the piston upward, forcing the spent (burnt) air/fuel mixture from the cylinder. In a four-stroke engine, the flywheel turns twice for each complete four-stroke cycle of events.

In the majority of the old slow-turning single-cylinder gas engines, the intake valve is atmospherically operated—meaning that during the intake cycle, the air pressure outside the cylinder is greater than that inside the cylinder and the intake valve is forced

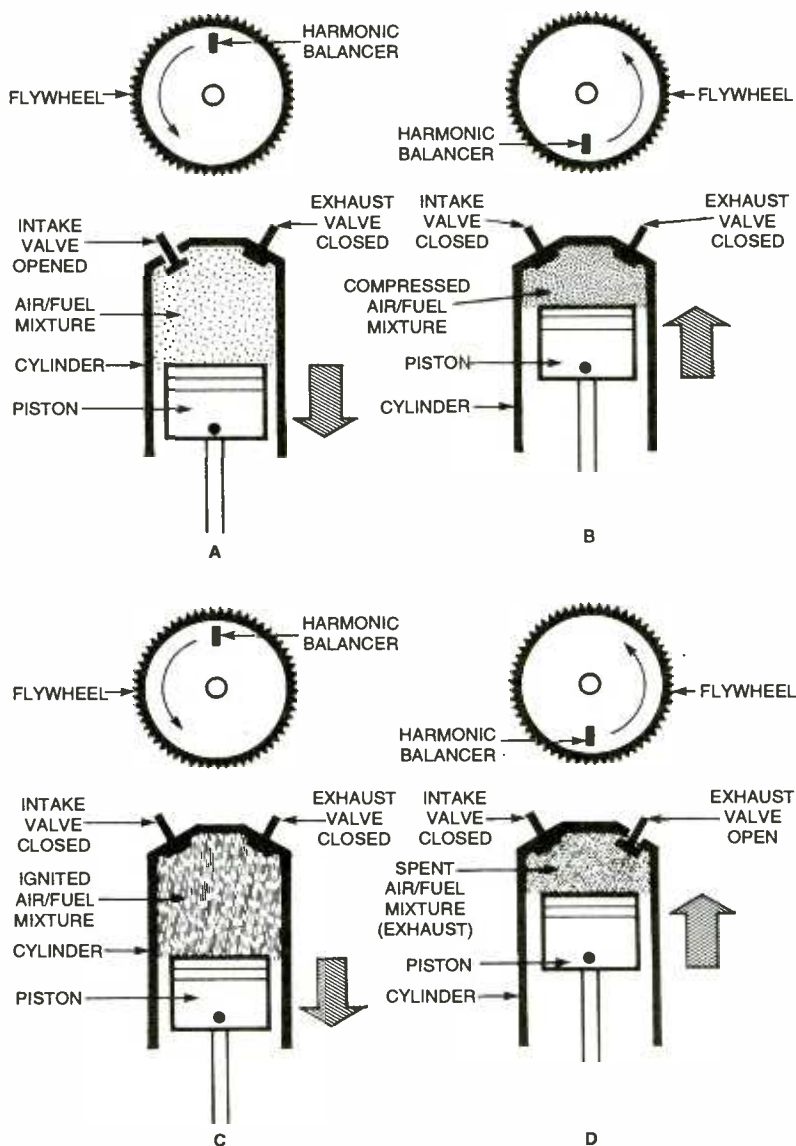

Fig. 1. Shown here are the various phases of a typical single-cylinder four-stroke gasoline engine. The drawing in A represents the intake stroke, B illustrates the compression period, C shows the power stroke, and D demonstrates the exhaust stroke.

open by the difference in air pressure. The exhaust valve must open once every two turns of the flywheel and remain open for about a half turn. That's usually accomplished by a two-to-one gear system along with a cam and linkage to the valve's rocker arm and valve.

Our mission is to replace as many as possible of the mechanical components in the exhaust and ignition system with electronic circuitry. To accomplish that task, the electronic circuit must generate an output signal for each one-half turn of the flywheel, so that the ignition- and exhaust-timing positions can be set.

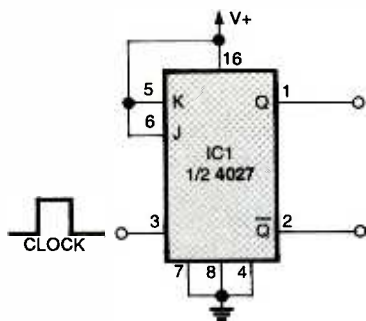

Fig. 2. Half of a 4027 dual JK flip-flop can easily be configured to function as a divide-by-2 counter.

There are several methods by which that can be done. One method calls for attaching two magnets—180-degrees apart—on the flywheel and using a Hall-effect device or magnetic reed switch to sense the passing of the magnets as the flywheel rotates. An alternate method hinges on an IR emitter/detector pair used in conjunction with two interrupters that are mounted 180 degrees apart on the flywheel.

Since we're working with a four-stroke engine, we'll need a circuit that can divide by two twice to give the piston's up and down positions for each revolution of the flywheel. The 4027 dual JK flip-flop (half of which is shown in Fig. 2) is a good candidate for the job, since its two flip-flops are electrically separate, allowing them to be connected in cascade to give outputs for each half rotation of the engine's flywheel. But, first, let's look at one of the 4027's JK flip-flops and see how it operates.

TAMING THE FLIP-FLOP

To perform the functions needed, both the J and K inputs must be tied to

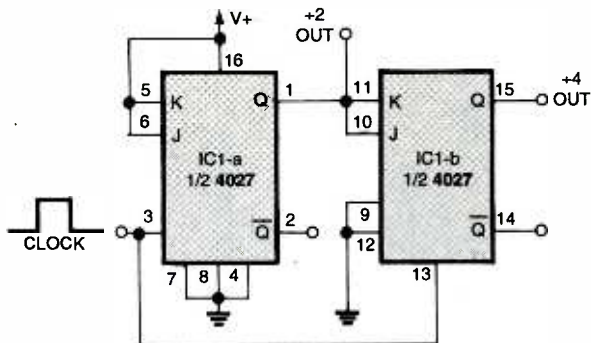

Fig. 3. By cascading the two halves of the 4027, this simple circuit can easily be made to generate both divide-by-2 and divide-by-4 outputs, as shown here.

the positive supply with the set and reset inputs connected to circuit ground. In our circuit configuration, the flip-flop is set up to operate in the clocked mode. With each positive-going clock pulse, the Q and \bar{Q} outputs alternately change states. The output transition occurs when the clock goes from ground to positive.

A divide-by-four circuit using both JK flip-flops is shown in Fig. 3. The first divide-by-two circuit (IC1-a) is just like our previous circuit, but the second divide-by-two circuit (IC1-b) differs somewhat. The J and K inputs on the second flip-flop (pins 10 and 11) are tied to the Q output of the first divider circuit. The only time the second divide-by-two flip-flop can change states is when the Q output of the first divider goes positive. That process allows the two flip-flops to be cascaded with common clock inputs, making them capable of providing both divide-by-two and divide-by-four binary outputs.

ELECTRONIC IGNITION/EXHAUST SYSTEM

A circuit that can be used to control the ignition and exhaust operations of a four-stroke engine is shown in Fig. 4. In that circuit, IC1-a ($1/4$ of a 4093 quad 2-input NAND Schmitt trigger) is configured as a signal-conditioning circuit that's used to eliminate any switch-contact bounce that might occur when S1 is activated via one of the magnets on the engine's flywheel.

When S1 (a normally open magnetic-reed switch) is open, the inputs (pins 1 and 2) of IC1-a are pulled high through R1, forcing its output at pin 3 low. Alternately, when S1 is momentarily closed (on the intake stroke), the output of IC1-a goes high, causing the divide-

by-two portion of the circuit (half of IC3) to advance by one count. Upon the completion of the intake stroke, the sensor detects the presence of the first magnet and generates a signal that causes the Q output of the first divider to go high.

As the piston approaches maximum compression, the second magnet rotates past the sensor, feeding a second trigger pulse to IC3. That causes pin 1 of IC3 to go low (extinguishing LED1), while pin 2 goes high. During that time, pin 15 of IC3 (the Q output of the second flip-flop) also goes high. The two high outputs of IC3 are applied to the inputs of IC1-c, forcing its output low. That low is applied to

PARTS LIST FOR THE ELECTRONIC IGNITION/EXHAUST SYSTEM (FIG. 4)

SEMICONDUCTORS

IC1—4093 CMOS quad 2-input NAND Schmitt trigger, integrated circuit
 IC2—4049 CMOS hex inverting buffer, integrated circuit
 IC3—4027 CMOS dual JK flip-flop, integrated circuit
 LED1, LED2—Light-emitting diode (any color)

RESISTORS

(All resistors are $1/4$ -watt, 5% units.)
 R1—100,000-ohm
 R2, R3—1000-ohm

ADDITIONAL PARTS AND MATERIALS

C1, C2—0.1- μ F, ceramic-disc capacitor
 S1—Magnetic-reed switch
 Perfboard or printed-circuit materials, IC sockets, power source, wire, solder, hardware, etc.

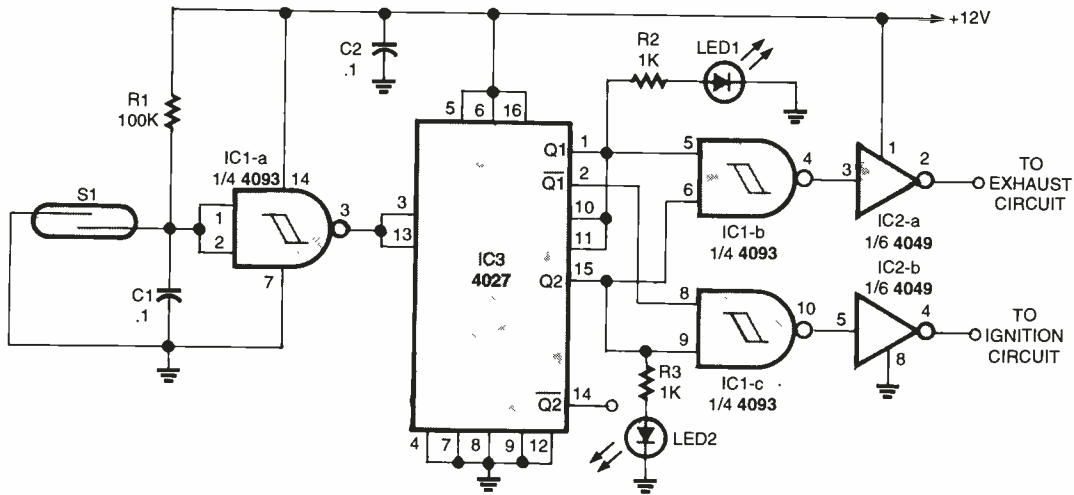

Fig. 4. This circuit can be used to govern the operation of the ignition and exhaust functions of a four-stroke engine. Note: S1 (a magnetic reed switch) and IC1-a form an input interface (or conditioning) circuit, through which the controller receives its timing pulses.

the input of IC2-b, causing its output to go high. The high output of IC2-b is fed to the ignition circuit, causing the spark plug to fire, which ignites the air/fuel mixture within the cylinder.

Once the air/fuel mixture has been ignited, the explosion (called the power stroke) drives the piston downward, causing the first magnet to pass by S1 a second time, producing a third clock pulse. The inputs to IC1-b are tied to the Q outputs of both IC3 flip-flops, so that when both go high, the output of IC1-b at pin 4 goes low. That low is inverted by IC2-b, producing a high output that is used to open the engine's exhaust valve.

As the flywheel continues to spin and the spent air/fuel mixture is being vented from the cylinder, the second magnet again approaches the sensor. When the magnet passes within the sensor's detection range, the sensor generates a fourth trigger pulse, which causes the exhaust valve to close and the intake valve to open. At that point, the four-stroke cycle repeats.

The timing for the engine's ignition and exhaust operations can be varied by changing the location of the pick-up sensor and/or the location of the magnets attached to the flywheel. The exact timing for a low-RPM engine isn't nearly as critical as it would be for a high-RPM engine.

IGNITION-TRIGGER CIRCUIT

A simple ignition-trigger circuit that can be added to the electronic igni-

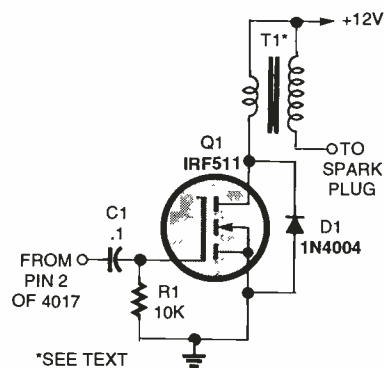

Fig. 5. Since the output of the electronic ignition/exhaust circuit in Fig. 4 lacks sufficient power to drive the engine's ignition system, this simple HexFET circuit can be tied to the output of IC2-b in Fig. 4.

PARTS LIST FOR THE IGNITION-TRIGGER CIRCUIT (FIG. 5)

SEMICONDUCTORS

Q1—IRF511 or similar N-channel

HexFET

D1—1N4004 1-amp, 400-PIV silicon rectifier diode

ADDITIONAL PARTS AND MATERIALS

C1—0.1- μ F, ceramic-disc capacitor

R1—10,000-ohm, 1/4-watt, 5% resistor

T1—12-volt auto ignition coil

tion/exhaust circuit in Fig. 4 is shown in Fig. 5. When the input to the circuit in Fig. 5 is coupled to the positive output of IC1-c in Fig 4, the HexFET (Q1)

in Fig. 5 turns on for a very brief period. That sequence causes the drain voltage of Q1 to drop rapidly, generating a current through the primary of the ignition coil and a spark output when Q1 turns back off. Although, the igni-

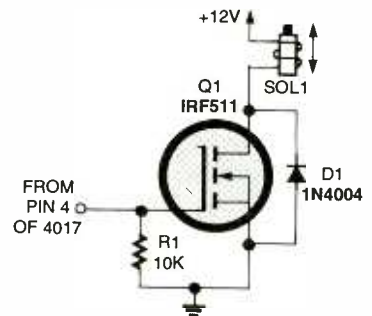

Fig. 6. Like the ignition output of the Fig. 4 circuit, its exhaust output also lacks sufficient drive to open and close the engine's exhaust valve. However, this HexFET driver along with its solenoid can be used in conjunction with the Fig. 4 circuit to actuate the exhaust functions.

PARTS LIST FOR THE EXHAUST-CONTROL CIRCUIT (FIG. 6)

SEMICONDUCTORS

Q1—IRF511 or similar N-channel

HexFET

D1—1N4004 1-amp, 400-PIV silicon diode

ADDITIONAL PARTS AND MATERIALS

R1—10,000-ohm, 1/4-watt, 5% resistor

SOL1—12-volt solenoid

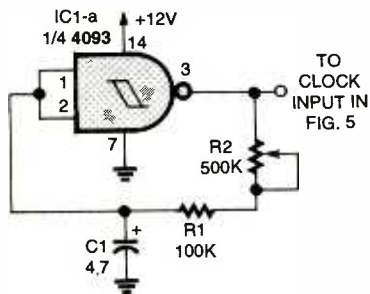

Fig. 7. Timing accuracy can be increased by replacing the electromechanically derived clock signal of the circuit in Fig. 4 with this simple variable-frequency oscillator.

PARTS LIST FOR THE ELECTRONIC TIMING CIRCUIT (FIG. 7)

- IC1—4093 CMOS quad 2-input NAND Schmitt trigger, integrated circuit
- R1—100,000-ohm, 1/4-watt, 5% resistor
- R2—500,000-ohm potentiometer
- C1—4.7- μ F, 25-WVDC, electrolytic capacitor

tion output in Fig. 4 remains high for one-half turn of the flywheel, the ignition-trigger pulse occurs at the very beginning of the output pulse.

EXHAUST-CONTROL CIRCUIT

A circuit to control the engine's exhaust valve is shown in Fig. 6. When the exhaust output of the circuit in Fig. 4 goes positive, the HexFET (Q1) in Fig. 6 turns on, pulling in the solenoid and opening the exhaust valve for one-half turn of the flywheel. The diffi-

culty in getting the exhaust system to operate properly is most likely to be encountered in setting up the mechanical linkage between the solenoid and the valve, so use care.

ELECTRONIC TIMING

Sometimes getting everything in an electro-mechanical combination to function as planned can be a frustrating experience. The simple auto-run circuit shown in Fig. 7 can be used to ease that problem. The interface portion of the circuit shown in Fig. 4 can be replaced by or modified to match the auto-run circuit—in essence, a free-running, variable-frequency oscillator—shown in Fig. 7. The oscillator circuit can be connected in place of R1, IC1-a, C1, and S1 of Fig. 4, eliminating the that circuit's dependence on an electromechanical timing system.

AN ALTERNATE IGNITION/EXHAUST CONTROLLER

Another method of controlling the engine's ignition and exhaust valve is shown in Fig. 8. In that circuit, a 4017 divide-by-ten counter—which has ten decoded outputs that sequentially go high—replaces the 4027 JK flip-flop used in the Fig. 4 circuit. Note that the input interface portion of the circuit shown in Fig. 8 is the same as that shown in Fig. 4. Because of the 4017 architecture, its output advances one count for each positive-going clock pulse.

The first count, which occurs during the compression stroke, generates a

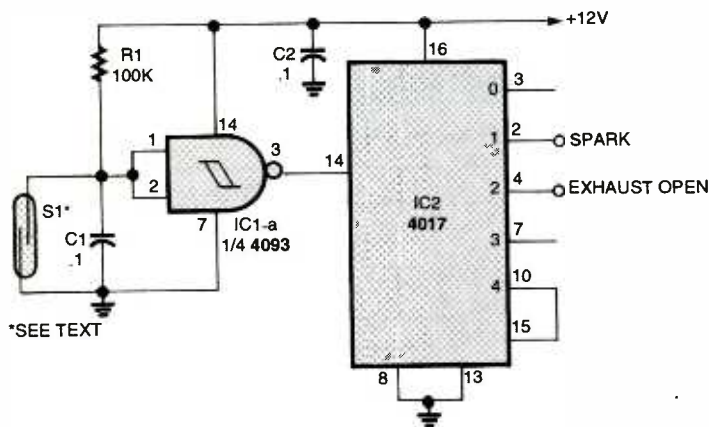

Fig. 8. Shown here is another method by which the engine's ignition and exhaust functions can be controlled. This circuit, while needing fewer components when compared to the Fig. 4 circuit, provides similar outputs to those of that circuit and can be used in conjunction with the previously discussed add-on circuits.

PARTS LIST FOR THE ALTERNATE IGNITION/EXHAUST CONTROLLER (FIG. 8)

SEMICONDUCTORS

- IC1—4093 CMOS quad 2-input NAND Schmitt trigger, integrated circuit
- IC2—4017 CMOS decade counter/divider, integrated circuit

ADDITIONAL PARTS AND MATERIALS

- R1—100,000-ohm, 1/4-watt, 5% resistor
- C1, C2—0.1- μ F, ceramic-disc capacitor
- S1—Magnetic reed switch (see text)

positive pulse at pin 3 of IC1-a that is applied to the clock input of IC2 at pin 14, causing IC2's pin 3 output (which is not used in this application) to go high. The next positive-going input from the interface circuit causes IC2 to advance one count, which causes pin 3 to return to a low state and pin 2 (the next one of IC2's sequential outputs) to go high, triggering the spark-generating circuit. The next count causes pin 4 of IC2 to go high, actuating the exhaust solenoid.

Using the 4017 in Fig. 8, as opposed to the 4027-based circuit in Fig. 4, requires fewer parts to do the same job. How many more methods can be used to accomplish the same task? Who knows, but the more ways we try to solve a problem the better prepared we'll be to solve future problems. What a dull world it would be if we all sang from the same book.

I know most of you will not run out and buy an old air compressor and turn it into a running antique, but I hope that you can use one of these circuits in a future project. ■

COMM LINKS

(continued from page 77)

appears to be successful. In some cases, such as VHF or UHF communications systems, the series-tuned LC network might be replaced with a cavity-tuned filter.

Well that's about all the space that's allotted to our discussion for this month, but be sure to join us next time around. Until then keep in touch. I can be reached by snail mail at PO Box 1099, Falls Church, VA, 22041, or by e-mail at carrij@aol.com. ■

NEW PRODUCTS

PORTABLE DATA COLLECTOR

An enhanced version of the LaserLite Pro, *LaserLite MX* is a highly functional, handheld portable (2 by 2 by 7½ inches and weighing 13½ ounces approximately) data collector. It provides one-handed operation with a direct line of sight from the display to the laser beam to the bar code. A small external memory card known as a Solid State Floppy Disk Card (SSFDC) adds 2MB to 4MB of memory to the unit's internal 256K RAM and allows for extensive searches, match inquiries, and large cross-reference files. The SSFDC cards insert into an external card slot located above the LCD display.



LaserLite MX contains two micro-processors that enable multi-tasking capabilities, so that while one processor is reading and storing data, the second can be processing complex data-access routes. Data can be entered three ways: bar code reading with a laser, Touch Memory button reading, or alphanumeric keypad entry. From one set of four alkaline batteries, LaserLite MX will scan over 100,000 bar codes or read 300,000 Touch Memory buttons.

The LaserLite MX is priced at \$1345. For more information, contact Videx, 1105 N.E. Circle Blvd., Corvallis, OR 97330; Tel. 541-758-0521; Web: www.videx.com.

CIRCLE 80 ON FREE INFORMATION CARD

INSULATED FRACTIONAL SOCKET SET

Specifically designed for working on live components without interrupting the power supply, the nine-piece *Facom 3/8-Inch Drive Fractional Socket Set* is ideal for use in power generation and distribution, as well as industrial and automotive applications. The insulated socket set comes in a molded plastic carrying case and includes a 3/8-inch drive ratchet; two extensions; and six sockets: 5/16, 3/8, 7/16, 1/2, 9/16, and 5/8.



The tools offer comfortable, ergonomic handgrips meant to be used with insulated gloves and overgloves to promote safe work habits. The socket set features a two-color warning system that alerts the user to potential problems in the insulating capacity. Orange means maximum protection and yellow means discard the tool.

The *Facom 3/8-Inch Drive Fractional Socket Set* costs \$184.85. For more information, contact S&K Hand Tool Corp., 3535 W. 47th Street, Chicago, IL 60632; Tel. 773-523-1300; Web: www.skhandtool.com.

CIRCLE 81 ON FREE INFORMATION CARD

POWER ANALYZER

An all-in-one digital meter, the *CP210A Power Analyzer* measures voltage, current, frequency, and watts. The ranges measured are: voltage-0-600V RMS, current-0-30A RMS, frequency-40-5000 Hz, and watts-up to 18 kW. Four bright auto-ranging, 3½-digit LED meters provide a simultaneous display of the readings of these four parameters, eliminating the need to use separate instruments. Data is updated 2.5 times per second.



The CP210A Power Analyzer is a high-precision, high-performance meter suitable for the testing of switching power supplies, UPS, motors, lighting electronics, and other equipment powered from an AC input. This instrument speeds up both the testing and the design process by providing the four simultaneous readouts. The CP-210A weighs about nine pounds and comes in an attractive metal case that measures approximately 10 by 4½ by 13½ inches.

The CP210A Power Analyzer costs \$615. For more information, contact Mid-Eastern Industries, 100 School St., Bergenfield, NJ 07621; Tel. 201-385-0500; Web: www.mideastind.com.

CIRCLE 82 ON FREE INFORMATION CARD

NETWORK CABLING TESTER

This test instrument, the *Model 500 LANScaper*, quickly and accurately pinpoints the location of open and short faults on networking installations, using statistical time-domain reflectometry (STDR). The Model 500 LANScaper (7.65 by 3.95 by 1.65 inches and 12.6 ounces) tests most common network cables, including RG-58/U

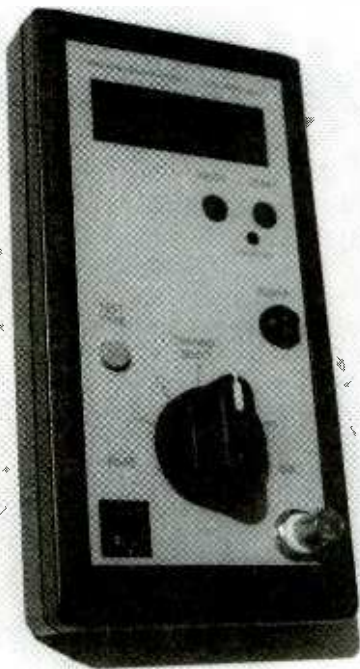

Thin Ethernet coaxial cable and RJ-45 terminated Category 5 cable.

Instantaneous testing is done by connecting one end of the subject cable to the appropriate jack on the portable test instrument. The LCD on the front of the of the unit displays Test Mode, Test Type (Short or Open), Distance, and Test Confidence Interval. Distance measured from the test unit's cable connection point to a cable fault is indicated on the LCD with a resolution of .1 foot, and it is calculated and displayed automatically.

The Model 500 LANScaper costs \$395. For more information, contact General Cybernetics Corp., 1061 MLK Blvd., Northport, AL 35476; Tel. 205-345-2600; Web: www.generalcybernetics.com.

CIRCLE 83 ON FREE INFORMATION CARD

CONTACT CLEANERS

The R5 contact cleaner product line stops contact problems; and it reduces intermittents, arcing, RFI, wear and abrasion, as well as preventing fretting corrosion. In addition, the contact cleaner improves conductivity, deoxidizes, cleans, and preserves metal surfaces. R5 offers a nonflammable, fast-evaporating solvent that is safe on plastics.

These contact cleaners are ideal for use on: switches, batteries, probes, connectors, plugs and sockets, edge connectors, terminal strips, interconnecting cables, and anywhere else that metal

conducts electricity. There are numerous applicators available: a unique pump spray, an aerosol spray, a precision dispenser, and bulk containers.



The R5 pump spray has a suggested retail price of \$24.95, and the aerosol spray has a suggested retail price of \$12.95. For more information, including other prices, contact CAIG Laboratories, Inc., 12200 Thatcher Court, Poway, CA 92064; Tel. 858-486-8388; Web: www.caig.com.

CIRCLE 84 ON FREE INFORMATION CARD

SINGLE-BOARD COMPUTER

Ideal for process-control applications that require an integrated user interface, the CP-550 is a high-speed single-board computer. The 87C550 processor used on the board provides the following new features: 8x faster execution speed; 8K of on-chip EPROM; 8-channel, 10-bit A/D converter; 1K of on-chip RAM; a second serial port; PWM outputs; up to 55 digital I/O lines; and enhanced STOP and IDLE operation.

In addition to the keyboard and LCD display and the DS1286 Cal-

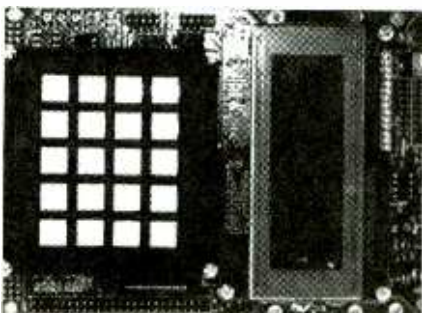

endar/Clock chip that are optional, various resources are included on the board. Among them are 32K of RAM; 28K of EPROM, EEPROM, or battery-backed RAM; and RS-232 and RS-485 buffering. The board measures 4.5 by 6.5 inches.

The CP550 comes in three configurations: without keypad or LCD (\$149), with keyboard and 2 by 20 LCD (\$229), and with keyboard and 4 by 20 LCD (\$249). For more information, contact Allen Systems, 2346 Brandon Road, Columbus, OH 43221; Tel. 614-488-7122; Web: members.aol.com/allensys.

CIRCLE 85 ON FREE INFORMATION CARD

CIRCUIT TEST SYSTEM

Used to test faults in printed circuit boards, the *CircuiTest 1000s Troubleshooting and Test System* allows for power-off and power-on component level tests. The 1000S, which can connect via a BNC connector to any standard oscilloscope, will convert the oscilloscope into a wide-ranging troubleshooting tool.



Once connected to the oscilloscope, the 1000S permits powered-off troubleshooting. It performs Voltage/Current (V/I) signature analysis, using any combination of four A/C levels, six frequencies and six impedance levels, plus scanner capability to scan ICs or other multiple-pin component's V/I signatures up to 12 pins at a time. Another feature of the system is the function generator, which provides three waveforms, and variable amplitude and frequency that can both be manually set. Also included in the 1000S is a shorts locator, which easily locates shorts on unpowered boards when combined with any standard meter.

The *CircuiTest 1000s Troubleshooting and Test System* costs \$1395. For more information, contact International Test Systems, Inc., 4703 Shavano Oak, Ste. 102, San Antonio, TX 78249; Tel. 800-595-1177 or 210-408-6019; Web: www.itestsystems.com.

CIRCLE 86 ON FREE INFORMATION CARD

RF SIGNAL GENERATOR

Geared toward R&D labs, schools, and production test and repair facilities, the *RSG-1000* is a full-featured *DDS-based synthesized RF signal generator* capable of generating from 100 kHz to 1 GHz, with a standard output level of 0 dBm. The unit, which measures 12 by 6 by 12 inches and weighs 11 lb., provides 10-Hz continuous tuning, a standard frequency reference stability of 1.0 PPM, and modulation of both calibrated FM and AM. In addition, the unit features a solid-state GaAs calibrated attenuator down to -130 dBm.

The bright, super-readable, two-line, vacuum fluorescent display shows all functions and can be read from anywhere on the bench. The handy "smart knob," an analog-style spinner knob, is easy to use to enter or change parameters in any field—or data can be entered via the keyboard. All functions can be continuously varied without the need to ever touch a "shifted" or secondary function key.



The RSG-1000 RF signal generator has a suggested retail price of \$1495. For more information, contact Ramsey Electronics, Inc., 793 Canning Parkway, Victor, NY 14564; Tel. 716-924-4560; Web: www.ramseyelectronics.com.

CIRCLE 87 ON FREE INFORMATION CARD

TELEPHONE TEST SYSTEM

A popular microprocessor-controlled telephone-line simulator, the latest version of *Ring-It!* acts like a phone company central office. Its updated design now supports E-911 training and Caller-ID signaling, and an external jack has been added for call-monitoring applications. The simulator tests and demonstrates telephones, answering machines, fax units, voice mail systems, or modems.

Telephone equipment connected to the simulator behaves as if it were

connected to a real analog telephone line. Five different test modes offer standard telephone line emulation or special repetitive cycle testing, including automatic ring-up. An LED digital read-out displays the DTMF digits that are dialed when checking the operation of touch-tone phones.

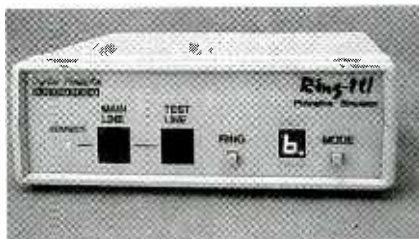

Ring-It! can be purchased factory assembled or as a kit. Factory assembled units (#RI-0001F) are \$325; the deluxe kit (RI-0001D) is \$205, including the caller-ID option and custom enclosure; and non-caller-ID kits start at \$149. For more information, contact Digital Products Company, 134 Windstar Circle, Folsom, CA 95630; Tel. 916-985-7219; Web: www.digitalproducts.com.

CIRCLE 88 ON FREE INFORMATION CARD

CURRENT PROBE

The *AmpFlex Flexible Current Probe SimpleLogger* combines two technologies into one measurement recording device. Combined with the recording technology of the Simple Logger, the flexible current probe measures, records, and graphs true RMS readings (250 and 2500 A RMS, and 500 and 5000 A RMS), keeping records for up to six months.

Designed to take measurements where standard clamp-ons cannot, the probe operates in tight breaker panels, around large buss bars, around cable bundles, and even wrapped around irregular shapes. The logger is a weatherproof NEMA 4X, IP65-rated self-contained unit with flexible sen-



sors, which range from 24–60 inches in length. Graphing software comes bundled with the logger.

Suggested list prices of the AmpFlex Flexible Current Probe SimpleLogger start at \$499. For more information, contact AEMC Instruments, 99 Chauncy Street, Boston, MA 02111; Tel. 617-451-0227; Web: www.aemc.com.

CIRCLE 89 ON FREE INFORMATION CARD

SOUND-LEVEL CALIBRATOR

The *Model 407744 Sound-Level Calibrator* is used to calibrate and verify the operation of sound-level meters with 1/2- and 1-inch microphones. The professional calibrator generates a 1-kHz sine wave at 94 dB to an accuracy of 0.8dB, and the Total Harmonic Distortion (THD) is 2%.

Features of the unit include an On/Off switch with a battery-test position and a battery-status LED. It comes complete with two 9-volt batteries, carrying case, and a screwdriver. The calibrator, which is 2.2 by 3.2 inches and weighs under a pound, is housed in a durable, die-cast aluminum case.



The Model 407744 Sound-Level Calibrator costs \$299. For more information, contact Exttech Instruments Corp., 335 Bear Hill Road, Waltham, MA 02451; Tel. 781-890-7440; Web: www.exttech.com.

CIRCLE 90 ON FREE INFORMATION CARD

Don't lose sight of Glaucoma.

IE NATIONAL EYE HEALTH EDUCATION PROGRAM

PLASMA SABER

(continued from page 34)

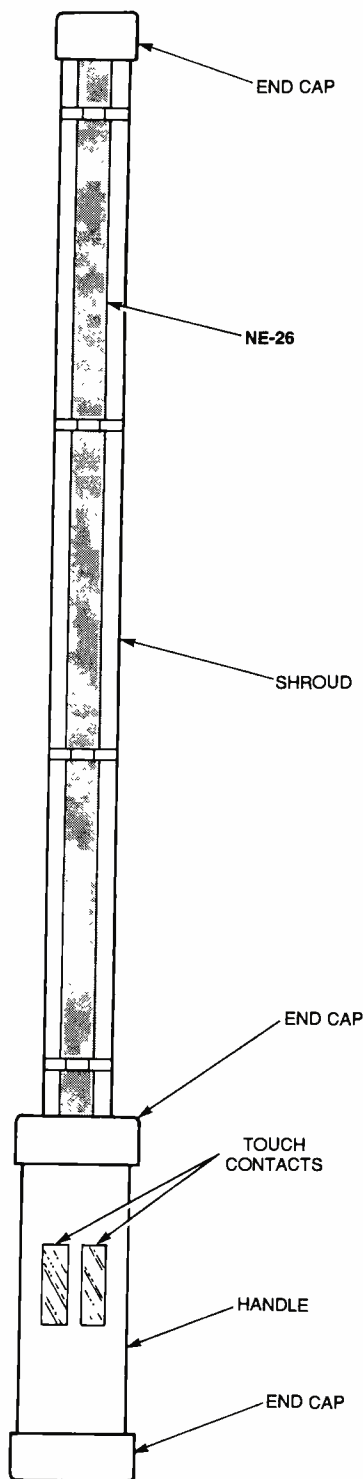

Fig 7. Insert the NE-26 tube assembly with spacer rings and assembled printed-circuit board into the shroud as shown: It may help to moisten the inner walls of the shroud by deeply exhaling into one end and quickly inserting the neon tube assembly.

open end of the handle.

Test unit by bridging the touch terminals and verify correct operation. Finish assembly by attaching caps into place and attach any labels or decals.

Now go forth and have some fun. The Plasma Saber looks amazing cutting through the air at night or in a darkened room. Just make sure not to smack it into anything with too much force. A shattered neon tube is no fun, and dangerous to boot. However, with some care, the Saber can prove a wonderful source of enjoyment for a long time in this galaxy. ■

PC BOARDS

(continued from page 40)

cult to spot. They can appear as open, intermittent, high-resistance, or even apparently normal connections. They can trick you into suspecting other components, such as resistors, transistors, capacitors, and ICs.

If you're having problems with an electronic project, closely examine all solder connections for dull, loose, or flaky joints and for "solder bridges" between adjacent components. A good magnifying glass and a sharp eye helps spot them. Usually, reapplying heat to all connections will solve most such problems.

Conclusion. For the newcomer, the prospects of designing and etching their own printed-circuit boards can be intimidating. And since a lot of people can't bear the thought of failure, for them it is much simpler to avoid the PCB production aspect of the hobby. But for those who are up to the challenge, the feeling of accomplishment experienced the first time you see a circuit that you've designed, laid out, and assembled with your own "wit-tle" hands makes the effort well worth a little trepidation. ■

METRANOME

(continued from page 74)

connect the circuit to a 6-volt DC power supply. If everything is working properly, LED1 should flash as BZ1 emits a rhythmic "beep." In case

of trouble, carefully recheck your wiring against the schematic diagram.

Calibration Procedure. To calibrate the Pocket Metronome, a watch and a pocket calculator are all that's needed. Start by adjusting R4 to the fully counterclockwise position and making sure that S3 is set to the FAST (closed) position. Count the number of beats in a 15-second interval as indicated by the watch. Multiply your finding by four to get the number of beats per minute. With a sharp pencil, write that quantity opposite the pointer, on the paper surrounding R4.

After that, with S3 still set to FAST, adjust R4 fully clockwise. Repeat the calibration procedure for this R4 position. Continue by rotating R4 to mid-position, etc. Once the fast-speed range has been calibrated, repeat the procedure with S3 set in the slow (open) mode, marking the slower beats above the faster set of markings already recorded. Your dial is now complete.

Conclusions. Using the Pocket Metronome can help a budding musician learn to keep time while practicing, or it can be used in both practice and performance settings. So if you need help keeping better time, try this simple project. ■

BUY BONDS

ELECTRONIC SECURITY DEVICES

A great book for project builders. It is quite common to associate the term "Security Devices" with burglar alarms of various types. However in fact it can refer to any piece of equipment that helps to protect people or property. The text is divided into three basic sections: Chapter 1 covers switch-activated burglar alarms and includes exit and entry delays. Chapter 2 discusses other types of burglar alarms and includes Infra-Red, Ultrasonic and Doppler-Shift Systems. Chapter 3 covers other types of security devices such as Smoke and Gas Detectors; Water, Temperature and Baby Alarms; Doorphones, etc. Most circuits are simple, and stripboard layouts are provided.



To order Book BP56 and send \$5.99 includes shipping and handling in the U.S. and Canada only to **Electronics Technology Today Inc.**, P.O. Box 240, Massapequa Park, NY 11762-0240. Payment in U.S. funds by U.S. Bank check or International Money Order. Please allow 6-8 weeks for delivery. ET09

ELECTRONICS LIBRARY

(continued from page 28)

wires, dirty video heads, and damaged tapes. All types of VCRs are covered—VHS, Beta, and 8mm—with specific maintenance and step-by-step repair instructions for dozens of different models.

The updated and expanded third edition includes information on VCR first aid, how to clean VCR and camcorder heads without damaging them, and troubleshooting flowcharts for a variety of common VCR malfunctions. In addition, there are helpful tips on soldering

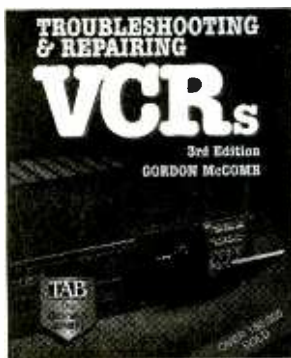

and desoldering components and wires. A list of popular VCR brands and manufacturers is also included.

Troubleshooting & Repairing VCRs: 3rd Edition costs \$22.95 and is published by McGraw-Hill, Inc., 1221 Avenue of the Americas, New York, NY 10020; Tel. 800-2MCGRAW; Web: www.books.mcgraw-hill.com.

ISDN EXPLAINED: 3rd EDITION

by John M. Griffiths

Significantly expanded, this edition provides an overview of the principles and applications of ISDN (Integrated Services Digital Network)—an established communications method that continues to replace modems as a fast



transmission mechanism. It is an authoritative text for all who are interested in the subject, from engineering and computing students to practicing engineers and computer professionals.

Featured in this comprehensive and highly readable introductory guide is extensive coverage of the increasing supplementary services and the embedded data channel, plus more details on the broadband aspects of this technology. A complete reference section has been added on the signaling access protocols that control an ISDN connection. There are end-of-chapter questions with solutions at the back of the book, as well as listings of ISDN terms in French, German, and Spanish.

ISDN Explained: 3rd Edition costs \$74.95 and is published by John Wiley & Sons, 605 Third Avenue, New York, NY 10158; Tel. 212-850-6336; Web: www.wiley.com.

DIGITAL VIDEO COMMUNICATIONS

by Martyn J. Riley and
Iain E. G. Richardson

This thorough and complete book offers readers a solid understanding of the applications and supporting technologies associated with digital video



communications. It explains how to provide reliable, flexible, and robust video transmissions over various networks. In-depth discussions of subjects ranging from new and emerging

BooksNow To order books in this magazine or, any book in print. Please call anytime day or night: (800) BOOKS-NOW (266-5766) or (801) 261-1187 ask for ext. 1456 or visit on the web at <http://www.BooksNow.com/popularelectronics.htm>.

Free catalogs are not available.

applications of digital video communications to digital video compression and decoding techniques are included.

The book's eleven chapters are fully illustrated. Each chapter ends with a summary and bibliographic references. A glossary and a complete index make it easy for readers to find the information they need.

Digital Video Communications costs \$69 and is published by Artech House, Inc., 685 Canton St., Norwood, MA 02062; Tel. 800-225-9977 or 781-769-9750; Web: www.artech-house.com/artech.html.

1999 NEW PRODUCT CATALOG—TEST INSTRUMENTS AND ACCESSORIES

from B&K Precision Corp.

Ideal for use by electronic and electrical field service, depot service, and engineering/R&D personnel, the 16-page full-color catalog contains B&K's most popular test instruments and

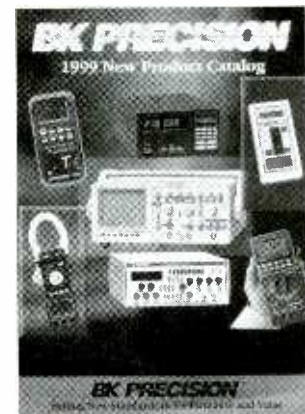

accessories. It features over 25 new products, including IC testers, programmable power supplies, and video monitor testers.

The catalog introduces the Model 570 Linear IC tester and the Model 575 Digital IC tester—two handheld, battery-powered units that feature extensive built-in libraries. Two new video monitor testers are also presented: the Model 1275 handheld, battery-powered video monitor tester and the Model 1280A benchtop tester, both of which can be used to test PC and Mac monitors.

The 1999 New Product Catalog is free upon request from B&K Precision Corp., 1031 Segovia Circle, Placentia, CA 92870-7137; Tel. 714-237-9220; Web: www.bkprecision.com.

ADVERTISING INDEX

Popular Electronics does not assume any responsibility for errors that may appear in the Index below.

Free Information Number	Page	Free Information Number	Page
- AES	.60	- KNS Instruments	.56
- Alfa Electronics	.66	- Lynxmotion	.68
- All Electronics	.65	161 MCM electronics	.59
- Allison Technology	.61	139 Mendelson's	.68
- Amazon Electronics	.64	175 MicroCode Engineering	.CV2
- Andromeda Research	.69	- Modern Electronics	.58
- Antique Radio Classified	.49	- Mondo-tronics	.70
- Arrow Electronics	.68	165 Mouser	.56
- Bsoft	.50	- OWI	.66
32 C&S Sales, Inc.	.54	156 Parts Express	.67
174 Cadsoft, Inc.	.15	- PCS, Inc.	.64
- Circuit Specialists	.57	- Pioneer Hill Software	.58
- CLAGGK, Inc.	.5, 44	150 Prairie Digital Inc.	.50
- Cleveland Inst. of Electronics	.33	143 Print	.61
- Command Productions	.50	142 Print	.51
- Conitec	.68	153 Print Products Int'l.	.69
- Connecticut microComputer	.51	- ProPlanet	.68
173 Cooks' Institute	.6	- Securetek	.64
164 Dalbani	.71	40 Sencore, Inc.	.11
- EDE Spy Outlet	.49	- Sescom Inc.	.58, 64
- Electronic Tech. Today	.82	- Smithy Company	.64
- EMAC, Inc.	.61	- Technological Arts	.68
- Engineering Express	.64	137 Telulex	.56
- Foley-Belsaw	.53	- Test Equipment Depot	.52
- Galaxy Electronics	.58	- UCANDO Videos	.51
- General Device Instruments	.58	- Ultima Associates	.49
- Grantham College of Eng.	.4	- Unbound Tech	.60
- Grich RC Inc.	.68	- Vision Electronics	.56
- Home Automation Systems	.69	- Weeder Technologies	.49
- Information Unlimited	.52	172 Windjammer Cruises	.4
26 Interactive Image Technologies	.CV4	- World Wyde	.64
- International Hanbai Co., Ltd.	.CV3	- XX Box	.60
- Intronics, Inc.	.60	- Zagros Robotics	.60

ADVERTISING SALES OFFICES

Gernsback Publications, Inc.
500 Bi-County Blvd.
Farmingdale, NY 11735-3931
Tel. 516-293-3000
Fax: 516-293-3115

Larry Steckler, EHF/CET
 President (ext. 201)
 e-mail: advertising@gernsback

Adria Coren
 Vice President (ext. 208)

Ken Coren
 Vice-President (ext. 267)

For Advertising ONLY
Tel. 516-293-3000
Fax: 516-293-3115

Larry Steckler
 Publisher

Marie Falcon
 Advertising Director (ext. 206)

Adria Coren
 Credit Manager (ext. 208)

**Subscription/
 Customer Service/
 Order Entry**
 Tel. 800-827-0383
 7:30 AM - 8:30 PM CST

ADVERTISING SALES OFFICES

EAST/SOUTHEAST

Megan Mitchell
 9072 Lawton Pine Avenue
 Las Vegas, NV 89129-7044
 Tel. 702-240-0184
 Fax: 702-838-6924
 e-mail: mmitchell@gernsback.com

MIDWEST/Texas/Arkansas/ Oklahoma, Colorado, Arizona

Ralph Bergen
 One Northfield Plaza, Suite 300
 Northfield, IL 60093-1214
 Tel. 847-559-0555
 Fax: 847-559-0562
 e-mail: bergenrj@aol.com

PACIFIC COAST/ Mountain States

Anita Bartman
 Hutch Looney & Assoc., Inc.
 6310 San Vicente Blvd.
 Suite 360
 Los Angeles, CA 90048-5426
 Tel. 323-931-3444 (ext. 227)
 Fax: 323-931-7309
 e-mail: anita@hlooney.com

New Models with Newly Added Features!!

TOUCH DISPLAY MODULE



CTD1047 COLOR

10.4-inch color TFT

NEW

CTD5741 COLOR

5.7-inch color STN

Model in photograph enclosed in case. (CTD5741-11)
CTD5741 is 100% compatible with μ TD4141.

NEW



μ TD4141

5.7-inch monochrome

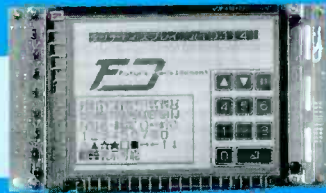

Development Support Tool

For Windows 98/95

\$150

NEW



New Features

Personalized Color Palettes

You can personalize the tone of the built-in 16-color palette by setting RGB (brightness) level.

Copying

Areas of the screen can be selected and copied onto other screens.

Expanded Flash Memory

Image Manipulation

Images imported from digital cameras or other sources can be easily bitmapped and registered on screens or keycaps. (The demonstration fish was created with the Development Support Tool.)

Screen-to-Screen Group Move

Screen data can be selected, grouped and moved to other screens.

System Setup Example

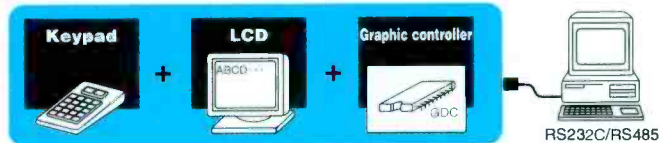

Specification	Model	μ TD4141	CTD5741	CTD1047
LCD		5.7-inch, monochrome	5.7-inch, color STN	10.7-inch, color TFT
Resolution		320 X 240	320 X 240	640 X 480
Maximum digits		40 columns X 30 lines	40 columns X 30 lines	80 columns X 60 lines
Effective display area (mm)		116 X 87	116 X 87	211 X 158
Key matrix input		10 X 6	10 X 6	13 X 10 (640 X 480)
Key size (mm)		12 X 14	12 X 14	15 X 15
Power supply		5V DC 0.8A	5V DC 1A	5V DC 1.2A
Dimensions (mm)		W189 X D112 X H32	W189 X D112 X H32	W272 X D205 X H43
Standard price		\$555	\$740	\$1225

※ Escutcheons and cases available for all models.

- Via RS-232C communications, simple commands let you easily display characters, draw graphics or collect key-input information.
- The built-in display memory can hold 4 full screens, making paging and other screen operations more convenient. (Up to 54 screens can be added with the Expanded Flash Memory.)
- Expansion features can be easily used with the Development Support Tool optional software.

- A wide array of characters can be displayed including kanji, kana, alphabet, numerals and special patterns.
- Key-input can be selected between polling and interrupt.
- Equipped with buzzer ON/OFF and backlight ON/OFF commands.
- Characters can be displayed as large as 64 X 64 dot.
- Easy backlight replacement (for color LCD models).
- Portrait monitor and RS485 model are available as special specification.

URL = <http://www2.dango.ne.jp/onomichi/inh/>

E-mail = inh@orange.ocn.ne.jp

INH International Hanbai Co., Ltd
22-30 Kanda-cho, Onomichi, Hiroshima, 722-0016, Japan

The world's most popular simulator just got better.

MULTISIM SCHEMATIC CAPTURE AND SIMULATION

**NEW
VERSION 6**

Flexible Symbol Editor **NEW**

To add or modify symbols for any component.

Power Meter **NEW**

Works just like with a real Wattmeter.

1000 New Components **NEW**

New families include Electromechanical, Connector, Wideband Opamp, and Tiny Logic.

Editable Footprint Field **NEW**

Add or change default footprint values directly from the schematic.

New Analyses **NEW**

AC sensitivity and DC sensitivity help determine the stability of your design.

Multiple Instruments **NEW**

Now you can have more than one copy of an instrument on the screen at once.

Enhanced Wiring **NEW**

Improved connections to pins and more intelligent autowiring.

Analysis Wizards **NEW**

Guide you through an analysis, making it easier than ever to take advantage of these powerful functions.

Virtual Instruments

Includes oscilloscope, function generator, multimeter, bode plotter, word generator, and logic analyzer.

9 Powerful Analyses

To analyze circuits in ways just not possible with real instruments. Includes DC, & AC operating point, transient, fourier, noise, DC sweep and Ac & DC sensitivity.

5,000 Components

Wide selection of commonly used components, all complete with simulation, symbol and footprint information.

Full-Featured Schematic Capture

Industry's easiest-to-use design entry is ideal for generating high-quality schematics.

Changes on the Fly

The world's only simulator that lets you tweak your circuit during simulation for instant feedback.

Analog and Digital SPICE Simulation

Fast, accurate SPICE simulation with no limit on circuit size.

Custom Model Support

Edit existing models to create new parts, or import components as SPICE models from vendors.

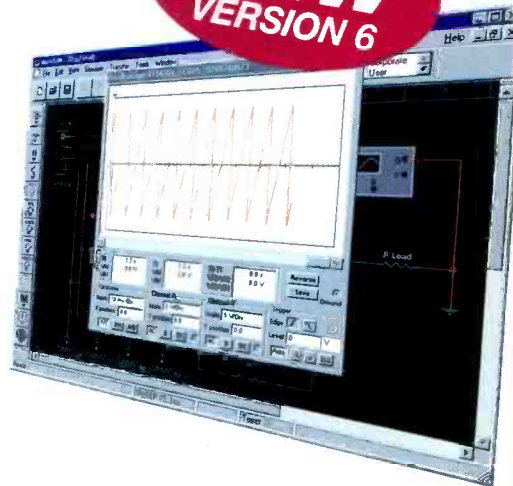

multisim **\$399**

Call for upgrade pricing

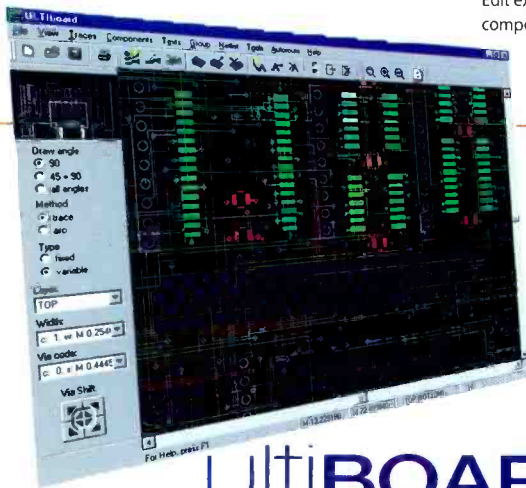

ULTIBOARD POWERFUL PCB LAYOUT

Fast Autorouting Multi-layer autorouter with configurable options for customized performance.

Real-Time DRC Automatic Design Rule Check prevents costly errors by monitoring the size and clearance of pads, vias and traces.

Ideal for all Boards Built-in board editor to create any shape board up to 50" X 50" in size, with as many as 32 layers.

Multiple Output Formats Outputs to the formats you need including Gerber, DXF, plotters, printers, and more.

Tight Integration with Multisim Supports forward and back annotation with Multisim, so that the programs share important design information.

Flexible Editing Full support of power and ground planes, with or without thermal relief. 'Reroute while move' to move copper without losing connectivity.

ultiBOARD **\$399**

TO ORDER

For a **FREE** demo visit www.electronicworkbench.com

**SAVE
\$10000**

Call **1-800-263-5552**

Save \$100 when you order the Personal Design Solution
(Includes Multisim and Ultiboard).



**Electronics
WORKBENCH**

DESIGN SOLUTIONS FOR EVERY DESKTOP

CIRCLE 26 ON FREE INFORMATION CARD