

STREAMING MOVIES AND MUSIC ONLINE

SEPTEMBER 1999

Popular Electronics[®]

PLUS!
Controlling Your Robots

200-Watt Audiophile Amplifier

Pump up the volume with a high-quality L-MOSFET amp that can be used with instruments, stereos, and PA equipment

Guitar Distortion Pedal

Get that heavy sound at a light price with this must-have effect

Gizmo[®]

Personal Surround Sound
Internet with Call Waiting
Family Radio Service
And much more

Also Inside

- LED Plant-Growing Experiment
- Capturing Video Frames
- More Electric-Train Circuits
- PC-Controlled Phone

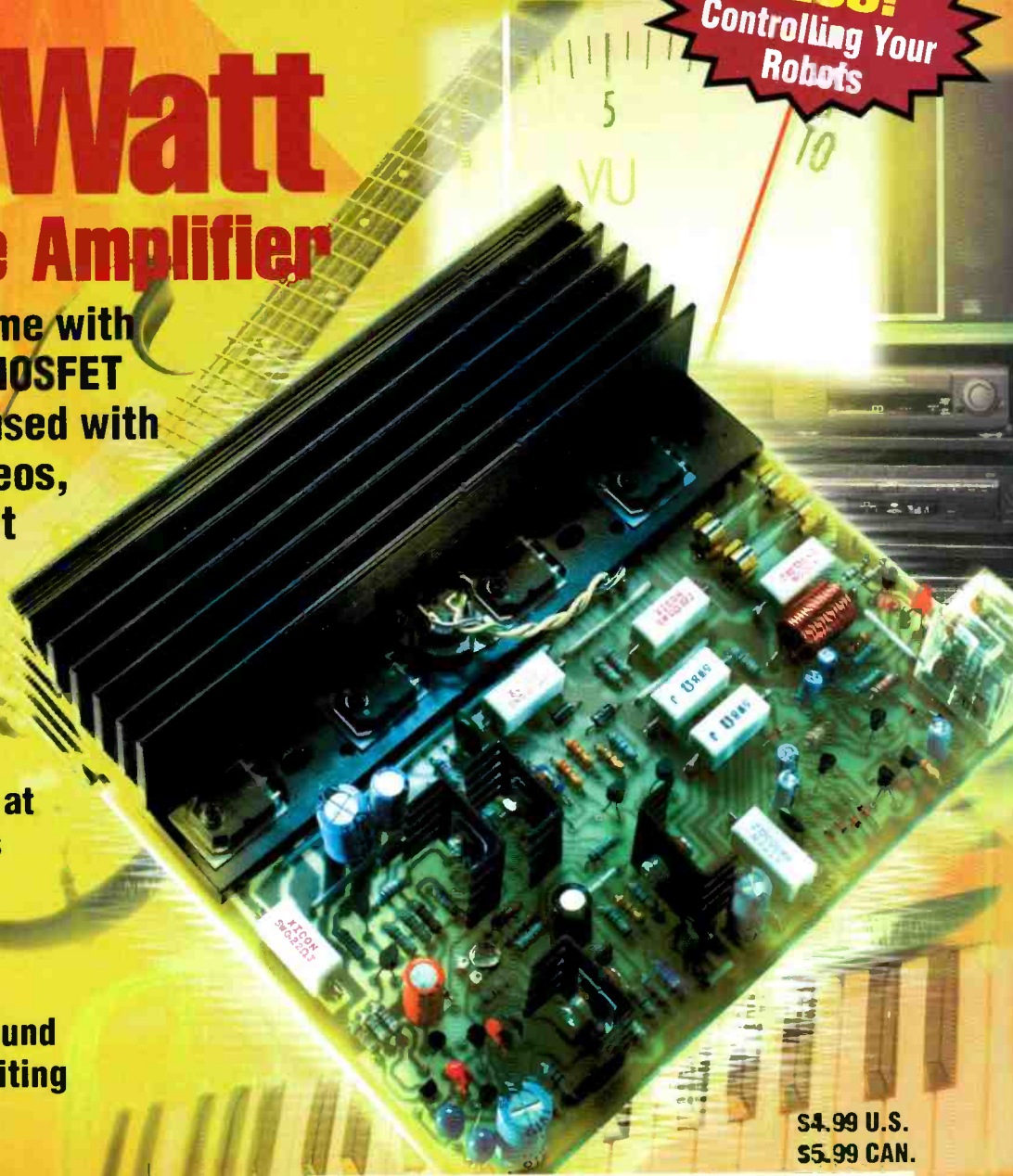

\$4.99 U.S.
\$5.99 CAN.



#BXBDCCCH CAR-RT SORT** C-012
 #35802YUN711GR004# JUN00 P25
 |||||
 STEPHEN R YOUNG RESP
 166
 7118 GARTH RD SE
 HUNTSVILLE AL 35802-1947

High-end features. Low-end price.



\$299

CircuitMaker 6:
Schematic design
and simulation
software

\$299

TraxMaker 3:
Printed circuit
board layout
software

CircuitMaker Version 6 and TraxMaker Version 3 give you the features of professional, high-end software at a fraction of the cost. Plus, with exceptional ease-of-use you'll spend less time learning to use the software and more time designing. Both applications are compatible with your existing software, and feature outstanding technical support. Call now for your free functional demo.

CircuitMaker 6 is a powerful schematic design and simulation program featuring:

- Professional schematic features including printout borders, title block and barred pin names
- Symbol editor and Macro feature for custom devices
- Fast, accurate SPICE3f5/XSPICE-based simulation
- Complete array of analysis types, including Fourier, AC, DC, Parameter sweep, Transient and more
- Virtual instruments including a digital oscilloscope, multimeter, Bode plotter, curve tracer and more
- Extensive library of over 4,000 models
- Tight integration with TraxMaker® for quick PCB layout
- Output PCB netlists in Protel®, Tango® and TraxMaker® formats for use in a variety of PCB layout programs
- Windows 3.1, 95 and NT

TraxMaker 3 is a powerful printed circuit board layout program featuring:

- Over 2,000 component footprints in a fully-documented, indexed library. Documentation shows footprints actual size
- Built-in autorouter and Design Rules Check
- Supports up to 6 signal layers plus power and ground planes, silk screen overlays and solder and paste masks
- Board sizes up to 32" x 32", with no pin limitations
- Intelligent manual routing with unroutable capabilities
- Import any PCB netlist in CircuitMaker®, Protel® or Tango® format
- Output RS274X Gerber files, Excellon N/C drill files and Bill of Materials
- Print to any Windows-compatible printer or plotter
- Windows 3.1, 95 and NT

MICROCODE For free demo software, or to order, call **1-800-419-4242**
ENGINEERING INC 927 West Center Street • Orem, UT 84057 • Phone (801) 226-4470 • Fax (801) 226-6532 • www.microcode.com

©1998 MicroCode Engineering, Inc. All rights reserved. CircuitMaker, TraxMaker, SimCode and MicroCode are registered trademarks of MicroCode Engineering, Inc. All other brand and product names are trademarks or registered trademarks of their respective companies.

CIRCLE 174 ON FREE INFORMATION CARD

www.americanradiohistory.com

Popular Electronics®

THE MAGAZINE FOR THE ELECTRONICS ACTIVIST!

FEATURES AND CONSTRUCTION

200-WATT AUDIOPHILE AMPLIFIER	<i>G. Randy Slone</i>	29
<i>Pump up the volume with this high-quality L-MOSFET device that can be put to a variety of uses</i>		
GUITAR DISTORTION PEDAL	<i>Juan Carlos Morales</i>	39
<i>It's the most widely used effect in modern music—build one at a huge savings</i>		
PHOTOTRANSISTOR BASICS	<i>Ian Poole</i>	83
<i>Learn how to use these photosensitive devices in your future projects</i>		

PRODUCT REVIEWS

PRODUCT TEST REPORT		17
<i>Marantz DVD Player</i>		
GIZMO®		20
<i>Personal surround sound, Internet with call waiting, Family Radio Service, and more</i>		

COLUMNS

NET WATCH	<i>Konstantinos Karagiannis</i>	3
<i>Streaming Media—The Next Generation</i>		
PEAK COMPUTING	<i>Andrew T. Angelopoulos</i>	5
<i>External Storage—Getting Elbow Room</i>		
COMPUTER BITS	<i>Ted Needleman</i>	9
<i>Lights, Camera, but No Action</i>		
MULTIMEDIA WATCH	<i>Marc Spiwak</i>	12
<i>A PC-Controlled Phone and More</i>		
SCANNER SCENE	<i>Marc Saxon</i>	44
<i>Going to the Source</i>		
CIRCUIT CIRCUS	<i>Charles D. Rakes</i>	65
<i>More Electric-Train Circuits</i>		
ROBOTICS WORKSHOP	<i>Gordon McComb</i>	69
<i>Parallel Port Control, Part 1</i>		
AMAZING SCIENCE	<i>John Iovine</i>	73
<i>Space Horticulture Continued</i>		
COMM LINKS	<i>Joseph J. Carr</i>	77
<i>Coax 'n' Stuff</i>		

DEPARTMENTS

EDITORIAL	2
LETTERS	16
ELECTRONICS LIBRARY	28
POPULAR ELECTRONICS MARKET CENTER	45
NEW PRODUCTS	80
ADVERTISING INDEX	88
FREE INFORMATION CARD	88A

Popular Electronics (ISSN 1042-170X) Published monthly by Gernsback Publications, Inc. 500 Bi-County Boulevard, Farmingdale, NY 11735. Second-Class postage paid at Farmingdale, NY and at additional mailing offices. One-year, twelve issues, subscription rate U.S. and possessions \$24.99, Canada \$33.15 (includes G.S.T. Canadian Goods and Services Tax Registration No. R125166280), all other countries \$33.99. Subscription orders payable in U.S. funds only; International Postal Money Order or check drawn on a U.S. bank. U.S. single copy price \$4.99. Copyright 1999 by Gernsback Publications, Inc. All rights reserved. Hands-on Electronics and Gizmo trademarks are registered in U.S. and Canada by Gernsback Publications, Inc. Popular Electronics trademark is registered in U.S. and Canada by Electronics Technology Today, Inc. and is licensed to Gernsback Publications, Inc. Printed in U.S.A. Postmaster: Please send address changes to Popular Electronics, Subscription Dept., P.O. Box 338, Mount Morris, IL 61054-9932

A stamped self-addressed envelope must accompany all submitted manuscripts and/or artwork or photographs if their return is desired should they be rejected. We disclaim any responsibility for the loss or damage of manuscripts and/or artwork or photographs while in our possession or otherwise.

As a service to readers, Popular Electronics publishes available plans or information relating to newsworthy products, techniques, and scientific and technological developments. Because of possible variances in the quality and condition of materials and workmanship used by readers, Popular Electronics disclaims any responsibility for the safe and proper functioning of reader-built projects based upon or from plans or information published in this magazine.

Larry Steckler, EHF, CET,
editor-in-chief and publisher

EDITORIAL DEPARTMENT

Konstantinos Karagiannis, editor
Robert Young, technical editor
Evelyn Rose, assistant editor
Teri Scaduto, assistant editor
Janine Abitabile, editorial assistant
Andrew T. Angelopoulos,
contributing editor
Joseph J. Carr, K4IPV, contributing editor
John Iovine, contributing editor
Gordon McComb, contributing editor
Ted Needleman, contributing editor
Charles D. Rakes, contributing editor
Marc Saxon, contributing editor
Marc Spiwak, contributing editor

PRODUCTION DEPARTMENT

Ken Coren, production director
Kathy Campbell, production assistant
Michele Musé, production assistant

ART DEPARTMENT

Andre Duzant, art director
Russell C. Truelson, illustrator

CIRCULATION DEPARTMENT

Gina L. Gallo, circulation manager
Christina M. Estrada, circulation assistant

REPRINT DEPARTMENT

Janine Abitabile, Reprint Bookstore

BUSINESS AND EDITORIAL OFFICES

Gernsback Publications, Inc.
500 Bi-County Blvd.
Farmingdale, NY 11735
516-293-3000
Fax: 516-293-3115
President: Larry Steckler
Vice-President: Adria Coren
Vice-President: Ken Coren

**SUBSCRIPTION
CUSTOMER SERVICE/
ORDER ENTRY**
800-827-0383
7:30 AM - 8:30 PM EST

Advertising Sales Offices
listed on page 88

Composition by Mates Graphics

Cover by Loewy Design

VISIT US ON THE INTERNET AT:
www.gernsback.com

Since some of the equipment and circuitry described in POPULAR ELECTRONICS may relate to or be covered by U.S. patents, POPULAR ELECTRONICS disclaims any liability for the infringement of such patents by the making, using, or selling of such equipment or circuitry, and suggests that anyone interested in such projects consult a patent attorney.

EDITORIAL

The Power of Audio

You'll hear many people argue that we're in the videophile age—that DVDs, widescreen TVs, and large computer monitors have exclusively captured our interest. But what good is a crystal-clear movie without realistic sound effects? How enjoyable is a multimedia title on a PC without the power of sound?

Also consider that in addition to all the dimensions it adds to the video medium, quality audio is still very much appreciated on its own. Popular music has never been more popular, with CD sale records constantly being topped by new artists. Stereo equipment to play these titles is flying off the shelves. Up-and-coming musicians are keeping stores that sell instruments and other gear quite busy. You get the idea.

What we hear is still as important as what we see.

So, are you an audiophile? If you are, you'll love our cover story this month, and if you're not, prepare to be converted. Why spend the big bucks to get an amplifier worthy of high-quality applications? We've got a do-it-yourself project capable of wall-shaking power, without any of the ear-irritating problems associated with most home-built amplifiers.

Build the 200-Watt Audiophile Amplifier, and your stereo system, musical instrument, or PA gear will sound better than ever. Based on L-MOSFETs, the design is an innovative one not likely to be rivaled by most store-bought units. Its applications are limited only by your creativity—just add the right speakers and input stages for the particular job at hand. For more information on this great-sounding project, turn to page 29.

If you plan on applying the Audiophile Amp to your guitar setup, or just want to give the latter a boost, consider our Guitar Distortion Pedal. Music both modern and old depends on this popular effect to add that extra zing to six-strings, and manufacturers are cashing in—on those without electronics know-how, that is. Rather than head to the music store, build our affordable project that lets you adjust not only distortion, but bass and treble as well, making it a great alternative to commercial units. The story begins on page 39.

Finally, on the theme of enjoying audio, this month's *Net Watch* features an update on streaming media. Now you can not only listen to CD-quality music online, but watch movies and other video titles that fall into a variety of genres. All for free! Learn more about the cutting edge of Net multimedia right on the facing page.

Konstantinos Karagiannis



Editor

NET WATCH

STREAMING MEDIA— THE NEXT GENERATION

We've covered streaming media here before. But like everything on the Net, the technology that makes this form of multimedia possible keeps on getting better and deserves a fresh look every once in a while. Recent developments have made now just such a time.

Thanks to the wider availability of high-speed connections to the Internet and the ability to make careful use of lower-speed lines, Web developers are producing a new generation of real-time multimedia. Content is being created that, though visually and aurally stunning, can be enjoyed as you download it.

Want to watch movies online? Or listen to CD-quality music while you work? These and many other entertainment sources are now available, all compliments of a reasonably peppy computer and Internet connection, as well as the latest in streaming-media player applications. It's the latter that we'll deal with first, before getting to the content available for them.

SOME REAL MEDIA

For years now, streaming media on the Internet has been monopolized by RealNetworks' very popular RealAudio and then RealVideo players. About a year and a half ago, the popularity of this company's technology only blossomed when RealNetworks unveiled RealPlayer G2, an app that could handle not only audio and video, but handle them well. Streams coming into the player at about 32 Kbps sound at least as good as a typical FM station, and higher-speed or broadband connections allow the RealPlayer to provide full-motion video in a truly watchable (that is, not too tiny) window.

Not wanting to miss out on the fun and certainly not wanting to lose hold of even one aspect of the computer industry, Microsoft released an enhanced version of its previously bundled Media Player (which came with all 32-bit versions of Windows). The Windows Media Player app (a free download from the Web) could handle multiple types of audio and video formats, both streaming and non-streaming.

Each of these players has its benefits and drawbacks, and we'll look at these in a moment. First, let me point out a simple fact: Because both are free downloads, and because some sites might only provide content for one and not the other, do download and install both to get the most out of the Net.

RealPlayer's biggest benefit is how long it has been around. With the popularity of the .RAM format and its predecessors, it's likely that your RealPlayer will be able to handle most of the streaming con-

tent found out there on the Web. The program uses very efficient encoding algorithms, and relatively small files provide decent audio and video quality. On the down side, the free version of RealPlayer can't handle high-quality non-streaming media such as MPEG video and .MP3 audio (to use the latter, you have to pay \$30 and buy the Plus version). Also, RealPlayer is difficult to get to work with some Firewalls



With the Windows Media Player, you can view and listen to a wide variety of streaming media. This hockey piece, available at Broadcast.com, is an example of what you can watch over a 56-Kbps connection.



If you don't feel like loading up your Web browser to test out your RealPlayer, simply choose from one of the presets in the scrolling frame to the left.

(if you're accessing the Net over a network at the office)—many network administrators even block it from working.

The biggest strength of the Windows Media Player is that even though it's 100-percent free, it does justice to high-quality non-streaming formats like .MP3, as well as to a wide variety of streaming media. While you can't play the .RAM or .RM files that

be easy for network administrators to block, without blocking all multimedia, that is.

When using either of these excellent player applications, though, you'll find that your best results are to be had with broadband or high-speed connections. If you never felt the itch to switch to cable, DSL, or some other type of speedy service, you will as you contemplate what you're missing from streaming sites.

Your first online visit after you download and install the two players (if you don't already have one or both of them) should be the sites that gave you the programs in the first place. Check out the RealNetworks and Windows Media Player URLs listed in our "Hot Sites" box. These Web pages will provide you with a world of content that you can check out with a few clicks of the mouse.

One of the links you'll come

across at these sites is so good, and so encompassing of a broad area of interests, that it will be the one we focus on for the rest of the column.

BROADCAST SAYS IT ALL

Here's a site with a name that leaves no doubt as to what it's about. Broadcast.com is a veritable hotbed of streaming media, covering a variety of topics and types of interests. Content is organized by category and by connection speed—a nice touch for those speedsters among you who don't want to be bothered with slow, frame-dropping video, or for those of you who don't want to be tempted by high-quality streams you can't enjoy on your modem.

You'll find movies on demand here ... yes, full motion pictures! These fall into all popular categories, including horror (my personal favorite), action, and comedy. When played over a broadband connection, the small window that will appear (usually in a Windows Media Player) will contain a nice picture that seems to drop almost no frames. It's almost like watching a videotape recorded on EP (six-hour) mode. Not quite cable quality, but enjoyable.

HOT SITES

- Broadcast.com**
www.broadcast.com
- Radio80s.com**
www.radio80s.com
- RealNetworks**
www.real.com
- Windows Media Player**
webevents.microsoft.com

Warning: Watching movies online is a real productivity killer.

Broadcast.com also has instructional videos, news broadcasts (both audio and video), live feeds from radio stations around the country, complete audiobooks, footage from concerts, and even sports coverage. I personally like the CD Jukebox, which lets you listen to high-quality transmissions of hundreds of CDs—most of these have every single track available for streaming enjoyment. Considering I was able to find underground-favorite Bauhaus in the mix, I'm certain you'll find a CD

(Continued on page 7)



At Broadcast.com, you can access hundreds if not thousands of hours of audio and video content, covering practically any topic you can imagine.

EXTERNAL STORAGE—GETTING Elbow Room

Removable storage is one of the most convenient and easy upgrades you can make to your system, and quite likely a necessary one. If you use your PC beyond basic word processing or spreadsheets, you'll eventually start to feel growing pains, no matter how large your PC's hard drive is.

And two factors are only making your need for extra storage space more urgent.

First, there's the trusty but obsolete 1.44MB floppy drive. Once upon a time, a few hundred kilobytes, let alone a megabyte, seemed like an infinite amount of storage. Now, it's next to useless. A small word processing file, with one or two BMP or TIFF color graphics, will not fit on a floppy. You could make it do so with lower-resolution, Web-style graphics, like JPEGs and GIFs, but these often won't look so good on the printed page. How do you get the large files from computer to computer? A larger disk would make it possible. Further, floppies are not the best solution because they are *slow*, with a transfer rate of only 62 KB/sec and an average seek time of around 80 ms. That ms rating is the amount of time it takes the read/write head to jump from one part of the disk to the next. It seems minuscule, but adds up when it happens a few hundred times. Smaller is better.

What floppies are good at is being cheap, sort of. People toss floppies back and forth without ever thinking they will see the disk again. But floppies are only cheap when measured by the piece. When measured by the megabyte, they cost a fortune. One



You can boot from it and even read 1.44MB floppies—what more could you want from an add-on drive? The SuperDisk from Imation comes in both PC and Mac versions, with the latter (shown here) connecting to the Universal Serial Bus (USB).

120MB disk (more on what format disk in a moment) will cost between \$10–\$15. An equal amount of storage in floppies, even with a bulk discount, will cost five or six times that much.

The second factor that may have you upgrading soon has to do with the way software is published. New software and applications are written with the assumption that the average hard drive is a certain size, and that assumption grows, it seems, with each passing month. What used to be a 75MB program that created 500K files has become a 250MB program that generates 2MB files. If you install a new printer or other device, the driver

is probably around 1MB, but all the bundled software can fill up hundreds of megabytes.

Increasing storage needs are insidious. Those programs adding up on your drive seem like nothing at first, but compound like bank interest. One large program with half-a-dozen 2MB files becomes three larger programs with a few dozen 10MB files. A gigabyte is gone before you know it. Add a couple of games, a few dozen downloads (updates, upgrades, games, demos, and fun stuff), a couple of multimedia presentations, and something having to do with your business, and you find yourself wondering what to delete

first, just when you would prefer to delete nothing.

WHICH DISK?

As with any other product in the computer biz, you have a choice when it comes to removable media. Good formats abound—the first step in deciding what format to use is to decide on its potential application. Is it just for your use? Will you be transporting data between work and home or friends and acquaintances? Do you need lots and lots of storage because you're a multimedia fiend, a graphic artist, or an aspiring musician with more audio files than you can mix in a lifetime? Are you someone with a large (OK, enormous) floppy library? Do you back up everything you ever work on?

These questions may seem a little silly, but answering them directs you to your storage options. If you need to occasionally back something up or transfer a reasonably small file (under 100MB), you can get by with one of two fiercely competing formats: Imation's SuperDisk or Iomega's Zip. Those of you who will need serious removable storage should consider another, larger media that we're fond of: SyQuest's SparQ.

IMATION 120MB SUPERDISK

Imation's SuperDisks will store up to 120MB of data, 20MB more than Iomega's 100MB Zip disk, and are backward compatible with floppies (SuperDisk drives will read from and write to 1.44MB and 720K floppies). In fact, if you buy the internal version of a SuperDisk drive, you can remove and toss your floppy drive to reduce workspace clutter. This is because SuperDisk drives are bootable (you can use a startup disk with it when you have system trouble, for instance). These internal drives use standard IDE connections (to a motherboard controller) and have a transfer speed 1100 KB/sec and a 60-ms seek time—plenty fast for any application you can throw their way.

External versions connect to your parallel port on the PC and to the Universal Serial Bus (USB) in a Mac. If you have an iMac, for instance, we recommend the USB version. The parallel port version for PCs has a sustained transfer speed of 565 KB/sec and a 70-ms seek time. The USB drive



When it comes to universal acceptance, it's difficult to beat Iomega's 100MB Zip media. It seems you can find these drives in just about any office and in many homes.

on a Mac will perform in a similar way to the internal PC version, depending on what other peripherals you have actively using your Mac's USB at any given moment. Both versions retail for around \$99, with a three-pack of disks costing about \$49.

IOMEGA ZIP 100MB AND 250MB DISKS

Even considering the obvious benefits of SuperDisk, the 100MB Zip disk, right now, has a wider install base. That is, you'll find it in more places, especially in art departments around the country (whether they use PC or Mac). It also has a reputation for being hardy and less prone to failure (the SuperDisk people would contest this point, of course). If you are going to use your removable storage to transport data to other locations, make sure you match formats. Most people still rely on Zip media, making this potentially a good choice.

Zip is the standard for middle- and high-level storage needs. The 100MB models of the drives all cost around \$99 (whether SCSI, IDE, or parallel port) and a three-pack of 100MB disks can be had for around \$49. Uniquely, Zip has an external USB drive for the PC (Win 98 only) for \$129. Performance for the non-parallel-port models is similar, with sustained transfer rates around 1.4 MB/sec and a 29-ms seek time.

A newer option to consider is the Zip 250 drive. This comes in two models so far, parallel port and SCSI, and has the same performance characteristics as the Zip 100. Each drive costs \$199 and \$19.95 per 250MB disk. What's great is that it is also backward compatible with, and can therefore use, Zip 100MB disks.

SYQUEST SPARQ 1GB DRIVE

While not as widely used as Zip, and therefore a little bit of a gamble, this might be the right product for the bargain-hunting heavy hitters in the crowd. Award-winning SyQuest (now, SYQT, Inc.) hit the financial skids. It sold most of its assets to Iomega this past April and was delisted from the stock market in November 1998. But it's continuing to make sales of its products from its Web site and through retail channels.

The SyQuest SparQ 1GB drive comes in parallel port and IDE configurations (the only "big capacity" drive that really comes with more than a SCSI connection). Each model has an average seek time of 12 ms. The par-

VENDOR INFORMATION

Castlewood Systems, Inc.
7133 Koll Center Parkway, Suite 200
Pleasanton, CA 94566
925-461-5500
www.castlewoodsystems.com

Imation Enterprises Corp.
1 Imation Place
Oakdale, MN 55128-3414
888-466-3456
www.superdisk.com

Iomega Corp.
1821 W. Iomega Way
Roy, UT 84067
801-332-1000
www.iomega.com

SYQT, Inc.
46939 Bayside Parkway
Fremont, CA 94538
510-226-4000
www.syqt.com

allel port model will handle around 0.9MB/sec while the IDE can handle a whopping 16.6MB/sec (similar to many internal hard drives). The cartridges weigh just 3 ounces and are ruggedized for portability. The drive costs \$249, but the cartridges are just \$49.95. For about \$300 you can get in on a very large storage solution.

There are other external drives, but we limited ourselves to those that provide a variety of installation options—that is, those that weren't just SCSI (more on this interface later). If you are interested in other, high-storage drives, check out the SyQuest 1.5GB SyJet drive, the 2.2GB ORB drive from Castlewood Systems, or even Iomega for its 1GB and 2GB Jaz drives.

Speaking of installation options, let's take a look now at the three main ones, which will vary slightly, from product to product. We'll give you the basics here, but be sure to check any documentation that comes with your drive.

EXTERNAL INSTALL

This is generally the easiest type of installation, either via parallel port or USB (though the latter has several benefits). Parallel-port devices are externally powered and require a free spot on your power strip. To install such a device, turn off your computer first. Connect the drive to your printer port, turn on your PC, and follow the "install new device" prompts. Windows should prompt you to insert a specific disk or CD after the device is detected. Generally, there is a pass-through port to connect your printer, so you won't have to give up use of the latter.

A faster, more convenient external install is accomplished using USB. These devices plug into either your machine's USB port or a hub, and drives often can get their power straight from the USB (high-drain devices like scanners still need power adapters). Because it's Plug and Play, USB presents no real hassle—your computer will ask for any drivers that are needed and you're on your way. Best of all, while parallel-port devices need to be connected with the PC turned off, USB peripherals can be "hot connected" at any time while the computer's running—so there's no down time.

MOVING INSIDE

Internal installations require a bit

more work, but these drives provide faster data throughput than external ones, making the extra effort worthwhile. To start, you have to turn off your computer and remove its cover. Newer computers usually have a turn-screw to make this removal easy.

Find an open drive bay that matches the size of your drive of choice—this will be either 3.5 or 5.25 inches wide. Slide the drive in and screw it into place.

There are two connectors on the back—one for power and one for data. Find a spare power coupling; these are bundled, multicolored wires (terminating in plastic connectors) that come off your computer's power supply. If you can't find one of these, you'll have to get a Y adapter and siphon power off another drive. Regardless of your approach, you will notice that the plug is key-shaped so that it can only be inserted in one way. Do this.

Next connect the data cable—the flat ribbon cabling that connects your floppy and hard drive to your motherboard. If you can't find a free connector (it looks like a black plastic clip that runs across the cable) on the cabling that connects your hard drive to the motherboard, you will have to buy a new cable with the extra plug. Or, you can check to see if you have an extra IDE (Integrated Drive Electronics) controller slot on the motherboard in which to plug your new drive directly (check your motherboard's manual for your options). Either way, connecting this connector requires you to fit it properly, so the plastic is key shaped.

After the new drive is connected, turn on your computer. Check with your manuals to see if your drive requires you to make a change to the system's CMOS. If not, go on to install any software that came with the drive.

MEET SCSI

Pronounced "scuzzy," SCSI (Small Computer System Interface) provides a fast interface for peripherals, coming in various flavors. The fastest, Ultra Wide, offers up to 40 MB/sec transfer rates.

SCSI peripherals can be internal or external, with both types of units connecting to a PC through a SCSI interface card, which plugs into a free PCI slot. This card, called a SCSI adapter, most likely has to be bought, since so few PCs come with one. Macs come

equipped to use SCSI in most cases (not the iMac, for instance).

Once you install the SCSI card, following whatever setup instructions come with it (these do vary), you can connect your chosen SCSI drive. Most adapters have internal and external connectors, so you can attach your device to the appropriate one using a SCSI cable. Otherwise, the power connections and drive placement are handled the same as other internal or external drives.

An important note: Make sure you're getting the most out of SCSI if you do choose to use this more expensive interface. Don't buy a high-speed device, for instance, and connect it to an outdated, slow SCSI adapter, such as the 8-bit SCSI-1 interface, which can only handle 4 MB/sec. Opt for a card that can handle the max speed of your device. Further, double-check to make sure that your SCSI adapter is compatible with a particular drive. Certain peripherals will only work with a matching-speed adapter. ■

NET WATCH

(continued from page 4)

to your taste.

This site gives other easy-to-use interfaces something to aspire to. You can find virtually anything in seconds either by browsing through the logical menus or by entering a search query. And, if you have a favorite player, you can search for content that will only play through said app.

To put it mildly, this site offers way too much to cover in a column (or even a series of them). You'd be wise to point your browser over to Broadcast.com as soon as you can. It's one of those rare sites that will by itself prove to you just how advanced the Net has become.

And that about does it for now. Please feel free to contact me via snail-mail to **Net Watch**, **Popular Electronics**, 500 Bi-County Blvd., Farmingdale, NY 11735, or e-mail to netwatch@gernsback.com. ■



POPTRONIX
Awaiting your call! Online Edition
<http://www.poptronix.com>

Budget Project and Computer Books

BP317—Practical Electronic Timing \$6.99. Time measurement projects are among the most constructed gadgets by hobbyists. This book provides the theory and backs it with a wide range of practical construction projects. Each project has how-it-works theory and how to check it for correct operation.

BP415—Using Netscape on the Internet \$8.99. Get with the Internet and with surfing, or browsing, the World Wide Web, and with the Netscape Navigator in particular. The book explains: The Internet and how the World Wide Web fits into the general scenario; how do you go about getting an Internet connection of your own; how to download and install the various versions of Netscape browsing software that are available; and how to use Netscape Navigator to surf the Web, and to find and maintain lists of useful sites. There's a heck of a lot more, too!

BP325—A Concise User's Guide to Windows 3.1 \$6.99. Now you can manage Microsoft's Windows with confidence. Understand what hardware specification you need to run Windows 3.1 successfully, and how to install, customize, fine-tune and optimize your system. Then you'll get into understanding the Program Manager, File Manager and Print Manager. Next follows tips on the word processor, plus how to use Paintbrush. There's more on the Cardfile database with its auto-dial feature, Windows Calendar, Terminal, Notepad, etc.

BP327—DOS: One Step at a Time \$5.99. Although you spend most of your time working with a word processor, spreadsheet or database, and are probably quite happy using its file management facilities, there will be times when you absolutely need to use DOS to carry out 'house-keeping' functions. The book starts with an overview of DOS, and later chapters cover the commands for handling disks, directories and files.

PCP119—Electronic Music and Midi Projects \$12.95. Save cash by building the MIDI gadgets you need. Want a MIDI THRU box, program change pedal, Metronome, analog echo unit, MIDI patchbay or switcher? Over 16 practical and very useful music and MIDI projects—all in this book! The projects are explained in detail with full instructions on assembly.

PCP120—Multimedia on the PC! \$14.95. What is Multimedia? What can it do for you? It can do lots of nice things! This 184-page book helps you create your own multimedia presentation. Multimedia applications by people like you can revolutionize educational and business applications as well bring more fun, fun, fun into your leisure computer activities.

BP404—How To Create Pages for the Web Using HTML \$7.99. Companies around the world, as well as PC users, are fast becoming aware of the World Wide Web as a means of publishing information over the Internet. HTML is the language used to create documents for Web browsers such as Mosaic, Net-scape and the Internet Explorer. These programs recognize this language as the method used to format the text, insert images, create hypertext and fill-in forms. HTML is easy to learn and use. This book explains the main features of the language and suggests some principles of style and design. Within a few hours, you can create a personal Home Page, research paper, company profile, questionnaire, etc., for world-wide publication on the Web.



BP377—Practical Electronic Control Projects \$7.99. Electronic control theory is presented in simple, non-mathematical terms and is illustrated by many practical projects suitable for the student or hobbyist to build. Discover how to use sensors as an input to the control system, and how to provide output to lamps, heaters, solenoids, relays and motors. Also the text reveals how to use control circuits to link input to output including signal processing, control loops, and feedback. Computer-based control is explained by practical examples.

BP411—A Practical Introduction to Surface Mount Devices \$6.99. This book takes you from the simplest possible starting point to a high level of competence in working with Surface Mount Devices (SMD's). Surface mount hobby-type construction is ideal for constructing small projects. Subjects such as PCB design, chip control, soldering techniques and specialist tools for SMD are fully explained. Some useful constructional projects are included.

BP136—25 Simple Indoor and Window Aerials \$2.99. Many people live in flats and apartments where outdoor antennas are prohibited. This does not mean you have to forgo shortwave listening, for even a 20-foot length of wire stretched out under a rug in a room can produce acceptable results. However, with experimentation and some tips, you may well be able to improve further your radio's reception. Included are 25 indoor and window antennas that are proven performers. Much information is also given on shortwave bands, antenna directivity, time zones, dimensions, etc. A must book for all amateur radio enthusiasts.

BP379—30 Simple IC Terminal Block Projects \$6.99. Here are 30 easy-to-build IC projects almost anyone can build. Requiring an IC and a few additional components, the book's 'black-box' building technique enables and encourages the constructor to progress to more advanced projects. Some of which are: timer projects, op-amp projects, counter projects, NAND-gate projects, and more.

BP401—Transistor Data Tables \$7.99. The tables in this book contain information about the package shape, pin connections and basic electrical data for each of the many thousands of transistors listed. The data includes maximum reverse voltage, forward current and power dissipation, current gain and forward transadmittance and resistance, cut-off frequency and details of applications.

ETT1—Wireless & Electrical Cyclopaedia \$4.99. Step back to the 1920's with this reprinted catalog from the Electro Importing Company. Antiquity displayed on every page with items priced as low as 3 cents. Product descriptions include: Radio components, kits, motors and dynamos, Leyden jars, hot-wire meters, carbon mikes and more. The perfect gift for a radio antique collector.

BP93—Electronic Timer Projects \$2.99. This book covers many of the possible applications of timer circuits. These circuits may turn on or off at either some preset time or after an elapsed time. Some of the more complicated timer and clock circuits are made up from a number of simpler circuits that the author deals with individually. Also included are several special interest circuits such as cars windshield wiper delay unit, a darkroom timer, metronome, etc.

BP88—How To Use Op-Amps \$5.99. Written as a designer's guide covering many operational amplifiers, serving both as a source book of circuits and a reference book for design calculations. There are chapters on Meet the Operational Amplifier, Basic Circuits, Oscillators, Audio Circuits, Filters, Miscellaneous Circuits, Common Op Amps, Power Supplies and Construction Notes and Fault Finding.

BP76—Power Supply Projects \$3.99. Presents a number of power-supply designs including simple unbiased types, fixed voltage-regulated types and variable voltage stabilized designs. All are low-voltage types intended for use with semiconductor circuits. Apart from presenting a variety of designs that will satisfy most applications, the data in this book should help the reader to design his own power supplies. An essential addition to the experimenters electronics library.

ELECTRONIC TECHNOLOGY TODAY INC.
P.O. BOX 240, Massapequa, NY 11762-0240

Name _____
Address _____
City _____ State _____ Zip _____

SHIPPING CHARGES IN USA AND CANADA

\$0.01 to \$5.00.....	\$2.00
\$5.01 to \$10.00.....	\$3.00
\$10.01 to \$20.00.....	\$4.00
\$20.01 to \$30.00.....	\$5.00
\$30.01 to \$40.00.....	\$6.00
\$40.01 to \$50.00.....	\$7.00
\$50.01 and above.....	\$8.50

SORRY No orders accepted outside of USA & Canada

	No. of Books Ordered <input type="checkbox"/>
Total price of books	\$ _____
Shipping (see chart)	\$ _____
Subtotal	\$ _____
Sales Tax (NYS only)	\$ _____
Amount Enclosed	\$ _____

All payments must be in U.S. funds!

LIGHTS, CAMERA, BUT NO ACTION

I love playing around with video. And computer video is the hottest thing on the market right now. But video isn't just one thing, it's a catchword for an entire industry. Analog video covers VCRs, camcorders, laserdiscs, DVD, and lots more. Use the term digital video, and you could be talking about products as diverse as an image scanner or digital camcorder.

Regardless of exactly which device you might be referencing at the moment, there are some things that remain constant. For example, motion video is achieved by displaying a number of single frames of video over a period of time, with the most common frame rate being 30 frames per second (fps). Since each individual frame has an image that differs slightly from every other frame (assuming that motion is actually taking place, and you're not shooting a real-time video of a plant growing), persistence of vision generally smoothes out the frame-by-frame jerkiness into a continuous flow of motion.

Still video is one of the more useful forms of video. I like to use images gotten from a variety of places. Sometimes, it will be a photo of the kids that I enlarge into an 8 x 10 for Grandma or a picture of Sparky, my canine office assistant, which I use to create a photo mug for Glen, the FedEx guy, who seems to be one of Sparky's favorite visitors. Other times, one of the kids will need to include a picture or diagram from a book, magazine, or Web site in with a report they are preparing for school.

We have a number of different ways to obtain images, including digital still cameras, several flatbed and sheet-fed scanners, and even the sim-

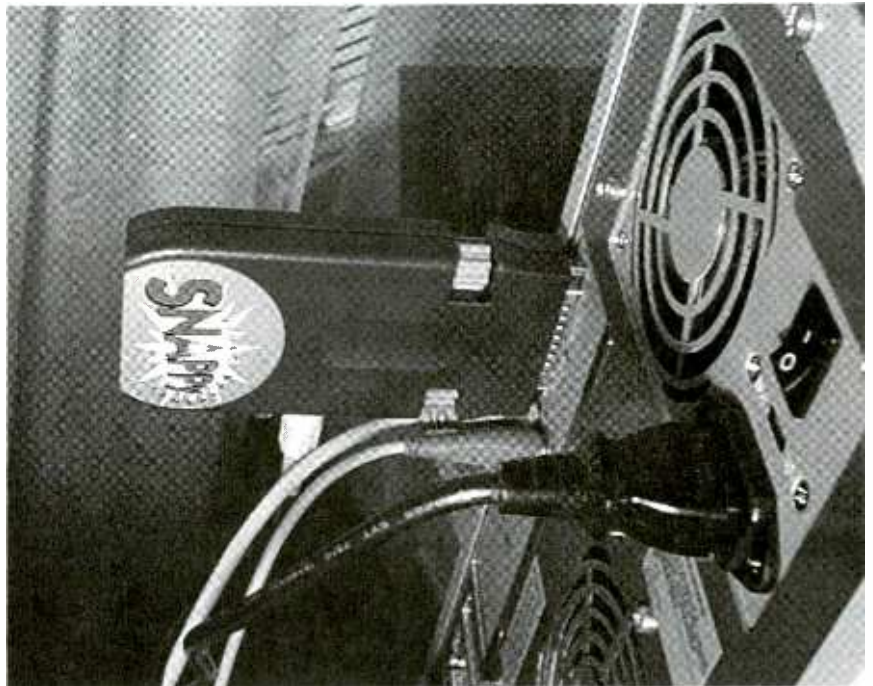

Installing the compact Snappy is easy—just plug it into your PC's parallel port.

ple expedient of right-mouse clicking on a Web graphic, and using the Save Image As menu choice. All of these methods work very well on the appropriate project, and I'll probably cover one or more of them in future columns, especially if you e-mail me and let me know you'd like to see how to use these techniques and devices.

CATCHING A FRAME

The topic of this particular installment is obtaining digital still images from a source of moving video. This source could be any device that puts out a stream of composite or S-Video, including a video game such as a PlayStation or Nintendo console. My needs were somewhat less dramatic

and with a little bit of imagination could translate into a project that many of you might want to emulate.

As an enthusiastic, though not particularly proficient, student of the martial arts, I wanted to learn a new Karate form from a videotape I purchased for that purpose. Many martial arts have forms that consist of a series of moves linked together. Unfortunately I have enough trouble staying in an upright position while learning one of these solo forms, much less having to worry about watching a TV, while pausing, playing, and re-winding a videotape. I had seen some books that featured an expert performing a form while being photographed by a high-speed still camera. These books have a sequence of 40,

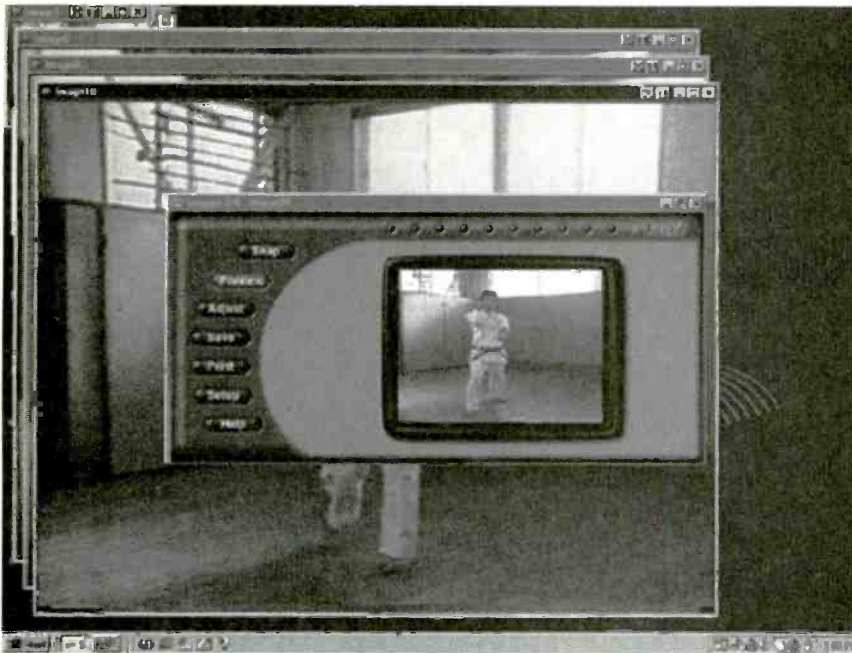

When you are actually grabbing frames of video, the Snappy interface is very effectively laid-out, and the preview window, though small, has a sharp image.

50, sometimes 100 photos capturing each move, with a narrative describing the sequence, and what was happening in each captured still.

Well, I had the tape—all I had to do was capture 50 or 60 images on a several-minute piece of tape that defined the major step in performing the form, drop each into a document, add a description, and I would have an easi-

er-to-learn-from tool. It sounds easy, and aside from being somewhat tedious, it actually was. And the technique that worked well on capturing and detailing a Karate form will work just as well if you are a baseball coach trying to pull together a booklet on how to bat and field or someone who wants to include a sequential set of images in a brochure.

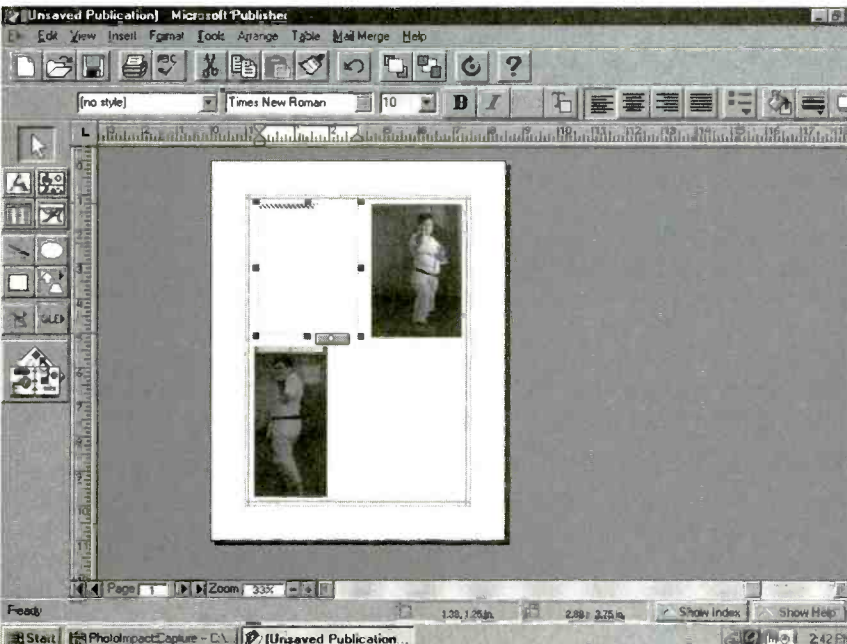

Publisher 98 makes it easy to work with captured images. Use the Insert menu to import the files into your document.

For a while, frame grabbers, which capture just a single frame out of a stream of full-motion video, were popular accessories. Today, these devices have been superseded to a large extent by motion-video capture devices, such as the one we'll look at next month. There are still a couple of frame grabbers on the market, including the ZipShot sold by ArcSoft, and Play, Inc.'s Snappy. The ZipShot, which sells for about \$99 and has a large collection of ArcSoft utilities, has a terrific and easy-to-use interface. But the Snappy, now in release 3.0, is really the benchmark against which the others are compared.

And while I didn't have the very latest version, I did have the previous 2.0 version up on a shelf. The Snappy 2.0 I used for this column looks identical to the latest model, and except for software interface, which has changed a bit, has very similar capabilities. The basic Snappy 3.0 retails for about \$100, and a Deluxe model, with several graphics programs included, adds about \$40 to the cost.

SNAPPY BASICS

Installing the Snappy takes about five minutes. It plugs right into the parallel port of your PC, then you install the TWAIN driver, video capture utility, and other bundled software applications. Snappy doesn't have a printer pass-through like the ZipShot offers, but if you want it always connected, you can use a parallel printer switch box, with the Snappy plugged into one of the ports in the rear of the box. Plug the output of your video source (in my case, a VCR) into the Snappy with the

WHERE TO GET IT

ArcSoft

46601 Fremont Blvd.
Fremont, CA 94538
800-762-8657
www.arcsoft.com

Microsoft Corporation

One Microsoft Way
Redmond, WA 98052-6399
425-486-9258
www.microsoft.com

Play, Inc.

2890 Kilgore Road
Rancho Cordova, CA 95670
916-851-0800
www.play.com

RCA patch cord provided (or an S-Video cable if your source has an S-Video output), and you're ready to start grabbing. Some frame grabbers use a patch cable between the keyboard and the connector to provide power for the unit. The Snappy operates off of a 9-volt battery that's pre-installed. Incidentally, my Snappy 2.0 unit is two years old, and still has the original battery that it came with.

The user interface to version 2.0 is very straightforward. Version 3.0 looks a little different, and provides the preview window in color, rather than the black and white of the version I used, but operates in a similar manner. Use the Setup button to determine whether the Snappy will operate in time-elapse mode, which captures a frame every X seconds (you set what "X" is). You can also set the Snappy to automatically capture frames for a set period of time. I generally use it in manual mode, clicking on the "Snap" button to grab a frame, with the VCR remote clutched in the opposite hand from the one working the mouse.

Once a frame is captured, a complete set of adjustments to color are

possible, and you can even crop the image using Snappy's crop tool, though I prefer to do my cropping in the application in which I will actually be using the image. You can set the size image you want to capture, and Snappy does an amazingly good job. Play boasts that Snappy will capture an image up to 1500 x 1125, and it will. But images this large in 24-bit color are enormous files, and the typical VCR or camcorder is really not capable of actually producing resolution better than the 640 x 480 pixels I generally set Snappy to.

Chugging away with my mouse and VCR remote, I captured upwards of 100 frames, culled out the ones that were inappropriate, and was then ready to build my forms manual.

Like most computer journalists, I have groaning shelves full of software packages. But for a simple project like this one, I generally turn to one of my "old faithfuls." In this case, it was Microsoft *Publisher 98*, although Microsoft *Word* would probably have worked just as well. *Publisher 98* has lots of templates for producing elaborate documents, but I used a simple

blank page, inserted each captured image, and cropped each to occupy about a quarter of the page. To the side of the image I typed in a description of what the move was. When I was done, I had an almost 30-page manual that detailed the form step-by-step. I still haven't got the form down pat (I'm a lot better at computers than I am at martial arts—sort of a living example of how the "pen" is mightier than the "sword"), but I put the document in a three-ring binder that rests on a music stand that I can easily move to keep in front of me as I practice the form.

Next time, we'll look at how to capture and use moving video. As always, feel free to e-mail me with your comments and suggestions at tneedleman@aol.com. ■

To learn how to talk with your kids about tough issues, like sex, AIDS/HIV and violence, call **1-800-CHILD-44** and get your free guidebook.



SENCORE "LITE"

High Quality Test Equipment At Affordable Prices

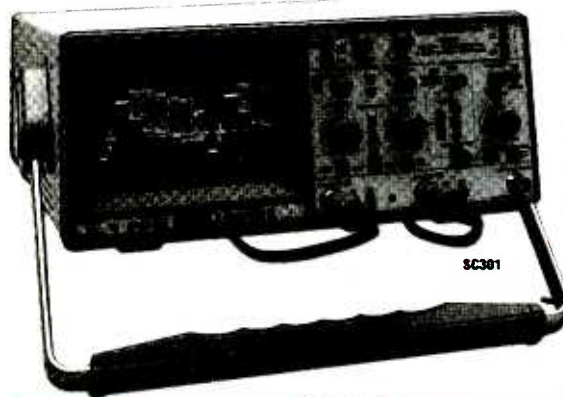

OSCILLOSCOPE

- 150 MHz CRT readout
- CRT readout of frequency, time, voltage
- 10 on-screen memory settings
- Dual channel
- Built-in component analyzer

- 3-year limited warranty

\$1,799

DM500 METER

- AC/DC voltage and current
- Resistance to 30 MΩ
- Beep Guard™ Input Protection
- Continuity/Diode Test
- Shockproof
- 1-year limited warranty



\$99

DM501 METER

- True RMS
- AC/DC voltage and current
- Resistance to 30 MΩ
- Data hold
- Water resistant
- Beep Guard™
- Current to 20A (limited)
- 1-year limited warranty



\$199



PS402

\$529



PS400

\$269



PS401

\$299

POWER SUPPLIES

- Low ripple
- Constant current and voltage
- Master slave operation
- 1-year limited warranty

SENCORE

3200 Sencore Drive Sioux Falls, SD 57107
1-800-SENCORE • www.sencore.com

CALL TODAY
1-800-SENCORE
or e-mail
sales@sencore.com

CIRCLE 40 ON FREE INFORMATION CARD

MULTIMEDIA WATCH

MARC SPIWAK
TECHNICAL EDITOR
COMPUTER RESELLER NEWS

A PC-CONTROLLED PHONE, AND MORE

The Microsoft name is appearing on more and more products in my home, including the latest and best cordless phone I've ever used. The Microsoft *Cordless Phone System* uses the power of a PC to provide full call management and messaging services, as well as enhanced Caller ID functions. The Cordless Phone System is a 900-MHz telephone with a base station that connects to a PC via a serial port.

Bundled with the phone is Microsoft *Call Manager* software that lets you create personalized greetings for different callers, block unwanted callers, and let high-priority callers ring through. The Caller ID Announce feature lets you hear who is calling before you pick up, thanks to a speaker built into the handset. You can even make calls and check messages using simple voice commands spoken into the cordless handset.

Call Manager's voicemail system lets you create separate voice mailboxes for different family members, business calls, and so on, and store thousands of messages. Messages can be retrieved via the handset or from an outside phone. Microsoft Cordless Phone System includes a 900-MHz cordless handset, a charging cradle that can be placed anywhere in your home, and a base station that connects to your phone line and PC. The phone's 40-channel, 900-MHz operation delivers much better range and sound quality than conventional cordless phones, all for \$199.

FLAT-SCREEN CRT

A relatively recent development in CRT technology is the flat-screen

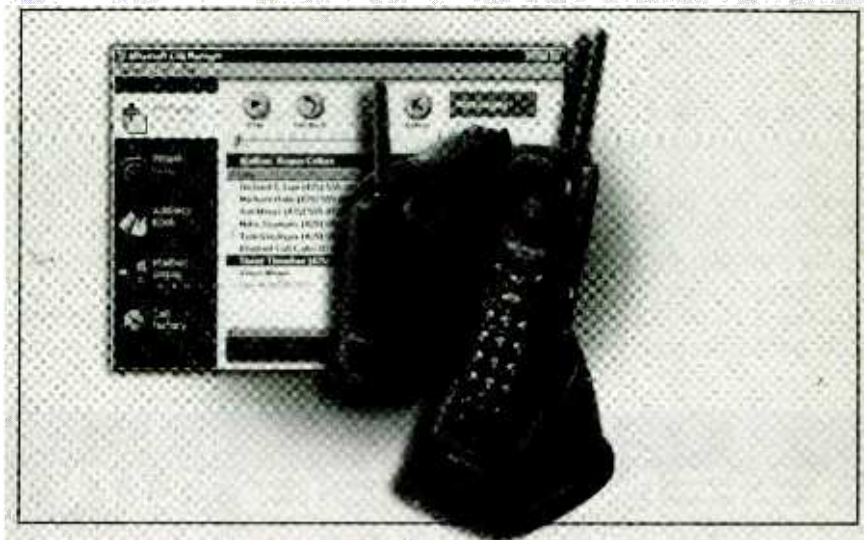

The Microsoft Cordless Phone System provides full call management and messaging services and enhanced Caller ID functions.

CRT. Several monitor manufacturers have found ways to make the viewing surface of a glass CRT perfectly flat or at least flat enough so that you can't detect any curve simply by looking at the screen. One manufacturer is Samsung, a brand that has won many awards for innovative display technology in recent years.

Samsung's *SyncMaster 700IFT* is a 17-inch monitor that has one of the more modern designs you'll see anywhere. So far I've tested only the 17-inch model, but Samsung also makes a flat-screen 19-inch bigger brother. "IFT" stands for Infinitely Flat Tube, and these new Samsung monitors feature DynaFlat display technology that results in no visible screen curvature from any angle. There's also less glare created by a flat-screen CRT than a curved one.

The 700IFT offers resolutions up to

1600 x 1200 at a 75-Hz refresh rate. The Invar shadow mask has a 0.20-mm stripe pitch for sharp images and brilliant color saturation. A drop-down onscreen control panel allows for easy adjustment of all digital functions such as horizontal, vertical, pincushion, moiré, and more. Users can select one of seven language displays. The Plug and Play 700IFT conforms to VESA Display Data Channel (DDC) standards—the 2Bi+ Plug and Play standard in particular supports onscreen control of the monitor via the mouse.

The 700IFT conforms to TCO '99 standards and features a four-stage power-management system that complies with VESA DPMS, NUTEK, and EPA Energy Star standards. The monitor comes with a universal Macintosh adapter and Colorific color-matching software. The 700IFT sells for under

\$650, which isn't bad for such a high-tech display.

ROCKET eBook

I have predicted that in order for conventional printed matter like books and magazines to give way to electronic media, the electronic "book reader" will have to be about the size of a paperback book, have a display that's as sharp as printed text, and a price of less than \$100. At least some of those predictions have already come true with NuvoMedia's *Rocket eBook*. At 22 ounces and about the size and thickness of a paperback dictionary, the Rocket eBook features a sharp, high-contrast LCD display suitable for just about any environment. The white backlight is bright enough for easy reading in bed without disturbing anyone else.

The Rocket eBook comes preloaded with *Alice in Wonderland* and the *Random House Dictionary*, and a limited selection of "books" can be downloaded from BarnesandNoble.com. While books are discounted, prices are still comparable with the physical product. With a subscription, users can also download a daily edition of *The Wall Street Journal*, which includes almost the entire printed version except for stock tables and such. Using the included RocketPress Web-based software, users and publishers can create their own Rocket eBook content.

The Rocket eBook stores about 4000 pages (approximately 10 novels). Additional books can be stored on a PC. This first-generation device costs \$499, which isn't as cheap as I think it will take to replace basic paperbacks. But this is just the beginning, and I am still sure that paper, or more specifically trees, will at some point in the future no longer be endangered.

GRAND ULTRAVIEW PRO

I recently came across a device that makes it easy to create your own professionally subtitled videotapes. All you need is Dobbs-Stanford Corporation's *Grand UltraView Pro* and a PC. Grand UltraView Pro is a desktop PC-to-TV converter with video overlay capabilities. Basically it places computer-generated text and graphics on top of a video signal for viewing or recording. The selected video source (composite or S-Video) is displayed at the unit's output with the VGA input overlaid on top of it. You can output the material to videotape

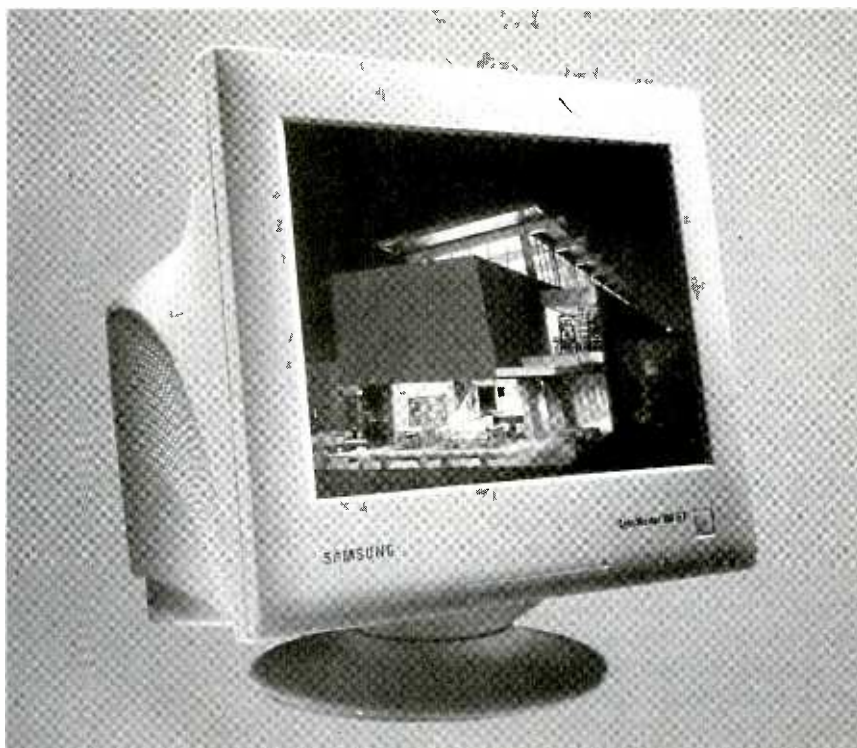

Samsung's SyncMaster 700IFT is a flat-screen 17-inch CRT monitor.

or an NTSC or PAL display.

Grand UltraView Pro comes with a full-function remote control for presentation use and convenience. All necessary cables for inputs and outputs are included, such as S-Video, composite, audio, serial, and so on. Grand UltraView Pro supports resolutions up to 1024 x 768 for NTSC or PAL and costs \$499.

GAME CONTROLLERS

I've been playing games on my computers with some pretty neat controllers. First we'll look at some from Advanced Gravis. The *BlackHawk Digital* is an awesome joystick that provides a 100% digital response to help you move, aim, and fire with great accuracy. The BlackHawk Digital joystick features 13 programmable functions, auto-calibration, smooth-action rotary throttle, 8-way point-of-view hat switch, and built-in 2-player connector. The molded grip and hand rest are great for extended gameplay. BlackHawk Digital costs \$39.95.

The Gravis *Xterminator* is a programmable digital game controller that looks and works like a game pad but has the functionality of a joystick. A proportional directional pad provides realistic control for a more joystick-like feel. A proportional throttle for flight

and driving games provides smooth acceleration and deceleration. It also features two proportional flippers, pre-set controls for popular games, and a lot more functionality than you would expect from such a compact game controller. Xterminator costs \$49.95.

Gravis' *Stinger* is a game pad designed specifically for laptop computers. This programmable digital game controller connects to a serial port, so notebooks don't need a game port. Stinger has a compact design that's perfect for travelling or for use in tight quarters. The proportional directional pad provides joystick-like control for all games. It features a short 3.5-foot cable and supports hot plugging. Stinger costs \$39.99.

I also have a terrific one from CH Products. The *Gamestick 3D USB* is a quality joystick with a USB interface and 3D twisting ambidextrous handle. It also features four fire buttons, a four-way point-of-view hat switch, precision trim controls, and more. This is a rugged joystick with an ambidextrous design and 7-foot cable. Its USB interface makes it compatible with both Windows systems and Macintosh systems alike. It costs \$49.95.

50X CD-ROM DRIVE

It seems that CD-ROM drive 13

speeds continue to creep up, at least when data is read continuously from a perfectly balanced, perfectly clean disc. ASUS' new *CD-S500 50X CD-ROM* drive transfers data at a peak speed of 7500 KB/sec with an access time of 75 milliseconds. The Double Dynamic Suspension System II reduces vibration for optimum stability and accuracy. The drive spins up to 10,400 rpm and supports Ultra DMA. The drive is compatible with all CD formats and supports high-speed CD digital audio extraction, which is great for making MP3s. It costs about \$150.

NEW SOFTWARE

I recently received a bunch of graphic-arts software titles from MetaCreations. Whether you've used any of it or not, you have no doubt seen what graphic-arts software can do in advertisements, on the Web, and so on. MetaCreations' *Headline Studio 1.0* is a set of tools specially designed for Web-banner creation. It features video effects such as walk-ins, dissolves, and fades for images and text. *Headline Studio 1.0* includes customizable color palettes, unlimited undo, and more. It costs \$199.

Also from MetaCreations is *Kai's Power Tools*, a collection of plug-in tools for Adobe *Photoshop* and compatible host applications such as MetaCreations' *Painter 5.5*. Included are textures, fractal vistas, 3D objects, and many other unusual image-altering algorithms. Creating elements with refracting glass edges, beveled metallic surfaces, and fancy textures is easy. You can also add motion blurs, twirls, and traditional photographic effects. The program costs \$129.

MetaCreations' *Painter Classic* provides digital artists with easy-to-use digital painting technology. The program features a simplified set of natural-media tools such as paintbrushes, chalk, pens, and more. *Painter Classic's* intelligent recognition of mouse or tablet automatically provides the correct brush library. It's available for \$99.

Finally, MetaCreations' *SuperGoo* is a set of image-distortion tools that make an image behave as though it's made of liquid. You can stretch, warp, and smear an image in real time. You can save a series of images and render them into an AVI or Quicktime animation file. *SuperGoo* includes a library of facial components—eyes,

Activision

3100 Ocean Park Boulevard
Santa Monica, CA 90405
310-255-2000
www.activision.com

**CIRCLE 60 ON FREE
INFORMATION CARD**

Advanced Gravis Computer Technology

2855 Campus Drive
San Mateo, CA 94403
650-572-2700
www.gravis.com

**CIRCLE 61 ON FREE
INFORMATION CARD**

ASUS Computer International

6737 Mowry Avenue
Mowry Business Center Bldg. 2
Newark, CA 94560
510-739-3777
www.asus.com

**CIRCLE 62 ON FREE
INFORMATION CARD**

CH Products

970 Park Center Drive
Vista, CA 92083
760-598-2518
www.chproducts.com

**CIRCLE 63 ON FREE
INFORMATION CARD**

Disney Interactive, Inc.

PO Box 2786
Van Nuys, CA 91401
800-900-9234
www.disneyinteractive.com

**CIRCLE 64 ON FREE
INFORMATION CARD**

Dobbs-Stanford Corporation

2715 Electronic Lane
Dallas, TX 75220
214-350-4222
www.dobbsstanford.com

**CIRCLE 65 ON FREE
INFORMATION CARD**

Hasbro Interactive

50 Dunham Road
Beverly, MA 01915
978-921-3700
www.hasbro.com

**CIRCLE 66 ON FREE
INFORMATION CARD**

MetaCreations

6303 Carpinteria Avenue
Carpinteria, CA 93013
805-566-6200
www.metacreations.com

**CIRCLE 67 ON FREE
INFORMATION CARD**

Microsoft Corporation

One Microsoft Way
Redmond, WA 98052
425-486-9258
www.microsoft.com

**CIRCLE 68 ON FREE
INFORMATION CARD**

Mill Reef Entertainment

2456 20th St. NW, Suite 405
Washington, DC 20009
800-485-8797
www.earthdvd.com

**CIRCLE 69 ON FREE
INFORMATION CARD**

NuvoMedia, Inc.

310 Villa Street
Mountain View, CA 94041
650-314-1200
www.rocket-ebook.com

**CIRCLE 70 ON FREE
INFORMATION CARD**

Samsung Electronics America, Inc.

105 Challenger Road
Ridgefield Park, NJ 07660
800-933-4110
www.samsung.com

**CIRCLE 71 ON FREE
INFORMATION CARD**

noses, etc.—that can be added to pictures or used to create a virtual person. This really is a fun program and affordable at \$49.

Hasbro Interactive has released another title that my son loves to play. It's the *Tonka Raceway* CD-ROM. This game lets kids design racecourses and race any of the 30 Tonka vehicles included in the game. There are four different types of terrain to choose from including desert, frozen tundra, jungle, and country. In addition to racing vehicles included with the games, kids can also use *Tonka Garage*, another game I covered in the past, to design custom vehicles that work in *Tonka Raceway*. If *Tonka Garage* is

loaded on the computer, *Tonka Raceway* will scan for saved vehicles and import them for racing. Along the way kids win new parts for upgraded performance. Kids can also print things such as racing certificates and course designs. This new game is for kids age four and up and costs \$29.95.

I recently received some new multimedia titles from Disney Interactive, and they cost about \$35 each. Hercules is one of my son's favorite Disney characters, and now there's a bunch of CD-ROMs that feature him. Kids with access to a color printer will have hours of fun with the *Hercules Print Studio*. This lets kids create personalized stationery, calendars, invita-

tions, certificates, stickers, and other Hercules-related graphics, all with the help of the hero himself. Included are more than 150 graphics and plenty of characters from Hercules' world. Everything looks best printed in color, but black and white printing is also fun.

The *Hercules Animated StoryBook* lets kids follow the Hercules tale at their own pace and engage in various diversions along the way. Kids join Hercules in his quest to save Mount Olympus and strengthen reading, vocabulary, and problem-solving skills at the same time. They can challenge Hades to a game of checkers, partake in sing-alongs, square off with the multi-headed Hydra, or find their way through the Mount Olympus maze. The *Hercules Action Game* features the characters from the *Hercules* movie in a modern arcade-like adventure game. Kids battle through three worlds with multiple levels and lush environments. There's wild 3-D action and multiple game paths so no game will ever be the same.

I also received two Disney titles based on *The Lion King II: Simba's Pride* (LKIISP), which was the sequel to

The Lion King. LKIISP *Active Play* is packed with games where kids can sing, dance, create things, and explore the Pride Lands with Kiara, Kovu, Timon, Pumbaa, and other great characters from the movie. Kids can create unique animals using different characteristics, colors, and textures. This CD-ROM even plays audio tracks in a regular CD player. LKIISP *Gamebreak* is a collection of different games based on the *Lion King* theme. It's fun to chase cubs, break bricks, sling swamp berries, and more, with 50 levels in each game.

A new and unusual DVD disc from Mill Reef Entertainment, called *Earthlight Special Edition*, is loaded with video shots of and from the space shuttle. This is some of the most beautiful video I've ever seen shot from space. Earth looks fabulous from way up above. You can choose different audio selections, multiple language subtitles, including Klingon, activate theater-quality video screensavers, and a lot more. Included is 80 minutes of NASA's best video of planet Earth, set to 5.1-channel Dolby Digital music. This disc costs \$29.95, and you need a DVD-ROM drive or DVD player to play it.

Open Season is an expansion pack for Activision's *Big Game Hunter II*, the virtual hunting game. *Big Game Hunter II* brings the thrill of the hunt to your living room, in a more humane virtual environment. The *Open Season* expansion pack adds the terrain of Alberta, Colorado, and a new Kentucky region. Featured are more than 50 new pieces of hunting gear, 36 new hunting stands, new ammunition, and more. *Open Season* has a suggested retail price of \$17.99.

Also from Activision comes *Extreme Bull Rider*, a rough and rowdy, action-packed virtual bull-riding game. Up to eight players can sign in at once and choose from 20 different riders and 10 bulls. You can watch the dirt fly from multiple angles in replay sessions. Clowns doing tricks like jumping over bulls is also part of the fun. This game costs \$24.95.

Fans of Activision's *Sin* game will want to know about the new *Sin Mission Pack: Wages of Sin*. This add-on to *Sin* adds four new characters, 17 single-player mission-based levels, 12 death-match levels, and more, you can pick up this disk for just \$29.95. ■

A Convincing Performance at an Unbelievably Low Price!!

MOTOR CONTROLLER

Low Price



Universal Controller
UVC2001 series



Integrated 2-axis Controller
EMC2M

Universal Controller

UVC2001 series

- Multi-functional controller featuring counter, general-purpose I/O interface, analog input and trigger output capabilities, in addition to the basic motor control functions (positioning or rotational control)
- Micro-driver built-in type suitable for stepping motors, and driverless type for servomotors

Integrated Controller

EMC series

- RS-232C/RS-485 communications
 - 5-phase stepping motor driver incorporated
 - 2-/3-axis simultaneous control available.
- Easy multiple-axis control through RS-485 communications (up to 16 units)

URL = <http://www2.dango.ne.jp/onomichi/inh/>

E-mail = inh@orange.ocn.ne.jp

INH International Hanbai Co., Ltd
22-30 Kanda-cho, Onomichi, Hiroshima, 722-0016, Japan

LETTERS

NO LONGER AVAILABLE

The ferrite beads and circuit breaker that I used for the "Semiconductor Tester" (**Popular Electronics**, May 1999) are no longer available from All Electronics.

After receiving a question on this topic, I thought I'd pass my answer on to the rest of your readers, just in case they have a similar concern.

However, there is nothing critical about ferrite beads FB1 and FB2 or circuit breaker CB1. The ferrite beads I used were 10 x 5 mm. All that is wanted is a lossy impedance at RF frequencies. You can substitute any 1/2-amp circuit breaker for CB1 or even use a 1/2-amp fuse.

I hope this helps.

Charles Hansen
via e-mail

HAVES & NEEDS

I am in need of user's manuals/schematics for a Sencore TF30 Super Cricket Transistor Tester and a Starkit, Model RFG2, RF signal generator. I will gladly pay copying and shipping costs.

Thanks in advance.

Darren Green
Box 192
Rocanville, Saskatchewan
S0A 3L0 Canada

I am researching a novel dealing with the loss of privacy due to the proliferation of electronic surveillance equipment. I am looking for reference sources on counter surveillance such as finding bugs, jamming signals, and other techniques of avoiding modern surveillance methods.

If any readers could be of assistance, I would be most appreciative.

Jack Hasselback
P.O. Box 78
Dubois, PA 15801

I have a special request for **Popular Electronics** readers. I need someone who can do "etching and drilling" of printed circuit boards on a small scale. I will design the foil artwork pattern on paper, and from there

the reader will etch and drill the board.

The boards will each be one of a kind (only one copy is needed), no larger than 4 by 6 in size, and usually smaller.

I have no means to do the board-making myself as I live in an apartment. I will be happy to make a reasonable and fair payment for this service. If any reader can help me with this, it would be greatly appreciated.

Craig Kendrick Sellen
Mallard Meadows RHC
476 Belmont St.
Waymart, PA 18472-0476

I need a copy of a construction arti-

KEEP IN TOUCH

We appreciate letters from our readers. Comments, suggestions, questions, bouquets, or brickbats ... we want to hear from you and find out what you like and what you dislike. If there are projects you want to see or articles you want to submit—we want to hear from you. And now there are more ways than ever to contact us at **Popular Electronics**.

You can write via snail mail to:

Letters
Popular Electronics
500 Bi-County Blvd.
Farmingdale, NY 11735

Please note the above address is the snail-mail way to get the quickest response. Some readers send letters to our subscription address, and although the mail is forwarded to our editorial offices, it does increase the time it takes to answer or publish your letters.

Send e-mail to:

peeditor@gernsback.com

Of course e-mail is *fast*.

Check the end of your favorite columns, too. Many of them list individual e-mail addresses for their respective authors.

And don't forget to visit our Web site: www.gernsback.com.

cle for a VLF receiver and antenna that originally appeared in *Elementary Electronics* magazine in the late 1970s. All I remember of the circuit is that it used a dual-gang tuning capacitor. I am willing to pay all copying and shipping costs.

Please keep up the great work, as I think your magazine is one of the best on the market. Thanks in advance for your help.

Rhonda Frank
2587 Capilano Crescent
Oakville, Ontario
L6H 6L4 Canada

I need schematics or the secondary voltage of the center-tapped transformer for the Mako piranha amplifier, 110V, 40 watts. I will be happy to pay any expenses.

Thank you.

A. P. Fischer
1110 Elm Avenue
Modesto, CA 95351-1204



YOU CAN WIND YOUR OWN COILS?

There's no trick to it except knowing what you are doing. In a unique, 106-page book you can become expert in winding RF, IF, audio and power coils, chokes and transformers. Practically every type of coil is discussed and necessary calculations are given with the mathematical data simplified for use by anyone. Get your copy today!

Mail coupon to:

Electronics Technology Today, Inc.
P.O. Box 240
Massapequa Park, NY 11762-0240

Please send me my copy of *Coil Design and Construction Manual* (BP160). I enclose a check or money order for \$8.99 to cover the book's cost and shipping-and-handling expenses. NY state residents must add local sales tax.

Name _____

Address _____

City _____ State _____ ZIP _____

All orders must be paid in U.S. funds only. Sorry, no orders accepted outside of USA and Canada. Please allow 6-8 weeks for delivery. ET07

Product Test Report

Marantz DVD Player

STEPHEN A. BOOTH

It's just over two years since the first Digital Versatile Disc (DVD) video players emerged, along with a slim selection of movie titles on the CD-size discs. That movie selection has grown to more than 3000 in the U.S. by now, where the DVD format is an unqualified success. The discs, which can cost as much as \$35, also can be had for as little as \$10—and even rented.

Meanwhile, the selection of DVD players has expanded as well. With prices already approaching the \$249 mark and possibly headed for \$199 this year, the format's within the grasp of the mass market. Even modestly priced PC systems now come with the sibling DVD-ROM drive built in, permitting movie viewing on either the PC monitor or on a TV if video outputs are available.

Some DVD players still command higher prices—say, \$500 to \$1000. These high-end devices have advanced features such as built-in decoding for the Dolby Digital surround sound or various video signal-processing capabilities such as smooth onscreen fast-advance or reverse viewing. At a suggested retail price of \$850, the *DVD-930* from Marantz has those advanced audio characteristics that you'd expect from this venerable hi-fi brand (more on them later on). But its video performance, although good, isn't all that it should be, especially at its stated price. You'll see why later, when looking at our bench-test measurements. Meanwhile, in case you've missed our previous DVD lab reports, here's some background on the format.

DIGITAL VIDEO

Compared with 12-inch video laserdiscs, which store images in analog format along with a digital soundtrack, CD-size (4¾ inch) DVDs hold video in the compressed digital standard called MPEG-2. This gives DVDs a data capacity 7 to 27 times greater than the roughly 650-megabyte limit of music CDs or computer CD-ROMs. For the record, MPEG-2 compression also makes it possible for direct-broad-



cast satellite (DBS) TV systems such as DIRECTV and EchoStar to deliver many high-resolution channels.

Horizontal resolution with MPEG-2 is about 480 lines, well within the display capability of most current TVs. By way of comparison, analog formats such as laserdisc, deliver about 425 lines, live NTSC broadcasts serve up 330, and VHS videotape 240. But any comparison has to go beyond sharpness, as digital encoding brings other benefits, such as perfect color purity compared with analog.

As for vertical resolution, progressive-scanning (nominally 480 lines) is inherent to the video stored on DVDs, but it's converted within the player to an interlaced output for proper scanning on current TVs (in 30 frames per second NTSC or 25 fps PAL/SECAM, where appropriate). Now that an increasing number of TVs are capable of progressive scanning (thanks to the advent of high-definition TV or HDTV), DVD players are likely to offer progressive-scan output through component-video jacks—possibly by the time you read this. Meanwhile, computer DVD-ROM drives already feed proscan video directly to the PC's inherently non-interlace monitor.

Like laserdiscs, DVDs can include supplemental information about the program and perform special effects such as freeze-frame, slow motion, random access to indexed "chapters," and more. DVD also can carry different versions of a movie, depending on the capacity of the disc used—nominally 5 to 18 gigabytes (GB).

The latter wide range is caused by the fact that different formatting options for a disc exist. DVDs can be

single-sided ("DVD-5") or dual-sided ("DVD-9")—and dual-layered on either side (so-called "DVD-14" and the new "DVD-18" scheduled to make its debut this fall). To read dual-layer discs, the player's laser pickup is instructed (by the coding that's on the disc) to shift its focus through the topmost strata of pits and bumps to those on the lower or inner layer. Because the new multi-read pickups vary wavelength as well as focus, there's sufficient reflectivity from either layer to bounce the ones and zeros back.

Although a single-layer DVD has enough data to handle most movies (up to 135 minutes), the other formatting options give content owners more flexibility. For example, most Hollywood studios now issue their movies on a single DVD in both pan-and-scan (4:3 aspect ratio) and "original widescreen" ("letterboxed" 16:9, 1.85:1, or even 2.35:1 Panavision) versions. Depending on the disc replicator, the two versions come either on a dual-sided or single-side, dual-layer DVD. The even-longer DVD-14s and -18s give programmers the option to cram multiple features (for example, multi-episode TV series) on the disc. If there's side-to-side continuity, though, you'll have to flip the platter yourself. Whereas top-shelf laserdisc players reposition the pickup to play the flip side of discs automatically, that feature has yet to emerge in DVD hardware at the time of this writing. Although "long-play" DVDs as yet have limited application in entertainment programming, the benefits of their capacity should be obvious with regard to computer DVD-ROM software such as encyclopedia and other reference works.

Audio-wise, DVD and laserdisc 17

Accredited B.S. Degree in Computers or Electronics

by studying at Home

Grantham College of Engineering
offers 3 distance education programs:

- B.S.E.T. emphasis in Electronics
- B.S.E.T. emphasis in Computers
- B.S. in Computer Science

NEW

-Electronics Workbench Professional 5.0
included in our B.S.E.T. curriculums
-Approved by more than 200 Companies,
VA and Dantes, (tuition assistance avail.)

For your free catalog of our programs dial

1-800-955-2527

<http://www.grantham.edu>

GCE

Your first step
to help yourself
better your future!



Grantham College of Engineering
34641 Grantham College Road
Slidell, LA 70460-6815

LynX-10

HOME AUTOMATION KIT

- Software Included
- Use Existing Wiring
- Simple Inexpensive

1-800-928-5299 www.marrickltd.com

have much in common. Each can be encoded with Dolby Digital AC-3 surround sound, which outputs the soundtrack as six discrete channels (including a subwoofer channel) instead of multiplexing the center and rear signals in a matrix with the stereo front channels. For less elaborate home-theater systems, DVD also carries analog Dolby Pro Logic surround, whose center and rear channels are matrixed on the stereo soundtrack.

But DVD differs from laserdisc in the number of soundtracks it can hold—up to eight in different languages, and as many onscreen subtitles for translation. In practice, though, discs sold in the U.S. usually carry only English, French, and Spanish dialogue and subtitles. It can be different elsewhere in the world; here's why.

BUYER BEWARE

When buying a DVD player or discs, be aware that both hardware and software are regionally coded and

paired for playback in different parts of the world. Simply, this means that software meant to be sold in one geographic region won't play on the

TABLE 1—PERFORMANCE MEASUREMENTS

The following test results were furnished by the Advanced Product Evaluation Laboratory (APEL), an independent testing facility located in Bethel, CT. All electrical measurements were performed using the Sony HLX-4001 and Delos DV7001 Video Essentials test discs for DVD video performance, and the CBS CD-1 standard test disc for digital audio performance.

BRAND: Marantz
MODEL: DVD-930 DVD Player
PRICE: \$850 (MSRP)

DIGITAL VIDEO MEASUREMENTS

Frequency Response (Measured with a multiburst test signal):

Frequency (MHz)	Video Output (dB)
0.50	-0.18
1.00	-0.09
2.00	-0.00
3.00	-0.00
4.00	-0.09
6.00	-0.18

Video Signal-to-Noise Ratio (Luminance, 10 kHz–4.2 MHz @ 50 IRE):

Composite Video	
Unweighted:	64.4 dB
Weighted:	65.6 dB
S-Video	
Unweighted:	65.2 dB
Weighted:	65.6 dB
Component Video	
Unweighted:	66.2 dB
Weighted:	67.2 dB

Video Signal-to-Noise Ratio, Red Field Chroma (Bandpass: 100 Hz–500 kHz):

Modulation	Output (dB)
AM	74.0
PM	54.4

Stairstep Linearity (see Fig. 3):

Step	Video Output (%)
1	-32
2	-4
3	-4
4	0
5	-11
6	-4
7	-9
8	-10
9	-13
10	-42

DIGITAL AUDIO MEASUREMENTS

Reference Level (0 dB, 1 kHz): 2.06 volts
Frequency Response (dB): 20 Hz to 20 kHz, 0.00 to -0.47 dB
Signal-to-Noise Ratio ("A" Weighted): >100 dB
Dynamic Range: >100 dB
Total Harmonic Distortion (Re 0 dB @ 1 kHz plus noise): 0.032%
Channel Separation (Re 0 dB, 1 kHz): 85.4 dB (left channel)

ADDITIONAL DATA

Random Access Time: 1.4 seconds
Scan Time: 2.2 seconds
Power Requirements: 17 watts
Dimensions (HWD, inches): 3 7/8 × 16 7/8 × 12 1/4
Weight: 8.00 pounds

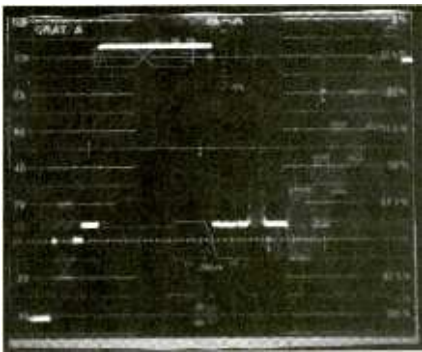

Fig. 1. As this squared sine wave "pulse and bar" test showed, there is no chrominance-to-luminance delay or gain in the DVD-930.

hardware available in another area.

For example, the U.S. is Region 1, and players and discs sold here are clearly marked so. If someone from Region 2 (Europe and Japan) tries to play a DVD obtained from Region 1, it's not supposed to run in his or her indigenous player. The same principle applies if you pick up some DVDs while on vacation in Mexico (Region 4)



Fig. 2. Color purity in the player is perfect, as this vectorscope shows. Notice that the color-reference bursts fall exactly into the correct areas of the screen.

that seem to be a steal at the currency exchange rate. They're not supposed to play in your U.S. Region 1 deck.

The purpose for splitting the world into six regions is to protect the movie industry's theatrical distribution schedules. Frequently, a Hollywood film is released overseas after its box-office run here—by which time Americans have access to VHS and DVD copies of the flick. So, by putting "lock-out" regional-codes on DVDs, Hollywood hoped to make sure that audiences outside the U.S. wouldn't be able to view movies on video before the studios could profit from the box-office take overseas.

Unfortunately for Hollywood, this

regional-coding scheme has largely flopped overseas, where resourceful hackers have come up with plenty of hardware and software methods to beat the system and play desirable Region 1 DVDs easily obtainable through Internet online shopping sites. If Necessity is the mother of Invention, she's prevailed because movie lovers outside Region 1 don't have the broad selection of DVDs (namely, the latest hits) that U.S. consumers do (and at the relatively cheap U.S. sale and rental prices).

But we mention regional coding here to alert U.S. owners that discs bought overseas won't necessarily run when you play them back home, where these region-code-killing hacks aren't readily available because there's been no need for them. (If, for whatever reason, you need or desire a "region-free" DVD player, you can run an Internet search for "code free DVD" to explore your options.)

Meanwhile, one thing that will play on any DVD deck worldwide is the ubiquitous music CD. The reason that digital audio is playable on any region's machines is because the DVD format was designed to be backward compatible with music compact discs. Every DVD player is a full-featured CD player to enable playback of your existing CD collection alongside the newer DVD-Audio format software that makes its debut this year.

This is why DVD means Digital "Versatile" Disc. Although the first DVD software was "video" for prerecorded movies, it was envisioned early on that the extra capacity of the DVD format would enable record labels to produce software far superior to CDs—with higher-resolution sampling rates and discrete (rather than multiplexed) multi-channel recording. That ship is about to arrive, and with it come still photos, graphics, text, and other material to supplement the multi-channel sound recording.

Not far off either are DVD recorders, although these will have to wait until anti-piracy protection methods become standardized. Even when they do, there's likely to be a lively format battle reminiscent of the old Beta-VHS conflict.

Yep, some things never change. Sony and Philips (Magnavox) are backing one DVD recording scheme (DVD+RW) while the rest of the indus-

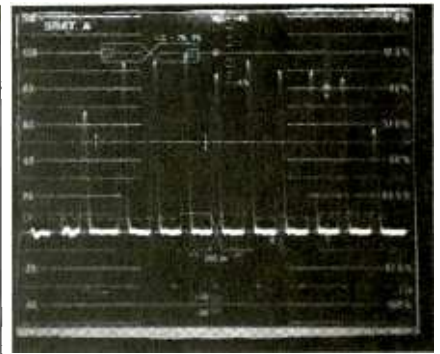

Fig. 3. The DVD-930 didn't fare well on the staircase linearity test—the linearity dropped a great amount at the full black and full white steps.

try (led by Panasonic-parent Matsushita) supports the DVD-RAM system. As in the Beta-VHS battle, they're mutually incompatible—and any decision probably will ride on where U.S. TV-giant RCA places its bet. (VHS beat Beta when RCA adopted the format. The stakes are international now, as RCA is the business-end of French-government-owned Thomson Multimedia, which is a worldwide consumer-electronics superpower.) While the next format war is brewing, let's get back to what's available here-and-now, namely the Marantz DVD-930.

SOME NICETIES

The unit we reviewed came with a lot of fine features. Before we get to the lab evaluation of the DVD-930, we'd like to point out some of its niceties—traits a high-end unit should have. First of all, in addition to being able to play DVDs, this Marantz unit can handle MPEG-1 discs. These are often called Video CDs, and though they're more popular in Europe, it's nice to see support for them.

The unit ships with a multifunction universal remote control—one you'll likely use to activate the built-in "virtual" surround sound while watching action movies. You could also use the front-panel headphone jack and volume-level control if you'd like to be considerate of others not taking part in your home-theater experience.

And with 96-kHz/24-bit digital audio playback resolution, and Dolby AC-3 Digital Surround decoding (6-channels), this could be *some* experience. There's even DTS surround-sound pass-through to further sweeten the

(Continued on page 87)

GIZMO®

Music Box

The *MR-2020 Tabletop Music System* (\$999) from Marantz is a full-function stereo system in a sleek, low-profile box. Measuring 18 × 12-1/2 × 4 inches, with subtly curved edges and a dark brown and champagne-gold finish, the MR-2020 presents a gracefully high-tech appearance. its



smoked gray motorized cover lifts to reveal the CD transport and AM/FM radio. The tuner includes an automatic station-setting function that enters favorite stations into memory for instant access. A clock/timer function allows the system to work as a wake-up alarm or to tune in a specified station at a pre-selected time. The streamlined tabletop box also houses the system's amplifier.

With black enclosures and a contoured, wedge-shaped design, the speakers complement the post-modern look of the control center, and different-color grille cloths are supplied. The sound system includes a powered subwoofer, and Digital Sound Control and Dynamic Bass Boost features that allow you to tailor the tonal balance to your personal preference. An enhanced stereo mode adds a greater sense of spaciousness to recordings. This is a compact system that can fit in anywhere—from dorm room to family room.

Big Screen Pager

With its extra-large, eight-line

display screen and 117,000 total character message memory, Motorola's *Model CP1250* word-message pager (\$209) is well equipped to receive and organize large quantities of personal and information service messages. The pager offers business professionals advanced word messaging and is capable of delivering multiple information services, including financial news, stock prices, headline news, weather reports, and sports scores—an easy way to keep up to the minute.

The pager's large screen displays up to eight lines of text with up to 26 characters per line. The unit's zoom function allows users to select a bigger font size with four lines of enlarged type. It can receive and display graphics such as logos, charts, and graphs. The Motorola Optimax EL feature automatically illuminates the display in low-light conditions.

The CP1250 has the capacity to store 26 personal messages and up to 15 different information services. It can organize large amounts of data into smaller sections with topics, making it easier to navigate and find relevant information. Several topics are stored in each of several "super maildrops." The Quickview feature



serves as a bookmark and a shortcut by allowing users to quickly access preselected maildrops. Other message-management tools allow users to move stored messages into various folders, including phone, to-do,

events, and trash.

The pager offers a built-in digital alarm clock, memory retention to save messages when the device is turned off or the battery (one AAA) is changed, and a Quiet Time feature that allows users to turn off all pager alerts at preselected times and still receive their messages.

Drop Down Video

Here's a new way to watch TV in the kitchen, without taking up valuable counter space. The Audiovox *VE-500* (\$600) is a 5-inch stereo LCD TV that mounts under a kitchen cabinet. The screen swivels for easy viewing from any angle, and flips back up



when you're not watching. The under-cabinet TV comes with a remote control and offers two audio/video inputs and an auxiliary speaker output.

Besides allowing you to watch the cooking shows while you cook, the VE-500 can also serve as a video security device. Adding an optional wireless remote video camera (\$300) to the drop-down TV allows you to monitor a baby's room or keep an eye on the kids who are playing in the yard, without leaving the kitchen, den, or workshop.

Weather Warning

We're writing this issue of *Gizmo* in the wake of the powerful tornadoes that killed dozens and left hun-

dreds homeless in Oklahoma and several other states. So it seems fitting to include mention here of Radio-Shack's seven-channel *Weatheradio* (\$69.95), which includes NOAA Weather Radio Specific Area Message Encoding (SAME) circuitry. The radio lets you program special National Weather Service (NWS) local county codes into memory, and will sound an alarm only when a weather emergency is declared in your immediate area.

The *Weatheradio* features 54 weather alert descriptions (including coastal flood warning/watch, severe thunderstorm watch, high wind warning/watch, hurricane, tornado) that appear on the display when a specific alert is issued. A radio that issues the SAME alert might provide just the extra time that's needed to secure your home and to get your family to safety.



When not sending specific alerts, the *Weatheradio* provides NWS broadcasts 24 hours a day. Those broadcasts include forecasts, reports, and travel advisories. They can be received at a distance of up to 40 miles, depending on terrain.

It offers an input jack for use with an optional antenna in more remote areas (it's a good thing to bring on a camping trip), an external connector for adding optional warning devices such as sirens or flashing lights, and a back-up battery system in case of a power failure.

Video Selector

The *Terk Video Selector* (\$49.95) allows you to hook up as many as

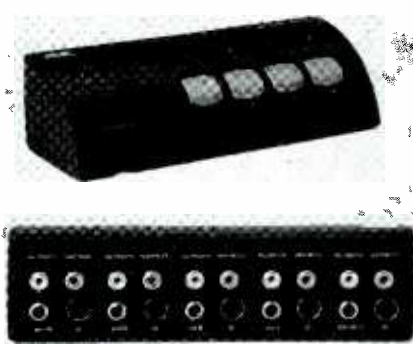

four audio/video components and one pair of powered speakers to your TV. It solves the dilemma of how to connect your VCR, satellite receiver, DVD player, Nintendo, and multimedia speakers to one monitor.

Installing the *Video Selector* is a simple matter of hooking up input and output A/V cables. Then, by pressing the matching selector button, you can switch between components. The device is S-Video compatible for optimum picture quality and works with RCA-type interconnects as well.

Online Home Theater Sales

Outlaw Audio is bypassing traditional sales and distribution channels and offering its home-theater products strictly via the Internet. "The Internet allows us to reach home-theater enthusiasts directly ... to deliver a superior product for a substantially lower price than anyone else," said

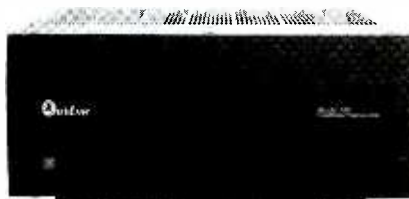

Outlaw's president, Thomas E. Young. The products offered online are designed and manufactured by Outlaw, eliminating multiple mark-ups from product inception to consumer.

The company's first offering is the *Model 750*, a five-channel power amplifier that sells for \$1099. With

all channels driven, the amp is FTC rated at 165 watts per channel into an 8-ohm load or 250 watts per channel into a 4-ohm load from 20–20,000 Hz, at 0.05% THD.

The unit is built around five interchangeable amplifier modules. Each amplifier contains its own power supply, six discrete output transistors, and power filtering. Replacing the typical noisy cooling fan, each module uses a huge heat sink with over 400 square inches of surface area, making for a much quieter unit. The chassis is made of powder-coated, 13-gauge steel. A 30-day, money-back guarantee is offered.

The Surround Sound of Silence

What can you do if your idea of relaxing after a hard day at work is to pop in a movie, crank up the surround sound, and watch Arnold Schwarzenegger beat the bad guys—but your wife's idea of a quiet evening at home is, well, quiet? She'd prefer a good book and some soft music to the blasting, booming soundtrack of your favorite film?

Unless you've got a very big house or a soundproofed media room, there's going to be a major conflict. Of course, you can compromise: You can keep the volume down, not even use the subwoofer, and she can retreat to another room with that book and a Walkman. But if you've been bitten by the home-theater bug, watching without listening is not going to be a satisfying experience. Well, there is a win-win solution available.

Sony offers a much more palatable form of compromise with its *MDR-DS5000 Virtual Dolby Digital Headphones* (\$549.99). The two-piece system consists of the wireless headphones and an infrared transmitter with built-in Dolby Digital and Dolby Pro Logic decoders. The open-air headphones feature a self-adjusting headband, soft cloth cushions, and ring supports that evenly distribute the headphones' weight, providing comfort even if your DVD of choice is as lengthy as *Titanic* or *Gone* 21

GIZMO®

with the Wind. The headphones have a 90-degree maximum transmission angle, allowing you to move freely throughout the room, and a range of up to 33 feet, which should be sufficient for most media rooms.

The transmitter is designed to stand upright. It's just over 7 inches

possible to replicate the effect to create the illusion of surround sound using two-channel headphones. The MDR-DS5000 "systematically applies the HRTFs to all 5.1 Dolby Digital channels and recreates the sound field of an ideal listening room."

That all sounds well and good, but

quick changes to better hear soft dialog or to avoid ear damage during blasts and crashes. And the auto-on/off feature is particularly cool—the headphones come on automatically when you put them on your head and shut off when you remove them—and can significantly cut back on battery changes (two rechargeable "AA" batteries are included).

Our second question was the big one. Can two headphone drivers act as an adequate fill-in for six home-theater speakers? Our initial reaction would be no, because headphones generate an image inside the head, as each ear gets its own signal without hearing any reflections. Much to our surprise, however, the MDR-DS5000 headphones were able to generate a realistic sound field. It wasn't so life-like that we would turn around to find the source of surround-channel noises, but it was impressive, nonetheless.

All in all, the MDR-DS5000 performed as promised, which says quite a bit because Sony promised a lot. The headphones delivered comfort, privacy, and surround sound. They were comfortable enough that we could forget we had them on, they never hampered our movements or got tangled up like wired headphones do, and they produced realistic surround sound. While we wouldn't actively choose the Virtual Dolby headphones over our home-theater speakers, they've allowed us to enjoy realistic home-theater sound, with the volume pumped up, at times when other family members would have been disturbed or awakened by it. We could listen to our choice of music, or indulge in extended late-night video-gaming sessions, at full volume, also without disturbing or waking anyone.

The MDR-DS5000 made it easier to live in a small house with people of



tall, only slightly deeper, and is slim enough (3-3/8 inches at the front, tapering back to about two inches) to fit next to the TV in many entertainment centers. It offers an analog stereo input as well as an optical digital input for either Dolby Digital or PCM signals.

What good is 5.1- or 5-channel sound, you might ask, if you're limited to the headphone's right and left speakers? After all, the sound no longer surrounds you. Ah, well, that's where the "virtual" comes in.

According to Sony, Virtual Dolby Digital reproduction is based on psychoacoustic head-related transfer functions (HRTFs), which the company defines as "changes to the volume and high-frequency content of sound caused as parts of your head obstruct the passage of sound from the source to your ears." Because HRTFs vary predictably (depending on whether the sound comes from the front, back, sides, or somewhere in between), it's

we were still skeptical. The fact that the MDR-DS5000 is the first headphone system to receive Virtual Dolby Digital certification did lend it some credence, and we were willing to suspend our disbelief in the cause of fair testing.

First, the headphones are as comfortable as claimed and offer a full range of movement without losing the signal. While we don't recommend performing household chores while watching films, the MDR-DS5000 makes it possible to fold the laundry and get it ironed while enjoying a movie at full volume after the kids have gone to bed—which just might make its price tag more palatable to some spouses.

If both of you parents want to watch a video without waking the children, you can buy additional headphone units separately, or plug in a wired headphone to the front-panel jack. The single volume control was within easy reach, allowing

Gizmo is published by Gernsback Publications, Inc., 500 Bi-County Blvd., Farmingdale, NY 11735. Senior Writers: Christopher Scott and Teri Scaduto. Copyright 1999 by Gernsback Publications, Inc. Gizmo is a registered trademark. All rights reserved.

disparate musical and video tastes and different sleep schedules—all without any compromising on audio enjoyment.

Big Idea for Little Fingers

Computers have become an integral part of children's lives, both at home and at school. Youngsters are spending hours in front of PCs, researching projects, doing homework, writing papers, surfing the 'Net, chatting with friends, and playing games. And, not surprisingly, like



adults, children can suffer debilitating physical symptoms from computer over-use. Parental concern that too many hours in front of the computer is not good for kids is justified.

Kids might not log the requisite hours of straight typing to develop carpal tunnel syndrome or repetitive stress injuries (though the latter might result from unlimited hours of clutching a joystick). Instead, computer-using youngsters are prone to what the experts call "musculoskeletal discomfort"—aches, pains, and poor posture stemming from using a computer and workstation designed for adults.

Watch an elementary-school child at work on a computer—perched on the edge of a chair, legs dangling above the ground; neck craned to see the monitor; arms stretched upward to reach a keyboard that's much too large for his hands. No matter how engrossed he might be, he doesn't

look very comfortable, does he?

There are a few things you can do to create a more ergonomic PC station for a child. Most of those adjustments involve furniture arranging more than electronics, however. Ergonomics experts advise you to place the keyboard and monitor at appropriate levels, include wrist or palm rests, and provide a foot rest, for instance.

But there is one PC peripheral that might make the family PC more child-friendly. The *LittleFingers* keyboard (\$99) from DataDesk Technologies has been scaled down to fit children's (and petite adults') hands. At 80% of the standard keyboard size, it allows kids to easily reach all of the keys. A built-in trackball is handy for the youngest family members who might not yet be ready for real typing. The device is PC and Mac compatible, and its "dual-mode" fea-

ture allows you to connect it to the family computer without disconnecting the standard keyboard—a definite advantage.

The *LittleFingers* Keyboard won't take up too much precious desk space. It's just 12-1/2 inches wide—that's a full five inches shorter than the standard keyboard on our desk. Although the *LittleFingers* Keyboard is an inch deeper than ours, a built-in wrist rest accounts for a third of its 7-fi-inches depth.

A built-in trackball further frees up desk space by eliminating the need for a mouse pad. The trackball's three-button design puts all point, click, and drag functions within easy reach of small hands. The large bar below the trackball is used for single-clicking, while two smaller buttons above the ball are used for "click-and-drag" and double-click functions.

The basic keyboard and the typing

keys are the standard putty color associated with PCs, but specialized keys brighten things up a bit. A row of 17 rounded-top function keys spanning the top of the keyboard are a pretty shade of purple. The arrow keys are sky blue, the ALT keys are sea green, the CONTROL key is melon, and the OPTION key is yellow.

To keep the size of the keyboard down, the numeric keypad was eliminated. The INSERT, DELETE, HOME, END, PAGE UP, PAGE DOWN keys that are usually found on the numeric keypad were included as secondary key functions on the *LittleFingers* Keyboard. Those functions can be accessed by pressing first the right shift key and then the second-function key. The alternate functions are printed on the front skirts of the keys.

That arrangement takes some getting used to. As writers, we rely heavily on the PAGE UP and DOWN keys, for instance. According to DataDesk, however, those keys, and the others that have been relegated to "secondary" status, are not often used by children (who adapt to that sort of change much more easily than do we set-in-our-ways adults).

As parents, what we liked best about the *LittleFingers* Keyboard was the "Dual-Mode" feature that allowed it to be used simultaneously with another keyboard and mouse. IBM PCs and compatibles normally won't even boot up with more than one keyboard connected, and Windows 95 and 98 won't recognize more than one mouse connected to the PS/2 port. *LittleFingers* circumvents those limitations with proprietary firmware and electronics. That means that you won't have to reboot every time you want to switch keyboards. (And, unless you have very small hands or have become so used to using a scaled down portable-PC keyboard, you won't want to trade in your adult model for this one!)

More important, having side-by-side keyboards connected to the same PC allows you to work or play beside your child—demonstrating how to do something on yours and letting him follow your lead on his own. In fact, you'll want to put a second chair in

front of the PC now that you don't have to say "Get up and let me show you what I mean" (countered by a whiny "No, I'm doing this now!") ever again! Of course, Dual-Mode can quickly devolve into "Dueling Mode," as the two of you do battle for keyboard control!

We let a four-year-old, a first grader, and a third grader, none of whom know touch-typing, try out the keyboard. The oldest kid, who had a few years of using a standard-sized keyboard under his belt, took the longest time to get used to the LittleFingers' scaled-down size. Once he got a feel for it, however, he pronounced it "Okay." (Hey, nine-year-olds are not known for their enthusiasm.) The six-year old, a relatively new reader and computer user, got the most out of the small-sized keyboard. The youngest tester liked the idea of having "his own keyboard" and the colored keys, but was too young to do much with it. All three of them really liked using the trackball.

With preschoolers becoming computer literate before they become literate, it makes sense to equip them with a keyboard that fits their hands just when they begin to learn to read, write—and type. And, in more and more districts, typing is being taught in elementary schools. It's much easier for a child to learn touch typing when his fingers can easily reach all the keys, and when he doesn't have to lift his hands from their proper positions to reach the ENTER/RETURN key.

Family Radio Service

Are you a member of a multi-cell-phone family? It's actually not that unusual in these days of dual-career families for each parent to be equipped with a cellular phone. In upscale neighborhoods, even the kids have their own cell phones.

But, let's face it—buying a cell phone for each member of the family, and then having to pay all those monthly bills, is more than most of us can comfortably fit into our budgets (or our consciences). Hey, we're from the generation whose parents refused

to even let us have an extension in our rooms, let alone our own phone lines! The thought of giving cellular phones to our own kids just doesn't sit right with us.

Of course, we're also from the generation whose moms could generally be found in or around the house, and whose after-school activities consisted of snack, homework, and playing with the neighborhood kids. Our parents didn't face the logistical nightmare of having to get kids to and from soccer, scouts, T-ball, library group, and music lessons—

all on the same afternoon. If Dad's coaching the soccer game, and Mom's leading a scout troop, how can the other kids get in touch to say that music lessons were canceled, or T-ball finished 20 minutes earlier than scheduled?

Well, as long as all of those activities are taking place within a two-mile radius, a less expensive solution would be to take advantage of the Family Radio Service, and equip each person with a two-way FRS radio, such as Kenwood's *FreeTalk* (\$159 each).

Although it's been around for over three years, "Family Radio Service" has yet to become a household phrase. FRS is a license-free, two-way radio service intended to provide affordable, convenient short-range communications between individuals and families. It's actually a type of Citizens Band radio service, operating on 14 channels in the 460-MHz band. Traditional CB radio, which offers a range of up to five miles, uses

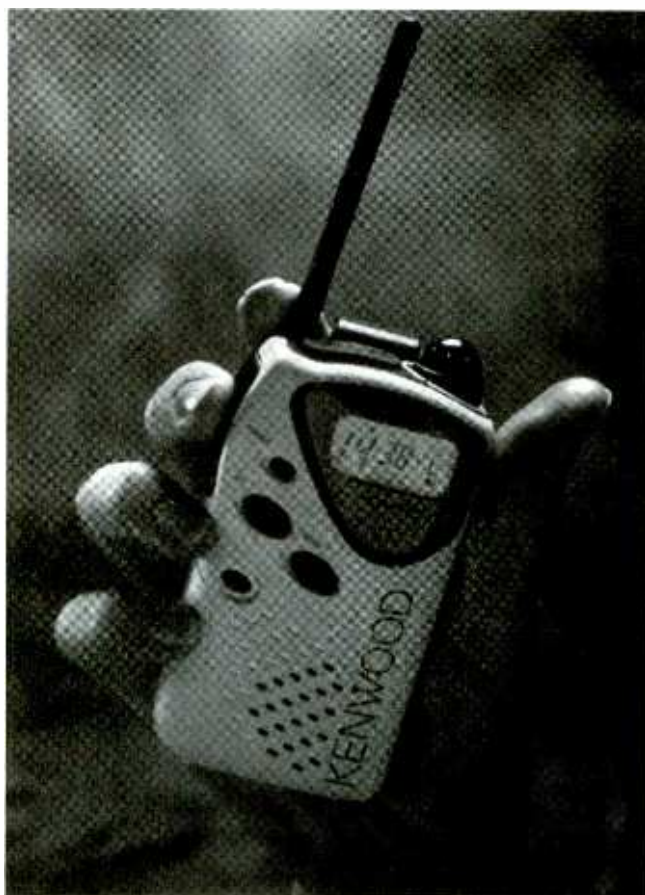

AM and is plagued by squawky interference. The Family Radio Service operates on UHF FM airwaves, which are quiet in comparison.

Instead of the usual narrow-band FM deviation of 5 kHz, Family Radio Service channels are set at 2.5 kHz apart. That's to avoid interference with General Mobile Radio Service (GMRS) stations. The 14 FRS channels are 462.5625, 462.5875, 462.6125, 462.6375, 462.6625, 462.6875, 462.7125, 467.5625, 467.5825, 467.6125, 467.6375, 467.6625, 467.6875, and 467.7125 MHz. Those channels are used on a "take turns" basis, with no channel assigned to any specific person or group. And, unlike GMRS users, FRS users are not required to get a license from the FCC or to pay any type of operating fees.

And that's the primary benefit over cellular phones for keeping in touch locally—there are no monthly fees. Once you buy the radios, you can use them as often as you like

without incurring further expense (besides batteries, that is).

The Kenwood FreeTalk transceiver is a pocket-sized communicator that measures approximately 2-1/4 x 4 x 1 inches and weighs in at just 6.3 ounces with the requisite three AA batteries installed. Available in either basic black or bright yellow, the radio comes with a belt clip that swivels, so that it can be worn upright or horizontal, and a swing-out antenna with two positions—allowing the antenna to be kept in a vertical position no matter how you choose to wear the radio.

Front-panel controls include a POWER button, up and down arrow keys for selecting channels, and a MODE button that lets the channel buttons change the desired “talk group” and turn Kenwood’s scrambling mode on or off. An LCD readout shows the current channel and displays icons indicating whether it’s receiving or transmitting, whether a talk group has been selected, or whether the scrambling feature has been activated.

To use the FreeTalk, you simply select the same channel (and talk group, if desired) as the person on the other end, press the PTT (“push-to-talk”) button found on the side of the unit, and speak normally. Release the PTT button to receive an answer. It really couldn’t be easier. Not even the youngest or most technology-shy family member will have trouble with it.

The hardest concept to grasp for most youngsters is the talk group. A common feature in FRS radios, the talk group allows you to limit the signals you receive to those on a user-specified “talk-group” subchannel. If for instance, your group opts to use channel 11, you would hear all FRS communications taking place on that channel in your area. Use the MODE button to select a talk group number as well, and your communications would be limited to, for instance, channel 11, talk-group 4. That way, you should hear communications only from others in the same talk group. Turn off the talk-group feature, and once again you’ll be able to

hear all communications on the channel.

When the FCC approved FRS, it spelled out several rules regarding its proper use. While Family Radio Service is intended to allow individuals or small groups to conduct two-way voice communications with another person or group, emergency messages must always be given priority status. Using FRS in connection with any type of illegal activity is strictly prohibited.

Of course, if you’re planning to rob a bank or set up a drug buy, you’re probably not too concerned about disregarding FCC regulations. But, on the other hand, you probably wouldn’t want to discuss your intended misdeeds over FRS channels, anyway, as they don’t provide much privacy.

But how much privacy do you really need to let your wife, who’s on the softball field on the other side of the park, know that the soccer game is over and you’re taking your winning team out for ice cream? Or to let the kids know that you’ve spent enough time at the mall, and it’s time to meet at some predetermined spot? Or to let the other hikers know you’re taking a different trail back down the mountain?

As the very name, *Family Radio Service*, suggests, FRS is not intended for confidential, illicit communications, but to help families keep in touch and keep track of each other’s movements. Kenwood’s FreeTalk, unlike most FRS radios, does offer a modicum of privacy with its “scramble” mode, which makes your conversations unintelligible to anyone but other FreeTalk users.

We found the FreeTalk radios convenient to carry and to use. They got their biggest workout during the Bike New York Tour, a 45-mile ride through all five boroughs that attracted some 30,000 riders on a recent Sunday morning. We don’t ride at the same pace, but were able to keep in touch easily—and meet up at the rest stops—with the help of the FreeTalk radios. They came in handy around the house, too, eliminating

the need to shout from floor to floor or house to yard. And during the melee that was soccer-signup day, we were able to split up, with one of us taking the kids to the nearby playground while the other waited on line at the registration booth. FreeTalk drew quite a bit of attention from the other “Soccer Moms”—we wouldn’t be surprised to see a lot of them on the field next season!

Keeping an Open Line

You’ve got an important report to deliver tomorrow morning at work, and you’ve got a lot of research to do on the Internet before you can get it finished. Unfortunately, you’re also expecting an important call from an associate who has the updated sales figures that must get into the report. Unfortunately, your PC and your phone share the same phone line. Do you wait for the phone



call before going online (and hope you don’t have to stay up all night to get the project finished) or do you start your research and figure that your associate will keep trying no matter how many times he gets a busy signal?

Actually, you don’t have to make a choice between receiving phone calls and going on line, even when you have only one phone line. A handy little device called the *HotCall HC2000* (\$79.95) from Command Communications, when used in conjunction with the local phone company’s call-waiting service, lets you know when a call comes in so that you can decide whether to answer it or remain on line.

HotCall is an unobtrusive little box, about 5 inches square and 1-1/2 inches tall, that connects between your phone and modem and the tele-

phone wall jack. There are no controls—besides the HotCall logo, the top/front of the unit is bare except for a small LED.

With the included 12-volt AC adapter plugged in, the phone and modem connected, and call-waiting service in place, HotCall is ready for action. When you are online and a call-waiting signal is detected, the light will flash red and an alert tone will sound. If you answer the phone and remain on the line, your modem will be disconnected. Or you can simply decide to ignore the incoming call. If you have phone-company voice mail, the caller can leave a message for you there.

If your modem is reasonably high-speed (faster than 9600 baud), you might be able to pick up the phone to which the HotCall is connected and hang up within a few seconds without losing your Internet connection. In such a case, the device performs a “hook-flash” to connect you to the calling party and automatically performs a second hook-flash upon hang-up. At that point, some modems are able to re-establish the online connection. This feature is a big help if you’re plagued by telephone solicitors. You can hang up on them right away and remain online.

HotCall also works with fax machines. Plug a fax machine instead of a telephone into the unit’s phone jack and set the fax to Automatic Receive Mode. When you hear the HotCall’s alert tone, you can opt to ignore the incoming fax or accept it by answering the telephone on the fax machine and pushing the start button to receive the transmission. Finally, you can use the HotCall 2000 with Command Communication’s ComSwitch 7500 and be able to receive phone, fax, and modem calls on the same line.

To be perfectly honest, we don’t care for call waiting. (In fact, we had to test the HotCall at a friend’s house.) We don’t like to be put on hold while someone decides if they’d rather stay on the line with us or talk to the new caller, and we’d rather not subject our friends to that treatment.

Working from a home office necessi-

tates two phone lines, anyway, so if there’s an emergency, we can usually be reached on one or the other.

But, rude or not, call waiting has become an accepted part of the American culture. And if you already have the service and have only one phone line, the HotCall 2000 can help you keep your lines of communication open even during extended ‘Net-surfing sessions.

Perhaps Command Communications will come up with a “HotCall HC2001” that will be compatible with Caller ID as well as call waiting. Now *that* would be really convenient!

GIZMO NEWS

Single-Minded Sony

Remember that old *Saturday Night Live* skit about the Scotch tape store? Okay, maybe it wasn’t the funniest concept—a store that sold tape, tape, and nothing but tape. But now, a couple of decades later, the idea of retail specialization seems to have caught on, as Sony prepares to open a store that sells PlayStations, PlayStation games, PlayStation accessories, and only PlayStation stuff. Named (what else?) PlayStation, the 5531-square-foot retail shop will be outfitted with more than 30 interactive gaming stations, each including displays for at least four top titles at a time.

The new store will be located at Sony Entertainment-owned Metreon, a complex in San Francisco’s hip downtown SoMo (South of Market) area. Metreon is a four-story, 350,000-square-foot mall and entertainment complex that includes the city’s first Sony IMAX theater, movie theaters, shops, and restaurants. The grand opening of Metreon, and the PlayStation flagship store, was slated for June 16.

“With a PlayStation in nearly one out of every five U.S. households, our new store at Metreon provides us the best opportunity to offer our loyal fans a one-stop shopping environment for everything that is PlayStation,” said Kaz Hirai, president and CEO of Sony Computer Entertainment America. “This store

will also provide the ideal venue for us to test out new merchandising and promotional concepts, which will ultimately benefit our retail partners, as well.”

Rocket-Fast Internet for Scholars

You’ve got a state-of-the-art PC and a high-speed modem. You’re all set to jump on the Information Superhighway and put your pedal to the metal—but instead you find yourself screeching to a halt, stuck in a virtual traffic jam, unable to reach your destination in a timely fashion, or perhaps not at all.

It’s happened to all of us, and there’s not much we can do about it, because the problem isn’t at the user’s end. The flaw is built into the basic infrastructure of the Internet as we now know it—there is simply no way for content providers to ensure that data reaches its intended destination or that it does so at a specified time. With the overwhelming, and quickly growing, popularity of the Internet, those “online traffic jams” are not likely to clear up on their own.

While it might be merely annoying for many of us, who waste time trying to download images from the Star Wars site, there are some applications in which time is of the essence. In telemedicine, for instance, images are needed instantaneously, and blurry is unacceptable. Researchers using digital libraries and virtual laboratories also demand speed and dependability from the Internet.

That’s why more than 150 universities and colleges across the country are participating in a project dubbed Internet2, which aims to resolve the problems plaguing today’s Internet—and, in so doing, to lay the groundwork for the next-generation Internet. Internet2, or I2, has the financial support of some of the biggest technology companies in the country, including AT&T, IBM, MCI/WorldCom, Nortel, and Microsoft.

Internet2, however, will not be used by the general public any time

MANUFACTURERS

Audiovox Corporation

150 Marcus Boulevard
Hauppauge, NY 11788
516-231-7750

www.audiovox.com

**CIRCLE 100 ON FREE
INFORMATION CARD**

Command Communications, Inc.

10800 East Bethany Drive
Aurora, CO 80014
303-751-7000

www.command-com.com

**CIRCLE 101 ON FREE
INFORMATION CARD**

Datadesk Technologies

7869 West Day Road NE
Bainbridge Island, WA 98110
888-327-8868

www.datadesktech.com

**CIRCLE 102 ON FREE
INFORMATION CARD**

Kenwood Communications

P.O. Box 22754
Long Beach, CA 90801
800-950-5005

www.kenwoodusa.com

**CIRCLE 103 ON FREE
INFORMATION CARD**

Marantz America, Inc.

440 Medinah Road
Roselle, IL 60172
630-307-3100

www.marantzamerica.com

**CIRCLE 104 ON FREE
INFORMATION CARD**

Motorola Consumer Solutions Group

600 North U.S. Highway 45
Libertyville, IL 60048
847-523-5000

www.motorola.com/pagers

**CIRCLE 105 ON FREE
INFORMATION CARD**

Outlaw Audio

18 Denbow Road
Durham, NH 03824
800-392-1393

www.outlawaudio.com

**CIRCLE 106 ON FREE
INFORMATION CARD**

RadioShack

100 Throckmorton Street
Suite 700
Fort Worth, TX 76102
800-THE-SHACK

www.radioshack.com

**CIRCLE 107 ON FREE
INFORMATION CARD**

Sony Consumer Electronics

One Sony Drive
Park Ridge, NJ 07656
800-222-7669

www.sel.sony.com

**CIRCLE 108 ON FREE
INFORMATION CARD**

Terk Technologies Corporation

63 Mall Drive
Commack, NY 11725
516-543-1900

www.terk.com

**CIRCLE 109 ON FREE
INFORMATION CARD**

soon. Its stated mission is "to develop a new family of advanced applications to meet emerging academic requirements in research, teaching, and learning." The first goal of the Internet2 participants is to create a leading-edge network for the national research community. The second is to direct network development efforts to enable a new generation of applications to fully exploit the capabilities of broadband networks. In stage three, I2 participants hope to transfer the new network services and applications to elementary and secondary schools, the business community, and finally, to the "broader Internet community, both nationally and internationally." (That's you and me.)

Just as today's Internet, which arose in the 1980s from academic and government research work, has found its way into mainstream American homes, so, too, will I2—eventually.

Discovery Groups Seek Standards

In an effort to smooth the road to consumer acceptance of new technologies, the Consumer Electronics Manufacturers Association (CEMA) has launched a series of discussion forums headed by CEMA's Technology and Standards department. Called "Discovery Groups," each forum will explore the needs for stan-

dards in a variety of product areas.

"We are pleased to take a leadership position and provide a forum for interested parties to participate in the brainstorming of issues and opportunities that might be addressed by new industry standards," said CEMA president Gary Shapiro. "These Discovery Groups will complement our standards-setting activities by identifying new areas where standards can be employed to help sustain the fantastic rate of new technologies being introduced into the consumer marketplace."

The first Discovery Group met on May 4th in Washington, D.C. to discuss home networking standards. "We felt that the first Discovery Group should focus on home networking because the Internet has created a clear and immediate need for standards in this area of consumer electronics," explained Jack Chaney, director of the multimedia technology center for Samsung Information Systems America. "We are pleased that CEMA has agreed to facilitate industry-wide collaboration on a home networking standard that will benefit consumers and industry stakeholders alike."

Other Discovery Groups will be scheduled to cover such topics as electronic books, DVD testing, copy protection, wireless products, and advanced audio recording. Each session is open to anyone with an interest in the subject covered in the particular group. **G**

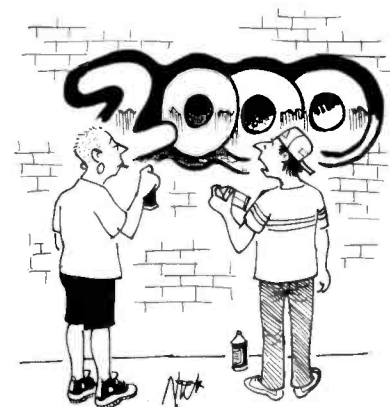

"My spray can quit ... I think it's the millenium bug."

ELECTRONICS LIBRARY

INTERNET IN A NUTSHELL

by Valerie Querica

This quick-moving guide goes right to the heart of the matter: how to get the Internet to work for you. The book starts with a tour of the Internet, focusing on the technology that makes it work. It then goes into detail on basic and "power user" features of popular browsers, e-mail and newsreaders, file handling, Web authoring, and more.



O'REILLY

Valerie Querica

Easy-to-browse entries make the book simple to use. Among the topics covered are: tips and reference for Netscape Communicator and Internet Explorer, a "living glossary" to the Internet, comparisons of the most popular search engines, and using tools such as basic HTML and JavaScript.

Internet In A Nutshell costs \$24.91 and is published by O'Reilly and Associates, Inc., 101 Morris Street, Sebastopol, CA 95472; Tel. 800-998-9938 or 707-829-0515; Fax: 707-829-0104; Web: www.oreilly.com.

INDUSTRIAL ELECTRONICS COMPONENTS CATALOG

from Allied Electronics, Inc.

This 1208-page catalog is a complete sourcebook for components. It is filled with products, ranging from electro-mechanical, interconnect and passive devices to cabinets, enclosures, tools, solder equipment, test equipment, and telephone products. Brand names include A. W. Sperry, AMP, Belden,

Hewlett Packard, BK Precision, Harris Semiconductor, Xcelite, Wavetek, Hitachi, Lamda Electronics, Tellures, Waldmann Lighting, and 3M.

Organized into 18 sections, the products are all arranged by manufacturer. Each product is accompanied by a diagram and specs. There are com-

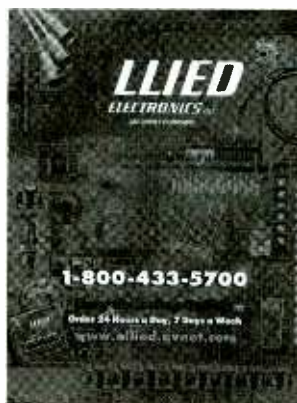

plete alphabetical indexes of manufacturers and products. The information in the catalog is also available on CD-ROM and on the Web site.

The Industrial Electronics Components Catalog is free upon request from Allied Electronics, Inc., 7410 Pebble Drive, Ft. Worth, TX 76118; Tel. 800-433-5700 (orders) or 817-595-3500; Web: www.allied.avnet.com.

PERSONAL ROBOTICS: REAL ROBOTS TO CONSTRUCT, PROGRAM, AND EXPLORE THE WORLD

by Richard Raucci

Interest in small robots and robot kits is growing, with science fiction movies grossing millions at the box office (*Star Wars*—anyone?). The incredible advances in microprocessor technology

have provided a real-life counterpart to the fictional robot. Many companies now offer "true" robots geared to electronics hobbyists and students.

This consumer guide helps readers find the robot kit that's right for their skill level and price range. The first section discusses educational-style kits from such companies as Capsela and Lego. The second section covers hobbyist level robots: OWI Elekit robots, the Rug Warrior Pro, and others. The final section focuses in detail on the most sophisticated type—the Pioneer 1 from ActivMedia Robots. The author also includes suggestions for interesting robot projects suited to the robots reviewed.

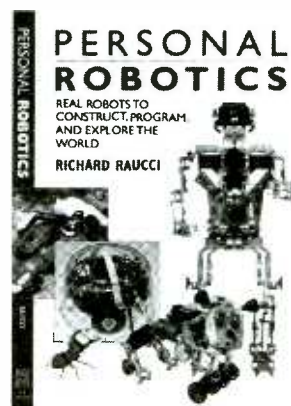

Personal Robotics: Real Robots To Construct, Program, And Explore The World costs \$25 and is published by A K Peters Ltd., 63 South Avenue, Natick, MA 01760-4626; Tel. 508-655-9933; Fax: 508-655-5847; Web: www.akpeters.com.

MAXIMIZING YOUR BUSINESS ONLINE: A 3.5.7 METHOD FOR INTERNET SUCCESS

by Craig Settles

This useful resource provides an Internet business model that any company can use to establish an efficient and successful new Web site or to increase the value of its existing one. Using the author's three-stage process, readers will learn how to assess the Internet's value, develop a

(Continued on page 86)

BooksNow To order books in this magazine or, any book in print. Please call anytime day or night: (800) BOOKS-NOW (266-5766) or (801) 261-1187 ask for ext. 1456 or visit on the web at <http://www.BooksNow.com/popular-electronics.htm>.

Free catalogs are *not* available.

PUMP UP THE VOLUME WITH THIS 200-WATT AUDIOPHILE AMPLIFIER

Build a high-power MOSFET amplifier that can form the basis of a "killer" home-stereo or subwoofer system, musical-instrument amplifier, PA system, or practically any custom audio project.

G. RANDY SLONE

Audiophiles have long recognized that there are significant performance shortcomings inherent in the majority of commercially available, audio power amplifiers. For example, distortion specifications are almost always measured at 1 kHz, but distortion generation in a typical generic amplifier can increase from 12-dB to 18-dB per octave as the frequency rises above 1 kHz. That's the reason why many solid-state power amplifiers sound harsh or gritty in the upper audio frequencies. Manufacturer's distortion specifications are measured using resistive loading. However, real-world speaker systems can be significantly reactive, causing the false activation of protection circuits and the consequential generation of very discernible distortion. Competition (combined with a little avarice) has motivated manufacturers to squeeze every watt possible from commercial amplifier designs, resulting in several other types of performance and reliability compromises.

The *200-Watt Audiophile Amplifier* (designated from here on as the *OPT13* module) represents a no-compromise approach to amplifier design for the serious audio enthusiast. Each module is capable of providing 200 watts rms into typical audio loads with only 0.006% THD @ 1 kHz at maximum output, with THD increasing to only 0.017% at 20 kHz. That exceptional distortion performance is provided by three specific improvements to the conven-

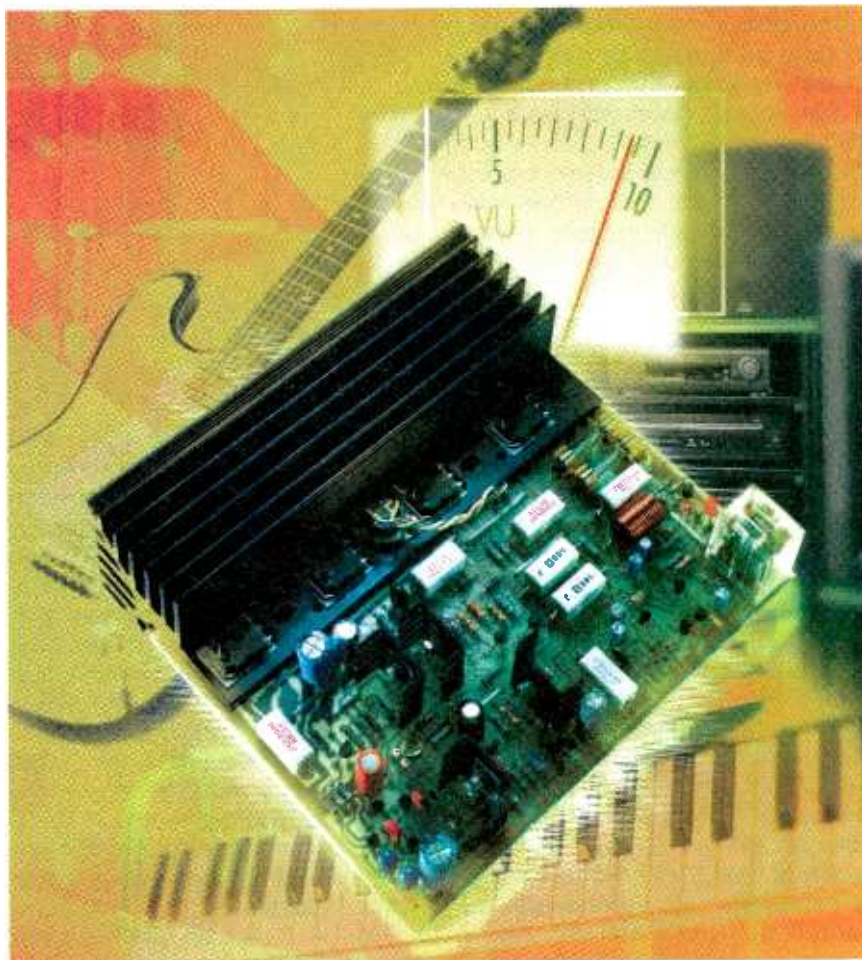

tional topology, as detailed later in this article. The amplifier's frequency response is virtually flat from 5 Hz to 100 kHz, with -1 dB points at approximately 3 Hz and 120 kHz. The amplifier has a signal-to-noise ratio (SNR) of better than -100 dB. Each module incorpo-

rates electronic short-circuit, thermal-overload, and DC-speaker protection, and also features on-delay muting, and a unique 3-way visual status indicator, at a cost per monaural-amplifier module (in kit form) of approximately \$160. Not a bad price for what you get.

Bipolar Junction Transistors Vs. Lateral MOSFETs?

The commercial audio market has been dominated by power amplifiers incorporating bipolar-junction transistor (BJT) output devices for almost four decades. In the plus column, BJTs provide excellent transient response, high transconductance, and low cost. On the down side, they suffer from the disadvantages of a positive temperature coefficient (i.e., increasing leakage current with temperature rise), susceptibility to secondary breakdown, beta droop (i.e., a decrease in beta with a corresponding rise in collector current), extreme sensitivity to exact bias requirements, and junction capacitance problems. In high-current applications, BJTs have traditionally been difficult to protect from secondary breakdown and cross-conduction resulting from stored carriers in the junction capacitances. Some BJT designs are more susceptible to blowing up under adverse loading conditions than others, but even extensive protective circuitry is not always successful in preventing BJT failure under every possible resistive- and reactive-load condition. To make matters worse, most protection circuits can produce false-limiting distortion if the speaker load is more than moderately reactive.

Lateral MOSFETs (L-MOSFETs) boast the distinctiveness of being the only solid-state devices developed and manufactured exclusively for audio-power applications. (Note: These devices should not be confused with D-MOSFET devices, which include the V-MOSFET and HexFET families.) Since all high-current signals flow through the "channel" region of enhancement type L-MOSFETs, cross-conduction and secondary breakdown problems are non-existent. The real-world reliability of L-MOSFET amplifiers is vastly improved over comparable BJT amplifiers, even if the BJT output stages are extensively protected.

L-MOSFETs also possess a "negative" temperature coefficient at high-current levels, eliminating the possibility of thermal runaway or the need for any type of *thermal-tracking* bias circuit. The sensitivity to quiescent bias conditions essential for optimum distortion perfor-

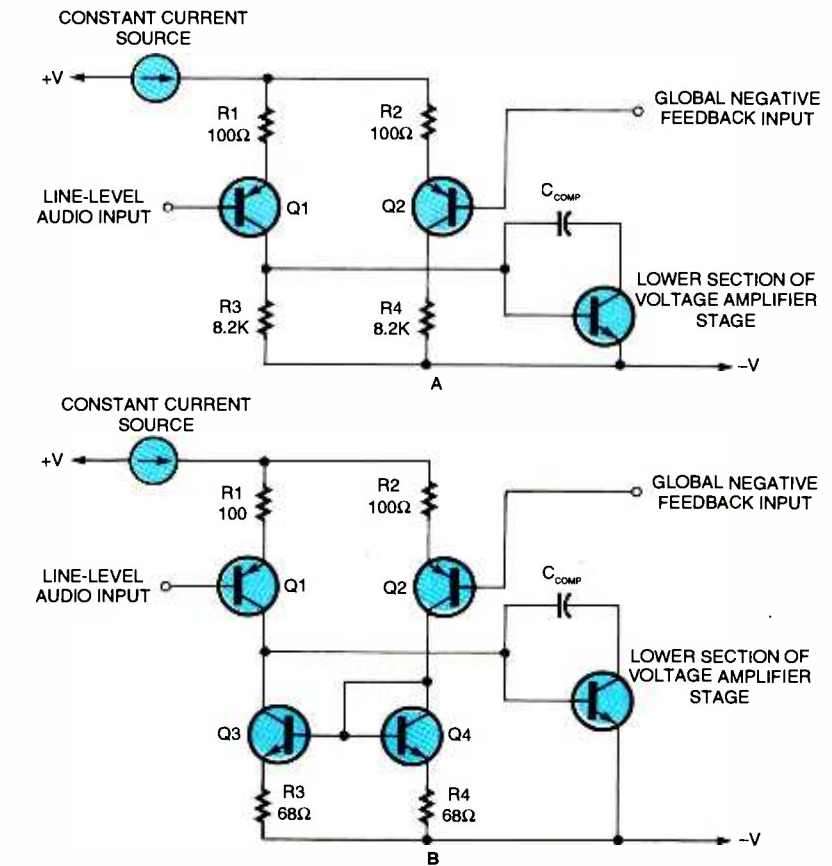

Fig. 1. The drawing in A illustrates a simplified generic input stage like that used in the majority of commercial amplifiers. In B, the differential collector loads have been replaced with a "current mirror," which reduces input stage distortion.

mance is greatly reduced in comparison to BJT output devices, so the initial bias adjustment is much less crucial and long-term performance stability is enhanced. The absence of any gain-loss mechanism at high currents (corresponding to "beta droop" in BJT devices) means the distortion performance of L-MOSFET amplifiers won't deteriorate when driving lower-impedance loads, such as 4- or 2-ohm speaker systems. The only significant disadvantages of L-MOSFETs in comparison to typical power BJTs is their higher cost and lower transconductance.

The OPT13 uses an L-MOSFET output stage in conjunction with three specific improvements to the conventional Lin 3-stage topology. Collectively, the improvements effectively solve the linearity compromise associated with L-MOSFETs and provide tangible improvements in several other areas of operation. Since it appears that the

published documentation on those techniques is somewhat obscure, we'll examine them individually and conclude with a general technical description of the complete amplifier.

A Balanced-Input Stage. It has not been widely published that the input-stage, differential-transistor pair must have a near-perfect collector-current balance for optimum distortion cancellation and maximum gain. That's a matter of transistor physics, requiring the placement of the quiescent operating point in the exact center of the differential pair's opposing transconductance curves. In simple terms, the collector currents of the differential input pair should be equal to within 1% of each other.

Figure 1A shows a simplified, generic input stage like that used in the majority of commercial amplifiers. A constant-current source supplies rail current, while R1 and R2

provide an appropriate level of degenerative feedback to flatten out the transconductance curve (improving linearity). Since R3 and R4 are equal in value, the concept of symmetry is suggested—although it's entirely illusory. Note that the input of the voltage-amplifier stage is directly coupled to the collector of Q1. That offsets the collector-current balance of Q1 and Q2 by a factor of more than 10 to 1, regardless of circuit design. Some designers have improved on that configuration by adjusting the values of R3 and R4 (in some cases, deleting R4 entirely). Unfortunately, that's not an effective technique, because the balance deteriorates with frequency rise and the associated impedance drop of the voltage amplifier stage.

In Fig. 1B, the differential-collector loads have been replaced with a "current mirror," comprised of Q3, Q4, R3, and R4. Current mirrors actively force a current balance between two circuit legs, thereby representing the ideal solution to our need for an accurate and dynamically correcting balance. For best results, Q3 and Q4 should be *beta matched* to within 10% of each other, and degeneration resistors R3 and R4 must be included in the circuit to compensate for the typical V_{BE} variations of Q3 and Q4. Once those conditions are met, the collector currents of Q1 and Q2 should stay well within a 1% balance throughout the audio-frequency range.

Although the primary motivation for using a current mirror is to reduce input-stage distortion, its inclusion offers two additional benefits. The current mirror allows the amplifier's "slew rate" to be increased by more than 100%, while greatly increasing the input stage's "power-supply rejection ratio" (PSRR). The only disadvantage is the cost of the two transistors.

In real-world testing and comparison, the basic current-mirror, differential-input stage arrangement illustrated in Fig. 1B exhibits much-improved linearity over typical generic, cascode, or mirror-image input stage.

Two-Pole Compensation. To take

full advantage of the conventional Lin 3-stage topology, all of the power amplifier's voltage gain should occur in the voltage-amplifier (VA) stage. Consequently, an optimum VA stage incorporates "beta enhancement" (i.e., a Darlington pair) and "active-loading" techniques (i.e., a constant-current source acting as the VA collector load). Figure 2A illustrates a simplified VA stage implementing those features.

Note that C_{COMP} (the compensation capacitor) in Fig. 2A is connected from the amplifier's output

back to its input, a configuration referred to as *dominant-pole compensation*. At frequencies above the first frequency pole, C_{COMP} reduces the voltage gain of the voltage amplifier by 6-dB/octave. In order to achieve a below-unity open-loop gain before excessive phase shifts can occur (causing instability), the first frequency pole of amplifiers using simple dominant pole compensation must be set rather low—usually about 1 kHz or lower. That produces an approximately 24- to 30-dB loss in open-loop gain and proportional global

**Get Ready!
Get Set!
Go!**

Design a board with the EAGLE freeware version, and see how fast you will be productive.

Boards designed under EAGLE are found in patient monitoring equipment, chip cards, electric razors, hearing aids, automobiles and industrial controllers. They are as small as a thumbnail or as large as a PC motherboard. They are developed in one-man businesses or in large industrial companies.

EAGLE is being used in many of the top companies. The crucial reason for selecting EAGLE is not usually the very favorable price, but rather the ease of use. On top of that comes the outstanding level of support, which at CadSoft is always free of charge, and is available without restriction to every customer. These are the real cost killers!

EAGLE 3.5 Light is Freeware!

You can use EAGLE Light for testing and for non-commercial applications without charge. The Freeware Version is restricted to boards: up to half Eurocard format, with a maximum of two signal layers and one schematic sheet. All other features correspond to those of the Professional Version. Download it from our Internet Site or order our free CD.

If you decide in favor of the Commercial Light Version, you also get the reference manual and a license for commercial applications. The Standard Version is suitable for boards in Eurocard format with up to 4 signal layers (max. 99 schematic sheets). The Professional Version has no such limitations.

<http://www.CadSoftUSA.com>

800-858-8355

CadSoft Computer, Inc., 801 S. Federal Highway, Delray Beach, FL 33483
Hotline (561) 274-8355, Fax (561) 274-8218, E-Mail: info@cadsoftusa.com



EAGLE 3.5

Schematic Capture • Board Layout
Autorouter

for Windows 95/NT

and Linux

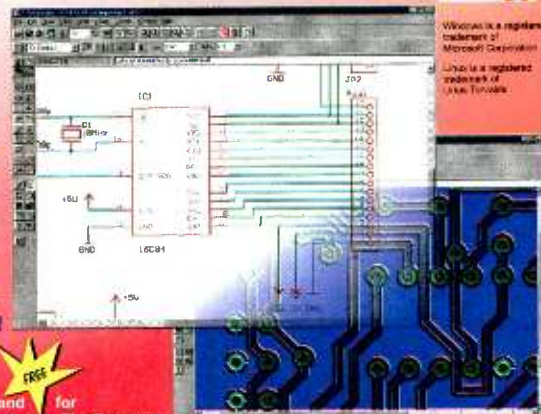

Prices	Light	Standard	Professional
Layout		199\$	399\$
Layout + Schematic		388\$	788\$
Layout + Autorouter		388\$	798\$
Layout + Schematic + Autorouter	49\$	587\$	1197\$

Pay the difference for Upgrades

CIRCLE 173 ON FREE INFORMATION CARD

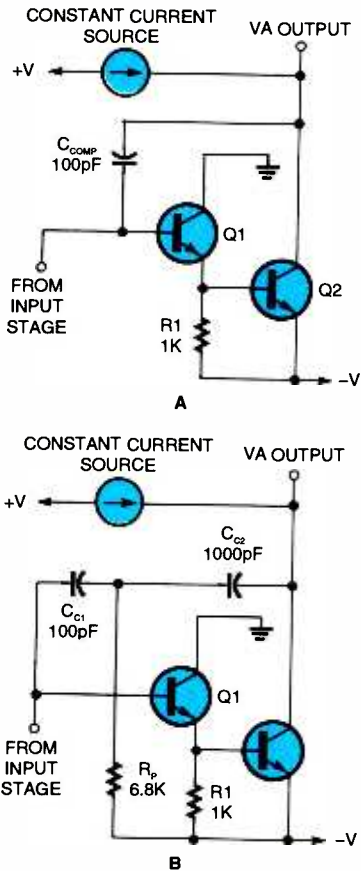

Fig. 2. Shown in A is a simplified voltage-amplifier stage that incorporates "beta enhancement" and "active-loading" techniques. The drawing in B illustrates how simple dominant pole compensation can be modified to "two-pole compensation" by adding capacitor C_{c2} and resistor R_p .

negative feedback by the time the high limit of the audio bandwidth (i.e., 20 kHz) is reached. The bottom-line consequence of that negative feedback loss is an approximate 10-fold increase in harmonic distortion in the upper audio frequencies. Reducing the value of C_{COMP} improves high-frequency distortion performance, but it also results in the loss of stability.

Figure 2B illustrates how simple dominant pole compensation can be modified to "two-pole compensation" by adding capacitor C_{c2} and resistor R_p . In effect, that design behaves like a 2nd-order filter, causing the voltage amplifier's gain to rolloff at the rate of 12-dB per octave instead of 6-dB. Consequently, the first frequency pole can be set at about 10 kHz, while still maintaining the same below-unity roll-off frequency as simple

dominant pole compensation. The outcome of that is an approximate three-fold THD performance improvement over conventional designs at higher frequencies.

A BJT/MOSFET Hybrid Output Stage.

Figure 3A illustrates a simplified source-follower L-MOSFET output stage. That's the enhancement MOSFET equivalent of a BJT-based emitter-follower output stage. The source-follower configuration is, by far, the most commonly used output stage arrangement used in commercial L-MOSFET, audio-power amplifiers, but it suffers the disadvantage of total reliance on global negative feedback to cure the problems associated with the poor inherent linearity of L-MOSFETs. In practice, source-follower, L-MOSFET amplifiers exhibit a distortion performance of approximately 0.03% @ 1 kHz. While that's not bad, it is about one order of magnitude worse than that which can be obtained with a well-designed amplifier that uses a BJT output stage. Hence, there is significant room for improvement.

Figure 3B illustrates a hybrid BJT/MOSFET output stage arranged in a "complementary-feedback" configuration. Note that the MOSFETs have been turned upside

down and reversed in position. Transistors Q1 and Q2 are laid out in a complementary common-emitter configuration, that provides a voltage gain of approximately 5, as determined by the ratios of $R1/R2$ and $R4/R3$. That voltage gain is then converted to 100% linearizing local negative feedback through the emitters of Q1 and Q2 via the speaker output rail. Therefore, the actual voltage gain of the entire output stage remains slightly below unity, but the low transconductance of the L-MOSFET is greatly compensated for.

The Complete Amplifier.

Figure 4 shows the complete schematic diagram of the audio-power amplifier. In that circuit, C1 and C2 (a pair of tantalum units) are used as input coupling capacitors, while R4 establishes the input impedance at 12K, with the requirement that R10 be the same value to minimize any DC offsets on the differential pair (Q1 and Q2). Resistors R2 and R3 are degeneration devices for the Q1 and Q2 differential pair, while components Q4, Q5, R5, and R6 make up the current mirror, as explained previously. Remember, Q4 and Q5 should be beta matched to within 10% of each other. Capacitor C3 attenuates

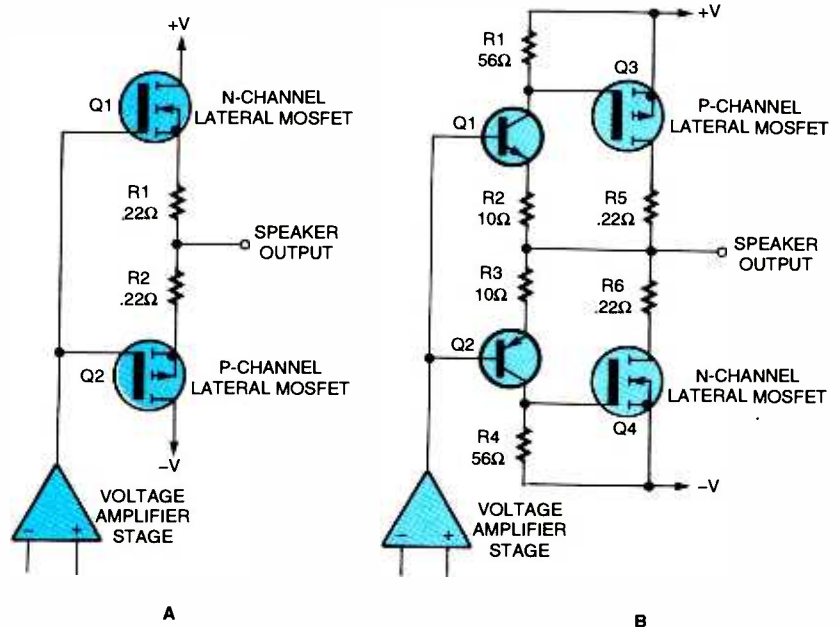

Fig. 3. Illustrated in A is a simplified "source-follower" L-MOSFET output stage (the enhancement MOSFET equivalent of a commonly-used BJT "emitter-follower" output stage). A hybrid BJT/MOSFET output stage arranged in a "complementary-feedback" configuration is shown in B.

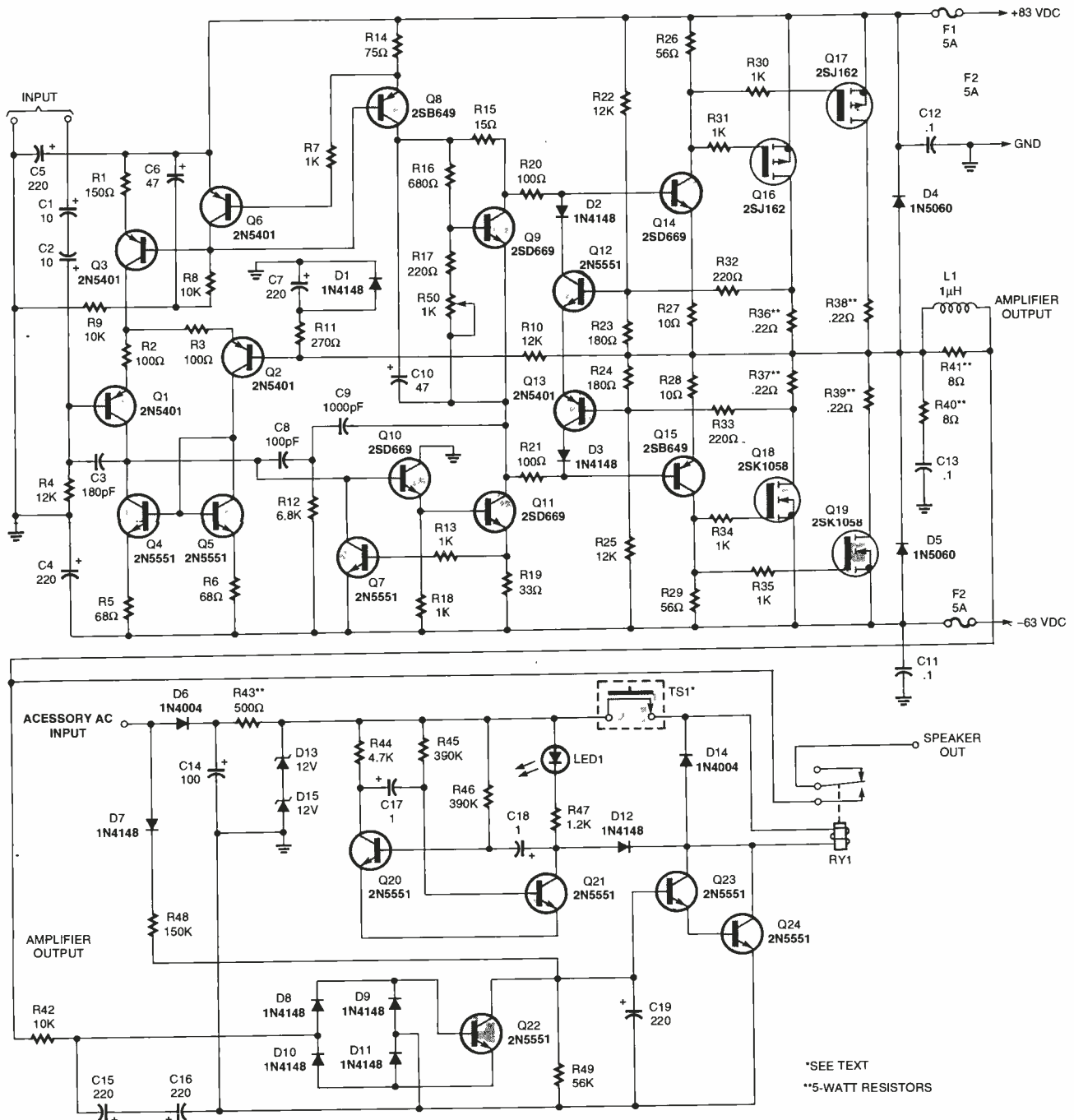

Fig. 4. A complete schematic diagram of the audio-power amplifier (which can drive either 4-ohm or 8-ohm loads) is shown here.

undesirable ultrasonic noise and interference signals that often find their way into input cabling. Capacitors C4 and C5 are decoupling units for the power-supply rails. Their function is to improve PSRR, which is already very high due to the inherent design of the amplifier.

The ratio of R10 and R11 determines the percentage of global negative feedback applied to the

input and sets the AC voltage gain of the amplifier (which also sets the sensitivity). With the values shown, sensitivity is approximately 800 millivolts rms. (If greater sensitivity is desired, the value of R11 can be reduced accordingly.) Capacitor C7 is a blocking capacitor for the global negative-feedback network. It forces the DC feedback to be 100%, thereby maintaining good

DC balance throughout the amplifier circuitry (the typical DC output offset voltage for this amplifier design is approximately 7 millivolts). Diode D1 keeps C7 from being destructively reverse-biased in the event of a high reverse-polarity DC voltage at the amplifier's output.

Components C8, C9, R12, R18, Q10, and Q11 make up the lower section of the beta-enhanced,

two-pole compensated voltage amplifier stage, as we have previously discussed. Components Q7, R13, and R19 provide current-limit protection for Q11 in the event of a short-circuit condition at the amplifier's output.

The quiescent bias circuit required to bring the output stage into precise class-B operation consists of R50, R17, R16, C10, Q9, and R15. That circuit is a variation of the common "amplified-diode" circuit, with a few refinements. Potentiometer R5 is placed in the circuit so that an open condition on the wiper arm (a common failure with trimmer potentiometers) decreases forward

bias rather than dangerously increasing it. Capacitor C10 adds additional stabilization to the bias voltage, while R15 provides significant immunity to changes in the bias voltage as a result of variations in current through Q9. As in the case of any other complementary-feedback, output-stage design, the bias transistor, Q9, should thermally track the temperature of the pre-driver transistors. In the amplifier, Q9 is physically mounted to the same small heatsink as Q14, but that's primarily for ambient-temperature compensation. The pre-driver transistors (Q14 and Q15) become only slightly warm during normal operation.

Components R1, Q3, C6, Q6, R8, R9, R7, R14, and Q8 comprise the two constant-current sources needed for the input and voltage-amplifier stages. Transistor Q6 is the voltage reference for both constant current sources, forcing the voltage drop across R14 to be equal to its own V_{BE} drop (approx. 0.67 volts). Since Q3's base and Q8's base are tied together, the reference voltage at the collector of Q6 forces the voltage drop across R1 to also equal about 0.67 volts. Therefore, due to the resistance of R1 and R14, the tail current for the input differential stage is held to approximately 4.5 milliamps, while

PARTS LIST FOR THE 200-WATT AUDIOPHILE-QUALITY L-MOSFET AMPLIFIER

SEMICONDUCTORS

Q1-Q3, Q6, Q13—2N5401 silicon PNP transistor
 Q4, Q5, Q7, Q12, Q20-Q24—2N5551 silicon NPN transistor
 Q8, Q15—2SB649 silicon PNP transistor
 Q9, Q10, Q11, Q14—2SD669 silicon NPN transistor
 Q16, Q17—2SJ162 P-channel L-MOSFET
 Q18, Q19—2SK1058 N-channel L-MOSFET
 D1-D3, D7-D12—1N4148 general-purpose, switching diode
 D4, D5—1N5060 general-purpose, fast-recovery diode
 D6, D14—1N4004 1-amp, 400-PIV, silicon rectifier diode
 D13, D15—12 volt, 1-watt Zener diode
 LED1—Light-emitting diode (red)

RESISTORS

(All fixed resistors are 1/2-watt, 5% units, unless otherwise noted.)

R1—150-ohm
 R2, R3, R20, R21—100-ohm
 R4, R10, R22, R25—12,000-ohm
 R5, R6—68-ohm
 R7, R13, R18, R30, R31, R34, R35—1000-ohm
 R8, R9, R42—10,000-ohm
 R11—270-ohm
 R12—6800-ohm
 R14—75-ohm
 R15—15-ohm
 R16—680-ohm
 R17, R32, R33—220-ohm
 R19—33-ohm

R23, R24—180-ohm
 R26, R29—56-ohm
 R27, R28—10-ohm
 R36-R39—0.22-ohm, 5-watt, 10%, wirewound, power
 R40, R41—8-ohm, 5-watt, 10%, wirewound, power
 R43—500-ohm, 5-watt, 10%, wirewound, power
 R44—4700-ohm
 R45, R46—390,000-ohm
 R47—1200-ohm
 R48—150,000-ohm
 R49—56,000-ohm
 R50—1000-ohm, horizontal-mount trimmer potentiometer

CAPACITORS

C1, C2—10- μ F, 35-WVDC, tantalum
 C3—180-pF, ceramic monolithic
 C4, C5—220- μ F, 100-WVDC, aluminum electrolytic
 C6—47- μ F, 100-WVDC, aluminum electrolytic
 C7, C15, C16, C19—220- μ F, 35-WVDC, aluminum electrolytic
 C8—100-pF, ceramic monolithic
 C9—1000-pF, ceramic monolithic
 C10—47- μ F, 35-WVDC, aluminum electrolytic
 C11-C13—0.1- μ F, 250-WVDC, Mylar
 C14—100- μ F, 100-WVDC, aluminum electrolytic
 C17, C18—1- μ F, 35-WVDC, aluminum electrolytic

ADDITIONAL PARTS AND MATERIALS

TS1—75°C thermal switch
 L1—1- μ H, air-core inductor (see text)
 RY1—DPDT relay, 24-volt DC coil (Jameco 139862)
 F1, F2—5-amp AGC fuse
 Printed-circuit materials, fuse clips, large heatsink, TO-220 transistor insulators, TO-3P transistor insulators, wire solder hardware, etc.

NOTE: The following items are available from Seal Electronics, PO Box 268, Weeksbury, KY 41667; Tel. 606-452-4135: A complete kit of parts for one OPTI3 module, including PC board, heatsinks, and all components for \$162, plus \$10 S&H (Canadian residents add \$17 S&H). Kentucky residents please add 6% local sales tax; an assembled and tested OPTI3 module for \$187, plus \$10 S&H (Canadian residents add \$17 S&H). Kentucky residents please add 6% local sales tax; an etched and drilled PC board for one OPTI3 module for \$32, plus \$4 S&H (Canadian residents add \$7 S&H). Kentucky residents please add 6% local sales tax.

Seal Electronics offers a complete line of power transformers, power-supply components, customized heatsinks, L-MOSFETs, and other components for the OPTI3 modular systems. Please call for details.

the VA's current source is held to approximately 9 milliamps.

The amplifier's output overload and short-circuit protection is provided by a "single-slope" protection circuit consisting of D2, D3, Q12, Q13, R22–R25, R32, and R33. That circuit monitors the instantaneous voltage across R36 and R37, while simultaneously summing that voltage with the difference voltage between the output and the power-supply rails. That produces a "protection locus" in the form of a slope line that allows high output currents to flow through the speaker load if the load voltage is high, but restricts load current if the voltage across the load is relatively low. Consequently, if a short-circuit condition occurs at the output (creating a very low-voltage condition across the load), the maximum output current is limited below the point of component destruction or blowing of the rail fuses. Such a protection circuit is greatly superior to the common Zener-diode, gate-clamp, protection circuits incorporated into virtually all commercial L-MOSFET amplifiers.

Many discerning audiophiles have totally rejected short-circuit protection because they fear it may cause distortion when the amplifier is called upon to drive moderately reactive loads. That's true for many "multi-slope" BJT protection circuits. However, in the case of L-MOSFETs, the current limit can be set much higher at lower load voltages (since it is not necessary to protect L-MOSFETs from secondary breakdown), effectively eliminating the problem. The OPT13 amplifier modules can drive either 4-ohm or 8-ohm loads paralleled with a 2- μ F capacitor at full power without any protection-circuit activation. As expected, neither stability or protection activation is affected by extreme values of inductive reactance (capacitive reactance is typically worst-case for most solid-state power amplifiers).

Resistors R20 and R21 raise the output impedance of the voltage amplifier so that the signal delivered to the pre-driver transistors (Q14 and Q15) can be more effectively shorted to the output rail by Q12 and Q13 if a short-circuit or

overload condition is detected at the output. Transistor Q7 also limits the current through Q11 to approximately 20 milliamps in this situation.

L-MOSFETs are voltage devices, meaning that they function on the basis of gate voltage without drawing any meaningful continuous level of gate current. However, their gate capacitance is relatively high compared to BJTs. For that reason, "gate-isolation resistors" should be incorporated into paralleled MOSFET-output stages to ensure good high-frequency stability. That's the function of R30, R31, R34, and R35.

Drain resistors R36 and R37 are used as current sensors for the overload-protection circuitry. Resistors R38 and R39 are installed to maintain the current-balance symmetry of the paralleled output devices.

Diodes D4 and D5 are often called "catching diodes." Their purpose is to absorb transients generated by fast current changes into an inductive load (*i.e.*, inductive "kickback" spikes). They also protect the amplifier from damage if you happen to accidentally reverse the power-supply polarities—something we are all guilty of sooner or later.

Components R40 and C13 make up what is commonly referred to as a "Zobel network" (sometimes called a "Boucherot Cell"). Its purpose is to protect the amplifier from instability resulting from inductive loads. At continuous frequencies of 20 kHz and above, it's normal for R40 to become very hot, due to the lower capacitive reactance of C13 and the subsequent increase of current through the Zobel network. The output inductor, L1, provides stability into capacitive loads by providing an isolating effect against shunt capacitance without imposing any significant impedance to audio frequencies. Resistor R42 provides damping to reduce the overshoot and ringing produced by L1 in combination with speaker-load capacitance. Capacitor C11 and C12 are used for high-frequency decoupling, primarily included in the circuit to reduce high-frequency noise that may be injected through the power-supply rails.

Additional Protection Circuits.

Additional protection circuits—including turn-on muting, DC speaker protection, and thermal shutdown—are incorporated into the OPT13 amplifier modules. It is best to provide operational power to the speaker-protection circuits from an external source, thereby eliminating any possibility of circuit malfunction if one of the rail fuses blow. In that case, AC operational power is obtained from either half of the power transformer secondary, which can range from 30 to 45 volts AC. The operational AC voltage is rectified by D6 and filtered by C14, while R43, D13, and D15 form a simple Zener regulated 24-volt DC power supply.

Components R44–R47, LED1, C17, C18, Q20, and Q21 make up an astable multivibrator. When operational power is first applied (*i.e.*, when the amplifier is turned on), the multivibrator causes LED1 to flash at about a 1-second rate. At the same time, C19 begins to charge from the 60-Hz rectified pulses provided by D7 through R48. It takes approximately 3 seconds for C19 to charge to a high enough voltage to turn on the Darlington pair consisting of Q23 and Q24. When that occurs, the muting relay (RY1) is energized and the collector of Q21 is pulled low through D12. That action inhibits the astable multivibrator and forces LED1 to light continuously. When RY1 is energized, the output of the amplifier is applied directly to the speaker output connection. The 3-second delay eliminates any irritating and potentially destructive "turn-on" thumps from being applied to the speaker system. The continuous illumination of LED1 provides a visual indication that operation is normal and the speaker system is connected to the amplifier.

Note that the amplifier output is also connected to R42. If any significant DC level appears at the amplifier output, C15 and C16 charges to that level through R42. If the DC level is above approximately 1.2 volts, the diode bridge consisting of D8 through D11 steers the DC potential so that it saturates Q22, thereby discharging C19. When C19 discharges, Q23 and

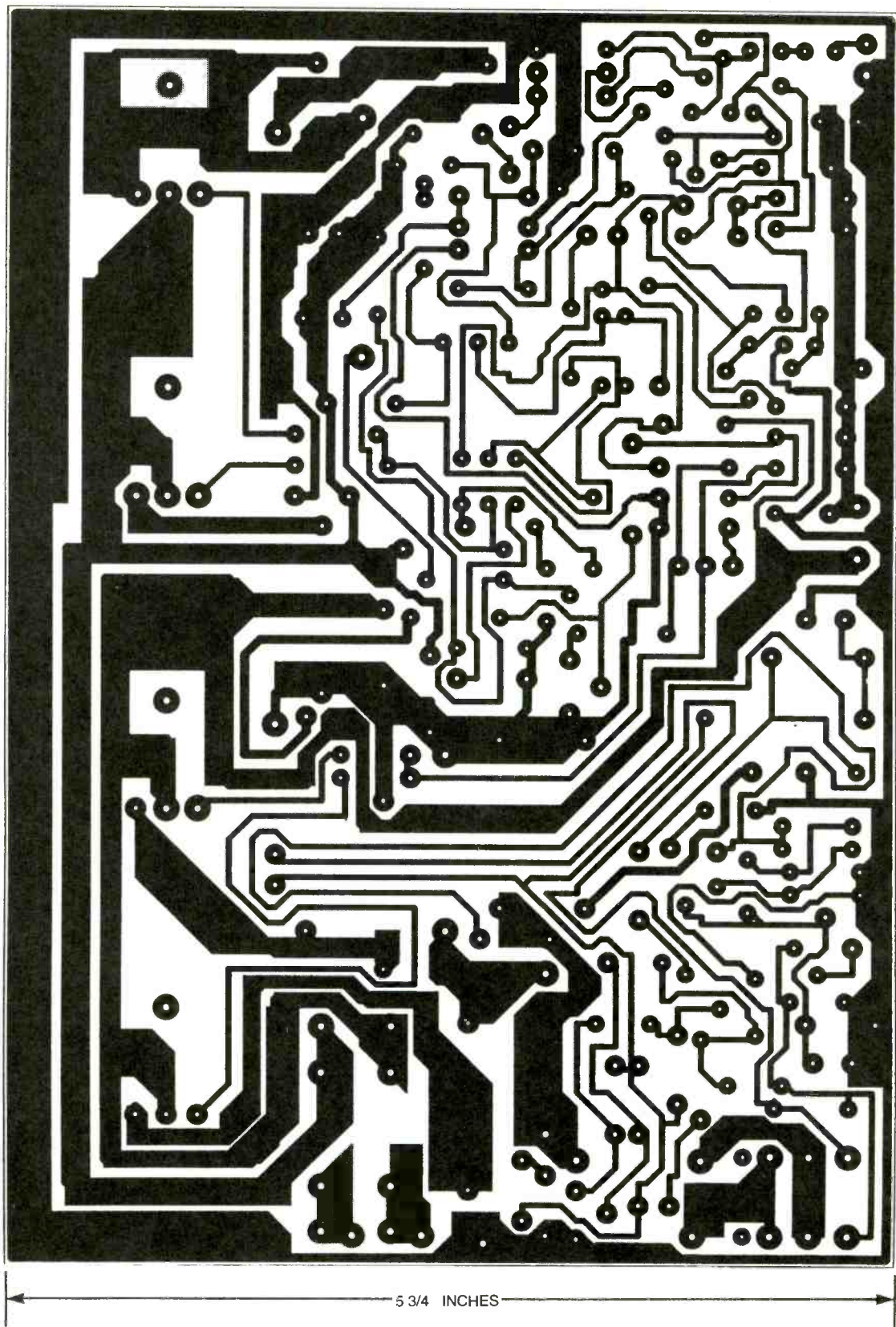

Fig. 5. The audio-power amplifier was assembled on a fairly large printed-circuit board, measuring 8 1/8 x 5 3/4 inches. A full-size template of that printed-circuit pattern is shown here.

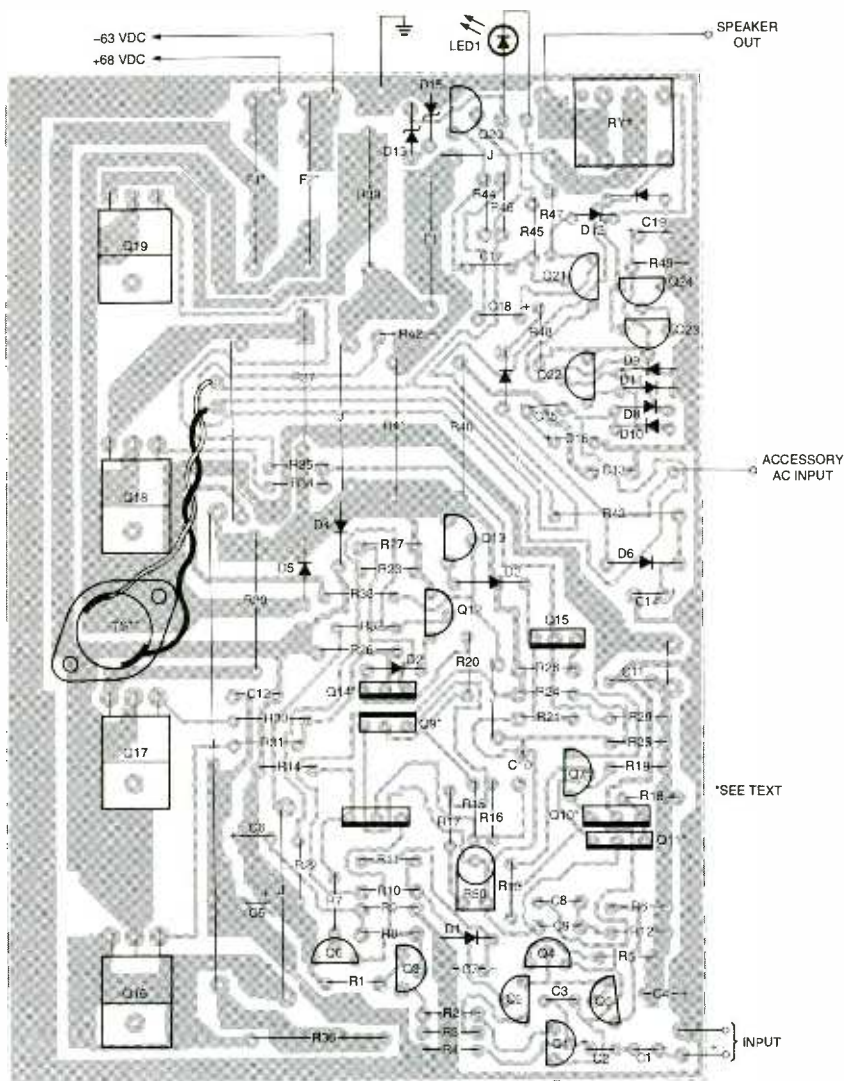

Fig. 6. Assemble the amplifier's printed-circuit board guided by this parts-placement diagram. Note that the layout contains seven jumper connections, which should be installed first, allowing them to serve as a point of reference for the installation of the remainder of the components.

Q24 go into cutoff and RY1 de-energizes, disconnecting the amplifier output from the speaker system. In that way, the speaker system is continuously protected from any destructive DC potentials originating in the amplifier circuitry. Also, at

the same time RY1 de-energizes, the astable multivibrator is once again activated, causing LED1 to begin blinking and providing a visual indication that a DC fault has occurred. Diode D14 is connected in parallel with RY1's coil to suppress

any inductive kickback spikes that may possibly occur when the relay is disengaged.

A 75°C thermal switch (TS1) is mounted to the amplifier's heat-sink. If the heatsink temperature rises above the TS1 specification temperature, its contacts open, de-energizing RY1 and disconnecting the speaker load from the amplifier. Once the speaker load is disconnected, the heatsink should begin to cool. After the heatsink temperature falls below the typical 2-3 degree hysteresis of the thermal switch, TS1's contacts close, restoring the circuit to normal operation. When TS1's contacts open, the Darlington (formed by Q23 and Q24) loses its collector load through RY1. The subsequent rise in collector impedance of the Darlington results in a dramatic increase in the oscillating speed of the multivibrator, causing LED1 to begin blinking at an approximate 6-Hz rate. That rapid blinking action is a visual indication that a thermal overload has occurred. The indicator (LED1) can be remotely located to a front panel if desired.

Amplifier Construction. As with most audio-power amplifiers, the construction of the OPT13 amplifier module is relatively easy in comparison to many electronic projects, due to the use of larger components and wider printed-circuit track widths. A double-sided printed-circuit board is not required and component spacing is not critical. The author's unit was assembled on a fairly large printed-circuit board, measuring 8 1/16 x 3 5/16 inches. A full-size template of that printed-circuit pattern is shown in Fig. 5. That pattern can be lifted from the page and used to etch your own printed-circuit board, or you can purchase the PC board or a complete kit of parts (which includes the board) from the supplier referenced in the Parts List.

Regardless of the route that you decide to take, once you've obtained the board and all of the components listed in the Parts List, construction can begin. Assemble the amplifier's printed-circuit board guided by the parts-placement diagram shown in Fig. 6. Note that

TABLE 1—ESTIMATED POWER OUTPUT VS. POWER TRANSFORMER SIZING

SECONDARY VOLTAGE		APPROX. VA RATING	AMPLIFIER OUTPUT POWER (RMS)	
E + I	Toroidal		4-ohm	8-ohm
60 VCT	30 + 30	300 VA	120 watts	80 watts
70 VCT	35 + 35	400 VA	170 watts	115 watts
80 VCT	40 + 40	500 VA	200 watts	150 watts
90 VCT	45 + 45	625 VA	200 watts	200 watts

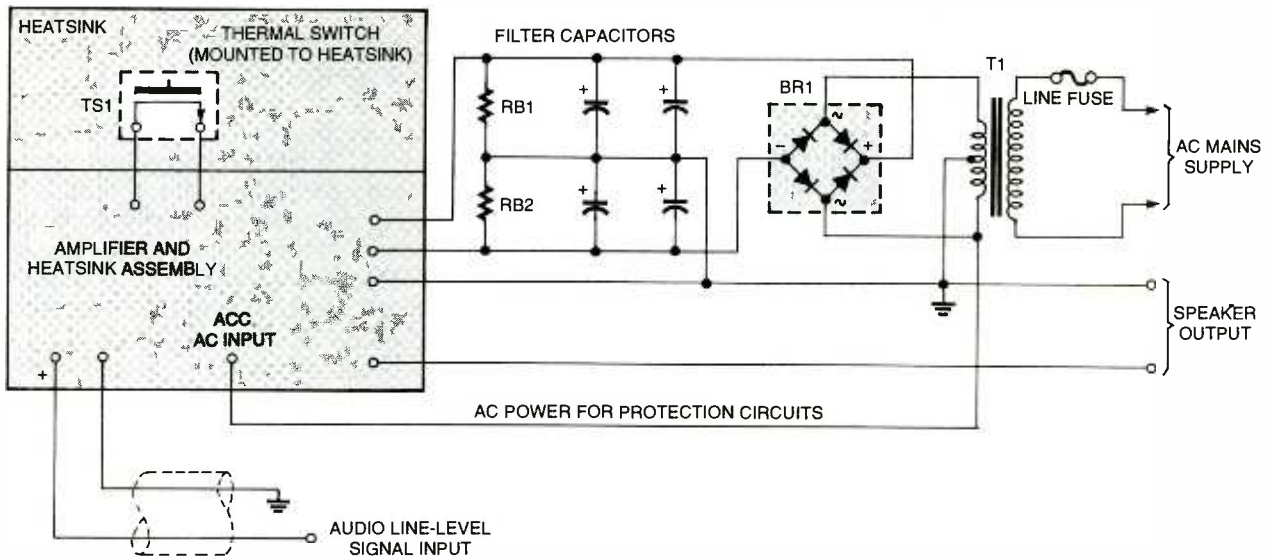

Fig. 7. This illustration shows how a typical dual-polarity power supply is linked to the amplifier circuit.

the board layout contains seven jumper connections. The seven-jumper connections can be made using 18 AWG solid-core insulated wire. All of the 5-watt power resistors (R36–R39, R40, R41, and R43) should be mounted slightly elevated above the board surface to provide better air circulation and keep the resistors from discoloring the board.

Four small heatsinks are used in conjunction with six of the medium-power transistors. Transistors Q9 and Q14 are mounted back-to-back onto one heatsink, providing the necessary temperature tracking of the pre-driver transistors by the bias circuit. Likewise, Q10 and Q11 are mounted to a single heatsink. Transistors Q8 and Q15 are each mounted to individual heatsinks. Insulators must be used in mounting all of those transistors. The small heatsink bases can be mounted flush to the PC board surface since they barely become warm during normal operation.

The thermal switch (TS1) is mounted to the large heatsink **before** the heatsink is mounted to the PC board, because the mounting holes for the thermal switch won't be accessible afterwards. A single mounting bolt (extending through the transistor, heatsink, and PC board) is used to secure each MOSFET in place. In that way, the heatsink is secured to the PC board via the same mounting bolts that

are used to hold MOSFETs in place. The specified L-MOSFETs are not susceptible to damage from static discharge, so there are no special handling precautions that need to be taken during installation.

Inductor L1 is an air-core unit that is formed by tightly winding 20 turns of 18 AWG insulated "magnet wire" around a 1/2-inch wooden dowel. After winding, the coil can be coated with epoxy to hold its shape (if needed).

The remaining construction is very straightforward. As in any electronics construction project, special care should be exercised to insure that all polarized components (i.e., electrolytic capacitors, diodes, and other semiconductors) are properly oriented. Take special care not to overheat the semiconductor components when soldering. Double-check the completed amplifier for defects in component placement and orientation, and other construction errors before applying operational power.

Options. If it is not desirable to use the specified heatsink, any type of heatsink rated for 0.358C/watt can be substituted, or a smaller heatsink can be used if the amplifier is appropriately derated in power output capability. If the MOSFETs must be remotely located to a heatsink surface, it is important to keep the wiring to the gate leads

at a minimum.

Due to the design of the protection locus, the standard amplifier will deliver approximately 110 watts rms into a 2-ohm load. Two-ohm speaker loads in conjunction with any high-quality amplifier are not recommended, but if you wish to do so on a regular basis, resistors R23 and R24 can be reduced to 150 ohms. That modifies the protection locus so that maximum power and headroom can be achieved with 2-ohm loads.

Amplifier Connections and Adjustment.

Figure 7 illustrates a typical raw dual-polarity power supply like those commonly used to provide operating power to audio-power amplifiers. Transformer T1 should be a "shielded" or "toroidal" type, with its ratings approximated based on Table 1. Note that the secondary voltage ratings of typical laminated transformers (commonly called "E11" transformers) are almost always specified in terms of center-tapped voltage (VCT), whereas toroidal transformers are specified based on two separate secondary windings. For example, a 70-VCT E11 transformer is the equivalent of a 35 1 35 toroidal transformer.

For applications requiring approximately 100 watts rms or less, only two 8200–10,000-mF filter capacitors are needed (one for each power

(Continued on page 85)

Step Into The Spotlight With The

Guitar Distortion Pedal

JUAN CARLOS MORALES

Many musicians use special effects of one type or another to augment their musical performance. Perhaps the most popular performance enhancer for guitarists is distortion. Musicians have been injecting distortion in their musical compositions for decades. In fact, it's a good bet that every new multi-effects processor to reach the market will include several memory programs dedicated to distortion effects. Your special-effects setup needn't be all that elaborate.

In this article, we'll describe how to build a musical-distortion generator—dubbed the *Guitar Distortion Pedal*—that features individual bass and treble controls. On top of that, this inexpensive and easy-to-build project can be assembled from “off-the-rack” components that can be picked up at your favorite electronics distributor.

Circuit Description. A functional block diagram of the Guitar Distortion Pedal, which is comprised of a variable-gain preamplifier and an active tone-control circuit, is shown in Fig. 1. Each of the unit's two stages are built around half of an LF353 dual JFET-input, op-amp.

A schematic diagram of the Guitar Distortion Pedal is shown in Fig. 2. The audio source is fed to the circuit through jack J1. From the jack, the source signal is fed through C1 (which is used to strip away any DC level that might be riding the input signal) and R1, and then applied to the inverting input of op-amp IC1-a. The voltage gain of IC1-a is determined by resistors

This inexpensive and easy-to-build, musical, special-effects project lets you add new dimensions to all your future guitar performances



R1, R2, and potentiometer R3, which controls the amount of distortion produced. That way, the gain can be made variable over the range of 1 to 51 to produce a great variety of distortion settings. Diodes D1 and D2 help to limit the gain to improve sustain.

Capacitor C2 provides a frequency-response rolloff at the upper end of the guitar's audio spectrum to limit noise. The two most frequent problems encountered with electric guitars are noise and hum, especially in low-priced

models. The hum is an inherent problem in single-coil pickups. Some high-quality pickups are designed to eliminate interference hum. Obviously, noise/hum limiters are incorporated into only high-priced or custom guitars. However, if your guitar exhibits a high level of noise and hum, the value of capacitor C2 (82 pF) can be increased to 150 pF or more. But, be aware that doing so will result in a signal with the highs partially rejected at higher distortion settings.

From the output of IC1-a, the signal is fed to an active tone-control circuit, comprised of R4-R10 and C3-C5. Potentiometers R5 and R9 set the bass and treble levels, respectively. The output level is set by R14. The final signal is coupled to output jack J2 via C6 and R11. The electrolytic capacitor blocks any DC offset appearing at the output of IC1-b. Switch S2 connects the audio input directly to the output, thereby bypassing the distortion circuit so that normal, clean audio can be heard.

Op-amps are normally powered

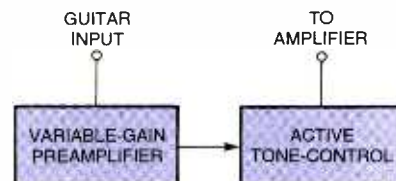

Fig. 1. This functional block diagram of the *Guitar Distortion Pedal* reveals that it is comprised of pair of sub-assemblies—a variable-gain preamplifier and an active tone-control circuit—each built around half of an LF353 dual JFET-input, op-amp.

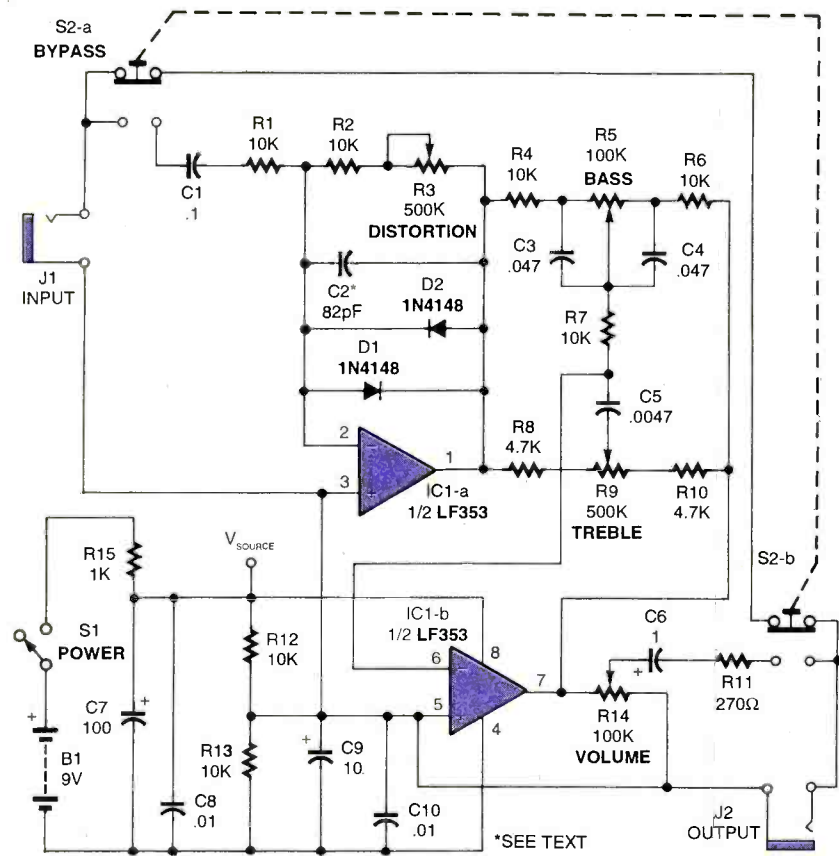

Fig. 2. Shown here is a schematic diagram of the Guitar Distortion Pedal, which also features a bypass switch, along with independent bass and treble controls.

by a bipolar supply. To ensure proper operation using a single-ended power supply, R12 and R13 are used to simulate a null condition equal to half the supply voltage, which is applied to the non-inverting inputs of IC1-a and IC1-b. Decoupling of the power supply is handled by capacitors C7 and C8.

The circuit is designed to be powered from a 9-volt battery: AC adapters are not recommended as a power source because they can introduce noise and hum to the output signal.

Construction. The Guitar Distortion Pedal was assembled on a printed-circuit board, measuring 3 1/2 by 2 inches. A full-scale template of the author's printed-circuit foil pattern is shown in Fig. 3. That pattern can be lifted or copied from the page and used to etch your own printed-circuit board. Once you've etched the board and obtained all of the parts listed in the Parts List, construction can begin.

Assemble the circuit's printed-circuit board guided by the parts-placement diagram shown in Fig. 4. Begin construction by installing all of the resistors, excluding the potentiometers. Follow up by installing the diodes and capaci-

tors, making sure that all of the electrolytic capacitors and the diodes are installed with the proper polarity. Next install a socket in the position where IC1 is indicated. Soldering the IC helps to prevent damage to the IC due to excessive heat (normally caused by sustained lead contact with the soldering iron). **Note:** All components for this project, except for the potentiometers, the jacks, and the switches, mount to the printed-circuit board.

Once the board-mounted components have been soldered in place, do a quick check of the board, looking for and correcting any construction errors (such as misoriented or misplaced components, cold solder joints, solder bridges, etc.) as they are encountered. If no errors are found or those that were discovered have been corrected, it's time to concentrate our attention on the off-board mounted components.

Begin this phase of construction by connecting short lengths of hook-up wire to the board for all of the off-board components, except R3, making sure that all wiring to the off-board components is long enough to reach from the board to the device's off-board mounting position. To prevent hum pick up, it's strongly recommended that potentiometer R3 be connected to the board through a length of two-conductor, shielded, microphone cable, as outlined in Fig. 5.

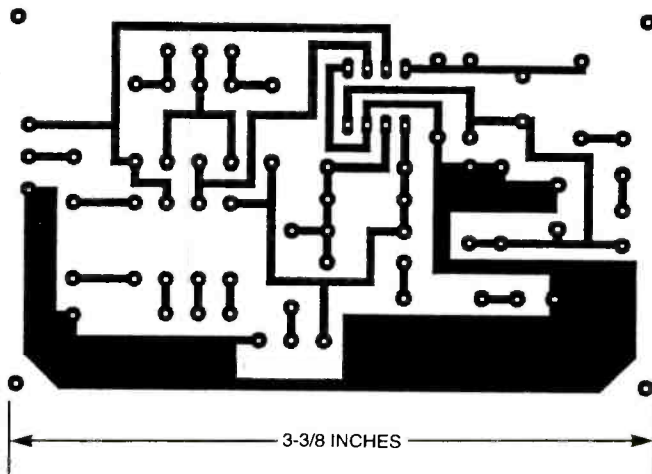

Fig. 3. This full-scale template of the Guitar Distortion Pedal's printed-circuit foil, measuring 3 1/2 by 2 inches, can be lifted or copied from the page and used to etch your printed-circuit board.

Viewing R3 as shown in Fig. 5, connect the center and right terminals of the potentiometer together and solder them to one of the two inner conductors of the shielded microphone cable. Then solder the remaining conductor to the free (left) terminal of R3. Solder the shield of the microphone cable to the metal case of R3, taking precautions not to damage the potentiometer or the cable from too much heat.

Continue by connecting the other end of the microphone cable

PARTS LIST FOR THE GUITAR DISTORTION PEDAL

SEMICONDUCTORS

IC1—LF353 dual JFET-input op-amp, integrated circuit

D1, D2—1N4148 general-purpose, low-power, switching diode

RESISTORS

(All resistors are 1/4-watt, 5% units, unless otherwise noted.)

R1, R2, R4, R6, R7, R12, R13—10,000-ohm

R3, R9—500,000-ohm, panel-mount potentiometer

R5, R14—100,000-ohm, panel-mount potentiometer

R8, R10—4700-ohm

R11—270-ohm

R15—1000-ohm

CAPACITORS

C1—0.1- μ F, polyester

C2—82-pF, ceramic-disc (see text)

C3, C4—0.047- μ F, polyester

C5—0.0047- μ F, polyester

C6—1- μ F, 50-WVDC, electrolytic

C7—100- μ F, 16-WVDC, electrolytic

C8, C10—0.01- μ F, ceramic disc

C9—10- μ F, 50 volts, electrolytic

ADDITIONAL PARTS AND MATERIALS

J1, J2—Monophonic, panel-mount, phone jack

S1—SPST switch

S2—DPDT pushbutton switch

B1—9-volt battery

Printed-circuit materials, 9-volt-battery connector, IC socket, two-conductor shielded microphone cable, case, solder, hardware, cable, knobs, cap for pushbutton switch, etc.

Electronics CD ROMs

Want to improve your design skills?

Then you should consider our range of CD ROMs by best-selling author Mike Tooley.

Electronic Circuits and Components provides a sound introduction to the principles and applications of the most common types of electronic components and how they are used to form complete circuits. Sections on the disc include: fundamental electronic theory, active components, passive components, analog circuits and digital circuits. Includes circuit s and assignments for Electronics Workbench.

The Parts Gallery has been designed to overcome the problem of component and symbol recognition. The CD ROM will help students recognize common electronic components and their corresponding symbols in circuit diagrams. Quizzes are included. The Parts Gallery is free with Electronic Circuits and Components.

Digital Electronics details the principles and practice of digital electronics, including logic gates, combinational and sequential logic circuits, clocks, counters, shift registers, and displays. The CD ROM also provides an introduction to microprocessor-based systems. Includes circuit s and assignments for Electronics Workbench.

Analog Electronics is a complete learning resource for this most difficult subject. The CD ROM includes the usual wealth of virtual laboratories as well as an electronic circuit simulator with over 50 pre-designed analog circuits, which gives you the ultimate learning tool. The CD ROM provides comprehensive coverage of analog fundamentals, transistor circuit design, op-amps, filters, oscillators, and other analog systems.

"...hammers home the concepts in a way that no textbook ever could." Electronics Australia

Interested in programming PIC micros?

We have the perfect solution:

Our PICutor CD ROM can teach you how to write assembly language programs for the PIC series of microcontrollers. The CD ROM's 39 tutorial sections will guide you from basic PIC architecture, commands, and programming techniques up to advanced concepts such as watchdog timers, interrupts, sleep modes, and EEPROM data memory use. Over 80 exercises and challenges are provided to test your understanding, and the unique Virtual PIC allows you to write and test programs on -screen.

The complementary development kit includes a reprogrammable PIC16C84, which you can program via your printer port. The institution version (designed for use in schools, colleges and industry) includes a quad 7-segment LED display and alphanumeric LCD display. The development kit provides an excellent platform for both learning PIC programming and for further project/development work. Assembler and send (via printer port) software is included on the CD ROM.

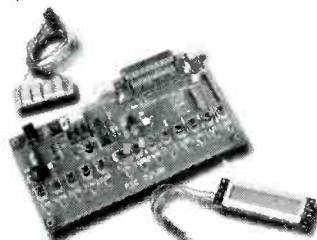

development board (institution version)

Prices and Versions

Institution versions are suitable for use in schools, colleges and industry. Student versions are for student/home use.

	student version	institution version
Electronic Circuits & Components	\$56	\$159
Digital Electronics	\$75	\$189
Analog Electronics	\$75	\$189
PICutor (CD and development board)	\$179	\$350

Shipping costs to Canada an additional \$5. Overseas orders please contact CLAGGK Inc. for shipping costs.

see <http://www.MatrixMultimedia.co.uk> for full specs and demos

Please circle the products you would like to buy on the table above right, calculate the total cost, fill in the form below and send it to us. Please allow 4 - 6 weeks for delivery.

Name: _____
 Address: _____
 Zip: _____ Telephone: _____
 I have enclosed my check for \$ _____
 Please charge my credit card for \$ _____ Signature: _____
 Note that the delivery address and the address at which the card is registered must be the same. Number: _____
 Card type: _____ Expire date: _____
 Mastercard, Visa, or Discover only

Order Form



CL02

Claggk Inc., PO Box 4099, Farmingdale, NY 11735-0792
 Tel: 516-293-3751 email claggk@poptronix.com

produced by
 matrix multimedia

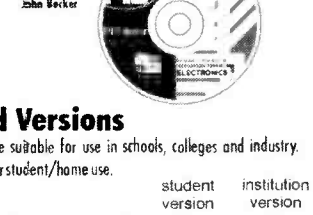
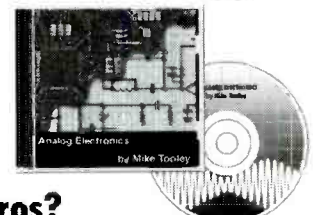
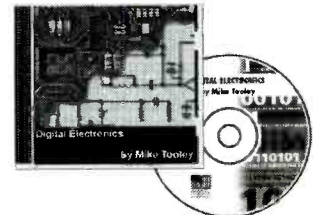
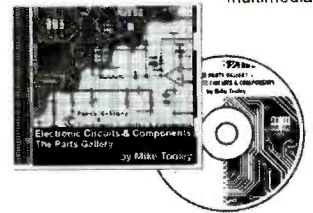

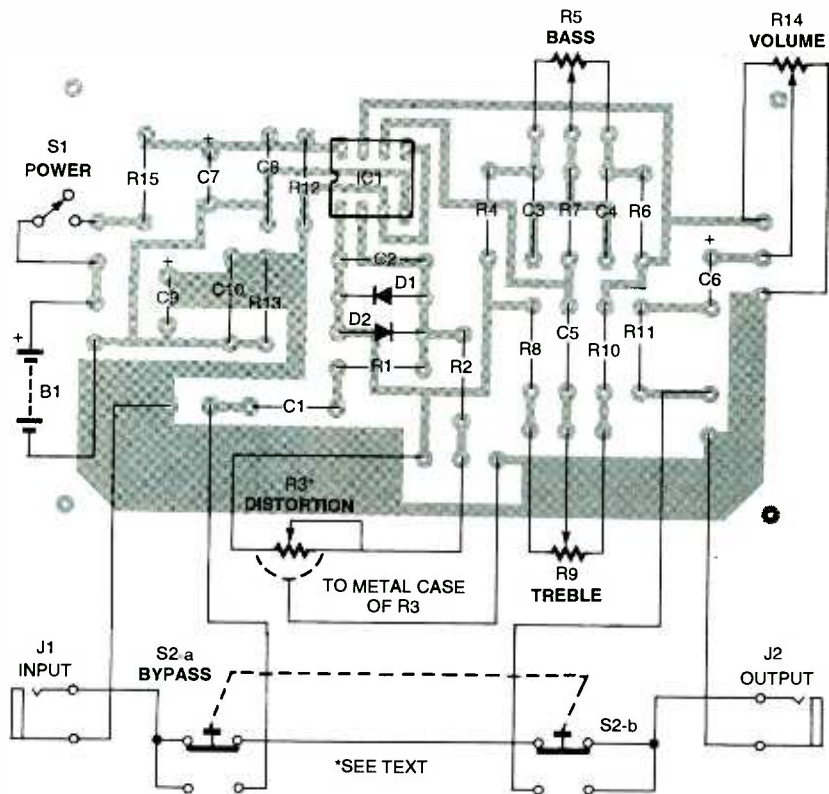

Fig. 4. Once you've etched the board and obtained all of the parts listed in the Parts List, assemble the circuit's printed-circuit board guided by this parts-placement diagram. Once the board-mounted components have been soldered in place, do a quick check of the board, looking for and correcting any construction errors (such as misoriented or misplaced components, cold solder joints, solder bridges, etc.) as they are encountered.

to the board as follows: Solder the end of the conductor that goes to the left terminal of R3 to the pad marked "A" on the PC board. Solder the end of the conductor that goes to the center and right terminals of R3 to the pad marked "B." Solder the shield to the pad marked "S" on the PC board.

Like the potentiometers, J1 and J2 (the input and output jacks) and switches S1 and S2 are panel mounted. Be sure that the leads (especially the cable from input jack J1) are kept as short as possible to minimize hum pickup. In the prototype, S1, J1, and J2 were mounted to the side of the cabinet, while S2 (a double -pole, single-throw switch) was mounted on the top of the enclosure to allow the switch to be foot operated.

After all the off-board components have been wired into the circuit and the circuit has been carefully checked for construction errors—i.e., solder bridges, loose connections, and improperly installed components—it's time to

think about an enclosure in which to house the unit. While a metal cabinet is preferred for its shielding properties, any other kind will work, as long as everything fits inside.

The author's unit was housed in a plastic enclosure. Once you've selected a suitable housing, ready the enclosure by drilling holes in the unit to accommodate the panel-mounted components—potentiometers, switches, jacks, etc. After the enclosure has been prepared, loosely mount the off-board components to the housing. Then connect the wires from the board to the off-board components, as indicated in the parts-placement diagram. The potentiometers were mounted to the top panel of the project's enclosure.

Once that's complete, install IC1 in its socket and attach a 9-volt battery to the battery connector. With that out of the way, we're ready to tackle the next phase of construction.

Operation. At this juncture, it's time

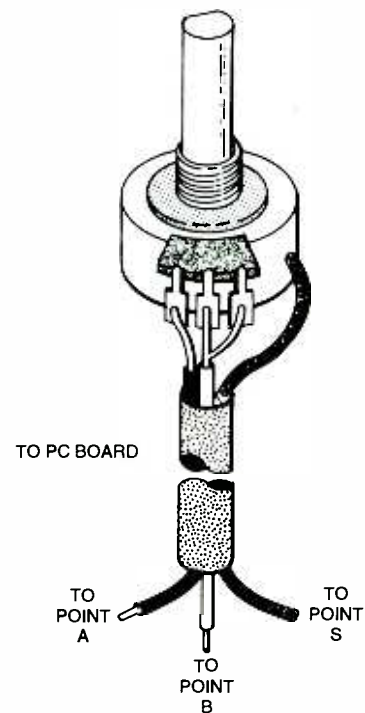

Fig. 5. All of the off-board components for the Guitar Distortion Pedal, excluding R3, can be connected to the board through short lengths of hook-up wire. Potentiometer R3 connects to the board through a length of two-conductor, shielded, microphone cable. Follow this diagram in preparing R3 for connection to the circuit board.

to test the unit. For that, you'll need a guitar and an audio amplifier of some type. Using a suitable patch cord, connect the output (J2) of the Guitar Distortion Pedal to the amp or mixing console, and then connect the guitar to J1. Set all of the potentiometers to their center positions, and turn on switch S1. Press the bypass switch, S2. If everything is working, you should hear two different sounds when you press switch S2. One will be a "clean" guitar sound, and the other will be a "distorted" one. Select the distorted sound and try varying the volume, distortion, and tone controls. Varying the volume, distortion, and tone controls should alter the sound produced by the project.

If any problems are detected, go over your work carefully to find the cause of the problem. It may just be a solder bridge or bad connection causing the problem.

In manipulating the controls, you'll find that the Guitar Distortion Pedal is capable of generating a wide range of sounds. ■

Times Are Tough...



Today's headlines scream of the lack of qualified individuals to fill new and existing high-tech job openings. If you feel the robust economy is passing you by, there is something you can do about it. **Become CIE Qualified.** Since 1934, The Cleveland Institute of Electronics has been providing its students with the necessary technical and academic credentials employers are seeking. In fact, CIE was started in 1934 to fill a similar void in the radio/television industry.

Since then, CIE boasts of over 150,000 worldwide graduates who have benefited from a patented, independent-study program that lets the student complete a Career Course, Associate Degree program, or through our affiliate school

World College, a Bachelor Degree program.

If you are currently "under-employed" and want to increase your level of income, the most proven method is an education. With CIE's independent-study program you study when and where you wish with no time constraints on how quickly you can proceed. And though it is an independent-study program you have the full support of the faculty and staff at CIE's Cleveland Campus.

To discover all the Benefits, Career Courses and Degree Programs available from CIE send for your Free Course Catalog Today!

The Cleveland Institute of Electronics has been approved for the training of eligible veterans and active duty military service members, under the G.I. Bill.

Military tuition assistance (Up-Front and Basic) is also available under the DANTES Distance Learning Program.

...For Employers

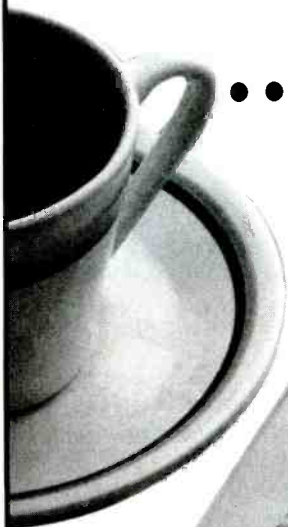

BUSINESS NEWS
Employers Searching For
Qualified Candidates

F R E E C A T A L O G



Cleveland Institute of Electronics
1776 E. 17th Street
Cleveland, Ohio 44114-3679
Visit Our Web-Site: www.cie-wc.edu

*A School of Thousands.
A Class of One. Since 1934.*

YES! Please send me a catalog. AH141

Name: _____

Address: _____

City: _____ State: _____ Zip: _____

Phone Number: _____

Check Box for a Bulletin on Military Education Benefits:

VA Benefits DANTES Benefits

SCANNER SCENE

Going to the Source

MARC SAXON

With the amazing increase in popularity of monitoring in the VHF aeronautical band (118–136 MHz), hobbyists have discovered several things. First, it's interesting and exciting. Second, data about ground-station communications facilities is readily available in specialized scanner directories such as *Airscan 6th Edition* (CRB Research). Lastly, information relating to the specific aircraft being monitored is difficult to come by. However, there is a source, which is used by the aviation industry, itself.

What we mean is the *International Air CD (Version 4.1)*, a CD-ROM containing over 1.2 million records relating to civil aircraft from 92 nations of the world. You can look up airliners, corporate jets, private aircraft, cargo planes, government planes, helicopters, gliders, blimps, balloons—virtually anything that flies (except military aircraft).

It carries information on single engine craft, twin engine, multi engine, and home builds. You can access data according to the aircraft's tail (registration) number, owner's name (or address, or location, or zip code, or phone number), or the aircraft's-make and model, or its engine type. You can view an owner's complete fleet.

You can even search for an aircraft according to its specific purpose or use, such as patrol, experimental, racer, agricultural, etc. You can find out the aircraft's date of manufacture and when it was purchased by its present owner. Complete name, address, phone, rating, and certification records are provided for all American and Canadian pilots.

This is an extremely user-friendly CD-ROM that loads easily and quickly into any computer using Windows. It's a cinch to use and contains an amazing amount of information of interest and use to aviation monitors.

The latest edition is \$239 (plus \$15 U.S. shipping) from HiTech Marketing, 2234 N. Federal Highway, Suite 469, Boca Raton, FL 33431; Tel. 561-243-44 1219; Web: www.infomart.net.

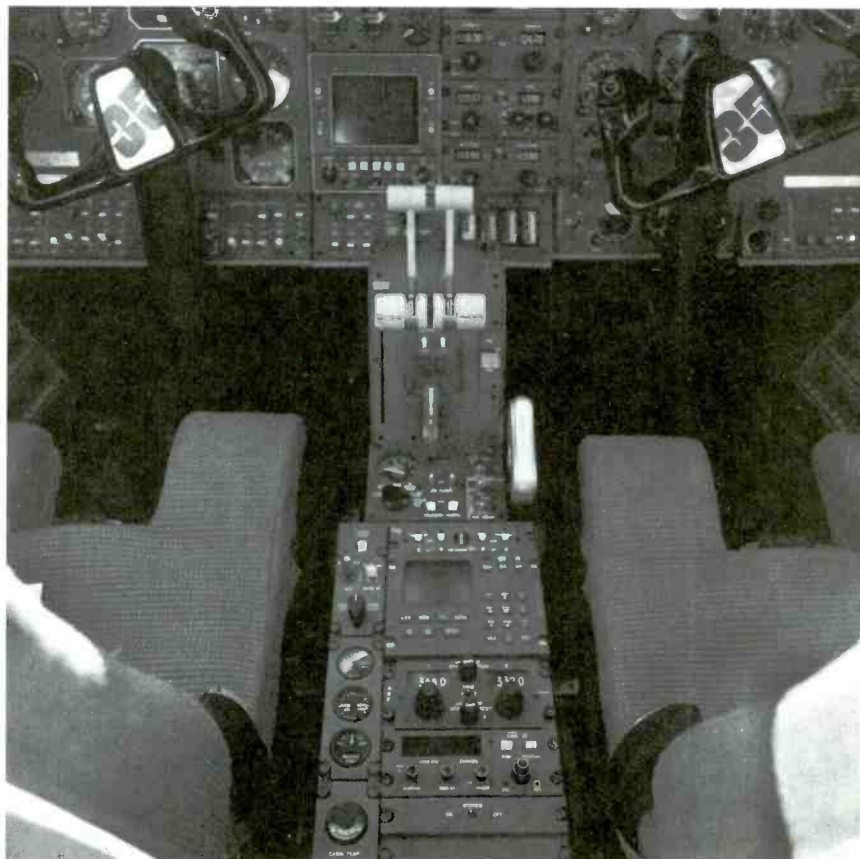

Catching conversations from the cockpit? Use the International Air CD to learn more about each aircraft you hear mentioned.

HAVE A BALL

In the past few months, several readers have sent us copies of ads for a tear-drop-shaped plastic gizmo intended to be clipped onto the tip of whip antennas of handheld scanners as well as car radios and CBs, cell-phones, boom boxes, and portable TVs. Selling for between \$4.95 and \$9.95, the device is touted as a miracle signal booster first used on tanks during Desert Storm. Without batteries, the ads say, it boosts reception and range. Readers ask how this is possible.

Well, it isn't possible. These ads appear only in novelty and similar merchandise catalogs sent to the very gullible general public—the same folks who are told and continue to believe

the lie that analog cellular and cordless phone calls are secure.

This plastic device was actually used in Desert Storm, but it was placed on tank antennas only to avoid the possibility of personnel accidentally getting their eyes poked out by the whip. They contain no electronic circuitry at all and have no ability whatsoever to enhance the performance of any wireless equipment.

MAILBAG

Mickey V., of Rutherford, NJ, writes that he is a taxi driver who makes frequent trips to New York City. He uses his scanner to avoid traffic detours, but has never been able to determine the police frequencies used in both the

(Continued on page 68)

Market Center™

Paperback Books

GREAT BOOKS AT BUDGET PRICES

100 RADIO HOOKUPS
—#7—\$3.00

First published in May, 1923 this popular booklet went into reprint editions nine times. It is packed with circuits, theory, antenna installation and tips on consumer radio receivers that were popular in the early 1920's. Antique radio buffs and those inquisitive about the early days of radio will find this booklet an exciting, invaluable and excellent reference into the minds of early-day radio listeners. Sorry, we cannot honor the original 25-cent cover price.

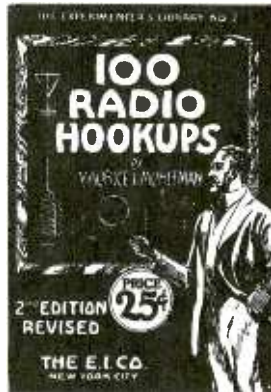

GUIDE TO THE WORLD'S RADIO STATIONS
—BP355—\$7.99

An easy-to-read guide for the casual listener and top notch QSL getter! The Guide is an essential reference work designed to steer the listener around the ever more complex radio bands. Listings cover world-wide shortwave stations with a special emphasis on international broadcasts in English. Medium and long-wave listings are also included for the US, Canada, European, Middle and Near East, and North Africa regions

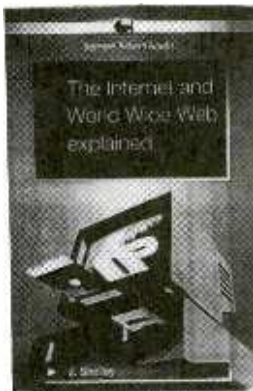

THE INTERNET AND WORLD WIDE WEB EXPLAINED
—BP403—\$7.99

Strip away the hype and mystery of the WWW and you'll be cruising on the information Superhighway! Understand the jargon used: ftp, protocols, TCP, hypertext, http, URL, home pages, threads, HTML, domains, FAQs, etc. Discover that e-mail is easy, fast and free! Learn how to guard against hackers and viruses. Develop friendships and "buddies" in Singapore, India, Cape Town, Peru—just about anywhere!

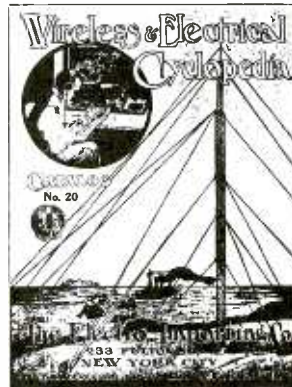

WIRELESS & ELECTRICAL CYCLOPEDIA
—ETT1—\$4.99

A slice of history. This early electronics catalog was issued in 1918. It consists of 176 pages that document the early history of electricity, radio and electronics. It was the "bible" of the electrical experimenter of the period. Take a look at history and see how far we have come. And by the way, don't try to order any of the radio parts and receivers shown, it's very unlikely that it will be available.

ELECTRONIC TECHNOLOGY TODAY INC.
P.O. BOX 240, Massapequa, NY 11762-0240

Name _____
Address _____
City _____ State _____ Zip _____

SHIPPING CHARGES IN USA AND CANADA

\$0.01 to \$5.00	\$2.00
\$5.01 to \$10.00	\$3.00
\$10.01 to 20.00	\$4.00
\$20.01 to 30.00	\$5.00
\$30.01 to 40.00	\$6.00
\$40.01 to 50.00	\$7.00
\$50.01 and above	\$8.50

SORRY No orders accepted outside of USA & Canada

Number of books ordered

Total price of merchandise	\$ _____
Shipping (see chart)	\$ _____
Subtotal	\$ _____
Sales Tax (NYS only)	\$ _____
Total Enclosed	\$ _____

All payments must be in U.S. funds!

ET01

CABLE SECRETS!!!

Build your OWN cable box "test" devices!

Why pay \$100.00 or more for a "test" device that someone else made? Make your own! Includes complete source code and plans for the most commonly used cable boxes. **Unlock all of the channels on your box!**

Or start your own lucrative business!

Complete source code \$79.95
Code for individual boxes \$29.95

DSS SECRETS — Vol. 2

Step-by-step instructions on programming your own DSS access card. **Unlock all channels on your own card!** This is the most current information on the market! Includes software, plans, and hardware sources. Book & CD-ROM.

DSS Secrets Vol. 2..... \$49.95

VISA • MasterCard • American Express

To order, call Worldwyde @ 1-800-773-6698

21365 Randall Street • Farmington Hills, MI 48336

Visit us on the web at www.worldwyde.com

OWN A MACHINE SHOP!

Do your own machining and shop work with a Smithy 3-in-1 Lathe•Mill•Drill

Do it yourself!

No more waiting to have parts or repairs done.



• Easy to use—Free training. You'll be doing quality work right away.

• Affordable—Four models starting at \$995.

• Versatile—Work metal—and wood or plastic.

• CNC adaptable

FREE Info Pak

"I can fix most anything. Now I don't know how I lived without it. It paid for itself in no time."

CALL TODAY!

1-800-345-6342

Visit us at www.smithy.com

or write: **Smithy.**

Dept. PE PE Box 1517

Ann Arbor, MI 48106-1517

Guaranteed to pay its own way

PCB LAYOUT

Software For Windows - FREE

- 1 Download our board layout software
- 2 Design your 2 sided plated-through PCB
- 3 Send us your layout over the Internet
- 4 In 2-3 business days, UPS delivers your boards, often under \$100

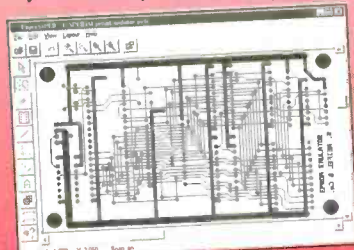

www.expresspcb.com

Direct from Manufacturer
We will beat any competitor's price

World's Smallest Wireless Video Camera!

- Transmits video up to 1000 ft.
- Runs on 9V battery for 12 hrs.
- Can be built into just about anything (beeper, clock, etc.)

World's smallest plug & play system about 1" x 1"

We also carry:

- Color micro video cameras
- B&W micro video cameras
- Hidden cameras
- Custom video systems
- Countersurveillance & More



Looking for Distributors

Call for a free catalog (305) 667-4545
SECURETEK Fax (305) 667-1744
7175 SW 47 St. #205 • Miami, FL 33155

PIC Programmer Kits



Super Value!
\$19.95 +S&H \$4.95

Code: 12C5xx, 14000 and 18, 28 & 40 pin PICs in the 16Cxx series (except 16C54-58). • All components, PCB and Instructions included. • Parallel port of PC is used with straight through (25 pin) cable (not supplied). • Kit uses the P16PRO shareware which is downloaded from the web and registered for \$20. • Can program 64 pin PICs with adapter (not supplied). • For more info and other PIC programmers visit www.electronics123.com

Running Lights Kit

Ideal for parties, discos, shop windows and X-mas decorations. 8 LEDs switch on and off in 10 push button selectable patterns. 8 different speed levels for a total of 80 combinations! Includes PCB, components & instructions. Based on a microcontroller. Can operate light bulbs by using TRIACs. (8xTRIACs are \$6 extra) *S&H to Canada is \$7.95

\$15.95 +S&H \$4.95

Toll Free: 1-888-549-3749 (USA & Canada)
Tel: (330) 549-3726. Request a FREE catalog or visit us at: www.electronics123.com for more products.
Amazon Electronics, Box 21 Columbiana OH 44408

BEST BY MAIL

Rates: Write National, Box 5, Sarasota, FL 34230

GAMBLING

WIN AT HORSE RACING. INCREDIBLE! Free audio tape. WB, Box 1540, Minden, NV 89423.

MONEYMAKING OPPORTUNITIES

FREE: MAILERS NEEDED! Long Self-Addressed Stamped Envelope: PAPST-(PE), Box 679, Council Bluffs, IA 51502.

FREE! (a \$20.00 VALUE)

CONSTRUCT THOSE SIMPLE AUDIO PROJECTS FROM SESCOM SIPs

JUST APPLY SIGNAL POWER AND OUTPUT CONNECTIONS AND YOU ARE READY TO GO. SIMPLE CONSTRUCTION. PINS ARE ON 0.1" CENTERS.

VISA MASTERCARD

GET YOUR SIP-1 AUDIO MODULE TODAY
*ONLY \$2.00 FOR SHIPPING AND HANDLING
EXPERIMENT FOR YOURSELF TO SEE THE BENEFITS OF THESE DEVICES.
THERE ARE 25 DIFFERENT DEVICES IN THE SIP PRODUCT LINE.
OFFER GOOD ONLY IN THE 48 STATES. OFFER ENDS DECEMBER 20, 1999.
LIMIT ONE REQUEST PER CUSTOMER. MUST BE PREPAID BY CREDIT CARD OR CHECK. MAILED 1ST CLASS. ALLOW 1-2 WEEKS FOR DELIVERY.

ORDERS 800-634-3457 • FAX 800-551-2749
OFFICE 702-565-3400 • FAX 702-565-4828
www.sescom.com • info@sescom.com
SESCOM, INC. 2100 WARD DR., HENDERSON, NV 89015
SESCOM, INC. is not responsible for inadvertent typographical errors and prices and specifications are subject to change without notice.

BEST DEALER PRICING!

CABLE DIRECT

CONVERTERS • FILTERS
DESCRAMBLERS

IMPROVE YOUR IMAGE WITH VIDEO STABILIZERS

FREE CABLE TV CATALOG!

100% MONEY BACK GUARANTEE!



Now you can tune-in your favorite cable TV programming and **SAVE \$100'S** - **EVEN \$1000'S** on premium CABLE TV EQUIPMENT.



MODERN ELECTRONICS

1-800-906-6664

2609 S. 156TH CIRCLE • OMAHA, NE 68130

<http://www.modernelectronics.com>

MECI 340 East First Street
Dayton, Ohio 45402
Your Electronics Value Company

Tons of Electronics

Get your FREE catalog today and discover some of the best deals in electronics. We have thousands of items ranging from unique hard-to-find parts to standard production components. Call, write or fax today to start your subscription to one of the most unique catalogs in the industry, filled with super values on surplus electronic and hobbyist type items.

FREE CATALOG!

Checkout our 10,000 item on-line catalog <http://www.meci.com>

Order Toll Free Why pay more?
1-800-344-4465 Call today!
Fax Order Line
1-800-344-6324

"I Got The Career I Wanted And The Pay I Deserve. You Can Too!"

*Earn up to \$20/Hour and
more as a PC Specialist*

Were you passed up for the promotion because someone had the computer skills you didn't? Are you entering the job market again? Or, do you want your business to run more efficiently?

A lot of ambitious people, like you, have been asking these same questions. Foley-Belsaw has the



answer. The Personal Computer Repair Course.

With Foley-Belsaw's Computer Repair Course, you'll get the computer skills to land a better job or start a business of your own. Trained Computer Repair Technicians can

earn \$25 to \$40 an hour and that's just a start. In a business of your own you can charge \$75 to \$125 an hour for many repair jobs.

The Computer Repair Course is complete. You'll learn using basic step by step easy to understand language. Soon you'll be proficient at all types of advanced repair procedures. With your new skills you can earn a good living and start living better - regardless of your previous computer experience. It's just that simple.

Get The Foley-Belsaw Training Advantage

Since 1926, Foley-Belsaw has been helping people build a better future. We provide you the training, technical support and resources to succeed. You set your own study pace and train at home. Our SkillPak lessons teach a variety of computer



operations. You practice as much as you want. There aren't any deadlines and most students complete the course in a few months - at home and in your spare time.

Turn your doubts into dreams. Get the career you want and the pay you deserve. Call or send for your free opportunity kit for the Computer Repair Course or in the electronics field that interests you. Opportunities await you. The information is free and there is no obligation.

*Fill in and
mail coupon below or
Call Toll-Free
1-800-487-2100 Ext. 16
to receive full
information and details
free by return mail.
DO IT TODAY!*

1. Computer Repair, Maintenance & Upgrade: (NEW) Service the information superhighway as a skilled computer technician. The computerization of America can mean big money to you.

2. Computer Programming: Skilled programmers are in demand and technology is the wave of the future. Secure your future. Learn computer languages and programming skills.

3. TV/Satellite Dish: Entertainment is big business. Here's your lucky break. Earn top dollar as a skilled satellite dish technician.

4. Electrician: The opportunities are endless. As a trained commercial or residential electrician your

future is sure to be bright. Earn while you learn in this fast-growing field.

5. VCR/DVD Cleaning, Maintenance & Repair: Learn troubleshooting skills for repairing and servicing VCRs and earn up to \$50 an hour.

6. Networking Specialist: Fast-paced America depends on

efficiency. Networking specialists can earn great money tying personal computers together to make efficient operating systems.

7. PC Specialist: Learn word processing, spreadsheet and database applications.



Foley-Belsaw Institute

6301 Equitable Road • Kansas City, MO 64120

Please Check Only ONE of the Following:

YES! Rush me a free information kit on the Computer Repair Course right away. 321

VCR/DVD Repair, 320

Computer Specialist, 325

Computer Programmer, 323

TV/Satellite Dish, 322

Electrician, 326

Networking Specialist, 324

Name _____

Street _____

City _____

State _____

Zip _____

Or Call Toll-FREE 1-800-487-2100 Ext. 16

"Even before I finished my course, I got my first raise. Thank you Foley-Belsaw."

John O., Chicago, IL

EARN MORE MONEY!

Be an FCC LICENSED ELECTRONIC TECHNICIAN!



Earn up to \$60 an hour and more!

Learn at home in spare time. No previous experience needed!

No costly school. No commuting to class. The Original Home-Study course prepares you for the "FCC Commercial Radiotelephone License." This valuable license is your professional "ticket" to thousands of exciting jobs in Communications, Radio-TV, Microwave, Maritime, Radar, Avionics and more...even start your own business! You don't need a college degree to qualify, but you do need an FCC License.

No Need to Quit Your Job or Go To School
This proven course is easy, fast and low cost! **GUARANTEED PASS**—You get your FCC License or money refunded. **Send for FREE facts now. MAIL COUPON TODAY!**

Or, Call 1-800-932-4268 Ext. 240

COMMAND PRODUCTIONS

FCC LICENSE TRAINING, Dept. 240
P.O. Box 2824, San Francisco, CA 94126
Please rush FREE details immediately!

NAME _____
ADDRESS _____
CITY _____ STATE _____ ZIP _____

Learn MICROCONTROLLERS EMBEDDED SYSTEMS and PROGRAMMING...

...with the AES learning system/ embedded control system. Extensive manuals guide you through your development project. All programming and hardware details explained. Complete schematics. Learn to program the LCD, keypad digital, analog, and serial I/O. for your applications.

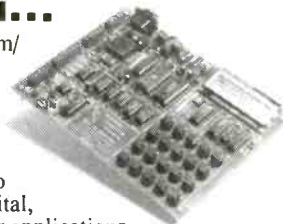

THREE MODELS AVAILABLE. Choose from an Intel 8051, Intel 8088, or Motorola 68HC11 based system. All models come with:

- 32K Byte ROM, 32K Byte RAM • 2 by 16 Liquid Crystal Display • 4 by 5 Keypad • Digital, Analog, and Serial I/O • Interrupts, timers, chip-selects • 26 pin expansion connector • Built-in Logic Probe • Power Supply (can also be battery operated) • Powerful ROM MONITOR to help you program • Connects to your PC for programming or data logging (cable included) • Assembly, BASIC, and C programming (varies with model) • Program disks with Cross Assembler and many, well documented, program examples • User's Manuals: cover all details (over 500 pages) • Completely assembled and ready to use • Source code for all drivers and MONITOR • Optional Text Book

Everything you need. From \$279. Money Back Guarantee

Call for Free Info Pack, or see WEB at <http://www.aesmicro.com>
714-979-1091, FAX 714-979-1093



Call 1-800-730-3232

AES MICRO, INC., 2110 S. LYON ST., SUITE C, SANTA ANA, CA 92705, USA

Top Secret! FORBIDDEN KNOWLEDGE

The Hack & Crack Bible Book & CD-ROM



Everything you've always wanted to know about hacking, but everyone was afraid to publish. Only \$29.95!

Secrets of DSS Book & CD-ROM



Hundreds of channels, and you can't get them all...until now! Learn the secrets of DSS! Only \$29.95!

PIC Projects Book & CD-ROM



The perfect PIC primer, complete with detailed instructions, full explanation, schematics, programming software & source code. Only \$29.95!

Home Automation Book & CD-ROM



Control every appliance in your home from one central location...or even remotely! The local control module doesn't even require a computer! Only \$29.95!

Virtual Reality Book & CD-ROM



Ever want to just reach inside your computer and grab something? Learn how to construct and use your own VR interface devices! Do it like the pros! Only \$29.95!

Secrets of Free Cable Book & CD-ROM



From test chips and boxes to line traps for stopping the "magic bullet" —everything you need to know to enhance your cable viewing experience! Only \$29.95!

- Free Energy \$19.95
- Anti-Gravity \$19.95
- Home-Brew Lasers \$24.95
- PlayStation Secrets \$29.95
- The Moon: NASA's Secrets! ... \$19.95
- Tesla/High Voltage \$29.95
- Secrets of UFOs \$19.95
- True Origins of Man \$29.95
- Earth-Mars Connection \$19.95

We accept the following:



1-800-773-6698

or visit us on the web @ <http://www.worldwyde.com>

CONTROL

RELAYS • LIGHTS • MOTORS

MEASURE

TEMPERATURE • PRESSURE • LIGHT LEVELS • HUMIDITY

INPUT

SWITCH POSITIONS • THERMOSTATS • LIQUID LEVELS

MODEL 30 \$79



- PLUGS INTO PC BUS
- 24 LINES DIGITAL I/O
- 8 CHANNEL- 8 BIT A/D/ IN
- 12 BIT COUNTER
- UP TO 14K SMP/SEC

MODEL 45 \$189



- RS-232 INTERFACE
- 8 DIGITAL I/O
- 8 ANALOG INPUTS
- 2 ANALOG OUTPUTS
- 2 COUNTERS-24 BIT

MODEL 100 \$279



- 12 BIT 100 KHZ A/D
- 4 ANALOG OUTPUTS
- 3 TIMER COUNTERS
- 24 DIGITAL I/O

MODEL 150-02 \$179



- RS-232 INTERFACE
- TRMS, 20 AMPS
- 12 BIT A/B
- OPTO-ISOLATED
- COMPLETE DMM

MODEL 40 \$109



- RS-232 INTERFACE
- 28 LINES DIGITAL I/O
- 8 ANALOG INPUTS
- PWM OUTPUT

MODEL 70 \$239



- RS-232 INTERFACE
- 18 BIT A/E
- 5.5 DIGIT
- UP TO 60 SMP/SEC

Prairie Digital, Inc.

PHONE 608-643-8599 • FAX 608-643-6754

228 SEVENTEENTH STREET - PRAIRIE DU SAC, WISCONSIN 53153

CIRCLE 150 ON FREE INFORMATION CARD

RS232/RS422/RS485 Converters



RS232 TO RS485 2 wire

- Makes your RS232 port an RS485 port
- Supports up to 40 RS485 devices
- Automatically determines data direction.
- Signal powered version available

CMC's low cost converters adapt any RS232 port for RS422 or RS485 operation. These converters provide your RS232 device with all the advantages of RS422 or RS485 including reliable high speed operation (upto 200kbaud) and data transmission distances up to 5000 feet. Two AD422s can be used to extend any RS232 link up to 5000 feet. Completely transparent to the system; no software changes of any type are necessary.

ADA485 (requires 9VDC) \$79.00
 ADA485-1 for 110VAC 89.00
 ADA485L signal powered 84.00

RS232 TO RS485 4 wire

- Converts an RS232 port for use with RS422 or RS485 devices
- Supports up to 40 RS485 or RS422 multidrop devices
- Adds multidrop capability to RS232 devices
- Automatically determines data direction.

RS232 TO RS422

- Converts bi-directionally between RS232 and RS422
- Use as a short haul modem
- Plug in and go. No software changes required

AD422 (Requires 9VDC) \$79.00 ADA425 (requires 9VDC) \$89.00
 AD422-1 for 110VAC 89.00 ADA425-1 for 110VAC 99.00

Mention this ad when you order and deduct 5%
 Use Visa, Mastercard or company purchase order

code P9H



Connecticut microComputer, Inc.
 PO BOX 186, Brookfield, CT 06804 (203)740-9890

WWW.2CMC.COM

Fax: (203)775-4595

Wireless Internet & TV

WIRELESS CABLE - IFTS - MMDS
 ATV - INTERNATIONAL - DIGITAL
 Amplifiers • Antennas • Books • Components
 • RF Frequency 2100-2700 MHz
 • SASE For "FREE" Catalog or Send \$1

PHILLIPS-TECH ELECTRONICS
 P.O. Box 13074 • Scottsdale, AZ 85267-3074
 CATALOG/INFO: 480-947-7700
 ORDER LINE: 800-860-MMDS
 FAX LINE: 480-947-7799
 WEBSITE: www.phillips-tech.com
 E-MAIL: product@phillips-tech.com

CHALLENGER SYSTEM
 31-Channel Complete \$249
 Other Systems Available
 3 Year Warranty
 FREE SHIPPING

Visa • MC • AmEx • Discovery • COD's • Quantity Pricing

VIDEO SYNC GENERATOR



Restores Horizontal and Vertical Sync Lines from Distorted Video

For Free Information Package and Pricing

Call (219) 233-3053
 www.south-bend.net/rcd

R.C. Distributing, P.O. Box 552, South Bend, IN 46624

FCC License Preparation

RADIOTELEPHONE LICENSE
 Electronics Tech, Avionics, Marine & Radar
 Homestudy - Fast-Fasy & inexpensive.
 Manuals-Audio-Video-pedisks-Q&As
 Guarantee Pass-see at www.wptfcc.com
 Details-800-800-7555. WPT Publications
 4701 NE 47ST, Vancouver, WA 98661

Weeder Technologies

Visit our

ON-LINE CATALOG

Pro-Kit

PO Box 2426, Ft. Walton Beach, FL 32549

www.weedtech.com

Voice/Fax 850-863-5723

Stackable RS-232 Kits

Digital I/O - 12 I/O pins individually configurable for input or output. DIP switch addressable; stack up to 16 modules on same port for 192 I/O points. Turn on/off relays. Sense switch transitions, button presses, 4x4 matrix decoding using auto-debounce and repeat. **\$32**

Analog Input - 8 input pins. 12-bit plus sign self-calibrating ADC. Returns results in 1mV steps from 0 to 4095. Software programmable alarm trip-points for each input. DIP switch addressable; stack up to 16 modules on same port for 128 single-ended or 64 differential inputs. **\$49**

Home Automation (X-10) - Connects between a TW523 and your serial port. Receive and transmit all X-10 commands with your home-brewed programs. Full collision detection with auto re-transmission. **\$39**

Caller ID - Decodes the caller ID data and sends it to your serial port in a pre-formatted ASCII character string. Example: *12/31 08:45 850-863-5723 Weeder, Terry <CR>. Keep a log of all incoming calls. Block out unwanted callers to your BBS or other modem applications. **\$35**

Touch-Tone Input - Decodes DTMF tones used to dial telephones and sends them to your serial port. Keep a log of all outgoing calls. Use with the Caller ID kit for a complete in/out logging system. Send commands to the Home Automation or Digital I/O kits using a remote telephone. **\$34**

Telephone Call Restrictors

Two modes of operation; either prevent receiving or placing telephone calls (or call prefixes) which have been entered into memory, or prevent those calls (or call prefixes) which have "not" been entered.

Block out selected outgoing calls. Bypass at any time using your password. **\$35**

Block out selected incoming calls. Calls identified using Caller ID data. **\$48**

IR Remote Control Receiver

Learns and responds to the data patterns emitted by standard infrared remote controls used by TVs, VCRs, Stereos, etc. Lets you control all your electronic projects with your TV remote. 7 individual output pins can be assigned to any button on your remote, and can be configured for either "toggle" or "momentary" action. **\$32**

Phone Line Transponder

7 individual output pins are controlled with buttons 1-7 on your touch-tone phone. Automatically answers telephone and waits for commands. Monitor room noises with built in mic. "Dial-Out" pin instructs unit to pick up phone and dial user entered number(s). Password protected. **\$49**

DTMF Decoder/Logger

Keep track of all numbers dialed or entered from any phone on your line. Decodes all touch-tones and displays them on a 16 character LCD. Holds the last 240 digits in a non-volatile memory which can be scrolled through. Connect directly to radio receiver's speaker terminals for off-air decoding of repeater codes, or numbers dialed on a radio program. **\$55**

CALL TOLL FREE

(800) 292-7711

Orders Only

Se Habla Español

C&S Sales

Excellence in Service

Look For Other
Monthly Specials
On Our Website

www.cs-sales.com

Power Supplies

Elenco Quad Power Supply
Model XP-581

\$79.95



4 Fully Regulated DC Power Supplies in One Unit

4 DC voltages: 3 fixed - +5V @ 3A, +12V @ 1A, -12V @ 1A
1 Variable - 2.5 - 20V @ 2A

Elenco Power Supply Kit
Model XP-720K

\$54.95



XP-720 Fully Assembled \$85

Elenco DC Power Supply
Model SPL-603

3A 0-30VDC \$79.95

The SPL-603 is a solid-state DC power supply providing the exact output voltage no matter what current you use. It contains one fully regulated power supply. The variable voltage is capable of delivering 0-30V at up to 3A. The output is precisely held to the desired output voltage by a special regulating circuit. Output fully protected from overload.

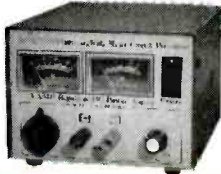

Miscellaneous

Elenco Model EP-50

Electronic Playground and Learning Center Contains Over 50 Experiments

\$19.95

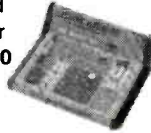

Elenco Model XK-150

Digital/Analog Trainer

\$89.95

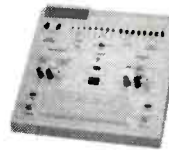

Ideal for Schools

Elenco Model MX-9300
Four Functions in One



\$450

Features:

- One instrument with four test and measuring systems:
- 1.3GHz Frequency Counter
- 2MHz Sweep Function Generator
- Digital Multimeter
- Digital Triple Power Supply - 0-30V @ 3A, 15V @ 1A, 5V @ 2A

Generators & Counters

Elenco Sweep Function Generator
w/ built-in frequency counter Model GF-8036



\$225

This sweep function generator with counter is an instrument capable of generating square, triangle, and sine waveforms, and TTL, CMOS pulse over a frequency range from 0.2Hz to 2MHz.

10 Function 1.3GHz Universal Counter
Elenco Model F-1300

- Frequency 0.5Hz - 1.3GHz 3 Ranges
- Period - Can read 60Hz to 60,000,000 F=1/T
- Totalize - Counts to 199,999,999
- RPM - 3 to 209,999 RPM
- Duty Cycle
- Max./Min./AVG with Time
- Stop-watch set. 2 sec. to 100 hrs.
- Math Functions
- Timer - 2 sec. to 99 days
- Pulse Width - 0.1ms to 66666.6ms

\$225



Multifunction Counter

\$189



Measures Frequency, Period, Data Hold, Relative, Memory (min., max., average). High Sensitivity, Microprocessor Controlled.

Elenco Handheld Universal Counter
10Hz - 2.8GHz
Model F-2800



\$99

Features: 10 Digit display, 16 segment and RF signal strength bargraph. Includes antenna, NiCad battery, and AC adapter.

Elenco RF Generator with Counter
(100kHz - 150kHz) Model SG-9500

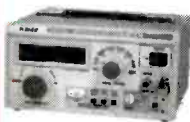

Features internal AM mod. of 1kHz, RF output 100MV - 35MHz. Audio output 1kHz @ 1V RMS.

\$225

SG-9000 \$119.95 (analog, w/o counter)

B&K 20MHz Sweep/Function Generator
with Frequency Counter Model 4040

- 0.2Hz to 20MHz
- AM & FM modulation
- Burst Operation
- External Frequency counter to 30MHz
- Linear and Log sweep

\$445



10MHz Model 4017 \$319
5MHz Model 4011 \$249

BK PRECISION

Kit Corner

over 100 kits available

Model AK-870

Radio Control Car Kit

\$24.95

- Solderless
- 7 Functions
- Radio Control Transmitter Included



Model AK-700

Pulse/Tone Telephone Kit

Ideal School Project



\$15.95

Model AM/FM-108K

AM/FM Transistor Radio Kit w/ Stand

\$29.95

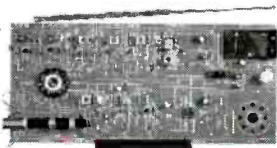

Elenco Digital / Analog Trainer

Model XK-700

Elenco's newest advanced Digital / Analog Trainer is specially designed for school projects. It is built on a single PC board for maximum reliability. It includes 5 built-in power supplies, a function generator w/ continuously sine, triangular and square waveforms, 1,560 tie point breadboard area. Tools and meter shown optional. (Mounted in a professional tool case made of reinforced metal).

XK-700 Assembled & Tested \$189.95

XK-700K - Kit \$159.95



Made in USA

Guaranteed Lowest Prices

UPS SHIPPING: 48 STATES 5%
OTHERS CALL FOR DETAILS
IL Residents add 8.25% Sales Tax

C&S SALES, INC.

150 W. CARPENTER AVENUE
WHEELING, IL 60090
FAX: (847) 541-9904 (847) 541-0710

15 DAY MONEY BACK GUARANTEE
2 YEAR FACTORY WARRANTY

PRICES SUBJECT TO CHANGE WITHOUT NOTICE

SAME DAY SHIPPING

C&S Sales

Excellence in Service

CALL OR WRITE FOR OUR FREE

**64 PAGE CATALOG!
(800) 445-3201**

Digital Multimeters

Elenco LCR & DMM Model LCM-1950



12 Functions
Freq. to 4MHz
Inductance
Capacitance
and Much More

\$69

Elenco Model M-1740 \$39.95



11 Functions:
• Freq. to 20MHz
• Cap. to 20µF
• AC/DC Voltage
• AC/DC Current
• Beeper
• Diode Test
• Transistor Test
• Meets UL-1244 safety specs.
Model M-2760 - \$24.95 (9 functions)

Fluke 79III \$185

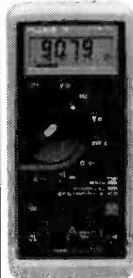

• Capacitance ranges from 99.99nF to 9999µF.
• Built-in frequency counter of voltage input from 1Hz to over 20kHz.
• Lo-Ohms range, a 40Ω range with Fluke's proprietary Zero Calibration, offers 0.01 resolution with increased noise rejection.

Series II (limited qty.)
\$179

Fluke 87III \$299



Features high performance AC/DC voltage and current measurement, frequency, duty cycle, resistance, conductance, and capacitance measurement.

Series II (limited qty.)
\$289

Elenco Model LCR-1810 \$99.95



• Capacitance .1pF to 20µF
• Inductance 1µH to 20H
• Resistance .01Ω to 2000MΩ
• Temperature to 750°C
• DC Volts 0 - 20V
• Frequency up to 15MHz
• Diode/Audible Continuity Test
• Signal Output Function
• 3 1/2 Digit Display

Elenco Model M-1005K \$14.95



Digital Multimeter Kit
• 18 Ranges
• 3 1/2 Digit LCD
• Transistor Test
• Diode Test

M-1000B (Assembled)..... **\$14.95**

Dual-Display LCR Meter w/ Stat Functions B&K Model 878 \$219.95



Auto/manual range
Many features with Q factor
High Accuracy

Elenco Model 6100 \$99.95



• True RMS of high speed signals
• Computer interface and software
• Frequency to 200kHz
• Capacitance to 40µF
• Large 3 3/4 LCD display
• Captures and displays max, min, & avg.
• Relative % to reference
• Three hold system
• Analog bar graph and pointer
• Audible continuity
• Auto power off
• Unlt indicator
• Diode test

Oscilloscopes

Free Dust Cover and 2 Probes



S-1325	25MHz	Dual Trace	\$325
S-1330	25MHz	Delayed Sweep	\$439
S-1340	40MHz	Dual Trace	\$475
S-1345	40MHz	Delayed Sweep	\$569
S-1360	60MHz	Delayed Sweep	\$749
S-1390	100MHz	Delayed Sweep	\$995

DIGITAL SCOPE SUPER SPECIALS

DS-203	20MHz/10Ms/s Analog/Digital	\$695
DS-303	40MHz/20Ms/s Analog/Digital	\$995
DS-603	60MHz/20Ms/s Analog/Digital	\$1295

TEKK Radios

Pro-Sport FRS Two-Way Radio Model PRO-SPORT+

Both Models Available in Yellow, Blue & Black

Talk up to 2 miles!

Model PRO-SPORT

• 1/2 Watt Output, 14 Channels.
• TX LED Indicator.
• Removable Belt Clip.
• Highly Water Resistant.
• Economy Type
• No License Required!

\$68.00 each or 2 for \$109.95



No License Required

Model PRO-SPORT +

• 1/2 Watt Output, 14 Channels.
• TX & RX LED/LCD Indicators.
• Large LCD Display.
• 38 Privacy (CTCSS) Tones.
• Plus All Features of Pro-Sport Model.

\$79.00 each or 2 for \$149.95



Elenco Technician Tool Kit

Model TK-1500 \$49.95

28 tools plus a DMM (M-1000B) contained in a large flexible tool case with a handle ideal for everyone on the go.



Guaranteed Lowest Prices

C&S SALES, INC.

**15 DAY MONEY BACK GUARANTEE
2 YEAR FACTORY WARRANTY**

UPS SHIPPING: 48 STATES 5%
OTHERS CALL FOR DETAILS
IL Residents add 8.25% Sales Tax

SEE US ON THE WEB

150 W. CARPENTER AVENUE
WHEELING, IL. 60090
FAX: (847) 541-9904 (847) 541-0710
www.cs-sales.com



PRICES SUBJECT TO CHANGE WITHOUT NOTICE

CIRCLE 32 ON FREE INFORMATION CARD

www.americanradiohistory.com

ATTENTION DEALERS: WHOLESALE ONLY!



**BEST PRICES!
FAST SERVICE
SAME DAY SHIPPING**

EXCLUSIVE:

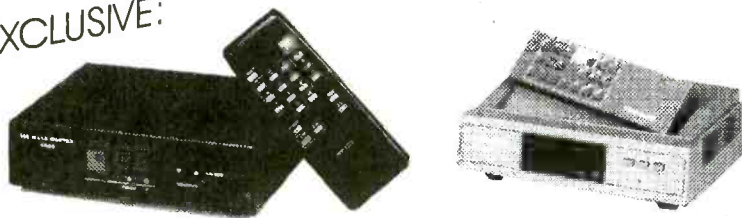

2 PIECE SETUPS: \$85⁰⁰

10 lot • 1 Year Warranty

**Latest Technology • Universal Combo's - Ask For Details
CALL US LAST! LOWEST PRICES GUARANTEED!**

TOLL FREE:

800-375-3682



FAX:

516-246-5634

ELECTRONIC COMPONENTS

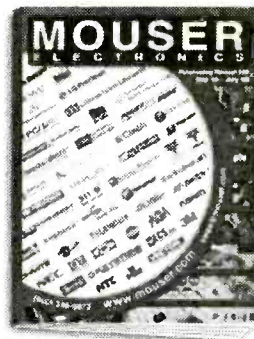

**Visit our web site!
www.mouser.com**

Subscribe, download, or
view catalog online!

- Over 87,000 Products
- More than 145 Suppliers
- Same Day Shipping
- No Minimum Order

800-992-9943

817-483-6828 Fax: 817-483-6899
catalog@mouser.com

958 North Main St., Mansfield, TX 76063

CIRCLE 165 ON FREE INFORMATION CARD

**Turn Your Multimedia PC into a Powerful
Real-Time Audio Spectrum Analyzer**

Features

- 20 kHz real-time bandwidth
- Fast 32 bit executable
- Dual channel analysis
- High Resolution FFT
- Octave Analysis
- THD, THD+N, SNR measurements
- Signal Generation
- Triggering, Decimation
- Transfer Functions, Coherence
- Time Series, Spectrum Phase, and 3-D Surface plots
- Real-Time Recording and Post-Processing modes

Applications

- Distortion Analysis
- Frequency Response Testing
- Vibration Measurements
- Acoustic Research

System Requirements

- 486 CPU or greater
- 8 MB RAM minimum
- Win. 95, NT, or Win. 3.1 + Win.32s
- Mouse and Math coprocessor
- 16 bit sound card

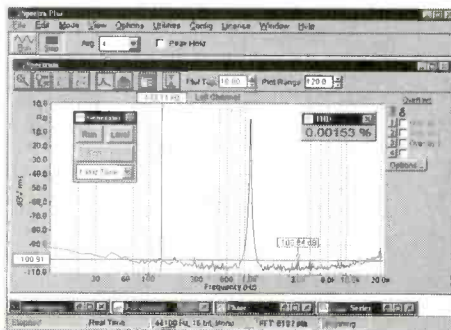

Priced from \$299

(U.S. sales only - not for export/resale)

DOWNLOAD FREE 30 DAY TRIAL!

www.spectraplus.com

PHS Pioneer Hill Software
24460 Mason Rd.
Poulsbo, WA 98370
a subsidiary of Sound Technology, Inc.

Sales: (360) 697-3472



Spectra Plus

FFT Spectral Analysis System

Fax: (360) 697-7717

e-mail: pioneer@telebyte.com

**COPY
RENTAL
TAPES**

**WITH OUR
VIDEO STABILIZERS**

BEFORE

AFTER



**FREE
CABLE TV
CATALOG!**

The clearest picture possible
playing back movies.
GUARANTEED
to eliminate copy protection.

- No Rolls/Jitters/Flickers/Fading
- Works on all TV's, VCR's Beta & Cable
- Gold Video Connectors & Cables Included
- 1 Year Warranty
- Money Back Guarantee



**VISION
ELECTRONICS**
1-800-562-2252

2609 S. 156TH CIRCLE • OMAHA, NE 68130

<http://www.modernelectronics.com>

Dalbani

www.dalbani.com

Computer Cases

Lexon®
\$45⁹⁹

Nickel Chassis with built in 250 power supplies
7 ATX Slots
7 AT Slots

FCC Approved

Item # 95-4025



Amplifiers

\$19⁹⁹

120 Watt
Separate
Bass/Treble Switch
Item # 89-3470



Soldering Station

\$34⁹⁵

Variable Power Control (5-40W)
Interchangeable Tip & Heating Element

Item # 51-1505



RCA Video Tapes

\$12⁹⁹
Min. 10 pieces

6 Hours
Hi-Fi Sound

Item # 50-1005



F-Quick Cable

\$2⁹⁹
Gold Plated
3ft.,
75Ω

Item # 17-7395



MAGNAVOX Remote Control

\$5⁹⁵
Min. 5 pieces
Controls
3 Units
TV, VCR,
Cable Box

Item # 82-1380



RCA Video Tapes

\$12⁹⁹
Min. 10 pieces

6 Hours
Hi-Fi Sound

Item # 50-1005



SONY PlayStation

\$24⁹⁹
Minimum 3 pieces

Laser Pickup

Original Sony # KSM-440ACM

Item # 46-4720



GEMINI II Power Strip

\$3⁹⁹
25 Joules
6 Outlets

Item # 40-1755



Multimeters

\$7⁹⁹
6 Functions
19 Ranges
9V Battery
Included

Item # 50-2895



Clearance

\$24⁹⁵

Aluminum frame
Tool Case

Item # 50-1890 Black



CALL TOLL FREE

e-mail: savings@dalbani.com

1-800-325-2264

\$20.00
Minimum Order
not including shipping & handling

UPS
2ND DAY AIR.



3⁹⁵ plus shipping and handling

Up to 5 lbs anywhere in the U.S.A.
Excluding Alaska, Hawaii & Puerto Rico.

SPECIAL SHIPPING RATE

CIRCLE 164 ON FREE INFORMATION CARD

www.americanradiohistory.com

Any waveform you want!



New Features:

- ✓ 21.5 MHz
- ✓ .01 Hz steps
- ✓ multi-unit phaselock

- **Synthesized Signal Generator**
Clean sinewaves DC-21.5 MHz, .001% accuracy!
.01 Hz steps. DC Offset. RS232 remote control.
- **Arbitrary Waveform Generator**
40 Megasamples/Second. 32,768 points. 12 bit DAC
- **Function Generator**
Ramps, Triangles, Exponentials & more to 2 MHz!
- **Pulse Generator**
Digital waveforms with adjustable duty cycle

Telulex Inc. model SG-100A

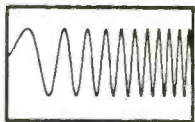

DC to 21.5 MHz linear and log sweeps



Int/Ext AM, SSB, Dualtone Gen.



Int/Ext FM, PM, BPSK, Burst

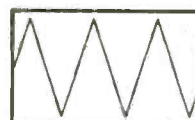

Ramps, Triangles, Exponentials



Pulse Generator

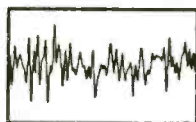

Noise

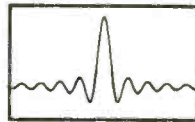

Arbitrary Waveforms

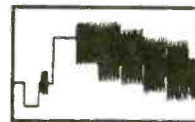

Unlimited Possibilities!

Telulex Inc.

2455 Old Middlefield Way S Tel (650) 938-0240 <http://www.Telulex.com>
Mountain View, CA 94043 Fax (650) 938-0241 Email: sales@Telulex.com
CIRCLE 137 ON FREE INFORMATION CARD

ALFA ELECTRONICS HIGH QUALITY TEST EQUIPMENT

Visit www.alfaelectronics.com for complete info
Call 1-800-526-2532 for Order and Free Catalog

<p>DMM-89S (\$179.00): true rms, AC/DC (V,A), Ω, bar graph, freq, capac., dBm, logic, diode</p> <p>DMM-23T (\$99.95): 4 1/2 digit, true rms, high resol. (10μV, 10nA, 10mΩ), hFE, diode, contin.</p> <p>DMM-20 (\$74.95): AC/DC (V, A), Freq, cont., Capac, Induct, Ω, hFE, diode, duty cycle</p> <p>DMM-122 (\$59.95): DC/AC(V,A), Ω, hFE, diode, capacitance, freq, logic, continuity</p> <p>DMM-123 (\$44.95): DMM + capacitance, DC/AC(V,A), Ω, hFE, diode, continuity</p> <p>DMM-10 (\$19.95): 3 1/2 digit, DC/AC V, Ω, hFE, diode, signal output(+3V, -0.5Vsq., 50% duty)</p>	<p>Digital Volt, Analog Current PS-8200 (\$179.95) 30V/3A PS-8201 (\$239.95) 30V/5A</p> <p>Digital Volt & Current Display PS-8300 (\$199.95) 30V/3A PS-8301 (\$259.95) 30V/5A</p>	<p>CAP/COUNTER</p> <p>CAP-15 (\$49.95): 3 1/2 digit, 0.1pF-20mF, 9 Ranges, 0.1pF resolution, zero adjustment</p> <p>LCR-24 (\$119.95): 0.1$\mu$H-200H, 0.1pF-2000$\mu$F, 0.01$\Omega$-20M$\Omega$, diode test. <i>New Model</i></p> <p>LCR-131D (\$219.95): autorange, 0.1$\mu$H-10kH, 0.1pF-10mF, 1m$\Omega$-10M$\Omega$, Q Factor, serial/parallel, 120Hz/1kHz testing mode.</p> <p>FC-1200 (\$129.95): 1.25GHz Handheld, 8 digits display, 10ppm accuracy, sensitivity 5mV (130-350MHz), 30mV (440MHz)</p>	<p>FLUKE</p> <p>12B \$ 94.95</p> <p>70-III \$ 99.00</p> <p>73-III \$125.00</p> <p>75-III \$155.00</p> <p>77-III \$173.00</p> <p>79-III \$195.00</p> <p>87-III \$325.00</p> <p>92B-III \$1,445</p> <p>96B-II \$1,695</p> <p>99B-III \$2,095</p> <p>105B \$2,495</p> <p>123-III \$1,130</p> <p>863E \$555</p> <p>867B \$740</p>	<p>SPECIALTY</p> <p>AC Current Probe \$34.95</p> <p>DC/AC Current Probe \$79.95</p> <p>Mini AC Clamp \$59.95</p> <p>AC Clamp w/temp \$89.95</p> <p>DC/AC Clamp \$109.95</p> <p>Thermometer \$69.95-\$89.95</p> <p>IR Thermometer \$189.95</p> <p>Sound Level Meter \$169.95</p> <p>Tachometer \$169.95-\$219.95</p> <p>EMF Tester \$69.95</p> <p>Pressure Meter \$299.95</p> <p>Watt Meter \$129.95</p> <p>High Voltgae Probe \$59.95</p> <p>pH Meter \$79.95</p> <p>Light Meter \$79.95-\$89.95</p>
		<p>Single Output DC Power Supplies</p> <ul style="list-style-type: none"> • Constant current, constant voltage mode • Short Circuit and overload protected 		<p>Triple Output</p> <ul style="list-style-type: none"> • Independence of Tracking operation • Parallel to double current output (PS-8102 & PS-8103 only)

<p>20 MHz Scope</p> <p>OS-620 \$324.95</p> <ul style="list-style-type: none"> • Most economical scope • Dual CH/X-Y operation • 1 mV/div sensitivity • Z-axis input, CH1 output • TV syn, ALT trigger • 2 probes (x1, x10) 		<p>Cursor Readout</p> <p>OS-626G \$599.95</p> <ul style="list-style-type: none"> • Readout & Cursor meas • Dual CH / Delay sweep • Built-in delay line • ALT trigger, Hold-Off • Z-axis input, CH1 output • 2 probes (x1, x10) 		<p>Triple Output</p> <ul style="list-style-type: none"> • 2 variable out 0-30V, 0-3A • One fixed 5V, 3A output • Auto track, serial, parallel • Const. volt, current mode • 4 analog or 2 digital display <p>PC-3030 (\$499.95)</p> <p>PC-3030D (\$549.95) digital</p>		<p>Single Output</p> <ul style="list-style-type: none"> • Const voltage, current mode • Voltage regulation $\leq 0.01\%$ • Current regulation $\leq 0.2\%$ <p>PS-1850 (\$214.95) 18V/3A</p> <p>PS-1830D (\$214.95) 18V/3A</p> <p>PS-1850D (\$244.95) 18V/3A</p>		<p>Programmable</p> <ul style="list-style-type: none"> • Auto serial/parall. (PPT ser) • Auto track (PPT series), IEEE-488.2 and SCPI compatible command set <p>PPS-1860G (\$1,149.95) 18V/3A</p> <p>PPS-3635G (\$1,149.95) 36V/5A</p> <p>PPT-1830G (\$1,499.95) 18V/3A</p> <p>PPT-3615G (\$1,499.95) 36V/5A</p>		<p>AUDIO/RF/FUNCT. GEN.</p> <p>RF Generator • SG-4160 (\$124.95) 100kHz-150MHz sinewaves in 8 ranges</p> <p>• SG-4162AD (\$229.95) with 6 digit counter</p> <p>Audio Generator • AG-2601 (\$124.95) 10Hz-1MHz, 0-8Vpp sine, 0-10Vpp squarewave</p> <p>• AG-2603AD (\$229.95) with 6 digit counter</p> <p>Function Generator • FG-2100A (\$154.95) 0.2Hz-2MHz, 5mV-20Vpp</p> <p>• FG-2103 (\$329.95) Sweep 0.5Hz-5MHz</p>	
--	--	--	--	--	--	--	--	---	--	--	--

<p>DC POWER SUPPLIES</p>		<p>FUNCTION GENERATOR</p>		<p>BENCHTOP DMM</p>	
<p>OS-620 \$324.95</p> <ul style="list-style-type: none"> • Most economical scope • Dual CH/X-Y operation • 1 mV/div sensitivity • Z-axis input, CH1 output • TV syn, ALT trigger • 2 probes (x1, x10) 		<p>OS-626G \$599.95</p> <ul style="list-style-type: none"> • Readout & Cursor meas • Dual CH / Delay sweep • Built-in delay line • ALT trigger, Hold-Off • Z-axis input, CH1 output • 2 probes (x1, x10) 		<p>DM-8034 (\$179.95) 3 1/2 dgt AC/DV(V,A), C, Ω, diode</p> <p>DM-8040 (\$339.95) 3 1/2 dgt ACV to 50kHz, true rms</p> <p>DM-8055G (\$889.95) 5 1/2 dgt • 0.006% accuracy, GPIB • dBm, auto, REL, min/max</p>	

ALFA ELECTRONICS P.O. BOX 8089 PRINCETON, NJ 08543-8089

TEL: (800)526-2532 / (609) 897-1135 FAX: 609-897-0206

E-mail: sales@alfaelectronics.com

Call / Write / Fax / Email for FREE CATALOG

Visa, MC, AMEX, COD, PO Accepted. OEM Welcome.

1 Year Warranty (2 Years for GW/Instek)

SUPPORTS DEVICES TO 32 MEG

EPR0M+

A device programming system for design, repair and experimentation

- ◆ EXCEPTIONAL POWER FOR THE PRO
- ◆ EASY-TO-USE FOR THE NOVICE
- ◆ INCLUDES STEP-BY-STEP TUTORIAL

Here's what you get: A rugged, portable programming unit including the power pack and printer port cable both of which store inside the case. A real printed user and technical manual which includes schematic diagrams for the programming unit plus diagrams for all technology family adapters.* Comprehensive, easy-to-use software which is specifically designed to run under DOS, Windows 3.1, 95 and 98 on any speed machine. The software has features which let you READ, PROGRAM, COPY and COMPARE plus much more. You have full access to your system's disk including LOADING and SAVING chip data plus automatic processing of INTEL HEX, MOTOROLA S-RECORD and BINARY files. For detailed work the system software provides a full screen buffer editor including a comprehensive bit and byte tool kit with more than 20 functions.

Broad device support: FIRST GENERATION EPROMS (2708, 27MS2716*, 25XX) SECOND GENERATION EPROMS (2716-28(08), 40 AND 42 PIN EPROMS* (27C1024-27C160) FLASH EPROMS (28F, 29C, 29E1, 29F), EEPROMS (2816-28(010), NVRAMS (12XX, X2210, 12) 8 PIN SERIAL EEPROMS* (24, 25, 85, 93, 95, 8001(A) PLUS E1400/M158657* AND ER5901 BIPOLAR PROMS* (72S, 82S), FPGA CONFIGURATORS (17CXXX) MICROCONTROLLERS* (874X, 875X, 87C5XX, 87C75X, 89C5X) ATMEL MICROS* (8-40) PIN 89C051, 89SXXX (AVR) 90SXXX PIC MICROS* 8, 18, 28, 40 PIN (12CXXX-16CXX, 16FX, 17C) MOTOROLA MICROS* (68705P34*, R3, 68HC705, 68HC711)

\$289

*REQUIRES SNAP-IN ADAPTER BOARD (FACTORY DIRECT) OR BUILD YOURSELF \$5.00 SHIPPING + \$5.00 C.O.D.
1 YEAR WARRANTY - 30 DAY MONEY BACK GUARANTEE VISA*MASTERCARD*AMEX

ANDROMEDA RESEARCH, P.O. BOX 222, MILFORD, OH 45150
(513) 831-9708 FAX (513) 831-7562 website - www.arlabs.com

Home Automation

- World's Largest Selection!
- Best Customer Service
- Top Technical Support

Take a step into the future -- discover the latest in innovative home technology, from remote controls to high-tech toys to voice-activated systems. We will show you the *smart* (and easy!) way to automate your home.

Lowest Prices Guaranteed!

call **800-SMART-HOME**
800-762-7846

or visit us on the web @ **smarhome.com**
to order your **FREE** catalog today!

Order 24 Hours • 7 Days

HOME AUTOMATION SYSTEMS, INC.

FREE
128 page full color catalog!

Dealers/Resellers ask about our SmartHome PRO Dealer Program 800-949-6255

Building a Micro Robot ?

MicroCore-11™

- tiny 2" x 2" stackable 68HC11 microcontroller module
- 32K SRAM plus 8K or 32K EEPROM
- RS232, 5V regulator, 8MHz xtal
- download programs via you PC serial port
- use assembler or BASIC (both included)

8K Starter Package #MC11SP8K.....US\$75.00
32K Starter Package #MC11SP32K.....US\$89.00
Motor driver board and accessories available.

Technological Arts
26 Scollard Street
Toronto, Ontario
Canada M5R 1E9
Phone: (416) 963-8996
Fax: (416) 963-9179

www.technologicalarts.com

Call Today And SAVE!

Unbeatable PRICES!

CABLE TV

**DESCRAMBLERS
CONVERTERS • FILTERS
VIDEO STABILIZERS**

FREE ➤ 30 Day Trial
FREE ➤ Product Catalog
FREE ➤ 1 Year Warranty

100% MONEY BACK GUARANTEE

Arrow Technologies
Omaha, Nebraska

**TOLL FREE
888-554-ARROW**

888-554-2776

Carpet Rover Kit \$115.00 Plus S&H

Lynxmotion

You can build this Mobile Robot

This easy to build mobile robot base is an excellent foundation for many different robotic experiments. The large 3" wheels handle rough terrain. Use the robot for demonstrating bumper switch or IR obstacle avoidance, maze negotiation, line following, light following, beacon locating, robot sumo, and robot art, to name a few. The kit includes the hardware, structural components, Hitec servos, wheels, First Step micro, software, and an illustrated assembly manual. It's a lot of fun to build and even more fun to operate.

We have many more cool robots, check out our web page or ask for our free catalog!

Lynxmotion, Inc.
104 Partridge Road
Pekin, IL 61554-1403
www.lynxmotion.com

2100 2100
Tel: 309-382-1816
Fax: 309-382-1254
sales@lynxmotion.com
tech@lynxmotion.com

For 26 EASY ways to help SAVE the EARTH CALL 1-800-488-8887.

SINGERS! REMOVE VOCALS

Unlimited, Low Cost, Instantly Available Background Music from Original Standard Recordings! Does Everything Karaoke does. Better and gives you the Thompson Vocal Eliminator. Free Brochure & Demo Tape. LT Sound Dept PE 7988 LT Parkway, Lithonia, GA 30058 Internet: http://www.LTsound.com 24 Hour Demo/Info Request Line (770)482-2485 • Ext 49 When You Want Something Better Than Karaoke!

BUGGED??

EAVESDROPPING is unbelievably widespread! Electronic Devices with amazing capabilities can be monitoring your telephone and room conversations RIGHT NOW! Are you sure you're safe? **FREE CATALOG tells you fast!** Includes Free Bonus details on fantastic opportunities now open in Counter-Surveillance field. Exciting, immensely interesting and EXTREMELY profitable (up to \$250 hr) full/part-time come. Call Now! **1-800-732-5000**

BROADCAST EQUIPMENT

We manufacture & carry Stereo FM Transmitters, RF Amplifiers, Low Pass Filters, Antennas, DJ Mixing Boards & Consoles, Mics, Compressor/Limiters, Digital Reverbs, Automation Software, RF Test Equipment, RF Parts including 8GY133's, and much more! Call For Free Catalog.

Progressive Concepts
PO BOX 586 STREAMWOOD, IL 60107
(630)736-9822 FAX: (630)736-0353

Kenwood CS-4125 Sale!!!

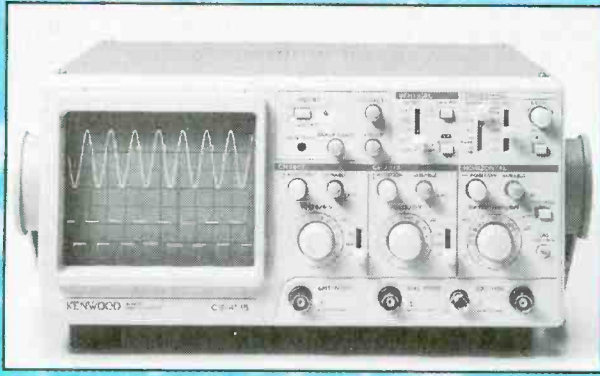

Free **KENWOOD** t-shirt
with purchase of
CS-4125 oscilloscope!!!

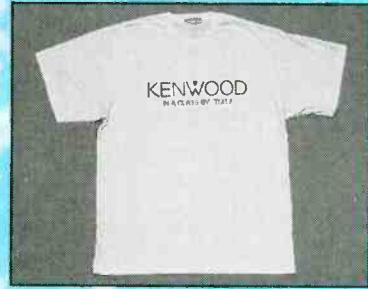

KENWOOD

MODEL CS-4125

20 MHz, 2 Channel, includes probes
Suggested Price \$595.00

SUPER SPECIAL \$389.00!!!

PRINT™
Products International

8931 Brookville Rd * Silver Spring, MD, 20910 * 800-638-2020 * Fx 800-545-0058

www.prodintl.com

SPARE SCOPE PROBE SPECIAL:

Kenwood PC-35 - 10:1, DC to 50 MHz	
Regular \$62.00	SALE \$29.95
Kenwood PC-41 - 10:1/1:1, DC to 50 MHz	
Regular \$62.00	SALE \$29.95

Call today for your free 84 page test & measurement instrument catalog!

CIRCLE 142 ON FREE INFORMATION CARD

DATA ACQUISITION & CONTROL

AFFORDABLE PLUG-IN BOARDS FOR PC's ISA BUS

ANA100 Analog I/O \$ 99



- * 8 Channel 8-Bit
- * 0 to 5 Volt Input
- * 14 TTL I/O lines
- * Analog Output
- * 400KHz Sampling

DIG100 Digital I/O \$ 39



- * 82C55 PPI
- * 24 or 48 TTL I/O
- * Lines option
- * Selectable Base Address

ANA150 Analog/Counter... \$ 89



- * 8 Channel 8-Bit
- * 0 to 5 Volt Input
- * 3 16-Bit Counters
- * 400KHz Sampling

DIG200 Counter I/O \$ 79



- * 3 16-Bit Counters
- * 8 TTL Input lines
- * 8 TTL Output lines
- * Selectable Clock Frequency Input

ANA200 Analog I/O \$ 79



- * 1 Channel 12-Bit
- * 0 to 5 Volt Input
- * optional bi-polar
- * 100KHz / 300KHz Sampling rate
- * 24 TTL I/O lines

ANA201 Analog \$ 119



- * 8 Channel 12-Bit
- * x1, x5, x10, x50 Programmable Channel gain
- * 100KHz Sampling rate

On-Line Product Catalog at Our Web Site

<http://www.Bsof.com>

E-Mail: Sales@Bsof.com

BSOFT Software, Inc.

444 COLTON ROAD * COLUMBUS, OH 43207
PHONE 614-491-0832 * FAX 614-497-9971

Electronic Training Videos



Learn electronics quickly and easily with UCANDO's computer-animated training videos. Students can learn at their own pace and professionals will find the UCANDO videos to be a valuable source of reference material. If these videos aren't the best learning tools you've ever seen, return them within 30 days for a

complete refund. These videos are being used by Tech-Schools, CET's, Military Branches, Ham Operators, Industries, and more, across the United States and around the world. Order today and see how UCANDO is ...

"Changing The Way The World Learns Electronics."

VCR Maintenance & Repair .. \$29.95 All others .. \$44.95 each
 * Intro to VCR Repair * Direct Current * Alternating Current *
 Semiconductors * Power Supplies * Amplifiers * Oscillators * Digital 1 *
 Digital 2 * Digital 3 * Digital 4 * Digital 5 * Digital 6 * AM Radio * FM
 Radio Part 1 * FM Radio Part 2 * TV Part 1 "Intro to TV" * TV Part 2
 "The Front End" * TV Part 3 "Audio" * Fiber Optics * Laser Technology *

SAVE!!! 6 videos for only \$240 or 12 videos for only \$450



1-800-678-6113

or mail check or money order to:

UCANDO Videos

P.O. Box 928

Greenville, OH 45331



FREE Shipping ... FREE Catalog

Fantastic DMM Offer!

Don't let this price fool you. This meter is a digital multimeter designed for engineers and hobbyists. Equipped with 5 functions and 19 ranges. Each test position is quickly and easily selected with a simple turn of the FUNCTION/RANGE selector rotary switch. Rubber Boot Included! Display: 3-1/2 Digit LCD, 21mm Figure Height with Automatic Polarity. Overrange Indication: 3 Least Significant Digits Blank. Temperature for Guaranteed Accuracy 23°C ±5°C RH<75%. Temperature Ranges: Operating: 0°C to 40°C (32°F to 104°F) Storage: -10°C to 50°C (14°F to 122°F) Power: 9V Alkaline or Carbon-Zinc Battery (NEDA 1604). Low Battery Indication: BAT on Left of LCD Display. Dimensions: 188mm(L) x 87mm(W) x 33mm thick. Net Weight: 400g. Get All the Specs From Our Web Site



7 1/2" Pro Modular Crimping Tool Kit

ONLY \$19. Includes: Heavy Duty Ratchet Crimp Tool, 5 Die Sets! Details on our Web Site

True RMS DMM

ONLY \$69. Full Sized, 4 1/2 Digit, Frequency Range to 20 KHz, Capacitance Ranges from 200 pF to 20 uF, N/A, Audible Continuity, 20A max 1000VDC/200A max & 700VAC max, Selectable Data Hold Function



Removable Hard Drive Rack

For IDE/Ultra DMA Hard Drives. We Sold Over 14,000 in 1998! This product can be used with any 3-1/2 IDE hard drive up to 1" high. It includes an electronic keylock for safe removal and insertion. Made of ABS 707 fireproof plastic. Use this product to protect sensitive hard drive data, take your hard drive between work and home or even set up different users with their own hard drives that they physically insert every time they use a PC. Other models available from C.S.I. Include RH10 series and RH20 series, which are interchangeable within the same interface design (IDE or SCSI). Other models are Available. See www.web-tronics.com under "hard drive and accessories" for more details and pictures.



ONLY \$14.95

Our Most Sophisticated DMM

We Sold Over 700 Last Year! SALE \$139 Reg. \$169. with RS-232 Interface & Software, 3-1/4 Digit, 4000 Count, Auto-Ranging with Analog Bargraph. True RMS Mode, 10MHz Frequency Counter, Time Mode with Alarm, Clock, and Stop Watch, Dual Display, 10 Location Memory, 2000 Pk, Avg and Relative Mode, Decibel Measurement, Cap and Ind. Measurement, Temperature Mode (C/F), K Type Temperature Probe Included. Pulse Signal for Logic & Audible Test, Continuity/Diode Test, Logic Test, Auto Power Off/Keep ON Mode, Fused 20A Input with Warning Beeper, Back Light, Data Hold/Run Mode, Safety Design UL1244 & VDE-0411, Protective Holster, Silicon Test Leads



PROTEK 506

COLOR CCD Mini Board Cameras

Low Power Consumption, 1 Lux Illumination, Built-in Electronic Auto Iris for Auto Light Compensation, Internal Synchronization, 12Volts, 400 TV Lines. VM3010PA 33mmx33mmx18mm Pinhole lens with audio \$149.00 \$137.00 5 or more. VM3011-A 45mmx40mmx24mm Standard lens with audio single board \$147.00 \$139.00 5 or more. VM3010-A 33mmx33mmx32mm Standard lens with audio \$144.00 \$129.00 5 or more. Detailed Specs on the Web



Auto-Temp Solder Station with Ceramic Element

ONLY \$39. With Ceramic Heating Element for More Accurate Temp Adjustment, 3 Conductor Grounded Power Cord, 250°C-480°C (470°F-900°F) Extra Tip Options Available. See Web! Fast Heating Feature. For More Info See www.web-tronics.com



www.web-tronics.com Don't forget the dash. In Business Since 1971. Easy to Navigate, Includes a Search Engine That Really Works, New Items Added Constantly. CTRL - D to bookmark this site. Circuit Specialists Inc.

CCD B&W Board Cameras

ASIC CCD Area Image Sensor, Extremely Low Power Consumption, 0.5 Lux Min Illumination, Built-in Electronic Auto Iris for Auto Light Compensation. Detailed Specs on the Web

Infra-Red! VMCB21 44mmx38.5mmx28mm with 6 Infra-Red LEDs, 12V, 380 horz TV lines. ON SALE \$59.00 any qty. Reg. \$69.00

VM1030A 10mmx30mmx26mm Standard lens with audio, 12V, 430 horz & vert TV lines \$59.00 \$49.00 5 or more

VM1030PA Pinhole lens with audio, 30mmx30mmx25mm, 12V, 430 horz and vert TV lines \$59.00 \$49.00 5 or more

VM1035A 42mmx42mmx25mm Standard lens with audio, 12V, 430 horz & vert TV lines with back light compensation \$77.00 \$68.00 5 or more

VM1036A 32mmx32mmx25mm Standard lens with audio, 12V, 430 horz & vert TV lines, reverse mirror image feature \$69.00 \$63.00 5 or more

Bullet CCD Cameras B&W and Color

Smart Rugged Metal Housing, Extremely Low Power Consumption, 12 Volt, CCD Area Image Sensor for Long Camera Life, Built-in Electronic Auto Iris for Auto Light Compensation, No Blooming, No Burning, 0.1 Min Lux Illumination (B&W), 1 Lux Min Lux Illumination (color)

VMBLT3025W Digital Color, Weatherproof 20mm(D)x83mm(L) \$219.00 \$199.00 5 or more

VM3LT1020W B&W Weatherproof 21mm(D)x58.5mm(L) \$96.00 \$89.00 5 or more

VMBLT1020A B&W with audio 21mm(D)x55mm(L) \$85.95 \$77.00 5 or more



Protek Amazing Test Equipment Offers

Series 6500 Deluxe 20MHz/40MHz/60MHz/100MHz Dual-Trace Oscilloscopes. Latest Designs! Asia's currencies are devalued against U.S. dollars. Take advantage of GREAT prices while they last!

Protek oscilloscopes: #6504 - 40MHz \$569, #6510 - 100MHz \$799, #6502 - 20MHz \$289, #6506 - 60MHz \$689. For More Information See www.web-tronics.com

Amazing Test Equipment Offers

10MHz Pulse Generator #B1010 \$269. Max. 10MHz Rate, Adjustable Delay Time & Pulse Width, External Oscillator Input, Variable Output Level Control, Delay Function, Frequency Counter. See the web site for details

2GHz Universal Counter #U2000A \$319. Frequency, Period, Totalize Ratio Measurements, Low Pass Filter, 3 Channel Input (CH A, CH B, CH C), Variable Trigger Level, 8 Digit LED Display, 4 Step Gate Time Control, F1/I0 Input Attenuator, Self Test. See the web site for details

1GHz Multifunction Counter #B-818 \$209. Frequency, Period, Totalize Measurements, Low Pass Filter, 2 Channel Input (100MHz, 1GHz), 8 Digit Gate Time Control, 1/20 Input Attenuator. See the web site for details

Digital Multimeter #9902A \$189. AC/DC Voltage, AC/DC Current, Resistance Measurement, 4 1/2 Digit Display, Over Range Indication, 7 Functions, Data Hold Function. See the web site for details

10MHz Sweep Function Generator #B-810 \$559. Sine, Triangle, Square, Ramp, Pulse Waveform, Gate & Trigger Output, Burst Waveform Output, Sweep Function (Linear/Logarithmic), VCC Input, GCV Function, AM Modulation, Variable Symmetry, Output Attenuator, DC Offset, Frequency Counter. See the web site for details

2MHz Sweep Function Generator #9205 \$219. Sweep Function Width: 1:1 to 1000:1, Sweep Rate: 0.5Hz to 50Hz, Attenuation: -20dB, Frequency Range: 0.02Hz to 2MHz in 7 Ranges, Outputs: Sine, Triangle, Square Wave, Pulse, Ramp, Swept Sine Wave, Sync Out: TTL, Square Wave. See the web site for details

20 Amp Switching Power Supply #SPS-1020G \$99. With Overvoltage Protection and Variable DC Output Specifications. Input Voltage: AC 110V ±5%, 50Hz/60Hz, Output Voltage: DC 9V - 15V variable, Polarity: Negative ground, Current (13.8V): 25A peak, 20A continuous, Overvoltage Protection, Cooling fan inside chassis. See the web site for details

2MHz Sweep Function Generator #9205C \$279. Sine, Triangle, Square, Pulse, Ramp, Swept Sine Waveform, Sync. Output (TTL Square Waveform), Sweep Function, VCC Input, DC Offset, Variable Symmetry. See the web site for details

PLASMA BALLISTIC GUN

SHOOTS A HIGH VELOCITY PROJECTILE
 Uses New Technology to Generate High Propellant Pressure Without Chemical Reactions
 Velocities Up To 3000 m/sec with 50mg Projectile!!
 Easily Scaled Up or Down
 Easy to Build-Kit and Parts Available
 Approximately .16 Caliber Bore
PPR01 Plans, Parts Lists and Sources.....\$20.00
 Includes Our HEP Series Plans Used for RAILGUNS, COIL GUNS, EMP LEVITATION, ANTIGRAVITY, MASS WARPING, LATTICE SNAPPING etc



BURNING LASER RAY GUN

BLASTS THRU THE HARDEST OF METALS!
 All Parts Available
A FUTURISTIC CONCEPT!!
LAGUN2 Plans.....\$20.00



BURNING CO2 BENCH LASER

HOTTER THAN MOST TORCHES!
 Easy to Assemble
LC7 Plans.....\$20.00



TAKE CONTROL!!

ELECTRONIC HYPNOSIS & MIND MACHINES
 Electronic Circuitry Induces Hypnotic as Well as ALPHA Relaxed States of the Mind. Place Subjects "Under" Your Control. Enhances Hidden PSYCHIC Ability in Many People!
MIND Plans.....\$15.00
MIND2K Kit and Plans.....\$49.95
MIND20 Assembled.....\$89.95

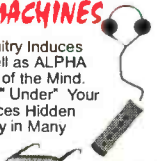

JACOBS LADDER

Observe a pyrotechnical display of "traveling" fiery plasma. Starts off as 1/2" arc and expands to over 3" before evaporating into space. This is an excellent attention getting display as well as a winning science project!! With arc control.



JACK1 Plans.....\$8.00
JACK1K Kit Minus Case.....\$129.95
JACK10 Ready to Use.....\$249.95
12KVGEN20 Pwr Supply Only.....\$99.95
12KVGEN2K Kit of Pwr Supply.....\$79.95

ALL NEW CYBERNETIC EAR!

Enhances Normal Hearing 3 to 4 Times. Provides That Extra "Edge" for Hunters Trackers Nature Enthusiasts
 Adjustable Volume Control Fits Into Either Ear Built In Long Lasting Batteries
CYBEAR Ready to Use.....\$19.95



PHASOR PAIN FIELD PISTOL

Blast out rats and rodents with high power Shock Waves Handheld and Battery Operated
PPPI Plans.....\$8.00
PPPIK Kit/Plans.....\$49.50
PPP10 Ready to Use.....\$79.50



TELEPHONE TAPING SYSTEM

EXTENDED X4 PLAY
 Tapes Both Sides of Phone Conversation - Check Laws!
TAP30X Ready to Use.....\$84.95
BEEP10 Beeper Alert.....\$29.95



TRANSISTORIZED TESLA COIL

URNS A LIGHT BULB INTO A SPECTACULAR PLASMA DISPLAY
 Transmits Wireless Energy. Brush and Corona Discharge. Noiseless Operation. Pyrotechnic Effect. 115 VDC/5 Amps or Battery 12 VDC/15 VAC Optional Converter. Adjustable Frequency Control For Effect.
 Shown With Oil Fill Option



TCL5 Plans.....\$8.00
TCL5K Kit/Plans.....\$59.95
TCL50 Ready to Use.....\$109.95
12DC/7 12VDC@7Amps.....\$39.95

3Mi FM VOICE TRANSMITTER

Safety Product Allows Listening to Children or Invalids in Hazardous Areas. Pools, Ponds etc. Great Security Intrusion Alert! Uses FM Table Top Radio. Become the local neighborhood D.J.
FMV1K Kit/Plans.....\$39.95



MICRO TESLA COIL

Lights up a 4 ft Fluorescent Tube Without Contact!!! Yet Only 3" Tall!
 Super Magic Trick Low Cost Science Project 12 VDC/115 VAC Operation
MTC1K Kit/Plans.....\$19.95
MTC10 Ready to Use.....\$34.95



HOVERBOARD PLANS **Research Project**

Kit Soon to be Available
 28 Pages of "how to" build a magnetic force field capable of containing a column of ionized air up to several psi! Includes theory on how to build a HOVERBOARD prototype capable of lifting 200 lbs.
HOVER Plans and Data.....\$25.00



1 800 221 1705 ORDERS ONLY! FAX 1 603 672 5406 INFO 9-5pm 1 603 673 4730 FREE CATALOG ON REQUEST
 Pay by MC, VISA, Cash, Chk, MO, COD. Please Add \$5.00 S&H plus \$5.00 if COD. Overseas Please Contact for PROFORMA

LEADER

For Professionals Who Know The Difference

- Oscilloscopes
- Video Sync/Test Generators
- Waveform Monitors/Vectorscopes
- EFP/ENG Instruments
- RF Signal Level Meters
- Audio Generators & Meters
- Frequency Counters
- Meters & Bridges
- Power Supplies
- Function Generators
- RF Generators

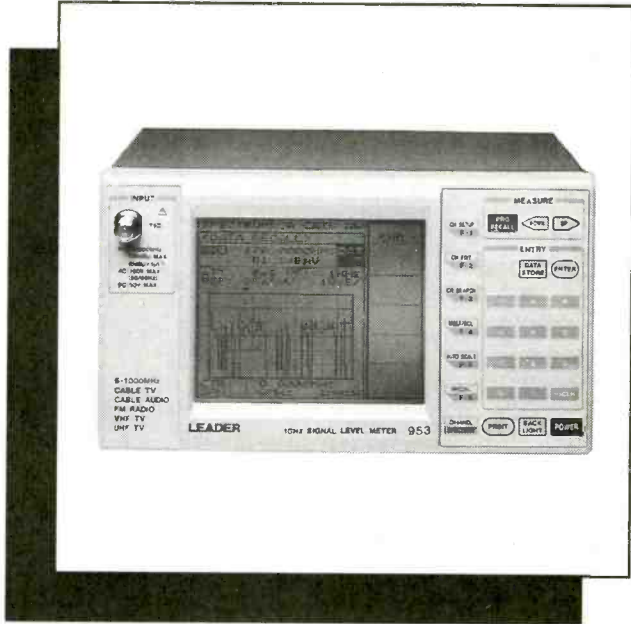

PRINT 
 Products International

Call, fax or email for your free test and measurement instrument catalog today!
800-638-2020 * Fax 800-545-0058
www.prodintl.com

Test Instruments, Equipment, Tools & Supplies For Electronic Production, Maintenance & Service
 8931 Brookville Road, Silver Spring, MD, 20910 * 800-638-2020 * Fax 800-545-0058

Development Boards, Microcontrollers, Kits, Control and Measurement

Development, Prototype and Testing

- **JCM Vulcan Logic Trainer:** Design and test digital circuits in minutes with this trainer and a breadboard. **\$32**
- **JCM Advanced dig daughterboard** **\$39**
- **JCM Analog Trainer:** Use on its own, or to complement to the logic trainer. Test analog circuits in minutes. **\$45**
- **UTI PIC-Micro Trainer:** This system gives you the flexibility to test and experiment with micro based designs. Includes a 64K-bit non-volatile E² mem. and RS-232 and RS-485 drivers. **\$129**
- **UTI Control Trainer:** Real world interface for the trainer series, with inputs and outputs for measurement and control. analog cond., relays, buffered dig I/O, and more. **\$69**
- **JCM Cybug1 kit:** a great little robot kit for the hobbyist **\$32**
- Prototyping breadboard to fit the above

Serial Control and Measurement

- **UTI-XX-232-485 Series:** measure inputs and trigger events over serial. uses simple ASCII protocol **\$99-\$299**
- UTI-05-XXX: 0-5VDC 4 channel 8 bit A/D
- UTI-DI-XXX: 0-30VDC 4 channel digital Input adjustable trigger level
- UTI-OC-XXX: 8 channel open collector outputs, opt 5V pull-up, drive relays or solenoids
- UTI-RE-XXX: 4 SPDT relays w/ 2A contacts
- UTI-PM-XXX: 2 channel PWM output with two buffered digital outputs, good for motor control apps. opt H-bridge version.
- UTI-WM-XXX: ambient temperature and relative humidity. 8 bit resolution - More available.
- **UTI- 232-485:** Speak to an RS-485 device with your PC, extend 500' to other serial devices, or chain several UTI-XX-485 devices. **\$129**

Microcontroller Boards and Interfaces

- These boards include voltage regulation, 64K-bit serial E², RS-232 and RS-485 drivers, interface with screw terminals and/or stackable expansion headers.
- **UTI-P76F:** A flash PIC micro dev board **\$169**
 - **UTI-11A1:** A 68HC11 based SBC **\$189**
- Some interfaces available:
- 4 and 8 channel analog zero and span cct
 - 8 SPDT relays with 2A contacts
 - 2A dual H-bridge for motors and solenoids
 - Audio capture, 2-4 min of audio
 - Micro modem rates @ 2400 - 28.8
 - LCD, 2 line x 16 char, and 4 line x 20 char
 - Ambient temperature and relative humidity
- **UTI-I2CM-XXX-X:** Non-volatile I²C memory boards (up to 512Kb per board!) **\$39**

Other Exciting Products

- **UTI-WC1: Serial CCD Camera.** Board level, takes serial commands through RS-232 at up to 115K Baud, returns CCD data in various res. Great for pics and experimenting. PC SW incl **\$249**
- **UTI-SCL: WinCam.Live.** Serial port based webcam system for your PC. **\$499**
- **UTI-SCP: SecureCam Pro.** Remote access surveillance camera, event trigger, motion detection, outdoor encl. available **\$599**
- **UTI-ACC:** Capture and play 2-4 min of audio. line level input, dry contact trigger **\$129**
- **UTI-MP-XXX:** serial RS232 radios, 900MHz narrow band RF, ch selectable, 1000' range outdoor, combine with our control and measurement products for a telemetry system. **\$519**

* All prices in US\$

**Shipping and handling not included

We also provide affordable electronic design, consulting, assembly, and product development.



UTI
Unbound
Technologies Inc.
1-877-UNBOUND
(1-877-862-6863)

#25-1725 30 Ave NE Calgary, Alberta, CANADA T2E 7P6

Tel: 403-291-0054 Fax: 403-291-0017

Payment by Cash, Chk, MO, COD

Call us to receive details via fax, mail or email.

OSCILLOSCOPES

from \$169 !!!

ATC O-Scope uses printer port to turn PC-AT into Digital Storage Oscilloscope, Spectrum Analyzer, Freq. Counter, Logger, DVM. DC-500KHz

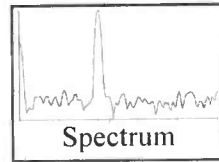
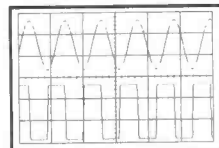

- Print, log to disk, or export data
- Accepts standard scope probes
- Uses standard printer port
- Small and portable
- Works with laptops
- Same day shipping
- Made in U.S.A.
- Single channel units from \$169
- Dual channel units from \$349

Options:

- Probe sets
- Automotive probes
- Battery packs

Order yours today.

800 980 9806

MC/Visa/Amex

Allison Technology Corporation

2006 Finney-Vallet, Rosenberg, TX 77471

PH: 281 239 8500, FAX: 281 239 8006

<http://www.atcweb.com>

New and Pre-Owned Test Equipment

Goldstar



Model OS-5100 → **\$899.00**
Full 100 MHz Bandwidth!

- Dual-Channel, High Sensitivity
- TV Synchronization Trigger
- Calibrated Delayed Sweep
- Includes Two Probes, 2 Year Warranty

Spectrum Analyzer
Avcom PSA-37D

Satellite Downlink
Installation
Maintenance & Service

- Band 1 10 - 1750 MHz
- Band 2 3.7 - 4.2 GHz
- Built-in DC Block & Power for LNA/LNB's
- Line or Battery Powered

Only \$2,475.00!

We Buy Surplus Test Equipment

SIMCHECK®II PLUS Module Tester

- * Tests SIMMs/168 p DIMMs
 - * Stand alone/portable
 - * Identifies Module properties
 - * Advanced Setup Capabilities
- Only \$2750.00!

(1-800-996-3837)

Leader CATV Signal Level Meter Model LF 941

- ✓ TV/CATV Coverage from 46 - 870 MHz
- ✓ Video/Audio Carrier Measurements **\$695.00!**

Just Released! → "Series III" Multimeters
Fluke Model 87III \$319.00 !!!



TOLL FREE 1-800-99-METER

Pre-Owned Oscilloscope Specials

Tektronix 2213	60 MHz	\$549.00
Tektronix 2215	60 MHz	\$649.00
Tektronix 465	100 MHz	\$599.00
Tektronix 465B	100 MHz	\$729.00
Tektronix 475	200 MHz	\$829.00
Tektronix 475A	250 MHz	\$999.00

- Professionally Refurbished
- Aligned & Calibrated to Original Specifications
- The Industry Standard of Oscilloscopes
- 1 Year Warranty - The Longest Available!!!

See us on the Web!
www.fotronic.com

Test Equipment Depot

A FOTRONIC CORPORATION COMPANY

99 Washington St. Melrose, MA 02176

(781) 665-1400 • FAX (781) 665-0780

email: sales@fotronic.com



The 5300 Series, one of the world's finest digital multimeters. The best of the ASYC II Series, it has the best accuracy, a built-in counter, and displays AC voltage as resistive power or dB (impedance selectable), saving you the time of making the calculation. A careful examination of the performance features and user-conscious design will tell you that you hold a superior DMM in your hand, designed with measurement capability needed by users who demand the best.



MFG	MODEL	ACC'Y	LIST	SPECIAL PRICE
B&K	5360/MX53B	0.1%	\$229.00	\$129.00
B&K	5380/MX55	0.025%	\$309.00	\$139.00
B&K	5390/MX56B	0.025%	\$325.00	\$149.00

(resistive power on model #5390/MX56B)

- meters made in France by Metrix for B&K, feature 50,000 count capability, bargraph, true RMS, mains disturbance indication, good transient protection, a wide temperature range, conform to IEC 1010 class 2 safety compliance and feature a 3 year warranty

PRINTTM
Products International

Call, fax or email today for complete specs, a free B&K Precision catalog, and a copy of our 84 page test and measurement instrument catalog

8931 Brookville Rd * Silver Spring, MD, 20910
800-638-2020 * Fx 800-545-0058 * www.prodintl.com * sales@prodintl.com

CIRCLE 153 ON FREE INFORMATION CARD

GREAT FOR TEST FIXTURE BUILDING

FREE!
PHONE, FAX, WRITE OR E-MAIL WITH YOUR MAILING ADDRESS MUST MENTION OFFER "LAB199"

PRE-PUNCHED END PANELS ALSO AVAILABLE
9 BOX SIZES
25 PREPUNCHED END PANELS

LAB-1
(1.5" x 2.0" x 0.75")

ALSO IN STOCK AT:
JENSEN TOOLS: 800-438-1194
MCM ELECTRONICS: 800-543-4330
TECH AMERICA: 800-442-7271

ALL ALUMINUM CONSTRUCTION **LOW COST**
OFFER GOOD ONLY IN THE 48 STATES. ENDS DECEMBER 20, 1999. LIMIT ONE REQUEST PER CUSTOMER. MAILED 1ST CLASS. ALLOW 1-2 WEEKS FOR DELIVERY.

ORDERS 800-634-3457 * FAX 800-551-2749
OFFICE 702-565-3400 * FAX 702-565-4828
www.sescom.com * info@sescom.com
SES.COM, INC. 2100 WARD DR., HENDERSON, NV 89015
SES.COM, INC. is not responsible for inadvertent typographical errors and prices and specifications are subject to change without notice.

CABLE TV BOXES

(WE'LL BEAT ANY PRICE!)

30 DAY TRIAL * 1YR. WRNTY. * FREE CATALOG
QTY. DISCOUNTS * DEALERS WELCOME!

1-800-538-2225

HABLAMOS ESPANOL

VISA MEXICO C.O.D.

<http://www.tvcableboxes.com>
GLOBAL ELECTRONICS INC.

SURVEILLANCE HIDDEN CAMERAS
DIRECT FROM MANUFACTURER - BEST PRICE IN THE MARKET

Ultra miniature hidden camera. In dome, photo or motion detector w/mic. B/W or Color. Wide view angle. Low light sensitivity + super sharp images, plus video and audio out put. From \$159.00. Also 1/3" B/W board camera w/mic. only \$99.00 USD. Wireless hidden camera, start at only \$249.00 USD. Plus \$5.95 for S/H. Wholesale Welcome. C.O.D. Check Money Order or Visa/MC.

BOLIDE INTERNATIONAL CORPORATION
Ph: (800) 355-0895 or (626) 575-8176
9660 Flair Drive #218, El Monte, CA 91731
<http://www.bolideamazingproducts.com/>

ELECTRICITY
STOP BUYING IT!

Reduce your Electric Bills to **\$10 to \$15 PER MONTH!**
And make **FANTASTIC MONEY** showing friends and neighbors how to do the same! Call Toll Free Now!

FREE INFO! **1 800 668-1878**

BE AN ELECTRONICS TECHNICIAN!

Home study. Learn to repair, service, and install TVs, VCRs, camcorders, stereos, sound and lighting systems, alarms, and more!

FREE LITERATURE:
800-223-4542

Name _____
Age _____ Phone (____) _____
Address _____
City/State _____ Zip _____

The School of Electronics, Dept. ELK341
PCDI, 430 Technology Pky., Norcross, GA 30092

PicC C Compiler \$59
for Microchip's PIC microcontrollers
Supports PIC16C55x, 16C6x, 16C62x, 16C6x, 16C92x PIC families

SnXC C Compiler \$59
Supports **ScnIX ax16ac** and **ax28ac** microcontrollers

Both compilers based on ANSI C standard. Arrays, unions, structures, pointers, strings, function calls, if, for, switch, while, interrupt vectors, in-line assembler code, 8 & 16 bit variables, etc. Outputs Intel Hex format and assembly code. Code optimizer included. Excellent development tools!

DebugIDE Debugger \$79
C source level debugger for PicC and SnXC compilers. Integrated Development Environment. Step, Run, Stop, Reset. Variable monitoring and modification. Oscillator/cable kit (\$39)

732-873-1519 fax 732-873-1582 e grichrc@aol.com
Grich RC Inc. 120 Cedar Grove Ln, Ste 340, Somerset NJ USA 08873
URL: <http://members.aol.com/piccompile>

Website www.j-tron.com

Visit us online and enter our contest for a test meter.
Call J-Tron today!

- Components
- Kits
- Meters

888-595-8766

Do You Repair Electronics?

Repair Databases for
TV, VCR, Monitor, UL
Audio, FCC, and more.

- Over 76,000 records
- Private user forums
- Live on-line chat rooms

RepairWorld.com
Electronics Corp. 1 Regal Sq. Fairburn, OH 45124 (937) 878-9878

SURVEILLANCE

The Latest High Tech Professional Electronic Devices
 Our latest catalog offers a HUGE selection of surveillance, countersurveillance - privacy devices: **spy pinhole camera \$99⁰⁰**, hidden video, **"realtime" 15-Hour telephone recorder \$149⁰⁰**, 12 hour VOX recorder phone call register, bug detectors, phone tap detectors, voice disguisers, locksmithing tools, wireless video, vehicle tracking via the internet and much more. Wholesale/retail. **We will not be undersold.** Catalog \$5.00 or www.spyoutlet.com

SPY OUTLET
 PO Box 337, Buffalo NY 14226
 (716) 691-3476/(716) 695-8660

FREE SAMPLE COPY!

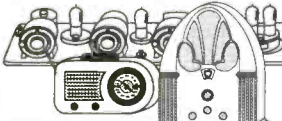

ANTIQUE RADIO CLASSIFIED
Antique Radio's Leading Monthly Magazine

Classifieds - Ads for Parts & Services
 Articles - Auction Prices - Flea Market Info.
 Early Radio & TV - Hi-Fi - Ham Equip.
 Art Deco - Telegraph - 40s & 50s Radios
 Also the source for Books & Price Guides

1-Year: \$39.49 (\$57.95 by 1st Class)
 6-Month Trial - \$19.95. Foreign - Write.
 Call: 978-371-0512 - Fax: 978-371-7129
 A.R.C., P.O. Box 802-L23
 Carlisle, MA 01741
 Web: www.antiqueradio.com

PROGRAMMERS OVER 50 MODELS

ADVANTECH EETOOLS NEEDHAMS DATA I/O ICE TECHNOLOGY HILO SYSTEM GENERAL CHROMA MODULAR CIRCUIT TECHNOLOGY XELTEK



PROMAX EMP-20 MEGAMAX MEGAMAX4 SIM/MSP TESTER EMU/PA

CALL ADVANTECH LABTOOL 629 ICE TECH MICROLY 650 EETOOLS ALLMAX + 409 EETOOLS MEGAMAX 509 EETOOLS MEGAMAX4 369 XELTEK SUPERPRO II 409 XELTEK SUPERPRO II P 249 XELTEK SUPERPRO L 165 XELTEK ROMMASTER II 479 MOD-MCT-EMU/PA 739 STAG ORBIT-32	599 EETOOLS SIMMAX 795 CHROMA SIMM/SIP 359 MOD-MCT-EMU/PA/R 279 MOD-MCT-EMU/PA/R 49 EPROM 1G TO 512K 69 EPROM 1G TO 1MEG 99 EPROM 4G TO 1MEG 199 EPROM 16G TO 1 MEG 89 EPROM 1G TO 8MEG 129 EPROM 4G TO 8MEG 250 EPROM 8G TO 8MEG
--	---

LABTOOL48 MICROMASTER SUPERPRO ALLMAX PLUS ROMMASTER2

General Device Instruments
 Sales 916-393-1655 Fax 916-393-4949 BBS 983-1234
 Web www.generaldevice.com E-Mail icdevice@best.com

CABLE EQUIPMENT
 LOW, LOW WHOLESALE PRICES!
 1-800-521-0512

New 1-piece Jerrold-5 units \$109/ea; 10 u. \$99/ea; 20 u. \$89/ea.
 New RFT-M -5 units \$109/ea; 10 u. \$99/ea; 20 u. \$89/ea.
 Basic Converter -5 units \$75/ea; 10 u. \$65/ea; 20 u. \$55/ea.

WHOLESALE ELECTRONICS
 Check out our website: www.whe.net

The Pocket Programmer \$129.95



The portable programmer that uses the printer port of your PC instead of an internal card.

Easy to use software that programs E(E)prom, Flash & Dallas Ram. 27(C)/28(C)(F)/29(C)(F)/25 series from 16K to 8 Megabit with a 32 pin socket. Adapters available for MCU's 874X, 875X, Pic, 40-Pin X 16 & Serial Eprom's, PLCC, 5-Gang and Eprom Emulator to 32K X 8.

Same Name, Address & Phone # for 13 Years.... Isn't it Amazing?

Intronics, Inc.
 Box 13723 / 612 Newton St.
 Edwardsville, KS 66113 Add \$4.75 COO
 Tel. (913) 422-2094 Add \$4.00 Shipping
 Fax (913) 441-1623 Visa / Master Charge

GALEP-III
 Pocket Multiprogrammer

This size fits all!



- Programs 8-bit and 16-bit EPROMs, EEPROMs, Zero Power RAMs, Flash, serial EEPROMs ♦ GAL, PALCE, ATF ♦ 87xxx, 89xxx, PIC12/16/17Cxx ♦ All DIL devices without adaptor ♦ Lightning fast parallel data transfer (e.g. 27C512 read/compare 2 sec!) ♦ Power supply independent due to rechargeable battery ♦ Uses PC printer port ♦ Hex, JEDEC, and binary file formats ♦ Hex and fusemap buffer editor ♦ Split & shuffle for 8-bit, 16-bit and 32-bit targets ♦ Runs under Win3.1, 95, 98 ♦ 'Remote control' by DDE scripts ♦ Designed for the future due to flexible pin driver technology - new devices will be added every month ♦ Device list, demo software and lifetime free updates from our website www.conteck.com!

GALEP-III Set with cable, battery, recharger \$389.00
 PLCC Adaptor for 8-bit EPROMs / 16-bit EPROMs / GALS each \$149.00

CONTECK
 1951 4th Ave, Ste 301 - San Diego, CA 92101
 Tel: (619) 702-4420 - <http://www.conteck.com>

Cable T.V. Converters & Equipment

Lower Prices Dealer Discounts 30-Day Money back 1-year warranty MC, Visa, AE, COD

Pro Planet

No Florida Sales
www.cable4you.com
1-(800) 888-5585

METERS!

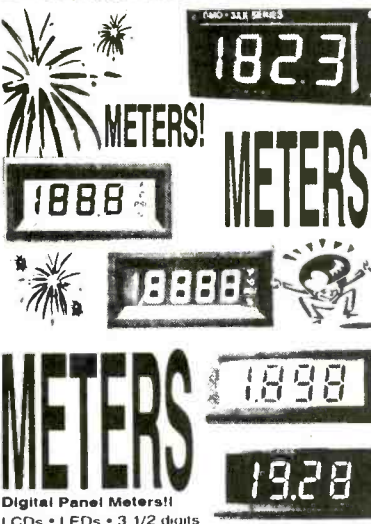

Digital Panel Meters!
 LCDs • LEDs • 3 1/2 digits
 • 4 1/2 digits • loop powered • adjustable voltage input • bezel mount • surface mount • miniatures • big digits • black • red • amber • green • negative backlighting • positive backlighting • RF resistant • EMI resistant • displayed engineering units • snap-in •

For the best selection...
800-356-4920
 Visit our catalog on the web www.knsinstruments.com

KNS Instruments
 PO Box 10158 Bedford, NH 03110-0158
 Fax 800-356-1250

Train At Home To Become A Telecommunications Technician



This is the hi-tech electronics career you've been searching for! Study the ins and outs of fax machines, modems, fiber optics, cellular networks, and more. And learn it all from your own home!

Work for telephone companies, hospitals, or electronics repair shops. And earn as much as \$35,000 a year! Endorsed by the National Association of Radio and Telecommunications Engineers (NARTE), this great ICS® program features a voucher for the NARTE Class IV Technician Certification exam.

Mail Coupon For FREE Facts Or Call Toll Free Today!
1-800-595-5505 ext. 3946
 Call anytime, 24 hours a day, 7 days a week. www.icslearn.com

International Correspondence Schools
 A Harcourt Higher Learning Company
 Dept. AEM079S
 925 Oak Street, Scranton, PA 18515

YES! Send me FREE FACTS on how I can train at home to be a Telecommunications Technician. I understand there is no obligation.

Name _____ Age _____
 Street _____ Apt. # _____
 City/State _____ Zip _____
 Phone () _____

ALL ELECTRONICS CORPORATION

MINI-RIGHT ANGLE GEARHEAD MOTOR

Omron # R2DG-41 Built-in control circuits allow this motor to be used in a continuous or a pulsed mode. In continuous mode the final drive gear turns at 22-45 RPM (3-6 Vdc). In the pulsed mode the final drive gear turns one revolution each time the controller is momentarily pulsed. The motor assembly is 1.75" x 1.25" x 0.5" overall. The nylon final gear is 0.62 diameter and has a little nipple slightly off-center to which a small push-rod could be attached. Motors are in good condition, removed from equipment. Hook-up instructions included.



CAT# DCM-110

\$7⁵⁰ each

10 for \$60.00

Switching Power Supply

Voltek Corp # SPEC7188B

Input: 100 - 240 Vac

Outputs: + 5 Vdc @ 3.70 A,

+12 Vdc @ 0.60 A,

-5 Vdc @ 0.05 A,

+5 Vdc Trickle @

0.1 A. Metal

encased switching

power supply. Standard three-prong IEC socket power input. 7 conductor, Molex-type connector output. 9" x 2.1" x 1.36". UL recognized.

Removed from new equipment.

CAT # PS-27

\$3⁵⁰ each

20 Character X 4 Line LCD

Oprex # DMC 20434-CEM

(PWB 20434-CEM)

5 x 8 dot format.

3" x 1" viewing area.

3.88" x 2.38" module.

Removed from new equipment, may have felt padding on metal bezel. 14 pin single row header is pre-attached. Includes spec/hook-up sheet.

CAT # LCD-46

\$7⁰⁰ each

10 for \$60.00

ORDER TOLL FREE

1-800-826-5432

CHARGE ORDERS to Visa, Mastercard, American Express or Discover

TERMS: NO MINIMUM ORDER. Shipping and handling for the 48 continental U.S.A. \$5.00 per order. All others including AK, HI, PR or Canada must pay full shipping. All orders delivered in CALIFORNIA must include local state sales tax. Quantities Limited. NO COD. Prices subject to change without notice

CALL, WRITE FAX or E-MAIL for our FREE

96 Page CATALOG

Outside the U.S.A. send \$3.00 postage.

MAIL ORDERS TO:
ALL ELECTRONICS CORPORATION
P.O. Box 567
Van Nuys, CA 91408
FAX (818)781-2653

www.allelectronics.com

e-mail allcorp@allcorp.com

BUSINESS OPPORTUNITIES

\$400 Weekly Assembling electronic circuit boards/products from home. For FREE information send SASE: Home Assembly-PE, Box 216, New Britain, CT. 06050-0216

TOO MANY BILLS? Free, Easy Debt Consolidation. One monthly payment - reduced up to 50%! **Genus Credit Management** - Nonprofit. 1-800-299-6778 (1265).

Ready for Success? The Future is Now! Digital Catalog Computer Software. Business Opportunities Subliminal Tapes. <http://future-world.com/cgi-bin/catalog/28133>.

CABLE TV

Cable TV descramblers. One-piece units. Scientific Atlanta, Jerrold, Pioneer, and others. Lowest prices around. **Precision Electronics**, Houston, TX anytime. 1-888-691-4610.

Cable boxes all models, all channels, lowest prices in the United States. Open seven days a week till midnite, Pacific Time. Call (877) 789-7337 Toll-Free.

Descramblers, Converters, Activators, Rft's, Ftg's, Bullet Snoopers, All Options Explained, Best Prices, Services, 2yr. Warranty, Free Catalog 1-800-854-1674 www.resource-leader.com/aapc

HAVE A BEEPING OR CHIRPING SOUND WITH SCRAMBLED VIDEO ON CHANNELS. WE CAN HELP. PROFESSIONAL QUALITY NOTCH FILTERS. \$16.00ea. DISCOUNTS on 5 or MORE. 100 for \$7.00ea. FAST COURTEOUS SERVICE. Visa, Mastercard and Discover. Visit our Website at www.gofilters.com. Call 1-800-684-0527

CABLE TV DESCRAMBLERS/CONVERTERS. LOWEST PRICES. 30 DAY MONEY BACK GUARANTEE. 1 YEAR WARRANTY. 1-800-785-1145.

CABLE DESCRAMBLER PLANS!!! Plus two free bonuses, Radar Jammer Plans and Cable manual \$14.00. 1-888-367-9972

Bewildered about descramblers? Call for your options. Same day shipping M-F, 9-8 Sat 12-5 **GLOBAL ELECTRONICS 1-888-221-8365.**

WHOLESALE PRICES, SUPERIOR QUALITY, INTERNAL AND EXTERNAL ACTIVATORS. 1ST TIME DISCOUNT. \$200.00 MIN, COD ONLY. 24/7 MESSAGE SERVICE. SALES OPEN M-F 8:00 AM TO 4:30 PM. CALL LUNAR INDUSTRIES 1-800-289-9566.

Awesome Cable Descrambling guides for all systems (TEST CUBES, STEALTH BOX, VHS, UNIVERSAL) with disk \$10 certificate included. Call 1-877-880-0197. Universal boxes DIRT CHEAP! 100% compatible in ALL areas. Call 1-877-539-9896. Dealers Welcome.

Free TV Cable Catalog. New Full Viewing Boxes works everywhere. 1-800-676-6342.

CB-SCANNERS

CB Radio Modifications! Frequencies, kits, high-performance accessories, books, plans, repairs, amps, 10-Meter conversions. The best price since 1976! Catalog \$3.00. CBCI, Box 1898 PE, Monterey, CA 93942. www.cbcontl.com

CABLE TV BOXES

Hablamos Español!

We'll Beat Any Price!

30 Day Trial • 1yr. Wrnty • Free Catalog • Qty. Discounts • Dealers Welcome!

1-800-785-1145

Galaxy Electronics Inc.
www.Galaxydescramblers.com

COMPUTER HARDWARE

ROBOT Module. Security Robot Kit. Free Catalog. www.actionrobotics.com. **ACTION ROBOTICS**, Box 138, Boston, NY 14025

COMPUTER SOFTWARE

Mother of all CD-ROMS! Everything you need to start your home business! Free Details: **PARA-DIGM-CD 1516 E. Fountain, Mesa, AZ 85203.**

MISC. ELECTRONICS FOR SALE

RF TRANSISTORS & TUBES MRF454, SD1446, 2SC2879, 2SC1969, 2SC2166, 3-500ZG, 4CX250B, 572B, 3CX3000A7, **WESTGATE 800-213-4563.**

www.industriologic.com Acquire, Control, & Display systems. Friendly, Fast, & Fun. 314-707-8818 CST.

Sale pending abandoned U.S.A. patents usefull electronic, quemistry information. Write **Mr. Peter**, P.O. Box 720202, Miami, Florida 33172-5160. Fax # 305-271-2919.

PLANS-KITS-SCHEMATICS

ELECTRONIC PROJECT KITS \$3.00 catalog. 49 McMichael St. Kingston, ON., K7M 1M8. www.qkits.com - QUALITY KITS

"HEATHKIT COMPANY is selling photocopies of most Heathkit manuals. Only authorized source for copyright manuals. Phone: 616-925-5899, 8-4 ET."

POTATOE CANNON with Electronic Trigger, Shoots to 1000ft. Plans \$8: **RODGERS**, PO BOX 270786-PE, Corpus Christi, TX. 78427

AWESOME KITS: Voice Changers, Levitators, Lasers, Solar Robots and more! Catalog \$1.00. **LNS Technologies**, PO BOX 67243, SCOTTS VALLEY, CA 95067. www.ncal.verio.com/~lnstech

REPAIRS-SERVICES

Circuit diagnostic initiatives provides schematic evaluation, trouble-shooting assistance and repair services for technicians, kit builders, students. Reasonable rates. 336-495-7032 8-4 ET.

Install the Lumecon Fluorescent Power Reducer on any 40 watt fluorescent lamp and cut electricity costs by 50%. Guaranteed \$6 each ppd. E.P. 41-11 150th St. Flushing, NY 11355.

SATELLITE EQUIPMENT

DSS Test card. Authorizes all channels for information, plus free bonus. Call toll free 1-888-416-7296.

FREE Satellite TV Buyer's Guide. Best Products - Lowest Prices - Fastest Service! Dish Network, DirecTV, C/Ku-band, including 4DTV. Parts - Upgrades - Accessories! **SKYVISION** - 800-543-3025. International 218-739-5231 www.skyvision.com

FREE DTV & DISH NETWORK test card information. \$10 gift certificate included. 1-877-856-0923.

TEST EQUIPMENT

Large assortment of used test equipment for sale. Request catalog or visit our website. **Stevenson Equipment Company** 609-888-2846 Fax: 609-888-2847 <http://www.stevensonlabs.com>

INVENTORS

INVENTORS: Free information package/initial consultation. 800-876-6670. Direct office: 301-990-9393. **John Halvonik**, Patent attorney.

Inventions/new products. ISC, America's leading invention firm, helps submit to companies. Patent Services. 1-888-439-IDEA.

USE POPULAR ELECTRONICS

READ BY BUYERS OF ELECTRONIC EQUIPMENT ACCESSORIES AND PARTS

INSTRUCTIONS FOR PLACING YOUR AD!

HOW TO WRITE YOUR AD

TYPE or **PRINT** your classified ad copy **CLEARLY** (not in all capitals) using the form below. If you wish to place more than one ad, use a separate sheet for each additional one (a photo copy of this form will work as well). Place a category number in the space at the top of the order form (special categories are available). If you do not specify a category, we will place your ad under miscellaneous or whatever section we deem most appropriate.

We cannot bill for classified ads. **PAYMENT IN FULL MUST ACCOMPANY YOUR ORDER.** We do permit repeat ads or multiple ads in the same issue, but, in all cases, full payment must accompany your order.

WHAT WE DO

The first word and company name of each ad are set in bold caps at no extra charge. No special positioning, centering, dots, extra space, etc. can be accommodated.

RATES

Our classified ad rate is \$1.75 per word. Minimum charge is \$26.25 per ad per insertion (15 words). Any words that you want set in bold are each .40 extra. Indicate bold words by underlining. Words normally written in all caps and accepted abbreviations are not charged anything additional. State abbreviations must be post office 2-letter abbreviations. A phone number is one word.

If you use a **Box number** you must include your permanent address and phone number for our files. **ADS SUBMITTED WITHOUT THIS INFORMATION WILL NOT BE ACCEPTED.**

For firms or individuals offering Commercial products or Services. **Minimum 15 Words.** 5% discount for same ad in 6 issues within one year; 10% discount for same ad in 12 issues. **Sorry, no discounts on credit-card orders. Boldface (not available as all caps), add .40 per word additional. Entire ad in boldface, add 20%. Tint screen behind entire ad, add 25%. Tint screen plus all boldface ad, add 45%. Expanded type ad, add \$2.25 per word.**

General Information: A copy of your ad must be in our hands by the 13th of the fourth month preceding the date of issue (i.e. Sept issue copy must be received by May 13th). When normal closing date falls on Saturday, Sunday or Holiday, issue closes on preceding work day. Send for the classified brochure.

DEADLINES

Ads not received by our closing date will run in the next issue. For example, ads received by November 13 will appear in the March issue that is on sale January 17. **POPULAR ELECTRONICS** is published monthly. No cancellations permitted after the closing date. No copy changes can be made after we have typeset your ad. **NO REFUNDS, advertising credit only. No phone orders.**

CONTENT

All classified advertising in **POPULAR ELECTRONICS** is limited to electronics items only. All ads are subject to the publishers approval. **WE RESERVE THE RIGHT TO REJECT OR EDIT ALL ADS.**

AD RATES: \$1.75 per word, Minimum \$26.25

Send you ad payments to:

POPULAR ELECTRONICS 500 Bi-County Blvd, Farmingdale, NY 11735-3931

CATEGORIES

100 -- Antique Electronics	270 -- Computer Equipment Wanted	450 -- Ham Gear Wanted	630 -- Repairs-Services
130 -- Audio-Video Lasers	300 -- Computer Hardware	480 -- Miscellaneous Electronics For Sale	660 -- Satellite Equipment
160 -- Business Opportunities	330 -- Computer Software	510 -- Miscellaneous Electronics Wanted	690 -- Security
190 -- Cable TV	360 -- Education	540 -- Music & Accessories	710 -- Telephone
210 -- CB-Scanners	390 -- FAX	570 -- Plans-Kits-Schematics	720 -- Test Equipment

CLASSIFIED AD COPY ORDER FORM

Place this ad in Category # _____

Special Category \$20.00 Additional _____

1 - \$26.25	2 - \$26.25	3 - \$26.25	4 - \$26.25
5 - \$26.25	6 - \$26.25	7 - \$26.25	8 - \$26.25
9 - \$26.25	10 - \$26.25	11 - \$26.25	12 - \$26.25
13 - \$26.25	14 - \$26.25	15 - \$26.25	16 - \$28.00
17 - \$29.75	18 - \$31.50	19 - \$33.25	20 - \$35.00
21 - \$36.75	22 - \$38.50	23 - \$40.25	24 - \$42.00
25 - \$43.75	26 - \$45.50	27 - \$47.25	28 - \$49.00

29 - \$50.75	30 - \$52.50	31 - \$54.25	32 - \$56.00
33 - \$57.75	34 - \$59.50	35 - \$61.25	36 - \$63.00
37 - \$64.75	38 - \$66.50	39 - \$68.25	40 - \$70.00

Total words _____ \$1.75 per word = \$ _____

Bold Face _____ \$0.40 per word = \$ _____

Special Heading _____ \$20.00 = \$ _____

Other _____ = \$ _____

Total classified ad payment \$ _____ enclosed

TOTAL COST OF AD \$ _____

Check Mastercard Visa Discover

Card # _____ Expiration Date ___/___

Signature _____

Name _____ Phone _____

Address _____ City State Zip _____

RETAILERS THAT SELL OUR MAGAZINE EVERY MONTH

Arizona

Circuit Specialists, Inc.
220 S. Country Club Dr.
Bldg 2
Mesa, AZ 85210

Elliott Elec. Supply
1251 S. Tyndell Ave.
Tucson, AZ 85713

California

All Electronics
14928 Oxnard Street
Van Nuys, CA 91411

California Electronics
221 N. Johnson Ave.
El Cajon, CA 90202

Electronics Plus, Inc.
823 4th St.
San Rafael, CA 94901

Electronics Warehouse
2691 Main Street
Riverside, CA 92501

Ford Electronics
8431 Commonwealth Ave
Buena Park, CA 90621

HCS Electronics
6819 S. Redwood Drive
Cotati, CA 94931

HSC Electronics
4837 Amber Lane
Sacramento, CA 95841

Halted Specialties Co.
3500 Ryder Street
Santa Clara, CA 95051

Inland Electronic Suppliers
1012 N. Carpenter Rd.
Modesto, CA 95351

JK Electronics
6395 Westminster Blvd.
Westminster, CA 92683

Kandarian Electronics
1101 19th Street
Bakersfield, CA 93301

Metro Electronics
1831 J Street
Sacramento, CA 95814

Minute Man Electronics
37111 Post St., Suite 1
Fremont, CA 94536

Orvac Electronics
1645 E Orangethorpe Ave.
Fullerton, CA 92631

San Mateo Elec. Supply
16 W. 42nd Ave.
San Mateo, CA 94403

Sav-On Electronics
13225 Harbor Blvd.
Garden Grove, CA 92643

Colorado

Centennial Elec. Inc.
2324 E. Bijon
Colorado Springs, CO
80909

Connecticut

Cables & Connectors
2198 Berlin Turnpike
Newington, CT 06111

Electronic Service Prod.
437 Washington Avenue
North Haven, CT 06473

Delaware

Wholesale Electronics
77 McCullough Dr., Ste. 10
New Castle, DE 19720

Illinois

BB&W Inc.
2137 S. Euclid Ave.
Berwyn, IL 60402

Tri State Elex
200 W. Northwest Hwy.
Mt. Prospect, IL 60056

Indiana

Hutch & Son, Inc.
300 N. Main St.
Evansville, IN 47711

King of the Road Elec.
409 E. Center Rd.
Kokomo, IN 46902

Maryland

Mark Elec. Supply Inc.
11215 Old Baltimore Pike
Beltsville, MD 20705

Michigan

Purchase Radio Supply
327 East Hoover Avenue
Ann Arbor, MI 48104

The Elec. Connection
37387 Ford Road
Westland, MI 48185

Minnesota

Acme Electronics
224 Washington Avenue N.
Minneapolis, MN 55401

New Jersey

Lashen Electronics Inc.
21 Broadway
Denville, NJ 07834

New York

LNL Distributing Corp.
235 Robbins Lane
Syosset, NY 11791

Unicorn Electronics
Valley Plaza
Johnson City, NY 13790

Ohio

Philcap Electronic Suppliers
275 E. Market Street
Akron, OH 44308

Oregon

Norvac Electronics
7940 SW Nimbus Avenue
Beaverton, OR 97005

Texas

Tanner Electronics
1301 W Beltline
Carrollton, TX 75006

Electronic Parts Outlet
3753 B Fondren
Houston, TX 77063

Computers Electronics Etc.
110 E. Medical Center Blvd.
Webster, TX 77598

If you'd like to sell our magazine in your
store, please circle 180 on free information card
or Contact

Christina Estrada at (516) 293-3000 ext 223

Circuit Circus

More Electric-Train Circuits

CHARLES D. RAKES

Hello, Circuiteers! I had so much fun last month playing with electric-train circuits that I've decided to continue that discussion. Most of the circuits that we'll look at this time around were designed for three-track "O" gage electric trains that are powered from an AC-voltage source, although several of them can easily be adapted for any of the other model-train layouts. Even if electric trains are not your forte, there's a chance that one of the circuits presented might find application in some present or future project. So stay tuned and share in the circuitry.

CURRENT-LIMITING ADD-ON CIRCUIT

If you are planning to build the "O" gage controller presented in Fig. 4 of last month's column, then our first circuit for this month might be of interest to you. Figure 1 shows a current-limiting circuit that can be added to the aforementioned controller to protect the circuit's transformer and power transistors from track shorts. In that circuit, a 0.66-ohm, 10-watt resistor is connected in the ground (or low voltage) end of T1 and used to sample the controller's output current. In my circuit, a pair of parallel-connected 0.33-

ohm, 5-watt resistors were used for R1, but any series or parallel combination that falls in the range of 0.5 to 0.7 ohms at 10 watts will do. Current limiting is controlled via a 1K potentiometer, R2. A complementary transistor pair (Q1 and Q2) is used to sample the positive or negative voltage that appears across R1.

When the voltage at the transistors' emitters rises above 0.6-volts (either polarity), one of the two transistors begins to conduct. When the voltage arriving at the emitters of Q1 and Q2 swings negative, Q1 turns on. That's because applying a negative voltage to the emitter of Q1 makes its emitter more negative than its base (which is grounded) and its base more negative than its collector. (Stated in the conventional manner: In order for an NPN transistor to conduct, its collector must be more positive than its base, and its base more positive than its emitter—a basic rule of bipolar transistor operation.) When the voltage presented to the emitters of the transistors in Fig. 1 goes positive, transistor Q1 turns off as Q2 turn on. (The opposite of the simple rule cited above applies to PNP bipolar transistors; *i.e.*, in order for a PNP transistor to conduct, its collector

must be more negative than its base, and its base more negative than its emitter.)

When either transistor conducts, the voltage applied to the bases of the power transistors in last month's Fig. 4 circuit is reduced. That, in return, lowers the voltage applied to the track, which lowers the circuit's output current. The current-limiting circuit should only be used when R2 in Fig. 4 (of last month's issue) is set to between mid-range and its maximum resistance value. If the resistance is set too low, the current through Q1 and Q2 in Fig. 1 can be excessive and both could be damaged.

LED INDICATOR

If you are looking to add an LED indicator to model-train engines or other powered vehicles, look no further than the simple add-on circuit shown in Fig. 2. In that circuit, two LEDs are connected in an opposing parallel configuration and wired to the track pick-up terminals through a current limiting resistor, R1. The two LEDs can be any color combination—just make sure that the LEDs share similar current ratings. Note that the value of R1 is given as a range of resistances, instead of a "precise" value. The actual value of R1

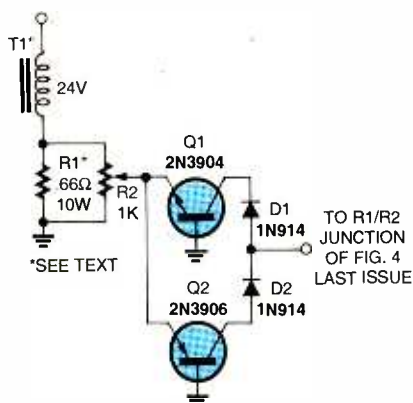

Fig. 1. This Current-Limiting Add-On Circuit can be integrated into last month's Fig. 4 circuit to protect its transformer and power transistors from track shorts.

PARTS LIST FOR THE CURRENT-LIMITING ADD-ON CIRCUIT (FIG. 1)

SEMICONDUCTORS

- Q1—2N3904 general-purpose, NPN silicon transistor
- Q2—2N3906 general-purpose, PNP silicon transistor
- D1, D2—1N914 general-purpose, small-signal, silicon diode

RESISTORS

- (All fixed resistors are 1/4-watt, 5% units.)
- R1—See text
- R2—1000-ohm potentiometer

ADDITIONAL PARTS AND MATERIALS

Printed-circuit or perfboard materials, wire, solder, hardware, etc.

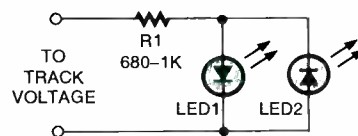

Fig. 2. In the LED Indicator, two LEDs are connected in an opposing parallel configuration and wired to the track pick-up terminals through a current limiting resistor, R1.

PARTS LIST FOR THE LED INDICATOR (FIG. 2)

- LED1, LED2—Light-emitting diode (any color)
- R1—680- to 1000-ohm, 1/4-watt, 5% resistor (see text)
- Printed-circuit or perfboard materials, wire, solder, hardware, etc.

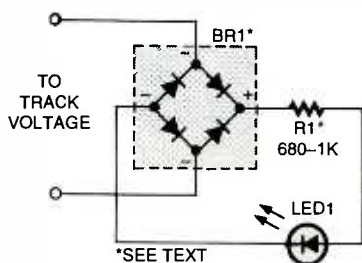

Fig. 3. The AC Indicator is designed to be used on-board an engine, car, or anywhere in the layout that receives power from the AC track source.

PARTS LIST FOR THE AC INDICATOR (FIG. 3)

- BR1—35-volt or greater, 100-mA, low-current bridge rectifier (see text)
- LED1—Light-emitting diode (any type or color)
- R1—680- to 1000-ohm, ¼-watt, 5% resistor (see text)
- Printed-circuit or perfboard materials, wire, solder, hardware, etc.

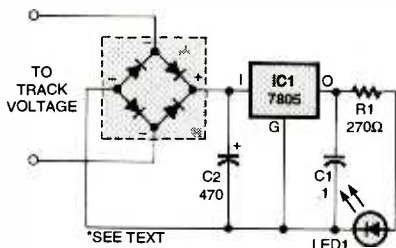

Fig. 4. The Regulated AC Indicator (shown here) is designed to supply a maximum or constant voltage to the LED to produce consistent light intensity so long as the circuit's supply voltage remains at 7 volts or more.

PARTS LIST FOR THE REGULATED AC INDICATOR (FIG. 4)

SEMICONDUCTORS

- IC1—7805 5-volt, 1-amp, fixed-voltage regulator, integrated circuit
- BR1—35-volt or greater, 100-mA, low-current, fullwave bridge rectifier (see text)
- LED1—Light-emitting diode (any color or type)

CAPACITORS

- C1—0.1-µF, ceramic-disc
- C2—470-µF, 35-volt, electrolytic

ADDITIONAL PARTS AND MATERIALS

- R1—270-ohm, ¼-watt, 5% resistor
- Printed-circuit or perfboard materials, wire, solder, hardware, etc.

is determined by the maximum current rating of the LEDs and the train's maximum operating voltage ($R = V/I$). If only one LED is used, simply replace the second LED with a 1N4001 or similar silicon diode. The LED circuit can also be connected directly to the track at any position along its length to produce special lighting effects.

AC INDICATOR

Our next circuit, see Fig. 3, with its single LED, is designed to be used on-board a model engine or car, or anywhere in a layout that receives power from the AC track source. Actually, several LEDs can be incorporated into the circuit by placing a current-limiting resistor in series with each LED and connecting the combination across the output of the bridge rectifier (BR1) and in parallel with the existing LED/resistor combination. In this and the previous LED circuit, the LED's light output depends on the voltage applied to the train track. The higher the voltage, the brighter the light output.

The bridge rectifier (BR1) can be any unit that's capable of delivering at least 35 volts at 100 mA or more, or a suitable unit can be fabricated from four 1N4001 (1-amp, 50-PIV) or similar diodes.

REGULATED AC INDICATOR

Our next LED lighting circuit, an adaptation of the circuit in Fig. 3, is designed to produce consistent, maximum LED illumination as long as the voltage applied to its input is 7 volts or greater. The circuit in Fig. 4 takes the Fig. 3 circuit a step further by introducing a fixed-voltage regulator to the mix.

Like the previous indicator, several LEDs can be incorporated into the Fig. 4 circuit by adding a 270-ohm resistor in series with each LED and connecting the combination in parallel with R1/LED1 across the regulator's output. The circuit can be used on-board or anywhere the AC track voltage is present.

CONSTANT-CURRENT AC INDICATOR

Our next circuit (see Fig. 5) takes a slightly different approach to maintaining a constant light output from an LED indicator—instead of feeding a regulated voltage to the LED, its illumination is governed by a constant-current source. In Fig. 5, a 7805 positive 5-volt

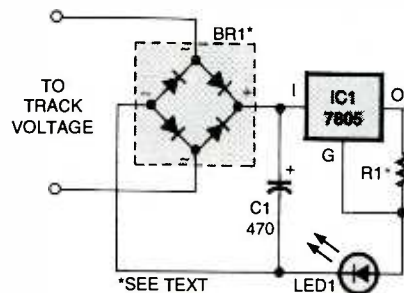

Fig. 5. The Constant-Current AC Indicator is almost identical to the Regulated AC Indicator (Fig. 4), except in this circuit the voltage regulator (IC1) has been re-configured to act as a current-regulating device.

PARTS LIST FOR THE CONSTANT-CURRENT AC INDICATOR (FIG. 5)

- IC1—7805 5-volt, 1-amp, fixed-voltage regulator, integrated circuit
- BR1—35-volt or greater, 100-mA, low-current, fullwave bridge rectifier (see text)
- LED1—Light-emitting diode (any color or type)

ADDITIONAL PARTS AND MATERIALS

- R1—See text
- C1—470-µF, 35-WVDC, electrolytic capacitor
- Printed-circuit or perfboard materials, wire, solder, hardware, etc.

regulator is connected in a constant-current configuration and used to drive LED1. Note that the value of R1 must be determined—i.e., $R1 = 5V \div I_{LED}$, where 5V is the output of the regulator and I_{LED} is the desired LED-operating current. For an LED current of 20 mA, use a 220-ohm resistor for R1. Like the previous circuits, this one can be used on-board or anywhere the AC track voltage is present.

FLASHING RAILROAD-CROSSING SIGNAL

Coming up next is a Flashing LED Railroad Crossing Signal that's designed to work with any gage or size model-train layout wherein a 9- to 12-volt DC power source is available. The crossing signal (see Fig. 6) can be broken down into two simple circuits, an infrared (IR) emitter/detector and a gated LED flasher. The IR emitter (LED1) is located on one side of the track facing the IR detector (Q1) located on the opposite side of the track. As long as the path between the two

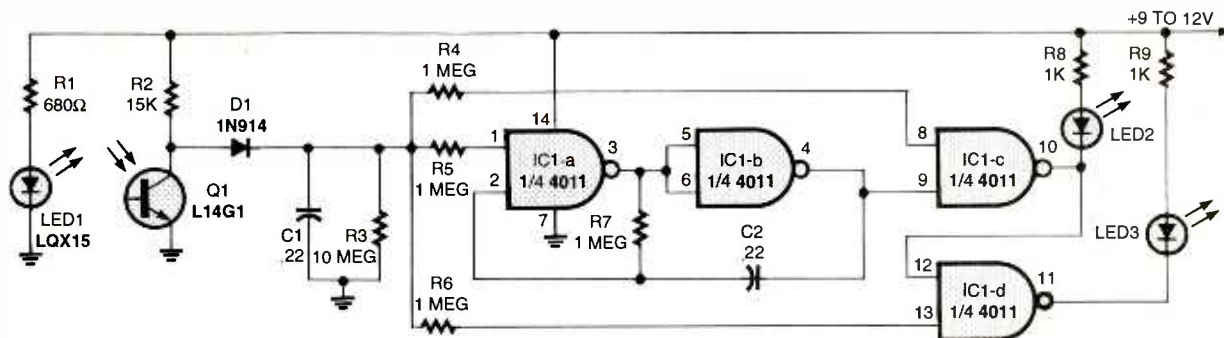

Fig. 6. The Flashing Railroad-Crossing Signal can be used with any gage or size model-train layout as long as a 9- to 12-volt DC source is available.

PARTS LIST FOR THE FLASHING RAILROAD-CROSSING SIGNAL (FIG. 6)

SEMICONDUCTORS

- IC1—4011 CMOS quad 2-input NAND gate, integrated circuit
- Q1—L14G1 infrared phototransistor (Mouser #512-L14G1)
- D1—1N914 general-purpose, small-signal, silicon diode
- LED1—LQX15 infrared emitting diode (Mouser #512-LQX15, or similar)
- LED2, LED3—Light-emitting diode (any color or type)

RESISTORS

- (All resistors are 1/4-watt, 5% units.)
- R1—680-ohm
 - R2—15,000-ohm
 - R3—10-megohm
 - R4—R7—1-megohm
 - R8, R9—1000-ohm

ADDITIONAL PARTS AND MATERIALS

- C1, C2—0.22- μ F, ceramic-disc capacitor
- Printed-circuit or perfboard materials, wire, solder, hardware, etc.

devices is clear, infrared radiation striking Q1 causes it to saturate, thereby pulling Q1's collector voltage to near ground level.

However, when an object (train car or engine) prevents IR radiation from reaching Q1, the transistor turns off, causing its collector voltage to rise toward the positive supply rail, forward biasing D1 and causing C1 to charge to near supply level. That sends a positive voltage to the inputs of gates IC1-a, IC1-c, and IC1-d, enabling those gates. Gates IC1-a and IC1-b are configured as a gated low-frequency oscillator that is triggered when the IR radiation is obscured from the "view" of

Q1. When triggered, the output of the oscillator causes LED1 and LED2 to alternately flash on and off.

As the train passes between LED1 and Q1, the IR beam is not constantly blocked because of the gap between the cars. That would normally cause the flasher to operate erratically, but with the addition of a smoothing circuit comprised of D1, C1, and R3 the brief gap between cars is "invisible" to the oscillator/LED driver circuit. If the train stops so that the gap between cars gives a clear path for IR to reach Q1, the signal turns off.

The signal's flash rate can be changed by varying the values of either or both C2 and R7. Increasing their values will lower the flash rate, while decreasing them will increase the flash rate. The gap timing is set by the values of C1 and R3. Increasing C1's value increases the time that the circuit ignores the gap between cars and reducing its value shortens the gap time. The value of R3 determines the discharge time of C1, which also affects the gap timing. Without R3, the circuit would continue to flash until C1 is finally discharged.

DIRECTIONAL MODIFICATION

There are two problems that can occur while using the flasher in Fig. 6. If only one IR detector is used, the flasher *only* works when the train approaches the crossing from the side on which the detector is located. If the train happens to come from the other direction, the flasher won't start until the train has passed the crossing. The other problem occurs when the train stops and the gap between cars allows the IR signal to transverse the space between emitter and detector. Adding more detector cir-

cuits to the flasher can solve both problems. Incorporating the emitter/detector arrangement shown in Fig. 7 into the Flashing Railroad-Crossing Signal solves the directional problem.

To eliminate the gap problem, simply mount two sensor circuits side-by-side separated by a distance slightly wider than the widest gap between train cars. That way, the gap never shows up at both sensors at the same time, and the

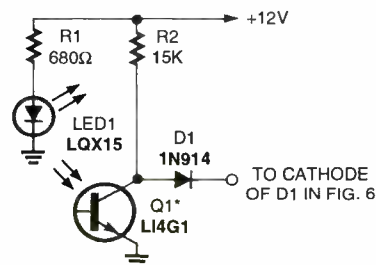

Fig. 7. This circuit modification is intended to transform the Flashing Railroad Crossing Signal into a circuit that can indicate the direction of a passing model train.

PARTS LIST FOR THE DIRECTIONAL MODIFICATION (FIG. 7)

SEMICONDUCTORS

- LED1—LQX15 infrared emitting diode (Mouser part #512-LQX15, or similar)
- Q1—L14G1 infrared phototransistor (Mouser part #512-L14G1)
- D1—1N914 general-purpose, small-signal, silicon diode

RESISTORS

- (All resistors are 1/4-watt, 5% units.)
- R1—680-ohm
 - R2—15,000-ohm

ADDITIONAL PARTS AND MATERIALS

- Printed-circuit or perfboard materials, wire, solder, hardware, etc.

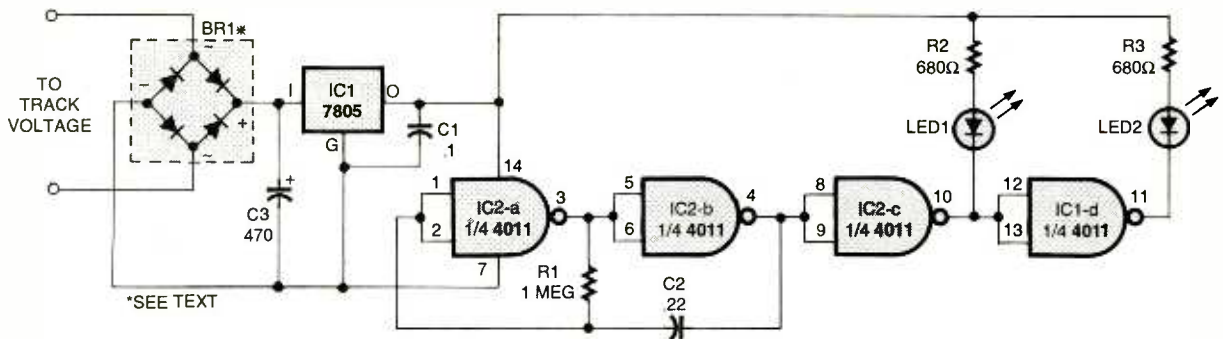

Fig. 8. The On-Board LED Flasher, which is designed to operate from the AC track voltage, works nearly identically to the one in Fig. 4.

PARTS LIST FOR THE ON-BOARD LED FLASHER (FIG. 8)

SEMICONDUCTORS

IC1—7805 5-volt, 1-amp, fixed-voltage regulator, integrated circuit
 IC2—4011 CMOS quad 2-input, NAND gate, integrated circuit
 BR1—35-volts or greater, 100-mA, low-current bridge rectifier (see text)
 LED1, LED2—Light-emitting diode (any color or type)

RESISTORS

(All resistors are 1/4-watt, 5% units.)

R1—1-megohm
 R2, R3—680-ohm

CAPACITORS

C1—0.1-µF, ceramic-disc
 C2—0.22-µF, ceramic-disc
 C3—470-µF, 35-WVDC electrolytic

ADDITIONAL PARTS AND MATERIALS

Printed-circuit or perboard materials, wire, solder, hardware, etc.

source. The back of the tube should be light sealed.

ON-BOARD LED FLASHER

Our last entry this time around is an LED flasher that's designed to be mounted on-board the model vehicle and operated from the layout's AC track voltage. The rectifier/regulator portion of the circuit shown in Fig. 8 is identical to the one used in Fig. 4. The On-Board LED Flasher is also similar to the previous circuit, but omits the gating portion of the Fig. 7 circuit. The LED's flash rate is set by the values of either or both lowers the flash rate, while doing the opposite increases the flash rate.

LEDs will continue to flash as long as one of the sensors is blocked.

The detector should be shrouded to prevent ambient light from hampering its ability to see the IR signal. One sim-

ple method of accomplishing that is to mount the photodetector (Q1) in an opaque plastic tube about 1-inch in length, with the detector in the back of the tube looking out toward the IR

SCANNER SCENE

(continued from page 44)

Holland and Lincoln Tunnels (that link NJ to New York City). Mickey hopes we can help him. The best information we have is 150.995 MHz for the Lincoln Tunnel, 453.80 MHz for the Holland Tunnel.

From Morty, in Ottawa, Ontario, Canada, we learn that the American Embassy there has been monitored on 165.18 MHz with a 110.9-Hz PL.

An anonymous contributor in Lincoln, Nebraska passes along information on easily monitored frequencies there. State Patrol on 42.46, the University police on 460.125 MHz, Game Warden on 151.205 and 159.33 MHz, and the State Prison on 158.82, 158.73, and 159.03 MHz.

A question from Carl Findlay of Paris, Texas. He reports often monitoring odd-sounding beeps on 341.75 MHz and wonders what they could be.

The general belief among military monitors is that the pips (as they are known), which have been reported nationwide on 341.75 MHz, are transmitted at certain times by Air Force AWACS aircraft. These timing signals are intended to allow several aircraft to precisely synchronize their onboard tracking equipment. I could tell you more, but then I'd need to report you to the Radio Police for espionage.

According to J. Blanco, of Florida, the bombing range at Camp Blanding, Florida, operates (in FM mode) on 47.05, 148.6875, and 148.7625 MHz. During the summer months, the fascinating experimental lightning test range there also uses these frequencies.

GASBAGS

Blimps are popularly used by Goodyear, Met Life, Fuji, and other companies for overflying major sporting events. Most of these commonly use 122.85 and 464.50 MHz; however,

the Goodyear fleet has also been monitored on additional frequencies.

If any of the Goodyear blimps are flying or moored within range of your station, monitor: 122.85, 122.9, 123.05, 123.2, 123.25, 123.3, 123.45, 123.5, 132.0, 151.625, 153.32, 161.64, 161.67, 462.05, 462.225, 464.50, 465.9125, 465.9375, 465.9625, and 469.9125 MHz.

BEST BETS

If you visit Reno, here are some interesting hotel frequencies to keep handy: Harrah's on 464.875 MHz, Harvey's on 463.20 MHz, Fitzgerald's on 464.20 MHz, Bally's on 464.575 and 859.9125 MHz, Pioneer on 463-975 MHz, Holiday Inn on 464.375 MHz, and El Dorado on 464.85 MHz.

Please pass along your frequencies and questions via mail at *Scanner Scene*, **Popular Electronics**, 500 Bi-County Blvd., Farmingdale, NY 11735 or e-mail at sigintt@aol.com.

Robotics Workshop

Parallel Port Control, Part 1

GORDON McCOMB

You've just finished your latest "robot." It's a nice collection of batteries, motors, gears, and wires, and it impresses your friends and family. But deep down you know it's not really a *robot*, not in the true sense of the word—your robot doesn't have a brain. Thank goodness for the space age we live in. These days, it's relatively cheap and easy to attach a brain—in the form of a personal computer—to that collection of batteries, motors, gears, and wires you'd like to call a real robot.

What's more, just about all modern computers (with the notable exception of the Apple Macintosh) come equipped with an interface port that's perfect for controlling robotic functions. That interface, the *parallel port*, is normally used to connect the computer to a printer. But the design of that handy port allows it to be connected to a wide variety of external devices. Your brainless robot might as well be one of them.

To complete the robot-to-parallel-port interface, all you need is a few common ICs and some rudimentary programming. If your computer has several parallel ports, you can use them together to make a very sophisticated control system.

In this column, we'll cover the hows and whys of interfacing a parallel port on an IBM PC compatible (the basic concepts apply if you have an older computer—like a Timex/Sinclair 1000 or RadioShack Model 100, but we won't get into specifics for those machines). Next month, we'll conclude our discussion with practical examples

of using a parallel-port interface to control a robot.

But before we begin, let's cover the usual caveats and cautions. This column discusses connecting a homebrew accessory to your computer. *You must exercise care in constructing and using this accessory, or else damage to your computer could result.* This is not a project for those who are new to electronics or uncomfortable with the construction of electronic devices.

(ALMOST) ALL ABOUT PARALLEL PORTS

When IBM created the first PC model in the early 1980s, it did the world a huge service: Their engineers designed the system using an "open" architecture and off-the-shelf parts. Though IBM would later rue its decision to be so open-minded, its design allowed the venerable PC to be upgraded with just about any kind of hardware that could be invented. Typical hardware enhancements provided for early PCs were input/output (I/O) boards, special expansion cards designed to allow interfacing between a printer and the computer by way of a Centronics-compatible parallel data connection. Although it was originally an extra-cost option, that functionality is now routinely built into PCs made and sold today.

The PC accesses its various I/O ports by using an *address* value. Each device or board in the computer has an address unique to itself, just as you have a home address that no one else in the world shares with you. The parallel port that was built into the original monochrome-

display adapter of the first PCs had a starting address of 956. Although that address is in *decimal* form (i.e., the base₁₀ numbering system), some program-

ming languages require that the address be given in *hexadecimal*, or base₁₆, form. In hexadecimal or hex, the starting address is 3BCH (the address is really 3BC; the H means that the number is in hex).

PCs no longer use monochrome-adaptor cards, but rather separate video and parallel port adapters (in some machines, the parallel port is integrated into the motherboard of the system). Most PCs reserve the decimal address 888 (or 378H hex) for the port. Some PCs have a second parallel-port adapter, which is typically addressed as decimal 632 (278H).

Since addresses are difficult for users to remember, the PC uses uniform *logical* names for its parallel ports, called LPT1 and LPT2. Some PCs have more parallel ports, but we can ignore them for this discussion. In

TABLE 2—PORT PIN FUNCTIONS

PIN	FUNCTION (PRINTER APPLICATION)
1	Strobe
2	Data bit 0
3	Data bit 1
4	Data bit 2
5	Data bit 3
6	Data bit 4
7	Data bit 6
8	Data bit 6
9	Data bit 7
10	Acknowledge
11	Busy
12	OE (out of paper)
13	Printer online
14	Auto line feed after carriage return
15	Printer error
16	Initialize printer
17	Select/deselect printer
18-25	Unused or grounded

TABLE 1—IBM PC/COMPATIBLE PORT ADDRESSES

ADAPTER	DATA	STATUS	CONTROL
Parallel port on monochrome display card	3BCH, 956D	3BDH, 957D	3BEH, 958D
PC/XT/AT printer adapter	378H, 888D	379H, 889D	37AH, 890D
Secondary LPTx card (as LPT2:)	278H, 632D	279H, 633D	27AH, 634D

"H" Suffix = Hex
"D" Suffix = Decimal

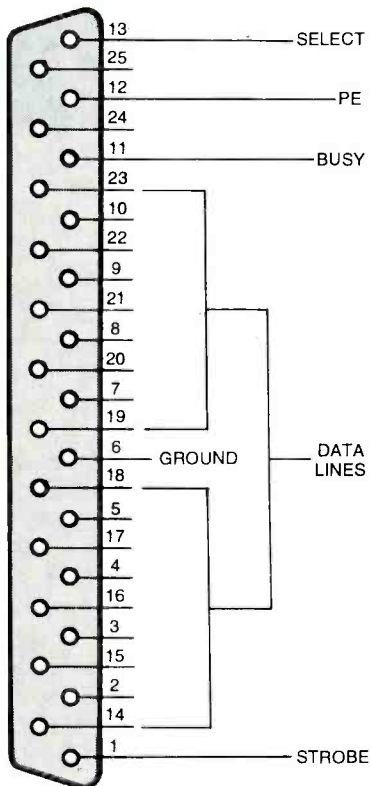

Fig. 1. The parallel ports on PC compatibles are typically DB-25 connectors, the pinout designations for which are shown here. (See Table 2 for the function of each pin.)

most modern PCs, port 378H is LPT1, and if the PC is equipped with a second parallel port, 278H is LPT2. If it's an older PC that's equipped with a monochrome adapter card, then LPT1 is 3BCH.

Table 1 lists the port addresses for all the typical parallel ports in the IBM PC/compatibles architecture. The logical port names are often used by applications software instead of the actual numeric addresses. In robotics, there is more flexibility using the decimal or

TABLE 3—BIT POSITIONS AND WEIGHTS

BIT POSITION	WEIGHT
D7	128
D6	64
D5	32
D4	16
D3	8
D2	4
D1	2
D0	1

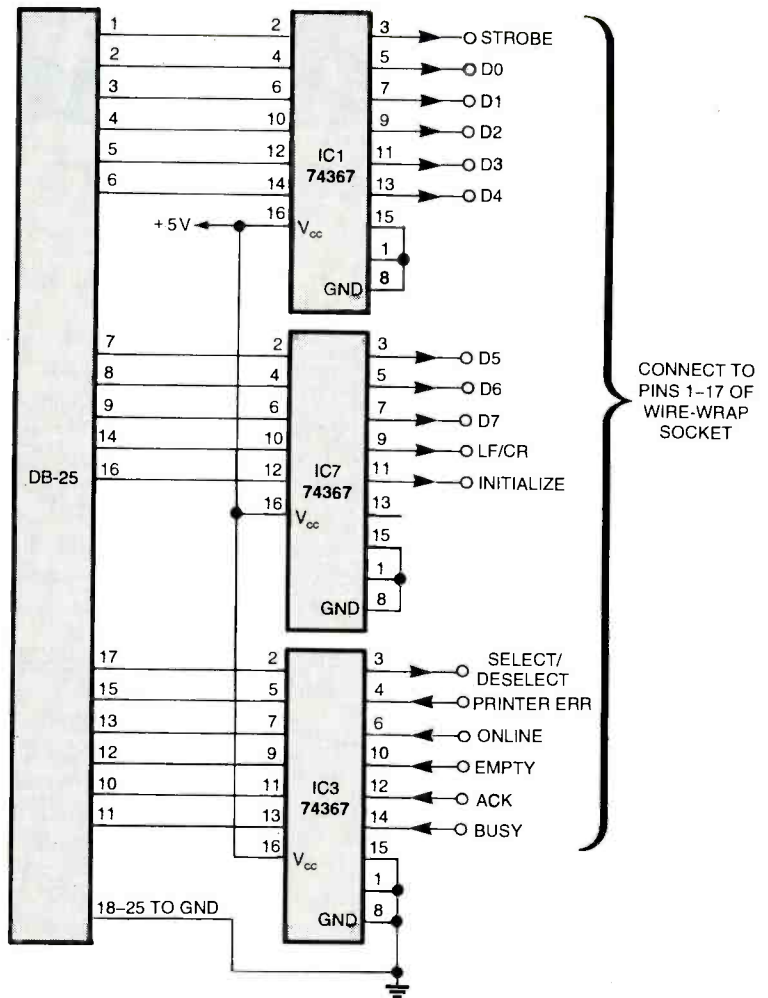

Fig. 2. This Parallel-Port Experimenter's Interface, which requires very few components, can be built in a matter of minutes.

PARALLEL-PORT INTERFACING WEB RESOURCES

PROGRAMMING IN BASIC

Basic Archives
www.fys.ruu.nl/~bergmann/basic.html

Beginner's Basic Homepage
www.users.globalnet.co.uk/~basic/

Home of Basic Gurus
www.basicguru.com/

QBasic Home Page
www.qbasic.com/

PowerBASIC
www.powerbasic.com/

INFORMATION ABOUT IBM PC/CENTRONICS PARALLEL PORTS
 Jan Axelson's Parallel Port FAQ
www.lvr.com/jansfaq.htm

Parallel Port Mini-FAQ
home.clear.net.nz/pages/kheidens/ppmfaq/khppmfaq.htm

Interfacing the PC
www.senet.com.au/~cpeacock/

Interfacing the Standard Parallel Port
www.geocities.com/SiliconValley/Bay/8302/parallel.htm

Parallel Port Central
www.lvr.com/parport.htm

Parallel Port Interface Box
www.cs.columbia.edu/~paul/circuits/parallel/parallel.html

Parallel Port Debugging Tool
www.senet.com.au/~cpeacock/pdebug.htm

TABLE 4—MOST COMMONLY USED STATUS AND CONTROL PINS

CONTROL BITS	FUNCTION
0	Low = Normal; High = Output Of Byte Of Data
1	Low = Normal; High = Auto Linefeed After Carriage Return
2	Low = Initialize Printer; High = Normal
3	Low = Deselect Printer; High = Select Printer
4	Low = Printer Interrupt Disables; High = Enabled
5-7	Unused
STATUS BITS	FUNCTION
0-2	Unused
3	Low = Printer Error; High = No Error
4	Low = Printer Not On-Line; High = Printer On-Line
5	Low = Printer Has Paper; High = Out Of Paper
6	Low = Printer Acknowledges Data Sent; High = Normal
7	Low = Printer Busy; High = Printer Ready

discussion.

The parallel ports on PC compatibles are typically 25-pin connectors (often referred to as DB-25 connectors). Figure 1 shows the pinout designations for the connector. Note that only a little more than half of the pins are in use. The others are not connected inside the computer or are grounded to the chassis of the machine. Table 2 shows the function of each of the pins.

Note Table 1 shows three addresses. The so-called starting address—378H (888D)—is used for *data output*. The data output is comprised of eight binary-weighted bits, such as 01101000. There are 256 possible combinations of

hexadecimal numeric addresses, so we'll stick with them throughout this

the eight bits. The data output pins are numbered 2 through 9. The bit posi-

LISTING 1

```

PORTADDRESS = 888 'LPT1 for
non-mono card ports
FOR X = 0 TO 255
OUT PORTADDRESS, X
FOR DELAY = 1 TO 250: NEXT
DELAY
NEXT X
    
```

tions and their weights are shown in Table 3. The other two addresses are used for *status* and *control*.

The functions of the most commonly used status and control bits are shown in Table 4. The most important control pin is pin 1—STROBE. The STROBE line is used to tell the device (printer, robot, etc.) that the data on lines 2 through 9 is ready to be read. The STROBE line, which functions as a kind of "data ready" line, is used because all the data may not arrive at their outputs at the same time.

It is important to note that the data outputs of a parallel port are latched, meaning that whatever data you place on each output stays there until you change it or turn off the computer. During printing, the STROBE line toggles high to low and then high again. You don't have to use the STROBE line when commanding your robot, though you will often find controlling the beast is easier if you do.

Other control lines you may find on parallel-printer ports (some of which aren't always implemented) include: AUTO FORM FEED, SELECT/DESELECT PRINTER, INITIALIZE PRINTER, and PRINTER INTERRUPT. Traditionally, the status lines were the only ones that fed back into the computer (today, however, most parallel-printer ports are bi-directional—but that's not a feature we'll get into this time around). There are five status lines—PRINTER ERROR, PRINTER NOT SELECTED, PAPER ERROR, ACKNOWLEDGE, BUSY—and not all parallel ports support every one.

PARTS LIST FOR THE PARALLEL-PORT EXPERIMENTER'S INTERFACE

- IC1-IC3—74367 TTL hex inverting buffer, integrated circuit
- 18-pin wire-wrap socket, solderless experimenters breadboard, three-way binding posts

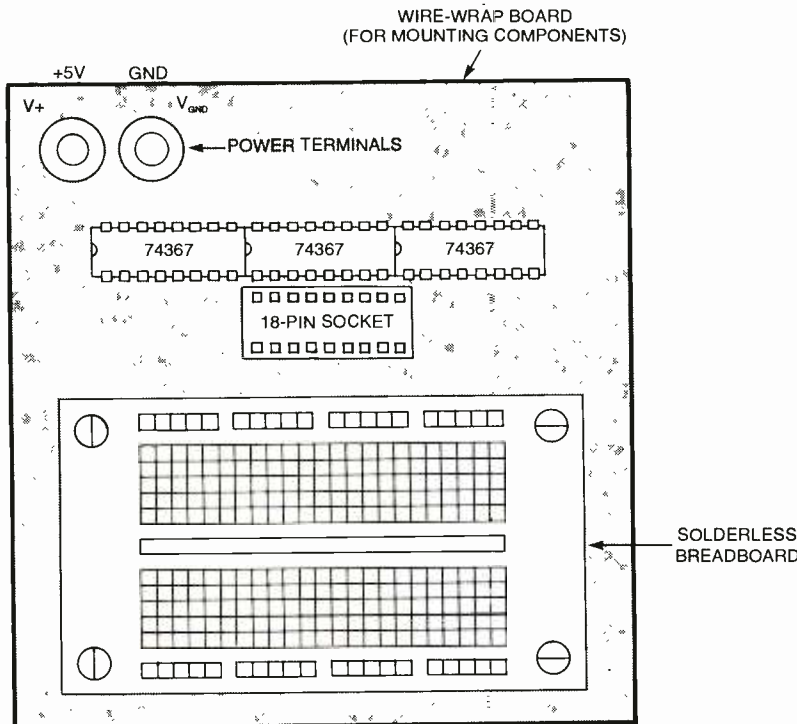

Fig. 3. As shown here, the interface can be built on a section of perfboard with the smaller components wired to a solderless breadboard. This assembly scheme and layout allows maximum design flexibility.

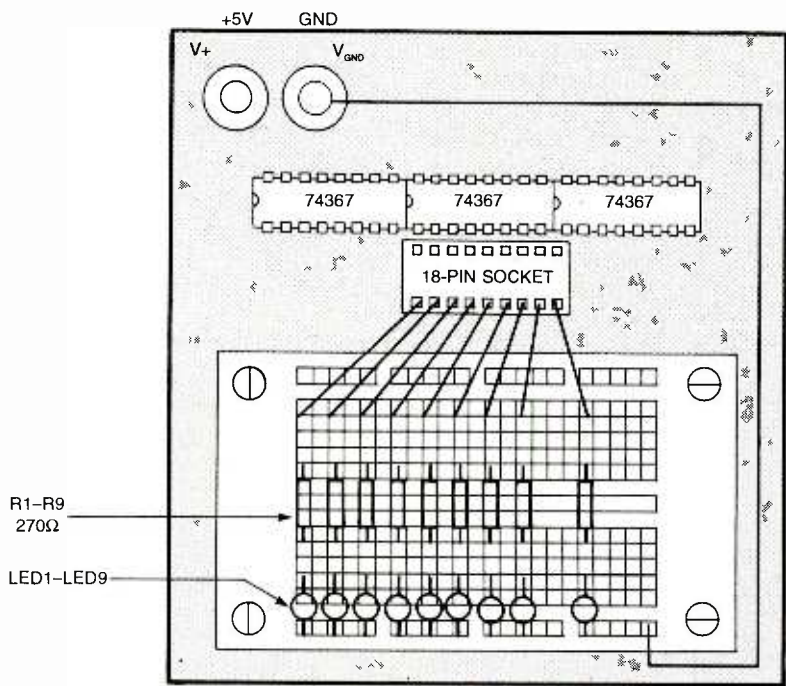

Fig. 4. Once the perfboard/solderless breadboard assembly shown in Fig. 3 has been put together, use this wiring diagram to test the Parallel-Port Experimenter's Interface.

The ACKNOWLEDGE and BUSY lines are commonly used for the same thing in a printer application, but you can use the two separately in your own programs (one helpful tidbit: for a printing application, when the BUSY line is low, the ACK line is high).

In next month's column we'll look at creative ways to use the control and status lines for purposes other than

their intended use for printing.

BUILD A PARALLEL-PORT EXPERIMENTER'S INTERFACE

You can actually attach relays and other robotic circuits directly to your PC's parallel port, but doing so is not recommended. The Parallel-Port Experimenter's Interface, shown in

schematic form in Fig. 2, can be built in a matter of minutes and requires very few components. The benefit of the experimenter's interface is that it provides buffering between your PC's parallel port and anything you want to connect to it. The input and output buffering is provided by a 74367 hex buffer/driver. Three such chips are used to provide 18 buffered lines, which is more than enough. The interface was assembled on a solderless experimenter's breadboard, so you can create and test circuits there.

The interface should be built on a wire-wrap board or into a suitable enclosure that is large enough to hold the breadboard, IC chips, and wire-wrap socket. Make a cable using a male DB-25 connector and a four- or five-foot length of 25-conductor ribbon cable. Solder the DATA OUTPUT, STATUS, and CONTROL line conductors to the proper pins of the 74367 ICs, as shown in Fig. 2. Route the outputs of the 74367 ICs to the bottom of the wire-wrap socket. One possible component layout for the interface is shown in Fig. 3.

Using the interface requires that you provide a +5-volt DC source, which must be supplied separately. Use lengths of 22-AWG solid-conductor wire to connect the signal lines from the wire-wrap socket to whatever points on the breadboard you desire.

The first order of business is to wire
(Continued on page 75)

BASICS ON GETTING BASIC

Perhaps the easiest way to program a PC's parallel port is with the BASIC programming language running under DOS. Sure, there are plenty of more modern programming languages around, including Microsoft Visual Basic for Windows, Perl, Rexx, C, Java, and scores of others. But BASIC—just plain BASIC—reigns as perhaps the easiest-to-use language for simple PC hardware manipulation.

Alas, the latest versions of Microsoft Windows lack BASIC, in any version. Back in the days of MS-DOS 5.0 and 6.0, and even Windows 3.1, Microsoft provided as part of the operating system a very handy version of BASIC called QBasic. If your PC runs under MS-DOS or under Windows 3.1, then it's likely that it has QBasic

on it, and you're ready to go. But if you have Windows 95 or Windows 98, you may need to do some hunting before you can run BASIC programs.

- *If you upgraded to Windows 95/98 from Windows 3.1:* QBasic may still be on your machine. Check the C:\Dos directory to be sure.
- *If you have Windows 95:* The Windows 95 CD-ROM comes with a copy of QBasic. Look in the \Other\Oldmsdos directory on the CD-ROM for QBASIC.EXE.
- *If you have Windows 98:* You may be able to download the QBasic program and help files from Microsoft's Web site. See the QBasic Home Page at <http://www.qbasic.com/> for more infor-

mation on downloading and using QBasic.

Of course, QBasic isn't the only choice for writing programs in BASIC. Microsoft Visual Basic is another option, but you'll need a support file (DLL or OCX) because Visual Basic cannot directly read and write to the parallel port I/O. Some sources to try for DLLs and OCXs for I/O control are:

- win95io.zip (free) http://www.softcircuits.com/sw_tools.htm
- DriverX (commercial), <http://www.tetradyne.com/driverx.htm>
- IOPort (shareware), <http://www.uct.on.ca/>

There's also PowerBASIC, a professional-level, commercial, programming environment. See <http://www.powerbasic.com/> for more information.

AMAZING SCIENCE

Space Horticulture Continued

JOHN IOVINE

Last month, in our inaugural column, we laid the foundation for conducting experiments related to sustaining life during long-term space exploration, discussing how the experiment should be conducted, how to measure and compare the growth of several groups of plants under various lighting conditions, possible light sources, light density, etc. but, most importantly, we took a look at a couple of circuits for use in our plant-growth experiments.

This time around, we're going to continue with the space-gardening topic, discussing how to build a plant-growth chamber in which to conduct your experiment, and how to outfit it with the lighting schemes that were worked out last month. So without any further ado, let's get to the task at hand, by picking up where we left off.

GROWTH CHAMBER

The growth chamber should be of simple design and constructed of readily available materials, such as a 2-liter soda bottle. To make the primary growth chamber (see Fig. 1), a line was drawn around the top of a two-liter

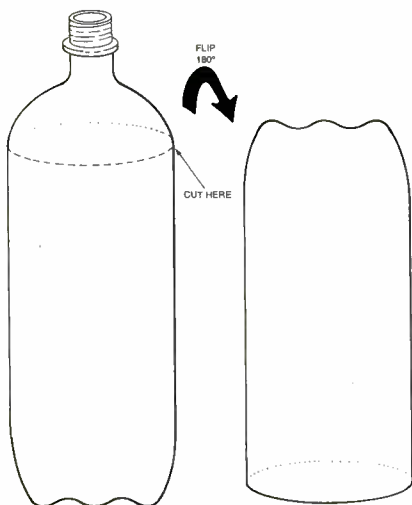

Fig. 1. The growth chamber for our experiment was fabricated from a 2-liter soda bottle. Preliminary preparations for primary growth-chamber fabrication are shown here.

soda bottle. The top of the bottle was then cut off using a scissors. Try to make the cut straight across, so the chamber will stand properly. Afterward, the bottle was turned upside down making the bottom the top. Numerous holes were then punched in the sides of the bottle (growth chamber) for ventilation.

As the plants grow, it will be necessary to raise the lights. To accomplish that, sleeves were fabricated by cutting the top and bottom from another 2-liter soda bottle, as shown in Fig. 2. Three or four equally spaced slits located about half way down the length of the sleeve (center section of the bottle). When the plants grow too tall, the growth chamber can be fitted over the sleeve (as shown in Fig. 3) to form a sort of telescoping growth chamber.

FITTING LED MODULE INTO GROWTH CHAMBER

The LED module was mounted into the top of the growth chamber using four plastic screws (see Fig. 4) that were pushed through small holes in the growth-chamber wall situated at equally spaced positions about its circumference. Wires from the LED module are fed into a $\frac{3}{16}$ -inch phone jack that is mounted at the top of the growth chamber. Power is fed to the LED module through a $\frac{3}{16}$ -inch phone plug.

PLANTS AND PLANTING SEEDS

While it would have been nice to have grown produce, there was insufficient time, so instead Wisconsin Fast Plants were selected as the subject of the experiment. Wisconsin Fast Plants germinate in 12 hours, can flower in 2 weeks, and complete their cycle in 40 days. The seeds can be planted in small plastic pill bottles (approximately 1.5 inches tall and $\frac{3}{4}$ inch in diameter). A small hole was drilled into the bottom of each bottle through which a small diamond-shaped wick was inserted so that half of the wick passed

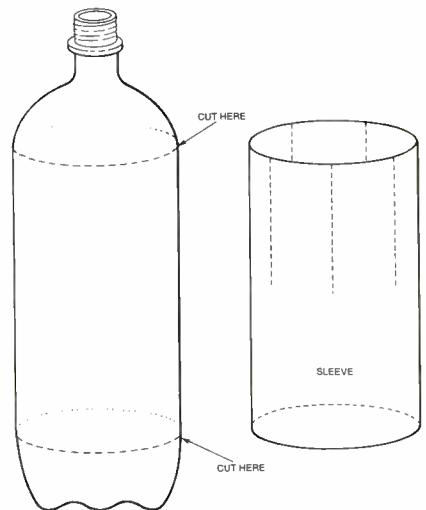

Fig. 2. To accommodate the plants as they grow, a sleeve was fabricated from a second 2-liter soda bottle. Details of sleeve manufacture are shown here.

through, as shown in Fig. 5.

With the wick in place, fill the pill bottle about half way with potting soil,

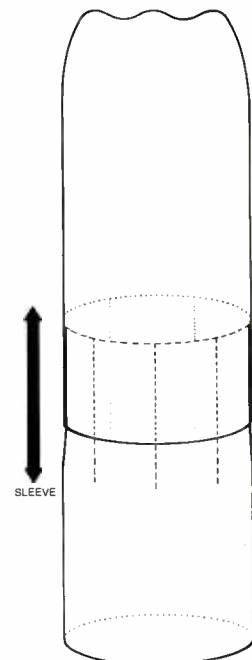

Fig. 3. The primary growth chamber combines with the sleeve to form a sort of telescoping growth chamber. Note: A separate growth chamber is required for each group of plants.

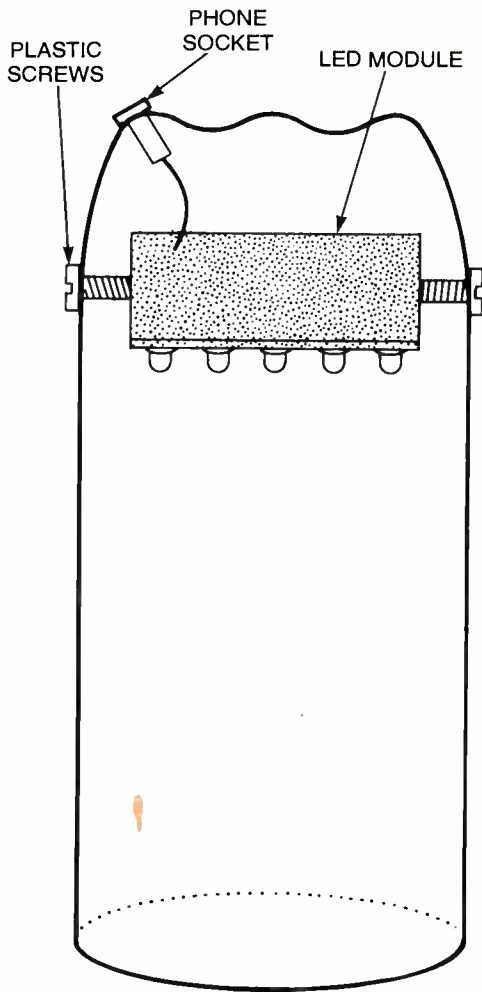

Fig. 4. The LED module was mounted into the top of the growth chamber using four plastic screws (which were all pushed through small holes in the growth-chamber wall that were situated at equally spaced positions about its circumference).

place two or three fertilizer pellets on top of that, and then add more soil to fill the bottle. **DO NOT** pack the soil. Make a small depression in the soil with your finger or the tip of a pencil and drop three seeds into the depression. Cover the seeds with a little more soil. Using a pipette, water the seeds.

WATER CONTAINER

The watering system is comprised

TABLE 1—PLANT GROWTH

STROBE LED	HEIGHT IN INCHES	
	CONTROL FLUORESCENT	CONTROL LED
2.5	2.0	
2.75	2.5	
3.0	3.0	
3.25	3.25	

Note: Leaf mass for all groups approximately equal

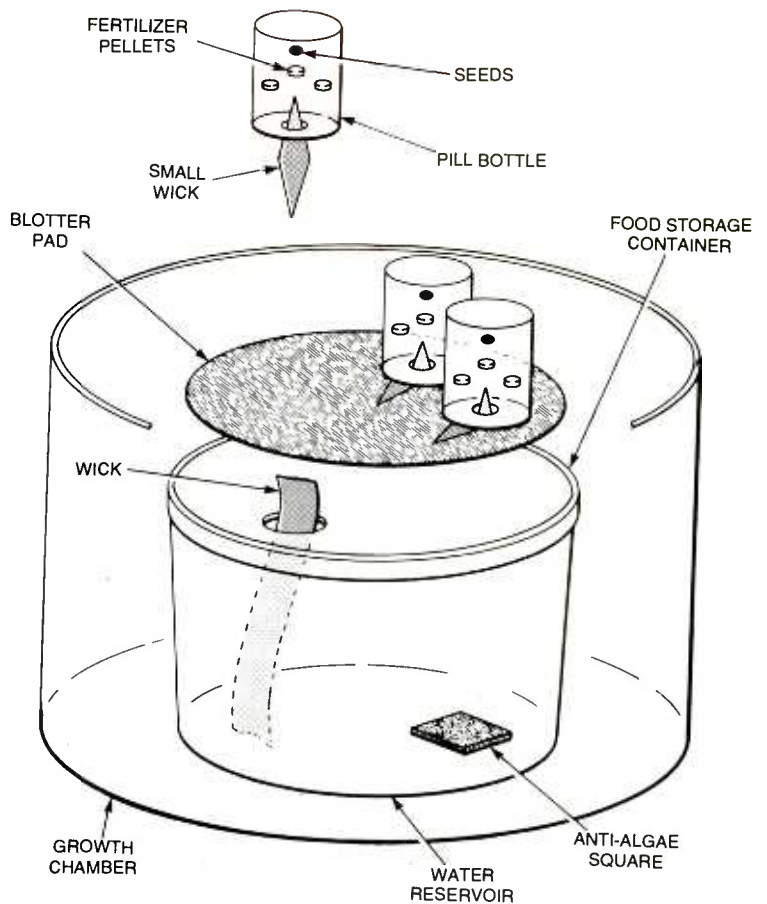
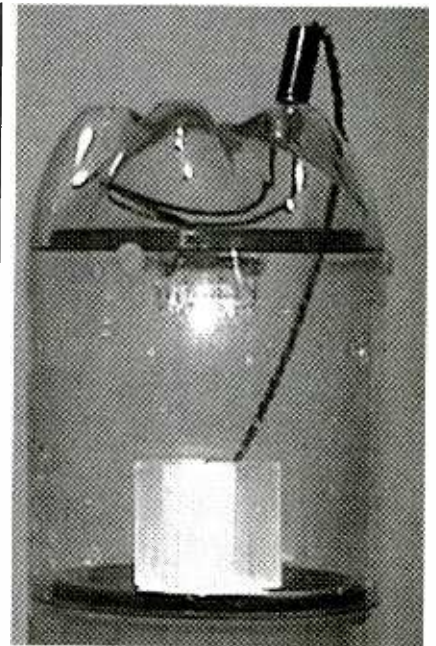

Fig. 5. Shown here are the final details of growth-chamber assembly.

of a water reservoir and series of wicks that combine to keep the soil moist and the plants watered. The water reservoir is little more than a plastic food-storage container that is small enough to fit into the growth chamber. Into the lid of the container, drill a 1/2-inch hole. Fill the container with water to about 3/4 full, and place an anti-algae square into the water. Place a large wick (pre-moistened) into the water and feed it through the hole in the lid. Place a pre-moistened blotter pad on top of the food-storage container. Make sure the large wick is underneath the blotter pad. Place the pill bottles on top of the blotter pad, so that the vial wicks are in contact with the blotter.

FIRST RUN

The first experiment was begun in early March. Within 24 hours, the control LED module started to burn out. First one line of LEDs, then another and another until only the center line of LEDs (two blue and one green)



Wires from the LED module are fed through a small hole in the top of the growth chamber and connected to a 1/16-inch phone jack. Power for the circuit is fed to the LED module through a matching 1/16-inch phone plug.

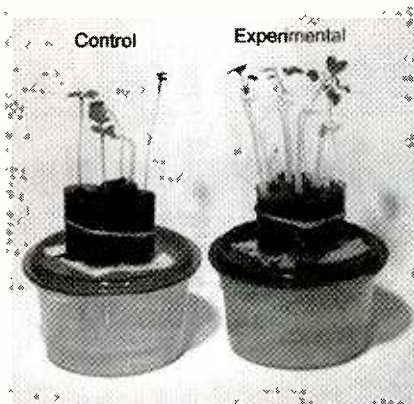

Shown here is a comparison between one control group and the experimental group. Note that the experimental group seems to have produced more foliage than the control group.

remained lit. The experiment was kept running because the second control group was still growing under the fluorescent lamp.

In the interim, fear set in that the experimental LED module was burning out. However, the experimental LED module kept running successfully for over two weeks without (as of yet) any ill effects. The 50% duty cycle allows the LEDs to cool off before thermal run-away occurs. To circumvent that problem, the manufacturer of the LEDs advised not to mix different LEDs in the same line.

ALTERNATE LED ARRAY

From the information gained during the first experiment, the LED array was redesigned so that it conformed to the layout in Fig. 5B (see last month's column for this figure). The green and yellow

PARTS LIST FOR THE LED GROWTH CHAMBER

Protoboard, appliance timer (Radio Shack # 61-1068; \$7.99), 1/8- or 3/16-inch phone-plug, sockets, two-liter soda bottles, plastic food-storage containers and lids, plastic screws, 12-volt DC wall transformer 500 mA.

Note: The following items are available from Images Company, 39 Seneca Loop, Staten Island NY 10314; Tel. 718-698-8305; Fax: 718-982-6145; Web: www.image-sco.com; a kit: containing 4 quad wicks, 1 blotter pad, 1 package fertilizer pellets, 1 antialgae pad, 1 felt wick, 4 plant vials, 1 package soil, and 1 pipette for \$10.95

low LEDs (which the plants didn't appear to be attracted to) were replaced in the reconstituted LED array. The new configuration, which is built around a single type of LED in a series branch, appears to last much longer than the original. If you decide to do this experiment, use the second LED array.

PRELIMINARY RESULTS

The experiment group appears to have grown just as well as the control group. If gauged solely by height, as documented in Table 1, it appears that the experimental plants slightly edged out the control group. However, the stems of the experimental plants required support where the control plant stems were stronger.

VARIATIONS ON THE THEME

This is an interesting experiment that lends itself to many variations. For example, the experimenter can alter the circuit to determine the optimum frequency and duty cycle required for a particular plant.

The light driving the photosynthesis cycle can be stepped through the light frequencies in an attempt to produce a higher efficiency. For instance, red light for 1/8 second, followed by blue light for 1/8 second, then darkness for 1/4 second, and the cycle repeats. Instead of using super-bright LEDs try Xenon flash tubes, which can produce brilliant light for a few milliseconds. Xenon flash tubes are commonly used in photography and standard strobe lighting.

In future experiments, we'll modify the growth chamber, change the LED array to the second unit, add an additional control group illuminated with half the light intensity of the experimental group, and use a computer to control all the lighting. The computer will make it easy to control and vary the frequency as well as the duty cycle of the strobed LED lighting. Feedback sensors can also be incorporated to insure that the lights are on when they're supposed to be and at the right intensity.

If you are interested in hearing about the results of future experiments or wish to share the knowledge you observed recreating this experiment, contact me in care of **Popular Electronics**, 500 Bi-County Blvd., Farmingdale, NY 11735. ■

ROBOTICS WORKSHOP

(continued from page 72)

PARTS LIST FOR TESTING THE PARALLEL-PORT EXPERIMENTER'S INTERFACE

LED1-LED9—Light-emitting diodes
R1-R9—270-ohm, 1/4-watt, 5% resistor
22-AWG solid-conductor, insulated, hookup wire

the interface as shown in Fig. 4. Connect the cable to the parallel port of your computer (some of the LEDs may light and stay lit; that's normal). To test the interface, run the QBASIC.EXE QBASIC interpreter that comes with your PC. (Whoops! Your PC didn't come with QBASIC? See "Basics on Getting Basic" for more information.)

Type the short test program in Listing 1. The program is written assuming that the LPT1 port in your computer is located at port 888 (378 hex), which is normal for a PC not equipped with a monochrome display card. If you are using an older PC with a monochrome-display card, the odds are that the LPT1 port is at address 956 (3BC hex). In that case, change the first line to "PORTADDRESS = 956."

Review the program for any errors. If none are found, run it. The LEDs should flash on and off very quickly as the program processes through the 256 possible combinations of the eight output lines. The LEDs that turn on represent a logic 1 state; those that are off represent a logic 0 state. Note that the LED for the STROBE line will not light when running this test program.

Debugging hardware-interfacing circuits can be tricky; it's often hard to know whether the problem is in the hardware or the software. You can eliminate the question of the problem being software related with the free-ware *Parallel Port Debugging Tool*, available at <http://www.senet.com.au/~cpeacock/pdebug.htm>. The debugging tool is a small DOS program that interactively displays the status of all the bits in the parallel port. For ease of use, run your interface program and the debugger under Microsoft Windows or some other multi-tasking environment, so they operate at the same time. Switch between the programs as needed. ■

ELECTRONIC TECHNOLOGY TODAY INC.

P.O. Box 240 • Massapequa Park, NY 11762



INVENTORY BLOWOUT SALE



BP07	100 Radio Hookups	\$3.00	BP304	Projects for Radio Amateurs and S.W.L.S	\$5.99
BP37	50 Projects Using Relays, SCR's and Triacs	\$3.99	BP317	Practical Electronic Timing	\$6.99
BP48	Electronic Projects for Beginners	\$2.99	BP320	Electronic Projects for Your PC	\$5.99
BP56	Electronic Security Devices	\$3.99	BP321	Circuit Source Book 1	\$6.99
BP64	Semiconductor Technology Elements of Elect Book 3	\$5.99	BP322	Circuit Source Book 2	\$6.99
BP74	Electronic Music Projects	\$3.99	BP329	Electronic Music Learning Projects	\$6.99
BP76	Power Supply Projects	\$3.99	BP332	A Beginners Guide to TTL Digital ICS	\$6.99
BP78	Practical Computer Experiments	\$2.99	BP333	A Beginners Guide to CMOS Digital ICS	\$6.99
BP88	How to Use OP Amps	\$5.99	BP334	Magic Electronic Projects	\$6.99
BP93	Electronic Timer Projects	\$2.99	BP355	A Guide to the World's Radio Stations	\$7.99
BP103	Multi-Circuit Board Projects	\$2.99	BP359	An Introduction to Light in Electronics	\$6.99
BP112	A Z-80 Workshop Manual	\$5.99	BP367	Electronic Projects for the Garden	\$6.99
BP114	The Art of Programming the 16K ZX81	\$3.99	BP370	The Superhet Radio Handbook	\$6.99
BP115	The Pre-Computer Book	\$2.99	BP371	Electronic Projects for Experimenters	\$6.99
BP124	Easy Add-On Projects for the Spectrum, ZX81 & ACE	\$3.99	BP374	Practical Fibre-Optic Projects	\$6.99
BP148	Computer Terminology Explained	\$2.99	BP378	45 Simple Electronic Terminal Block Projects	\$6.99
BP154	An Introduction to MSX Basic	\$3.99	BP379	30 Simple IC Terminal Block Projects	\$6.99
BP156	An Introduction to QL Machine Code	\$3.99	BP384	Practical Electronic Model Railways Projects	\$6.99
BP187	A Prac Ref Guide to Word Pro Amstrad PCW8256/PCW8512	\$7.99	BP391	Fault-Finding Electronic Projects	\$6.99
BP190	More Advanced Electronic Security Projects	\$3.99	BP392	Electronic Project Building for Beginners	\$6.99
BP194	Modern OPTO Device Projects	\$3.99	BP393	Practical Oscillator	\$6.99
BP232	A Concise Introduction to MS-DOS	\$3.99	BP394	An Introduction to PIC Microcontrollers	\$7.99
BP245	Digital Audio Projects	\$3.99	BP396	Electronic Hobbyists Data Book	\$7.99
BP248	Test Equipment Construction	\$3.99	BP401	Transistor Data Tables	\$7.99
BP256	An Intro to Loudspeakers and Enclosure Design	\$3.99	BP411	A Practical Intro to Surface Mount Devices	\$6.99
BP264	A Concise Advanced User's Guide to MS-DOS	\$3.99	BP413	Practical Remote Control Projects	\$7.99
BP267	How to Use Oscilloscopes and Other Test Equipment	\$5.99	PCP107	Digital Logic Gates and Flip-Flops	\$10.99
BP272	Interfacing PCS and Compatibles	\$5.99	PCP112	Digital Electronics Projects for Beginners	\$10.99
BP290	An Intro to Amateur Communications Satellites	\$5.99	PCP114	Advanced MIDI Users Guide	\$10.99
BP297	Loudspeakers for Musicians	\$6.99	ETT1	Wireless & Electrical Cyclopedia	\$4.99
BP299	Practical Electronic Filters	\$6.99			

PRICES DO NOT INCLUDE SHIPPING & HANDLING. ALL SALES ARE FINAL, NO RETURNS

ORDER FORM

Book No.	Title	Price	No. of Copies	Cost

Name _____
 Address _____
 City _____ State _____ Zip _____

If you wish to use a Credit Card:

MasterCard Visa Expire Date _____ / _____

Card No. _____

Signature _____

Allow 6-8 weeks for order to be fulfilled.

Please return this order form to:
 ELECTRONIC TECHNOLOGY TODAY, INC.
 P.O. Box 240
 Massapequa Park, NY 11762-0240



SHIPPING COSTS		Total Amount \$	
\$0.01 to \$5.00	\$2.00	\$20.01 to \$30.00	\$5.00
\$5.01 to \$10.00	\$3.00	\$30.01 to \$40.00	\$6.00
\$10.01 to \$20.00	\$4.00	\$40.01 to \$50.00	\$7.00
\$50.01 and above	\$8.50		
		30% off Subtotal	
		Add shipping cost (see table)	
		Local NY State Sales Tax	
		TOTAL COST \$	

Telephone Orders: If you wish to place your credit-card order by phone, call 516/293-0467. Automated order taking system functions 24 hours a day. Have your credit-card ready. Sorry, no orders accepted outside of U.S.A. and Canada, New York State Residents must add applicable sales tax. Offer expires 12/31/99.

COMM Links

Coax 'n' Stuff

JOSEPH J. CARR

Radio transmitters and receivers usually don't work well unless connected to some sort of antenna or other load. The wire that connects the transmitter or receiver to the antenna is the transmission line, which in modern systems usually means coaxial cable. That class of cable comes in a variety of types, but all share one thing: They consist of two conductors arranged such that the inner and outer conductors share the same axis (hence, the name *co-axial*) and are separated by an insulator (*dielectric*). The inner conductor might be either stranded (in larger forms) or solid wire.

Several different forms of coaxial line are available. Flexible coaxial cable is perhaps the most common form. The outer conductor in such cable is made of either braid or foil. An example of foil-dielectric coaxial cable can be found linking television-broadcast receivers to outdoor antennas. Another form of flexible or semi-flexible coaxial cable is helical line—a form of coax, in which the outer conductor is spiral wound. Hard line is coaxial cable that uses a thin walled pipe as the outer conductor. Some hard-line coax used at microwave frequencies are comprised of a rigid outer conductor and a solid dielectric.

Gas-filled coax is a special breed of hard line, which is hollow with the center conductor supported by a series of thin ceramic or Teflon insulators. The dielectric is either anhydrous (*i.e.*, dry) nitrogen or some other inert gas. Some flexible microwave-coaxial cables use a solid, *air-articulated* dielectric—a configuration in which the inner insulator is not continuous around the center conductor, but is ridged instead.

Obviously, reduced dielectric losses increase the usefulness of the cable at higher frequencies. Double-shielded coaxial cable provides an extra measure of protection against radiation from the line, while reducing the possibility of EMI from outside sources getting into the system.

CHARACTERISTIC IMPEDANCES

An impedance of 50 ohms is accepted as standard for RF systems, except in the cable-TV and video industries (which use 75 ohms). The reason for the difference is that power-handling ability and low-loss operation

TABLE 1—TRANSMISSION-LINE CHARACTERISTICS

TYPE OF LINE	Z ₀ (ohms)	VEL. FACTOR (v)
Polyethylene Coaxial Cable	50	0.66
Polyethylene Foam Coaxial Cable	50	0.79
Air-Space Polyethylene Foam Coaxial Cable	50	0.86
Teflon	75	0.70

* Various impedances depending upon cable type. RG-8/U and RG-58/U are 52 ohm cables, while RG-11/U and RG-59/U are 75 ohm cables.

don't occur at the same characteristic impedance. For example, maximum power-handling ability in RF coaxial cables occurs at about 30 ohms, while the lowest loss occurs at 77 ohms; 50 ohms is, therefore, a reasonable trade-off between the two points. In the cable-TV and video industries, however, the RF power levels are minuscule, but lines are long. The trade-off for TV is to use 75 ohms as the standard system impedance in order to take advantage of the reduced attenuation factor.

VELOCITY FACTOR

The velocity of the wave or signal in the transmission line is less than the free-space velocity; *i.e.*, less than the speed of light. Further, the velocity is related to the dielectric constant of the insulating material that separates the conductors in the transmission line. Velocity factor (v) is usually specified as a decimal fraction of c, the speed of light (3×10^8 m/s). For example, if the velocity factor of a transmission line is

rated at 0.66, then the velocity of the wave is 0.66c or $(0.66)(3 \times 10^8 \text{ m/s}) = 1.98 \times 10^8 \text{ m/s}$.

The velocity factor becomes important when designing things like transmission-line impedance matching transformers, phasing harnesses, or any other device in which the electrical length of the line is important. Transmission-line length is specified in terms of electrical length, which can be either an angular measurement (*e.g.*, 180 degrees or Π radians) or a relative measure keyed to wavelength (*e.g.*, one-half wavelength, the equivalent of 180 degrees). The physical length of the line is longer than the equivalent electrical length. For example, let's consider a 1-MHz, half-wavelength transmission line.

A rule of thumb tells us that the length of a wave (in meters) traveling through free space is $300/f$, where f is frequency expressed in megahertz; therefore, a half-wavelength line is $150/f$. At 1 MHz, the line must be $150/1 \text{ MHz}$, or 150-meters long. If the velocity factor is 0.80, then the physical length of the transmission line that will achieve the desired electrical length is $[(150 \text{ meters})(v)]/f = [(150 \text{ meters})(0.80)]/1 \text{ MHz} = 120 \text{ meters}$. (The derivation of the rule of thumb is left as an exercise for the student: Hint: It results from the relationship between wavelength, frequency, and velocity of propagation for any form of wave.)

There are certain practical considerations regarding velocity factor resulting from the fact that the physical and electrical lengths are not equal (physical length is shorter than electrical length). For example, in a certain type of phased-array antenna design radiating elements are spaced a half-wavelength apart and must be fed 180 degrees out-of-phase with each other. The simplest interconnects use a half-wave transmission line between the 0-degree and 180-degree elements. According to standard wisdom, the transmission line creates the 180-

degree phase delay required for the correct operation of the antenna. Unfortunately, because of the velocity factor, the physical length for a one-half electrical wavelength cable is shorter than the free-space half-wave distance between elements. In other words, the cable will be too short to reach between radiating elements by an amount proportional to the velocity factor!

Clearly, velocity factor is a topic that must be understood before transmission lines can be used in practical situations. Table 1 shows the velocity factors for several types of popular transmission line.

TRANSMISSION-LINE NOISE

Transmission lines are capable of generating noise and spurious voltages that are seen by the system as valid signals. Several such sources exist. One source is coupling between noise currents flowing in the inner and outer conductors. Such currents are induced by nearby electromagnetic interference and other sources (e.g., connection to a noisy ground plane). Although coaxial design reduces noise pick-up compared with parallel line, the potential for EMI still exists. Selecting a high-grade line with a high degree of shielding significantly reduces the problem.

Another source of noise is thermal noises in the resistances and conductances of the line. That type of noise is proportional to both the resistance and the temperature.

There is also noise created by mechanical movement of the cable. One species of noise results from the movement of the dielectric against the two conductors. That form of noise is caused by electrostatic discharges in much the same manner as the spark created by rubbing a piece of plastic against woolen cloth.

A second species of mechanically generated noise is piezoelectricity in the dielectric. Although more common in cheap off-brand cables, one should be aware of it. Mechanical deformation of the dielectric causes electrical potentials to be generated. Both species of mechanically generated noise can be reduced or eliminated by proper mounting of the cable so that it remains relatively motionless. Although rarely a problem at lower frequencies,

TABLE 2—TYPICAL COAXIAL CABLE LOSS IN DECIBELS PER 100-FEET

CABLE TYPE	FREQUENCY (MHz)									
	100	200	300	400	500	600	700	800	900	1000
RG-8/U	1.8	2.7	3.45	4.2	4.73	5.3	5.8	6.25	6.7	7.1
RG-58/U	4.9	7.3	9.4	11.5	13.3	15.2	17	18.5	20	21.5

mechanical noise can be significant at microwave frequencies when signal levels are low.

COAXIAL CABLE CAPACITANCE

A coaxial-transmission line possesses a certain capacitance per unit of length. A long run of coaxial cable can build up a relatively large capacitance. For example, a common type of coax is rated at 65 pF/meter. Thus, a 150-meter roll has a capacitance of (65 pF/m)(150 m), or 9750 pF.

When charged with a high voltage, as is done in performing cable breakdown voltage tests at the factory, the cable acts like a charged, high-voltage capacitor. Although rarely lethal, the stored energy in new cable can deliver a nasty electrical shock, which can irreparably damage electronic components. In a very few, fortunately rare, cases, the high voltage used to test coaxial cable remains in the cable when it is rolled up and shipped to the customer. From time to time, the technician or amateur operator preparing the cable will get a nasty (but usually harmless) electric shock.

COAXIAL CABLE CUT-OFF FREQUENCY (f_c)

The normal mode in which a coaxial cable propagates a signal is as a transverse electromagnetic (TEM) wave, but other modes are possible—usually undesirable. There is a maximum frequency above which TEM propagation becomes a problem, and higher modes dominate. That figure becomes important when frequencies in the upper UHF or microwave region are being carried. Coaxial cable should not be used above the cut-off frequency. When maximum operating frequencies for cable are listed, it is the TEM mode that is cited. Beware of attenuation (loss), however, especially when making selections for VHF, UHF, and microwave frequencies. A particular cable may have a sufficiently high

TEM-mode frequency, but still exhibit a high attenuation per unit length at those frequencies that are of interest to you.

CABLE LOSS

Coaxial cable is not a perfect conductor of RF currents. Losses in coax are usually measured in decibels per one hundred feet (dB/100-ft). There are two basic forms of loss: copper loss and dielectric loss. The copper losses are due to the fact that: 1) copper conductors have resistance, and 2) RF currents tend to flow on the surface of conductors because of "skin effect." When a current passes through the conductor, the ordinary I^2R losses are seen, as with any wire. The dielectric losses arise from the fact that voltage fields affect the molecules of the dielectric inner conductor. Table 2 shows some typical losses for generic cable for the sake of comparison, but for any particular type of cable you will have to consult the manufacturer's literature. Note that the thinner forms of cable (RG-58) have considerably higher losses than the thicker cable (RG-8/U) of the same impedance.

Cable loss can severely afflict signal levels in a system. Keep in mind that -3 dB represents a 2:1 loss of RF power. If an RG-58/U cable of the type depicted in Table 2 is used at 900 MHz, then the loss is 20 dB/100-feet. Suppose the antenna is on a 100-foot tower (not an unreasonable choice); that means the power ratio between output and input is 20 dB, so the output power is 0.01 of the power applied to the input end. In other words, if 10 watts is input to the transmitter end of the cable, only 10 watts \times 0.01 = 0.1 watts will appear at the antenna. The same problem occurs on the receive end . . . few systems can afford a -20-dB loss that isn't necessary!

A lossy transmission line can also make a high VSWR look perfectly normal. I've seen a situation where a high

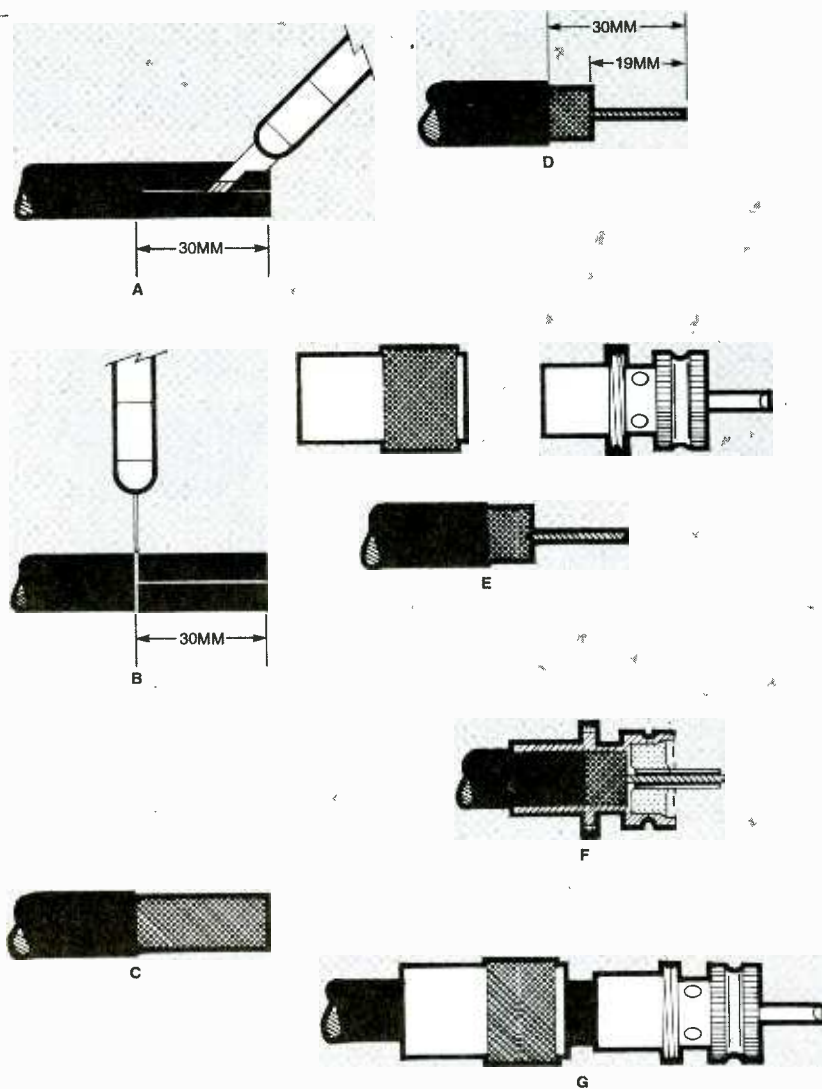

Fig. 1. Shown here are the steps required to meld a PL-259 "UHF" coaxial connector with a length of coax. Begin by cutting the cable to the required length using a razor, knife, hobby knife, or scalpel and then slitting the outer insulation (as illustrated in A). Then, as shown in B, make a circumferential cut at the inner end of the slit and remove the outer insulation (C). Follow that (as shown in D) by cutting away the tinned outer braid and inner insulation so that 0.75-inch (19-mm) of inner conductor is exposed. The PL-259 UHF connector and the prepared cable are shown in E. Slip the outer shell of the connector over the cable as shown in F, and finally slip the inner portion of the connector over the exposed cable end, making sure that the inner conductor goes into the hollow connector center pin, without bending or buckling (as shown in G).

VSWR (>6:1) caused by antenna mismatch was read as 2:1 at the transmitter end solely because of the loss in the coaxial cable.

INSTALLING COAXIAL CONNECTORS

I've messed up my share of RG-8/U and RG-11/U coaxial cable. Putting a PL-259 "UHF" coaxial connector on the end of a length of coax appears to be a daunting task. But it's really quite easy. Figure 1 shows the steps. Begin by cutting the cable to the length needed and following these

steps. The first step is to slit the outer insulation (as illustrated in Fig. 1A). Take care to slit *only* the outer insulation and not damage the shield braid beneath it. Use a razor knife, hobby knife, or scalpel to make a 1 1/8 inch (30mm) slit from one end of the cable. Next, as shown in Fig. 1B, make a circumferential cut at the inner end of the long slit, so that the outer insulation can be removed (Fig. 1C).

Once the outer insulation is removed, use a soldering iron to lightly tin the braid, making it stiff. Take care to not use too much heat, or the

inner insulation will be damaged. Also, if too thick a layer of solder is laid on, then the connector will not slip over the end in the following steps.

After soldering, you should, as shown in Fig. 1D, proceed to cut away the tinned outer braid and inner insulation so that 0.75-inch (19-mm) of inner conductor is exposed. Note that the inner insulator and shield will be flush with each other at the end of the 19-mm section.

Figure 1E shows the PL-259 UHF connector and the prepared cable. Now here's a bit of wisdom for you: unless the cable is relatively short, and you have free access to both ends, now is the time to slip the outer shell (the piece with the thumb threads) over the cable, back first. Next, slip the inner portion of the connector over the exposed cable end, making sure that the inner conductor goes into the hollow connector center pin, without bending or buckling (Fig. 1F). Some people prefer to solder tin the inner conductor, especially if the cable uses a stranded wire for the inner conductor.

Once the connector is firmly seated on the cable (see Fig. 1G), use an ohmmeter to make sure there is no short between the inner and outer conductors. If the cable checks out on the ohmmeter, solder the outer shield to the connector by soldering through the view holes in the thinner portion of the connector. Make sure that *all* of the holes are soldered. I've seen a connector that was "tacked on" by soldering only one hole go bad. The connection failed . . . and the blankety-blank cable was buried inside a wall (which itself was an installation mistake!). Finally, you should solder the inner conductor at the end of the hollow center pin. After it has cooled, check the cable with an ohmmeter.

I use a soldering gun with 100-, 200-, and 250-watt three-way switchable settings, rather than a pencil iron. The pencil iron is fine for printed-circuit boards, but the metal of the braid and connector provide enough heat-sinking to cool off the connection too much. Give it a try . . . you'll find that the connector is actually relatively easy to install.

I can be reached by snail mail at PO Box 1099, Falls Church, VA, 22041, or you can send me an e-mail at carrj@aol.com. ■

NEW PRODUCTS

DIGITAL/ANALOG MEGOHMMETERS

These *Digital/Analog Megohmmeters* (Models 1030, 1040, and 1045) are the latest design in multiple voltage insulation, resistance, and continuity meters. Housed in an over-molded slip-proof rugged case, the meters are a convenient-to-use size—8.31 × 4.26 × 2.36 inches. They test voltage combinations from 250V and 500V up to 1000V and perform insulation mea-



surements up to 2000 megohms.

Features include a multi-line 4000-count backlit digital display and analog bargraph, built-in auto-ranging AC/DC 600V default voltmeters and warnings, automatic discharge, and alarm and timer functions. An optional test probe is available for remote test activation.

The suggested list price for the Models 1030, 1040, and 1045 Digital/Analog Megohmmeters is \$389. For more information, contact AEMC Instruments, 99 Chauncy Street, Boston, MA 02111; Tel. 800-343-1391 or 617-451-0227; Fax: 423-2952; Web: www.aemc.com.

CIRCLE 80 ON FREE INFORMATION CARD

WORLD BAND RECEIVER

The *MFJ-8121 World Band Receiver* operates FM, Medium Wave, Long Wave, and Shortwave bands 1–18, with excellent sensitivity and selectivity. A built-in telescopic antenna (6 inches retracted, 26 inches fully extended), and a Sony integrated circuit bring in stations loud and clear. The multicolored tuning dial glides smoothly across the bands, and a

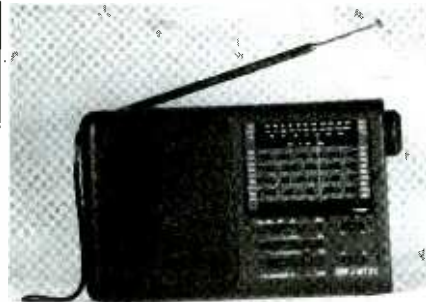

front-panel switch easily allows the user to switch from AM to FM. The built-in 3-inch speaker provides plenty of clear, room-filling sound, and it automatically disconnects when earphones are plugged in.

The compact receiver (4½ × 7 × 1½ inches) has detailed World Time Zone and frequency charts permanently silkscreened on the back panel. Easy to take anywhere, the MFJ-8121 has a wrist wrap-around carrying handle, and it can be powered from either 6VDC or four AA batteries.

The MFJ8121 World Band Receiver costs \$39.95. For more information, contact MFJ Enterprises, Inc., P.O. Box 494, Mississippi State, MS 39762; Tel. 800-647-1800 or 601-323-5869; Fax: 601-323-6551; Web: www.mfjenterprises.com.

CIRCLE 81 ON FREE INFORMATION CARD

DIGITAL FORCE GAUGE

The *Digital Force Gauge Model 475044* measures up to 20 Kg, 44 lbs., and 196 Newtons with 0.5% accuracy. Measurements are displayed on a 5-digit LCD with peak hold and pushbutton zero. The display reverses so that it's always readable however the gauge is oriented.

Features include selectable fast/slow response, exclusive load cell measurement transducer, and indication of overrange, low battery, and special function. An optional test stand permits precise tension/compression analysis. The force gauge, which is 8.9 by 3.3 by 1.5 inches and weighs 1.2 lbs., comes complete with extension rod, carrying case, six AA batteries, and four adapters.



The Digital Force Gauge Model 475044 costs \$439. For more information, contact Extech Instruments Corp., 335 Bear Hill Road, Waltham, MA 02451; Tel. 781-890-7440; Fax: 781-890-7864; Web: www.extech.com.

CIRCLE 82 ON FREE INFORMATION CARD

MULTI-MODE SIGNAL GENERATOR

Ideal for use by engineers, technicians, designers, scientists, and hobbyists in a wide variety of applications including communications, audio, video power systems and consumer electronics, the *Model 4070 Synthesized Arbitrary Waveform/Function/Pulse Generator* is a signal generator based on Direct Digital Synthesis (DDS) technology. Designed for ease of use, the Model 4070 acts as an Arbitrary Waveform Generator, Function Generator, and Pulse Generator, as well as a Synthesized Waveform Generator that produces modulated sinewaves from DC to 21.5 MHz—all in one.

Users are able to design any waveform and download it to the Model

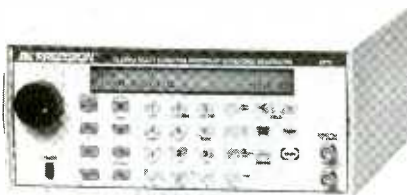

4070 for generation, without any special downloading software or protocols. Results can be retrieved over the RS-232 port, using the 4070 as a data acquisition unit. Features of the unit include an RS-232 remote control, full-size numeric keypad and encoder, and a large easy-to-read illuminated LCD screen. Because the Model 4070 signal generator uses Flash memory to hold its operating software, the unit is field upgradeable.

The Model 4070 Synthesized Arbitrary Waveform/Function/Pulse Generator costs \$1495. For more information, contact B&K Precision Corp., 1031 Segovia Circle, Placentia, CA 92870; Tel. 714-237-9220; Fax: 714-237-9214; Web: www.bkprecision.com.

CIRCLE 83 ON FREE INFORMATION CARD

PATTERN GENERATOR

Designed for both bench and field use, the portable *PC Scan Pattern Generator, Model LT 1607*, meets the test-signal needs of most computer monitors and handles NTSC and Y/C monitors as well. A little larger than a paperback book, the LT 1607 uses simple controls to call up raster formats for VGA, SVGA, XGA, MAC13,



MAC16, and MAC19 computer monitors. In addition, the unit outputs composite NTSC and Y/C feeds for adjustments of very large screen displays and video walls.

Test signals include color bars, circle/crosshatch, window, computer characters, and a raster that can be set to white, yellow, cyan, green, magenta, red, blue, and black. Auto pattern sequencing may also be selected. Individual RGB level controls are provided.

The Model LT 1607 PC Scan Pattern Generator costs \$995. For more information, contact Leader Instruments Corp., 380 Oser Avenue, Hauppauge, NY 11788; Tel. 800-645-5104 or 516-231-6900; Fax: 516-231-5295; Web: www.leaderusa.com.

CIRCLE 84 ON FREE INFORMATION CARD

MINI THERMO-ANEMOMETER

The *Mini Thermo-Anemometer, Model 45118*, measuring 5.25 by 2.75 by .75 inches and weighing 3 oz., is designed for HVACR technicians, plant maintenance personnel, greenhouse and nursery growers, and for use in recreational sports. It displays air velocity



plus temperature or air velocity plus windchill on a large LCD, with updates every few seconds. Measurements are displayed in four different units with $\pm 3.0\%$ accuracy, ranging from 60 to 7830 feet per minute (FPM), 0.4 to 77

nautical miles per hour (knots), 0.5 to 89 miles per hour (MPH), and 1 to 17 Beaufort. Readings are averaged every two seconds, but 5-, 10-, or 13-second averaging can be selected for special applications.

Features include Max Display to recall the highest reading, Data Hold to freeze the most recent display, and Auto shut off to preserve battery life. The meter folds into a water-resistant housing, which is designed to float and to withstand drops to six feet. With the cover open, the meter extends to nine inches for reaching into vents.

The Mini Thermo-Anemometer, Model 45118, costs \$89. For more information, contact Extech Instruments Corp., 335 Bear Hill Road, Waltham, MA 02451; Tel. 781-890-7440; Fax: 781-890-7864; Web: www.extech.com.

CIRCLE 85 ON FREE INFORMATION CARD

FIBER VERIFIERS

When quick, basic operational testing of fiber runs is needed, the *FV40 Series of Fiber Verifiers* verify multi-mode fiber-optic cable and determine power loss. Each fiber verifier features an easy-to-read LED bargraph and is powered by a 9-volt battery.



The *FV41* is a transmitter (light source) and receiver (power loss read-out) in one. It checks uninstalled cable where both ends are looped back in the *FV41*. With the *FV42* added, an 850-nm-light-source transmitter, users are able to check installed cable or long runs where a remote light source is needed. The *FV42* and *FV43* are designed to be used together. The *FV43* is a power-loss meter featuring ten LED bars to indicate optical power loss from -22dBm to -40dBm , in -2dBm increments.

The *FV40 Series Fiber Verifiers* cost \$295 (*FV41*) and \$195 (*FV42* and *FV43*), respectively. For more information, contact Wavetek, Wandell &

Goltermann, Inc., 9045 Balboa Avenue, San Diego, CA 92123; Tel. 619-279-2200; Fax: 619-565-9558; Web: www.wavetek.com.

CIRCLE 86 ON FREE INFORMATION CARD

AC CURRENT CLAMPS

The *i200* is a single-range 200A clamp-on AC current clamp with current output via safety-shrouded banana plugs. It is intended for use with any Fluke DMM or current measurement device equipped with banana inputs. In addition, the *i200*



has a 1-mA/a output signal, with a measuring range from 0.5 to 240A.

A dual-range 20A and 200A clamp-on AC current clamp, the *i200s* is suitable for use with DMMs, oscilloscopes, and power analyzers, or ScopeMeter test tools that have BNC connectors and accept voltage inputs. The *i200s* is equipped with voltage output via a safety-insulated BNC connector and has a dual banana-to-BNC adapter, allowing it to be connected to any multimeter with banana input.

Both clamps have a 40-Hz–10kHz frequency response. The *i200* costs \$89 and the *i200s* costs \$149. For more information, contact Fluke Corp., P.O. Box 9090, Everett, WA 98206; Tel. 888-492-7538; Fax: 425-356-5116; Web: www.fluke.com.

CIRCLE 87 ON FREE INFORMATION CARD

PROFESSIONAL MULTIMETER

Ideal for household appliance testing, installation and service, electrical projects, electronic design and testing, and auto repair and tune-up, the *Craftsman Professional* handheld (4.2 × 8.3 × 2.2) *Multimeter + Scope* combines a True RMS multimeter with a single-channel 100-kHz graphical oscilloscope. The oscilloscope provides glitch capture, pre/post trigger, and graphic LCD with a HELP mode. Among the multimeter functions are True RMS AC voltage/current, DC voltage/current, resistance, capacitance, frequency, dB, temperature

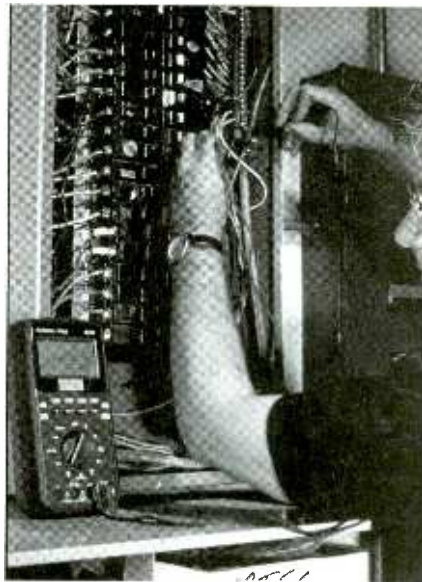

(with adapter), %Duty Cycle, pulse width, period, TTL level generator, and diode and continuity tests.

The meter features a built-in RS-232 interface (cable and software sold separately), minimum/maximum/average displays, 15 waveform memory, auto power off, and surge protection. The 4000-count (3³/₄-digit) multimeter display with analog bar graph also offers data-hold and over-range indication. The unit comes complete with built-in stand, six AA batteries, fuses, test leads, and alligator clips.

The Craftsman Professional Multimeter + Scope (#82089) retails for \$299.99. For more information, contact Sears Roebuck, Inc.; Tel. 800-390-8792 (information) or 800-377-7414 (sales).

CIRCLE 88 ON FREE INFORMATION CARD

HOME SURGE PROTECTOR

Installed at the loadcenter or breaker panel, the *Complete Home Surge Protector (Clipper)* provides five times the protection of traditional surge units or surge breakers. It protects AC power, telephone/fax, and coaxial cable lines in one unit. The *Complete Home Surge Protector* provides AC power protection for 120/240-volt systems, with 39,000 amps per phase of surge current capacity and nanosecond response time.

The device has two connections for incoming telephone/fax lines, with 10,000 amps of surge protection per pair. Additionally, the unit features two coaxial-cable F connections (input and output) that are compatible with satellite or cable TV systems and include



line-to-shield (ground) protection. Two status indicator lights identify operational problems. Four 24-inch leads are included for easy installation of the protector.

The Clipper costs \$120. For more information, contact Cutler-Hammer, Inc.; Tel. 800-525-2000.

CIRCLE 89 ON FREE INFORMATION CARD

24-HOUR CLOCK

Designed for DXers, the *MFJ-125 24-Hour Wall Clock* features a 12-inch diameter face that shows 24-hour and 12-hour time, day of the week, and day of the month simultaneously. The highly visible 24-hour clock has smaller day, date, and 12-hour time cylinder insets. All of its dials can be independently set to accommodate special formats.

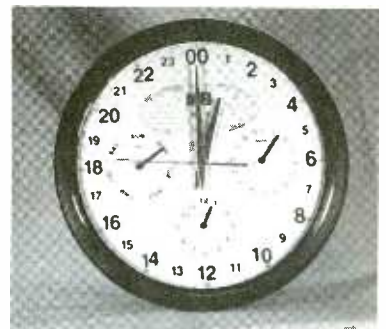

The clock comes with black and gold trim, a white face with large 24-hour numerals, a gold map, and gold hands. The smaller hands for day, date, and 12-hour time are black.

The MFJ-125 24-Hour Wall Clock costs \$29.95. For more information, contact MFJ Enterprises, Inc., P.O. Box 494, Mississippi State, MS 39762; Tel. 601-323-5869; Fax: 601-323-6551.

CIRCLE 90 ON FREE INFORMATION CARD

Phototransistor Basics

Get acquainted with one of the many photovoltaic devices that are making our lives a little more enjoyable as they carve out a niche for themselves in our burgeoning electronics industry.

IAN POOLE

There is a wide selection of photosensitive devices available to the electronic designer—ranging from the simple photodiode to the more modern photoelectric components, many of which integrate complicated control circuitry to help the photosensitive element more efficiently carry out its duties. While simple photodiodes fulfill many requirements, more complex phototransistors are more suitable for a number of applications. The standard photovoltaic devices are low cost, provide high levels of current gain, and can be adapted to optoelectronic circuits, such as in optoisolators or photosensors.

The idea of the phototransistor has been around for many years. William Shockley first proposed the idea in 1951, not long after the ordinary transistor had been discovered. It was then only two years before the phototransistor was demonstrated. Since that time, phototransistors have been used in a variety of applications, such as optoisolation, optical sensing, etc., and their development has continued ever since.

Structure. Although ordinary transistors exhibit photosensitive properties when exposed to light, the structure of a device intended specifically for photo applications

must be optimized for that purpose. The manufacture of phototransistors, which have much larger base and collector areas than a normal transistor, is generally based on diffusion or ion implantation techniques. Early phototransistors generally used the same material (such as germanium or silicon) throughout the device (forming a homo-

junction can be used for the collector, although that practice is less common these days because other structures offer better performance levels.

Operation. Phototransistors are operated in their active region, with the base connection left open or disconnected because a bias is generally not required. Base voltage would only be used to bias the transistor in order to allow additional collector current to flow; however, that would mask any biasing current that flows as a result of the photo action. The different current flows are illustrated in Fig. 2.

For operation, the phototransistor's bias conditions are really quite simple. The collector of an NPN transistor is made positive with respect to the emitter, or is made negative for a PNP transistor. Incident light enters the base region where it causes

hole-electron pairs to be generated. The generation of such pairs mainly occurs in the reverse-biased base-collector junction. The hole-electron pairs move under the influence of that electric field and they provide the base current that causes electrons to be injected into the emitter.

hole-electron pairs to be generated. The generation of such pairs mainly occurs in the reverse-biased base-collector junction. The hole-electron pairs move under the influence of that electric field and they provide the base current that causes electrons to be injected into the emitter.

Characteristics. As already men-

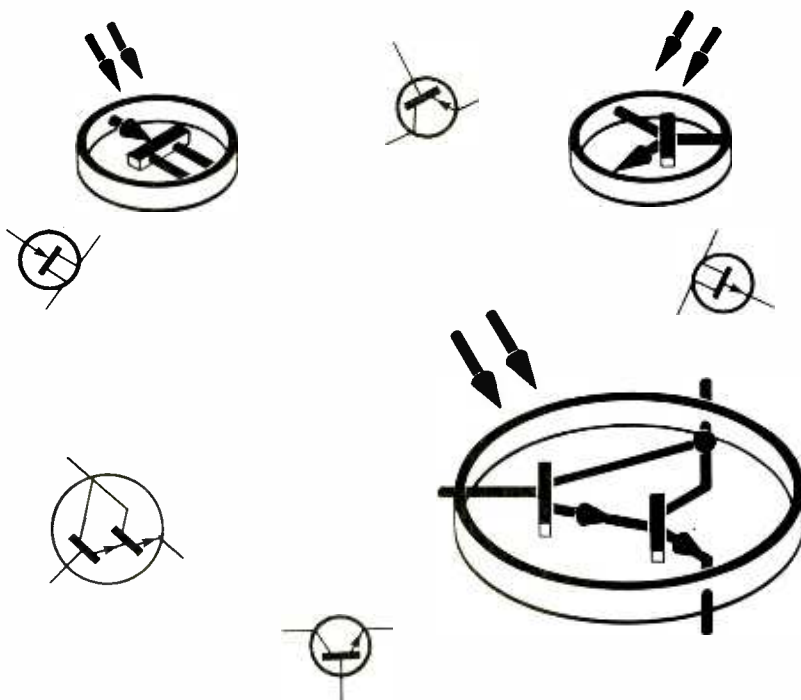

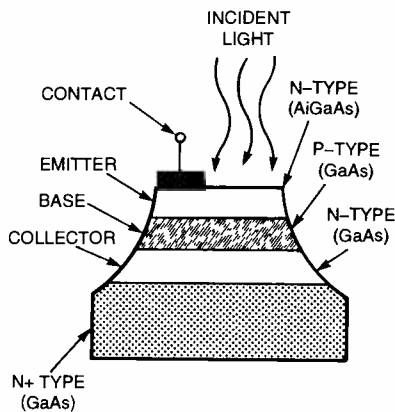

Fig. 1. Phototransistors are generally manufactured with a mesa structure—using heterojunctioning, which produces a device that has different materials on either side of the junction.

tioned, the phototransistor has a high level of current gain resulting from the transistor action. For homostructures, i.e. ones using the same material throughout the device, the gain can range from about 50 up to a few hundred. However, for heterostructure devices—i.e., those with structures comprised of different materials on either side of the junction—gain levels can rise to ten thousand. Despite their high level of gain, heterostructure devices are not widely used because they are considerably more costly to manufacture. A further advantage of all phototransistors—when compared to the avalanche photodiode, another device that offers gain—is that the phototransistor has a much lower level of noise.

One of the main disadvantages

of the phototransistor is its lack of a particularly good high-frequency response. That arises from the large capacitance associated with the base-collector junction. The junction is designed to be relatively large, enabling it to pick up sufficient quantities of light. For a typical homostructure device, the bandwidth may be limited to about 250 kHz. Heterojunction devices have a much higher limit, and some can be operated at frequencies as high as 1 GHz.

The characteristics of the phototransistor under different light intensities are shown in Fig. 3. From that graph, it can be deduced that the characteristics of a phototransistor are very similar to those of a conventional bipolar transistor, but with the different levels of base current replaced by the incident-light intensity. From the diagram, note that a small current—called *dark current*, which represents the small number of carriers that are injected into the emitter—flows even when no light is present. Like the photo-generated carriers, that's also subject to the amplification by transistor action.

Photo-Darlington. Another device that belongs to the same family is the Darlington phototransistor, or photo-Darlington. It is essentially a pair of transistors in a Darlington arrangement where the first transistor, Q1, acts as the photodetector, and is emitter-coupled into the base of the second transistor, Q2, as shown in Fig. 4. That gives a very

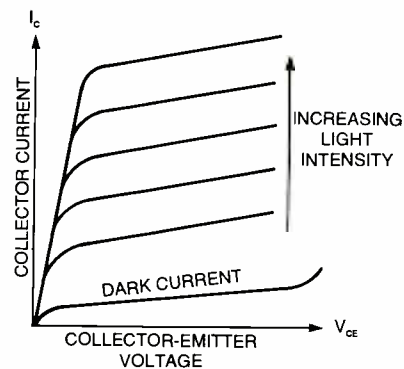

Fig. 3. Shown here is a graph illustrating the collector-current versus collector-emitter-voltage characteristics of a phototransistor at various light intensities. Note that once the phototransistor is triggered, it functions pretty much like any other transistor.

much higher level of gain, but it is very much slower than the ordinary phototransistor, having a maximum frequency of only around 20 kHz.

Another alternative is to use an

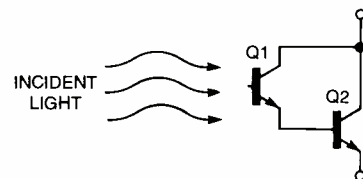

Fig. 4. A photo-Darlington, like a regular Darlington, is comprised of a phototransistor that is emitter-coupled into the base of a second transistor. That configuration, like its conventional counterpart, provides higher gain levels but with reduced frequency response.

avalanche phototransistor. In such devices, the collector-base junction is biased so that a very high field is created in the collector-base region, causing avalanche multiplication to occur. That increases the device's gain quite significantly.

Photo-FET. There are a number of types of photosensitive field-effect transistors (FETs). The simplest mode in which a photo-FET can operate is based on photoconductivity. In such devices, light (a form of electromagnetic radiation) causes the generation of additional carriers that are used to increase the level of conductivity. The various types of junction FETs use the fact that the diode formed at the reverse-biased

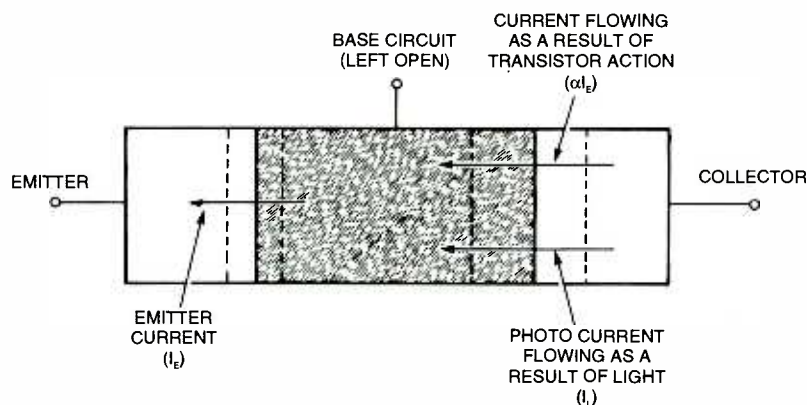

Fig. 2. In normal operation, the collector of an NPN phototransistor (as is the case with regular NPN BJTs) is made positive with respect to the emitter; but, unlike a normal transistor, the base is left open.

junction, between the gate and channel, can act as a photodiode. Gate current flows if the gate is connected to an external resistor and the resultant current is amplified by the action of the FET.

Conclusion. Phototransistors of various configurations have found widespread use in modern electronics—with their applications encompassing everything from home-entertainment-center control and home-lighting system and security control to automotive creature comforts and security systems. And more applications for these simple but useful devices are sure to surface in the near future, as the consumer demands more and more from their electronic equipment. ■

AUDIOPHILE AMPLIFIER

(continued from page 38)

supply polarity). For applications approaching the full ratings of the power amplifier, it's recommended that 15,000–20,000- μ F per voltage polarity be used (usually achieved by paralleling two capacitors per supply rail as illustrated in Fig. 7). Naturally, the voltage ratings of the capacitors should be chosen according to the "peak" secondary voltage ratings of T1.

The full-wave-bridge rectifier, BR1, should be rated for 200 PIV @ 20 amps (or higher). The high current rating provides an extra margin of safety against the high surge currents of the power-supply filter capacitors.

A pair of "bleeder" resistors, RB1 and RB2, are installed to safely discharge dangerous capacitor charges in the event that one (or both) of the rail fuses blow. Those resistors can be 12K, 1/2-watt units for any application up to 63-volt rail supplies.

The audio line-level signal is fed to the amplifier at the points indicated in Fig. 7. The input signal should be wired to the amplifier module through a good grade of shielded audio cable, which should not run close to any other wiring in the amplifier enclosure. The sensitivity for maximum output into 4-ohm loads is approximately 630 millivolts

rms. For 8-ohm loads, the sensitivity is approximately 800 millivolts. The speaker load is connected between the speaker output and circuit common.

Due to the inherent insensitivity of this amplifier design to quiescent bias adjustments, R50 can simply be centered for near-optimum distortion performance. Referring to Fig. 4, precise bias adjustment can be obtained by measuring the DC voltage from Q17's drain to the drain of Q19 and adjusting R50 for a reading of 20 millivolts, which establishes the bias current applied to the MOSFETs at approximately 45 milliamperes.

Final Comments. The OPT13 amplifier modules are intended for the serious hobbyist or professional desiring a no-compromise design for a wide variety of audio applications. The incorporation of L-MOSFETs and the increased circuit complexity force the construction cost to be a little higher than many generic designs, but the sonic purity and long-term reliability will be well-worth the cost difference to most audiophiles. ■

Get your copy of the CRYSTAL SET HANDBOOK



Go back to antiquity and build the radios that your grandfather built. Build the "Quaker Oats" type rig, wind coils that work and make it look like the 1920's! Only \$10.95 plus \$4.00 for shipping and handling. Clagg Inc., P.O. Box 4099, Farmingdale, NY 11735. USA Funds ONLY! USA and Canada—no foreign orders. Allow 6-8 weeks for delivery. MA01

THE TRANSDUCER PROJECT BOOK



1992T—From TAB Books. A unique collection of practical transducer devices that you can put together simply and inexpensively. You can build a seismic sensor, a temperature survey meter, an open-door annunciator, a moisture detector, an automatic night light, and more. To order—ask for book **1992T**, and include your check for \$6.99 - clearance (includes s&h) in the US and Canada, and order from—**Electronic Technology Today Inc., P.O. Box 240, Massapequa Park, NY 11762-0240**. US funds only; use US bank check or International money order. Allow 6-8 weeks for delivery. MA06

TIPS FOR MAIL ORDER PURCHASE

It is impossible for us to verify the claims of advertisers, including but not limited to product availability, credibility, reliability and existence of warranties. The following information is provided as a service for your protection. It is not intended to constitute legal advice and readers are advised to obtain independent advice on how to best protect their own interests based upon their individual circumstances and jurisdictions.

- 1. Confirm price and merchandise information** with the seller, including brand, model, color or finish, accessories and rebates included in the price.
 - 2. Understand the seller's return and/or refund policy**, including the allowable return period, who pays the postage for returned merchandise and whether there is any "restocking" or "return" charge.
 - 3. Understand the product's warranty.** Is there a manufacturer's warranty, and if so, is it for a U.S. or foreign manufacturer? Note that many manufacturers assert that, even if the product comes with a U.S. manufacturer's warranty, if you purchase from an unauthorized dealer, you are not covered by the manufacturer's warranty. If in doubt, contact the manufacturer directly. In addition to, or instead of the manufacturer's warranty, the seller may offer its own warranty. In either case, what is covered by warranty, how long is the warranty period, where will the product be serviced, is there a charge for service, what do you have to do to obtain service and will the product be repaired or replaced? You may want to receive a copy of the written warranty before placing your order.
 - 4. Keep a copy of all transactions**, including but not limited to cancelled check, receipt and correspondence. For phone orders, make a note of the order including merchandise ordered, price, order date, expected delivery date and salesperson's name.
 - 5. If the merchandise is not shipped within the promised time**, or if no time was promised, within 30 days of receipt of the order, you generally have the right to cancel the order and get a refund.
 - 6. Merchandise substitution** without your express prior consent is generally not allowed.
 - 7. If you have a problem with your order or the merchandise**, write a letter to the seller with all the pertinent information and keep a copy.
 - 8. If you are unable to obtain satisfaction from the seller**, contact the consumer protection agency in the seller's state and your local Post Office.
- If, after following the guidelines, you experience a problem with a mail order advertiser that you are unable to resolve, please let us know. Write to Advertising Department, Gernsback Publications Inc., 500B Bi-County Blvd. Farmingdale, NY 11735.

Be sure to include copies of all correspondence.

ELECTRONICS LIBRARY

(continued from page 28)

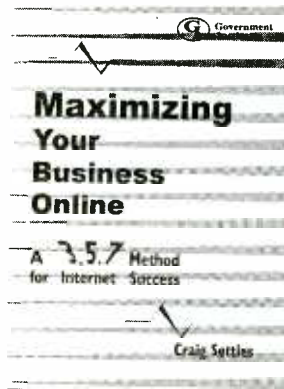

five-dimensional business strategy, and implement effective tactics for maximizing results from their Web-based business.

The author explains how to market to Internet users and build brand loyalty electronically. To provide perspective and a thorough understanding of conducting business online, the 200-page book discusses the evolution of the Internet, strategies for better communication, direct response marketing, public relations, and customer service and support.

Maximizing Your Business Online: A 3.5.7 Method For Internet Success costs \$59 and is published by Government Institutes Division, ABS Group, Inc., 4 Research Place, Suite 200, Rockville, MD 20850-3226; Tel. 301-921-2323; Fax: 301-921-0264; Web: www.govinst.com.

RF EXPOSURE AND YOU

by Ed Hare, W1RF1

What are the Federal Communication Commission's requirements on RF

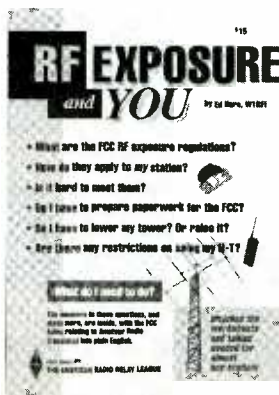

exposure? They are regulations designed to ensure that Amateur Radio operators, their families, neighbors, and passersby are exposed only to low levels of radio frequency energy. This book explains the rules and provides simple worksheets to allow hams to determine if their station is in compliance with the rules and, if not, how to modify the station or antenna to comply.

The first chapter provides a set of instructions for figuring out what actions are needed, if any. Later chapters include a review of the basic electromagnetic theory upon which the rules are based and clear explanations of the rules. The complete text of the rules as they apply to ham radio is included in one appendix. Other appendixes contain a list of resources and FCC information sources, primarily on the Internet.

RF Exposure and You costs \$15 and is published by American Radio Relay League, 225 Main Street, Newington, CT 06111-1494; Tel. 800-243-7767; Fax: 860-594-0303; Web: www.arrl.org.

HANDBOOK OF OCCUPATIONAL SAFETY AND HEALTH, 2ND EDITION

by Louis J. DiBerardinis

Expanded by more than 50 percent, this handbook demonstrates how to control hazards to safety and health in many types of work environments—and how to deal with injuries when they do occur. With up-to-date contributions from occupational physicians, public health professionals, legal experts, and specialists in areas ranging from chemicals and radiation to noise exposure, this book provides a complete program of effective responses to a vast range of occupational safety and health problems.

The book presents an overview of the field and its recent advances plus coverage of a variety of issues—safety evaluations, health assessment, control practices, physical hazards,

BooksNow

To order books in this magazine or any book in print. Please call anytime day or night: (800) BOOKS-NOW (266-5766) or (801) 261-1187 ask for ext. 1456 or visit on the web at <http://www.BooksNow.com/popular-electronics.htm>.

Free catalogs are not available.

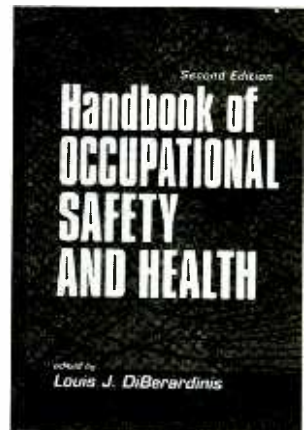

and legal affairs. There is step-by-step guidance on how to conduct an accident investigation and how to maintain a quality medical surveillance program, as well as discussion of the prevention of specific hazards.

Handbook of Occupational Safety and Health, 2nd Edition costs \$149 and is published by Wiley-Interscience, John Wiley & Sons, Inc., 605 Third Avenue, New York, NY 10158-0012; Tel: 212-850-6336; Web: www.wiley.com.

PARTS EXPRESS CATALOG

from Parts Express

Geared toward the consumer electronics industry and the technical hobbyist, this comprehensive 260-page catalog presents the distributor's full line of parts and accessories, specializing in audio-related products. There is an extensive selection of raw loudspeakers, drivers for home and automotive applications, as well as CATV repair parts. Also shown are semiconductors, tools and technical aids, home theater and home automation products, alarm systems for home and car, test equipment and chemicals. Other items include telephone products, wire, connectors, instructional books and videotapes, speaker design software, cellular phone accessories, stage lighting, and pro sound equipment.

The catalog features 600 new products. Tech tips provide helpful information regarding product applications, design ideas, and repair tips.

The Parts Express Catalog is free upon request from Parts Express, 725 Pleasant Valley Drive, Springboro, OH 45066-1158; Tel. 800-338-0532 or 513-743-3000; Fax: 513-743-1677; Web: www.parts-express.com.

PRODUCT TEST REPORT

(continued from page 19)

audio features of the DVD-930.

All nice features, indeed. But how did the unit fare under test conditions?

EVALUATION

Earlier on, we said the DVD-930's video performance isn't all it might be given the player's price. Let's put that in context.

Much like when music CD first made its debut, any digital device is likely to seem much better than the analog playback sources you're used to, even when reproduced through run-of-the-mill TVs or stereo systems. Although inexpensive displays or amp-loudspeaker combos aren't likely to be able to exploit the video or audio signal they're fed, they'll still benefit from some characteristics inherent to digital technology, which will have an immediate impact.

In the case of CD, the lack of mechanical interface (read "needle-in-groove") eliminated some noise ("hiss" and its siblings "snap, crackle, and pop") and thereby increased the apparent dynamic range even with boom-box-class equipment. And since DVD also is an optical format, the vagaries of mechanical systems (e.g., the tape-head contact in VHS) also dematerialize. So, there's a cleaner blackboard on your TV for the laser to chalk its mark.

But that's not to say that the drawing couldn't be better (anyone who's bought cheap chalk and a cheeseboard blackboard should understand). The drawback of the DVD-930 is that it's marketed to people with above-the-norm video display equipment—whether direct-view TVs or higher-end front and rear projectors. As such, it ought to serve up a better picture.

TEST RESULTS

In most aspects of video performance, the DVD-930 acquits itself well.

Frequency Response is virtually flat over the range that matters, meaning that the deck maintains sharpness to the extent of the DVD format's inherent resolution. Meanwhile, the SIN/2 (squared sine wave) pulse and bar measurements (see Fig. 1) indicate there's no overshoot or undershoot in the way the player handles the relative

timing of chrominance and luminance components.

When it comes to color purity, the DVD-930 performs as even the cheapest DVD player should: Absolute, on-the-bull's-eye accuracy for all hues including Red ("Magenta" in tech-speak)—usually the toughest color for video systems to resolve. Check out the dartboard-like vectorscope photo (Fig. 2). Every color is right on the mark. There's no shift in phase, no under- or oversaturation. This is one of the aforementioned benefits of digital technology.

Lab results also indicate that video signal-to-noise ratio is excellent, whether coming from the pedestrian composite outputs or the superior S-Video and component jacks. In fact, the DVD-930's video signal-to-noise ratio is the best among DVD players that APEL has tested to date—some 13 dB better than the nearest runnerup in the unweighted measurement for composite-video output.

Where the DVD-930 trips up is on the measurements for stairstep linearity, as seen in Table 1 and Fig. 3. This test measures how well the player resolves different shades of gray.

The ping-pong results for the DVD-930 simply are not acceptable. It's not just a matter of the deviation from 0% perfection—few video devices can achieve that. It's the wide swings between intermediate steps of grayscale that are damning, because these ultimately affect how a color picture is reproduced on your TV screen. There would be room for some slack had the sub-perfect pattern been more consistent, let's say, a uniform X-db off target. But it's not, and the erratic measurements indicate to us that you'll see shifts in color-tone that aren't warranted in this age of digital perfection.

SOUNDS PERFECT

In all aspects of digital audio performance, the DVD-930 performs quite well.

Frequency response is virtually ruler-flat through the audible range from 20 Hz to 20 kHz, dropping off just a bit at the high end. Signal-to-noise ratio and dynamic range are all you could ask for, and what you'd expect from a Marantz-brand product.

Channel separation is not the best APEL has measured in a DVD player, but it's more than sufficient to provide

accurate location steering from the analog Dolby Pro Logic surround matrixed on the stereo soundtrack.

CONCLUSION

If you're in the market for a DVD player, it's a good idea to pay attention to performance. This is because your financial investment goes beyond the hardware—eventually, what you spend on software will surpass what you paid for the player.

So, study comparative test reports and buy the best-performing DVD player you can afford, to make the most of your library. Read competent DVD media reviews, too, to learn if the studio really made a film-to-disc transfer that's worth buying for keeps.

As for the Marantz DVD-930 and its hit-or-miss stairstep linearity, this might not be important if you're an uncritical viewer, or if you plan to use it with an undemanding TV display. But it's likely that if you're willing to spend this much for a DVD player, you'll probably be in the market for one of today's improved-definition TV sets, possibly even an HDTV or HDTV-ready monitor. In that case, you'll want a digital video source that can feed the display all the performance inherent to the DVD format.

For more information on the Marantz DVD-930 DVD Player, contact Marantz America, 440 Medinah Rd., Roselle, IL 60172; Tel. 630-307-3100; Fax: 630-307-2687; Web: www.marantzamerica.com; or circle 50 on the Free Information Card. ■

An Introduction to Light in Electronics

An Introduction to Light in Electronics

F A WILSON

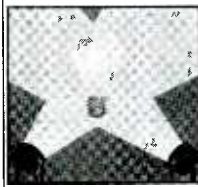

Taken for granted by us all perhaps, yet this book could not be read without it, light plays such an impressive role in daily life that we may be tempted to consider just how much we understand it. This book makes a good start into this fascinating and enlightening subject. It has been written with the general electronics enthusiast in mind.

To order Book #BP359 send \$6.99 plus \$3.00 for shipping in the U.S. and Canada only to Electronics Technology Today Inc., P.O. Box 240, Massapequa Park, NY 11762-0240. Payment in U.S. funds by U.S. bank check or International Money Order. Please allow 6-8 weeks for delivery.

ET08

ADVERTISING INDEX

Popular Electronics does not assume any responsibility for errors that may appear in the index below.

Free Information Number	Page	Free Information Number	Page
- AES	.48	- KNS Instruments	.61
- Alfa Electronics	.54	- Lynxmotion	.55
- All Electronics	.62	161 MCM electronics	.CV3
- Allison Technology	.59	139 Mendelson's	.46
- Amazon Electronics	.46	174 MicroCode Engineering	.CV2
- Andromeda Research	.55	- Modern Electronics	.46
- Antique Radio Classified	.61	165 Mouser	.52
- Arrow Electronics	.55	- Pioneer Hill Software	.52
- Bsoft	.56	150 Prairie Digital Inc.	.49
32 C&S Sales, Inc.	.50	143 Print	.58
173 Cadsoft, Inc.	.31	142 Print	.56
- Circuit Specialists	.57	153 Print Products Int'l.	.60
- CLAGGK, Inc.	.41	- ProPlanet	.61
- Cleveland Inst. of Electronics	.43	- School of Electronics	.60
- Command Productions	.48	- Securetek	.46
- Conitec	.61	40 Sencore, Inc.	.11
- Connecticut microComputer	.49	- Sescom Inc.	.46, 60
164 Dalbani	.53	- Smithy Company	.46
- EDE Spy Oultet	.61	- Technological Arts	.55
- Electronic Tech. Today	.8, 45, 76	137 Telulex	.54
- Engineering Express	.46	- Test Equipment Depot	.59
- Foley-Belsaw	.47	- UCANDO Videos	.56
- Galaxy Electronics	.62	- Unbound Tech	.59
- General Device Instruments	.61	- Vision Electronics	.52
- Global Electronics	.60	- Weeder Technologies	.49
- Grantham College of Eng.	.18	- World Wyde	.46, 48
- Grich RC Inc.	.60		
- Home Automation Systems	.55		
- ICS	.61		
- Information Unlimited	.58		
26 Interactive Image Technologies	.CV4		
- International Hanbai Co., Ltd.	.15		
- Intronics, Inc.	.61		
- James Electronic Services	.52		

ADVERTISING SALES OFFICES

Gernsback Publications, Inc.
500 Bi-County Blvd.
Farmingdale, NY 11735-3931
Tel. 516-293-3000
Fax: 516-293-3115

Larry Steckler, EHF/CET
 President (ext. 201)
 e-mail: advertising@gernsback

Adria Coren
 Vice President (ext. 208)

Ken Coren
 Vice-President (ext. 267)

Christina Estrada
 Assistant to the President (ext. 209)

For Advertising ONLY
Tel. 516-293-3000
Fax: 516-293-3115

Larry Steckler
 Publisher

Marie Falcon
 Advertising Director (ext. 206)

Adria Coren
 Credit Manager (ext. 208)

**Subscription/
 Customer Service/
 Order Entry**
 Tel. 800-827-0383
 7:30 AM - 8:30 PM CST

ADVERTISING SALES OFFICES

EAST/SOUTHEAST

Megan Mitchell
 9072 Lawton Pine Avenue
 Las Vegas, NV 89129-7044
 Tel. 702-240-0184
 Fax: 702-838-6924
 e-mail: mmitchell@gernsback.com

MIDWEST/Texas/Arkansas/ Oklahoma, Colorado, Arizona

Ralph Bergen
 One Northfield Plaza, Suite 300
 Northfield, IL 60093-1214
 Tel. 847-559-0555
 Fax: 847-559-0562
 e-mail: bergenrj@aol.com

PACIFIC COAST/ Mountain States

Anita Bartman
 Hutch Looney & Assoc., Inc.
 6310 San Vicente Blvd.
 Suite 360
 Los Angeles, CA 90048-5426
 Tel. 323-931-3444 (ext. 227)
 Fax: 323-931-7309
 e-mail: anita@hlooney.com

MCM ELECTRONICS®

The Source For All Of Your Electronics Needs

When ordering, please provide this code: ► SOURCE CODE: POP68

Prices Effective July 15 through September 30, 1999

For over 20 years, MCM has been the leading supplier to the electronics service industry. Huge inventory, rapid delivery and competitive prices have made MCM the choice for:

- Hobbyists
- Educators
- Service Technicians
- Installers

Discover the MCM difference, call today for your free literature.

ONLY \$99.95

New!

Order #50-6265

100W Subwoofer Amplifier Module

Ideal for anyone interested in making their own powerful subwoofer. Internally, this amplifier isolates, then sums the left and right inputs to give a single mono channel with 100W RMS output @ 4ohm, 85W RMS @ 8ohm. •Speaker level inputs •Satellite outputs •Line level inputs •Auto turn-on •12dB continuously variable 60Hz~160Hz crossover •Adjustable level control •0°/180° phase selector •Fully sealed rear housing •Requires 8 1/2" square opening •Call for larger quantity pricing

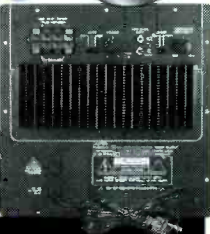

ONLY \$24.50

Order #72-2055

TENMA® Portable DMM

Affordable hand held meter features 3 1/2 digit LCD display, DC voltage measurement to 600V, transistor and battery test. Input impedance 10Mohm. Includes holster and test leads. **Regular price \$31.95**



ONLY \$34.95

Order #21-3462

Clarke

Aluminum Tool/Equipment Case

Includes one tool pallet and pre-cut foam bottom. Ideal for carrying test equipment with small hand tools and accessories. Black finish, measures approximately 19" x 14" x 6". **Regular price \$51.50.**



ONLY \$249

Order #72-6602

TENMA®

10MHz Oscilloscope

•Single channel with 10MHz bandwidth •Norm, Auto, TV sync and External triggering •Very easy to operate •Ideal for student and hobbyist use

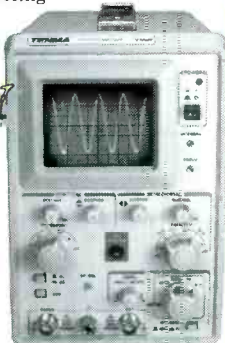

ONLY \$49.95

Order #21-147

TENMA®

Solder Station

Perfect for most soldering applications including SMD. Overheat protection with closed loop temperature control provides precise heat. Includes replaceable iron clad conical 3/8" tip. Linear LED display shows operating temperature. **Regular price \$79.95.**



ONLY \$72.00

Order #82-3890

DEFENDER SECURITY

Ultra Compact

CCD Camera

•Black and white with over 430 lines of resolution •Housing measures only 1 1/2" x 1 1/2" •Standard 75ohm NTSC composite video output •Requires only 12VDC, 100mA •**Regular price \$79.95**



ONLY \$9.95

Order #55-1190

MCM AUDIO SELECT®

8" Rubber Surround Polypropylene Woofer

Popular woofer design is the foundation of many home and auto speaker systems. 70W/100W RMS/peak capacity, frequency response 30Hz~3.5KHz. 8ohm. Other sizes available. **Regular price \$13.50**



ONLY \$149

Order #60-9234

4" LCD Color Monitor with Audio

•Ideal for automobile multi-media and security use •TFT type display •Resolution 383 (H) x 234 (V) •Internal 500mW audio amplifier with speaker •A/V inputs and outputs for easy daisy chaining •Requires 12VDC 350mA •Includes AC adaptor and cables •**Regular price \$179.00**



FREE Literature!



1-800-543-4330

www.mcmelectronics.com

Hours: M-F 7 a.m.-9 p.m., Sat. 9 a.m.-6 p.m., EST.

Same Day Shipping!

In stock orders received by 5:00 p.m. (YOUR TIME), are shipped the same day.



MCM ELECTRONICS®

650 CONGRESS PARK DR.
CENTERVILLE, OH 45459
A PREMIER FARNELL Company

SOURCE CODE: POP68

CIRCLE 161 ON FREE INFORMATION CARD

www.americanradiohistory.com

The world's most popular simulator just got better.

MULTISIM SCHEMATIC CAPTURE AND SIMULATION

Flexible Symbol Editor **NEW**

To add or modify symbols for any component.

Power Meter **NEW**

Works just like with a real Wattmeter.

1000 New Components **NEW**

New families include Electromechanical, Connector, Wideband Opamp, and Tiny Logic.

Editable Footprint Field **NEW**

Add or change default footprint values directly from the schematic.

New Analyses **NEW**

AC sensitivity and DC sensitivity help determine the stability of your design.

Multiple Instruments **NEW**

Now you can have more than one copy of an instrument on the screen at once.

Enhanced Wiring **NEW**

Improved connections to pins and more intelligent autowiring.

Analysis Wizards **NEW**

Guide you through an analysis, making it easier than ever to take advantage of these powerful functions.

Virtual Instruments

Includes oscilloscope, function generator, multimeter, bode plotter, word generator, and logic analyzer.

9 Powerful Analyses

To analyze circuits in ways just not possible with real instruments. Includes DC, & AC operating point, transient, fourier, noise, DC sweep and Ac & DC sensitivity.

5,000 Components

Wide selection of commonly used components, all complete with simulation, symbol and footprint information.

Full-Featured Schematic Capture

Industry's easiest-to-use design entry is ideal for generating high-quality schematics.

Changes on the Fly

The world's only simulator that lets you tweak your circuit during simulation for instant feedback.

Analog and Digital SPICE Simulation

Fast, accurate SPICE simulation with no limit on circuit size.

Custom Model Support

Edit existing models to create new parts, or import components as SPICE models from vendors.

**NEW
VERSION 6**

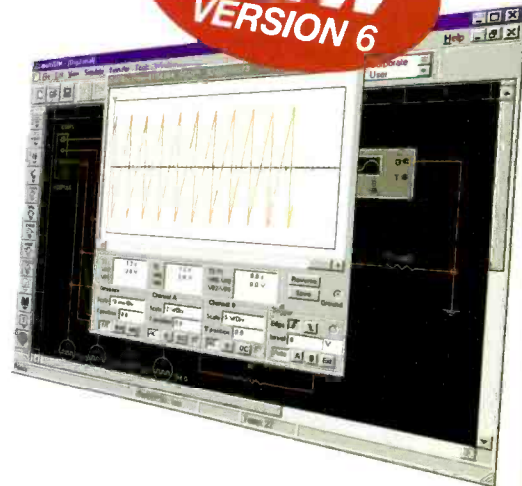

multiSIM \$399

Call for upgrade pricing

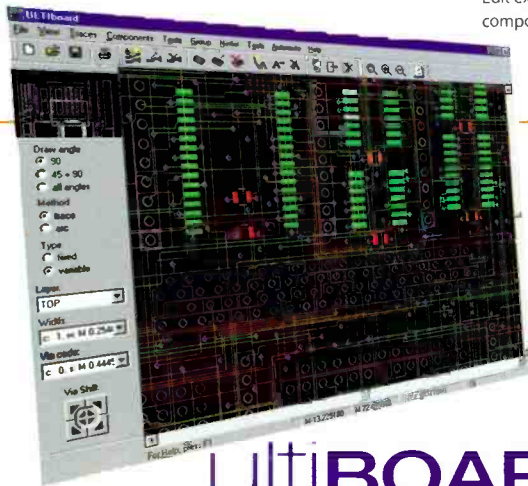

ULTIBOARD POWERFUL PCB LAYOUT

Fast Autorouting Multi-layer autorouter with configurable options for customized performance.

Real-Time DRC Automatic Design Rule Check prevents costly errors by monitoring the size and clearance of pads, vias and traces.

Ideal for all Boards Built-in board editor to create any shape board up to 50" X 50" in size, with as many as 32 layers.

Multiple Output Formats Outputs to the formats you need including Gerber, DXF, plotters, printers, and more.

Tight Integration with Multisim Supports forward and back annotation with Multisim, so that the programs share important design information.

Flexible Editing Full support of power and ground planes, with or without thermal relief. 'Reroute while move' to move copper without losing connectivity.

ultiBOARD \$399

TO ORDER

For a FREE demo visit www.electronicworkbench.com

SAVE
\$100.00

Call 1-800-263-5552

Save \$100 when you order the Personal Design Solution
(Includes Multisim and Ultiboard).



Electronics
WORKBENCH

DESIGN SOLUTIONS FOR EVERY DESKTOP

CIRCLE 138 ON FREE INFORMATION CARD

www.americanradiohistory.com