

GET STARTED ON COMPUTER HARDWARE DESIGN

July 1997

Popular Electronics

DTMF Wire Tracer

Automatically lets you sort out 16 cable leads single-handedly!

Electronic Ruler

It can measure down to one-billionth of a meter!

Heartbeat Machine

Keep tabs on the rhythmic fluctuations of your heart!

Emission Clean-Up

Electronics keeps the old heap perking to new clean-air standards!

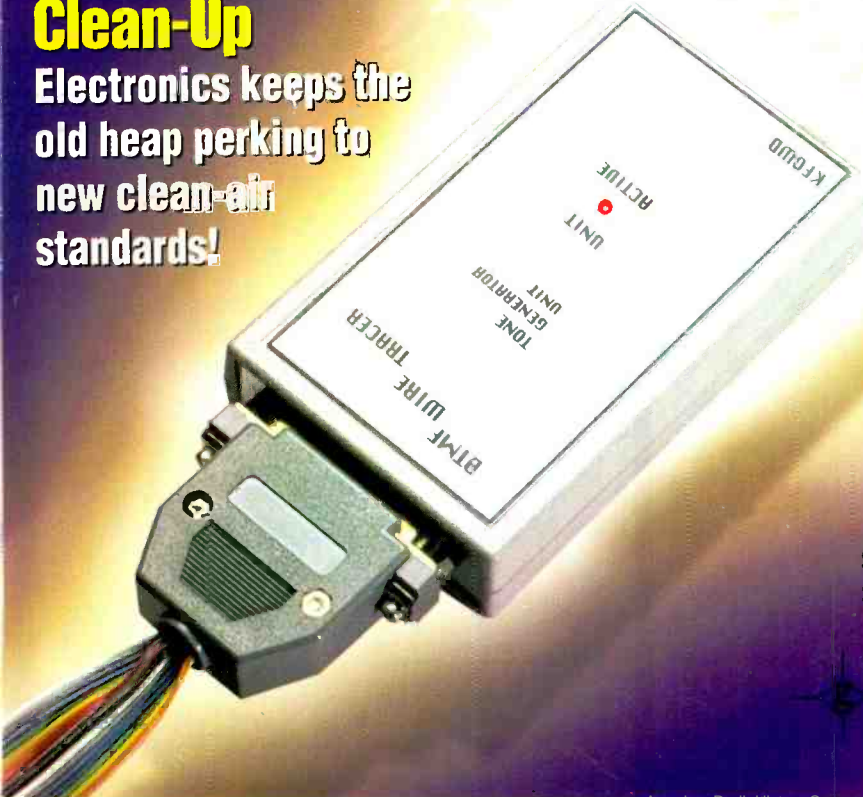
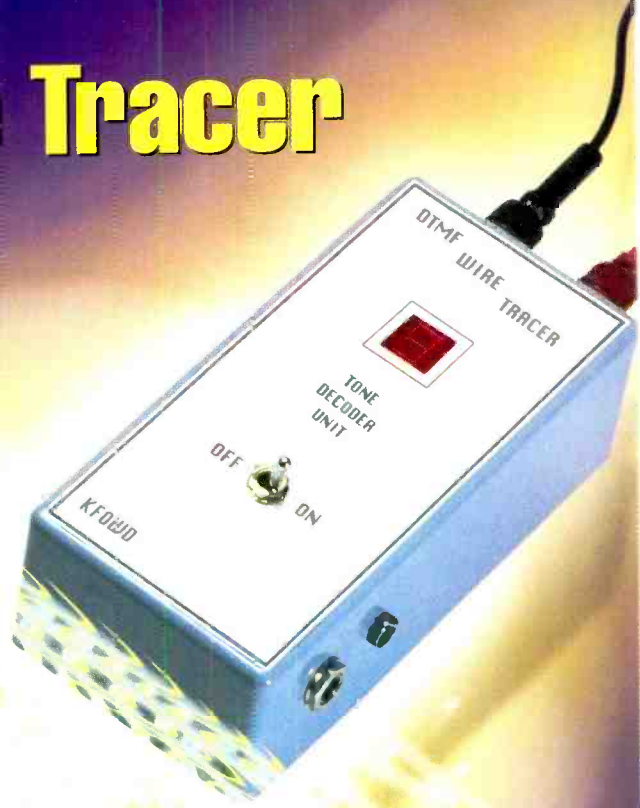

Battery Design Update

Better rechargeable cells made of carbon threads from old socks!

\$3.99 U.S.
\$4.99 CAN.



Better Designs -Faster

\$299

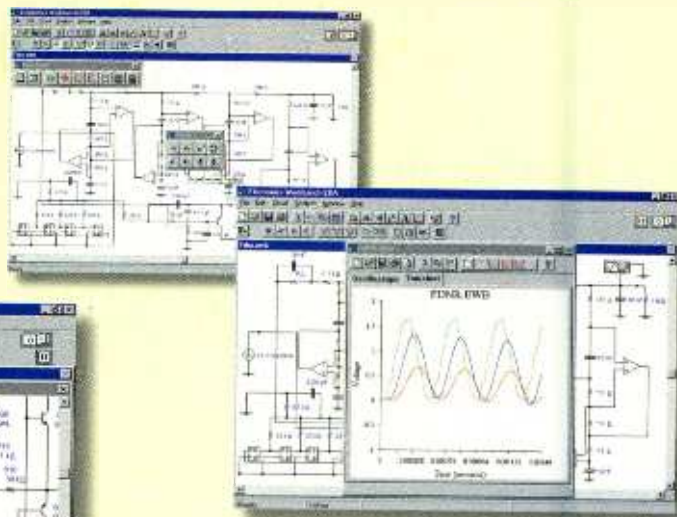
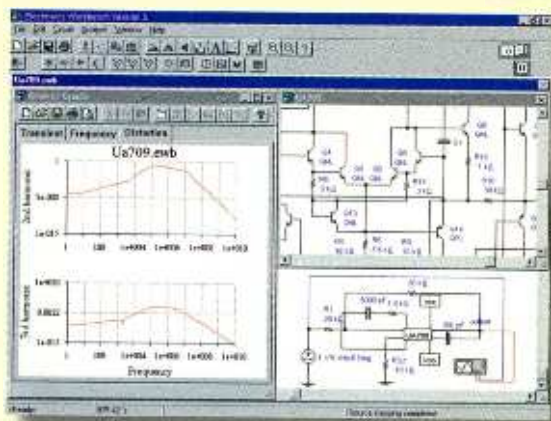

NEW!

Electronics Workbench Version 5 with analog, digital and mixed A/D SPICE simulation, a full suite of analyses and over 4,000 devices. Still the standard for power and ease of use. Now ten times faster. Still the same low price.

Join over 75,000 customers and find out why more engineers and hobbyists buy Electronics Workbench than any other SPICE simulator. You'll be working productively in 20 minutes, and creating better designs faster. We guarantee it!

For a free demo, check out our web site at <http://www.interactiv.com>

30-DAY MONEY-BACK GUARANTEE

VERSION 5.0 FOR WINDOWS 95/NT/3.1. Upgrades from previous versions \$79.

CALL 800-263-5552



INTERACTIV

Fax: 416-977-1818 Internet: <http://www.interactiv.com> CompuServe: 71333,3435/BBS: 416-977-3540/E-mail: ewb@interactiv.com

High-End Features

TRUE MIXED ANALOG/DIGITAL	YES
FULLY INTERACTIVE SIMULATION	YES
ANALOG ENGINE	SPICE 3F5, 32-BIT
DIGITAL ENGINE	NATIVE, 32-BIT
TEMPERATURE CONTROL	EACH DEVICE
PRO SCHEMATIC EDITOR	YES
HIERARCHICAL CIRCUITS	YES
VIRTUAL INSTRUMENTS	YES
ON-SCREEN GRAPHS	YES
ANALOG COMPONENTS	OVER 100
DIGITAL COMPONENTS	OVER 200
DEVICE MODELS	OVER 4,000
MONEY-BACK GUARANTEE	30-DAY
TECHNICAL SUPPORT	FREE

Powerful Analyses

DC OPERATING POINT	YES
AC FREQUENCY	YES
TRANSIENT	YES
FOURIER	YES
NOISE	YES
DISTORTION	YES

Electronics Workbench[®]

VERSION 5

INTERACTIVE IMAGE TECHNOLOGIES LTD., 908 Niagara Falls Boulevard, #068, North Tonawanda, New York 14120-2060/ Telephone 416-977-5550

TRADEMARKS ARE PROPERTY OF THEIR RESPECTIVE HOLDERS. OFFER IS IN U.S. DOLLARS AND VALID ONLY IN THE UNITED STATES AND CANADA. ALL ORDERS SUBJECT TO \$15 SHIPPING AND HANDLING CHARGE

CIRCLE 13 ON FREE INFORMATION CARD



COVER STORY

33 The DTMF Wire Tracer

Get a handle on those time-consuming wire sorting or installation jobs with an easy-to-build, two-piece, wire identification system! Using a DTMF tone generator (which produces 16 distinct tones) and a tone decoder (that identifies all 16 DTMF tones), this speedy tracer makes short work of your wiring worries—*Brian Pflizer*

CONSTRUCTION

43 The Heartbeat Machine

This fascinating but simple circuit allows you to keep tabs on the rhythmic fluctuations of your heart, by detecting changes in the flow of blood through your finger! The pulsed blood-flow is used to determine heart rate—*Anthony J. Caristi*

FEATURES

47 Electronics Help Clean Up The Air

Rather than forcing people to junk those old "smoke generators," electronics manufacturers are now producing retrofit emission-control systems to help older vehicles comply with the new clean-air standards!—*Bill Siuru*

51 Technological Arts ADAPT-11 Microcontroller Starter Package

This "foxy" little portable microcontroller, which generates Morse code at variable time intervals, is perfect for learning electronics, computer fundamentals, hardware and software microcontroller design, and can be incorporated as the core of custom or new product design—*Larry R. Antonuk*

57 Stretching Rechargeable Battery Technology

Tailoring a synthetic carbon fiber commonly found in socks, scientists at Sandia National Laboratory in Livermore, California, have created safer, lighter, longer-lasting, and less-expensive rechargeable batteries, using a lithium-ion technology—*Douglas Page*

58 Computers—They're Taking Control

—*Cartoon Fun*



Page 33



Page 47



Page 43

POPULAR ELECTRONICS (ISSN 1042-170-X) Published monthly by Gernsback Publications, Inc. 500 Bi-County Boulevard, Farmingdale, NY 11735. Second-Class postage paid at Farmingdale, NY and at additional mailing offices. One-year, twelve issues, subscription rate U.S. and possessions \$21.95, Canada \$28.84 (includes G.S.T. Canadian Goods and Services Tax Registration No. R125166280), all other countries \$29.45. Subscription orders payable in U.S. funds only. International Postal Money Order or check drawn on a U.S. bank. U.S. single copy price \$3.99. Copyright 1997 by Gernsback Publications, Inc. All rights reserved. Hands-on Electronics and Gizmo trademarks are registered in U.S. and Canada by Gernsback Publications, Inc. Popular Electronics trademark is registered in U.S. and Canada by Electronics Technology Today, Inc. and is licensed to Gernsback Publications, Inc. Printed in U.S.A.

Postmaster: Please send address changes to Popular Electronics, Subscription Dept., P.O. Box 338, Mount Morris, IL 61054-9932

A stamped self-addressed envelope must accompany all submitted manuscripts and/or artwork or photographs if their return is desired should they be rejected. We disclaim any responsibility for the loss or damage of manuscripts and/or artwork or photographs while in our possession or otherwise.

As a service to readers, Popular Electronics publishes available plans or information relating to newsworthy products, techniques, and scientific and technological developments. Because of possible variances in the quality and condition of materials and workmanship used by readers, Popular Electronics disclaims any responsibility for the safe and proper functioning of reader-built projects based upon or from plans or information published in this magazine.

O N T H E H O R I Z O N

59 The Ultimate Electronic Ruler

Government researchers at the National Institute of Standards and Technology in Gaithersburg, Maryland, have developed a ruler that will be hard to measure up to! Dubbed the Molecular Measuring Machine, it has a range that is 250,000 times greater than that of most scanning tunneling microscopes (STM)—*Douglas Page*

P R O D U C T R E V I E W S

15 Hands-on Report

Casio Cassiopeia Pocket PC with Windows CE

21 Gizmo

Olympus D-200L Digital Camera, Adobe Systems Adobe Photodeluxe, Play Inc. Snappy Video Snapshot Video Digitizer, Meta-Tools, Inc. Kai's Power Goo SE, Gryphon Software Corp. Morph V2.5,

50 Product Test Report

Technics SL-MC60 Compact Disc Changer

C O L U M N S

11 Multimedia Watch

Unbelievably affordable GPS navigation, plus a bunch of new software—*Marc Spiwak*

13 Net Watch

Shopping for a Car, Web Style—*Dan Karagiannis*

16 Computer Bits

Indispensable PC Utilities—*Jeff Holtzman*

60 Scanner Scene

Tracking Trunked Transmissions—*Marc Saxon*

61 DX Listening

Hallicrafters S-41G Skyriider Jr.—*Don Jensen*

63 Antique Radio

Introducing the Freed-Eisemann NR-5—*Marc Ellis*

65 Think Tank

Audio Fun—*John Yacono*

68 Circuit Circus

ICs that Oscillate—*Charles D. Rakes*

71 Ham Radio

Hanging Loop Antennas—*Joseph J. Carr*

D E P A R T M E N T S

4 Editorial

6 Letters

19 New Products

20 Electronics Library

85 Popular Electronics Market Place

118 Advertiser's Index

118A Free Information Card

Larry Steckler, EHF, CET,
editor-in-chief and publisher

EDITORIAL DEPARTMENT

Julian Martin, editor

Robert Young, technical editor

Edward Whitman, associate editor

Teri Scaduto, assistant editor

Evelyn Rose, editorial assistant

Joseph J. Carr, K4IPV,

contributing editor

Marc Ellis, contributing editor

Jeffrey K. Holtzman,

contributing editor

Don Jensen, contributing editor

Charles D. Rakes,

contributing editor

Marc Saxon, contributing editor

Marc Spiwak, contributing editor

John Yacono, contributing editor

PRODUCTION DEPARTMENT

Ruby M. Yee, production director

Ken Coren,

desktop production director

Lisa Baynon, desktop production

Kathy Campbell,

production assistant

ART DEPARTMENT

Andre Duzant, art director

Russell C. Truelson, illustrator

CIRCULATION DEPARTMENT

Theresa Lombardo

circulation manager

Gina L. Gallo

circulation assistant

Michele Torrillo,

POPULAR ELECTRONICS bookstore

BUSINESS AND EDITORIAL OFFICES

Gernsback Publications, Inc.

500 Bi-County Blvd.

Farmingdale, NY 11735

1-516-293-3000

FAX: 1-516-293-3115

President: **Larry Steckler**

SUBSCRIPTION CUSTOMER SERVICE/ORDER ENTRY

1-800-827-0383

7:30 AM - 8:30 PM EST

Advertising Sales Offices listed on page 110

Composition by Mates Graphics

Cover by Laewy Design

Cover Illustration by Chris Gould



Since some of the equipment and circuitry described in POPULAR ELECTRONICS may relate to or be covered by U.S. patents, POPULAR ELECTRONICS disclaims any liability for the infringement of such patents by the making, using, or selling of such equipment or circuitry, and suggests that anyone interested in such projects consult a patent attorney.

What's better than speed reading? Speed Learning.

Speed Learning has replaced speed reading. It's a whole new way to read and learn. It's easy to learn...lasts a lifetime... applies to everything you read. It may be the most productive course you've ever taken.

Do you have too much to read and too little time to read it? Do you mentally pronounce each word as you read? Do you frequently have to go back and reread words, or whole paragraphs, you just finished reading? Do you have trouble concentrating? Do you quickly forget most of what you read?

If you answer "Yes" to any of these questions — then here at last is the practical help you've been waiting for. Whether you read for business or pleasure, school or college, you will build exceptional skills from this major breakthrough in effective reading, created by Dr. Russell Stauffer at the University of Delaware.

Not just "speed reading" — but speed reading — thinking — understanding — remembering — and — learning

The new *Speed Learning Program* shows you, step-by-proven step, how to increase your reading skill and speed, so you understand more, remember more and use more of everything you read. The typical remark from over one million people taking the *Speed Learning* program is, "Why didn't someone teach me this a long time ago." They were no longer held back by their lack of skills and poor reading habits. They could read almost as fast as they could think.

What makes Speed Learning so successful?

The new *Speed Learning Program* does not offer you a rehash of the usual eye-exercises, timing devices, and costly gadgets you've probably heard about in connection with speed reading courses, or even tried and found ineffective.

In just a few spare minutes a day of easy reading and exciting listening, you discover an entirely new way to read and think — a radical departure from anything you have ever seen or heard about. *Speed Learning* is the largest selling self-study reading program in the world. Successful with Fortune 500 corporations, colleges, government agencies and accredited by 18 professional societies. Research shows that reading is 95% *thinking* and only 5% eye movement. Yet most of today's speed reading programs spend their time teaching you rapid eye movement (5% of the problem), and ignore the most important part, (95%) *thinking*. In brief, *Speed Learning* gives you what *speed reading* can't.

Imagine the new freedom you'll have when you learn how to dash through all types of reading material at least twice as fast as you do now, and with greater comprehension. Think of being able to get on top of the avalanche of newspapers, magazines and correspondence you have to read...finishing a stimulating book and retaining facts and details



FOR FASTER SHIPMENT CALL 1-800-729-7323 OR FAX 1-609-273-7766

more clearly, and with greater accuracy, than ever before.

Listen — and learn — at your own pace

This is a practical, easy-to-learn program that will work for you — no matter how slow a reader you think you are now. The *Speed Learning Program* is scientifically planned to get you started quickly...to help you in spare minutes a day. It brings you a "teacher-on-cassettes" who guides you, instructs, and encourages, explaining material as you read. Interesting items taken from *Time Magazine*, *Business Week*, *Wall Street Journal*, *Money*, *Reader's Digest*, *N.Y. Times* and many others, make the program stimulating, easy and fun...and so much more effective.

Executives, students, professional people, men and women in all walks of life from 15 to 70 have benefitted from this program. *Speed Learning* is a fully accredited course...costing only 1/4 the price of less effective speed reading classroom courses. Now you can examine the same easy, practical and proven methods at home...in your spare time...without risking a penny.

Examine Speed Learning RISK FREE for 15 days

You will be thrilled at how quickly this program will begin to develop new thinking and reading skills. After listening to just one cassette and reading the preface, you will quickly see how you can achieve increases in both the speed at which you read, and in the amount you understand and remember.

You must be delighted with what you see, or you pay nothing. Examine this remark-

able program for 15 days. If, at the end of that time you are not convinced that you would like to master *Speed Learning*, simply return the program for a prompt refund. (See the coupon for low price and convenient credit terms.)

RISK-FREE ORDER FORM

YES! I want to try *Speed Learning* for 15 days without risk. Enclosed is the first of 4 monthly payments of \$32.25*. If I'm not completely satisfied, I may return it for a prompt refund.

SAVE 8.00! I prefer to pay the \$129.00 now, and save the \$8.00 shipping & handling charge. I may still return the program for a full refund.

Method of payment: (Federal Tax Deductible)

Check or money order payable to Learn Incorporated

Charge to: Visa MC Am Ex Discover

Card # _____ Exp. _____

Signature _____

Phone (_____) _____

Name _____

Address _____

City _____ State _____ Zip _____

*Plus \$8.00 shipping and handling. U.S. funds only. For New Jersey residents, sales tax will be added.

Learn
INCORPORATED

Dept. LPE-01, 113 Gaither Drive,
Mt. Laurel, NJ 08054-9987

EDITORIAL

Pandora's Part Box

Obtaining parts for a project can be a problem.

I received a letter from a reader who was distressed, because he had trouble obtaining the parts he sought for a project published in a previous issue of **Popular Electronics**. His gripe was that he had to go to several mail-order sources to obtain all the parts. The total cost of shipping and handling from all the sources was excessive. I agreed with him until I looked at the published article. The author offered a kit of parts with PC board and the cost with shipping and handling was less than the reader's cost derived from several mail-order sources. I guess for most of us, the ultimate buying decision would have been simple without traumatic reaction.

The reader had a problem. He had a few of the parts in his junk box and saw no reason why he should purchase the same parts in a complete kit. I agree with the reader's reaction; however you can't ask the kit supplier to sculpture the kit set up so that selected parts are removed and prices lowered. Most kit suppliers are either authors or small businesses that would lose money should they provide the services of large electronic parts suppliers. Even large suppliers say that you either buy the kit or the parts you require from their catalog. You may very well over-pay should you take the latter course.

Is there a solution to the parts problem? Not for all cases but with a full junk box of spare parts you can save bucks. Whenever I visit a ham fest or computer show, I buy bags of resistors, capacitors of all types, chips of all types, etc. These parts are usually manufacturers' over-stocked parts that are surplus once a production run finished. They are inexpensive. Last year I picked up a bag of PC board electrolytics that came out to 15 cents per capacitor. That's cheap. Now, all you may need to complete a project are the chip(s) required.

From time to time, there are good buys listed in the 30 to 40 pages of the Market Center in this magazine. Thumb through it, today! If you don't whip out your check book and buy something, you are a stronger person than I am.

Back to our distressed reader. For the most part, for the kit of parts listed in the Parts List for construction projects we publish, the prices are good. A one-source supplier makes buying easy and gets you into the project quickly.

Whoops! Just spotted a \$14.95 TV notch filter in the Market Center. Gotta go now. Where is my checkbook?



Julian Martin, Editor

EARN YOUR B.S. DEGREE IN COMPUTERS OR ELECTRONICS



By Studying at Home

Grantham College of Engineering, now in our 47th year, is highly experienced in "distance education" – teaching by correspondence – through printed materials, computer materials, fax, modem, and phone.

No commuting to class. Study at your own pace, while continuing on your present job. Learn from easy-to-understand but complete and thorough lesson materials, with additional help from our instructors.

Grantham offers three separate distance-education programs, leading to the following accredited degrees;

(1) the B.S.E.T. with Major Emphasis in Electronics. (2) The B.S.E.T. with Major Emphasis in Computers. (3) The B.S.C.S. – the Bachelor of Science in Computer Science.

The B.S.E.T. programs now include Electronics Workbench Professional 5.0.

An important part of being prepared to *move up* is holding the right college degree, and the absolutely necessary part is knowing your field. Grantham can help you both ways – to learn more and to earn your degree in the process.

Write or phone for our free catalog. Toll free, 1-800-955-2527, or see mailing address below.

Accredited by
the Accrediting Commission of the
Distance Education and
Training Council

GRANTHAM
College of Engineering
Grantham College Road
Slidell, LA 70460

Your Ultimate Source!

For Quality Electronic Components
Internet Access...

- 24 hours-a-day, 7 days-a-week!
- Online ordering & stock status!
- Fast, efficient parts search!
- No minimum order!

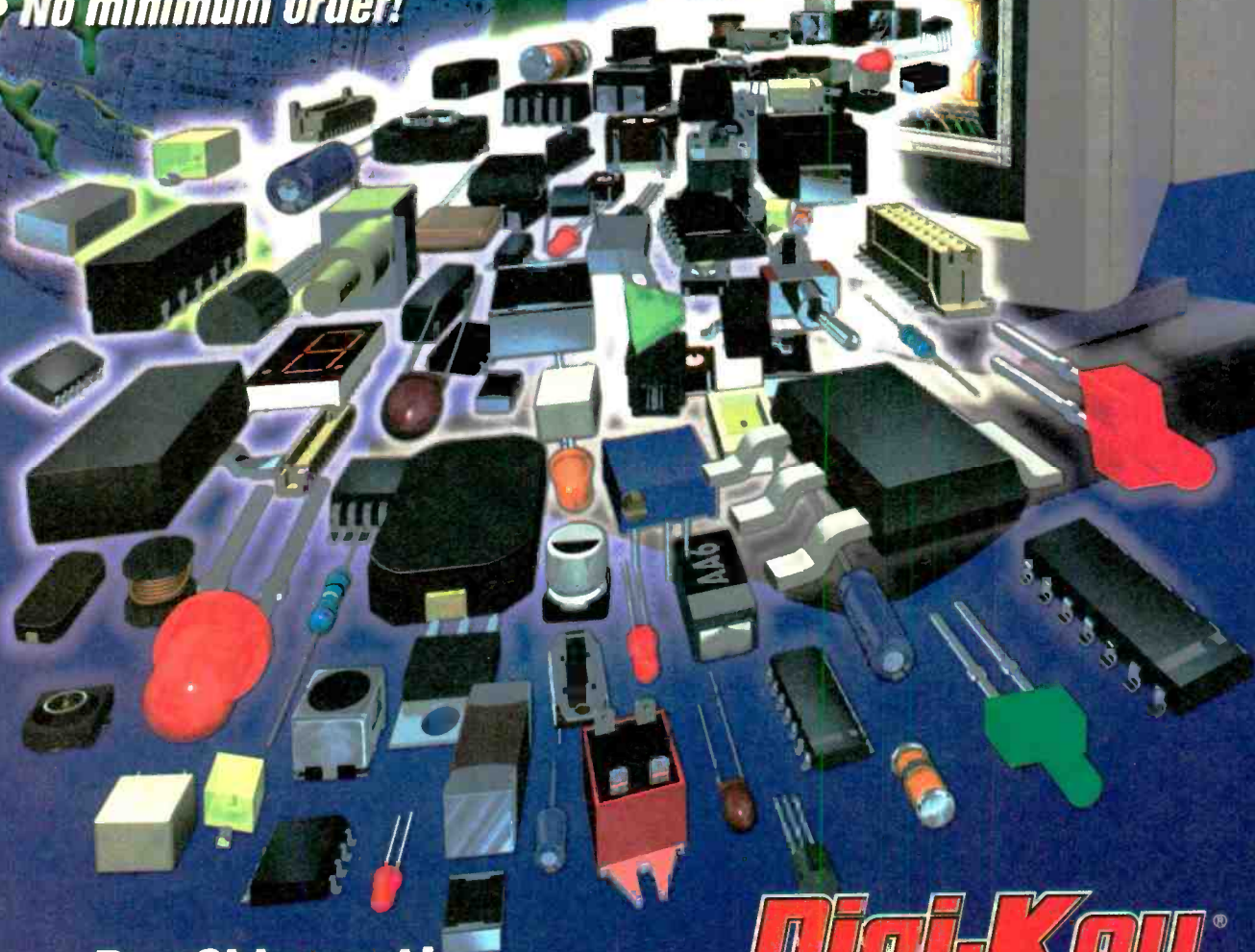

Same-Day Shipment!
on orders entered by 5:00pm central (M-F)

Digi-Key®

www.digikey.com/cx



CIRCLE 173 ON FREE INFORMATION CARD

LETTERS

SPEAKER CLARIFICATION

I plan to build Gary Clifton's "22-Watt Amplifier" project, which was featured in the February 1997 issue of **Popular Electronics**. Before I begin, however, I have one question. Would I have to modify the circuit if I were to use 8-ohm speakers with the amplifier instead of the 4-ohm speakers mentioned in the article?

R.S.

Goshen, OH

The simple answer to your question is that you can use 8-ohm speakers with this amplifier, without modification. As I state in the article, the amp is intended for use with 4-ohm speakers. I will try to explain this sensibly rather than with a bunch of hocus-pocus.

Most car audio systems work with 4-ohm speakers, and most in-home equipment uses 8-ohm speakers. While "watts is watts," Ohm's Law defines the relationship between voltage, resistance (or, in this case, impedance), and current. To put 22 watts into a 4-ohm speaker requires less voltage, but more current, than putting 22 watts into 8 ohms. If an amplifier is designed for a 4-ohm load and you use an 8-ohm load instead, the result will be that the amplifier works just fine but it cannot put out its full rated power. Typically it will deliver just over half the rated power. (I'll describe "ratings" further on.) This does not harm the amplifier in any way—it's rather like driving a car at 50 mph when its top speed is 95 mph.

Going the other way is a different story. If an amp is designed for an 8-ohm load and you use a 4-ohm load instead, the results could be fatal to the amp. Because it has half the load impedance, it will attempt to deliver twice as much power as it should—typically by trying to produce twice as much current at the same voltage. That can cause output transistors to fail as they exceed their current-carrying capabilities—like using a 1/2-ton pickup to haul five tons of gravel.

Amplifier ratings used to be a slippery business, with manufacturers making all kinds of wild claims. The so-called "rms" rating is the most reliable. To rate output power in watts using the

rms method, the amplifier is set up with a dummy load of the rated impedance—typically 8 ohms for home gear and 4 ohms for car equipment. A 1-kHz sine wave is used as a signal source to drive the amplifier. The input signal is increased until the output signal begins to clip. The output voltage is then measured across the load with an rms voltage meter.

As an alternative, the signal can be measured on a calibrated oscilloscope. When using the scope, the peak-to-peak voltage is measured; and the rms voltage calculated from the measured peak-to-peak rms voltage is 35.35% of the peak-to-peak (or 1/2 the peak-to-peak voltage multiplied by 0.707). Power is I^2R , so the rms voltage and the load resistance are used to calculate the current and finally the rated power in watts. "Peak power" can mean anything. An amplifier rated at 50 watts rms into 4 ohms could claim as much as 400 watts "Peak power."

Because the TDA1554Q used in this amplifier project is rated at 4 ohms, I relied on the manufacturer's ratings and verified that my amplifier design performed up to the IC-maker's specifications. Partly out of laziness and partly out of the fact that most car audio uses 4 ohms, I did not record, calculate, and rate performance into 8 ohms. As I recall, the results were approximately 14 watts per channel into 8 ohms, measured at a maximum clipping distortion of 10%.

I started listening tests with 8-ohm speakers because I had 8-ohm speaker boxes but no 4-ohm speakers. In fact, to listen to 4-ohm speakers, I had to put two 8-ohm boxes in parallel to

make a 4-ohm load. Although it didn't blow out the windows, driving 8-ohm speakers with this amp still got loud enough that I could not stand full volume for very long at a time.

I hope this answers your question without causing further confusion.
—Gary Clifton

FOND MEMORIES

I restore radios and test equipment as a hobby, and I am a regular reader of Marc Ellis' *Antique Radio* column. I also love to build crystal sets, and greatly enjoyed building the NBS set.

Mr. Ellis' recent restoration of the Knight Star Roamer brought back memories. That was my second shortwave receiver (my first was a Knight Space Spanner). I enjoyed many hours of shortwave listening all through my teens on the Star Roamer, oblivious to the fact that the BFO drifted, image rejection was terrible, etc. As a collector, I now wish that I still had both sets, and I look forward to adding them to my collection some day.

I have approximately 40 pieces of restored Heathkit test equipment, most of which I use constantly. Poor solder joints, as Mr. Ellis experienced in the Star Roamer, are common when restoring kits. You are at the mercy of the original builder. I have, on more than one occasion, opted to simply resolder an entire unit, thus eliminating any future problems.

Although I have several modern receivers (Icom R71a and Kenwood R1000), I would much rather fire up one that glows, whistles, or uses no power! Keep up the good work.
B.M.

Des Plaines, IL

KEEP IN TOUCH

Now there are more ways than ever to contact us at **Popular Electronics**.

You can write to:

Letters
Popular Electronics
500 BI-County Blvd.
Farmingdale, NY 11735

Or you can send e-mail to:

peeditor@gernsback.com

And don't forget to visit to our Web site at:

<http://www.gernsback.com>

PAGER DECODER LEGALITIES

Is it legal to use the "Pager Decoder" (**Popular Electronics**, March 1997) to decode messages other than one's own?

I would think not, because of the Communications Act of 1934 and the Electronic Communications Privacy Act of 1986, but I would appreciate an expert opinion. The article mentions police agencies that intercept pager

(Continued on page 10)

How to make your car invisible to radar and laser...legally!

Rocky Mountain Radar introduces a device guaranteed to make your car electronically "invisible" to speed traps—if you get a ticket while using the product, the manufacturer will pay your fine!

by Phil Jones



The Phazer will "jam" both radar and laser guns, preventing police from measuring your speed.

If your heart doesn't skip a beat when you drive past a speed trap—even if you aren't speeding—don't bother reading this. I can't tell you how many times that has happened to me. Driving down the interstate with my cruise control set at eight miles over the limit, I catch a glimpse of a police car parked on the side of the road. My heart skips a beat and for some reason I look at my speedometer. After I have passed the trap, my eyes stay glued to my rear view mirror, praying the police officer will pass me up for a "bigger fish."

It seems that as speed-detection technology has gotten more and more advanced, speeding tickets have become virtually unavoidable. And although devices exist that enable motorists to detect these speed traps, they are outlawed in many states, including mine.

The solution. Today, Rocky Mountain Radar offers drivers like me a perfect solution—the Phazer. Combining a passive radar scrambler with an active laser scrambler, the Phazer makes your automobile electronically "invisible" to police speed-detecting equipment.

The radar component works by mixing an X, K or Ka radar signal with an FM "chirp" and bouncing it back at the squad car by way of a

waveguide antenna, effectively confusing the computer inside the radar gun. The laser component transmits an infrared beam that has the same effect on laser Lidar units.

Shown actual size, the Phazer is only 3"W x 4"L x 1.5"H!



Shown actual size, the Phazer is only 3"W x 4"L x 1.5"H!

Perfectly legal. Some radar devices have been outlawed because they transmit scrambling radar beams back to the waiting law enforcement vehicle. The Phazer, however, reflects a portion of the signal plus an added FM signal back to the police car. This, in effect, gives the waiting radar unit an electronic "lobotomy."

Best of all, unless you are a resident of Minnesota, Oklahoma or Washington, D.C., using the Phazer is completely within your legal rights.

HOW TO MAKE YOUR CAR DISAPPEAR

Radar and laser scramblers are devices that foil speed traps by making vehicles electronically "invisible" to police radar. Radar scramblers mix a portion of the radar signal with background clutter and reflect it back to the squad car. This technique, pioneered by Rocky Mountain Radar, creates an unreadable signal that confuses the computer inside the radar gun.

The laser scrambler in the Phazer works in a similar manner. It transmits a special infrared beam with information designed to scramble the laser signal. The result? Readouts on police radar and laser guns remain blank. As far as the police officer is concerned, your vehicle is not even on the road.

The Phazer makes your car invisible to police radar and lasers or the manufacturer will pay your speeding ticket!



How it scrambles radar.

Police radar takes five to 10 measurements of a vehicle's speed in about one second. The Phazer sends one signal that tells the radar the car is going 15 m.p.h. and another signal that the car is going 312 m.p.h. Because police radar can't verify the speed, it displays no speed at all. To the radar gun, your car isn't even on the road.

Works with laser, too! The Phazer also protects your vehicle from Lidar guns that use the change in distance over time to detect a vehicle's speed. The Phazer uses light-emitting diodes (LEDs) to fire invisible infrared pulses through the windshield. Laser guns interpret those pulses as a false indication of the car's distance, blocking measurement of your speed. Again, it's as if your car isn't even on the road.

Range up to three miles.

The Phazer begins to scramble both radar and laser signals as far as three miles away from the speed trap. Its range of effectiveness extends to almost 100 feet away from the police car, at which point you should be able to make visual contact and reduce your speed accordingly.

Encourage responsible driving.

While the Phazer is designed to help you (and me) avoid speed traps, it is *not* intended to condone excessive speeding. For that reason, within the first year, the manufacturer will pay tickets where the speed limit was not exceeded by more than 30%, or 15 miles per hour, whichever is less.

Double protection from speed traps. If the Phazer sounds good, but you prefer to be notified when you are in range of a police radar, the Phantom is for you. The Phantom combines the Phazer (including the Ticket Rebate Program) with a radar detector. It's legal in every state except Minnesota, Oklahoma, Virginia and Washington, D.C. Ask your representative for more details!



4"W x 4"L x 1.5"H

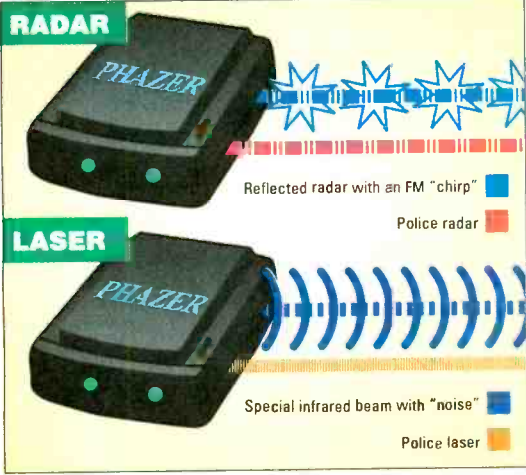

Risk-free. Thanks to Rocky Mountain Radar, speed traps don't make my heart skip a beat anymore. Try the Phazer or the Phantom yourself. They're both backed by our risk-free trial and three-year manufacturer's warranty. If you're not satisfied, return them within 90 days for a full "No Questions Asked" refund.

The Phazer \$199 \$14 S&H
The Phantom \$349 \$18 S&H

Please mention promotional code 1906-10811

For fastest service call toll-free 24 hours a day
800-399-7863



comtradindustries

2820 Waterford Lake Drive, Suite 102 Midlothian, VA 23113

CATALOG SUPERMARKET



Top Secret Consumertronics

This eye-popping catalog features 200+ exciting and controversial Hi-Tech Survival Offers. Includes Computers, Phones, Crime, Security, Survival, Vehicles, Energy, Mind Control, Strange Phenomena, Medical, Financial, much more! Discover how people are making \$\$\$\$ hacking just about everything! How to protect yourself from hi-tech crimes. Since 1971. Order today! **\$3.00**

number 504 in coupon



RNJ Electronics, Inc. New 1997 Catalog

RNJ Electronics, Inc., a distributor of electronic products since 1981, is now offering their new 1997 catalog. The catalog contains 136 pages of test equipment, TV and VCR repair parts, electronic kits, instructional videos, tools & soldering equipment, CCTV systems, commercial sound & intercom systems as well as parts and accessories. In addition the catalog also contains breadboarding aids, digital trainers, as well as A/V carts, screens and projectors. **\$2.00**

For a catalog call 1-800-645-5833.

number 509 in coupon



All Phase Video Security Inc.

The All Phase Video Security Catalog contains electronic test equipment, cable TV converters, connectors and cable accessories. Video surveillance equipment, video cameras, monitors, etc. Power supplies, metal detectors (power line stabilizers and UPS's). Cables for audio. Telephone connectors & accessories. Hand tools. PA sound equipment. DJ lighting effects & sound systems. Car Radios. C.B.'s & two-way radios. Solder & soldering equipment. Security mirrors. **\$2.00.**

number 503 in coupon



Professional Sign Making Machines

Production machines for professional sign makers. The Roland Corporation produces the CAMM-1 series of roll-feed sign making machines. Catalog 963 features a sampling of the 10,000 computer items that California Digital offers. Please contact our technical service representatives to assist you with items not featured in this publication. **\$2.00**

number 508 in coupon



A.M.C. Sales, Inc.

A.M.C. Sales, Inc., a 27 year old company, specializing in Electronic Surveillance offers its catalog which contains equipment of all types for the individual and/or company who are active in Electronic Surveillance. 80 to 100 items are displayed and priced, a must for the amateur and/or professional. **\$5.00**

number 507 in coupon



American Eagle Publications

American Eagle Publications offers a unique catalog of educational information about computer viruses, computer hacking, security and cryptography that you just won't find anywhere else. The information offered here goes far beyond the vague descriptions offered by most publications, giving you the solid how-to information you need if you want to explore these little-discussed subjects from a technical point of view. **\$2.00**

number 500 in coupon



Alltronics

Distributor of electronic components from franchised manufacturers and overstocked sources, operating over-the-counter service. Distributors for: American Antenna - antennas; American Hakko - soldering irons, desoldering systems; Amidon - toroids, baluns; Centurion - two-way antennas, batteries; Circuit Works - conductive IC pens for PC board repair; ICO-Rally - tubing, sleeving, insulation, terminals, cable ties; KLM - antennas; Larsen - antennas; LMB Heeger - metal cabinets, chassis boxes. **\$2.00**

number 512 in coupon

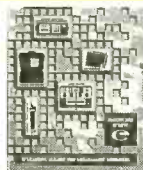

Global Specialties Electronic Testing & Prototyping Equipment

Global Specialties offers a catalog and new-product, short-form insert. This package includes product descriptions and specifications for a new 1-GHz spectrum analyzer scope adapter, AC RMS power-line analyzer, full range of AC & DC power supplies, function and pulse generators, frequency counters, capacitance meters, logic probes & logic analysis test kits, breadboard design workstations, a line of protoboard systems & quick-test sockets, surface-mount breadboard systems, project kits, data acquisition products, PC protolab circuit-design program, and more. Call toll free: 1-800-572-1028. **FREE**

number 513 in coupon

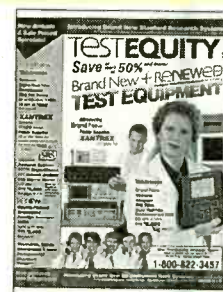

TestEquity

TestEquity distributes brand new test equipment from Tektronix, Fluke, Stanford Research Systems, TQ Racks and Xantrex. TestEquity also offers a higher grade of used test equipment — called ReNewed™ equipment — which is cleaned and calibrated in TestEquity's lab and warranted for one year, parts and labor. TestEquity also buys recent-model test equipment. **FREE**

number 514 in coupon



Antique Radio Classified

Antique Radio Classified is antique radio's largest-circulation monthly magazine. A typical 100-page monthly issue contains articles and hundreds of classifieds for old radios, TVs, ham equipment, hi-fi, art deco and transistor radios, telegraph, books & more. We also offer price guides and books on repair and restoration and guides for the novice collector. Antique Radio Classified is your link to the world of collecting old radios. Sample: **\$4.00**

number 502 in coupon

AMERICAN INNOVATIONS

**SURVEILLANCE
COUNTERSURVEILLANCE
PROTECTION
SECURITY EQUIPMENT**
FOR BUSINESSES, INDIVIDUALS &
LAW ENFORCEMENT AGENCIES

American Innovations Catalog

Featuring: Micro Cameras, Hidden Cameras, Board Cameras, Voice Changers, Scrambling Systems, Tracking Devices, Transmitters, Bomb & Weapons Detection, Drug Detection, Telephone Analyzers, Tape Recorder Detection, Video Detection, Recording Devices, Telephone Recorders, PBX Security, Wireless Video Systems, Night Vision, Bionic Ears, Body Armor, Air Tasers, And Much More...

\$6.00 (Includes \$10 discount off 1st order.)

number 501 in coupon

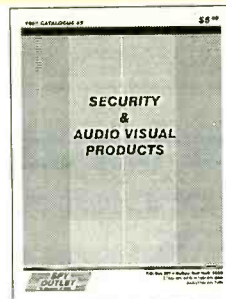

EDE Spy Outlet

The Latest High Tech Professional Electronic Devices. Our latest catalog offers a **HUGE** selection of surveillance, counter-surveillance/privacy devices: hidden video equipment, pinhole camera w/audio \$159., electronic kits, telephone recording systems: 7-Hour \$125. - 16-Hour \$199., touch tone decoders, scanners, bug/phone tap detectors, voice disguisers, telephone scramblers, locksmithing tools, and more. **\$5.00**

number 510 in coupon



Information Unlimited

The catalog of amazing and fascinating electronic and scientific products. Learn how to build a burning, cutting laser, an electronic gun capable of ballistic velocities, particle beams, surveillance devices, force fields, anti-gravity, mind control and hypnotism, ultrasonic, infrasonic shockwaves, telsa coils, lightning generators, free energy, telekinetic enhancers, time quenchers, plasma guns, high power pulsers for rail guns and exploding water, security, personal protection, electronic, magic devices plus etc., etc. **\$2.00 refundable on first order.**

number 505 in coupon



Free

Electronics Purchasing Manual

For same day shipping, helpful technical assistance, no minimum orders and broad inventory selection, send for Mouser's newest catalog featuring 68,000+ components from 125+ leading manufacturers including 3M, Amp, NEC, SGS Thomson, Rohm and more. Mouser also provides many specialized services including cross-referencing, same day credit, drop shipments, scheduled orders and guaranteed pricing. **Mouser Electronics**, 958 N. Main St., Mansfield, TX, 76063. Catalog (800) 992-9943/ (817) 483-6828; Fax (817) 483-0931; <http://www.mouser.com>; E-mail: catalog@mouser.com.

number 506 in coupon

IEC

We are committed to quality products ...

Kit Products Catalog

Orders:
(423)584-8600

COPYRIGHT © 1997
International Electronics Corp
ALL RIGHTS RESERVED

International Electronics Corporation

International Electronics Corporation offers a variety of quality SMT kits for students and hobbyists as well as engineers. Our 1997 catalog contains pictures, detailed descriptions, and pricing of all kits currently available, as well as manufacturing services offered. **\$2.00**

number 511 in coupon

ORDER YOUR CATALOG TODAY!

Circle the numbers of the items you are ordering. Completely fill out the coupon.
Enclose your payment, add \$1.50 for service and handling.

- | | | | |
|--|----------|----------------------------------|----------|
| 500 - American Eagle Catalog | - \$2.00 | 508 - California Digital Catalog | - \$2.00 |
| 501 - American Innovations Catalog | - \$6.00 | 509 - RNJ Catalog | - \$2.00 |
| 502 - Antique Radio Classified | - \$4.00 | 510 - EDE Spy Outlet Catalog | - \$5.00 |
| 503 - All Phase Video Security Catalog | - \$2.00 | 511 - IEC Catalog | - \$2.00 |
| 504 - Consumertronics Catalog | - \$3.00 | 512 - Alltronics Catalog | - \$2.00 |
| 505 - Information Unlimited Catalog | - \$2.00 | 513 - Global Specialties Catalog | - Free |
| 506 - Mouser Electronics Catalog | - Free | 514 - Test Equity Catalog | - Free |
| 507 - A.M.C. Sales Inc. Catalog | - \$5.00 | | |

Payment, please check one Check Money Order

Total for items selected \$ _____ Service and Handling \$1.50 _____ Total Enclosed

Name _____

Street _____

City/State/Zip _____

Mail to: CATALOG SUPERMARKET, P.O. Box 5110, Pittsfield, MA 01203-5110

Void after September 30, 1997

You can Build Gadgets!

Here are 3 reasons why!

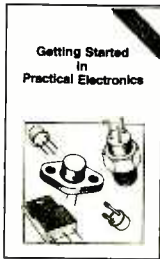

BP345—GETTING STARTED IN PRACTICAL ELECTRONICS \$5.95

If you are looking into launching an exciting hobby activity, this text provides minimum essentials for the builder and 30 easy-to-build fun projects every experimenter should toy with. Printed-circuit board designs are included to give your project a professional appearance.

BP349—PRACTICAL OPTO-ELECTRONIC PROJECTS \$5.95

If you shun opto-electronic projects for lack of knowledge, this is the book for you. A bit of introductory theory comes first and then a number of practical projects which utilize a range of opto devices, from a filament bulb to modern infrared sensors and emitters—all are easy to build.

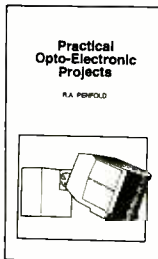

BP363—PRACTICAL ELECTRONIC MUSIC PROJECTS \$5.95

The text contains a goodly number of practical music projects most often requested by musicians. All the projects are relatively low-in-cost to build and all use standard, readily-available components that you can buy. The project categories are guitar, general music and MIDI.

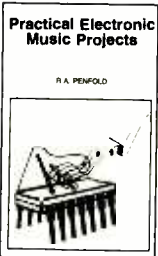

Mail to:

Electronic Technology Today, Inc.
P.O. Box 240
Massapequa Park, NY 11762-0240

Shipping Charges in USA & Canada

\$0.01 to \$5.00.....\$2.00	\$30.01 to \$40.00.....\$6.00
\$5.01 to \$10.00.....\$3.00	\$40.01 to \$50.00.....\$7.00
\$10.01 to \$20.00.....\$4.00	\$50.01 and above.....\$8.50
\$20.01 to \$30.00.....\$5.00	

Sorry, no orders accepted outside of USA and Canada. All payments must be in U.S. funds only.

Number of books ordered.

Total price of books..... \$ _____
 Shipping (see chart)..... \$ _____
 Subtotal..... \$ _____
 Sales Tax (NYS only)..... \$ _____
 Total enclosed..... \$ _____

Name _____
 Address _____
 City _____ State _____ ZIP _____

Please allow 6-8 weeks for delivery.

LETTERS

continued from page 6

messages—do they have to get a court's permission to do so?
 M.A.C.
 Athens, GA

The Communications Act of 1934 authorized rules and regulations—including provisions for privacy—to be established. I cannot give you an expert legal opinion; however, I believe the following to be an excellent guideline: You can listen to (or view, i.e. TV) anything that you can receive, but private conversations (other than broadcasts) are not to be shared with anyone, nor can you profit from information gleaned from them.—Editor

DON'T FORGET THE MAC USERS!

I have been reading **Popular Electronics** for almost five years and have enjoyed it very much. I have just one problem. I see articles now and then for projects using the computer. That would be great if I had a PC. I don't. I have a Macintosh.

The truth is, I hate PCs. The Mac is many times easier to use. You only have one type of system software, instead of Windows and DOS. Even though there are different versions of the system software, applications that run on one version will usually work on a later version and, in some cases, vice versa.

Also, the Macintosh usually warns you that a problem is about to occur, instead of letting you know after the fact, when it is too late. For example, if you are copying a file to a floppy disk that doesn't have enough memory left, the Macintosh lets you know before you copy, not when you are halfway done.

I realize that many electronics hobbyists do use PCs. But please realize that there are some of us that don't. It would be nice to see a project now and then that was based on the Macintosh.
 M.C.
 Hudson, FL

We'll keep you in mind, Michael. The staff agrees that the Mac should get some coverage, but articles are scarce and Mac readers even scarcer.—Editor

HAVES & NEEDS

I need the readout display board from any of the following Heath televisions: GR2000, GR2001, GR2050, GR300, GR400, or GR500. The board contains an MM584 IC (Heath part number 443-616), which is in the video generator for the clock and channel number on-screen display.

I have not been able to locate a source for the IC, so maybe someone has a readout display board from which I can salvage one. I'll be glad to buy the board (or even the TV, if necessary). Thanks.

ROBERT M. HARKEY
 14401 Cabarrus Road
 Charlotte, NC 28227

I am looking for information on frequency grabbers. I'm into scanning and it would be really cool to make one or order a kit for one. I'd also like plans for making a field strength signal meter so that I can get an idea of how far the signals are coming in. Does anyone know where I could get the plans for either of those projects?

J. FISHER
 4401 Hillside
 Lincoln, NE 68506

I have the *Most Often Needed Radio Diagrams* published by Supreme Publications for the years 1940-1942 and 1947 and up. Is there anyone out there willing to give a new, loving home to the Supreme Publications published before 1940 and for 1943-1946? Also, does anyone have a list of all the Supreme Publications books for consumer radios. I am not interested in TV receivers. Drop a note to the Editor, and he will contact me. Thank you.

J.V.
 Brooklyn, NY

I have an old multi-band, 5-tube, superhet Howard Radio receiver (vintage 1939-40) that still works like a dream. My dad used it aboard a merchant ship throughout WWII. It has a metal case and a black, crinkled finish. I believe the paint finish is referred to as "Japaning." The paint is worn to the metal in some places, and I'd like to refinish the case. How do I get to crinkle (wrinkle) the finish on black paint? Can anyone help?

June Houser
 Chicago, IL

MULTIMEDIA WATCH

Unbelievably Affordable GPS Navigation plus New Software

MARC SPIWAK
TECHNICAL EDITOR
WINDOWS MAGAZINE

Usually I start off this column with an interesting piece or two of hardware, and then go through all the new software. This month I'm still starting with hardware, but it would be nothing without its marvelous companion software. I'm talking about the *Delorme Tripmate Hyperformance GPS Navigation System*. It's a portable GPS receiver that's packaged with the mapping program *Street Atlas USA 4.0*. I've talked about that amazing program before. A single CD-ROM containing maps of every street in the country. When Street Atlas has a GPS receiver to work with, it can show you exactly where you are and on what road. And get this: The receiver is bundled with Street Atlas for only \$149! The only catch is that you need a notebook computer.

Maps can't tell you where you are, but the Global Positioning System, or GPS, can. This constellation of satellites lets a GPS receiver lock onto a position fix. The general public can't use the GPS system to the same degree of accuracy that the military has access to. Even so, Tripmate's accuracy is limited to 328 feet horizontally and 512 feet vertically, 95 percent of the time. But because Street Atlas compares the GPS fix to road maps, it usually knows exactly where you are. Street Atlas lets you search for any city, town, or street, and prints maps as well. It costs \$45 without the GPS receiver. But if you have a notebook computer, you'd be crazy not to purchase the software with the GPS receiver.

The GPS receiver connects to the serial port of a notebook PC. You need at least a 386SX/33 and Windows 3.1 or higher, 8 MB of RAM, 8 MB of hard disk space, SVGA graphics, and a CD-ROM drive to run Street Atlas. But because the receiver connects to a serial port, at least you don't need PCMCIA slots. If your notebook computer doesn't have a built-in CD-ROM drive, or if you don't want to run a CD-

ROM drive continuously, you can extract what you need from the Street Atlas disc to your hard drive using a portable CD-ROM drive.

The GPS receiver is about the size of a Walkman stereo, and it sits on the dashboard of your car. It's powered by 4 AA batteries, so it doesn't suck power off your computer's batteries. The first time you start Street Atlas with GPS, you must enter the state or province where you are. In a few minutes the GPS starts tracking. A green arrow marks your location and follows you through the map. It also gives you latitude and longitude, elevation, heading, and speed information. This is a great toy for only \$149, not to mention an extremely useful navigational tool.

New Stuff

New games from Microsoft abound this month, with two sports titles, two flying games, a lizard game that's a bit more unusual, and something to help plan trips. To start off, there's *Microsoft Golf 3.0*, the latest update to the now-classic title. It's now been redesigned for Windows 95, with instant hole rendering, an improved user interface, and more. Two new courses include Banff Springs and Harbour Town. *Microsoft Soccer* for Windows 95 puts you right on the field with rich graphics and sounds, realistic player movements, field types and conditions, as well as the usual unruly crowds. Both titles will sell for \$44.95.

People who have been using com-

YOU CAN'T CHANGE IT...

but you can gauge it,
test it, measure it,
monitor it, record it,
project it, extrapolate
it, computerize it...

with the
Weather Wizard III
from
DAVIS INSTRUMENTS



1-800-678-3669

PE6797

CIRCLE 162 ON FREE INFORMATION CARD

ATTENTION! ELECTRONICS TECHNICIANS

EARN YOUR
**B.S.E.E.
DEGREE**

THROUGH HOME STUDY

Our Highly Effective Advanced-Placement Program for experienced Electronic Technicians grants credit for previous Schooling and Professional Experience, and can greatly reduce the time required to complete the program and reach graduation. No residence schooling required for qualified Electronic Technicians. Through our Special Program you can pull all of the loose ends of your electronics background together and earn your B.S.E.E. Degree. Upgrade your status and pay to the engineering level. Advance rapidly! Many finish in 12 months or less! Students and graduates in all 50 states and throughout the world! Established Over 50 Years! Write or call for free Descriptive Literature. (601) 371-1351

COOK'S INSTITUTE OF ELECTRONICS ENGINEERING



4251 CYPRESS DRIVE
JACKSON, MISSISSIPPI 39212

CIRCLE 170 ON FREE INFORMATION CARD

July 1997, Popular Electronics

11



The Tripmate Hyperformance GPS Navigation System is a portable GPS receiver for a notebook computer. It comes with Street Atlas, a CD-ROM containing maps of every street in the country. You get both for only \$149.

puters for years should remember the time it was very important that a PC-compatible system could run Microsoft Flight Simulator—if it couldn't, it wasn't compatible enough. Most ads for PCs even stated that "this system runs Microsoft Flight Simulator," so it really was important. That's because the program was extremely complex for its time, but it was nothing compared to *Microsoft Flight Simulator for Windows 95*. This version features ultra-realistic planes, with two new planes—the Boeing 737-400 and the aerobatic Extra 300S—joining the Cessna 182 RG, Learjet 35A, Schweizer 2-32, and Sopwith Camel. You fly the plane you like best. You can start flying in seconds if you like, and fly over 3D-detailed cities including San Francisco, London, Tokyo, New York, Paris, Chicago, Seattle, and more. Flight Simulator for Windows 95 takes you to new heights of flight and realism.

Another flight game for Windows 95, one that's more of a fantasy shoot-em-up type scene, is *Hellbender*. This one makes you the commander of the Hellbender prototype attack craft, a warship that bristles with high technology. You must destroy the Bion invaders before it's too late. *GEX* for Windows 95 is a more unusual game. This one features a wise-cracking gecko lizard named GEX who takes you for rides through five worlds based on classic TV shows and "B" movies. This is a Super

Mario type game, except that GEX can whip his tail; stick to surfaces including faces, swim under water, and more. This one's also \$44.95.

The *Microsoft Automap Trip Planner* is an all-new version of the popular road atlas and travel guide for North America. Featuring over one million miles of roadways, detailed city maps, and tons of information on key attractions and places to visit, this is a complete travel-planning package. The Route Wizard will help you design a trip tailored to your personal driving preferences, and you can specify the quickest, shortest, and most scenic route. The highly detailed maps can be viewed on-screen or printed. No matter what kind of trip you're planning, the Automap Trip Planner can help you get there for \$44.95.

I just took a trip into the past with E.M.M.E. Interactive's *Myths and Legends, Volumes 1 and 2* which are available separately or as a set. *Volume 1: Monsters and Mythical Creatures* deals with the Yeti, Cyclops, Leviathan, Pegasus, The Golem, The Unicorn, The Gorgons, The Phoenix, and more of the same. *Volume 2: Legendary Lands and Lost Cities* covers The

Garden of Eden, The Fountain of Youth, Easter Island, Atlantis, The Bermuda Triangle, and more. These mythical creatures and lost lands are brought to life through photos, videos, animation, text, and a lot more. If you're as fascinated by these mysterious creatures and places as I am, you'll enjoy these titles.



Monty Python and the Quest for the Holy Grail (on CD Rom) takes you through the story with King Arthur interacting with nutty Pythonesque.

I was just playing *Monty Python and the Quest for the Holy Grail* on CD-ROM from 7th Level. Monty Python's Complete Waste Of Time was a great disc when it came out, and so is this one especially if you've seen and liked the film. Basically you get to go through the story in your own quest for the Holy Grail, with nutty Pythonesque interactivity with the cast and scenery along the way. Plenty of wacky games are thrown in as well, including Burn the Witch and Kill the Black Knight. \$49.95 is the suggested admission fee to this fun-filled desktop romp through 932 AD. Also from 7th Level comes *Ace Ventura* on CD-ROM. In over 60 exotic locations, Ace must battle animal-hating villains, dodge obstacles, and solve puzzles. You keep inventory of the clues you've collected along the way to help Ace solve the case. Danger, babes, and butt yodeling can be yours for \$39.99.

I've got two new discs from MicroProse, one's a sequel and the other's an expansion pack. *Master of Orion II: Battle at Antares* is the Sequel game to Master of Orion, and it continues the theme of space exploration, colonization, and combat. Not for the casual game player, Orion II can be a very involving game, and the instruction manual is practically a soft cover book in itself. If you're a fan of Sid Meier's Civilization II, you'll want to pick up *Sid Meier's Civilization II Scenarios*, an expansion disc with 20 new challenges including the Civil War, Alien Invasion, the Crusades, and more.

WHERE TO GET IT

DeLorme

181 US Route 1 South
PO Box 298
Freeport, ME 04032
1-800-452-5931
<http://www.delorme.com>

E.M.M.E. Interactive

1200 Summer Street
Stamford, CT 06905
203-406-4040
800-424-EMME

MicroProse

2940 Mariner Square Loop
Alameda, CA 94501
800-695-GAME
<http://www.microprose.com>

Microsoft Corporation

One Microsoft Way
Redmond, WA 98052
206-882-8080
<http://www.microsoft.com/games/>

7th Level, Inc.

1110 E. Collins Blvd., #122
Richardson, TX 75081
972-498-8100
<http://www.7thlevel.com>

NET WATCH

Shopping for a Car Web Style

DAN KARAGIANNIS

Never trust a used-car salesman. That's a bit of advice you might have heard from a friend or seen in old movies. However, what if a sales person trying to get you to buy a new or used set of wheels wasn't able to use his or her pushiness? What if you were free of all the pressure that dealing with a live individual brings? While sales people are only doing their job, you should still be able to shop at your own pace.

AutoWeb is also a site that was named appropriately. You'll find it *all* here.

Of course, a lot of information can seem a bit intimidating at first glance. Don't get scared by all the data and options that you'll be assaulted by when you first log on to this site. There are miniature versions of some of AutoWeb's features found here. For example, you can enter a make of a particular used car you're looking for, and then be whisked away to that sec-

showroom, but you just might be able to get a price quote as well. That way, you don't have to put up with an hour of hard sell to find out a car's too expensive for you at this time.

Want a new car? 1997 Vehicles will provide you with an interactive way of finding what's out there right now. First choose what kind of car or truck you're interested in, then submit a form with your location. AutoWeb will find a dealer close to you that can help you get just the right vehicle.

Used Vehicles provides you with several helpful ways to buy and even sell a pre-owned set of wheels. There are so many features under this link, we'll have to spend a moment on each.

The Used Vehicles Listing presents you with, as the name implies, listings of all types of advertised used vehicles by region and make. Have something particular in mind? Use AutoFinder to search through all those used vehicles to find the ones that match your particular criteria. For example, you can ask for a listing of all Cadillac Eldorados costing between \$5,000 and \$12,000 from New York that are later models than 1986.

If you can't find what you're looking for, AutoAgent might be able to help. It's a free service that sends you e-mail when a vehicle matching your needs becomes available in the site's database. Maybe you'd like instead to go down to a showroom. Used Car Dealers will "bring you" to the pre-owned areas of many of AutoWeb's dealers.

But perhaps the most useful feature of the Used Vehicles section is the Blue Book Values link. This is the online version of the Official Kelley Blue Book used to obtain vehicle price information. Simply enter the model, make, and year of the car, then answer some questions about how many miles the vehicle has, what features it contains, and so on. In the blink of an eye you can receive one of two values: either the trade-in value of your car, or what it's worth if sold privately.

Free Ads lets you actively become a 13



AutoWeb gives you a real edge when it comes to shopping for new or used cars. The site even makes it easy to sell a car you have.

Now, thanks to the Web, you can shop for a car or truck from the silence of your home, without a smiling guy asking you every five seconds how much of a deposit you'd like to leave. Of course, you'll still have to commit to see in person both a car and the person selling it, but only after you're confident you've chosen the right vehicle to meet your needs.

Autoweb

When I first learned about the World Wide Web, I thought it was aptly named. Webs convey a sense of broad coverage, and for that reason,



tion of the site (more on this later). If you're not into chaos, look instead at the listing of areas of interest found to the left of the site.

Choose from Dealers, 1997 Vehicles, Used Vehicles, Free Ads, Autos Wanted, AutoTalk, Specials, Loan Calculator, and others. Let's look at each.

Dealers lets you find a good car dealer in your area who is affiliated with AutoWeb. What are the benefits to choosing such a person or dealership? Well, for starters, not only can you be armed with important make and model information before you enter the

AutoWeb Interactive - 1997 Lamborghini Vehicles - Microsoft Internet Explorer

Address: http://www.autoweb.com/aw-bin/new/new_awi?m=Lamborghini&v=Diablo

Passenger	2	
Body	Aluminum alloy and layout composite material with autoclave technology	LAMBORGHINI DIABLO
Transmission	5-speed manual	
Wheelbase	104.3"	LAMBORGHINI DIABLO
Length	175.6"	
Height	43.5"	
Width	80.3"	
Displacement	5.7 liters	
Wheels	Aluminum-front 8.5"x17", Aluminum-rear 13"x17"	
Tires	Pirelli PZero-front 245/40 ZR17, Pirelli PZero-rear 335/35 ZR17	
Steering	Manual, rack and pinion	
Brakes	Power Vacuum H System, Four wheel discs-front 12.99"/rear 11.2"	
Engine type	V-12 quad-valve DOHC	

Whether you're in the market for a Lamborghini or a Yugo, AutoWeb can help you find the car that's right for you.

part of the trading that's always going on at AutoWeb. If you have a car or truck to sell, Place a For Sale By Owner ad. Looking for a particular automobile, and want car owners to come to you? Just place an Autos Wanted ad. AutoWeb makes these ads available for free for private owners.

Autos Wanted lets you read the ads we just described, while AutoTalk lets you find out what's available in a BBS fashion. You can also share tips with

others, or pick up a few pointers from someone else's experience. Specials lets you in on hot deals that you won't want to miss.

Another great interactive feature of this site is the Loan Calculator. Most people have a difficult time translating a new car's sticker price into monthly payments. With the Calculator, you just enter in three of the following factors to solve for the remaining one: the amount of your loan in dollars, the interest rate

as a percentage, the number of payments, and the amount of your payment in dollars.

Edmund's Buying Guides

Interactive sites are not the only types of places worth your time on the Web. We should never take for granted the power of information. That's the benefit of visiting Edmund's Automobile Buyer's Guides. An informed shopper is truly the best shopper, especially when that consumer is planning on spending thousands of dollars.

The Edmund's site lets you choose from a few headings. First there's the New Car listing. Here you'll find the HTMLized version of Edmund's Complete, Updated, New Cars Book. Check out over 565 models, including MSRP and dealer invoice prices, standard and optional equipment, specifications, reviews, and more. You can also click on Edmund's Road Tests of New Cars! to find out how vehicles performed, and even get advice on affordable car insurance.

HOT SITES

AutoWeb

<http://www.autoweb.com>

Edmund's Buying Guides

<http://www.edmunds.com>

New Truck Information is also available. Edmund's Complete, Updated New Trucks Book features over 500 pickups, vans, and sport utilities. Similar information to the New Car listings is given here as well.

Previously owned vehicles are a growing market, and Edmund's is keeping up with it in Used Car Information. Just like with the other headings, there's an Edmund's Complete, Updated Used Cars Book. Read about prices, ratings, reviews, recalls, and more, dealing with cars from 1987-1996.

But information on buying isn't the only thing you'll find here. Edmund's Safety Information fills you in on what cars will protect you the most, and contains facts about things like daytime running lights and traction control.

That about wraps it up for this month. I hope your vehicle hunting goes well. Join us again next time for another look at all the Net and Web have to offer.

1997 Cadillac Catera - Microsoft Internet Explorer

Address: <http://www.edmunds.com/edweb/whitmore/catera.html>

Cadillac has had a few hits, though, and the redesigned Seville and Eldorado, with their amazing Northstar engines, have somewhat revitalized this company's ailing image. Still getting whooped by the imports, Cadillac has once again decided to use a little sleight-of-hand to entice near-luxury buyers. Unlike the Cimarron, Cadillac's latest offering is based on a car that lends itself to luxury. The Catera is sold in Europe through the General Motors subsidiary Opel as the Omega. Designed in Germany for a European market, the Omega was a natural choice for Cadillac to bring to these shores to compete with those pesky BMWs, Volvos, and Mercedes that have been stealing their piece of the pie for so long. A few tasteful pieces of chrome, upgraded upholstery, and some snazzy wheels were all it took to transform this beautiful bahn-stormer into Cadillac's near-luxury sports sedan.

Cadillac is worried, however, that this car may alienate traditional Cadillac buyers. The Catera



Without getting into dealership information, Edmund's Buying Guides online still provide lots of useful information like actual test-drive reports of cars such as this Cadillac Catera.



CASIO CASSIOPEIA POCKET PC with Windows CE

Takes two to tango! Now the pocket PC can dance all night with Microsoft as a partner!

Pocket computers haven't caught on like desktop systems, or even notebook systems have. It's just that they're usually so small and have such limited resources that most people find themselves able to resist purchasing one. Sometimes it's very confusing to figure out how to get all the functions to work on these gadgets. But a recent software development in the pocket-PC arena might lead to more people latching onto them and yet another windfall for Microsoft.

Windows CE is Microsoft's new operating system for hand-held computers. It brings with it all of the familiarity of Windows 95, and some of its functionality, to the world of palmtop computing. If you're familiar with Windows 95, then you'll immediately be able to use one of these hand-held PCs, or HPCs. Windows CE provides most of the tools you need on the road, and it runs in a computer that can fit in your shirt pocket. Of course the computers have to be designed to run Windows CE. We look at a Casio unit.

Casio Cassiopeia. Casio's new *Cassiopeia* has a suggested retail price of \$499 for the Model A10 and \$599 for the Model A11, depending on the configuration you choose. We tested one with 2 MB of RAM and 4 MB of ROM (Model A10). It's also available with 4 MB of RAM (Model A11). It has no hard drive. It contains one Type II PCMCIA slot, an infrared port, integrated sound and a tiny speaker, a serial-port, and a data communication jack for equipment such as digital cameras. The unit is powered by two AA batteries, and a lithium ion battery provides backup power when changing the batteries. An AC power adapter is optional. (Casio, 570 Mt. Pleasant Ave., PO Box 7000, Dover, NJ 07801, 800-962-2746, 201-361-5400.)

Cassiopeia is small, measuring 1-inch high by $6\frac{7}{8}$ -inches wide by $3\frac{5}{8}$ -



inches deep when folded shut, and weighs 13.4 ounces including the batteries. The two AA cells can provide up to 20 hours of use, but you generally get less than that if you use it continuously, and much, much less when you run a PCMCIA card. A lithium battery provides backup power when you change the AA batteries. The unit's single PCMCIA slot can be used to add memory cards or peripherals. If you already own a PCMCIA modem, it will work with the *Cassiopeia*.

A serial port on the *Cassiopeia* and the included cable connect it to a desktop or notebook host system. This lets you exchange data and synchronize files with your desktop system. *Cassiopeia* also has an IrDA standard infrared port that eliminates the hassle of wires, but to use it your desktop system must also have an IR transceiver.

The keyboard has a standard, although miniature arrangement. While you can't touch type on the tiny keyboard, it's easy enough to find the keys. Keyboard use is minimized by having a touch-screen and pointing stylus. It lets you tap your way through the screen

much as you would with a mouse. The 4-grayscale monochrome screen has a resolution of 480 x 240 dots, and measures about $5\frac{1}{4}$ inches diagonally. A contrast dial is very effective, although the screen isn't very readable when the contrast is set low.

Cassiopeia comes with two CDs (Windows CE and a bonus application disc), a serial cable, and two manuals; a hardware manual basically explains how to work the controls and a Windows CE manual explains everything else. When you first turn on the system, you have to calibrate the touch screen by pointing at an "X" that moves around the screen. The pointing pen slides out of a holder built into the front of the unit. Next, a welcome wizard helps you set up the system with the proper date, time zone, user information, and so on. The LCD screen is hard to see in dim light, but at least it has a backlight for when it's too dark to see. Unfortunately the backlight really drains the batteries, so it shuts off automatically after several seconds.

You load Windows CE and all of its
(Continued on page 83)

COMPUTER Bits

Indispensable PC Utilities

JEFF HOLTZMAN

Utility programs fill in gaps left by operating system vendors. Here are several indispensable yet reasonably priced programs; many cost less than \$50. I use all of these programs, usually on NT 4.0, but also on Win95 and occasionally on DOS or other operating systems.

PowerDesk Utilities

The PowerDesk Utility set includes a combination launch and toolbar, a file

finder, a disk-space display and management utility, and the star of the show, Explorer Plus, which is unequivocally my most used utility. Explorer Plus starts where the Windows Explorer leaves off. Highlights include better file sorting options, multiple windows, built-in zip file handling, extensive customization options, built-in launchbar, access to a one-line DOS prompt, viewing pane for seeing file internals, and for even better file viewing, tight integration with QuickView Plus.

QuickView Plus

QuickView Plus is a file-viewing utility that functions with either (or both) the Windows Explorer, and Mijenix Explorer Plus. The program supports

buttons to launch your favorite programs, group programs into menus, configure the size and position of the toolbar, and configure the size, icon, and caption of the buttons. Each button can have an associated program or menu that can be launched by the left, right, or middle mouse button. With a two-button mouse, you can simulate the third button by clicking the other two simultaneously. It also works with Microsoft's new IntelliMouse.

Stiletto has an innovative approach to positioning its toolbar. You can embed it in one of almost three dozen screen positions, or in one of several positions in the title bar of the current application. The three applications (or menus) associated with each button may be listed in a pop-up window (like a tooltip). You can also define button labels to display system information such as time, date, free memory, and free disk space. Stiletto also provides an integrated set of functions for generating alarms, and changing desktop wallpaper and sound themes.

If you like to have a fine degree of control over how you launch programs, you will love Stiletto. You will also love its \$22 price, and you can download an evaluation copy from CompuServe or the author's home page.

Partition Magic

In case you have not run across the concept yet, the FAT file system, which has been in use since DOS 2.0, becomes less and less efficient as hard disk size increases. You can easily end up wasting virtually hundreds of megabytes on a 1-GB or larger drive. One way around the problem is to break the drive down into two or more partitions. The key is to reduce the value of the cluster size, where a cluster is a group of sectors.

Until Partition Magic came along, the problem was that there was no way to change partition size, hence cluster size, without reformatting a drive from scratch. This would involve backing up everything, partitioning, formatting, and

(Continued on page 83)

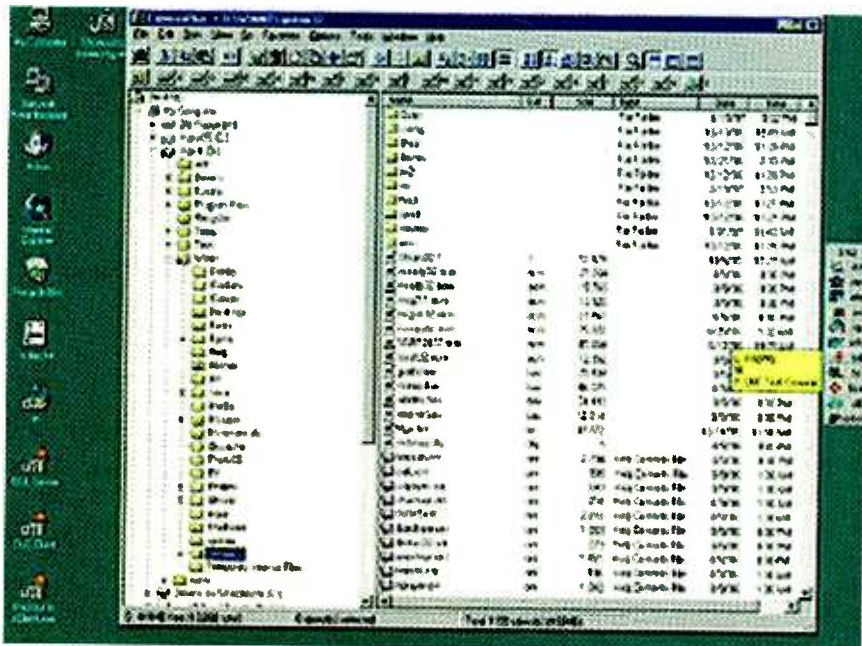

My two favorite Win95/NT utilities: The large window is Explorer Plus, from Mijenix Corporation. It has built-in zip-file handling, a wealth of sorting options, and extensive customizability. Stiletto is the small rectangle on the right. It allows me to create my own program launchbar in the size and position I want, lets me use all the mouse buttons to select different options, and even displays launch programs as tooltips.

finder, a disk-space display and management utility, and the star of the show, Explorer Plus, which is unequivocally my most used utility. Explorer Plus starts where the Windows Explorer leaves off. Highlights include better file sorting options, multiple windows, built-in zip file handling, extensive customization options, built-in launchbar, access to a one-line DOS prompt, viewing pane for seeing file internals, and for even better file viewing, tight integration with QuickView Plus.

over 200 file formats, including most common word processing (including HTML), spreadsheet and graphics formats. The current 4.0 version lacks support for Office 97 file formats, but the company is working on it. My only complaint is that the program supports Access database files only through version 2.0, which is now two revisions out of date.

Stiletto

Stiletto is an ultra-customizable launch-bar utility. You can easily create

NEW PRODUCTS

CombiScope Oscilloscopes

The five new models of Fluke's CombiScope Oscilloscope, offer a combination of an analog oscilloscope and a digital storage scope (DSO). All of them add functionality and improved performance with a number of features that were previously available only as options.

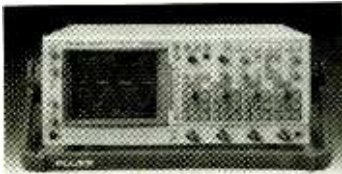

The CombiScope B Series have higher sampling rates on some models and deeper memory per channel, along with built-in software for mathematical processing of waveforms. The latest models include the PM 3384B and PM 3394B, which are 4-channel models with 100- or 200-MHz bandwidth; and the PM 3370B, PM 3380B, and PM 3390B, 2-channel models with bandwidths of 60, 100, or 200 MHz.

For repetitive signals, the PM 3390B and PM 3394B have a random repetitive sampling mode that results in an equivalent sampling rate of 25 GS/s (10 GS/s on the 60- and 100-MHz models). That mode allows users to view repetitive signals at a much higher resolution than is possible with more traditional sampling methods. A single-shoot sampling rate of 200 MS/s is standard on all models.

The four-channel models have 32K deep memory as a standard feature, allowing users to scroll time windows several screens wide for convenient viewing of all single shot events. The memory can also be used to study a single screen time window acquired with greater time axis resolution, and zoom in to study a particular area of a waveform.

All five CombiScope B Series DSOs offer a multiple signal shot mode, which lets users capture a series of single-shot waveforms and automatically store them for later analysis or comparison. The feature makes it possible to find all the malfunctions that occurred during

long-term monitoring without constantly having to watch the screen.

All models also feature add, subtract, and multiply mathematical processing. The Fluke Math+ package adds advanced mathematical processing of waveforms such as Fast Fourier Transformation (FFT), integration, differentiation, and histogram. The built-in digital signal processor can run two mathematical operations at any one time on any waveform. Other Math+ features include automatic pass/fail testing and amplitude qualified cursors, and a program for customer-specified test setups.

The CombiScope B Series is priced at \$2995 for the PM 3370B, \$3575 for the PM 3380B, \$5850 for the PM 3384B, \$4790 for the PM 3390B, and \$6925 for the PM 3394B. For more information, contact Fluke Corporation, P. O. Box 9090, Everett, WA 98206; Tel: 1-800-44-FLUKE; Fax: 1-800-FLUKE-FAX; e-mail: fluke-info@tc.fluke.com; Web : <http://www.fluke.com>.

CIRCLE 80 ON FREE INFORMATION CARD

Camera/Digital Video Modulator

According to NetMedia, its CAModulator is the world's first and only black-and-white camera combined with a digital video channel modulator. The modulator allows you to view the camera signal on any TV and combine that signal with existing cable service or other video in the home or business. The combination of small size, easy use, discrete installation, and coax power makes the CAModulator ideal for security, surveillance, and monitoring applications, indoors or out. Travelers can take advantage of the 12-volt operation to use the device for a back-up camera in their RVs. A homeowner can watch the front door on channel 60 and the back door on channel 62, while monitoring the baby's room on 64. An office can watch the warehouse and the front door.

The CAModulator uses coax-powered™ technology. It requires only one wire to the camera for both power and video signal. It can use UHF channels 14-44 and cable channels 45-94. Well-

sited for stealth surveillance, the CAModulator weighs only 3.5 ounces and fits in a single-gang junction box or mud ring (preferred). It comes with a 12 volt DC transformer; the power injector that lets you power the unit through the coax cable; and a choice of clear, IR, or smoke-gray lens cover. No one knows there is a camera behind the wall plate.



The device does not need to see straight ahead. It adjusts up and down and right and left to match most installations. Thanks to its ability to see with infrared illumination, the CAModulator can be used for all forms of nighttime surveillance. Other features include adjustable focus from one foot to infinity, electronic automatic iris, and built-in wide-angle lens.

The CAModulator has a suggested retail price of \$399. For more information, contact NetMedia, Inc., P. O. Box 68416, 10940 North Stallard, Tucson, AZ 85737-8416; Tel: 1-888-RUN-TABS.

CIRCLE 81 ON FREE INFORMATION CARD

Two-Terminal Digital Voltmeter

Datel's DMS-20PC-3-DCM digital voltmeter (DVM) is designed for applications such as large client servers or MPP (massively paralleled processing) computers, in which multiple, low-voltage, high-current processors operate from a single power bus, and where it is imperative to closely monitor and carefully regulate the bus voltage. The DVM is totally self-contained and has only two input terminals. The DVM is "self-powered" in that it is powered by the voltage it is measuring and requires no external components. Absolutely no technical skills or special tools are required for installation.

The DMS-20PC-3-DCM measures just 1.38 × 0.88 inches with a "behind-the-panel" depth of exactly one inch. It features a large bright-red LED display

(Continued on page 74)

ELECTRONICS LIBRARY

Modern Solder Technology For Competitive Electronics Manufacturing

by Jennie S. Hwang, Ph.D.

Today's and tomorrow's electronics products must deliver faster speeds, lighter weights, and smaller sizes at lower cost and with increased durability—a continuing challenge for manufacturers. This comprehensive book helps you meet that challenge and exceed the demands of the global marketplace.

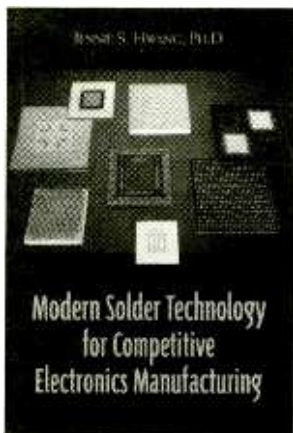

Aimed at anyone who is involved in research, production, quality control, or decision-making management, the book provides complete coverage of all relevant technologies that are associated with the application of solder for electronic and microelectronic packaging and assembly. It explores the underlying fundamentals and focuses on real-world applications. The book is an integrated source of knowledge and information for implementing a manufacturing system that will produce ever-improved electrical, thermal, and mechanical performance of electronic circuits.

The book examines market-driving forces and benchmark technologies, as well as future prospects and emerging technologies, including flip chip and chip-scale packaging and assembly. It covers surface-mount soldering chemistry, wetting and solderability, no-clean and water-clean manufacturing, fine-pitch technology, solder joint failure modes and reliability, materials charac-

teristics and process troubleshooting, state-of-the-art IC packages, IC lead coating and PCB surface finish, atmosphere soldering, lead-free solders, and new specifications and standards. A wealth of data and tables are provided for quick reference.

Modern Solder Technology for Competitive Electronics Engineering costs \$69 and is published by McGraw-Hill, Inc., 11 West 19th Street, New York, NY 10011; Tel: 212-337-5951; Fax: 212-337-4092.

CIRCLE 91 ON FREE INFORMATION CARD

Java Security: Hostile Applets, Holes, and Antidotes

by Gary McGraw & Edward Felten

In March, 1996, the Safe Internet Programming Team at Princeton University discovered a serious security flaw in the Java programming language. More recently, additional flaws in Java-enabled Web browsers have been discovered and patched, only for new flaws to appear.

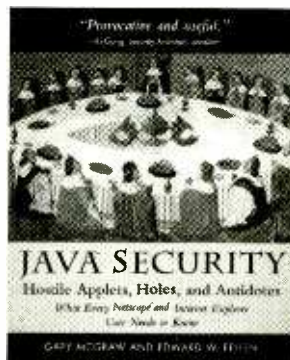

This book informs readers of the risks and provides an intelligent security policy for safe Java use. Written for Webmasters, information technology managers, and concerned Web users, the book explains the three prongs of the current Java security model—the byte code verifier, the applet class loader, and the security manager. It points out the deficiencies in the Java security situation, and provides guidelines for safer Java use. The book not only identifies and differentiates between dangerous attack applets and annoying malicious applets, it also sug-

gests improvements in future Java design for a secure, mission-critical language.

Java Security: Hostile Applets, Holes, and Antidotes costs \$19.95 and is published by John Wiley & Sons, Inc., 605 Third Avenue, New York, NY 10158-0012; Tel: 1-800-225-5945; Web: <http://www.wiley.com>.

CIRCLE 92 ON FREE INFORMATION CARD

Personal Computers In The Ham Shack

by Paul Danser, N111 & Richard Roznoy, K1OF

A recent survey conducted by the American Radio Relay League (ARRL) about hams and computers revealed not only that the majority of hams have and use PCs in their shacks, but that most of them were equipped with state-of-the-art systems with fast processors and CD-ROM drives.

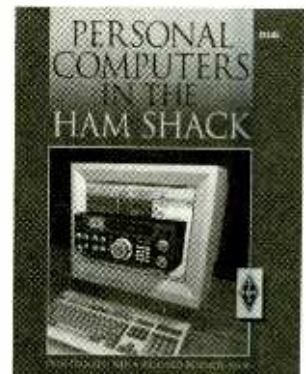

Regardless of how long you've been a ham, and how much or how little computer experience you have, this book will come in handy. Organized to cover the most common uses of PCs in the ham shack, the book opens with a few basic definitions followed by discussions of PC hardware and software. It explains how to choose an operating system and the computer accessories that are right for you. The next chapter looks at the PC as a communications terminal that can get you on packet, RTTY, AMTOR, SSTV, and many other digital modes with just software and a simple interface.

(Continued on page 73)

GIZMO®

Photography's Future?

Gizmo zooms in on digital cameras

It's 4 A.M., and you've just left your wife and brand new baby sleeping soundly at the hospital. You phoned family and friends hours ago with the good news and basic statistics. Now the house is empty, and you're just too wired for sleep. Too bad there are no one-hour photo places open so that you could see the first pictures of your newborn.

If you had snapped those photos with a digital camera, you wouldn't be at the mercy of any photo developer—your PC could serve as a desktop darkroom. You could download those pictures to your computer and be able to view them almost immediately.

A digital camera is like an electronic Polaroid, but with some high-tech advantages. For instance, you could e-mail those electronic images to both sets of new grandparents, all the aunts and uncles, and family friends. Wherever they might live, they'd be able to see the baby as soon as they turned on their computers. If you have a Web page, you could post a photo for everyone on the Internet to see. And—perhaps after getting some much-needed sleep—you could create your own custom birth announcements incorporating one of those photos.

Beginning to wonder why you're hanging onto your old 35mm job? Don't shelve it yet. Digital cameras are beginning to make inroads, but they're not going to replace standard 35mm cameras any time soon. That's because there are a few major drawbacks to the format.

First, "within reach" doesn't mean cheap. Digital cameras are now available for less than \$500. Similarly equipped point-and-shoot 35mm cameras can be bought for well under \$50, often under \$25—even under \$10 for a disposable one.

Second, the potential market is limited



to computer users. Some digital cameras are equipped with (or offer as options) LCD screens for immediate viewing. But to take advantage of all they have to offer, you must have a PC. That immediately eliminates as potential digital-camera buyers the 60%–70% of U.S. households that somehow manage to muddle along without a computer. (That percentage does drop to around 50% if you take into account only those households with children, which are the ones most likely to be taking pictures anyway.)

Third, very few consumer-priced digital cameras offer more than basic point-and-shoot features. Serious photographers would sorely miss the lack of control over focus and exposure, not to mention the paucity (or complete unavailability) of lens options.

Fourth, and perhaps most important, the picture quality of digital images is not quite up to par with standard photos. All

of them produce images that are adequate for viewing on a computer screen, but prints are another thing altogether. You can actually get better pictures from a \$10 disposable camera than from a \$500 digital camera.

The difference in picture quality is directly linked to the differences in technology between 35mm and digital cameras. Traditional cameras capture images on light-sensitive silver-halide film, which can reproduce an almost infinite number of colors and tones. Instead of film, digital cameras use light-sensitive chips called charged-coupled devices or CCDs, to collect images. CCDs are semiconductor devices that convert light into picture elements (pixels). To create color information, the light must be passed through red, green, and blue color filters. The accumulated electronic information is sampled and converted into digital data, which is then compressed and saved



Fujifilm's DS-220 digital camera stores images on a PC card that conforms to the ATA storage standard.

in the camera's electronic memory.

The process works admirably, but there are some limitations in color reproduction. In addition, silver-halide crystals are much more closely spaced than the pixels of even the highest resolution digital cameras. That results in a loss of detail that becomes particularly apparent in enlargements. You can blow up a 3×5 image taken with a 35mm camera to 11×14-inch size, without any detectable image degradation. On a digital photograph with a resolution of 640×480, the image becomes pixelated (it is possible to see the individual pixels) on any size larger than 2.4×3.2 inches.

Why would anyone spend so much money on a camera that produced inferior pictures? How could market-research firm Dataquest possibly estimate that close to 2,000,000 consumer digital cameras will be sold this year?

The answer lies not in the camera, *per se*, but in its role as a gateway to the future. Those of us who regularly use the Internet and online services find them liberating. They free us from having to stand on line at the bank, travel to a library to conduct research, wait for snail-mail responses to consumer inquiries, or depend on some local kid to deliver our newspaper on time. They allow us to communicate quickly and efficiently with far-flung family members and friends, and to leave messages for business contacts without having to negotiate through voice mail systems.

Similarly, a digital camera—along with the necessary software and your computer—can free you from having to buy film,

Gizmo is published by Gernsback Publications, Inc., 500 Bi-County Blvd., Farmingdale, NY 11735. Senior Writers: Christopher Scott and Teri Scaduto. Copyright 1997 by Gernsback Publications, Inc. Gizmo is a registered trademark. All rights reserved.

change rolls in the middle of an event, pay a photo lab to develop your pictures, trust them to do it without over- or under-exposing them, pay for photos that make you look awful, pay for copies of good pictures, or rely on snail-mail to get copies to your friends and relatives.

The software designed to manipulate digital photos offers a different type of freedom: It unleashes your creativity. You can crop photos, correct "red eye," remove blemishes, and correct color balance and contrast.

Digital cameras have been around for more than a decade. Professional models, ranging in price from \$10,000 to more than \$40,000, allow photojournalists to get late-breaking stories, complete with pictures, back to the main office as quickly as possible. And digital cameras can actually reduce costs by speeding up the production schedules in the fast-paced fields of magazine publishing, print advertisements, and catalogs.

Lower priced models have been popular choices for realtors who include photographs on computer listing sheets and insurance adjusters who require picture documentation for claims. The speed and ease of posting such business photos more than made up for the initial price of the camera and the less-than-ideal image quality. The camera pays for itself over time when frequent camera users no longer rack up costly film purchases and developing fees.

In the past couple of years, dropping prices and improved resolution have made digital cameras more appealing to consumers. But what is really driving the market for digital cameras is the skyrocketing consumer involvement in the Internet.

YOU'D BETTER SHOP AROUND

Once you've decided to take the digital-camera plunge, you'll soon discover that you have plenty of other decisions to

make. Today's crop of digital cameras includes dozens of models from a wide variety of manufacturers—from traditional camera companies like Kodak, Fuji, Polaroid, Ricoh, and Canon; computer companies such as Apple; and consumer-electronic giants including Sony and Panasonic. Many look just like pocket-sized point-and-shoot film cameras; some sport high-tech, futuristic packaging. Some offer auto focus, and others have fixed-focus lenses. Some have built-in LCD screens for immediate viewing of photos.

Prices currently range from \$300 up to almost \$3000, resolutions from 480×240 up to 1600×1200 on Polaroid's \$2995 PDC-2000/T. (A resolution of 640×480 is considered standard on entry-level digital cameras.) Making matters difficult for comparison shoppers (but better for consumers in general), prices are coming down and resolutions are getting better all the time.

Less obvious differences abound in the capacity and type of memory storage used in different models. No standard has been agreed upon, and three incompatible technologies—Compact Flash (CF), Miniature Card, and Solid State Floppy Disk Card (SSFDC)—are now competing. All three use tiny memory cards that can be plugged into special PCMCIA adapters.

The Compact Flash, manufactured by San Disk and backed by Kodak, currently seems to have the edge. Not much larger than a postage stamp, the Compact Flash card is compatible (with an adapter) with Type I/II PC ATA devices.

You'll want to buy a camera with sufficient storage capacity to keep up with your picture-shooting style. Keep in mind that digital photography encourages you to take lots and lots of photos—it doesn't cost anything to develop them, and if you don't like one (or a dozen), you can easily erase it and try for a better shot.

Picture capacity varies widely from camera to camera—and the numbers don't tell the whole story. Some offer two or even three resolution levels; the higher the resolution, the fewer pictures you can store.

Low-end cameras have only a limited amount of built-in memory; use it up, and you'll have to erase some pictures or download them to a computer before you can take any more. To squeeze in as many photos as possible, they compress the data from each image file. You can take a lot of photos before running out of memory, but the compression degrades the image quality. (Casio's \$650 QV 100, for instance, stores 64 compressed high-resolution pictures or a whopping 192 low-resolution photos.) Other digital cameras have enough built-in RAM to store a small number of high-resolution pictures,

but also use removable memory cards. (Kodak's DC50, priced at \$1000, stores 7 high-resolution, 11 medium-resolution, or 22 low-resolution photos in 1MB of internal RAM; it also accepts CF cards.) You can remove a storage card that's full and insert a new one without having to pause and download the images to a PC.

Downloading is another factor to consider. It should be—but isn't always—a quick and easy process. Downloading an image can take as little as two seconds, or as long as a minute. The time factor depends on the type and amount of compression used (the more an image is compressed, the less time it takes to transfer it), as well as the software driver supplied with the camera.

Once the images are stored in your computer, the fun begins. Popular digital image-processing programs like Adobe PhotoDeluxe are included with many digital cameras. Such programs allow you to touch up your pictures, alter them artistically, use them in cards and calendars, and post them on the Internet.

Read on for close-up looks at the Olympus D-200L digital camera and PhotoDeluxe software, as well as a different type of digital photography with the Snappy Video SnapShot.

Image-ine That!

MODEL D-200L DIGITAL CAMERA. From Olympus America Inc., Two Corporate Center Drive, Melville, NY 11747-3157; Tel: 1-800-622-6372; Web: <http://www.olympus.com/digital>. Price: \$599.

One of the main reasons that digital cameras are not likely to replace their film-based counterparts any time soon is that they hold very little appeal for anyone who does not know how to use a computer. After all, you can't take advantage of all the neat things that a digital camera does without linking it to a laptop or PC. And people who don't even want to know how to use a computer or surf the Net are even less likely to want to switch from their trusty old 35mm cameras.

Olympus is trying hard not to scare off the large segment of our population that feels overwhelmed by computer technology. Its D-200L digital camera is designed to look and feel like a regular camera. It is also supposed to be so easy and familiar to use that consumers intuitively know just how it works. "It's a digital camera, not a computer in a camera bag," the press material proudly states.

The D-200L does look quite a bit like a regular camera. Attractively styled in black and gray, the pocket-sized (5.7 × 2.8 × 1.8 inches) camera weighs 10.4 ounces without its one lithium and four "AA" (alkaline, NiCd, nickel-hydrate, or lithium) batteries installed. Its "lens cap" is actually a door that slides shut to protect the lens—you never have to worry about losing it. The flash and an indicator that lets you know when the self-timer is engaged are also on the front of the camera.

The top panel also looks like that of a standard camera, with its large, round SHUTTER RELEASE button; a small LCD screen that displays number of photos, battery status, and the like; and buttons for setting the flash mode and the timer.

Looks can be deceiving. The SHUTTER RELEASE button doubles as an ERASE OK control, the SELF-TIMER is also a SLIDE-SHOW button. The control panel displays not the number of pictures taken, but the number remaining. It also uses some icons you won't find on 35mm cameras—resolution setting, write, and erase—along with the more common macro (close-up) mode, self-timer, and flash mode icons. Two additional top panel buttons are used to select macro mode/protect mode, and to select the resolution/display type.

Other differences are apparent at the back of the camera. There you'll find a traditional optical viewfinder—but there's also a 1.8-inch color LCD monitor, a button for turning it on and off, and two buttons for viewing previous/next images on the LCD. On the side of the camera, a covered compartment holds a

jack for a DC power adapter—and one for an RS232C computer interface.

Although the differences are not readily apparent to the eye, they are sufficient to cast a technophobe into a state of confusion. We loaned the D-200L to a friend who was on the way to watch her son march in his first parade—she had forgotten her pocket camera and didn't have time to go home for it. Nor was there time to explain the workings of the D-200L; we didn't really think it was necessary, anyway. But when she returned the camera, she reported that she didn't get a single picture—she couldn't figure out how to turn it on. She thought her problem was solved when she noticed a computer-savvy neighbor accompanying his son's scout troop in the parade—he couldn't get it going either.

In reality, all you do is slide open the lens cover, and the D-200L is ready to go. You can tell it's on when indicators appear on the control panel. Our friend's problem arose when she opened the lens cover several minutes before she was ready to shoot; the D-200L automatically turns itself off after three minutes of inactivity to conserve battery life. Our friend—and her neighbor—didn't realize that she had to close and reopen the cover, or press the SHUTTER RELEASE button halfway, to turn it on again.

Another potential source of confusion is that when "01" appears in the control panel, you're not about to take your first photo, you're on your last one. The D-200L stores 20 high-resolution, or 80 standard, pictures in its 6MB of internal RAM. No provision is provided for external image storage cards; when the internal



memory is full, you must either erase some of the stored images or download them to a PC.

When the high-resolution mode is selected, an "HQ" icon appears in the control panel; there is no icon in standard mode. The pictures-remaining count changes when you change modes. For instance, you might have four pictures left in standard mode, but just one if you switch to HQ. In high-quality mode, the picture resolution is 640×480 pixels; in standard mode, it is 320×240.

Had our friend managed to turn the camera on properly, and figure out how many shots she had left, she might still have had trouble with the SHUTTER RELEASE button. Taking a picture is a two-step process. The button must be depressed halfway first, and then fully to release the shutter and snap the shot.

The D-200L captures images at shutter speeds of up to 1/10,000 second. The camera beeps twice to let you know the shot was taken, and a writing indicator appears in the control panel to show that the image is being transferred to memory. After about six seconds in HQ mode, or two seconds in standard, the indicator disappears, and the camera is ready for the next picture.

You can use either the optical viewfinder or the LCD monitor to frame your photos. The manual suggests using the standard viewfinder because it's easier to hold the camera steady when it is pressed up close to your face. Besides, using the LCD runs down the batteries faster.

The LCD is really intended to view the photos that you've just taken. With the lens cover closed, a press of the green ON/OFF turns on the monitor. The last picture taken appears on the monitor, scrolling down from the top line-by-line until it fills the screen. The frame number and battery power indicators are also displayed. If you selected high-quality or protection mode or set the date when you took (view) the pictures, those indicators will also be shown. Pressing the PREVIOUS button moves you backward through the pictures; the NEXT button moves you forward.

If you want to be sure to keep one of the images, you can press the PROTECT button while that image is displayed in the monitor. A second press of the button cancels protection. If you don't want to keep a picture, and that picture isn't being protected, pressing first the ERASE button and then the ERASE OK (shutter release) button will permanently delete that picture.

Suppose your child got his hands on the D-200L and used up its entire picture memory taking pictures of the floor, the ceiling, and his shoes. You can easily erase all of the pictures in one fell swoop

by simultaneously pressing the ERASE and the FLASH buttons, and then pressing the ERASE OK button to verify. Any protected pictures will remain in the camera's memory.

The monitor also performs a couple of neat tricks. In slide-show mode, it automatically runs through all of the pictures, in the order in which they were taken. In multi-display mode, nine frames appear on the LCD monitor at the same time, in three rows of three. You can even combine the two modes for a multi-image slide-show.

Besides the LCD monitor, the D-200L offers a number of features not found on many entry-level digital cameras. Those include a self-timer, macro mode, and several flash modes. The self-timer gives you 12 seconds to get into the picture before the shutter is released. Macro mode is used for taking close-up shots, from a range of 0.65–2.46 feet.



The above is an actual image, real size, taken with the D-200L in 640×480 resolution.

The D-200L has four flash modes to meet various conditions. Autoflash automatically fires in low-light and backlight conditions. Fill-in flash forces the flash to fire even under bright light conditions—when the subject is sitting in front of a sunny window, for instance. Flash override turns off the flash even in low light conditions. Red-eye reducing mode helps avoid pictures in which the subject's eyes appear to glow red. The camera emits a series of low-power flashes, which make the subject's pupils contract, before the regular flash goes off.

If you forget to use red-eye reduction, don't worry. You can correct red-eye, and all sorts of other flaws, when you "develop" your photos on your computer.

The D-200L is compatible with IBM PCs and Macs; interface cables for each type of computer are included with the camera. They plug into either the COM 1 or COM 2 serial port on an IBM-compatible PC, or to the printer or modem serial port of your Mac. Windows 3.1 or 95, or MacOS 7.0 or higher are required, as is a monitor with a minimum of 256 colors and 640×480 resolution. The version of

Adobe PhotoDeluxe that is included with the D-200L also requires a double-speed CD-ROM drive, as well as more than 45MB of free hard disk space, and more than 16MB of RAM.

The supplied disk contains all the software needed to download photos from the camera and manipulate them on your computer. For Windows-based systems, the D-200L's software uses the TWAIN standard interface. For Macintosh systems, the software uses an Adobe PhotoShop-compatible plug-in module. Installation is an easy question-and-answer process that takes just a few minutes. (A separate review of Adobe PhotoDeluxe follows.)

Comparing digital and 35mm point-and-shoot cameras is like comparing apples and oranges—they're really two completely separate product categories. Despite Olympus's attempts to "maintain a modicum of familiarity" in styling the D-200L, the digital camera is not likely to hold much appeal for avowed technophobes. If you aren't comfortable using a computer, you can't take full advantage of digital photography. About all it has to offer "camera-shy" users is freedom from having to load film (which actually throws many amateur photographers for a loop.)

If you have a good rapport with your Mac or PC, enjoy taking photos, and have any artistic bent at all, you'll have a blast using the D-200L and its supplied software. In no time, you'll be making digital photo albums, flyers, and greeting cards, or including photos on your Web page.

The D-200L is easy to use and offers a few features that have not yet become standard fare on consumer digital cameras. Our only major complaint is that it does not accept any type of photo-storage memory card. If you're at a wedding, or on vacation, and don't have access to a laptop or desktop PC, you can soon find yourself running out of "film." It doesn't take much time to snap the maximum 20 high-quality photos—especially when the camera is so much fun to use.

Olympus has introduced a "big brother" to the D-200L. The D-300L can store ten extra high-quality photos, for a total of 30 (or 120 in standard mode). And high-quality is not an exaggeration: In HQ mode, the resolution is 1024×768 pixels. Actually, standard-quality is not bad either—at 512×384 pixels, it's still better than what passes for high-res on some of the lowest priced digital cameras out there.

The D-300L, whose suggested retail price is \$899, also offers auto focus and something called "focus lock," which allows you to focus on something, lock it, and then move the camera so that something else is in the center of the frame. ■

Desktop Darkroom

ADOBE PHOTODELUXE 1.0. From Adobe Systems, Mountain View, CA; Tel: 1-800-833-6687; Web: <http://www.adobe.com>. Price: \$90.

Digital photography is wonderful—in concept. But, let's face it: The straight-from-the-camera images leave a lot to be desired. They simply can't compete with 35mm photos in terms of resolution and color quality. In reality, it takes digital image processing to bring those digital photos to life—to insert them into school projects or business presentations, post them on the Web, or create customized calendars or greeting cards.

In the world of professional digital image processing, Adobe Photoshop is highly touted for its sophisticated, innovative handling of high-end graphics tasks. Unfortunately, the software carries an \$895 price tag and takes a lot of time and effort to learn.

Adobe Systems has wisely come up with a scaled-down version of Photoshop: *PhotoDeluxe*. With a street price of about \$90 and an interface that couldn't be easier to use, the program is aimed squarely at the growing population of consumer digital-camera users. In fact, *PhotoDeluxe* is included with many models, including the Olympus D-200L (also reviewed in this issue).

The *PhotoDeluxe* program does not provide the full functionality of Photoshop; nor does it plague users with Photoshop's complexities. What it does—and does quite well—is allow anyone with basic computer skills to take a so-so digital image and convert it into a work of art. So what if the color isn't quite right—you can adjust it. Red-eye making your little darlings look like little devils? "Paint" away the red and turn the pupil black again. Is your subject a mere speck in the corner of a photo? Crop the shot and enlarge the subject. Don't stop there. Adobe *PhotoDeluxe* lets you change all the colors in your photos, create posterized or Impressionist versions of your pictures, "frame" them, turn them into screen-savers, and post the finished product on the Internet.

The program is exceptionally easy to use. It offers two modes: Guided Activities and On Your Own. As its name implies, Guided Activities walks beginners step-by-step through each specific task required to complete a goal. On Your Own provides users with more freedom, but still retains the simple interface.

Three general categories are presented in Guided Activities mode: Touch-Up

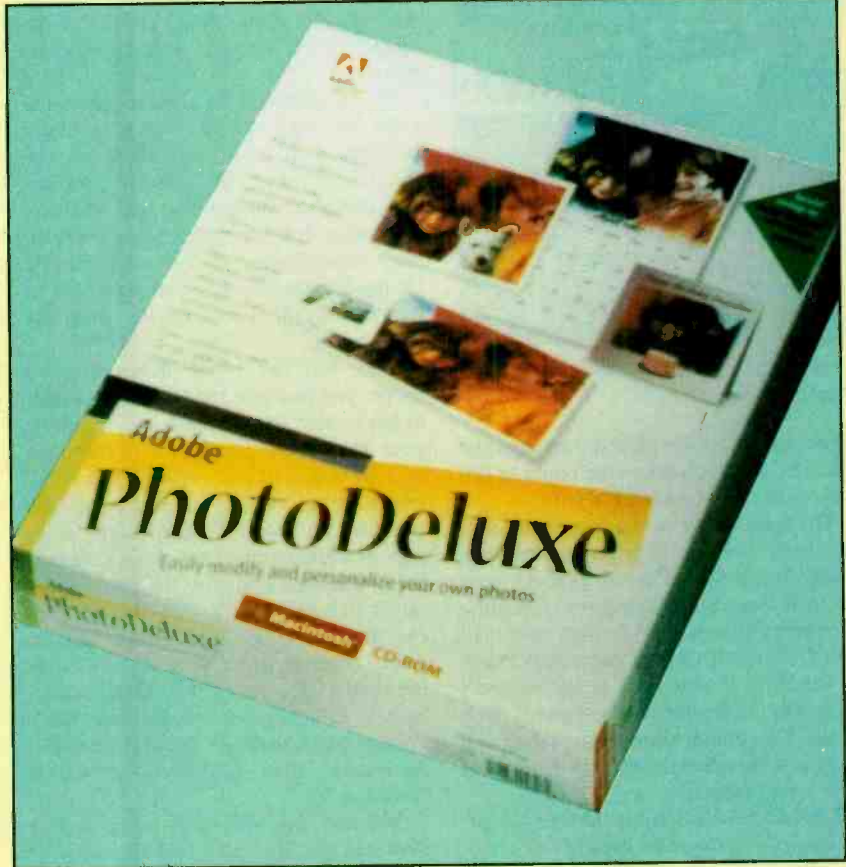

Photo, Transform Photo, and Cards and More. Within each, numbered "folders" are used to represent every step required to complete the activity. You simply click on each number in order to open the folder, follow the instructions provided inside, and move onto the next—from "Get Photo" right through to instructions for saving and printing your finished product.

You might be tempted to jump right into the creative categories, but it's a good idea to start off with Touch-Up. There, you can select Size/Orientation to straighten out the image or crop it to better focus in on the subject; Quality to adjust the overall lighting and colors; and Remove Red-Eye to restore the subject's eye color. Once you've fixed any basic problems with the original, you can start to put your own personal stamp on the image.

The Transform category offers dozens of different options, arranged into five sub-sections: Collage, Fun, Art, Cool, and Internet. In the Collage folder, for instance, you can create Funny Money by replacing Ben Franklin on a \$100 bill with your face (or your cat's face); or you can opt to disguise a subject's face by adding glasses, a moustache, or a hat. Select Change Background to put your subject in front of a famous landmark or have him float in outer space, choosing from Adobe's library of backgrounds or

using one of your own. Finally, Body Switch allows you to swap between photos to put your cat's head on your dog's body, for instance. Or you can replace any subject's body with one of Adobe's selection of "famous bodies."

Options within the Fun folder include the ability to warp, bend, or twirl all or part of an image; add type that swirls and warps; add the illusion of motion; play with the perspective to create a feeling of depth; or turn your photos into black-outlined coloring-book pictures, which can then be "painted" on- or off-screen.

The Art category provides six ways to create artistically stylized versions of your photos. You can turn a photo into a line drawing, or achieve an old-fashioned look by making a color image black-and-white or sepia-toned. You can create "posterized" images that exaggerate pixels and reduce the number of colors, or create soft, impressionistic versions of your photos. You can hand-color your images to add color to black-and-white shots or to highlight elements of color shots. Finally, you can alter colors in all or part of the image.

In the Cool folder, you'll find some of Kai's Power Tools, a sampling of special effects filters from MetaTools. They include Page Curl, which makes your photo seem to be peeling up off the page; Vortex, for a kaleidoscope effect; Charcoal Edges, which transforms the



This image was modified using Adobe PhotoDeluxe.

photo into a colored-pencil drawing; and Glass Lens, which warps the photo as if it were reflected in a curved mirror.

The final folder in the Transform section helps you get your photos Internet-ready. Select Web Page to prepare your photo for use on a Web page (including converting it to a .GIF format) or e-mail (JPEG format). Or you can select Photo to PageMill if you want to use Adobe's PageMill software for creating Web pages. This option allows you to drag and drop a photo directly to a Web page of your own creation.

PhotoDeluxe's Cards and More category allows you to create monthly or annual calendars and all sorts of greeting cards. In addition, you can create magazine covers, album covers, report covers, flyers, signs, labels, and gift tags that incorporate your digital photos.

Novice image-processors will find enough variety in the Guided Activities area to keep them happily creative for a long time. Those who are looking for more artistic freedom can find it in the On Your Own mode. There you'll find the same basic interface, although you no longer have to proceed through numbered steps to accomplish various tasks.

On Your Own offers three main categories from which to select: Get Photo, Modify Photo, and Save/Print. Get Photo offers the same options as in the Guided Activities mode, plus one. You can open an existing file or one of Adobe's sample photos, use a scanned image, or download a photo from a digital camera, a Photo CD, Snappy, Fuji Film, Kodak Photo Disk, Konica Picture Show, or Floppy Shots. In addition, you can use Adobe's decorations, which aren't available in Guided Activities.

Modify Photo allows you to unleash your creativity. You can edit the photo—cut, copy, paste, duplicate, or delete it, or delete the background only. Several tools are available, including a paintbrush, color change, lines, text, an eraser, and "smudge." You can change the orientation of a photo by rotating it left or right and flipping it horizontally or vertically.

And you can even modify the size of the image, trim it, distort it, or change its perspective.

Digital photographs often require quite a bit of touching up, which is easily accomplished after you click on the "quality" folder. Two automatic options are available: instant fix, and sharpen. The color balance, brightness, contrast, hue, saturation, and lightness can be changed manually. It's even possible to remove any dust or scratches from the photograph.

Once you have your photos in good shape, you can select the "effects" folder to have some fun. It's possible to outline your subject to distinguish it from the background, and then change the background to a solid or graduated color. You can draw an oval, circle, rectangle, polygon, or square around the subject, or outline it freehand (which is a bit difficult—rather like using an Etch-a-Sketch). You can also erase any part of the image, select areas to move around, or change the entire image to black-and-white. Special Effects gives you the same Kai's Power Tools that are found in Guided Activities, plus a fifth one called "smudge."

We had a good time using Adobe PhotoDeluxe. To get a feel for some of the options, we took a photo of our son, "matted" it with an oval outline, colored the mat, wrote his name in contrasting letters down the side, and framed the entire image. We liked it so much, we used the framed image for his birthday party invitations. Next, we made a calendar using seasonal photos taken in the garden, at the beach, raking leaves, and building a snowman. We plan to create home-made Christmas cards next year—and to "mail" quite a few of them electronically! ■

It's a Snap!

SNAPPY VIDEO SNAPSHOT VIDEO DIGITIZER. From Play Inc., 2890 Kilgore Road, Rancho Cordova, CA 95670-6133; Tel: 800-306-PLAY; 916-851-0800; Web: <http://www.play.com>. Price: \$199.95.

Digital cameras are still in their infancy—and the pictures that they take show it. But the things that you can do with them, from creating custom greeting cards to posting them on the Web, sound like a blast. Fortunately, you don't have to invest big bucks on an emerging technology to be able to have the fun of playing with digital photos on your computer. If you own a camcorder, there's an easy—and relatively cheap—way to get high-quality images into your PC: the *Snappy*

Video SnapShot V2.0 from Play, Inc. Snappy digitizes video images from your camcorder, and allows you to download them to a computer. It's easy, and you can actually get better quality images than you can with consumer digital cameras.

The Snappy is a small, simple-looking device, about the size of a deck of playing cards. (Or a Walkman. Or a cellular phone.) It measures about 5 × 2½ × ¾ inches. On one edge is a DB-25 connector that plugs into a computer's parallel port. Two RCA phono jacks are on one side of the unit. One accepts a video input, and the other passes the video on to another device. The 9-volt battery compartment is concealed by a bright-blue plastic cover that sports the Snappy logo. A 5-pin "mystery connector" is located by the video jacks. We don't know what it's for, and it's not mentioned in the manual. But we're sure that Play, Inc. has some interesting plans for it down the road a bit.

The manual accompanying the Snappy is a thin 20 pages—which is more than enough to explain how to get started. A more detailed manual is included as a PDF (portable document format) file. The Adobe Acrobat PDF reader is also included.

Using the hardware could hardly be easier. (Once you plug the Snappy into the computer's parallel port and connect a video source to it, you're done.) A pass-through video connector is provided, allowing you to watch on a video monitor the video from which you were looking to capture images. The Snappy doesn't offer pass-through printer support, however. So you might have to unplug your printer to use it, or get a switch box that would let you go back and forth between the two. Although that sounds like a bit of a hassle, we never found it to be. Acquiring images and printing them were never things we did at the same time.

(Actually, we usually used the Snappy on our notebook computer, attached to our camcorder, because most of the images we wanted to capture were found outside the confines of our office. We could have taped the images, and then played them back later at our desktop computer. But images captured directly from a video camera can have higher resolution than those taken from tape. We'll discuss resolution in more detail—no pun intended—later.)

What we did find to be a hassle was Snappy's size—it's a wee bit too fat. Although we had no problem connecting it to most computers, we did run into trouble on some computers with tightly spaced jacks on their rear panels. In one instance, we had to remove the serial cable to get Snappy to wedge in beside the video cable. Getting to the back side



of a computer is usually a bit of a job in itself because of all the cables. Trying to wedge something in just makes it more difficult. Of course, a short connecting cable could cure that problem.

Snappy is supplied with software on two CD-ROMs. The acquisition software serves as the main interface with the device. Other software includes Adobe PhotoDeluxe, Gryphon Morph, and Kai's Power Goo SE. (PhotoDeluxe is reviewed elsewhere in this issue of *Gizmo*. Morph and Kai's Power Goo will be covered in detail following our description of the basic acquisition software.)

Installing the Snappy software is as simple a process as you'd expect. If you're running Windows 95 (or NT 4.0), you just pop in the CD-ROM, and it will run automatically. Otherwise, with older versions of Windows, you just have to run SETUP.EXE from the CD-ROM. Answer the usual install questions, and you'll painlessly install the Snappy software. You can do the same for Kai's Power Goo SE and for Gryphon Morph. PhotoDeluxe is on its own CD-ROM, and can be installed equally painlessly.

When you launch the Snappy software, you're greeted by a main screen. If the hardware isn't detected, you're warned immediately. Otherwise, you're greeted with a large Snappy logo in a rectangular box with seven buttons down the left side; from top to bottom, they are SNAP, PREVIEW, ADJUST, SAVE, PRINT, SETUP, and HELP.

Their order has little to do with the order in which they're used. We'd suggest starting with the SETUP button, which

brings up the setup menu. As the user's manual says in its typical flippant fashion, "No, this menu isn't about betrayal, but rather, flexibility."

From the Setup screen, you can select the type of snap (normal, continuous, or delayed); the video source (videotape or live camera); the picture quality (moving picture, still, high-quality still, or highest quality still); the picture type (color, black-and-white, color negative, or black-and-white negative); and whether new pictures use the same window, create a new one, or create a storyboard. You can choose whether to show the picture while the software is processing it, or to wait until it's finished. You must also tell it whether you are using the video-through jack to connect to a video monitor. Snappy will electronically terminate the output if it's not in use.

The Preview mode presents a 160 × 120-pixel black-and-white thumbnail of what the video source sees—sort of. Its low frame rate (about two frames per second) makes it a poor way to snap just the frame you want. That's why the video-through jack is there. It allows you to watch the video real-time on a monitor.

Once you see the shot you want, it's time to hit the Snap button. The magic begins, and Snappy grabs a field of video—or maybe more, depending on your choices in the Setup menu. If you are snapping a moving image and you chose that in the Setup menu, then you'll capture one field of video. If you're shooting a still image, and you have a stable video source (playing laserdisc, TV broadcast, or live camera—but not a video tape) then

you can grab a one-frame (two-field) image for higher resolution. Choosing High-Quality Still will tell Snappy to grab four fields, and Highest-Quality Still will grab eight fields.

What happens if you set the software for "highest quality still," when you are really capturing a moving image? It's worse than what happens if you try to shoot sports action with a still camera set to a shutter speed of 1/60th of a second. With the still camera, you'll get a blurred image (which can be a good thing if you're trying to convey speed and motion).

Snappy is different, however. One of the ways that it's able to capture high resolution (1500 × 1125—higher than NTSC can produce) is by examining the video and processing it, interpolating to fill in the gaps. That processing takes time. So while the Snappy will capture eight fields of video, it can't capture eight *consecutive* fields. Motion can really throw off its interpolation routines. Moving around when acquiring images, for example, isn't a good idea—your moving shadow can mess up your image. A camcorder's auto iris or auto focus can do the same—set them to manual control.

Once you've taken your snapshot, it appears on the screen behind the preview window. If you're not happy with the results—or even if you are—you can call up the Adjust screen. Down the right side of the screen are various centered sliders for changing the color saturation, brightness, contrast, and other picture parameters. For example, the PICTURE slide lets you adjust the picture's gamma correction, or the range from the lightest to darkest areas of the frame. The SHARPNESS slide can add a little snap to object edges. Color can be controlled with a TV-like tint control, or with separate red, green, and blue sliders.

Any changes are updated quickly in the low-resolution preview window. If you want to see them full size, just hit the PROCESS button. From the Adjust screen, you can also zoom into a part of the image, and crop it.

Images can be saved in a variety of typical Windows sizes, or you can create a custom size by adjusting the pixel width and height. Images can also be saved with different color depths, from 24-bit true color down to 16 color.

Acquiring images that look good on your PC monitor is relatively easy. Getting images that look good in more demanding applications is a little more difficult.

The most important part of getting good pictures is starting with good lighting. Most people are tempted to just point their camcorder at a person or object and press the SNAP button. After all, that's

pretty much how they shoot video. With the Snappy, however, you should pretend that you are in a photo studio. Set up those lights!

Shooting people is more difficult if quality is what you're after, because moving video can't produce the same quality as still video. If you can get your subject to stay *really* still, however, you can achieve success. (Very still for a long time—remember, although Snappy grabs eight video fields, it doesn't grab eight consecutive video fields.)

Keeping that factor in mind, we found one of the most impressive things about the Snappy is the packaging that it comes in. OK, it's just a cardboard box with four-color images—just what you'd expect to find on a typical computer-peripheral box on the shelf of your local computer superstore. But those professional-looking, glossy images were all acquired by a Snappy. Now, that indicates that Play has confidence in its products. And why not? There's really nothing that comes close to what the Snappy can do—especially when you take price into consideration.

Once you've captured your images and saved them to your disk, it's time to start putting them to use. The Snappy Version 2 package gives you a couple of excellent ways to start making the most of your captured images—and to start having fun. Keep reading for descriptions of Morph and Kai's Power Goo. ■

Cool Tools

KAI'S POWER GOO SE. Published by MetaTools, Inc., 6303 Carpinteria Ave, Carpinteria, CA 93031; Price: N/A, OEM version supplied with Snappy Video SnapShot.

Every once in a while (unfortunately, not very often), someone comes along and shows how things can be done differently. Before Aldus introduced PageMaker, for example, WYSIWYG and personal computers had never met. Before NCSA Mosaic, Web pages containing both text and graphics didn't exist.

Photo- or graphic-manipulation tools are nothing new. But *MetaTools* has certainly put a new spin on things with its *Kai's Power Goo*. We examined only the SE edition ("special edition"—which usually means "stripped") that we received with the Snappy Video SnapShot. We can't say how it differs from the full retail version, but we can tell you how it differs from any other image-manipulation program that we've ever used.

Although we writers here at *Gizmo* are



far from being graphic artists, we are somewhat adept at image manipulation. In our work, we sometimes have to crop images, or touch up some color on occasion. Now, however, we also might find the need to create some cool birthday invitations, or T-shirt iron-ons, or whatever strikes our fancy. After all, now that we have Kai's Power Goo, we can do things that previously couldn't be done by mere mortals (with the exception of those who work at TV studios, and those real artists who are willing to invest in serious image-manipulation systems).

Kai's Power Goo, which MetaTools calls a "creative entertainment tool," lets you do extraordinary things with digital images in seconds. MetaTools claims that its user interface is revolutionary and intuitive. Well, it is different. We were able to use it without opening the on-disk user manuals (in PDF format), but not without a few stumbles along the way.

We'll readily admit that Windows 95 does not have the ideal user interface—such a thing probably doesn't exist. The advantage of Windows 95, of course, is that it allows software publishers to maintain some consistency in how their programs operate.

(Kai's Power Goo is a 32-bit program that runs under Windows 95 or NT only—it won't run on Windows 3.1. It requires a 486 or better processor. The software is also available for the Macintosh platform, and requires a 68040 or better processor.)

MetaTools does away with the "clutter and confusion of a complicated or rigid menu structure," but we're not convinced that it really advances the state of the art of user-interface design. Making it

impossible to access the start menu or desktop is not our idea of an improvement—even if, as MetaTools claims, it reduces the clutter that might interfere with our creative processes.

Kai's Power Goo is primarily a way to have fun with digital images. Anyone can have a go at it—kids who want to make their friends look goofy, adults who want to make their bosses or favorite politicians look devilish. What makes it so much fun is that the effects are virtually immediate (at least on a 133-MHz Pentium-based machine.) Pick a "nudge" Goo brush, brush it on the image, and the image responds as if you literally had pushed it. (MetaTools calls what it does "liquid imaging.") If you're used to image-editing programs where every change takes a couple of minutes as the screen is refreshed, forget it. In that way, Kai's Power Goo is radically different.

For input, Kai's Power Goo supports TIFF, BMP, Photo-CD, and Photoshop



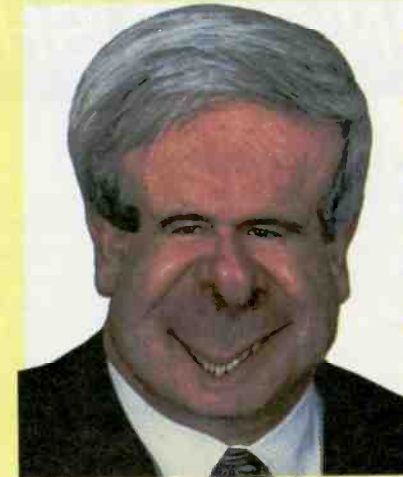
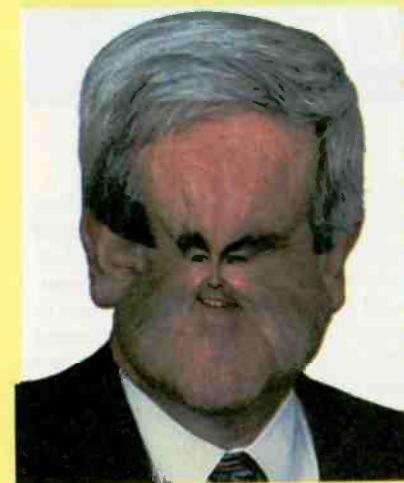
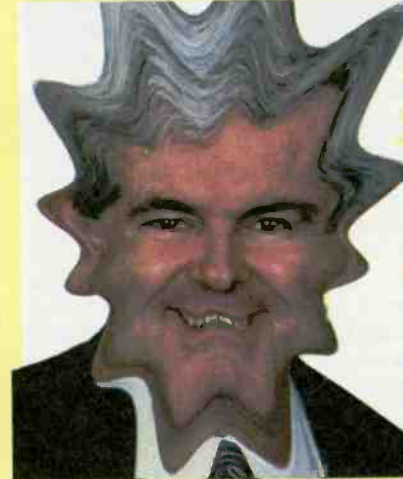
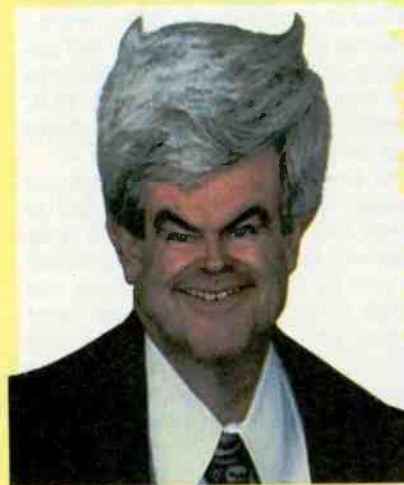
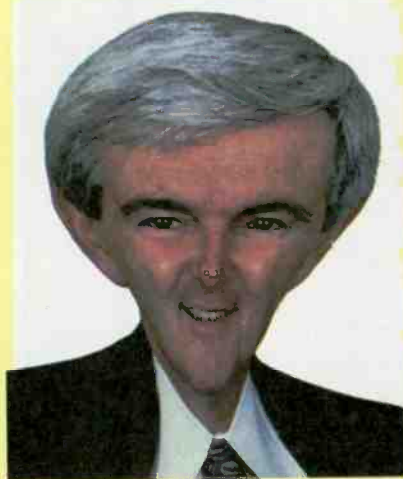
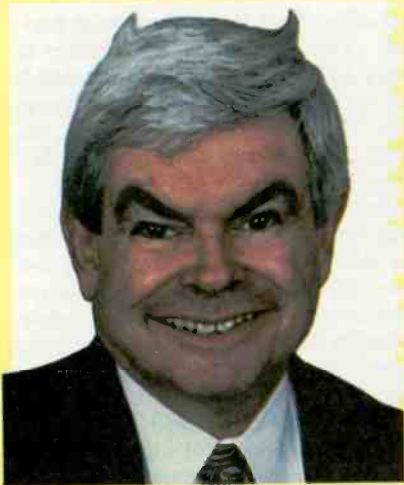

Spike, Static, and Unwind. The difference between the two palettes is that the brushes are used to create distortion where you “paint” the image, while the changes created by the Effects Palette are global to the image. The strength of the effect is determined by the position of the Control Slider. The control slider can also be used with the brushes to transition between the current Goo composite image and the original.

The Keyframe Palette can store up to 64 keyframes, which can be used to create animated AVI movies. Kai’s Power Goo will morph from one image to the next—the speed of the animation can be controlled by the playback slider.

It’s very easy to go way too far out of control when using Kai’s Power Goo—creating what MetaTools calls Gootesque images. Just turning the Twirl effect on full, for example, will render an image unrecognizable. But untwirling it is just as easy—and you might want to create an animation that uses unrecognizable frames as part of a transition. You can always get back to your starting point by hitting the Reset button.

That’s part of the fun—you really can’t go wrong. Get as crazy as you like—turn your boss into a grotesque ogre—just be sure to hit Reset if you hear him approaching your cubicle! ■

Morphing Magic

MORPH V2.5. Published by Gryphon Software Corp., 7220 Trade St., Suite 120, San Diego, CA 92121; Tel: 619-536-8815. Price: N/A—included with the Snappy Video SnapShot.

What are you going to do with all of those images that you’ve been snapping, scanning, and digitizing? If you have no desire to post pictures on a Web page, and printing greeting cards just doesn’t turn you on, then maybe you’d like to imitate some high-priced advertising agencies and rock-video makers and do a little morphing.

Just what is a morph? It’s a mix of two images in which similar elements of each of the two images move to an intermediate position between them, so that one picture appears to meld into the other. Even if you’ve never heard the word used (it comes from the word metamorphosis), you know what morphing is—think of the Exxon video with the car that turns into a tiger (or is it the other way around?) Or think of the Michael Jackson video with the faces of people of all different ages, races, and gender that change seamlessly

file formats. For output, only BMP and Photoshop formats are supported. When started, the program defaults to an image of the Mona Lisa. To import a different image, you don’t choose File, Open as you might expect. No such menu exists (nor does a title bar). Instead, you click on the word “In” at the bottom left corner of the screen.

The main user interface—the Goo Room—contains a Goo Brush palette, a

Goo Effects Palette, a control slider, and a playback slider. You put your “goood” images into the Keyframe Palette found along the bottom of the screen.

The Goo Brush Palette contains nine different distortion brushes: Reset, Grow/Shrink, Move, Smear, Smudge, Nudge, Mirror Toggle, Smooth and UnGoo. The Goo Effects Palette also has nine different distortion effects: Reset, Bulge, Twirl, Rotate, Stretch, Squeeze,



from one to another. We don't remember the name of the song, but that morphing technology sure stuck in our minds.

Gryphon Software's Morph V2.5 lets you create morphs as either still images or AVI movies. Morph's interface is reasonably friendly and easy-to-use. It would have been easier if we had a user's manual to go along with the program, but the version supplied with Snappy doesn't even contain an on-disk one, and the help files were less than helpful when getting started. Just a short overview section

would have been appreciated. But muddling through by trial and error got us on our way.

Morph lets you define how the points in a starting image and an ending image correspond to each other. For example, let's say that you want to morph your dog's face into your own. You would want to mark features that both you and the dog have in common—you both have two eyes, a nose, two ears, and a mouth. You would mark those points on the starting image, and then go to the final image

and adjust them to the appropriate position. Then you can tell the software to create a still image—or a movie in which the dog's face fades, or morphs, into your own. The more key points you mark, the better. You can join the points with key lines.

You can manipulate the points and lines from either direction, working from the start or the finish. Working in two directions makes it much easier to get good-looking morphs. (It took us a while to realize that this was possible, but once we did, our results improved dramatically.)

But good-looking morphs don't come without a fair amount of work. The more points you have, the better the results. And putting the points in the right place isn't so obvious without a little practice.

Morph saves movies as either AVI animations or QuickTime for Windows. You can also save them as Autodesk FLIC animations, but then they can't be played back in Morph.

As impressive as it is to morph two images together, it is also possible to morph two AVI videos. We were quite impressed by a couple of samples included with the software. For example, one morph movie showed a woman's head turning into a man's as her/his head turned. We didn't have the patience to get such good stuff, but we got pretty good at creating morphs between two images. ■

ELECTRONICS WISH LIST



Pioneer Model CCS-406 Mini-System

Pro Logic Mini-System

The *Model CCS-406* mini-system from *Pioneer Electronics (USA) Inc.* (2265 East 220th Street, Long Beach, CA 90810-1639) features full Dolby Pro Logic surround circuitry and high-power, high-fidelity amplification for powerhouse surround sound. The system's 25-disc CD File offers disc title input and 25 × 2 "best selection memory" functions for customizable music on demand listening. Discs can be stored in groups of five for easy access. The double auto-reverse cassette deck has a music search mode. The six-inch two-way speaker system includes three full-range surround sound speakers for center and rear channels. Other features include an integrated sleep timer, a full-function remote control, and one-touch Karaoke mode. Price: \$785.

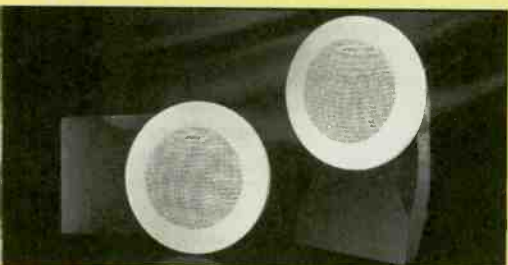

Bose Model 131 Marine Speakers

All-Weather Speakers

Just in time for the boating season, *Bose Corporation* (The Mountain, Framingham, MA 01701-9168) has introduced the *Model 131 Marine Speakers*. Providing a practical solution for achieving stereo sound in the marine environment, the round flush-mount 131 speakers are compatible with the pre-cut speaker holes on many boats. Their 3½-inch mounting depth and overall 8-inch grille diameter make installation easy on any water craft. The speakers feature Bose's proprietary full-range composite driver designed to meet and exceed industry standards for performance in harsh conditions. The 4½-inch drivers and tuned, ported enclosures allow the speakers to produce sound that is consistently clear, full, and rich. Price: \$259/ pair, including mounting hardware.

AMAZING ELECTRONIC & SCIENTIFIC DEVICES

Lasers, Tesla, Ions, Anti-Gravity, Magnetics & More!

Plans • Ready-to-Use • Easy-to-Build Kits

Laser Ray Gun
Handheld, battery operated. Produces an intense burst of light capable of burning holes.
LAGUN2 Plans \$20.00
LAGUN2K Kit / Plans Price on Req



250KV Tesla Coil
10-14" of Explosive Bolts of Lightning!
• Transmit Wireless Energy
• Ion Motors
• Anti-Gravity
• Strange and bizarre pyrotechnical effects
• Many other experiments shown in detail
• Award winning science project!

BTC3 Plans \$15.00
BTC3K Kit/Plans with coil \$299.50
BTC30 Assbl'd Ready to Use \$399.50
BTC4 Plans, 500KV unit \$20.00



ATTENTION: Experimenters & Researchers!
Anti-Gravity, Rail & Coil Guns, Mass Warping, Levitation Research, Exploding Water, Propulsion Drivers, Lattice Snapping, EMP etc. Loss-less Energy Charger with triggered spark switch. • Adjustable 500 to 3KV out
• Charges up to 25KJ • Programmable Output

HEP1 Plans \$15.00
HEP1K Kit/Plans with 500J \$399.50
HEP10 Lab Assembled - to your spec's.
Write, call or fax for price & delivery

HEP10
...shown connected to potential rail gun system



Visible Beam Gas Lasers
Millions degree temp equiv. Illuminates low level clouds
• Light Shows
• Window Listener
• Optical Projects
• 12/115V
• Science Project

LAS1KM 1 mw, low cost Kit \$69.50
LUG6K 2-3mw Kit \$119.50
HNE70 5-7mw, ready to use \$299.50



Gravity Generator
Levitate an object!
Great science fair project!

GRA1 Plans \$15.00
GRA1K Power Supply Kit/Plans \$99.50
GRA10 Assbl'd Kit/Plans \$149.50
Includes text book on Anti-Gravity theory!

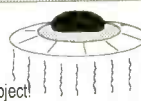

Solid State Tesla Coil
• Generate fiery electrical plasma discharge
• Powers light and objects without contact
• Experiment with electrical and mechanical fields. TCL5 Plans \$8.00
TCL5K Kit/Plans 12VDC \$49.50



Pioneer a Futuristic Weapon!
Electric Gun - prototype designed in our lab - Join the research!
• Ballistic Velocities
• Handheld • Battery Operated
• Labelled as DANGEROUS Product
Experiment now before it is classified as a firearm! EGUN1 Plans \$20.00
(Must be 21 for purchase of hardware)



Ion Ray Gun
Project Energy!
Star Wars technology demonstrates weapons potential. IOG7K Kit/Plans \$99.50



4000 Volts 10ma High Voltage Module - Ready to use - for many projects from hoverboards to pyrotechnics.
MINMAX4 While they last! \$19.50

"Talking" Plasma Globe
Spectacular color. Pulsates to music, sounds! 8-9", with intensity and sound controls. PLASMA1 Ready to Use \$79.50



Electronic Hypnotizer *Caution Required*
Control their minds! Programmable audible and visual stimuli induces hypnotic trances. HYP2K Kit with Book \$39.95
EH2 Hypnosis Book & Plans \$14.95



We can design and build high voltage systems - to your specs!
Call or fax us with your requirements!

TACTICAL ELECTRONICS

Cybernetic Ear!
Enhances normal hearing 3-4 times!
Adjustable volume control, fits easily into either ear. Many, many uses.
Ready to Use!
CYBEREAR \$19.95



ALL NEW Telephone Line Grabber/Infinity Transmitter
Use tone phone anywhere in the world to:
• Monitor your premises - avoid break-ins
• Access ongoing calls - longwinded kids
• Control up to 8 appliances in your home!
• Re-direct costly toll calls from pay phones!

TELCON3 Plans (credit to purch) .. \$ 10.00
TELCON3K Plans/Kit \$99.50
TELCON30 Ready to Use \$149.50



Long Range "Ultra-Ear"
Parabolic Mic can hear a distant whisper!
BUG Mother Nature!
20" dish uses satellite technology to capture distant sounds. PM5 Plans \$ 8.00
PM5K Kit/Plans \$149.50

• Optional Wireless Retrofit transmits captured sounds to an FM radio.
WMSK Kit for Wireless Option \$29.50



Phasor Sonic Blast Pistol
Rids areas of unwanted pests. Trains and conditions wild and domestic animals. Great for barns, attics, cellars, gardens.
PPP1K Kit/Plans \$39.50



3 Mi Telephone Xmitter
• Tune-able 80-130 Mhz • Undetectable
• Only transmits when phone is used
VWPM7K Kit/Plans \$39.50

3 Mi Voice Transmitter
• Ultra-Sensitive Mike
• Crystal Clear
• Tunes 80-130 MHz.
FMV1K Kit/Plans \$39.50



FireBall Gun
Shoots flaming ball - two shot capacity. Great for special effects and remote fire starting. CAUTION REQUIRED!
FIREBALL Plans (dangerous product) \$10.00



Shocker Force Field/Vehicle Electrifier
Make hand and shock balls, shock wands and electrify objects. Great payback for those wiseguys!
SHK1K Easy to Assemble Kit \$19.50



Extended Play Telephone Taping System
• Tapes Phone Conversation • Extends Tape X4 • Check Local Laws before using!
TAP30X Ready to Use \$84.50



"Drop-In" (1mi) Telephone Transmitter
Easily tunable over FM radio. Never needs battery! #DROPIN Kit/Plans \$ 19.95



See In Total DARKNESS!
• High Quality IR Night Vision
Scope with IR illuminator.
SD10 Ready to Use \$199.50



Electric Charge Gun
Life is Precious - PROTECT IT!
Stuns & immobilizes attackers 15 feet away! Check your state laws for legality. More knockdown power than most handguns. No permanent injury. ID coded.
ECG1 Data
(Creditable to purch) \$10.00
ECG10 Charge Gun, Ready to Use, includes FREE Stun Gun! \$249.50
STUN GUNS - sold separately:
STUN100 100,000 Volts \$34.50
STUN200 200,000 Volts \$49.50



3 Mi Tracker Transmitter
• Tunable Output
• Uses FM Radio
• Excellent Signal Beacon
HOD1K Kit/Plans \$39.50



MIND CONTROL!
Places subjects under your control. Programmable audible & visual stimuli with biofeedback. Induces strange & bizarre hallucinations without drugs. Caution - not FDA approved.
MIND2 Plans \$15.00
MIND2K Kit and Plans \$49.50
MIND20 Assembled Unit \$69.50



FANTASTIC BRIGHTNESS!
High Quality Laser Pointer
LAPN64 15mw equiv, 2000' \$39.50
LAPN61 50mw equiv, 4000' \$84.50



Window Bounce Laser Listener
Aim at window and listen to sounds from reflected light. CAUTION - Not for illegal use. LWB3 Plans \$10.00
LWB3K Kit/Plans (req's vid tripod) \$149.50



1000' Potato Cannon
Not a Toy! Uses electronic or piezo ignition. CAUTION REQUIRED!
POT1 Plans (dangerous product) ... \$10.00



VISIT US ON THE WEB!
<http://www.amazing1.com>

INFORMATION UNLIMITED

Dept PEM-7, Box 716, Amherst, NH 03031
Phone: 603-673-4730 FAX: 603-672-5406
MC, VISA, COD, Checks accepted Please add \$5.00 S & H

CATALOG!
FREE with Order or send \$1 P&H

24 Hour Phone
800-221-1705
Orders Only Please!

RETAILERS THAT SELL OUR MAGAZINE MONTHLY

Alaska

Frigid North Co.
1207 W. 36th Avenue
Anchorage, AK 99503

California

California Electronics
221 N. Johnson Ave.
El Cajon, CA 90202

Ford Electronics
8431 Commonwealth Avenue
Buena Park, CA 90621

All Electronics
14928 Oxnard Street
Van Nuys, CA 91411

Gateway Electronics of CA
9222 Chesapeake Drive
San Diego, CA 92123

Mac's Electronics
191 South "E" Street
San Bernardino, CA 92401

Electronics Warehouse
2691 Main Street
Riverside, CA 92501

Orvac Electronics
1645 E Orangethorpe Ave.
Fullerton, CA 92631

Sav-On Electronics
13225 Harbor Blvd.
Garden Grove, CA 92643

JK Electronics
6395 Westminster Blvd.
Westminster, CA 92683

Marvac Dow Electronics
980 S. A Street
Oxnard, CA 93030

Kandarian Electronics
1101 19th Street
Bakersfield, CA 93301

Whitcomm Electronics
105 W. Dakota #106
Clovis, CA 93612

Marvac Dow Electronics
265-B Reservation Road
Marina, CA 93933

Minuteman Electronics
37111 Post St., Suite 1
Fremont, CA 94536

HCS Electronics
6819 S. Redwood Drive
Cotati, CA 94931

Halted Specialties Co.
3500 Ryder Street
Santa Clara, CA 95051

Metro Electronics
1831 J Street
Sacramento, CA 95814

HSC Electronics
4837 Amber Lane
Sacramento, CA 95841

Colorado

Gateway Electronics of CO
2525 Federal Blvd.
Denver, CO 80211

Connecticut

Signal Electronics Supply
589 New Park Avenue
W. Hartford, CT 06110

Cables & Connectors
2198 Berlin Turnpike
Newington, CT 06111

Electronic Service Prod.
437 Washington Avenue
North Haven, CT 06473

Georgia

Norman's Electronics, Inc.
3653 Clairmont Road
Chamblee, GA 30341

Illinois

Tri State Elex
200 W. Northwest Hwy.
Mt. Prospect, IL 60056

Maryland

Mark Elec. Supply Inc.
5015 Herzel Place
Beltsville, MD 20705

Amateur Radio Center
1117 West 36th Street
Baltimore, MD 21211

Massachusetts

U-Do-It Electronics
40 Franklin Street
Needham, MA 02194

Michigan

Purchase Radio Supply
327 East Hoover Avenue
Ann Arbor, MI 48104

The Elec. Connection
37387 Ford Road
Westland, MI 48185

Minnesota

Acme Electronics
224 Washington Avenue N.
Minneapolis, MN 55401

Missouri

Gateway Electronics Of MO
8123-25 Page Blvd.
St. Louis, MO 63130

William Elec & Ind Supply
803 Davis Blvd.
Sikeston, MO 63801

New Jersey

Lashen Electronics Inc.
21 Broadway
Denville, NJ 07834

New York

Sylvan Wellington Co.
269 Canal Street
New York, NY 10013

R&E Electronics
4991 Rt. 209
Accord, NY 12404

Unicorn Electronics
Valley Plaza
Johnson City, NY 13790

Ohio

Philcap Electronic Suppliers
275 E. Market Street
Akron, OH 44308

Oregon

Norvac Electronics
7940 SW Nimbus Avenue
Beaverton, OR 97005

Pennsylvania

Business & Computer Bookstore
213 N. Easton Road
Willow Grove, PA 19090

Texas

Mouser Electronics
2401 Hwy. 287 N
Mansfield, TX 76063

Tanner Electronics
1301 W Beltline
Carrollton, TX 75006

Electronic Parts Outlet
3753 B Fondren
Houston, TX 77063

GMD Electronics
2625 S. Loop Hwy.
Alvin, TX 77511

Electronic Parts Outlet
17318 Highway 3
Webster, TX 77598

Washington

Amateur Radio Supply Co.
5963 Corson Ave., Ste 140
Seattle, WA 98108

If you'd like to sell our magazine in your store,
please circle 180 on Free Information Card.

CHECKOUT THE DTMF WIRE TRACER

Popular Electronics

July 1997

Get a handle on those time-consuming wire sorting or installation jobs with an easy-to-build, two-piece, wire identification system!

BRIAN PLILER

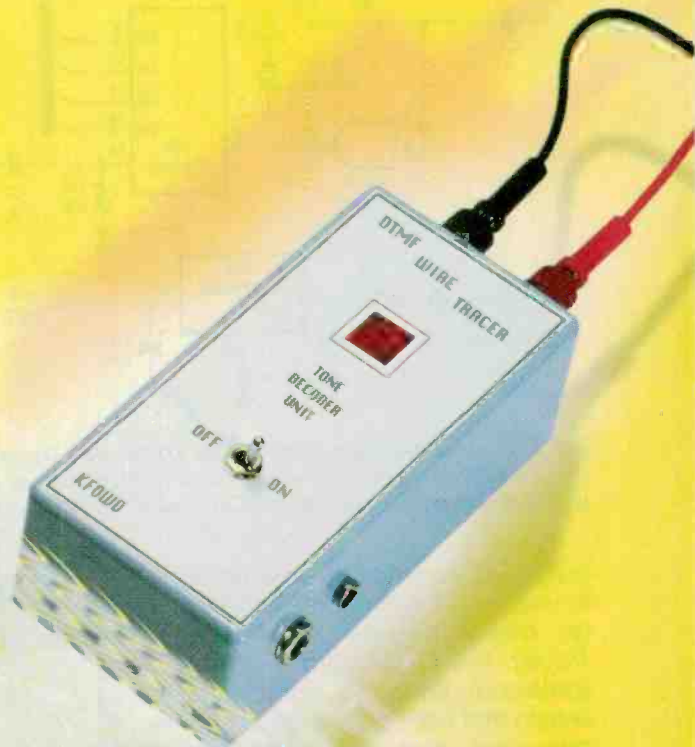

If you have ever installed wiring for electronic equipment, such as telephones, intercoms, P.A. systems, home theater, alarms, or any type of multiconductor equipment, you are probably familiar with the frustration that goes along with the territory. If you're a professional wiring installer, then you probably already have most of the modern equipment that is available to make your job a little easier. But if you are a hobbyist (or even a handyman) who only occasionally must delve into the wiring maze that is part and parcel of modern electronic equipment, you probably can't justify the cost of

July 1997, Popular Electronics

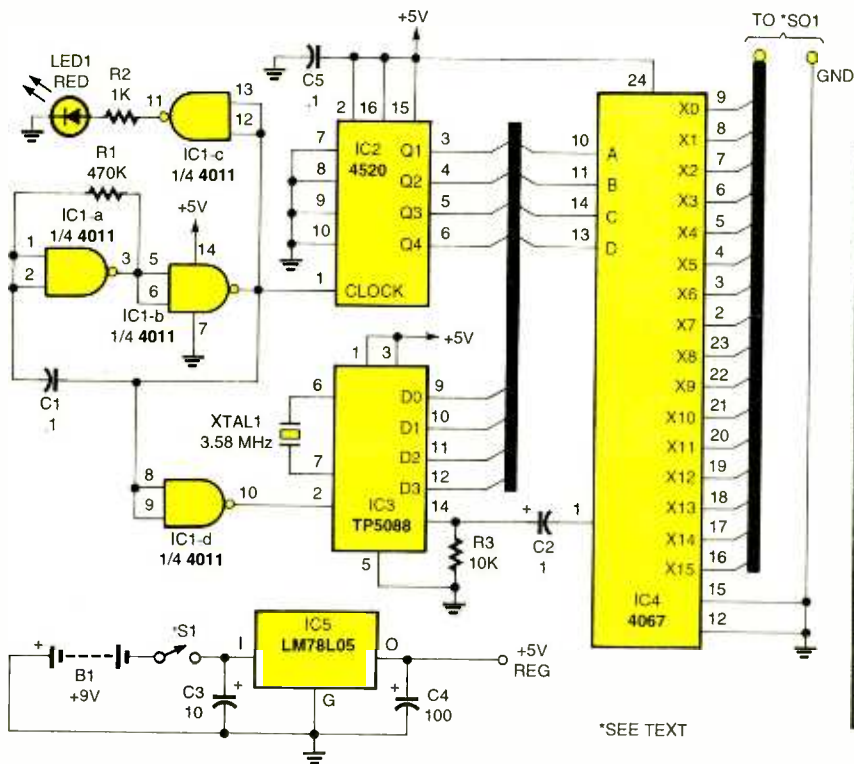

BINARY DATA FROM IC2	DTMF DIGIT GENERATED BY IC3	SELECTED 4067 OUTPUT
0000	0	0
0001	1	1
0010	2	2
0011	3	3
0100	4	4
0101	5	5
0110	6	6
0111	7	7
1000	8	8
1001	9	9
1010	0	10
1011	1	11
1100	2	12
1101	3	13
1110	4	14
1111	5	15

Fig. 1. The tone generator portion of the DTMF Wire Tracer is comprised of five integrated circuits—a 4011 quad 2-input NAND gate (IC1), a 4520 dual synchronous up counter (IC2), a National Semiconductor TP5088 DTMF generator (IC3), a CD4067BE 16-channel analog multiplexer/demultiplexer (IC4), and a 78L05 100-mA, 5-volt regulator (IC5)—along with a handful of support components.

adding a commercial wire tracer to your tool box. Fortunately, there is an alternative—the *DTMF Wire Tracer*. The DTMF Wire Tracer is somewhat similar to commercial units in that both a transmitter (tone generator), and a receiver (tone decoder) are required. But, unlike commercial units, the project described here allows up to 16 conductors to be easily identified in only a matter of seconds.

That feat is accomplished with the aid of a tone generator. The tone generator produces 16 distinctly different tone combinations (DTMF signals), by way of 16 separate outputs. The tone generator is paired up with a tone decoder that is capable of identifying all 16 DTMF tone combinations, and displaying the appropriate character on a dot-matrix alphanumeric LED display. For example: if the tone decoder is connected to output 1 of the tone generator, the number "1" will appear in the decoder's display. If, on the other hand, the decoder is connected to output 2, then the number "2" will be displayed. Both units are battery operated for maximum portability. The

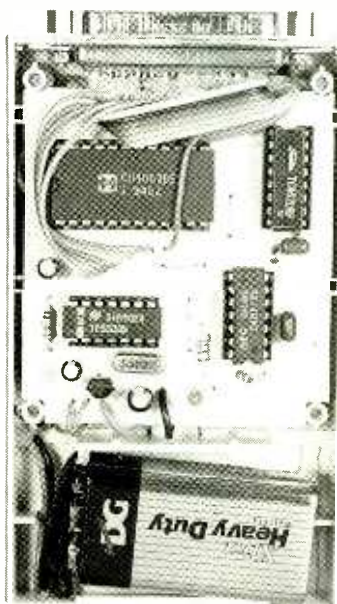

The tone generator's completed printed-circuit board, along with its 9-volt battery power source, was installed into a small enclosure. The board was secured in place with double-sided tape, but hot glue will also do the job.

system has been used by the author to identify individual conductors in multiple runs of inexpensive telephone cable at lengths exceeding

50 feet. **CAUTION!!!:** The DTMF Wire Tracer is not designed, or intended, for use on "live" or otherwise "in-use" conductors whatsoever.

Tone Generator Description. The schematic diagram for the tone generator is shown in Fig. 1. In that circuit, half of a 4011 quad two-input NAND gate (IC1-a and IC1-b), along with R1 and C1, form a simple oscillator. The oscillator, operating at approximately 12 Hz with a 50% duty cycle, is used to generate the necessary clock and timing signals for the tone generator. The clock signal is used to drive IC2 (half of a 4520 dual synchronous up counter), which repeatedly counts from hexadecimal 0 to F (or in binary from 0000 to 1111), and outputs the count data in binary form. The binary output of the counter is fed along two paths: In one path, the output data is applied to the address/data select inputs of IC3 (a National Semiconductor TP5088 DTMF generator), and in the other path the signal is fed to IC4 (a CD4067BE 16-channel analog multiplexer/demultiplexer).

The DTMF generator (IC3), cou-

TAKE ANY 5 BOOKS FOR ONLY \$4.95

Values to
\$288.85

plus 1 book FREE upon prepayment
when you join the

Electronics Book Club®

0331898-XX \$39.50
Hardcover/Counts as 2

0241936 \$44.95
Hardcover

0345285 \$39.95
Hardcover

1554637 \$16.95

0052387 \$28.95
Hardcover



0497060 \$29.95
Hardcover



5869179 \$12.95

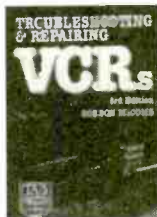

155016X \$34.95
Hardcover



0535469 \$29.95
Hardcover



0053146 \$24.95



0765359 \$34.95
Hardcover

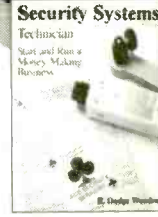

0717753 \$19.95



1570519 \$17.95

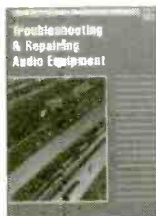

0157553 \$44.95
Hardcover



073092X \$19.95



0304068 \$17.95



036432X \$29.95
Hardcover



1577564 \$24.95

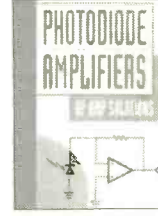

024247X \$49.00
Hardcover

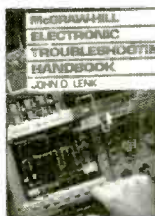

0375581-XX \$39.50
Hardcover/Counts as 2



0157626 \$24.95



0112738-XX \$47.95
Hardcover/Counts as 2



0359758 \$19.95



0053553 \$50.00
Hardcover



0487375 \$24.95



0380899 \$60.00
Hardcover



0215286 \$19.95

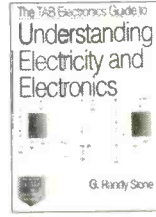

0582157 \$26.95
Hardcover



1574875 \$19.95



0242048-XX \$39.95
Hardcover/Counts as 2



882138X \$32.95



0304122 \$17.95



5869349-XX \$44.00
Hardcover/Counts as 2

As a member of the **Electronics Book Club**... you'll enjoy receiving Club bulletins every 3-4 weeks containing exciting offers on the latest books in the field at savings of up to 50% off the regular publishers' prices. If you want the Main Selection, do nothing and it will be shipped automatically. If you want another book, or no book at all, simply return the reply form to us by the date specified. You'll have at least 10 days to decide. If you ever receive a book you don't want due to late delivery of the bulletin, you can return it at our expense. And, you'll be eligible for FREE BOOKS through the Bonus Book Program. Your only obligation is to purchase 3 more books during the next 12 months, after which you may cancel your membership at any time. PE797

Phone: 1-614-759-3666 (8:30 am to 5:00 pm EST Monday-Friday) • Fax: 1-614-759-3749 (24 hours a day, 7 days a week)

If card is missing, write to: the Electronics Book Club, A Division of The McGraw-Hill Companies, P.O. Box 549, Blacklick, OH 43004-9918

All books are softcover unless otherwise noted. Publishers' prices shown. If you select a book that counts as 2 choices, write the book number in one box and XX in the next. A shipping/handling charge & sales tax will be added to all orders. ©1997 EBC

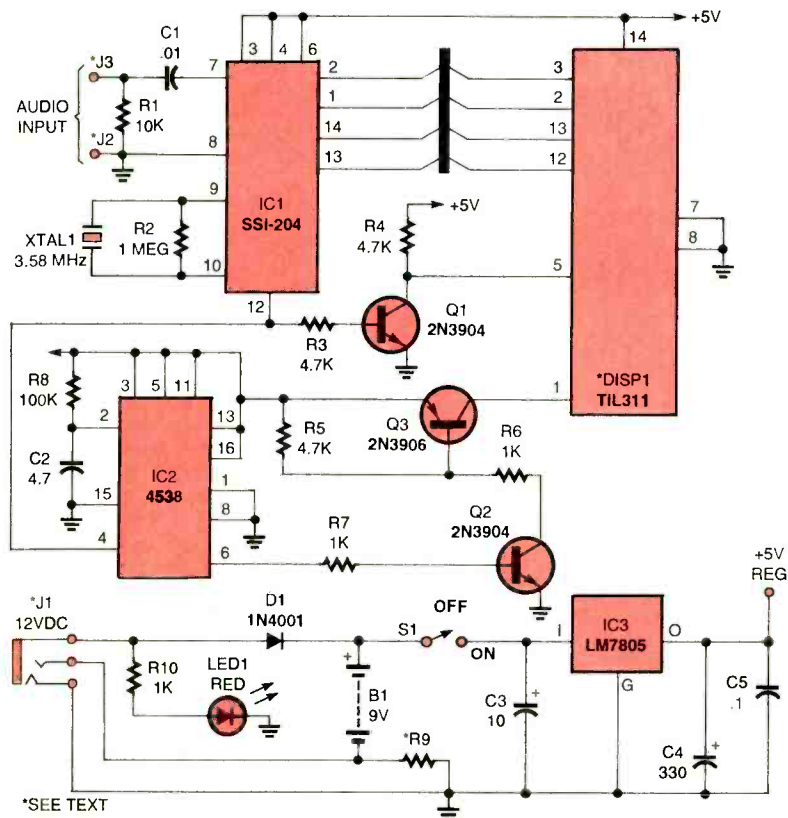

RECEIVED DTMF DIGITS	DECODED BINARY DATA	DISPLAYED HEXADECIMAL DIGIT
D	0000	0
1	0001	1
2	0010	2
3	0011	3
4	0100	4
5	0101	5
6	0110	6
7	0111	7
8	1000	8
9	1001	9
0	1010	A
*	1011	B
#	1100	C
A	1101	D
B	1110	E
C	1111	F

Fig. 2. The second half of the DTMF Wire Tracer—the tone decoder, which is designed to detect and identify signals produced by the tone generator—is composed of three ICs (an SSI-204 DTMF decoder, IC1; a 4538 dual monostable multivibrator, IC2; and an LM7805 5-volt, 1-amp voltage regulator, IC3), three transistors (Q1–Q3), and a display module (DISP1, a TIL311 Hybrid dot-matrix LED display, with built-in hex decoder/driver).

pled with a crystal reference (XTAL1), generates a DTMF tone in accordance with binary data applied to its inputs at pins 9 to 12. The binary data represents the DTMF digit to be generated. While the binary data is being applied to the inputs of IC3, a tone enable signal is applied to pin 2 by coupling the clock signal through an inverter comprised of IC1-d. The DTMF tones generated by IC3 are output at pin 14. Resistor R3 provides a reasonable load impedance for the audio output stages of IC3. Capacitor C2 is used for DC blocking, preventing any DC component of the output from reaching the following stage, while allowing the DTMF signals to travel on to the input of IC4, which is responsible for routing individual DTMF tone to their appropriate outputs. While IC3 is performing its job, binary data from IC2 is fed to IC4, and is used to select appropriate output pins of IC4, ensuring that each distinct tone has its own output terminal. The 16 outputs of IC4,

plus a ground wire, are then connected to individual pins of a DB-25 female connector (SO1, which is not shown). The generator uses a mating male DB-25 connector out-

fitted with 17 leads (16 signal lines, plus a ground connection), each terminated in an alligator clip, to feed the tone signal(s) to the cable to be tested.

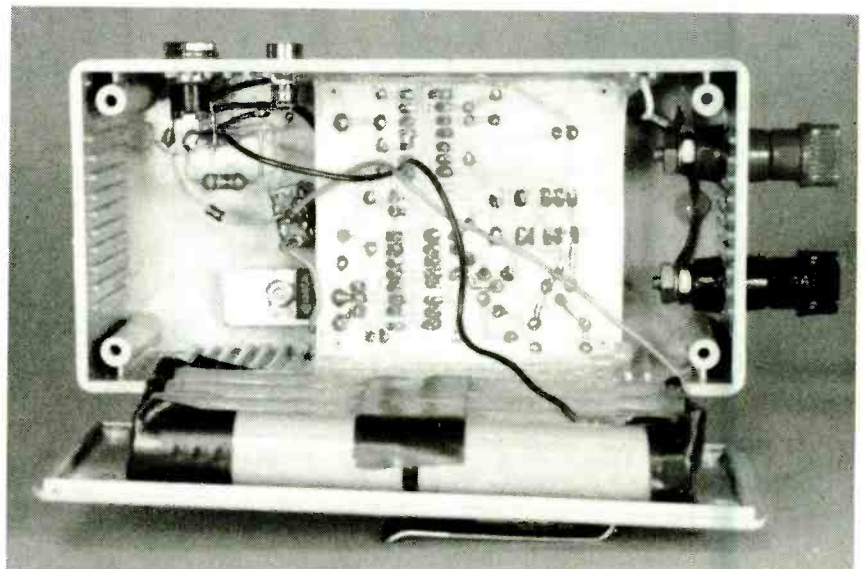

Here is the tone decoder board mounted into its enclosure, along with its rechargeable power pack. The power pack and binding posts (J1–J3), as well as DISP1, and the on/off switch (S1) are mounted at various locations of the enclosure.

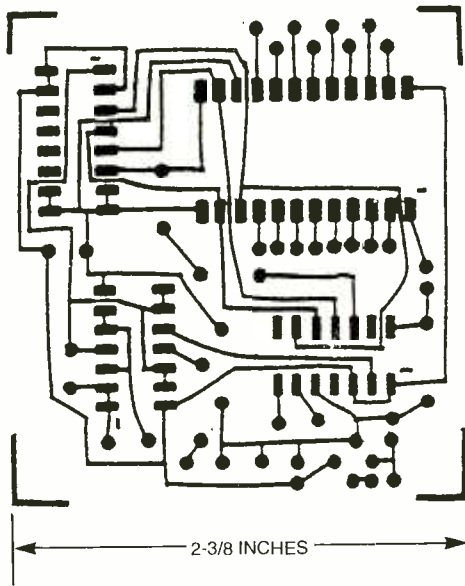

Fig. 3. The tone generator was assembled on a small printed-circuit board, measuring $2\frac{3}{8}$ by $2\frac{7}{16}$ inches. A template of the author's printed-circuit board pattern is shown here full-scale. Note that the layout is fairly tight with numerous traces routed between component pads. So once you've etched your printed-circuit, carefully inspect it for faults such as incomplete traces and copper bridges between traces.

Power for the tone generator is supplied by an ordinary 9-volt transistor radio battery. The source voltage is regulated to 5 volts by IC5 (a 78L05 100-mA, 5-volt regulator). Capacitors C1-C3 filter and stabilize the supply voltage. LED1 serves as the project's power on indicator, and is flashed on and off through IC1-c, which is also driven by the 12-Hz clock signal.

Tone Decoder Description. Figure 2 shows the schematic diagram for the second half of the DTMF Wire Tracer—the tone decoder—which is used to detect and identify signals produced by the tone generator. Tone bursts (from the tone generator) are applied to the wires being sorted. Test leads connected to J2 and J3 (black and red binding post, for the ground and signal leads, respectively) are used to route the signal to the tone decoder. Resistor R1 provides a suitable load impedance to the conductor being tested; it also helps to counteract any mutual coupling effects between conductors, which are often present in long multiconductor cables. The tone bursts are AC coupled, via C1 (which passes

DTMF tones, while blocking DC voltages), to IC1 (an SSI-204 DTMF decoder).

The decoder (IC1), coupled with a 3.58 MHz colorburst crystal (XTAL1), decodes all 16 DTMF tone bursts output by the tone generator and, in turn, outputs a distinct 4-bit binary number for each decoded DTMF digit. The decoded data is applied to DISP1 (a TIL311 hybrid dot-matrix LED display), where the data is translated into its corresponding hexadecimal character, and to illuminate the readout. When IC1 decodes a DTMF digit, a DV (data valid) signal output at pin 12, signifying that the current binary output is correct.

The DV signal divides along two paths. In the first path, the DV signal is

then inverted by transistor Q1 and is used to clock the binary data into DISP1. In the other path, the DV signal is used to activate half of a 4538 dual monostable multivibrator (IC2), which is configured as a 0.5 second timer. The output of IC2 at pin 6, a 5 volt pulse, is fed to the base of Q2. The pulses generated by IC2 causes Q2 to turn on, pulling the base of Q3 low, causing it to turn on. When Q3 turns on, power is supplied to DISP1 for 0.5 seconds, thereby allowing the hexadecimal character to be displayed. After 0.5 seconds has elapsed, the display goes blank. That arrangement not only extends battery life considerably, but also prevents incorrectly (or erroneously) identifying the conductors.

Power for the decoder circuit is supplied by a 9.6-volt Ni-Cd battery pack (B1). Battery voltage is fed through S1 to IC3 (an LM7805 5-volt, 1-amp voltage regulator) to provide regulated 5-volt power source for the project. Capacitors C3-C5 filter against voltage transients. The battery pack used in the author's prototype is made up of eight individual 800 mAh "AA" cells wired in series. The battery pack

PARTS LIST FOR THE TONE GENERATOR

SEMICONDUCTORS

- IC1—CD4011 or similar, quad 2-input NAND-gate, integrated circuit
- IC2—CD4520 or similar, dual binary up-counter, integrated circuit
- IC3—TP5088 DTMF generator (Digi-Key #TP5088N-ND), integrated circuit
- IC4—CD4067BE or similar, 16-channel, analog multiplexer/demultiplexer, integrated circuit
- IC5—LM78L05 5-volt, 100 mA, voltage regulator, integrated circuit
- LED1—Red, T-1 size, light-emitting diode

RESISTORS

(All fixed resistors are $\frac{1}{4}$ watt, 5% units.)

- R1—470,000 ohm
- R2—1000 ohm
- R3—10,000 ohm

CAPACITORS

- C1, C5—0.1- μ F, 50-WVDC, polyester film
- C2—1- μ F, 50-WVDC, miniature electrolytic
- C3—10- μ F, 16-WVDC, miniature electrolytic
- C4—100- μ F, 6.3-WVDC, miniature electrolytic

ADDITIONAL PARTS AND MATERIALS

- XTAL1—3.58 MHz colorburst crystal (Mouser #520-HCU357-17 or similar)
- SO1—Female DB-25 socket
- B1—9-volt transistor battery
- S1—See text
- Printed-circuit board materials, alligator clips, male DB-25 connector, IC sockets, battery clip, wire markers (R.S.#278-1650A), enclosure (R.S.#270-211), wire, solder, hardware, etc.

allows the project to operate for about 8 to 10 hours per charge. The prototype unit draws about 80 mA in standby (display blank) and 100 mA when the display is active. Battery recharging is accomplished by connecting jack J1 to a suitable 12 volt DC source.

The value of R9 determines the charge rate (normally $\frac{1}{10}$ of rated battery capacity for a 14 hour charge), and can be found using Ohms law. Resistor R9 is automatically bypassed via the switching contacts of J1, whenever a plug is not inserted in J1. LED1 serves as the

PART LIST FOR THE TONE DECODER

SEMICONDUCTORS

- IC1—SSI204, CD22204 or similar, DTMF decoder integrated circuit
 IC2—CD4538 or similar, Dual monostable multivibrator integrated circuit
 IC3—LM7805 or similar, +5 volt, 1 amp voltage regulator integrated circuit
 Q1, Q2—2N3904 or similar, NPN general-purpose switching transistor
 Q3—2N3906 or similar, PNP general-purpose switching transistor
 D1—1N4001 or similar, 1-amp, 50 PIV silicon diode
 DISP1—TIL311 Hybrid dot-matrix led display (with built-in hex decoder/driver)
 LED1—Red light-emitting diode in chrome holder (R.S. #276-068 or similar)

RESISTORS

- (All fixed resistors are 1/4 watt, 5% units, unless otherwise noted.)
 R1—10,000 ohms
 R2—1000,000 ohms
 R3—R5—4700 ohms
 R6, R7, R10—1000 ohms
 R8—100,000 ohms
 R9—See text

CAPACITORS

- C1—0.01- μ F ceramic disc
 C2—4.7- μ F, 25-WVDC electrolytic
 C3—10- μ F, 25-WVDC electrolytic
 C4—330- μ F, 10-WVDC electrolytic
 C5—0.1- μ F, 50-WVDC polyester

ADDITIONAL PARTS AND MATERIALS

- XTAL1—3.58 MHz colorburst crystal
 S1—Miniature SPST toggle switch
 J1—Male panel-mount barrel jack 2.0 mm \times 5.5 mm
 J2—Black binding post
 J3—Red binding post
 B1—9.6-volt battery pack (see text)
 Printed-circuit materials, enclosure, IC sockets, dark red plastic lens for display, test leads, DC adapter, wire, solder, hardware, etc.

charging indicator, lighting only when the battery is being charged. Diode D1 prevents the battery pack voltage from appearing at J1. It should be noted that if the battery pack becomes discharged during use, the unit can still be used while recharging. An ordinary AC to DC power adapter, or other suitable 12 volt source capable of supplying at least 200 mA can be used instead.

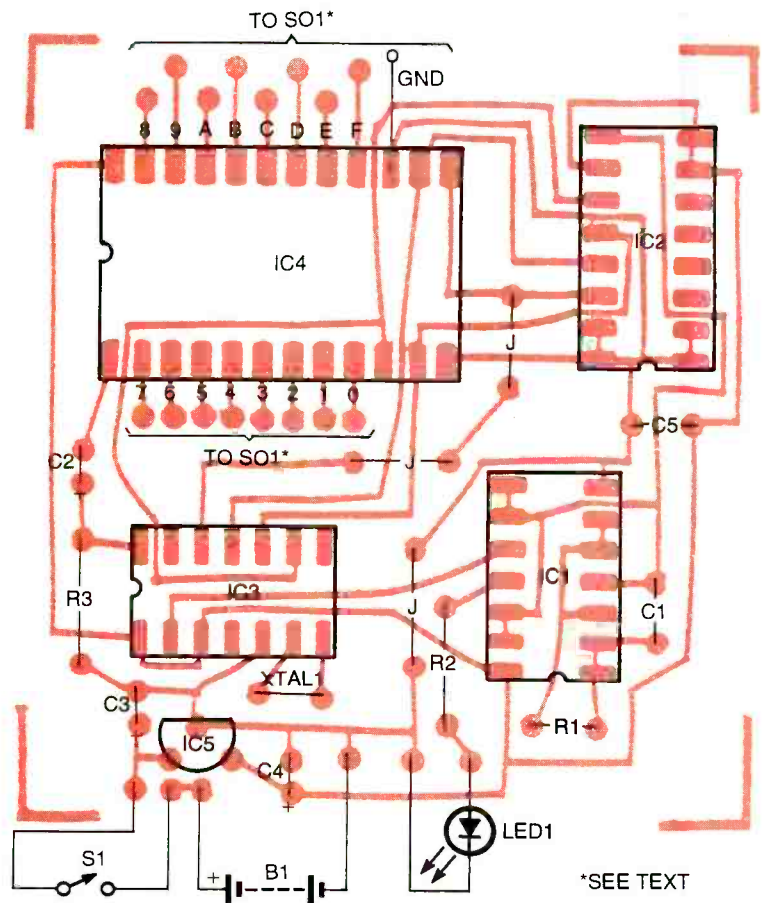

Fig. 4. Assemble the tone generator using this parts-placement diagram as a guide, installing the low-profile components (i.e., jumper wires and horizontally-installed resistors) first, followed by the taller units (IC sockets, capacitors, etc.).

Tone Generator Construction. Since the project is a portable test instrument, and is therefore likely to be subjected to somewhat rough handling in everyday use, it is strongly recommended that the unit be assembled on a printed-circuit board. A full-size template of the author's printed-circuit board pattern for the tone generator, measuring 2-3/8 by 2-7/16 inches, is shown in Fig. 3. The layout is fairly tight with numerous traces routed between component pads. That was done so that the completed board would fit into a compact enclosure. If you are uncomfortable with that layout, or plan to use a different enclosure, please feel free to redesign the circuit-board layout to suit your own needs.

In any case, once the printed-circuit board has been etched, carefully inspect it for faults such as incomplete traces and copper

bridges between traces. After correcting any problems, install the components, using the Fig. 4 parts-placement diagram as a guide. It is suggested that low-profile components (i.e., jumper wires and horizontally-installed resistors) be installed first, followed by the taller units (IC sockets, capacitors, etc.). Sockets are strongly recommended for all ICs, except the voltage regulator—not only do they simplify testing the project, but they also make any future IC replacements quick and easy.

After all of the board-mounted components have been installed, but before inserting any of the ICs, temporarily apply power to the board and confirm that 5 volts DC appears at the output of IC5. Remove power, install IC1 into its socket, and re-apply power. LED1 should now start blinking. Once again remove power, and install

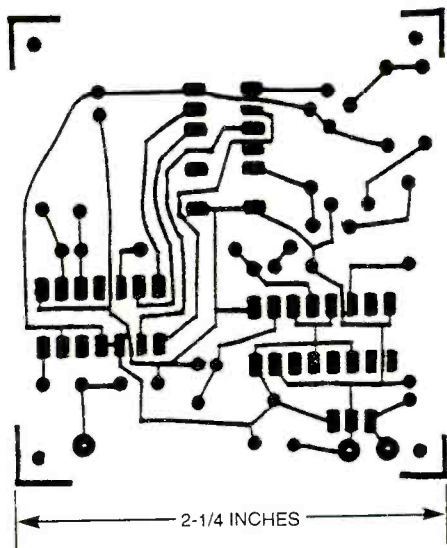

Fig. 5. The tone decoder was assembled on a small printed-circuit board, this one measuring $2\text{-}\frac{7}{16}$ by $2\text{-}\frac{1}{4}$ inches. A full-size template of that foil pattern is shown here.

the remaining ICs in their respective sockets. With power re-applied, and using a small audio amplifier with its input connected to pin 1 of IC4, a continuous stream of DTMF tone bursts should be heard. Now check the individual output pins of IC4, and confirm that a different DTMF tone burst is heard at each output pin. Once it's confirmed, the 16 individual outputs of IC4 can be connected to SO1. The completed printed-circuit board can now be installed into a suitable enclosure using double-sided tape or hot glue. A bit of hot glue can also be used to help prevent the ICs from working out of their sockets. The DB-25 connector is mounted to one end of the enclosure.

It will also be necessary to prepare a 17-conductor test harness terminating to a male DB-25 connector. The author used a length of ribbon cable connected at one end to the male DB-25 connector and the other end connected to 17 miniature alligator clips—16 red jacked alligator clips for the signal leads and one black clip for the ground lead.

Tone Decoder Construction. The tone decoder, like the tone generator, was assembled on a small printed-circuit board, this one measuring $2\text{-}\frac{7}{16}$ by $2\text{-}\frac{1}{4}$ inches. A full-size

template of that foil pattern is shown in Fig. 5. Once the printed-circuit board has been etched, and any problems corrected, begin installing the components, guided by the parts-placement diagram shown in Fig. 6. Just as with the tone generator, be sure to install the low-profile components first, followed by the taller components. Again sockets are recommended for all ICs except the regulator (IC3); a socket is absolutely necessary for the display (the reason for this will become apparent later). Several of the pins on the display socket must be clipped off or removed before it can be installed on the printed-circuit board. Note that diode D1, resistors R9 and R10, and LED1 are not installed onto the printed-cir-

cuit board, but are instead mounted to the leads of jack J1. Be sure to locate resistor R9 away from the other components, as it does dissipate heat while the batteries are charging.

After installing all of the board-mounted components, but before inserting IC1, IC2, and the display into their respective sockets, temporarily apply power to the board and confirm that 5-volts appears at the output of IC3. Once verified, remove power and insert IC1, IC2, and DISP1 into their respective sockets. With power applied once more, connect the unit to any one of the 16 available outputs from the tone generator. The hexadecimal character representing the connected generator output should appear in DISP1 for half a second, before the display goes blank. If left connected, the same character will reappear about one second later. That sequence of events will occur for as long as the

resistors R9 and R10, and LED1 are not installed onto the printed-cir-

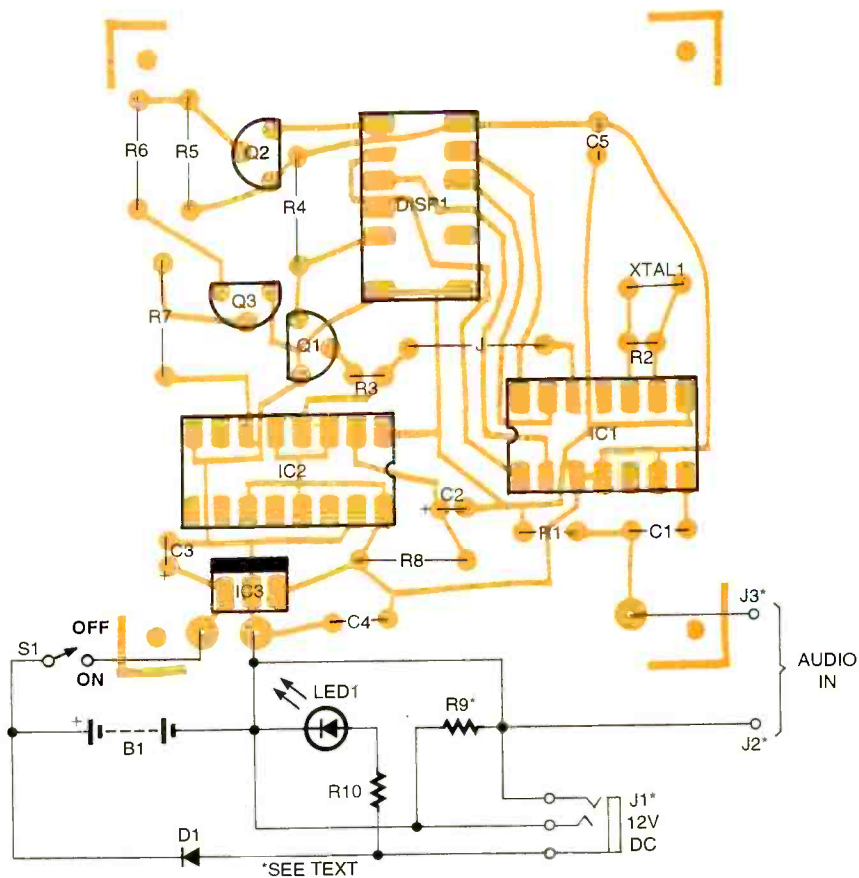

Fig. 6. Assemble the tone decoder board guided by this parts-placement diagram. As with the tone generator, be sure to install the low-profile components first, followed by the taller components. Again sockets are recommended for all ICs except the regulator (IC3). Note, however, that a socket is absolutely necessary for the display (DISP1).

PARTS SOURCES

SURPLUS NI-CD BATTERIES

Falkner Enterprises,
PO Box 1378
Ottumwa, IA 52501
Tel: 515-683-7621
Fax: 515-683-7631
Free catalog upon request

PARTS SUPPLIERS

B.G. Micro

PO Box 280298
Dallas, TX 75228
Tel: 800-276-2206
Fax: 214-271-2462

Circuit Specialists, Inc.

PO Box 3047
Scottsdale, AZ 85271-3047
Tel: 800-528-1417
Fax: 602-464-5824

Debco Electronics, Inc.

4025 Edwards Road
Cincinnati, OH 45209
Tel. Orders: 800-423-4499
Tel. Inf.: 1-513-531-4499
Fax: 513-531-4455

Jameco Electronics

1355 Shoreway Road
Belmont, CA 94002-4100
Tel. Orders: 800-831-4242
Fax: 800-237-6948
BBS: 415-637-9025

JDR Microdevices

1801 South 10th Street
San Jose, CA 95112-4108
Tel. Orders: 800-538-5000
Fax: 800-538-5005
BBS: 408-494-1430

Mouser Electronics

Mouser Central
958 North Main Street
Mansfield, TX 76063
Tel. Orders: 800-346-6873

Newark Electronics

(Has distributors nationwide)
To request a catalog, call:
800-298-3133 ext.48

input of the tone decoder is connected to any one of the 16 available tone generator outputs. Now connect the tone decoder's input to each of the other tone generator outputs one at a time, and verify that a different numerical character is displayed for each output. Refer to the table that is part of Fig. 2 if necessary.

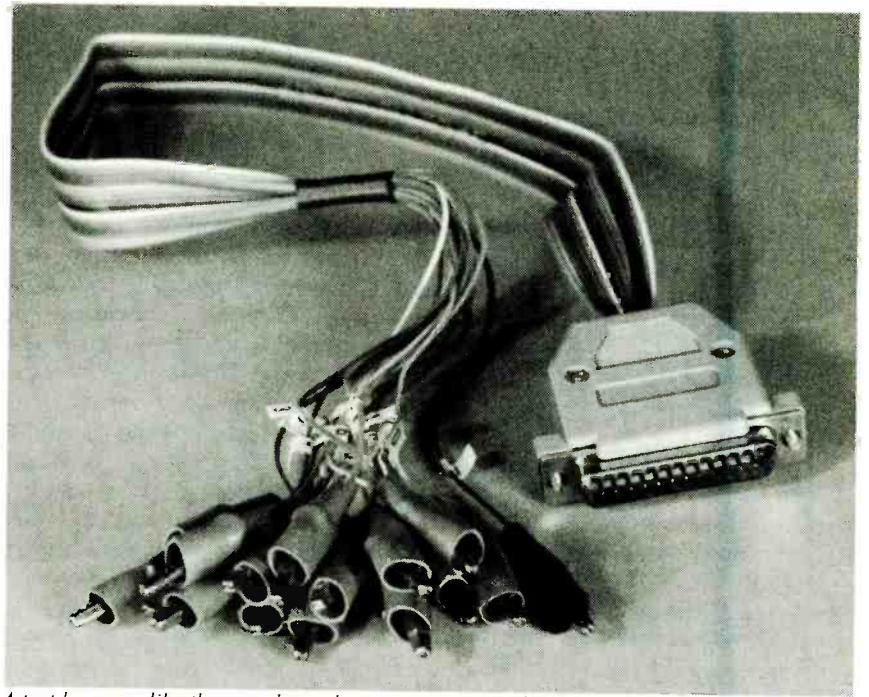

A test harness, like the one shown here—comprised of a male DB-25 connector; a length of ribbon cable, and 17 miniature alligator clips (16 red and one black)—is used to feed individual tone signals to several different conductors simultaneously.

If one character is continually displayed, regardless of which tone-generator output is selected, check transistor Q1 of the tone decoder for its proper operation. If the LED display fails to operate at all, then check transistors Q3 and Q2, followed by IC2 (in that order) for proper operation.

After the unit is operating correctly, it's time to prepare the enclosure that will house the unit. Before permanently installing the printed-circuit board into the enclosure, it might be necessary to increase the overall height of DISP1 by placing an additional IC socket between DISP1 and the board-mounted socket (i.e., insert an empty socket into the board-mounted socket, and then install DISP1 into this socket). That will make the display easier to see once the unit is assembled. A suitable Ni-Cd battery pack can be assembled from individual tabbed "AA" size, or a 9.6-volt battery pack of the type commonly used in radio-controlled toys can also be used.

Use. Suppose that you needed to identify 16 individual conductors in a computer cable. First, connect the tone generator's ground lead to the shield wire on the cable. Then, simply connect one output from the

tone generator to each conductor that's to be identified, and apply power to the generator. Now go to the opposite end of the cable, and connect the tone decoder's ground wire to the shield wire on the cable.

By simply "probing" each of the 16 wires one at a time, their identity will be clearly displayed by the Tone Decoder Unit. Now all that needs to be done is to apply the proper labels to each of the wires at both ends of the cable. Note that it is perfectly normal for a second or so to pass before a character is displayed on the tone decoder. That's because the tone generator takes approximately 1.25 seconds to completely cycle through all 16 possible DTMF tone pairs. If the probe on the tone decoder is left connected to a conductor being tested for several seconds or more, the displayed character will appear blinking in the display.

If you suspect some wires are crossed, check all of them for more than one response.

The companies cited in the sidebar are valid parts sources for items listed in this feature. To the best of my knowledge, these suppliers are willing to sell parts and materials in small quantities by mail. ■

For those who are interested in physiological electronic instruments, this project can be both educational and entertaining, especially at your next party. Its design is based on a medical instrument called a *plethysmograph*. The plethysmograph, derived from the Greek word "plethore," meaning filled, is used in physiology to study variations in the size of parts of the body, as caused by the quantity and circulation of blood. The *Heartbeat Machine* is specifically designed to respond to blood flow, and visually indicate the heartbeat or pulse rate of a human subject. As reported in the *Journal of the American Society of Psychological Research*, and the *International Journal of Neuropsychiatry*, such an instrument could also be used as an indicator of extra sensory perception (ESP) in telepathy experiments.

The Heartbeat Machine responds to the varying quantity of blood in the finger, and operates on the principle that transmission of light through the body is influenced by the pulsating flow of blood as caused by the heart. The project is a self-contained unit that allows the subject to rest his or her finger on a transducer assembly, thereby allowing the circuit to detect blood flow. Each time a heartbeat is detected, an LED will flash. An optional feature allows the builder to provide an audible tone burst in addition to, or in place of, the LED indicator.

The Heartbeat Machine is easy and fun to use. It is battery operated for portability, and completely harmless to the bystander and user. You can try it yourself or on your relatives and friends for entertainment purposes. Find out what external stimuli influence the heart rate. The next time you have a party, bring it out to break the ice!

Monitor your
"Ticker" With



THE HEARTBEAT MACHINE

*This fascinating but simple
circuit allows you to keep tabs
on the rhythmic fluctuations
of your heart.*

ANTHONY J. CARISTI

About the Circuit. Figure 1 is a schematic diagram of the Heartbeat Machine. The circuit is comprised of three integrated cir-

cuits (IC1 through IC3), a transistor (Q1), (which is composed of two components: LED1 and R17, a cadmium sulfide photocell, also known as a light-dependent resistor), and a handful of support components. Key to the circuit's operation is the transducer, which is used to detect the flow of blood in the finger. The photocell and LED are placed in close proximity to each other surrounded by a light-proof enclosure.

The subject places a finger over both the LED and the photocell. Since human body tissue is somewhat transparent to red light while blood is not, light emitted by the LED is transmitted to the photocell through the finger. This process causes the resistance of the photocell to vary in accordance with the subject's heartbeat and pulse rate. The electrical change in photocell conductivity is detected and amplified to allow the instrument to visually display the heartbeat of the subject, by means of a synchronized flashing light.

When the circuit is turned on via S1, the battery voltage is regulated to 5 volts by IC1 (a fixed 5-volt, 100-mA regulator). That voltage is used to light LED1, which provides the light source that passes through the subject's finger, to drive the photocell (R17). The photocell is biased with a small current through R2. In total darkness the resistance of the photocell is about 500,000 ohms. But as light intensity striking the photosensitive area of the photocell increases, the photocell's resistance decreases. That's an important point, as we will soon see. The voltage drop across R17 is AC coupled to the non-inverting input of IC2-a— $1/4$ of an LM324N quad op-amp (which is configured as an AC amplifier, and has a gain of 46)—at pin 3.

The output of IC2-a is fed to the

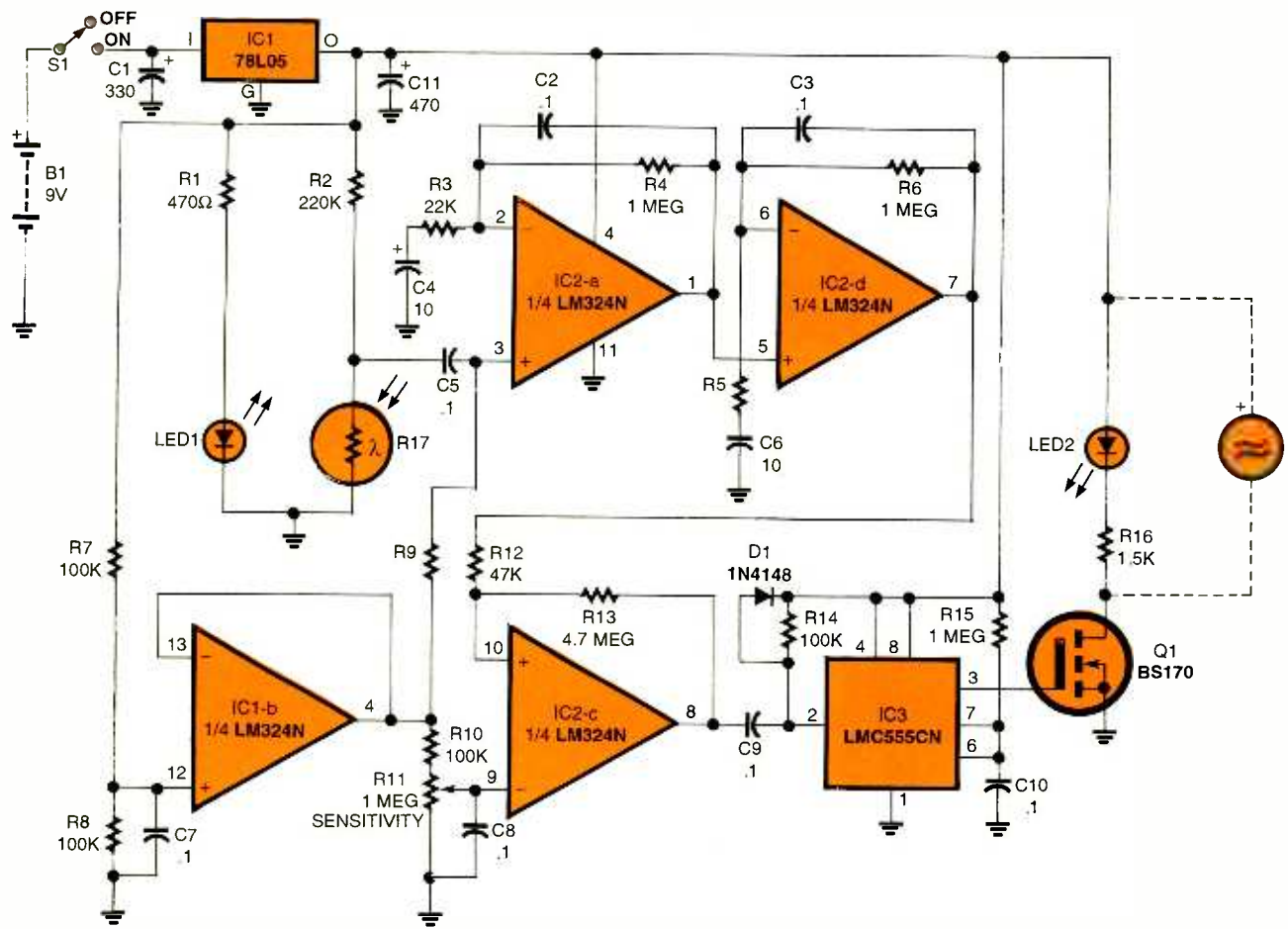

Fig. 1. The Heartbeat Machine is comprised of three integrated circuits (IC1 through IC3), a transistor (Q1), a transducer, and a handful of support components. Key to the circuit's operation is the transducer (composed of LED1 and R17), which is used to detect the flow of blood in the finger.

non-inverting input of IC2-d, another op-amp configured as an AC amp, with a gain of 46. Together those two amplifiers, (which are connected in cascade) provide a total gain of more than 2000. That produces an output voltage variation of one or more volts at the output of IC2-d at pin 7. Capacitors C2 and C3 are included in the feedback loops of the two AC amps to limit their high frequency responses. Note that a voltage follower, comprised of IC2-b, along with R7 and R8 form a low impedance voltage source. The output of the voltage follower divides along two paths. In one path, the output of IC2-b is used to bias the non-inverting input (pin 3) of IC2-a at about 2 ⁻¹/₂ volts. Since IC2-a drives IC2-d directly, that amplifier is also biased at the same voltage.

Each time the heart beats, a surge of blood passes through the finger. That variation of blood flow

causes a change in the amount of light striking R17 (the photocell, which has a resistance of 500,000-ohms in total darkness and increasing to 3000-20,000-ohms depending on increasing light intensity), causing its resistance to change. That, in turn, varies the voltage across the photocell and therefore, the voltage applied to U2-a. The waveform produced (see Fig. 2) represents the flow of blood. The output of IC2-d at pin 7 is fed through R12 to IC2-c, another op-amp, one configured as a voltage comparator. A voltage comparator is a high-gain amplifier that compares the voltage levels applied to its input terminals, and always generates either a logic 1 or logic 0 output. Hysteresis is provided by the positive feedback through R13.

In the second path, the output of IC2-b is applied to R11 (a 1-megohm potentiometer), which is used to set the circuit's sensitivity

level. The output of U2-b is fed through the wiper of R11 to the non-inverting input of IC2-c to set the biased voltage (at pin 9) at somewhat less than 2 ⁻¹/₂ volts. Because of that, the output of IC2-c at pin 8 will always be near 5 volts when the circuit is at rest (no light excitation on R17). When a finger is placed in position, the amplifier produces the heartbeat waveform at IC2-d pin 7. That signal is fed to the voltage comparator through R12, producing a negative-going pulse train at pin 8 of IC2-c that's synchronized with the heart rate. That pulse train is used to trigger IC3 (an LMC555 CMOS oscillator/timer) that's connected as a monostable (or one-shot) multivibrator. The monostable produces a positive going pulse at its pin 3 output each time it's triggered.

The pulse duration (about ¹/₁₀ second) is determined by R15 and C10. Transistor Q1 and LED2 are

PARTS LIST FOR THE HEARTBEAT MACHINE

SEMICONDUCTORS

- IC1—78L05 5-volt, 100-mA, voltage regulator, integrated-circuit
 IC2—LM324N quad op-amp, integrated circuit
 IC3—LMC555CN CMOS oscillator/timer, integrated circuit
 Q1—BS170 N-channel enhancement TMOS FET
 D1—1N4148 or similar silicon switching diode
 LED1—Light-emitting diode
 LED2—Jumbo LED (Mouser 351-7542 or similar)

RESISTORS

- (All fixed resistors are 1/4-watt, 5% units, unless otherwise noted.)
 R1—470-ohm
 R2—220,000-ohm
 R3, R5—22,000-ohm
 R4, R6, R15—1-megohm
 R7, R8, R10, R14—100,000-ohm
 R9—470,000-ohm
 R11—1-megohm cermet potentiometer (Digi-Key 36C105 or similar)
 R12—47,000-ohm
 R13—4.7-megohm
 R16—1500-ohm
 R17—Cadmium-sulphide light-dependent resistor, (Mouser 338-76C348)

CAPACITORS

- C1—330- μ F, 10-WVDC, low-leakage radial-lead electrolytic
 C2, C3, C5, C7, C8, C9, C10—0.1- μ F, ceramic disc
 C4, C6—10- μ F, 10-WVDC, radial-lead, electrolytic
 C11—470- μ F, 6.3-WVDC radial-lead electrolytic

ADDITIONAL PARTS AND MATERIALS

- B1—9 volt alkaline transistor radio, battery
 S1—SPST toggle or slide switch
 Battery clip, enclosure, hookup wire, hardware, adhesive, tape

Note: The following parts are available from A. Caristi, 69 White Pond Road, Waldwick, NJ 07463: Set of two boards @ \$15.50; photocell (R17) @ \$5.75; 78L05 regulator (IC1) @ \$2.00; LM324N quad op-amp (IC2) @ \$3.25; LMC555CN CMOS oscillator/timer (IC3) @ \$3.25. Please add \$5.00 postage/handling.

activated each time IC3 produces a pulse. That provides a visual indication of the heartbeat or pulse rate of the subject. Note that a piezo buzzer may also be used in addition to LED2 to produce an audible indication of the heart rate.

Transducer Construction. The Heartbeat Machine is made up of

two parts: the transducer assembly—comprised of a piece of unetched printed-circuit material, containing R17 (the photocell) and LED1—and a printed-circuit containing the amplifier and indicator circuitry. The boards are stacked and separated by spacers, and held together with hardware.

The transducer assembly is made up of a piece of unetched circuit-board material, plus three lengths of 3/16 or 1/4-inch square, plastic, wood, or metal rod. The transducer assembly layout is shown in Fig. 3. Drill holes in the board at the locations shown for the photocell and LED. For ease of assembly, drill the holes for the LED and photocell ever so slightly smaller than those components so as to produce a snug fit. Note: Although not shown in Fig. 3, there should be four mounting holes drilled in the transducer board matching the mounting holes in the amplifier board. The easiest way to do that is to drill the mounting holes in both boards at the same time.

Once all of the holes are drilled, mount the photocell, LED, and square rods and secure them in place using RTV silicone rubber, epoxy, or other adhesive. The rods are placed so that they position the finger to rest squarely over the LED and photocell. The larger hole is for the photocell and the smaller one is for the LED. Cut the pieces of square rod to the length shown in Fig. 3. The top of the LED should be 1/8 inch above the copper side of the board, and adhesive should be placed underneath. The photocell should be set so that its light sensitive surface is about 1/32 inch above the copper side of the board. Do not get any of the adhesive on the surface of the photocell or on the top part of the LED. Set the assembly aside until the adhesive has fully cured. That can take a day.

Identify the cathode lead of the LED. Then, using a small drill bit (such as #57), drill a hole at a location away from the finger-rest area for the cathode lead of the LED. Solder the cathode lead to the copper surface of the board. Finally, drill one more small hole in the board for the common lead connection as indicated in Fig. 3. That completes the transducer assembly. The remaining

three component wires and the common lead will be connected to the main circuit board later.

Circuit-Board Construction. Figure 4 shows a full-size template of the author's printed-circuit layout for the main board. An etched and drilled board is available from the source given in the parts list. Hardwiring the circuit on a perf-board is not recommended, due to the high gain of the amplifier. A parts-placement diagram for the author's circuit board is shown in Fig. 5. When installing the components, pay close attention to the orientation of the polarized parts. Just one part placed in the circuit backwards will render the circuit inoperative and may cause damage to one or more components. Sockets for the two integrated circuits are optional. Capacitors C1,

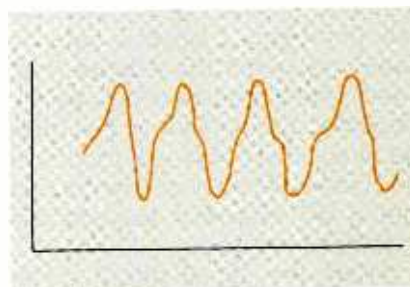

Fig. 2. The subject places a finger over both the LED and the photocell, which are placed in close proximity to each other surrounded by a light-proof enclosure. The circuit detects changes in blood flow and produces the waveform shown here. It is then processed to give a visual indication of the heartbeat or pulse rate of the subject.

C4, C6, and C11 can be mounted in a horizontal position to keep board height to a minimum.

Note the location of the four connections to the transducer assembly, as well as those for the battery, LED2, and power switch. LED2 should be temporarily connected to the circuit for the preliminary test, which must be performed before the transducer and circuit board are stacked and secured together. Attach a 9-volt battery connector to the board where indicated in Fig. 5. The connector can be salvaged from an old 9-volt battery by removing the connector, and soldering flexible

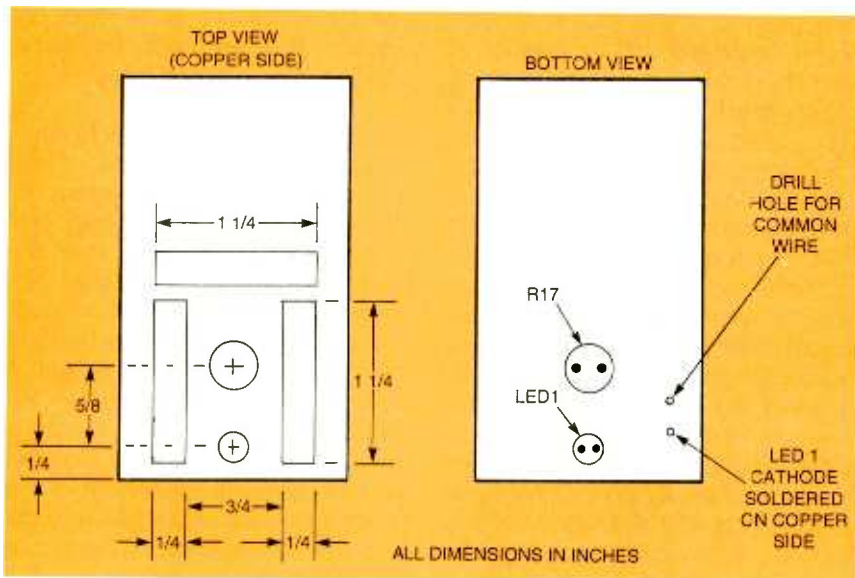

Fig. 3. The transducer assembly (details of which are shown here) is made up of a piece of unetched circuit-board material, containing R17 (the photocell) and LED1, plus three lengths of $\frac{3}{16}$ - or $\frac{1}{4}$ -inch square-plastic, wood, or metal-rod.

is about 2.5 volts. If not, remove power and check all components associated with IC2. Check the board for opens, shorts, and bad solder joints. Try a new chip. After repairing the fault, proceed with the test.

Set the sensitivity control to the maximum clockwise position so that the voltage at pin 9 of IC2-c is about 2 volts, for maximum circuit sensitivity. Place the transducer assembly into the light-proof box and rest your index finger firmly on the LED and photocell. Apply power and wait until the circuit settles down. Note that LED2 blinks for $\frac{1}{10}$ second at a rate that is synchronized with your pulse.

If LED2 flashes reliably with your pulse rate, the sensitivity control may be left in the maximum clock-

insulated wires to the terminals. Use red and black if possible, and be sure to connect the positive (red) wire to the female terminal and the negative (black) wire to the male terminal. When finished, plug a 9-volt battery into the connector and use a DC voltmeter to verify the polarity of the wires.

When the circuit board is fully assembled, examine it very carefully for opens, short circuits, and bad solder connections, which may appear as dull blobs of solder. Any solder joint which is suspect should be redone by removing the old solder with desoldering braid, cleaning the joint, and carefully applying new solder. It is far easier to correct problems at this stage rather than later on if you discover that your Heartbeat Machine does not work.

Preliminary Test. The circuit must be checked before final assembly, by first making four temporary connections between the transducer assembly (the LED1, photocell, and common) and main circuit board, using four pieces of small gauge flexible insulated wire about 12 inches long. Be careful when handling the transducer assembly so as not to break the wires on the photocell and LED. Additionally, LED2 should be temporarily connected into the circuit using wires that are long enough to position the LED so

that none of its light can affect the photocell.

You'll need a DVM or VOM to check out the circuit. You can also use an oscilloscope to visualize the slow moving heartbeat waveform at pin 7 of IC2-d. The photocell must not be exposed to any light during the test, so that it can detect blood flow. One way to blackout its environment is to place the transducer into a small light-proof covered box. The box should have a small hole in it that allows your finger to be inserted to rest in its proper location. Another method is to perform the test in a very dark area.

Connect a 9-volt battery to the circuit, apply power, and measure the voltage at the output of the regulator. Your meter should read between 4.75 and 5.25 volts. Allow a few seconds for the circuit to settle down. With no light striking the photocell, measure the voltage at pins 1 and 7 of IC2. The reading should be about 2.5 volts. Expose the photocell to light while observing the voltage at pin 7. Note that it moves 1 or 2 volts in each direction as the light source is applied and removed from the photocell. If you get a different response, check battery voltage and polarity under load to be sure it is at least +8 volts. Check the orientation of C1, C11, and U1. Measure the voltage at pins 13 and 14 of IC2 to verify that it

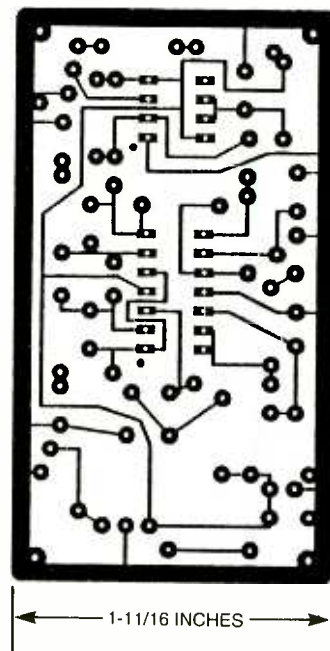
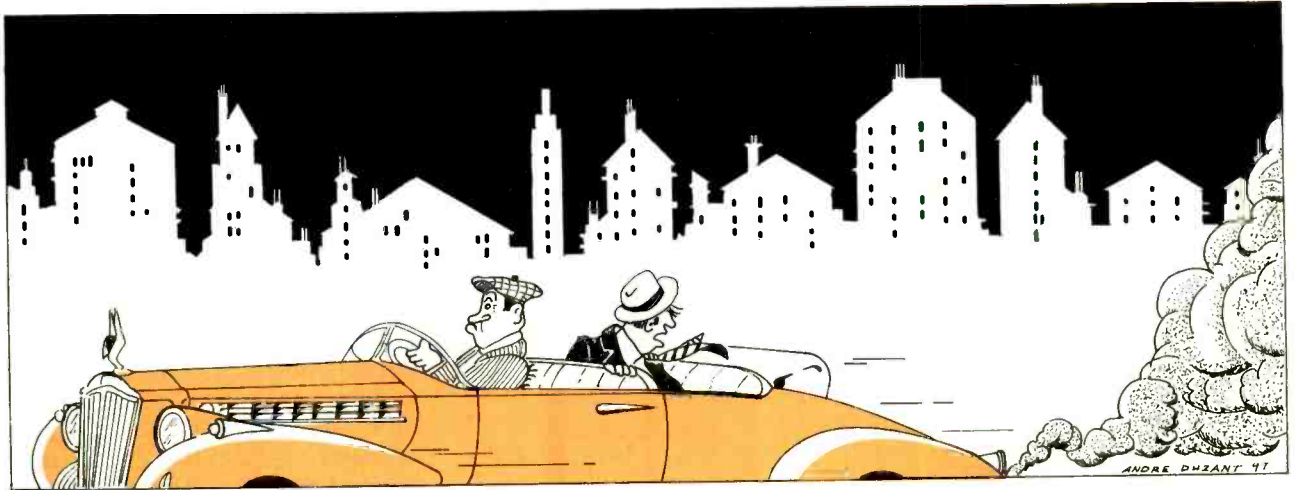

Fig. 4. This full-size template of the author's printed-circuit layout for the amplifier board can be lifted from the page and used to etch your own printed circuit board. Or, if you prefer, an etched and drilled board is available from the source given in the Parts List.

wise position. If the circuit seems to be too sensitive, set the control slightly CCW to reduce sensitivity. Try the circuit on more than one person if possible. If the Heartbeat Machine operates normally, proceed to the final assembly. Otherwise trou-
(Continued on page 84)

ELECTRONICS HELP CLEAN UP THE AIR



Rather than forcing people to junk those old "smoke generators," electronics manufacturers are now producing retrofit emission-control systems to help older vehicles comply with the new clean-air standards!

Now that new vehicles have become extremely clean running, greater attention is being focused on cleaning up the emissions produced by old cars and trucks. Those "gross emitters" contribute far more than their fair share to the air pollution problem. For instance, in California, 1980 and older vehicles account for only about 20% of the vehicle population and total miles driven. However, they produce about half of the vehicle emissions. One answer is to remove the high emitters from the road through accelerated retirement programs. There are "clunker" programs that purchase old cars for scrap for a few hundred dollars. Unfortunately, those old cars are often owned by the people who can least afford to replace them. The alternative for them is to install aftermarket emission-control equipment that will reduce the amount of pollutants that the cars produce, allowing them to provide daily transportation with minimum harm to the environment.

The KAT 200. One such retrofit emissions scrubber is the KAT 200 developed by Neutronic Enterprises Inc., San Diego, California. After retrofitting with the KAT 200 Micro

BILL SIURU

Controlled Emission system, most vehicles, even those without either

feedback controlled emission systems or three-way catalytic converters, can meet current U.S. Federal or E.C. (European Community) emission standards.

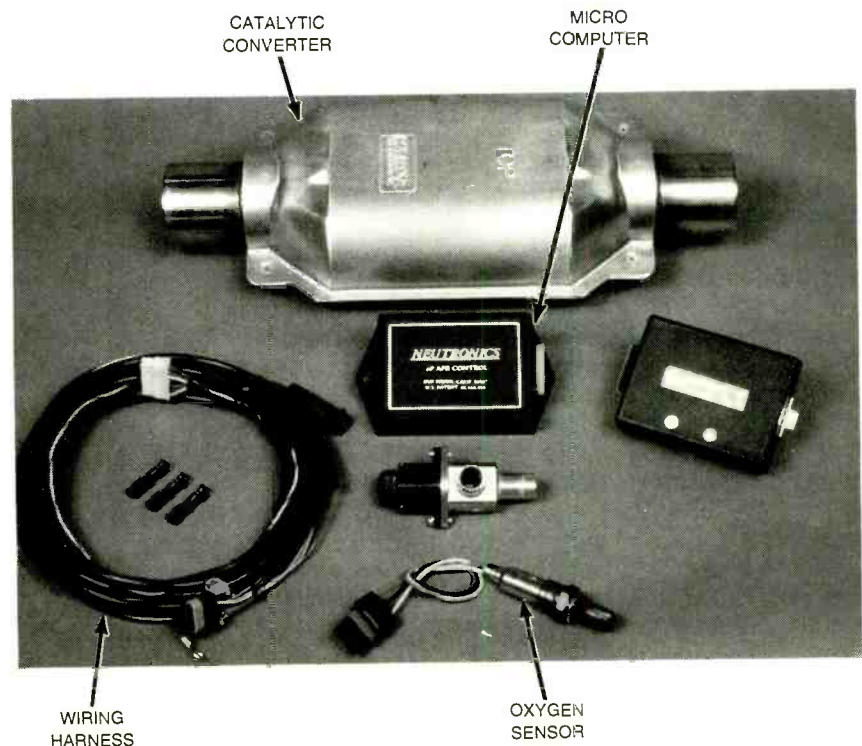

The Neutronics aftermarket emission system consists of a Kat 200 Micro computer, a heated or unheated oxygen sensor, a linear actuated stepper-motor induction control valve, wiring harness, and a three-way aftermarket catalytic converter which are added to the exhaust.

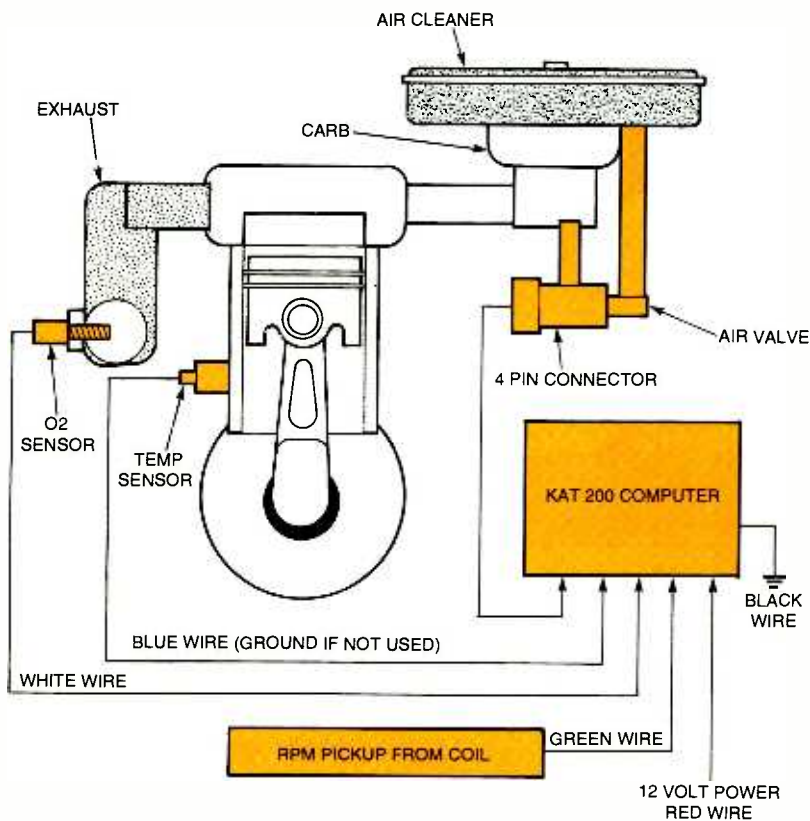

Fig. 1. The Neutronics system's oxygen sensor is mounted to or near the exhaust manifold, where it can measure the oxygen content of the exhaust. The oxygen content of the exhaust allows the computer to infer the air-to-fuel ratio of the air-fuel mixture. If the mixture is too rich, the computer commands the control valve to increase the amount of air in the mixture. On the other hand, if the mixture is too lean, the computer commands the control valve to reduce the amount of air entering the intake manifold. The particular catalytic converter used depends on engine size and vehicle weight.

Neutronic Enterprises, Inc. already exports about 70% of its aftermarket air pollution control devices to Germany and South America.

The KAT 200 microprocessor feedback control system replaces the original oxidation catalytic converter used on cars with a new closed-loop control device and three-way catalytic converter. The system can be used with either carburetors or fuel injection systems. It can also be used on vehicles without catalytic converters. The device monitors the air-fuel mixture and maintains the air-fuel mixture close to the ideal, or stoichiometric, ratio. The term stoichiometric refers to a condition in which a precise amount of air is mixed with the optimal amount of fuel, so as to achieve complete and total combustion. If the mixture ratio is less than stoichiometric, the mixture is

deemed rich because there is more fuel than needed for complete combustion. Greater than stoichiometric means that the mixture is lean with an excess amount of air.

The Neutronics system consists of a KAT 200 Micro computer, a heated or unheated oxygen sensor, a linear-actuated induction control valve with a stepper motor, wiring harness, and a three-way aftermarket catalytic converter. The Neutronics system's oxygen sensor is mounted to or near the exhaust manifold, where it can measure the oxygen content of the exhaust. The oxygen content of the exhaust allows the computer to infer the air-to-fuel ratio of the air-fuel mixture. If the mixture is too rich, the computer commands the control valve to increase the amount of air in the mixture. On the other hand, if the mixture is too lean, the computer commands the control valve

to reduce the amount of air entering the intake manifold. The particular catalytic converter used depends on engine size and vehicle weight.

The Neutronics system is the only retrofit emission control device that has been certified by the California Air Resources Board for use on models with open-loop, oxidation catalyst systems. As required for certification, the device reduces two of the three measured emissions—non-methane hydrocarbons (NMHC), carbon monoxide (CO) and nitrous oxides (NO_x)—by at least 20% without increasing the third emission gas. An extensive test program showed the system actually does much better. The testing was done on thirteen 1975-80 American and imported vehicles (both cars and pickups) with 111,000 to 387,000 kilometers (68,800 to 240,000 miles) on their odometers.

Compared to the "baseline" measurements taken after the vehicles had received maintenance, but before the retrofit system was installed, the average emissions for the 13 vehicles was reduced by 72% for NMHC, 64% for CO and 62% for NO_x (see Fig. 2) with the installation of the device. Maintenance included oil and filter

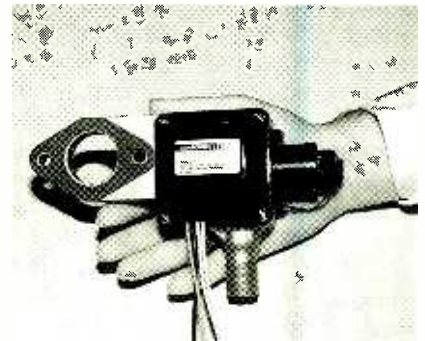

In the LeanPower system, air is supplied via the intake tube at the bottom of the device. The carburetor plate at the left fits between the carburetor and intake manifold. The black box contains the Lean 2000 signal processor.

changes plus tune-ups, and repairs to the fuel and ignition systems that are normally performed to pass emission tests. Six of the vehicles were driven 48,000 kilometers in long-term road testing. The average reductions after 48,000 kilometers was still 51% for NMHC, 22% for CO, and 47% for NO_x.

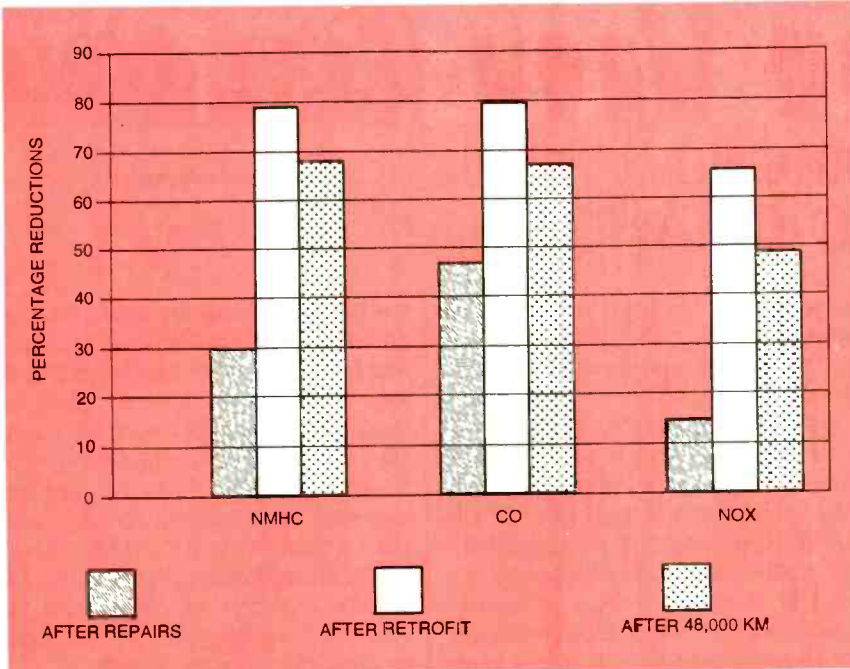

Fig. 2. Reduction in hydrocarbons, carbon monoxide and nitrogen oxide emissions in the various phases of testing the KAT 200 system. "As Is" emissions were measured as the vehicles were received at the testing site. The "48000 km" condition is only for the six vehicles in the duration testing.

A prototype retrofit program is being sponsored by the San Diego County Air Pollution Control District (SDCAPCD). The program has been funded to retrofit 1250 vehicles over the next three years. Using cost sharing with revenue collected from vehicle registration fees, the district can give owners of vehicles that fail bi-annual smog tests and cannot be repaired under California cost limits two options—scrap the vehicle and accept \$600 or pay a maximum of \$150 to prepare the vehicle for the KAT retrofit.

If the owner decides on the retrofit, the vehicle is taken to the retrofit repair station, which determines if it can be repaired. That ensures that the owner's or district's funds are not wasted on a non-repairable vehicle. If the vehicle is repairable, the owner pays up to \$150 to tune and prepare the vehicle for retrofitting. The district then pays \$500 to retrofit the vehicle. Now the owner has a vehicle that can be used for at least two more years, and the public gains a clean vehicle.

LeanPower. LeanPower Corporation of College Park, Maryland has also developed and patented an after-market emission control system to

reduce pollution from older cars and light trucks. The LeanPower system controls the air/fuel mixture so that the engine operates at the leanest air-fuel mixture the engine can tolerate under most driving

conditions. (See Fig. 3.) The leanest conditions minimize emissions.

The LeanPower closed-loop, feedback control system uses a signal processor, the *Lean 2000* chip, (see Fig. 4) to keep the engine run-

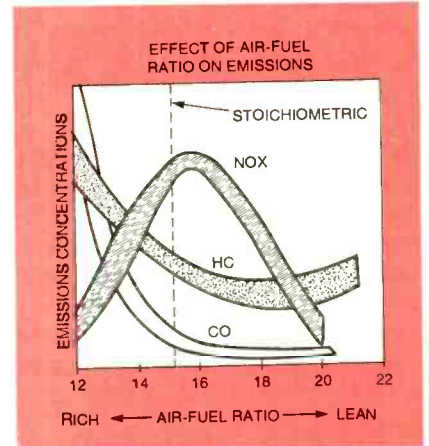
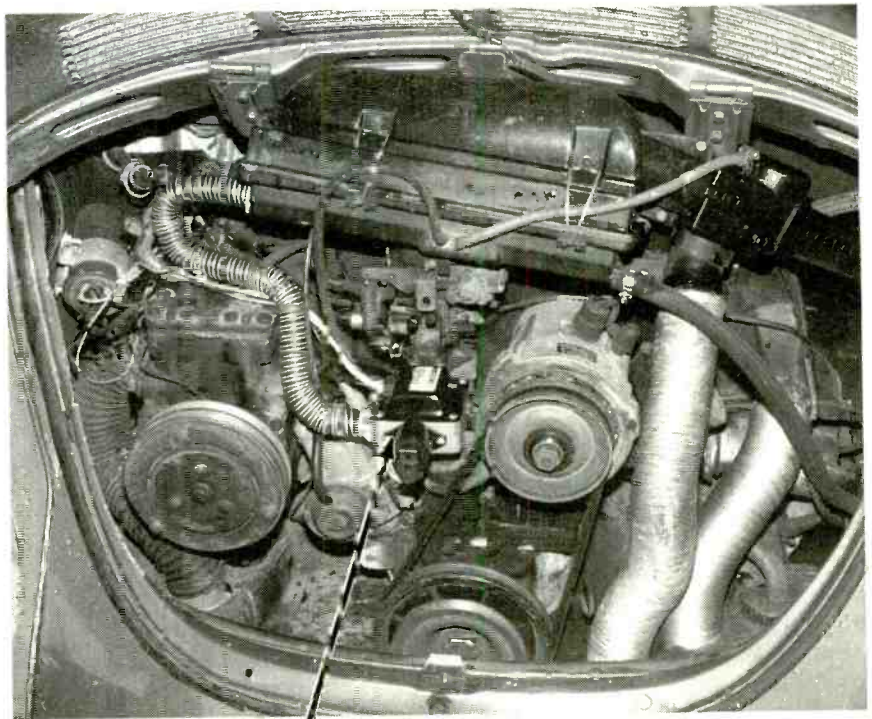

Fig. 3. It is desirable to operate an engine at the leanest mixture ratio possible in order to keep hydrocarbon, carbon monoxide and nitrogen oxide emissions at their lowest level.

ning at its leanest limit. On carburetted engines, the engine is set up so that the air/fuel mixture is at stoichiometric, or perhaps slightly richer. The signal processor commands

(Continued on page 78)



MODEL V1601

The LeanPower emission system installed on an old Volkswagen Beetle.

PRODUCT TEST REPORT

TECHNICS SL-MC60 COMPACT DISC CHANGER

STEPHEN A. BOOTH

Multi-disc changers remain the most popular form of compact disc player. For some time, the so-called carousel changers have led the hit-parade. These house five CDs on a retracting-drawer turntable, and let you insert or change CDs even while one is playing. Lately jukebox-style "mega-changers," holding 24 discs or more, have been giving the carousel a run for the money.

With suggested retail prices as low as \$250 for the 60-disc Technics SL-MC60 CD changer tested here, and dimensions no bigger than a carousel, the CD jukebox is finally a viable choice for many people limited by budget and space on the stereo shelf. They have just about all the same features and programmability options as single CD and carousel players, and sometimes more. What might be most interesting is that the access time from CD to CD isn't much longer than a carousel's despite the greater capacity of the jukebox.

For its price and convenience, the Technics SL-MC60 is a very alluring audio product. Operating instructions are well written and complete, and most important, its performance in electrical tests is respectable, though not spectacular. You will find a summary of these test results in the accompanying table, conducted by the Advanced Product Evaluation Laboratory (APEL), an independent testing facility located in Bethel, CT.

Features

The SL-MC60 holds 60 CDs standing on end side by side in a rack behind its drop-down front panel. There's also a slot for a single-disc play, which lets you insert or remove a CD without affecting the programming of the rest of the library. The actual player mechanism (laser pickup and CD drive) shunts back and forth laterally behind the rack and extracts the selected CD for playback. At any time, even when music's playing, you can open the front panel to load or swap discs. That's easy

enough, and this way you can keep track of what's inside.

Some more expensive and elaborate jukeboxes have LCD readouts that identify the CDs within. But, unless connected to a personal computer and monitor, they seldom display the entire play list. You usually have to scroll through, title by title. Technics' solution is low-tech but decidedly easier. If direct access to the data is what you want, a photo-style album accompanies the player, so you can insert a CD's liner-notes in a transparent sleeve numbered to correspond with a disc's position in the changer. Simple-but effective, an easy way to store and manage your entire music collection. The CDs are always in the changer, eliminating the need to handle them. What you do with the unoccupied CD jewel-boxes is up to you!

The changer offers another easy way to at least organize, if not identify,

the 60 titles behind the door. You can program the discs into five "groups", and then label the groups according to any of 14 musical genres (such as Rock, Jazz, Classical, Country, Ballads, Dance, Party, and others). Happily, this doesn't pigeon-hole the CD into an exclusive classification. You can program a disc into more than one "group." For example, a Rock title might also be in your selection for Dance and for Party, or a selection for Country might be cross-referenced to Ballads.

As you might suspect, all this cross-referencing might become a little tiresome if discs are widely separated in the changer rack, and you had to figuratively watch paint dry while waiting for the machine to get to one place from another! Here's where the relatively fast access-time of the SL-MC60 comes into play. The jukebox takes 6.1

(Continued on page 75)



The Technics SL-MC60 60-CD changer.

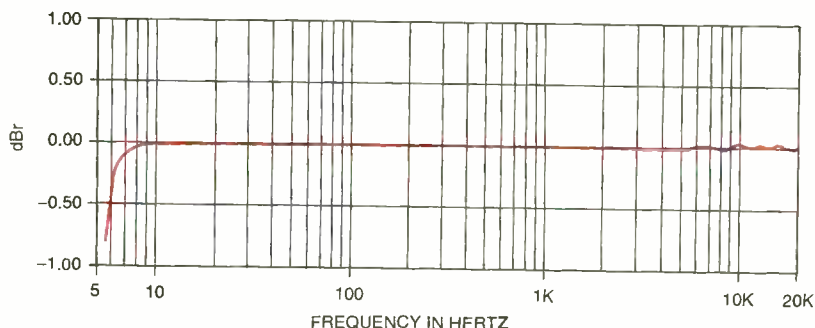

Fig. 1. As this figure shows, the frequency response of the SL-MC60 is virtually ruler-flat over the entire audio range.

MICROCONTROLLER STARTER KIT

The monthly ham radio meeting was just about over. I glanced at my watch as Randy, the club president, made a final announcement. "OK then— it's settled. We'll have our first hidden transmitter hunt, or "foxhunt" next month, on the Saturday before the next meeting."

I knew this was coming—the group had been kicking the idea back and forth for a few months now. Of course, none of them had ever actually been in a foxhunt, or even really knew what one was, but they thought it sounded like it could be fun.

"Just a minute. Just a minute!" It was Jim, the club pessimist. "I don't mean to rain on anyone's parade here, but to have a foxhunt you need a fox! There are plenty of spare radios around, but don't we need some sort of timer to turn the thing on and off? We can't just put a brick on the key and expect the thing to transmit for three hours! Besides, that would be too easy to find. We need some sort of timer—maybe a half a minute on, a couple of minutes off. You know, take a direction bearing, drive a little bit, take another bearing—like that. Who can whip us up some sort of timing circuit?"

I was glancing at my watch again, and when I looked up I noticed everyone looking in my direction. You see, I had some kind of reputation as the club's electronics expert. "Oh," I said. "Sure, no problem. I can throw something together by next month." Heck, I could throw that together on my way home tonight. Just take a 555 timer chip, set it up with a variable pot to change the duty cycle...

"Hold it. Hold it!" It was Jim again. "I was at a foxhunt once where they sent the 'end of message' sign—you know, SK just before the transmitter turned off. That was great—it let you know when you were about to lose the signal, so you could take that one last reading. Can we get something like that?"

Well, uh.. sure, no problem." This was getting sticky. Now I had to put together a tone circuit—maybe another 555 timer chip—and some-

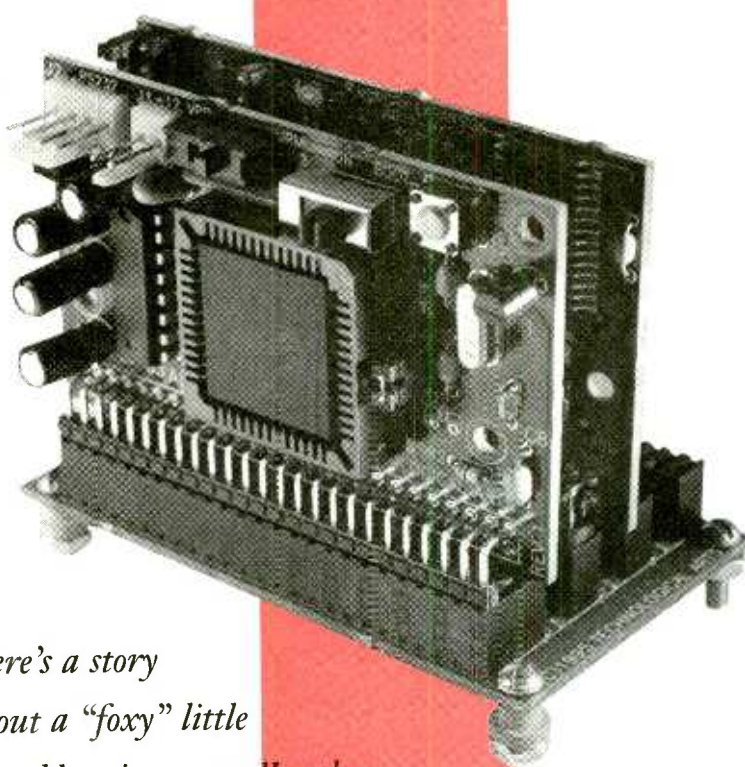

*Here's a story
about a "foxy" little
portable microcontroller that
generates Morse code at variable time intervals!
This microcontroller kit is perfect for learning electronics,
computer fundamentals, hardware and software
microcontroller design, and it can be incorporated
as the core of custom or new gadget design.*

thing to make the SK signal in Morse code, dit-dit-dit-dah-dit-dah—maybe some sort of shift register chip, and a clocking circuit, and maybe a...

"Excuse me, gentlemen. Aren't we forgetting something?" Oh boy, it was Bruce, the Public Service fanatic. "FCC Rules and Regulations clearly state that all transmitters shall be clearly identified, either by Morse code or in plain English, at an interval not to exceed ten minutes. I hope you foxhunters plan on having a call sign tacked on the end of

those transmissions!"

Randy walked over to the podium, keeping one eye in my direction. "I'm sure that'll be no problem for 'Mr. Electronics' over there. Well, it's nine-o'clock. Hearing no further business, I declare this meeting adjourned!" He rapped on the podium with his gavel, and twenty-eight hams jumped up and headed for the coffee and brownies.

"Hang on!" I leapt to my feet. "You know, the Morse ID part may be a little tricky. Maybe we could do something else for the fox.

Maybe some remote control thing, or maybe a...".

It was no use. I was talking to myself. As I watched the feeding frenzy at the coffee maker, I pondered my situation. The fox required a variable timing circuit that would put a short bit of Morse code at the end of each push-to-talk (PTT) interval, and also had to transmit a call sign at ten minute intervals. It needed to be battery powered, and pretty small—the fox hider had to be pretty creative when he stashed the fox. The final package needed to be ready in three weeks. And my reputation as the club electronics guru depended on how well it worked. I was in deep trouble!

In Search of a Fox. When I got home that night I pulled out a few



Fig.1. The ADAPT-11 starter package comes with an instruction manual, reference guide, programming cable, and a disk of firmware.

of my radio handbooks. I could handle the timing circuit, and the tone generation was no problem, but keying the tone on and off to create Morse code characters—Yikes! There was some serious circuitry involved there. Not only that, but it was digital circuitry, and I was really an analog kind of guy. I put the books on the shelf and went to bed in dismay.

T-minus twenty days, and counting. I awoke the next morning and reviewed the situation. I was still dismayed, but I was just as determined to find a solution. Later on at work I pulled out all the electronics

journals and magazines. I knew that this was a job for some sort of microcontroller unit, but which one? I'd been saying that I needed to explore this technology for about five years now, but the prices for the development kits were always beyond my budget. As I thumbed through the back pages of the magazines, I found that things had changed. There were several chips available that were erasable and re-programmable, and the prices for the development kits now started at under one hundred dollars. I quickly narrowed the field down—I needed just a few I/O ports, some sort of timer capability, and I felt I wanted it to be programmable in a language other than BASIC. (I couldn't keep my guru status if I admitted I'd programmed something in BASIC!). Of course, it needed to be affordable.

ADAPT-11 Microcontroller Starter Kit.

After much searching, I decided on the ADAPT-11 microcontroller modular system starter package from Technological Arts, in Toronto, Ontario, Canada. According to the ad, their board plugged right into a standard prototyping board; could be programmed from a PC; and the starter kit came with a board, a programming cable; and demo software. The ADAPT-11 used a Motorola MC68HC811E2 microcomputer chip, which contained 2K of electrically erasable on-chip memory, three eight-bit I/O ports, eight analog-to-digital converters, and an on-chip timer system. It was just the ticket! With much relief, I ordered their starter kit (P/N AD-11-SP) at a price of \$74.95 postpaid (US dollars). It was T-minus nineteen days, but at least I had some direction in fox building!

Over the next several days I decided to do some research on the 68HC811 microcontroller, so I could get right into the thick of things when the ADAPT-11 arrived. I went to the public library, then the college library, and struck out in both places. What I was looking for was a complete foxhunt transmitter control program, ready to download into any 68HC811 microcontroller.

About a week passed, and I did

not think the project much. However, I noticed that whenever I did think about it I was overcome with a vague feeling of gloom and despair. One night I came home from work and found a small parcel in the mailbox. Sure enough, it was from Canada—Technological Arts. But the box was only about 5 x 9 x 1 inches; maybe this was just the documentation. I opened it up, and found that this was indeed the whole order—the microcontroller board (a mere 2 x 3 inches), a couple of cables, a 3.5 inch disk, a Motorola Programming Reference Guide, a User manual along with data sheet and schematic from Technological Arts. Hmmm. I had to be at a meeting that evening, but I quickly popped the disk into my computer. A few .ARC files, some .ASM files, a few .BAT files — nothing like CW.EXE or FOXHUNT.TX. I flipped through the ADAPT-11 User's Guide —just a few notes on how to download files to the board. I grabbed the Programming Reference Guide — memory maps, opcode tables, control bit assignments.

It could just as well have been written in Greek. Maybe it was. Then it occurred to me—this whole kit was meant for someone who already knew what he was doing! The microcontroller kit looked insurmountable, but there wasn't enough time to go back to the discrete IC approach. I sure couldn't hide in the bushes and key the transmitter myself. There was only one solution—I was just going to have to buckle down and figure out enough about microcontroller programming to get myself out of this jam.

T-minus five days and counting. On the next available night, I sat down with the kit. The first thing to do was to figure out how to program the thing. The ADAPT-11 came with a three foot cable with a DB-9 connector on one end and a three conductor header plug on the other. I plugged the cable into my computer, and the other end into the ADAPT-11. I popped the board into a standard prototyping board, and jumped the five volt and ground pins to their respective sockets. According to the book, the board came pre-loaded with a

It's Not Just Training...

"I needed a refresher in fundamentals and a piece of paper that said I had a degree. CIE gave me both."

Louis P. Briant
Senior Engineer
Sentel Corp.

"CIE allowed me to use my G.I. Bill benefits and independent study allowed me to continue my studies while deployed."

Charles Hepper
Electronics Senior Chief
U.S. Navy

"The fact that I intended to continue pursuing my Associate Degree with CIE was a key factor in being considered for my current position."

Annamarie Webster
Project Engineer -
Instrumentation
Ketchikan Pulp

"My associates at work recommended CIE... The lessons were structured so they were easy to comprehend."

Vincent R. Buescher
Communications Technician
AT&T

"I re-enrolled and received my A.A.S. degree from CIE because of the good experiences I had in one of CIE's career courses."

Maurice M. Henthorn, Jr.
Electronic Technician
The Denver Post

...It's an Education.

Independent study from CIE will give you the skills you need to win your own independence in a successful career.

At CIE, we pride ourselves in keeping pace with the latest developing technologies. In turn, this assures our students that upon graduation they can mesh seamlessly into a variety of exciting and rewarding technology-based careers.

Back in the 1930's, we specialized in teaching radio and television sciences. Today, it's computer technology, programming, robotics, broadcast engineering, information systems management, and the electronics behind it all.

But some things have not changed, like the desire of CIE's faculty and staff to see their graduates succeed.

That is why at CIE we teach not only the hands-on, practical aspects of electronics technology, but also delve into the "why" behind today's technology. Why does it work the way it does?

The insights to be gained from such a broad, rich and comprehensive

education at CIE matches or exceeds those gained through traditional commuter institutes while providing an education schedule to match your commitments and lifestyle.

Our patented learning program is specifically tailored for independent study and backed up by a caring team of professional educators who are at your call whenever you need their help.

At CIE, we'll match our training with your background and career goals and help you decide which of the many career courses that we offer suits you best. We offer an Associate Degree Program and through our affiliation with World College a Bachelor Degree

Program.

If you have the sincerity, the smarts and the desire, CIE can make it happen. CIE is already the institute of choice for many Fortune 1000 companies. Why shouldn't you be next?



Computer Programming



Electronics Technician



1776 East 17th Street
Cleveland, OH 44114
(216) 781-9400 • 1-800-243-6446

YES! Please send me more information on:

- CIE's Associate Degree Program
- CIE's Career Courses
- World College's Bachelor Degree Program

Name _____

Address _____

City _____ State _____ Zip _____

Phone: _____

Check for G.I. Bill Active Duty Veteran

AH96

demonstration program. I wired up a small amplified speaker to one of the output ports as the manual suggested, and hit the power. The speaker dutifully beeped twice. I stared at the board—no smoke or steam was coming from any of the parts—so far, so good. I loaded a terminal program into the computer, and set the communications parameters as the book stated. I hit the enter key, and a small menu appeared on the screen. Well, the board was alive! The menu was simply a system that let the user perform a variety of operations on the board via the RS-232 port. For example, hitting "A" caused the board to output the status of the eight different inputs on the A Port. Hitting "0" to "7" caused the corresponding output of the B Port to toggle from high or low. Hitting one key caused the speaker to beep, and another displayed all the values present at the inputs of all eight analog to digital converters.

While there wasn't a pre-built foxhunt transmitter controller program on the disk, I did have all the functions I needed right here in this demo program. At the basic level, I really needed only two functions. First, I needed a pin to go high or low following a time interval—this would key the transmitter via the push-to-talk line. Second, once the PTT was activated, I needed to send some tones to the audio input of the transmitter. Somehow, the demo program was making a beep, and a beep is fairly close to a Morse code tone! I had no use at all for the analog inputs, or even reading whether a single pin was high or low, but apparently the demo program could do that too. The only problem now was how to modify the demo program to make it do what I wanted.

Yikes! It's Assembly Language. I dumped the supplied disk onto my hard drive, and reviewed the files. There was a file called DEMO.ASM—that looked like a good choice. I highlighted the file and chose VIEW. At first, I thought I'd looked at the wrong file. You know, like when you print out an .EXE file by mistake—all gibberish.

```
STACK equ $00FF
portb equ rbase+$04
```

As I looked closer I noticed that things were lined up a little too nicely for trash...wait a minute! I'd seen this stuff before—assembly language! Yikes! That was a long time ago, and it was scary then. *(Editor's note: For the non-guru's out there, software is also supplied to program the 68HC11 in C or BASIC language).* As I scrolled through the program listing, things slowly came into focus. I found what looked like the beginning of

clicked my cursor on the `ldab #2` line, and changed the 2 to a 3. No problem. Now I just needed to get the new program into the chip.

Several cups of coffee later, I finally got through the directions in the manual and figured everything out. Most of us have compiled a program on a PC, creating an .EXE file, but it's a little different on a microcontroller chip. Still, the EDIT/COMPILE/TEST cycle remains mostly the same. In a nutshell, the .ASM file contains the assembly language code which can be modified as we did in the above para-

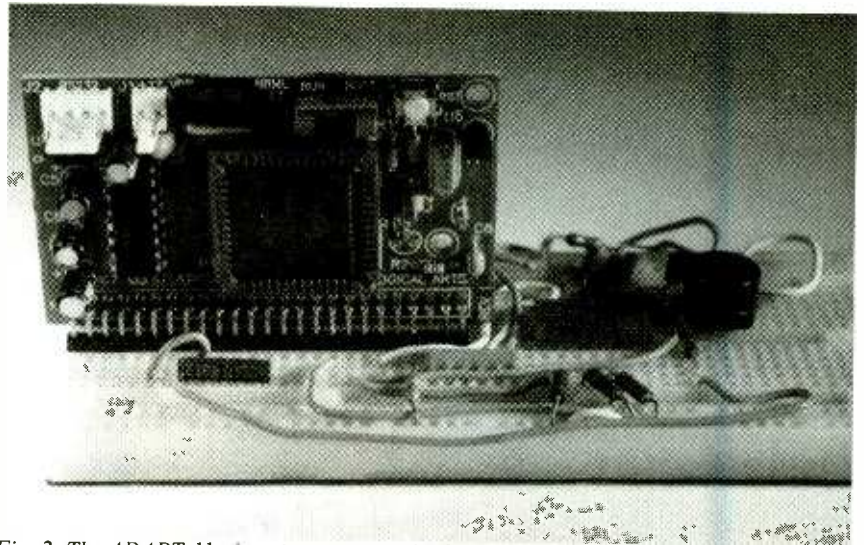

Fig. 2. The ADAPT-11 plugs into any standard prototyping board.

the actual program, after all of the variables and stuff. There was the following code:

```
ldx #TONE_440; generate two 100 ms beeps @ 440 Hz
ldab #2
ldy #_100MS
jsr PulseXToneB
```

Generate two beeps, eh? I wasn't exactly sure how they did it, but it looked like this loaded some stuff into some registers, then jumped-to-subroutine (`jsr`) `PulseXToneB` to make the beeps. I found the subroutine later on in the program and found that it let you load the frequency of the tone into the X register, load the number of beeps into the B register, load the duration of the beeps and the space between them in the Y register—and make beeps! (I eventually found that they were simply flipping an output pin high and low at an audio rate.) I

graph. The assembly file is changed into an S-record file, which is a standard file format for Motorola microcontrollers. This S-record file is changed into a binary object file using a conversion utility. The binary file is then sent to the controller via the RS-232 port. This whole process takes longer to explain than to perform, and all of the necessary assemblers, converters, and batch files are included with the ADAPT-11 package.

Once the binary file is ready to send to the microcontroller, you simply load up a batch file, flip a switch on the board, and hit the board's RESET switch. This puts the board in a "ready to get programmed" mode. Hitting a key on your computer starts the batch file that sends the information to the micro. The download process takes about a minute and a half—the

(Continued on page 81)

STRETCHING RECHARGEABLE BATTERY TECHNOLOGY

Douglas Page

Tailoring a synthetic carbon fiber commonly found in socks, researchers have stretched rechargeable battery technology to new limits.

Scientists at Sandia National Laboratory in Livermore, California, have created safer, lighter, longer-lasting, and less-expensive rechargeable batteries, using a lithium-ion technology that shows considerable promise. The new batteries were specifically developed for use in electric vehicles. However, other industries, such as consumer electronics, aerospace, and defense, could potentially benefit—a prospect that excites researchers. "Lithium-ion rechargeable batteries will eventually replace almost all rechargeable battery technologies," Sandia materials scientist Bob Crocker predicts, "because they have four times the energy density of lead-acid batteries, such as those used in automobiles, and two to three times the

energy density of nickel-cadmium batteries. The heavy metals used in those conventional batteries are costly and pose environmental risks."

Lithium-ion Virtues. The new rechargeable lithium-ion batteries are safer to manufacture and operate, use less raw material, and are environmentally benign. The intercalation material for the new batteries was designed at Sandia from an inexpensive chemical called polyacrylonitrile. That is a fiber made of synthetic carbon and manganese dioxide, which is commonly used in socks and carpets. Sandia chars the polymer to create a carbon matrix that is then impregnated with extremely light

lithium ions. That process eliminates the need to use inefficient and flammable, solid lithium metal. The carbon serves as a negative electrode where electrons are generated in a battery. The batteries convert the chemical energy into electrical energy.

The project is part of a three-year cooperative research and development agreement begun in 1992 with the U.S. Advanced Battery Consortium intended to develop new battery technologies. Its purpose is to meet the power needs of electric vehicles being developed to comply with approaching zero-emission standards. The requirements for zero-emission vehicle sales begin with ten percent of the vehicles sold in the Los Angeles area in 2003. Lithium-ion technology, using carbon and manganese oxide electrode materials, has an inherent advantage in cycle life and low material cost.

A lithium-ion battery the size of a book can store 400-watt hours and enable an electric vehicle to go four times farther than electric vehicles operated from lead-acid batteries. The bad news is, right now about 100 of the lithium-ion batteries would be needed for an electric vehicle to operate at acceptable range and acceleration demands. That liability does not apply to other applications. "In addition to electric vehicles, lithium-ion rechargeable batteries are useful in any power-hungry application," said Crocker, "such as laptop computers, cellular phones, lawn mowers, camcorders, and cordless power tools, because of their ability to work longer or lighter." Standard size batteries (currently dominated by NiCd cells, particularly 9-volt standard cells) could easily be

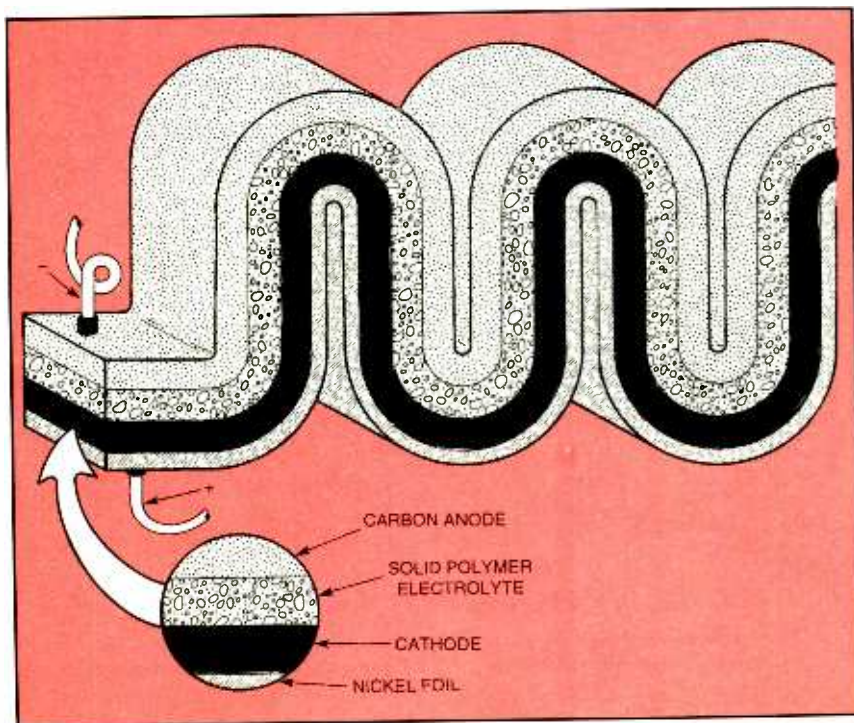

Fig. 1. Here is a cross-sectional view of the breakthrough rechargeable lithium-ion battery developed by researchers at Sandia National Laboratories using common carbon fibers found in ordinary socks and carpets.

replaced by lithium-manganese dioxide rechargeables, due to their low cost and low environmental impact. Sony and Sanyo are already marketing cellular phones and camcorders with lithium-ion batteries. Toshiba and Dell have laptop computers with lithium-ion batteries on the market.

The lithium-ion batteries are also attractive to aerospace and defense contractors. Their high energy density and potentially long life offers significant advantages to satellite technology, where launch weight is critical. Not only will they last four times longer than conventional batteries, but more instruments can be designed into satellites.

Lithium is a desirable anode material for rechargeable batteries because of its high energy density. Non-rechargeable lithium batteries have been available for years, but rechargeable lithium technology has been hampered by the electrode position of lithium metal during charging. During recharge, lithium metal is prone to form dendrites—metal whiskers—that tend to short the electrodes. Those shorts limit the number of charge-recharge cycles of the battery. The shorts also induce a fire risk. The development of the lithium-ion cells based on lithium intercalation materials heralds a breakthrough in rechargeable batteries. Lithium intercalation materials donate or accept lithium ions without dissolving or depositing lithium or any other solid.

Carbon's low-cost and high-charge density (comparable to lithium metal) has elevated it to the prime lithium intercalation anode material. That material is produced from a commercially available, low-cost polymer precursor, which is manufactured through an oxidative stabilization process, followed by heating to 1100° C, producing a fine powder whose particle size averages 5 microns. For battery manufacturing, the powder can be either bound into conventional porous electrodes for use in cells with liquid electrolytes or it can be processed into polymer composite electrodes for solid polymer electrolyte cells.

Computers ---- They're taking control!



"It's sneaky, but we let them play a game while we're really teaching them to read."



"I don't see how a child that does his family's income taxes can be failing at computer math!"



"Ms. Rose, it is very obvious to me that you are not IBM compatible!"



"I like working with the computer. It's so much easier to erase than the blackboard!"



"All my students read two grades above level. Is it me or the software?"



"I may not be a great wizard, but look at what I can do with a computer!"

Or are they?

RESEARCHERS INCH UP ON THE ULTIMATE ELECTRONIC RULER

Scientists at the National Institute of Standards and Technology in Gaithersburg, Maryland, recently unveiled a tool, called the Molecular Measuring Machine, that, after some fine tuning, is expected to be able to precisely locate and measure molecule-sized features. The range of the new machine, the only one of its kind in the world, is 250,000 times greater than that of most scanning tunneling microscopes (STM), whose needle-like probes can already spot individual atoms.

The New Equipment

The new machine, known as M³, will be used to shrink the microelectronics world even further, allowing semiconductor manufacturers to align masks during the complex process of printing ever smaller cir-

Government researchers have developed a ruler that will be hard to measure up to!

DOUGLAS PAGE

cuit patterns. M³ will also be used to calibrate various manufacturing measurement references that manufacturers can use to check the accuracy of their own measurement equipment. The instrument is the invention of a team lead by Clayton Teague, chief of the Nanoscale Metrology Group in NIST's Manufacturing Engineering Laboratory. He began the project in 1987 to meet the U.S. microelec-

tronics industry's most advanced measurement requirements into the 1990s. M³ is the result of that effort.

The researchers expect M³ to measure, within one billionth of a meter—the equivalent of a string of four or five silicon atoms—the distance between two points. That's an area that is about a square 50 millimeters on a side, just smaller than a folded dollar bill. By comparison, the range of most STMs is about one thousandth of a meter, or one-tenth the diameter of a grain of sand. Figure 1 demonstrates M³'s measuring capabilities relative to common objects.

For perspective, M³'s capabilities are similar to being able to locate two widely separated grains of sand in a 2,500 square-kilometer (960 square-

(Continued on page 77)

Molecular Measuring Machine

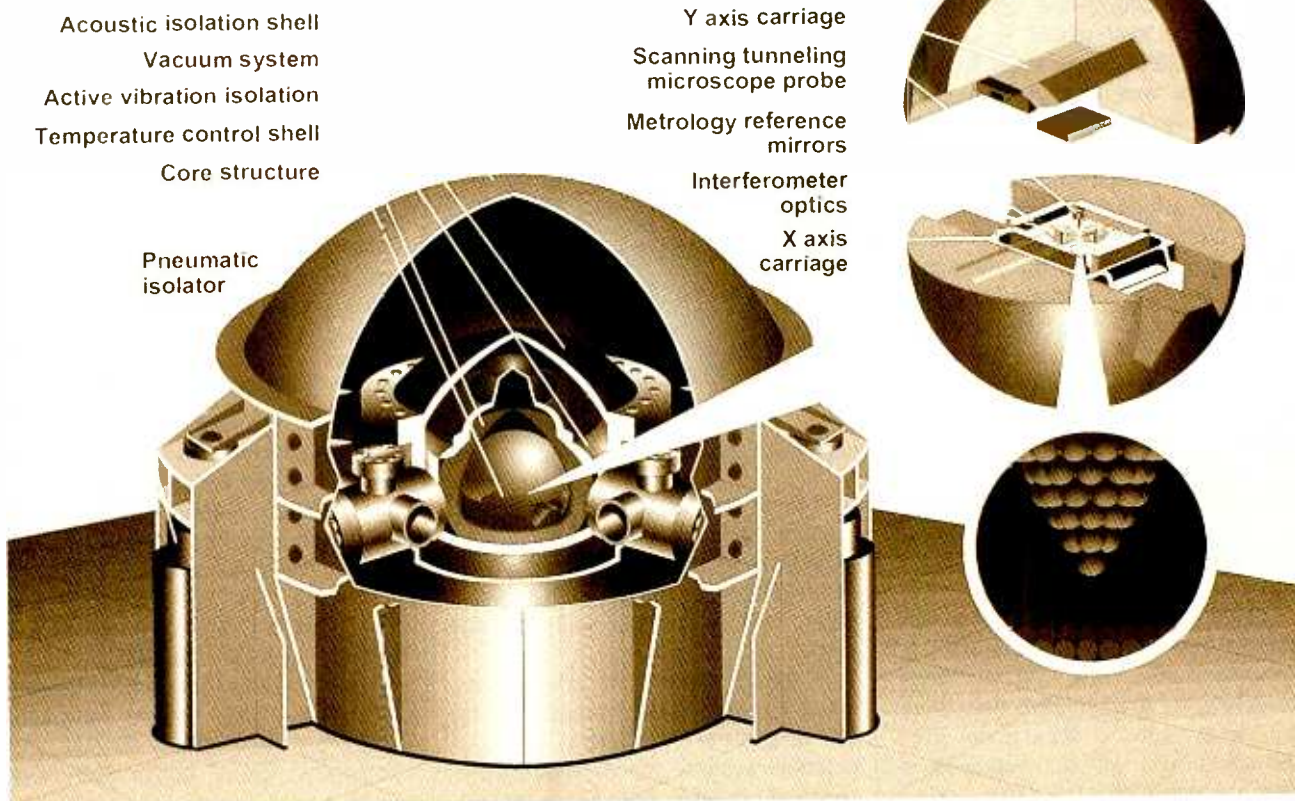

Here are the components of the molecular measuring machine, known as M³, designed by the National Institute of Standards and Technology. The machine will help shrink the microelectronics world even further.

SCANNER SCENE

Tracking Trunked Transmissions

MARC SAXON

The prayers of many scanner fans were answered with the introduction of *Uniden America Corporation BC235XLT Trunk Tracker*, the world's first scanner capable of tracking a selected radio transmission as it moves across a trunked radio system. This is a revolutionary unit, to say the least.

Multi-channel trunked 800-MHz radio systems are now becoming very popular in the public-safety, business, and other radio services. Using standard scanners, monitoring enthusiasts have found it extremely difficult, if not altogether impossible, to track a conversation as it shifts from one frequency to another within a trunked system's repeaters. With a standard scanner, you need to initiate a new search each time the conversation breaks and the channel switches. You could end up in another conversation, and by the time you find the one you wanted, you might have missed most of the traffic. But the BC235XLT follows the conversation from channel to channel.

The BC235XLT can track Type I, II, and III, as well as hybrid systems. There are ten trunking banks. You program the repeater output channels for a particular trunked system into one of the banks, which will accommodate up to 30 channels. Program the system type: Type II (sort of the default) or Type I. If Type I is selected, then you can enter the individual fleet sizes and start locations; or you can select from 16 preset fleet maps. For hybrid systems, you enter all of the Type I and III fleets and everything else will be Type II. This is rather a nuisance if you don't know the fleet map for a particular system, but most now are Type II, and as time goes on you'll be better able to figure out the fleet maps.

Once the scanner is programmed, select trunked mode and one of the 10 trunking banks. The unit will begin searching for the system's data channel. When it's found, the scanner starts searching. IDs will be displayed as they are received. If the delay mode is activated, when the conversation pauses the ID remains in view. The

scanner seeks out the rest of the conversation on another channel until the delay expires. If the feature is off, the scanner immediately grabs the next ID. Type II IDs are displayed as "2048"; Type I as: "1-5."



Uniden's revolutionary Trunk Tracker can actually follow trunked conversations as they jump from frequency to frequency.

There are ten scan lists for each trunking bank. You enter IDs that you want to scan into those lists. Each list can take ten IDs, and you can select or delete any of the lists while in scan mode.

While in search or scan mode, there are 15 repeater activity indicators across the top of the LCD screen to show system status. Each represents a repeater, and the ones displayed represent active conversations. When the scanner locks onto a con-

versation, the indicators turn off except for the control channel and the one being monitored.

When you find a conversation you want to monitor, push "hold," and the BC235XLT will look for and track it until you return to scan or search mode.

This is 300-channel scanner that receives 12 bands plus VHF aeronautical and preprogrammed Service Scan for police, fire, emergency, marine, and weather channels. There are ten priority channels. The internal memory backup will hold programmed frequencies for more than three days without power. The scanner's suggested retail price is \$429.95.

Marines to the Rescue

Now is the time of year when the marine channels are at their most active and interesting. If you are monitoring within earshot of a coastline, navigable river, inland waterway, or large lake, why not tune up on at least some of these channels.

Pleasure craft, yacht clubs, marinas, and the like literally swarm on 156.425, 156.475, 156.50, 156.55, 156.875, 156.95, 156.975, and 157.025 MHz. Try 156.45 MHz as the calling channel.

Commercial craft, including ferries, tugs, water taxis, tankers, ore carriers, harbor pilots, etc., can be heard on 156.30, 156.35, 156.375, 156.40, 156.50, 156.55, 156.875, 156.90, 156.95, 156.975, and 157.025 MHz. Try 156.45 MHz as the calling channel.

Vessels report emergencies to the Coast Guard on 156.80 MHz, and are usually asked to switch to 157.10 to continue their communications.

The Coast Guard can be monitored on 156.60, 157.05, 157.075, and 157.15 MHz. The Coast Guard Auxiliary uses 157.175 MHz.

Near large commercial harbors, monitor 156.275, 156.30, 156.325, 156.60, 156.65, 156.675, 156.725, and 157.00 MHz. Some harbor police use 156.85 MHz. Vessels requesting that canal locks or drawbridges be opened

(Continued on page 79)

DX LISTENING

Hallicrafters S-41G Skyrider Jr.

DON JENSEN

One day, nearly 50 years ago, my father brought home a used shortwave receiver.

As a young boy I had already discovered the fun of tuning in stations in far off lands on the family's all-band console radio. I heard HCJB in Quito, Ecuador, stations in Australia, Switzerland and a few other countries. I'd even logged, somewhat furtively in those days, R. Moscow!

maybe 40 or more countries. Then, though, it was time for something bigger, and better, and newer. So I sold the S-41G.

Many years later, I regretted doing it. I was, by then, using a new solid-state-of-the-art receiver that could perform rings around that old six-tuber. But middle-age nostalgia demanded I find another Skyrider Jr., the SW radio of my youth.

them on, not wanting my memories dashed by the reality of 1940's vintage technology.

Ever since, these two table-toppers have served me as a set of bookends in my DXing corner. But just the other day, I received a copy of Fred Osterman's new book, *Shortwave Receivers Past & Present: Communications Receivers 1945-1996*. And as I paged through it, I came across, on page 121 of this 350-page softcover book, my Skyrider Jr., with photo and lots of information.

I found out a lot about my boyhood radio that I hadn't known before. It was, I learned, manufactured by Hallicrafters in 1945 and 1946, and sold new for \$34 to \$37. Even a half century later, Osterman indicates, it is a commonly found model with a value between \$40 and \$80, depending on condition.

As I looked a bit further down the page, though, I saw a smaller photo, a picture of my "mistake," an S-41W in its white metal cabinet. Next to it was the caption:

"The S-41W is very scarce and highly collectible model. In good condition it sells for \$100 to \$150."

Hey, Fred, you made my day!

Shortwave Receivers Past & Present (Universal Radio Inc., 6830 Americana Parkway, Reynoldsburg, OH 43068-4113; \$19.95) is a great reference text and a fascinating read for anyone with an interest in SW receiver history, covering, in text and photos, over 500 SW receivers from 70 American and international manufacturers.

And may you also find your own first SW receiver, whatever it may be.

It's In The Mail

Coincidentally, this month I have a letter from Robert Johnson of Anacortes, WA, who also is interested in radios from an earlier era.

"I've looked in several radio shops at shortwave receivers," Robert writes. "And I wonder whatever became of Nordmende."

"I recall, some years back at least, Nordmende offered several models of

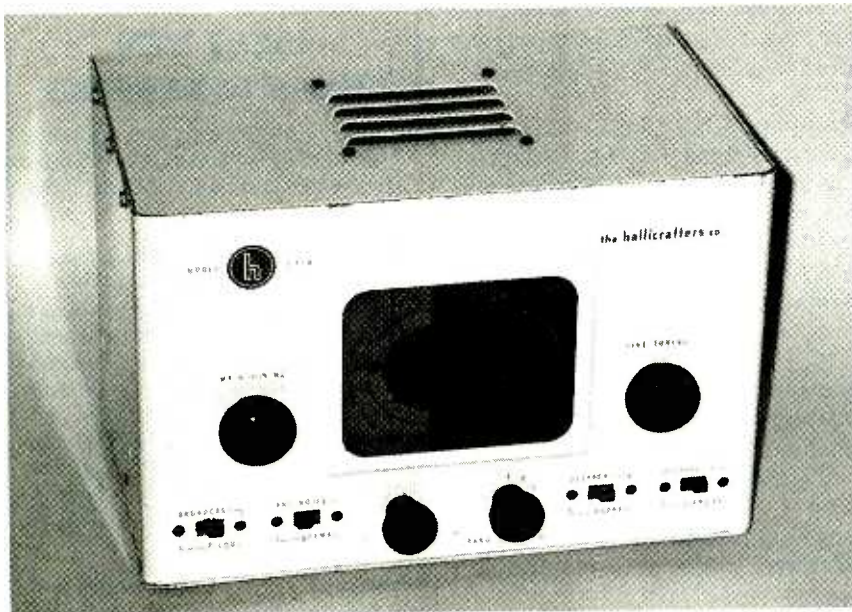

Rare and unusual shortwave receiver, the Hallicrafters S-41W Skyrider Jr., vintage 1945-46.

But this set changed things. Now I had a *real* shortwave receiver!

It was a Hallicrafters S-41G. This was no "living-room set;" it had no console-styling, varnished-wood cabinet. This was an honest-to-goodness, six-tube, shortwave receiver in a no-nonsense, boxy, metal cabinet, finished in black and crackled-finish gray enamel. On its face was stenciled the model number and its name, Skyrider Jr.

Its very appearance seemed to shout: This is a *DX machine!*

It served me well, for the next three or four years, allowing me to hear,

I advertised in radio magazines and, soon, a fellow responded saying he had one he was willing to sell me. I sent him a \$60 check and, before long, a cardboard box arrived at my door.

With anticipation, I opened the carton. And there it was, a Skyrider Jr. But this was not the radio of my boyhood. Instead of the rugged looking gray and black cabinet, this metal cabinet was *white!* It was, I learned subsequently, an S-41W, for white, not an S-41G, for gray.

Well, I kept it anyway. And, a year or so later, I did come across another Skyrider Jr., this one an honest-to-goodness S-41G. I was pleased to have them both, but never switched

CREDITS—Erik Bueneman, MO; William Flynn, OR; Don Moore, MI; Ed Newbury, NE; Sheryl Paszkiewicz; Christos Rigas, IL; Betsy Robinson, TN

first class receivers. Now when I ask salespeople in stores or on the phone, they've never heard of the brand. I don't plan to part with my radio funds until I find out what, if anything, is available from Nordmende!"

I remember Nordmende, Robert! Back in the 1950s, this German firm—Norddeutsche Mende Rundfunk KG of Bremen—turned out some slick looking, AM-FM table model sets during the early days of "hi-fi" radio. They fiercely competed with similar looking and sounding Grundig sets, also German-made.

Though most people bought them for their FM sound, they were all-band sets, meaning shortwave, and they performed fairly well on the SW bands.

But I too lost track of what happened to this once well-known brand name. So I asked receiver guru, Larry Magne, editor-publisher of the well-known *Passport To World Band Radio*.

"Nordmende—it appeared as nordMende on the dial—made shortwave radios at least into the mid-1970s," says Larry. "During that decade, the company was taken over by French electronics giant, Thomson. A few years later, Thomson was nationalized by the French government, which moved it away from consumer products area and toward government—military, avionics and the like.

"Today, Thomson is being re-privatized, but is still effectively controlled by the French government, and Nordmende is under the division of Thomson known as Thomson multimedia (spelled with a lower-case "m").

"As a brand, Nordmende still exists, the name appearing on such products as TV sets. But I haven't seen a new Nordmende shortwave portable in a good 20 years."

So there you have it, Robert. Wait no longer for a new Nordmende radio. If you've set your heart on a German-made SW portable receiver, you might want to consider one of the new Grundig Yacht Boy models.

Down The Dial

Looking for something interesting in SW signals-to-tune?

Try these. You, no doubt, are hearing other stations, so why not drop me a note telling about your loggings. Please list reception times in Coordinated Universal Time (UTC), which is equivalent to EDT + 4 hours,

Abbreviations

AM—amplitude modulation
 CDT—Central Daylight Time
 DX—distance, long distance reception
 EDT—Eastern Daylight Time
 FM—frequency modulation
 ID—station identification
 kHz—kilohertz
 MDT—Mountain Daylight Time
 PDT—Pacific Daylight Time
 R.—Radio
 SW—shortwave
 UTC—Coordinated Universal Time

CDT + 5 hours, MDT + 6 hours, or PDT + 7 hours. Your DX receptions could be listed here next month.

If you have any shortwave-related questions and/or topics we should cover, send them along too.

Address your letters in care of DX Listening, **Popular Electronics**, 500 Bi-County Blvd., Farmingdale, NY 11735.

Antigua—6,160 kHz, Germany's Deutsche Welle has been heard via this West Indian island relay transmitter. Look for it in English at around 0930 until it leaves this frequency at 0950.

Armenia—9,965 kHz, Voice of Armenia noted in English at 2130 UTC, with talk about Armenian history and a newscast.

Czech Republic—13,580 kHz, R. Prague broadcasts in English here at 1400 UTC, with identification and news. At 1430 UTC, the programming language switches to Czech.

Hungary—5,905 kHz, R. Budapest has been heard here at 0225 UTC with English programs, including a shortwave DXing program.

Surinam—4,991 kHz, R. Apintie, broadcasting from this former Dutch colony in South America, is heard mornings around 1040 UTC, and evenings until sign off shortly after 0400 UTC. Programs usually consist of popular music and Dutch news announcements.

Taiwan—7,130 kHz, Taipei's Voice of Free China broadcasts here at 1200 UTC in English, with news, ID and a program called "Jade Bells and Bamboo Pipes." ■

You can reach us on the Web!
www.gernsback.com

VCR Cross Reference

NOW Find the right Part
for your VCR

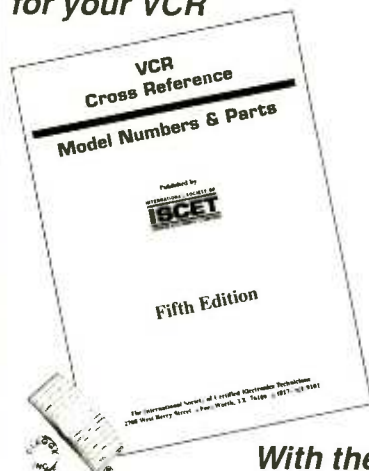

With the

IS CET VCR

CROSS REFERENCE

This 119-page reference contains both model and part-number cross-references updated to include 1994 units.

VCR's are made in a few factories from which hundreds of different brand names and model numbers identify cosmetically-changed identical and near-identical manufactured units. Interchangeable parts are very common. An exact replacement part may be available only a few minutes away from you even though the manufacturer supplier is out-of-stock. You may be able to cannibalize scrap units at no cost!

The IS CET VCR Cross Reference is pre-punched for standard loose-leaf binding. . . \$38.00 plus \$3.00 for shipping for each Reference.

Claggg Inc.

VCR CROSS REFERENCE OFFER

P.O. Box 4099

Farmingdale, New York 11735-0793

Name _____
 Business _____
 Address _____
 City _____
 State _____ Zip _____
 Phone _____

Enclose \$38.00 for the Fifth Edition of the IS CET VCR Cross Reference and \$3.00 for shipping for each Reference.

The total amount of my order is \$ _____
 Check enclosed—do not send cash,
 or please charge my credit card.

Visa MasterCard Exp. Date ___/___/___
 Card No. _____

Signature _____

New York State residents must add applicable local sales tax to total. US funds only. Use US bank check or International Money Order. CB02

ANTIQUE Radio

Introducing the Freed-Eisemann NR-5

MARC ELLIS

Last issue, we discussed the development of the tuned-radio-frequency, or TRF, circuit and its application in the ubiquitous "three-dialer" radio so common during most of the 1920s. This month, we'll look in more detail at one particular three-dialer—the *Freed-Eisemann Model NR-5*. In future issues, we'll carefully check out an example of one of these radios and

lation. But the elegant method was a circuit trick introduced by L. A. Hazeltine, a professor of electrical engineering at the Stevens Institute of Technology. The method was called *neutralization*, and Professor Hazeltine's circuit was dubbed the *Neurodyne*.

In the Neurodyne, some of the RF amplifier's output was coupled back to

Freed-Eisemann and the Neurodyne

According to Alan Douglass (*Radio Manufacturers of the 1920's, Volume 2*, copyright 1989, published by Sonoran Publishing, 116 North Roosevelt, Suite 121, Chandler, AZ 85226), the Freed-Eisemann company had its beginnings in 1921 with the introduction by Joseph Freed of an inexpensive crystal-set out-

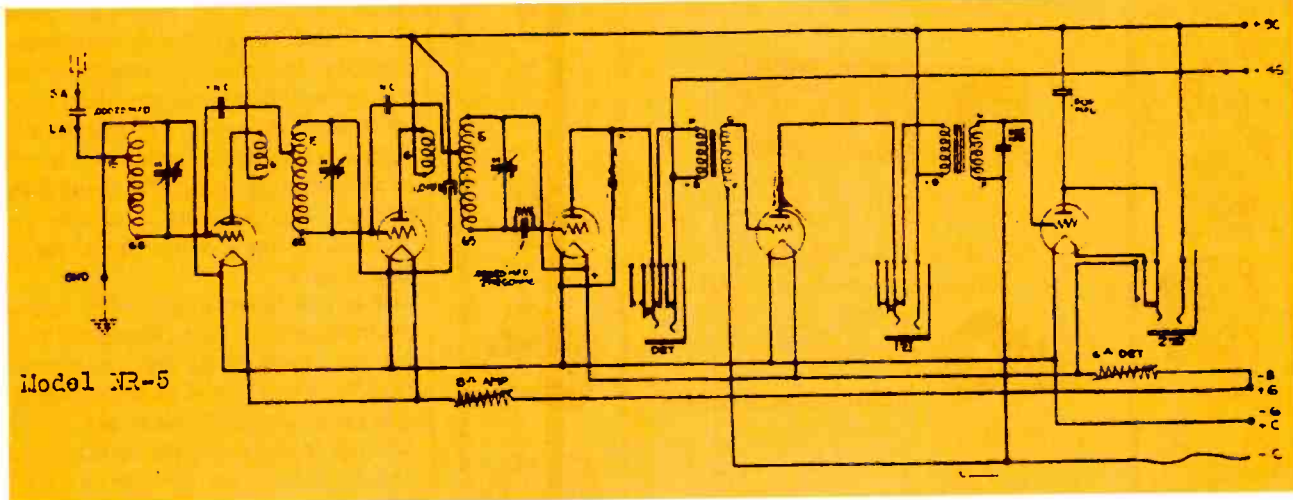

Fig. 1. Sorry! This is the best NR-5 schematic I've been able to find—but it does allow you to trace the basics of the circuit.

restore it as necessary. Then we'll apply the proper filament and plate voltages, hook up a speaker, antenna, and ground, and see what comes out!

Why the NR-5?

A lot of 1920's manufacturers made three-dialers. Such sets typically included five tubes, two of which were used as RF amplifiers with inputs and outputs tuned to the same frequency. As was discussed last time, a few different approaches were used to suppress the feedback and resulting oscillations that were so apt to occur when the simple triode tubes of the era were hooked up in that manner.

Some manufacturers, among them Atwater Kent, Kolster, and Freshman, deliberately introduced inefficiencies or "losses" into the circuit to "tame" the triodes and reduce the likelihood of oscil-

lation. The result was a cancellation of the tube's internal capacitance, suppressing the tendency to oscillate. Many manufacturers resorted to other methods (as described above) to avoid paying royalties for the Hazeltine circuit. But the Freed-Eisemann firm bought in, and was one of the first companies to produce and heavily advertise (beginning in 1923) a Neurodyne set.

That set was the Model NR-5, a radio I always think of as the classic three-dialer. In fact, one reason that I haven't done a three-dialer restoration in all the years I've been writing this column is that I didn't have a good NR-5 to work with. However, that is no longer true. There is now one waiting in the wings, ready to appear on stage when the restoration begins!

fit dubbed "Marvel." The little set sold so well that Freed, seeking capital to expand, formed a partnership with his brother Arthur's employer, Alexander Eisemann. (Arthur eventually became secretary of the firm.)

But in 1922, the first major wave of broadcast set purchases was coming to an end, and sales were ebbing. On top of that, a company known as "The Wireless Specialty Apparatus Co.," which held key patents in crystal-set technology, had begun threatening to sue all other companies making or selling crystal detectors. Freed-Eisemann took an aggressive stance, organizing a group of New York crystal-set makers into the Independent Radio Manufacturers, Inc. for the purpose of filing counter-suits.

But the point became moot when the Hazeltine breakthrough was

The New Hazeltine Neutrodyne

AND DEPENDABLE PARTS FOR OTHER CIRCUITS

A startling advance in radio progress. Non-regenerative. Non-oscillating. No howling or hissing. Remarkable clarity and power and tremendous distance. Simple operation. Built by the Freed-Eisemann engineering organization of master craftsmen.



Model NR-5
\$150.00

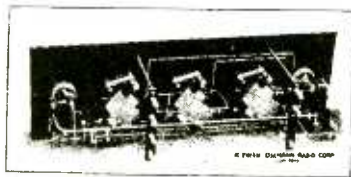

REAR PANEL VIEW MODEL NR-5
(No Voltmeter Not Recommended Used)

ESSENTIAL PARTS for Hazeltine Neutrodyne Circuit



Model NR-5
\$3.00



Model NR-5
\$3.00

Freed-Eisemann apparatus is guaranteed. If your dealer cannot supply you—write us.

Freed-Eisemann Radio Corporation

"Pioneers in Radio Broadcast Reception"

255 Fourth Avenue New York, N. Y.



CRYSTAL DETECTOR - 701



Model NR-5
\$3.00



Model NR-5
\$3.00



Model NR-5
\$3.00



Model NR-5
\$3.00



Model NR-5
\$3.00



Model NR-5
\$3.00



Model NR-5
\$3.00



Model NR-5
\$3.00



Model NR-5
\$3.00

Freshman Company, soon to be renamed Earl Radio Corporation.

Basic NR-5 Circuitry

The NR-5 schematic diagram that accompanies this column, taken from *Rider's Volume 1*, is regrettably not the best quality. But it's the best one I've been able to get my hands on and presumably is the same one that many early radio servicemen also had to struggle with! In any case, it is good enough so that you can see the general design of the receiver.

The first thing you'll notice is that the set has five tubes, which is characteristic of the three-dialer receiver. Although not marked on the schematic diagram, these are intended to be the 01-A tubes found in almost every set of this type made during that era. Notice that there is a tuned circuit (coil and variable capacitor) in the antenna/ground circuit. It is followed by two RF amplifier tubes, each working into an RF transformer whose secondary is tuned with a coil and variable capacitor. The tuning dials for those capacitors are, of course, the "three dials" that give this type of set its jargon name.

Each of the two RF tubes has a neutralizing capacitor connected from the secondary of its RF transformer back to its grid. Although the schematic is fuzzy, you might be able to make out that these capacitors are labeled "N.C." The third tube is wired as a conventional grid leak detector. You can see the grid leak resistor, with its parallel capacitor, in series with the grid of the tube.

The output of the detector is coupled, via an audio transformer, to the grid of the fourth tube, which is the first audio amplifier. This, in turn, is coupled via another audio transformer to the grid of the fifth tube, or final audio amplifier.

Notice that three audio-output jacks are provided. For local stations and other strong signals, the earphones can be plugged directly into the output of the detector tube. For weaker signals, the listener might plug the phones into the output of the next, or first audio, tube. Where room-filling volume is required, a loudspeaker would be plugged into the output of the last, or second-audio, tube.

It's interesting to study the automatic switching arrangements built into the

(Continued on page 80)

announced. Now it was possible to leave crystal technology behind and make a good tube radio, which previously could not be done without infringing upon the closely held Armstrong regenerative patents. Freed-Eisemann geared up its manufacturing operation to switch from simple crystal sets to five-tube Neutrodynes and, in 1923, began selling NR-5s hand over fist.

Advertising copy for the NR-5 (which sold for the hefty sum of one hundred and fifty 1923 dollars without tubes or batteries) promised: "A startling advance in radio progress. Non-regenerative. Non-oscillating. No howling or hissing. Remarkable clarity and power and tremendous distance. Simple in

operation. Built by the Freed-Eisemann engineering organization of master craftsmen."

Sales in 1923 and 1924 were excellent, and some model variations were introduced. But the numbers began to slump the following year due to competition from manufacturers turning out lower priced three-dialers using "losser" circuitry to circumvent the Hazeltine patents. The firm introduced a non-Neutrodyne model (the 10) to compete, but it didn't work well. Despite other innovations, including a pioneering but premature AC model introduced in 1927, Freed-Eisemann never regained its leadership position. In 1928, the company was sold to the Charles

Think Tank

Audio Fun

JOHN J. YACONO
LAB TESTING COORDINATOR
WINDOWS MAGAZINE

This month's column is filled with audio circuits from readers. Before we get to those letters, let's continue our discussion about diodes and their uses by discussing "alternating current" (AC). With the exception of our discussion on transformers, we have mostly talked about direct current (DC), or current that flows in one direction through a component or conductor. To discuss the usefulness of diodes as rectifiers, we should start with a definition of AC, or current which flows first in one direction, then another. Most often, the change in current direction is not

sudden but gradual, and is caused by a shift in polarity of the voltage source. For example, household AC is the result of voltage that rises, falls and changes direction 60 times a second. Plotting this voltage over time results in the sine wave graph shown in Fig. 1A. The voltage rises from zero (at time T0) to a maximum voltage (at time T1), falls back to zero (at time T2), and changes polarity as it falls to a negative maximum voltage (at time T3), and then rises to zero again (at time T4). For household outlets, this cycle occurs at 60 times a second, or 60 "Hz". If the resistor of Fig. 1B is exposed to such a voltage source, the current through the resistor would rise and fall as shown in Fig. 1C.

much less loss than DC. Electrical utility power is also sent out at much higher voltages than required for most devices. Again that increases the effective distance you can transmit the power. Before it comes into your home, this voltage is reduced by a distribution transformer to 117 volts AC (actually two supplies at 117 volts each).

Next month, we will discuss how that voltage is reduced further by transformers in most electronic devices and how diodes help convert that to DC. But now, it's time for the letters!

Twenty Watt Audio Amplifier

This push-pull amplifier circuit of Fig. 2 uses two TO-220 monolithic Darlington transistors to produce the audio output. Frequency response is flat within ± 1 dB from 30 Hz to 200 kHz, with typical harmonic distortion below 0.2%. One other transistor is needed, a 2N5961, to provide voltage gain for driving the Darlington pairs. The input signal must reach 1.2-volts for a full 20-watt output into an 8-ohm

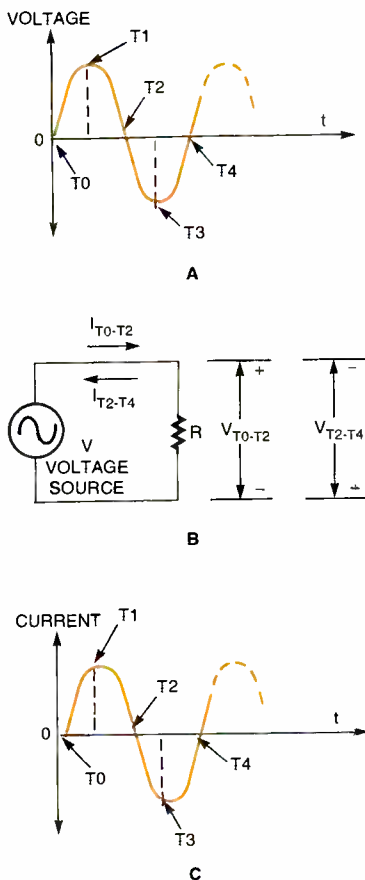

Fig. 1. Faster than you can blink your eyes, a household alternating voltage (A) completes 60 of these cycles in a second. (B) When resistor R is connected to this voltage source, alternating current flows in C. AC flows in the same time relationship as the voltage source.

While motorized devices such as blenders, electric can openers, shop equipment, etc., are designed to run directly from AC current, many electronic devices require DC. Why do power authorities use alternating current and voltage to transmit electrical power? The main reason is it can be transmitted over long distances with

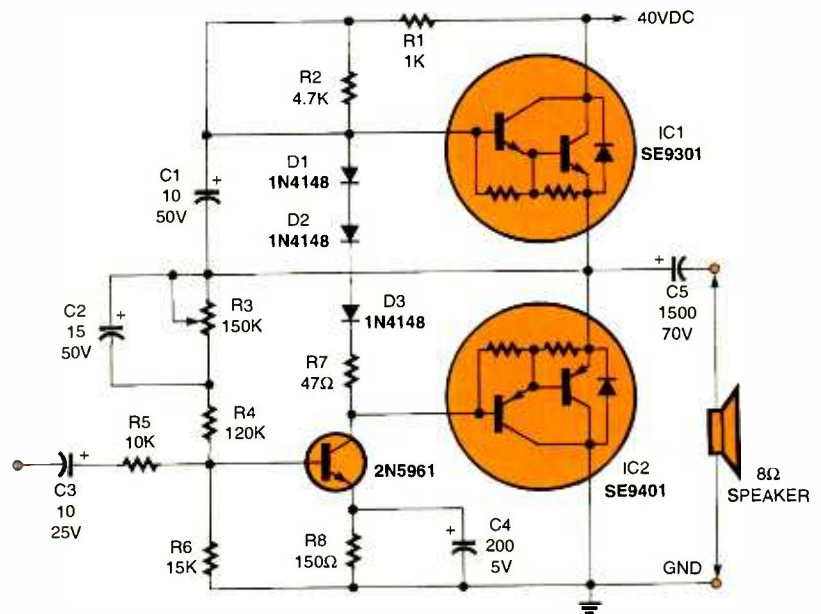

Fig. 2. This simple inexpensive audio amplifier delivers a punch of 20-watts. An equivalent Darlington pair to use is SK3180 for IC1 and SK3181A for IC2—and don't forget to heatsink these devices!

load. The input resistance of the source is 10,000-ohms.

—Alex Belenky, Brooklyn, NY

Very nice. Naturally, heat sinks are required for Darlingtons, and typical input signals will need some preamplification. The trimmer potentiometer needs adjusting to prevent distortion.

Amplifier Built With One Integrated Circuit

After seeing the various amplifier circuits (walkman amps, preamps, etc.) featured in your column, I thought it might be fun to build a power amplifier circuit. The circuit I came up with is shown in Fig. 3, and is surprisingly simple. It is based on the LM383 8-watt audio amplifier integrated circuit. This IC needs only a few additional components and a heat sink to make a high quality 8-watt audio amplifier. This circuit is a perfect match for simple one or two transistor preamps used in a PA system or intercom. If you have a portable CD player, you could build two of these and use them with some good speakers to get very high-quality sound.

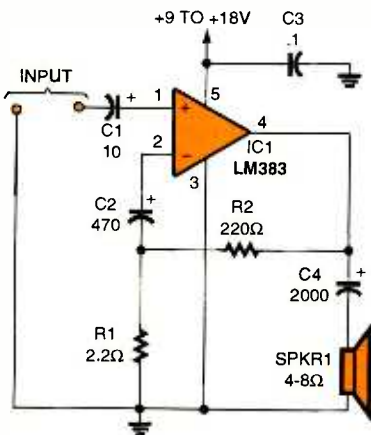

Fig. 3. This one-chip amplifier is the perfect circuit for any portable audio application.

The low current consumption (only 45-mA) makes the amplifier very portable and compact. I didn't include a volume control, because I wanted the amplifier's volume to always be "full out." I'm sure a 100-ohm potentiometer connected to the input would do the trick.

—Aaron Cake, London, Ontario

That is nice and simple. If you're going to build a stereo version of the circuit with the recommended 100-ohm volume control, make sure the potentiometer is a stereo (dual-ganged) unit.

Guitar Practice Amplifier

I've found that the most challenging aspect of amplifier design is avoiding 60 Hz noise. The power amplifier rarely adds much power line noise, so the preamplifier is usually the culprit. Typical common-emitter transistor preamplifiers seem to add the most noise, with op-amps being not far behind. I recently decided to try the LM382 low-noise dual preamplifier for my guitar preamplifier. The trick is likely that the preamplifier circuitry is run off a regulated supply, with the regulator being included inside the IC.

My resulting circuit (Fig. 4) has good volume and power levels, very low 60 Hz noise, and an output level or distortion meter—all with a minimum of parts and fuss. In the schematic, IC1 is the LM382 dual preamplifier (only one preamp is used), IC2 is an LM383 audio power amplifier, and IC3 is an LM3915 LED dot/bargraph display driver with an external LED bargraph display unit.

A curious feature of this circuit is the input at the preamplifier. Note that the inverting input (pin 2) is unconnected! This is not a schematic error. My IC Databook didn't give much guidance; I happened to try it as shown,

and it works well. Maybe it's internally ground-referenced? I don't know for sure.

If you use component and power values exactly as shown, when the bargraph gets up to the 9th or 10th segment, you will start to get a clipped, distorted output, particularly notable at low audio frequencies. This is a very handy feature for bad, tone deaf musicians like me! Besides, it's just plain fun to watch the bargraph jump around in response to clumsy pickin'!

Anyway, the best suggestion is to breadboard it exactly as shown, see how it works, and then experiment with component values, if desired. Don't forget to heatsink the LM383. A particularly interesting area for experimentation with this circuit is to utilize the other half of the LM382 dual preamplifier for a second guitar or an effect feedback like reverberation. Naturally, the two preamplifiers would need to be mixed before being applied to the LM 383 power amplifier.

—Nick Cinquino, Schaumburg, IL

The bargraph is a good finishing touch. By changing the resistor values, the 382 portion of the circuit might make a nice preamplifier stage for the circuit in the previous letter.

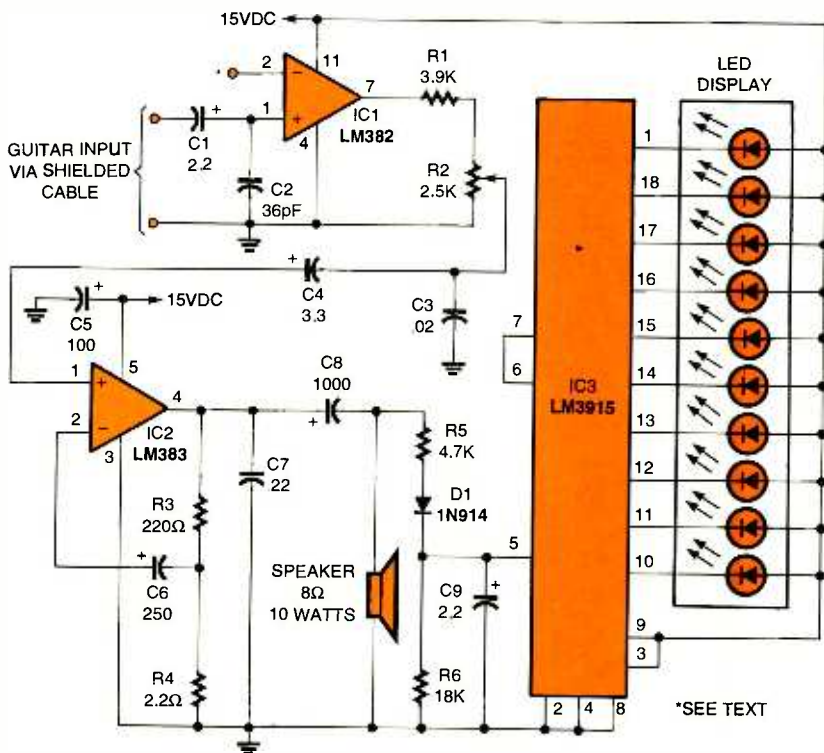

Fig. 4. Here's a guitar amplifier that lets you see the audio!

Microphone "Transformerless" Transformer

One of the advantages enjoyed by circuits employing solid-state devices over their vacuum tube counterparts is their ability to provide impedance matching in varied circuit configurations. That ability has been successfully exploited in transformerless amplifier drivers, resulting in almost unlimited fre-

quency response and nearly perfect damping.

The transformerless circuit shown in Fig. 5 may prove valuable to the audiophile who wishes to eliminate all transformers from the sound system. Not only does that device surpass the specifications of typical impedance matching microphone transformers, but it can be built for about one-third the price. This

design provides impedance matching for low impedance (50 to 150-ohm) professional microphones, and sufficient voltage gain to drive a 1-volt RMS amplifier input.

The circuit is a two-stage, direct-coupled op-amps with the input transistor Q1 in a common-base configuration. The input resistor R1 is chosen to match the microphone's nominal impedance, and the feedback resistor R2 sets the closed-loop voltage gain. By deriving Q1 base current from the divider network connected to the emitter of Q2, a high degree of DC feedback is established to compensate for component variations and temperature coefficients. Since the input and output signals are out of phase, neutralization is unnecessary for stabilization.

I constructed five of these units on a single circuit board. The microphone complex was terminated in a patch panel and powered by a well-regulated negative 24-volt supply. Since 50-ohm microphones were principally employed (the characteristic impedance of most moving-coil assemblies), the input resistor in each case was a 51-ohm unit. A feedback resistor of 100,000-ohms provided optimum gain to drive

(Continued on page 76)

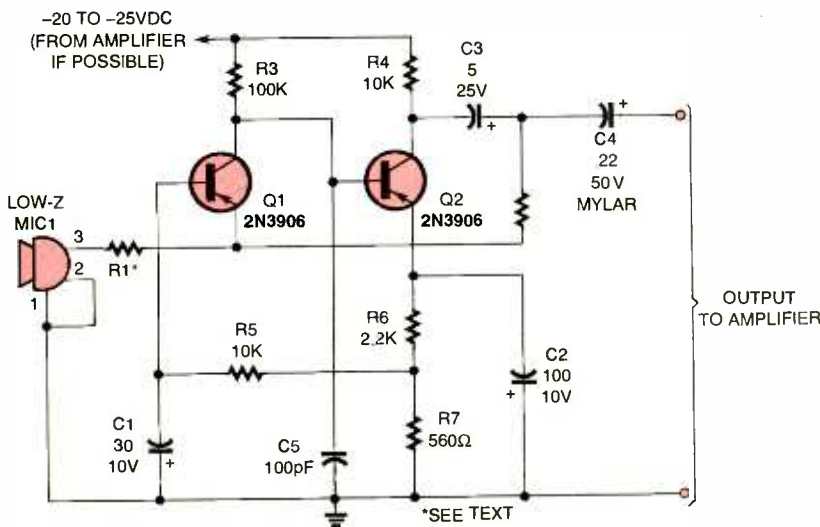

Fig. 5. This little preamp provides a transformerless match for low impedance microphones and can drive most system amplifiers.

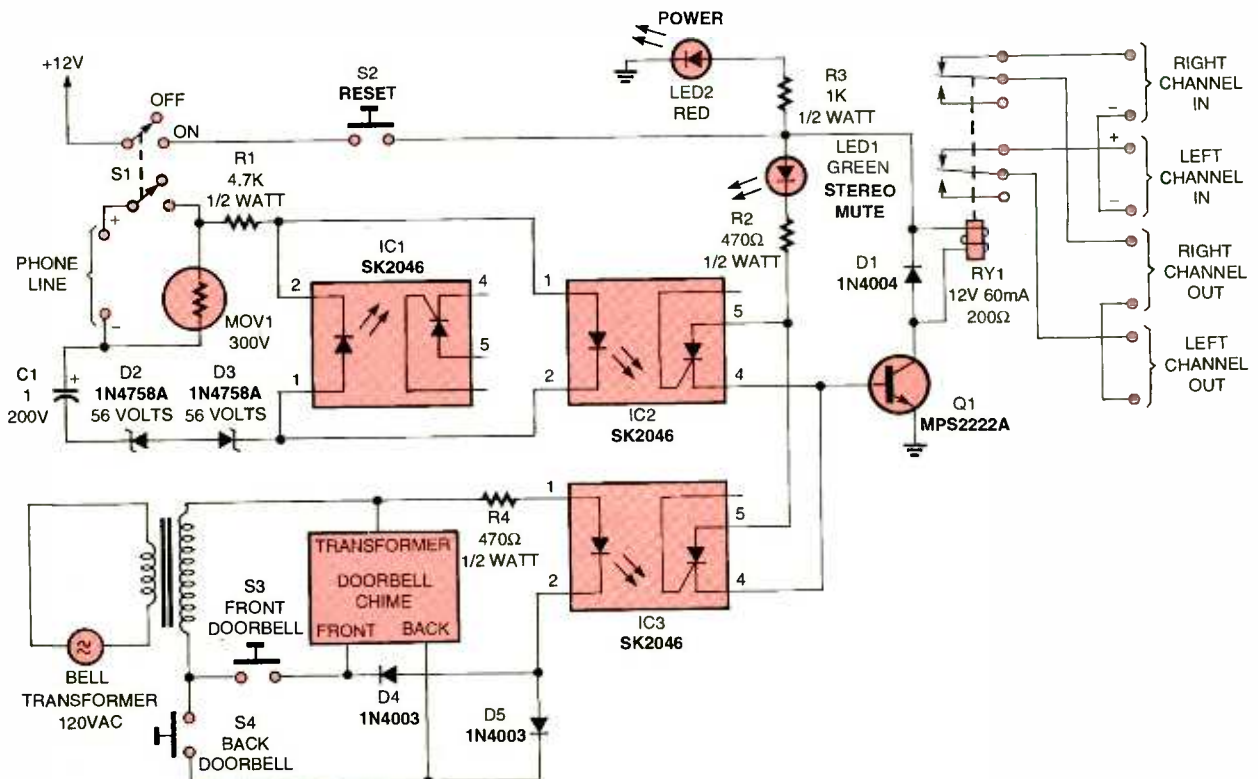

Fig. 6. If you need a device to mute your stereo when the doorbell rings, then this doorbell/stereo mute circuit is for you!

CIRCUIT CIRCUS

ICs that Oscillate

CHARLES D. RAKES

In our last visit we looked at a number of basic oscillator circuits using transistors and logic gates as the active elements. This month we are going to continue on with our oscillator lesson and take a look at several oscillator circuits using ICs that are designed for a variety of different applications.

ohm and 25,000-ohm. The oscillator's frequency tuning range, with a potentiometer for R4, is about ten to one.

Very low frequency operation is possible if a good quality low leakage electrolytic capacitor is used for C1. Using a 47- μ F capacitor results in a variable frequency range of about 1 Hz to 10 Hz.

mined by the RC values of C4, R1 and R2. The values of R1 plus R2 should be no greater than 25,000-ohm, while the following capacitor values for C4 will help in selecting a frequency range:

- 4.7- μ F = 10 Hz to 100 Hz;
- 0.47- μ F = 100 Hz to 1 kHz;
- 0.047- μ F = 1 kHz to 10 kHz;
- 0.1- μ F = 500 Hz to 5 kHz;
- and 0.01- μ F = 5 kHz to 50 kHz.

The oscillator circuits of Figs. 1 and 2 are very similar and produce about the same frequency range with similar RC tuning values. Both outputs are high impedance and should be isolated with a buffer between the IC and any connected circuitry.

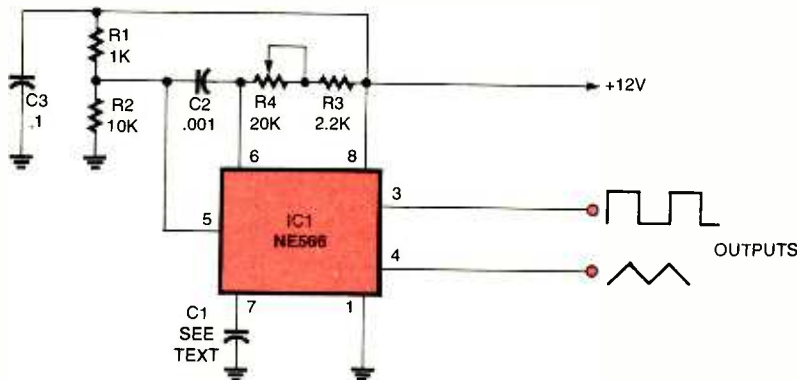

Fig. 1. Using a NE566 VCO IC to produce square and triangle wave outputs.

PARTS LIST (FIG. 1)

CAPACITORS

- C1—See text
- C2—0.001- μ F, ceramic-disc
- C3—0.1- μ F, ceramic-disc

RESISTORS (All fixed resistors are $\frac{1}{4}$ -watt, 5% units unless otherwise indicated.)

- R1—1000-ohm
- R2—10,000-ohm
- R3—2200-ohm
- R4—20,000-ohm potentiometer

ADDITIONAL PARTS AND MATERIALS

- IC1—NE566 (Radio Shack RSU 11392529, or equivalent)

Voltage-Controlled Oscillator

Our first oscillator, see Fig. 1, uses a NE566 IC in a basic function generator circuit that produces square wave and triangle wave outputs. The NE566 IC is a linear Voltage-Controlled Oscillator (VCO) that uses external resistors and a capacitor combination to cover an approximate frequency range between 1 Hz to 1 MHz. The resistance values of R3 and R4 should be between 2,000-

Since the actual value of an electrolytic capacitor can vary greatly from its marked value, selecting a capacitor will probably be necessary to obtain the desired frequency range. C1 can be as small as a few hundred picofarads to operate near the maximum frequency range. Experimenting with different capacitor values will help in determining the needed value for a given frequency range. A square waveform is available at pin 3 and a triangle waveform at pin 4. The NE566 oscillator can also be used as a FM signal source by coupling an external AC modulating signal to pin 5.

Phase Locked Loop

Our next IC oscillator, see Fig. 2, uses a 567 Phase Locked Loop (PLL) Tone Decoder IC in an encoding circuit arrangement. The input to the PLL on pin 3 is tied to ground to disable the decode function of the IC and to help stabilize the oscillator. The decoder output at pin 8 is not used. A square waveform is available at pin 5 and a triangle waveform is produced at pin 6. The circuit's operating frequency is deter-

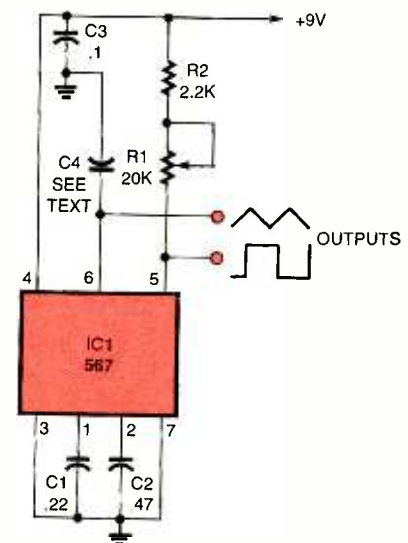

Fig. 2. A simple circuit with a 567 PLL Tone Decoder results in square wave and triangle wave outputs.

PARTS LIST (FIG. 2.)

CAPACITORS

- C1—0.22- μ F, ceramic-disc
- C2—0.47- μ F, ceramic-disc
- C3—0.1- μ F, ceramic-disc
- C4—See text

ADDITIONAL PARTS AND MATERIALS

- R1—20,000-ohm potentiometer
- R2—2200-ohm, $\frac{1}{4}$ -watt, 5% resistor
- IC1—567 (Radio Shack RSU 10872125, or equivalent)

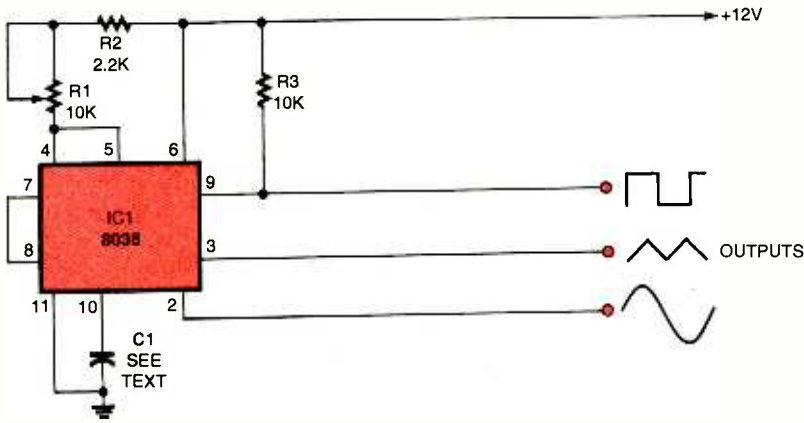

Fig. 3. The versatile 8038 Waveform Generator IC in its simplest configuration to generate several waveforms.

PARTS LIST (FIG. 3.)

- C1—See text
- R1—10,000-ohm potentiometer
- R2—2200-ohm, 1/4-watt, 5%, resistor
- R3—10,000-ohm, 1/4-watt, 5%, resistor
- IC1—8038 (Intersil ICL8038CCJD)

PARTS LIST (FIG. 4.)

CAPACITORS

- C1—See text
- C2—0.1- μ F, ceramic-disc

RESISTORS

- (All fixed resistors are 1/4-watt, 5% units unless otherwise indicated.)
- R1, R2—4700-ohm
 - R3—10,000-ohm
 - R4—25,000-ohm potentiometer
 - R5—10,000-ohm potentiometer
 - R6, R7—100,000-ohm potentiometer

ADDITIONAL PARTS AND MATERIALS

- IC1—8038 (Intersil ICL8038CCJD)
- D1—1N914 diode

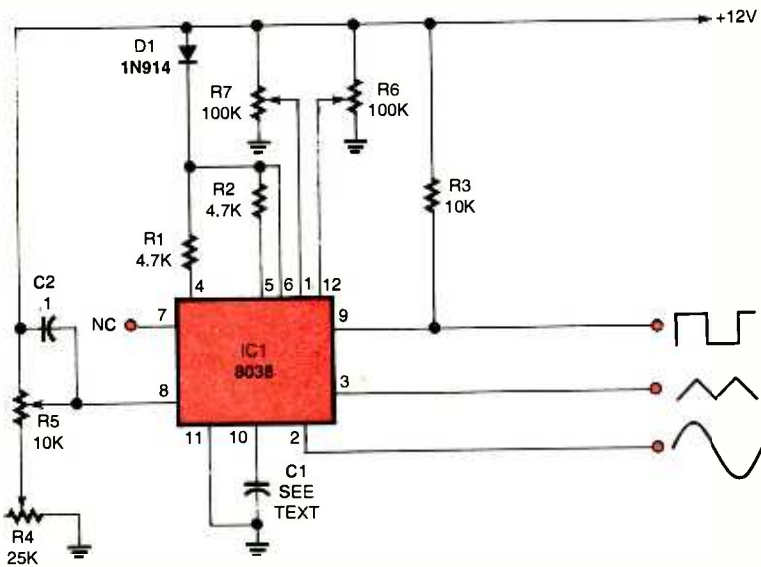

Fig. 4. Here's the 8038 Waveform Generator IC with additional circuitry to improve operation and control.

Versatile Waveform Generator

The next two oscillator circuits use an 8038, Waveform Generator IC that is designed to output a triangle, square, and sinusoidal waveforms simultaneously.

The first waveform generator circuit using the 8038, shown in Fig. 3, illustrates the minimum number of external components necessary to generate the three different output waveforms. The values of R1, R2, and C1 determine the frequency range of the generator. (Editor's note: Component values can be determined by use of the approximate formula:

$$f = 0.15 / (R1 + R2) \times C1,$$

where f is the desired frequency of operation.)

There is a price to pay in performance for this circuit's simplicity. The

output waveform symmetry suffers because no provision has been made to balance the current feeding the two duty cycle inputs at pins 4 and 5. A simple fix is to add two 500-ohm potentiometer controls to the circuit. Place one of the controls between pin 4 and R1, and the other potentiometer between pin 5 and R1. Adjust both controls for the best output waveform shape.

The 8038 waveform generator circuit in Fig. 4 has a number of components added to improve the circuit's operation. Diode D1 allows a greater tuning range by permitting the voltage at pin 8 to rise above the voltage at pins 4 and 5. The two variable resistors, R6 and R7 are used to adjust the output waveforms for best possible symmetry. Potentiometer R5 varies the voltage at

pin 8 to control the oscillator's frequency, and R4 sets the maximum frequency range. The oscillator produces the lowest frequency when the voltage at pin 8 is at its maximum, and the highest frequency when the voltage is at its minimum. Note that pin 7 is disconnected from pin 8 in this circuit.

The following capacitor values for C1 will give you a starting point in setting up the oscillator for a desired frequency range:

- 1.0- μ F = 1 Hz to 100 Hz;
- 0.1- μ F = 100 Hz to 1 kHz;
- 0.01- μ F = 1 kHz to 10 kHz; and
- 0.001- μ F = 10 kHz to 100 kHz.

These values are only for starters because the actual value needed will also depend on the setting of R4 as well as R5. Once again here's where experimenting will help find the optimum results.

CMOS

The IC oscillator of Fig. 5 uses a versatile 4046 CMOS PLL IC in a simple variable frequency square wave generator circuit. The heart of the generator's circuitry is the IC's voltage-controlled oscillator. The circuit's operating frequency is determined by the voltage at

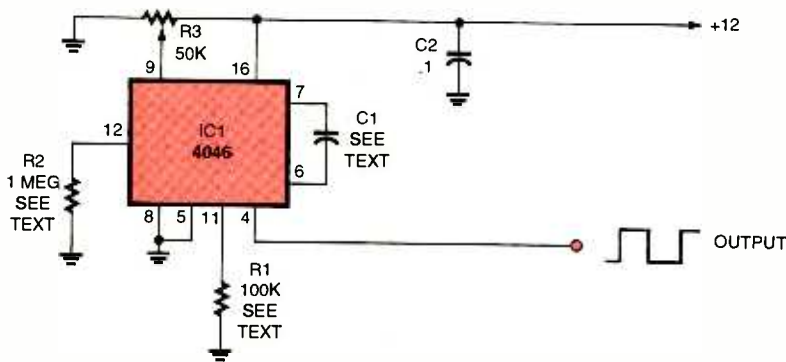

Fig. 5. This circuit uses the 4046 CMOS PLL IC to produce a variable frequency square wave generator.

**PARTS LIST
(FIG. 5.)**

- C1—See text
- C2—0.1- μ F, ceramic disc
- R1—100,000-ohm $\frac{1}{4}$ -watt, 5%, resistor
- R2—1-megohm, $\frac{1}{4}$ -watt, 5%, resistor
- R3—50,000-ohm potentiometer
- IC1—4046 (Radio Shack RSU 10870616, or equivalent)

pin 9 (controlled by potentiometer R3), and the capacitor C1 across pins 6 and 7. The maximum and minimum frequency of the oscillator is determined by resistors R1 and R2 connected to pins 11 and 12, respectively. The 4046 frequency range goes from less than 1 Hz to about 1 MHz, depending on the external components.

With the component values shown in Fig. 5, the oscillator will range from a low of about 100 Hz to over 10 kHz. If we remove R2, leaving pin 12 open, the frequency range is increased above 10 kHz. The values of R1 and C1 set the basic frequency range and the voltage at pin 9 varies the frequency. Minimum voltage at pin 9 produces a minimum frequency and maximum voltage produces a maximum frequency. Resistance R2 determines a frequency operating "window" (minimum to maximum frequency range), by raising the minimum frequency and increasing the maximum frequency. One method to use in setting the frequency "window" is to make R2 a variable resistor, approximately ten times the value of R1, and use it to fine tune the "window" limits.

For a desired frequency range, choose capacitor C1 from the following values:

- 1.0- μ F = less than 1 Hz to 100 Hz;

- 0.1- μ F = 10 Hz to 1 kHz; and
- 0.01- μ F = 100 Hz to 10 kHz.

The 4046 package also includes other goodies. A dual phase detector is included which allows the 4046, with added components, to become a full-fledged PLL. Since we are only dealing with oscillators this time around, these features might show up here at a later date.

Multivibrator

In our next circuit, see Fig. 6, we go up one number in the CMOS line to the 4047 Multivibrator IC operating in the astable (free running) mode. This IC offers three square wave output waveforms. The oscillator's fundamental frequency appears at pin 13. Outputs at pins 10 and 11 appear at one half this frequency and are phased 180-degrees apart.

If you need a square wave signal with a near perfect 50% duty cycle,

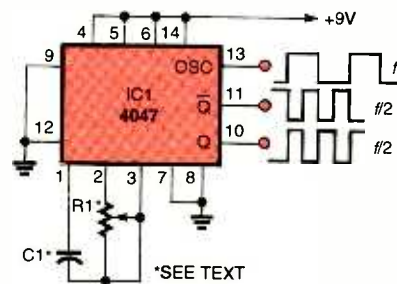

Fig. 6. This 4047 Multivibrator IC circuit results in three square wave output waveforms.

**PARTS LIST
(FIG. 6.)**

- C1—See text
- R1—Potentiometer, see text
- IC1—4047 (National Semiconductor CD4047BC)

this circuit can do it. The fundamental output signal is fine for many applications, but it is not always a 50% duty cycle waveform. If you run the oscillator at twice the desired frequency and take the signal at either pin 10 or 11, the output will be a perfect square wave.

The oscillator's frequency is determined by the values of C1 and R1. The value for resistor R1 can be any value from a few thousand ohms to over 1 megohm. The capacitor can be just about any good quality (low leakage) unit that is 100-pF or larger. Good low leakage electrolytic capacitors are necessary for very low frequency applications. Capacitor values for C1 can be selected from the following list—choose a value which sets up your circuit to oscillate over the desired frequency range:

- 1- μ F = less than 1 Hz to 10 Hz;
- 0.1- μ F = 10 Hz to 1 kHz; and
- 0.01- μ F = 100 Hz to > 10 kHz.

LED Flasher/Oscillator

You have probably seen our next choice of IC operating in various circuit applications which make LEDs flash on and off. The popular LM3909 LED Flasher/Oscillator IC has been doing this for years. This versatile IC can

(Continued on page 79)

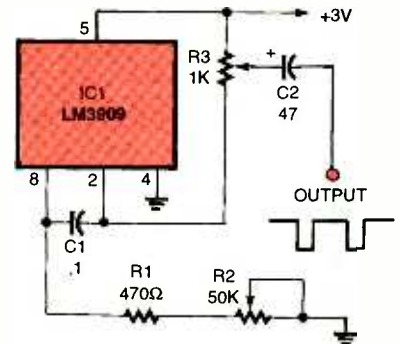

Fig. 7. The popular LM3909 LED Flasher/Oscillator IC designed to function as a simple audio oscillator.

**PARTS LIST
(FIG. 7.)**

- C1—0.2- μ F, ceramic disc
- C2—47- μ F, 25 WVDC, electrolytic capacitor
- R1—470-ohm, $\frac{1}{4}$ -watt, 5%, resistor
- R2—50,000-ohm potentiometer
- R3—1,000-ohm potentiometer
- IC1—LM3909 (Radio Shack 276-1705)

HAM Radio

Hanging Loop Antennas

JOSEPH J. CARR, K4IPV

There are a number of different loop antennas that can be built, and for the higher frequency bands they can be reasonably sized. I have received a lot of correspondence over the years about those antennas, and also about antennas for people who have limited space. The loop antenna described in this column is small and will find many applications. It is called the hanging loop antenna.

Figure 1 shows the basic concept for the hanging loop antenna. It consists of two half wavelength ($\lambda/2$) ele-

ments spaced one-sixth wavelength ($\lambda/6$) apart. The horizontal elements are made with aluminum or copper tubing of either 0.75-inch or 1-inch diameter. In a pinch, you can also use wooden dowels of about 1-inch diameter, with antenna wire running along the length. The vertical elements are made of ordinary antenna wire, although if you want to use aluminum tubing it's all right.

The feedline to the transmitter is 52-ohm coaxial cable, which is connected to the antenna with a 4:1 balun transformer. The connection points of

the balun are along the vertical wires, and the exact point is found by testing for minimum VSWR. A good starting point is to make the connection point about one-third the way up from the bottom of the loop. Because the antenna is fed along the bottom edge, this antenna is horizontally polarized.

The lengths of the elements are determined from simple equations given below. For a half-wavelength ($\lambda/2$), use:

$$L_{FT} = 468/F_{MHz}$$

For a one-sixth wavelength ($\lambda/6$) lengths:

$$L_{FT} = 156/F_{MHz}$$

In both equations, L_{FT} is a length in feet and F_{MHz} is frequency in MHz. Typical lengths for five popular ham bands and the Citizens Band are shown in Table 1 below.

TABLE 1 — Loop Antenna Element Lengths

Band	Freq (MHz)	$\lambda/6$ (Feet)	$\lambda/2$ (Feet)
10 m	28.5	5.47	16.42
11	27	5.77	17.33
12	24.9	6.27	18.80
15	21.1	7.39	22.18
17	18.1	8.62	25.86
20	14.1	11.06	33.19

These lengths are approximate, of course, as with all antenna lengths calculated from equations. The actual lengths will be very close to these.

This type of antenna has a gain of about 2 to 2.5 dB over a dipole. It has a figure-8 radiation pattern, which means that the two main lobes are perpendicular to the plane of the loop (i.e. in and out of the page). The reason that this gain is higher than a dipole is that this the pattern is narrower in both the horizontal and vertical extent, putting more power into a narrower beam.

The electrical connections should be made permanent by soldering the wires from the balun transformer to the

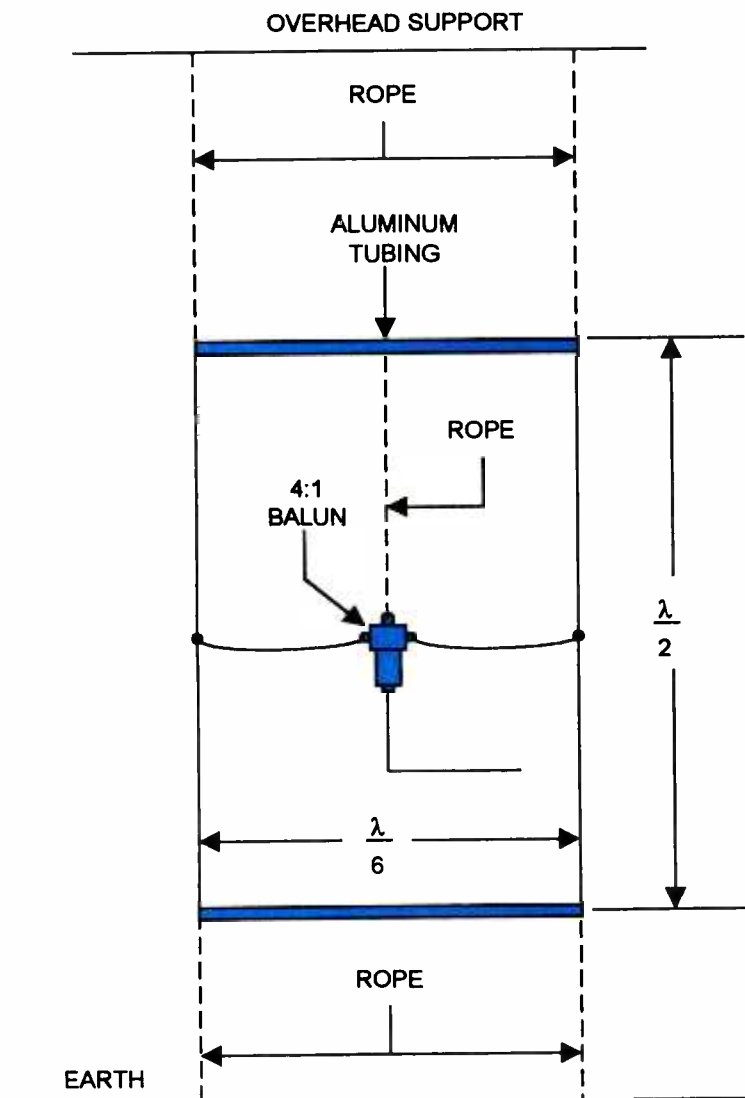

Fig. 1. Construction details for the hanging loop antenna.

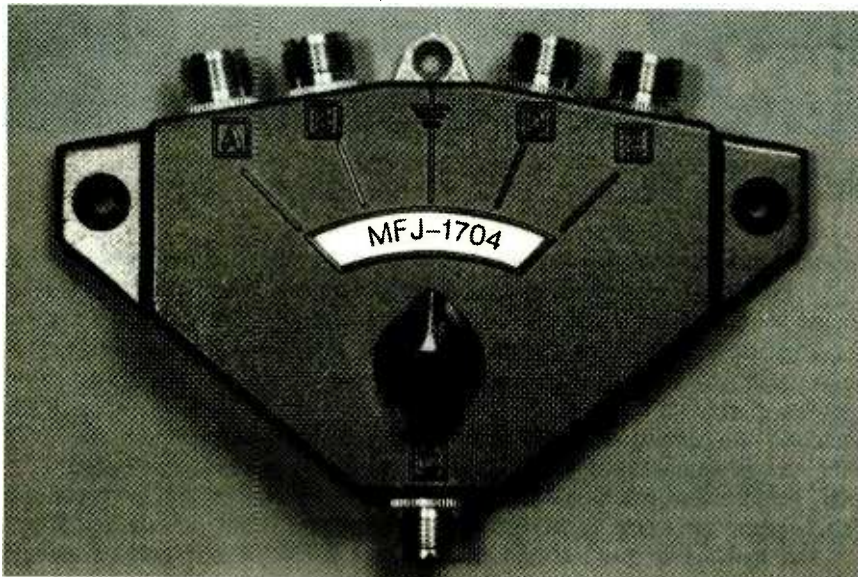

Fig. 2. A typical coaxial four-position switch. The center position is used to connect the receiver's antenna input terminal to ground when transmitting or shut down.

vertical members. When you are testing the antenna, however, use alligator clips to move the connection point up and down the vertical members. The alligator clip idea cannot be used with even moderate power levels, or else they may burn and cause problems.

I use an MFJ Enterprises, Inc. Model MFJ-259 VSWR analyzer (which runs micropower) to make adjustments before turning on the transmitter. Besides, it's rude and in some cases illegal to test antennas under power. At the very least you will cause unnecessary QRM to others on the same band.

If you use more than one antenna, or if you do a lot of antenna experimentation, then you might want to install a coaxial switch. These switches are used to allow a receiver or ham radio set to use one of several antennas. Up to 16-port switch models are available, but the one shown in Fig. 2 is a four-port model. This particular coaxial switch is the MFJ-1704 made by MFJ Enterprises, Inc. (Box 494, Mississippi State, MS, 39762). The common connector is for the receiver or transmitter, while each antenna is connected to one of the four switched ports. Alternatively, one can turn the switch around backwards (it's bi-directional, after all), and use the same antenna on different receivers or transmitters.

The use of the coaxial switch in antenna tuning is for comparing the antenna being tested with either another antenna or a dummy load. The kind of off-the-air checks that amateurs and SWLs can make are

notoriously inaccurate, but can be made a lot more useful by making comparisons with known antennas.

A friend of mine, the late Johnnie H. Thorne (K4NFU/5), had an antenna farm in Texas (and it did seem that he grew antennas, judging from the number he had). He kept a standard dipole, optimally installed and cut for 20-meters, and made all of his test designs for the same frequency. He would compare new designs to the dipole by switching back and forth while monitoring the signal strength on the receiver S-meter. He could also compare two different antennas by comparing them against each other or against the dipole.

Antenna comparisons are a little fuzzy around the edges if you don't have an antenna test range. It is wise to make a number of observations, and then average the results. This is especially true with high-frequency antennas where variations along the transmission path are a wild card for the antenna experimenter.

I learned a lot about antennas from my friend, Johnnie. Unlike a lot of gurus, he had notebooks full of data to back up his claims. He also had a lot of old, but professional quality, instrumentation to make antenna measurements. Not to mention a Stoddard field strength meter mounted in a Taylorcraft airplane (a kit-built thing like a Piper Cub) to fly around and make antenna pattern measurements.

Most ham antenna builders have to satisfy their curiosity about the pattern

by noting where the call signs seem to come from when the new antenna is erected. Unfortunately, there are so many variables in that technique that it is utterly useless in making any real observations.

Another friend of mine lived down in the Shenandoah Valley of Virginia. He complained that his "omni-directional" vertical seemed to have a gap in the pattern. He complained that signals to the east were a lot weaker than when he lived close to Washington, DC, and the signal reports he received were lower. I found the problem rather quickly: He lived on the west slope of a mountain, down at the bottom of the hill. Sighhhhh.

Hamfests

The summer months are the hamfest season in most areas of the country. My wife once referred to hamfests as a spasm of "musical junk" (after the child's game "Musical Chairs") in which otherwise grown people go out to buy, sell and trade all manner of ham-related equipment. I've even known a couple people who made a fair amount of their annual income buying and selling stuff. I've done my share of both, although I admit (and my basement lab testifies) that buying is more of what I do.

If you haven't done a hamfest, then I recommend that you find one and attend. If you want to buy stuff, then bring cash (only dealers can accept credit cards). Also, be careful about being out in the sun. I am one of those who burn easily, so use plenty of sun block lotion.

Most hamfests of any size will have amateur radio license examinations available (although many of them do the exams the day before the hamfest). You can contact the sponsors to find the exam schedule. Also, you can get a list of sanctioned events (not all hamfests fall into that category, but that doesn't mean that something is wrong with them) from American Radio Relay League (225 Main Street, Newington, CT 06111, or e-mail at HQ@ARRL.ORG).

Connections...

I can be reached by snail mail at PO Box 1099, Falls Church, VA, 22041, or by e-mail at carrij@aol.com. I welcome your questions, comments, and suggestions. ■

ELECTRONICS LIBRARY

Continued from page 20

Subsequent chapters cover using the PC as a record keeper (to keep track of station logs and other databases), as a design tool (for antennas and other hardware), and for control and calculations; using the Internet to find ham information; and using simple software to log and enter contests.

Personal Computers in the Ham Shack costs \$15.95 and is published by The American Radio Relay League, 225 Main Street, Newington, CT 06111-1494; Tel: 860-594-0200; Fax: 860-594-0303; E-mail: pubsales@arrl.org; Web: <http://www.arrl.org/>.

CIRCLE 93 ON FREE INFORMATION CARD

1997 General Catalog from Contact East

This 252-page, full-line catalog is packed with descriptions of hundreds of new test instruments and tools for engineers, managers, technicians, and hobbyists. It features quality products from brand-name manufacturers for testing, repairing, and assembling electronic equipment.



Highlighted new products include the Tektronix TDS 200 series compact digital scopes, Fluke's 105B Scopemeter, and B+K-Precision's spectrum analyzers. The catalog also offers a wide selection of DMMs, portable and benchtop digital storage scopes, tool kits, power supplies, EPROM programmers, soldering/desoldering equipment, breadboards, heat guns, data communications tools and testers, measuring tools, adhesives, precision hand tools, and reference books. Also featured are Contact East's popular lines of commu-

nication test equipment, static-protection products, ozone-safe cleaners, magnifiers, inspection equipment, work benches, and cases.

The 1997 General Catalog is free upon request from Contact East, Inc., 335 Willow Street, North Andover, MA 01845; Tel: 508-682-2000; Fax: 508-688-7829.

CIRCLE 94 ON FREE INFORMATION CARD

Lingo And Shockwave Sourcebook: A Complete Guide to Developing Multimedia for the Web and CD-ROMs by Vineel Shah & John Musser

You don't need to be an experienced programmer to create sophisticated multimedia with Lingo and Shockwave. This friendly and fun book shows you how to deliver high-quality multimedia products that can be distributed on CD-ROM or the World Wide Web. It walks you step-by-step through planning, developing, and troubleshooting eight multimedia projects.

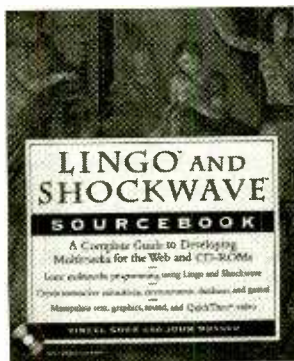

The book covers using and manipulating text, audio, and QuickTime video, as well as animating and synchronizing text, graphics, and audio. It explains how to use Lingo and Shockwave to create Java-like Web interfaces and to put dynamic, interactive multimedia on the Web. The book also serves as a multimedia programmer's primer on the subtleties of QuickTime video.

The included CD-ROM contains all of the completed projects featured in the book; movies, ready to be programmed with Lingo; and artwork, audio, and QuickTime video samples for you to work with. A fully functional graphical interface makes it easy to navigate through the material on the CD-ROM.

Lingo and Shockwave Sourcebook: A Complete Guide to Developing Multimedia for the Web and CD-ROMs costs \$39.95, including CD-ROM, and is published by John Wiley & Sons, Inc., 605 Third Avenue, New York, NY 10158-0012; Tel: 1-800-225-5945; Web: <http://www.wiley.com>.

CIRCLE 95 ON FREE INFORMATION CARD

1997 Passport To Web Radio: Really Cool Wired Sounds from All Over the World edited by Lawrence Magne

Did you know that there's a whole world of radio waiting to be explored over the Internet? As of last August, there were 178 Web Radio stations broadcasting from 32 countries. By the beginning of 1997, those figures had jumped to 390 stations from 50 countries. Most are in the United States, with Canada, Europe, and Asia strongly represented too. Others transmit from South America, Australia, Central America, Africa, and the Middle East. You get to hear actual local broadcasts from cities and small towns across the country—Cajun music from New Orleans; country music from Paris, Texas; and sporting events straight from dozens of home-town stadiums—and around the world. Most are live broadcasts, and some are on demand, allowing you to click on a program whenever you want to listen to it. And you can still use your computer for other applications while you're tuned into Web radio.

This book tells you all you need to know to get listening. It offers a brief history of and introduction to Web radio, and then describes all the hardware and software that's required to get started.

The rest of the book lets you know what's on, and what's worth hearing. An entire section—written by ESPN's Phil Schoen—is devoted to sports programming. Subsequent chapters describe Web radio transmissions from the United States, Canada, Latin America, Europe, Africa, Asia, and the Pacific.

1997 Passport to Web Radio costs \$9.95 and is published by International Broadcasting Services, Ltd., Box 300, Penns Park, PA 18943; Tel: 215-794-8252; Fax: 215-794-3396; Web: <http://www.passport.com>.

CIRCLE 96 ON FREE INFORMATION CARD

NEW PRODUCTS

Continued from page 19

that can be read from as far away as 20 feet. The device has a +2.00 volt to +6-volt input voltage range. The DVM uses an advanced A/D converter, an ultra-stable reference, and metal-film resistors to achieve ± 0.01 -volt accuracy. It never requires adjustment or recalibration, and it is reverse-polarity input protected over its full rated operating range.



The DMS-20PC-3-DCM DVM costs \$45 each in single quantities, \$38 in hundreds. For further information, contact Datel, Inc., 11 Cabot Blvd., Mansfield, MA 02048; Tel: 508-339-3000 or 1-800-322-2765; Fax: 508-339-6356.

CIRCLE 82 ON FREE INFORMATION CARD

Pc Card Modems

Three models of high-speed, state-of-the-art data/fax PC Card modems; are available from Logicode Technology. The 33.6-bps modems include a basic, economy data/fax modem; one with voice mail; and one with speaker-



phone capabilities. Designed for laptops, notebooks, and sub-notebooks with standard Type II and Type III PCMCIA expansion slots, all three models

feature a built-in, advanced power-management system. With full AT command capability, the PC Cards are optimized for high-speed, stable Internet connections. Dial tones, busy signals, and carrier signals are automatically detected, as are fax/modem/voice-mail functions. All models except the basic one are equipped with a corporate-style, digital voice-mail answering system with multiple password-protected mailboxes.

The PC Card modems come with a telephone cord, full-featured communications software, Internet and online access software, and an operating manual. The modems operate on DOS, Windows 3.X, Windows 95, and Apple System 7 or later.

Estimated street prices for the Models 33PC, 33PC-V, and 33PC-SP range from \$189.95 to \$269.95. For more information, contact Logicode Technology, Inc., 1380 Flynn Road, Camarillo, CA 93012; Tel: 805-383-2500 or 1-800-735-6442; 24-hour BBS: 805-445-9633; Web : <http://www.logicode.com>.

CIRCLE 83 ON FREE INFORMATION CARD

Touch-Screen Universal Remote

Instead of the host of often-confusing buttons found on most multi-component remote controls, Rotel's RR 990's front panel is a flat, touch-sensitive LCD panel measuring $2\frac{3}{8} \times 4\frac{1}{2}$ inches. The backlit display allows easy use even in darkened rooms. A "beep" that usually confirms each operating step can be switched off for totally silent, non-intrusive operation.

The LCD touch-screen is divided into thirds. The top section contains five always-visible function buttons and five hidden confirmation indicators that appear on a "need to know" basis. The bottom portion contains selectors for eight different system components. Touching any one of them will call up a dedicated control panel for that component in the much larger center portion of the screen.

Three different center views—complete, basic, and custom—are available. The complete view shows a comprehensive array of pre-mapped button icons. The basic view displays only essential controls. The custom mode allows the end-user to configure a control panel specifically geared to his

own system or a particular way of using it. Short-cut keys encourage quick customization based on a library of self-contained templates. Users can also reconfigure each control panel without deleting commands linked to individual buttons.

For easy setup, the RR 990 allows users to input only the codes needed to operate a particular system. It also supports custom "macro" programming in which a single key touch can trigger a string of up to ten consecutive commands.



The RR990 touch-screen remote control has a suggested list price of \$199.90. For further information, contact Rotel of America, 54 Concord Street, North Reading, MA 01864-0008; Tel: 1-800-370-3741; Fax: 508-664-4109. ■

CIRCLE 84 ON FREE INFORMATION CARD



TECHNICS SL-MC60—TEST RESULTS

Brand: Technics
Model: SL-MC60 Compact Disc Changer
Price: \$250

Features

- 60+1-disc jukebox-type changer
- Single-play CD slot
- User-programmable disc/track play
- Automatic random-play (250 tracks)
- Custom groupings (5)
- Music-type classifications (14 genres)
- Wireless IR remote control

The following test results were performed by the Advanced Product Evaluation Laboratory, using the CBS CD-1 standard test disc.

Output voltage (@ 0 dB, 1 kHz)	
Left:	2.24 volts
Right:	2.21 volts
Frequency response (10 Hz to 20 kHz)	0.0 dB to 0.0 dB (see Fig. 1)
Dynamic range	
Left:	90.2 dB
Right:	90.3 dB
Signal-to-noise ratio ("A" weighted):	-98.8 dB
Total harmonic distortion + noise (@ 0 dB)	
Frequency	THD (%)
31 Hz:	0.005
1 kHz:	0.006
10 kHz:	0.011
16 kHz:	0.023
Wow and flutter:	Unmeasurable
Channel separation (@ 0 dB, 1 kHz)	
Left:	87.6 dB
Right:	87.2 dB
De-emphasis error	
Frequency	Error
1 kHz:	0.02 dB
4 kHz:	0.06 dB
16 kHz:	0.05 dB
Linearity error (@ 1 kHz)	
Signal level (dB)	Error (dB)
0	0
-10	-0.1
-20	0
-30	-0.1
-39.99	-0.2
-49.97	-0.1
-59.94	-0.3
-70.31	-0.2
-80.77	+0.3
Linearity error with dither (@ 1 kHz)	
Signal level (dB)	Error (dB)
-70.31	-0.3
-80.77	-0.4
-90.31	-0.7
-100.0	+0.6
Additional data	
Short Access Time (Track 1 to 2):	1.8 seconds
Long Access Time (Track 1 to 21):	4.1 seconds
Disc Access Time	
Disc 1 to Disc 15:	6.1 seconds
Disc 1 to Disc 30:	7.0 seconds
Disc 1 to Disc 45:	7.7 seconds
Disc 1 to Disc 60:	9.0 seconds
Power Requirements:	8.5 watts
Dimensions:(HxWxD, inches.):	6- ¹¹ / ₁₆ x 16- ¹⁵ / ₁₆ 15- ³ / ₈
Weight:	14.5 pounds

TECHNICS TEST REPORT

Continued from page 50

seconds to get from Disc 1 to Disc 15, just 7 seconds to get from home plate to second base (Disc 30), and does 0 to 60 in 9 seconds. These are impressive times compared to a high-performance five-disc carousel tested here in the past (**Popular Electronics**, January 1996). That changer (the Marantz CC45U) took 6.9 seconds to get from Disc 1 to Disc 5—having only to reverse one position (and not spin past Discs 2, 3 and 4)!

Despite all its programmability options, the SL-MC60 works just fine in the lazy-man mode—also known as Automatic Random Play, where the machine's brain just picks and choose among discs and tracks at random. In this case, though, with 60 CDs to choose from, it can sustain this solo game for 250 selections.

Is there anything to regret about the SL-MC60? Perhaps only the lack of a headphone jack—so for private listening you will have to patch into your pre-amplifier or receiver.

FOR MORE INFORMATION

TECHNICS

One Panasonic Way
 Secaucus, NJ 07094
 Tel: (201) 348-7000

Performance

As the APEL measurements show, the changer's electrical performance is good in every area, though not the best ever measured. At some points where the SL-MC60 falls short of perfection, it doesn't really matter. These shortcomings can be measured by lab equipment but can't be heard by human ears.

The frequency response (Fig. 1) is virtually ruler-flat, as you should expect in the CD format. Likewise wow and flutter are nonexistent. Both signal-to-noise ratio and left/right channel separation are good, but no record-breaking marks. Dynamic range, which measures the spread between the softest and loudest sound the player will resolve, is adequate. The changer's 90 dB (decibels) reach will cover the range recorded on most CDs. As for total harmonic distortion (THD), APEL's readings for the SL-MC60 are par for the

(Continued on next page)

THINK TANK

Continued from page 67

the 1-volt program lines. Measured frequency response of the circuit was found to be within ± 3 dB from 5 Hz to 250 kHz. Noise generated in this circuit is almost entirely dependent upon the power supply used. When used with battery operation, for all practical purposes, this circuit would be totally noiseless.

—Craig Kendrick Sellen, Waymart, PA

Wow, for budding musicians this is a nice companion to the guitar-practice amplifier mentioned earlier. It's simple and very inexpensive. A bunch of these connected to a home-brew mixer would be nice for a practicing band.

Telephone/Doorbell Stereo Mute Circuit

It has been a while since I have submitted a circuit to this column (November 1990 issue to be exact, entitled "Telephone Privacy"). So it's about time! The doorbell-stereo mute circuit in Fig. 6 has been in operation at my home now for around two years with no problems. My dad gave me the idea, as he knocked on my front door for around fifteen minutes while my stereo blasted! Well, that wasn't too cool so I built this circuit. The telephone muting portion came from *Radio Electronics*, January 1990; in addition, as pointed out in the *May 1993 issue of Electronics Now*, I changed the circuit to make it more FCC acceptable.

When the front or back doorbell is pushed (closure of switch S3 or S4, respectively), AC flows from the bell transformer through resistor R4, the doorbell chime, the LED portion of the photo-SCR isolator IC3, diodes D4 or D5 (depending which doorbell switch was pushed), and back to the bell transformer. The current flowing through the LED in IC3 activates the light-sensitive gate of the SCR causing it to conduct. With the ON/OFF switch S1 and RESET switch S2 closed, current then flows from the 12-volt power source (noted by the illumination of the red LED2) through the switches into LED1 (the Stereo Mute Indicator) and R2, through the SCR of IC3 and then from the base to the emitter of Q1 to ground. Transistor Q1 conducts and collector current flows through relay RY1 to ground. RY1 energizes and pulls its

DPDT normally closed contacts open, thereby muting the stereo speakers. Note that diodes D4 and D5 prevent both front and back door chimes from going off at the same time, since they both are tied to pin 2 of IC3.

In the telephone-activated part of the circuit, capacitor C1 and Zener diodes D2 and D3 block the phone line voltage, which is normally 48-volts. Ringing current is around 90-volts AC, which overcomes the breakdown voltage of these Zener diodes. The positive half-cycle flows from the positive end of the phone line through R1, the LED portion in IC2, D3, D2, and C1, to the negative side of the phone line. The flow of current through the LED of IC2 activates the light-sensitive gate of the SCR, causing conduction. Current then flows through the green Stereo Mute LED1, R2, the SCR of IC3, and from the base to the emitter of Q1 to ground. Transistor Q1 conducts and current flows through the collector and relay RY1 to ground. RY1 energizes and mutes the stereo as described for the doorbell circuit.

Note that the SCR portion of Photo-SCR Isolator IC1 is not connected because the positive half of the ringing current is enough to operate the circuit, and the LED in IC1 balances the phone line. A plain diode could replace IC1; however, I do not know just what diode would be sufficient (possibly a 1N4007). I do think the LED match is better by using IC1 as shown.

There is a bit of work involved in this circuit, but it is worth it! You will need to run a phone line near your stereo. I used a four conductor phone cable; two for the phone line (red and green wires) and the unused pair for the bell line. You will also need to run a line from the doorbell chime to the (unused pair) telephone line input of the circuit. The telephone stereo muting portion of the circuit is fairly simple, and you could build just that eliminating the extra doorbell wiring and components IC3, R4, D4 and 5. Whatever way you choose; have fun!

—Daniel P. Rieskamp, Cincinnati, OH

As a fellow listener to loud music, I can really appreciate this circuit. Builder be advised to use a relay with a high contact amperage rating, as the voltage, and therefore the current produced by some amplifiers can be significant at loud volumes.

That's all we have room for this

time. Remember, if you'd like to win a book from our library, send a schematic of your working circuit and a thorough explanation to *Think Tank, Popular Electronics*, 500 Bi-County Blvd., Farmingdale, NY 11735. If you send enough usable circuits to fill a column, you'll receive a MCL1010 chip and a kit, in addition to the book awarded for single submissions. ■

TECHNICS TEST REPORT

Continued from page 75

course. In any event, in the opinion of most experts, THD would have to reach 1.0% to be audible.

Similarly, for de-emphasis and linearity, 3 dB is considered the threshold beyond which other errors become audible. De-emphasis error measures how accurately the player's circuitry reverses the pre-emphasis curve on the disc recording. It should be a perfect mirror-image but seldom is symmetrical. The SL-MC60's errors here at least track with the curve with no gross diversions. Linearity error measures the accuracy of the CD player's digital-to-analog converter (DAC) section. Does it translate each of the 65,536 possible digital codes on the CD to its exact frequency and level? The Technics decoder does well enough—the worst error is within 0.3 dB and therefore not audible above the stereo system's inherent noise. To keep things honest, the linearity error with dither test accounts for system noise; again, the degree of DAC error is not audible.

So if you want a neat way to store and manage your entire CD music collection, be able to play any disc with utmost ease and convenience, and obtain a great performer in your stereo system—the Technics SL-MC60 is the CD changer for you! For more information on the Technics SL-MC60 compact disc changer, contact the manufacturer directly at the address provided in the box, or circle No. 123 on the Reader Service Card. ■

We're on the Web!

www.gernsback.com

ELECTRONICS RULER

(Continued from page 59)

mile) plot of desert and then to measure the distance between them to within one-millimeter. M^3 works by combining the atomic imaging capability of an STM with technology for moving and positioning the STM probe over much larger areas with unprecedented precision. That gives M^3 the ability to survey the landscape between atoms on the molecular frontier.

The Outlook

Right now, however, M^3 is flying blind, without instruments. Like other STMs, M^3 suffers from 'tunnel vision.' "The hard part is discerning and fixing the positions of things that are so far apart," Teague said. For objects at opposite ends of M^3 's range... "the separating distance spans a billion times the diameter of the objects themselves." Without navigational aids, M^3 would be limited to exploring only small corners of the molecular domain.

To locate and track the probe as it scans billions of atoms over the surface of a specimen, Teague's team uses what amounts to a Global Positioning System. Both M^3 and the sample are mounted on sliding carriages machined to move in extremely precise increments. A "metrology box" made of an ultra-high-stability ceramic is used to pro-

vide coordinate reference frames when determining the positions of both the probe and specimen. Movements relative to the metrology box are tracked and measured with laser-based instruments called interferometers. The system is capable of measuring movements as small as 0.05 nanometers—less than the diameter of an atom.

Until recently, the machine has been limited to measuring only a small part of its full range. While the team continues to characterize precision and accuracy performance, NIST can, at this point, finally see the whole field. "There are some measurement uncertainties that remain," said metrologist John Kramar, the current project leader, "but we can now essentially measure specimens and map out surfaces over the full 50 x 50-millimeter range."

Measurement with M^3 may be more accurate but it is not faster. "It takes a long time," said Kramar, "orders of magnitude longer than typical measurements from the measuring microscopes like those used in semiconductor manufacturing process control. Typically, for a 5x5 micrometer image with the raster scan lines spaced 50 nanometers apart, the scan time is 30 minutes." For example, in a comparison of different methods for measuring line width on integrated circuits, M^3 operated for 40 straight hours, performing roughly one-million separate measurements of an area centered

on a chrome line designed to be 750 nanometers wide. It made 16 overlapping images, each one 3 micrometers by 5 micrometers.

The results of M^3 's line-width measurements in that test corresponded closely with those obtained with an electrical method. Although only suggestive because of the small sampling size, the results were consistent with other comparisons that found electrical and microscope-based methods to yield systematically differing results. The explanation of these differences is significant as the semiconductor industry demands greater measurement accuracy and reliability. The industry must understand the capabilities and limitations of existing measurement methods being considered for future generations of integrated circuits.

The results of the study were presented in Japan last year at the International Conference on Microelectronic Test Structures. Aside from its immediate industrial applications, M^3 has physicists excited about investigating scientific questions. What happens when you remove a single atom or bunch of atoms from the surface of a crystal? "What distortion does that cause," Teague wonders. "How far does the disturbance propagate over the surface? Does it affect the squareness of the crystal lattice?" M^3 may even be able to use nature's own geometry to validate measurements. Interatomic spacings in a crystal, for example, with its highly ordered, regularly repeating arrangement of atoms, could serve as the molecular world's version of a ruler. "For measuring squareness," says Teague, "the right angles of a cubic crystal lattice would be the ultimate reference." ■

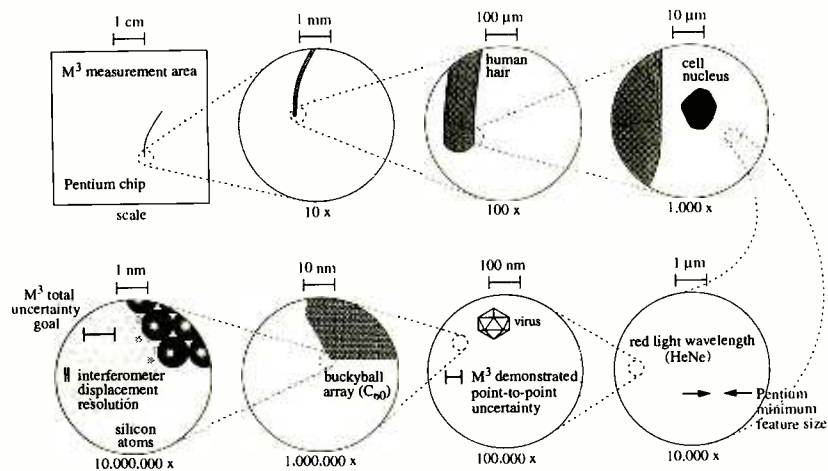

Fig. 1. The new M^3 electronic ruler, which is expected to measure to within one billionth of a meter, works by combining the atomic imaging capability of an STM with the technology for moving and positioning STM probes over much larger areas with unprecedented precision; thus giving it the ability to survey the landscape between atoms.



CLEAN UP THE AIR

(Continued from page 49)

the opening of a servo valve that injects additional air into the intake manifold between the carburetor and intake manifold to produce the leaner mixture. Under normal conditions, the system keeps the engine running precisely at the lean limit. If performance falls off because the engine is operating beyond the lean limit, the computer senses that over-lean condition and commands the valve to reduce the amount of supplemental air so that the mixture ratio decreases.

Engine performance is monitored by a magnetic transducer that senses changes in the rotation-

al speed of the flywheel by tracking the teeth on flywheel's ring-gear (as shown in Fig. 3). Flywheel speed is very sensitive to engine instabilities from too-lean conditions, which cause the motion of the pistons to become irregular. When performance improves, as indicated by a return to the flywheel's normal, smooth angular velocity, the processor starts adding air to lean the mixture again. All that happens very quickly—in about 2.5 milliseconds—so that the adjustment is as close as possible to the ideal. Ideal is an adjustment in the lean level happening before the next cycle fires. When the driver applies full throttle during acceleration, passing, or hill climbing, the computer rapidly commands a richer mixture.

According to LeanPower, retro-

FOR MORE INFORMATION

Neutronics Enterprises, Inc.
11421 West Bernardo Court
San Diego, CA 92127

LeanPower Corporation
335 Paint Branch Dr
College Park, MD 20742

fitting an old car with the LeanPower system would cost about \$250, including a needed tune-up. That price, however, could decrease with a new sensor the company is working on to replace the flywheel sensor. The sensor would determine performance via an input from the tachometer. On fuel injected cars, the LeanPower system is tied in directly to the fuel injection control system.

Aftermarket emission equipment could be the ticket for anyone who wants to keep an old car, whether it is a daily-driver or a collectible, environmentally-friendly. By installing millions of them, cities like Cairo, Bombay, Mexico City, and many others notorious for their foul air could be cleaned up. ■

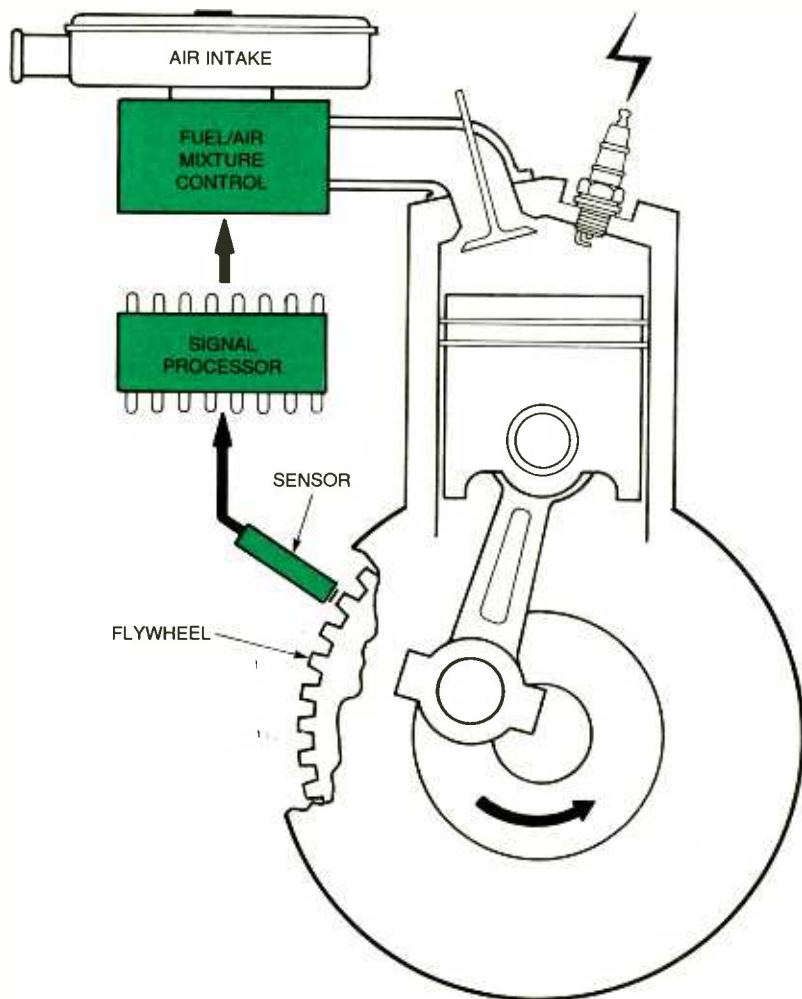
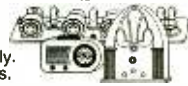

Fig. 4. The LeanPower system uses a magnetic transducer to sense minute changes in the flywheel's rotational speed. The Lean 2000 signal processor controls a servo valve that regulates the quantity of air (oxygen) injected into the intake manifold on engines with standard carburetors.

ANTIQUE RADIO CLASSIFIED

Free Sample!

Antique Radio's
Largest Circulation Monthly.
Articles, Ads & Classifieds.



6-Month Trial: \$18.95. 1-Yr: \$38.95 (\$55.95-1st Class).
A.R.C., P.O. Box 802-L18, Carlisle, MA 01741
Phone:(508) 371-0512 VISA/MC Fax:(508) 371-7129

Timid about getting on the . . . World Wide Web?

You've heard about the *Information Superhighway* and all the hype that goes with it! Sort of makes you feel timid about getting on the Web. Put your fears aside! A new book, *The Internet and World Wide Web Explained*, eliminates all the mystery and presents clear, concise information to build your confidence. The jargon used is explained in simple English. Once the tech-talk is understood, and with an hour or two of Web time under your belt, your friends will believe you are an Internet guru!

To order Book #403 send \$6.95 plus \$3.00 for shipping in the U.S. and Canada only to Electronics Technology Today Inc., P.O. Box 240, Massapequa Park, NY 11762-0240. Payment in U.S. funds by U.S. bank check or International Money Order. Please allow 6-8 weeks for delivery.

CIRCUIT CIRCUS

Continued from page 70

also be used as a tone/pulse generator. The oscillator circuit in Fig. 7 produces narrow negative output pulses which can be tuned from about 100 Hz to over 10 kHz. The circuit may be used to drive a piezo transducer for high frequency audio experiments.

Double Balanced Mixer

Our last oscillator circuit uses a very popular and versatile NE602 Double-Balanced Mixer IC, complete with a built-in oscillator circuit that is good up to several hundred megahertz. This IC has been a real boom for the ham circuit builder in the front-end of many receiver and transceiver circuits. But for now we are only going to look at the IC's oscillator section.

The oscillator in Fig. 8 is configured as a Hartley circuit with inductor L1 and variable capacitor C1 setting the operating frequency. The following nominal L1/C1 values are a good start in choosing components for a desired center frequency for the oscillator:

L1 = 5-uH and C1 = 150-pF, for a center frequency of 5 MHz; and
L1 = 1.5-mH and C1 = 50-pF,

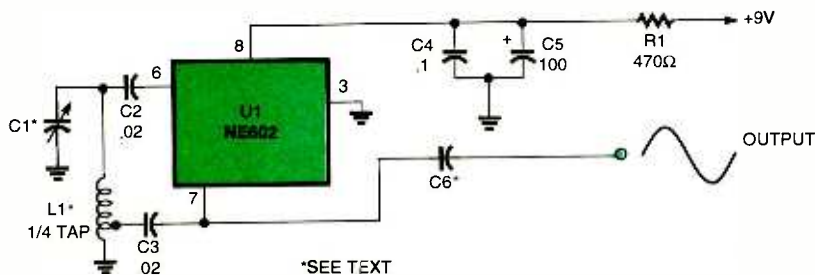

Fig. 8. The NE602 Double-Balanced Mixer IC can be used as a sinusoidal RF oscillator in this configuration.

PARTS LIST (FIG. 8.)

- C1—Variable capacitor, see text
- C2, C3—0.02-uF, ceramic disc
- C4—0.1-uF, ceramic-disc
- C5—100-uF, 25 WVDC, electrolytic capacitor
- C6—See text
- R1—470-ohm, 1/4-watt, 5%, resistor
- L1—Inductor, see text
- IC1—NE602 (Philips NE602A)

for a center frequency of 15 MHz.

Feedback for the NE602 is taken off at the tap of coil L1. The feedback tap is about 1/4 to 1/5 of the way up from the ground end of L1. The sinusoidal wave output is sampled at pin 7 through coupling capacitor C6. Choose a value for this capacitor no greater than 15% of the value of tuning capacitor C1. The NE602's oscillator also operates with other resonance circuits such as crystals, piezo elements, and other LC configurations.

There's many more great ICs in circulation suitable for oscillator action, but we'll have to take a look at these at a later date. May all of your oscillators oscillate at the correct frequency! See you here next month. ■

SCANNER SCENE

Continued from page 60

use 156.65 MHz. Around busy harbors, you might also be able to monitor low-power dockside communications on the 457.525-457.60- and 467.75-467.825-MHz bands.

Digital Data

Responding to a reader last February, we stated that digital mode communications cannot be monitored successfully using present-era scanners. Well, you just knew we would get called out with a remark like that! We pass the following information along with neither comment nor confirmation, except to observe that it does sound very interesting.

Darryl Barry wrote, "There is a unit that can demodulate digital transmissions. I have used a working prototype of this unit on my scanner. There are actually two units working in prototype stages. One is a self-contained unit that is already programmed and attaches directly to a scanner. The second unit requires a notebook computer, SCSI card (internal or external), and software program."

He said that he is prepared to sell these units, and invites interested readers to get in touch with him. If you wish, to pursue this, contact Darryl Barry, Elite Security Professionals, 33331 Old Yale Road, #108, Abbotsford, BC, Canada V2S 2J6. His phone number is 604-859-4080.

Cellular Modification Update

Last issue, we mentioned that some new scanner models manufactured after the FCC's April 1994 cutoff date for readily restored cellular bands still could be unlocked to hear cell-phone calls if owners sent their sets to certain companies that knew how to do the job. Possibly as a backlash to the taping of Newt Gingrich's cellular call that was then turned over to the media, the FCC subsequently announced that companies are no longer allowed to offer that service.

Keep in Touch

We need your frequencies, loggings, and circuit ideas. Write to us at *Scanner Scene*, **Popular Electronics**, 500 Bi-County Blvd., Farmingdale, NY 11735. ■



Muscular Dystrophy Association

(800) 572-1717

TIPS FOR MAIL ORDER PURCHASE

It is impossible for us to verify the claims of advertisers, including but not limited to product availability, credibility, reliability and existence of warranties. The following information is provided as a service for your protection. It is not intended to constitute legal advice and readers are advised to obtain independent advice on how to best protect their own interests based upon their individual circumstances and jurisdictions.

1. **Confirm price and merchandise information** with the seller, including brand, model, color or finish, accessories and rebates included in the price.
 2. **Understand the seller's return and/or refund policy**, including the allowable return period, who pays the postage for returned merchandise and whether there is any "restocking" or "return" charge.
 3. **Understand the product's warranty.** Is there a manufacturer's warranty, and if so, is it for a U.S. or foreign manufacturer? Note that many manufacturers assert that, even if the product comes with a U.S. manufacturer's warranty, if you purchase from an unauthorized dealer, you are not covered by the manufacturer's warranty. If in doubt, contact the manufacturer directly. In addition to, or instead of the manufacturer's warranty, the seller may offer its own warranty. In either case, what is covered by warranty, how long is the warranty period, where will the product be serviced, is there a charge for service, what do you have to do to obtain service and will the product be repaired or replaced? You may want to receive a copy of the written warranty before placing your order.
 4. **Keep a copy of all transactions**, including but not limited to cancelled check, receipt and correspondence. For phone orders, make a note of the order including merchandise ordered, price, order date, expected delivery date and salesperson's name.
 5. **If the merchandise is not shipped within the promised time**, or if no time was promised, within 30 days of receipt of the order, you generally have the right to cancel the order and get a refund.
 6. **Merchandise substitution** without your express prior consent is generally not allowed.
 7. **If you have a problem with your order or the merchandise**, write a letter to the seller with all the pertinent information and keep a copy.
 8. **If you are unable to obtain satisfaction from the seller**, contact the consumer protection agency in the seller's state and your local Post Office.
- If, after following the guidelines, you experience a problem with a mail order advertiser that you are unable to resolve, please let us know. Write to Advertising Department, Gernsback Publications Inc., 500B Bi-County Blvd. Farmingdale, NY 11735.
- Be sure to include copies of all correspondence.**

ANTIQUÉ RADIO

Continued from page 64

three audio jacks. For example, no power reaches the filament of the second audio tube until a set of switch contacts is closed by the act of inserting a plug into the second audio jack. Thus the tube remains dark, conserving "A"-battery power, except when it is in use.

The switching arrangement built into the detector and first audio jacks doesn't involve the filament circuits (although there are some unused contacts on those jacks that could have been intended for possible filament switching). When a plug is inserted into one of those jacks, the connection from the plate of its associated tube to the following audio transformer is broken, and the phones are placed in series with the B+ supply.

Power Feeds

Before leaving the NR-5 circuit diagram, let's take a look at how plate, filament, and bias voltages are fed to the various portions of the circuit. The voltages (obtained from batteries, of course) reach the set through the group of labeled binding posts shown at the right of the schematic diagram.

The topmost post, labeled "+90," supplies the required 90-volt B+ to the RF and AF amplifier tube plates (the first two and last two tubes). Directly under that, labeled "+45," is the post supplying the 45-volt B+ required for the plate of the detector (middle) tube. Below that (labeled "B +6") is the filament and plate connection. And under that (labeled "-6 +C") is the post supplying filament ("A") voltage to the five 01-A tubes and serving as the return for the grid bias ("C") voltage. Finally, the bottom post (labeled "-C") supplies grid bias voltage to the audio amplifier tubes (the final two tubes).

Notice the two filament-control rheostats located toward the bottom of the schematic (one under the third tuned circuit, the other roughly under the second audio phone jack). Although you might not be able to make it out, the former is labeled as an amplifier control and the latter as a detector control. It would make sense to have the detector filament controlled separately because detector adjustments are more critical than amplifier adjustments.

However, tracing the wiring, it looks as if the "amplifier" rheostat controls only the filaments of the two RF amplifiers, while the "detector" rheostat controls everything else. It will be interesting, later, to compare the wiring of an actual NR-5 with this schematic to see if it is hooked up the same way.

The "Knock-Down" Neutrodyne

I do happen to have in my collection a five-tube Neutrodyne that, although not specifically identified as such, has to be the KD-50 Neutrodyne kit put on the market by Freed-Eisemann about 1924. Now that I've had a chance to compare it with the NR-5, I'm more convinced of that than ever. The set sold for \$80, which was quite a savings over the \$150 cost of a factory-assembled NR-5. The set did not come with a cabinet or tubes, although it did have a pre-drilled and labeled front panel.

Panel layout was a little different than that of the NR-5, with both filament control knobs on the right side of the panel instead of at opposite ends. And the audio output jacks are grouped under the filament knobs instead of being spread out across the bottom of the panel.

The kit schematic, which I traced out many years ago, is very similar to the NR-5 schematic. But there are a couple of interesting differences in the filament circuit. In this case, the "detector tube" rheostat does indeed control just the detector filament, and the "amplifier tubes" rheostat controls all of the other tubes. In addition, plugging phones into the detector socket kills the filament of the first audio stage. The second audio filament, just as in the NR-5, is always off except when a speaker is plugged into the second audio jack.

See you next issue! ■



MICROCONTROLLER

(Continued from page 56)

most boring part of the process. Once the batch file is finished you simply flip the switch back to RUN, hit the RESET switch, and—Hey! Three Beeps, not two! It worked! My three beep modification was in the micro!

The next night I rushed right home from work buoyed by my success of the previous evening. The tones generated by the program were created using an “output compare” function, which is a built-in timer function on the 68HC11 chip. While the operation of this function was beyond my comprehension, I was still able to modify the existing code to produce a workable Morse code routine. As it turned out, I simply wrote subroutines to produce tones and spaces that were multiples of a basic unit. In other words, a dot was one unit long, a dash was three units long, a space between letters was three units of no tone, a space between words was five units long—all according to Morse code convention. I simply named these subroutines and called them as necessary to produce the desired code string. For example, to produce the SK prosign, I simply called these subroutines:

```
jsr    dit
jsr    dit
jsr    dit
jsr    dah
jsr    dit
jsr    dah
```

In other words, jump to subroutine dit, return, jump to subroutine dit, return, and so on. This allowed me to string together the following code: DE WB9RRT SK (from; my call-sign; end-of-transmission). While not very elegant, this got the job done. Of course, it only sent the code each time the board was turned on. I needed a way to have it repeat at a given interval. While I was working out the code subroutines, I noticed that the Technological Arts programmers had set up a bunch of variables and a timing subroutine. To introduce a wait period, all you had to do was the following:

```
loadx  #_25SECONDS
jsr    WaitX
```

So just put the amount of time you want to wait in the X register, and jump to the subroutine called WaitX. It will dilly-dally for 25 seconds, then return to the program. I put that code before the Morse code section, and put a label at the top of the program (top:). At the end of the Morse code section I just said:

```
jmp    top
```

Now I was cycling through the Morse code, returning to the top of the program, waiting for 25 seconds, and hitting the Morse code again, and so on. I could fiddle with the timing once I got all the bugs worked out, but at least now I had the hard part of the program done. Of course, I still hadn't turned the transmitter on or off, but I did have

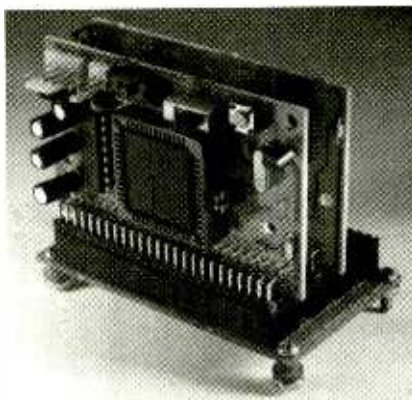

Fig. 3. Technological Arts produces a variety of plug-in carriers that make permanent installations a snap.

a few nights left.

T-minus three days and counting. I had plenty of time until Saturday, but wanted to get things working ahead of time—just in case. My objective for the evening was the PTT line. I needed to write a subroutine that would flip an output port high, and then flip it low after a delay.

I went back to the DEMO. ASM program to see how they did it. I knew that the 68HC11 used memory-mapped I/O. This means that the physical I/O ports are given addresses right along with the memory addresses, and that you can read to or write from a port the same way you can read a memory

variable.

As I viewed the code the DEMO program used to toggle the B Port lines, I found that they were using a fairly elegant way of flipping the bits. Since the programmer wants to only affect a single bit, he can't just write a new variable into the I/O port location, as this would disrupt the other bits on the port. For instance, if I want the second and third bits high, I would just write a 6 to the port (binary 00000110). This sets the proper bits high, but also sets all the other bits low, which may not be what I want. In order to accomplish this properly I need to use a bitwise OR operator. In my case, I wanted to turn on the first bit of the port, so I used the following code:

```
TX_ON:
ldab   #1
orab   portb
stab   portb
rts
```

Create a subroutine called TX_ON. Load the value 00000001 in accumulator B. Use the OR function, and OR this with the value of Port B. The new value will be in accumulator B. (By ORing the values I know that the first bit will be a 1, no matter what is already in Port B, and the rest of the bits will remain as they are.) Store this value back in the slot for Port B, which will cause the output pins to toggle accordingly. Then, return from the subroutine (rts). Likewise, to turn the bit off I used the following:

```
TX_OFF:
ldab   #1
comb
andb   portb
stab   portb
rts
```

The TX_OFF subroutine performs by loading the value of 00000001 in the B register. This is then complemented, changing it to 11111110. This value is then ANDed with whatever is in Port B, (the first bit will become 0 no matter what is in Port B, and all the rest of the bits will remain as they are). This is stored back in portb (written to the port), and the subroutine ends.

Using the TX_ON and TX_OFF functions with the WaitX function, I

was able to turn the transmitter PTT line on and off at will, for any duration of time. I had completed all the basic functions necessary for a foxhunt transmitter controller, and I still had two nights left.

As luck would have it, I heard Jim talking on the local ham repeater on the way home the next night. I broke in just to say hello. "Glad to hear from you," he said. "How's that controller coming along? I've got my yagi and attenuator all tuned up for Saturday morning!"

"Well, I've given it some thought," I said. "Should be able to whip something up the next night or two. Been pretty busy."

"Sure hope you whip something up! There's gonna be about thirty guys there looking for something to hunt—I hope it won't be you they'll be looking for! By the way, I got to thinking about the time interval on

Technological Arts

Suite 1704
1644 Bayview Avenue
Toronto, Ontario M4G 3C2
Canada
Voice/Fax: (416) 963-8996
Web: <http://www.interlog.com/~techart>
e-mail: techart@interlog.com

that thing. I hope you make it adjustable. Not really sure how much on time and off time we're supposed to get. Wouldn't want it to be too discouraging to the guys. Not really sure if we need that SK business either. Oh well, whatever you think." I signed off with Jim, and headed home. Great. Now I needed to vary the time off, at least the off interval to make it sporting, and I needed to make the SK optional. It was a good thing I had some extra time.

T-minus one day and counting. Friday night I rushed home, and hit the computer. I needed to make the off delay adjustable—not a bad idea, even if Jim did think of it. I knew that you could get an adjustable value into the micro by putting a potentiometer on one of the A/D converter inputs. I'd played with this on the DEMO program, and knew you could get a value from 0 to 255 based on the voltage coming off a simple voltage divider pot. I found out where this was

stored in the program, and used that value to modify the time off period like this:

```
ldab      adr4
timeoff:
ldx      #_1SECOND
jsr      WaitX
decb
bne      timeoff
```

This code simply takes whatever value (between 0 and 255) that comes in from the A/D converter address 4, and puts it in the B accumulator. "Timeoff:" is simply a label. The next two lines just perform a one second wait. The decb instruction decrements the value in the B accumulator by one. The next line, Branches if Not Equal (bne) loops back to the label "timeoff:". In effect, this code loops through the one second delay once for as many times as are stored in the B accumulator. The delay will be one second, multiplied by the value coming in from the potentiometer. In this case, the off delay will be from zero to four and one quarter minutes—a short enough wait time for even a total novice foxhunter.

The final problem turned out to be the easiest. In order to toggle the SK function on or off, I simply tied one of the input port lines high or low, and tested it with an AND function. If the result of the AND was zero, I simply skipped the SK code lines with a branching function, like so:

```
ldab      porta
andb      #1
beq      no_SK
jsr      dit
jsr      dit
...rest of SK code...

jsr      dah
no_SK:
```

It was 1:30 AM. I figured the rest could wait until morning.

The Fox is Alive! The foxhunt was at nine o'clock, so I had plenty of time to sleep. It had been a struggle, but I had accomplished my objectives. I had built a foxhunt transmitter that could generate a Morse code ID, an SK end-of-message signal, and had variable time intervals and a switchable SK function. Knowing absolutely nothing about micro-

controllers, I had generated tones, controlled a transmitter, read an analog value, and read a switch—all in five night's work. With that all done, I hit the pillow, and slept like a log.

So much, in fact, that I slept right through the alarm.

"I thought I'd let you sleep for another hour or so, honey - you've been up so late all week. It is Saturday, you know. Are you still having that ham radio thing today?"

Yikes! Quarter after eight. I leapt out of bed, and bolted for the workshop. I hacked the end off an old mic cord, and hooked up the audio line to the cord via a small electrolytic capacitor. I jammed an NPN transistor into the protoboard, and tied the collector to the PTT line. I hooked the mess up to my two meter handheld, and fired it up. It worked! I gently squeezed the whole mess together, and wrapped it up with thirty-seven turns of duct tape. After stopping at McDonald's for coffee, I dropped the whole package into an outside garbage can. (It was the pre-arranged hiding place—I knew the manager). I rolled into the parking lot at the mall at ten minutes to nine. Several teams were already taking bearings from the starting point; the 1-watt signal was strong enough even four miles away!

I was chatting with Randy when Jim came over. "Sounds like you got something lashed together after all!", he said.

"Oh, yeah," I shrugged. "Nothing major. One of those new Motorola microcontrollers. I programmed it up in assembly language. They're really pretty simple, once you've worked with them a bit!"

Summary. This little package can accommodate a multitude of applications. In no time, you too can be the electronics guru in your neighborhood! Maybe the best one on the block! For more information on Technological Arts' ADAPT-11 series of microcontroller modular starter kits, contact the company at the address given in the box (middle of the first column), or circle no. 124 on the Reader Service Card. ■

COMPUTER BITS

Continued from page 16

then restoring the contents of the drive.

Partition Magic (PM) changes all that. With it, you can re-partition to your heart's content. (You should still back up in case anything goes wrong during the process!) Version 3.0 of PM is less an improvement over the previous version than I would have liked. The program has a Win95 look and feel, but still operates as a DOS-mode program. The company cleverly makes a transparent installation, so that when you click on the icon, PM shuts down Windows, runs itself, then runs Windows again. You can save the aggravation simply by running it from the DOS command line.

The new version includes an anemic boot manager (built by IBM and supplied as part of OS/2), that is certainly functional, but much weaker overall than System Commander. The new version of PM also includes an application-move utility that helps you move applications (Windows 3.x and 95) from one drive to another after re-partitioning. The mover updates all INI files and Registry settings. Both 16- and 32-bit versions are included.

Together, the PM bundle provides a lot of power, but I wish the components were better integrated. One good thing is the inclusion of a text-only version of PM, which can run from a floppy disk.

Version 3 supports the new FAT32 system that comes with new PCs as part of the Win95 service pack release (only). Version 3 also supports more options concerning conversion of partition among operating system formats (FAT, NTFS, HPFS).

As of this writing, Surplus Direct (800-753-7877) is selling Version 2.0 for about \$25. That's a true bargain. It has an OS/2 look and feel, but does 90% of what the newer version does, for about one-third the cost.

System Commander

System Commander has one purpose in life—it enables you to run more than one operating system on one machine. In fact, you can install and run more than 100 OSs. Depending on the OS, you can install each to a different partition. However, all DOS and Windows (through Win95) OSs must reside on the primary partition (NT can boot from an extended partition). That is because the OSs themselves are hard-

VENDOR INFORMATION

The prices shown below are suggested retail prices. Price discounts available through software retailers.

PowerDesk Utilities (\$34.95, \$24.95 for upgrade), Mijenix Corporation, 6666 Odana Road, Suite 122, Madison, WI, 53719. (800) 645-3649, (608) 277-1981. www.mijenix.com

PartitionMagic 3.0 (\$69.95, \$29.95 for upgrade), PowerQuest Corp., P.O. Box 1911, Orem, UT 84059-1911. (800) 379-2566, (801) 226-8977. www.powerquest.com

QuickView Plus 4.0 (\$59.99, \$29 for upgrade), Inso Corp., 330 North Wabash, 15th floor, Chicago, IL 60611. (800) 333-1395, (312) 329-0700. www.inso.com

Stiletto (\$22), Bruce Switzer, 204 Duplex Avenue, Toronto, Ontario, Canada, M5P 2B2. bswitzer@ican.net, 104722. 1260@compuserve.com. www.inforamp.net/~crs2086/index.htm

System Commander, V Communications, Inc., 2290 North 1st Street, Suite 101, San Jose, CA 95131. (408) 965-4000. The version reviewed 2.26, is no longer available. The latest version 3.0, with added features, is available for \$99.95.

coded to boot only from the primary partition of the first physical drive.

I run my main workstation using DOS 6.2, Windows 3.11, Windows 95, and Windows NT 4.0. It would be possible to use just the built-in boot managers in Win95 and NT to handle this arrangement, but doing so would involve complex installation and making a series of choices from nested menus at every boot. System Commander allows standard installation and integrates all choices on one menu. You can set a default OS and a time-out, so that your normal configuration will boot unattended.

A truly integrated version of Partition Magic and System Commander would be unbeatable. ■



Guess whose skull is found 750,000 years hence!

CASIO CASSIOPEIA

Continued from page 15

accessories onto a desktop or notebook system from one of the included discs. You then connect the host system to Cassiopeia with a serial cable. Cassiopeia comes pre-loaded with Windows CE, but you modify your setup by connecting to a host system that has a CD-ROM drive. Our test system found Cassiopeia right away, and synchronized right up. We were able to control Cassiopeia from the desktop system, and easily drag and drop files between the two. You can also synchronize appointments with desktop applications such as Schedule+.

Windows CE applications include Pocket Word, Pocket Excel, Pocket Mail, and Pocket Internet Explorer. There's also a calculator, world clock, calendar with scheduling and desktop synchronization, and more. You even get the solitaire game!

Pocket Word and Excel are neat little programs, both very much like the full-blown products in look and feel. In Word, for example, you can define words and paragraphs, drag and drop text, change fonts, point size, and so on, all with the pen. While you probably won't want to type anything very long, you can send completed files to a desktop system for printing.

It was pretty neat to surf the web with Pocket Internet Explorer. We used a 28.8 modem to connect to an ISP provider, and were able to view tiny, plain web pages. One major problem is very excessive power usage when you have a modem running. Our 28.8-rated modem caused a low-battery warning to trigger after only about 15 minutes of use on a brand-new set of batteries. Then the unit shuts off, cutting off our connection. You really need an optional AC adapter when you're using a modem. Of course you can go through lots of batteries, rechargeable or otherwise, but you'll still get cut off when they run out.

Without trying to send even more business Microsoft's way, Windows CE makes pocket computing more productive than ever, and Cassiopeia is a neat little gadget that provides you with all the connectivity you need when you're on the go. If you've never been satisfied with what palmtop PCs have offered in the past, you might want to take a new look at the Cassiopeia. ■

HEARTBEAT MACHINE

(Continued from page 46)

bleshoot the circuit by checking the voltage at pin 8 of IC2-c. It should be about 5 volts when the photocell is completely dark with no variation of ambient light striking it. When the subject's finger is in place, the voltage should switch back and forth between zero and five volts. If not, check R10-R13 and IC2-c.

If LED2 is inoperative, check its polarity or try a new LED. The operation of IC3 can be checked by manually triggering it with a momentary short between pin 2 and circuit common. Each time that pin 2 is shorted, pin 3 should go to

Using four 1/2-inch spacers, with 2-56 or 4-40 machine screws and nuts, secure the boards together. Drill holes on the bottom of the enclosure to accommodate the four screws of the assembly. Temporarily assemble it to the enclosure with four spacers and nuts. Once the assembly is properly positioned in the enclosure, determine the location of the hole required for the subject's finger to rest on the transducer. Then remove the assembly and drill or cut a hole which is just large enough to accommodate your finger. Remember, the hole should be as small as practical to preclude ambient light striking the photocell.

The power switch and LED2 can be mounted at any convenient location on the top of the enclou-

sure with the photocell to ensure adequate light transfer. Allow sufficient time for the circuit to stabilize. LED2 will then blink in synchronization with the subject's heartbeat. The pulse rate is easily determined by using the second hand of a watch to count the number of flashes that occur in 15 seconds. Multiply that number by four, and the result is the heartbeat rate of the subject.

The normal pulse rate for many adults is about 70 to 75 beats per minute; children typically exhibit noticeably higher rates. Some people experience an increase in the rate when they know it is being checked. After checking the subject's normal heart rate, you may provide any kind of external stimulation to see if and by how much it will increase. This could be a very entertaining exercise! When finished using the Heartbeat Machine, always turn power off to conserve the battery. A new 9 volt alkaline battery will provide more than 40 hours of intermittent use. If the display LED becomes dim or erratic, the battery should be replaced.

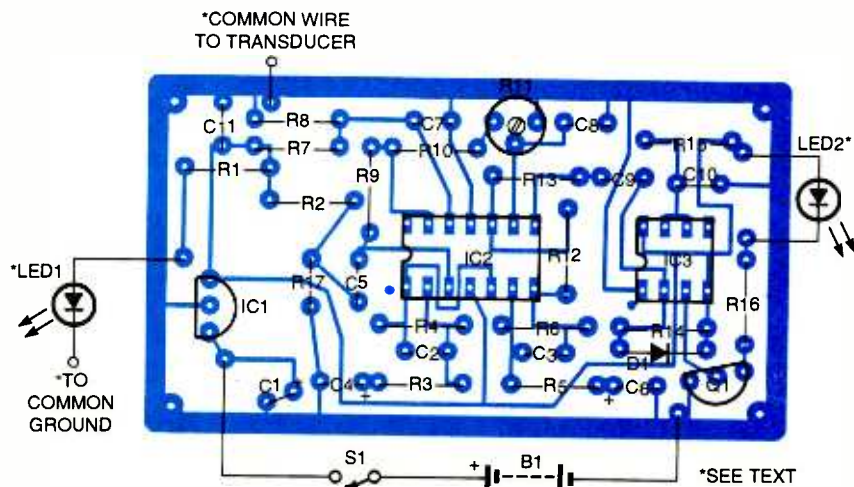

Fig. 5. Install the parts in the printed-circuit board guided by this parts-placement diagram. When installing the components, pay close attention to the orientation of the polarized parts—electrolytic capacitors, transistors, etc.

about five volts for a tenth of a second and LED2 should flash. Check Q1, D1, R14-R16, and C10. Try a new CMOS 555 chip and transistor.

Final Assembly. When you are satisfied that the circuit is operating properly, the two boards can be permanently stacked. Place the transducer assembly over the circuit board and feed the remaining leads of LED1 and the photocell into their respective holes. Allow 1/2 inch spacing between the boards and solder the leads in place. Then take a short piece of insulated wire and make the ground connection between the two boards.

sure. It is mandatory that no light from LED2 strike the photocell. One way to accomplish that is to use black electrical tape to shield the bottom side of the LED. Install the assembly into the enclosure. Complete the wiring to LED2, S1, and the battery connector, as indicated in the schematic diagram.

Using the Heartbeat Machine. Operation of The Heartbeat Machine is very simple. Just turn power on and have the subject place an index finger into the enclosure so that it rests firmly in place on the LED and photocell. The tip of the finger must be in solid

Free Best Seller! Write:
Consumer Information Catalog
Dept. BEST, Pueblo, CO 81009

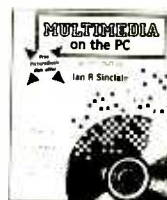

MULTIMEDIA on the PC!

What is Multimedia? What can it do for you? It can do lots of nice things! This 184-page book helps you create your own multimedia presentation.

Multimedia applications by people like you can revolutionize educational and business applications as well as bring more FUN, FUN, FUN into your leisure computer activities.

Mail coupon to:

Electronics Technology Today, Inc.
P.O. Box 240
Massapequa Park, NY 11762-0240

Please send me my copy of *Multimedia on the PC* (PCP120). I enclose a check or money order for **\$18.95** to cover the book's cost and shipping-and-handling expenses. NY state resident must add local sales tax.

Name _____

Address _____

City _____ State _____ Zip _____

All orders must be paid in U.S. funds only. Sorry, no orders accepted outside of USA and Canada. Please allow 6-8 weeks for delivery. MA02

Popular Electronics[®] Market Center[™]



Are you overpaying . . .
. . . your cable company?

You are if . . . 
. . . you are leasing their equipment.

- Forest Electronics, Inc. offers a complete line of New Cable Decoders and Converters that are fully Compatible with your cable system.
- All systems come with: Remote Control, & Parental Guidance Feature. Volume Control is also available.
- All Equipment is fully guaranteed & comes with a 30 day money back option.

For More Information Call Us 24 Hours a Day At:
800-332-1996
FAX: 813-376-7801

Don't rent! Own!
**Cable TV
Descramblers**
We'll Beat Any Price!

- Same Day Shipping!
- 30 Day Money Back Guarantee!
- Credit Cards/C.O.D.
- One Year Warranty!

Have make and model number of equipment used in your area
REPLACEMENTS FOR MOST SYSTEMS

CALL TOLL FREE
CD Electronics
1-800-684-9135

NO NEW JERSEY SALES!
Anyone implying theft of service will be denied assistance.

ROBOTIC MACHINING

ROUTE, MILL, DRILL, CARVE, ENGRAVE, PAINT
IN WOOD, PLASTIC, VINYL, PC BOARD, & LIGHT METALS!

STARTING AT
\$695.00

- 4 & 5 MOTOR GANTRY MILL CONFIGURATIONS
- PC COMPUTER CONTROLLED CNC/DNC
- IMPORT/ EXPORT FILES TO OTHER CADS
- AUTO-BACKLASH COMPENSATION
- PRE-MACHINED HEAVY CASTINGS
- SIMULTANEOUS 4 AXIS MOTION
- FREE 3D CAD/CAM SOFTWARE
- AVAILABLE IN KITS OR ASSEMBLED
- EXPEDITE SERVICE ALSO AVAILABLE
- OPTIONAL ALUMINUM WAY COVERS
- .0005" RESOLUTION / AMERICAN MADE



3 & 4 AXIS UNITS
FROM 12" X 12" TO
66" X 66" MACH. AREA

U.S. CYBERLAB, INC. 14786 SLATE GAP RD., WEST FORK, AR 72774

CALL NOW FOR INSTANT SPECS 501-839-8293 24 HR. FAX-BACK

SPECIAL PROJECTS

We design/build/modify/repair/consult on any device / system / process / project electronic / computer / mechanical / optical (eg: phone/auto/security/Radionic/lab/energy/HV/EM/RF/radar/ultrasonic/IR/UV/commo) for business and personal/invention needs. Describe & include nonrefundable \$30 pre-engineering fee. Time & cost estimates sent in 7-10 days. Confidentiality guaranteed!

OFF-THE-SHELF HARDWARE

Van Eck Systems ★ Data Card Reader/Writers ★ RF/EM/μWave/Radar/Ultrasonic/IR/Light/Sound Detectors/Xmitters/Jammers/Blasters ★ Security/Surveillance ★ EM Weapon Countermeasures ★ Neurophone/Rife/Crystal Radionics ★ Bug & Tap Detectors/Blasters ★ Lineman's Handsets ★ Phone Color Boxes ★ Voice Disguisers ★ ESS Infinity Devices ★ DTMF Decoders ★ Child Finder ★ Panic Button ★ Slot Machine Masters ★ Subliminal Mixer/Amps (Ultrasonic/Infrasonic) ★ TENS ★ Hearing Assistors ★ Electronic Dowsers ★ Shriek Modules ★ Ghost Detectors ★ Vortex Generators ★ Alien Brainblasters ★ 6th Sense Communicators ★ More! Order Catalog Today!!

AUTOMATIC TELLER MACHINES

ATM crimes, abuses, vulnerabilities and defeats exposed! 100+ methods detailed, include: Physical, Reg. E, cipher, PIN compromise, card counterfeiting, magnetic stripe, false front, TEMPEST, Van Eck, tapping, spoofing, inside job, super-cool, vibration, pulse, high voltage-others. Case histories, law, countermeasures, detailed security checklist, labeled internal photos, figures. ATMs contain up to \$250,000 in cash!

PAGER (BEEPER) MANUAL

Describes in detail how Pagers work, different types and uses, frequencies, advantages over and uses with cellphones, and tips and tricks. How Pagers are hacked and countermeasures. Includes plans for a Personal Pocket Paging System (xmitter and receiver).

HACKING FAX MACHINES

Describes in detail how Fax Machines are hacked and countermeasures. Includes G3 Fax protocols, commo parameters, compression algorithms, Class 1 & Class 2 commands, Spy Fax Switcher, Fax Servers, FODs/FOCs, and Makeup/Terminating Codes. And insights into designing Fax interception devices and modifying existing Faxes into Stealth Faxes. Eye-popping and invaluable!

PBX HACKING

PBXs are hacked to the tune of about \$8 Billion/yr! "PBX Hacking" exposes all issues relating to PBX hacking, including countermeasures. This manual was featured in Forbes Magazine! Shocking!

VOICE MAIL HACKING

Exposes how Voice Mail Box systems are used and specific ways they are hacked. Includes ASPEN, MESSAGE CENTER, BIX, GENESIS, RSVP, CENTAGRAM, EZ, AUDIX, SYDNEY, PHONE MAIL, CINDY, SPERRY LINK, etc. A must for all users, hackers, and security personnel!

10% OFF
Orders Over
\$100!!

TOP SECRET

NEW
LOWER
PRICES!

CONSUMERTRONICS

P.O. Box 23097 ABQ, NM 87192

ORDER TODAY! 505-237-2073

Fax: 505-237-2073, then "#11 #11"

Web Adventure: www.tsc-global.com

Established in 1971. Featured on CBS "60 Minutes," Forbes, New York Times. Add \$5 total S/H (US, Canada). Sold for educational purposes only. Postal M.O. is fastest. VISA, MC OK. COD (\$49-\$999), add \$7.

STOPPING POWER METERS

As reported on "60 MINUTES"! How devices can slow down (even stop) watt-hour meters - while loads draw full power! Device plugs into one outlet and normal loads into other outlets. Describes meter creep, overload droop, etc. Plans!

THE I.G. MANUAL: External magnetic ways (applied to meter) to slow down and stop power meters while drawing full loads. Plans. \$25.

KW-HR METERS: How watt-hour meters work, calibration, error modes (many), ANSI Standards, etc. Demand and Polyphase Meters. Experimental results to slow and stop meters by others. A real eye-opener! \$25.

Special! All 3 (above), Only \$59!

BEYOND PHONE COLOR BOXES

Dozens of PCB's described - many circuits. Plus Call Forwarding, Conferencing, Phreak History, Glossary, Diverters, Extenders, Loops, REMOBS, Bridging Heads & Cans, Optocom, 3rd Party and many other non-box methods - more! \$29.

MIND CONTROL

Fear increases over EM and ultrasonic mind control technologies - especially implants! Many more lies published than facts. Secret agents are often used for reporting back to covert organizations. Learn shocking truth about this bizarre phenomena! \$29.

HACKING ANSWERING MACHINES

All the known ways answering machines are hacked to listen to and erase messages, and to convert them into mini-VMBs. Plus countermeasures - protect yourself from hackers/thieves! \$19.

UNDER ATTACK!

Electromagnetic weapon attacks cause cancer, birth defects, and profound psychological and neurological disorders! This manual includes actual cases of EM attacks (we investigated)! Includes how to tell if you are under an EM attack, and specific countermeasures. Much more! Shocking! \$19.

PHREAKING CALLER ID & ANI

Details on how they work and dozens of effective ways of defeating Caller ID, ANI, *69, *57, Call Blocking,*67 etc. Also describes Caller ID, Orange, Beige, Cheese & CF Boxes, ESS, SS7, E-911, various Class services, CN/A, Non Pub DA, CAMA, DNR, 800-ECR, Diverters, LD Extenders, Centrex - much more! \$19.

BY AN ORDER OF THE MAGNITUDE

The most comprehensive, hard-hitting, hi-tech survival book ever written! Topics include electronic, computer, commo, chemistry, weaponry, cryptography, energy, concealment, revenge, alarm, disguise & ID change. Designs, tactics & strategies to survive an increasingly dangerous and brutal world. Field-expedient use of technology in various threat and conflict environments and scenarios. \$49.

CELLULAR AND CORDLESS MODS

The ultimate cellular modification guide! See our Catalog for our infamous cellphone mod guide - very detailed, comprehensive, covers most makes - 10 times more info than any competitors' manual!

THE ULTIMATE SUCCESS MANUAL

How to lie, cheat, steal, influence, and intimidate your way to success! Underpaid? Overworked? Harassed? Manipulated? Forget job performance. This manual outlines what it really takes to make it to the top in today's corporate BS world! \$19.

THE HACKER FILES

Compilation of 100s of the best eye-popping articles written by top hackers/phreakers. ASCII text. Covers every major topic in hackerdom! On 3 HD PC Disks! \$39.

INTERNET CONS & SCAMS

Net cons and related frauds now rake in \$2+ Billion annually! Most are done with little fear of prosecution. Detailed, + countermeasures.

INTERNET TRACKING & TRACING

The Net is infected with spammers, stalkers, scammers, infectors, and other wrongdoers who hide behind its anonymity. Learn how to trace them down in this comprehensive, eye-popping manual!

COMPUTER PHREAKING

Describes in detail how computers penetrate each other, and how VIRUSES, TROJAN HORSES, WORMS, etc are implemented. Dozens of computer crime and abuse methods and countermeasures. Includes disk filled with hacker text files and utilities, and the legendary FLUSHOT+ protection system. Internet advice, password defeats, glossary - much more! Manual + PC Disk!

BEYOND VAN ECK PHREAKING

Eavesdropping on TV and computer video signals using an ordinary TV described in detail. Includes security industry reports. Range up to 1 KM. Plans include both the Consumertronics and the original Top Secret Van Eck designs!

CREDIT CARD SCAMS

Completely describes every known means of credit card fraud and scams, + countermeasures. Protect yourself!

OTHER EXCITING TITLES!

CONS & SCAMS \$29

Most comprehensive manual on C&S available! Details 100s, their many variations, and countermeasures!

STEALTH TECHNOLOGY \$29

Every known police radar error - stealth method and material used to minimize radar and laser reflections - tactic and strategy to fight speeding tickets!

THE PLACAK REPORT \$29

How to read and decrypt the magnetic flux-reversals on popular credit and debit card magnetic stripes. How to determine the decrypted PIN, PAN, bank number, dates, number of uses remaining. No hardware needed!

HIGH VOLTAGE DEVICES \$29

Many HV device plans: Shan Gun, Taser, Prod, Cane, Flasher, Blaster, Zapper, Radar Jammer, Jacob's Ladder, Fence Charger, Geiger Counter, Fish Stunner, much more!

RADIONICS MANUAL \$29

Exciting electromagnetic therapeutic, diagnostic devices (mostly experimental). Descriptions, plans, availability.

ROCKET'S RED GLARE \$29

The most definite and comprehensive source on solid-propellant survival and amateur rocketry! Many plans!

FREE! \$14

How you can get FREE money, jobs, land, housing, meals, medical care, equipment, merchandise, much more!

POLYGRAPH DEFEATS \$19

How anyone can tell "the truth" to a "lie detector". Many proven methods to beat the test, and what to avoid.

SHOCKING!

ALL-NEW TOP SECRET CATALOG. FEATURES 200+ SURVIVAL PRODUCTS! WILL BLOW YOUR MIND! MAIL \$3, OR \$1 WITH ORDER!
ORDER TODAY!!

MCM ELECTRONICS®

Your Electronics Authority!

Prices Effective May 20 through July 31, 1997

To take advantage of these prices, you must supply this special price code:

CODE: POP42

ATC Lead Wire Fuses

Finally there is a fast, easy, low cost way to tap an automotive fuse box. Expanded fuse tap contacts can short out fuse boxes—but not ATC lead wire fuses!

Order #	Amps	Order #	Amps
60-3855	5	60-3875	20
60-3860	7.5	60-3880	25
60-3865	10	60-3885	30
60-3870	15		



NEW!

ONLY \$2.25

Order #81-2055

VCR Model SuperCross™

Allows you to cross reference VCRs with all models that are mechanically the same. Great for second sourcing parts, service manuals and more. Crosses over 2000 VCRs. **Regular price \$29.95**

Sale \$24.95



TV/VCR Repair Tech Disk Set

More than 24,000 TV/VCR trouble shooting suggestions! **Regular price \$69.95.**

Order #	Version
81-2205	DOS
81-2206	Windows



Sale \$59.95

Order #102-006

IC Protector Kit

Kit contains 90 popular IC protectors used in many VCRs and camcorders like JVC, RCA, Hitachi, Zenith and Sony. **Regular price \$41.95**



Sale \$21.95

TENMA®

Order #72-4030

DMM With Temperature Function

3 1/2 Digit DMM also doubles as an accurate temperature meter. Ideal for appliance repair and many other applications. **Regular price \$79.95.**



Sale \$59.95

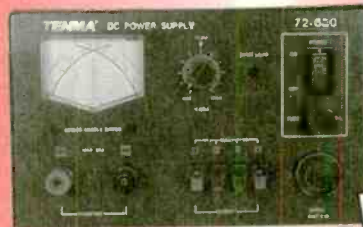

Order #72-630

30 Amp Power Supply

1-15VDC variable supply is capable of 24A continuous, 30A duty cycle. Great for the service bench or ham shack. **Regular price \$215.00.**

Sale \$159

Sale \$219



Order #72-870

NTSC Pattern Generator

Precision NTSC generator is a must when servicing TVs and VCRs. Generates dot, cross hatch, color raster and color bar patterns. Channel 3/4 and composite output. **Regular price \$279.00.**

Security Bits

Great for removing tamper-proof screws found in Nintendo, Sega and more! Works with standard 1/8" hex driver.

NEW LOW PRICE!

Order #	Size
22-1145	3.8mm
22-1150	4.5mm



\$3.49 ea.

1-800-543-4330

Hours: M-F 7 a.m.-9 p.m., Sat. 9 a.m.-6 p.m., EST.

Same Day Shipping!
In stock orders received by 5:00 p.m. (YOUR TIME), are shipped the same day.



MCM ELECTRONICS®
650 CONGRESS PARK DR.
CENTERVILLE, OH 45459
A PREMIER FARNELL Company

FREE CATALOG!

CODE: POP42

CIRCLE 144 ON FREE INFORMATION CARD

Visit MCM's website at www.mcmelectronics.com

TEST INSTRUMENT CATALOG !!!

Call, fax or email today for your free copy of our test instrument catalog, jam-packed with the **BEST VALUES** in test and measurement instruments available today!!!

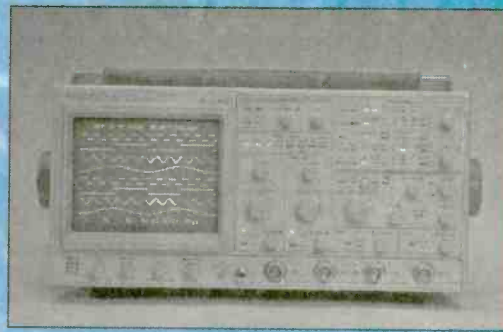

8931 Brookville Rd * Silver Spring, MD, 20910 * 800-638-2020 * Fx 800-545-0058 *
Email: SMPRODINTL@aol.com

CIRCLE 46 ON FREE INFORMATION CARD

START A GREAT CAREER IN ELECTRONICS

Professional-level home study. Learn to repair, install, and service consumer, automotive, and commercial electronic devices.

You could make *excellent* money in a repair shop or service center. Or open your own full-time or part-time business.

You'll know all about transformers, capacitors, diodes, resistors, digital electronics, integrated circuits, and much more!

 For your free career literature, send or call 24 hours a day.

CALL NOW: 800-223-4542

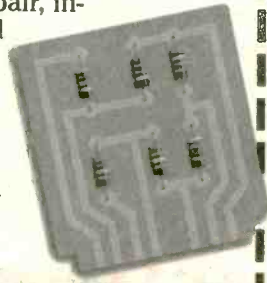

Name _____ Age _____

Address _____ Phone () _____

City _____ State _____ Zip _____

THE SCHOOL OF ELECTRONICS
Dept. ELH341, 6065 Roswell Road, PCDI, Atlanta, Georgia 30328



Free Catalog

If you are not getting this catalog you are missing out on some of the best deals in electronics today! We have thousands of items ranging from unique, hard-to-find parts to standard production components. Call, write, or fax today to start your free subscription to the most unique catalog in the industry, filled with super values on surplus electronic and hobbyist type items. If you have a friend who would like to receive our catalog, send us their name and address and we will gladly forward them a complementary 100 page catalog.

Why pay more? Call today.

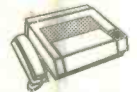

340 East First Street Fax Order Line
Dayton, Ohio 45402 1-800-344-6324

Order Toll-Free
1-800-344-4465

CIRCLE 147 ON FREE INFORMATION CARD

Digital Entertainment
also available through
Skyvision



USSB



AlphaStar

4D TV
FOR C-BAND



BEST Values from Skyvision!

Receivers
from \$259
including 4DTV

Dish Movers
12" to 52" for all
C- and Ku-band dishes

LNBS
All kinds
to heat up your picture

Tune-Up Kits
for C/Ku-band & DBS

Programming
Save 30% - 50% with Skypac™

Support
Customers enjoy toll-free technical help

Keep your C-band System Running Strong

Everything on the arc for complete variety

Enjoy debut of new channels
Often in the clear for months

Wild feeds... Action as it happens

Programming you want at a price
you can afford to pay

Whether you're considering your first
satellite TV entertainment system or
looking for an upgrade to your
current system, Skyvision provides
the best in hardware, technical
support, convenience,
low cost and service.

1048 Frontier Drive
Fergus Falls, MN 56537

All marks shown are registered trademarks
of their respective owners.

Fax: 218-739-4879 Int'l: 218-739-5231

1-800-334-6455
www.skyvision.com

Skyvision

EARN MORE MONEY!

Be an FCC LICENSED ELECTRONIC TECHNICIAN!



Learn at home in spare time.
No previous experience needed!

No costly school. No commuting to class. The Original Home-Study course prepares you for the "FCC Commercial Radiotelephone License." This valuable license is your professional "ticket" to thousands of exciting jobs in Communications, Radio-TV, Microwave, Maritime, Radar, Avionics and more...even start your own business! You don't need a college degree to qualify, but you do need an FCC License.

No Need to Quit Your Job or Go To School

This proven course is easy, fast and low cost! **GUARANTEED PASS**—You get your FCC License or money refunded. **Send for FREE facts now. MAIL COUPON TODAY!**

Or, Call 1-800-932-4268 Ext. 240

COMMAND PRODUCTIONS

FCC LICENSE TRAINING, Dept. 240
P.O. Box 2824, San Francisco, CA 94126
Please rush FREE details immediately!

NAME _____
ADDRESS _____
CITY _____ STATE _____ ZIP _____

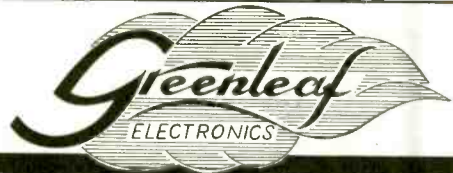

CABLE TV Converters & Descramblers

Compatible with
**Jerrold, Scientific Atlanta,
Pioneer, Oak, & Hamlin
Equipment**

BRAND NEW!

6-MONTH GUARANTEE

LOWEST PRICES

Volume Control & Parental Lockout Available

Greenleaf Electronics

1-800-742-2567

NO ILLINOIS SALES

It is not the intent of Greenleaf Electronics to defraud any pay television operator and we will not assist any company or individual in doing the same.



www.pueblo.gsa.gov

9 out of 10 mice prefer it.

Catch the free Consumer Information Catalog online and you'll get the latest info from the U.S. Government. Just point and click your way to www.pueblo.gsa.gov and you'll find more than 250 free publications ready to read or download.

Or, order the Catalog by mailing your name and address to **Free Catalog, Pueblo, CO 81009**. Scurry, this info's the cat's meow.

U.S. General Services Administration

**FREE CATALOG
CALL TOLL FREE
1-800-338-0531**

E-Mail: xpress@parts-express.com



**Parts
Express™**

**UNBELIEVABLE
VALUE!**

X-10 POWERHOUSE
SECURITY AND AUTOMATION

Check our catalog for a full line of X-10 Home Security and Home Automation products.



Weller WLC100 Soldering Station

The Weller WLC100 solder station is ideal for the professional, serious hobbyist, or kit builder who demands higher performance than usual of a standard iron, but without the high cost of an industrial unit. Power is adjustable from 5 to 40 watts. Includes 40 watt pencil iron. UL approved. Net weight: 1-3/4 lbs.



**SUPER
VALUE**

#PO-372-120 **\$39⁹⁵** EACH

**"The Sound Bridge" FM Stereo
Wireless Transmitter**

The Sound Bridge is a mini FM wireless transmitter that can be used to broadcast stereo sound from any audio source like portable CD players, TVs, electronic games, CD-ROM, even computer soundcards, to your home stereo receiver! Adjustable from 89 to 95.5 MHz.



**HOT
NEW
ITEM!**

#PO-249-220 **\$14⁹⁵** EACH

**3 Way Indoor/Outdoor
Speaker System**

These are the best sounding little speakers you can find at anywhere near this price! Perfect for rear channel use in a home theatre system or for outdoor use. Features 4" polypropylene woofer, 2" polycone midrange, 3/4" dome tweeter housed in a weatherized polystyrene enclosure. Frequency response: 90-20,000 Hz. Impedance: 4 ohms. Power handling: 30 watts RMS/60 watts max. Mounting brackets included. 7-1/4" H x 4-5/8" W x 4-3/8" D. Net weight: 6 lbs.



#PO-319-020 (Black) **\$45⁰⁰** PAIR
#PO-319-025 (White) **\$29⁹⁵** PAIR

Home Theatre In-Floor Subwoofer

To fully appreciate the potential of movie soundtracks, a dual voice coil subwoofer is a must! Many film special effects are extremely demanding in the low frequency range and require a subwoofer that can duplicate explosions, earthquakes, even the footsteps of Tyrannosaurus Rex! This subwoofer fits the bill by featuring a 10" dual voice coil woofer for true stereo operation and high pass filters for your main speakers. The most unique feature of this subwoofer is the fact that it is designed to be mounted in between the floor joists in new and existing home constructions. Simply mount the in-floor sub to the joists and mount a heat register grill above opening in subwoofer front enclosure. The subwoofer is now totally out of view and ready to rumble! Includes detailed installation manual.



Specifications: 10" dual voice coil treated paper cone woofer with poly foam surround ◆ Frequency response: 30-100 Hz ◆ Nominal impedance: 8 ohms per coil ◆ Power handling: 100 watts RMS channel/140 watts max ◆ SPL: 89 dB 1W/1m ◆ Dimensions: 27" D x 14-5/8" W x 9" H ◆ Net weight: 29 lbs.

#PO-300-445 **\$139⁹⁵** EACH

Peak Instrument Co.

"The Woofer Tester"

Peak Instrument Co. proudly introduces "The Woofer Tester". Just ask any loudspeaker engineer, and they will tell that the only way to design enclosures of the correct size and tuning is to measure the Thiele-Small parameters for the actual drivers to be used. The reason? Manufacturers published specs can be off by as much as 50%! But until now, measuring the parameters yourself required expensive test equipment and tedious calculations, or super expensive measurement systems (\$1,200 to \$20,000). The Woofer Tester changes all that.

Finally, a cost effective, yet extremely accurate way to derive Thiele-Small parameters. In only minutes! The Woofer Tester is a combination hardware and software system that will run on any IBM compatible computer that has EGA or better graphics capability and an RS232 serial port. The Woofer Tester will generate the following parameters. Raw driver data: Fs, Qms, Qes, Qrs, Vas, BL, SPL @ 1W/1m, Mmd, Cm, and Rm. Sealed box data: Fsb and system Q. Vented box data: Fsb, ha, alpha, and Q loss. The Woofer Tester system includes hardware, test leads, serial cable, AC wall adaptor, detailed instructions, and software.



**QUICPLY AND
ACCURATELY
MEASURES: Fs,
Qms, Qes, Qrs, Vas,
BL, SPL @ 1W/1m,
Mmd, Cm, and Rm
IN MINUTES!**



◆ 30 DAY MONEY BACK GUARANTEE
◆ 1 YEAR WARRANTY ◆ SAME DAY SHIPPING

#PO-390-800 **\$249⁰⁰** EACH

5 Foot Stereo RCA Patch Cord

High quality, Japanese made patch cord features color coded RCA plugs on each end for easy polarity identification. Molded strain reliefs for extra long life and durability. Limited availability.



Part #	Description	Price (1-9)	Price (10-UP)
PO-189-070	Red/white plugs	\$1.20	\$9.95
PO-189-072	Yellow/black plugs	1.20	9.95

Copper Clad PC Board

Now's the perfect time to start building your own PC boards! A factory buyout enables us to bring you this premium quality copper clad PC boards at unheard of low prices. Each board is coated with .0014" copper and is at least .060" thick. Limited availability.

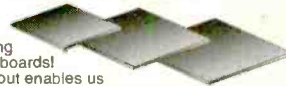

Part #	Description	Price (1-9)	Price (10-UP)
PO-055-204	6" x 18" single sided	\$1.50	\$1.35
PO-055-206	6" x 21" single sided	1.75	1.55
PO-055-222	8" x 24" single sided	2.65	2.40
PO-055-252	6" x 18" double sided	2.25	2.00

**Speaker
Surround
Repair Kits**



- ◆ Do it yourself
- ◆ Save Money
- ◆ Complete instructions
- ◆ Wide variety of sizes and styles
- ◆ Hard to find Advent Woofer and Red Foam kits available

**CALL NOW FOR
SIZES AND MORE
INFORMATION**

900 MHz Wireless Speaker System

- ◆ 900 MHz technology sends signal up to 180 ft., through walls, floors and ceilings.
- ◆ Ideal for use as rear surround speakers or for adding wireless sound to every room in the house!
- ◆ Full range, bass reflex design with built-in high power, low distortion amplifier.
- ◆ Weather resistant cabinet for outdoor use.
- ◆ Selectable battery (six C size for each speaker) or AC operation, adaptor included. Built-in recharging circuit for ni-cad batteries.
- ◆ System includes: 900 MHz transmitter, wireless speaker pair, AC adaptors, and all cables necessary to hook up system.
- ◆ Limited availability. ◆ Net weight 9 lbs.
- ◆ Frequency response: 20-18KHz.



#PO-319-030 **\$169⁹⁵** EACH

◆30 day money back guarantee ◆\$20.00 minimum order ◆We accept Mastercard, Visa, Discover, and company C.O.D. orders ◆24 hour shipping ◆Shipping charge = UPS chart rate + \$1.90 (\$5.00 minimum charge) ◆Hours 9:00 am - 8:00 pm ET, Monday - Friday ◆9:00 am - 5:00 pm Saturday. Mail order customers, please call for shipping estimate on orders exceeding 5 lbs. ◆Foreign destination customers please send \$5.00 U.S. funds for catalog. ◆Quantity pricing available.

1-800-338-0531

340 E. First St., Dayton, OH 45402-1257
Phone: 937-222-0173 ◆ Fax: 937-222-4644



CIRCLE 146 ON FREE INFORMATION CARD

WORLD'S SMALLEST

Wireless Video Transmitters

Used by hundreds of hobbyists and professionals alike in R/C models, Robots, Surveillance Video, movie Special Effects, and Law Enforcement.

"... previously, I used expensive wireless units from Pelco, MVP, and Supercircuits. Nothing approaches the VidLinks in power, picture quality, size, and value. Thank you." *R. Leslie, CCTV Installer, NY.*
 "The best... Incredible color, resolution... very easy to use... cool." *P. Davis, Movie Props, CA.*

Actual Size!!!



Live Remote Video From \$99.00

- Full 100 mW RF Power. Range 500ft. to 1/2mile •
- Crystal Controlled •
- High-Resolution Full Color/ B&W video •
- Fully epoxy encased- no exposed components •
- Fully assembled- only two wires to attach •
- **MONEY BACK GUARANTEE.** •

VidLink 100: 100mW Power- upto 1/4 Mile
\$199.00 New! High-Power!

VidLink 15: 15mW Power- upto 150 Feet
\$99.00 New! Low Price- Same Size!

Covert Camera: 1 1/4" sq. Pinhole Lens
\$169.00 Pro Grade Japanese Quality!

*** Audio Module Now Available. Call. ***
 Check/MO, COD +\$5.00, S&H \$5.50

**AEGIS
RESEARCH**

#671-1225 E. Sunset Dr.
 Bellingham, WA
 98226-3529 USA

1-604-224-0416

Visit our virtual catalog on the INTERNET at:
<http://www.lynx.bc.ca/virtualspy>

TRIDENT



\$699⁰⁰
 SV150

1000KHz to 1.00GHz Spectrum Analyzer System Up to 500MHz Span. Two bands.

All the advantages of a Spectrum Analyzer at a very affordable price. Great for interference and signal hunting. RS232 connect for logging signals to disk. Real time display sweep outputs on any X,Y scope. Variable span and sweep rate. Marker function and selectable bandwidth. Demods in AM/NFM/WFM plus BFO for CW/SSB modes. For instant information use our fax back service at 317 849 8683, #405. Or, email Scanns@www.acecomms.com . <http://www.acecomms.com/Scanns>.



Order Line: 1 888 445 7717

10707 E. 106th, Fishers, IN 46038 International: 317 842 7115

Fax 317 849 8794 Email: Scanns@www.acecomms.com

CIRCLE 25 ON FREE INFORMATION CARD

CONTROL

RELAYS • LIGHTS • MOTORS

MEASURE

TEMPERATURE • PRESSURE • LIGHT LEVELS • HUMIDITY

INPUT

SWITCH POSITIONS • THERMOSTATS • LIQUID LEVELS

MODEL 30 \$79



- PLUGS INTO PC BUS
- 24 LINES DIGITAL I/O
- 8 CHANNEL:
- 8 BIT A/D / IN
- 12 BIT COUNTER
- UP TO 14K BMP/SEC

MODEL 45 \$189



- RS-232 INTERFACE
- 8 DIGITAL I/O
- 8 ANALOG INPUTS
- 2 ANALOG OUTPUTS
- 2 COUNTERS-24 BIT

MODEL 100 \$279



- 12 BIT 100 KRZ A/D
- 4 ANALOG OUTPUTS
- 3 TIMER COUNTERS
- 24 DIGITAL I/O

MODEL 60 \$179



- 8 2-AMP RELAYS
- 16 DIGITAL I/O
- 1 8-BIT ANALOG INPUT

MODEL 40 \$109



- RS-232 INTERFACE
- 28 LINES DIGITAL I/O
- 8 ANALOG INPUTS
- PWM OUTPUT
- OPTIONAL 12 BIT A/D

MODEL 70 \$239



- RS-232 INTERFACE
- 18 BIT A/D
- 5.5 DIGIT
- UP TO 60 BMP/SEC

NEED A CUSTOM PCB? TRY US.

PRAIRIE DIGITAL, INC.

PHONE 608-643-8599 • FAX 608-643-6754

920 SEVENTEENTH STREET • PRAIRIE DU SAC, WISCONSIN 53578

CIRCLE 45 ON FREE INFORMATION CARD

FM TRANSMITTERS! FUN PROJECTS! AND MORE!

PRICES SUBJECT TO CHANGE WITHOUT NOTICE



TOLL FREE ORDER LINE: 1-800-336-7389

FAX LINE: 1-602-731-4748

TECH SUPPORT NUMBER: 1-602-829-0755

XANDI ELECTRONICS, INC.

YOUR MANUFACTURER OF HIGH QUALITY KITS!

143.775 MHz CRYSTAL CONTROLLED TRANSMITTER KITS



XTR300EZ \$79.95
XTL3000EZ \$99.95
XTL1000EZ \$69.95

XTR300 TRACKING TRANSMITTER KIT
Transmits continuous beep-beep-beep
Ideal for locating lost or stolen items
Range up to 1 mile

XTL3000 LONG RANGE TRANSMITTER KIT
Sensitive built in microphone
Range up to 1 mile
Custom frequencies available

XTL1000 TRANSMITTER KIT
Sensitive built in microphone
Range up to 1/2 mile
Custom frequencies available

CRYSTAL TRANSMITTER KITS

- Ultra-miniature surface mount construction.
- E-Z kit approach makes assembly a snap.
- Miniature battery and holder will mount directly to the circuit board.
- Transmit to any scanner type receiver

BUG DETECTOR

XBD500
\$129.95

- Professional quality.
- Assembly is a snap.
- Covers 1 to 2,000MHz.
- Uses new Microwave Integrated Circuit amplifier.
- Adjustable sensitivity.
- Audio jack for privacy ear phone.



Any intercepted signal causes an audio tone that increases from a low pitched growl to a high pitched squeal as the signal strength increases.

88-108 MHz FM RECEIVER

XMR2000
\$29.95

- World's smallest FM radio.
- As small as a hearing aid.
- Weighs less than 1/4 oz.
- Digital touch tuning.
- Ideal for use with our 88-108MHz FM transmitters



88-108 MHz FM TRANSMITTER KITS



XST 500EZ \$49.95
XWB 1000EZ \$46.95
XFM 100C \$21.95



XSP 250EZ \$34.95
XTR 100C \$29.95
XTT 100C \$19.95

XST 500 Voice transmitter. Range up to 1 mile. Supersensitive mic. Uses 9 volt battery. Uses surface mount components.

XWB 1000 Voice transmitter. Range up to 1/2 mile. Includes mic and battery on circuit board. Uses surface mount components.

XFM 100 Voice transmitter. Range up to 1 mile. 9 v battery and leaded components.

XSP 250 Super-miniature telephone transmitter. Range 1/4 mile. Powered by phone line. Uses surface mount component.

XTR 100 Tracking transmitter. Range up to 1 mile. Uses 9 volt battery. Transmits a BEEP - BEEP - BEEP tone

XTT 100 Telephone transmitter. Range up to 1 mile. Uses 9 volt battery.

NEW!!



XPC 200
PIN HOLE CAMERA
400 LINE RESOLUTION

- Audio and Video outputs.
 - See entire room through pin sized hole.
 - Use with any TV or VCR with audio & video input connectors.
 - Other models available.
- Assembled \$169.95



XVS100
TV TRANSMITTER

- Use with XVC200, VCR, Camcorder, etc.
 - Power cube included.
 - Uses VHF TV Band.
 - Transmits video & audio.
 - Up to 100 foot range.
- E-Z Kit \$29.95

"THE ENFORCER!" NEW!



XXE-1000
as a kit \$39.95
assembled \$49.95

Use it to test radar detectors in other cars from your own vehicle! 10.450 to 10.550 GHz hand held transmitter. Extra high output level. Includes an input connector for keyed amateur band operation.

PHONE VOICE CHANGER KIT

16 levels of digital voice changing. Sound tougher, older or younger, female or male.

NEW!!

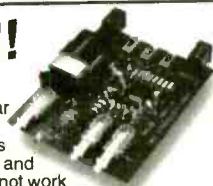

Works with regular or multi-line phones. Connects between handset and phone. Note: will not work with cordless or cellular type telephones.

XVC-2005C
\$59.95

XANDI ADVANCED HOBBY KITS



XPS 1000C
\$55.95

- TELEPHONE SNOOP KIT**
- Dial home from anywhere and hear inside your home.
 - TouchTone coded for secure operation.
 - Stop burglars and intruders.
 - Reliable 24 hour protection.



XLC 900C
\$49.95

- SCANNER CONVERTER KIT(800-950MHz)**
- Uninterrupted coverage of the 800 to 950 MHz band!
 - Works with any 400-550MHz scanner.
 - Gain: 6 dB typical.
 - Noise figure: 3 dB typical.



XVA 250C
\$49.95

- VOICE-STRESS ANALYZER KIT**
- See at a glance if your being lied to!
 - Subject need not be present. Works with voices from recordings, TV or radio.
 - Has built-in microphone.
 - Easy to use LED display output.



XFS 108C
\$39.95

- 88-108 MHz FM STEREO TRANSMITTER KIT**
- Separate level control for both left and right channels.
 - Output level circuit with test points for quick and easy tuning.
 - Transmit from any stereo audio source to most any FM stereo receiver.

Serving the public since 1981

XANDI ELECTRONICS, INC.
1270 E Broadway Rd. # 113
Tempe AZ 85282

WE ACCEPT CHECK, VISA, MC, MO, COD
SHIPPING & HANDLING EXTRA



CALL FOR YOUR FREE CATALOG

CIRCLE 134 ON FREE INFORMATION CARD

SEND MAIL ORDERS TO:
XANDI ELECTRONICS, INC.
BOX 25647
TEMPE, AZ 85285-5647

Our Complete Catalog is now online

http://www.cir.com

CIRCUIT SPECIALISTS INC.

Check Out What We Have To Offer:

Fantastic DMM Offer!!!

Don't let the price fool you. This meter is a digital multimeter designed for engineers and hobbyists. Equipped with 5 functions and 19 ranges. Each test position is quickly and easily selected with a simple turn of the FUNCTION/RANGE selector rotary switch.

Rubber Boot Included

General

Display: 3-1/2 Digit LCD, 21mm Figure Height with Automatic Polarity

Overrange Indication: 3 Least Significant Digits Blank

Temperature for Guaranteed Accuracy: 23°C±5°C RH<75%

Temperature Ranges:

Operating: 0°C to 40°C (32°F to 104°F)

Storage: -10°C to 50°C (14°F to 122°F)

Power: 9V Alkaline or Carbon-Zinc Battery (NEEDA 1004)

Low Battery Indication: BAT on Left of LCD Display

Dimensions: 188mm long x 87mm wide x 33mm thick

Net Weight: 400g

DC Voltage (DCV)

Range: Resolution: Accuracy:

200mV 100µV

2000mV 1mV ±(1%rdg+2dgts)

20V 10mV

200V 100mV

1000V 1V

Maximum Allowable Input: 1000V DC or Peak AC

DC Current (DCA)

Range: Resolution: Accuracy:

200µA 100nA

2000µA 1µA ±(1.2%rdg+2dgts)

20mA 10µA

200mA 100µA

10A 10mA ±(1.2%rdg+2dgts)

Overload Protection: mA Input, 2A/250V fuse.

AC Voltage (ACV)

Range: Resolution: Accuracy:

200V 100mV ±(1.2%rdg+10dgts)

750V 1V

Frequency Range: 45Hz-450Hz

Maximum Allowable Input: 750V rms

Response: Average Responding, Calibrated In rms of a Sine Wave.

Maximum Allowable Input: 1000V DC or Peak AC

Maximum Allowable Input: 1000V DC or Peak AC

CAT NO	DESCRIPTION	PRICE
9300G	Rugged High Quality DMM with Rubber Boot	\$19.00

\$19.00 any qty

Resistance (Ω)

Range: Resolution: Accuracy:

200Ω 100mΩ

2000Ω 1Ω ±(1.2%rdg+2dgts)

20KΩ 10Ω

200KΩ 100Ω

2000KΩ 1KΩ

20MΩ 10KΩ ±(2%rdg+10dgts)

Maximum Open Circuit Voltage: 2.8V

Maximum Open Circuit Voltage: 2.8V

Diode Test

Measures forward voltage drop of a semiconductor junction in mV test current of 1.5mA Max.

ohFE Test

Measures transistor hFE.

Our Best Offer Ever on a

High Quality Full Sized DMM



Switchable Scope Probe Sets

(Selectable X1/Ref/X10) These high quality scope probe sets are for oscilloscopes up to 60MHz (model HP 9060) or 50MHz (model HP 9150). Both sets include a handy storage pouch and include an IC test-hook adapter for the probe. The BNC connector rotates to avoid cable tangle or kink. Cable length is 1.4 meters.

These high quality scope probe sets are for oscilloscopes up to 60MHz (model HP 9060) or 50MHz (model HP 9150). Both sets include a handy storage pouch and include an IC test-hook adapter for the probe. The BNC connector rotates to avoid cable tangle or kink. Cable length is 1.4 meters.

CAT NO	DESCRIPTION	PRICE EACH
HP-9060	Scope Probe Set DC~60MHz	\$16.49 \$14.49 \$11.58
HP-9150	Scope Probe Set DC~150MHz	24.95 21.95 18.62

Etching Chemicals/Ferric Chloride

A dry concentrate that mixes with water to make 1 pint of etchant, enough to etch 400 sq. inches of 1oz board.

CAT NO	DESCRIPTION	PRICE EACH
ER-3	Makes 1 pint	\$3.50 \$2.75



Positive Photo Resist Pre-Sensitized Printed Circuit Boards

These pre-sensitized printed circuit boards are ideal for small production runs. They provide high resolution and excellent line width control. High sensitive positive resist coated on 1oz. copper foil allows you to go direct from your computer plot or art work layout. No need to reverse art.

Single-Sided, 1oz. Copper Foil on Paper Phenolic Substrate

CAT NO	DESCRIPTION	PRICE EACH		
		1	10	50
PP101	100mm x 150mm/3.91" x 5.91"	\$2.55	\$1.90	\$1.70
PP114	114mm x 165mm/4.6" x 6.6"	2.98	2.45	1.98
PP152	150mm x 250mm/5.91" x 9.84"	5.40	3.98	3.60
PP153	150mm x 300mm/5.91" x 11.81"	6.15	4.48	4.10
PP1212	305mm x 305mm/12" x 12" NEW!	12.78	10.65	8.52

Single-Sided, 1oz. Copper Foil on Fiberglass Substrate

CAT NO	DESCRIPTION	PRICE EACH		
		1	10	50
GS101	100mm x 150mm/3.91" x 5.91"	\$ 3.90	\$2.98	\$2.60
GS114	114mm x 165mm/4.6" x 6.6"	4.80	3.49	3.20
GS152	150mm x 250mm/5.91" x 9.84"	8.69	5.98	5.78
GS153	150mm x 300mm/5.91" x 11.81"	10.20	7.20	6.80
GS1212	305mm x 305mm/12" x 12" NEW!	18.88	15.73	12.59

Double-Sided, 1oz. Copper Foil on Fiberglass Substrate

CAT NO	DESCRIPTION	PRICE EACH		
		1	10	50
GD101	100mm x 150mm/3.91" x 5.91"	\$ 5.07	\$3.68	\$3.38
GD114	114mm x 165mm/4.6" x 6.6"	5.95	4.29	3.99
GD152	150mm x 250mm/5.91" x 9.84"	10.47	7.39	6.98
GD153	150mm x 300mm/5.91" x 11.81"	11.95	8.69	8.30
GD1212	305mm x 305mm/12" x 12" NEW!	22.09	18.35	14.68



Developer This product is used as the developer on our positive photo-resist printed circuit boards. Includes instructions. 50 gram package, mixes with water, makes 1 quart.

CAT NO	DESCRIPTION	1	10	25
POSDEV	Positive Developer	\$.95	\$.80	\$.50



Etching Tank This handy etching system will handle PC boards up to 8" x 9", two at a time. Ideal for etching your PCB's! System includes an air pump for etchant agitation, a thermostatically controlled heater for keeping etchant at optimum temperature and a tank that holds 1.35 gallons of etchant. A tight fitting lid is also supplied to prevent evaporation when system is not being used. Typical etching time is reduced to 4 minutes on 1oz. copper board!

CAT NO	DESCRIPTION	PRICE
12-700	Etch Tank System	\$37.95

Removeable Hard Drive Racks

The ideal solution for protecting highly sensitive data. Or, buy one computer and allow individual users to keep their hard drive with their own applications and set-ups. Just turn the system off, lift the handle and the hard drive pops right out. Key lock included to avoid accidental or unauthorized removal. Includes hard drive activity LED's. Rack includes mounting hardware, keylock, front panel LED, convenient pull out handle. Made from high impact ABS plastic. Fits in 5.25" bay.

Features: • Ideal for Hard Drive Portability • Solve Software Data Security Issues • Carry Your Hard Drive Between Home and Office • Each User Can Have His or Her Personal Hard Drive

CAT NO	DESCRIPTION	PRICE
SpecialHDRACK-IDE	For IDE Hard Drive	\$14.95



SEE OUR ON-LINE CATALOG AT
www.cir.com

Digital Panel Meters (LCD & LED)

Don't let the prices fool you. These digital panel meters are not surplus, so even if you design them into an ongoing manufactured product, you can be assured of continued availability. These high quality digital panel meters are decimal point selectable with guaranteed zero reading at zero volts input.



Applications Include:

- Voltmeter
- Thermometer
- pH Meter
- dB Meter
- Watt Meter
- Current Meter
- Capacitance Meter
- LUX Meter
- LCR Meter
- Other Industrial & Domestic Uses

PM-128: 3-1/2D LCD Digital Panel Meter

PM-129: 3-1/2D LED Digital Panel Meter

Features

- 200mV Full Scale Input Sensitivity
- PM-128 - Single 9VDC Operation
- PM-129 - Single 9VDC Operation
- Decimal Point Selectable
- PM-128 - 13mm Figure Height
- Automatic Polarity Indication
- Guaranteed Zero Reading for 0 Volt Input
- High Input Impedance (>100Mohm)

Specifications - PM-128/PM-129

Maximum Input	: 199.9mV DC
Maximum Display	: 1999 counts (3-1/2 Digits) w/Automatic Polarity Indication
Indication Method	: PM-128 - LCD Display PM-129 - LED Display
Measuring Method	: Dual-Slope Integration A/D Converter System
Overrange Indication	: '1' Shown in the Display
Reading Rate Time	: 2-3 Readings per sec.
Input Impedance	: >100 Mohm
Accuracy	: +0.5% (23+5°C, <80% RH)
Power Dissipation	: PM-128 - 1mA DC PM-129 - 60mA DC
Decimal Point	: Selectable w/Wire Jumper
Supply Voltage	: PM-128 - 9V DC PM-129 - 9V DC
Size	: 67mm x 44mm

Specifications - PM-328

Maximum Input	: 199.99mV DC
Maximum Display	: 19999 counts (4-1/2 Digits) w/Automatic Polarity Indication
Indication Method	: LCD Display
Overrange Indication	: '1' Shown in the Display
Input Impedance	: >100 Mohm
Accuracy	: +0.05% (23+5°C, <80% RH)
Power Dissipation	: 1mA DC
Decimal Point	: Selectable w/Wire Jumper
Supply Voltage	: 9V DC
Size	: 67mm x 44mm

AS LOW AS \$5.25 ea.

CAT NO	DESCRIPTION	PRICE EACH				
		1	10	25	100	250
PM-128	3-1/2 Digit LCD Panel Meter	\$ 9.90	\$ 7.09	\$ 6.40	\$ 5.86	\$ 5.25
PM-129	3-1/2 Digit LED Panel Meter	11.49	9.54	8.67	7.95	6.95
PM-328	4-1/2 Digit LCD Panel Meter	19.88	16.40	14.90	13.66	11.93



Ball Bearing 12V DC Fans

These High Quality Fans feature Ball Bearings and Brushless DC Motors. All of them are designed to meet UL, CSA & VDE Standards. Design these fans into power supplies, computers or other equipment requiring additional air flows for heat removal. These fans are regular Circuit Specialists stock items — they are not surplus.

INDUSTRY BEST PRICING!

CAT NO	PRICE EACH			
	1	10	25	100
CSD 4010-12	\$ 9.88	\$ 6.38	\$ 5.48	\$ 4.87
CSD 6025-12	9.38	5.91	5.41	4.71
CSD 8025-12	8.88	5.85	5.19	4.49
CSD 9225-12	8.95	6.14	5.29	4.59
CSD 1225-12	11.45	8.96	7.82	6.85

Specifications

CAT NO	DIMENSIONS (MM)	RATED VOLTAGE (V)	START VOLTAGE (V)	INPUT CURRENT (A)	AIR FLOW (CFM)	STATIC PRESSURE (INCH-H ₂ O)	SPEED (RPM)	NOISE LEVEL (dB)	WEIGHT (g)
CSD 4010-12	40x40x10mm	12	7	0.06	5.1	0.19	5,500	26	20
CSD 6025-12	60x60x25mm	12	5	0.13	13.7	0.165	4,500	28	65
CSD 8025-12	80x80x25mm	12	5	0.16	37.8	0.177	3,000	31	80
CSD 9225-12	92x92x25mm	12	5	0.32	42	0.18	2,800	37	95
CSD 1225-12	120x120x25mm	12	5	0.35	62	0.180	2,500	42	135

- SOLDER • SOLDER • SOLDER
- SOLDER • SOLDER • SOLDER

We stock high quality 60/40(Sn%/Pb%), .031" and 63/37, .031" diameter. This is prime JIS certified solder that we maintain as a regular stock item (It is not "Left-overs, Rejects or Surplus") and you can buy it from us at a fraction of the price that you are used to.

Tired of Paying Inflated Prices for Solder?

CAT NO	DESCRIPTION	PRICE EACH		
		1	10	25
RH60-1	1-lb. Spool, .031", 60/40	\$ 6.90	\$ 5.96	\$ 5.30
RH63-1	1-lb. Spool, .031", 63/37	6.95	6.10	5.41
RH60-4	4.4-lb. Spool, .031", 60/40	24.00	21.90	17.92
RH60-TUBE	6-oz. Tube, .031", 60/40	.99	.89	.79

CAT NO	DESCRIPTION	PRICE EACH	
		1	5
CA-H34A	PCB Mounted IRCCD Camera	\$99.00	\$85.00
A34	Power Supply Regulating Kit	\$6.95	----

CCD Camera - IR Responsive

As Low As \$85!!

This black and white monochrome CCD Camera is totally contained on a PCB (70mm x 46mm). The lens is the tallest component on the board (27mm high from the back of the PCB) and it works with light as low as 0.1 lux. It is IR Responsive for use in total darkness. It comes with six IR LED's on board. It connects to any standard monitor, AUX or video input on a VCR or through a video modulator to a TV. Works with a REGULATED 12V power supply (11V-13V). Hooks up by connecting three wires: red to 12V, black to ground (power & video) and brown to video signal output.

Power Supply Regulating Kit for CA-H34 This simple kit is designed to fit onto the back of the CA-H34 CCD camera. It resolves the problem of hooking up the camera to an UNREGULATED supply (which damages the camera) by providing safe regulated power from any 12V-14V DC supply. It also provides regulated 12V DC from a 12V AC source.

SEE OUR ON-LINE CATALOG AT www.cir.com

CIRCUIT SPECIALISTS, INC.

SINCE 1971

800-811-5203

602-464-2485

602-464-5824 (FAX)

WE ACCEPT:



RECEIVE OUR LATEST 132 PAGE CATALOG!

It's chock full of all types of electronic equipment and supplies. We've got I.C.'s, capacitors, resistors, pots, inductors, test equipment, breadboarding supplies, PC supplies, industrial computers, data acquisition products, personal computers and computer parts, plus much, much more. FAX us your name and address or call 800-811-5203, ext. 5, to leave a message on our catalog request line.



**Zenith
ST 1000's
\$25.00**

**Zenith
Jerrold
Tocom
Pioneer
Panasonic
&
Scientific Atlanta**

All converters unmodified

**KABLEWORKS
1-800-899-5000**

www.kableworks.com

**IMPROVE
YOUR
IMAGE!
WITH OUR
VIDEO STABILIZERS**

BEFORE AFTER

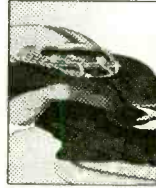

**SUPER VHS
MODEL
AVAILABLE!**

The clearest picture possible
playing back movies.
GUARANTEE
to eliminate copy protection.

- No Rolls/Jitters/Flickers/Fading
- Works on all TV's, VCR's Beta & Cable
- Gold Video Connectors & Cables Included
- 2 Year Warranty
- Money Back Guarantee



**VISION
ELECTRONICS**

1-800-562-2252

2125 S. 156TH CIRCLE • OMAHA, NE 68130

**CABLE
DIRECT
CONVERTERS
DESCRAMBLERS
VIDEO STABILIZERS
FILTERS**



**100%
MONEY BACK
GUARANTEE!**

**30 DAY
FREE
TRIAL!**

FREE Cable TV Catalog.



Now you can tune-in your favorite
cable TV programming and
SAVE \$100'S - EVEN \$1000'S
on premium **CABLE TV EQUIPMENT.**

**MODERN
ELECTRONICS**

1-800-906-6664

2125 S. 156TH CIRCLE • OMAHA, NE 68130

**New and Pre-Owned
Test Equipment**

Goldstar

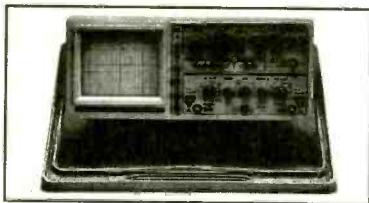

Model OS-9100P → **\$899.00**

Full 100 MHz Bandwidth!

- Dual-Channel, High Sensitivity
- TV Synchronization Trigger
- Calibrated Delayed Sweep
- Includes Two Probes, 2 Year Warranty

FREE SHIPPING!

ON GOLDSTAR EQUIPMENT
ANYWHERE IN THE U.S.
Excluding AK & HI



BK PRECISION

MAXTEC INTERNATIONAL CORP. Model 4040 \$499.00

20 MHz Sweep/Function Generator

- 0.2 Hz to 20 MHz, 5 digit LED Display
- AM & FM Internal or External Modulation
- Sine, Square, Triangle, TTL, CMOS Outputs
- Burst Operation
- External 30 MHz Frequency Counter

NEW!

Pre-Owned Oscilloscope Specials

B + K Precision 1476 10 MHz \$229.00
Great Starter Scope!

Tektronix 465	100 MHz	\$599.00
Tektronix 465B	100 MHz	\$699.00
Tektronix 475	200 MHz	\$799.00
Tektronix 475A	250 MHz	\$899.00

- The Industry Standard of Oscilloscopes
- Dual Channel, Calibrated Delayed Sweep
- Professionally Refurbished
- Aligned & Calibrated to Original Specifications
- 6 Month Warranty - The Longest Available!

LOWEST PRICES EVER!

NEW FLUKE MULTIMETERS & TEKTRONIX OSCILLOSCOPES

The Industry Standard in Multimeters

Fluke Model 87 ..\$285.00

**TEKTRONIX TDS SERIES
ON SALE!**

See us on the Web!
www.fotronic.com

1-800-996-3837

Test Equipment Depot

A FOTRONIC CORPORATION COMPANY

P.O. BOX 708 Medford, MA 02155

(617) 665-1400 • FAX (617) 665-0780

email: afoti@fotronic.com



TOLL FREE 1-800-99-METER



RAINBOW KITS

Many of our kits are available completely built!



AUDIO PREAMP

Boost your microphones output up to line level!

Plug your mic into our AP-1 and drive your amp. to full capacity. Connect an AP-1 to a pair of amplified speakers, plug your mic in and you have an instant PA system. Requires 6 to 12v DC Size: 1.75" X 1"

AP-1 **KIT \$9.95**

Read the code from any INFRARED Device



- Complete with Software for any 80386 or 80486 base machine, operating on DOS 3.3 or higher.
- Sampled data can be saved to disk for instant comparison & analysis.
- Zoom in on and view any 8 millisecond portion.

TIR-1 **KIT \$89.95**

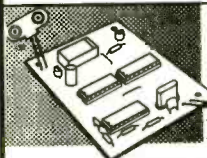

Sweet 16

16 TONE DECODER

Sweet 16 tone decoder operates great over phone lines, radios or scanners.

- 16 TTL Level Outputs
- DTMF Decoder Decodes 16 different touch tones using the phone, radios, or scanners.
- One relay & driver circuit on board.
- 9v battery powered. Size: 2 3/4" x 2 1/8"

TT-16 **KIT \$34.95**

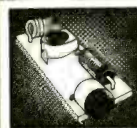

MICRO-MINIATURE WIRELESS MIKE

So small you could hide this one on some real bugs! It's the smallest we've ever seen. With it's super sensi-

tive mike it transmits a whisper or a room of conversation to an FM radio, tunable from 88 to 108MHz FM. With a proper antenna it transmits about 1/2 mile. The kit is made with surface mounted parts, we have already mounted these parts. You install the leaded parts. Power requirement 6 to 12v DC. Size .35"x.9"

MMWMS **KIT \$34.95**

TV NOTCH FILTERS FOR CHANNELS 2 thru 22 ONLY

Our TV filters eliminate unwanted TV channels or interference that alters both sound and video with a beep beep beep. Works on cable channels (2 thru 22) only.



NOTE: All TV Filter Kits are sold for educational purposes only. You must obtain permission from your local cable company before using these filters on your cable system.

DF-222 **KIT \$14.95**

AUTO CALL ID'ER

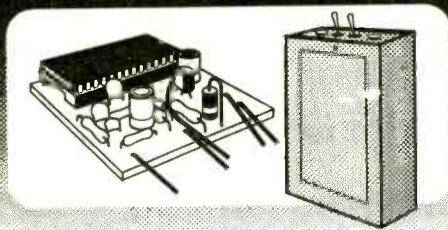

Send your call sign or call CQ automatically with the push of a button. Change your message as often as you like.

The AUTO CALL enables you to electronically store a 20 second message of your choice.

- (Your call sign or call CQ, for instance) and send it with the push of a button. Change your message as often as you like.
- Your message is stored in on board non-volatile memory cells, providing zero-power data storage. This is a high-quality voice recording and playback unit.

RX-1 **KIT \$49.95**
RX-1C **CABINET \$12.95** SIZE: 1"H x 2.4"W x 3.8"D

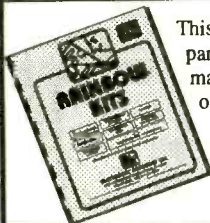

This Manual contains schematics, parts lists & P.C. board layouts for many of the Rainbow Kits. Use your own parts to construct our kits.

KIT BOOK \$14.95
\$9.95 with the purchase of any kit.



ELECTRONIC RAINBOW

Please add sufficient postage First lb \$5.00 Canada \$7.00 Additional LB. Add \$1.00 US FUNDS ONLY We will accept telephone orders for Visa or Mastercard

Electronic Rainbow Ind., Inc.
6227 Coffman Rd. Indianapolis, IN 46268

CALL 317-291-7262 FAX 317-291-7269
INTERNET: www.rainbowkits.com

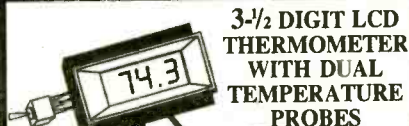

3-1/2 DIGIT LCD THERMOMETER WITH DUAL TEMPERATURE PROBES

MANY PRACTICAL APPLICATIONS:

- Indoor / Outdoor temperature.
- Temperature of electronic equipment vs room temperature.
- Furnace or Air Conditioner efficiency (return air) vs (output air).
- Temperature inside car / outside car
- Attic temperature / outside temperature.

LCD-T1 **KIT \$34.95**
LCD-T1C **CABINET \$9.95**



STROBE LIGHT

Do you need an attention getter, warning light, or flashing light for model airplanes? Then this kit is for you. Use it as an emergency light for your auto, radio tower, even use it on your bicycle. Has a variable flash rate. Power requirement 6 or 12v DC.

Size 3.5"x1.9" ST-1 **KIT \$11.95**



SUPER SNOOPER BIG EAR

Listen through walls, hear conversations across the room. Add a parabolic reflector and hear blocks away. The BIG EAR can be hidden about anywhere. Makes an ultra sensitive intercom. Can be used as a 1.5W AMP. We supply a mini-electret mike in the kit. Power requirement 6 to 12v DC. SIZE: 1.75" x 1"

AA-1 **BUILT \$29.95 KIT \$10.95**



PHONE TRANSMITTER

Small but mighty, it fits anywhere. Phone line powered, never needs batteries. Transmits both sides of a phone conversation loud and clear, wireless, to any FM radio at great distances. Variable tunes from 70MHz to 130MHz FM. You can also use it as a speaker phone. SIZE: 1.25" x .6".

TEL-B1 **KIT \$12.95**



WIRELESS FM MICROPHONE

Small but mighty this little jewel will out perform most units many times its price. It really stomps out a signal. The WM-2 kit is a buffered wireless mike that operates from 80MHz to 120MHz FM, the frequency of any broadcast FM radio. Includes a mini-electret mike. 6 to 12v DC. SIZE: 1.25" x 1"

WM-2 **KIT \$14.95**



LEADER

For Professionals Who Know The Difference

- Oscilloscopes
- Video Sync/Test Generators
- Waveform Monitors/Vectorscopes
- EFP/ENG Instruments
- RF Signal Level Meters
- Audio Generators & Meters
- Frequency Counters
- Meters & Bridges
- Power Supplies
- Function Generators
- RF Generators



Test Instruments, Equipment, Tools & Supplies For Electronic Production, Maintenance & Service
 8931 Brookville Road, Silver Spring, MD, 20910 * 800-638-2020 * Fax 800-545-0058

CIRCLE 47 ON FREE INFORMATION CARD

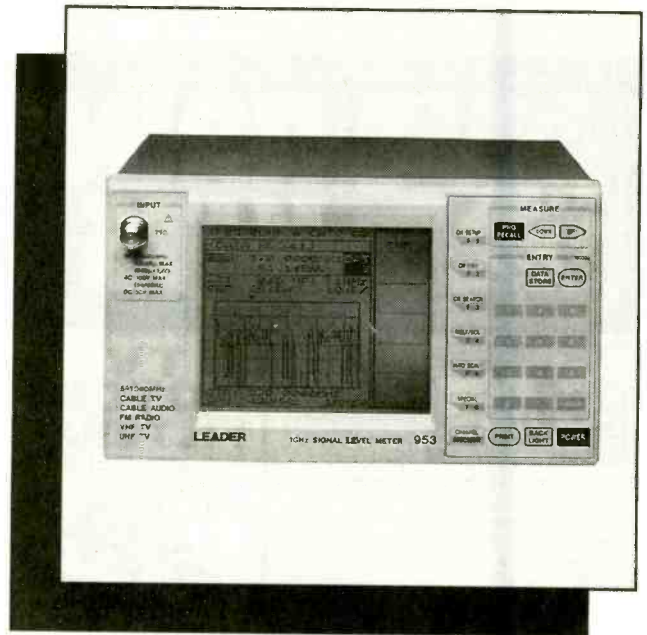

Call, fax or email for your free test and measurement instrument catalog today!
 800-638-2020 * Fax 800-545-0058
 Email: SMPRODINTL@aol.com

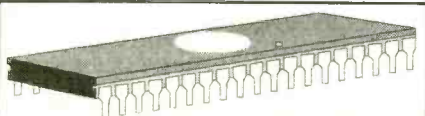

CABLE CONVERTER DIAGNOSTIC TEST CHIP

LOAD FULL ACTIVATION OF CABLE CONVERTER

WE STOCK A COMPLETE LINE OF CHIPS, TOOLS, WIRELESS QUICK INSTALL TEST BOARDS AND DIAGNOSTIC CUBES FOR ALL CONVERTERS!

***ANYONE IMPLYING ILLEGAL USE WILL BE ***

DENIED SALE. WE SELL PRODUCTS ONLY!! TO TECHNICIANS OR CABLE REPAIR FACILITIES!!

#1 IN CUSTOMER SERVICE & TECH. SUPPORT!

*ALL ORDERS SHIP WITHIN 24HRS, UPS/ FED-X.

*PRIORITY NEXT DAY SHIPPING AVAILABLE!

*SALE= BUY 5 TEST BOARDS AND GET 1 FREE.

*MON-FRI - 8AM-7PM - SAT 10AM-2PM EST.

*WEB PAGE [HTTP://WWW.800-GOCABLE.COM](http://WWW.800-GOCABLE.COM)

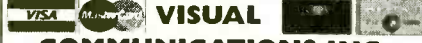

COMMUNICATIONS INC.
 ORDERS/CATALOG 1-800-GO-CABLE
 TECHNICAL SERVICE DEPT. 717-620-4363 EST. 1976

WHOLESALE PRICES* STARTING AS LOW AS \$99.00

CABLE TV DESCRAMBLERS CONVERTERS FILTERS · VIDEO STABILIZERS



1 Year Warranty on All Products,
 Affordable Extended Warranty.
FREE CATALOG!

30 Day
 FREE
 TRIAL

Call the Cable Professionals 24 Hours A Day!

Orion
 Electronics
1-800-379-3976
[HTTP://WWW.ORION-ELECTRONICS.COM](http://WWW.ORION-ELECTRONICS.COM)

SURVEILLANCE

The Latest High Tech Professional Electronic Devices

Our latest catalog offers a HUGE selection of surveillance, counter-surveillance/privacy devices: hidden video equipment, pinhole camera w/audio \$159⁰⁰, electronic kits, telephone recording systems: 7-Hour \$125⁰⁰ - 16-Hour \$199⁰⁰ touch tone decoders, scanners, bug/phone tap detectors, voice disguisers, telephone scramblers, locksmithing tools, and more.

Catalog \$5.00

SPY OUTLET

P.O. Box 337, Buffalo, NY 14226
 (716) 691-3476/(716) 695-8660

BE AN ELECTRICIAN!

Home study. Maintain and install electrical systems, wiring, utilities, phones, and more.
FREE LITERATURE: 800-223-4542

Name _____ Age _____
 Address _____ Phone _____
 City/State _____ Zip _____
 The Electrician School, PCDI, DEPTTEH341
 6065 Roswell Road, Atlanta, Georgia 30328



PROTOTYPES

Or large runs. PCBs, wave soldering, cabinets and other metal parts, silk screen printing, plastic injection, xformer/coil winding, etc. Assembly, wiring. Very low prices! Twin plant in Mexico. We ship to your door. V&V. PH. (713) 537-7518 Fax. 011 (525) 361-5996.

CABLE TV CONVERTERS

Equipment & Accessories
 Wholesalers Welcome
 Call C&D ELECTRONICS
 1-888-615-5757 M-F 10a-6p

ALFA ELECTRONICS

HIGH QUALITY TEST EQUIPMENT
BEST PRICE



DMM 89 \$179.00

Most Advanced DMM

-80.7 to 81.4 dBm with 4Ω - 1200Ω
20 reference impedances
True RMS
Frequency counter, 100 Hz - 10MHz
Capacitance: 5nF-50mF
Measure AC volt to 20kHz
5000 counts, 0.1% basic accuracy
Auto/manual range, fast bar graph
Min/Max/Ave/DH/Relative/Zoom
Auto power off
Input warning
Splash proof
Volt, amp, ohm, logic, diode, continuity
Ruggedized case
Rubber holster included



DMM A91

\$49.95
NOW \$39.00

Plus Free Case Solar Cell Powered Large Display

Diode, Continuity
Volt, Amp, Ohm
Data Hold
Auto power off
7 functions, 18 ranges
3.5 Digit, 0.6% accuracy
Auto/Manual ranging
Energy saver
Student & hobbyist's favor



DMM 20 \$74.95

Inductance: 2mH-20H
Capacitance: 2nF-200uF
Resistance: 200-200MΩ
Frequency: 2kHz-20MHz
3.5 Digit, 0.5% accuracy
DC/AC Current and Volts
Transistor hFE, diode test
Continuity, Duty %
Peak hold/Max
Ruggedized case
Rubber holster \$8.00

Full line of DMMs,
economy, compact,
ruggedized, solar cell,
automotive, heavy duty,
industrial, electrical
starts from: \$19.95

Fluke Multimeter

- Fluke 12 \$84.95
- Fluke 70 II \$75.95
- Fluke 73 II \$97.50
- Fluke 75 II \$129
- Fluke C70 \$116
- Fluke 77 II \$155
- Fluke 79 II \$175
- Fluke 29 II \$175
- Fluke 76 \$175
- Fluke 87 \$287
- Fluke 867 \$1199

Scope Meter
Fluke 97 \$1785
Fluke 105 \$2799



LCR Meter 131D

\$229.95

Most Advanced LCR

Dual display: L/Q or C/D
Inductance: 10mH-10,000H
Capacitance: 10nF-10mF
Resistance: 10Ω-10MΩ
Auto/manual range
Dissipation factor & Q factor
Serial & parallel mode
Relative mode for comparison
and to remove parasitics
Statistics, tolerance,
Best for design, incoming
testing & production
SMD and chip component
test probe \$25.00



LCR Meter 814

\$189.95

Best Resolution LCR

Inductance: 200uH-200H
Capacitance: 200pF-20,000uF
Resistance: 2Ω-20MΩ
Resolution of 0.1uF, 0.1pF, and
1mΩ are useful for high frequency
and SMD
Dissipation factor indicates leakage
in capacitor and Q factor in inductor
Zero adjustment to reduce parasitics
Best for high frequency RF
SMD and chip component test probe
\$25.00
Padded deluxe case \$8.00

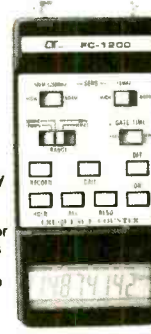

Frequency Counter FC-1200 \$129.95

Frequency: 10Hz-1.25GHz
Display: 8 digit LCD
Period: 0.1μs-0.1s
Records Max/Min/Average
Data hold, relative mode
Telescoping antenna \$8.00
Deluxe case \$5.00

Also Available:

AC/DC clamp meter, Light meter,
Thermometer, pH meter, High voltage
Probe, Digital Caliper, Anemometer,
Electronic scale, Force Gauge,
Tachometer, Stroboscope, Humidity
& EMF adapter, Sound level meter,
Frequency counter, SWR/field
strength/power meter, Dip meter

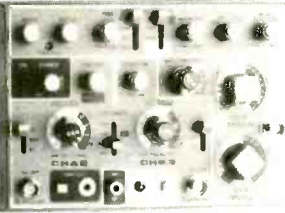

20 MHz Oscilloscope with Delay Sweep PS-205 \$429.95

Dual Trace, Component test, 6" CRT, X-Y Operation, TV
Sync, Z-Modulation, CH2 Output, Graticule illum, 2 probes
each has x1, x10 switch. Best price with delay sweep.
PS-200 20 MHz DUAL TRACE \$339.95
PS-400 40 MHz DUAL TRACE \$494.95
PS-405 40 MHz DELAY SWEEP \$589.95
PS-605 80 MHz DELAY SWEEP \$789.95
PS-1000 100 MHz DUAL TRACE \$999.95
Scope Probe: 60MHz x1, x10 \$15, 100MHz x1, x10 \$22
250MHz x1, x10 \$29, 250MHz x100 \$39

Digital Storage Scope

DS-303 30MHz, 20M Sample/sec \$849.95

DS-303P w/ RS-232 Interface \$1,049.95

Switchable between digital and analog modes
2 K word per channel storage
8 bit vertical resolution (25 Level/div)
Expanded Timebase 10ms/div - 0.5 s/div
Refresh, Roll, Save all, Save CH2, Pre-Trig
Plotter control

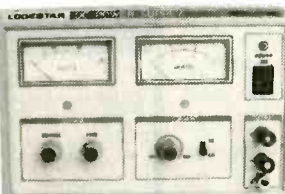

DC Power Supply PS-303 \$159.00

0-30 VDC, 0-3A output

Constant voltage & constant current mode
0.02% + 2mV line regulation
0.02% + 3mV load regulation
1 mVrms noise and ripple
Short circuit and overload protected
PS-8200 with digital voltmeter \$179.00
Also available: 30V/5A, 60V/3A, 60V/5A
16V/10A, 30V/10A

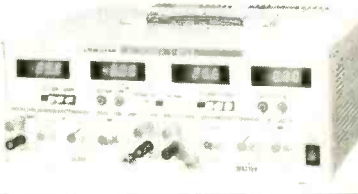

DC Power Supply Triple Output PS-8202 \$499.95

Two 0-30 VDC, 0-3A outputs
One fixed: 5VDC, 3A output
Capable of independent or tracking operation
Constant voltage and constant current mode
Four digital meters for volt and current display
Excellent regulation and low ripple
Short circuit and overload protected
Also available: 30V/5A triple output \$549.95
Dual tracking 30V/3A, 30V/5A, 60V/3A, 60V/5A

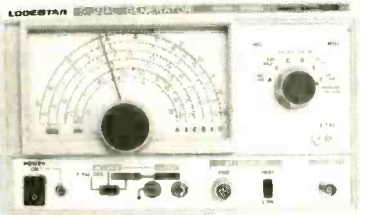

RF Signal Generator SG-4160B \$124.95

100 kHz-150MHz sinewave in 6
ranges
RF Output 100mVrms to 35 MHz
Internal 1kHz, External 50Hz-
20kHz
AM modulation
Audio output 1 kHz, 1 Vrms
Output Impedance: 50 Ohm
Size: 5.9"H x 9.8"W x 8.1"D

Audio Generator AG-2601A \$124.95

10Hz - 1MHz in 5 ranges
Output: 0-8Vrms sinewave
0-10Vp-p squarewave
Synchronization: ±3% of oscillation
frequency per Vrms
Output distortion:
0.05% 500Hz - 50kHz
0.5% 50Hz - 500kHz
Output impedance: 800 ohm

Function Generator FG-2100A \$169.95

0.2 Hz - 2 MHz in 7 ranges
Sine/square/triangle/pulse/ramp
Output: 5mV-20Vp-p
1% distortion, DC offset ± 10V
VCF: 0-10V control freq. to 1000:1

Function Gen./Counter FG-2102AD \$229.95

Generates signal same as FG-2100A
Frequency counter 4 digits
Feature TTL and CMOS output

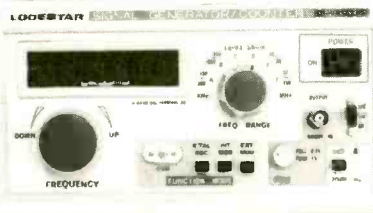

RF Signal Generator Counter SG-4162AD \$229.95

Generates RF signal same as
SG-4160B
6 digit frequency counter 1Hz -
150 MHz for internal and external
source Sensitivity <50mV

Audio Generator/Counter AG-2603AD \$229.95

Generates audio signal same as
AG-2601A
6 digit frequency counter 10Hz-
150MHz for internal and external
sources Sensitivity <50mV

Sweep Function Gen./Counter \$329.95

0.5Hz to 5 MHz in 7 ranges
Sweep: Linear 10:1/Log 10:1 20ms-2s
AM Modulation
Gated Burst, Voltage Control Gen.
Generator Control Voltage & 8 digit
counter 1Hz-10MHz for internal &
external sources

ALFA ELECTRONICS

P.O. BOX 8089, Princeton, NJ 08543-8089

(800) 526-2532/(609) 897-1135

FAX: (609) 897-0206

Visa, Master Card, American Express, COD, Purchase Order Welcome

1 YEAR PARTS AND LABOR WARRANTY

CALL / WRITE / FAX FOR FREE CATALOG

CIRCLE 26 ON FREE INFORMATION CARD

Learn MICROCONTROLLERS EMBEDDED SYSTEMS and PROGRAMMING...

...with the AES learning system/
embedded control system.

Extensive manuals guide you
through your development
project. All programming and
hardware details explained.

Complete schematics. Learn to
program the LCD, keypad digital,
analog, and serial I/O. for your applications.



**THREE MODELS AVAILABLE. Choose from an
Intel 8051, Intel 8088, or Motorola 68HC11
based system. All models come with:**

•32K Byte ROM, 32K Byte RAM • 2 by 16 Liquid Crystal Display • 4
by 5 Keypad • Digital, Analog, and Serial I/O • Interrupts, timers, chip-
selects • 26 pin expansion connector • Built-in Logic Probe • Power
Supply (can also be battery operated) • Powerful ROM MONITOR to
help you program • Connects to your PC for programming or data
logging (cable included) • Assembly, BASIC, and C
programming (varies with model) • Program disks with Cross Assembler
and many, well documented, program examples • User's Manuals:
cover all details (over 500 pages) • Completely assembled and ready to
use • Source code for all drivers and MONITOR • Optional Text Book

Everything you need. From \$279.
Money Back Guarantee

Call for Free Info Pack, or see
WEB at <http://www.aesmicro.com>
714-550-8094, FAX 714-550-9941



Call 1-800-730-3232

AES 970 W. 17TH STREET. SANTA ANA, CA 92706, USA

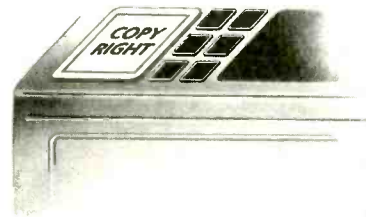

THE MOST
**AN IMPORTANT PART
OF YOUR PHOTOCOPIER
ISN'T PART OF
YOUR PHOTOCOPIER**

Having a machine may not permit you to photocopy
books, journals, newsletters and magazines.

The Copyright Clearance Center CAN.

Contact us to find out
how you too can COPY RIGHT!SM

COPYRIGHT CLEARANCE CENTER

222 Rosewood Drive, Danvers, MA 01923 ☐ Tel. (508) 744-3350 ☐ Fax (508) 741-2318

© 1993 Copyright Clearance Center

PROGRAMMERS OVER 50 MODELS

ADVANTECH EETOOLS NEEDHAMS DATA I/O ICE TECHNOLOGY HILO
SYSTEM GENERAL CHROMA MODULAR CIRCUIT TECHNOLOGY XELTEK



PROMAX EMP-20 MEGAMAX MEGAMAX4 SIMM/SIP TESTER EMUPA

CALL ADVANTECH LABTOOL	599 EETOOLS SIMMAX
629 ICE TECH MICROLV	795 CHROMA SIMM/SIP
650 EETOOLS ALLMAX +	359 MOD-MCT-EMUPA/R
409 EETOOLS MEGAMAX	279 MOD-MCT-EMUP/R
509 EETOOLS MEGAMAX4	49 EPROM 1G TO 512K
369 XELTEK SUPERPRO II	69 EPROM 1G TO 1MEG
409 XELTEK SUPERPRO II P	99 EPROM 4G TO 1MEG
249 XELTEK SUPERPRO L	199 EPROM 16G TO 1 MEG
165 XELTEK ROMMASTER II	89 EPROM 1G TO 8MEG
479 MOD-MCT-EMUPA	129 EPROM 4G TO 8MEG
739 STAG ORBIT-32	250 EPROM 8G TO 8MEG



LABTOOL48 MICROMASTER SUPERPRO ALLMAX PLUS ROMMASTER2

General Device Instruments

Sales 408-241-7376 Fax 241-6375 BBS 983-1234

Web www.generaldevice.com E-Mail icdevice@best.com

The Pocket Programmer

\$129.95



The portable
programmer
that uses the
printer port of
your PC
instead of a
internal card.

Easy to use software that programs
E(E)prom, Flash & Dallas Ram. 27(C)/
28(C)(F)/29(C)(F)/25 series from 16K to 8
Megabit with a 32 pin socket. Adapters
available for MCU's 874X, 875X, Pic, 40-
Pin X 16 & Serial Eprom's, PLCC, 5-Gang
and Eprom Emulator to 32K X 8.

**Same Name, Address & Phone # for
13 Years.... Isn't it Amazing ?**

Intronics, Inc.

Box 13723 / 612 Newton St.

Edwardsville, KS 66113 Add \$4.75 COD

Tel. (913) 422-2094 Add \$4.00 Shipping

Fax (913) 441-1623 Visa / Master Charge

INSIDE CRYSTAL SETS

An easy-to-read book
on crystal set theory
and construction opens
vistas for novices and
pros alike. Build radios
like Grandpa did, do it
better, and know what
you are doing. *The
Crystal Set Handbook*,
published by The
Crystal Set Society, is an authentic guide on
the topic.



To order *The Crystal Set Handbook*, send
\$10.95 plus \$4.00 for shipping in the U.S. and
Canada only to **Electronics Technology Today
Inc.**, P.O. Box 240, Massapequa Park, NY 11762-
0240. Payment in U.S. funds by U.S. bank check or
International Money Order. Please allow 6-8 weeks
for delivery.

American Heart Association



TRAVEL LIGHT.



EXERCISE.

DALBANI

PLEASE MENTION **CODE PE97** WHEN ORDERING
 Items are subject to availability. Prices are subject to change without any prior notice.

ORIGINAL JVC OPTICAL PICK-UP ASSEMBLY
 • Optima-6s
 Order N° 46-2705

\$53.80



30 WATTS PENCIL SOLDERING IRON
 • 30 Watts Power
 • Bakelite Construction • 1/8" Tip

Order N° 51-1055

\$3.65

HOT PRICES ON POPULAR SEMI'S

Order #	Brand	Min	Price
BU-208	TESLA	10	\$1.49
BU-208/O	TOSHIBA	1	3.49
2N-3055	TESLA	10	0.29
2N-3773	TESLA	5	1.20
2SD-1398	SANYO	10	1.39
2SD-1650	SANYO	5	0.99
STR-30130	SANKEN	1	2.66
TA-7777N	TOSHIBA	1	5.25
TDA-2005	SGS	5	1.49

SOLDER PASTE
 • For soldering and tinning
 • net/content 50g
 Order N° 51-1920

92c



\$20 MINIMUM ORDER
 CALL NOW FOR YOUR FREE CATALOG
1-800-325-2264

Over 30,000 items to choose from

- | | |
|-----------------------|--------------------|
| Semiconductors | Headphones |
| Security Product | Cleaning kits |
| Cellular Accessories | Telephones |
| Educational Video | Connectors |
| Power Products | CATV/MATV |
| Remote Controls | Terminal |
| Cable assembly | Switches |
| VCR Heads | Speakers |
| Power Supplies | Boombbox |
| Soldering tools | Resistors |
| Educational kits | Batteries |
| Frequency Counters | Fuses |
| Car Audio Accessories | Tools |
| Microwave Accessories | Idlers |
| Telephone Accessories | Belts |
| | Tuners |
| | Triplers |
| | Idler Tires |
| | Flybacks |
| | Lanterns |
| | Pinch Rollers |
| | Clips & Ties |
| | Multimeters |
| | Chemicals |
| | Antennas |
| | Microphones |
| | Capacitors |
| | And many many more |

DALBANI

STAGE 17



CALL TOLL FREE
 1-800-325-2264

\$3.95

UNIQUE REALTIME OSCILLOSCOPE BUILT-IN FUNCTION GENERATOR 2-CH DUAL TRACE 1 MHZ FUNCTION GENERATOR



Features: • Wider than specified frequency response • High deflection factor of 1mV/div. • Wide dynamic range up to 30MHz without waveform distortion • Algebraic sum of CH1 and CH2 • Low drift with compensation circuit • Superb trigger sensitivity • Maximum sweep rate of video signals with internal TV sync, separator • Jitterless trigger circuitry • CH1 signal output terminal available • Variable trigger hold-off • High precision X-Y phase difference measurement up to 50kHz • Built-in function generator with BNC output of 50Ω and TTL • Three kinds of waveform are available with 50Ω output • Flat output waveform frequency up to 1MHz

Specifications: **Vertical deflection:** • Bandwidth: DC coupled (DC to 20MHz normal), AC coupled: (10Hz to 20MHz normal) • Deflection factor: 5mV/div to 5V/div in 10 calibrated steps of 1-2-5 sequence • Rise time: 17.5ns or less

Horizontal deflection: • Time Base A: 0.2μs to 0.25s/div in 19 calibrated steps, 1-2-5 sequence • Uncalibrated continuous control between steps of at least 1: 2.5.

20 MHZ
 Manuf # OS-9020G

\$450.00

Order N° 50-820

The most popular VCR ALIGNMENT TOOL KIT

- VCR Head pulley
- Retaining ringremover
- Spring hook
- Micro screwdriver
- Hex key set
- Fitted vinyl
- Soft zippered case
- 7 Assorted head & guide aligners
- Dimensions: 9 1/2"(W) X 12 1/4"(L)
- 3 Reversible screwdrivers (Small-Flat-Fillips)

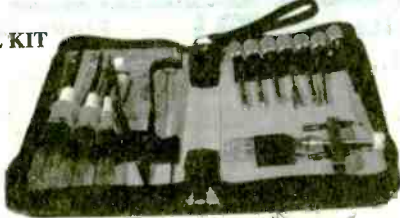

\$24.99

Order N° 50-888

DIGITAL MULTIMETERS DALCO

• Overload protect 1000V DC or peak AC on all other ranges • Input impedance 10MΩ on all ranges • Base accuracy range ± 0.5 % to ± 1.0 % • Resistance 200Ω, 2K, 20K, 200K, 2M, 20M • Audible continuity response lower than 50Ω • DC Voltage 200mV, 2V, 20V, 200V, 1000VAC Voltage 200mV, 2V, 20V, 200V, 700V • Dim.: 6.75"(H) x 3.33"(W) x 1.15"(D)

\$19.95

Order N° 50-850



TUN-O-WASH (12.5 Oz aerosol)

Fast drying electronics grade cleaner for tuners, controls and PC boards. (CFC Free)

- Designed for cleaning and degreasing consumer electronics
- Cleans in one step, no rinsing required • Contains no ozone depleting compounds HCFC free • Not for use on energized equipment • CFC and

\$7.50

Order N° 30-0100



FLYBACK TRANSFORMERS

Replaces GOLDSTAR 154-074R

Order N° 63-850



UNIVERSAL AUDIO/VIDEO REMOTE

- Controls basic functions of TV, VCR, cable box, and CD or laser player
- Ergonomic design! Main buttons are in line with natural thumb motion • Two-minute memory allows time to replace batteries without reprogramming • Programming reminder sticker inside battery compartment • Sleep time for 60, 30, or 15 minutes (according to your TV) • Set key recessed to prevent accidental deprogramming • Requires four AAA Batteries (not included)

Order N° 82-1055

MAGNAVOX
 Smart. Very smart

\$9.95

- Cable (11 brands)
- VCR (68 brands)
- TV (77 brands)
- Compact disc and Laser Disc (94 brands)

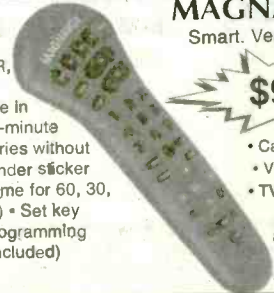

TEMPERATURE CONTROLLED SOLDERING STATION

- Voltage Input: AC 110V (or 220V) 50 Hz/ 60 Hz • Power Consumption: 35 W
- Operating Voltage: AC 24V Warm-Up Time: 40 sec. • Ceramic Heater Element
- Temperature Indicator °C
- Digital LED Display • Heat Sensor At Element Tip • Controlled range from 150° To 420°C Fused Circuit • Low Power High Efficiency-Compare with the majority it requires only 1/2 of electricity low consumption

Order N° 51-1000

DALCO



Digital Auto-Temp

\$79.00

6-PIECES PRECISION SCREWDRIVER SET

- Three flat head : 2.4x75mm, 3x100mm, 3.8x150mm
- Three Phillips : No. 0x75mm, No. 1x100mm, No.1x150mm
- A screwdriver with three sections, precision production with long life to be used.
- Available for fixing and combination of computer TB set, communicated instrument, ratio, camera, glasses, clock, watch and kinds of precision units.

\$5.95

New

Order N° 50-1040

4225 N. W. 72nd AVE MIAMI, FLORIDA 33166 TEL: (305)716-1016 FAX : 594-6588

CIRCLE 48 ON FREE INFORMATION CARD

CALL TOLL FREE
(800) 292-7711 orders only
Se Habla Español

C&S SALES
EXCELLENCE IN SERVICE

CALL OR WRITE FOR
A FREE 60 PAGE
CATALOG!
(800) 445-3201

XK-550 Digital / Analog Trainer

Elenco's advanced designed Digital / Analog Trainer is specially designed for school projects. It is built on a single PC board for maximum reliability. It includes 5 built-in power supplies, a function generator with continuously sine, triangular and square wave forms. 1560 tie point breadboard area.

XK-550
Assembled and Tested
\$169.95

XK-550K - Kit
\$139.95

Tools and meter shown optional



TK-3000
\$89.95

Tools Included:

- SR-2 - Deluxe Soldering Iron
- SH-1 - Soldering Iron Stand
- ST-1 - Diagonal Pliers
- ST-2 - Long Nose Pliers
- ST-30 - Deluxe Wire Stripper
- SE-1 - Solder Ease Kit
- ND-3 - 3 pc. Nut Driver Set
- TL-8 - Precision Screw Drivers
- ST-5 - Screw Driver Slotted 3/16"
- ST-6 - Screw Driver #1 Phillips
- ET-10 - IC Puller
- SP-2 - Solder Pump
- ST-20 - Safety Goggles
- ST-9 - Pocket Screw Driver
- ST-4 - Solder Tube
- SW-3 - Solder Wick



A professional technician service tool kit in a metal reinforced tool case with heavy-duty handle and locks. A removable pallet handles most of the tools listed with more room for tools and parts in the lower half.

GF-8026 w/ Frequency

- Linear and Log Sweep
- .02Hz to 2MHz
- Counter Range 1Hz to 10MHz
- 4 Digit Display

\$225



MX-9300 Four Functions in One

• One instrument with four test and measuring systems:
 1.3GHz Frequency Counter • 2MHz Sweep Function Generator
 Digital Multimeter • Digital Triple Power Supply
 (0-30V @ 3A, 15V @ 1A, 5V @ 2A)



\$479.95

Model XP-581

4 Fully Regulated DC Power Supplies In One Unit
 4 DC voltages: 3 fixed - +5V @ 3A, +12V @ 1A, -12V @ 1A
 1 Variable - 2.5 - 20V @ 2A

\$85



Auto Ranging Hand-Held DMM w/ Bar Graph Model EDM-163

\$99.95

7 Functions with data hold
 Compares to Fluke Model 77II

Digital Multimeter Model M-1700

\$39.95

11 functions including freq to 20MHz, cap to 20µF. Meets UL-1244 safety specs.



Fluke Multimeters

70 Series	80 Series
Model 70II \$69.95	Model 83 \$235.00
Model 73II \$97.50	Model 85 \$269.00
Model 75II \$135.00	Model 87 \$289.00
Model 77II \$154.95	
Model 79II \$175.00	

B&K Precision Multimeters

Model 391 \$159.00	Model 388A \$99.00
Model 390 \$139.00	Model 2707 \$79.00
Model 389 \$109.00	Model 2860A \$85.00

Kit Corner

over 100 kits available

PT-223K

\$15.95

Phone kit with training course.



Fiber Optics Technology

with training course
Model FO-30K

\$19.95



Model AM/FM-108K Transistor Radio Kit

with training course

\$29.95

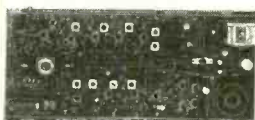

M-1005K Compact Multimeter Kit

\$19.95

6 Functions & Transistor Test



Model M-6100

Programmable DMM

Includes **FREE** Computer Interface and **FREE** Software

- Analog Bar Graph
- Large 3 3/4" LCD Display
- Menu Driven
- Triple Display
- RS-232 Interface
- True RMS
- 9 Basic Functions including cap. & freq.
- Auto Power Off
- Easy-to-use

\$125



WE WILL NOT BE UNDERSOLD

C&S SALES, INC.

150 W. CARPENTER AVENUE
 WHEELING, IL 60090
 FAX: (847) 541-9904 (847) 541-0710
http://www.elenco.com/cs_sales/



15 DAY MONEY BACK GUARANTEE
FULL FACTORY WARRANTY

PRICES SUBJECT TO CHANGE WITHOUT NOTICE

CIRCLE 32 ON FREE INFORMATION CARD

**FREE PROBES
WITH ALL
SCOPES**

OSCILLOSCOPES

Lowest Prices of the Year!

**CALL OR WRITE FOR
A FREE 60 PAGE
CATALOG!
(800) 445-3201**

B&K Precision Scopes

60MHz ANALOG WITH DIGITAL STORAGE

- Model 2560**
- Cursors and readouts
 - RS-232 port
 - 20MS/s real time sampling
 - 1GHz equivalent time sampling (at 0.1µs/div)
 - Prints via RS-232 port to any HP-GL printer
- \$1995**

20MHz ANALOG WITH DIGITAL STORAGE

- Model 2522A**
- 20MHz analog bandwidth
 - 20MS/s sampling rate
 - 2K memory per channel
 - 300MHz equivalent time sampling
 - Pre-trigger capture
- \$869.95**

100MHz THREE-TRACE

- Model 2190A**
- 1mV/division sensitivity
 - Sweeps to 5ns/division
 - Dual time base
 - Signal delay time
 - 15KV accelerating voltage
- \$1379.95**

60MHz DUAL-TRACE

- Model 2160A**
- 1mV/division sensitivity
 - Sweeps to 5ns/division
 - Dual time base
 - Signal delay time
 - V mode-displays two signals unrelated in frequency.
 - Component tester
- \$949.95**

40MHz DUAL-TRACE

- Model 1541C**
- 1mV/division sensitivity
 - Video sync separators
 - Z-axis input
 - Single Sweep
 - V mode displays two signals unrelated in frequency
 - Component tester
- \$695**

60MHz, CURSORS & READOUTS, DUAL TIME BASE

- Model 2260**
- Cursors and readouts
 - 1mV/div sensitivity
 - 23 calibrated ranges - main time base
 - 19 calibrated ranges - delayed time base
 - Signal delay time
 - V-mode - displays 2 signals unrelated in frequency.
 - Component tester
 - Z-axis input
 - Single sweep
- \$1225**

20MHz DUAL-TRACE

- Model 2120 - 2 Year Warranty**

Special \$389.95

- Model 2125 with delayed sweep**

\$539.95

- 1mV/division sensitivity
- AUTOMATIC triggered sweep operation
- AC, TVH, TVV and fine coupling
- Calibrated 19 step time-base with x10 magnifier
- Compact low-profile design

Quality Scopes by Elenco



60MHz

DS-603 \$1350

- Analog / Digital Storage
- 20MS/s Sampling Rate

S-1360 \$749

- Analog with Delayed Sweep



40MHz

S-1345 \$569

- Analog with Delayed Sweep

S-1340 \$475

- Analog

25/30MHz

DS-303 \$1095

- Analog / Digital Storage

S-1330 \$439

- 25MHz Analog
- Delayed Sweep

S-1325 \$325

- 25MHz Analog

**2 Year
Warranty**

OSCILLOSCOPE SELECTION CHART

ANALOG		Sensitivity (max)	No. of Channels	Sweep Rate Max ns/div	Delayed Sweep	Video Sync	Component Tester	Beam Find	Time Base
Model	Bandwidth MHz								
S-1360	60	1mV/div	2	10ns/div	Yes	Yes	Yes	Yes	2
S-1345	40	1mV/div	2	10ns/div	Yes	Yes	Yes	Yes	2
S-1340	40	1mV/div	2	10ns/div	No	Yes	No	No	1
S-1330	25	1mV/div	2	10ns/div	Yes	Yes	Yes	Yes	2
S-1325	25	1mV/div	2	10ns/div	No	Yes	No	No	1
DIGITAL STORAGE		Analog Sen (max)	No. of Channels	Sampling Rate	Memory Channel	Internally Backed Up	Pretigger %	Output	
Model	Bandwidth MHz								
DS-303	30	1mV/div	2	20MS/S	2K	Yes	0, 25, 50, 75	RS232	
DS-603	60	1mV/div	2	20MS/S	2K	Yes	0, 25, 50, 75	RS232	

Affordable Spectrum Analyzers by B&K

500MHz Series

- Model 2615 - \$1595**
Model 2620 w/ tracking generator - \$1895

1.05GHz Series

- Model 2625 - \$2395**
Model 2630 w/ tracking generator - \$2995



WE WILL NOT BE UNDERSOLD

UPS SHIPPING: 48 STATES 5%
OTHERS CALL FOR DETAILS
IL Residents Add 8% Tax

C&S SALES, INC.

150 W. CARPENTER AVENUE
WHEELING, IL 60090
FAX: (847) 541-9904 (847) 541-0710
http://www.elenco.com/cs_sales/

CIRCLE 32 ON FREE INFORMATION CARD

Fluke Scopemeters



- 91 \$1225
- 92B \$1445
- 96B \$1695
- 97 \$1795
- 97A \$2945
- 99B \$2095

Call or write for complete specs.

**15 DAY MONEY BACK
GUARANTEE**

FULL FACTORY WARRANTY
PRICES SUBJECT TO CHANGE WITHOUT NOTICE

REMOTES Remote Control for Any Application

NEW NEW NEW NEW NEW

3.5" x 2.75"



\$69⁹⁵

- 3 Channel Receiver
- Channel 1 - 5 amp Relay, N/O, N/C
- Channel 2 and 3 Digital Outputs
- Compatible with 2 Button or 4 Button Remote
- Code Hopping Receiver at 434 Mhz
- Compatible with All Garage Doors and Some Car Alarms

2.75" x 2.75"



\$99⁹⁵

- 6 Channel Receiver with Digital Outputs
- All Channels are Programmable for Momentary, Latched, Latched with Condition
- 30-60-90 Sec. Timed Outputs
- Code Hopping Receiver at 434 Hhz
- Compatible with 2 Button or 4 Button Remote
- Compatible with Some Car Alarms

1.25" x 1.75"



\$29⁹⁵

- 2 Button - 3 Channel Remote
- Extra Long Range 434 Mhz with S.A.W. Resonator
- Push Both Buttons together for Channel 3

1.25" x 1.75"



\$39⁹⁵

- 4 Button - 15 Channel
- Extra Long Range 434 Mhz S.A.W. Resonator
- Push Combination of Buttons together for Channel 5 through 15, i.e.: Push Button 1 and 2 together for Channel 5

Street Smart Security ■ 800-908-4737

1717 University Avenue • La Mesa, CA 91941

Send, Fax or Call Order In - Use Credit Card or Check. Fax (619) 462-0652

CABLE BOX EXPRESS

CALL 1-888-561-4796

FOR ALL YOUR CABLE TV NEEDS

GET THE COMPLETE PICTURE

ORIGINAL EQUIPMENT

TEST ACTIVATORS

FILTERS (97,106,108,110)

REPLACEMENTS FOR ALL SYSTEMS

HAVE MAKE AND MODEL NUMBER READY!

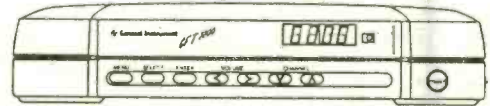

GUARANTEED LOW PRICE!

****SAME DAY SHIPPING****

CALL NOW 1-888-561-4796

1 YEAR WARRANTY ON ALL PRODUCTS

VOID WHERE PROHIBITED

Anyone implying theft will be denied assistance

RS-232 Networkable Devices

Only 2 Wires are Required to Operate Most NCD Devices from a Single RS-232 Serial Port.

NCD



GRAPHIC DISPLAY

NEW: RS-232 programmable 240x64 Graphic Display Module. Upload your BMP/GIF Image Files at 9600/19200/38400/115200 Baud. Complete Support for 30x8 and 40x8 Text. Documentation and QBasic Software Gets You Running FAST!! Counts as 2 Devices on the NCD RS-232 Network, use up to 8 GDSPs on a Single Serial Line. Many Price Options Available \$99-\$299.

Includes Drivers in QBasic. Mac & Amiga Software Also Supported.

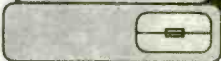

National Control Devices
Contact Ryan Sheldon
Phone: (404) 244-2432
FAX: (417) 646-8302

Include \$5 Shipping.
Visa/MC Accepted.

NCD, Box 384, Osceola, MO 64776

RS-232 Combine 16 Devices in ANY Combination to Your RS-232 Port



High-Power DC Motor Controller: 9-12 Volt Operation for Motors Up to 4 Amps. Forward/Reverse 64 Speeds. With Infrared Receiver. Hexfet H-Bridge Driver stage.
NCD-M1 Kit \$89 Asm \$149

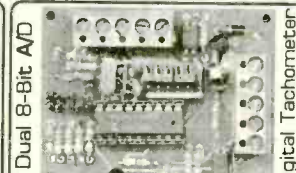

Dual 8-Bit A/D
Digital Tachometer

Dual 8-Bit Analog Inputs, 3 Programmable Outputs, Pulse Width Mod, Period Measurement, Use as a Digital Tachometer: Optoisolated, RS-232 Networkable. Easy to Program. Requires \$12 RSB booster.
NCD-AD8 Kit \$34, Assembled \$49



RS-232 Networkable
IR Controllable

8-Relay Driver, includes 8 LED Status Lights. 12V Operation. Includes Infrared Receiver for Remote Operation. Attach 16 per serial port. With Omron Mechanical Relays. 4-Relay Model available.
RB5 (5A) Kit \$89 Asm \$139
RB10 (10A) Kit \$109 Asm \$159



Audio/Video Switcher: 8 Inputs, 2 Outputs, Infrared Controllable, Routes Any Input to Any Output. 12-18 volt DC operation. For Low-Power (Line-Level) Signal Switching/ Routing of Most Analog Signals.
AVS8 Kit \$89 Asm \$139

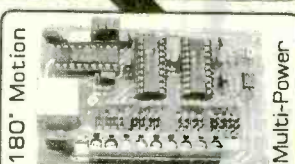

180° Motion
Multi-Power

8/16 Hobby Servo Controller: Futaba-J Compatible, Infrared Receiver Included with SV16 upgrade. Designed for all animatronic applications.
SV8 Kit \$39 Asm \$54
SV16 Upgd Kit \$19 Asm \$29

Infrared Transceiver for Remote RS-232 Communication with 16 IR Controllable Devices. IRTK Kit \$24 Asm \$39
RSB Serial Booster Gives your RS-232 Port the Power it Needs to Drive 16 NCD Devices. RSB Kit \$12 Asm \$24

On-Line Catalog: <http://members.aol.com/ncdeat/index.html> E-mail: ncdryan@aol.com

ALL ELECTRONICS

C O R P O R A T I O N

QUALITY PARTS

FAST SHIPPING

DISCOUNT PRICING

CALL, WRITE, FAX
or E-MAIL For A
Free 96 Page
CATALOG.
Outside the U.S.A.
send \$2.00 postage.

Low Low Price!
25' BNC-BNC CABLE



25 foot RG58-A/U, 50 ohm co-ax cable with male BNC connectors molded with strain reliefs on both ends. Ideal for studio, lab or communications use. Inquire for quantity pricing.

\$475
each

CAT# CBL-25

10 for \$45.00

6KV TRANSFORMER

Primary:
110/220 Vac , 18.6
Ohms DC resistance.
Secondary:
6,000 Vac @ 0.01
Amps, 17.89K Ohms
DC resistance. Ideal for ozone
generators, bug zappers and other
high-voltage applications.

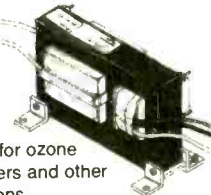

4.7" X 2.6" X 3.43" high.
Plastic mounting feet
with holes on 4.5" X 2.25"
centers. 9" long leads.

CAT# HVTX-4

\$20⁰⁰
each

**NOTEBOOK COMPUTER
CARRYING CASE**

Great looking, padded
carrying case, suit-
able for most
notebook
computers
or similar
equipment.



Black
leatherette exteri-
or with separate
zippered compartment
for papers or accessories.
Detachable nylon web shoulder strap. Interior
space is 13.5" X 9" X 2.5"

CAT # CSE-12

\$975
each

**470 UF, 450 VOLT
SNAP-IN CAPACITOR**

Nichicon LGQ2W471MHSC
1.375" diameter x 2" high.
0.4" lead spacing.

CAT#
EC-4745

\$450
each

10 for \$40.00



**THE INSULTINATOR
A Programmable
Electronic
Insult Machine**

"You're A Totally Freaky
Wacky Bonehead!"

Hand-held voice synthesizer plays
a variety of insults which can be altered by
selecting various programming buttons.
Thousands of possible insults. Even though no
profanity is used, a major nationwide retailer
rejected these as being too insulting for their cus-
tomers. Wild green and black case with belt or
pocket clip. Includes 3 AA batteries. Attractive
display package.



CAT# INS-5

\$495
each

24 for \$4.50 each

**AUTOMOBILE VOLTAGE
CONVERTER**

Run audio, communications
and other battery
operated
devices
from your
car
cigarette
lighter.

Regulated DC-DC
converter supplies
selectable voltages from 1.5 Vdc to 12 Vdc
at up to 800 milliamps. Adjustable polarity.
Includes six different adapter plugs that fit
most equipment.



CAT # APC-800

\$400
each

**410 UF, 300 VOLT
PHOTOFLASH
CAPACITOR**



Rubycon # 1A2304A
0.7" dia. X 1.7" long. Right angle PC
or solderleads on 0.25" centers.

CAT# PPC-410

\$200
each

10 for \$18.50

200 for \$320.00

**AUTOMOTIVE POWER
CORD**



3 foot wire. Cigarette lighter plug
to 2.1mm co-ax plug, center positive
polarity.

CAT# CLP-33

\$150
each

10 for \$12.50

100 for \$100.00

6-12 Vdc MOTOR

Mabuchi # RS-375S-16115
1.08" dia. x 1.75" long.
0.9" dia. shaft is 0.5" long.
Solder terminals.



CAT#
DCM-80

\$175
each

**"HI-8" VIDEO CASSETTE
(USED)**

SONY Hi-8
Top quality, metal
particle 120 minute
video cassettes. Used
for a short time, then
bulk-erased. Each cassette
has its own plastic storage
box. Satisfaction
Guaranteed.



\$300
each

CAT # VCU-8

10 for \$28.00 • 100 for \$250.00

ORDER TOLL FREE

1-800-826-5432

MAIL ORDERS TO:
ALL ELECTRONICS CORP.
P.O. BOX 567
VAN NUYS, CA 91408-0567

FAX (818) 781-2653 • INFO (818) 904-0524
INTERNET <http://www.allcorp.com/>
E-MAIL allcorp@allcorp.com

NO MINIMUM ORDER • All Orders Can Be Charged to Visa, Mastercard, American Express or Discover • Checks and Money Orders Accepted by Mail • Orders
Delivered in the State of California must include California State Sales Tax • NO C.O.D. • Shipping and Handling \$5.00 for the 48 Continental United States - ALL
OTHERS including Alaska, Hawaii, P.R. and Canada Must Pay Full Shipping • Quantities Limited • Prices Subject to change without notice.

MANUFACTURERS - We Purchase EXCESS INVENTORIES... Call, Write, E-MAIL or Fax YOUR LIST.

CIRCLE 28 ON FREE INFORMATION CARD

❖ ATTENTION CABLE VIEWERS ❖

CABLE VIEWERS . . . get back to your **BASIC** Cable Needs

Call 800-577-8775

For information regarding all of your **BASIC** cable needs.



**BASIC
ELECTRICAL
SUPPLY &
WAREHOUSING
CORPORATION**

- 5 GOOD REASONS TO BUY OUR FAR SUPERIOR PRODUCT
- ❖ PRICE
- ❖ EFFICIENT SALES AND SERVICE
- ❖ WE SPECIALIZE IN 5, 10 LOT PRICING
- ❖ ALL FUNCTIONS (COMPATIBLE WITH ALL MAJOR BRANDS)
- ❖ **ANY SIZE ORDER FILLED WITH SAME DAY SHIPPING**

We handle **NEW** equipment **ONLY** - Don't trust last year's **OBSOLETE** and **UNSOLD** stock!
COMPETITIVE PRICING—DEALERS WELCOME

HOURS: Monday-Saturday 9-5 C.S.T.

It is not the intent of B.E.S.W. to defraud any pay television operator as we will not assist any company or individual in doing the same.
*Refer to sales personnel for specifications.

P.O. Box 8180 ■ Bartlett, IL 60103 ■ 800-577-8775

CABLE T.V.
Converters & Equipment
WISE PRODUCTS

30-day money back
1-year warranty

Dealers
Welcome!

1-(800) 434-2269

Visa, MC, Amex, COD

BROADCAST TRANSMITTER

The FM52 studio quality transmitter is FULLY crystal controlled and programmable to any FM broadcast frequency.

Unit features: ALC, 2:1 compressor, audio buffer / amplifier, pre-emphasis, roll off filter, stereo generator, digital PLL tuning, 75 MHz-125MHz bandwidth, 500mW power output and a special introductory price of only \$295.00 us.

SCHEMATICS FOR UNIT \$27 CATALOG 800-504-1178
FAX/TELE INFO 416-243-1067 TEK LINE 416-243-2260

Quality Microwave TV Systems

WIRELESS CABLE - ITFS - MMDS
ATV - INTERNATIONAL - S-BAND
Amplifiers • Antennas • Books • Components
Filters • Systems • Video Products

- RF Frequency 1990 - 2700 MHz
- Cable Ready - VHF - UHF Outputs
- SASE For "FREE" Catalog or Send \$1

PHILLIPS-TECH ELECTRONICS
PO Box 8533 • Scottsdale, AZ 85252

ORDER LINE 800-880-MMDS
CATALOG/INFO 602-947-7700
FAX LINE 602-947-7799

CHALLENGER SYSTEM
33-Channel 50dB Gain
Complete Grid \$265
Five Year Warranty
FREE SHIPPING

Visa • MC • Amx • Disc • COD's • Qty Pricing

Zenith Test Chips

Notch Filters

Beep-Beep

Free Brochure

Buzz-Buzz

Assembled Kits

1 to 2 \$30 each	1 to 2 \$20 each
3 to 9 \$25 each	3 to 9 \$15 each
10 to 49 \$16 each	10 to 20 \$9 each
50 or more \$14 each	21 or more \$7 each

www.tvfilter.com

Video Media
P.O. Box 93/6025
Margate, Fl. 33093-6025
(954)-752-9202 Fax (954)-340-5201

BUY BONDS

ELECTRONICS WORK at HOME

Part time/ Full time up to \$35+/hour

Just Published! "Home Based Electronics Businesses"
Comprehensive GuideBook reveals secrets to using technical skills to make big money NOW! 250+ pages of insider info & sources. *Be your own boss & get out of the rat race NOW*

Send \$24 FREE SHIPPING USA. Canadians add \$2

DCP Enterprises 24hr Recording & Faxback California residents add Sales Tax
15 Mayflower (800)326-4560 x 218

Aliso Viejo, CA 92656 | 30 day MONEY BACK GUARANTEE!

Debco is a Kit Builders Paradise

Electronic Kits - Plans - Parts - Computers - Amateur Radio

Call Debco today for your FREE copy of The Electronic Experimenter's Journal

1 800 423 - 4499

Debco Electronics 4025 Edwards Rd. Cincinnati, OH 45209

"FULL VIEWING" CABLE BOXES

FREE

Converter Box Catalog
Open Every Day!

LOWER YOUR CABLE BILL NOW!

CHANNEL SURFERS

1-800-447-7634

I DOUBLED MY INCOME...

WORK ONLY HALF THE HOURS!

I covered a lot of miles driving a cab for 13 years... but I sure didn't get anywhere! I mean the hours were long. The pay was short. My boss pushed, pushed, pushed all the time. In the meantime bills were piling up. Medical bills. House repairs. Charge cards. Just the everyday things. I was not just behind the wheel, I was behind the eight ball.

That's when I saw a magazine article that talked about the hottest big money-making career opportunities of the 90's. The one that interested me the most pertained to the **NEW explosive SATELLITE DISH/TV/ELECTRONICS field.**

I mailed the coupon for the FREE information kit they offered. I liked what I saw when the information packet came in the mail. What really caught my eye, however, was the idea I could gain all the knowledge I needed to make a success of this business studying in my spare time at home. **Foley-Belsaw's modern, practical hands on course combines simple step-by-step lessons with easy-to-follow video cassette guidance.** No special experience, education or electronics background is necessary. Just average mechanical aptitude to follow simple A-B-C repair procedures that are clearly outlined for you.

I decided to get in on the action... and just look at me now! Now I'm really in the driver's seat. I'm doing what I want to do. I'm my own boss. I set my own hours. I'm making more money than my wife and I ever dreamed possible. **Would you believe I'm making twice what I made driving a cab...and I work only half as many hours.**



Hottest career opportunity since invention of the VCR!

Get in the FAST LANE on the New "INFORMATION SUPERHIGHWAY" Everyone's Talking About!

It's exciting! It's gigantic! The technology of tomorrow is here today! You've been reading and hearing about the amazing INFORMATION SUPERHIGHWAY. **It's so NEW that few technicians are equipped to service this fast emerging field! Foley-Belsaw gives you SATELLITE DISH technology (including New MINI-DISH)...** along with the electronics expertise you need to make BIG MONEY servicing TVs and other electronics equipment.

Be Your Own Boss!

It's quick and easy to become an expert at home in your spare time. Earn really BIG money adjusting, installing and repairing **Satellite Dish Systems, TVs, Amplifiers, CD Players, AM/FM Tuners, Home Entertainment Centers.** Every home, every business, every office in your area desperately needs your expertise!

Your Timing Couldn't Be Better!

Never before and probably never again will you have a ground-floor opportunity like this to get into a

booming business of your own, make really big money, be your own boss and enjoy financial freedom and security. The fact you're reading this message shows you're smart enough to realize this!

Learn In Spare Time At Home!

It's easy to learn in your spare time at home. And when you complete the course you will receive Foley-Belsaw's official diploma acknowledging your accomplishment

Send Coupon Today for FREE Kit. No Obligation.

Don't miss out on this once-in-a-lifetime opportunity. Send in the coupon NOW. Get all the facts and study them in the privacy of your own home. There's absolutely no obligation and no salesman will call on you. So don't delay. Mail the coupon today.

"Took in over \$3,200 in the past 10 days!"
H.H., Denver, CO

"Doubled my income within 6 weeks."
R.B., Bakersfield, CA

Mail for FREE Information Package

Foley-Belsaw Institute
6301 Equitable Road
Kansas City, MO 64120-1395



Please Check Only ONE of the Following:

- Satellite Dish, Dept. 31431
- Computer Repair, Dept. 64557
- Gunsmithing, Dept. 92464
- PC Programming, Dept. 35377
- VCR Repair, Dept. 62659
- Vinyl Repair, Dept. 71314
- Locksmithing, Dept. 12966
- Small Engine Repair, Dept. 52844
- Woodworking, Dept. 43713
- Upholstery, Dept. 81382
- Saw & Tool Sharpening, Dept. 21781

Name _____

Address _____

City _____

State _____ Zip _____

Call Toll-FREE 1-800-487-2100

Fix It Yourself!



- Hands-on, detailed, troubleshooting instructions
- "How to" primer for test equipment: oscilloscopes, frequency counters, video analyzers, etc.
- Schematic diagrams
- Trouble analysis flowcharts
- Preventive maintenance techniques
- Safety precaution checklists
- Comprehensive replacement parts list
- Directory of manufacturers

It's easy, fast, and rewarding to repair it yourself with the Electronics Repair Manual!

Leading Manufacturers Represented...

- Emerson • Nintendo • RCA • Technics
- Hitachi • Panasonic • Sanyo • Toshiba
- IBM • Pioneer • Sharp • Zenith
- NEC • Quasar • Sony and others!

✓ Dozens of Fix-It-Yourself Projects for...

- CD Players
 - VCRs
 - Televisions
 - Camcorders
 - Computer Equipment
 - Fax Machines
 - Telephones
 - Amplifiers
 - Car Radios
 - Home Appliances
 - AM/FM Tuners
 - Thermostats
- ...and more!**

30-Day Free Trial!



Keep Your Skills Up-to-Date!

The Electronics Repair Manual and the Modern Manual Electronics Manual will be a valuable reference for years to come. Supplements, each containing over 125 pages, add new repair projects, valuable insights into new technologies, diagnostic and repair techniques, electronics projects, and more schematic diagrams into your manual. Just \$35 each for Electronics Repair and \$49.50 each for Modern Electronics plus shipping and handling. Supplements are sent 4-5 times a year and are fully guaranteed. Return any supplements you don't want within 30-days and owe nothing. Cancel anytime.

PC-based Front Panel Access Computer

7-11 PC --- 24-hour Working Computer from \$600

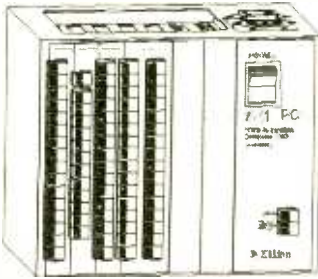

For Computer
Telephony Server or
Home Automation or
Network Computer
Fanless, compact size
9.0"W 7.5"H 6.5"D

**Handy PC --- Field
Computer** from \$700
In between of Laptop
& Desktop for the size,

Using regular CD-ROM, HD, FD and mini keyboard
Easy to carry around, 10.5"W 11"H 6.5"D

PLC PC --- Industrial Computer from \$900
Accessibility like PLC (Programmable Logic Controller)
Euro Bus and PCI
Bus for higher
reliability & better
performance.
17"W 11"H 6.5"D

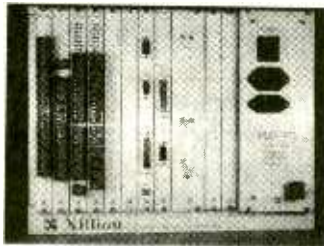

All above 3 models
accept ISA or PCI
interface cards, and
proprietary front panel
connecting cards: I/O, A/D, D/A, X-10, up to 10A/220V

NETWORK your phones !

Boost your telecommunication performance.
Make small business sounds big & professional.
FX207 is easy to use and very low cost.

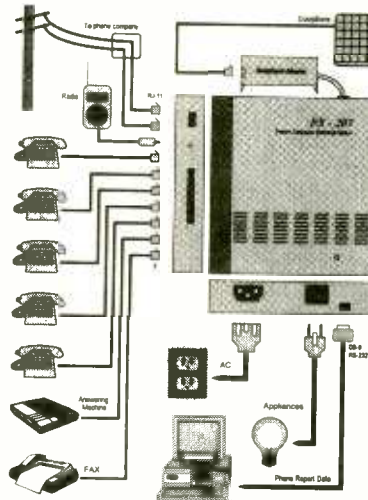

This small device provides
same functions found in
big, expensive PBX units;
call transfer, conference,
intercom, do not disturb,
call restriction (blocking)
call pickup, call waiting,....
Plus some extras you
don't normally find in most
regular PBX units such as:
Voice direct incoming calls
with your own message,
transfer fax automatically,
Tele-remote control your
appliances or computer,
Record and manage call
numbers & time usage
through your computer.
You might even use it for
phone projects - control
phone operation with PC.

For home, For office, For home office.

FX207 handles two phone lines expanding to seven extensions
using standard tone or rotary phones, FAX and answer machines.
Plug in with regular phone plugs. Easy to install. Do it yourself.

\$298 limited time special !

(Plus S&H, California add sales tax, Discount Code X4PE, MSRP\$399)

XILLION Co. <http://www.xillion.com> 15447 Proctor Av. City of Industry, CA91745, Tel: (818)336-1890, Fax:(818)336-2061

NSI NEVADA SYSTEMS, Inc.

P.O. BOX 68337 - BOULDER CITY - NEVADA - 89006
PHONES: (800) 788-7888 (702) 294-3187 FAX: (702) 294-3188
INTERNET: WWW.NVSYSTEMS.COM E-MAIL: INFO@NVSYSTEMS.COM

NSI 2.4TR-CLOCK 2.4 GHZ - WIRELESS 4 CHANNEL
VIDEO/AUDIO TRANSMITTER BUILT INTO CLOCK FOR SPECIALIZED
SURVEILLANCE APPLICATIONS ... SUCH AS KEEPING AN EYE ON THE
BABY SITTER or EMPLOYEE & RECORD THEM ON ANY STANDARD VCR.
(500 FOOT RANGE PLUS - MORE WITH HIGH GAIN ANTENNAS)

- BUILT IN CAMERA & MICROPHONE
- BUILT IN TRANSMITTER
- RECEIVER INCLUDED
- INCLUDES ANTENNAS & AC ADAPTERS



\$ 495.00 COMPLETE SYSTEM

NSI-4LCD 4" ACTIVE MATRIX LCD COLOR MONITOR



- 6-3/4"W x 6"H x 2-3/4"
- 480(H) x 240(V) RESOLUTION
- STANDARD NTSC INPUT
- 12 - 15 VDC OPERATION

\$ 235.00 COMPLETE

**WE SPECIALIZE IN SECURITY PRODUCTS - WIRELESS VIDEO/AUDIO
SYSTEMS & VIDEO SURVEILLANCE EQUIPMENT
SEND FOR FREE CATALOG**

Low Cost CAD Software for the IBM PC and Compatibles Now In Windows™

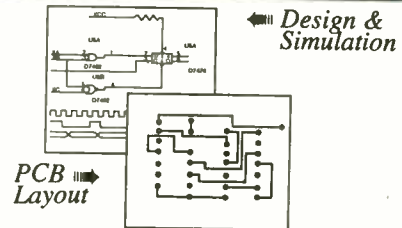

- Easy to use schematic entry program (SuperCAD) for circuit diagrams, only \$149. Includes netlisting, bill of materials, extensive parts libraries, More parts, and automatic wiring available in enhanced CAD package (SuperCAD+) for only \$249.
- Powerful, event-driven digital simulator (SuperSIM) allows you to check logic circuitry quickly before actually wiring it up. Works directly within the SuperCAD editor from a pulldown menu and displays results in "logic analyzer" display window. Starting at \$149 this is the lowest cost simulator on the market. Support for PALs, a larger library, and a separate interactive logic viewer are available in full-featured SuperSIM+ for only \$399. Library parts include TTL, CMOS and ECL devices.
- Circuit board artwork editor and autorouter programs (SuperPCB), starting at \$149. Produce high quality artwork directly on dot matrix or laser printers. You can do boards up to 16 layers including surface mount. Includes Gerber and Excellon file output. Autorouter accepts netlists and placement data directly from the SuperCAD schematic editor.
- Low cost combination packages with schematics and PCB design: 2-layer for \$399, 16-layer for \$649.
- DOS version available.

Write or call for free demo disks:

MENTAL AUTOMATION, INC.

5415 - 136th Place S.E.
Bellevue, WA 98006
(206) 641-2141 • BBS (206) 641-2846
<http://www.mental.com>

EPROM+

PROGRAMMING SYSTEM USES PARALLEL PORT

EPROMS (24,28,32 & 40 PIN*)+27C AND 25XX
1702*, 2708, TMS2716*, 32,32A, 64,64A, 128, 128A
256, 512, 513, 011, 010, 101, 1001, 1000, 1024, 210, 020
2001, 220, 2048, 4001/2, 040, 080, 240, 4096, 68764/66
FLASH EPROMS 28F256, 28F512, 28F010
28F020, 29C257, 29C010, 29C040, 29F010, 29F040
EEPROMS & NVRAMS (18, 24 & 28 PIN-CXX)
2210, 2212, 2804, 2816, 2816A, 2817, 2864, 2865
28256, 28C010, DS1220, DS1225, DS1230
SERIAL EPROMS* (8 & 14 PIN PLUS CXX)
ER1400, MS8657, 2401, 02, 04, 08, 16, 32, 65, 2444
59C11, 80011A, 9306, 46, 56, 66, 8572, 82, 92, 168/9XX
BIPOLAR PROMS* (16 THROUGH 24 PINS)
74SXXX AND 82SXXX FAMILY
MICROCONTROLLERS* 8741, 42, 48, 49, 8751
C51, 52, C52, 87C5XXX, 87C75X, 89C5X, 68705
68HC705, 68HC711E9, PIC16CXX, TMS7742
*ADAPTER REQUIRED - DIAGRAMS INCLUDED

SOFTWARE READ, VERIFY, PROGRAM, COPY
DISK FILE LOAD/SAVE, CHECKSUM, FULL
SCREEN BUFFER EDITOR W/20 COMMANDS
READS HEX, S-RECORD AND BINARY FILES
FAST DEVICES PROGRAM IN UNDER 20 SEC
RUGGED (9" X6" X3") ENCLOSURE W/HANDLE
MADE IN USA - 1 YEAR WARRANTY

ANDROMEDA RESEARCH, P.O. BOX 222, MILFORD, OH 45150
(513) 831-9708 FAX (513) 831-7562



SYSTEM INCLUDES:
PROGRAMMING UNIT
PRINTER PORT CABLE
POWER PACK, MANUAL
AND SOFTWARE.

\$289

ADD \$5.00 SHIPPING
\$5.00 C.O.D.
VISA/MASTERCARD

HOME AUTOMATION

World's Largest Selection!

Widest Selection of X-10 Devices Available

Hundreds of hard-to-find automation, X-10 and wireless control products. Computer interfaces, software, development tools, lighting control, telephone systems, security systems, surveillance cameras, infra-red audio/video control, HVAC, pet care automation, wiring supplies, books and videos and much more!



Packed with Pictures
& Diagrams

Home Automation Systems, Inc.

Questions: 714-708-0610 Fax: 714-708-0614

e-mail: catalog@smarthome.com

http://www.smarthome.com/smarthome

**Lowest Prices
Guaranteed!**

24 Hours **Call 800-SMART-HOME** 800-762-7846

CABLE TV CONVERTERS

Equipment & Accessories
Wholesalers Welcome

Call C&D ELECTRONICS

1-888-615-5757 M-F 10a-6p

BUGGED??

EAVESDROPPING is unbelievably widespread! Electronic Devices with amazing capabilities can be monitoring your telephone and room conversations RIGHT NOW! Are you sure you're safe? **FREE CATALOG** tells you fast! Includes Free Bonus details on fantastic opportunities now open in Counter-Surveillance field. Exciting, immensely interesting and EXTREMELY profitable (up to \$250/hr) full/part-time income. Call Now! **1-800-732-5000**

Pete's Wholesale

Wholesale distributors of cubes and one piece units works on all major systems call us last for the best price!

800-763-7277

Electronic Training Videos

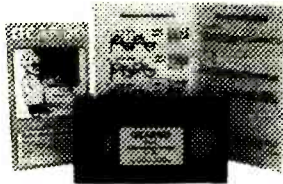

Learn electronics quickly and easily with **UCANDO's** computer-animated training videos. Students can learn at their own pace and professionals will find the **UCANDO** videos to be a valuable source of reference material. If these videos aren't the best learning tools you've ever seen, return them within 30 days for a

complete refund. These videos are being used by Tech-Schools, CET's, Military Branches, Ham Operators, Industries, and more, across the United States and around the world. **Order today** and see how **UCANDO** is ...

"Changing The Way The World Learns Electronics."

VCR Maintenance & Repair ... \$29.95 All others ... \$44.95 each
* Intro to VCR Repair * Direct Current * Alternating Current *
Semiconductors * Power Supplies * Amplifiers * Oscillators * Digital 1 *
Digital 2 * Digital 3 * Digital 4 * Digital 5 * Digital 6 * AM Radio * FM
Radio Part 1 * FM Radio Part 2 * TV Part 1 "Intro to TV" * TV Part 2
"The Front End" * TV Part 3 "Audio" * Fiber Optics * Laser Technology *

SAVE!!! 6 videos for only \$240 or 12 videos for only \$450



1-800-678-6113

or mail check or money order to:

UCANDO Videos

P.O. Box 923

Greenville, OH 45331



FREE Shipping ... FREE Catalog

CIRCLE 136 ON FREE INFORMATION CARD

CABLE T.V. EQUIPMENT

Friendly, Knowledgeable Service



**ORDERS CALL:
1-800-361-4586**



- All Equipment New
- Convertors & Descramblers
- 30 Day Money Back Guarantee
- 6 Month Warranty
- Visa, MC, C.O.D. Welcome

KDE ELECTRONICS, INC.

P.O. Box 1494

Addison, IL 60101

Info. 630-889-0281

HRS: Mon-Fri, 9-6 CST

Fax 630-889-0283

Sat, 10-2 CST

VIDEO SYNC GENERATOR



Restores Horizontal and Vertical Sync Lines from Distorted Analogue Video Formats

For Free Information Package on Completed Units and Pricing
Call 219-236-5776

R.C. Distributing • PO Box 552 • South Bend, IN 46624

Digital Entertainment GREAT VALUES ON:

USSB dish AlphaStar

SAVE 30%-50%

Compare to Cable
 MORE ENTERTAINMENT OPTIONS ALL THE HOT ACCESSORIES PAY LESS

1038 Frontier Dr. Fergus Falls, MN 56537

Call Now **800-500-9264** **Skyvision**

New Surveillance Devices!

Smoke Alarm and Table Clock Video Cameras
 Ultra miniature video cameras hidden in smoke alarm or alarm clock - your choice. Wide field of view and super 1 lux low light sensitivity! Undetectable!

SC-600 TC-70 High quality B/W with 420 lines of resolution for ultra sharp images.
 Direct output of video and audio. **\$189.95 ea.**

Best price on surveillance cameras anywhere!

Telephone Transmitter Kit hidden in dual modular adaptor Transmits both sides of conversation to any FM radio up to 1/4 mile. "SnapKit" technology. Uses phone line for power and antenna. Goes completely unnoticed. **MA-100 \$25.95**

High quality cassette deck plugs directly into telephone jack! Records up to 12 hours of conversations on a single cassette. Recording starts and stops automatically when phone is used!
THR-12 12 Hour Telephone Recorder \$99.95 (Free shipping! Check/MO Question line: (972) 255-7490)

Seymour-Radix Inc. Box 166055-E Irving, TX 75016
 Now you can visit us on the internet at <http://www.wfy.net/home/sr/>



NEW DX SERIES DMMs

3 YEAR WARRANTY

COVERS FULL PERFORMANCE

Bel MERIT DX Series DMMs have best values for performance, features and dependability with 3 year warranty.

Each DX model has standard DMM measurements with a set of additional capabilities; diode, continuity, TRhFE, capacitance, inductance, frequency, logic and temperature.

Additional features include auto power-off, data hold, annunciator, and input warning beeper & peak hold (DX451/DX460L only)

Deluxe holster, safety test leads and thermocouple probe (DX360T) supplied as standard accessories.

MODEL	DX350	DX360T	DX400	DX405	DX451	DX460L
AC/DC Voltage (750V/1000V)	•	•	•	•	•	•
AC/DC Current (10A)	20A	•	•	•	•	•
Resistance (20MΩ)	20Ω	2000M	•	•	2000M	2000M
Continuity Beeper/Diode	•	•	•	•	•	•
Temperature w/Probe, Type K	•	•	•	•	•	•
TRhFE	•	•	•	•	•	•
Capacitance (20μF)	•	•	•	•	•	•
Frequency (20MHz)	•	•	•	•	•	2000μ
Logic (TTL & CMOS)	•	•	•	•	•	•
Inductance (20H)	•	•	•	•	•	•
Auto Power-Off	•	•	•	•	•	•
Input Warning Beeper	•	•	•	•	•	•
Data Hold	•	•	•	•	•	•
Peak Hold	•	•	•	•	•	•
Protective Holster	•	•	•	•	•	•
Suggested Resale Price	49.95	64.95	64.95	69.95	89.95	109.95

• Lots more High Standard Test Instruments available
 All in One Instrument, Oscilloscope, Power Supply, Function Generator, Frequency Counter, Multimeter, Capacitance, Engine Analyzer, Clamp-On, Electrical Tester and More.
 • See your local distributors or Call for Catalog

Bel MERIT SOLUTIONS FOR THE TEST INSTRUMENT

1-800-532-3221
 (714) 586-2310 • FAX (714) 586-3399
 P.O. Box 744, Lake Forest, CA 92630

\$139* Laser LightShow



Draw with a laser beam! Animation, text, music & more! Includes disks, mirrors, servo amp, demo software disk, analog and digital computer interface. Use an inexpensive pen pointer or high power gas laser.

Computerized Motors \$39*



Includes: 2 Stepper motors, 2 DC motors, computer interface, training manual, & demo software disk. Expandable! Up to 12 motors, up to 3 amps per phase.

Now with 4 Axis Linear Interpolation
 * Add \$6 for shipping. Computer with parallel printer port & cable, assembly, power supply, & laser arc required

FREE FLYER

Voice 510-582-6602 Fax 510-582-6603

SVS 1273 Industrial Pkwy West Bldg. 460
 PO Box 55125 Hayward CA 94545-0125

!!! BROADCAST FARTHER !!!

The model 220 is a 80-110MHz RF amplifier that connects to mono or stereo FM transmitters and produces a powerful 2-15 watt signal which could broadcast up to 5 miles or more! Requires 50-150 mW drive.

Step by step plans complete with part source information and antenna designs... **ONLY \$14 PLUS \$2 S&H NO C.O.D.s**

Progressive Concepts
 Box 586 STREAMWOOD, IL 60107
 (708) 36-9822 FAX: (630) 736-0253

CABLE TV CONVERTERS AND DESCRABLERS

WE CARRY A FULL LINE OF CONVERTERS AND DESCRABLERS COMPATIBLE WITH MOST MAJOR BRANDS INCLUDING:

- Scientific Atlanta™
- Jerrold™
- Tocom™
- Zenith™
- Pioneer™

30 DAY MONEY BACK GUARANTEE
BEST PRICES FREE CATALOG

ALLSTAR ELECTRONICS

800-782-7214

HOURS: 9-6 M-F 10-3 Sat EST

It is not the intent of Allstar Electronics to defraud any pay TV operator. Anyone implying theft of service will be denied assistance. All brand names are registered trademarks of their respective owners & are used for reference only. 110-64 Queens Blvd., #445, Forest Hills, NY 11375. NO NYSALES.

TURN YOUR PC INTO A DIGITAL STORAGE OSCILLOSCOPE!

The all new PC-MultiScope 2

10Mhz analog bandwidth!

At right: Actual scope screen as seen on your PC monitor.

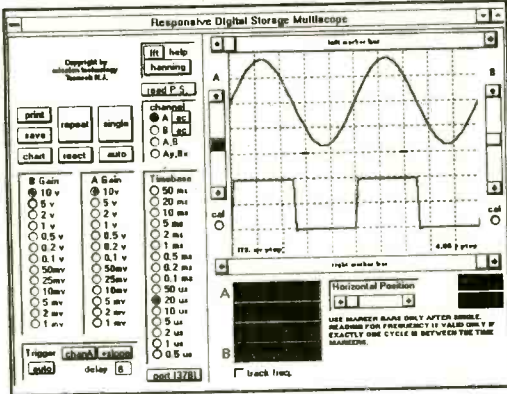

For industrial, educational, hobbyist, auto, and audio test & measurement

\$399 + S/H. Visa/MC/Check OK
Add \$99 for source code option

The top choice of corporations, universities and scientists worldwide!

AMAZE ELECTRONICS CORPORATION
amaze@hooked.net www.hooked.net/users/amaze
Phone: 800-996-2008 Fax: 408-374-1737

FEATURES:

1. Dual channel; external triggered
2. Digital storage; Windows based
3. Connects to PC parallel port
4. 20Megasamples/sec sampling; 10Mhz max. analog bandwidth
5. 8 bit resolution/ 8K RAM buffer
6. Prog. gain: 10v/div to 1mv/div
7. Spectrum analyzer (fft) function
8. Strip chart recorder function
9. TTL output for control app's
10. Visual Basic source code avail.

OSCILLOSCOPES

from \$169 !!!

ATC O-Scope uses printer port to turn PC-AT into Digital Storage Oscilloscope, Spectrum Analyzer, Freq. Counter, Logger, DVM. DC-500KHz

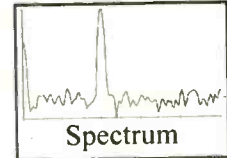
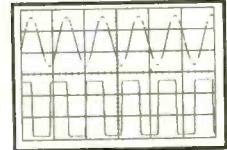

- Print, log to disk, or export data
- Accepts standard scope probes
- Uses standard printer port
- Small and portable
- Works with laptops
- Same day shipping
- Made in U.S.A.
- Single channel units from \$169
- Dual channel units from \$349

Options:

- Probe sets
- Automotive probes
- Battery packs

Order yours today.

800 980 9806

MC/Visa/Amex

Allison Technology Corporation

8343 Carvel, Houston, TX 77036 USA

PH: 713 777 0401, FAX: 713 777 4746, BBS: 713 777 4746

<http://www.atcweb.com>

CIRCLE 137 ON FREE INFORMATION CARD

Coil Design and Construction Manual

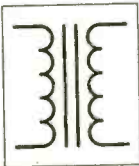

YOU CAN WIND YOUR OWN COILS?

There's no trick to it except knowing what you are doing. In a unique, 106-page book you can become expert in winding RF, IF, audio and power coils, chokes and transformers. Practically every type of coil is discussed and necessary calculations are given

with the mathematical data simplified for use by anyone. Get your copy today!

Mail coupon to:

Electronics Technology Today, Inc.
P.O. Box 240 • Massapequa Park, NY 11762-0240

Please send me my copy of *Coil Design and Construction Manual* (160). I enclose a check or money order for \$8.95 to cover the book's cost and shipping-and-handling expenses. NY state residents must add local sales tax.

Name _____

Address _____

City _____ State _____ ZIP _____

All orders must be paid in U.S. funds only. Sorry, no orders accepted outside of USA and Canada. Please allow 6-8 weeks for delivery.

AT LAST! DC-20 MHz SYNTHESIZED PERFORMANCE FOR ONLY \$795!



- DC-20 MHz, .1 Hz resolution, DC offset
- Linear/Log Sweep
- Internal/External AM
- Internal/External FM
- Internal/External PM
- Internal/External SSB
- Internal/External BPSK
- Dualtone Generation
- Internal/External FSK
- Burst
- DTMF Generation
- DTMF Detection
- Power Level Measmt

Arbitrary Waveform Generation Now Available!

\$795

The SG-100 gives you clean .1 Hz synthesized precision and a wide diversity of modulation functions all of which can be performed using an internally generated or externally applied signal. You also get signal analysis functions that are just not offered on any other signal source such as DTMF Detection and Power Level Measurement. And because you can download new instrument functions to Flash memory, you can ensure that your SG-100 will never become obsolete.

Call, email, or fax us for your free information kit. Visit us on the web for specs and applications.
C.O.D. P.O.
Telulex Inc. (415) 938-0240
2455 Middlefield Way S, Mountain View, Ca. 94043
email:sales@telulex.com
Fax: (415) 938-0241 http://www.telulex.com



✓ - Check Your Jensen Benefits

- ✓ Tool Kits for Installing, Maintaining
Trouble-Shooting & Repairing PC/Computers
- ✓ Electronics Testing & Diagnosing Equipment
- ✓ Networking Accessories . . . and much more!
- ✓ Prompt Delivery of Your Order
- ✓ Courteous Customer Service at All Times
- ✓ Free Technical Support, Including FaxBack®
- ✓ Lifetime Guarantee on Jensen Brand Hand Tools

**FREE
CATALOG!**

Call Dept. 362

800-426-1194

CIRCLE 150 ON FREE INFORMATION CARD



JENSEN TOOLS

7815 S. 46th St., Phoenix, AZ 85044
Tel: 800-426-1194 or 602-968-6231
Fax: 800-366-9662 or 602-438-1690
<http://www.jensentools.com>

A WHOLE NEW WORLD IN SCIENCE KITS.

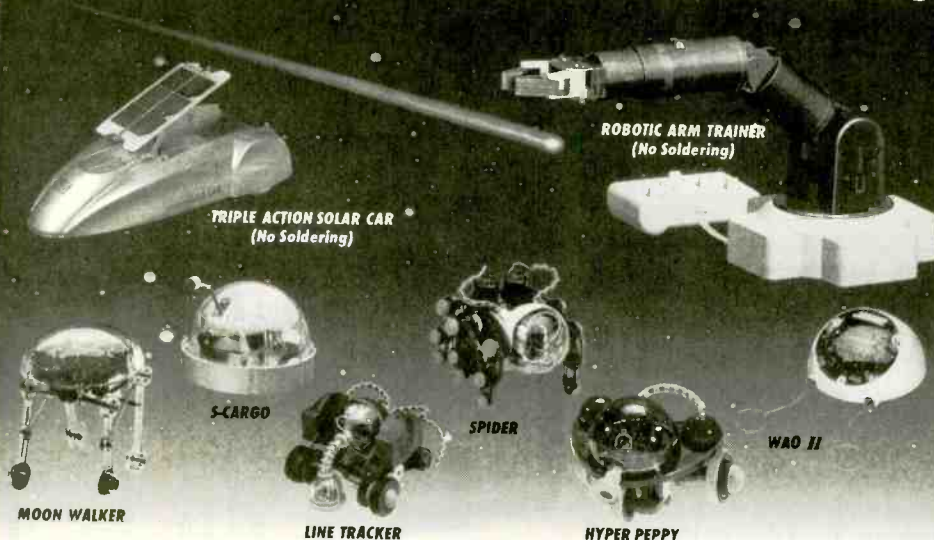

OWI's "Next Generation" of affordable, rugged Robot Kits challenge the enthusiast to solder circuit boards and / or mechanically assemble.

Each OWIKIT also incorporates the basic principles of robotic experiments, sensing and locomotion, guaranteeing an exciting, hands-on adventure of knowledge and fun!

But remember! OWI is the recognized founder and leader in Educational Robot Kits. **ACCEPT NO IMITATIONS.**

Visit our homepage
@ <http://www.owirobot.com>

ROBOTIC ARM TRAINER	OWI-007	5 Axis Control	NEW	69.95
TRIPLE ACTION SOLAR CAR	OWI-685	Solar Sensor	NEW	39.95
S-CARGO	OWI-936K	Sound Sensor	47 Pg. Book	36.95
WAO II	OWI-961K	Programmable - Graphic	59 Pg. Book	69.95
SPIDER	OWI-962K	Infrared Sensor	49 Pg. Book	49.95
LINE TRACKER	OWI-963K	Infrared Sensor	48 Pg. Book	49.95
HYPER PEPPY	OWI-969K	Sound / Touch Sensor	46 Pg. Book	24.95
MOON WALKER	OWI-989K	Solar Sensor	10 Pg. Book	34.95



EK
ELEKIT

1160 Mahalo Place, Suite B
Rancho Dominguez, CA 90220-5443

(310) 638-7970

Fax: (310) 638-8347



Order M - F: 8a.m. - 4p.m. PST

OWN A MACHINE SHOP

The Smithy 3-in-1 lathe-mill-drill gives you all 3 basic machine

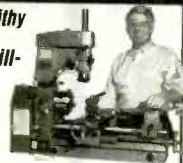

tools in one easy-to-use benchtop machine. Save time & money. For home or business.

Call for your FREE Info Pak.

1-800-345-6342

FREE Info Pak

Ask for Operator PE77 or write

Dept. PE77
PO Box 1517
Ann Arbor, MI
48106-1517

Smithy.

RAIN FOREST RESCUE: TO HELP SAVE THE BIRDS OUTSIDE YOUR WINDOW

Support Rain Forest Rescue. Help put a stop to the destruction of the planet's rain forests.

To contribute to Rain Forest Rescue, call 1-800-222-5312



The National Arbor Day Foundation

Whaddya Say To
A Guy Who's Had
The Same Job
For 50 Years,
Has Never Called
In Sick Or
Showed Up Late,
Never Taken A
Vacation Or A
Holiday, Never
Asked For A
Raise Or Griped
About His Bonus
And, Believe It Or
Not, Has No
Plans For
Retirement?



Thanks.

Remember - only you can prevent forest fires.

SPY EQUIPMENT

AI-6600 PHONE TAP DETECTOR

- DETECTS:
- Radio Frequency Taps
 - Series and Parallel Taps
 - Line Impedance Taps
 - Extension Phone Listeners



\$149⁹⁵

AI-2100 VIBRATING TRANSMITTER DETECTOR

- DETECTS:
- Body Wires
 - FM Wireless Mics
 - AM Transmitters
 - UHF Transmitters

\$189⁹⁵



AI-5500 COMPLETE SAFETY SYSTEM

- DETECTS:
- All Phone Taps and Extension Phone Listeners
 - All Body Wires, Wireless Mics, AM/FM and UHF Transmitters
- DEFEATS:
- All Body Wires, Transmitters and Distance Microphones with its built-in white noise generator

\$379⁹⁵



TRVD-900 TRANSMITTER / TAPE RECORDER & VIDEO DETECTION SYSTEM

- DETECTS:
- Body Wires • FM Wireless Mics
 - AM Transmitters • UHF Transmitters
 - Tape Recorders • Video Equipment
- Alerts User By Vibrating and/or Illuminated LEDs



\$495⁰⁰

WSS-100 WIRELESS SURVEILLANCE SYSTEM SEES & HEARS EVERYTHING!

- FEATURES:
- 2.4 GHz Video / Audio Transmitter
 - 4 Channel Receiver • 300' Transmission Range
 - Black & White CCD w/ Auto-Iris Lens
 - 410(H) TV Line Resolution • FCC Approved Frequency



\$649⁹⁵

Items May Be Purchased by Credit Card, Certified Check, Money Order or C.O.D.

Send \$6.00
for 32-Page
Catalog
(FREE w/ Purchase)

AMERICAN INNOVATIONS, INC.

119 ROCKLAND CENTER ~ SUITE 315 • MANUET, NY 10954

VOICE: (814) 735-6127 • FAX: (814) 735-3560

HTTP://WWW.SPYSITE.COM • E-MAIL: AMERICAN@SPYSITE.COM

Dealers &
Distributors
Welcome

Prices valid thru 9/1/97

Weeder Technologies

Add \$4
Ship/Hand
US & Canada

FREE
CATALOG!



Pro-Kit™

PO Box 421, Batavia, OH 45103

weedtech@iglou.com

513-752-0279

Home Automation

Connects between a TW523 and an RS-232 serial port. Use your PC/Mac to receive and transmit all X-10 commands. Create your own program to control your home automation system, turning on/off any device plugged into an electrical outlet with response to time/date, other X-10 transmissions or any other computer input stimuli. **\$38.50**

Caller ID / RS-232

Connects between a telephone wall jack and an RS-232 serial port. Decodes the caller ID data sent over the phone line and sends it to your PC/Mac, in a pre-formatted ASCII character string. Create your own program to log the name, number, date, and time of all incoming calls. Block out unwanted callers to your BBS/modem. **\$34.50**

Telephone Call Restrictor

Connects to telephone wall jack. Disables all phones on the line if attempting to either: dial a number that has been stored in memory "Block" mode or, dial a number that has not been stored in memory "Allow" mode. Use touch-tone phone to enter telephone numbers into memory, and choose mode. Program from any phone on the line using your password. **\$35.00**

50 MHz Frequency Counter

Reads frequency from 1Hz to 50MHz and displays up to 7 digits on a 16x1 character LCD display. Auto-range feature provides floating decimal point and automatic placement of suffix (Hz, KHz, or MHz). Microcontroller based provides for very small parts count, only 2" x 3" big. **\$48.50**

Telephone Scrambler

Scrambles your voice before sending it over the telephone line. Prevent eavesdropping from an extension or tap. Connects between your telephone and wall jack. No modifications are required to your telephone. Full duplex operation. **\$43.00**

IR Remote Control Receiver

Learns and records the data patterns emitted by standard infrared remote controls used by TVs, VCRs, Stereos, etc. Lets you control all your electronic projects with your TV remote. Seven Individual I/O pins can be assigned to any button on your remote, and can be configured for either "toggle" or "momentary" action. **\$32.00**

RS-232 Digital I/O

Give your home-brewed PC/Mac programs a link to the outside world! 12 I/O pins can be configured individually for input or output. Turn on/off relays, triacs, etc. Respond to button presses, switch changes, 4x4 matrix decoding with auto-debounce. Stack up to 16 units on the same serial port for a total of 192 I/O points. **\$32.00**

DTMF Decoder/Logger

Keep track of all numbers dialed or entered from any phone on your line. Connects to your telephone wall jack. Decodes all 16 touch-tones and displays them on an LCD display. Holds the last 240 digits in a non-volatile memory. Scroll through and view all telephone numbers dialed, credit card numbers entered, etc. **\$54.50**

CLASSIFIED

CABLE TV CHANNELS
EQUIPMENT Direct!
GUARANTEED **FREE 30 DAY TRIAL**

SAVE \$1000's
The Nationwide source for cable TV equipment.
BUY WHERE THE DEALERS BUY!

FREE TV Cable Descramblers, Converters and Magic Box Catalog. Open Every Day!

Your VCR TAPES CAN PLAY AS CLEAR AS DAY!
Eliminates copy protection on any tape.

UNJAM NOW WITH Video Decoder!
• Copy any rental/bought tape
• Power Cord and RC Plug Included

2 Year Warranty
CALL NOW!
Member Better Business Bureau

MEGA ELECTRONICS!
1-800-676-6342 VISA • MC • COD

FREE 30 Day Trial!

WE HAVE IT ALL! Surveillance

Infinity Transmitters
FM Wireless Transmitter Kits
Vehicle Tracking Systems
Bug Detectors • Caller I.D.
Telephone Register with Printer
Long-play Recorders
Wired Mikes • Shotgun Mikes
Telephone Recording Adapters
Alcohol Testers • Drug Testers
Telephone Scramblers
Hidden Video Cameras
Telephone Tap Detectors
MUCH, MUCH, MUCH MORE.

Our 27th Year!

Small catalog FREE. Larger catalog send \$5.
Mail Order only. Visa, MasterCard and C.O.D. accepted for equipment only.
Inquire for dealers' prices.

A.M.C. SALES, INC.

193 Vaquero Dr. • Boulder, CO 80303
Mon.-Fri. 8 a.m.-5 p.m. Mtn. Time
800-926-2488

(303) 499-5405 • Fax (303) 494-4924
Internet: <http://www.siteleader.com/catalogdepot/AMCSC-home.html>
E-mail: amc-sales@siteleader.com

BE A TEACHER. BE A HERO.

Call
1-800-45-TEACH.

MISCELLANEOUS ELECTRONICS FOR SALE

THE Case Against Patents. Thoroughly tested and proven alternatives that work in the real world. \$28.50. **SYNERGETICS PRESS**, Box 809-C, Thatcher, AZ 85552. (520) 428-4073. Visa/MC.

FM Micro-Broadcasting 88-108MHz. Assembled PLL transmitters and rf amps mono/stereo 1/2-100 watts. Photo catalog/info call (250) 642-2859. **R. SCOTT COMMUNICATIONS, LTD.** We ship world wide from Canada.

INTERNATIONAL clients wanted. "Can do" engineer locates, purchases, ships U.S. technical products, systems, parts, services worldwide. Our job: Get the facts; get you what you want! Professional, confidential, discreet. Fax today: (806) 792-0207. Or, write **TESCO TECH** Box 53743, Lubbock, Texas, 79453, USA.

CALL for a free electronics catalog or visit our web page at www.bgmicro.com/. **B.G. MICRO** PO Box 280298, Dallas, TX 75228. Order line 1 (800) 276-2206.

PLANS-KITS-SCHEMATICS

TRANSISTOR Data Tables — Given are the basic electronic parameters for the worlds popular transistors in one volume. A must for servicemen, hobbyists and engineers. Order "Transistor Data Tables" (BP401) for only \$9.95 (price includes shipping) from **ELECTRONIC TECHNOLOGY TODAY, INC.**, PO Box 240, Massapequa Park, NY 11762-0240. USA and Canada only. US funds.

CRYSTAL Set Handbook — Visit antiquity by building the radios your grandfather built. Assemble a "Quaker Oats" rig, wind coils that work and make it look like the 1920's! Only \$10.95 plus \$4.00 for shipping and handling. **CLAGGK INC.**, PO Box 4099, Farmingdale, NY 11735. US funds only! USA and Canada — no foreign orders.

HEATH COMPANY is selling photocopies of most Heathkit manuals. Only authorized source for copyright manuals. Phone: (616) 925-5899, 8-4 ET.

ELECTRONIC Project Kits. www.qkits.com. 1 (888) GO-4-KITS, 292 Queen St., Kingston, ON., K7K 1B8. **QUALITY KITS.**

TRANSFER paper for printed circuits with laser or copier, excellent quality. 30 sheets 8.5 X10 with instructions \$24.00, send check or money order to **G. SANTA MARIA**, 1602-A Washington Ave., Suite #915, Miami Beach, FL 33139.

ALL-in-one catalog, 60 mouth-watering pages. CB/HAM/audio/TV/spy/broadcast/science projects, micropower broadcasting, broadcast transmitters, amplifiers, antennas, "secret books", start your own radio station and more. Send \$1.00 to **PAN-COM INTERNATIONAL**, PO Box 130-P7, Paradise, CA 95967.

AWESOME Kits: Voice changers, levitators, lasers, gas sensors and more! Catalog \$1.00. **LNS TECHNOLOGIES**, 20993 Foothill Blvd., Suite 307P, Hayward, CA 94541. www.cnet.com/~instech

FREE catalog of fascinating electronics! 3D stereo, detectors, testers, tesla, jammers, robotics, much more! **QUANTUM RESEARCH**, 17919-77 Ave., Edmonton, Alberta T5T 2S1.

HOME automation Ideas. Ideas, construction projects: speaker switch, vehicle detection, interactive control, speech recordings, more! Send \$15.00 to **CREATIVE CONTROL**, 937 S. Leyden, St., Denver, CO 80224.

LASER show under \$20.00. Laser and stereo with cassette required. Plans, tape \$20.00. **GLYDEWELL TECHNOLOGY**, P.O. Box 16853, Hattiesburg, MS 39404.

HACKERS software and information on everything else you want. Call **BOXCOM 1** (800) 345-7800.

GET electricity from your phone line. Plans to build the device. Send \$23.00 to: **BOXCOM**, P.O. Box 696, Plant City, FL 33564.

ALTERNATIVE free energy (government suppressed) and electronic weapons. Many plans and kits available. Catalog \$1.00. **UNLIMITED UNDERGROUND ELECTRONICS**, 1839-D West Vistaway #515, Vista, CA 92083. ninteach@incom.net. (619) 414-6631 VM.

COMPUTER SOFTWARE

AOL hacking tricks & software information. Send \$34.00 to: **BOXCOM**, P.O. Box 696, Plant City, FL 33564.

COMPONENTS

STEPPER IC: EDE1200 is perfect for robotics, etc. **E-LAB DIGITAL ENGINEERING, INC.** (712) 944-5344. www.netins.net/showcase/elab

ANTIQUÉ ELECTRONICS

WANTED Eico 239 volt meter. Built before 1978. (717) 845-6678 collect. After 5:00 pm. \$50.00 to \$75.00.

CABLE TV

CABLE descrambling, new secret manual. Build your own descramblers for cable and subscription TV. Instructions, schematics for SSAVI, gated sync, sinewave, some free methods (HBO, Cinemax, Showtime, UHF, Adult)\$12.95, \$2.00 postage. **CABLETRONICS**, Box 30502PE, Bethesda, MD 20824.

CABLE TV equipment & accessories. Wholesale! Free catalog! 30 day moneyback guarantee! **Free catalog! PERFORMANCE ELECTRONICS, INC.** 1 (800) 815-1512.

CABLE descrambler! Anyone can build in seven steps with **Radio Shack** parts. Plans/kits from \$5.00, plus free bonus. 1 (800) 818-9103.

DESCRAMBLE cable using simple circuit. E-Z to follow instructions, and Complete universal kit with free "Bullet Stopper". \$20.00. 1 (800) 522-8053.

CABLE "Bullet Terminator and I.D. Blocker". Electronically shields yourself and your box. Also new Super Bullet/ID Eliminator! Lifetime guarantee. 1 (800) 820-9024.

GIANT Sale!! Original equipment descramblers from \$149.00. Positive Notch filter \$18.00. E-Z install cable test activation chips/boards for all models. "Magic Activator" External activator for all Dp(v), DPBB, CFT 2000/2200. Great features-restore locked box, multimode, hrc/standard much more. Dealers wanted. 1 (800) 449-9189 Anytime.

TEST chips. Provides full service mode. DP(V)5 & 7, DPBB7, CFT 2xx. BA -5000-6700. SA 8550-8600, Tocom 5503/07 VIP. Zenith ST 1000-5612. Call anytime. 1 (800) 449-9189.

CABLE TV, descramblers, converters. Quantity discounts. 30 day free trial. Competitive prices. Call now! 1 (800) 322-0921 **REGAL SALES, INC.**

CABLE TV descramblers. One piece units. Pioneer 8310's, Scientific Atlanta 8580's, DPV7's and others. Lowest prices. Money back guarantee. Houston, TX (713) 691-4610.

CLASSIFIED

CABLE - test chips; Jerrold; Pioneer; Tocom; Scientific Atlanta, Zenith, Jerrold cubes; Pioneer programmable cubes; HUDSON, 1 (800) 863-3237.

ZENITH compatible test chips-activates full test mode. All except PZ1. \$24.95 REALVIEW (888) 732-5843 Visa/MC/Cod.

CABLE Descramblers - All major makes and models of original equipment, aftermarket replacements, and accessories. Quantity discounts and dealer pricing available. Call **CABLE CONNECTION** toll free at 1-888-83-CABLE or e-mail to cable@midusa.net

FREE cable descrambler plans. For details write: **SIERRA PUBLISHING**, 909 E. Yorba Linda Blvd., Suite H-181, Dept. PEG, Placentia, CA 92670.

CABLE TV notch filters. Request our free brochure today! Voicemail: 1 (800) 433-6319. Address: **STAR CIRCUITS**, PO Box 94917, Las Vegas, NV 89193.

DESCRAMBLE cable with simple circuit added to Radio Shack RF modulator and using VCR as tuner. Instructions \$10.00. **TELCOM**, Box 832P07, Brusly, LA 70719.

WE carry all Regal models, RR-92, RC-83, 550 MHz 99 Ch., DQN7 - 550 MHz 99 Ch., OAK-Micro 550 MHz 99 Ch., BC 4535 550 MHz 86 Ch., SA - 8529 550 MHz 99 Ch., SA - 8540 550 MHz with Vol. Ctrl. 99 Ch., DRZ-DIC, DP 5, DPV 5, Pioneer 5135 & Zenith 1086. Dealers are welcome. Please call us for the latest price!!!! Or, visit us at our website <http://www.vntechology.com>

ALL chips \$9.00 - \$18.00, security bits from \$9.95, converters, filters. Lowest price guarantee. Anytime. 1 (800) 780-0555.

MASTER files test modules & cable boxes for all types of CATV converter units. (909) 941-4858.



www.pueblo.gsa.gov

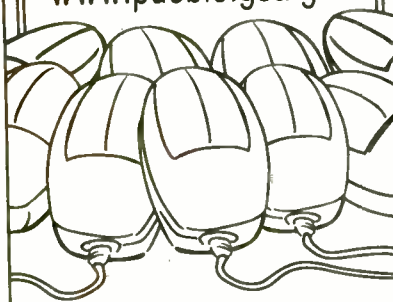

9 out of 10 mice prefer the Consumer Information Catalog online. Just point and click your way to www.pueblo.gsa.gov and you'll find more than 250 free publications ready to read or download.

U.S. General Services Administration

SATELLITE EQUIPMENT

VIDEOCYPHER II descrambling manual. Schematics, video and audio. Explains **DES, EPROM, CloneMaster, Pay-per-view (HBO, Cinemax, Showtime, Adult, etc.)** \$16.95, \$2.00 postage. Schematics for **VideoCypher Plus**, \$20.00. Schematics for **VideoCypher 032**, \$15.00. Collection of Software to copy and alter EPROM codes, \$25.00. **VCII Plus EPROM**, binary and source code, \$30.00. **CABLETRONICS**, Box 30502PE, Bethesda, MD 20824.

DSS Hacking: How to construct and program smart cards, w/pic16C84, software. Complete **DSS** system schematics. \$16.95. **CABLETRONICS**, Box 30502R, Bethesda, MD 20824.

OBTAINING Sound for your VCII and VCII Plus is easy. No codes needed. Also **DSS** Test Card information. Details: 1 (800) 211-5835.

FREE Big Dish Catalog - Low prices - systems, upgrades, parts...and "4DTV", **SKYVISION**®, 1048 Frontier Dr., Fergus Falls, MN 56537. 1 (800) 334-6455. International (218) 739-5231. www.skyvision.com.

SOUND for VideoCypher-II and Plus without codes. Free details. **SASE. NASSIRIAN**, Box 382-P, Rio Linda, CA 95673.

SECURITY

ELECTRONIC sales of security systems for home, apartment, or business. Will send information. Call (812) 295-4240.

BUSINESS OPPORTUNITIES

START your own technical venture! Don Lancaster's newly updated **Incredible Secret Money Machine II** tells how. We now have autographed copies of the Guru's underground classic for \$18.50. **SYNERGETICS PRESS**, Box 809-C, Thatcher, AZ 85552. (520) 428-4073. Visa/MC.

INVENTIONS, ideas, new products! Presentation to industry/exhibition at national innovation exposition. Patent services. 1-800-288-IDEA.

\$\$\$ millions in scrap gold from old electronics, computers, circuit boards, jewelry, 24 hours: (603) 645-4767.

EDUCATION

FCC/CET software. General Radiotelephone, CET preparation. Five 3.5 inch diskettes. Q/A format: interactive, comprehensive. **EGA/VGA**. Complete program, \$35.00. **TUTOR-TECH**, 170 Locksunart Way, #2, Sunnyvale, CA 94087. (408) 481-9543.

BE a computer programmer. Train at home for an exciting new career with ICS-Accredited Member of the Distance Education and Training Council. Call today for free information with absolutely no obligation. 1-800-595-5505, ext. 1186.

BE an electrician. Train at home for an exciting new career with ICS-Accredited Member of the Distance Education and Training Council. Call today for free information with absolutely no obligation: 1-800-595-5505, ext. 1102.

INVENTORS

INVENTORS. Free information/forms on patents/trademarks. 1 (800) 876-6670. **J.P. HALVONIK**, reg. Pat. Atty.

Converters & Descramblers
Call 1-800-715-6789

30 Day Money Back Guarantee

FREE Catalog



•Panasonic®
•Jerrold®
•Pioneer®

•Zenith®
•Scientific Atlanta®

ALL MAJOR CREDIT CARDS ACCEPTED

11497 Hwy. 71, Box 100 • Suite 120-113 • Austin, TX 78758

To learn how to talk with your kids about tough issues, like sex, AIDS/HIV and violence, call **1-800-CHILD-44** and get your free guidebook.



Radiotelephone - Radiotelegraph

FCC Commercial License

Why Take Chances?

Discover how easy it is to pass the exams. Study with the most current materials available. Our **Homestudy Guides**, Audio, Video or PC "Q&A" pools make it so fast, easy and inexpensive. No college or experience needed. The new commercial FCC exams have been revised, covering updated Aviation, Marine, Radar, Microwave, New Rules & Regs, Digital Circuitry & more. We feature the Popular "Complete Electronic Career Guide" 1000's of satisfied customers **Guarantee** to pass or money back. Send for **FREE DETAILS** or call **1-800-800-7588**

WPT Publications
4701 N.E. 47th Street
Vancouver, WA 98661

Name _____

Address _____

City _____ St. _____ Zip _____

1-800-800-7588

ADVERTISING INDEX

Popular Electronics does not assume any responsibility for errors that may appear in the index below.

Free Information Number	Page	Free Information Number	Page
25	Ace Communications.....92	150	Jensen Tools.....114
—	Aegis Research, Canada.....92	—	Kableworks.....96
—	AES.....100	—	KDE Electronics.....111
26	Alfa Electronics.....99	—	Learn Inc.....3
28	All Electronics.....105	144	MCM Electronics.....87
137	Allison Technology.....113	—	Mega Electronics.....116
—	Allstar Electronics.....112	147	Mendelson's.....88
—	Amaze Electronics.....113	—	Mental Automation.....110
—	AMC Sales.....116	171	MicroCode Engineering.....CV4
—	American Innovations.....115	—	Millennium Enterprises.....117
—	Andromeda Research.....111	—	Modern Electronics.....96
—	Basic Electrical Supply.....106	—	National Control Devices.....104
—	Bel Merit.....112	—	Nevada Systems.....110
32	C&S Sales, Inc.....102	—	NRI Schools.....17
—	CD Electronics.....85	—	Orion Electronics.....98
—	Circuit Specialists.....94	—	OWI.....114
—	CLAGGK Inc.....62	146	Parts Express.....91
—	Cleveland Institute of Electronics.....55	45	Prairie Digital Inc.....92
—	Command Productions.....90	46	Print.....88
—	Comtrad Industries.....CV3, 7	47	Print.....98
—	Consumertronics.....86	—	RC Distributing.....112
170	Cook's Institute of Elec. Eng.....11	—	School of Electronics.....88
48	Dalbani.....101	—	Silicon Valley Surplus.....112
162	Davis Instruments.....11	—	Skyvision.....89
173	Digi-Key Corp.....5	—	Smithy Company.....114
—	EDE Spy Outlet.....98	—	Street Smart Security.....104
148	Electronic Rainbow.....97	—	Tab Books.....37
—	Electronic Technology Today .10, 80	—	T.C. Tronics.....104
—	Foley-Belsaw.....107	149	Telulex.....113
—	Forest Electronics.....85	136	UCANDO Videos.....111
—	Fotronic Corporation.....96	—	US Cyberlab.....85
—	General Device Instruments.....100	—	Vision Electronics.....96
—	Grantham College of Engineering.4	—	Visual Communications.....98
—	Greenleaf Electronics Inc.....90	—	Weeder Technologies.....115
—	Home Automation Systems.....111	—	Weka Publishing.....108
—	Information Unlimited.....31	—	WPT Publications.....117
13	Interactive Image Technologies CV2	134	Xandi Electronics.....93
—	Intronics, Inc.....100	—	Xillion.....110

ADVERTISING SALES OFFICES

Gernsback Publications, Inc.
500 Bi-County Blvd.
Farmingdale, NY 11735-3931
1-(516) 293-3000
Fax 1-(516) 293-3115

Larry Steckler, EHF/CET
 President (ext. 201)
 e-mail advertising@gernsback

Christina Estrada
 Assistant to the President (ext. 209)

For Advertising ONLY
1-516-293-3000
Fax 1-516-293-3115

Larry Steckler
 publisher

Arline Fishman
 advertising director (ext. 206)

Michele Torrillo
 advertising assistant (ext. 211)

Adria Coren
 credit manager (ext. 208)

**Subscription/
 Customer Service/
 Order Entry**
 1-800-827-0383
 7:30 AM - 8:30 PM EST

ADVERTISING SALES OFFICES EAST/SOUTHEAST

Stanley Levitan
 Eastern Sales
 1 Overlook Ave.
 Great Neck, NY 11021-3750
 1-516-487-9357, 1-516-293-3000
 Fax 1-516-487-8402
 slevitan26@aol.com

**MIDWEST/Texas/Arkansas/
 Oklahoma, Colorado, Arizona**

Ralph Bergen
 Midwest Sales
 One Northfield Plaza, Suite 300
 Northfield, IL 60093-1214
 1-847-559-0555
 Fax 1-847-559-0562
 bergenrj@aol.com

PACIFIC COAST/Mountain States

Anita Bartman
 Hutch Looney & Assoc., Inc.
 6310 San Vicente Blvd.
 Suite 360
 Los Angeles, CA 90048-5426
 1-213-931-3444 (ext. 227)
 Fax 1-213-931-7309

Patented microelectronic antenna converts your home's wiring into a giant signal-grabbing magnet!

This little box uses your home's electrical wiring to give non-subscribers, cable subscribers and satellite users better TV reception on your local broadcast networks!

Until recently, the only convenient way to guarantee great TV reception was to have cable installed or place an antenna on top of your TV. But who wants to pay a monthly cable fee just to get clear reception, or have rabbit-ear antennas that just don't work on all stations? Some people just aren't interested in subscribing to cable. Or they may live in an area where they can't get cable and TV-top antennas

aren't powerful enough. And what about those people who have cable or satellite systems but still can't get certain local stations in clearly?

Now, thanks to fifteen years of microelectronics research, a new device has been developed that actually makes conventional antennas a thing of the past. It's called the Spectrum Universal Antenna/Tuner!

Advanced technology. If you live in a rural area, you may have resigned yourself to accept the fact that your local TV reception is poor. (This may be true even if you don't live in a rural area!) Now imagine watching TV and seeing a picture clearer than before. Simply plug the Spectrum Antenna into a standard AC outlet and plug your TV into the Spectrum. Get ready for great reception because your TV will display a clearer, focused picture, thanks to Spectrum's advanced signal controls.

Uses your home's electrical wiring. The Spectrum Antenna is a sophisticated electronic device that plugs into a standard wall outlet. Basically, the outlet interfaces the Spectrum with the huge antenna that is your home wiring network. Simply put, it turns the electrical wiring in your house or apartment into a multi-tunable TV reception antenna that will improve your TV's overall tuning capability.

How it works. Broadcast TV signals are sent out from the local broadcast station. Those signals interface with your home's AC power line system, creating an aerial antenna network of wiring as large as your home itself. When the Spectrum Antenna connects to the AC line, the signal is sent to its signal processing circuit. It processes and separates the signal into 12 of the best possible antenna configurations. These specially-processed signals route themselves into 12 separate circuits. A 12-position rotary tapping switch, the "Signal Switch" control, gathers 12 of the best antenna configurations resulting in improved picture quality.

Spectrum Antenna

Parallel 75 ohm resistance

For minimum loss of signal

Signal search control

For selecting multiple antenna configurations

Resonant fine tuner control

For dialing in crisp, clear TV/stereo reception, eliminates ghosting

Dual outlets with surge protection

For plugging in additional TV/stereo equipment guarding against damage and surges

Polarized three-prong plug for grounding

For optimum signal grounding to stop noise and static

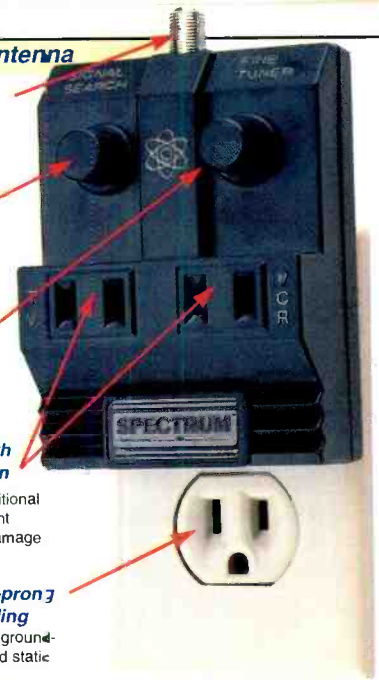

Why don't conventional antennas work as well as the Spectrum?

Bandwidth of TV Signal

1 2 3 4 5 6



When TV signals are tuned at the TV channel's center frequency, optimum tuning has been achieved.

Other antennas can't offer center frequency tuning like the Spectrum Antenna can. They only offer such tuning up to the edge of the center frequency. As a result your TV picture remains snowy.

Spectrum system Precision tuning

Other systems Non-precision tuning

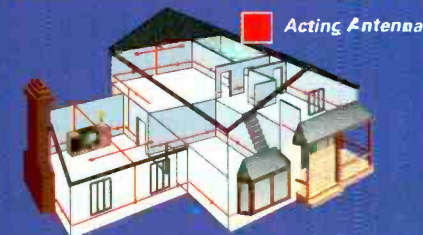

The Spectrum Antenna "activates" the giant antenna that already is in your home. It uses all of the wiring throughout your home's walls and ceilings to make an antenna as large as your house for unbelievably clear reception of local broadcasting.

Spectrum with Gain Booster Features

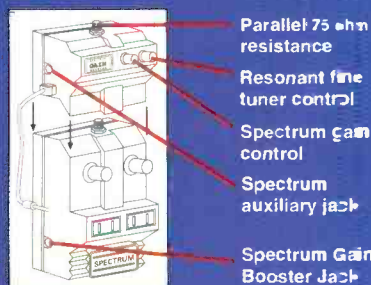

Who can use Spectrum?

- **Cable users-You have cable but you can't get certain local stations in clearly.**
- **Non-cable users-You don't have cable and want the stations to come in more clearly.**
- **Satellite users-You have a digital satellite system but can't get local stations clearly.**

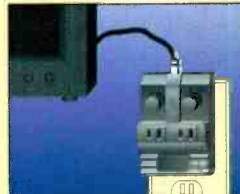

The Spectrum Antenna gets plugged into a three-prong outlet and can accommodate two additional plugs in its surge protected ports.

The "Signal Search" offers varying antenna configurations for you to select from the best signals of all those being sent. The signal then passes through the Spectrum Antenna's special "Fine Tuner" circuit for producing more clear reception.

Rural areas. Most TV signals in rural areas are weak, making them harder to fine tune. The "Gain Booster" is a high-frequency signal booster designed to increase the output level of the signal entering your television. It delivers a 10-fold greater signal which will bring richer color and a noise-free picture. By using the Gain Booster, Spectrum's fine tuning controls will function better, giving it a stronger signal to tune. It also works in conjunction with your outdoor antenna!

Risk-free. The Spectrum Antenna/Tuner comes with our 90-day risk-free trial as well as a 90-day manufacturer's warranty. Try it yourself, and if you're not satisfied, return it for a "No Questions Asked" refund.

Limited time offer! We realize that most people have more than one TV in their home. That's why we're offering a special discount on additional Spectrum Antennas so you get great reception on all your TVs!

Spectrum Antenna.....\$39 \$4 S&H
Additional antennas just.....\$34 S&H free

Gain Booster.....\$19 \$2 S&H
Please mention promotional code 2154-10812

For fastest service, call toll-free 24 hours day

800-230-5023



comradindustries

2820 Waterford Lake Drive, Suite 102 Midlothian, VA 23113

The **Only** Complete Virtual Electronics Lab™

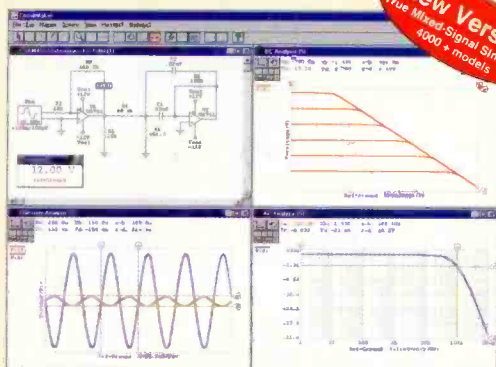

New Version
True Mixed-Signal Simulation
4000+ models

CircuitMaker 5

**The Fastest, Most Accurate,
True Mixed-Signal SPICE Simulator**

CircuitMaker is a virtual electronics lab where you can quickly and easily design and verify digital, analog and true mixed-mode circuits. You layout your circuit design as a schematic, connecting an assortment of over 4000 indestructible components. Click on the simulation button and view the results as if you were looking at real laboratory instruments. It really is that easy!

New users love CircuitMaker's user friendly environment and short learning curve. Experienced users appreciate its time saving features and respect its accurate simulation and numerous in-depth analysis capabilities. No matter what level of electronics you are at, CircuitMaker, The Virtual Electronics Lab, will match your needs. We are so confident you will love its performance that we back every copy with our iron clad satisfaction guarantee!

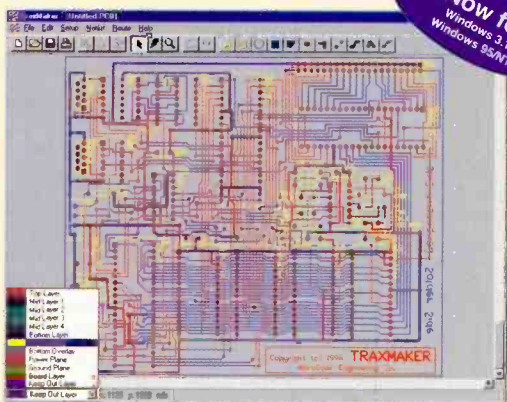

Now for
Windows 3.1
Windows 95/NT

TraxMaker 2

**The Most Affordable,
Professional Quality, PCB Design Tool**

TraxMaker is a Printed Circuit Board (PCB) layout program with advanced features such as a built-in autorouter, 8 layer capability, support for surface mount devices, and full design rule checking. Most importantly, TraxMaker provides these features while remaining exceptionally easy to use.

TraxMaker is a truly cost effective package which is sure to handle your most demanding PCB design tasks. TraxMaker can be used as a stand-alone product or with compatible schematic capture products. When used in conjunction with CircuitMaker, TraxMaker completes a powerful start to finish circuit design system. TraxMaker provides more power than any other product in its class!



NEW
Product

CircuitMaker CBT

**Electronics Training Featuring
An Award Winning Curriculum**

MicroCode Engineering and Lab-Volt Systems present CircuitMaker CBT comprising 28 analog and digital lessons organized into four modules covering DC Concepts, AC Concepts, Analog Device Concepts and Digital Device Concepts. This is not another one of those "textbooks on a computer", rather it is an interactive presentation in an intuitive multimedia CD ROM format providing over 200 virtual labs simulated in CircuitMaker.

The award winning curriculum provides the most powerful teaching/learning tool for electronics available today. This complete electronics program includes on-line instruction and testing, workbooks, and virtual labs. Best of all, you do not have to purchase any expensive laboratory equipment to have an exciting and accurate electronics training program. CircuitMaker CBT will help the user learn and understand electronics and troubleshooting of both analog and digital circuits. We guarantee it!

CircuitMaker - \$299 TraxMaker - \$299
CircuitMaker CBT - \$75 per module

**Call now to order or
request additional information
800-419-4242**



Total Customer Satisfaction

At MicroCode Engineering we are committed to total customer satisfaction. When you purchase one of our products you have the confidence of knowing that a trained staff of professionals is available to serve you after the sale. Our free unlimited customer service is second to none! Whether you have general or technical questions they will be answered promptly by a knowledgeable representative.

FREE Functional Demo

Additional literature and free functional demos of our products are available on the Internet at <http://www.microcode.com> and on CompuServe (GO MICROCODE).