



# MIXED-MODE POWER

## Design & Verify Faster with Electronics Workbench®

**New  
Version 4**

### Analog, Digital & Mixed Circuits

Electronics Workbench® Version 4 is a fully integrated schematic capture, simulator and graphical waveform generator. It is simple to mix analog and digital parts in any combination.

### Design and Verify Circuits... Fast!

Electronics Workbench's simple, direct interface helps you build circuits in a fraction of the time. Try 'what if' scenarios and fine tune your designs painlessly.

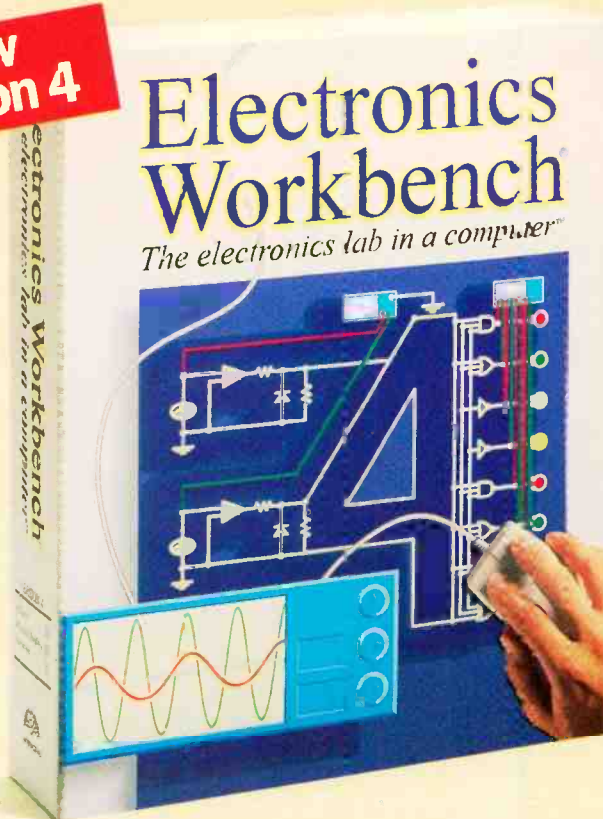

### More Power

Simulate bigger and more complex circuits. Faster. On average, Electronics Workbench Version 4 is more than 5 times faster than Version 3.

### More Parts

Multiple parts bins contain over twice the components of Version 3.

### More Models

Over 350 real world analog and digital models are included free with Electronics Workbench. And, if you need more, an additional 2,000 models are available.

Electronics Workbench delivers the power you need to design and verify analog, digital and true mixed mode circuits. Over 20,000 customers have already put Electronics Workbench to the test. The result: Better designs... Faster. And over 90% would recommend it to their colleagues.

Electronics Workbench will save you time and money. We guarantee it.\*

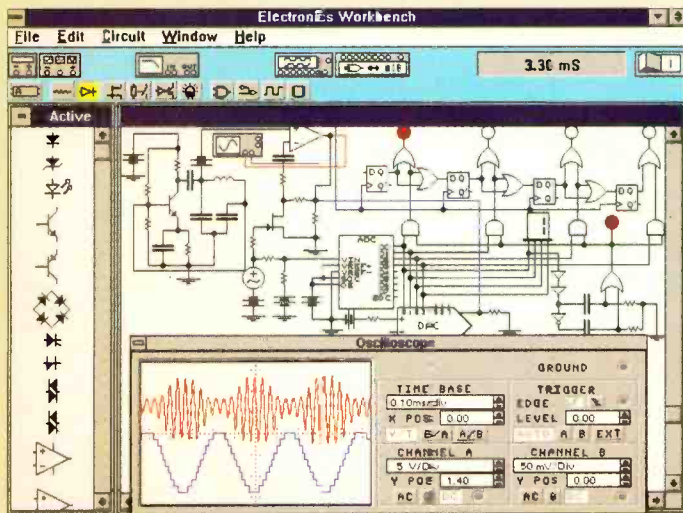

True mixed-mode simulation: Simultaneous AM transmission, digitization and pulse-code modulation of a signal.

Trademarks are property of their respective holders. \*Offer in U.S. dollar and valid only in the United States and Canada.

Australia: 2519-9933 • Brazil: 11-535588 • Cyprus: 262-1068 • Denmark: 3325-0109 • Finland: 0-297-5033 • France: 1-9089-0000 • Germany: 71162-740 • Greece: 1-524981 • Hungary: 1-215-0082 • India: 11-541-1545  
Israel: 3617-5613 • Italy: 11-437-5549 • Japan: 3-3382-3136 • Malaysia: 3-77-2189 • Mexico: 5-996-3075 • Netherlands: 18031-7666 • New Zealand: 9-267-1756 • Norway: 22-1670-15 • Portugal: 18146609  
Singapore: 4620006 • Slovenia: 61-317-830 • South Africa: 331-68309 • South Korea: 2-222-3431 • Spain: 1-553-3234 • Sri Lanka: 1-86-5970 • Sweden: 8-740-5500 • Thailand: 66-2-3986952 • UK: 203-23-3216

CIRCLE 114 ON FREE INFORMATION CARD

## Call Now: 800-263-5552

### Just \$299 + \$15 S/H For Windows, DOS or Macintosh

\*30 day money-back guarantee  
Free unlimited technical support



Yes, I'm interested in Electronics Workbench.

Name: \_\_\_\_\_

Title: \_\_\_\_\_

Organization: \_\_\_\_\_

Address: \_\_\_\_\_

Phone: \_\_\_\_\_

I prefer to be contacted by e-mail/fax at:

INTERACTIVE IMAGE TECHNOLOGIES LTD.

908 Niagara Falls Blvd. #068, North Tonawanda, NY 14120-2060

Telephone: 416-977-5550 FAX: 416-977-1818

E-mail: ewb@interactiv.com

CompuServe: 71333.3435 BBS: 416-977-3540

9EA1FE2



INTERACTIVE

## CONSTRUCTION

### 43 Build a Subwoofer

Is something missing from your home-theater or audio system? Give it the bass oomph it needs to make music and movies really rumble and roll—*William R. Hoffman*

### 60 Build a Telephone-Wiring Tester

Test all types of telephone cable, jacks, and more; you can even test items while they are still connected to the telephone system—*Christopher Zguris*

### 63 Build the Galviamp

It's two valuable test aids—a galvanometer and a variable-gain amplifier—in one handy device—*Joseph J. Carr*



Page 9

## FEATURES

### 37 Designing Loudspeaker Crossovers

Create your own great-sounding speaker designs with these easy-to-use computer programs—*William R. Hoffman*

### 46 The Truth about Speaker Cables

What's inside those expensive audiophile cables that makes them cost so much? Are they worth the money? Learn the answer to the first question in this article, and use that information to answer the second one for yourself—*William R. Hoffman*

### 49 Fun with Random-Dot Images

Make them yourself on a PC, but don't go blind!—*Marc Spiwak*

### 54 ... And The Bananas were Green: The Early Days of Color TV

The road to the color TV we enjoy today was far from smooth—*James P. Rybak*

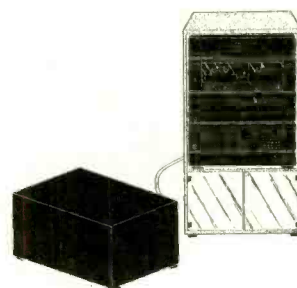

Page 43



Page 49

POPULAR ELECTRONICS (ISSN 1042-170-X) Published monthly by Gernsback Publications, Inc. 500-B Bi-County Boulevard, Farmingdale, NY 11735. Second-Class postage paid at Farmingdale, NY and at additional mailing offices. One-year, twelve issues, subscription rate U.S. and possessions \$21.95. Canada \$28.84 (includes G.S.T. Canadian Goods and Services Tax Registration No. R125166280), all other countries \$29.45. Subscription orders payable in U.S. funds only, International Postal Money Order or check drawn on a U.S. bank. U.S. single copy price \$3.50. Copyright 1995 by Gernsback Publications, Inc. All rights reserved. Hands-on Electronics and Gizmo trademarks are registered in U.S. and Canada by Gernsback Publications, Inc. Popular Electronics trademark is registered in U.S. and Canada by Electronics Technology Today, Inc. and is licensed to Gernsback Publications, Inc. Printed in U.S.A.

Postmaster: Please send address changes to Popular Electronics, Subscription Dept., P.O. Box 338, Mount Morris, IL 61054-9932

A stamped self-addressed envelope must accompany all submitted manuscripts and/or artwork or photographs if their return is desired should they be rejected. We disclaim any responsibility for the loss or damage of manuscripts and/or artwork or photographs while in our possession or otherwise.

As a service to readers, Popular Electronics publishes available plans or information relating to newsworthy products, techniques, and scientific and technological developments. Because of possible variances in the quality and condition of materials and workmanship used by readers, Popular Electronics disclaims any responsibility for the safe and proper functioning of reader-built projects based upon or from plans or information published in this magazine.

P R O D U C T R E V I E W S

**9 Gizmo**

A look at the Primestar DBS system, plus BeeperKid child-monitoring system, WinNet Plus internet-access software, Radio Shack Personal Emergency Phone Dialer, and lots more

**28 Hands-On-Report**

Media Vision Reno portable CD-ROM player

C O L U M N S

**24 Multimedia Watch**

Two big games, and more—*Marc Spiwak*

**30 Think Tank**

More comments from our readers—*John Yacono*

**68 Antique Radio**

Putting the Minerva Tropicmaster back together—*Marc Ellis*

**74 Computer Bits**

Soldering irons and cyber circuits—*Jeff Holtzman*

**78 Circuit Circus**

Using a voice-storage chip—*Charles D. Rakes*

**82 DX Listening**

Fun in the summertime—*Don Jensen*

**84 Ham Radio**

All about selectivity—*Joseph J. Carr*

**86 Scanner Scene**

Up in the air—*Marc Saxon*

D E P A R T M E N T S

**3 Editorial**

**4 Letters**

**6 New Products**

**76 Electronics Market Place**

**88 Electronics Library**

**95 Popular Electronics Market Center**

**134 Advertiser's Index**

**135 Free Information Card**

**Larry Steckler**, BHF, CET,  
editor-in-chief and publisher

**EDITORIAL DEPARTMENT**

**Carl Laron**, editor  
**Don Karagiannis**, associate editor  
**Teri Scaduto**, assistant editor  
**Evelyn Rose**, editorial assistant  
**Marc Spiwak**, editorial associate  
**Joseph J. Carr, K4IPV**,  
contributing editor  
**Marc Ellis**, contributing editor  
**Jeffrey K. Holtzman**,  
contributing editor  
**Don Jensen**, contributing editor  
**Charles D. Rakes**,  
contributing editor  
**Marc Saxon**, contributing editor  
**John Yacono**, contributing editor

**PRODUCTION DEPARTMENT**

**Ruby M. Yee**, production director  
**Karen S. Brown**,  
production manager  
**Kathy Campbell**,  
production assistant

**ART DEPARTMENT**

**Andre Duzant**, art director  
**Russell C. Truelson**, illustrator

**Jacqueline P. Cheeseboro**,  
circulation director

**Michele Torrillo**,  
POPULAR ELECTRONICS bookstore

**BUSINESS AND EDITORIAL  
OFFICES**

Gernsback Publications, Inc.  
500-B Br. County Blvd.  
Farmingdale, NY 11735  
1-516-293-3000  
FAX: 1-516-293-3115  
President **Larry Steckler**

**SUBSCRIPTION  
CUSTOMER SERVICE/  
ORDER ENTRY**

1-800-827-0383  
7-30 AM - 8:30 PM EST

**Advertising Sales Offices  
listed on page 134**

Composition by Mates Graphics

Cover by Loewy Design  
Cover Illustration by Tim McGarvey



Since some of the equipment and circuitry described in POPULAR ELECTRONICS may relate to or be covered by U.S. patents, POPULAR ELECTRONICS disclaims any liability for the infringement of such patents by the making, using, or selling of such equipment or circuitry, and suggests that anyone interested in such projects consult a patent attorney.

# EDITORIAL

## A DBS ALTERNATIVE

Regular readers of my editorials might recall that earlier this year I dumped my cable service in favor of the DSS direct-broadcast satellite (DBS) system (see Editorial, February and March 1995). I've had the system for a while now, and I am as happy with it as I was the day I got it.

But that's not what we are going to talk about this month. Instead, we are going to turn our attention to another DBS system—Primestar. For those not familiar with it, Primestar was actually the first digital DBS service provider, and while DSS has, at least for the time being, passed it in size, Primestar has also shown dramatic growth over the past year.

Primestar and DSS probably have more in common than either would like to admit, but there are also some significant differences. Those differences might make one or the other more suitable for your needs.

The most glaring difference, and perhaps Primestar's chief advantage, is initial cost. If you want DSS, you must buy the hardware, then either pay for installation or install it yourself. With Primestar, you pay only an installation charge that varies by location. The installation charge is required because Primestar does not allow consumers to install the equipment themselves.

On the negative side of the ledger, Primestar's monthly fee for programming (which includes a charge for equipment rental) is slightly higher than that of DSS, and the service offers significantly fewer channels. Then again, Primestar's 70 channels might be more than enough for you!

In any event, if you are considering going the DBS route, Primestar represents a viable, and often more-practical alternative for many. This month, our Gizmo section takes a closer look at the Primestar system. Discussed are its strengths, weaknesses, costs, and much more. The story begins on page 9.



Carl Laron  
Editor

## EARN YOUR B.S. DEGREE IN COMPUTERS OR ELECTRONICS



### By Studying at Home

Grantham College of Engineering, now in our 45th year, is highly experienced in "distance education"—teaching by correspondence—through printed materials, computer materials, fax, modem, and phone.

No commuting to class. Study at your own pace, while continuing on your present job. Learn from easy-to-understand but complete and thorough lesson materials, with additional help from our instructors.

Our Engineering Technology B.S. Degree Program is available in either of two options:

- (1) The B.S.E.T. with Major Emphasis in Electronics, OR
- (2) The B.S.E.T. with Major Emphasis in Computers.

Our Computer Science B.S. Degree Program leads to the B.S.C.S.—the Bachelor of Science in Computer Science.

An important part of being prepared to *move up* is holding the right college degree, and the absolutely necessary part is knowing your field. Grantham can help you both ways—to learn more and to earn your degree in the process.

Write or phone for our free catalog. Toll free, 1-800-955-2527, or see mailing address below.

Accredited by  
the Accrediting Commission of the  
Distance Education and  
Training Council

**GRANTHAM**  
*College of Engineering*  
Grantham College Road  
Slidell, LA 70460

# LETTERS

## SQUARE-WAVE CORRECTION

I am writing in regard to Joseph Carr's article, "Making Square Waves at Home" (**Popular Electronics**, March 1995). Mr. Carr says that a square wave contains "only even-order harmonics." That is contrary to everything that I learned when I got my engineering degree. My training was that square waves were composed mainly of odd-order harmonics, while even-order harmonics produced triangular waveforms. Other engineers in my work group are in agreement that this is still true.

To test this theory, I checked the signal on an HP3585B low-frequency spectrum analyzer with the HP3325B synthesis/function generator as the square-wave source. The test frequency was 1 kHz, and the spectrum analyzer was set to a start frequency of 1 kHz and a stop frequency of 21 kHz. Sure enough, the peaks of the displayed signal were on the

vertical graticule lines at 3 kHz, 5 kHz, 7 kHz, etc.

I have subscribed to many electronics publications over the past 40 years, including **Popular Electronics**, and have from time to time noticed some minor errors. To state that square waves are composed of even-order harmonics is more than a minor error—it's just plain wrong.

B.R.  
Sunnyvale, CA

*You are correct, and my article is wrong: Square waves are made up of odd-order harmonics (3f, 5f, ...) not even-order (2f, 4f, ...) as stated. What bothers me the most about the mistake is that I've known the correct information since high school (late 1950s).*

*The general rules are:*

1. A waveform with symmetry

*across the zero axis has no DC component.*

2. *A waveform with half-wave symmetry (such as a square wave) has no even harmonics.*

3. *In a waveform with quarter-wave symmetry, but not necessarily half-wave symmetry, any odd-order harmonics present are in phase with the fundamental.*

*Sorry about the error.—*  
JOSEPH CARR

## SORRY, WRONG NUMBER

*There was an error made in the phone number listed for requesting Jensen Electronics' catalog (**Popular Electronics**, Electronics Library, March 1995). The correct number for phone requests is 1-800-426-1194. We're sorry for any inconvenience that this may have caused.—Editor*

## \$20 MINIMUM

*In the article, "Build a Solar Airplane" (**Popular Electronics**, February 1995), Kelvin Electronics (10 Hub Drive, Melville, NY 11747; Tel: 516-756-1750) was referenced as a source for parts. While the total cost for the parts required for that project is about \$13, we have since become aware that Kelvin's policy requires a minimum order of \$20. While Kelvin is a good source for a variety of hobbyist needs—soldering-iron tips, hobby-knife blades, test equipment, electronic components, and more—we nevertheless recognize that meeting that minimum could be a problem for some. We apologize for any inconvenience.—*  
MARC SPIWAK

## CURRENT-CROWBAR CIRCUITS RE-EXAMINED

The discussion of current limiting and foldback current versus the current crowbar ("Current-Crowbar Circuits," **Popular Electronics**, April 1995) was

extremely interesting, but a major protection-failure mode was completely ignored.

When the main high-current series-pass transistor, Q1, develops a collector-to-emitter short, essentially all of the regulator input voltage will be passed on to the output terminals. The over-voltage has the capability of doing great harm to the connected load if, for example, it was 5-volt logic circuitry.

The cute cartoon depicting a mechanical crowbar removing the power cord from the wall outlet is *not* true for the case described in Mr. Kaliangile's article. A true crowbar circuit will prevent over-voltage damage to the load. When Q1 develops an emitter-load short, a true crowbar circuit will blow either a primary circuit fuse or a secondary fuse—a small price to pay for not damaging the load.

The case in which the load represents a short on the power supply is only one of the protection modes to be considered. The most important protection mode—against over-voltage due to regulator failure—was not mentioned in the article. A true crowbar circuit incorporates such protection.  
W.E.P.  
Columbus, OH

## HAVES & NEEDS

I am looking for service information on a Hanimex model 2818B AM/FM/CB portable radio (or another, similar, radio for reference). I also need a source for Goldstar TV parts.  
KEITH TONA, N9PQU  
741 Oconto Avenue  
Peshtigo, WI 54157

I would appreciate any help in locating service literature for a Jerrold P.A. amplifier model CAP 40T. I would gladly pay copying and postage costs.

I would also like to find someone with software for the Atari 800XL computer.  
J. H. SOUSER  
511 West Wayne Street  
Randolph, NE 68771



### Cable TV Converters and Descramblers



## STARGATE SST

**Features include:**

- Upgradeable card slot
- Volume control
- Parental control
- Audio/Video ports
- Sleep timer

OFFER EXPIRES ON JUNE 30, 1995

# 1-800-228-7404

FREE CATALOG

3250 Hatch Rd. Cedar Park, TX 78613



Obtain required certification...  
Enhance your career potential...  
Improve your earning power...

# Prepare Yourself to Pass The Communications Licensing and Certification Exams!

Give yourself the competitive edge it takes to succeed in the expanding world of communications. For the first time ever, McGraw-Hill offers you the opportunity to thoroughly prepare yourself to pass the difficult tests required for licensing and certification by major sponsoring organizations.

Use Communications Licensing and Certification Examinations The Complete TAB Reference to "prep" yourself in a wide range of electronics subjects and concentrate on the areas where you need to "brush up."

Practice Tests for Communications Licensing and Certification Examinations provides you with full-length practice tests that cover virtually every subject needed to master the actual test. Answers let you focus on your weak points and improve your overall knowledge.

Much more than just a textbook, this set provides a focused review of the material you need to know. Fill out and return the coupon, or call, toll-free **1-800-822-8158** — now — for this

extraordinary study reference set.

**PRACTICE TESTS FOR COMMUNICATIONS LICENSING AND CERTIFICATION EXAMINATIONS THE COMPLETE TAB REFERENCE**

Sam Wilson and Joseph A. Risse

- FCC
- ISCEET
- ETA

**COMMUNICATIONS LICENSING AND CERTIFICATION EXAMINATIONS THE COMPLETE TAB REFERENCE**

Sam Wilson and Joseph A. Risse

- FCC
- ISCEET
- ETA

**2-BOOK SET ONLY \$69.90!**

(plus \$6 S&H and applicable sales tax)

Get a **TAB Electronics** brief bag, absolutely free!

**Satisfaction Absolutely Guaranteed**

We're so sure that you'll be satisfied with your selection, we'll even pay the postage if you decide to return it.

**PAYMENT METHOD:**

Check or Money Order Enclosed     Please charge my credit card:



Account No. \_\_\_\_\_  
Expiration Date \_\_\_\_\_  
Signature \_\_\_\_\_



**TAB Electronics**  
P.O. Box 182606  
Columbus, OH 43271-3033

**YES!** Please rush my 2-volume set (#587064-9). Payment of \$69.90 (plus \$6 S&H and applicable sales tax) is enclosed. I understand that if I purchase this set now, I will receive a TAB Electronics brief bag, absolutely free.

Name \_\_\_\_\_  
Address \_\_\_\_\_  
City \_\_\_\_\_ State \_\_\_\_\_  
Zip \_\_\_\_\_ Phone (    ) \_\_\_\_\_

**FOR FASTEST RESPONSE CALL TOLL-FREE, 1 800 822-8158, 24 hours a day!**

Key=SP75PEA

July 1995, Popular Electronics

# NEW PRODUCTS

## Full-Spectrum Desktop Scanner



ACI's *Trident TR4500* pulls in broadcast frequencies from the shortwave bands through the microwave-range public-service bands—from below AM broadcast to 1.300 GHz—and can be controlled via a personal computer. Users can tune in to practically every type of voice broadcast from around the world, including the broadcast, world-band, and civil and military aviation frequencies found in AM mode; police, fire, and emergency services in Narrow FM; radio and TV-audio broadcasts in Wide FM; and even single sideband for transoceanic aircraft and ship communications.

Desired frequencies can be selected directly using the keypad, or the unit can be set to search through all active channels. The user can store any interesting frequencies in any of 2016 permanent memory locations. Up to 16 different search ranges can be set into memory. Tuning increments can be selected in steps as low as 5000 cycles. The TR4500 will scan through memorized frequencies at up to 36 channels per second, and will lock on active calls to receive the broadcast. The user can listen through the built-in speaker or use the supplied headphone.

With the TR4500 connected to a PC's serial interface, the computer can be used to set the search ranges. The computer allows various frequencies to

be loaded and saved, and active frequencies to be stored. And, when used with a computer, the TR4500 effectively becomes a storage spectrum analyzer. An MS-DOS "comm" program is included.

The desktop scanner measures just 2¼ × 5½ × 6½ inches. It comes with a 12-volt DC cord, an AC adaptor, an earphone, a flexible antenna, software, and operating instructions that include a listing of allocated uses for all frequencies covered by the unit.

The TR4500 desktop scanner with computer interface has a suggested retail price of \$849; the street price is expected to be under \$500. For more information, contact ACI; Tel. 1-800-445-7717 or 317-849-2570; Fax: 1-800-448-1084 or 317-849-8794.

**CIRCLE 100 ON FREE INFORMATION CARD**

## MULTIMEDIA SPEAKERS

Although many of today's personal computers are equipped with a CD-ROM drive and sound card, the built-in speakers are usually inadequate. The *Media 3* and *Media 4* speakers from JBL Consumer Products address the needs of PC users seeking to enhance their multimedia experiences in learning, entertainment, and game-playing.

The *Media 3* powered speaker incorporates a 4-inch woofer and a 1.5-inch tweeter with a seven-watt-per-channel hi-fi amplifier. Subwoofer output allows the system to be further upgraded, dual inputs accommodate a second audio source, and a headphone jack provides private listening. The *Media 3* speakers also feature separate bass and treble controls and automatic power on/off.

The *Media 4* incorporates a five-inch woofer, a one-inch tweeter, and a 10-watt-per-chan-



nel hi-fi amplifier. Key features include switchable subwoofer output or headphone output, polyolefin cabinet material to dampen internal resonances, automatic turn on/off, and an acoustically efficient design for loud sound levels.

The *Media 3* (pictured here) and *Media 4* multimedia speakers have suggested retail prices of \$199/pair and \$299/pair, respectively. For more information, contact JBL Consumer Products, Multimedia Division, 80 Crossways Park West, Woodbury, NY 11797; Tel. 516-496-3400.

**CIRCLE 101 ON FREE INFORMATION CARD**

## FIELDPACK WITH "STICK" DMM

The *HS24K11 Fieldpack* from *Fieldpiece Instruments* consists of a leather holster that holds a heavy-duty *HS24* "stick" digital multimeter along with a 300-amp current clamp head, deluxe test leads, two short and two long probe tips, and one alligator ground clip. All the accessories are modular, using standard banana plugs and jacks for connections.



Specifically designed for field-service use, the leather holster holds the meter and test leads



on the inside and has loops for the current clamp head and long probe tips on the outside. A belt loop on the back allows easy carrying.

The HS24 meter offers the 12 most popular ranges for field service and will withstand steady-state voltages up to 1000-volts DC and 750-volts AC. It measures volts, ohms, continuity, capacitance, and AC current (with the included current clamp). A HOLD button freezes the display to make one-handed testing easy. Its Valox plastic case withstands drops up to 10 feet, "O"-ring seals protect against contaminants, and metal-oxide varistors (MOVs) protect against voltage transients. An audible beeper and a blinking red LED warn of voltages over 28 volts, even if the meter is set to the wrong range or function.

The heavy-duty HS24K11 Fieldpack costs \$159. For more information, contact Fieldpiece Instruments, 231 East Imperial Highway, Suite 250, Fullerton, CA 92635; Tel. 714-992-1239; Fax: 714-992-6541.

**CIRCLE 102 ON FREE INFORMATION CARD**

### PCMCIA MODEM

The MT2834LT PCMCIA modem features a patent-pending "CoolJax" duplex phone connector, eliminating the need for messy cables. The modem is compliant with the recently adopted ITU standard for 28.8-kilobyte per second, V.34 modems, and also supports all lower



speed standards. It is designed for use in standard Type II PCMCIA slots, and comes with MultiExpress fax and data communications software for Windows. The MT2834LT uses industry-standard "AT" commands for modem configuration and dialing, and includes a remote configuration feature that allows the user to remotely change parameters and run di-

agnostics for troubleshooting, technical support, and system administration purposes.

The MT283LT PCMCIA modem costs \$399. For additional information, contact Multi-Tech Systems, Inc., Tel. 800-328-9717 or 612-785-3500.

**CIRCLE 103 ON FREE INFORMATION CARD**

### PERSONAL POCKET DIGITAL MULTIMETERS

The Model 380933 3200-count, autoranging, digital multimeter from *Extech Instruments* offers high-resolution, bar-graph display, function indicators, data hold, diode test, and an audible continuity checker. It measures DC voltage from 300 mV to 450 volts, AC voltage from 3 to 450 volts, and resistance from 300 ohms to 30 megohms. The digital multimeter weighs just 3.4 ounces and measures 4.8 x 3 x 0.8 inches.



The Model 380933 pocket-sized digital multimeter, complete with a wallet-style carrying case, test leads, 1.5-volt batteries, and a user's manual, costs \$39. A 2000-count, manual-ranging version (*Model 380929*), which features a larger display, 200-mA range, continuity indication, data hold, and diode test, costs \$25. For further information, contact Extech Instruments, 335 Bear Hill Road, Waltham, MA 02154-1020; Tel. 617-7440; Fax: 617-890-7864.

**CIRCLE 104 ON FREE INFORMATION CARD**

### DIGITAL STILL CAMERA

Casio's QV-10 handheld digital still camera allows you to view images as they are shot, thanks to a high-resolution, active-matrix, 1.8-inch color LCD screen. The images can then be transferred to a personal computer by using an optional transfer



package, or to a TV or VCR using a video cable.

The camera's semiconductor memory can hold up to 96 color still images that can be added or deleted at any time. The fixed-focal-length lens with macro positioning allows point-and-shoot picture taking. The camera also features a high-speed (1/8 to 1/4000-second) shutter, 1/5-inch CCD element, and aperture-priority automatic exposure system.

The QV-10 LCD digital camera has a suggested retail price of \$700. For further information, contact Casio, Inc., 570 Mt. Pleasant Avenue, Dover, NJ 07801; Tel. 201-361-5400.

**CIRCLE 105 ON FREE INFORMATION CARD**

### LOW-PASS FILTERS

Intended for amateur-radio use, two low-pass filters from *Tucker Electronics* are designed to provide protection from TVI. The T-100 and the T-150 each use a 9-pole Chebyshev filter. They operate from 0-30 MHz and provide 70-dB or more of attenuation at 40 MHz and above. The filters' impedance is 52 ohms, and VSWR is less than 1.5:1 throughout their passband.

The T-100 will handle 1500 watts continuously. The T-150 is the first 2500-watt continuous low-pass filter for amateur-radio use. Each carries a one-year warranty and a 30-day no-questions-asked return policy.

The T-100 and T-150 low-pass filters have list prices of \$49.95 and \$109.95, respectively. For additional information, contact Tucker Electronics Company, 1717 Reserve Street, Garland, TX 75042-7621; Tel. 1-800-527-4642; in Texas: 214-348-8800; Fax: 214-348-0367.

**CIRCLE 106 ON FREE INFORMATION CARD**



**National Electronic Wholesalers**

**CHIPS**

**Jerrold Compatible**  
 DP5, DPV5...as low as \$5.00  
 DP7, DPV7 ..as low as \$7.00  
 R2, V5, CFT modules from \$15.00

**Scientific Atlanta**  
 Quick-Boards for:  
 8550, 8570, 8580, 8590, 8600  
 all as low as \$14.75

ALSO AVAILABLE FOR TOCOM, PIONEER AND ZENITH

**1-800-639-6369**

**CIRCLE 167 ON FREE INFORMATION CARD**

# New device turns any electrical outlet into a phone jack

Engineering breakthrough gives you unlimited phone extensions without wires or expensive installation fees

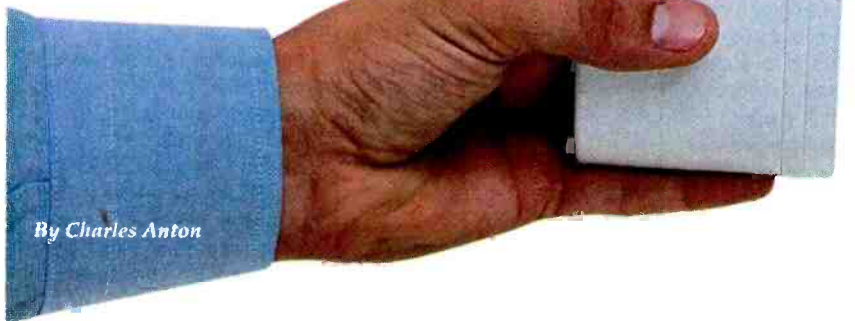

By Charles Anton

**Y**ou don't have to have a teenager to appreciate having extra phone jacks. Almost everyone wishes they had more phone jacks around the house.

When I decided to put an office in my home, I called the phone company to find out how much it would cost to add extra phone jacks. Would you believe it was \$158?

**No more excuses.**

Today, there are a thousand reasons to get an extra phone jack and a thousand excuses not to get one. Now an engineering breakthrough allows you to add a jack anywhere you have an electrical outlet. Without the hassle. Without the expense. And without the miles of wires.

**Like plugging in an appliance.**

Now you can add extensions with a remarkable new device called the Wireless Phone Jack. It allows you to convert your phone signal into an FM signal and then broadcast it over your home's existing electrical wiring.

Just plug the transmitter into a phone jack and an electrical outlet. You can then insert a receiver into any outlet anywhere in your house. You'll be

able to move your phone to rooms or areas that have never had jacks before.

**Clear reception at any distance.** The Wireless Phone Jack uses your home's existing electrical wiring to transmit signals. This gives you sound quality that far exceeds cordless phones. It even exceeds the quality of previous devices. In fact, the Wireless Phone Jack has ten times the power of its predecessor.

Your range extends as far as you have electrical outlets: five feet or five hundred feet. If you have an outlet, you can turn it into a phone jack—no matter how far away it is. The Wireless Phone Jack's advanced companding noise reduction features guarantee you crystal-clear reception throughout even the largest home.

**Privacy guarantee.**

You can use The Wireless Phone Jack in any electrical outlet in or around your home, even if it's on a different circuit than the transmitter. Each Wireless Phone Jack uses one of 65,000 different security codes. You can be assured that only your receiver will be able to pick up transmissions from your transmitter.

**Is the Wireless Phone Jack right for you?**

The Wireless Phone Jack works with any single-line phone device. Almost anyone could use it, especially if...

- **Few jacks.** You want more phone extensions without the hassle and expense of calling the phone company.
- **Bad location.** You have jacks, but not where you need them most, like in the kitchen, garage, home office or outside on the deck.
- **Renting.** You want to add extensions, but you don't want to pay each time you move.
- **Other phone devices.** You have an answering machine, modem or fax machine you want to move to a more convenient place.

**The Wireless Phone Jack System**

consists of a transmitter (right) and a receiver (left). One transmitter will operate an unlimited number of receivers.



**Unlimited extensions—no monthly charge.** Most phone lines can only handle up to five extensions with regular phone jacks. Not with the Wireless Phone Jack. All you need is one transmitter, and you can add as many receivers as you want. Six, ten, there's no limit. And with the Wireless Phone Jack, you'll never get a monthly charge for the extra receivers.

**Works with any phone device.**

This breakthrough technology will fulfill all of your single-line phone needs. It has a special digital interface for use with your fax machine or modem. You can even use it with your answering machine just by plugging it into the Wireless Phone Jack receiver.

**Special factory-direct offer.**

To introduce this new technology, we are offering a special factory-direct package. For a limited time, the transmitter is only \$49. One transmitter works an unlimited number of receivers priced at \$49 for the first one and \$39 for each additional receiver. Plus, with any Wireless Phone Jack purchase, we'll throw in a phone card with 30 minutes of long distance (a \$30 value) for only \$9.95!

**Try it risk-free.** The Wireless Phone Jack is backed by Comtrad's exclusive 30-day risk-free home trial. If you're not completely satisfied, return it for a full "No Questions Asked" refund. It is also backed by a one-year manufacturer's limited warranty. Most orders are processed within 72 hours and shipped UPS.

**Wireless Phone Jack transmitter ...\$49 \$4 S&H**  
**Wireless Phone Jack receiver .....\$49 \$4 S&H**  
**save \$10 on each additional receiver—\$39**

**30-minute long distance phone card.....\$30**  
**\$9.95 with Wireless Phone Jack purchase**

Please mention promotional code 017-PL-6620.

For fastest service, call toll-free 24 hours day

**800-992-2966**



To order by mail, send check or money order for the total amount including S&H (VA residents add 4.5% sales tax). Or charge it to your credit card by enclosing your account number and expiration date.

**COMTRAD INDUSTRIES**

2820 Waterford Lake Drive, Suite 106  
 Midlothian, Virginia 23113



The Wireless Phone Jack lets you add a phone, modem, fax machine or answering machine almost anywhere.

# GIZMO®

## Prime Star Gazing

**PRIMESTAR DIGITAL DIRECT BROADCAST SATELLITE SERVICE.** Primestar Partners, Three Bala Plaza West, Suite 700, Bala Cynwyd, PA 19004; Tel. 610-617-5300; Price: Monthly fee varies with distributor and program options.

Astronomers tell us that the universe is expanding. We'll have to take their word for it, because it certainly isn't apparent to us, and doesn't have much effect on our day-to-day lives.

We don't need astronomers, however, to tell us that the *television* universe is, has been, and continues to be, expanding. All we have to do is open up the latest issue of *TV Guide*, and then recall the way it looked during our childhood, when there were the three major commercial networks, three local stations, and PBS.

Then cable TV hit the scene, offering first better reception on local stations in many areas and, later, a host of new programming choices. Most people who lived in areas where cable was offered considered themselves lucky to be able to see recently released motion pictures, sporting events, MTV, and the like. They were even happy to pay the reasonable fees that were charged to receive the improved services being offered.

Over the years, however, the thrill wore off. Prices for services (many of which we no longer found enthralling) began slowly, but very surely, to rise, and the cable company began using equipment and techniques that tended to interact poorly with state-of-the-art TVs and VCRs. Movies came out on video long before they hit cable—and it was much easier to fit a rented movie into the viewer's busy schedule than to watch a movie as it was shown on cable.

With virtual monopolies in their markets, many cable companies have taken advantage of their subscribers, charging excessively high prices and offering poor service in return. We are certainly not the

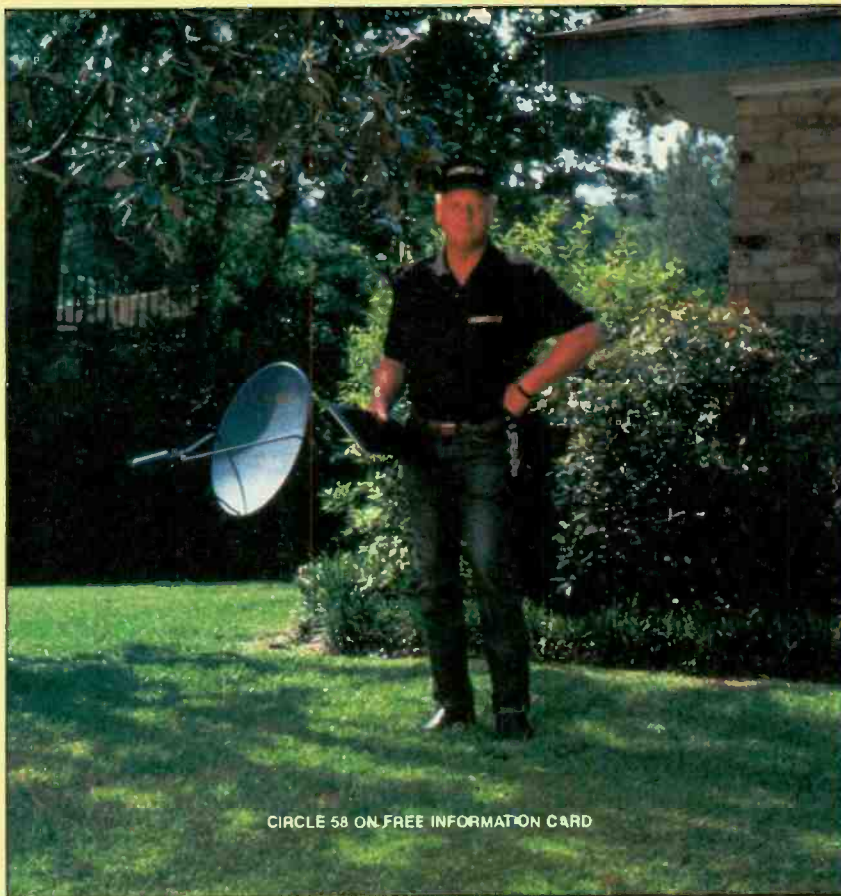

CIRCLE 58 ON FREE INFORMATION CARD

only folks to become disenchanted with the service offered by local cable companies, but we did something about it. We finally got fed up and went cold turkey, canceling our cable subscription, and reverting to watching only the UHF/VHF stations pulled in by our rooftop antenna.

Those who live in areas where decent network reception is not possible without cable haven't had the option to disconnect. And millions of households, mostly in rural areas, haven't even had the option to try cable to see if they like it—cable service simply isn't available in their neighborhoods.

One such spot is Arietta, New York, located in the Adirondack State Park, about 65 miles north of Albany. The rural

town is so tiny that it has no doctor and no full-service grocery store. And, with only 301 residents, providing cable service is not an economically feasible proposition.

People living in Arietta had rather limited viewing options. They could use their rooftop antennas to pull in (under optimal reception conditions) two broadcast channels. Usually, those channels were plagued by interference, and sometimes they couldn't be seen at all. The only other option—besides giving up on TV altogether—was to buy and install a large-dish satellite system.

Satellite TV has been an option since the 1970s for cable-deprived (or anti-cable) people. It provides hundreds of channels, and generally better reception than

that offered by cable. On the downside, it requires somewhat complex, usually professional installation, a major financial outlay, and a dish-shaped antenna that measures up to 10 feet in diameter and must be mounted with a clear line of sight to the satellites orbiting above the earth. Although there is plenty of free programming on satellite, owners still have to pay an additional monthly fee for subscriptions to traditional cable channels.

Last fall, however, Arietta entered the new age of satellite TV. The town was chosen as the site for a 60-day free trial of *Primestar*, a digital DBS (direct broadcast satellite) service. The residents' viewing options jumped overnight from two to 77 channels.

Primestar is one of two digital DBS systems making news across the country these days; the other is RCA's DSS. This month, Gizmo offers a hands-on review of Primestar; RCA, Primestar's main competitor, chose not to participate in a head-to-head review. Both systems are taking the television world by storm.

#### DIGITAL SATELLITE SYSTEMS

The two systems have a lot in common. Both Primestar and DSS use digital compression to squeeze more channels from less satellite, and both offer what they call "near laserdisc-quality" video and CD-quality sound. The move to digital transmission wasn't motivated to provide better picture quality, but to increase channel capacity. Both systems use higher-power satellites than standard satellite TV, allowing smaller dishes to be used. (DSS broadcasts from the FSS or fixed satellite band. Primestar broadcasts from a traditional, medium-powered Ku-band satellite.)

Both systems also promise to be an alternative to standard cable services and to standard satellite TV. However, each service shares many similarities with cable companies, and in fact, Primestar is owned by a consortium of cable providers.

The biggest difference between the two small-dish systems is that DSS is a consumer product, while Primestar is a "service." The potential DSS owner can go to his or her local electronics store and spend between \$700 and \$1000 for a basic system, and about \$150 more for professional installation (although about 40% opt to install it themselves). Adding a second TV to the system requires the purchase of a \$650 "slave" receiver. The DSS owner then calls one or two program suppliers to subscribe. Maintenance and upgrades are his or her responsibility.

Gizmo is published by Gernsback Publications, Inc., 500-B Bi-County Blvd., Farmingdale, NY 11735. Senior Writers: Chris F. O'Brien and Teri Scaduto. Copyright 1995 by Gernsback Publications, Inc. Gizmo is a registered trademark. All rights reserved.



The Primestar receiver should look right at home on your equipment rack. It's about the same size as a VCR.

Primestar customers, on the other hand, don't buy any equipment. Instead, they pay a one-time installation fee of about \$150, and then a monthly fee that starts at about a dollar a day for the rental of the dish, the decoder, the remote control, and some basic programming. A "nominal" fee is added to the monthly bill for extra set-top decoders. Maintenance and upgrades are handled, and paid for, by the Primestar supplier.

The buy vs. rent debate reflects philosophical as well as practical differences. DSS advocates tout the independence that comes with owning your own gear. Primestar stresses the worry-free nature of renting equipment, the lack of a high, initial cash outlay, and the promise of free upgrades as the technology improves.

Those opposing viewpoints are not surprising when you consider that DSS is the brainchild of a consumer-electronics company, Thomson Consumer Electronics. Primestar Partners, on the other hand, is a consortium made up of subsidiaries of six major cable companies—Tele-Communications, Inc., Time Warner Cable, Comcast Cable, Continental Cablevision, Newhouse Broadcasting, and Cox Cable Communications—and G.E. American Communications, Inc., which owns the satellite used by Primestar.

The two systems also use different compression methods and satellite dishes. Although both intend to upgrade to the international MPEG-2 standard in the near future, at present DSS uses MPEG-1, while Primestar uses General Instrument's DigiCipher compression scheme. Perhaps the most obvious physical difference between the two systems is dish size. Both use dishes that are much smaller than standard C-band antennas, but at 18 inches in diameter, the DSS dish is somewhat smaller than those used by Primestar.

Primestar's antennas vary in size from 32 to 39 inches, depending on geographic location and weather patterns.

#### PUTTING PRIMESTAR TO WORK

Our installation, on the south shore of Long Island, New York—an area that is one of the most heavily penetrated by cable in the U.S.—contained one of Primestar's new elliptical dishes. It measures approximately 39 inches across, and 29 inches in height. For our temporary installation, the dish was mounted at ground level on the backyard lawn, with the mount secured by strategically placed cinder blocks. (Because we're familiar with C-band dishes mounted in concrete or something similarly stable, we worried that our cats might accidentally knock the dish off kilter. But the installers assured us that, while they had seen a few cases of cows rubbing against the dishes and causing problems in rural areas, not even our largest domestic cat could do any damage.)

Finding a clear line of sight to the Primestar satellite, even from ground level, presented no problem to the experienced installer. (The installer, from Halstead Communications in Albany, NY, actually used the installation to train a local crew.) Cable was run through a hole drilled in a basement-window frame, then up through a previously installed PVC conduit to the living room. The set-top decoder was connected to our TV and to a phone line, which allows the box's built-in modem to communicate billing and pay-per-view information.

The entire process was quick and painless. From the front of the house, no one would know that a satellite system had been installed. And, like the residents of Arietta, we suddenly had access to about 70 cable channels.

## TAKING CONTROL

The Primestar 300D decoder box is standard component size—much bigger than the typical cable box, but about the same size as a VCR. A prominent display shows the channel number, and also features signal, timer, and SAT/TV indicators. Front-panel controls are limited to POWER; CENTER, used to confirm and activate channel selections and to terminate user passwords; GO BACK, to return to the last-viewed channel; and CHANNEL UP and DOWN and VOLUME UP and DOWN arrow keys, arrayed around a MENU button that's used to access Primestar's on-screen menu system. When the menu is on-screen, the four up and down arrow keys take on a different role; selecting and maneuvering through sub-menus.

All of the front-panel control keys are duplicated on the remote. In addition, the remote control offers a numeric keypad for directly entering channel or password numbers, a BUY button for purchasing pay-per-view programming, a SAT/TV key for switching between Primestar and local TV inputs, and MUTE. Pressing the VIEW button calls up an on-screen display consisting of the currently selected channel, service, program name, rating (if applicable), and time of day. The NEXT key provides the same information about the next program that will be shown on the current channel. If the current channel is a pay-per-view station, the "view" or "next" display will also include prompt lines—for instance, "Press BUY to purchase program."

The remote control that came with our system was one of Primestar's new, upgraded units, that also features five buttons labeled "future entertainment services." Those buttons currently serve no purpose, but they eventually will be used to access the interactive guide Primestar plans to launch next year, along with any future interactive capabilities as they become available. For now, the only interacting you'll do is with the on-screen menu system.

The main menu offers eight options, any of which can be selected using the remote's numeric keypad or by scrolling through the main-menu options with the arrow keys and then pressing ENTER to access the submenu. Three of the sub-menus probably will be used only during the initial system set-up. Those include the Receiver Status Screen, used by the installers to check signal power and quality (if you call for service, your distributor might ask you to read some of the information shown on the status screen); the Set or Change Password menu; the Rating and Channel Lockouts screen, to censor your kid's viewing options; and Favorite Channel Scan, for deleting channels from the scan function.

The other on-screen display menus can be used to buy pay-per-view programs, view your purchase history, set program and sleep timers, and receive messages from your Primestar distributor. The purchasing submenu lets you know the name of the movie or event, the actors' names, the price, the rating, the starting time, and the amount of time remaining before it starts. The sleep timer turns off the audio and video—although not your TV or VCR—at a user-specified time. The program timer lets the Primestar decoder work in conjunction with your VCR. It won't control your VCR, but it allows you to set the decoder box to tune into as many as two daily programs and three one-time events up to a year in advance. The settings are saved in memory, and protected by a battery backup. You can use the program timer to purchase a pay-per-view event in advance for later viewing or taping. Should your distributor send you a message, the word "message" will appear the first time you press the VIEW key on the remote control, letting you know to check the message submenu.

## TUNING IN TO PRIMESTAR

As soon as the installers left, we settled down, remote in hand, to see what Primestar was all about. A quick scan through the "dial" revealed several movie channels—three HBO, two Cinemax, and four Encore (each dedicated to a different

theme: love stories, westerns, mystery, and general interest). Two versions of The Disney Channel and two versions of TV Japan (one in English, one in Japanese) rounded out the premium stations. Special interest programming included C-Span, The Weather Channel, CNN, Headline News, TNT, Turner Classic Movies (TCM), TBS, The Discovery Channel, The Learning Channel, A&E, USA Network, the Sci-Fi Channel, The Family Channel; the Cartoon Network, The Nashville Network (TNN), and Country Music Television (CMT). Besides ESPN and the Madison Square Garden Network (MSG), Primestar offers 14 regional sports channels. In addition, it's possible to buy "season passes" to NBA basketball and NHL hockey games. There are 10 PrimeCinema pay-per-view channels, and six PrimeAudio music channels—commercial-free, audio-only satellite radio.

All the major broadcast networks—ABC, CBS, NBC, Fox, and PBS—are also represented, but not as we're used to seeing them. Rather than local affiliates, Primestar delivers NBC out of Boston, ABC from Miami, CBS from Washington DC, Fox from San Francisco, and PBS from Philadelphia. Although the programming lineups are virtually identical to those on our local stations, it can be disconcerting to watch the evening news (particularly the weather reports) from other cities. Of course, the decoder's pass-



Primestar's new elliptical dish can be quite unobtrusive. For our temporary installation, no effort was made to hide it.

## HOW PRIMESTAR WORKS.

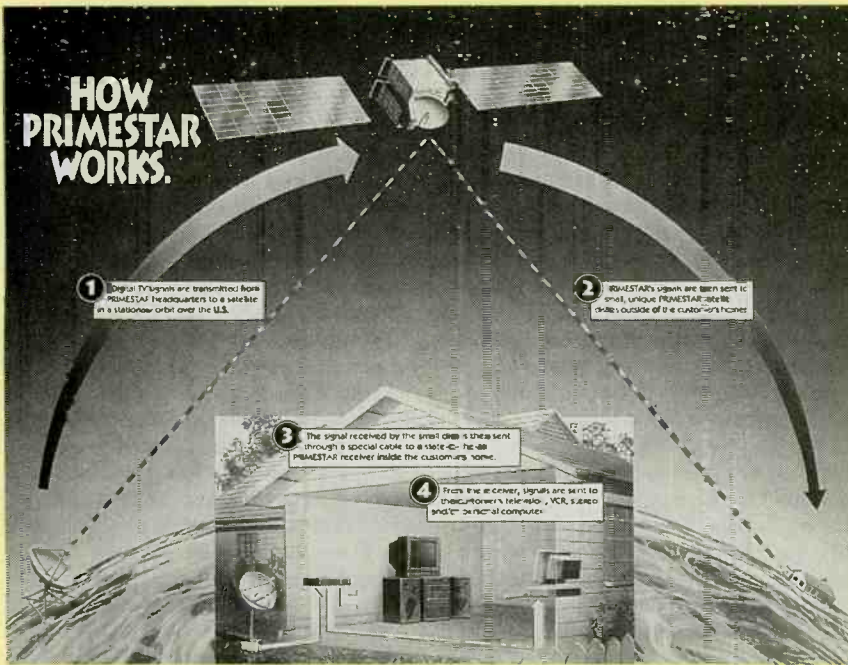

Primestar digitizes its signals before they are transmitted to a geostationary, medium-power, KU-band satellite. They are then distributed across the continental U.S.

through antenna connector (SAT/TV button) makes it easy to watch local broadcasts or cable-delivered programming as well.

Between our test period and our publication date, Primestar added six new services. Those include another premium movie channel, Starz!; Playboy TV pay-per-view adult entertainment; CNN International news; QVC home shopping network; CNBC for stock-market coverage and business features; and The Golf Channel, featuring all golf, all the time.

Completing the lineup is the PreVue Channel on-screen program guide. It offers a continuously scrolling program grid that displays what's on each channel for the next 1½ hours. Simultaneously, "coming attractions" or other advertising for various movies and events are shown at the top of the screen.

The current PreVue Channel is not interactive in any way—you can't click on a program choice for more details, or choose to view only certain categories of programming. Nor will the channels you blocked out using the "favorite channel scan" on-screen menu be deleted from the guide. You have to watch the entire thing. Beginning in 1996, however, Primestar expects to offer an interactive program guide.

In general, we found it much easier to refer to the free monthly program guide that's included with any Primestar subscription. To augment the printed guide—i.e., when we couldn't easily locate it—we made frequent use of the handy VIEW and NEXT keys on the remote control.

Watching, and listening to, Primestar

programming is a delight. As promised, the digital satellite system provides excellent video and audio quality. We had no complaints about "rain fade," which is often associated with small-dish satellite reception. In fact, we experienced no interference whatsoever in our two-month trial period.

On a few occasions the picture would take on a very slight jumpiness. Perhaps that is an exaggeration—we couldn't pinpoint any digitization of the picture. On rare occasions, however, the video was less than smooth. The effect never lasted longer than a minute or so, however, and usually didn't detract from our viewing pleasure. The only exception was when watching hockey—perhaps because the white ice surface made artifacts more noticeable. However, during quick scene changes, say, from a face-off circle to a corner, we could detect a slight, but perceptible, delay.

### HOW DOES IT WORK?

Primestar started out in 1990, delivering 20 channels of satellite service to subscribers located in rural areas not reached by cable. The original Primestar service delivered analog Ku-band signals to relatively small (36–39-inch) stationary dishes.

It wasn't until last year that Primestar began using the General Instrument DigiCipher digital compression system, which allowed them to squeeze 70 channels from the same satellite, provided by GE Americom. The April 1994 launch date did, however, make Primestar the first digital satellite system on the market.

April 1994 marked the beginning of Primestar's national roll out. It is now available to every household in all 48 contiguous states. Primestar announced in March at the SBCA show that their subscriber count had surpassed the 300,000 mark—a dramatic increase from the total of 70,000 subscribers just one year earlier.

Like all satellite delivery systems, the Primestar signal originates in ground stations, where it is digitized, compressed, and beamed up to a satellite, which then sends the signals back down to antennas on earth. Primestar uses several transmission locations in Colorado and New Jersey. The signal is boosted in power once it reaches the satellite. It is then channeled back via the dish antenna to the subscriber's set-top decoding box, where the signal is decompressed before being sent on to the television set.

Primestar dishes vary in size to suit the installation site, taking into account the geographic location and local weather conditions. They currently range in size from 32 to 39 inches in diameter.

That could change in the near future, however. Primestar plans to deploy two high-powered satellites in 1996. Those birds, built by Loral, are said to be the most advanced satellites of their type available. The more powerful satellites will allow the use of smaller dishes, and will increase Primestar's channel capacity to up to 200 channels with Dolby AC3 digital audio compatibility.

### WHAT DOES IT COST?

Because Primestar is a service, not a product, initial costs are limited to installation fees, which vary by distributor. Generally, installation will set you back between \$150 and \$200.

Next, you start paying for the service itself. Again, prices are determined by the local distributor. Approximately \$30 a month gets you the Primestar basic package, which includes use of the equipment and 30 or more "top" (not premium) cable channels. The 70-odd channels that we received would cost about \$75 a month. If you want to hook up a second TV, a small additional monthly fee is charged for the extra decoder box required.

There are no other fees involved. As the new satellites and services are launched, Primestar distributors will absorb the cost of the required equipment upgrades. They will supply subscribers with updated remote controls, smaller dishes, and MPEG-2-compatible decoder boxes at no charge.

Of course, if programming pricing continues along the same lines (30-plus channels for \$30, 73 channels for \$76), those distributors are facing a no-lose situation when Primestar begins broadcasting more than 200 channels next year. ■



## How ultrasonic power can safely deter unwelcome animals from your yard...

*Yard Gard creates a wall of silent noise that drives away annoying dogs, cats and many wild animals without harming them.*

by Charles Anton

**B**e honest. Even if you're an animal lover, you don't want strange animals in your yard.

You know what I'm talking about... dogs that dig holes and foul your lawn, cats that trample your flowers and sleep on your car. If you live in a rural area, you've probably had trouble with uninvited visitors like raccoons, possums, rabbits, or armadillos.

Until now, there weren't many options. After all, you wouldn't want to harm a stray animal, and your animal control agency may take days to respond, if they ever do.

**High-tech solution.** Fortunately, modern technology has provided an answer: the new Yard Gard. It uses high frequency sound waves to force unwanted animals to leave the area.

Yard Gard eliminates the need for repellents, trapping or physical attacks. Pests learn to avoid the areas Yard Gard protects.

### Cruelty-free pest control that works...

**I**n the past, people relied on poisons or violent means to get rid of unwanted animal pests. Recent environmental awareness has increased the demand for clean, non-lethal methods of pest control. Safe and humane. Yard Gard is the modern solution for pest control.

**Humane.** Yard Gard causes no harm to animals. By creating a wall of high frequency sound, it forces them to leave the area and create new habitual routes. While the sound is very annoying to animals, it is virtually unobtrusive to people.

**Nature friendly.** Poisons and pesticides can pollute soil and water sources. Yard Gard deters pests with sound so it causes no damage to the environment.

**Non-toxic.** Chemicals used to eliminate pests can be dangerous to humans or neighborhood pets. Yard Gard poses no health risk when used as directed.

**Ultrasonic Power.** Yard Gard's electronic ultrasonic generator broadcasts powerful "silent noise" that repels four-legged yard pests, yet is generally unobtrusive to people. Tones are harmless but animals find the sounds so unpleasant that they flee.

**Why it works.** Small animals depend on their acute hearing for survival. They can hear in the 18 to 25.5 kilohertz range which is beyond the range of most humans. When critical hearing frequencies are disrupted by strong pulses, animals feel threatened and leave the noisy area. Yard Gard takes advantage of this fact to protect your yard from pests.

**Break their habits.** Animals are creatures of habit. They establish a territory and generally follow the same travel routes. Yard Gard forces animals to change their patterns and establish new ones. They soon modify their habitual routes to avoid Yard Gard zones.



### Just plug it in. Are animals turning your yard into a zoo?

Yard Gard's transformer plugs into any standard household outlet. Electricity consumption is very low and costs only about 25¢ a month to operate.

Yard Gard is designed for outdoor operation in all types of weather. You can use your Yard Gard all year.

Mount your Yard Gard on a wall, post, or fence or place it on a flat surface. Yard Gard is essentially maintenance-free and requires only a minimum of care.

**Three settings.** Yard Gard has three frequency settings. At its lowest frequency setting, one Yard Gard covers an oval area of approximately 4,000 square feet the size of an average city lot. Additional units can be added to especially large yards.

### Keep the birds.

Do you love to watch and feed birds in your yard? If you have problems with cats chasing birds away or killing them, Yard Gard is the answer. Birds are not affected by the high frequency sound waves. They can't hear it, but cats can't stand it.

**Risk-free offer.** For a limited time, you can get the new Yard Gard at the introductory price of just \$99. Call today to take advantage of this special factory direct pricing. All Comtrad products are backed by our "No Questions Asked" money-back guarantee. If you're not satisfied with the Yard Gard, simply return it within 30 days for a full refund. Yard Gard is also backed by a two year manufacturers warranty.

Yard Gard.....\$99 \$12 S&H

Please mention promotional code 502-PL-6621.

For fastest service call toll-free 24 hours a day

**800-992-2966**



To order by mail, send check or money order for the total amount including S&H (VA residents add 4.5% sales tax.) Or charge it to your credit card, enclose your account number and expiration date

**COMTRAD INDUSTRIES**

2820 Waterford Lake Drive Suite 106  
Midlothian, Virginia 23113



**Do dogs like your yard better than their own?**



**Are rabbits eating as much from your garden as you are?**



**Do you have problems with unusual animals?**



**Do neighborhood cats think your garden is a litter box?**



CIRCLE 49 ON FREE INFORMATION CARD

## Beeper Babysitter

**BEEPERKID CHILD MONITORING SYSTEM.** From A + H International Products, Shoreline Square Tower, 301 East Ocean Boulevard, Suite 1010, Long Beach, CA 90802; Tel. 800-455-4345. Price: \$149.95.

When friends who'd moved to the Midwest returned to Long Island with their kids for a visit last summer, the old gang immediately planned an outing to the beach. The group included four adults and eight kids, aged 11, 9, 6, 5, 4, 3, and 2 years, and 6 months.

As soon as we hit the sand, all of the kids who were old enough to walk stripped down to their bathing suits and raced for the ocean before we'd managed to spread out a single blanket. One of the adults went to the water's edge to keep an eye on the kids, while the rest of us set up "camp."

As soon as we'd settled in, the rest of us went down to the shoreline to help supervise the kids who were swimming. We automatically did the routine head count—and suddenly realized there were only seven kids with us. The three-year-old had wandered off.

In a state of barely controlled panic, we began to search for him. We knew he was too afraid of the water to have gone in without being carried, so we concentrated on the three other directions he could have headed. We split up, with one person looking either way along the shoreline, and a third heading back toward the parking lot.

Less than 10 minutes later, a woman, holding the little boy by the hand, found us. Having seen him wandering westward, she turned him around and led him back to where she'd assumed (correctly) that he'd come from.

Those few minutes seemed like hours. Although we were all pretty sure that he wouldn't have gone in the water by choice,

there was always the chance that he could have fallen or been knocked down by a wave. And it was impossible not to think of all the horror stories of kidnappings that are in the news. It was an experience that none of us—except the boy himself, of course, who wasn't aware that anything was wrong—is likely ever to forget.

It's easy for anyone who doesn't have kids to think, "What kind of parents are you? Can't you keep an eye on your own kids?" But anyone who has ever cared for a toddler knows that, once they learn how to walk, children can move as fast as lightning on those stubby little legs. We rarely told the lost-at-the-beach story without hearing similar tales from other parents, whose kids had wandered off at amusement parks, tourist attractions, malls, playgrounds, or even from their own backyards.

It's often said that parents need eyes in back of their heads, and even that might not be enough. In the time it takes to pay for an admission ticket or a Happy Meal, tie another child's sneaker, or greet a friend, a small child can disappear.

Some parents rely on leashes and harnesses to keep their kids from straying away in crowded public places. Such rigs are likely to draw disapproving stares from strangers who believe leashes are proper only for pets. But if your child tends to wander, we believe it's better to keep him or her safe than to pacify strangers.

A less obtrusive, and more high-tech means of keeping track of your child is the *BeeperKid* child-monitoring system from A + H International Products. The wireless, digital system consists of a transmitter, worn by the child, that automatically sets off an alarm on the parent's receiver unit when it moves beyond a 15-foot range. A series of beeps warns the parent that his or her child is wandering.

The parent's unit is oval-shaped and measures approximately  $2\frac{1}{2} \times 2 \times \frac{3}{4}$  inches. A clip built into the back of the receiver allows it to be attached to a belt or pocket. At the top of the unit is a yellow MUTE button. A green LED on the front blinks slowly to show that the unit is charged and working. When the child is out of range, the LED flashes, even if the unit has been muted. The speaker is also found on the front of the unit.

The transmitter is even smaller and plainer. The circular unit measures just over two inches in diameter and  $\frac{3}{4}$ -inch wide. It also features a speaker and an LED on the front. Instead of a clip, however, the transmitter has a "safety pin" built into its back panel, and there is no MUTE button. That design makes it difficult for the child to remove or tamper with the monitoring system.

The *BeeperKid* also comes with a charging stand and an AC adapter cord.



The two units slide together, back-to-back, and then snap into the stand. An overnight charge provides up to six hours of monitoring. When the two units are disconnected, the system powers up automatically and emits a confirming beep. Sliding the transmitter and receiver together again shuts down the system.

Once charged, the BeeperKid is simple to use. You simply clip on your receiver and your child's transmitter, and forget about it—until you hear a series of beeps, that is. Then it's time to locate your little wanderer, knowing that he or she can't have more than a half-second's lead, being approximately 15 feet away when the first beep sounded. Should the child roam back into range, or be found, the beeping will cease, and the unit automatically resets. The mute button will silence the alarm, but the LED will keep flashing as long as the child is out of range.

Although the idea behind BeeperKid is simple, its execution was anything but. According to A + H, the original concept relied on radio-frequency technology, but that design had several flaws. At the top of the list was reliability. Two units moving continuously, particularly in an urban environment, were subject to signal-strength variations—and dropouts—caused by reflection and blockages. Reflected signals could cross and cancel each other out, making the parent think incorrectly that the child was still within range. And the rate of false alarms was too high.

The performance of RF-based products technology is also highly dependent upon antenna orientation. At one point during the design process, it was suggested that the parent wear an antenna on his or her head to provide an unobstructed view of the child's transmitter. Somehow, we can't see adults rushing out to buy a product that required them to walk around with an antenna sticking out of their heads!

FCC regulations caused further problems with the original RF design. The FCC requires at least a ten-second delay between the time the child leaves the range and the time of transmission. To help eliminate false alarms, that delay is multiplied two or three times. That means that there could be a delay of up to 50 seconds in some situations.

A + H finally abandoned the early, RF model. Instead, it licensed from a Fortune 150 defense contractor a proximity-detection technology that had been developed for military applications by aerospace and defense engineers. The company is close-mouthed about the proprietary technology, except to say that it is "essentially a wireless modem, modulating and demodulating digital data across a wireless medium," and that custom Application Specific Integrated Circuits (ASICs) are used in its manufacture. The adapted mili-

tary technology eliminates the reliability problems inherent in RF technology, and complies with FCC regulations.

In addition, each BeeperKid system has its own code. That allows it to recognize its companion transmitter/receiver even if other BeeperKid systems are being used in the area.

Despite the "secret" proprietary technology, the BeeperKid is affected by the presence of a strong interference source—such as a computer or a television—within a few feet of the parent's receiver unit. When there is strong enough interference present to affect communication between the transmitter and the receiver, the receiving unit will beep to alert the parent to the situation. The manual advises parents to become familiar with the effects of interference on the system before leaving home—by experimenting with the BeeperKid near a TV or computer—so that they will realize when it is detected in a public place—at a check-out counter, for instance. The more interference being emitted, the shorter the effective range becomes.

The range also shortens when the battery power is running low. The unit will also begin to beep, even though the child remains in range, letting you know that recharging is needed.

With those two exceptions, the

BeeperKid's proximity-detection technology is extremely reliable in virtually all environments, even when there is no clear line of sight between the parent and the child. Our tests verified A + H's claims that the transmitter and receiver worked through walls, such as when the child moved into another room, up a flight of stairs, out the front door, or even into an elevator. Of course, it also worked when the toddler moved off a backyard deck toward the pool or the driveway, and out of the sandbox toward the swing area of the playground, where he was in danger of being hit by moving swings.

The 15-foot range was determined by the manufacturer's tests to be "the natural limit most parents place on their kids... when their child moves beyond that range, they immediately notice and pay more attention." We tend to differ with that opinion; in real life, the range would vary according to the situation. In the backyard, for instance, where there are few hazards and the parent has a fairly clear line of sight, a child could be given much greater leeway than he would, for instance, in a crowded mall or amusement park. In either of those places, he could quickly disappear behind a stranger's legs, a ticket book, a rack of clothing, or a merchandise counter—without getting more than a couple of feet away from his parents. ■



The BeeperKid receiver (front) and transmitter (rear) slide together for easy storage and recharging when not in use. Note the "safety pin" fastener on the back of the receiver, which prevents toddlers from removing the transmitter.

# Entering the Internet

**WINNET PLUS INTERNET ACCESS SOFTWARE.** Published by: WinNET Communications, 330F Distillery Commons, Louisville, KY 40206-1919; Tel. 502-589-6800. Price: \$39.95; Subscription also required.

Are you on the Internet? The worldwide network—the much-heralded information superhighway—is experiencing a fantastic population explosion with good reason: it's not only incredibly useful, but it can be a lot of fun, too.

Most people on the Internet don't pay for the access—it's provided by their companies or schools. But a growing number of individuals are recognizing the importance of the Internet and are setting up private accounts to obtain access. One popular way to get Internet access is through the "big five"—America Online, CompuServe, Prodigy, Delphi, or GENie. But there are plenty of smaller companies that can provide access as well.

One of those is WinNET Communications, which has bundled an access program, WinNET Plus, together with its online service to give consumers an easy way to access the two most popular services available on the Internet.

There are many different ways to access the Internet, and before you can choose an Internet-access provider, you have to determine what *kind* of access you need. Some dedicated access providers will supply you with a Unix shell account. Others will set up what is known as a SLIP or PPP account that lets your computer actually become part of the Internet. WinNET Plus, and the corresponding service from WinNET Communications, offers Internet e-mail and Usenet newsgroups with the friendly face of Microsoft Windows—there's no need to even think about Unix.

The main benefit of WinNET Plus is that it is very efficient. The software is used primarily offline, so that users can compose mail and read mail and news "off the clock" without being charged for connect time.

By the time you read this, WinNET Communications will be able to provide other services beyond mail and news, including SLIP/PPP connections that put your computer directly on the Internet, and that provide access to the World Wide Web. That access wasn't available during our review.

Although the World Wide Web is getting the most attention these days, e-mail and Usenet are by far the most popular Internet services—each day, about 25 million people around the world access the

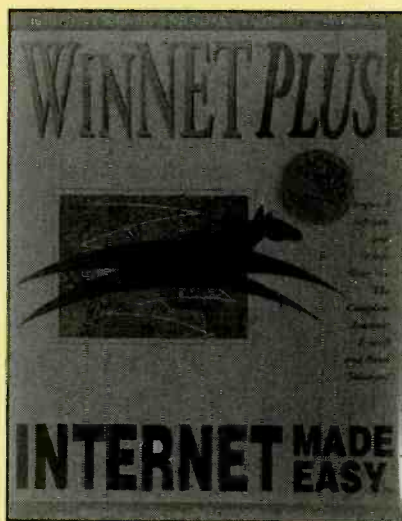

CIRCLE 60 ON FREE INFORMATION CARD

Internet to exchange e-mail and to communicate on Usenet newsgroups. People who access the Web frequently are happy with the information it provides—but they still see much of it as a novelty. New Internet users find that e-mail and Usenet move beyond the novelty stage and become indispensable resources almost immediately.

The WinNET software is designed to work "hand and glove" with WinNET Communications' Internet/Usenet service. However, the software can work with other providers as well, as long as they support UUCP, the Unix-to-Unix Copy Protocol.

The primary use of e-mail is to send messages to other members of the online community. But there are ways to access other Internet services via e-mail as well, which we'll describe shortly.

Usenet can be thought of as a global bulletin board—the world's largest BBS. It is divided into thousands of categories or newsgroups (now about 7000 and growing all the time). Anyone is free to read and post bulletins in categories that range from computer security to gardening, and that cover virtually every subject in between. Newsgroups are an incredibly vast source of information because everyone can contribute—and people on Usenet talk about everything imaginable.

If you have a question, for example, about who played drums on John Coltrane's classic LP "Giant Steps," you might post your query in the newsgroup rec.music.jazz. If you are wondering about the security of the encryption in PKZIP file-compression software, you might ask for comments in the sci.crypt newsgroup. If you have a problem trying to choose the right analog-to-digital converter for a speech-recognition system that you are designing, you might post questions in sci.electronics.

The real value of newsgroups is the peo-

ple who read them. If an engineer who regularly works on A/D-converter design reads your post and can contribute to solving your problem, he will.

The minimum computer requirements for running WinNET Plus are an 80386-based system with two megabytes of RAM and a modem. The software is supplied on a single floppy diskette and is very easy to set up: From the Windows Program Manager, just run SETUP.EXE.

The setup program copies all necessary program components to the directory of your choice, and sets up the subdirectories that are necessary for the program's proper operation. It then asks several questions so that it can configure the system properly. For example, it asks for your local time zone.

It also asks whether you wish to use WinNET Communications as your Internet/Usenet provider—an alternative provider can be chosen instead. If you do select WinNET as your Internet/Usenet provider (as we did), you must choose a system name and a User Name that will be used to create your Internet mailing address. Your Internet address then takes the form:

user—name@system—name.win.net

The program then asks you to provide the information necessary for WinNET Mail to talk with your modem—port, speed, and setup string. You can also set the CPU utilization in four steps from low to very high. Setting it high can improve the communications performance somewhat. However, it makes it difficult to run other programs concurrently. So, for example, if you wanted to run other applications while the mail program downloaded your e-mail and news, you would set the CPU utilization to a low or middle setting.

The setup software creates a new Program Group for WinNET programs. The five programs are: WinNET Plus, Call Server, Scheduler, WinNET Setup, and Account Setup.

WinNET Plus (WNMAIL.EXE) is the main program that is run daily to send and receive mail. Call Server (UUCICO.EXE) is the communications program that you can run directly when you want to send or receive your mail immediately.

Scheduler (DAEMON.EXE) is a background program that schedules communications calls for any time of the day or night. You might set it to call your provider in the morning before you get to work so that when you arrive at your desk, you'll have your mail and news waiting for you.

The Account Setup (ACCOUNT.EXE) program is run to establish your WinNET Internet account. WinNET Setup (SETUP.EXE) also provides an icon so that you can re-run it and adjust communications settings if it ever becomes necessary.

The rate for on-line usage of the Win-



## With convenient wireless installation, two lighting systems offer the brightest solar light ever available!

*Alpan's industrially-proven solar technology harvests the power of the sun to protect your home and family.*

by Bob S. Garrard

**H**ow many nights have you had to negotiate a dark walkway to the door hoping you wouldn't trip on something? Or how often have you stood in the dark fumbling with keys? If you're like me, you leave the porch light on all day, but you still have to find the porch in the dark!

Now there's a better way to come home to the warmth and safety of a well-lit home.

Alpan, in collaboration with Siemens, has developed two new lighting systems—the Solar Pathway Light and Solar Sensor Light.

**The fluorescent advantage.** Built with a fluorescent bulb, the new Solar Pathway Light provides the maximum amount of illumination while using a minimum amount of energy. In fact, the unique fluorescent tube is up to 100 times brighter than non-fluorescent solar-powered lights.

**Industrial technology.** Alpan has put the single crystal cell, the same powerful cell found in industrial power modules, to work for you in the Solar Pathway Light. Using the energy collected by the cell during the day, the power source is charged. At night, the built-in photo sensor detects darkness and automatically turns the light on to provide up to six hours of illumination.

### No bills, no wires.

The Solar Pathway Light can be installed in minutes. Simply twist the two parts together and put the light in the ground. All of the connections are internal, so there are no wires. And because these lights store and use energy from the sun, you'll never pay for outdoor lighting.

**Ensured safety.** Outdoor lighting is not just convenient. It makes your home safer. Well-lit walkways and yards discourage burglars

### The brightest solar lighting system

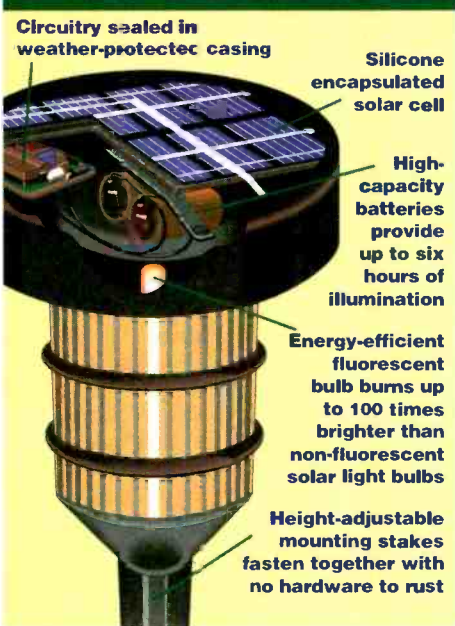

**Circuitry sealed in weather-protective casing**

**Silicone encapsulated solar cell**

**High-capacity batteries provide up to six hours of illumination**

**Energy-efficient fluorescent bulb burns up to 100 times brighter than non-fluorescent solar light bulbs**

**Height-adjustable mounting stakes fasten together with no hardware to rust**

and vandals. And they can keep you from tripping over unexpected objects in the path—like toys or ice and snow.

**Factory-direct offer.** This advanced solar lighting technology would retail for hundreds in stores. But through this special factory-direct offer, you can get the Solar Pathway Light for just \$59. Order extras, and receive them for just \$49. The Solar Sensor Light is available for only \$79 with additional lights costing only \$69 each. Take advantage of this special offer to add beauty and safety to your home and yard.



### Solar Sensor Light for extra security.

Equipped with the same powerful technology as the Solar Pathway Light, the Solar Sensor Light offers you and your family extra protection for your home and outbuildings. This powerful floodlight uses solar power to light your yard with a powerful quartz-halogen bulb. And it has a built-in heat and motion sensor. With no timers or switches to set, this light automatically switches on when triggered and stays on after you leave for 30 to 60 seconds. The adjustable 30 to 60 second delay ensures that you'll never be left in the dark. With no wiring,

it's easy to install. The solar panel mounts directly on your roof. The light mounts anywhere. The 14-foot plug-in cord simply connects the two. The solar storage system is so powerful it will switch on as many as 120 times with just a single full charge. And it's able to run for up to two weeks—even if there's no sun.

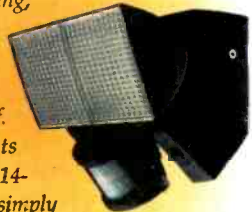

**Economical and dependable, the Solar Sensor Light has a built-in heat and motion sensor.**



**Try them both risk-free.** Both systems are backed by a "No Questions Asked" 30-day risk-free home trial and a one-year manufacturer's limited warranty. If you're not satisfied, return them within 30 days for a full "No Questions Asked" refund. Most orders are processed in 72 hours and shipped UPS.

Solar Pathway Light® .....\$59 \$6 S&H  
 Additional Solar Pathway Lights .....save \$10 each  
 Solar Sensor Light® .....\$79 \$8 S&H  
 Additional Solar Sensor Lights .....save \$10 each  
 Please mention promotional code 851-PL-6622.  
 For fastest service call toll-free 24 hours a day

**800-992-2966**



To order by mail, send check or money order for the total amount including S&H (VA residents add 4.5% sales tax.) Or charge it to your credit card by enclosing your account number and exp. date.

**CONSUMER INDUSTRIES**

2820 Waterford Lake Drive, Suite 106  
 Midlothian, Virginia 23113

July 1995, Popular Electronics

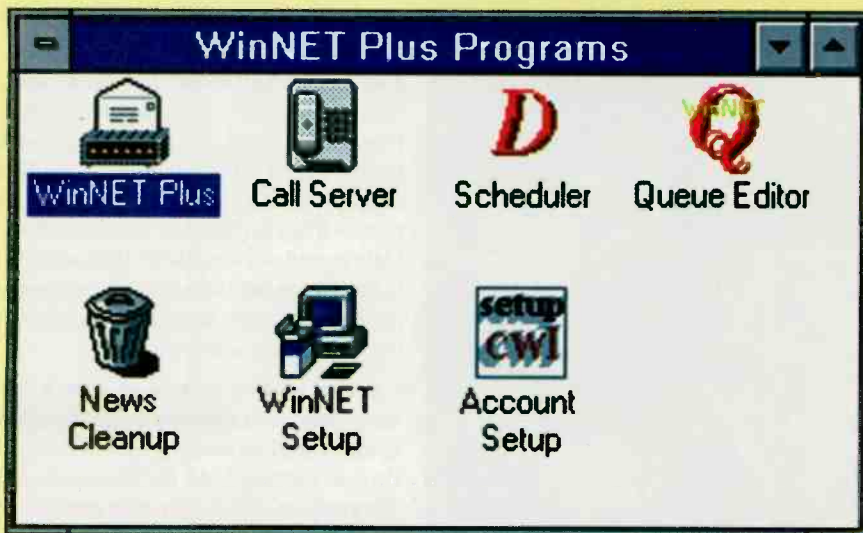

WinNET Plus includes seven applications, including an automatic scheduler that lets you access the Internet even when you're nowhere near your computer!

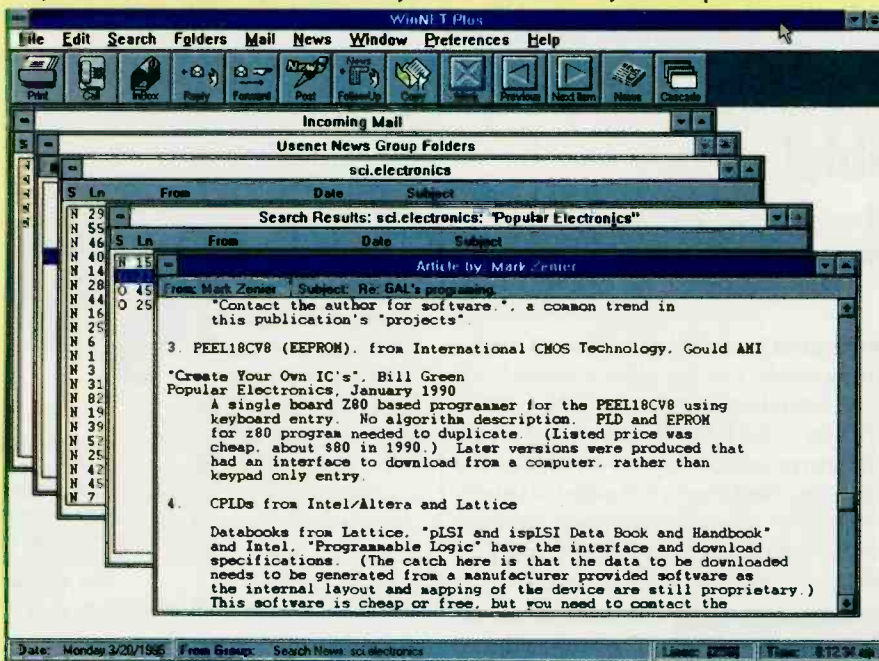

A search for "Popular Electronics" allowed us to quickly find how members of the Internet community were using the magazine.

NET system is \$8.00 per hour, and the monthly minimum charge is \$9.95. That means that if you use less than \$9.95 worth of connect time, you will be billed the minimum of \$9.95.

Unlike many on-line services and bulletin boards, you are only connected to WinNET for just long enough to send or receive any pending e-mail at speeds as fast as your modem will go. That results in connection times of typically one to just a few minutes. According to the company, its customers average 1.75 hours of connect time per month, which results in a charge of \$14.00.

In addition to connect-time charges, you are responsible for phone-line charges. WinNET does have an 800

number—it isn't toll-free, however. Instead, it is billed at a rate of 18 cents per minute during peak times (8 AM to 5 PM Eastern Time) and 12 cents per minute of off-peak access.

The 800-number service is optional. If you are local to the company, or if you have a long-distance company with lower rates, you are free to access WinNET at its standard number.

A new price structure is due to go into effect when WinNET Communications introduces its new SLIP/PPP services. As of this writing, the service is expected to cost a flat \$19.95 per month, for four hours of access though a toll-free number. After the first four hours, each additional hour will cost \$5.40. According to WinNET Com-

munications, less than 4 percent of its current customers use more than four hours of connect time. Current customers will be able to opt to keep their current pricing structure when the new pricing is introduced.

As mentioned previously, WinNET can communicate with alternate service providers. To do so, you need to give the software information about the provider. First, of course, is the provider's telephone number and such connection information as the maximum connect speed. Also, you must provide your assigned machine name or system name, your password, and your provider's server's UUCICO machine name.

You must also provide the login sequence for your provider's server. (Many providers can provide a sample login script that shows what prompts and responses are required). Next, you must provide the e-mail address of the news administrator so that you can subscribe to newsgroups.

The setup program generates a file called CHAT.RC that contains a simple script that the communications program uses to negotiate the login sequence after it connects to your UUCP provider. That chat.rc file will work unmodified for many systems, but in other cases additional configuration of the file might be required.

Although e-mail is primarily for sending and receiving personal messages to other members of the on-line community, you can do a lot more with it. For example, you can send a message to a list of users, send text files or binary files, and subscribe to mailing lists. The number and scope of available mailing lists is tremendous, and include everything from discussions of the TV show *Beverly Hills 90210* to calculus.

But e-mail can also be used to access other Internet services, too. For example, although WinNET Communications doesn't offer direct FTP (file transfer protocol) capability, we were able to use e-mail to retrieve files from FTP archives. Archie, Gopher, and other Internet services are also available via e-mail.

Archie is an Internet utility that lets you search indexes to locate files that are available on public servers. By e-mailing instructions to an Archie site, you can instruct the program to search through an index of files and e-mail a list of the matching files and the sites where they are located.

Archie knows only four commands: help, prog, list, and whatis. Those commands can be set to the Archie server in an e-mail message to locate files. The response that would be sent by e-mail would be the same as if you typed the commands at a terminal connected to the Internet.

Gopher is an Internet tool that allows  
(Continued on page 20)

# Home Alone

**PERSONAL EMERGENCY PHONE DIALER (CAT. NO. 61-2659).** From Radio Shack, 700 One Tandy Center, Fort Worth, TX 76102. Price: \$99.99.

Over the last half century or so, several demographic trends have led to an unprecedented number of senior citizens living alone. First, of course, we, as a society, are simply getting older. Advances in medicine and health care have resulted in longer life expectancies. While it used to be common for grown children to settle in the same areas in which they grew up, today's society is always on the move. Many young families pack up and move clear across the country, in search of better job opportunities, or simply "greener pastures." It is no longer common for grandparents to live in the same neighborhood, let alone in the same house, as the younger generations and their families.

It used to be the norm for several generations to live under one roof. These days, however, such a situation is often threatening to all parties concerned. In part, that's because older people no longer hold the same respected position that they once did, when their experience and opinions were valued. In our fast-paced, quick-changing, technologically oriented society, senior citizens can have a difficult time keeping up with, and fitting into, the lifestyles of their children and grandchildren. And it can be equally difficult for their busy, stressed-out children and grandchildren to find the time or patience to appreciate their older family members.

At the same time, over the last few decades, the number of women in the work force has dramatically increased. Many of those women have also postponed having children until they were established in their careers. As a result, many women—traditionally, the primary caregivers for young and old alike—now find themselves sandwiched between the demands of young children and elderly parents, while trying to hold down a full-time job and also care for the home.

As the nuclear family continues to replace the extended family, and the American population continues to age, the number of senior citizens living alone is on the rise. For many older Americans, such independence is welcome. They would much prefer to stay in their own homes, near the friends they've enjoyed for decades, and keeping to their own established routines, than uproot their lives to move in with one of the "kids."

As long as the older person is in good health, capable of taking care of her own daily needs, and not lonely living alone, there's no reason for her to relinquish her



CIRCLE 61 ON FREE INFORMATION CARD

independence. The biggest potential problem in such a situation is the threat of sudden illness, injury, or other emergency. If an elderly woman living alone was to suffer a heart attack, or slip in the bathtub, how could she summon help?

Radio Shack provides one solution: the *Personal Emergency Phone Dialer*. It makes phone calls for you if you can't get to the phone in the event of an emergency.

The system consists of a pendant intended to be worn around the neck, and an easy-to-install phone-dialer console. The dialer plugs into an AC outlet and is connected to the phone line. The user then records a message ("This is Ann Jones. I'm at home at 222 Main Street and I'm in trouble. Please help."), and enters up to four phone numbers to be dialed in case of emergency.

Pressing the call button on the pendant sends a signal that sounds an alarm and activates the phone-dialer console. The console then automatically dials the pre-programmed phone numbers of family members, neighbors, or friends, and plays the prerecorded emergency message. A built-in microphone on the console allows the family member to listen to what is happening in the older person's home.

The pendant is a heart-shaped, off-white unit that's about two inches in length and slightly more than ½-inch thick. At the top of the heart is a loop through which a chain can be attached. The front of the pendant features two buttons labeled CALL and STOP. We would have liked to see a clip placed on the back of the device as

well as the necklace loop, so that it could be attached to a shirt pocket or belt—an arrangement that most men would prefer. The pendant is water resistant, so it can be worn in the tub or shower, the sites of many household accidents.

The console measures approximately 7 × 5 × 1½ inches. Its front panel features a numeric keypad; two piezoelectric buzzers; a microphone; a RECORD button; an INSTALL/RUN switch; and AC power, low battery, and record indicators. A 9-volt battery provides memory backup in case of power failure. A telescopic antenna on the back of the console picks up the RF signals sent by the pendant.

To begin programming the console, you must switch it to its install setting, and then press the CALL button on the pendant, which lets the console recognize the transmitter. Next, you program in the phone numbers in the order you'd like them to be dialed, using the numeric keypad.

Keep in mind that the Emergency Phone Dialer will not "wait for the tone" before leaving a message on an answering machine, or "press 1" if it has a touch-tone phone. Make sure the numbers you input are likely to be answered by a real person, not an answering machine or voice-mail system!

Next, you can record your message. When you press and release the RECORD button, the record indicator will light to let you know to begin speaking. Unless you're leaving messages with four of your children—all of whom know who "Mom" is and precisely where she lives—it's a

good idea to include in the message your full name and address. With the set-up complete, the front-panel switch can be moved to the RUN position.

Should an emergency occur, a press of the pendant causes a piercing piezoelectric alarm to sound, and activates the console phone dialer. It isn't necessary for the person wearing the pendant to be in the same room as the console for the signal to be picked up.

The console is also compatible with the X-10 control standard, so it can be used to control lights and appliances in the home. Using your home's wiring to send and receive signals to and from other, optional Radio Shack Plug 'n Power modules, the system can flash indoor and outdoor lights and sound a remote siren to help emergency personnel find your house or to attract your neighbors' attention.

The system might not be foolproof, but it will surely bring some peace of mind to the person living alone, as well as that person's loved ones. ■

## WINNET

*(Continued from page 18)*

you to browse for resources using menus. When you find something you like, you can access it without having to worry about domain names, IP addresses, or other such details. Gopher Mail is a tool that allows you to use the Gopher search system to find items of interest. It allows you to see and use a site's Gopher menus through e-mail. Just send a message to a Gopher Mail server, and you'll receive its menu in an e-mail message. You then reply to the message, marking the menu item or items that interest you with an "X". The Gopher site then sends you the results by e-mail. It's not point-and-click access—it is a little cumbersome, and you have to become familiar with command-line options—but it does work!

Although UUCP service does have its limitations, we have no hesitation recommending WinNET Plus because of the ease-of-use and efficiency it brings to Usenet. Once you download the day's news, you are free to take as long as you want to read it and to compose replies. Better yet, unlike the "big guys" (read: America Online and CompuServe), you can be very selective in what you want to see thanks to the program's built-in search capabilities.

Let's say you are interested in electronics, but only as it pertains to digital signal processing. Rather than reading through all of the sci.electronics newsgroup, you could tell WinNET Plus to search through all entries for "DSP" or "digital signal processing," and increase the efficiency of your Usenet access. ■

# GIZMO NEWS

## New Little Dishes

DirecTV Inc. has selected three additional companies to manufacture DSS satellite receivers: Toshiba America Consumer Products Inc., Uniden America Corp., and Hughes Network Systems. The three join Thomson Consumer Electronics and Sony Corp.

Thomson, of course, rolled out the first receivers in June of 1994, and began its national rollout in October. Thomson had the exclusive right to manufacture receivers for 18 months or until the first million receivers were sold—whichever came first. The million came first, however, as DSS became the most successful new product introduction in consumer electronics history.

Sony, as of this writing, was gearing up to become the second supplier of DSS equipment, and was due to have product on the shelves by as early as May. The three new suppliers are expected to release product to the market in 1996. Hughes Network Systems will be first, early in the year. Toshiba and Uniden will follow in mid-1996.

## Copy Protection

Macrovision Corporation's digital copy-protection scheme will likely become the de facto standard for the digital set-top decoder industry and for pay-per-view networks. The company recently signed a license agreement with Hyundai Electronics, the fourteenth manufacturer of digital set-top decoders to be licensed.

The copy-protection technology is based on a digital-to-analog converter that processes incoming digital video and converts it to an NTSC or PAL analog output. The output signal carries the copy-protection process that allows the video to be displayed normally on a TV screen, while at the same time preventing acceptable recording on VCRs.

According to Macrovision, its copy-protection scheme will allow pay-per-view system operators to "offer the most current hit movies and events to subscribers and to maximize current and future revenues for those programs."

Macrovision-enabled integrated circuits are available from nine authorized semiconductor manufacturers: Analog Devices, Brooktree, GEC Plessey, Philips, Raytheon, Samsung, SGS Thomson, Sony, and Texas Instruments.

## Cassettes Live

A market-research study conducted early this year revealed that cassettes encoded

with Dolby S-type noise reduction were preferred by consumers. That held true even when compared to the sound of compact discs.

Attendees of the Winter Consumer Electronics were asked to listen to audio demonstrations in different simulated environments. One survey was conducted in a home-listening situation, where the sound of mass-produced Dolby S-type prerecorded tape was compared to a compact disc. The tape was recorded on Type I (ferric-oxide) tape at 80 times normal speed. Eighty-five percent of the respondents claimed to have heard little or no difference or actually preferred the Dolby S-type sound.

In "beach" and "car" environments, listeners compared Dolby B with Dolby S. Dolby S noise-reduction clearly won with 88 and 90 percent, respectively, of the listeners in each environment preferring it.

The study was conducted by Dolby Laboratories. It was not a double-blind comparison—listeners were informed about what they were listening to.

## Cable Interface

The Electronic Industries Association's Consumer Electronics Group has submitted a new proposal for an interface between television sets, VCRs, and set-top cable boxes.

The FCC—in an attempt to solve consumer complaints about the incompatibility of cable systems with such consumer-electronics features as picture-in-picture, on-screen tuning systems, and video recording of one program while viewing another—required the cable and consumer-electronics industries to adopt a suitable interface. If they are unable to come to an agreement, the FCC will impose an interface standard on them. Up to now, the two industries have been unable to reach agreement.

According to the EIA, the cable and electronics industries had agreed on all elements of a decoder interface that would make cable boxes obsolete. However, the cable industry insisted that an infrared bypass be included. That would have allowed cable systems to circumvent the interface and interfere with TV set and VCR functions.

The EIA's new proposal calls for a descrambling-only interface. Besides making it possible for consumers to use all of the features built in to their consumer-electronics equipment, the decoder interface should make set-top boxes open to competition. ■

# ELECTRONICS WISH LIST

## A Remote Possibility

A new line of universal remote controls from *Sole Control* (46-23 Crane Street, Long Island City, NY 11101) promises to "forever change the shape of remote controls." The remotes are designed with a vertical, standard format that should make them easier to find on a cluttered coffee table. They are also designed to be easier to use. The keys, for example, are color coded and grouped by function. The remotes offer the ability to control DSS and other satellite receivers, and they are designed to access the menu systems that are now common to feature-laden TVs. As an added bonus, the remotes can provide a sleep timer even to components that don't have one. Just leave the remote aimed at the component, and set it to shut down after a predetermined interval from one to 90 minutes. Price: from \$14.95 to \$29.95.

CIRCLE 62 ON FREE INFORMATION CARD

## Superhighway Telephone

The multi-service *PhonePlus* telephone from *US Order* (13873 Park Center Road, Suite 480, Herndon, VA 22071) lets users pay their bills, shop from catalogs, and conduct ATM transactions from their homes. *PhonePlus* is a speaker phone built around a Motorola 68000 CPU and 256 kilobytes of memory. It has a normally-hidden full alphanumeric keyboard, a 4-line x 20-character display, and a credit-card and ATM-card reader. It can store up to 250 names, addresses, and phone numbers. The phone is designed to be used with *BankPlus* and *ShopPlus*, which are available by subscription for a monthly fee of about \$15. Future services include *EmailPlus* and *InfoPlus*, which allow users to send e-mail through the Internet and to retrieve such information as sports scores, weather reports, stock quotes, and news. Price: \$200.

CIRCLE 63 ON FREE INFORMATION CARD

## Automotive Sound.

The *7004A* from *Autotek* (855 Cowan Road, Burlingame, CA 94011) is a four-band graphic equalizer that contains a two-way crossover and dual inputs. Each crossover switch has separate low- and high-pass crossover points and the dual inputs can accommodate dual-source units such as CD and cassette decks. The half-DIN sized chassis can be dash or console mounted. A front/rear fader is included, as are separate input sensitivity controls. Price: \$199.

CIRCLE 64 ON FREE INFORMATION CARD

## Bedside Phone

It's a close race between our desktop and night table—each is equally crowded. In an attempt to help out, *AT&T* (5 Wood Hollow Road, Parsippany, NJ 07054) has combined a clock radio and telephone in one package: the *Clock Radio Telephone 340*. The unit features such conveniences as a dual alarm (so that couples can wake up at different times), a sleep timer, a mute button, last-number memory, a lighted dial, and a 12-number memory. The AM/FM radio automatically lowers its volume when a phone call is answered. If that won't solve your clutter problem, you might choose to mount the unit on the wall. Price: \$69.99

CIRCLE 65 ON FREE INFORMATION CARD



Sole Control Universal Remotes



US Order PhonePlus Telephone



AT&T Clutter-Reducing Phone

# ELECTRONICS WISH LIST



Atari's Jaguar Videogame System

## More than a Videogame

The *Jaguar* interactive multimedia home entertainment system from the originator of home videogame systems, *Atari Corporation* (1196 Borregas Ave., Sunnyvale, CA 94089) features 64-bit architecture that makes it "more than twice as fast as 32-bit platforms," according to the company. The system is designed for high-speed animation, textured 3-D graphics, and CD-quality sound. The system contains five processors: a proprietary graphics processing unit, a digital signal processor, an object processor, a "blitter graphics accelerator," and a Motorola 68000 16-bit microprocessor that handles secondary processing functions. The machine is supplied with *Cybermorph*, a flying/action videogame. Other games are available at prices between \$50 and \$70. Price: \$249.95.

CIRCLE 66 ON FREE INFORMATION CARD



Cerwin-Vega Sensurround Speaker System

## Home-Theater Speakers

Nothing brings video to life like great sound. *Cerwin-Vega* (555 E. Easy Street, Simi Valley, CA 93065) had that in mind when designing the *Sensurround Home Theater Powered System 8*. The system, which is designed for both home-theater and music applications, features three matched front speakers, a 150-watt, 12-inch powered subwoofer with remote volume control, and two rear-channel satellite speakers. The front speakers are magnetically shielded so that they can be placed directly above or beside a TV monitor. Each has dual 5/4-inch high-excursion midrange drivers and a 1-inch dome tweeter. They are rated to handle 80 watts. The rear-channel satellite speakers feature a single 5-inch midrange and a 1-inch dome tweeter, and are rated to handle 60 watts. A variable crossover control located on the rear panel of the subwoofer permits the crossover point to be adjusted from 45 to 150 Hz. Price: \$1935.

CIRCLE 67 ON FREE INFORMATION CARD



Kenwood Car Stereo

## On the Road Again

Those traffic jams will become a lot more bearable with *Kenwood's* (P.O. Box 22745, Long Beach, CA 90801) *KDC-PS900* car CD receiver. The head unit features the ability to control CD and MiniDisc changers, such as the *KMD-C80* also offered by the company. Built with "autosound competition-level quality," the unit offers a signal-to-noise level of 96 dB and a dynamic range of 98 dB. The unit's total harmonic distortion (THD) is rated at 0.004 percent. Three RCA preamp outputs are available, and can be switched for either two- or four-volt operation. A digital output is also offered. Kenwood's proprietary digital control system, called *K-Bus*, allows for system expansion. Price: \$600.

CIRCLE 68 ON FREE INFORMATION CARD



Eveready Automotive Lanterns

## Shedding Some Light

Nothing is worse than breaking down on the highway—unless it's breaking down on the highway at night. *Eveready* has two products that are designed for just such an occurrence: the *Dashboard Plug-in Trouble Lantern* and the *Dashboard Plug-in Emergency Lantern*. The *Trouble Lantern* is equipped with a swivel hook that rotates 360 degrees and allows hands-free illumination. That rugged ABS plastic lantern comes with a 16-foot cord that is designed to plug into a cigarette lighter to run off a car battery, and uses a bright automotive bulb. The *Emergency Lantern* also comes with a plug-in adapter and 16-foot cord. Its head can tilt 120 degrees, and it comes equipped with an extra-bright krypton bulb. A red warning flasher is built into the handle. Both lanterns come with a lifetime warranty. Price: n/a.

CIRCLE 69 ON FREE INFORMATION CARD



**More lessons!**

**More Services!**

# A Shocking Offer!

Now you don't have to be enrolled at CIE to receive our introductory Electronic and Electricity Lesson Modules. This program is available for a limited time to non-students for the shockingly low price of only \$99.50.

With CIE's patented AUTO-PROGRAMMED method of learning you will quickly learn and then master the basics of electronics and electricity and then move on to... DC/AC circuit theories, fundamentals of bi-polar junction transistors (BJT), field effect transistors (FET), wiring, diagram and schematic readings, component identification, soldering techniques... and much, much, more. This introductory offer includes the first 39 lessons in CIE's Associate in Applied Science in Electronic Engineering Technology Degree.

Your commitment to CIE ends with your payment, but CIE's commitment to your success just begins when you receive your lessons, exams, binder and equip-

ment. This special introductory price includes all the benefits and assistance CIE normally extends to its full time students. You'll be entitled to unlimited access to CIE's faculty and staff to assist you in your studies via a toll free 800 number six days a week, 24-hour turnaround on grading your submitted exams, CIE bookstore privileges, a patented learning method, reference library, access to CIE's electronic bulletin board and a free issue of CIE's school newspaper The Electron.

**And best of all, when you decide to continue your electronics education in any of CIE's programs you'll receive full academic credit for successful lessons submitted and a \$100.00 Tuition Credit Certificate.**

All this knowledge and support will put you on the road to understanding digital electronics, automotive and industrial electronics, microprocessing principals, computer systems, telecommunications and much, much, more.

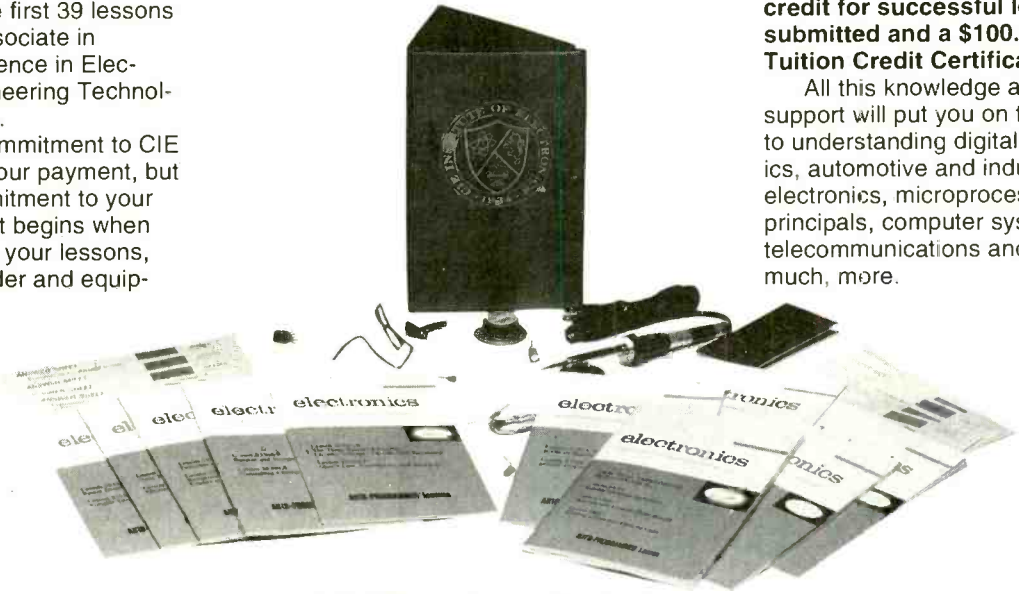

**All This For Only!**

# \$99.50

- \$100.00 Tuition Credit
- Academic Credit
- Free issue of The Electron
- Build your personal burglar alarm
- Toll Free Instructor Assistance
- 24-hour grading
- CIE bookstore privileges

- 39 theory and hands-on training lessons and exams.
- Patented learning method
- CIE electronic bulletin board privileges

**Yes! Send me CIE's Introductory Electronic and Electricity Lessons and Equipment.** A7332

Name: \_\_\_\_\_  
 Street: \_\_\_\_\_ Apt#: \_\_\_\_\_  
 City: \_\_\_\_\_  
 State: \_\_\_\_\_ Zip: \_\_\_\_\_  
 Age: \_\_\_\_\_ Phone: (\_\_\_\_) \_\_\_\_\_



**BOOKSTORE**  
1776 East 17th Street  
Cleveland, Ohio 44114

Total Merchandise: \_\_\_\_\_ \$99.50  
 Ohio Residents add 7% Sales Tax: \_\_\_\_\_  
 California Residents add 6 1/2% Sales Tax: \_\_\_\_\_  
 Total This Order: \_\_\_\_\_  
 Shipping and Handling Charge: \_\_\_\_\_ \$5.00  
 Method of Payment/Amount Enclosed: \_\_\_\_\_ \$  
 Personal Check or Money Order  
 Master Card    Visa    Discover

Card Expiration Date: \_\_\_\_\_  
 Signature: \_\_\_\_\_



**CHARGE BY PHONE!**  
9 AM to 4:30 PM Eastern Time;  
1-800-321-2155 ext. 7332

July 1995, Popular Electronics

# MULTIMEDIA WATCH

By Marc Spiwak

## Worth the Wait



*It's been a long wait, but The 11th Hour, the sequel to The 7th Guest, is expected to be out by the time you read this.*

**M**any of us remember *The 7th Guest* as being one of the best multimedia games to date. The 7th Guest took place in an eerie haunted mansion where the player had to solve the mystery of the house and its deceased owner, toy maker Henry Stauf. The game would keep a person busy for weeks on end playing it. That was the only problem I had with the game, that it was too much game for me to finish in the free time I have. Others, however, thought that it was the best

game ever, and played it through to the end, solving its many mysteries.

The 7th Guest played well on most PCs, its graphics were superb, and there was obviously enough action there to keep millions of game players happy. But where was the long-awaited sequel? After a few false starts, it was rumored that *The 11th Hour* would be released in October '94. But it never

arrived. Legions of game players were disappointed. What was taking so long?

### TOPPING THE BEST

It's always hard to top the best, and *The 7th Guest* was one of the best. With multimedia technology accelerating at such a frantic pace, and all multimedia products continually improving, Trilobyte, Inc. had to make *The 11th Hour* even better than *The 7th Guest*, and not simply just as good.

*The 11th Hour* should finally be released by the time you read this, and I hope to take a look at it before then. The main reason its release has taken so long is that most of the technology that enhances the installation and playing of the game did not exist when its development and production phase began.

The game will be a storytelling thriller with multiple endings, and not just an interactive movie. Throughout the game, puzzles related to the thriller, but able to stand on their own, will help the player unlock bits and pieces of the story. The story will be divided into five acts, and solving the final puzzle in each act reveals the completed tale to that point. At the end of the final act, the player will decide how to end the story. All throughout the game's development, the intended content and how it would be delivered was what drove the technology's evolution.

One of Trilobyte's goals was to make the video

quality of *The 11th Hour* indistinguishable from that of a TV show or movie. The game is to have instant responsiveness and speed, and will run at 30-frames-per-second in full-screen video—not just in a small window. There will be 65 minutes of full-motion video in all, and audio will be CD-quality.

It takes a lot of data to make a multimedia game of this magnitude. The 11th Hour is twelve times the size of *The 7th Guest*. Trilobyte got it to fit on two CD-ROMs, even though it is 134 gigabytes uncompressed—that would normally fill nearly 200 CD-ROMs. Clearly something had to be done, so Trilobyte set out to develop its own compression schemes.

*Encode*, Trilobyte's proprietary software tool, allows compression ratios far greater than MPEG, but does not require any special hardware for playback. Even with the newly developed compression techniques, it would have taken years to compress nearly 200,000 frames of video, so the animations were run on a number of computers simultaneously within a NEXTSTEP Distributed Computing Environment (DCE) network.

Another problem that can plague multimedia software is a difficult installation process for the game player. The 11th Hour will automatically retrieve configuration information from the machine on which it is played, so no one

should have any trouble getting the game to work. Will *The 11th Hour* be worth the wait? I think so, considering how good *The 7th Guest* was, and how much more work is going into *The 11th Hour*. We're all anxious to see what *The 11th Hour* brings.

### ANOTHER BIG ONE

While I'm on the subject of big games, I've got another one for you. *Under a Killing Moon*, from Access Software, is billed as an "interactive movie." UKM features a number of well-known actors including Brian Keith, Margot Kidder, Russell Means, and James Earl Jones, along with 25

others. The game takes you to the radioactive streets of post-World-War-III San Francisco, where you follow the exploits of a down-on-his-luck private eye, Tex Murphy, as he unravels a series of seemingly unrelated mysteries that eventually lead to a crime of timeless horror.

It is an understatement to say that this game is big. Two years and \$2.5 million dollars in the making, the game is over 2.4 gigabytes in size, includes 3.5 hours of video sequences, and comes on four CD's! You'll also need a big computer to get the big results. While the minimum requirements seem modest enough (386/25 MHz, 4 MB of RAM),

you will not be happy with the game's performance on such a machine. Indeed, the documentation that came with the game recommends a 486 DX2/66, local-bus video, and 16 MB of memory, and suggests that the game will perform even better on a Pentium. The documentation includes a card that explains why the memory is needed and illustrates a typical game scene on a system with 4 MB and on one with 16 MB. That said, the game performed fine on a 486 DX2/60 with 8 MB, although between-scene transitions could have been speedier.

On the plus side, installation was a snap (relatively), the richness of the detail made for a stunning visual experience, and the total freedom of movement within the game lets you explore every inch, including the ceilings and the floors, of the virtual world it presents. To be honest, I haven't gotten that far into the game, but so far the puzzles are challenging enough without being needlessly difficult to solve. If you do get stuck, an on-line hint system is available. If you have the hardware, *Under a Killing Moon* is a must have. If you don't, it's a great excuse to upgrade!

### SUPERB SPEAKERS

We have some more software to cover this month, but first I'd like to report on one of the best multimedia speaker setups I've seen and heard so far. The *ProSound* product line from Audiophile includes speakers that are of very high quality and are also extremely versatile. I've tested their *Reference 10/Subwoofer SW300* combo, and I was very impressed. They also offer a more expensive combo, the *Reference 30/SW20*; the main difference

in the latter combo is that it features slightly larger speaker elements.

To be more precise, I evaluated the *Reference 10A* speakers, the "A" meaning that they come with a 20-watt amplifier. (The equivalent *Reference 30A* speakers also come with the same 20-watt amplifier.) The *Reference 10* speakers contain a 0.5-inch tweeter and 3-inch mid-bass speaker enclosed in a wood cabinet, while the 30s have a 1-inch tweeter and a 5-inch mid-bass driver.

One of the most important features that any good speaker should have is a solid cabinet. The *ProSound* speakers have wood cabinets. When I first looked at the *Reference 10s*, although they were extremely heavy for their size, I couldn't see how they were made of wood because there were no visible seams or joints. Upon further reading of the manufacturer's literature, I learned that the cabinets are made of medium-density fiberboard, assembled to tight tolerances with epoxy cement, sanded smooth to remove seams, painted, sanded again, and painted again. All I can say is that they are rugged, heavy cabinets, and that goes a long way toward producing excellent sound.

The *SW300* subwoofer is about a foot tall, and very heavy; it's made with the same type of construction as the *Reference 10s*. The 20-watt amplifier, a small stand-alone unit, connects to the line-level output on a sound card or any other audio component and to the inputs on the subwoofer. The *Reference 10s* connect to outputs on the subwoofer, and additional speakers can be added to the setup.

The amplifier has a volume-control knob on it

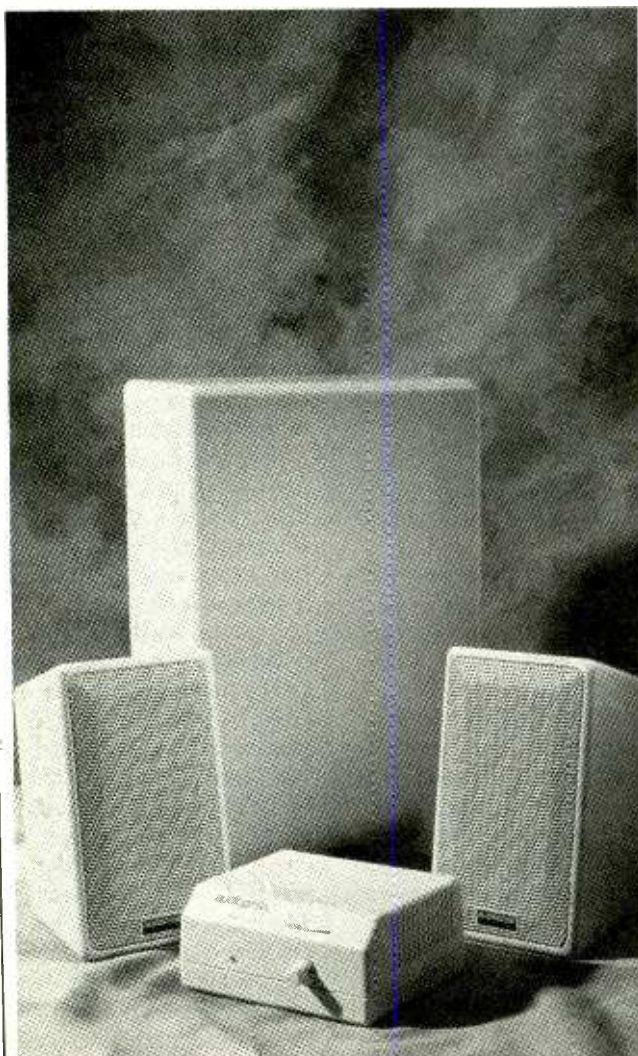

*This Audiophile 10A/SW300 combo has some of the best desktop sound I've ever heard.*

which eliminates the need for software volume controls. Plenty of wire is included to connect the speaker in any location. The system can also be connected to a regular stereo amplifier.

To get the best performance out of the system, it is important to place the speakers properly. That means setting the subwoofer on the floor, and placing the satellites on either side of the monitor, at about ear level. When set up that way, the highs were high, there was bass aplenty, and more than sufficient volume for any desktop applications. Games such as *Doom* are better with a subwoofer, and the PC now doubles as a Hi-Fi CD player in the living room. I even have to turn it down all the time.



*Sony Imagesoft lets you decorate your screen with Playboy Playmates or the antics of Beavis and Butt-Head—you decide.*

If you have been considering purchasing high-end speakers for your PC, you should seriously consider these. The 10A/SW300 combo lists for \$299, but one national chain, Egghead Software, sells it for \$199. Speakers and subwoofers are also sold separately. As for as desktop sound goes, the 10A/SW300 combo is hard to beat.

## NEW STUFF

Getting back to the software, another big action/fantasy game this month is *Dragon Lore* from Mindscape. If dungeons and dragons excite you, then you'll love this game. Centuries ago, a fellowship of Dragons and Knights escaped a war-torn world and joined together in a beautiful remote valley, to establish peace of mind and a better quality of life. But today, after eons of peace, the most powerful enemy knight has sworn to destroy the valley. Only you can restore things to what they once were. Players can take multiple approaches to *Dragon Lore*. One can fight with weapons of steel or with intellect. There's over 50 hours of gameplay with rich, 3D graphics and fluid animation. Realistic sound effects and full voice support round off the game.

New from Creative Multimedia this month is *Automania*, a \$29.95 CD-ROM filled with automotive information from the experts at *Automobile Magazine*. The disc contains specifications on thousands of new cars and trucks to help people make the right car-buying decisions. You can search through over 1600 vehicles and 75,000 specifications, view photos and video, see pricing information on new and used cars from 1977 to

## WHERE TO GET IT

### Access Software

4910 West Amelia Earhart Drive  
Salt Lake City, UT 84116

**CIRCLE 50 ON FREE INFORMATION CARD**

### Audiophile

7416 Washington Avenue South  
Eden Prairie, MN 55344

**CIRCLE 51 ON FREE INFORMATION CARD**

### Corel Corporation

The Corel Building  
1600 Carling Avenue  
Ottawa, Ontario  
Canada K1Z 8R7

**CIRCLE 52 ON FREE INFORMATION CARD**

### Creative Multimedia

513 NW 13th Ave., Suite 400  
Portland, OR 97209

**CIRCLE 53 ON FREE INFORMATION CARD**

### Mindscape

60 Leveroni Court  
Novato, CA 94949

**CIRCLE 54 ON FREE INFORMATION CARD**

### Sony Imagesoft

2400 Broadway Ave. Suite 550  
Santa Monica, CA 90404

**CIRCLE 55 ON FREE INFORMATION CARD**

### Trilobyte, Inc.

1225 Crater Lake Ave.  
Medford, OR 97504

**CIRCLE 56 ON FREE INFORMATION CARD**

### Viacom Newmedia

1515 Broadway  
New York, NY 10036

**CIRCLE 57 ON FREE INFORMATION CARD**

1995, determine dealer invoices, and study over 275 reviews and road tests by the editors of *Automobile Magazine*.

MTV is getting into the multimedia action with a new game that feature the network's unique graphics and captures its sense of humor. *Club Dead*, from Viacom Newmedia, lets you play Sam Frost, the best cyberplumber in the business, who also happens to be a virtual reality, or "V" addict. You've been plucked from jail to figure out why people who try to

experience "V" at a posh resort are dying.

I've also got two new discs this month from Sony Imagesoft, and one of them features the two most famous personalities ever from MTV, *Beavis and Butt-Head*, in *MTV's Beavis and Butt-Head Multimedia Screensaver*. The disc lets you play preset or customized scripts of video clips pulled directly from the animated series. The disc also includes many .WAV files and wallpaper to let you customize your desktop with the pair of funny idiots. This one is \$34.95. The second, *The Women of Playboy*, is another multimedia screen-saver package, but this one includes photos and video of the women from *Playboy Magazine*. You can even make your own custom screen-saver modules. The disc includes magazine covers, centerfolds, cartoons, bunnies, artwork, and more, from the 1950s through the 1990s. There's an adults-only version and a mature-audiences version; both cost \$39.95. The disc is a must-have for fans of the magazine.

And now for something completely productive. *CD Creator* from Corel software, lets you create your own digital audio, data, or mixed-mode compact discs in the Windows 3.1x environment. A CD recorder becomes necessary only when it's time to make the disc; everything until that point is done on a PC. The software includes an audio-tracks editor, a data-files editor, a jewel-case insert editor, a photo-CD editor, and more. It keeps track of CD space used and space required for new tracks. For only \$249, users can make their own custom CDs, right down to the artwork for the jewel box. ■

# What Do These Prestigious Companies Have In Common?

## Aerovox®

DC Film and RFI Suppression Capacitors, Aluminum Electrolytic and AC Oil Capacitors, EMI Filters

## AMP

Electrical/Electronic Connectors, IC Sockets, PCB Switches

## AMRAD Engineering, Inc.

Motor Run Capacitors, HID Lighting Capacitors, Power Factor Correction Capacitors



Miniature and Subminiature Coaxial Connectors and Cable Assemblies.

## AVX CORPORATION

MLC, Tantalum and Thin Film Capacitors, Resistors, Networks, Integrated Passive Components, Trimmers, Oscillators, Resonators, Filters, Piezo Devices, and Connectors

## BERG ELECTRONICS

High Density and Industry Standard Connectors/Subsystems

## CAROL

Electronic and Electrical Wire and Cable and Power Supply Cords

## COLE FLEX

Tubing, Conduits, Hose, Sleeveings, Splices, Insulation and Cable Harness Products, Power Cords and Cordsets

## Communications Instruments, Inc.

CII Midtex  
Relays and Solenoids

## COOPER

**Bussmann**  
Fuses, Fuseholders, Fuse Blocks, and Fuse Accessories

## CORNELL DUBILIER

Capacitors-Aluminum Electrolytics, Mica, AC Oil, Film, MICA Paper and Relays



**Dale Electronics, Inc.**

Resistors, Networks, Oscillators, Displays, Inductors, Thermistors, Connectors, & Transformers

## DI DANTONA INDUSTRIES, INC.

Batteries: Computer, Cordless Phone, Laptop, Scanner, Alarm and Medical  
Antennas: Cordless Phone and Scanner

## DEARBORN WIRE AND CABLE L.P.



## EATON

**Eaton Corporation, Commercial & Military Controls Operation**  
Switches, Relays, Displays and Keyboards



Quartz Crystals, Clock Oscillators, Surface Mount Products, Programmable Devices

## A GERNSBACK PUBLICATION Popular Electronics

Electronics Now Magazine

## GUARDIAN

Relays and Solenoids

## KEMET Electronics Corporation

Multilayer Ceramic and Solid Tantalum Capacitors

## KOA SPEER

Resistors, SMT Tantalum Capacitors Inductors, Resistor Networks, SMT Thermistors

## MALLORY

North American Capacitor Company  
Tantalums, Aluminums, Sonalerts® Ceramics, Films and AC's

## M-tron

Quartz Crystal Hybrid Oscillators

## muRata®

Fixed Ceramic Capacitors, Variable Capacitors and Resistors, Crystal Oscillators, Ceramic Filters, Resonators, EMI Filters, Hybrid Circuits and more.

## Panasonic Industrial Company

Resistors, Resistor Networks, Ceramic, Film, Electrolytic, Double Layer Capacitors, Potentiometers, Switches, Inductors, Filters, Resonators, Varistors, Thermistors

## Philips Components

Philips Electronics North America Corporation  
Resistors, Ferrite Components  
Alluminum Electrolytic, Film & Ceramic Capacitors

They sell through distributors.  
They belong to the E.I.A.  
They belong on your vendor list.

## Quam

Loudspeakers and Commercial Sound Products

## ROHM

Rohm Electronics Division  
Resistors, Ceramic Capacitors, Transistors/Diodes, Opto Components and IC's

## SELECTA

Switches, Relays, Terminals, Indicator/Pilot Lights, LED Indicators, Test Clips, Test Leads, Cable Ties and Heat Shrinkable Tubing

## A COMPANY OF SPRAGUE

Tantalum Capacitors, Wet & Foil Capacitors, Resistor Networks, Resistor Capacitor Networks, Filters

## Switchcraft

A Raytheon Company  
Switches, Connectors, Jacks, Plugs, Jackfields & Audio Accessories, Cable Assemblies

Leadership in electronics is not just a matter of designing products better and manufacturing them better, but also of marketing them better. And the sponsors of this message understand that better service to customers requires effectively involving distributors as part of their marketing teams.

Distributor involvement means lower prices, quicker deliveries, better service over-all. The Buyer wins...the Seller wins.

Distributors help achieve marketing leadership. So does the manufacturer's involvement in the Components Group of the Electronic Industries Association. EIA fosters better industry relations, coherent industry standards, and the sharing of ideas, which helps one another and serves customers better.

In choosing your component supplier, look for the marks of leadership--

availability through distribution membership in E.I.A.



Our 70th Anniversary Year

Electronic Industries Association/Components Group  
2001 Pennsylvania Avenue, N.W.,  
11th Floor  
Washington, D.C. 20006  
Phone: (202) 457-4930  
Fax: (202) 457-4985

Committed to the competitiveness of the American electronics producer.



## MEDIA VISION RENO PORTABLE CD-ROM DRIVE



CIRCLE 119 ON FREE INFORMATION CARD

*Take CD-ROMs along for the ride with the Reno portable CD-ROM drive.*

It seems that CD-ROM drives have become as popular in new computer systems as the venerable floppy drive. As a matter of fact, the double-speed CD-ROM drive has more or less replaced the 5¼-inch floppy drive as a standard PC peripheral. Most new PCs come with a CD-ROM drive and no 5¼-inch floppy drive.

With computer users beginning to rely on the presence of a CD-ROM drive, the absence of one can be a real nuisance. Once CD-ROM became standard on the desktop, it was only a matter of time before people wanted to use CD-ROMs on the go. People now want to be able to use a CD-ROM drive with their powerful laptops and portables, and maybe even swap a CD-ROM drive from computer to computer.

Short of buying a new laptop with a built-in CD-ROM, which can cost a king's ransom, the ideal way to do that would be to have a CD-ROM drive that you could take along with your laptop. But of course it would have to be light and portable, battery powered, and specially tailored for portable use. That fairly accurately describes the *Reno*, Media Vision's portable CD-ROM drive. As a bonus, the *Reno* can also double as a port-

able music-CD player. The *Reno* comes with an AC adapter, a SCSI cable, headphones, Mac and PC drivers, and a carrying case.

The *Reno* is a fully capable CD-ROM drive on the desktop or on the go. For desktop use, an AC adapter makes it behave just like any other CD-ROM drive; for portable use, a set of AA alkaline batteries is used for power.

**Specifications.** *Reno* will work with a PC or Mac. PC use requires a SCSI2 interface card—a tiny one is available for \$39 from Media Vision. Macs have a SCSI connector built in, and so Mac users don't need the card. *Reno*'s SCSI2 interface is more versatile than a proprietary interface, as the drive can be controlled by anything with SCSI2 compatibility. Many sound cards contain a suitable interface.

The double-speed *Reno* drive has a fast seek time of 180 milliseconds, which is faster than many other double-speed drives—portable or not. Transfer rate is up to 306 kilobytes per second. Discs load into the drive without a caddy, which is quite convenient. The drive easily meets MPC level-2 specifications. It is photo-CD and multisession compatible, and features a 64-kilobyte buffer memory.

*Reno* is about the same size as a

portable music-CD player. The back of the drive docks into a similarly shaped SCSI interface/AC adapter that links the drive to the computer. The docking station adds about 4 inches in length to the player. A SCSI cable connects the docking station to your computer. The *Reno* will also work off a parallel port with an optional parallel-to-SCSI adapter, although performance will likely be reduced.

Four AA batteries install in the docking station, and two AA batteries install in the player. For portable use as a CD-ROM drive, *Reno* runs off all six batteries, while as a music-CD player, it works from only the two batteries in the player section. That eliminates the bulk and weight of the docking-station section, which is unnecessary for music CDs anyway. When used as a battery-powered CD-ROM drive, the six AA batteries will last about 1½ hours with continuous use, but rarely does a CD-ROM drive run continuously.

For fixed operation, an AC adapter can be used to save batteries. Both the player and docking station have 13.5-volt DC input jacks that the AC adapter can plug into; the jack on the docking station is used when the two pieces are joined together.

As a music CD player, *Reno* has the usual Open, Reverse, Stop, and For-

ward play controls on the front panel, and a small liquid-crystal display. Reno is light in weight, even with the batteries installed (about one pound). The player can be shaken around pretty well while playing a music CD without skipping. An audio-output jack can be used with either the included headphones, or with a pair of amplified speakers.

Reno is a fine CD-ROM drive, and it doesn't take up a drive bay—another advantage as many of today's compact PC cases are short on drive bays to begin with. For portable use, an adjustable carrying case fits and protects Reno with or without the docking station attached. You won't be afraid to carry the unit around when it's in the protective custody of the spongy rubber case.

The portable CD-ROM drive can be purchased separately for a list price of \$349; street prices are well under \$300. The drive-only package includes an AC adapter, a SCSI cable, headphones, Mac and PC drivers, and a carrying case. The optional SCSI adapter card for a PC is \$39. The unit is also available as part of a multimedia upgrade package that includes the drive, a 16-bit sound card, amplified speakers, headphones, microphone, a carrying case, and 15 CD-ROM titles; that package has a list price of \$599.

Reno is a good investment for anyone who doesn't already have a CD-ROM drive, and who wants the added bonus of CD-ROM portability and a portable music CD player. Anyone contemplating the purchase of just a portable CD player might want to consider throwing in some extra bucks to get a CD-ROM drive, as well. Any way you look at it, you really can't go wrong with a Reno. The many ways it can be configured and used make it as versatile as a CD-ROM drive can get.

For more information on the Reno portable CD-Rom drive, contact Media Vision directly at the address given below, or circle no. 119 on the Free Information Card.

#### FOR MORE INFORMATION

##### Media Vision

47300 Bayside Parkway  
Fremont, CA 94538  
Tel. 510-770-8600

# "YOUR FREE CATALOG KNOCKED MY SOCKS OFF"

We get that sort of comment all the time. People are impressed that our free Consumer Information Catalog lists so many free and low-cost government booklets. There are more than 200 in all, containing a wealth of valuable information.

They tell you how to make money, how to save money and how to invest it wisely. They tell you about federal benefits, housing, jobs, and learning activities for children. They fill you in on nutrition, health and much, much more.

Our free Catalog will very likely impress you, too. But first you have to get it. Just send your name and address to:

**Consumer Information Center  
Department KO  
Pueblo, Colorado 81009**



A public service of this publication and the Consumer Information Center of the U. S. General Services Administration

# 51,092

## ELECTRONIC COMPONENTS

Whether you order 1 part or all 51,092...MOUSER stocks and...ships same day!!

**CALL... (800) 992-9943**

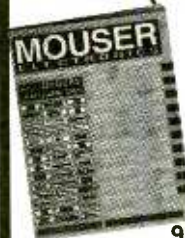

for your **FREE CATALOG**

958 North Main St.  
Mansfield, TX 76063

## MOUSER ELECTRONICS

Sales & Stocking Locations Nationwide

CIRCLE 115 ON FREE INFORMATION CARD

## Earn \$1000

**A Week While You Learn High Paying VCR Repair.**

**Earn While You Learn . . .  
Secrets Revealed . . .**



### Train at Home

If you are able to work with small hand tools and possess average mechanical ability, you could earn top dollar part time or full

time. Our learn by doing method teaches you how to work on VCR's without boring unnecessary electronic basics.

**For Free Information Package Send Coupon to:**  
Foley-Belsaw Institute, 6301 Equitable Road,  
Kansas City, MO 64120

<b>Check VCR or another High Paying Career Field</b> 	(Check One Box Only)
	<input type="checkbox"/> VCR Repair, Dept. 62332
	<input type="checkbox"/> Computer Repair, Dept. 64230
	<input type="checkbox"/> TV/Satellite Dish, Dept. 31115
	<input type="checkbox"/> Advance VCR Repair, Dept. 65043
	<input type="checkbox"/> Camcorder Repair, Dept. 66053
<input type="checkbox"/> Fax Repair, Dept. 67053	
<input type="checkbox"/> Printer Repair, Dept. 68052	
<b>Since 1926</b>	
Name _____	
Address _____	
City _____	
State _____ Zip _____	

CIRCLE 154 ON FREE INFORMATION CARD

# THINK TANK

By John J. Yacono  
Technical Editor  
Windows Magazine

## More Readers' Comments

**W**e've almost completely covered resistors, so this will be the last tutorial regarding them specifically. Right after the tutorial we'll explore letters regarding past *Think Tank* columns.

As you know, the power (heat) dissipated by a resistor can be found if you know the amount of current flowing through the resistor and the component's value by using:

$$P = I^2R$$

which is Joule's Law. Now, let's use that with Ohm's Law:

$$I = V/R$$

and substitute  $V/R$  for  $I$  to get:

$$P = (V/R)^2R$$

That simplifies to:

$$P = V^2/R$$

That equation is typically more useful, as you usually

So far when we've talked about voltage and current, they have always been constant. But what if voltage and current change? How does that affect Ohm's Law and Joule's Law? Well the laws are still valid, but they only apply to the relationship between current, voltage, and power at any given instant.

To indicate the impermanence of the variables (when applicable), they would have to be written in lowercase. So our equations would become:

$$p = i^2R$$

$$p = v^2/R$$

$$i = v/R$$

Note that the resistor's value is constant (it does not vary over time), so it's written in upper case. Frankly, in most circumstances, knowing the heat dissipated by a resistor at a given instant is not very useful. If the changes in power dissipation (really in voltage and current) occur quickly enough, we really need to know the average power dissipation required. Averages of current, voltage, and power will be next month's topic; for now, let's read those letters.

### THD ADAPTER REVISITED

I just wanted to thank you for the nice write-up you did on my THD adapter (see Fig. 1) in your November 1994 *Think Tank* column. Your final comments were really appreciated. As a semi-retired electronics professional at 48, I still enjoy seeing my letters published. I figure that if I am successful in stimulating

a few minds out there, it's worth the effort to write.

A couple of notes on the THD: I used a length of 6-32 threaded rod with a small nylon "clevis" (used on R/C servos) connected to the slide-pot sliders as a push-pull tuner. The pots were mounted in the cabinet with the rod protruding through a clearance hole in the side. Coarse tuning was done in the TUNE position, and a very fine null was accomplished by rotating a knurled 6-32 nut on the rod in the TEST position, using the cabinet side as a stop for the nut. That method is very useful for measuring THD below about 1 to 2 percent. Also, use a shielded cable on the input only—the twisted pair should only be used at the output to your RMS meter. You'll love the performance of this circuit!

Thanks again.

—Skip Campisi, South Bound Brook, NJ

You and I have the same opinion about what this column is about—stimulating the mind. Thank you for your continued participation. You have sent me more circuits than any other reader. The quality of your work is much appreciated, too.

### WALKMAN AMP

How can the small amplifier circuit on page 31 of the December issue of **Popular Electronics** (shown here as Fig. 2) work? There are no bias resistors on either base. Also, C5, which bypasses R1, would bypass all the highs letting only very low frequencies come through. Both Q1 and Q2

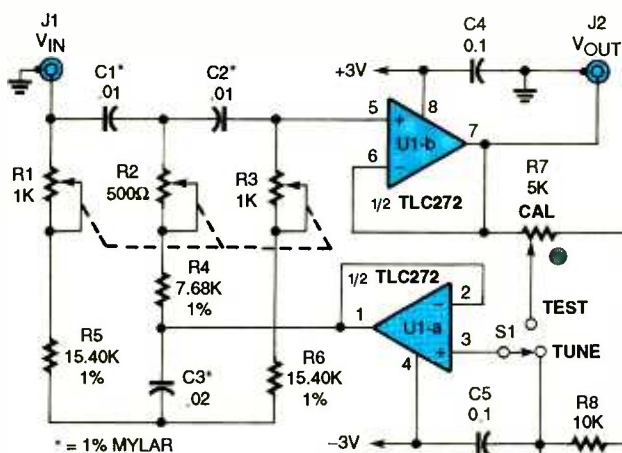

Fig. 1. This THD adapter can be enhanced by using a threaded rod to set the slide pots to precise values. That allows you to get readings down to 1 or 2 percent.

know the voltage across a resistor rather than the current through it.





the value of R1 to around 1.7 ohms, at 5 watts.

## SWITCH II

I would like to build the low-RF switch mentioned on pages 29–30 in the February 1995 **Popular Electronics**. You stated that it had previously appeared on page 53 in the May issue under "Soldering Iron Controller." Guess what, it is not there! I also researched every issue from April 1994 to January 1995 and I could not find it.

Even if I find your old article, however, I would still have difficulty with it if the schematic is the same as that shown in February. I'm skeptical about the wattage of the resistor and the pot. Following the discussion of this circuit is a section called "Label Dilemma," which states that unless otherwise indicated on a schematic or parts list, all resistors are 1/4-watt units in this magazine. With 110-volts AC applied to the circuit, should the resistor values still be 1/4-watt?

My other problem is that no electronic parts store in town can cross reference to a TL783 part. I have a suspicion that it might be a 9- or 12-volt-DC voltage regulator. Am I right? I want to use the circuit to dim a 100-watt light on my ceiling fan. Would any 1-amp 12-volt DC regulator work?

I'm sorry to bother you on all those details, but there is limited space in my light/fan, and store-bought dimmers are too large. I hope I could fit this dimmer into the light. Thanks, I'm waiting to hear from you.

—George Kozar, Erie, PA

You are right about the resistor wattage; however, not because it is exposed to 110-volts AC. In fact, because of the regulator, the resistor never sees more than 1.25 volts, even with

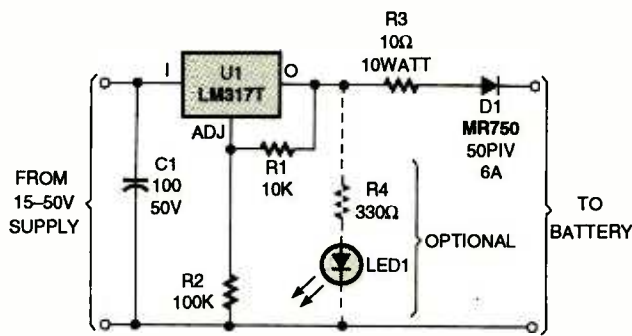

Fig. 4. Keep those batteries nice and juicy all year long with this trickle battery charger. Be sure to use heavy-gauge wire for all connections.

the pot shorted. Nonetheless, the resistor should have been denoted as a 1/2-watt unit. The artwork was lifted from the old article, in which the wattage was mentioned in the parts list instead of the drawing (the reprint of the schematic in Fig. 3 reflects those changes).

The TL783 is actually a special, floating, high-voltage regulator (see the old article for more information on the chip's features). I would not recommend using another regulator in its place. I got mine from Active Electronics (Tel. 800-677-8899), so give them a call to get one.

Unfortunately, even under optimal conditions (see the previous letter), the best you can do is control a 75-watt bulb with the circuit. Of course you might be able to piggyback two such circuits, provided that you can mechanically connect the two pots.

## CHARGE!

I have found a circuit in *Think Tank* that I have problems with. It was Joseph Gaskill's *Charge It* in the June 1994 **Popular Electronics** (see Fig. 4). In that circuit, the values of R1 and R2 are much larger than are usually used with an LM317T. Most circuits I have seen, and some spec sheets, use a value of 240

ohms for R1, and a correspondingly lower value for R2. Sometimes smaller values such as 220 or 120 ohms are used for R1. Because the LM317T maintains a voltage of 1.25 volts between the output and adjust terminals, that gives a current of 5 mA in R1 and R2. A 12-volt battery charger shown in the "Typical Applications" section for the 317T in the 1990 *Radio Shack Semiconductor Reference Guide* shows a value of 240 ohms for R1 and 2400 ohms for R2, even though Radio Shack does not stock either value.

In the last few months, I have built battery chargers and power supplies using the LM317T and other 3-terminal regulators. The trickle-charge voltage for a 12-volt lead-acid battery should be about 13.8 volts. If 5-percent resistors are used, the output could vary by a volt. Therefore, either 1% resistors should be used, or R2 should be variable. There are also slight differences between LM317T's. I would use a 240- or 220-ohm resistor for R1, and a pot (either 2000 or 5000 ohms) in series with a 1000-ohm resistor for R2.

My next concern is the value of R3. Although the LM317T can supply 1.5 amps, with a 1-amp current the voltage drop across 10 ohms is 10 volts! The Radio

Shack circuit uses 0.2 ohms. I think I would use one or two ohms as a starting value. Because the LM317T has internal current limiting and thermal overload protection, little external protection is needed.

When I started building my battery charger, I used D1, but because of the voltage drop across it, which varies non-linearly with current, I took it out. Removing D1 causes one possible problem: if the charger is connected to a battery before power is applied, a backwards current will flow through U1 to charge C1. The LM317T does not like backwards current! That can be remedied by connecting a 1-amp diode between the input and output terminals of U1 (connect the cathode to the input terminal). Then C1 would charge through the diode instead of U1. That diode, although often omitted, should always be used with three-terminal regulators in battery chargers or other circuits where there is a possibility of a voltage on the output terminal that is higher than that on the input terminal.

Next, the value of R4 (330 ohms) will give a current of 36 mA—rather high for a standard LED. I like to keep LED current at or slightly below 20 mA, which would require a resistor of 590 ohms (the standard value of 560 should be close enough). In my charger, I used a 300-mA transformer and wanted the entire 300 mA available for charging, so I used a low-current LED (Radio Shack 276-044 or similar) which is easily visible at a current of 2 mA.

A 7805 or 7806 regulator will also work well in this circuit. Use the ground terminal of the 78xx as the adjust terminal, and

(Continued on page 81)

# Be a high-paid computer service technician

Train With NRI — America's #1 Choice in Computer Training

Only NRI gets you inside a powerful 486DX2/66 MHz Intel-based computer system you keep—giving you the hands-on experience you need to work with, troubleshoot, and repair today's most widely used computer systems. There's no more affordable way to start a money-making career, even a business of your own, as a computer service technician.

## Rely on the original -- NRI

Over a decade ago, NRI pioneered at-home training in computer servicing. Today, NRI offers the *only* computer servicing course with real-world experiments using state-of-the-art computer equipment and professional diagnostic tools.

There's no doubt about it: Working "hands-on" with all the most sought-after technology gives you practical skills and lasting confidence. Performing key tests and demonstrations, you're able to see for yourself how things work, what can go wrong, and how you can fix it.

## Train with and keep the most advanced computer in home study today

NRI's unique training has you explore a top-notch computer system and its peripherals, beginning with the 486DX2 Intel CPU and Pentium Overdrive-ready motherboard.

Your computer features 8 meg RAM, 420 meg hard drive, and fax/modem to store, receive, and send huge amounts of data.

You'll also appreciate the brilliant display of your Super VGA color monitor, the drama of your CD-ROM drive and 16-bit sound card, as well as the cutting-edge technology of Windows 95.

Plus learn to use Ultra-X professional diagnostic hardware and software to pinpoint problems on any IBM-compatible machine.

## No experience needed, NRI builds it in

Studies show that jobs for computer service technicians will be up by 38% in the next 10 years. Even if you've never worked with



computers before, NRI's interactive training builds such a solid foundation of know-how and practical experience that tomorrow's jobs can be yours.

Right from the start, hands-on experiments reinforce concepts presented in NRI's bite-sized lessons. And because your work is reviewed by your personal instructor, you know for certain that you can apply theory to real-world demands.

## FREE NRI catalog tells more

Send today for your free, full-color catalog describing every aspect of NRI's innovative computer training in the up-and-coming field of your choice.

IBM is a registered trademark of the IBM Corporation. R.A.C.E.R. and QuickTech-PRO are registered trademarks of Ultra-X, Inc.

## YOU GET EVERYTHING YOU NEED FOR SUCCESS

- **POWERFUL 486DX2/66 MHz INTEL-BASED COMPUTER**  
Features IBM compatibility, 8 meg RAM, Pentium Overdrive-ready motherboard, and math coprocessor
- **SUPER VGA COLOR MONITOR**  
With .28mm dot pitch for high-resolution graphics and tilt-swivel base
- **420 MEG HARD DRIVE**  
For greater data storage capacity and data access speed
- **EXCITING MULTIMEDIA PERIPHERALS**  
Double-speed CD-ROM drive, 16-bit sound card with speakers, and reference CD
- **FAX/MODEM**  
Gives you access to a world of on-line information
- **ULTRA-X DIAGNOSTIC PACKAGE**  
R.A.C.E.R. plug-in card and QuickTech-PRO software help you detect problems on virtually all IBM-compatible machines, even if computer is 5% operational.
- **NRI DISCOVERY LAB**  
Complete breadboarding system lets you design and modify circuits, diagnose and repair faults
- **DIGITAL MULTIMETER**  
Professional, hand-held test instrument for quick and easy measurements
- **WINDOWS 95**  
The time-saving operating system that everyone will be using tomorrow

If the coupon is missing, write to: NRI Schools, McGraw-Hill Continuing Education Center, 4401 Connecticut Avenue, NW, Washington, DC 20008.

## SEND TODAY FOR FREE NRI CATALOG!



McGraw-Hill Continuing Education Center  
4401 Connecticut Avenue, NW, Washington, DC 20008



Check one **FREE** catalog only

MICROCOMPUTER SERVICING

Computer Programming

TV/Video/Audio Servicing

Desktop Publishing & Design

LAN Specialist

Bookkeeping and Accounting

Programming in C++ with Windows

Check for details on career courses approved under GI Bill

Name (please print)		Age
Address		
City	State	Zip

Accredited Member, National Home Study Council

18-0795

# RETAILERS THAT SELL OUR MAGAZINE MONTHLY

## Alaska

Frigid North Co.  
1207 W. 36th Avenue  
Anchorage, AK 99503

## Alabama

Radio Distributing Supply  
121 East Broad Street  
Gadsden, AL 35903

## Arizona

Dalis Electronics  
2829 E. McDowell Road  
Phoenix, AZ 85008

## California

California Electronics  
221 N. Johnson Ave.  
El Cajon, CA 90202

Ford Electronics  
8431 Commonwealth Avenue  
Buena Park, CA 90621

All Electronics  
1498 Oxnard Street  
Van Nuys, CA 91411

Willy's Electronics  
1636 D. Avenue  
National City, CA 91950

Gateway Electronics of CA  
9222 Chesapeake Drive  
San Diego, CA 92123

Mac's Electronics  
191 South "E" Street  
San Bernardino, CA 92401

Electronics Warehouse  
2691 Main Street  
Riverside, CA 92501

Orvac Electronics  
1645 E. Orangethorpe Ave.  
Fullerton, CA 92631

Sav-On Electronics  
13225 Harbor Blvd.  
Garden Grove, CA 92643

Marvac Dow Electronics  
980 S. A Street  
Oxnard, CA 93030

Kandarian Electronics  
1101 19th Street  
Bakersfield, CA 93301

Whitcomm Electronics  
105 W. Dakota #106  
Clovia, CA 93612

Marvac Dow Electronics  
265-B Reservation Road  
Marina, CA 93933

Minuteman Electronics  
37111 Post St., Suite 1  
Fremont, CA 94536

HCS Electronics  
6819 S. Redwood Drive  
Cotati, CA 94931

Halted Specialties Co.  
3500 Ryder Street  
Santa Clara, CA 95051

JDR Micro Devices  
2233 Branham Lane  
San Jose, CA 95124

Metro Electronics  
1831 J Street  
Sacramento, CA 95814

The Radio Place, Inc.  
5675-A Power Inn Road  
Sacramento, CA 95824

HSC Electronics  
4837 Amber Lane  
Sacramento, CA 95841

## Colorado

Gateway Electronics of CO  
2525 Federal Blvd.  
Denver, CO 80211

Centennial Electronics  
2324 E. Bijou  
Colorado Sps., CO 80909

## Connecticut

Signal Electronics Supply  
589 New Park Avenue  
W. Hartford, CT 06110

Electronic Service Prod.  
437 Washington Avenue  
North Haven, CT 06473

## Georgia

Norman's Electronics, Inc.  
3653 Clairmont Road  
Chamblee, GA 30341

## Illinois

Tri State Elex  
200 W. Northwest Hwy.  
Mt. Prospect, IL 60056

## Kentucky

P.I. Burks Co.  
842 S. 7th Street  
Louisville, KY 40203

## Maryland

Mark Elec. Supply Inc.  
5015 Herzel Place  
Beltsville, MD 20705

## Massachusetts

U-Do-It Electronics  
40 Franklin Street  
Needham, MA 02194

## Michigan

Purchase Radio Supply  
327 East Hoover Avenue  
Ann Arbor, MI 48104

The Elec. Connection  
37387 Ford Road  
Westland, MI 48185

## Minnesota

Acme Electronics  
224 Washington Avenue N.  
Minneapolis, MN 55401

## Missouri

Gateway Electronics Of MO  
8123-25 Page Blvd.  
St. Louis, MO 63130

## Nebraska

Phil's Fun Stuff  
616 Broadway  
Imperial, NE 69033

## New Jersey

Lashen Electronics Inc.  
21 Broadway  
Denville, NJ 07834

## New York

Computs  
7 Great Jones Street  
New York, NY 10012

Sylvan Wellington Co.  
269 Canal Street  
New York, NY 10013

Unicorn Electronics  
Valley Plaza  
Johnson City, NY 13790

## Ohio

Philcap Electronic Suppliers  
275 E. Market Street  
Akron, OH 44308

## Oregon

Norvac Electronics  
7940 SW Nimbus Avenue  
Beaverton, OR 97005

Portland Radio Supply  
234 S.E. Grand Avenue  
Portland, OR 97214

## Texas

Tanner Electronics  
1301 W. Beltline  
Carrollton, TX 75006

Mouser Electronics  
2401 Hwy. 287 N  
Mansfield, TX 76063

Electronic Parts Outlet  
17318 Highway 3  
Webster, TX 77598

## Virginia

Elec. Equipment Bank  
323 Mill Street, N.E.  
Vienna, VA 22180

Cain Electronics Co.  
1530 Ingleside Road  
Norfolk, VA 23502

## Washington

Amateur Radio Supply Co.  
5963 Corson Ave., Ste 140  
Seattle, WA 98108

## Wisconsin

Appleton Electronic Dist.  
205 W. Wis Avenue  
Appleton, WI 54911

## Wyoming

Chris Supply  
2007 S. Douglas Hwy., Ste. C  
Gillette, WY 82716

If you'd like to sell our magazine in your store,  
please circle 180 on Free Information Card.

# Designing Loudspeaker Crossovers

*Some easy-to-use programs to help you create impressive-sounding speaker designs.*

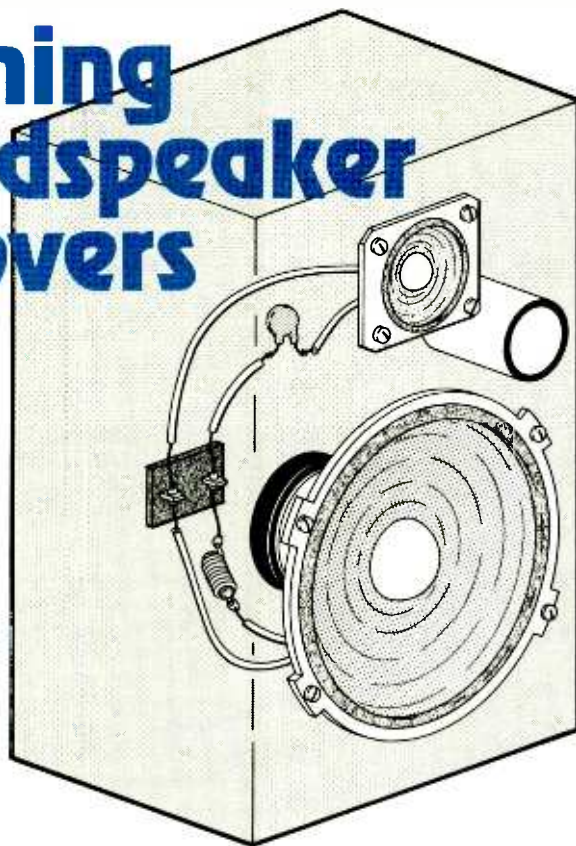

**D**esigning loudspeakers might seem like an occult art to those who are not initiated in the techniques used. There's obviously a lot more involved than just hooking up a few drivers together and applying a signal. Now, with the help of the simple computer programs presented here, you can lift the veil of mystery from the practice of loudspeaker design, and create terrific-sounding speaker systems of your own.

Incidentally, this article builds upon a previous one, "Design Your Own Loudspeakers" (**Popular Electronics**, February 1994), in which we took a look at three BASIC programs for designing loudspeaker systems using a PC. Those programs calculated the correct dimensions for an enclosure for a particular bass driver, and aided in the design of a simple, speaker-crossover network. The five programs in this article make it possible to design even-more-sophisticated crossovers, as well as compensate for driver-efficiency differences, and eliminate peaks in a speaker's response.

Before we start, though, something should be made clear: These new programs will require highly accurate

information about your drivers, and might require actual measurements of a speaker's frequency-response, impedance, and its voice coil's DC resistance and inductance values. If you purchase raw drivers from one of the more reputable sources, you might find that they can provide you with much or all of that information, making use of these new programs a lot easier. Now, let's proceed.

**Program Use.** The programs in this article were written in generic BASIC, and should work with all current versions of both GWBASIC and BASICA for the IBM-compatible PC. Enter the programs into your computer and save them in the directory that is used by your computer for its BASIC interpreter, being sure to use all the letters, punctuation, and spacing exactly as shown. If you aren't familiar with BASIC, just ask a friend who is; entering programs is as easy as typing a letter.

Once the programs are entered, accessing them is also simple. If you have GWBASIC on your PC, do it like this: from the DOS prompt type GWBASIC, a space, and the filename of the program (for example, XDES-2.BAS); then hit enter. In a few seconds the opening screen of the

BY WILLIAM R. HOFFMAN

program should appear on your monitor. If you have BASICA, then start with: BASICA, a space, the filename, and the enter key. Once you have the program running, simply answer the various prompts that appear on the screen by entering the data required, and the program will automatically calculate the values for the circuit components.

**XDES-2.BAS.** The program XDES-2.BAS, shown in Listing 1, will provide crossover-circuit values for first-, second-, and third-order networks (6-, 12-, and 18-dB-per-octave filter slopes, in that order). Figure 1 shows the circuits and component designa-

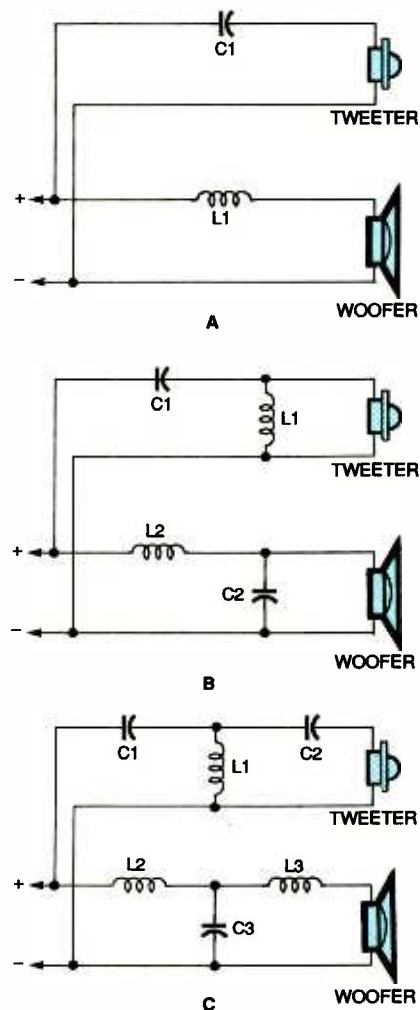

Fig. 1. The three crossover circuits that can be used with a two-way speaker configuration (consisting of a woofer and tweeter) are first-order (A), second-order (B), and third-order types (C).

## LISTING 1

```

5      CLS
10     PRINT:PRINT:PRINT:PRINT
20     PRINT " A PC BASED PROGRAM TO
      CALCULATE CROSSOVER"
25     PRINT
30     PRINT " NETWORK VALUES FOR 2-WAY
      SPEAKER SYSTEMS"
35     PRINT
40     PRINT:PRINT
45     PRINT " By William R. Hoffman"
46     PRINT
55     PRINT " The following program computes
      crossover network values"
60     PRINT " for 2-way speaker systems using
      either L/R or Butterworth"
65     PRINT " transfer functions and first thru third
      orders."
70     PRINT:PRINT
75     INPUT " Do you wish to continue? (1=yes
      2=no) and Enter. ";A
80     ON A GOTO 85
85     IF A=1 THEN 100
90     IF A=2 THEN 990
100    CLS:PRINT:PRINT:PRINT "
      CROSSOVER TYPE SELECTION"
110    PRINT:PRINT:PRINT
120    PRINT " (1) First order Butterworth (all pass)."
125    PRINT:PRINT
130    PRINT " (2) Second order Linkwitz-Riley."
135    PRINT:PRINT
140    PRINT " (3) Third order Butterworth (all
      pass)."
155    PRINT:PRINT:PRINT
160    PRINT " Enter number of crossover type and
      order from above list."
165    INPUT " then <ENTER>.";B
175    CLS
190    PRINT:PRINT:PRINT
200    PRINT " CROSSOVER
      PARAMETERS"
201    PRINT:PRINT:PRINT
205    INPUT " Crossover frequency is (Hz) =";C
206    PRINT:PRINT
210    PRINT " Impedance of low frequency driver at
      the crossover"
211    INPUT " frequency is (ohms) =";D
212    PRINT:PRINT
220    PRINT " Impedance of high frequency driver at
      the crossover"
221    INPUT " frequency is (ohms) =";E
222    CLS
250    IF B=1 THEN 300
260    IF B=2 THEN 400
270    IF B=3 THEN 500
300    LET C1=.159/(E*C)*10^6
310    LET L1=D/(6.28*C)*10^3
320    PRINT:PRINT:PRINT:PRINT
330    PRINT " The inductor/capacitor values for a
      first order"
331    PRINT " Butterworth crossover at "C"Hz are:"
335    PRINT:PRINT
340    PRINT " L1 ="L1" mHy."
341    PRINT:PRINT
345    PRINT " C1 ="C1" uF."
350    PRINT:PRINT " Where the LF driver has an
      impedance of"D"ohms,"
355    PRINT " and the HF driver has an impedance
      of"E"ohms."
530    PRINT:PRINT " To print above information,
      use <PRN SCR> key now."
365    PRINT:PRINT " Do you wish to try another
      set of values?"
530    INPUT " (1=yes 2=no, and Enter) =";F
375    IF F=1 THEN 100
380    IF F=2 THEN 990
400    LET C1=.0796/(E*C)*10^6
410    LET C2=.0796/(D*C)*10^6
420    LET L1=(.3183*E)/C*10^3
430    LET L2=(.3183*D)/C*10^3
440    CLS
445    PRINT:PRINT:PRINT:PRINT
450    PRINT " The inductor/capacitor values for a
      second order"
455    PRINT " Linkwitz-Riley crossover at ";C"Hz
      are:"
460    PRINT:PRINT
465    PRINT " L1 ="L1" mHy."
466    PRINT:PRINT
467    PRINT " L2 ="L2" mHy."
468    PRINT:PRINT
469    PRINT " C1 ="C1" uF."
470    PRINT:PRINT
471    PRINT " C2 ="C2" uF."
475    PRINT:PRINT " Where the LF driver has an
      impedance of "D" ohms,"
476    PRINT " and the HF driver has an impedance
      of "E"ohms."
477    PRINT:PRINT " To print above information,
      use <PRN SCR> key now."
478    PRINT:PRINT " Do you wish to try another
      set of values?"
479    INPUT " (1=yes 2=no, and Enter) =";F
480    IF F=1 THEN 100
481    IF F=2 THEN 990
500    LET C1=.1061/(E*C)*10^6
505    LET C2=.3183/(E*C)*10^6
510    LET C3=.2122/(D*C)*10^6
515    LET L1=(.1194*E)/C*10^3
520    LET L2=(.2387*D)/C*10^3
525    LET L3=(.0796*D)/C*10^3
527    CLS
530    PRINT:PRINT:PRINT:PRINT
535    PRINT " The inductor/capacitor values for a
      third order"
536    PRINT " Butterworth crossover at "C"Hz are:"
537    PRINT:PRINT
538    PRINT " L1 ="L1" mHy"
539    PRINT " L2 ="L2" mHy"
540    PRINT " L3 ="L3" mHy"
541    PRINT " C1 ="C1" mHy"
542    PRINT " C2 ="C2" mHy"
543    PRINT " C3 ="C3" mHy"
544    PRINT:PRINT " Where the LF driver has an
      impedance of"D'ohms,"
545    PRINT " and the HF driver has an impedance
      of"E'ohms."
546    PRINT:PRINT " To print above information,
      use <PRN SCR> key now."
547    PRINT:PRINT " Do you wish to try another
      set of values?"
548    INPUT " (1=yes 2=no, and Enter) =";F
550    IF F=1 THEN 100
551    IF F=2 THEN 990
990    PRINT:PRINT:PRINT:PRINT " Good listening!"
      END

```

tions (the values of which are calculated by the program) for a two-way speaker with a bass (woofer) and a high-frequency driver (tweeter). Figure 1A is a first-order crossover, Fig. 1B is a second-order crossover, and Fig. 1C is a third-order crossover.

You might notice references to unfamiliar names in the program; let's clear that up now. Butterworth was the name of a mathematician who showed that a particular set of mathematical coefficients will give the fastest filter slope possible with both flat-in-band response and minimum phase shift in the circuit. In speaker design that is highly desirable, so we'll use that filter type. Also, two engineers at Hewlett Packard whose names are Linkwitz and Riley noted that cascading two Butterworth filters to create a second-order type (which is not possible directly with the Butterworth equations) will provide a more desirable flat phase and amplitude, along with a faster 12-dB-per-octave filter action.

**XDES-3.BAS.** This second program is another crossover program, like XDES-2.BAS, that also allows for filter slopes of 6-, 12-, and 18-dB per octave, but this time for a more advanced three-way system. That is, we can use three drivers: bass (woofer), midrange (sometimes called a squawker), and high-frequency (a tweeter). Input the XDES-3.BAS program from Listing 2, once again being careful to see that it is entered exactly as shown, and access it by typing either GWBASIC XDES-3.BAS or BASICA XDES-3.BAS at the DOS prompt.

When you run the program and the opening screen comes up, simply answer all the prompts for information. The program will then automatically calculate all the values of the components shown in Fig. 2 (Fig. 2A is a first-order crossover, Fig. 2B is a second-order crossover, and Fig. 2C is a third-order crossover). Note that the mathematical coefficients used in deriving those circuit values do not exactly match those of Butterworth or Linkwitz-Riley. The reason for that is that all passive filters of the type used as speaker crossovers are never ideal (i.e. their effect never sharply starts and ends). Because of that, the action of the filter for the lower-frequency crossover point (between the woofer

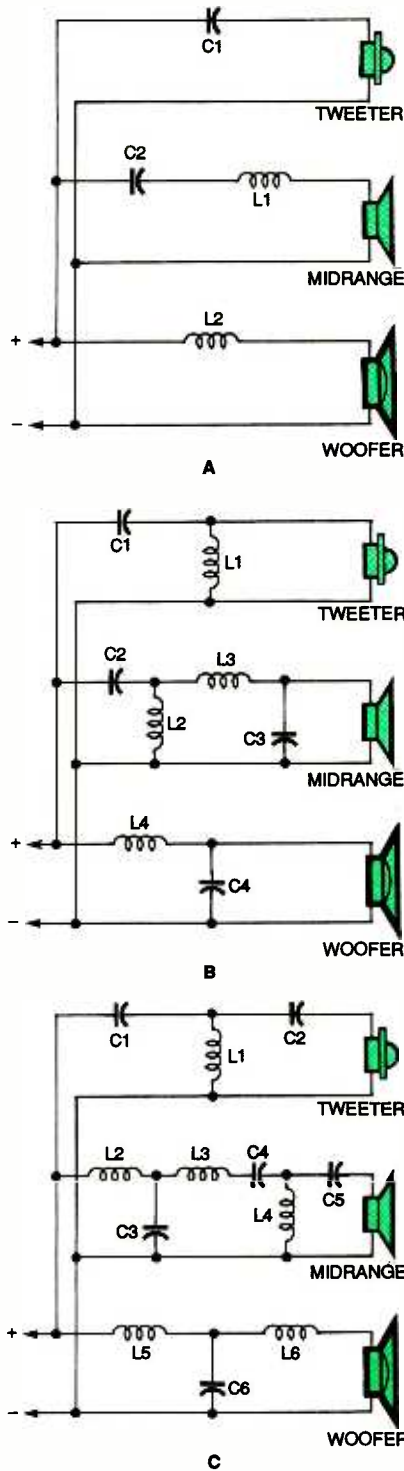

Fig. 2. Here are the three crossover circuits that can be used with a three-way speaker configuration (consisting of a woofer, midrange, and tweeter): they are a first-order crossover (A), a second-order crossover (B), and a third-order crossover (C).

and midrange) and the higher-frequency crossover (between the midrange and tweeter) will interact with

each other. Therefore, the calculations must take that into account. Provided that the upper crossover frequency is at least 4-5 times the lower one, the calculated component values should provide a good "all pass" type of response, similar to the Butterworth filter.

(One important thing to note here is that if you use the second-order design, be sure and reverse the connections to the midrange driver as the crossover network inverts its signal phase relative to the other drivers.)

**Some General Rules.** Here are a couple of things to keep in mind: First, while a 6-dB-per-octave crossover (first order) can be designed with only approximate driver-impedance values, a second- or third-order design requires more-exact information to be successful. That means you have to know the precise values of driver impedance and, in the case of a third-order (18-dB per octave) crossover, the acoustic response of the drivers used. That is because the sharper the filter action, the more the driver's impedance and frequency response

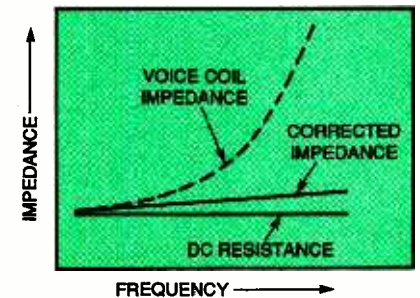

Fig. 3. This graph shows the rising impedance curve of a typical moving-coil driver in comparison to the corrected impedance of the same coil connected to a Zobel circuit.

become significant. As mentioned earlier, quality drivers from major suppliers will usually come with that information, or the information will at least be made available from the manufacturer. The same goes for recommended crossover frequencies.

Second, the impedance of the drivers in a second- or third-order crossover system must be constant to make the network work correctly. Because a driver's voice coil has substantial inductance (about 30 to 300  $\mu$ H for tweeters and 0.5 to 1.5 mH for

large woofers) the impedance might vary quite a bit with frequency. Therefore, compensation must be added to make it appear to the crossover as if it were constant instead. Compensating for the individual drivers with a

capacitor/resistor combination is the purpose of our next PC program.

### Driver-Impedance Equalization.

Figure 3 is the impedance curve of a typical moving-coil driver, the kind we

all commonly use. The voice coil is essentially a coil of wire and therefore has inductance; it produces a rising impedance with frequency because of inductive reactance.

So how can we make sure that a

## LISTING 2

```

10 PRINT:PRINT:PRINT:PRINT
15 PRINT " A PC BASED PROGRAM TO
CALCULATE CROSSOVER"
16 PRINT:PRINT " NETWORK VALUES
FOR 3-WAY SPEAKER SYSTEMS"
20 PRINT:PRINT:PRINT " by"
21 PRINT:PRINT " William R. Hoffman."
22 PRINT:PRINT
25 PRINT " The following program calculates the
inductor and capacitor"
26 PRINT " values for first thru third order
crossovers for a 3-way"
27 PRINT " speaker system."
30 PRINT:INPUT " Do you wish to proceed?
(1=yes 2=no) and Enter ",A
31 ON A GOTO 35, 990
35 PRINT:PRINT:PRINT
40 PRINT " What order of crossover do you
wish?"
42 INPUT " (first=1, second=2, third=3) and
Enter? ",B
43 PRINT
45 PRINT:PRINT " Crossover frequency from
low frequency driver to"
46 INPUT " midrange driver is (Hz) = ",X1
47 PRINT:PRINT " Impedance of low
frequency driver at "X1"Hz is "
48 INPUT " (ohms) = ",Z1
49 PRINT:PRINT " Impedance of midrange
driver at "X2"Hz is"
50 INPUT " (ohms) = ",Z2
52 PRINT:PRINT " Crossover frequency from
midrange driver to"
53 INPUT " high frequency driver is (Hz) = ",X2
54 PRINT:PRINT " Impedance of midrange
driver at "X2"Hz is"
55 INPUT " (ohms) = ",Z3
56 PRINT:PRINT " Impedance of high
frequency driver at "X2"Hz is"
57 INPUT " (ohms) = ",Z4
60 IF B=1 THEN 100
61 IF B=2 THEN 200
62 IF B=3 THEN 400
100 LET C1=(.16/(Z4*X2))*10^6
110 LET C2=(.53/(Z2*X1))*10^6
120 LET L1=((.047*Z3)/X2)*10^3
130 LET L2=((.16*Z1)/X1)*10^3
150 PRINT:PRINT:PRINT
155 PRINT " Crossover values are:"
160 PRINT:PRINT " C1 ="C1" uF."
165 PRINT:PRINT " C2 ="C2" uF."
170 PRINT:PRINT " L1 ="L1" mHy."
175 PRINT:PRINT " L2 ="L2" mHy."
180 PRINT:PRINT " To print the above
information, use <PRN SCR> key."
185 PRINT:PRINT " Would you like to try
another set of values?"
190 INPUT " (1=yes 2=no) and Enter? ",Y
195 ON Y GOTO 35, 990
200 LET C1=(7.900001E-02/(Z4*X2))*10^6
205 LET C2=(.31/(Z2*X1))*10^6
210 LET C3=(.023/(Z3*X2))*10^6
215 LET C4=(7.900001E-02/(Z1*X1))*10^6
220 LET L1=((.32*Z4)/X2)*10^3
225 LET L2=((.1*Z2)/X1)*10^3
230 LET L3=((.088*Z3)/X2)*10^3
235 LET L4=((.32*Z1)/X1)*10^3
240 PRINT:PRINT:PRINT
245 PRINT " Crossover values are:"
250 PRINT:PRINT " C1 ="C1" uF."
251 PRINT:PRINT " C2 ="C2" uF."
252 PRINT:PRINT " C3 ="C3" uF."
253 PRINT:PRINT " C4 ="C4" uF."
254 PRINT:PRINT " L1 ="L1" mHy."
255 PRINT:PRINT " L2 ="L2" mHy."
256 PRINT:PRINT " L3 ="L3" mHy."
257 PRINT:PRINT " L4 ="L4" mHy."
258 PRINT:PRINT " NOTE: midrange driver
must be wired out-of-phase"
259 PRINT " to correct for phase inversion by
crossover network."
260 PRINT:PRINT " To print the above
information, use <PRN SCR> key."
270 PRINT:PRINT " Would you like to try
another set of values?"
275 INPUT " (1=yes 2=no) and Enter? ",Y
295 ON Y GOTO 35, 990
400 LET C1=(.11/(Z4*X2))*10^6
402 LET C2=(.29/(Z4*X2))*10^6
404 LET C3=(.083/(Z3*X2))*10^6
406 LET C4=(.33/(Z2*X1))*10^6
408 LET C5=(.99/(Z2*X1))*10^6
410 LET C6=(.21/(Z1*X1))*10^6
412 LET L1=((.12*Z4)/X2)*10^3
414 LET L2=((.062*Z3)/X2)*10^3
416 LET L3=((.027*Z3)/X2)*10^3
418 LET L4=((.36*Z2)/X1)*10^3
420 LET L5=((.22*Z1)/X1)*10^3
422 LET L6=((.086*Z1)/X1)*10^3
425 PRINT:PRINT:PRINT
430 PRINT " Crossover values are:"
431 PRINT " C1 ="C1" uF."
432 PRINT " C2 ="C2" uF."
433 PRINT " C3 ="C3" uF."
434 PRINT " C4 ="C4" uF."
435 PRINT " C5 ="C5" uF."
436 PRINT " C6 ="C6" uF."
437 PRINT " L1 ="L1" mHy."
438 PRINT " L2 ="L2" mHy."
439 PRINT " L3 ="L3" mHy."
440 PRINT " L4 ="L4" mHy."
441 PRINT " L5 ="L5" mHy."
442 PRINT " L6 ="L6" mHy."
450 PRINT:PRINT " To print the above
information, use <PRN SCR> key."
460 PRINT:PRINT " Would you like to try
another set of values?"
465 INPUT " (1=yes 2=no) and Enter? ",Y
470 ON Y GOTO 35, 990
990 PRINT:PRINT " Good listening!"
END

```



crossover has a constant impedance instead? Many years ago, an engineer by the name of Zobel showed that it is possible to make a circuit operate as if it has a constant impedance by adding a series network of

electronic components in parallel with it. The program, ZOBEL.BAS (shown in Listing 3), will give us a set of values for a resistor/capacitor series combination that will do just that. That will give the result in Fig. 3 that is shown

as "corrected impedance."

After entering the ZOBEL.BAS program, run it as you did with the others, and follow the prompts. The voice-coil's DC resistance and its inductance can usually be found in the manufacturer-supplied specifications. If the information is not there, or if it's not available, the values can be measured using an ohmmeter and an inductance meter. The values that

### LISTING 3

```

10 PRINT:PRINT
15 PRINT " LOUDSPEAKER ZOBEL DESIGN PROGRAM"
20 PRINT:PRINT:PRINT
25 PRINT " by"
30 PRINT
35 PRINT " William R. Hoffman"
40 PRINT:PRINT:PRINT
45 INPUT " Proceed? (1=yes 2=no) and Enter ",A
50 ON A GOTO 60, 990
60 PRINT:PRINT:PRINT
65 INPUT " Driver voice coil DCR is (ohms) = ",R
70 PRINT
75 INPUT " Driver voice coil inductance is (millihenries) = ",L
76 LET L=L*10^-3
80 LET R1=R*1.2
85 LET C=(L/(R1^2))*10^6
90 PRINT:PRINT:PRINT
100 PRINT " Series resistor-capacitor combination in parallel"
105 PRINT " with the driver voice coil is:"
110 PRINT:PRINT:PRINT
115 PRINT " R = "R1"ohms"
120 PRINT:PRINT
125 PRINT " C = "C1"microfarads"
126 PRINT:PRINT " To print above values, use <PRN SCR> key"
127 PRINT:PRINT:PRINT
130 PRINT " Would you like to try another set of values?"
135 INPUT " (1=yes 2=no) and Enter ",B
140 ON B GOTO 60, 990
990 PRINT:PRINT " Good listening!"
999 END

```

### LISTING 4

```

100 PRINT:PRINT:PRINT
110 PRINT " DRIVER RESISTIVE ATTENUATION"
115 PRINT:PRINT " CALCULATION PROGRAM"
120 PRINT:PRINT:PRINT " by"
125 PRINT:PRINT " William R. Hoffman"
130 PRINT:PRINT " Do you wish to continue?"
135 INPUT " (1=yes 2=no) and Enter. ",B
140 ON B GOTO 200, 990
200 PRINT:PRINT:PRINT
210 INPUT " Driver average in-band impedance (ohms) = ",Z
215 PRINT
220 PRINT " Required attenuation, in dB, as a negative"
230 INPUT " value (i.e. -3dB) = ",A
300 LET R2=(10^(A/20)*Z)/(1-(10^(A/20)))
310 LET R1=Z-(1/R2+1/Z)^-1
320 PRINT:PRINT:PRINT
400 PRINT " Resistor in series with the driver is = "R1" ohms"
410 PRINT:PRINT
420 PRINT " Resistor across the driver voice coil is = "R2" ohms"
430 PRINT:PRINT
440 PRINT " To print the above values, use <PRN SCR> key."
450 PRINT:PRINT " Do you wish to try another set of values?"
460 INPUT " (1=yes 2=no) and Enter. ",C
470 ON C GOTO 200, 990
990 PRINT:PRINT " Good listening!"
999 END

```

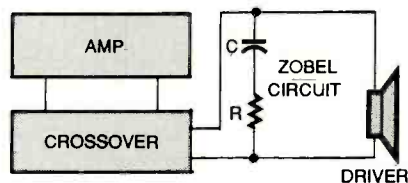

Fig. 4. A Zobel circuit is nothing more than a capacitor and resistor connected in parallel to the driver's leads.

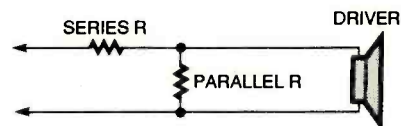

Fig. 5. These two resistors, one in parallel and one in series with the driver, make up the attenuator circuit.

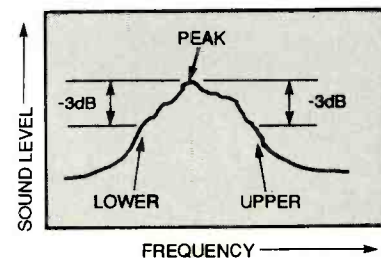

Fig. 6. This graph shows the parameters for determining the upper- and lower-frequency ranges of an audio peak.

the program calculates will be for the capacitor and resistor shown connected to the block diagram in Fig. 4.

**Driver-Level Matching.** Not all speaker drivers are matched in their efficiency (or more properly, sensitivity), with the result that a system might not have flat frequency response. Typically, a tweeter or mid-range is several dB more sensitive than a woofer, which will make the sound of a system very "forward" or "bright." Check and compare the driver-sensitivity specifications using the data supplied by their manufacturers, or use a small sound-level

### LISTING 5

```

100 PRINT:PRINT:PRINT
110 PRINT " PARALLEL ELEMENT TRAP FILTER"
120 PRINT:PRINT " CIRCUIT CALCULATION PROGRAM"
125 PRINT:PRINT:PRINT
130 PRINT " by"
135 PRINT:PRINT " William R. Hoffman"
140 PRINT:PRINT:PRINT
145 PRINT " To calculate a parallel L/C/R filter that will"
150 PRINT " selectively reduce a band of frequencies in the"
155 PRINT " output of the loudspeaker."
160 PRINT:INPUT " Proceed? (1=yes 2=no) and Enter? ",A
165 ON A GOTO 200, 990
170 PRINT:PRINT:PRINT
210 PRINT " What is upper -3dB frequency of the peak to be"
220 INPUT " reduced (Hz) ? ",FH
230 PRINT:PRINT
240 PRINT " What is lower -3dB frequency of the peak to be"
250 INPUT " reduced (Hz) ? ",FL
300 LET B=FH-FL
310 LET FM=(FH+FL)/2
320 LET C=.03/FM
330 LET L=.023/((FM^2)*C)
340 LET R=1/(6.28*C*B)
350 LET C1=C*10^6
360 LET L1=L*10^3
370 IF L1>8 THEN 380 ELSE 400
380 LET R=R-.5
400 PRINT:PRINT
410 PRINT " The parallel L/C/R network values are:"
420 PRINT:PRINT " L ="L1" mHy."
430 PRINT:PRINT " C ="C1" uF."
440 PRINT:PRINT " R ="R" ohms."
450 PRINT:PRINT " NOTE: this network is wired in series with the driver."
455 PRINT:PRINT " To print the above values, use <PRN SCR> key."
460 PRINT:PRINT " Would you like to try another value?"
470 INPUT " (1=yes 2=no) and Enter. ",C
480 ON C GOTO 200, 990
990 PRINT:PRINT " Good listening!"
END

```

shown in Fig. 5). That circuit arrangement keeps the apparent load impedance of the crossover network the same as that of the driver alone. Therefore you don't have to go back and recalculate any crossover-component values. If the required resistor values are odd, simply use the nearest standard value available, or a combination of resistors in either series or parallel to get the necessary value. Exact values are not usually required as the application is not very critical; however, be sure the resistors have an adequate power rating, because quite a bit of current might be flowing through them. For a tweeter, use at least a 5-watt unit, and for a mid-range, use a resistor rated at 10 watts or more. If you encounter a situation where the woofer is more efficient, never "pad it down" with resistors because that will reduce the amplifier's damping effect upon its bass resonance, and likely create a muddy bass sound. In that case, start over with either a less-efficient woofer, or a more-efficient tweeter.

**Smoothing the Sound.** Our last program, TRAPFIL.BAS, can be very useful if a driver is discovered to have a peak in its response, especially if that peak happens to be in the mid range, where the ear is most sensitive. TRAP-FIL.BAS designs a trap filter that can

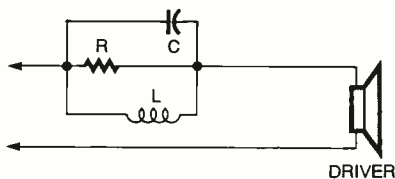

Fig. 7. A trap filter contains three components—a capacitor, a resistor, and an inductor—in series with a driver.

meter like the inexpensive one from Radio Shack (part no. 32-2050), and an oscillator or tape with test tones on it to determine each driver's sensitivity. Then, to compensate for the level differences, use two resistors to form a voltage divider that will reduce the input power to the more sensitive driver. Calculating those resistor values is done in our next PC program: DRIVERAT.BAS, shown in Listing 4. Enter that program into your BASIC directory, and load it as you did the others.

Once the program is running, an-

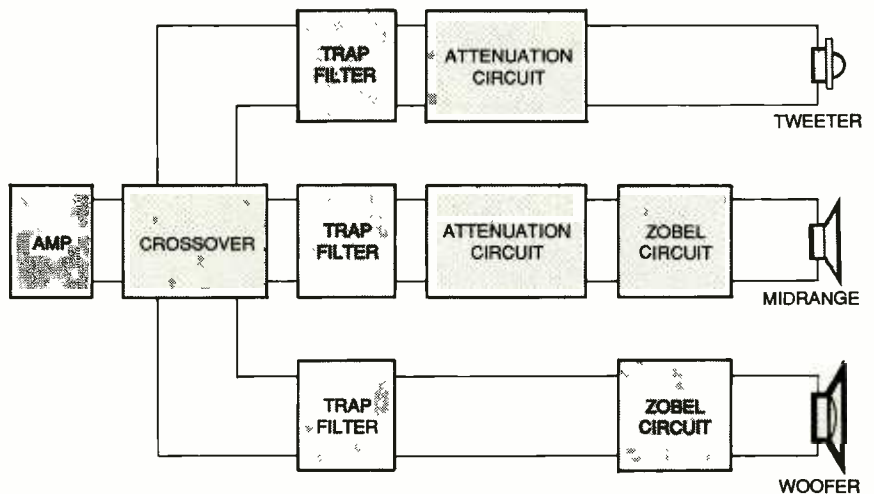

Fig. 8. This block diagram shows the proper way to make all the speaker circuits described in this article work together.

swer the prompts asking for the driver impedance and attenuation required, and it will calculate the values of series and parallel resistors needed (the placement of those resistors is

"notch out" or attenuate a small band of frequencies in the speaker's response. Enter the TRAPFIL.BAS program shown in Listing 5 and run it.

(Continued on page 93)

The first thing that everyone notices about a big, expensive stereo or home-theater speaker system is always the bass. Whether you're listening to the sound of a giant pipe organ, or the footsteps of the T. Rex in *Jurassic Park*, it's always the bass that makes the sound so exciting!

So, does your own speaker system provide you with all the bass that you want? If your answer is no, then how about making some changes to your system so that it does! By building the *Subwoofer* described in this article, it is possible to get all the extra bass you could possibly use in an average-size living room or den. Best of all, you can build it for less than \$50, and in about an evening.

**About the Subwoofer.** Figure 1 contains two graphs that display the performance of the Subwoofer. The graph in Fig. 1A is the actual frequency response of the unit (measured with a PC-based FFT analyzer and condenser microphone) in a room of about 1600 cubic feet, with the known standing waves and resonances of the room eliminated. Note the flat response down to a solid 35 Hz—the system will have little trouble meeting the frequency-response requirements of the current THX/Dolby home-theater standards!

Shown in the graph in Fig. 1B is the maximum, continuous sound-pressure level that the system is capable of: 105 dB SPL above 35 Hz and more than 100 dB at 28 Hz, with both readings taken at a 1-meter distance from the system. Again, those are definitely up to home-theater standards! (For additional information on the woofer used in the unit, see the "Subwoofer Specifications" box.)

**The Cabinet.** Let's begin by looking at the general assembly of our system. Figure 2A shows the construction of the cabinet itself. It is a simple rectangular box that measures about 1 × 1½ × 2 feet, and is made from ¾-inch-thick chipboard material. The bass driver is placed on the cabinet's bottom side behind the larger hole shown in Fig. 2B, and faces downward toward the floor. As shown in Fig. 2B, the Subwoofer is a vented system, with the ducted port cut adjacent to the woofer. In addition, the aforementioned particular set of physical di-

*Our design is easy to build, inexpensive, and a great way to add oomph to your stereo or home-theater system.*

BY WILLIAM R. HOFFMAN

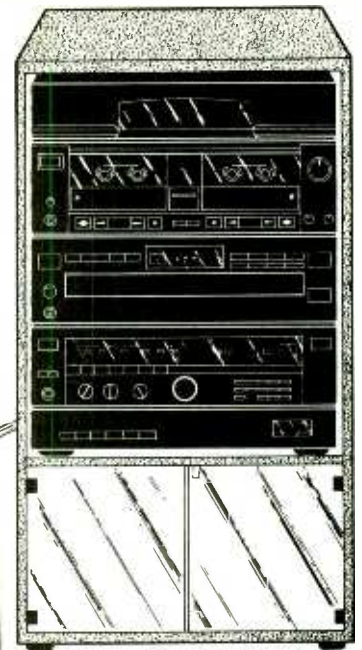

# Build a Subwoofer

mensions, taken from the requirements for a box with 1.8 cubic feet of interior volume, was chosen to mini-

mize any possible standing waves within the enclosure.

Supports that raise the cabinet about 3 inches above the ground are also required. Those can be rubber feet, short blocks of wood, or even nicely carved rounded feet with brass or plastic glides. That's up to the builder. Finishing of the system is also up to the builder. The cabinets can be either covered with veneer in a finish to match the furniture in the room, or else given a painted finish. The author's prototype Subwoofer was finished with textured, interior house paint that matched the color scheme of the room it was intended for.

**Construction.** The process of building the Subwoofer, as described here, is simple enough so that even the most amateur of wood workers can probably build one or more of them. Simple "butt joints" are used throughout the design. But that is not meant to prevent more-advanced cabinet builders from using other woodworking methods. Provided that the interior volume and shape of the enclosure remains as specified, mitered, dovetailed, or even routed corners

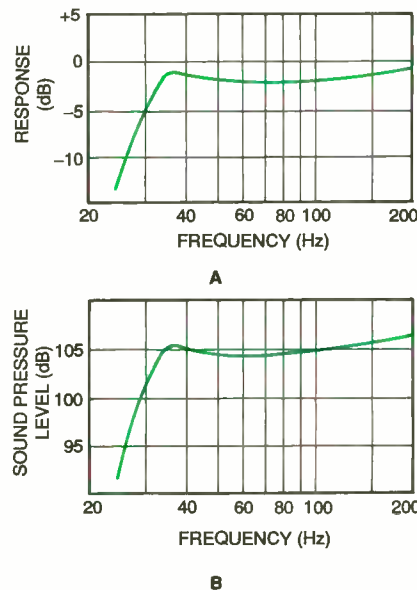
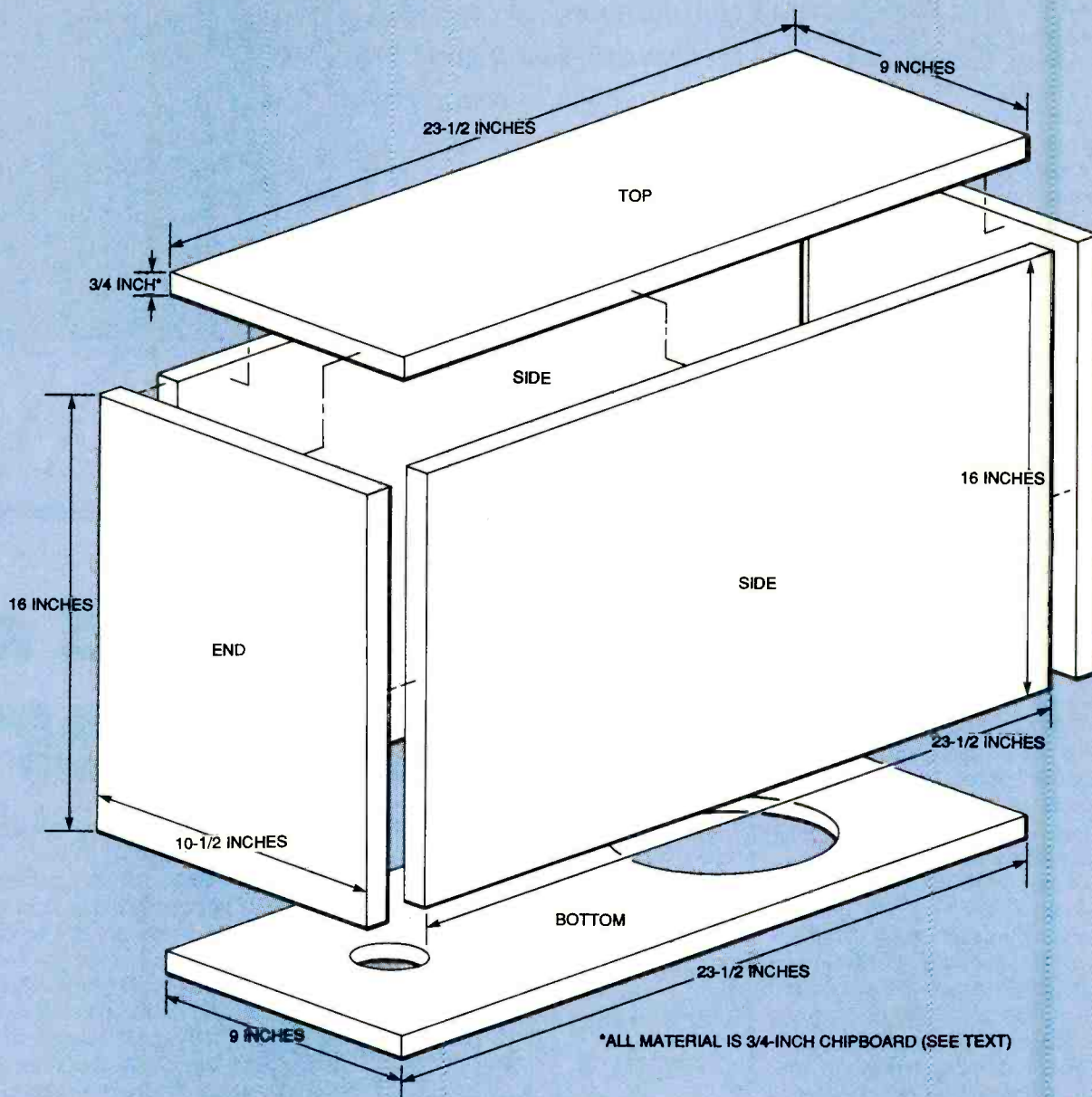
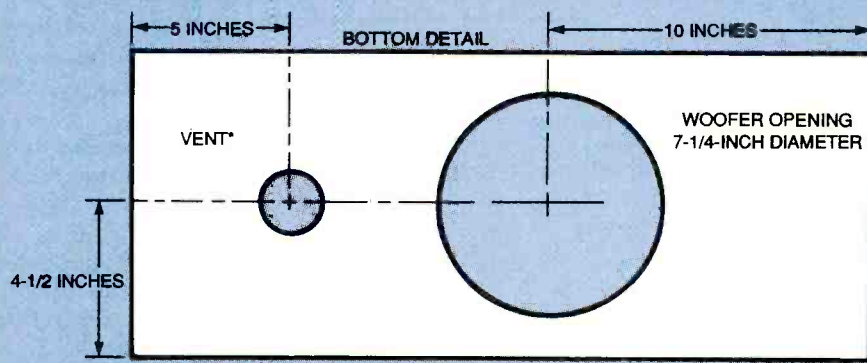

Fig. 1. This graph (A) shows the frequency response of the unit; note the flat response down to 35 Hz. That response, along with the speaker's maximum continuous sound-pressure level (B) is up to home-theater standards!



A



B

\*SEE TEXT

Fig. 2. When assembling the cabinet (A), attach the top and bottom pieces last, as they must be inserted flush with the side and end pieces. As the bottom detail shows (B), two holes must be cut—one for the speaker and one for the port-tube vent.

## PARTS AND MATERIALS LIST FOR THE SUBWOOFER

**Note:** All wood material is 3/4-inch thick chipboard, plywood, or similar material; see text.

End pieces (2): 10 1/2 × 16 inches  
Side pieces (2): 23 1/2 × 16 inches  
Top and bottom pieces: 23 1/2 × 9 inches

Low-pass filter (see text)

8-inch woofer (see text)

Two-position pushbutton terminal (Radio Shack part no. 274-315)

2 1/4-inch diameter, 3-inch-long port tube (see text)

Wood glue, 2-inch finishing nails, support legs (see text), 3/4-inch wood screws, 18-gauge 2-conductor wire, solder, hardware, etc.

**Note:** The following are available from Parts Express (340 E. First St., Dayton, OH 45402; Tel. 800-338-0531): An 8-inch Thruster woofer, part no. 290-053—\$26.80; a port tube, part no. 260-322—72 cents; any of the inductor coils mentioned in the text—call for prices. Shipping costs vary by region and type of delivery chosen; please contact Parts Express for more information.

can be used to make the cabinet's corners. Also, solid wood material, or plywood, as long as it is 3/4 inches thick, can be used instead of chipboard. In addition, extra internal cabinet bracing can be added to make the system more rigid. For those who wish to do any of those things, just study Fig. 2, draw up your own plans, and then proceed!

Now, let's take a look at the method that was used to build the Subwoofer prototype, step-by-step: First, you will of course have to get all the materials together. The woofer, as well as other speaker components are available from the source given in the Parts and Materials List. Also, be sure and arrange for whatever you will use for legs to support the cabinet off the floor.

Second, cut the wood to the sizes listed, and cut the openings for the bass driver, and port-tube vent, as indicated in Fig. 2B. The hole for the port tube is slightly larger than 2 inches in diameter; that extra thickness is to accommodate the width of the tube itself, which has a 2-inch inside diameter, and a 2 1/8-inch outside di-

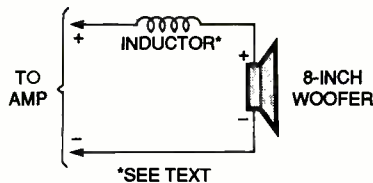

Fig. 3. Here's how to wire the low-pass inductor in series with the speaker. It can be placed either inside or outside of the cabinet.

ameter. With the tube on hand, cut and file the cabinet's bottom panel until the tube just slides into the hole. When the cabinet is actually assembled, the port tube will protrude into the Subwoofer cabinet.

Now it's time to assemble the Subwoofer cabinet. Because all of the enclosure joints are butt type, they can be assembled by applying a thin line of wood glue along the surfaces to be joined. After the pieces are carefully fit together to make sure they are straight, finishing nails will be used to hold the wood pieces together. Let's use that technique to assemble the cabinet in the following order:

Attach one of the side panels to an end piece; consult Fig. 2A. Note that in the cabinet assembly, the side pieces are fitted in between the ends. That makes up the four walls of the box. When those are glued and nailed together, insert the top and bottom panels down flush with the top or bottom edges of the cabinet's walls. When fitting the top and bottom pieces, first nail them in place, and then reach in through the woofer's cutout and run a bead of glue around the joining areas. Using your finger or a rag, smooth and spread the glue around until all the seams are filled. Also, go back over all the other cabinet seams as well, and fill and seal them as necessary so that there is no



The 8-inch Thruster woofer shown here makes the Subwoofer really come alive.

## SUBWOOFER SPECIFICATIONS

### DRIVER

Cone: 8-inch diameter  
Voice coil: 1.5-inch diameter  
Magnet weight: 20 ounces  
Nominal impedance: 6 ohms  
Resonance frequency: 26 Hz  
Sensitivity: 88 dB@1W/1M

### ENCLOSURE

Enclosure type: vented, 4th order  
Tuning frequency: 33 Hz  
Internal volume: 1.8 cubic feet

### SYSTEM

-3dB frequency: 31 Hz  
Frequency response (± 3dB): 29 Hz to > 1 kHz  
Maximum continuous SPL: about 105 dB above 35 Hz  
Power capacity: 50 watts RMS, 70 watts maximum

possibility of small air leaks occurring. That is important, as leaks will cause the enclosure to be tuned improperly, affecting the system's performance.

Now you are ready to mount the woofer and make the wiring connections. Pick a place on the enclosure's bottom, preferably near where the woofer mounting hole is, and install a terminal block. Drill the necessary holes for the electrical connections on the enclosure's bottom, and after soldering some short lengths of 18-gauge wire to the terminals, feed them through into the cabinet's interior, toward where the woofer will be mounted. Also, be sure and mark which wire goes to the red or "hot" terminal on the strip. That one must go to the "+" or "hot" terminal on the woofer so that the Subwoofer and other speakers in the system will be connected in phase. If the wires were reversed, nothing would be harmed, but less bass would result.

After mounting the terminal strip, seal around its edges (or around the holes going through into the interior of the cabinet) with more glue so that everything is airtight. Solder the wires from the terminal strip to the terminals on the woofer. Mount the woofer by inserting it face out into the hole cut for it in the cabinet. It will rest in place because of its outer rim. Secure the woofer by fastening a 3/4-inch wood screw through each of the mounting holes in the rim, making sure that the

(Continued on page 92)

# The Truth About

# Speaker



# Cables

BY WILLIAM R. HOFFMAN

*Some of them cost a lot,  
but does that make them any better?*

**A**ny audiophile who has ever seen one of those monstrous sets of speaker cables protruding out of the back of an amplifier and running to the nearest loudspeaker, might have wondered what was so important about them. Or more important, how could they be worth their enormous asking prices? And then, if audiophiles look to buy a pair for themselves, they discover that there are about 60 manufacturers offering them in a bewildering array of shapes, materials, and designs! On top of all that confusion, is it really possible to hear a difference in sound quality at all?

Starting with the last question first, try asking some of your audiophile friends what they think. It's likely that as many as you ask, you would probably also get the same number of different answers! Although each would likely acknowledge that differences exist, it is doubtful that any two would consider the same manufacturer's product as being the "best." Still no help!

Then, if you approached an "expert" with questions about speaker cables, what could you expect to get? Many researchers in the electronics and audio field would probably say there is no audible difference. They

might even cite tests and studies, "proving" their point. So then, where does that leave you?

Well, the best bet is to decide on your own if there really is a difference. And the best way to start is to understand just what is inside some of those fancy audiophile cables.

**Some Cable Basics.** To begin with, the conductors (wires) in a cable come in two basic forms: round (circular cross-section) conductors, and flat (square or rectangular cross-section) "ribbon" types. Both those forms are used today by many manufacturers, although the round conductor is certainly the most common. By using one of those wire types, most manufacturers attempt to create a cable that has low DC resistance, and a low, or selective, reactance characteristic (capacitive or inductive) that they feel will make a stereo system sound better.

But how does a speaker cable have inductance and capacitance? Any current flowing through a conductor induces a magnetic field around itself; a wire is therefore said to have inductance. In a single speaker cable there are usually two conductors, one for the current from the amplifier to go

out on, and the other for it to return by. Because of that, there is a difference in potential between the two adjacent conductors, which gives the cable capacitance. The currents in the two conductors, being in opposition to each other, cause the inductive fields to be opposing, and therefore to partially cancel each other.

**(Note:** Low capacitance can be especially important with some types of solid-state amplifiers that use large amounts of negative feedback. Too much capacitance can lead to instability and oscillation, and can be damaging to the amplifier's circuitry.)

Now, let's move on to the cable designs themselves. To begin with, we'll review those that are based on the use of round conductors—the most common type in use today.

**Round-Conductor Cables.** Cables using round conductors generally come in 7 basic configurations. In Fig. 1, those types of cables are illustrated (A through G). Let's discuss each one in turn:

Figure 1A shows a stranded parallel pair. That is the common "zip-cord-type" speaker wire we're all likely to be familiar with; part of the wire's popularity has to do with the fact that it's

mass produced and quite cheap. The conductors are stranded (usually 7-25 strands per conductor), and commonly used in 14-, 16-, and 18-gauge sizes for a home stereo. Because it is stranded, the wire is quite flexible and has a greater surface area than a simple, solid-conductor type would have. The circumference, and therefore the surface area, is proportional to the radius squared. Also, as we have just discussed, the proximity of the two conductors affects both the capacitance and inductance of the complete cable assembly. The conductors are usually molded into a thermoplastic-type material, for flexibility and ease of cutting and stripping.

In Fig. 1B is shown a round, solid-core, parallel pair. That type of wire is commonly used for household AC wiring, and comes in 12- through 16-gauge sizes. Being a solid core wire, it has the most conductivity for a given conductor outside circumference (there are no wire strands with air spaces between them). As far as the other properties go, it is similar to the stranded type mentioned above. Some years back, 4- or 6-gauge, solid-core conductor cables commonly used in arc-welding rigs were used for audio, and some audiophiles liked them very much, despite the difficulty with the stiffness and bulkiness of the cables. Such speaker wiring certainly had low DC resistance because of its large cross-sectional area and circumference!

Shown in Fig. 1C is a circumferentially distributed, stranded, multiple-conductor cable. One of the first attempts at improving the standard, two-conductor parallel-pair cable types was to break up each of the conductor-wire bundles into multiple smaller ones, and distribute them around the circumference of the cable surrounding an insulated, solid core. That method of construction allowed the manufacturer to maximize the number of wire strands (and therefore the wire surface area), and to keep the two sets of conductors apart as much as possible (reducing the cable capacitance). The only slight disadvantage is that the cable inductance rises because the effect of parallel inductive-field cancellation due to opposing currents in adjacent conductors is reduced.

Figure 1D shows a radially dis-

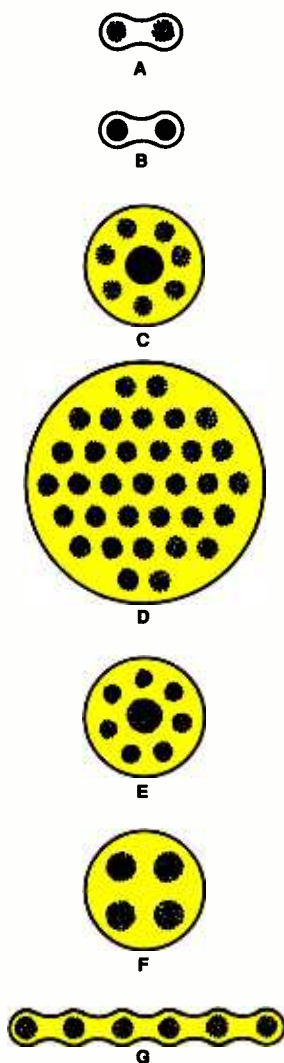

*Fig. 1. Cables containing round conductors come in the seven basic configurations shown here. They are: a stranded parallel pair (A); a round, solid-core, parallel pair (B); a circumferentially distributed, stranded multiple-conductor cable with a solid core (C); a radially distributed, stranded multiple-conductor cable (D); a cable with multiple, circumferentially stranded sets around a large-core conductor (E); a cable with multiple parallel pairs, terminated at ends (F); and a cable with parallel stranded wires woven together as a parallel flat braid (G).*

tributed, stranded multiple-conductor cable. With that design we have the unique opportunity to have the low audio frequencies pass through a different set of wires than the high frequencies! Consider the arrangement of the cable wire bundles shown in Fig. 1D. Those near the center of the cable assembly will be completely surrounded by others nearby and

therefore have very low values of inductance (because of the mutual cancellation effect). High frequencies will therefore find that the easiest path. While at the same time, those near the outer circumference will have minimized cable-to-cable capacitance, making that the easiest path for the low frequencies.

Figure 1E shows a cable with multiple, circumferentially stranded sets around a large-core conductor (a variation of the design shown in Fig. 1C). Here, the cable is designed to have an absolute minimum of inductance. With the center, large-wire bundle as one conductor, and the multiple, smaller-wire bundles circumferentially arranged around it as the other, the surface area between the two conductors is maximized, therefore also maximizing the mutual inductance cancellation effect between them. (The only way that could be made more effective is by creating a cable with a single, round inner conductor surrounded by another conductor formed as a solid circumferential shell.) The down side of that is, of course, the very high conductor-to-conductor capacitance.

Figure 1F shows a cable with multiple parallel pairs, terminated at ends. That design consists of multiple parallel bundles of smaller bundles of stranded wires. The many small wires make for a low DC resistance, while the spacing of the bundles can allow the maker to adjust the values of inductance and capacitance to anything desired. It's an interesting "universal" design.

A cable with parallel stranded wires woven together as a parallel flat braid is shown in Fig. 1G. It is an interesting design, based loosely on the parallel-conductor ribbon cables used in computers. In the only known example of the flat-braid design, 36 heavy, 16-gauge insulated wires were woven together to form a ribbon about 5-inches wide. Very low DC resistance and minimum capacitance were its features. On the other hand, the weight and extreme stiffness of the cable made it extremely difficult to use.

**Ribbon-Conductor Cables.** Figure 2 shows three (A through C) basic flat-wire (ribbon conductor) cable designs. Those are usually much more

expensive than the simple round-wire types because of the cost of the wire in the ribbon form, and the increased cost during manufacturing of molding the conductors accurately into the insulated sheathing around them. Let's discuss the designs in order.

Figure 2A shows a cable design that has ribbon conductors that are spaced apart with parallel flat sides. That is probably the most common flat-wire cable form. The advantage is, of course, that each conductor has a large cross-sectional area, yielding a low DC resistance. But there are some definite problems with the design too. The cable can be very stiff and difficult to use; it might be possible to bend it in only one direction, perpendicular to the large, flat sides of the conductors. Also, unless the conductors are spaced some distance apart, high capacitance from wire-to-wire is possible—something that is definitely not desirable.

The type of cable shown in Fig. 2B contains ribbon conductors that are spaced apart with their edges closest together. That is a variant on the cable in Fig. 2A. By placing the ribbon conductors with their edges (instead of flat faces) facing each other, cable capacitance is much reduced—a good feature to have. On the other hand, the cable's bending problems might even be worse with that design.

Another variant, shown in Fig. 2C, features multiple ribbon conductors per cable. Unfortunately, that conductor arrangement has the potential to be worse than either of those we have already mentioned, combining the potentially high cable-to-cable capacitance of the cable shown in Fig. 2A, with the very stiff physical form of the cable shown in Fig. 2B.

**Conductor Materials.** Because it is very desirable to have a cable with the highest conductance possible, a good cable should start out with a basic wire type that has the lowest possible resistance. Two choices are possible: The first is to make the wire as large as possible, and the second is to use a conductor material that has as low an intrinsic resistivity as is possible.

Taking those in order, let's start out with conductor size, (or more properly, cross-sectional area). Table 1 shows us, by A.W.G. (American Wire Gauge), the

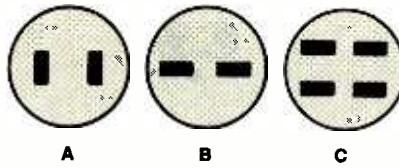

Fig. 2. The three basic flat-wire cable types shown here are designed to have either: ribbon conductors that are spaced apart with parallel flat sides (A); ribbon conductors that are spaced apart with their edges closest together (B); or multiple ribbon conductors per cable (C).

TABLE 1

A.W.G. Gauge	Resistance (Ohms per Foot)
4	.00026
6	.0004
8	.0065
10	.0010
12	.0016
14	.0026
16	.0042
18	.0066
20	.0105

resistance of stranded, drawn copper wiring (7 strands per conductor). Note that the sizes commonly used for speaker cables, 14, 16, and 18 gauge, have very low resistance: from about 2 to 6 milliohms per foot. For cable lengths of, say, 30 feet or less, that will be only about a third of an ohm in total resistance, which is probably small enough that it can be ignored. Why? Let's look at an example for the answer.

Let's say the damping factor of the bass driver in our speaker system is what we are most concerned about. The higher the DC cable resistance, the poorer the damping will be, so it should be kept down. An audio power amplifier might have an output impedance of about 50 milliohms, which will act like a near dead short (and a good "brake") on the back EMF (electromotive force) generated by the dynamic motion of the woofer's voice coil. That is good because it would control the driver's bass resonance, and lower its distortion. But there is one other factor here we cannot forget: The crossover inductor placed in series with the woofer's voice coil might have a DC resistance

of 0.5 to 1.2 ohms by itself. So, as long as we keep the speaker cable's resistance down to a few tenths of an ohm, or less, the inductor's resistance will make those cable losses insignificant.

Now, let's turn to the basic resistivity of the metal conductor itself. If we look at Table 2, we can see that copper (which is commonly available and quite cheap) is almost as good as can be had. Only silver is better, and then only slightly. But considering the cost of silver, most manufacturers would agree that using copper is just fine.

What about the exotic alloys, pure metals, and other "special" materials used by manufacturers to eke out extra performance? We'll get to them in a moment.

TABLE 2

Material	Resistivity (Ohms/Meter × 10)
Aluminum	2.7
Beryllium	4.6
Copper	1.7
Gold	2.3
Magnesium	3.9
Molybdenum	5.7
Nickel	6.8
Rhodium	4.7
Silver	1.6
Tungsten	5.5
Zinc	5.9

### About Insulation Materials.

Besides preventing electrical shorts between conductors in a cable, insulation has only one other significant effect: It is one of the factors that determines the capacitance between opposing cable conductors.

Conductor-to-conductor capacitance is basically determined by four factors: conductor spacing, area of conductor surfaces facing each other, potential difference, and the dielectric constant of whatever is between the conductors (the constant of air is approximately 1). The first three capacitance-defining parameters are determined by a cable's physical design, so we now need to examine only the dielectric constant. Because it is desirable to keep cable capacitance down, a material with the

(Continued on page 93)



# Fun With

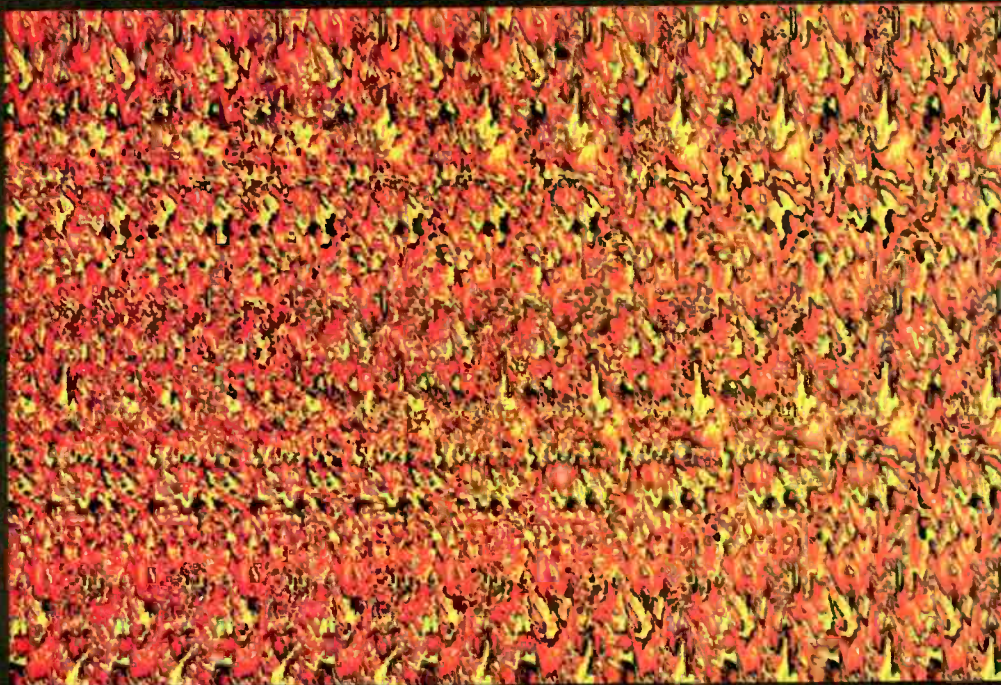

## Random-Dot Images

*Random-dot images are lots of fun, and it is easier than ever to make your own.*

BY MARC SPIWAK

**T**he image that appears at the beginning of this article might appear as a random hodgepodge of color, but if you look at it correctly (or is it incorrectly?), a 3-D image of a warrior with a sword will jump out of the page. That image is an example of a Single Image Stereogram (SIS), and it is a member of a family of related images that also includes random-dot images, stereograms, Single Image Random Dot Stereograms (SIRDS), 3D images, and more.

Those images have become quite popular in recent years with T-shirts, posters, greeting cards, and puzzles decorated with them for sale in stores everywhere. The images can be in black and white or in color, and can be formed from patterns, photographs, drawings, or any other kind of image.

The trick to seeing the stereograms is to focus your eyes not on the image, but *behind* it. It's like having droplets of water on a pair of glasses; you don't really see the drops unless you try, but you can see them. Some people find it easier to see the image when looking at it through glass, and focusing their eyes not on the image but on the glass.

### Seeing Random-Dot Images.

There are various tricks and techniques to seeing the images. One is to relax yourself and hold the image between 8 and 16 inches from your eyes. Get into a trance-like state, and try to "unfocus" your eyes on the image. If you are quick to pick up the technique, you'll see the image after only a few seconds.

Another technique is to bring the image to the tip of your nose. Let your eyes settle into focus, then slowly move the image away without changing that focus.

Some images, like the black-and-white ones that accompany this article, include two dots to aid the viewer. Before you try the dots, though, try this: Hold two fingers in front of your eyes and focus them on something farther away. At first you should see four fingers. If you vary your focus, the two center finger images will overlap at some point and you'll see the illusion of three fingers. The two dots at the

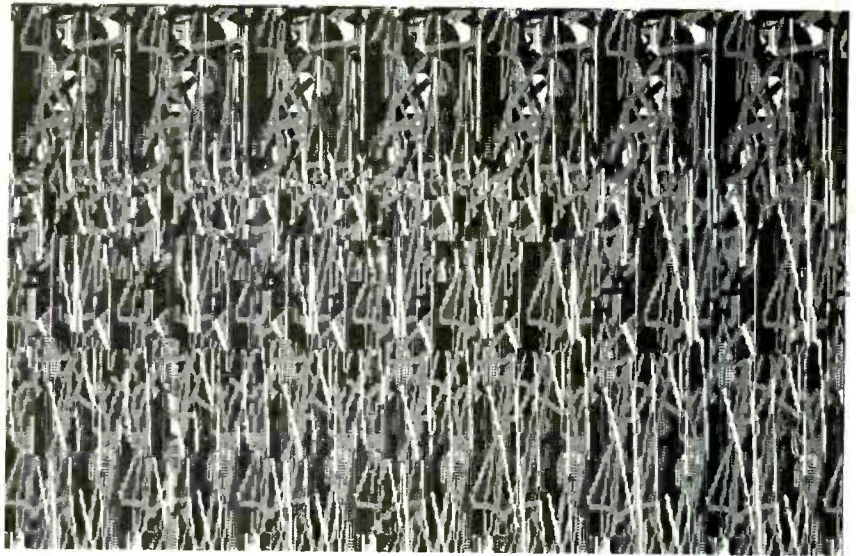

*Can you see the bull's head in this SIS image? The pattern used to form the image was supplied with the Stereolutions package. Unlike some SIS images, this one also works in black-and-white.*

top of each image are used in the same way to help focus your eyes. When your eyes are properly focused

to see the image, the two dots should appear as three dots. Once you see that, the trick is to transfer your focus from the dots to the image below.

### How The Images Are Formed.

When you look at a three-dimensional object, your brain uses the different perspective between your two eyes to judge depth. Most people have seen stereoscopic art that provides a slightly different image for each eye to give the illusion of depth. Three-dimensional movies require the viewer to wear glasses with different-colored filters for each eye to achieve the same effect.

The random-dot images do the same thing by hiding different images for each eye in vertical strips of dots. The strips are as wide as the distance between the two dots. When one eye is looking at a dot in one strip, the other eye should be looking at the same dot two strips over. Sometimes you'll see some very unusual double images when one eye focuses on a dot three strips away from the other. Some people find it easier to see the image if they cross their eyes slightly.

**Where You Can Get Them.** If you haven't seen any of these images anywhere, it's probably because you don't go out to the shopping malls very much; the images are everywhere. But there is also a mail-order company that specializes in these im-

*(Continued on page 92)*

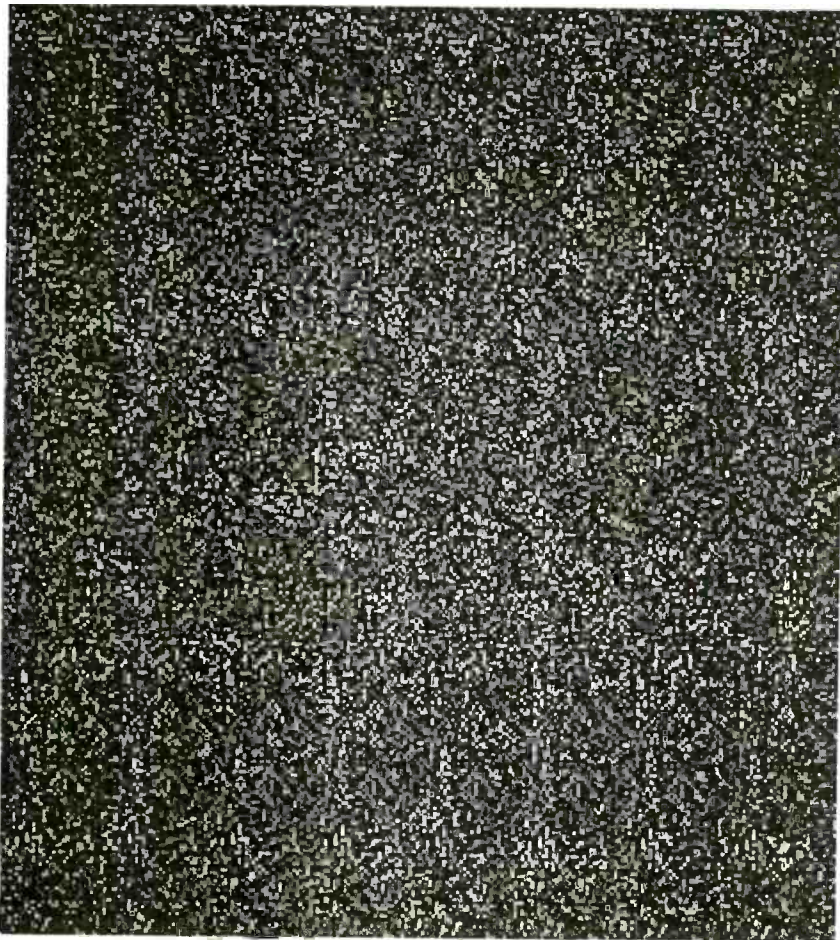

*The image of a horse, a flock of birds, and the planet Saturn are hidden in the random-square pattern of this SIRDS picture.*



3765P \$19.95



3795P \$19.95

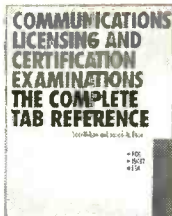

0708223-XX \$44.95  
Counts as 2/Hardcover



4261P \$24.95



0306362 \$13.95



0304165 \$26.95  
Hardcover



0156778-XX \$44.95  
Counts as 2/Hardcover



4112H-XX \$32.95  
Counts as 2/Hardcover



0487375 \$24.95

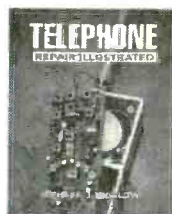

4179H \$28.95  
Hardcover



3258P \$19.95



3475P \$21.95

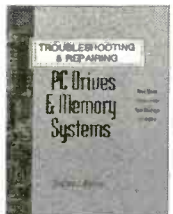

4491P \$22.95

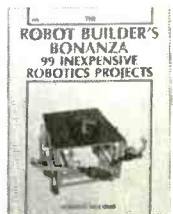

2800P \$17.95

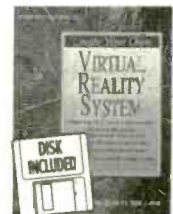

0376514-XX \$44.95  
Counts as 2/Hardcover

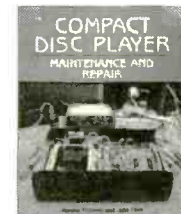

2790P \$17.95

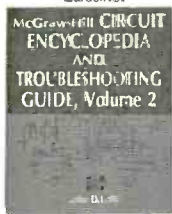

0376107-XX \$59.50  
Counts as 2/Hardcover



4227P \$15.95



3711P \$19.95



2613P \$19.95

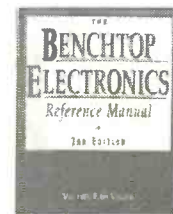

0873764-XX \$54.95  
Counts as 2/Hardcover



3671P \$18.95

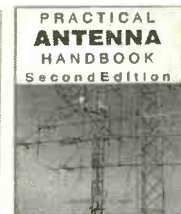

0111049-XX \$49.98  
Counts as 2/Hardcover



3802H-XXX \$84.95  
Counts as 3/Hardcover



4270P \$19.95

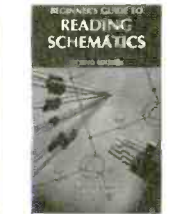

3632P \$10.95



0376026 \$42.95  
Hardcover



3279P \$26.95

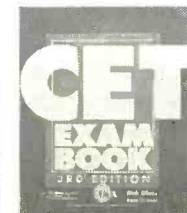

4199H \$29.95  
Hardcover

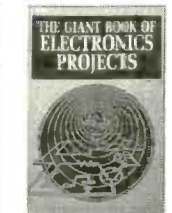

1367P \$29.95

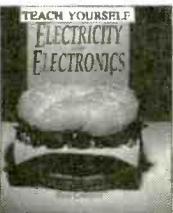

4230H-XX \$39.95  
Counts as 2/Hardcover

# Select any 5 books

## for only \$4<sup>95</sup>

(values up to \$158.75)

when you join the Electronics Book Club®

### As a member of the Electronics Book Club . . .

. . . you'll enjoy receiving Club bulletins every 3-4 weeks containing exciting offers on the latest books in the field at savings of up to 50% off of regular publishers' prices. If you want the Main Selection, do nothing and it will be shipped automatically. If you want another book, or no book at all, simply return the reply form to us by the date specified. If you ever receive a book you don't want due to late delivery of the bulletin, you can return it at our expense. You'll have at least 10 days to decide. And you'll be eligible for FREE BOOKS through the Bonus Book Program. Your only obligation is to purchase 3 more books during the next 12 months, after which you may cancel your membership at any time. A shipping/handling charge and sales tax will be added to all orders. All books are softcover unless otherwise noted. (Publishers' prices shown.) If you select a book that counts as 2 choices, write the book number in one box and XX in the next. If you select a book that counts as 3 choices, write the book number in one box and XXX in the next 2 boxes. ©1995 Electronics Book Club PE795

If card is missing, write to: Electronics Book Club, A Division of McGraw-Hill, Inc., Blue Ridge Summit, PA 17294-0810

The monkeys were green, the bananas were blue, and everyone had a good laugh," according to David Sarnoff, RCA's president and chairman. The "everyone" who had laughed at the 1949 demonstration of RCA's experimental, all-electronic, and compatible color-television system, however, had not included Sarnoff. At the time, the situation had not been the least bit funny to him.

That's because Sarnoff and RCA were locked in battle with CBS, who advocated an electromechanical, non-compatible, color-TV system. While in hindsight, the winner of that battle should have been obvious, in 1950 things were not so clear. In fact, after hearings and demonstrations that dragged on for eight long months, the FCC disregarded the compatibility issue and endorsed the CBS system.

**What Does "Compatible" Mean?** A "compatible" color-television system is one that is capable of producing, without any modification, a high-quality monochrome version of a color transmission on an ordinary black-and-white receiver. Similarly, in a compatible system, a monochrome television transmission produces high-quality monochrome images on a color receiver. If the new color system were not compatible with the existing monochrome system, the millions of monochrome receivers already in existence at the end of 1949 would have to undergo expensive modifications in order to receive the color transmissions in black and white.

The FCC seemed not to realize that the technologically outmoded CBS system, although it seemed to offer somewhat better picture quality, was performing about as well as it ever could and was fundamentally incapable of achieving compatibility with the then existing monochrome-television systems. The commissioners also apparently did not realize that the RCA system, in addition to already having demonstrated that it was compatible with existing monochrome television receivers, still was in the developmental stages and clearly had the potential for greatly improved picture quality.

David Sarnoff, however, was confident that while he had lost that par-

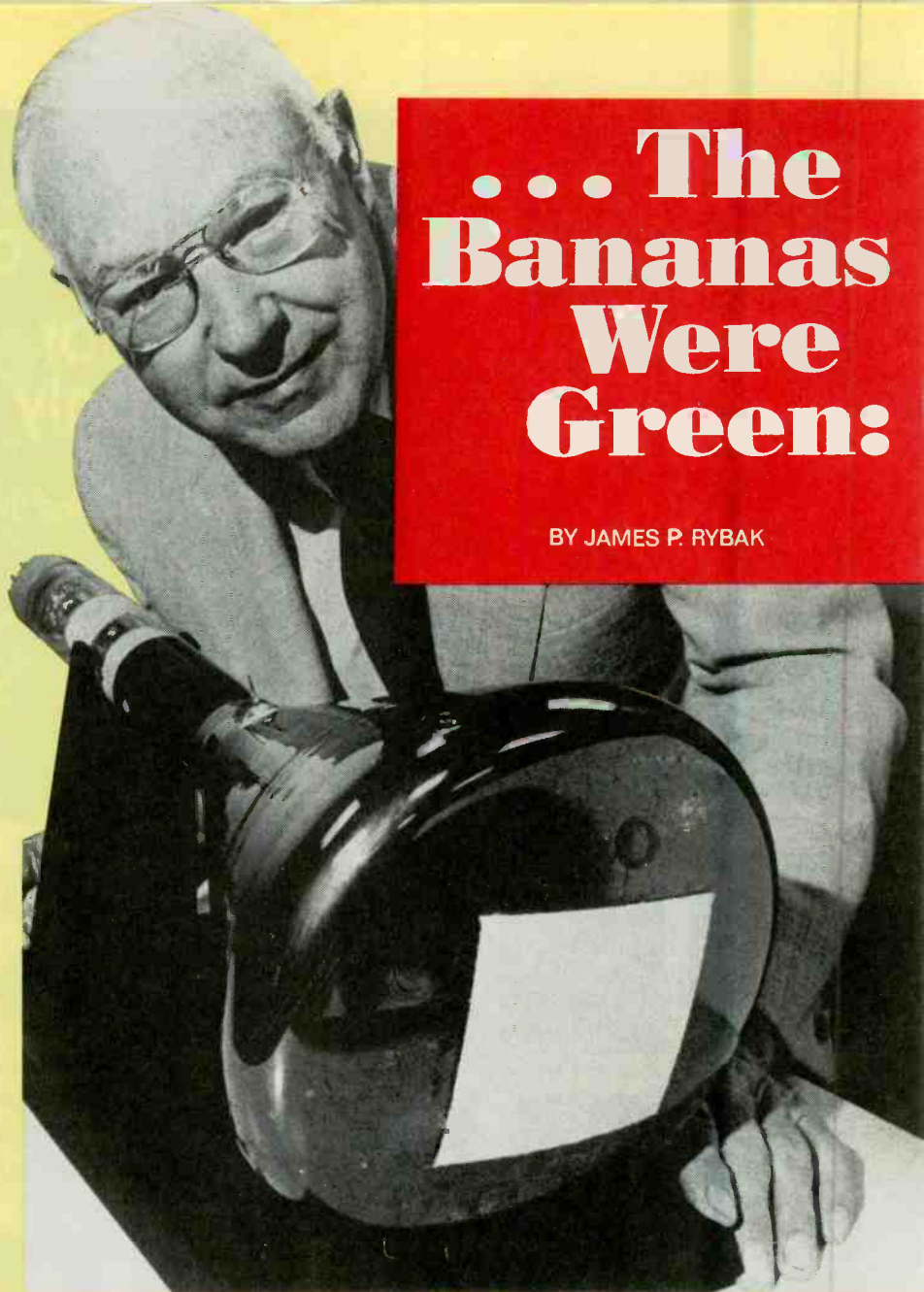

*Harold B. Law led the team that developed the three electron-gun shadow-mask color-TV picture tube.*

ticular "battle," the "war" to establish the ultimate superiority of RCA's color-television system was far from over. He was convinced that he would have the last laugh.

**The Beginnings of Color Television.** Most people are not aware that the birth of color television occurred in the late 1920s. However, the technology did not exist at that time to produce a color- (or even monochrome-) television system capable of transmitting and receiving "entertainment quality" broadcasts. The American public had to wait well over thirty years until color television be-

# ... The Bananas Were Green:

BY JAMES P. RYBAK

came a practical reality that could be enjoyed by all.

On July 3, 1928 in England, John Logie Baird conducted the world's first documented demonstration of color television. Baird also had conducted in London the first public demonstration of a crude monochrome "television" system in March of 1925.

Work was taking place on this side of the Atlantic as well. Three months after Baird's 1925 demonstration of monochrome television, Charles Francis Jenkins demonstrated his own, similar, monochrome system near Washington, DC. By 1928, there were 15 licensed experimental mono-

*The road to an all-electronic, compatible, color-TV system was far from smooth. Here's a look at the people and discoveries that made such a system possible.*

# The Early Days of Color TV

chrome-television stations in the U.S. broadcasting over the airwaves at various times. In June of 1929, scientists at Bell Laboratories demonstrated a color-television system that was somewhat different from Baird's. All those color and monochrome systems displayed only coarse images due to the type of "scanning" used.

**What Is "Scanning?"** When a person reads a page of printed text, all the information on that page is not transmitted to the brain instantaneously. Rather, the person's eyes "scan" the page, line by line, from left to right and from top to bottom (assuming, of course, that the page is written in English or another Western language). The video information to be transmitted by television must be scanned in a similar manner.

In the early days of television, the scanning of a scene to be transmitted and its reconstruction at the receiver was achieved through the use of a rotating "Nipkow" disk (see Fig. 1). The Nipkow disk consists of a thin, circular sheet of metal with a series of small holes arranged in a single spiral ring around the circumference. Each hole in the Nipkow disk allows only the light from a designated portion of the scene to be televised to reach a photocell.

A scene was completely scanned in one complete revolution of the Nipkow disk. The spacing between the holes in the Nipkow disk determined the width of the reproduced image while height of the image was determined by the pitch of the spiral pattern of holes. Putting more holes in

the Nipkow disk increased the number of scanning lines and, hence, increased the amount of definition, but decreased the size of the image reconstructed at the receiver.

An identical Nipkow disk at the receiver was located between a neon glow lamp and the surface on which the image was to be reconstructed. The intensity of the neon lamp was proportional to the intensity of the light reaching the photocell at the transmitter. Because the rotation of both Nipkow disks was synchronized, the light passing through the Nipkow disk at the receiver reconstructed the televised image. As long as the rotational speed of the Nipkow disks exceeded 15 revolutions per second, and the brilliance of the image was kept low, the persistence-of-vision capability of the human eye and mind interpreted the reconstructed image as being "flicker free."

Very large, rapidly rotating Nipkow disks were required to achieve even moderately high-definition, flicker-free images of what then was considered "acceptable" size. Disks with a diameter of approximately 40 inches and rotating at 1200 rpm were required to produce twenty 60-line images per second with an image width at the receiver of two inches.

John Logie Baird used special Nipkow disks, each with three separate spiral sets of holes, in his 1928 color television demonstration. At the transmitter, the three sets of holes were covered with red, blue, and green filters, respectively. That produced sequential scanning in the three primary colors. Each of the three

spiral sets of holes had its own photocell detector.

At the receiver, Baird also used a Nipkow disk with three sets of spirals. He used two gas-discharge tubes as his light sources. One tube contained neon and provided light for the "red" spiral of holes. The other tube contained a mixture of helium and mercury vapor. That tube provided the light for both the "blue" and "green" spirals. A commutator was used to turn the gas-discharge lamps on and off at the proper times. That arrangement, coupled with the persistence-of-vision effect supplied by the observer, resulted in sequential reconstruction of the image in recognizably appropriate colors.

Researchers at the Bell Laboratories used a color-television system in 1929 that had some somewhat different features from Baird's. The Bell Laboratories' system was based on the "flying spot scanner" principle. Rather than flooding the entire scene to be televised with bright light, a carbon arc lamp was located behind a rotating Nipkow disk that had only one set of spiral holes. That caused a moving or "flying" spot of intense light to scan the objects comprising the scene.

Photocells responding only to red, green, or blue light, respectively, and located at strategic locations around the scene detected the reflected light. The selective responses of the photocells were achieved through the use of appropriately colored filters. The outputs of those three sets of photocells were transmitted to the receiver using three separate wire circuits.

Reconstruction of the image in color at the receiver was accomplished using a single Nipkow disk, like that used in monochrome television, together with separate red, green, and blue light sources. The intensities of the three light sources were made proportional to the light detected by the photocells at the transmission location. The outputs of the three light sources were simultaneously directed on the appropriate portion of the Nipkow disk through the use of specially designed semi-transparent mirrors.

**All Electronic Television.** It was clear to many by the early 1930s that mechanical scanning could never

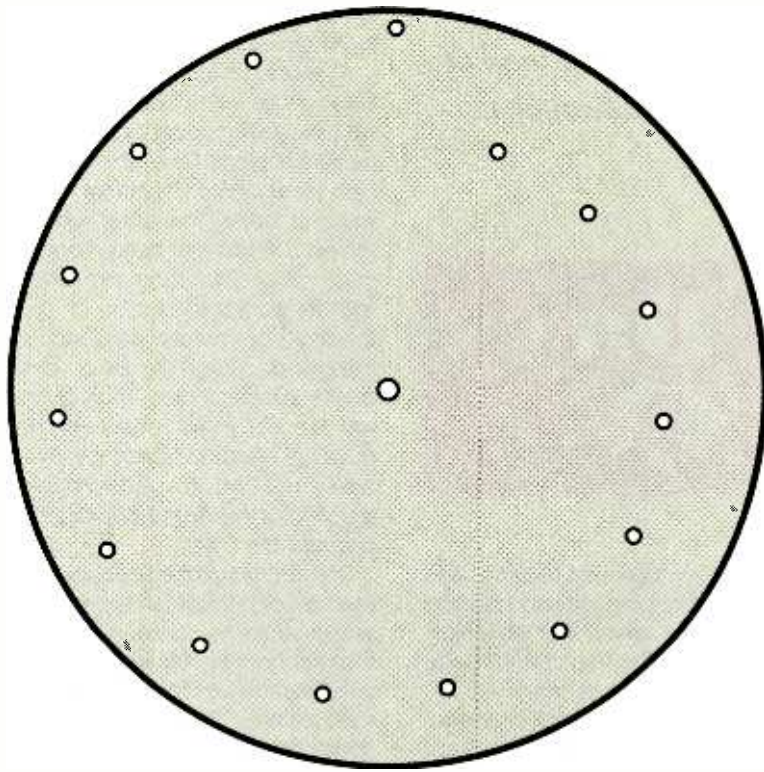

Fig. 1. A Nipkow disk, like the one shown here, consisted of a thin, circular sheet of metal with a series of small holes arranged in a single spiral around its circumference.

achieve the "entertainment-quality" images necessary to make television commercially successful. In addition, the large physical size of the equipment required for reception of even very small color images made mechanical scanning impractical for home use. Although John Logie Baird continued his work with mechanical scanning until the late 1930s, most of the research was by then being directed toward developing all-electronic television.

For some time, many researchers had recognized that the ability to control a beam of electrons in a cathode-ray tube offered the possibility of completely electronic image scanning at both the transmitting and receiving ends of a television transmission. The companion technology needed to achieve electronic scanning was lacking, however. Vladimir Zworykin achieved the first step toward that goal while working for the Westinghouse Electric & Manufacturing Company in Pittsburgh in 1923, a mere four years after immigrating to the United States from revolution-ravaged Russia.

Zworykin realized that a scene to be televised had to be broken down into

literally millions of individual points of light at the transmitter in order to achieve high-quality image definition at the receiver. He and his research associates developed a means for producing a mosaic of microscopic individual photocells on a mica or glass surface.

The photocells converted the points of light from the scene into electrical charges proportional to the amount of light received. The charges were sequentially converted into electrical impulses by a scanning beam of electrons. Those impulses then were transmitted. Zworykin called his device the "Iconoscope." (The Greek word *eikon* means image and *skopon* means to watch.) He filed a patent application on the Iconoscope in 1923, but legal challenges delayed the granting of the patent until late in 1938.

Vladimir Zworykin also had begun work on developing a cathode-ray tube suitable for displaying the received television image. His progress in that area came more slowly, however. Zworykin was working for RCA in 1933 when he developed his first "Kinescope" (*Kinema* means moving in Greek) receiving tube. He used mag-

netic deflection of the electron beam in both the horizontal and vertical directions, together with electrostatic focusing. With the Kinescope and the Iconoscope, Zworykin was able to achieve monochrome television consisting of 120 lines per image and 24 images per second.

Philo Farnsworth, working by himself and without the financial backing of a large corporation, was developing similar all-electronic television equipment concurrently with Zworykin. By 1930, Farnsworth had obtained patents on his "Image Dissector" camera tube and "Oscillite" receiving tube.

Work on developing all-electronic television was progressing in Europe as well. However, while a definite improvement over mechanical scanning, the expensive equipment required for all-electronic television still could not produce "entertainment quality" images.

One problem was the flicker associated with high-brilliance images. It was eventually found that the flicker problems could be reduced by using a process called "interlaced scanning." With interlaced scanning, lines 1, 3, 5, 7, etc. are scanned first. The result is called a "field." Lines 2, 4, 6, 8, etc. are then scanned to produce a second field. The two fields are finally combined to produce a complete picture, called a "frame."

Work also was continuing during the 1930s to develop a practical color-television system. The lack of phosphors capable of producing the primary colors of red, green, and blue in the receiving tube, together with numerous other technological problems, kept the development of all-electronic color television considerably behind that of its monochrome counterpart. As a result, color-television systems that used some mechanical moving parts continued to be investigated.

**First Color-TV Broadcasts.** In 1940, Peter Goldmark, President of the Columbia Broadcasting System (CBS), demonstrated a color-television system based on Farnsworth's "Image Dissector" camera tube. Color was added to that fundamentally monochrome system by placing rotating disks containing red, green, and blue filters in front of both the camera tube and the receiver picture tube.

The 1200-rpm rotation of the filter disk in front of the camera tube was synchronized to the scanning process. Three fields, formed by using only alternate scanning lines, were scanned in succession. The first field was scanned with the red filter in front of the camera tube, the second with the green filter, and the third with the blue filter. The process was then repeated to generate three additional fields with the scanning lines unused in the previous field of a given color.

The filter disk in front of the picture tube rotated in synchronization with that at the camera tube. Consequently, a red field was formed first, followed by a green field, then a blue field, and so on. Those fields, comprised of alternate scanning lines, were effectively combined into 60 fully scanned fields (20 red, 20 green, and 20 blue) per second by the persistence-of-vision capability of the human eye and mind. Persistence-of-vision then effectively combined the 20 fields in each of the primary colors to produce 20 complete color pictures (or frames) per second. That resulted in flicker-free viewing, even at

moderately high brilliance levels. The CBS technique for generating color television pictures was called the "field-sequential" method because the red, green, and blue fields were produced sequentially.

CBS began demonstrations of color television broadcasting using the aforementioned system on August 28, 1940 in New York City. Initially, color motion-picture films were broadcast but soon after, "live" broadcasts were made as well. On July 1, 1941, CBS began a limited daily schedule of color-television broadcasting. During that same year, RCA rushed to put together a similar field-sequential system of its own design and also began test transmissions using that system. Color television seemed to be off to a good start.

Several problems existed, however. A filter disk 20 inches in diameter was required for the 9-inch-diameter picture tube Goldmark used in his demonstration. In an attempt made after World War II to demonstrate the impracticality of rotating disks for color television, engineers at the DuMont Laboratories constructed a model of

the disk needed for a larger picture tube. A 21-inch-diameter picture tube would require a filter disk 5 feet in diameter. For a home-receiver picture tube, 30 inches in diameter, the engineers showed that a filter disk 8 feet in diameter, driven by a 5-horsepower motor, was required!

An equally important negative feature of those color-television systems was that they were incompatible with the industry-wide standards adopted for monochrome television in 1941. The National Television Systems Committee (NTSC), an agency of the Radio (later Radio and Television) Manufacturers Association, had established 525 scanning-lines per interlaced frame, and 30 interlaced-frames per second, as the standards. The CBS color system used 343 scanning-lines per interlaced frame and produced 60 interlaced-frames (20 in each of the primary colors) per second. RCA's field sequential system also was incompatible with the monochrome standards.

The Second World War brought all commercial television research to a halt. During that period, the major re-

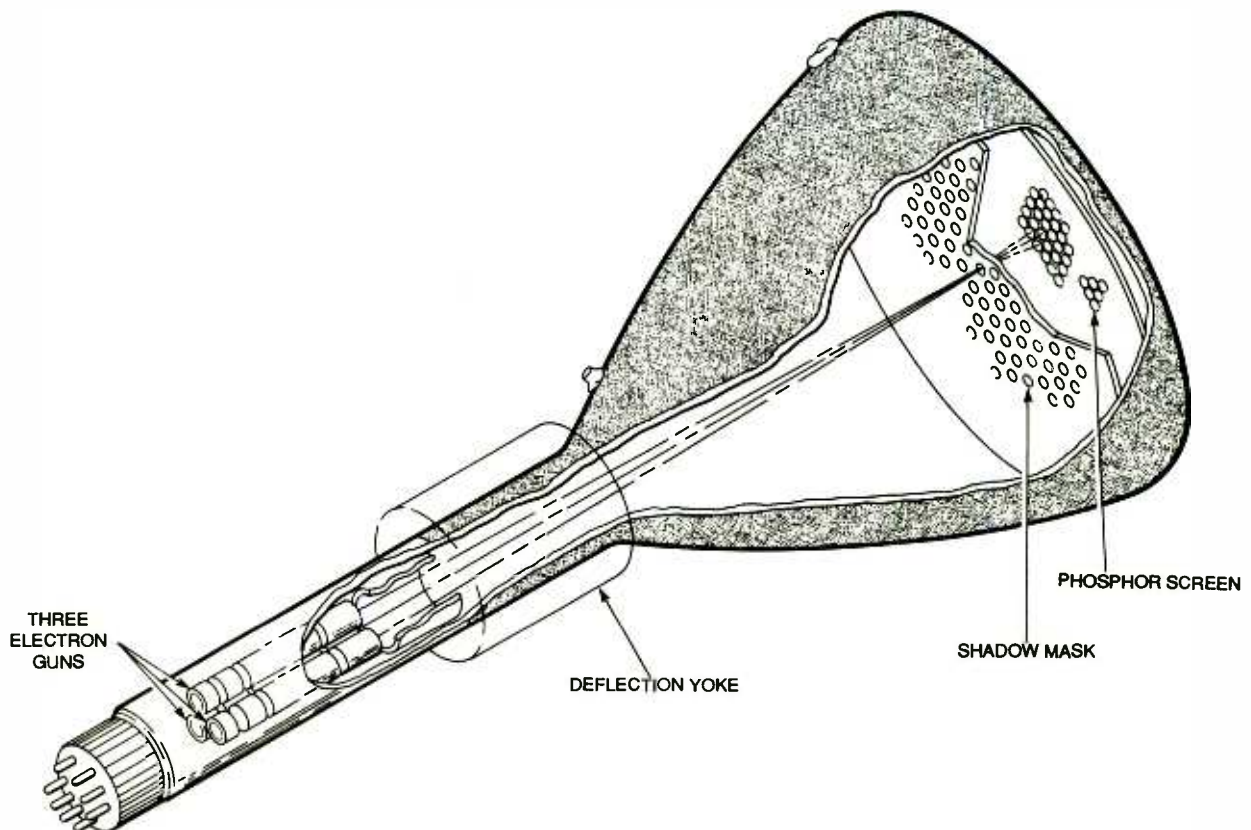

Fig. 2. The three electron-gun, shadow-mask color-TV picture tube led to RCA's successful development of a compatible color-TV system.



*David Sarnoff of RCA led the fight to develop an all electronic and compatible color-TV system.*

search laboratories devoted their efforts to war-related work.

**Post-War Developments.** In the fall of 1946, CBS petitioned the FCC to approve a field-sequential color-TV system with 144 fields per second and 525 lines per frame as the color-television standard. That required a 12-MHz bandwidth per channel, twice that used by monochrome broadcasting. The FCC denied the CBS request.

At the same time, RCA was developing a "simultaneous" color-TV broadcasting system that required four separate transmitters (one for each of the primary colors and one for the sound) that occupied a total bandwidth of 14 MHz per channel. RCA claimed that its system was "compatible" by maintaining that one video signal (the green one) together with the sound signal could be

viewed in black and white on monochrome receivers equipped with a UHF-to-VHF frequency converter. Unfortunately for RCA, that system could produce shades of gray and good detail on monochrome receivers only if green subjects were being televised!

Both the field-sequential and simultaneous color-television systems actually transmitted three separate pictures. As a result, the bandwidths required for those transmissions were inherently greater than that required by monochrome television. With more and more television stations being licensed all the time, available frequency space was becoming scarce. A new color-television system that could operate within the 6-MHz channel bandwidths used by monochrome television had to be developed.

Color television experiments of vari-

ous types continued at both CBS and RCA. CBS began demonstrating a modified field-sequential system that now occupied only a standard 6-MHz bandwidth. The CBS engineers accomplished that using 405 scanning lines and 144 fields, but could achieve only 77 and 55 percent, respectively, of the vertical and horizontal resolutions of standard black-and-white transmissions. Even though the bandwidth of the CBS color system now was the same as monochrome television's, the two systems were not compatible due to the different number of scanning lines and field rates used.

By early 1949, RCA was committed to developing a truly compatible, all-electronic, color-television system that occupied the standard monochrome-channel bandwidth of 6 MHz. That reduction in bandwidth was achieved using a "time-division multiplex" system for transmitting periodic samples of the signals rather than transmitting entire signals. In addition, RCA soon incorporated a technique called "dot interlacing." That permitted increased picture brightness without increased flicker, while still maintaining a 6-MHz bandwidth.

CBS continued to produce color pictures at the receiver through the use of a large filter disk rotating in front of a monochrome kinescope (picture tube). RCA, however, used three separate picture tubes, each one with its own special phosphors, to produce the red, green, and blue images, respectively. The three picture tubes were mounted in a single very large cabinet with mirrors to combine the three images into a single picture.

RCA knew that the large size and high cost of the three-picture-tube, or "triniscope," receiver was not likely to have much appeal to potential home viewers. A crash program was initiated to develop a single display tube that would produce a color picture without the use of rotating disks and other external equipment. David Sarnoff made sure that all the resources of RCA were made available to that project.

**Standards for Color TV?** In September of 1949, the FCC began hearings to determine if industry-wide standards now could be established for color television. Testimony began immediately, while demonstrations of



the systems being proposed were scheduled to begin later on, in October. The testimony and demonstrations would continue off-and-on for many months. The only serious contestants in that technological competition were CBS and RCA.

The RCA system required numerous adjustments to be precisely set in order to have it perform reasonably well. Color instability, a serious problem even under the best of conditions, was aggravated by temperature and humidity effects. The day of RCA's initial demonstration was one of record-breaking heat and humidity. It was in reference to that initial demonstration that David Sarnoff later reported that "The monkeys were green, the bananas were blue, . . ."

The demonstration of the CBS system went much better. The picture quality was more than acceptable; it was good. However, the hearings were not yet over. Many more months of testimony and demonstrations remained.

RCA engineers were at work virtually around the clock to improve the design of their system. Noticeable improvements were made prior to the next demonstrations, held in

#### Further Reading

Abramson, Albert, *The History of Television, 1880-1941*, McFarland & Co. Pub., Jefferson NC, 1987.

Barstow, J.M., "The ABC's of Color Television," *Proc. IRE*, vol. 44, pp. 1574-1579, November 1955.

Brown, G.H., *and part of which I was—Recollections of a Research Engineer*, Angus Cupar Pub., Princeton NJ, 1982.

Dreher, Carl, *Sarnoff—An American Success*, Quadrangle/The New York Times Book Co., New York, 1977.

Harold, Edward W., "History and Development of the Color Picture Tube," *Proc. Soc. Info. Display*, vol. 15/4, pp. 141-149, 1974.

Ives, H.E., "Television in Colors," *Bell Lab. Rec.*, vol. 7, pp.439-444, July 1929.

Knapp, J.G. and Tebo, J.D., "The History of Television," *IEEE Communications Society Magazine*, vol. 16, pp. 8-22, May 1978.

Lyons, Eugene, *David Sarnoff*, Harper & Row Pub., New York, 1966.

Ryder, J.D. and Fink, D.G., *Engineers and Electrons*, IEEE Press, New York, 1984.

Udelson, Joseph H., *The Great Television Race*, Univ. of Alabama Press, University AL, 1982. ■



Vladimir Zworykin, who made many important contributions to the development of all-electronic television, is shown holding his "Iconoscope." (All photographs courtesy of the David Sarnoff Research Center.)

November. By the end of the November demonstrations, the most serious and obvious remaining drawback to the RCA system was its need to use three picture tubes in the receiver. RCA already could very convincingly demonstrate the compatibility of its color system with existing monochrome television.

CBS engineers also were busy at work during that time. They attempted to overcome their "incompatibly" problem through the use of a converter circuit that could be added to monochrome television receivers built in the future. The question of how to enable the millions of already existing monochrome sets to receive the CBS color transmissions was left unanswered, however.

#### The Shadow-Mask Picture Tube.

RCA's crash program to produce a single-tube color display paid off. After only approximately four months of intensive work, RCA scientists and engineers succeeded in producing prototypes of two versions of what was called a "shadow-mask" picture tube. The company then planned to use both types at the next round of demonstrations scheduled for March, 1950.

The shadow-mask picture tube used many tiny phosphor clusters, each consisting of three different light-emitting phosphors arranged in tiny dots on the surface of the viewing screen. One dot in each cluster emitted red light when activated by a

(Continued on page 94)



*Save time and money with this easy-to-use tester that can check the condition of telephone lines, jacks, and more.*

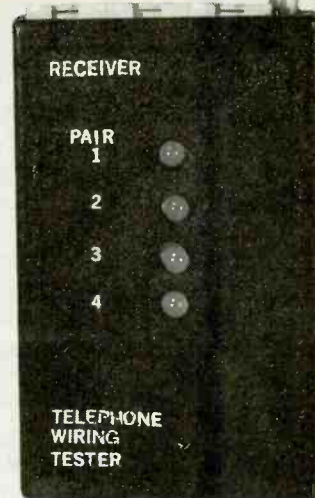

# BUILD THIS TELEPHONE-WIRING TESTER

BY CHRISTOPHER ZGURIS

As most of you probably know, since deregulation allowed homeowners and businesses to own their own telephone equipment, phone companies have responded by taking no responsibility for any gear, including the wiring, inside a building unless an extra charge is paid. As a result, calling the phone company in the event of a service outage can be an expensive proposition. If the problem does not lie with the phone company's equipment outside, you can be charged a hefty fee for a service call, and the problem might still not be resolved.

If you'd like to avoid that problem, or if you regularly install or maintain telephone equipment, the *Telephone-Wiring Tester* described in this article could be for you. The Tester consists of two units, a transmitter and a receiver, and is designed to test installed telephone wire, modular cords, modular jacks, or any combination of those for continuity and reversed polarity.

As we will see later on, the transmitter and receiver can be used together or individually, depending on what is being tested. When both units are used together, the 9-volt battery in the transmitter provides power (on the transmitter's face, there are four standard single-color LEDs that will glow when the two units are properly connected to each other).

The receiver uses tri-color LEDs to indicate line operation and polarity.

Each tri-color LED contains a red and green element wired in parallel. When DC is applied to the LED, it will glow either green or red (depending on the polarity); if AC is applied, both internal elements will glow, resulting in an orange color. The Tester can test up to four voice pairs at once using one tri-color LED for each voice pair (each voice pair has two wires that carry one telephone line).

**Modular-Jack Basics.** Both the transmitter and receiver each contain three modular jacks: one 6-position, 6-contact Jack, and two 8-position, 8-contact Jacks. Let's look closely at each of those, as well as the plugs that match them.

The 6-position, 6-contact Jack is similar to the jack used for single-line telephones, with one difference: the single-line version of the jack has 6 positions and 4 contacts. Even though the 6-position, 6-contact jacks used in the Tester units have more contacts than the ones used for single-line telephones, they are compatible and the latter can still be tested. If you look at the clear modular plug on the end of a telephone cable, you will notice from four to six gold "teeth;" those are the contacts. You should also notice that the "teeth" are set within grooves; those grooves are the positions. Not all the grooves (positions) will necessarily have "teeth" (contacts).

Now, if you look straight into a modular jack you will notice tiny bare wires. When the modular plug goes into the modular Jack, the grooves on the modular plug guide those little wires onto the teeth and contact is made. The 6-position jack is designed to carry up to three voice pairs, depending on the number of contacts. Even though the jack could be a 4-contact unit, it can only carry two voice pairs if it is hooked up to multi-pair wire.

If the wire going to and from the jack has four conductors (red, green, yellow, and black) it is a quad cable and not meant for two voice pairs. That cable is meant for a single voice pair, carried on the red and green wires, with the yellow and black ones carrying power for telephone accessories. If the cable going to and from the jack has white-with-blue, blue-with-white, white-with-orange, and orange-with-white wires, it is twisted-pair cable that is designed to carry more than one voice pair. The difference between the quad and twisted-pair cable is that the latter has the two voice-pair wires twisted together throughout the length of the cable, as opposed to the bundled, individual wires in quad cable. The twisted voice-pairs are highly immune to crosstalk and noise.

If you find a modular plug that has eight teeth, then it is not compatible with a 6-position jack. Although it looks similar and works in the same manner, it is noticeably larger and can only be

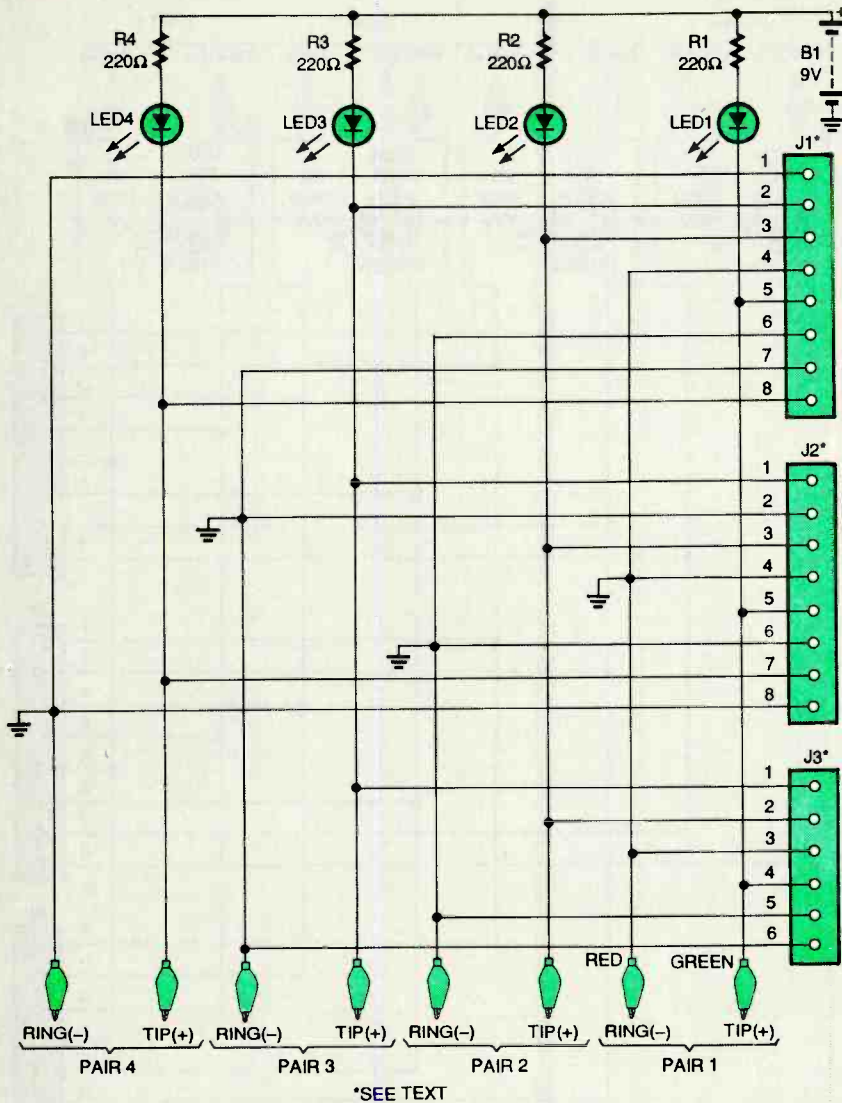

Fig. 1. Here is the schematic for the transmitter unit of the Telephone Wiring Tester. The alligator clips shown at the bottom of the diagram can be used to connect the transmitter to the receiver or to telephone-line voice pairs. Of course, telephone lines can also be connected to modular-jacks J1-J3.

used with an 8-position, 8-contact modular jack.

The two 8-position, 8-contact jacks in each unit are wired differently. One is wired as a USOC (Universal Service Order Code) jack (usually used to carry four telephone lines) and the other is wired for the AT&T standard (used for the Merlin and other key systems). The 6-position, 6-conductor jack in each unit is wired to the USOC standard, which is what most standard telephone devices use.

**How it Works.** Figure 1 shows the schematic of the Tester transmitter. No power switch is used in the unit; the circuit is turned on either when the clips in pairs 1-4 or jacks J1-J3 are

connected to a closed circuit (that could be the receiver unit, a telephone line, etc.). When all the lines (pairs) of the circuit are closed, power from the 9-volt battery, B1, flows through the 220-ohm current-limiting resistors, R1-R4, to the single-color LEDs, LED1-LED4, causing them to light. If only some of the line pairs are connected to closed circuits, then only the LEDs in series with those lines light up (LED1 connects to pair 1, LED2 connects to pair 2, etc.).

Power from the transmitter goes out the positive contacts on the modular jacks or green alligator clips. The negative contacts and red alligator clips are attached to ground (the negative terminal of B1).

## PARTS LIST FOR THE TRANSMITTER

- LED1-LED4—Light-emitting diode, any color (see text)
- R1-R4—220-ohm, ¼-watt, 5% resistor
- J1, J2—8-position, 8-contact, modular phone jack
- J3—6-position, 6-contact, modular phone jack
- B1—9-volt battery
- Perforated board, project enclosure, red and green alligator clips (four of each), battery clip and leads, telephone wire, wire, solder, hardware, etc.

## PARTS LIST FOR THE RECEIVER

- LED1-LED4—Two-lead, tri-color light-emitting diode (see text)
- R1-R4—330-ohm, ¼-watt, 5% resistor
- J1, J2—8-position, 8-contact, modular phone jack (see text)
- J3—6-position, 6-contact, modular phone jack
- Perforated board, project enclosure, red and green alligator clips (four of each), telephone wire, wire, solder, hardware, etc.

**Note:** The following is available from Christopher Zguris (521 West 26th St. 5th Fl., New York, NY 10001): A partial kit of parts for both Tester units containing all LEDs, resistors, modular jacks, alligator clips, and four-conductor wire: \$23.00 + \$4.00 S/H. New York residents please add appropriate sales tax.

When the receiver (see Fig. 2) is attached to the transmitter (using the modular jacks or the alligator clips), power flows through the 330-ohm current-limiting resistors, R1-R4, to the tri-color LEDs, LED1-LED4. If power comes through the modular jack contacts or alligator clips with the correct polarity, the tri-color LEDs on those lines will glow green. When power comes in reversed, the tri-color LEDs in the proper lines will glow red. Finally, if there is a short, the LEDs in the transmitter will glow because the short has completed the circuit, and the tri-color LEDs in the receiver will not glow.

Jacks J1–J3 in the transmitter (Fig. 1) are exact matches for jacks J1–J3 in the receiver (Fig. 2), and are wired in the same way. Modular-jack J1 is a 8-position, 8-contact unit that is wired as a USOC jack. Jack J2 is also an 8-position, 8-contact unit, but is wired for the AT&T standard. Finally, jack J3 is a 6-position, 6-contact unit, that is also wired as a USOC jack.

**Construction.** The author's prototype units were built on perforated board using point-to-point wiring, but any standard project-building method can be used. Just make sure that the correct wires are connected to the correct LEDs. To make things easier, use multicolored connection wires to connect each point on the modular jacks to the correct component or common point.

The project enclosures used for the prototype units are the transmitter cases available from Radio Shack (catalog no. 270-293); they have built-in 9-volt battery compartments with slide-off covers. You will probably have to cut the circuit boards to make them fit into the cases. For that reason, make sure to keep the circuit connections close together; the wiring can get a bit cramped, but if you are careful you should have no problems. You will also have to cut holes in the cases for the LEDs. Make sure to label those holes with the matching pair number (LED1 in both units should be labeled "Pair 1," LED2 is "Pair 2," etc.).

The tri-color LEDs used in the receiver have to be of the type with only two leads; the ones used in the prototype are available from Radio Shack (catalog no. 276-012). Three-lead tri-color LEDs are available, but they will not work in the receiver circuit. If you cannot find two-lead tri-color LEDs you can get the same result by taking a red LED and a green LED and wiring them together in parallel with their polarities crossed (anode-to-cathode, cathode-to-anode), or you can order the LEDs as part of the partial kit available from the source given in the Transmitter Parts List. Tri-color LEDs must be installed correctly to get the color results mentioned in the tests. In the Radio Shack LEDs that were mentioned earlier in this article, the flat pin should be connected to the negative line.

The next step is to create wire as-

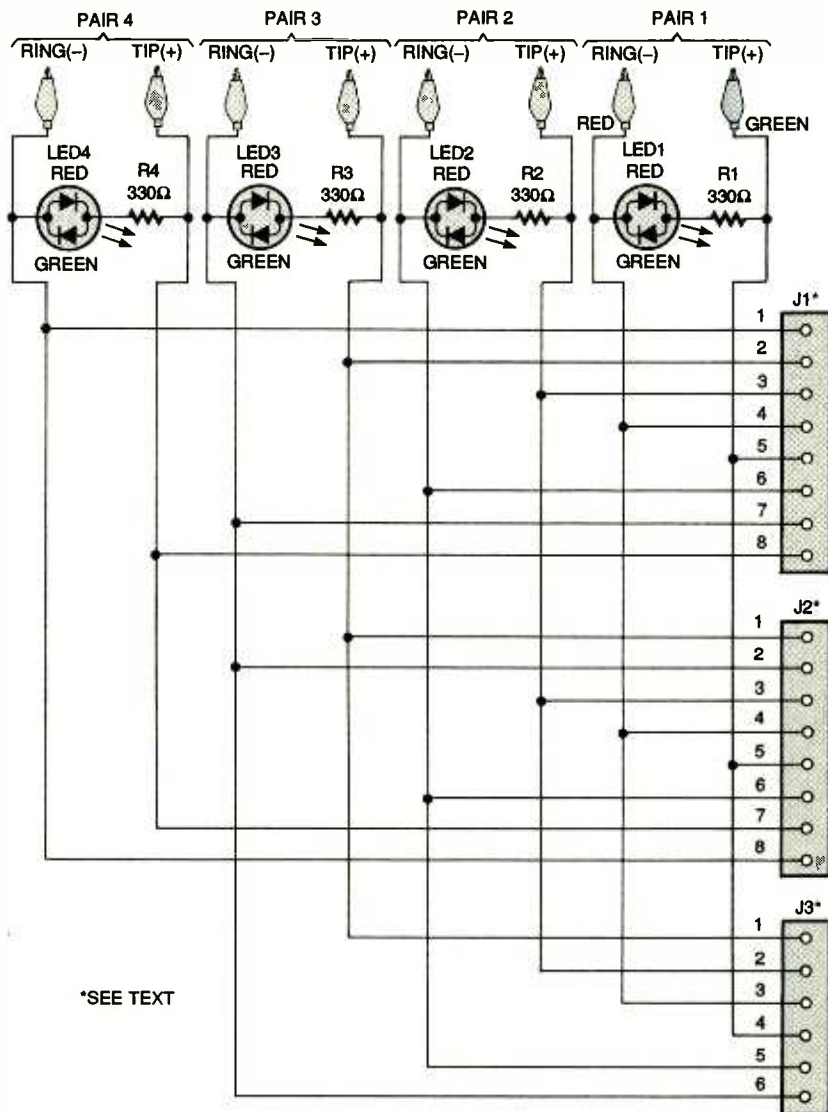

Fig. 2. The receiver circuit shown here contains tri-color LEDs to let the user determine whether polarity on a phone line is correct (a green glow) or reversed (a red glow). Also, it indicates if AC is on the line (an orange glow).

semblies for the pairs of alligator clips. To do that, take eight short lengths of 4-conductor, 22-gauge, solid-copper station wire, strip off the ends of the outer sheaths, and clip the protruding yellow and black wires at both ends. Then solder one red and one green alligator clip to the remaining red and green leads on one end. Repeat that for the other seven cables. When that's completed, solder the red and green leads at the other end of the cable pairs to the correct points in the circuit.

Each cable pair should be numbered to correspond with the voice pair it is connected to. To accomplish that, you could use colored wire-marking tape and write the pair num-

bers on it. If you use the colored tape, the colors should be blue for pair 1, orange for pair 2, green for pair 3, and brown for pair 4. Those colors correspond with the standard color order for twisted-pair cable.

When you have completed all the electrical connections in the circuits, it is time to attach the modular jacks to each other, side by side, using a few drops of epoxy. Then take those three-jack assemblies and attach to them to their respective project cases using epoxy. After the epoxy dries, use a few more drops of epoxy to glue the wire assemblies to the cases. Once the epoxy dries the whole assembly should be very strong.

(Continued on page 94)

**A** zero-center DC voltmeter, often called a galvanometer, is a useful addition to any hobbyist's workbench. That's because many circuits, including the Wheatstone bridge, need to be used with that type of null indicator. Also, another handy device to have around is a variable-gain amplifier that can be used with an external device, such as an oscilloscope. Of course, purchasing both of those devices could be expensive.

So, do you want an inexpensive way to get both units? Build the *Galviamp* described in this article. The project is a combination of a galvanometer and a variable-gain amplifier in the same package. And best of all, the *Galviamp* doesn't sacrifice performance for compactness.

**Circuit Description.** Figure 1 shows the schematic for the *Galviamp*. Op-amps U1-a, U1-b, and U2-a form a differential amplifier with a very high input impedance, while U2-b is used as a driver for a pair of back-to-back LEDs (LED1 and LED2) that help find the null condition. Both U1 and U2 are CA3240 BiMOS dual op-amps, available from Digi-Key (P.O. Box 677, Thief River Falls, MN, 56701-0677; Tel. 1-800-344-4539), as well as other sources.

A differential-input amplifier is formed by U1-a and U1-b. Each of those op-amps is connected in a noninverting-follower configuration. That configuration is used because the input impedance of the overall amplifier is essentially the input impedance of the device (which is not true if the inverting follower circuit is used). For a BiMOS op-amp, the input impedance is approximately 1012 ohms!

Op-amp U2-a is configured as a DC-differential-amplifier circuit that combines the outputs of U1-a and U1-b. The output of U2-a is equal to the difference between the outputs of U1-b and U1-a. That output voltage is applied to both meter M1 and output-jack J4 (which can be used to send the analog output signal to an os-

cilloscope, external voltmeter, or other display device).

The voltage gain ( $A_v$ ) of the *Galviamp* is a function of the resistance between the inverting outputs of U1-a (pin 2) and U1-b (pin 6). That function can be solved for using the formula:

$$R = 112,000/(A_v - 1)$$

where R is the resistance in ohms between the two inverting outputs. In the *Galviamp*, that resistance value is selected by a double-pole triple-throw (DP3T) switch, S1. That switch selects a 220-ohm resistance in the HIGH position, a 2200-ohm resistance in the

also an output indicator. That device is a zero-center milliammeter with a range of  $-1$  to  $+1$  mA. Because the output signal at pin 1 of U2-a is a voltage, and the meter is a current meter, it is necessary to convert M1 into a voltmeter. That is accomplished by resistor R13, which is connected in series with the meter. The value shown for R13 is probably suitable for most common milliammeters, but there is a possibility that it will have to be replaced for certain meters (more on that later). The value of R13 is set to produce a 1-mA current in M1 when the output voltage of U2-a is at its maximum permissible value. Because 9-volt batteries are used for the power supply in the *Galviamp*, the maximum output voltage will be around 8.5 volts.

The third output indicator for the *Galviamp* is made up of LED1 and LED2. Because they are connected "back-to-back," the LEDs become forward biased with opposite polarities. In other words, when a positive voltage is applied to the point where pins 6 and 7 of U2-b are connected, LED2 emits light and LED1 remains off. But when the voltage is negative, LED2 remains off and LED1 lights. Resistors R11 and R12 limit the current to protect the LEDs.

The LEDs are driven from the output of U2-b. That op-amp is connected in the unity-gain, noninverting-follower configuration, which is when the output (pin 7) is

connected to the inverting input (pin 6). The voltage gain is  $+1$ , so the voltage where pins 6 and 7 meet is equal to the output of U2-a.

The DC power for the *Galviamp* is supplied from a pair of 9-volt batteries. The op-amps require two power supplies because their outputs might have to swing either positive or negative, depending on the input signals and their polarities. Battery B1 supplies a negative power source with respect to ground or common, while battery B2 supplies a positive source with respect to ground or common. Those power-supplies are switched on and off by switch S4, a

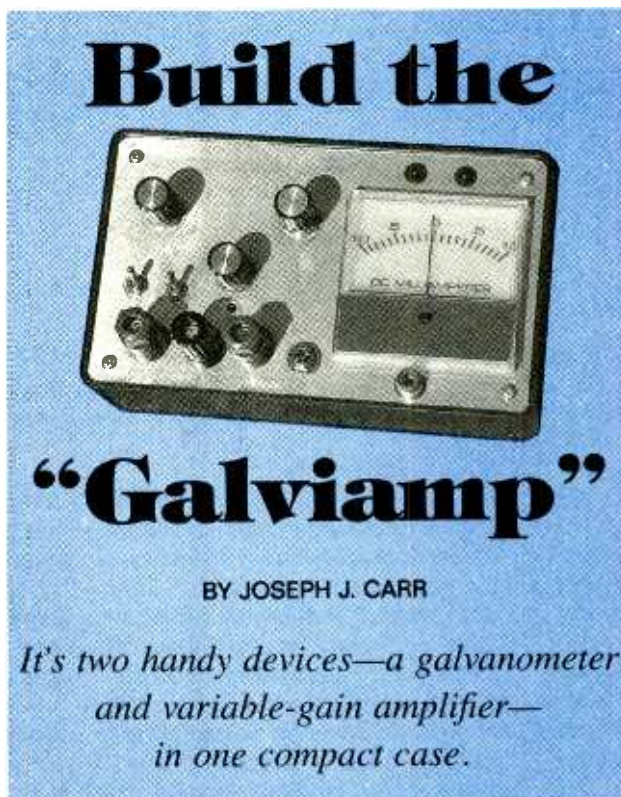

**Build the**  
**“Galviamp”**  
BY JOSEPH J. CARR  
*It's two handy devices—a galvanometer and variable-gain amplifier—in one compact case.*

low position, and a variable resistance of 150 to 1150 ohms in the VARIABLE position. The HIGH and LOW positions produce fixed gains of about 500 and 50, respectively, and the VARIABLE position results in a variable gain of 96 to 745 (depending upon the adjustment of R4).

There are three output indicators used on the *Galviamp*. First, there is the analog-output jack, J4, which can be used to drive any of several display or recording devices (for example, an external voltmeter, an oscilloscope, or the analog-to-digital-converter input of a computer).

Second, the built-in meter, M1, is

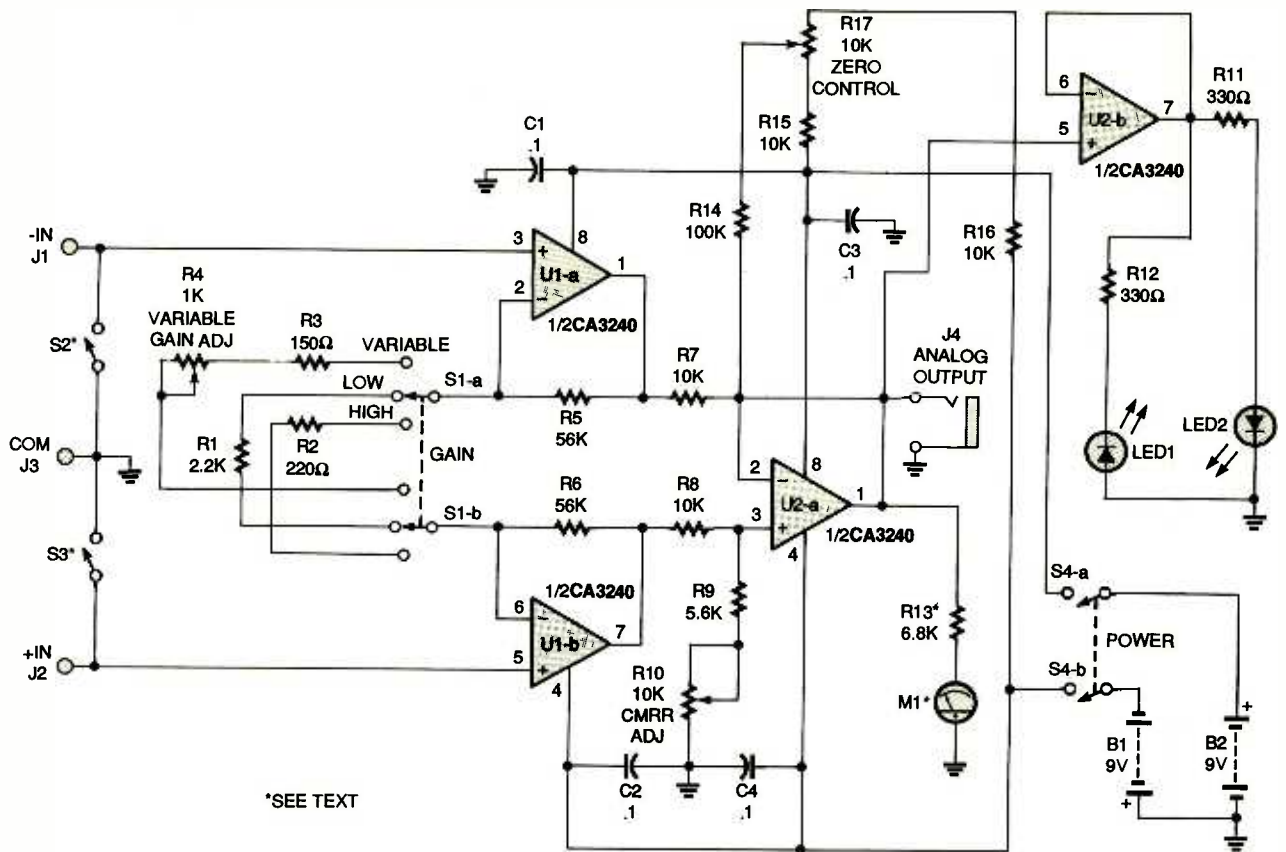

\*SEE TEXT

Fig. 1. Here's the schematic for the Galviamp. Notice that batteries B1 and B2 are configured to provide either positive or negative power to U1 and U2; those op-amps require two power supplies because their outputs might have to swing either positive or negative, depending on the input signals and their polarities.

double-pole single-throw (DPST) toggle switch.

Note that a 0.1- $\mu$ F capacitor is connected between the power-supply pins of both op-amps and ground. Those capacitors are needed to prevent the op-amps from bursting into self-oscillation—an undesirable problem. Those capacitors must be mounted as close to the power-supply pins (pins 4 and 8) of each op-amp as possible, and the leads must be kept as short as possible.

Potentiometer R17, the zero control, is essentially an offset null control. It is adjusted to force the output voltage of U2-a to zero when the input voltage is zero. That is done with both inputs, J1 and J2, shorted to the common terminal, J3 (more on that later). The CMRR (common-mode rejection-ratio) adjust control, potentiometer R10, is used to balance the amplifier to make it truly differential (a differential amplifier does not respond to common-mode signals—signals that are applied equally to both inputs).

The Galviamp uses a differential input. That is, there are two inputs (each

of which are referenced to ground) and the amplifier responds to the difference between the signal voltages applied to each. The +IN input, J2, is "noninverting" (that is what is indicated by the "+" sign) so it produces an output that is in-phase with the input. In other words, a positive signal at J2 will produce a positive-polarity output signal at J4 and M1; similarly, a negative input on J2 places a negative signal at J4 and M1.

The -IN input, J1, is inverting (as indicated by the "-" sign), so it produces an output signal that is 180-degrees out-of-phase with the input signal. That is, a positive signal applied to J1 produces a negative signal at J4 and M1, while a negative signal at J1 produces a positive signal at J4 and M1.

Switches S2 and S3 can be used to set the circuit to four operating modes: First, when both S2 and S3 are closed, both inputs (J1 and J2) are shorted to ground; that mode can be used for testing, and for ensuring the zero-volts baseline is, indeed, zero volts. Second, if S2 is open and S3 is closed the input of J2 is grounded, so

the Galviamp operates as a one-input inverting amplifier. Third, when S2 is closed and S3 is open, the J1 input is grounded, and the circuit operates as a noninverting amplifier. Fourth, if S2 and S3 are both open, the circuit goes into a differential mode.

**Construction.** In the author's prototype, the amplifier electronics were built on a perforated board with a ground bus, using point to point wiring, but any other project-building technique can be used. The interconnections on the board can be made with 24-gauge solid hook-up wire. As with most projects, install the ICs last, to prevent them from being damaged. Several components mount off-board, on the front panel of the project enclosure. Those are: J1-J4, S1-S4, R4, R17, LED1 and LED2, and M1.

Before mounting milliammeter M1, make sure that you have a proper-value resistor for R13. If you find that a value other than 6800 ohms is needed, try this method to find a suitable substitution: To begin, determine

the value of your meter's resistance. You might find that number inscribed in nearly imperceptible type in a lower corner of the meter face. Otherwise, you might have to consult the manufacturer's catalog or data sheet. In a pinch, you can measure it with an ohmmeter, but that might be dangerous to the milliammeter.

If you use an analog ohmmeter to measure the resistance, then make sure that it doesn't use an internal battery with a value of more than 1.5 volts. Some older-model vacuum-tube voltmeters used a 22.5-volt battery, and those are guaranteed to wipe out a milliammeter being tested. Your best bet is to use a digital multimeter on the low-powered ohmmeter setting. Be careful not to use the "diode" setting, however, as that will probably damage the milliammeter as well.

Whichever ohmmeter you use, start

### PARTS LIST FOR THE GALVIAMP

#### RESISTORS

(All fixed resistors are 1/4-watt, 5% units, except where noted.)

- R1—2200-ohm
- R2—220-ohm
- R3—150-ohm
- R4—1000-ohm, linear-taper potentiometer
- R5, R6—56,000-ohm
- R7, R8, R15, R16—10,000-ohm
- R9—5600-ohm
- R10, R17—10,000-ohm, linear-taper potentiometer
- R11, R12—330-ohm, 1/2-watt
- R13—6800-ohm (see text)
- R14—100,000-ohm

#### ADDITIONAL PARTS AND MATERIALS

- U1, U2—CA3240 BiMOS dual op-amp, integrated circuit
- LED1, LED2—Red light-emitting diode (see text)
- C1-C4—0.1-μF, Mylar capacitor
- M1—Zero-center milliammeter (see text)
- S1—DP3T rotary switch
- S2, S3—SPST miniature toggle switch
- S4—DPST miniature toggle switch
- J1-J3—Binding post
- J4—Phono jack, chassis-mounted
- B1, B2—9-volt battery
- Perforated board, project enclosure (Radio Shack 270-627 or equivalent), two battery clips, two 8-pin IC sockets for U1 and U2, wire, solder, hardware, etc.

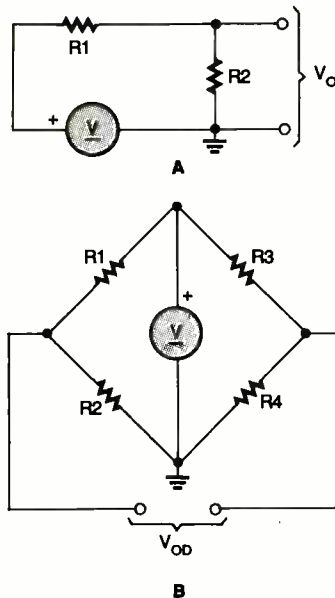

Fig. 2. A simple resistor voltage-divider network (A) is one half of a Wheatstone-bridge circuit (B).

at the highest ohms scale and connect one lead of the ohmmeter to the milliammeter. Then quickly and lightly tap the other lead to the other milliammeter terminal while watching that meter's pointer. If that pointer doesn't deflect rapidly, then it's probably safe to continue. If it does move rapidly to one end, then lower the ohmmeter scale and try again until you don't get a deflection.

Once you know the value of the meter's resistance ( $R_m$ ), then the value of R13 (in ohms) can be calculated from:

$$R13 = 1000V_{max} - R_m$$

where  $V_{max}$  is the maximum output voltage at pin 1 of U2-a (that should be approximately 8.5 volts).

Once the value of R13 is determined, select an actual resistor that is of the next-higher standard value. Alternatively, make a series combination of a potentiometer and a fixed resistor; adjust the potentiometer so that the combination equals the calculated required resistance value.

There are two other components that need to be selected carefully for use in the circuit: LED1 and LED2. They are connected in a back-to-back configuration, and to work properly, the LEDs should be uniform in output light levels. To test LEDs for that, connect them in series with 470-ohm resistors to 9-volt batteries and com-

pare their light output. Try several, and use the pair that seem to match the best.

The project enclosure used in the author's prototype is the Radio Shack "Experimenter's Box" (270-627)—it is made of plastic, and has an aluminum front panel (if the Galviamp is to be used in the presence of strong RF fields, then an all-aluminum cabinet can be substituted to provide shielding). Insulated 24-gauge hook-up wire can be used for connecting the panel-mounted components to the remainder of the circuit. However, you might want to use wires of different colors to spare yourself some eye strain.

When you are done wiring all the on- and off-board components together, carefully go over all your connections a second time. Make sure in particular that the ICs are hooked up correctly.

**Adjustment and Setup.** Adjusting the Galviamp is relatively simple, especially if you have an oscilloscope or AC voltmeter available to use as an AC output indicator. To begin, turn on switch S4 and note the indication on M1. If M1 slams to one peg, immediately turn off S4 and look for a wiring error. But if M1 is either at zero, or some moderate positive or negative deflection, then proceed with adjustment after letting the unit warm up for about 5 minutes (to control drift).

Next, short J1, J2, and J3 together by closing switches S2 and S3. Turn R10 approximately to the middle of its range, and set S1 to the low position. Adjust R17 (zero control) for a zero-mA indication on M1. Then set S1 to the HIGH position, and re-adjust R17. Connect either an AC voltmeter or an oscilloscope to analog-output-jack J4. Open switches S2 and S3, and connect a short piece of uninsulated wire from J2 to J3. Connect an audio-signal generator to that wire (use 100 to 2000 Hz if an oscilloscope or AC voltmeter is used at J4, or 100 to 400 Hz if the "AC" function of an ordinary multimeter is used). Adjust the signal generator output to about 1- to 3-volts peak-to-peak.

Set S1 to the low position again, and adjust R10 for minimum AC-signal output. Set switch S1 to the HIGH position and adjust R10 again until no further improvement is possible. Disconnect

the audio-signal generator and remove the short from between J2 and J3. The Galviamp is now ready for use. As a matter of practice, keep S2 and S3 closed when the amplifier is not being used.

**Wheatstone Application.** The Galviamp can be used for a wide variety of workbench and experimenter applications, but it also has its applications in scientific instrumentation. One such application is to use the Galviamp as an amplifier for a Wheatstone bridge.

A Wheatstone bridge can be developed from a simple resistor voltage-divider network, shown in Fig. 2A. Output-voltage  $V_o$  is a fraction of applied-voltage  $V$ . The value of  $V_o$  is found from:

$$V_o = VR2/(R1 + R2)$$

In the context of the Wheatstone bridge, Fig. 2A is sometimes called a half-bridge circuit. If R2 is either a thermistor or a photoresistor, then the output voltage will be proportional to either the temperature or light level, respectively. A disadvantage of that circuit is that there is a perpetual DC offset unless R2 has a value of zero ohms. If we have a temperature probe at R2, therefore, a zero-degree temperature does not yield a zero-volt output state. That problem can be solved by the Wheatstone bridge circuit shown in Fig. 2B.

If we connect two half bridges in parallel, as in Fig. 2B, we have the classic Wheatstone bridge circuit; R1 and R2 form one half of the bridge, while R3 and R4 form the other. The differential output voltage  $V_{od}$  is the difference between the output voltages of the two half bridges, and can be calculated using:

$$V_{od} = V \left( \frac{R2}{R1 + R2} - \frac{R4}{R3 + R4} \right)$$

When the two half bridges are in balance, the output voltage is zero. In that state, the bridge is said to be in a null condition. If the values of resistors R1 through R4 are correctly selected, then the null condition can exist when the physical parameter (e.g. temperature) is also zero. Exact values of the applied parameter can be read as deviations of  $V_{od}$  from zero.

The Wheatstone bridge can also be used for comparison measurements.

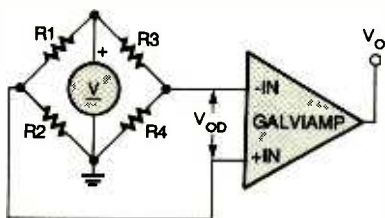

Fig. 3. Simply connect the  $V_{od}$  output of a Wheatstone bridge to the  $-IN$  and  $+IN$  inputs of the Galviamp to use the two circuits together.

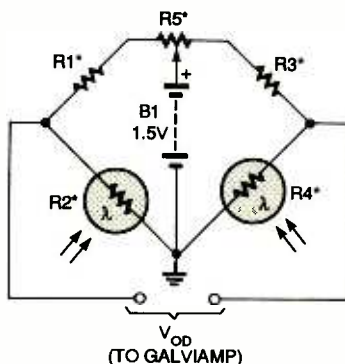

Fig. 4. By using two photoresistors in a Wheatstone bridge, and adding a potentiometer, you can make a colorimeter for use with the Galviamp.

Suppose R2 is a potentiometer, and R4 is a temperature sensor. Calibrate a dial connected to the shaft of R2 in units of temperature, using the characteristics of the thermistor used for R4 to determine the range. If you allow the thermistor to stabilize, and then adjust R2 for a null condition on M1, the temperature can be read from the dial attached to R2.

When designing Wheatstone bridge circuits for an experiment, remember this: The ratio of the two half bridges must be equal for a null to occur, but the actual resistance values can be different. That is:

$$R1/R2 = R3/R4$$

Figure 3 shows how to connect the Wheatstone bridge to the Galviamp. The output voltage  $V_{od}$  is connected across the differential inputs ( $-IN$  to  $+IN$ ) of the Galviamp. The output voltage  $V_o$  is equal to the product of the differential gain of the Galviamp and the bridge output voltage ( $V_{od}$ ).

**A Colorimeter.** Figure 4 shows an application for the Galviamp that uses two photoresistors, R2 and R4. That little circuit is called a colorimeter, and is the basis for a large

family of medical, engineering, and scientific instruments.

The photoresistors can be any two matching units. Once you have selected two identical ones, use an ohmmeter to measure their nominal resistance at normal room-illumination levels (be sure that the resistance is not less than about 500 ohms, or battery life will be short, and the photoresistors might self-heat, causing errors). Select fixed resistors for R1 and R3 that have approximately the same resistance value as the photoresistors. The value of R5 should be from  $0.3R1$  to  $1.5R1$  to make it easy to balance the bridge.

Build the circuit on a piece of perf-board, keeping photoresistors R2 and R4 about 2 to 3 inches apart. If the photoresistors have clear edges, cover the perimeter with black tape or black paint to prevent scattered light from entering. Make sure that light only enters through the front of the lens over the active region.

Connect the output of the colorimeter ( $V_{od}$ ) to the input of the Galviamp, and then expose the photoresistors to room light so they are equally illuminated (with no shadows). Adjust R5 for a null condition on the Galviamp meter. By interposing colored filters between the light source and one (only one) photoresistor, it is possible to get a rough idea of the percentage of the white light that the color represents. Just consider the one-milliampererange of M1 to be a 100-percent range.

(Note: The response of a photoresistor is not consistent across the entire visible-light spectrum, so any percentages derived with the colorimeter are approximate only.)

One use for the colorimeter in science is to measure the absorption of certain wavelengths of light or infrared (with different sensors) of a sample. In one measure of blood-oxygen level ( $pO_2$ ), for example, a standard-wavelength red filter is placed in front of one photoresistor, and a calibrated volume of blood is placed in front of the other. The unbalance of the bridge is proportional to the oxygen saturation of the blood sample. Although blood analyzers are now complex instruments driven by computers, early models (some still used) are little more than expensive, precision versions of Fig. 4!



1990 was a Great Year for

# Popular Electronics®

The twelve 1990 issues of *Popular Electronics* reveal many fascinating articles. There's a bonanza of build-it project plans, informative theory articles and timeless feature stories. Check out the partial list of titles packed into the 1990 issues and you'll agree that 1990 was a banner year. If you see an article about a project, theory topic or newsworthy feature, you can have that article, with the entire issue for only \$6.50. To get your 1990 issue(s) of *Popular Electronics*, place a ✓ in the box that indicates the month you want and complete the coupon below. Note that ordering six or more copies reduces the price per issue! Tear out this page, or make a photo copy of it, and mail or FAX it today! Just follow the directions below.

## TOPICS FROM THE PAST

### Selected Projects

Audio Ambiance Ditherizer, **April**  
 Bit Grabber for Parallel I/O Testing, **December**  
 Car-Radio Silencer, **October**  
 Cordless Test Probes, **January**  
 CW and SSB, Add to a SW Receiver, **May**  
 Digital Entry Switch, **November**  
 Economy Portable SW Receiver, **August**  
 Exhaust Monitor for Car, **June**  
 Experimental AC Hum Sniffer, **September**  
 Game Reaction Timer, **April**  
 Headphone Output for Your CD Player, **July**  
 Hot-Wire Glass Bottle Cutter, **December**  
 Indoor Burglar Alarm, **December**  
 IR-Triggered Sound-Effects Generator, **October**  
 Lie Detector, Simple, **January**  
 Microphone Preamp, Simplest, **March**  
 Mobile Battery Charger, **March**  
 NiCd Battery Tester, **August**  
 Plasma Display, Custom, **February**  
 Receiver Circuits You Can Build, **March**  
 Remote-Control FAX Switch, **August**  
 Serial Cable Tester, **January**  
 Telephone Toll Totalizer, **August**  
 Tesla's Lightning Generators, **September**  
 The Lepton Candle, **October**  
 Ultrasonic Morse-Code Transceivers, **July**  
 Universal 3-Terminal Power Supply, **November**  
 Video Titrer, Super Simple, **September**  
 Vision System for Robotic Toys, **March**  
 VLF Receiver and Transmitter, **July**  
 Water Leak Alarm, **January**

External Drive for Laptop, **June**  
 First Electric Motor Project, **October**  
 Ground Fault Technology, **November**  
 Keeping Up with Pacemakers, **July**  
 Living with Lightning, **October**  
 Make Your Own Iron-on PC Patterns, **July**  
 Old-time Radio Circuits, **March**  
 Oliver Lodge: Radio's Forgotten Pioneer, **July**  
 Restoring a Classic SW Receiver, **April**  
 Solar Power, Experimenting with, **June**  
 St. Elmo's Fire, **September**  
 Surface Mount Technology, **November**  
 Television Night, a Look Back, **July**  
 Tune-in to Satellite Radio, **May**  
 Using Appliances Overseas, **January**

### Theory for Everyone

3-Terminal Voltage Regulators, **May**  
 200,000-volt van de Graaff Generator, **October**  
 All About Batteries, **August**  
 All About Thermistors, **December**  
 CCTV Installation Guide, **November**  
 Connect Anything to Your Computer, **August**  
 Designing Power-supply Circuits, **February**  
 Digital Electronics Introduction, **April**  
 Experiments in Electrophotography, **March**  
 Fiber-Optic Communications, **April**  
 Galvanometer, Build and Learn, **September**  
 Lasers, All About, **September**  
 Printer Technology, **October**  
 Signal Generator Circuits Cookbook, **November**  
 Stepping Motors Introduction, **March**  
 Troubleshooting Computer Disk Drives, **May**  
 Troubleshooting Your Printer, **December**  
 Typing Practice Program, **August**  
 Sideband Amplifiers, **January**  
 Wimshurst Machine, **December**  
 WW1 Long Island Spy Station, **December**

### Special Features

Antenna Installation, **September**  
 Capacitors, Choosing and Using, **June**  
 Classic Amateur Receivers, **November**  
 Drying Out Flood-Damaged Equipment, **January**  
 Early Radio Transmitters, **May**

**Popular Electronics**

**1990 Issues**

January	February	March	April	May	June	July	August	Sept.	Oct.	Nov.	Dec.
---------	----------	-------	-------	-----	------	------	--------	-------	------	------	------

✓ Check the issue(s) you want.  
**How to Determine Cost per Copy**

	Price per copy		
Quantity	United States	Canada	Foreign
1-5	\$6.75 US	\$7.75 US	
6-12	5.75	6.75	\$8.50 US

Prices include handling and shipping costs. Prices subject to change. All Canada and foreign orders payable in U.S.A. funds only, via international money order, check drawn on a U.S. bank, or acceptable credit card (Visa, MasterCard) in U.S.A. funds. Allow 6-8 weeks delivery. Minimum foreign order--6 issues. Foreign orders may take longer.

Visa  MasterCard  USA Bank Check  US or International Money Order

Credit Card Number \_\_\_\_\_ Exp. Date \_\_\_\_/\_\_\_\_  
 (If used)  
 Signature \_\_\_\_\_ Total No. of Copies \_\_\_\_\_  
 Print Name \_\_\_\_\_ Total Amount \$ \_\_\_\_\_  
 Address \_\_\_\_\_  
 City \_\_\_\_\_ State \_\_\_\_\_ ZIP \_\_\_\_\_

Send orders to: CLAGGK, Inc. P.O. Box 4099, Farmingdale, NY 11735. No COD orders.  
 Credit Card user may telephone or FAX order. Telephone 516-293-3751 or FAX 516-293-3115.

# ANTIQUE RADIO

By Marc Ellis

## Putting Minerva Back Together

As those who have been following this column for the past few months know, we're in the process of restoring a *Minerva Tropicmaster Model W-117*. Not much is known about the history of either the set or its manufacturer, but the radio's high-performance circuitry, battleship construction, and just-post-WWII release date war strongly suggest that it is really a surplus military morale radio in civilian dress.

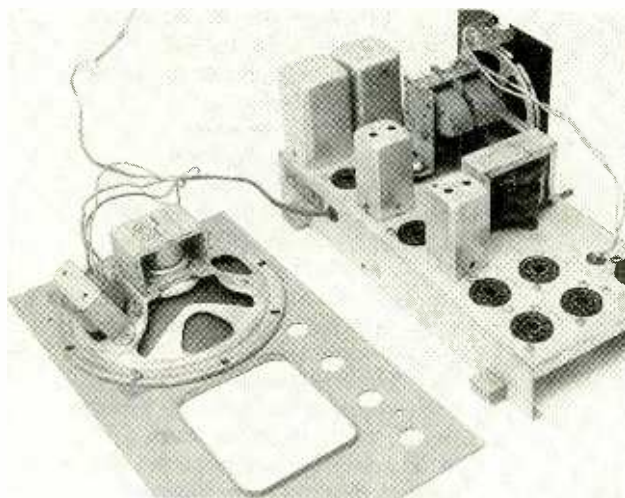

*The early stage of the reassembly process. The filter choke (behind the forward IF transformer) and the dial plate are in place; the speaker is mounted on the front panel.*

At the start of last month's session the set was already partly dismantled to facilitate the restoration work, and the top surfaces of the chassis were given a careful cleaning with Brasso, a relatively non-abrasive metal polish. The radio was also completely recapped, a procedure deemed necessary because of its obviously long residence in a damp environment (very destructive to the wax-covered paper capacitors found in sets of that era).

Later on in the session, I treated all of the controls with a control cleaner/lubricant and spent some time on the damaged filter choke, which had been dismantled for inspection and repair in the last session. Both choke leads had become disconnected from the winding inside. They were successfully reconnected, then secured in place on the surface of the winding with a couple of globs of epoxy cement.

Finally, the tuning capacitor frame, which someone had dismantled from the chassis (it was held in place only by its wiring), was snugged down against its rubber-grommet shock absorbers with a new set of screws, nuts, and washers.

### REINSTALLING THE CHOKE

I had gotten a lot of satisfaction out of replacing the Tropicmaster's dingy and mold-covered paper and electrolytic capacitors with a new set of dependable, modern units. But I was no less pleased to be putting the filter choke back together at last. Digging out the ends of the winding from the sticky layers of electrical and Scotch tape that had temporarily secured the leads to the choke core had been an annoying experience, but it felt good to have successfully reconnected a new set and securely anchored them so that they would not pull loose again.

Now that the epoxy "anchors" had completely set, I carefully taped a layer of black duct tape around the

outside of the winding to further protect the leads and give the repair a more finished appearance. The winding was then slipped back on the choke's "E"-shaped iron core, and the iron pole-piece was laid across the open end of the "E." After returning a fiber spacer/shim to its place on top of the pole piece, the choke's metal frame could be slid over this assembly to hold everything together.

The metal tabs that locked the coil/core assembly into the frame had been removed during a previous disassembly, but that didn't matter. Once the choke was reinstalled, the open end of the frame would be pressed tightly against the chassis, locking all parts together. I now fed the choke's new leads down through the grommetted "pass-through" hole provided for them and refastened the frame to the chassis. It certainly felt good to have the unit's leads, coil, core, and other parts securely reunited once and for all!

### SPEAKER AND DIAL REASSEMBLY

Next, I took a look at the speaker, which those who have been following the story from the beginning know was covered by a coating of fine rust. I had originally intended to clean up the rust a bit and try to duplicate the original finish of the speaker frame with coat of aluminum paint. But now I reexamined this plan and decided not to go through with it.

The chassis itself had not come out exactly pristine-

## Just like these Fully Trained Electronics Professionals



"Thanks to CIE I have tripled my previous salary, and I am now in a challenging and rewarding new field where only the sky is the limit."

Daniel Wade Reynolds  
Industrial Electrician  
Ore-Ida Foods



"CIE was recommended to me by my boss. It was appealing since I could study at my own pace at home and during business travel."

Dan Parks  
Marketing Manager/Consumer Products  
Analog Devices, Inc.



"I loved the flexibility CIE offered. It was the only way I could continue both school and my demanding job."

Britt A. Hanks  
Director of Engineering  
Petroleum Helicopters, Inc.



"I liked the way the school was set up with laboratory assignments to enforce conceptual learning. The thing which impressed me the most about CIE's curriculum is the way they show application for all the theory that is presented."

Daniel N. Parkman  
Missile Electro-Mechanical Technician  
U.S. Air Force



"Completing the course gave me the ability to efficiently troubleshoot modern microprocessor based audio and video systems and enjoy a sense of job security."

Tony Reynolds  
Service Manager/Technician  
Threshold Audio & Video

# Graduate with an Associate Degree from CIE!

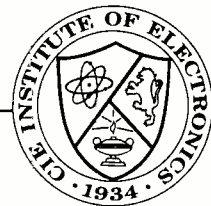

CIE is the best educational value you can receive if you want to learn about electronics, and earn a good income with that knowledge. CIE's reputation as the world leader in home study electronics is based solely on the success of our graduates. And we've earned our reputation with an unconditional commitment to provide our students with the very best electronics training.

Just ask any of the 150,000-plus graduates of the Cleveland Institute of Electronics who are working in high-paying positions with aerospace, computer, medical, automotive and communications firms throughout the world. They'll tell you success didn't come easy...but it did come...thanks to their CIE training. And today, a career in electronics offers more rewards than ever before.

### CIE'S COMMITTED TO BEING THE BEST...IN ONE AREA...ELECTRONICS.

CIE isn't another be-everything-to-everyone school. CIE teaches only one subject and we believe we're the best at what we do. Also, CIE is accredited by the National Home Study Council. And with more than 1,000 graduates each year, we're the largest home study school specializing exclusively in electronics. CIE has been training career-minded students for nearly sixty years and we're the best at our subject...  
**ELECTRONICS... IT'S THE ONLY SUBJECT WE TEACH!**

### CIE PROVIDES A LEARNING METHOD SO GOOD IT'S PATENTED.

CIE's AUTO-PROGRAMMED® lessons are a proven learning method for building valuable electronics

career skills. Each lesson is designed to take you step-by-step and principle-by-principle. And while all of CIE's lessons are designed for independent study, CIE's instructors are personally available to assist you with just a toll free call. The result is practical training... the kind of experience you can put to work in today's marketplace.

### LEARN BY DOING...WITH STATE-OF-THE-ART EQUIPMENT AND TRAINING.

CIE pioneered the first Electronics Laboratory

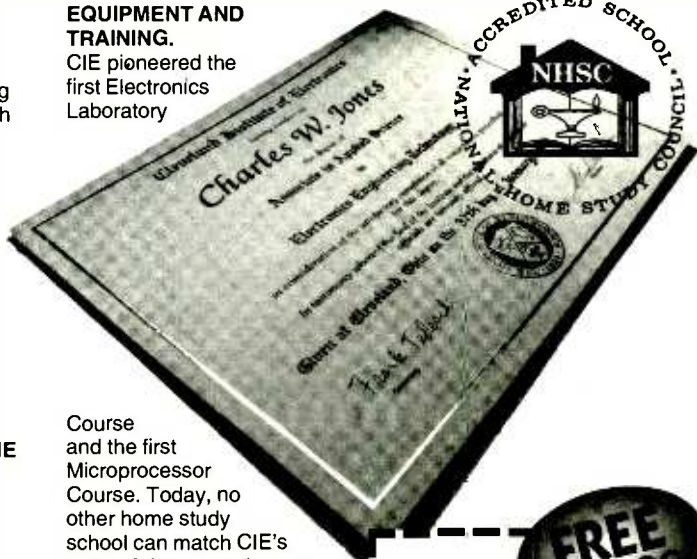

Course and the first Microprocessor Course. Today, no other home study school can match CIE's state-of-the-art equipment and training. And all your laboratory equipment, books and lessons are included in your tuition. It's all yours to use while you study and for on-the-job after you graduate.

### PERSONALIZED TRAINING....TO MATCH YOUR BACKGROUND.

While some of our students have a working knowledge of electronics others are just starting out. That's why CIE has developed twelve career courses and an A.A.S. Degree program to choose from. So, even if you're not sure which electronics career is best for you, CIE can get you started with core lessons applicable to all areas in

electronics. And every CIE Course earns credit towards the completion of your Associate in Applied Science Degree. So you can work toward your degree in stages or as fast as you wish. In fact, CIE is the only school that actually rewards you for fast study, which can save you money.



## YES!

I want to get started. Send me my CIE course catalog including details about the Associate Degree Program. (For your convenience, CIE will have a representative contact you - there is no obligation.)

Please Print Clearly

Name \_\_\_\_\_

Address \_\_\_\_\_

City \_\_\_\_\_

State \_\_\_\_\_ Zip \_\_\_\_\_ Age \_\_\_\_\_

Phone No. \_\_\_\_\_

Check box for G.I. Bill Benefits.  
 Veteran  
 Active Duty **AH67**

Cleveland Institute of Electronics, Inc.  
1776 East 17th Street  
Cleveland, OH 44114

A School of Thousands.  
A Class of One. Since 1934.

Send for CIE's FREE Course Catalog and See How We Can Help Your Career Too!

looking after cleaning. The grime was gone, but there were plenty of dark and pitted spots where moisture had attacked the anodized finish. A completely re-finished speaker frame would look quite out of place, and I'm not sure how well the aluminum paint would have matched the frame's original paint (or anodizing) anyway.

Using a fine emery cloth (I had to stay away from steel wool because of the danger of fouling the speaker's permanent magnet with metal dust), I cleaned off as much rust as I could. That resulted in a speaker that was definitely better looking and quite consistent in appearance with the rest of the chassis.

The speaker was now mounted on the front panel and that assembly was set aside while I turned my attention to replacing the dial cord. That is something I do with every set I restore whether it needs it at the time or not. I've had too many old cords break after a set was reassembled and put back into use!

The Tropicmaster's dial-cord arrangement was quite simple and the re-stringing was accomplished in a matter of minutes.

## PANEL INSTALLATION AND FINAL WIRING

With that done, I re-mounted the dial plate and was ready to reinstall the radio's front and rear panels. Those fasten, at their bottom edges, at pairs of Bakelite spacers mounted on the front and rear chassis apron (the idea is to insulate the front panel and cabinet from the chassis, which—being of AC/DC design—has the potential of being "hot" to ground). The tops of the panels are fastened together by a pair of transverse braces, which

complete the panel-and-radio sandwich—locking everything together in a rigid assembly.

Once mounted between the panels, the radio chassis is suspended about a half-inch above their bottom edges so that—after the set is mounted in its metal cabinet—the chassis can't come in contact with the cabinet floor. All of that went together quite

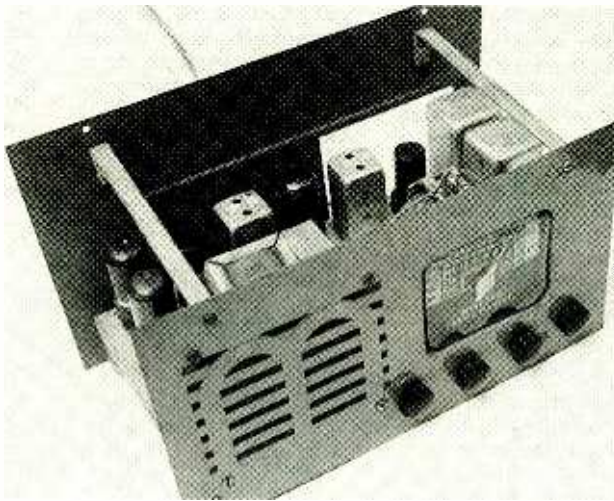

*Here's the Tropicmaster chassis completely reassembled, re-tubed, and ready to try out.*

smoothly, although I had to stop and backtrack a bit when I realized I had forgotten to install the new "cabinet isolation capacitor," a 0.005- $\mu$ F unit wired between the chassis and the front panel.

After poking the leads from the speaker's output transformer primary down through their pass-through grommet, I was ready to finish the last few wiring connections that would need to be made. Those included hooking up the output transformer primary to the push-pull audio-output stage and wiring the choke back into the set's filter circuit. The last capacitor to be installed in the set (the second of the two electrolytics) would also be installed in conjunction with the wiring of the choke.

## SMOKE TEST TIME

Now all I had to do before it would be possible to try the set out was to re-install the tubes. They had been tested when the set was originally dismantled, and (although some of the metal tubes had suffered from corrosion) all except the 25Z6 rectifier had tested good. The latter was dead as a doornail, probably a casualty of the same short-

Tropicmaster does not have a built-in loop antenna. I moved the set into my radio shack, where I could hook it up to the long-wire ham antenna.

However, I decided to check for signs of life before actually connecting the set to the skywire. Since all of the capacitors were new, there was no need bring the line voltage up slowly during start-up. I just flicked on the power switch, whereupon the room was bathed in white light from the biggest dial-light flare-up I had ever seen! I don't know why the bulb didn't burn out before it dimmed down to its normal operating level.

Making a mental note to investigate the pilot-light situation later, I continued to observe the set as it warmed up. No plumes of smoke drifted out of the chassis, but—even after several seconds—there was no sound from the speaker. It was beginning to look as if more troubleshooting would be necessary before I could have an operating set.

As sometimes happens during moments that are pregnant with tension, the phone rang. Being the only one in the house (and because the ringing phone was at my elbow and couldn't be ignored), I had to take the call. It was brief and, returning my attention to the Tropicmaster, I could hear a reassuring low hum in the speaker when the volume control was turned up full. Tuning around on the broadcast band, I heard a couple of faint stations.

Now I hooked up the outside antenna to the Minerva's antenna post and was gratified to hear many strong signals all over the broadcast band. Switching over to shortwave, I was

ed capacitor that caused the demise of the filter choke.

The 25Z6 is not the most common rectifier tube, and I didn't happen to have one on hand. However, I was able to buy a new-old-stock replacement at a local hamfest and had it standing by to fill the empty socket. Before installing it, I ran it by my tube checker, which gave it a clean bill of health.

That was something of a relief because the original 25Z6 had given no reading at all on the tester. I had never seen a tube with a good filament not cause at least a flicker on the meter and wondered if the fault might be in the instrument.

But the moment of truth had now arrived; it was smoke test time! Since the

also able to tu\*althy-  
 goody num\*over  
 sounding emed  
 the dial  
 cast-ugh sev-  
 un\*vel  
 passing  
 r  
 g is prob-  
 of  
 nsformers.  
 .nat during  
 k session—  
 ll give the Tropic-  
 er a complete  
 gignment, which will  
 (hopefully) return it to top  
 operating condition.

Looking into the pilot-light  
 problem, I checked the  
 Tropicmaster's original spec-  
 ifications. They called for  
 the usual type-47 (brown  
 bead) 6-8-volt lamp. The  
 lamp in the set was marked  
 "6-8 volts," all right, but had  
 a white bead. It also had a  
 round bulb instead of the  
 elongated cylinder usual  
 on the type 47.

Searching through my  
 stores, I was able to find the  
 proper lamp. It was marked  
 as a type 47, and had both  
 a brown bead and the usu-  
 al elongated envelope.

When that lamp was sub-  
 stituted for the one  
 originally in the set, things  
 returned to normal. Flare-  
 up was reduced to a prop-  
 er level and died down  
 much more quickly.

**POSTSCRIPT FROM  
 THE PREVIOUS OWNER**

I just received a note  
 from Alan Douglas, from  
 whom I purchased the

Minerva at last September's  
 AWA Rochester meet. He  
 had just seen the first col-  
 umn in this series and  
 wanted to let me know that  
 the set's cabinet-insulating  
 spacer blocks were not  
 original, having been re-  
 placed by him some time  
 in the past.

He also informed me that  
 the cabinet had been  
 spray-painted by a prior  
 owner. That would certainly  
 explain why the outside of  
 the radio looks so much  
 better than the inside! How-  
 ever, I never suspected a  
 repaint because the cab-  
 inet color was such a good  
 match to the front panel  
 (which still has its original  
 silk-screened control labels,  
 not to mention its rust spots,  
 and so probably wasn't  
 part of the repaint project).

The paint also didn't look  
 new, perhaps because it  
 was done some time ago.  
 And, more important, the  
 flamboyantly calligraphed  
 silk-screened Tropicmaster  
 logo on the cabinet's front  
 door—which would have  
 been all but impossible to  
 mcsk for repainting—was in  
 perfect condition with no  
 sign of any overspray. Alan  
 tells me that this is due to  
 his meticulous clean-up  
 with acetone.

Thanks, Alan! I think that  
 was the only true restoration  
 work done on the radio. My  
 own efforts have been con-  
 fined to making practical  
 repairs and returning the  
 set to serviceable operat-  
 ing condition.

That's it for now. See you  
 all next month. ■

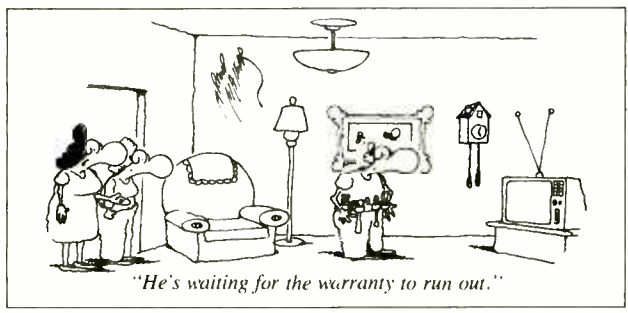

# 3 NEW BOOKS for the Project Builder

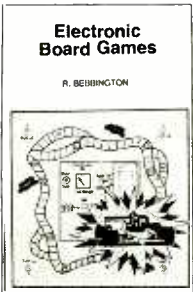

**BP350—ELECTRONIC BOARD  
 GAMES .....\$6.00**

Twenty novel electronic board games that you can build from the plans in this book. Whether you are interested in motor racing, searching for buried treasure on a desert island or for gold in Fort Knox, spinning the wheel of fortune, or doing a musical quiz—there is something for you to build and enjoy!

**PCP119—ELECTRONIC MUSIC  
 AND MIDI PROJECTS .....\$14.95**

Save cash by building the MIDI gadgets you need. Want a MIDI THRU box, program change pedal, Metronome, analog echo unit, MIDI patchbay or switcher? Over 16 practical and very useful music and MIDI projects—all in this book! The projects are explained in detail with full instructions on assembly.



**BP301—ANTENNAS FOR VHF  
 AND UHF .....\$6.00**

From installing a TV or FM antenna to setting up a multi-antenna array for shortwave listening or amateur radio, this book explains the basics of VHF and UHF antenna operation and installation. The text describes in easy-to-understand terms the essential information about how antennas work, the advantages of different antenna types, and how to get the best performance from an antenna.

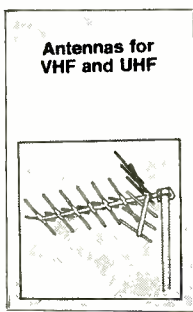

Mail to: **Electronic Technology Today, Inc.**  
 P.O. Box 240 • Massapequa Park, NY 11762-0240

**Shipping Charges in USA & Canada**

\$0.01 to \$5.00.....	\$1.50	\$30.01 to \$40.00 .....	\$5.50
\$5.01 to \$10.00.....	\$2.50	\$40.01 to \$50.00 .....	\$6.50
\$10.01 to \$20.00.....	\$3.50	\$50.01 and above .....	\$8.00
\$20.01 to \$30.00.....	\$4.50		

Sorry, no orders accepted outside of USA and Canada. All payments must be in U.S. funds only.

Number of books ordered.

Total price of books ..... \$ \_\_\_\_\_  
 Shipping (see chart) ..... \$ \_\_\_\_\_  
 Subtotal ..... \$ \_\_\_\_\_  
 Sales Tax (NYS only) ..... \$ \_\_\_\_\_  
 Total enclosed ..... \$ \_\_\_\_\_

Name \_\_\_\_\_  
 Address \_\_\_\_\_  
 City \_\_\_\_\_ State \_\_\_\_\_ ZIP \_\_\_\_\_

Please allow 6-8 weeks for delivery.

July 1995, Popular Electronics

# COMPUTER BI

By Jeff Holtzman

## Soldering Irons And Cyber Circuits

I was just a kid when LEDs came along (ca. 1965). Before LEDs, there were incandescent lamps and neon lamps. Incandescent lamps are available in a wide range of voltages, but they have an insatiable appetite for electrons (current). Plus, they generate heat, they're fragile, and they're simply not cool. Neon lamps, on the other hand, have very low current drain, and they do produce a cool glow. But they require voltages much higher than are available in a

LEDs. For a couple of dollars, you could get perhaps ten LEDs, of which six or seven wouldn't even work!

I remember the thrill I had when I connected my first LED to a nine-volt battery and a resistor. My ten-year-old perception of the world changed in an instant, and my expectations changed forever. I couldn't have articulated it at the time, but something in me knew that the bulky old vacuum-tube radios and TVs were dead. They might not have known it yet, but they were dead; walking dead perhaps, but nonetheless dead. I did know that I wanted to have as little as possible to do with that dingy, dusty, hot, fragile, high-voltage world of vacuum tubes; and as much as possible with cool, clean, miniature semiconductor devices like LEDs.

I experienced a similar thrill when interesting, useful integrated circuits were introduced. Devices like the 78xx series of voltage regulators totally changed the scope of project building. Prior to the 78xx, just creating a reliable source of power for a given project could consume a major part of the project. In fact, general-purpose, variable power supplies were themselves popular projects.

I remember when the 555 "programmable" timer was introduced. Another messy, repetitive problem solved once and for all.

I also remember when National Semiconductor started introducing its LM line of audio amplifiers, preamplifiers, tuners, and so on. Ditto.

When I was a kid, numerous magazines were publishing articles on electronics, parts were readily available, and there was an incredible feeling of innovation and experimentation.

### LATER

Fast forward about ten years. A magazine called *Radio-Electronics* published plans for building a computer. Six months later, another magazine called *Popular Electronics* (then owned by Ziff-Davis Publishing Corp.) published its own plans for a computer called the Altair. And the Altair changed history.

The energy and innovation once seen in electronics was now shifting to computers, *microcomputers*. A new generation of magazines (*Byte*, *Kllobaud*, *80 Micro*, and many, many others) sprung up to fuel that revolution, and to profit from it. Only a few of those original publications remain today, and those in a much-altered format. Where once they catered to technical users and hobbyists, they focus now on business users and product reviews. That's where the money is. But where is the fire?

Look at it another way. As I define it, the "Golden Age of Electronics" occurred (roughly) from 1965–1975. The "Golden Age of Personal Computers" occurred from 1975–1985. What happened between 1985 and 1995? And what will the next decade bring?

### VIRTUAL, CYBER, AND ARTIFICIAL

I experienced and participated directly in those

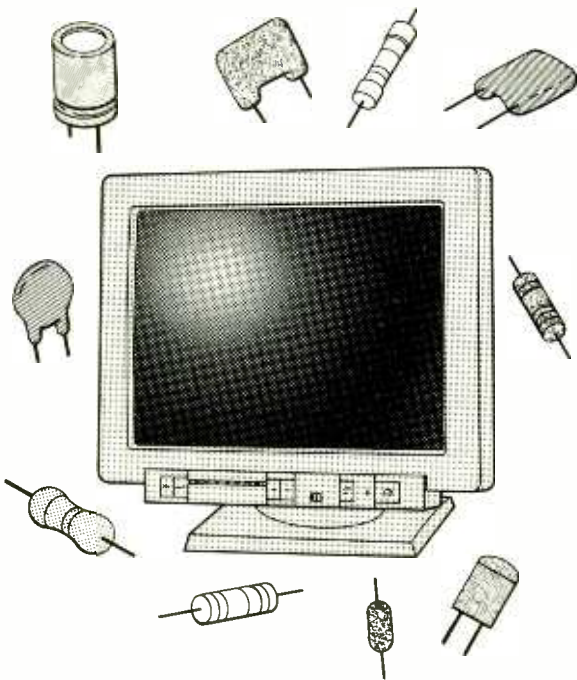

*As our world becomes ever more cyber, will the components and test gear of our hobby give way to computer software and hardware?*

typical solid-state circuit. They're also fragile.

I remember seeing ads for the first LEDs. They were expensive. Eventually, prices dropped, and surplus vendors and other retailers began selling grab-bags of

first two Golden Ages. But then I entered the work force, had my own family, and settled into middle age. I simply don't have the same type of intuitive, certain knowledge about the last decade as for those preceding it. But I do have a theory (and you're welcome to challenge it, confirm it, or confound it; you can e-mail me at [jkh@acm.org](mailto:jkh@acm.org)). The theory goes like this:

I believe that technically inclined youth need a channel for communicating, experimenting, challenging, building. It is both an intellectual and a social channel. I believe that prior to the 1960s, that channel evolved much slower. For perhaps as long as five decades leading up to the 1960s, that channel centered on vacuum-tube electronics, ham radio, and shortwave listening. In the 1960s, things burst wide open. Technology started to evolve much faster, and so did people.

From roughly 1965 to 1985, hardware reigned in that channel, first in analog electronics, then in digital electronics. After 1985, the channel turned "virtual" or "cyber." I dislike both words because of their appropriation by the technically illiterate, but I have nothing better to offer. Whatever you call it, the idea is that the underlying physical reality became infinitely less important than the things you could do in the "artificial" or "virtual" or "cyber" space offered by the computer.

After 1985, people put down their soldering irons, and started to learn BASIC, C, or the script language of their word processor or multimedia-authoring environment. The reason is that it's hard to do anything really new or interesting in hard-

ware on a hobbyist scale. The closest we've come is projects based on micro-controllers, which represent a real boundary-crossing phenomenon between physical and cyber spaces.

I'm not saying that no one uses a soldering iron—it hasn't come to that yet. I am saying that fewer people are doing it, and of those who do, they do it not as a socially compelling and captivating activity, as occurred in the 1960s and 1970s. I don't know what the next step will be. But given both the popularity and the immaturity of the on-line-services industry in general, and the Internet in particular, my hunch is that networking—internetworking—will be a strong area of growth. And there's no soldering on the net.

About ten years ago, in a discussion with a popular author of electronics projects, I made the rash prediction that it wouldn't be long before people wouldn't know how to use a soldering iron, that they would never have seen a real resistor, capacitor, transistor, or LED. I had a hunch that we would be building "circuits" (or actually, cyber-circuits) on computer screens and viewing voltages and waveforms on simulated test equipment. My friend laughed. Today, however, every issue of this magazine advertises several such programs.

The days of the soldering iron may soon be over. Long live the computer. ■



"You won't believe what he's invented now."

*THE MOST*  
**AN IMPORTANT PART  
 OF YOUR PHOTOCOPIER  
 ISN'T PART OF  
 YOUR PHOTOCOPIER**

Having a machine may not permit you to photocopy books, journals, newsletters and magazines. The Copyright Clearance Center CAN. Contact us to find out how you too can COPY RIGHT!<sup>SM</sup>

**COPYRIGHT CLEARANCE CENTER**

222 Rosewood Drive, Danvers, MA 01923 □ Tel. (508) 744-3350 □ Fax (508) 741-2318

© 1993 Copyright Clearance Center

**COMING NEXT MONTH**  
 In the AUGUST 1995 issue of

**Popular Electronics<sup>®</sup>**

**T**hat station went off the air minutes ago! Surprised exclamations like that one are uttered by many amateur operators and SWLers after hearing signals that appear to be seconds, or even minutes, late. What causes those delays? Are aliens involved? The next issue of Popular Electronics will try to answer those and other questions.

**PLUS...**

**A TV Transmitter:** Build it and rebroadcast TV programs throughout your house.

**For Guitar Players:** Coax some rock-and-roll distortion effects out of your favorite guitar with our preamp/distortion box.

**For the Workbench:** Build our oscilloscope calibrator and use it to check your oscilloscope's vertical gain, time base, probe compensation, and more!

**And:** Outstanding columns and departments like Gizmo, Think Tank, DX Listening, Scanner Scene, Multimedia Watch, Circuit Circus, and a whole lot more!

**On Sale June 15, 1995**

Pick Up Popular Electronics at your favorite Newsstand, Bookstore, Convenience Store, or Supermarket

# ELECTRONICS MARKET PLACE

## FOR SALE

**CABLE test chips.** Jerrold, Tocom, S.A., Zenith. Puts cable boxes into full service model! \$29.95 to \$59.95. 1 (800) 452-7090. (310) 902-0841.

**PARTS for \$1.00.** Resistors .25W 12, .5W 8. Capacitors .001uF 5, .01uF 5, .1uF 4, 1uF 3, 10uF 2, 100uF 1. Semiconductors 1N4004 4, 2N2222 1, 2N3904 2, 2N3906 2, TIP31A 1, TIP32A 1, LM741 1, LM555 1, LEDES red 3, green 2. Catalog \$1.00, foreign add \$1.00. **ZIPFAST**, Box 12238, Lexington, KY 40581-2238.

**300 Experimenters Circuits** — Complete in 6 practical books using diodes, relays, FET's, LED's, IC 555's, and IC CA3130's for building blocks. Only \$33.00 plus \$6.00 for shipping. USA and Canada only. US funds. **ETT, INC.**, PO Box 240, Massapequa Park, NY 11762-0240.

## ANTIQUE RADIO CLASSIFIED

### Free Sample!

Antique Radio's  
Largest Circulation Monthly.  
Articles, Ads & Classifieds.



6-Month Trial: \$17.95. 1-Yr: \$34.95 (\$51.95-1st Class).  
A.R.C., P.O. Box 802-L14, Carlisle, MA 01741  
Phone:(508) 371-0512 VISA/MC Fax:(508) 371-7129

**CABLE descramblers.** Bargain headquarters, below wholesale prices. Absolutely the lowest prices! Money-back guarantee. Nobody beats us! **RP ELECTRONICS**, 1 (800) 304-3604.

**CABLE descramblers** and test turn-on kits available for most makes and models. No catalog, no 800 number equals your lowest prices. Call others, then compare our prices! We pay cash for unwanted cable boxes. No Florida sales. (305) 425-0751.

**DESCRAMBLE** cable with simple circuit added to Radio Shack RF modulator and using VCR as tuner. Instructions \$10.00. **TELCOM**, PO Box 832-P7, Brusly, LA 70719.

**SURVEILLANCE** Privacy security protection. Catalog \$5.00. **SPY EMPORIUM**, 6065 Hillcroft 414, Houston, TX 77081. (713) 774-1000.

## BEST BY MAIL

Rates: Write National, Box 5, Sarasota, FL 34230

### BUSINESS OPPORTUNITIES

**GUARANTEED! BIG MAIL** Home Based Businesses And Opportunities. Only \$5.00: J & M SPECIALTIES, 3403 Cameron Drive, Henderson, NC 27536.

**PERSONAL COMPUTER OWNERS CAN EARN \$1000 to \$5000** monthly offering simple services part time. Free list of 100 best services. C.B.C.A.Z, PO. Box 926168, Houston, TX 77292.

**MANUFACTURING GIANT SCREEN** Projection TV'S. Big Profits, High Quality, Simple. Catalog \$1.00 P&H: SP-Vision, Box 115, Taylor, PA 18517.

**EARN \$3000.00 MONTHLY** By Fax, FREE DETAILS FAX INQUIRIES TO: 412-343-5843.

**PT/FT PEOPLE** Needed To Prepare Labels At Home. Call Now 1-809-474-2836. LD Toll.

### FINANCIAL

**WANT FINANCIAL INDEPENDENCE?** Send \$1.00: RONNIE, 923 Realty, Carson, CA 90745.

**GUARANTEED LOANS WITHIN** two weeks! No income, credit checks! PLUS! \$1,000 credit card! **GUARANTEED APPROVAL!** Limit increased \$300.00 annually! Reports, PRE-APPROVED applications, \$5.00. **NEWSOM**, 3352 Broadway, Garland, TX 75043.

### OF INTEREST TO ALL

**HIGH SCHOOL DIPLOMA** At Home, Accredited, Fast, "Failure-Proof" 1-800-470-4723, American Academy, 12651 S. Dixie Highway, Miami, FL 33158.

**MEXICO TRADE DIRECTORY** \$15.00 Postpaid. Box 661, Dallas, GA 30132.

**SECRET cable descramblers!** Build your own descrambler for less than \$12.00 in seven easy steps! **Radio Shack** parts list and free descrambling methods that cost nothing to try, included. Send \$10.00 to: **INFORMATION FACTORY**, PO Box 669, Seabrook, TX 77586. For COD's (713) 922-3512 any time.

**FREE catalog.** Chips, ICs, parts, products. Amiga, C64/128, IBM, quality electronics. **J.S.P.**, SSF, CA 94083-5060. 24hrs. (415) 871-5158.

**ZAP IT!** For Jerrold or Pioneer cable boxes. Other quality cable products too! Toll free: 1 (800) 899-9707.

## CLASSIFIED AD ORDER FORM

To run your own classified ad, put one word on each of the lines below and send this form along with your check to:

**Popular Electronics Classified Ads**, 500-B Bi-County Boulevard, Farmingdale, N.Y. 11735

**PLEASE INDICATE** in which category of classified advertising you wish your ad to appear. For special headings, there is a surcharge of \$11.00.

( ) Plans/Kits ( ) Business Opportunities ( ) For Sale  
( ) Education/Instruction ( ) Wanted ( ) Satellite Television

Special Category: \$11.00

### PLEASE PRINT EACH WORD SEPARATELY, IN BLOCK LETTERS.

(No refunds or credits for typesetting errors can be made unless you clearly print or type your copy.) Rates indicated are for standard style classified ads only. See below for additional charges for special ads. **Minimum: 15 words.**

1	2	3	4	5
6	7	8	9	10
11	12	13	14	15 (\$23.25)
16 (\$24.80)	17 (\$26.35)	18 (\$27.90)	19 (\$29.45)	20 (\$31.00)
21 (\$32.55)	22 (\$34.10)	23 (\$35.65)	24 (\$37.20)	25 (\$38.75)
26 (\$40.30)	27 (\$41.85)	28 (\$43.40)	29 (\$44.95)	30 (\$46.50)
31 (\$48.05)	32 (\$49.60)	33 (\$51.15)	34 (\$52.70)	35 (\$54.25)

We accept MasterCard and Visa for payment of orders. If you wish to use your credit card to pay for your ad fill in the following additional information (Sorry, no telephone orders can be accepted):

Card Number \_\_\_\_\_

Expiration Date \_\_\_\_\_

PRINT NAME \_\_\_\_\_

SIGNATURE \_\_\_\_\_

**IF YOU USE A BOX NUMBER YOU MUST INCLUDE YOUR PERMANENT ADDRESS AND PHONE NUMBER FOR OUR FILES. ADS SUBMITTED WITHOUT THIS INFORMATION WILL NOT BE ACCEPTED.**

**CLASSIFIED COMMERCIAL RATE:** (for firms or individuals offering commercial products or services) \$1.55 per word prepaid (no charge for ZIP code)...**MINIMUM 15 WORDS**, 5% discount for same ad in 6 issues within one year; 10% discount for 12 issues within one year if prepaid. **NON-COMMERCIAL RATE:** (for individuals who want to buy or sell a personal item) \$1.25 per word, prepaid...no minimum. **ONLY FIRST WORD AND NAME** set in bold caps at no extra charge. Additional bold face (not available as all caps) **30¢ per word additional**. Entire ad in boldface, \$1.85 per word. **TINT SCREEN BEHIND ENTIRE AD:** \$1.90 per word. **TINT SCREEN BEHIND ENTIRE AD PLUS ALL BOLD FACE AD:** \$2.25 per word. **EXPANDED TYPE AD:** \$2.05 per word prepaid. Entire ad in boldface, \$2.45 per word. **TINT SCREEN BEHIND ENTIRE EXPANDED TYPE AD:** \$2.55 per word. **TINT SCREEN BEHIND ENTIRE EXPANDED TYPE AD PLUS ALL BOLD FACE AD:** \$2.95 per word. **DISPLAY ADS:** 1" x 2 1/8" — \$225.00; 2" x 2 1/8" — \$450.00; 3" x 2 1/8" — \$675.00. **General information:** Frequency rates and prepayment discounts are available. **ALL COPY SUBJECT TO PUBLISHERS APPROVAL. ADVERTISEMENTS USING P.O. BOX ADDRESS WILL NOT BE ACCEPTED UNTIL ADVERTISER SUPPLIES PUBLISHER WITH PERMANENT ADDRESS AND PHONE NUMBER.** Copy to be in our hands on the 13th of the fourth month preceding the date of issue (i.e.; Sept. issue copy must be received by May 13th). When normal closing date falls on Saturday, Sunday or Holiday, issue closes on preceding work day. Send for the classified brochure. Circle Number 49 on the Free Information Card.

Please make checks payable to Gernsback Publications Inc.



**HOME automation & computer control:** Two-way IR, two-way X-10, & hardware. Control devices from serial computer link or stand-alone operation. **COMPCO**, (615) 436-5189 BBS, (615) 436-6333 evenings.

**CABLE T.V. Installers Manual.** Single dual cable systems. Telephone poles, houses, apartments, explained! Send \$14.95 to **INFOTEK**, PO Box 71072, Milwaukee, WI 53211.

**PRINTED circuit boards** — etched, drilled, tin plated. Single sided \$1.25/sq. inch. **CHELCO ELECTRONICS**, 61 Water Street, Mayville, NY 14757. 1 (800) 388-8521. Fax (716) 753-3220.

**CABLE TV equipment & accessories.** Wholesale welcome! 30 day moneyback guarantee! Free catalog! **PERFORMANCE ELECTRONICS, INC.**, 1 (800) 815-1512.

**UNDETECTABLE** Cable/satellite descrambler will work on all systems **guaranteed!** Send SASE-info, \$98.95-kit, \$14.95-plans. **MYSTICAL ELECTRONICS**, PO Box 481 Cooper Station, New York, NY 10276.

**FREE:** Send name & address for unique gifts & collectable catalogue. **A & J THINGS**, PO Box 879, Dept. PE, Apple Valley, CA 92307.

**ELECTRONIC sales** installation of **Intruder ID** security systems for home, apartment, or business, call (812) 295-4240.

**THE Case Against Patents.** Thoroughly tested and proven alternatives that work in the real world. \$28.50. **SYNERGETICS PRESS**, Box 809-C, Thatcher, AZ 85552. (520) 428-4073. Visa/MC.

**T.V. notch filters**, free brochure. **MICROTHINC**, Box 63/6025, Margate, FL 33063. (305) 752-9202.

## PLANS & KITS

**60 Solderless Breadboard Projects** in two easy-to-read pocket books. Complete with circuit descriptions, schematics, parts layouts, component listings, etc. Both books (BP107 & BP113) only \$11.90 plus \$4.00 for shipping. USA and Canada only. US funds. **ETT, INC.**, PO Box 240, Massapequa Park, NY 11762-0240.

**SURVEILLANCE/countersurveillance**, bugging/phone tapping detector, telephone/fax encryption, vehicle tracking, covert video, transmitter kit, and more... **A.B. ELECTRONICS**, 1 (800) U-ANTI-BUG.

**CRYSTAL set Handbook** — Visit antiquity by building the radios your grandfather built. Assemble a "Quaker Oats" rig, wind coils that work and make it look like the 1920's! Only \$10.95 plus \$4.00 for shipping and handling. **CLAGG INC.**, PO Box 4099, Farmingdale, NY 11735. US funds only! USA and Canada — no foreign orders.

**FIBER optics experimenters parts, supplies and tools:** Fiber, cable, connectors, splices, detectors, lasers, kits, plans, newsletter. Send \$2.00 for catalog. **LIGHTLINE ENGINEERING**, PO Box 24, Mullica Hill, NJ 08062.

**MINI-transmitters.** Low to high power! Voice changers and much more! Send \$2.00 for information. **PARSEC ELECTRONICS**, PO Box 34594, Phoenix, AZ 85067.

**PRECISION power zener diode kits.** Available assembled and calibrated to your voltage specs. Build inexpensive IC power supplies with custom split voltages. Free info. Write **LINTON**, 325 Marston, Suite 212, Glen Ellyn, IL 60137.

**SURVEILLANCE schematics.** State of the art designs. Large selection. Free literature. **STACKHOUSE**, POB 502, Dayton, OH 45401-0502.

**FREE phone calls** through your CB radio. Project plans \$5.00. **DB INTERNATIONAL**, POB 1933, Lynnwood, WA 98046.

## WANTED

**TEST equipment repair**, including power supplies, and other measuring devices, excluding oscilloscopes, power supply repair of computer equipment, call (812) 295-4240.

## EDUCATION/INSTRUCTION

**FCC General Radiotelephone Operator's license.** Answers, solutions to latest 889 for elements 1,3 examinations. Prepared by professional engineer. To receive this publication, send \$20.00 to **UNIVERSAL COMMUNICATIONS**, PO Box 11646, Palm Desert, CA 92255-1646.

**LEARN VCR repair.** Great profits. Home study. **P.C.D.I.**, Atlanta, Georgia. Free literature. 1 (800) 362-7070 Dept. VRH341.

**BECOME** an electrician. Approved home study. Free career literature. **P.C.D.I.**, Atlanta, Georgia. 1 (800) 362-7070 Dept. TEH341.

**LEARN PC repair** — troubleshooting, servicing. Home study. Free literature. **P.C.D.I.**, Atlanta, Georgia. 1 (800) 362-7070 Dept. JH341.

## SATELLITE TELEVISION

**EXCLUSIVE** new 18" satellite broadcast network with multi-educational programming. Extra business opportunity and more! 1 (800) 899-9707.

## BUSINESS OPPORTUNITIES

**EASY** work! Excellent pay! Assemble products at home. Call toll free 1 (800) 467-5566 ext. 5730.

**START** your own technical venture! Don Lancaster's newly updated **Incredible Secret Money Machine II** tells how. We now have autographed copies of the Guru's underground classic for \$18.50. **SYNERGETICS PRESS**, Box 809-C, Thatcher, AZ 85552. (520) 428-4073. Visa/MC.

**GET paid \$268.20** per roll taking easy snapshots! No experience. Film supplied. **PHOTOTEK**, Box 2457, Dept. 2, Pinecove, CA 92549. Recorded information: (909) 659-9757 ext. 8.

**INCREDIBLE opportunity!** New 18" satellite system sells itself! Now you can participate in "the most lucrative business opportunity of the 90's!" 1 (800) 899-9707.

**COMPUTER** profit secrets revealed! Discover many homebased businesses. Free information. **S. B. COMPANY**, 51 MacDougal Street #24E, New York, NY 10012.

## INVENTIONS

**FREE Invention package:** **DAVISON & ASSOCIATES** offers customized development, patenting, and licensing for new products and ideas. Proven results: 1 (800) 677-6382.

## NEW DESCRAMBLER TECHNOLOGY REVEALED

**REVEALED** Halcyon's new universal 4000 descrambler! My manuals/kits perfects all universal descramblers guaranteed. **SNOW**, POB 22048, Lansdowne, St. John, Canada E2K 4T7.

## PROGRAMMABLE LOGIC

**LOW-cost FPGA** training kit teaches you FPGA design for only \$165.95. Includes textbook, programming software, experimenter's board, re-useable 3500-gate FPGA chip. Money-back guarantee. Contact **XESS CORP**: 1 (800) 549-9377 or devb@vnet.net.

**MASTERCARD AND VISA** are now accepted for payment of your advertising. Simply complete the Classified Ad order form and we will bill you.

**THIS IS A BOLDFACE EXPANDED AD.** If you like this format, request it. Your cost is \$2.20 per word.

## TIPS FOR MAIL ORDER PURCHASE

**It is impossible for us to verify the claims of advertisers, including but not limited to product availability, credibility, reliability and existence of warranties. The following information is provided as a service for your protection. It is not intended to constitute legal advice and readers are advised to obtain independent advice on how to best protect their own interests based upon their individual circumstances and jurisdictions.**

**1. Confirm price and merchandise information** with the seller, including brand, model, color or finish, accessories and rebates included in the price.

**2. Understand the seller's return and/or refund policy**, including the allowable return period, who pays the postage for returned merchandise and whether there is any "restocking" or "return" charge.

**3. Understand the product's warranty.** Is there a manufacturer's warranty, and if so, is it for a U.S. or foreign manufacturer? Note that many manufacturers assert that, even if the product comes with a U.S. manufacturer's warranty, if you purchase from an unauthorized dealer, you are not covered by the manufacturer's warranty. If in doubt, contact the manufacturer directly. In addition to, or instead of the manufacturer's warranty, the seller may offer its own warranty. In either case, what is covered by warranty, how long is the warranty period, where will the product be serviced, is there a charge for service, what do you have to do to obtain service and will the product be repaired or replaced? You may want to receive a copy of the written warranty before placing your order.

**4. Keep a copy of all transactions**, including but not limited to cancelled check, receipt and correspondence. For phone orders, make a note of the order including merchandise ordered, price, order date, expected delivery date and salesperson's name.

**5. If the merchandise is not shipped within the promised time**, or if no time was promised, within 30 days of receipt of the order, you generally have the right to cancel the order and get a refund.

**6. Merchandise substitution** without your express prior consent is generally not allowed.

**7. If you have a problem with your order or the merchandise**, write a letter to the seller with all the pertinent information and keep a copy.

**8. If you are unable to obtain satisfaction from the seller**, contact the consumer protection agency in the seller's state and your local Post Office.

**If, after following the guidelines, you experience a problem with a mail order advertiser that you are unable to resolve, please let us know. Write to Advertising Department, Gernsback Publications Inc., 5008 BI-County Blvd, Farmingdale, NY 11735.**

**Be sure to include copies of all correspondence.**

# CIRCUIT CIRCUS

By Charles D. Rakes

## Voice Recording and Playback

**G**ather around, circuiters, because this visit we're going to investigate a most interesting voice-record/playback integrated circuit. It's the ISD1000A Direct Analog Storage Technology (DAST) IC manufactured by Information Storage Devices; the chip is available from Radio Shack (catalog no. 276-1325), as well as other sources. That neat little 28-pin chip stores data in analog form in a special EEPROM requiring neither an analog-to-digital nor a digital-to-analog converter.

The ISD1000A can sample an audio signal at a 6.4-kHz rate, store each input bit in

a single sample-and-hold circuit, and then record it in one of 128,000 EEPROM cells. That amount of memory allows the storage of a 20-second sample with 8-bit accuracy. After the data has been stored in the EEPROM, the memory is maintained without power.

Only a minimum amount of external components are required to build a complete voice recording and playback system. The pre-amplifier, filters, AGC, power amplifier, control logic, and analog storage are all in the same chip!

### SIMPLE RECORDER/PLAYER

Our first entry is a recorder/player circuit (see Fig. 1) that is similar to the one shown in the IC's data sheet. When switch S3 is set

to RECORD, pin 27 ( $\overline{P\overline{R}}$ ) and pin 24 (PD) of U1 go low. Holding down switch S1 will then cause pin 23 ( $\overline{CE}$ ) to go low. That starts the recording process and activates the electret microphone, MIC1.

During recording, LED1 will remain on and will go out when the end of memory is reached. Letting go of switch S1 will stop the recording process. If the recording is stopped before the end of memory is reached, an end-of-message bit is set internally to mark where the message ended. That allows other messages to be recorded in a sequential manner until the total memory is used up.

Setting switch S3 to PLAY causes pin 27 to go high, and pin 24 to go low. To

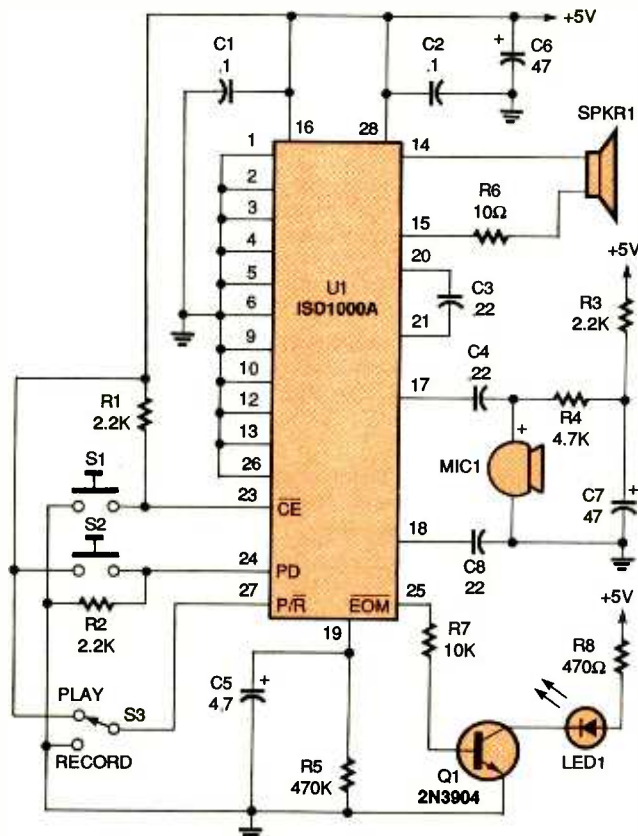

Fig. 1. This basic recorder/player circuit is easy to use. Turn S3 to RECORD and hold down S1 to record your message. To play it back, turn S3 to PLAY and press S2.

### PARTS LIST FOR THE SIMPLE RECORDER/PLAYER (Fig. 1)

#### SEMICONDUCTORS

U1—ISD1000A voice record/playback, integrated circuit  
Q1—2N3904 NPN transistor  
LED1—Light-emitting diode, any color

#### RESISTORS

(All resistors are 1/4-watt, 5% units.)

R1—R3—2200-ohm  
R4—4700-ohm  
R5—470,000-ohm  
R6—10-ohm  
R7—10,000-ohm  
R8—470-ohm

#### CAPACITORS

C1, C2—0.1-μF, ceramic-disc  
C3, C4—0.22-μF, Mylar  
C5—4.7-μF, 16-WVDC, electrolytic  
C6, C7—47-μF, 16-WVDC, electrolytic

#### ADDITIONAL PARTS AND MATERIALS

S1, S2—Pushbutton switch, normally open  
S3—SPDT switch  
MIC1—electret microphone  
SPKR1—8-ohm speaker  
Wire, solder, etc.

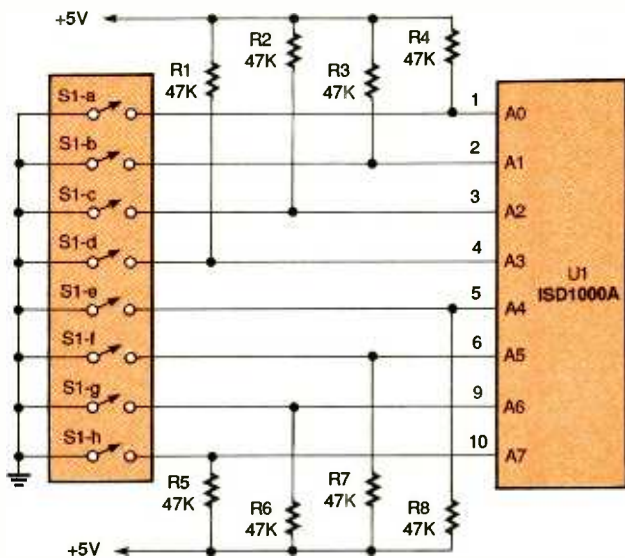

Fig. 2. Adding an 8-position DIP switch to the ISD1000A makes it possible to find a particular location in the 20 seconds of message time.

### PARTS LIST FOR THE MESSAGE-START LOCATOR (Fig. 2)

- U1—ISD1000A voice record/playback, integrated circuit
- R1—R8—47,000-ohm, ¼-watt, 5% resistor
- S1—8-position DIP switch
- Wire, solder, etc.

begin playback, switch S2 must be depressed momentarily to set pin 23 low.

### MESSAGE-START LOCATOR

Pins 1–6, 9, and 10 can be used to address the ISD1000A for multiple messages. Those pins control an internal register called the Message Start Pointer, or MSP. The MSP indicates the location where the next record or play operation will begin.

So, how do you find a particular message location to either begin playback or recording? To do that, an eight-section DIP switch, S1, must be connected to the eight address inputs of the ISD1000A (see Fig. 2). Address inputs A0–A7, which correspond to switches S1-a to S1-h, allow you to split the message area into 160 equal

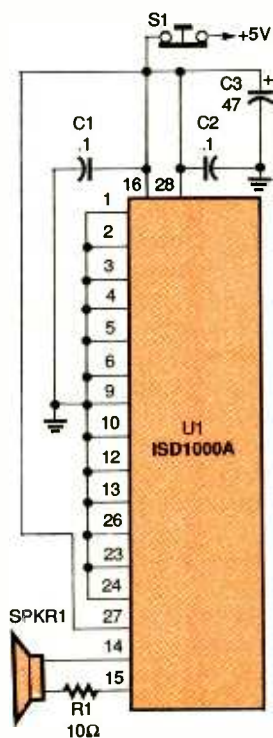

Fig. 3. This circuit could make a favorite picture frame speak out.

### PARTS LIST FOR THE PICTURE-FRAME AUDIO (Fig. 3)

- U1—ISD1000A voice record/playback, integrated circuit
- R1—10-ohm, ¼-watt, 5% resistor
- C1, C2—0.1-μF, ceramic-disc capacitor
- C3—47-μF, 16-WVDC, electrolytic capacitor
- S1—Pushbutton switch, normally closed
- SPKR1—8-ohm speaker
- Wire, solder, etc.

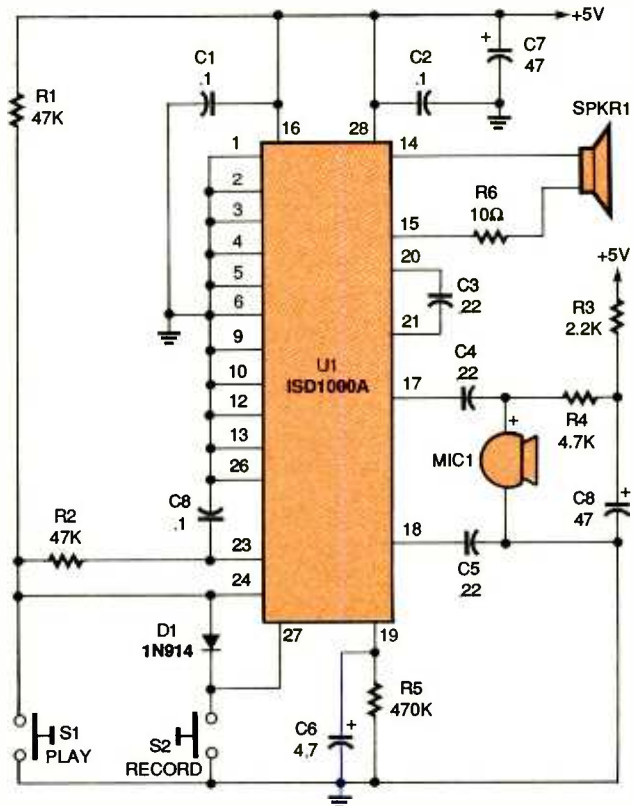

Fig. 4. This recorder/player is real easy to use. Hold down S2 to record a message and then hold down S1 to play it back.

segments of 0.125 seconds each. The address-input decimal values are as follows: A0 = 1, A1 = 2, A2 = 4, A3 = 8, A4 = 16, A5 = 32, A6 = 64, and A7 = 128.

To start the recording or playback function at a desired time (MSP), divide the time in seconds by 0.125. That will be the decimal number that is set by the address switches of S1. As an example, to start the recording or playback function at the 10-second point of memory, you would have to first divide 10 by

0.125; that equals 80. Because the address inputs use positive logic, switches S1-e (decimal value of 16) and S1-g (decimal value of 64) are placed in the open position to obtain the decimal value of 80. All other switches must be closed.

### PICTURE-FRAME AUDIO

Now that we know how to make the ISD1000A perform, it's time to have some fun. Add the simple playback circuit shown in Fig. 3 to a photo of a special

## PARTS LIST FOR THE ADVANCED RECORDER/PLAYER (Fig. 4)

### RESISTORS

(All resistors are 1/4-watt, 5% units.)

R1, R2—47,000-ohm  
R3—2200-ohm  
R4—4700-ohm  
R5—470,000-ohm  
R6—10-ohm

### CAPACITORS

C1, C2—0.1- $\mu$ F, ceramic-disc  
C3—C5—0.22- $\mu$ F, Mylar  
C6—4.7- $\mu$ F, 16-WVDC, electrolytic  
C7, C8—47- $\mu$ F, 16-WVDC, electrolytic

### ADDITIONAL PARTS AND MATERIALS

U1—ISD1000A voice record/playback, integrated circuit  
D1—1N914 silicon diode  
S1, S2—Pushbutton switch, normally open  
MIC1—electret microphone  
SPKR1—8-ohm speaker  
Wire, solder, etc.

## PARTS LIST FOR THE SOUND-ACTIVATED PLAYER (Fig. 5)

### SEMICONDUCTORS

U1—ISD1000A voice record/playback, integrated circuit  
Q1—Q3—2N3904 NPN transistor  
D1—1N4002 silicon rectifier diode  
D2—D4—1N914 silicon diode  
LED1—Light-emitting diode, any color

### RESISTORS

(All resistors are 1/4-watt, 5% units.)

R1, R2—47,000-ohm  
R3—2200-ohm  
R4, R5—4700-ohm  
R6—1000-ohm  
R7, R10—10,000-ohm  
R8, R9—220,000-ohm  
R11—10-ohm

### CAPACITORS

C1—C3—0.1- $\mu$ F, ceramic-disc  
C4, C5—0.22- $\mu$ F, Mylar  
C6, C7—4.7- $\mu$ F, 16-WVDC, electrolytic  
C8, C9—47- $\mu$ F, 16-WVDC, electrolytic

### ADDITIONAL PARTS AND MATERIALS

MIC1—electret microphone  
SPKR1—8-ohm speaker  
Wire, solder, etc.

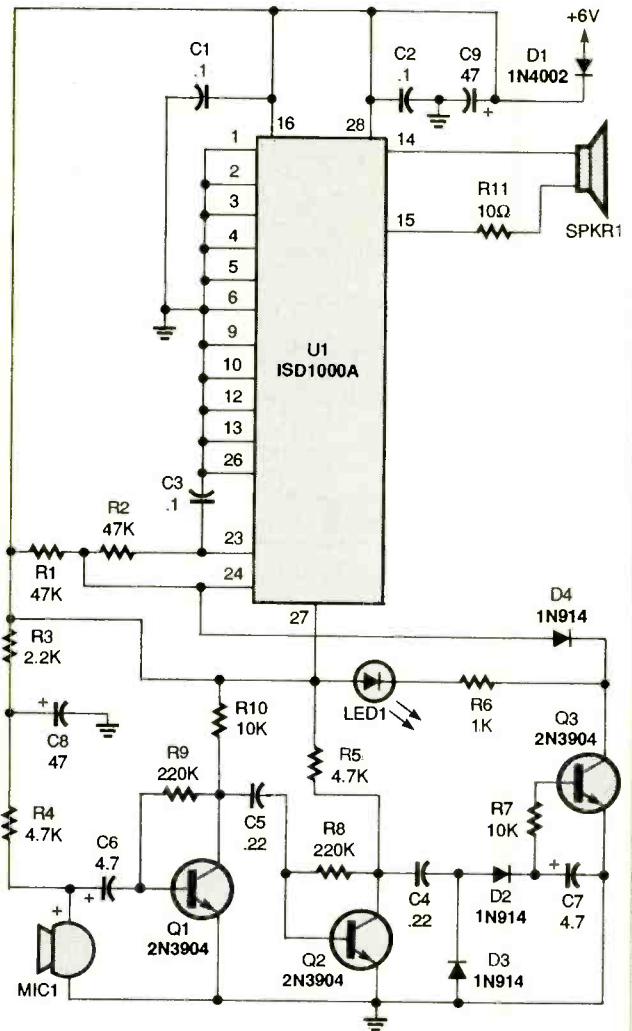

Fig. 5. When this circuit "hears" a noise, it plays back a prerecorded sound, such as a dog barking.

in Fig. 3 is a good choice for the photo caper because it makes it impossible to accidentally erase a message which at a later date might be impossible to recreate. So how do you get a message onto the chip? Simply use either the circuit in Fig. 1 or Fig. 4 (we'll get to that in a moment) to record the message and then move the chip to the playback-only circuit.

### ADVANCED RECORDER/PLAYER

Our next entry (see Fig. 4) is a mini solid-state message recorder/player circuit. To keep Murphy at bay, follow good project-building practices by keep-

ing all component leads short and close to the IC.

Using the solid-state recorder is easy. To record, depress switch S2 and hold it closed until you have completed your message or until the 20-second message limit has run out. To play the message back, hold switch S1 closed.

### SOUND-ACTIVATED PLAYER

Now let's take a look at a sound-activated talk-back circuit (see Fig. 5). One great application for the circuit is as a simulated watchdog. You could record the sound of a barking dog onto the ISD1000A using either of the recorder

friend or relative and you can have his or her looks and voice frozen in time. Place the circuitry in a small plastic case and attach it to the back of the picture. Mount S1, the normally closed pushbutton switch, on the bottom of the case so that when the picture

frame is resting in place, the switch is open. When the picture is picked up, the switch will close and the frame will appear to speak. Of course, that might cause the person holding the frame to drop it when it starts talking!

The playback-only circuit

circuits we already examined, insert the chip into the sound-activated player, and locate the circuit near an entry door. When someone bangs on the door a ferocious dog will bark back. With a little thought, I am sure you can come up with other uses for the circuit.

An electret microphone, MIC1, picks up sounds which are amplified several-hundred times by transistors Q1 and Q2. The audio output at the collector of Q2 feeds a voltage-doubler detector circuit that supplies a positive bias to Q3. Transistor Q3's collector then goes low, lighting LED1 and forcing pins 23 and 24 of U1 low. That starts the play function. As long as the sound level reaching the microphone is sufficient to keep Q3 on, the recording will continue to play until the 20-second time period runs out. When the audio reaching the microphone ceases, the playback will stop within a few seconds (the value of C7 determines how long that is; increase the value of C7 to make it longer, and reduce the value to make the time period shorter). The next time the circuit is activated, the playback will start over at the beginning and repeat the message.

While the circuit is not playing, power consumption is only a few milliamps. When pins 23 and 24 of U1 are high, the IC is in a sleep mode drawing only about 10-microamps of current.

If you would like to increase the playback audio level, you can connect an external amplifier to the circuit. The audio can be taken from either pin 14 or 15 through a suitable coupling capacitor.

That's all for now. If you would like to see more on the ISD1000A, check out the "Circus" next month. ■

## THINK TANK

(Continued from page 32)

change R1 from 240 ohms to 1000 or 1200 ohms.

—Bill Stiles, Hillsboro, MO

*The values of R1 and R2 are not too important; their ratio is. That's why the ratio of the values in the spec sheet is the same as that shown here. The 240- and 2400-ohm values are hard to find (even at Radio Shack), and that's probably why Joseph used more-common stock. That aside, your comment about using precision units or an adjustable circuit is well taken.*

*Regarding R3, the circuit is designed to be a trickle charger—a 1-amp current draw is not a trickle. The circuit is supposed to keep batteries at the ready, not to recharge them after a significant drain. For that reason, the drop across D1 is insignificant. It can also be overcome by adjusting the value of R2. Placing a crowbar diode across a regulator in most power-supply circuits is a good idea. But in this case, using it to replace D1 still does not prevent the battery from discharging through the resistors if the charger loses power. As shown, D1 protects both the regulator and the battery.*

*You are absolutely right about the value of R4—it's too low. I generally shoot for an LED current of 15 mA, but LED life should not be significantly reduced with your value of 20 mA. However, I generally round-up a current-limiting resistor's value to the next standard value, not down. That provides a tiny safety margin.*

*That's all until next month. In the meantime, send your circuits to Think Tank, Popular Electronics, 500-B Bi-County Blvd., Farmingdale, NY 11735. ■*

## Coil Design and Construction Manual

• • •

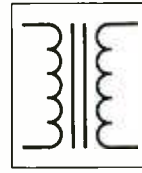

## YOU CAN WIND YOUR OWN COILS?

There's no trick to it except knowing what you are doing. In a unique, 106-page book you can become expert in winding RF, IF, audio and power coils, chokes and transformers. Practically every type of coil is discussed and necessary calculations are given

with the mathematical data simplified for use by anyone. Get your copy today!

Mail coupon to:

**Electronics Technology Today, Inc.**  
P.O. Box 240 • Massapequa Park, NY 11762-0240

Please send me my copy of *Coil Design and Construction Manual* (BP160). I enclose a check or money order for \$8.45 to cover the book's cost and shipping-and-handling expenses. NY state residents must add local sales tax.

Name \_\_\_\_\_

Address \_\_\_\_\_

City \_\_\_\_\_ State \_\_\_\_\_ ZIP \_\_\_\_\_

All orders must be paid in U.S. funds only. Sorry, no orders accepted outside of USA and Canada. Please allow 6-8 weeks for delivery.

## ON WATCH FOR AMERICA.



On ships, planes and submarines, in locations around the world, the men and women of the United States Navy are on watch. They're putting their training to work in jobs that make a difference, while developing skills they'll need for a successful future. Just as important, they're doing it for their country. They're Navy people, working hard for America. And that makes us proud.

## Navy. Full Speed Ahead.

# DX LISTENING

By Don Jensen

## Fun in the Summertime

Some SWLs abandon their listening during the summer months. More static, some say, and yes, there's some truth to that. For others, there are too many other outdoor activities to compete with DX listening, and that's true too. But before you pull the plug on shortwave listening until autumn, be aware that if you're up to battling the band noise, there can be some terrific DX out there.

Summertime can produce some of the best trans-equatorial signals to

eastern Pennsylvania for a weekend of alfresco listening fun. This month, Rich continues with his answers to questions I put to him about organizing a SW DXpedition.

What goes into planning a shortwave DX outing, Rich?

"In addition to bringing along the receivers and other gear, it is wise to plan your listening time. You want to maximize the opportunities to catch those DX signals when they appear.

"Have a list of 'target' stations ready to go. Since, hopefully, you are in a DXing environment that's better and quieter than home, don't be afraid to stretch your listening goals and interests.

"For example, maybe you've never heard a SW station from Indonesia before. Decide in advance which frequencies and times may give you the best opportunities. Then, with a good propagational opening and reduced band noise, Indonesian reception may become a reality!"

What sort of DXing equipment should one bring along?

"At more primitive locations, battery portables would be required, but since the cabin where we set up has electrical power, that's not a concern for us.

"Today's AC-powered tabletop SW sets are lightweight and compact, excellent for our SWling in the 'wild.' But one of our guys, Hans has brought along his old and very heavy military surplus R-390 tube receiver, which is a real 'boat anchor.'

"In addition, don't forget to bring along the other things you'll need for your SW listening, maybe a tape recorder to capture those rare SW signals you hear, reference books, frequency lists and the rest."

How about creature comforts?

"Our cabin is comfortable and little more than an hour's drive away for most of us. And we all cook, sort of. I'm in charge of the traditional Friday-evening spaghetti dinner. Fred brings lunch meats and rolls. Hans has made his breakfast muffins legendary. Dave's mom has supplied us with delicious pies. . . ."

Okay, okay, Rich, we get the idea. Is there an ideal size for a DXpedition group?

"Four or five, and their listening setups, fit easily in a cabin. More can fit in with a bit of crowding, but a larger group means plenty of enjoyable conversation and storytelling. And it's nice to have the extra ears listening for the rare DX signals.

"Actually, though, we've had DXpeditions with as few as two people and we had a ball. What's important is that everyone has similar DX interests."

What about antennas?

"Gifford Pinchot State Park in eastern Pennsylvania is a wooded area, which allows the opportunity to experiment with antennas, more so than back home. We've tried truly long, long-wire antennas. We've used special switching arrangements to couple several antennas to a receiver. We've experimented with



Thanks, Mr. Jensen, . . . . . for the report on a United Nations broadcast at 0815-0830 GMT, 26 Oct. on KNBH, 9,515 Kcs. . . . the details of which are correct.

RADIO DIVISION  
DEPARTMENT OF PUBLIC INFORMATION

Here's a vintage QSL card from United Nations Radio, which at the time was rebroadcast via the powerful Voice of America shortwave transmitters.

Northern Hemisphere SWLs. Those signals can include some very elusive African and South American SW ones. And, as I suggested last month, you can add more fun to your summer SWling by doing at least some of it in the great outdoors.

In our June column, long-time DXer Rich D'Angelo told us about his regular DXpeditions with a group of friends to a state park in

'delta loops' and 'eavesdroppers,' and they've worked well.

"I may be an antenna cynic, but I'm convinced that in a low-noise environment, just 100 feet of wire produces as good results as almost any other antenna combination. Our long antennas are simply strung over low tree branches. At the state park, fortunately, there is no shortage of tree branches. Although we'd love to leave them up, making for a more permanent installation for our next visit, that's not possible in the park. We put them up when we arrive and take them down when we leave.

"Although I wouldn't recommend going on a DXpedition with only the portable receiver's built-in whip antenna, Larry managed to log the Indonesian station, *RRI Tanjungkarang* on 3,395 kHz two years ago on a Sony 2010 with just its whip. Since the station was booming in on our Drakes and NRDs with long wire 'Beverage' antennas, he thought it worth a try with the portable and whip. It worked, but I wouldn't expect results like that on a regular basis."

Any other tips?

"Be careful during hunting season? Stringing an antenna in the woods, and hearing gunshots in the distance, can shorten a longwire antenna faster than bad weather! And the usual camping-out cautions also apply.

"As far as our group is concerned, another safety tip is to keep Hans away from the stove. He earned the nickname 'Torch' last year when he almost burned the cabin down while cooking a shrimp dish. It made for some great conversation and pictures!"

Thanks, Rich, for your vivid

picture of an SWling weekend.

### AN INTERESTING IDEA

In an Op Ed think piece in the *New York Times*, Keith Spicer, chairman of the Canadian Radio-TV and Telecommunications Commission, noted that hate broadcasts have helped to brew some of the worst horrors in places like Bosnia and Rwanda.

In those trouble spots, the United Nations staggers under huge peacekeeping bills that are a result of those conflicts. Couldn't the UN head off or stop ethnic wars by mobilizing airwaves that are too often used to set them off?

Spicer notes that broadcasts can convey anti-racist facts and perspectives in the same powerful way that broadcasts now are used to inflame ethnic hatreds. Unlike the print media, radio can reach all social and cultural groups, especially the illiterate or poorly educated, he points out. Broadcast stations require only a modest amount of equipment and supplies, and only a few staff members. Volunteers from the West's private media-aid organizations could be enlisted to help the U.N., Spicer suggests.

"We're talking about technology, a few volunteers and some vision—all at a pittance—to stop ethnic bloodbaths," Spicer says.

Longtime SWLs remember that the U.N. once was a major presence on shortwave. U.N. Radio, then relayed by powerful Voice of America transmitters, was easily heard around the

**CREDITS:** Richard D'Angelo, PA; Marie Lamb, NY; Ed Rausch, NJ; Robert Tucker, GA; North American SW Association, 45 Wildflower Road, Levittown, PA 19057.

world. But in 1985, faced with a hike in airtime charges levied by the VOA, the U.N. decided it could no longer afford to lease the facilities.

The United Nations, of course, didn't abandon radio entirely. It continued to furnish brief weekly news and current-event programs to world SW broadcasters willing to re-broadcast them. Today, those continue, broadcast by just a handful of stations in places like Nigeria, Egypt, China, Zambia, Poland, and others.

Needless to say, the impact of these broadcasts is insignificant. So maybe Spicer has a worthy idea. Maybe U.N. Radio should be beefed up to air "Propaganda for Peace."

### DOWN THE DIAL

Time again to turn our

attention to some of the SW broadcasts that are being logged on the bands these days. What are you hearing? Drop a line to me in care of "DX Listening," **Popular Electronics**, 500-B Bi-County Blvd., Farmingdale, NY 11735.

**CUBA**—9,820 kHz. *Radio Havana Cuba* was heard at 0345 UTC with its English-speaking shortwave-listeners program, "DXers Unlimited," with host Arnie Coro. It's also on 6,010 kHz at the same time.

**JAPAN**—11,885 kHz. *Radio Japan*, out of Tokyo, was noted at 0530 UTC with an English-language feature, then into Japanese programming at 0600 UTC.

**MOROCCO**—17,595 kHz. *Radio TV Marocaine* was logged at 1400 UTC announcing, "Welcome to the International Service of Radio Morocco." ■

## From Not-Working to Networking!

### Troubleshooting Local-Area Networks!

Now, complete for the first time in one detailed booklet!

Gain a fuller knowledge of network fundamentals and how they developed from the early days of main frames, from XNS to Ethernet technology, the OSI stack for interconnecting different computers, basic and specialized test instruments, etc. Several tough LAN case histories bring from theory to the practical side of troubleshooting.

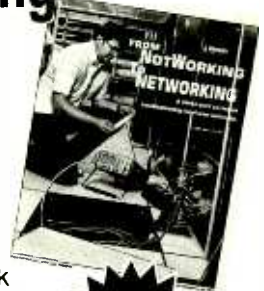

ONLY \$5.00

CLAGGK Inc., Reprint Bookstore  
P.O. Box 4099, Farmingdale, NY 11735

Please rush my copy of "From Not-Working to Networking." I enclosed payment of \$5.00 which includes shipping charges.

Name \_\_\_\_\_

Address \_\_\_\_\_

City \_\_\_\_\_ State \_\_\_\_\_ ZIP \_\_\_\_\_

Sorry, no orders excepted outside of United States and Canada. All Payments must be in U.S. funds. Send check or money order payable to CLAGGK Inc.—do not send cash or stamps. New York State residents add applicable sales tax.

# HAM RADIO

By Joseph J. Carr, K4IPV

## Receiver Selectivity

**A**lthough transmitter power is often the first thing a ham looks at when looking for a transceiver, that's actually one of the least important specifications. For overall operating usefulness, the specs of the receiver are much more important. And among receiver specs, one of the most important is selectivity.

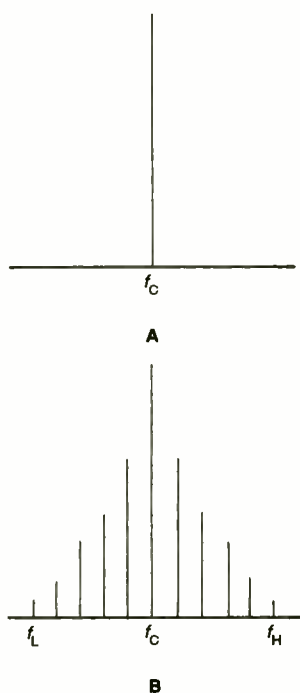

*Fig. 1. An unkeyed carrier (A) has only a very small bandwidth, but when the carrier is keyed, the signal spreads out as shown in B.*

Of course, sensitivity, dynamic range, third-order intercept point, and other matters are important as well, but in the limited space that a column affords us we can tackle only one topic at a time . . . so this month it's selectivity.

Selectivity is the measure of a receiver's ability to reject adjacent-channel

interference. Or to put it another way, it's the ability to reject interference from signals on frequencies close to the desired signal frequency.

In order to understand the selectivity requirements of a receiver, you must first understand a little bit of the nature of real radio signals. An unmodulated radio carrier theoretically has an infinitesimal bandwidth (although all real unmodulated carriers actually have a very narrow bandwidth because they are modulated by noise and other artifacts). As soon as the radio signal is modulated to carry information, however, the bandwidth spreads. An on/off telegraphy (CW) signal spreads out on either side of the carrier frequency by an amount that depends on the sending speed and the shape of the keying waveform. Figure 1A shows an unmodulated CW signal. When the carrier is keyed, however, the signal spreads out as shown in Fig. 1B, with a bandwidth centered on the carrier of  $f_H - f_L$ .

An AM signal spreads out an amount equal to twice the modulating frequencies. That means that the AM waveform will occupy a spectrum that is equal to the carrier frequency ( $f_c$ ) plus/minus the audio bandwidth. For example, in the case of an AM transmitter with audio components from 300 to 3,000 Hz transmitting on a carrier frequency of 14,300 kHz, the upper and lower sidebands will extend from 14,297 kHz to 14,303 kHz ( $f_c \pm 3,000$  Hz) as shown in Fig. 2.

An implication of the fact that radio signals have bandwidth is that the receiver must have sufficient bandwidth to recover all of the signal. Otherwise, information might be lost, resulting in distorted audio. On the other hand, allowing too much bandwidth increases the noise picked up by the receiver and thereby deteriorates the signal-to-noise ratio. The goal of the selectivity system of the receiver is to match the bandwidth of the receiver to that of the signal. That is why receivers will use a 270 to 500-Hz bandwidth for CW, 2 to 3 kHz for SSB, and 4 to 6 kHz for AM signals. They allow you to match the receiver bandwidth to the transmission type.

The selectivity of a receiver has a number of aspects that must be considered. Those are the front-end bandwidth, IF bandwidth, IF shape factor, and more.

### FRONT-END BANDWIDTH

The "front-end" of a modern superheterodyne radio receiver is the circuitry that is between the antenna input terminal and the first mixer stage. Front-end selectivity is the key factor that keeps out-of-band signals from raising havoc with the receiver. For example, AM-broadcast band transmitters located near your QTH can easily overload a poorly designed shortwave receiver. Even if those signals are not heard by the operator (as they often are), they can desensitize a receiver, or create harmon-



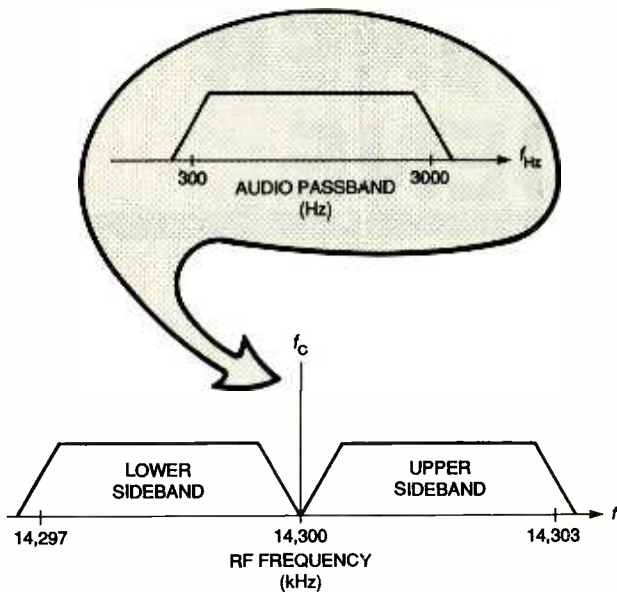

Fig. 2. Assuming an audio spectrum of 300 Hz to 3,000 Hz, and a carrier frequency of 14,300 MHz, an AM signal's upper and lower sidebands will extend from 14,297 to 14,303 MHz.

ics and intermodulation products that show up as "birdies" or other types of interference on the receiver. Strong local signals can take a lot of the receiver's dynamic range, and thereby make it harder to hear weak signals.

Two forms of front-end frequency selection are typically found. A designer might choose to use only one of them in a design. Alternatively, both might be used in the design, but separately (i.e. the operator selects the type used). Or finally, both might be used together. Those forms can be called the resonant-frequency-filter and band-pass-filter approaches.

The resonant-frequency-filter approach uses L-C elements tuned to the desired frequency to select which RF signals reach the mixer. In some receivers, those L-C elements are designed to track with the local oscillator (LO) that sets the operating frequency. That's why you see two-section variable capacitors for AM-broadcast receivers with two different capacitance ranges for the two

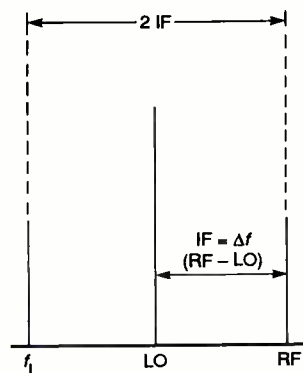

Fig. 3. An image is a response to a signal that is located the same distance away from the desired signal, but on the opposite side of the local oscillator frequency.

sections; one section tunes the LO and the other section tunes the tracking RF input.

The other approach uses a bandpass filter to admit only a portion of the RF spectrum into the front-end. For example, a shortwave receiver that is designed to take the HF spectrum in 1-MHz hunks could have an array of RF input bandpass filters that are each 1 MHz wide (for example, 7-8 MHz).

In addition to the reasons cited above, front-end se-

lectivity also helps improve a receiver's image-rejection and 1st-IF-rejection capabilities. All superheterodyne receivers are subject to image responses. An image is the response to a signal that is located at a point that is the RF frequency plus/minus the IF, on the other side of the LO from the RF signal. In the example shown in Fig. 3, the LO is on the low side of the RF signal, so the IF frequency is  $\Delta f$ , or  $RF - LO$ . But if there is a signal at frequency  $f_i$ , it also is  $\Delta f$  from the LO, so it is seen as a valid IF signal by the receiver!

If the IF frequency is low compared to the RF frequency, the image might

receiver's first-IF frequency. For example, if your receiver has a first IF of 8.83 MHz, it must be able to reject radio signals operating on that frequency when the receiver is tuned to a different frequency. Although the shielding of the receiver is also an issue with respect to that performance, the front-end selectivity affects how well the receiver performs against 1st-IF signals. If there is no front-end selectivity to discriminate against signals at the IF frequency, then they arrive at the input of the mixer unimpeded. Depending on the design of the mixer, they then may pass directly through to the high-gain IF amplifiers and

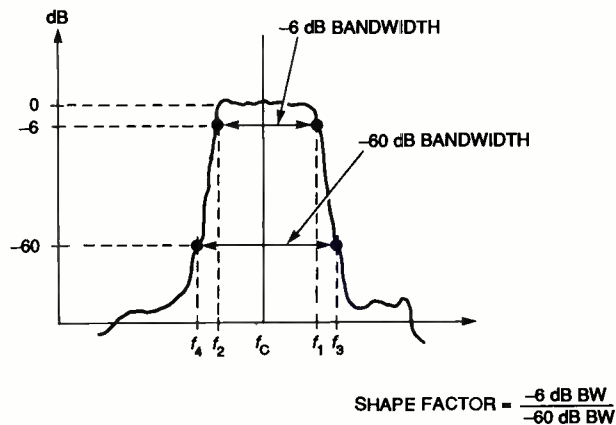

Fig. 4. The shape factor is determined by measuring the ratio of the bandwidths at the -6 dB and -60 dB points.

well fall within the pass-band of most front-end tuning schemes. For example, at 25 MHz, a 455-kHz IF could produce images at 24.55 MHz and 25.455 MHz. A 1-MHz bandpass filter would scarcely affect that problem. However, if the first IF frequency is 9 MHz or 50 MHz (as it is in many modern shortwave receivers), then the images would be far enough removed from the RF signal that a 1-MHz bandpass front-end design would work well.

The 1st-IF rejection specification refers to how well a receiver rejects radio signals operating on the

be heard in the receiver output.

### IF BANDWIDTH

Most of the selectivity of the receiver is provided by the filtering in the IF-amplifier section. The filtering might be L-C filters (especially if the principal IF is a low frequency, like 50 kHz), a ceramic resonator, a crystal filter, or a mechanical filter. Of those, the mechanical filter is usually regarded as best, with the crystal filter and ceramic resonator coming in next.

The bandwidth is expressed in kilohertz, and is  
(Continued on page 90)

# SCANNER SCENE

By Marc Saxon

## Up In The Air



*Uniden's BearTracker BCT-7 "highway-information-system" scanner detects and alerts the driver to the presence of any mobile extenders—used by state police and highway patrols—in a three-mile radius. It also comes preprogrammed with thousands of highway-patrol, local-police, D.O.T. and weather channels.*

Uniden America Corporation tells us that their new *BearTracker BCT-7* scanner is the most complete highway-information system available. If it isn't, it must be pretty close to the top of the list.

Basically, the BCT-7 is a "Highway-Patrol Driver-Alerting Machine." The sophisticated, multiband scanner responds to transmissions from what Uniden describes only as "special secondary radios installed on most highway patrol vehicles across the United States." You and I know that such non-technical wording refers to mobile extenders, which are low-powered, short-range mobile transmitters used especially by many state police and highway patrols. For example, Florida Turnpike mobile extenders use 156.18 MHz, while the Ohio Turnpike extenders are on 465.525 MHz.

The BCT-7 is preprogram-

med to alert its user with audible and visual alarms announcing the presence of any mobile extenders within a three-mile radius. One might then assume that there's a possibility that the vehicle is heading toward a speed-clocking area.

More than that, the BCT-7 is also preprogrammed with a complete frequency list of highway-patrol, local-police, Department of Transportation, and weather channels. Literally thousands of frequencies are stored in a state-by-state matrix. All U.S. and Canadian weather channels can be scanned.

The BCT-7 is also a full-featured scanner that covers all of the standard action bands (including the 800-MHz band). It offers 100 user-programmable channels, and features 12 separate band-search capabilities, including CB radio and the VHF aeronautic band. One-touch band-search includes weather-scan, news, police, fire, and more.

You can get a look at the versatile *BearTracker BCT-7* at any of Uniden America's many dealers.

### DEMO TEAMS

Since 1946, millions have been awed by the inspiring aerial artistry of the U.S. Navy's flight demonstration squadron, the Blue Angels. Their name has become synonymous with precision. Those who have attended their demonstrations and seen others there with scan-

ners often write requesting frequency information so they can tune in as the sleek FA-18 aircraft go through their paces.

Thanks to Ron Bruckman, of the *Radio Monitors Newsletter of Maryland*, we have the following current (and confirmed) frequencies used by the Blue Angels. Even better, Ron has furnished frequencies for the other military demonstration teams. Now you can get in on all the action.

The U.S. Navy Blue Angels' lead pilot uses 238.15 MHz. Air coordination at show sites is on 123.4, 142.00, 143.00, and 241.4 MHz. Show-site frequencies include 250.8, 251.6, 275.35, 360.4, 384.4, 391.9, and 395.9 MHz. Other related frequencies include 34.35, 118.1, 118.2, 121.9, 141.45, 142.025, 142.625, 143.60, 250.4, 251.4, and 394.4 MHz.

The U.S. Air Force Thunderbirds' show-site frequencies are 114.95, 118.1, 120.45, 123.4, 123.45, 124.925, 138.875, 141.85, 148.552, 236.55, 236.6, 241.4, 241.6, 250.85, 273.5, 283.5, 294.7, 295.7, 322.3, 322.6, 382.9, 394.0, and 413.025 MHz. Listen for ground support on 66.90 MHz.

The U.S. Army Golden Nights Parachute Team uses 32.30, 42.35, 123.4, and 123.6 MHz.

The Canadian Snowbirds operate on 227.0, 227.6, 236.0, 236.6, 239.4, 239.8, 240.5, 243.4, 245.0, 245.7, 266.3, 275.8, 283.9, 294.5, 295.6, 310.8, 316.5, 322.8, and 344.5 MHz.

Readers who would like to obtain a sample copy of the *Radio Monitors Newsletter of Maryland* can obtain one by sending \$2 to Radio Monitors of Maryland, P.O. Box 394, Hampstead, MD 21074-0394. A one-year membership, which includes 12 newsletters, costs \$15.

### MONITORING DATA

The updated and expanded *Air-Scan Guide to Aeronautical Communications, 6th Edition* has just come out. It is the one all-inclusive scanner-monitoring guide to VHF aeronautical communications facilities in the U.S. and Canada. Civil and private airports, seaplane bases, heliports, military fields, and some "unlisted" landing towers are listed. Frequencies are provided for control towers, approach/departure, ground control, clearance delivery, unicom, ATIS, weather, operations, Flight Service Stations, VOR, etc.



If you're looking for a single source of VHF aeronautic listings, your search is ended with the 6th edition of *Air-Scan Guide to Aeronautical Communications*.

U.S. listings are supplemented (as known and applicable) with additional on-site frequencies, in the 30-800-MHz range, for aeronautic-related activities including airline ground op-

erations, airport security and fire, Air and National Guard, ultralights, and more. There are complete VHF listings of all U.S. and Canadian ARTCC remote sites and all their frequencies. Much more is also contained in the sixth edition of the largest single source of aeronautical frequency listings.

*Air-Scan, 6th Edition* can be ordered for \$18.95, plus \$5 shipping and handling (\$6 to Canada), from CRB Research Books, P.O. Box 56, Commack, NY 11725-0056; Tel. 1-800-656-0056 (1-516-543-9169 in Canada, Alaska, and Hawaii). New York State residents must add \$2.36 tax. MasterCard and Visa are accepted.

### BYE, BYE BIRDIE

Ben, from Cherry Valley, New York, writes that he purchased a used scanner

at a ham swapmeet. Ben didn't say which scanner it was, but it worked fine. Fine, that is, except that he can't hear stations on 155.295 MHz, which is an active EMS channel in his area. All he hears on that frequency is an "open carrier," although 155.295 MHz comes in without any problems on his other scanner.

Alas, Ben has encountered a *birdie*. It happens in the best of scanners! In order to function, all scanners require circuits that use certain frequencies. Those frequencies vary from one model to another, and every modern scanner has its own share. As an example, the sophisticated Radio Shack PRO-2035 has no less than 91 birdies sprinkled between 25 and 1200 MHz.

Usually, a birdie won't coincide with a particular local frequency that you

want to monitor. The PRO-2035 can receive nearly 200,000 different frequencies, so 91 birdies really isn't many. Many lie on oddball spots, including frequencies that the set doesn't receive. The odds are long that you'd ever be inconvenienced, but it does happen on occasion—for instance, if you wanted to monitor a PRO-2035 birdie frequency such as 155.625 MHz. It's a real police frequency and is used in some cities. Ben "beat" the odds with 155.295 in his particular scanner.

Try backing down on the scanners squelch to see if you can knock out the birdie. If the scanner has a sound squelch, try that as well. Maybe readers can suggest alternate cures that have worked for them.

That's all for now. See you next time. ■

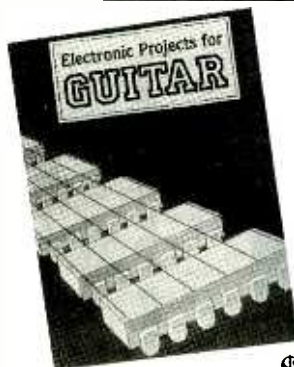

Whether you wish to save money, boldly go where no guitarist has gone before or simply have fun building electronic gadgets designed for your musical pleasure, then read

## Electronic Projects for GUITAR

Some of the add-on guitar gadgets you can build are:

\$12<sup>95</sup>

**Preamplifier • Headphone Amplifier • Soft Distortion Effects Unit • Compressor • Auto-waa • Waa-waa Pedal • Phaser • Dual Tracking Effects • Distortion Unit • Expander • Dynamic Treble Booster • Direct Injection Box • Dynamic Tremelo • Thin Distortion Unit • and Guitar Tuner.**

**Anyone with some previous electronic project building experience should have no problem assembling the projects.**

ELECTRONICS TECHNOLOGY TODAY INC.  
P.O. Box 240, Massapequa Park, NY 11762-0240

Yes, send my copy of ELECTRONIC PROJECTS FOR GUITAR by RA Pentold to the address at right. I am enclosing \$12.95 plus \$2.95 for shipping charges in USA and Canada. All payments must be made in US funds. Sorry, no orders accepted outside of USA and Canada. New York State residents add local sales tax. Allow 6-8 weeks for delivery.

Check enclosed.

Please charge my  Visa  MasterCard

Signature \_\_\_\_\_

Account No. \_\_\_\_\_ Expir. Date \_\_\_\_\_

Name \_\_\_\_\_

Address \_\_\_\_\_

City \_\_\_\_\_ State \_\_\_\_\_ ZIP \_\_\_\_\_

# ELECTRONICS LIBRARY

## Tuning in to RF Scanning From Police to Satellite Bands

by Bob Kay

There's much more to radio-frequency scanning than listening to police, fire, and ambulance calls. If you know where to tune, you can also monitor aircraft communications, satellite signals, and even the Space Shuttle.

This guide to the world of scanning teaches beginners all they need to know to get started, and provides experienced scanners with the information they need to make their hobby more interesting and exciting. It begins with the basics: choosing a scanner and an antenna,

radios. The book also explains how to establish a professional listening post and find scanning clubs and publications. It includes a chart that lists hundreds of frequencies.

*Tuning in to RF Scanning; From Police to Satellite Bands costs \$14.95 and is published by Tab Books Inc., Blue Ridge Summit, PA 17294-0850; Tel. 1-800-233-1128.*

**CIRCLE 98 ON FREE INFORMATION CARD**

## MACINTOSH REVELATIONS: Customizing, Upgrading & Troubleshooting Using System 7.5

by Ken Maki

Macintosh computers are particularly easy to use. With a simple click of the mouse, Mac users can play games, write letters, enter a spreadsheet, or do almost anything else. But they are also powerful machines, and this book shows users how to unleash that power.

With an emphasis on the undocumented features of the Mac's latest operating platform, the book and its included CD-ROM provide practical advice and valuable hints that can make a System 7.5 run like a 10. It teaches readers how to customize their Macs, guides them through the upgrade process, and provides troubleshooting help for both software and hardware. The book also offers chapters on networking and system enhancements.

The CD-ROM contains more than 600-MB of System-7.5-compatible software. It contains software for games and entertainment; telecommunications; fonts, graphics, and sounds; educational programs; programming utilities; PowerPC utilities; and BMUG information.



Users can design their own icons, paint their desktop with interesting patterns, have Elvis drop by, or have Bullwinkle the Moose remind them to call home.

*Macintosh Revelations costs \$32.95 and is published by John Wiley & Sons, Inc., 605 Third Avenue, New York, NY 10158-0012; Tel. 1-800-CALL-WILEY.*

**CIRCLE 92 ON FREE INFORMATION CARD**

## WERNER VON SIEMENS: Inventor and International Entrepreneur

by Wilfried Feldenkirchen

Although Werner Von Siemens is best known as an inventor and pioneering electrical engineer—he developed the electric dynamo and an improved pointer telegraph—this biography focuses on his life as a businessman. Siemens was also an entrepreneur with a broad and international business vision.

His firm, Siemens & Halske, built Germany's first important telegraph line and then built lines elsewhere in Europe and Asia. When he later turned his hand to electric technology, Siemens was instrumental in creating the conditions for the advancement of electrical technology, helping to bring it from the experimental stage into the modern electrical industry.

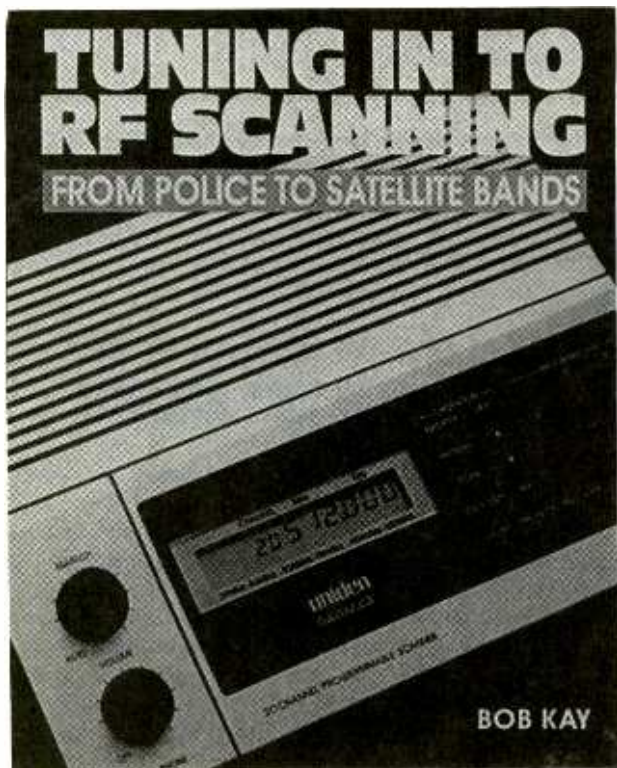

buying and installing accessories, and laws and regulations. The book goes on to tell you how to monitor cordless telephones and baby monitors; military aircraft, exercises, and ground maneuvers; NASA; sports and entertainment frequencies; computers; and

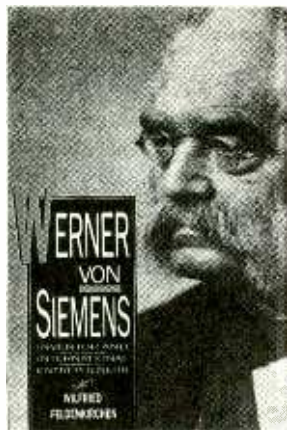

From their earliest days, Siemens' businesses had a multinational flair, with activities nearly spanning the globe. In covering the business history of Werner Von Siemens, this book also depicts the history of European industrialization, German history, and the history of business and technology.

*Werner Von Siemens: Inventor and International Entrepreneur* is available for \$19.95 in hard cover and \$12.50 in paperback from Ohio State University Press, 180 Pressey Hall, 1070 Carmack Road, Columbus, OH 43210-1002; Tel. 614-292-6930; Fax: 614-292-2065.

**CIRCLE 93 ON FREE INFORMATION CARD**

## PACKET: SPEED, MORE SPEED, AND APPLICATIONS

compiled by Bob Schetgen, KU7G

There have been a lot of exciting developments in packet radio recently, if you look beyond the local BBS and packet cluster. Hams are increasing their speed, building high-speed LANs that span whole towns, using packet to report weather conditions automatically, mapping positions using Global Positioning receivers or LORAN-C, tracing the flow of messages through the packet network, and exchanging packet information via meteor scatter propagation. This book—actually a collection of articles from such publications as *QST* and *QEX*, and ARRL Conference Proceedings—shows you how to find the areas that interest you.

The book is divided into five sections. The first, "9600 Bits/s," shows readers how to increase their basic packet speed to 9600 bits per second. It includes basic information on high-speed packet, hands on advice for getting started, and a review of modems that work at both 1200 and 9600 bps. The second section, "56 kBits/s and Faster," is aimed at those who

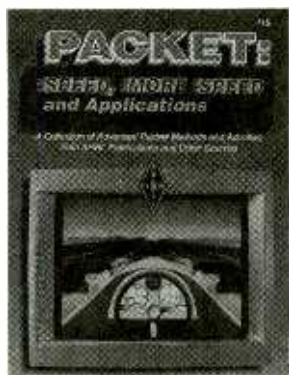

want to go even faster—up to two megabits per second. Section 3 is devoted to packet projects, including modems, a telemetry adapter, and a modem interface. The fourth section covers special topics including the future of packet radio, and Section 5 provides references.

*Packet: Speed, More Speed, and Applications* costs \$15 and is published by The American Radio Relay League, 225 Main Street, Newington, CT 06111; Tel. 203-666-1541; Fax: 203-665-7531.

**CIRCLE 94 ON FREE INFORMATION CARD**

## 1995 GENERAL CATALOG OF PRODUCTS FOR TESTING, REPAIRING & ASSEMBLING ELECTRONIC EQUIPMENT

from Contact East

The 144 pages of this full-line catalog are filled with hundreds of new test instruments and tools for engineers, technicians, hobbyists, and managers. Quality, brand-name products for electronic testing, repair, and assembly are featured.

Highlights of the 1995 catalog include digital multimeters and accessories, soldering tools,

EPROM programmers, power supplies, custom tool kits, measuring tools, adhesives, data-communication tools and testers, heat guns, reference books, portable and bench-top digital storage oscilloscopes, ELF meters, precision hand tools, and breadboards. The catalog also offers full lines of communication test equipment, static-protection products, inspection equipment, soldering/desoldering systems, ozone-safe cleaners, workbenches, and cases. All products are fully guaranteed, and orders placed by 4 PM will be shipped by 5 PM that same day.



*The 1995 Catalog of Products for Testing, Repairing & Assembling Electronic Equipment* is free upon request from Contact East, 335 Willow Street South, North Andover, MA 01845-5995; Tel. 508-682-2000; Fax: 508-688-7829.

**CIRCLE 85 ON FREE INFORMATION CARD**

## THE WHOLE SPY CATALOG

by Lee Lapin

This 440-page, hands-on encyclopedia of "secret sources" provides a wealth of professional secrets, tricks of the trade, "insider" phone numbers, and cutting-edge techniques for tracing, tracking, surveillance, and investigating anyone or anything.

The book shows how to locate and bug people, using the latest audio bugs and telephone taps. It shows where to buy exotic and inexpensive subcarriers, narrow-band, and burst bugs that are easy to hide and almost impossible to find; and how to turn a \$45 tape recorder

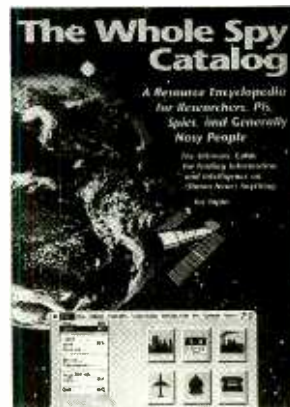

into a powerful room monitor. It also offers a look at the newest bugs, antennas, listening-post equipment, and intelligence kits from around the world, and lists sources for buying it all—even actual KGB surveillance equipment.

The book also shows readers how to locate and tap any telephone. It provides distribution schemes, details the equipment needed, and shows how to use it. Photos, tips, and tricks from professionals are included, as are tests of cellular-phone interceptors (including how they work, and how to follow and intercept any nearby cellular calls). Also included is software that turns your PC into a cellular reader, as well as sources.

The book explains how to research a person's background and finances from the comfort of your living room, using mail forwarding, warranty-card information, magazine subscriptions, reverse directories, and credit information to find and build a dossier on anyone. It shows how to track down a person's real property, bank accounts, stocks, bonds, offshore accounts, and cars.

Other chapters cover Starlight night-vision technology, on-line resources, scrambling and encryption to protect your own personal information, high-tech countermeasures, and how to find and hire a good private detective.

*The Whole Spy Catalog* costs \$44.95 and is published by Intelligence Incorporated, 2228 South El Camino Real #349, San Mateo, CA 94403; Tel. 415-851-3957 (1-800-805-5544 for credit-card orders); Fax: 415-851-5403.

**CIRCLE 86 ON FREE INFORMATION CARD**

# VCR Cross Reference

**NOW Find the right Part  
for your VCR**



## With the ISCET VCR CROSS REFERENCE

This 119-page reference contains both model and part-number cross-references updated to include 1994 units.

VCR's are made in a few factories from which hundreds of different brand names and model numbers identify cosmetically-changed identical and near-identical manufactured units. Interchangeable parts are very common. An exact replacement part may be available only a few minutes away from you even though the manufacturer supplier is out-of-stock. You may be able to cannibalize scrap units at no cost!

The ISCET VCR Cross Reference is pre-punched for standard loose-leaf binding. . . \$38.00 plus \$3.00 for shipping for each Reference.

**Claggk Inc.  
VCR CROSS REFERENCE OFFER  
P.O. Box 4099  
Farmingdale, New York 11735-0793**

Name \_\_\_\_\_

Business \_\_\_\_\_

Address \_\_\_\_\_

City \_\_\_\_\_

State \_\_\_\_\_ Zip \_\_\_\_\_

Phone \_\_\_\_\_

Enclose \$38.00 for the Fifth Edition of the ISCET VCR Cross Reference and \$3.00 for shipping for each Reference.

The total amount of my order is \$ \_\_\_\_\_

Check enclosed—do not send cash.

or please charge my credit card.

Visa  MasterCard Exp. Date \_\_\_\_/\_\_\_\_/\_\_\_\_

Card No. \_\_\_\_\_

Signature \_\_\_\_\_

New York State residents must add applicable local sales tax to total. US funds only. Use US bank check or International Money Order. CB02

## HAM RADIO

*(Continued from page 85)*

measured from the points on the IF frequency-response curve where gain drops off -3 dB from the mid-band value. That is why you will sometimes see selectivity referred to in terms such as "2.8 kHz between -3 dB points."

The IF bandwidth is that which must be matched to the bandwidth of the received signal for best performance. If a too-wide bandwidth is selected, then the received signal will be noisy, and the signal-to-noise ratio deteriorates. If too-narrow, then you might experience difficulties recovering all of the information that was transmitted. For example, an AM-broadcast-band radio signal has audio components to 5 kHz, so the signal occupies up to 10 kHz of spectrum space ( $f_c \pm 5$  kHz). If a 2.8-kHz SSB IF filter is selected, the audio will tend to sound "mushy" and distorted.

## IF-PASSBAND SHAPE FACTOR

The shape factor is a measure of the steepness of the receiver's IF passband, and is taken by measuring the ratio of the bandwidth at -6 dB to the bandwidth at -60 dB (see Fig. 4). The general rule is that the closer those numbers are to each other, the better the receiver. Anything in the 1:1.5 to 1:1.9 range can be considered high quality, while anything worse than 1:3 is not worth looking at for "serious" use. If the numbers are between 1:1.9 and 1:3, then the receiver could be regarded as being middling, but useful.

The importance of shape factor is that it modifies the

notion of bandwidth. The cited bandwidth (e.g. 2.8 kHz for SSB) does not take into account the effects of strong signals that are just beyond those limits. Such signals can easily "punch through" the IF selectivity if the IF passband "skirts" are not steep. After all, the steeper they are, the closer a strong signal can be without messing up the receiver's operation. Thus, selecting a receiver with a shape factor as close to 1:1 as possible will result in a more usable radio.

Some manufacturers specify the shape factor based on -50-dB bandwidth, rather than -60 dB. That could indicate that the receiver is being made to appear a lot better than it really is . . . so be careful. When comparing shape factors, make sure that you are comparing apples and apples, not apples and oranges.

## MORE ON THE SID RECEIVER

Following the offer of a schematic for the AAVSO-Solar Division VLF SID receiver I made a few months ago (**Popular Electronics**, February, 1995), I received and filled more than 80 requests. Since then, the Chairman of the AAVSO-SD, Peter O. Taylor, contacted me and informed me that they have a new receiver design based on the op-amp gyrator circuit. That new SID receiver does not require the hard-to-find inductances needed by the older design. Pete offers information on the gyrator SID receiver to anyone sending him a business-sized (#10) self-addressed envelope with 32-cents postage affixed. If you are interested in getting that information, his address is: 4523 Thurston Lane, #5, Madison, WI, 53711-4738. ■

# GET THE LATEST ADVANCES IN ELECTRONICS

SUBSCRIBE TO—

# Electronics NOW

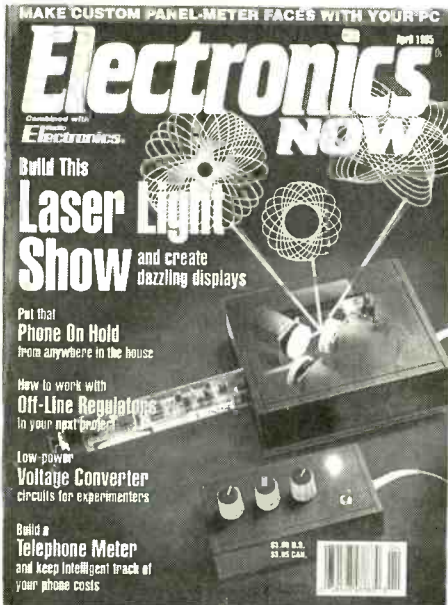

## ENJOY THE WORLD OF ELECTRONICS EACH MONTH!

Subscribe to the best informed electronics magazine—the one that brings you the latest high-tech construction projects, feature articles on new technology, practical troubleshooting techniques, circuit design fundamentals, and much more.

**Electronics Now** looks to the future and shows you what new video, audio and computer products are on the horizon. You'll find helpful, monthly departments such as Video News, Equipment Reports, Hardware Hacker, Audio Update, Drawing Board, Computer Connections, New Products, and more. All designed to give you instruction, tips, and fun.

### Electronics Now gives you exciting articles like:

- Buyer's Guide to Digital Oscilloscopes
- Build A Scanner Converter
- Single-Chip Voice Recorder
- Build A MIDI Interface for your PC
- Troubleshoot Microprocessor Circuits
- Build A High-Power Amplifier for your Car
- Add Music On Hold to your Phone
- All About Binaural Recording
- VGA-to-NTSC Converter



FOR FAST SERVICE CALL OUR TOLL-FREE NUMBER!

# 1-800-999-7139

## DON'T DELAY — SUBSCRIBE TODAY!

If you prefer, just fill out the order card in this magazine and mail it in today.

7PG50

## BUILD A SUBWOOFER

(Continued from page 45)

driver is tightly fastened down to the surface. If necessary, use a little silicon sealer, or putty, to make sure the mounting is really airtight.

Of course, the type of finishing chosen for the Subwoofer cabinet is at the discretion of the individual builder. Here are a few of suggestions that you might want to consider: Foil-backed wood veneer is available at cabinet shops and some lumber-supply houses. Those might require a special adhesive, so check with the person who sells you the veneer for the right product to use. Also, applying the veneer will require a very smooth, clean surface, so be sure and sand off or fill-in any ridges or uneven edges on the cabinet's walls.

As was mentioned, painting the enclosure is also a possibility. After sanding and priming the cabinet's surfaces, use a good grade of house paint. It fills small surface imperfections easily, dries quickly, and can be selected to match any room interior.

### Wiring and Testing the System.

Before you try out your system, you should arrange some kind of crossover filter for it, to allow only low frequencies to go to the Subwoofer. Here are the values of inductor coils that can be used as low-pass filters,

followed by the crossover frequencies they work with: use a 10-mH inductor for an 80-Hz crossover frequency; an 8-mH inductor for 100 Hz; a 7-mH inductor for 125 Hz; and a 6-mH inductor for 150 Hz. Those inductors can be obtained from the source given in the Parts and Materials list; prices vary from about \$10 to \$15 each.

Figure 3 shows a wiring suggestion for the inductor. The distance between the inductor and the woofer is not important, so the coil can be located outside of the speaker cabinet, or if you know ahead of time just what value you want, then it could be mounted inside. However, if it is mounted inside the enclosure, make sure it is very firmly secured to one of the cabinet surfaces with glue or silicon sealer so that it doesn't rattle. After installing the inductor and wiring the Subwoofer to the terminals of your amplifier, along with the other speakers, you are finally ready to enjoy some first-class bass! ■

## RANDOM DOT IMAGES

(Continued from page 50)

ages. N.E. Thing Enterprises (19C Crosby Drive, Bedford, MA 01730; Tel. 617-275-6960) carries a full line of clothing, calendars, posters, post cards, puzzles, software, and more, all in full color. All kinds of three-dimensional images and illusions are featured. But there's also another way to get your hands—or eyes—on some of these images: You can make your own on your personal computer. We took a look at *Stereolusions*, which is just one of the several software packages available that let you have fun with 3-D images.

**Stereolusions.** The Windows environment has become a great place to work with images. With all the software that lets you create and manipulate graphic images, it's the perfect place to create an image that you want turned into a 3D image. *Stereolusions* from I/O Software (10970 Cucamonga, CA 91730; Tel. 909-483-5700) lets you import any image in the Windows Bitmap (BMP) or Windows Metafile (WMF) format and turn it into a Stereolusion. The images pictured in this article were created

using that software, which has a list price of \$39 (street prices are, of course, lower).

The Windows software is very easy to use. Several sample images are included; you simply open them as you would any other file. Then you select "Render" from a menu that transforms the image. Special adjustments can be made, if necessary or desired, for such things as coarseness, depth, color, and so on.

An image can be imported and instantly turned into a Single Image Random Dot Stereogram (SIRDS) that hides the image in a field of small squares or circles. Or a separate pattern or image can be used to disguise the hidden image in a Single Image Stereogram (SIS), rather than just appearing as dots or squares. Stereolusions comes with several sample images and patterns that can be superimposed on other included images, or on ones you import or make on your own. The possibilities are endless, and the ease with which the software works makes it very encouraging to keep trying new possibilities that stretch the imagination.

The rendered images appear on-screen in the colors that they are created. The beauty of Windows is that anything can be printed easily, including the 3D images. And if you are fortunate enough to have a color printer, you can print the images in color as they appear on your computer screen. When printed on a black-only printer, a few of the SIS images lose some of their effect. But the SIRDS images, which appear as multi-colored speckled patterns on-screen, don't lose any of their visual effect when printed in black and white, as you can see from the ones that are presented in this article.

The worst thing about these 3D images is that a lot of people don't believe they are there, and think they are being made fools of. But for people who can see them, there's nothing like making your own. Making these images is just one more thing that a personal computer makes short, and entertaining, work of. ■

# BUY BONDS

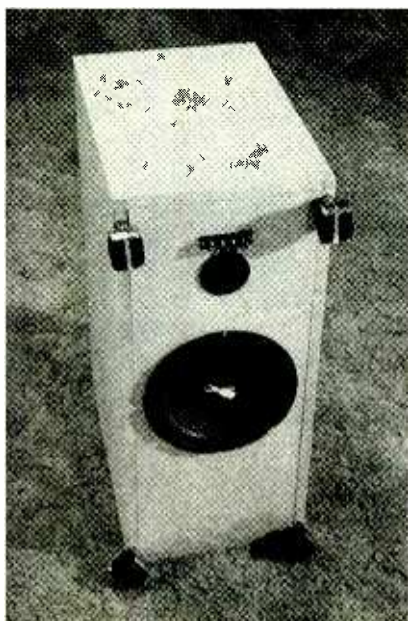

This bottom view shows the placement of the woofer and the vent.



## DESIGNING CROSSOVERS

(Continued from page 42)

Now, using the program will require some exact knowledge of just what the sonic problem is: With a test tape or oscillator and a sound-level meter, take a series of readings to determine just what the frequency range of the peak is. See Fig. 6 for an example of the type of measurement to be made. Once that is done, answer the program prompts with the required information and it will calculate the necessary component values for a trap filter (see Fig. 7). Inserting that circuit as part of the speaker's crossover and compensation network should have the desired effect, but it is always good to go back and check because the other networks in the system might affect the filter's action a little, in which case, some trial-and-error work with other component values might be required to make things work just right. Also, be sure that the resistor that is used in the filter has an adequate power rating—at least 10 watts or so.

**Putting it all Together.** The complex network of circuits with varying component values that we have just calculated might seem confusing to a home experimenter. Where do all the pieces fit in relation to each other; can we just put them anywhere, in any circuit arrangement? In this case, the answer is no. To work correctly, they must be assembled in a particular sequence in the overall circuit.

Figure 8 shows, in block-diagram form, the wiring sequence that should be used. Here is that sequence in order, along with the programs used to determine the component values:

1. The crossover network, 2- or 3-way as needed—XDES-2.BAS or XDES-3.BAS.
2. The trap filter, as needed—TRAP-FIL.BAS.
3. The attenuation circuit, as needed—DRIVERAT.BAS.
4. The Zobel impedance-compensation circuit, as needed—ZOBEL.BAS.

**Note:** All circuits are independent of each other, and any can be deleted anywhere in the network without significantly changing the performance of the other circuits, as long as the sequence of those remaining are as shown in Fig. 8. ■

## SPEAKER CABLES

(Continued from page 48)

lowest dielectric constant possible should ideally be used in its design. Table 3 is a listing of the standard dielectric constants for most of the common speaker-cable insulating materials. Note that the values of those materials do not vary by much.

TABLE 3

Material	Dielectric Constant (At 1 kHz)
Polyethylene	2.26
Nylon	3.5
Vinyl Chloride/ Vinyl Acetate (Polymer)	3.15
Polypropylene	2.25
Teflon	2.1

**Resistance and Capacitance.** Now that we have reviewed several cable designs, you might have noticed just how many factors determine the resistance and capacitance of the cables. That results in there being a range of resistance and capacitance values for currently produced speaker cables. The minimum resistance value is less than 1 milliohm per foot, and the maximum value is about 50 milliohms per foot. The minimum capacitance value is about 5 pF per foot, and the maximum is about 160 pF per foot.

Note that the resistance values have an upper to lower value spread of about 50 to 1. Also, the capacitance values have a spread of about 30 to 1. Most manufacturers don't give inductance values, so none were available to make a comparison. That is not unreasonable, because it is resistance and capacitance that are the most critical parameters.

**Weird Science?** Anyone who keeps up with all the happenings in the audio world knows that from time to time there are claims made of unexplained physical processes, especially when it comes to cables and wire. In many cases, though, only a few people have been able to "hear" the results of those phenomenon.

Is it possible to sort through (and avoid) some of the more suspect of

these theories? Let's see if we can by limiting our discussions to those with at least some backing in reality:

**Wire Metal Crystals:** Back in 1980, A. J. van den Hul did some research on the electrical behavior of speaker cables. Using a spectrum analyzer, he discovered that "good-sounding" cables seemed to have one characteristic in common: they produced a "regular set of harmonics" starting above 500 Hz. He then went on to attribute that to an effect of the crystal structure of the wire, and developed a wire-manufacturing process to duplicate the effect.

**Pure-Metal Conductors:** Research by some cable manufacturers suggests that very pure metals (specifically copper) make a more perfect conductor. From that, the use of very pure copper (more than 99.99%), oxygen-free copper, and long-grain copper, is presumed to make a noticeable difference. Based on that, a great many manufacturers use those materials in their products.

**Litz Wire Cables:** Some years ago, when the first special-purpose audio cables were being developed, insulated, fine, stranded wire woven in a braid was thought to be very good. That was a form of what is commonly called Litz wire. Typically it is used where extreme flexibility is important, like in headphone cable wiring. The problem with those early cables was that the two conductors' wires were all braided together in one piece, making the inductance extremely low, but the capacitance extremely high! Many amplifiers didn't "like" that much capacitance, and blew fuses or activated their protection circuitry.

**Stranded-Wire Noise:** Some manufacturers have claimed that in stranded but uninsulated wiring bundles, a small amount of "noise" is generated by the wire current crossing back and forth from strand to strand as it moves down the length of the cable. For that reason, some manufacturers use wire where each strand is individually insulated from the next.

**Metal-Alloy Wire Materials:** This is a relatively new development, and only a few commercial cables of that type exist. Companies using alloys in their cables are not saying too much at this time, other than that some of the alloys are a hybrid of a certain metal and carbon. ■

## COLOR TV

(Continued from page 59)

beam of electrons, the second dot emitted green light, and the third emitted blue light. Those three primary colors of light could be combined to produce any desired color.

Three separate electron guns directed beams toward the phosphors through a metallic grid of tiny holes located only one-half inch from the phosphor screen. The holes were arranged so that only the electrons from the red gun could strike the red-emitting phosphor dots, the beam from the green gun could strike only the green-emitting dots, and the beam from the blue gun could strike only the blue-emitting dots. The three-gun shadow-mask picture tube is illustrated in Fig. 2.

The demonstrations by RCA of its shadow-mask picture tubes (a single-gun prototype had also been developed) went well. The RCA color-television system still had a few "rough edges" but improvements and modifications were being made almost daily. Because of that, RCA could not provide the FCC with exact numerical recommendations for the "standards" that would have to be established if its system were to be adopted by the industry.

**The First Standard.** The color-television hearings ended in May, 1950 after eight months of testimony and demonstrations. Over 9700 pages of testimony had been taken from 53 witnesses. The FCC issued its "First Report of the Commission on Color Television Issues" on September 1st.

It was obvious in the "First Report" that the FCC had relatively little concern about the issue of compatibility with existing receivers despite the fact that now some 8-million monochrome television sets were in use. The television industry was told that it had only three months to demonstrate a color system superior to CBS' field-sequential system.

Despite the formal protests by RCA and most other manufacturers (with the obvious exception of CBS), the Commission soon issued its "Second Report on Color Television." In that report, the CBS system was established as the industry standard effective

November 20, 1950. A furious David Sarnoff directed RCA's legal staff to file suit to reverse the FCC's directive. The legal challenge ultimately reached the Supreme Court where the FCC's ruling was upheld.

CBS was then forced to begin color broadcasting despite the fact that virtually no one owned a CBS color receiver. The incompatible broadcasts caused video "garbage" on monochrome sets. CBS rapidly lost viewers and sponsors. Fortunately for CBS, the government suspended the manufacture of color-television equipment late in 1951 so that manufacturers could direct their efforts toward aiding the Korean War effort. That allowed CBS to stop color telecasting.

**RCA Vindicated.** An ad hoc subcommittee of the NTSC had been established in November, 1950 to review the state of the art as it existed with respect to color television. Clearly, most of the industry had not been pleased with the FCC's decision to endorse the CBS system. After many months of discussion, the subcommittee's report recommended establishing a totally electronic and compatible color-television system that was remarkably similar to the one RCA had been proposing.

The result of that report was the creation of what became known as the "Second NTSC" to conduct additional tests of and establish complete standards for the system proposed by the subcommittee. Field tests and system modifications would take place for approximately two years.

On July 21, 1953, the NTSC filed a petition with the FCC proposing the adoption of the color-television standards we know today. To his credit, Peter Goldmark of CBS took a lead part in recommending the adoption of those standards. The FCC adopted the NTSC-recommended standards on December 17, 1953. While those color television standards were not established solely from RCA's efforts, they did follow directly from RCA's work to achieve "all electronic compatible color television." The fact that those same standards remain in use in the U.S. today attests to the job done by the television engineers and the NTSC at that time. Indeed, David Sarnoff now was able to have the "last laugh." ■

## TELEPHONE TESTER

(Continued from page 62)

**Checkout and Use.** To test the transmitter and receiver, connect a battery to the transmitter. Then attach the pairs of alligator clips on one of the units to the corresponding pairs on the other unit. Make sure that the proper colors are connected and the pairs are matched. The LEDs on both units should glow green. If some or all of the tri-color LEDs on the receiver glow red, something has been wired backwards (possibly the LEDs themselves). If an LED on either unit doesn't glow, check for a poor connection.

Once you have verified proper operation of the clips on the units, check the modular jacks of the transmitter and receiver using a patch cable. If the patch cable you are using has reversed the voice pair or pairs, the tri-color LEDs will glow red. If you are testing the 6-position, 6-contact jack, the third voice pair might not be present in your patch cable and the LEDs for that voice pair won't glow.

In addition to being used with the transmitter, the receiver can be used on its own to test "live" voice pairs. When the receiver is connected directly to a live, standard telephone line (using the modular cord, alligator clips, etc.) the proper LEDs should glow. Red indicates that the respective voice pair is polarity-reversed, green means its polarity is correct, no glow means the circuit is dead, and orange means that there is AC on the line (if you get that indication you should determine where it is coming from and have the problem corrected immediately).

Please note that the test just described should not be done on multi-line key-system wiring. If the system in question is a multi-line telephone unit (especially with more than two lines) the modular cable and jack might only appear to be standard telephone jacks. Those systems usually have digital signals—not telephone lines—that are carried on one or more of the pairs. If you use the Tester on one of those you might damage the telephone, the telephone system, or both. For those systems, the Telephone-Wiring Tester should be used to test cables only after they have been disconnected at both ends. ■

# Market Center™

## Paperback Books

GREAT BOOKS AT BUDGET PRICES

**100 RADIO HOOKUPS**  
—#7—\$3.00

First published in May, 1923 this popular booklet went into reprint editions nine times. It is packed with circuits, theory, antenna installation and tips on consumer radio receivers that were popular in the early 1920's. Antique radio buffs and those inquisitive about the early days of radio will find this booklet an exciting, invaluable and excellent reference into the minds of early-day radio listeners. Sorry, we cannot honor the original 25-cent cover price.

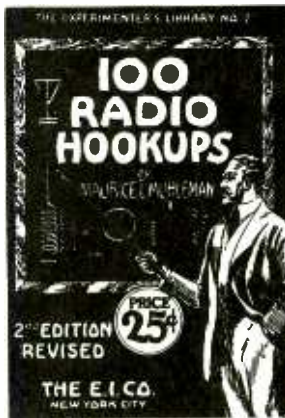

**INTERNATIONAL RADIO STATIONS GUIDE—BP255**  
—\$9.95

Provides the casual listener, amateur radio DXer and the professional radio monitor with an essential reference work designed as a guide for listening to the complex radio bands. Includes coverage on Listening to Shortwave Radio, ITU Country Codes, Worldwide Radio Stations, European Long Wave and Medium Wave Stations, Broadcasts in English and more.

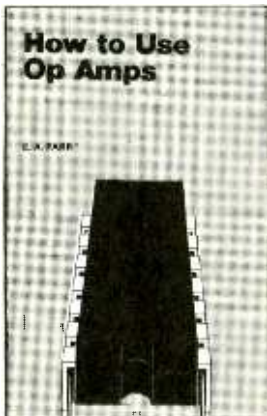
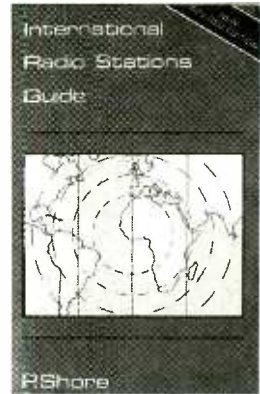

**HOW TO USE OP AMPS**  
—BP88—\$5.95

The engineer's best friend is the op amp. This basic building block is found in many circuits, analog and digital alike. The op amp finds many useful purposes such as: oscillators, inverters, isolators, high- and low-filters, notch and band-pass filters, noise generator, power supplies, audio, MIDI, and much more. Prepared as a designer's guide, some limited math is used, however engineers and hobbyists alike find it a useful text for their design needs.



**WIRELESS & ELECTRICAL CYCLOPEDIA**  
—ETT1—\$5.75

A slice of history. This early electronics catalog was issued in 1918. It consists of 176 pages that document the early history of electricity, radio and electronics. It was the "bible" of the electrical experimenter of the period. Take a look at history and see how far we have come. And by the way, don't try to order any of the radio parts and receivers shown, it's very unlikely that it will be available.

**ELECTRONIC TECHNOLOGY TODAY INC.**  
P.O. BOX 240, Massapequa, NY 11762-0240

Name \_\_\_\_\_  
Address \_\_\_\_\_  
City \_\_\_\_\_ State \_\_\_\_\_ Zip \_\_\_\_\_

**SHIPPING CHARGES IN USA AND CANADA**

\$0.01 to \$5.00 .....	\$2.00
\$5.01 to \$10.00 .....	\$3.00
\$10.01 to 20.00 .....	\$4.00
\$20.01 to 30.00 .....	\$5.00
\$30.01 to 40.00 .....	\$6.00
\$40.01 to 50.00 .....	\$7.00
\$50.01 and above .....	\$8.50

**SORRY No orders accepted outside of USA & Canada**

Number of books ordered

Total price of merchandise .....	\$ _____
Shipping (see chart) .....	\$ _____
<b>Subtotal</b> .....	\$ _____
Sales Tax (NYS only) .....	\$ _____
<b>Total Enclosed</b> .....	\$ _____

All payments must be in U.S. funds!

ET01

# ALFA ELECTRONICS

HIGH QUALITY TEST EQUIPMENT  
BEST PRICE



**DMM 89 \$199.95**  
**Most Advanced DMM**  
*All Purpose & Communication*  
-80.7 to 81.4 dBm with 4Ω - 1200Ω  
20 reference impedances  
True RMS  
Frequency counter: 0.01Hz-10MHz  
Capacitance: 1pF-50,000μF  
Measure AC volt to 20kHz  
5000 counts, 0.1% accuracy  
Auto/manual range, fast bar graph  
Min/Max/Ave/DH/Relative/Zoom  
Auto power off  
Input warning  
Splash proof  
Volt, amp, ohm, logic, diode, continuity  
Ruggedized case  
Rubber holster included



**DMM 2360 \$119.95**  
**DMM+LCR Meter**  
*Very Versatile DMM*  
Inductance: 1μH-40H  
Capacitance: 1pF-40μF  
Frequency: 1Hz - 4MHz  
Temperature: -40-302 °F  
TTL Logic Test: 20MHz  
Diode, Continuity  
Volt, Amp, Ohm  
3999 count display  
Peak Hold  
Auto power off  
Ruggedized case  
Temperature probe included  
Rubber Holster \$8.00



**DMM 20 \$74.95**  
Inductance: 1μH-40H  
Capacitance: 1pF-200μF  
Frequency: 1Hz-20MHz  
Volt, amp, ohm, diode,  
20 Amp AC/DC current  
Transistor HFE  
Continuity, duty %  
Peak hold/Max  
Ruggedized case  
Rubber holster \$8.00  
  
Full line of DMMs,  
economy, compact,  
ruggedized, solar cell,  
automotive, heavy  
duty, industrial,  
starts from \$15.95

**Fluke Multimeter**  
Fluke 12 \$84.95  
Holster C-10 \$10  
Fluke 70 II \$67.5  
Fluke 73 II \$94  
Fluke 75 II \$129  
Holster C-70 \$16  
Fluke 77 II \$149  
Fluke 79 II \$169  
Fluke 29 II \$169  
  
Fluke 83 \$225  
Fluke 85 \$259  
Fluke 87 \$287  
  
Fluke 97  
Scope Meter \$1785



**LCR Meter 131D \$229.95**  
**Most Advanced LCR**  
Dual display L/Q or C/D  
Inductance: 0.1μH-1000H  
Capacitance: 0.1pF-10,000μF  
Impedance: 1mΩ-10MΩ  
0.7% basic accuracy  
Auto/manual range  
Dissipation factor & Q factor  
Serial & parallel mode  
Relative mode for comparison  
and to remove parasitics  
Statistics, tolerance,  
Best for design, incoming  
testing & production  
SMD and chip component  
test probe \$25.00



**LCR Meter 814 \$189.95**  
**Best Resolution LCR**  
Inductance: 0.1μH-200H  
Capacitance: 0.1pF-20,000μF  
Resistance: 1mΩ-20MΩ  
1% basic accuracy  
Dissipation factor indicates leakage  
in capacitor and Q factor in inductor  
Zero adjustment to reduce parasitics  
Best for high frequency RF  
SMD and chip component test probe  
\$25.00  
**LIMITED QUANTITY SPECIAL**  
**DIGITAL LCR METER \$74.95**  
0.1pF, 1μH, 10mΩ resolution

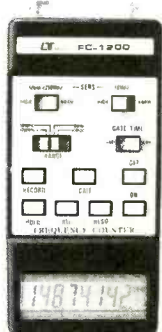

**Frequency Counter FC-1200 \$129.95**  
Frequency: 0.1Hz-1.25GHz  
Display: 8 digit LCD  
Period: 0.1us-0.1s  
Records Max/Min/Average  
Data hold, relative mode  
Telescoping antenna \$8.00  
Deluxe case \$5.00  
  
Also Available:  
AC/DC clamp meter, Light meter,  
Thermometer, pH meter, High  
voltage probe, Digital caliper,  
Anemometer, Electronic scale,  
Force gauge, Tachometer,  
Stroboscope, Humidity & EMF  
adapter, Sound level meter,  
Frequency counter, SWR/field  
strength/power meter, Dip meter

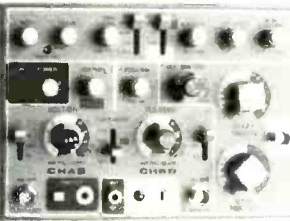
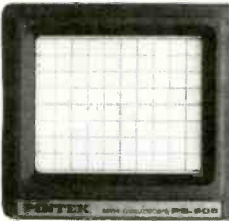

**20 MHz Oscilloscope with Delay Sweep PS-205 \$429.95**  
Dual Trace, Component test, 6" CRT, X-Y Operation, TV Sync, Z-Modulation, CH2 Output, Graticule Illum, 2 probes each has x1, x10 switch. Best price with delay sweep.  
PS-200 20 MHz DUAL TRACE \$339.95  
PS-400 40 MHz DUAL TRACE \$494.95  
PS-405 40 MHz DELAY SWEEP \$589.95  
PS-605 60 MHz DELAY SWEEP \$769.95  
**Scope Probe: 60MHz x1, x10 \$15, 100MHz x1, x10 \$22 250MHz x1, x10 \$29, 250MHz x100 \$39**

**Digital Storage Scope**  
DS-203 20MHz, 10M Sample/sec \$729.95  
DS-303 30MHz, 20M Sample/sec \$849.95  
DS-303P with RS-232 Interface \$1,049.95  
Switchable between digital and analog modes  
2 K word per channel storage  
8 bit vertical resolution (25 Level/div)  
Expanded Timebase 10ms/div - 0.5 s/div  
Refresh, Roll, Save all, Save CH2, Pre-Trig  
Plotter control

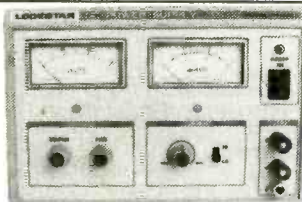

**DC Power Supply PS-303 \$159.00**  
**0-30 VDC, 0-3A output**  
Constant voltage & constant current mode  
0.02% + 2mV line regulation  
0.02% + 3mV load regulation  
1 mVrms noise and ripple  
Short circuit and overload protected  
PS-8200 with digital voltmeter \$179.00  
Also available: 30V/5A, 60V/3A, 60V/5A 16V/10A, 30V/10A

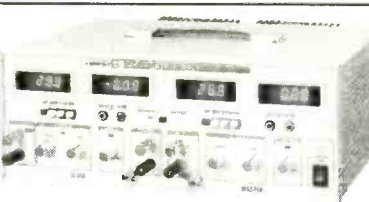

**DC Power Supply Triple Output PS-8202 \$499.95**  
Two 0-30 VDC, 0-3A outputs  
One fixed 5VDC, 3A output  
Capable of independent or tracking operation  
Constant voltage and constant current mode  
Four digital meters for volt and current display  
Excellent regulation and low ripple  
Short circuit and overload protected  
Also available: 30V/5A, triple output \$549.95  
Dual tracking 30V/3A, 30V/5A, 60V/3A, 60V/5A

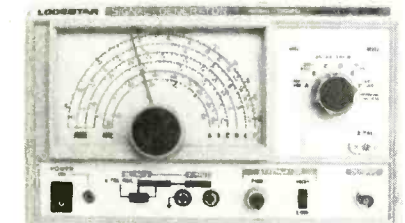

**RF SIGNAL GENERATOR SG-4160B \$119.00**  
100 kHz-150MHz sinewave in 8 ranges  
RF Output 100mVrms to 35 MHz  
Internal 1kHz, External 50Hz-20kHz  
AM modulation  
Audio output 1 kHz, 1 Vrms

**AUDIO GENERATOR AG-2601A \$119.00**  
10Hz - 1MHz in 5 ranges  
Output: 0-8Vrms sinewave  
0-10Vp-p squarewave  
Synchronization: ±3% of oscillation frequency per Vrms  
Output distortion:  
0.05% 500Hz - 50kHz  
0.5% 50Hz - 500kHz  
Output impedance: 600 ohm

**FUNCTION GENERATOR FG-2100A \$169.95**  
0.2 Hz - 2 MHz in 7 ranges  
Sine, square, triangle, pulse and ramp  
Output: 5mV-20Vp-p  
1% distortion, DC offset ± 10V  
VCF: 0-10V control frequency to 1000:1

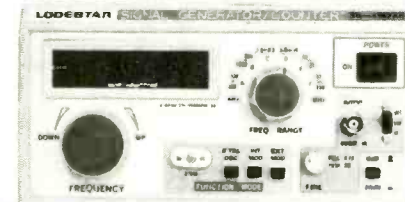

**RF SIGNAL GEN./COUNTER SG-4162 AD \$229.95**  
Generates RF signal same as SG-4160B  
6 digit frequency counter 1Hz - 150 MHz for internal and external source Sensitivity <50mV

**AUDIO GEN./COUNTER AG-2603AD \$229.95**  
Generates audio signal same as AG-2601A  
6 digit frequency counter 1Hz-150MHz for internal and external sources Sensitivity <50mV

**FUNCTION GEN./COUNTER FG-2102AD \$229.95**  
Generates signal same as FG-2100A  
Frequency counter 4 digits  
Feature TTL and CMOS output  
  
**SWEEP FUNCTION GEN./COUNTER \$329.95**  
0.5Hz to 5 MHz in 7 ranges  
Sweep: Linear 10:1/Log 10:1 20ms to 2s  
AM Modulation  
Gated Burst, Voltage Control Generator  
Generator Control Voltage & 6 digit counter  
1Hz-10MHz for internal & external sources

**ALFA ELECTRONICS**  
741 Alexander Rd., Princeton, NJ 08540

(800) 526-2532/(609) 520-2002 15 DAY MONEY BACK GUARANTEE. 1 YEAR WARRANTY  
FAX:(609) 520-2007 CALL OR WRITE FOR FREE CATALOG AND BEST OFFER.  
Visa, Master Card, American Express, COD, Purchase Order Welcome

CIRCLE 26 ON FREE INFORMATION CARD

# Are Cable Companies Sucking You Dry?



**FREE  
Catalog!**

**All Major  
Brands!**

Take a Bite out of High Rental Fees  
with your own

## Converters & Descramblers



Everquest • Panasonic • Jerrold • Zenith • Pioneer  
Scientific Atlanta • Oak • Eagle • Hamlin • Tocom



Order  
Toll-Free **1 800 624-1150**

Call today for a FREE catalog!

# MD Electronics

875 S. 72 Street • Omaha, NE 68114



**CALL TOLL FREE**  
1-800-292-7711  
1-800-445-3201 (Can)

# C&S SALES

## EXCELLENCE IN SERVICE

**WRITE FOR  
FREE CATALOG**



**Line Tracker**  
MV-963  
**\$52.95**  
(Infra-red Sensor)  
The robot follows  
a black line  
on white paper  
Preassembled PCB



**Dual-Display**  
**LCR Meter**  
w/ Stat Functions  
B+K Model 878  
**\$239.95**  
Auto/manual range  
Many features  
with Q factor  
High Accuracy

**Electronic Tool Kit Model TK-1000**  
A professional organizer tool kit at affordable prices. No student should be without this unique tool kit that holds all the tools you need.  
**\$39.95**

Including:  
Diagonal Cutter  
Long Nose Pliers  
6" Wire Stripper  
Solder 60/40  
6" Screwdriver  
6" Phillips Driver  
Safety Goggles  
IC Puller  
3pc Nut Drivers  
Iron 25W  
Iron Stand  
Solder Wick  
Desoldering Pump  
5 pc Solder Ease Kit  
6pc Precision Screwdrivers

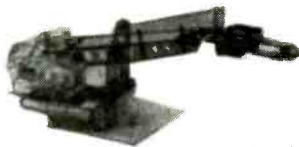

**Robotic Arm**  
Y-01  
**\$49.95**  
(Wired Control)  
Movement grabs  
& releases,  
lifts & lowers,  
pivots from side to side



**Stereo Cassette Player**  
Kit  
Model  
TR-18K  
**\$16.95**  
Headphones  
Included



**Digital**  
**Multimeter**  
EDM-83B  
**\$175.00**  
Almost every  
feature available  
Bargain of  
the decade



**Elenco**  
**LCR + DMM**  
LCM-1950  
**\$79**  
12 Functions  
Freq to 4MHz  
Inductance  
Capacitance



**Digital**  
**Capacitance**  
**Meter**  
CM-1555  
**\$49.95**  
Measures capacitors  
from .1pf to 20,000µf



**Digital**  
**LCR Meter**  
LCR-680  
**\$79.95**  
3-1/2 Digit  
LCD Display  
Inductance  
1uH to 20MΩ



**Function Generator**  
GF-8026  
**\$239**  
Int/Ext  
Operation  
Sine, Square, Triangle, Pulse  
Ramp, .2 to 2MHz, Freq Ctr



**3-3/4 Digit Multimeter**  
BK-390  
**\$139.00**  
0.1% DCV acy  
Analog bar graph  
Auto/manual ranging  
Capacitance meas  
Temperature probe



**Digital**  
**Multimeter Kit**  
w/ Training Course  
M-2665K  
**\$49.95**  
Full function 34 ranges  
Ideal school project  
M-2661 (Assembled) **\$55.00**



**Frequency Counter**  
F-1225  
**\$225.00**  
8 Digit LED display  
Wide meas range  
High sensitivity  
Data hold function  
Input impedance 1MΩ or 50Ω  
10:1 input attenuation function

**Fluke Multimeters**  
(All Models Available Call)  
**Scopemeters** 70 Series  
Model 97 \$1,795 Model 7011 \$69.95  
**10 Series** Model 7011 \$97.50  
Model 10 \$62.95 Model 7711 \$149  
Model 12 \$84.95 Model 7911 \$175  
**20 Series** 80 Series  
Model 2911 \$175 Model 87 \$289



**Triple Power**  
**Supply**  
XP-620  
By Elenco  
**\$75.00**

3 fully regulated supplies; 1.5-15V @ 1A, -1.5 to -15V @ 1A or 3-30V @ 1A & 5V @ 3A Kit XP-620K \$49.95



**Quad Power**  
**Supply**  
XP-581  
By Elenco  
**\$79.95**

Four supplies in one unit; 2-20V @ 2.5A, 5V @ 3A, -5V @ .5A and 12V @ 1A. All regulated and short protected



**High Current DC**  
**Power Supply**  
BK-1686 **\$169.95**  
3 to 14 VDC Output  
12A @ 13.8V  
For servicing high  
power car stereos,  
camcorders, ham radios, etc.  
Connect 2 or more in parallel



**Wide Band**  
**Signal**  
**Generators**  
SG-9000  
**\$124.95**

RF Frequency 100K-450MHz  
AM modulation of 1KHz Variable  
SG-9500 150MHz \$239.00

**Telephone Kit**  
PT-223K  
**\$14.95**



Available  
Assembled  
PT-223  
**\$15.95**

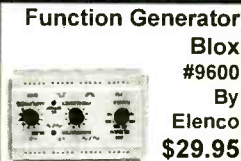

**Function Generator**  
**Blox**  
#9600  
By  
Elenco  
**\$29.95**

Kit \$28.95  
Sine, Triangle, Square Wave

**Learn to Build & Program**  
**Computers with this Kit**

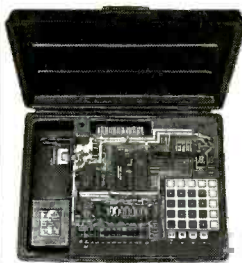

**MM-8000**  
By Elenco  
**\$129.00**

From scratch you build a complete system. Our Micro-Master trainer teaches you to write into RAMs, ROMs and run a 8085 microprocessor, which uses similar machine language as IBM PC.

**Digital/Analog Trainer**  
Complete Mini-Lab For Building,  
Testing, Prototyping Analog and Digital



By Elenco  
in U.S.A.  
XK-525  
**\$159.95**  
Kit  
XK-525K  
**\$129.95**

Designed for school projects, with 5 built-in power supplies. Includes a function generator with continuously variable, sine, triangular, square wave forms. All power supplies are regulated and protected against shorts.

**AM/FM Transistor**  
**Radio Kit**  
with Training Course  
Model AM/FM 108  
**\$29.95**

14 Transistor, 5 Diodes  
Easy to build because  
schematic is printed on the PCB  
Makes a great school project  
Model AM-550 AM Only \$17.95



**Telephone Line**  
**Analyzer**  
Kit TT-400K **\$19.95**  
Assembled TT-400 **\$26.95**

**WE WILL NOT BE UNDERSOLD**  
UPS SHIPPING: 48 STATES 5%  
IL RES 7.5% TAX (\$3 min \$10 max)  
OTHERS CALL

**C&S SALES INC.**  
1245 ROSEWOOD, DEERFIELD, IL 60015  
FAX: 708-520-0085 (708) 541-0710



**15 DAY MONEY BACK**  
**GUARANTEE**  
**FULL FACTORY WARRANTY**  
PRICES SUBJECT TO CHANGE WITHOUT NOTICE

**FREE PROBES  
WITH ALL  
SCOPES**

**ELENCO ♦ HITACHI ♦ B+K  
SCOPES  
AT GUARANTEED LOWEST PRICES**

**WRITE FOR  
FREE  
CATALOG**

**QUALITY - ELENCO OSCILLOSCOPES  
2-YEAR WARRANTY**

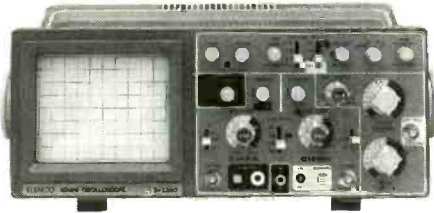

**60MHz**

**S-1360 \$775**

Delayed Sweep

**S-1365 \$849**

Cursor Readout

- ♦ Voltage, Time
- ♦ Frequency differences displayed on CRT

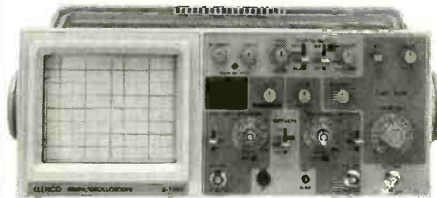

**40MHz**

**S-1340 \$495**

2-Channel

**S-1345 \$575**

Delayed Sweep

- ♦ Beam Find
- ♦ Component Tester

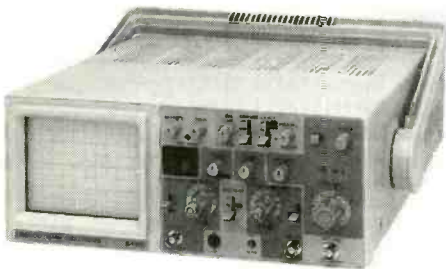

**25MHz**

**S-1325 \$349**

2-Channel

**S-1330 \$449**

Delayed Sweep

- ♦ Beam Find
- ♦ Component Tester

*Dependable Equipment at Affordable Prices*

**B+K 20MHz**

2 Channel

**Model 2120 \$389.00**



Delayed Sweep

**Model 2125 \$539.95**

**40MHz DUAL-TRACE**

**Model 1541B**

**\$749.95**

- 1mV/div sensitivity
- Video sync separators
- Z axis input
- Single sweep
- V mode-displays 2 signals unrelated in frequency

**60MHz DUAL-TRACE**

**Model 2160**

**\$949.95**

- 1mV/div sensitivity
- Sweep to 5ns/div
- Dual time base
- Signal delay line
- Component tester
- V mode-displays 2 signals unrelated in frequency

**100MHz THREE-TRACE**

**Model 2190**

**\$1,379.95**

- 1mV/div sensitivity
- Sweeps to 2ns/div
- Dual time base
- Signal delay line
- 19kV accelerating voltage
- Calibrated delay time multiplier

**20MHz ANALOG with  
DIGITAL STORAGE**

**Model 2522A**

**\$869.95**

- 20MHz analog bandwidth
- 20MS/s sampling rate
- 2k memory per channel
- 20MHz equivalent time sampling

**HITACHI POPULAR SERIES**

V-212 - 20MHz, 2 Channel	\$425.00
V-222 - 20MHz, DC Offset	\$695.00
V-422 - 40MHz, Dual Trace	\$849.00
V-522 - 50MHz, Dual Trace	\$975.00
V-523 - 50MHz, Delayed Sweep	\$995.00
V-525 - 50MHz, w/ Cursor	\$1,069.00

**HITACHI COMPACT SERIES SCOPES**

V-660 - 60MHz, Dual Trace	\$1,375.00
V-665A - 60MHz, DT, w/cursor	\$1,449.00
V-1060 - 100MHz, Dual Trace	\$1,549.00
V-1065A - 100MHz, DT, w/cursor	\$1,595.00
V-1085 - 100MHz, QT, w/cursor	\$2,125.00
VC-6045A - 100MHz, Digital Stor	CALL
VC-6025A - 50MHz, Digital Stor	CALL

**Elenco DS-203 20MHz, 10MS/s  
Digital Storage Oscilloscope**

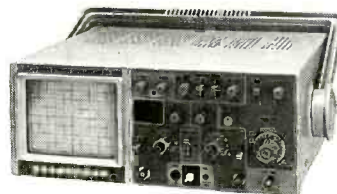

**\$749**

2K Word Per Channel • Plotter Output  
8 Bit Vert. Resolution • 2048 Pts Hor.  
Resolution • Much More....

**FLUKE SCOPEMETERS**

A handheld instrument that combines a 50MHz, 25MS/s dual channel digital storage oscilloscope with feature-packed 3000 count digital multimeter.



**Model 93 - \$1,225**

**Model 95 - \$1,549**

**Model 97 - \$1,795**

- Autoset, automatically sets voltage, time & trigger
- Multimeter display;
- 3-2/3 digits (>3000 counts)
- True RMS volts; AC or AC+DC up to 600V

**C&S SALES INC.**

1245 ROSEWOOD, DEERFIELD, IL 60015  
FAX: 708-520-0085 (708) 541-0710

**CALL TOLL FREE**

**1-800-292-7711**

**1-800-445-3201 (Can)**



**15 DAY MONEY BACK GUARANTEE  
FULL FACTORY WARRANTY  
ALL PRODUCTS ARE FACTORY NEW**

PRICES SUBJECT TO CHANGE WITHOUT NOTICE

CIRCLE 132 ON FREE INFORMATION CARD

# ACE COMMUNICATIONS



**Get instant tech information FREE from your Fax or Computer!**

You can obtain specs, freq. info, software and more from our automated services. For fax facts, call from your stand alone fax machine and follow the voice prompts. Use the BBS from your modem of fax/modem equipped computer. Dial 317-849-8683 for fax back service, or dial 317-579-2045 for our computer bulletin board service.

## Continuous Coverage

## Shortwave Radios

## Total Coverage Radios

### TRIDENT

**TR1200XLT**  
AM Broadcast to  
Microwave 1000 Scan  
Channels \$389.00

500KHz to 1300MHz coverage in a programmable hand held. Ten scan banks, ten search banks. Lockout on search and scan. AM plus narrow and broadcast FM. Priority, hold, delay and selectable search increments. Cell Lock. Permanent memory. 4 AA ni-cads and wall plus cig charger included along with belt clip, case, ant. & earphone. Size: 6 7/8 x 1 3/4 x 2 1/2. Wt 12 oz. Fax fact document # 205



### TRIDENT

**TR4500 \$449**  
2016 Channels  
1 to 1300MHz  
Computer Control

62 Scan Banks, 16 Search Banks, 35 Channels per second. Patented Computer control for logging and spectrum display. AM, NFM, WFM, & BFO for CW/SSB. Priority bank, delay/hold and selectable search. Cell Lock Permanent memory. DC or AC with adaptors. Mtng Brkt & Antenna included. Size: 2 1/4H x 5 5/8W x 6 1/2D. Wt. 1lb. Fax fact #305



### TRIDENT

**TR980 \$279.00**  
125 Channels  
5MHz to  
999MHz

Most Economical receiver in its class, offers AM, NFM Wide FM, modes. 5KHz increments. Delay & hold & Search. Cell Lock NiCads, chgr & whip ant. Size: 5 7/8H x 1 1/2W x 2 D. Wt 14oz.



Three new Bearcat units offer expanded coverage and more memory than before. The 890 offers 200 channels, base/mobile operation, VFO tuning, service search, weather alert, search and store, and more. The 2500 hand held has 400 channels, fast scan and more. The Bearcat 8500 has 500 channels in 20 banks, VFO, auto store, alpha numeric display, 10 priority channels, aux tape output jacks, and coverage to 1.3 Gigahertz.

**Bearcat 2500XLTA hand held.....\$349.95**  
**Bearcat 8500XLTC mobile.....\$389.95**  
**Bearcat 890XLTB mobile.....\$259.95**  
25-1300MHz, 500 ch. in 8500, 400 in 2500. 890 has 200 ch. & 29-956MHz. All cell locked. Features include turbo scan, VFO, search and store, Priority, LCD display, and more. Fax Facts 474,475,476



## Mobile Scanners

**TRIDENT**  
**TR2C**  
Police & CB  
\$69.95

Scans police pre-programmed by state channel plus the CB channel of your choice. Also has Mobile Repeater and Weather. Extra cost option of CB and laser detectors built in. Compact size allows for dash or visor mounting. Mtng hardware and power connectors included. Size: 5 5/8 x 4 7/8 x 1 3/4. Wt: 1.5lbs. Fax fact #580



**Bearcat 700AX 50Ch w/800..... \$159.95**  
**Bearcat 350A 50 Ch H/L/U..... \$119.95**  
**Bearcat 560XLJ 16 Ch H/L/U..... \$ 89.95**  
**Bearcat 760XM100Ch H/L/U/Air/800 \$219.95**  
**Bearcat T2 state/state scan..... \$144.95**

**Sangean ATS-818CS..... \$219.95**  
**Sangean ATS-818..... \$184.95**  
**Sangean ATS-803A..... \$169.95**  
**Sangean ATS-808..... \$179.95**  
**Sangean ATS-606..... \$149.95**  
**Sangean ATS-606P..... \$169.95**  
**Sangean ATS-800..... \$89.95**  
**Grundig YB400..... \$219.00**  
**Grundig Satellit 700..... \$399.00**



## Hand Held Scanners

### Bearcat 200XLTN

**\$209.95 200 Channels 800 MHz**  
Ten scan banks plus search. Covers 29-54, 118-174, 406-512 and 806-956MHz (with cell lock). Features scan, search, delay, 10 priorities, mem backup, lockout, WX search, keylock. Includes NiCad & Chgr. Size: 1 3/8 x 2 11/16 x 7 1/2.



**Bearcat 120XL TJ 100Ch H/L/U..... \$149.95**  
**Bearcat 150XLT 100Ch H/L/U/8..... \$199.95**  
**Bearcat 220XL TJ 200 Ch H/L/U/8.... \$249.95**

Coverage of above hand helds is: 29-54, 136-174, 406-512, and 800MHz band as indicated. Fax facts #475

## Table Top Scanners

**Bearcat 855XLTE 50 Ch w/800..... \$159.95**  
**Bearcat 142XLML 10Ch H/L/U..... \$ 73.95**  
**Bearcat 147XLJ 16 Ch H/L/U..... \$ 89.95**  
**Bearcat 172XM 20Ch H/L/U/Air..... \$124.95**  
**Bearcat 145 16Ch H/L/U..... \$ 79.95**

## Accessories & Etc.

**Mag Mount Mobile Ant MA100..... \$ 19.95**  
**Base Ant. 25-1000MHz AS300..... \$ 59.95**  
**Pre-Amp .1-1500MHz GW2..... \$ 89.00**  
**Wide Coverage Antenna..... \$119.95**  
**Base Discone Ant DA300..... \$ 89.00**  
**External Speaker MS190/opt. amp.... \$ 19.95**  
**Old Scanner Repair, all brands..... \$ CALL**  
**Extended Warranties..... \$ CALL**  
**Frequency Info FaxFact/Modem..... \$ FREE**  
**On Glass Mobile Antenna..... \$ 32.95**

## 2 Way Radios

VHF hi band programmable mobiles as low as \$299.95. Call for quotes or Fax Fact #775

**TRIDENT** Winner of the 1994 INNOVATIONS Design & Engineering Honors, Electronic Industries Association. Trident TR2400 Total Coverage Receiver

Trident TR2400: 100KHz to 2060MHz. Ten scan banks of 100 channels each, ten search banks. Tuning increments as low as 1KHz. Beat Freq. Oscillator for SSB and CW modes. Search lockout and store. VFO tuning knob. Permanent memory. Bank lock and linking. Attenuator switch. Backlit LCD. 1 Yr Warranty. AM/NFM/WFM. Selectable increments. Delay, Hold, Priority. 5 7/8H x 1 1/2D x 2W. Wt 14 oz. \$499.00



**Toll Free, 24 Hours! 800-445-7717 Fax Orders 800-448-1084 Fax Facts 317-849-8683**

Computer BBS Modem & Fax/Modem, 317-579-2045. Toll Free Tech Support, Dial 800-874-3468

International Fax: en Espanol, en Francais, und auf Deutsch, or just fax in plain English to: 317-849-8794

**ACE Communications 6975 Hillsdale Court, Indianapolis, IN 46250**

Service & Support hours: Mon.-Fri. 9AM to 6PM, Sat. 10-4 EST. Mastercard, Visa, Checks, Approved P.O.'s & COD (add \$5.50) & AMEX, Discover. Prices, specifications and availability subject to change. Flat rate ground shipping and handling charge only \$6.95 per unit. Express Air only \$9.95, for most units, to most locations. One week trial, no returns accepted two weeks after original receipt without substantial restocking charge. All units carry full factory warranty. Indiana residents add 5 per cent sales tax.



**FLY IT! ONLY \$9.95**

CIRCLE 125 ON FREE INFORMATION CARD

www.americaradiohistory.com



# Check Out These Deals From CIRCUIT SPECIALISTS!

## Circuit Specialist's Positive Photo Resist Pre-Sensitized Printed Circuit Boards



These pre-sensitized printed circuit boards are ideal for small production runs. They provide high resolution and excellent line width control. High sensitive positive resist coated on 1oz. copper foil allows you to go direct from your computer plot or art work layout. No need to reverse art.

### Single-Sided, 1oz. Copper Foil on Paper Phenolic Substrate

CAT NO	DESCRIPTION	PRICE EACH		
		1	10	50
PP101RE	100mm x 150mm/3.91" x 5.91"	\$2.55	\$1.90	\$1.70
PP114RE	114mm x 185mm/4.6" x 6.6"	2.98	2.45	1.98
PP152RE	150mm x 250mm/5.91" x 9.84"	5.40	3.98	3.60
PP153RE	150mm x 300mm/5.91" x 11.81"	6.15	4.48	4.10

### Single-Sided, 1oz. Copper Foil on Fiberglass Substrate

CAT NO	DESCRIPTION	PRICE EACH		
		1	10	50
GS101RE	100mm x 150mm/3.91" x 5.91"	\$ 3.90	\$2.98	\$2.60
GS114RE	114mm x 185mm/4.6" x 6.6"	4.80	3.49	3.20
GS152RE	150mm x 250mm/5.91" x 9.84"	8.69	5.98	5.78
GS153RE	150mm x 300mm/5.91" x 11.81"	10.20	7.20	6.80

### Double-Sided, 1oz. Copper Foil on Fiberglass Substrate

CAT NO	DESCRIPTION	PRICE EACH		
		1	10	50
GD101RE	100mm x 150mm/3.91" x 5.91"	\$ 5.07	\$3.68	\$3.38
GD114RE	114mm x 185mm/4.6" x 6.6"	5.95	4.29	3.99
GD152RE	150mm x 250mm/5.91" x 9.84"	10.47	7.39	6.98
GD153RE	150mm x 300mm/5.91" x 11.81"	11.95	8.69	8.30

## Etching Chemicals/Ferri Chloride

A dry concentrate that mixes with water to make 1 pint of etchant, enough to etch 400 sq. inches of 1oz board.



CAT NO	DESCRIPTION	PRICE EACH	
		1	5
ER-3RE	Makes 1 pint	\$3.50	\$2.75

## Developer



This product is used as the developer on our positive photo-resist printed circuit boards. Includes instructions. 50 gram package, mixes with water, makes 1 quart.

CAT NO	DESCRIPTION	PRICE EACH		
		1	10	25
POSDEVRE	Positive Developer	\$ .95	\$ .80	\$ .50

## Etching Tank



### REDUCES ETCHING TIME!

This attractive injection moulded designed tank is ideal for etching your PCBs. It includes a thermostatically controlled glass heater, electric agitator and PCB hanging accessories. Measuring graduations are included. Maximum PCB size is 160mm x 250mm or 200mm x 250mm w/o heater. Typical etching time is 4 minutes.

CAT NO	DESCRIPTION	PRICE
ET10RE	Etch Tank System	\$52.00

QUANTITY PRICING DOES NOT APPLY TO MIXED ITEMS!

## Electronic Soldering System

Here's the ideal solution when **Temperature Control** is required. Easy to use slide control allows user to set system from 300°F to 840°F. Voltage to iron from control unit is 24V. Iron heating power is 48W. Replaceable 5.3mm tip is standard. Replacement irons and tips are available.



CAT NO	DESCRIPTION	PRICE EACH	
		1	5
SL10RE	Temperature Controlled Soldering Iron	\$56.00	\$50.00
SL24VRE	Spare 24V Soldering Iron	10.50	7.50

## Electronic Soldering Systems LOW with LED Display

Deluxe temperature controlled system with LED display for maximum accuracy. Temperature is adjustable from 160°-480°C (320°-900°F). Iron heating power is 48 Watts. Runs on 24V from controller unit. Replacement irons and tips are available. Tip size is 5.3mm.

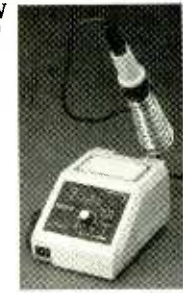

CAT NO	DESCRIPTION	PRICE EACH	
		1	5
SL30RE	Deluxe Soldering System w/LED	\$86.00	\$75.00
SL24VRE	Spare 24V Soldering Iron for SL10 or SL30	10.50	7.50

## Replacement Tips for SL10/SL30

### Replacement Tips



We now offer a variety of replacement tips for the SL10/SL30 soldering stations.

CAT NO	DESCRIPTION	PRICE EACH	
		1	5
821RE	1/32" Pencil Tip	\$1.39	\$1.19
822RE	1/32" Pencil Tip	1.39	1.19
823RE	1/64" Pencil Tip	1.39	1.19
824RE	1/16" Chisel Tip	1.49	1.29
825RE	1/8" Chisel Tip	1.49	1.29
826RE	3/64" Chisel Tip	1.49	1.29
827RE	3/64" Pencil Tip	1.59	1.39

## RECEIVE YOUR FREE COPY OF OUR 100 PAGE CATALOG!

It's chock full of all types of electronic equipment and supplies. We've got I.C.'s, capacitors, resistors, pots, inductors, test equipment, bread-boarding supplies, PC supplies, industrial computers, data acquisition products, personal computers and computer parts, plus much, much more. FAX us your name and address or call 800-528-1417, ext. 5 and leave a message on our catalog request line.

**CIRCUIT SPECIALISTS, SINCE 1971**

**800-528-1417**  
**602-464-2485**  
**602-464-5824 (FAX)**

WE ACCEPT:

**VISA, Mastercard, Discover Card & American Express**

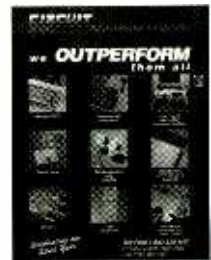

# RAINBOW KITS

## Laser Pens 4 mW

Beam visible up to 500'

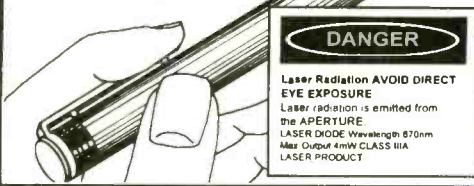

**DANGER**  
Laser Radiation AVOID DIRECT EYE EXPOSURE  
Laser radiation is emitted from the APERTURE  
LASER DIODE Wavelength 670nm  
Max Output 4mW CLASS IIIA  
LASER PRODUCT

INCLUDES  
2 AAA Batteries  
Pen Size: 5 1/2" x 1/2"

**SUPER  
NEW LOW PRICE**  
**\$59.95**



## STROBE LIGHT

Do you need an attention getter, warning light, or flashing light for model

airplanes? Then this kit is for you. Use it as an emergency light for your auto, radio tower, even use it on your bicycle. Has a variable flash rate. Size 3.5"x1.8" operates on 6 or 12v DC only.

ST-1 **\$9.95**

## The Exciting New TELEPHONE MONITOR



*Monitors your phone system, See how accurate your phone company really is!*

- RECORDS OUTGOING CALLS :**
  - Date & time of each call.
  - Length of the call.
  - What number was dialed.
  - If you use a credit card it records the card number.
- RECORDS INCOMING CALLS :**
  - Date & time of call.
  - How many times phone rings.
  - If answered the length of call.
- RECORDS ANY DTMF TONE :**
  - Detects any tone on line sent by phone company or any other source.

*Records to Screen or Floppy Disk*

### EASY TO INSTALL

- Connects to parallel port
- Phone line in.
- Phone line out to telephone.

**All software included!**

**\$99.95**  
TM-1 ONLY KIT

**BUILT \$169.95**

## WIDE BAND PREAMP

The ideal preamp for scanners, hand held radios, frequency counters. Amplifies low level

(weak) signals. If the signal is extremely low 2 amps can be used in series. 1MHz to 2.5MHz @ 2.8dB of 1dB compression = +0 dBm gain: 1MHz-20dB to 2.5Hz-6dB Requires 12vDC @ 16Ma

WBA-6 **\$19.95**

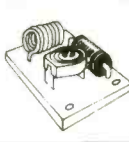

## MICRO-MINIATURE PHONE TRANSMITTER

We haven't seen a smaller phone transmitter than the MMPT2 kit. Powered by the phone, it requires no battery. Transmits both sides of a phone conversation to an FM radio up to a 1/4 mile away. Tunable from 88 to 108MHz FM. Attach it to one phone or add it to the line to pick up all incoming calls. The MMPT2 is undetectable if properly installed. Unit has surface mounted parts, you install the leaded parts. Size .45"x.6"

MMPT2 **\$29.95**

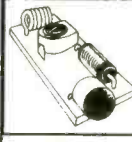

## MICRO-MINIATURE WIRELESS MIKE

So small you could hide this one on some real bugs! It's the smallest we've ever seen. With it's super sensitive mike it transmits a whisper or a room of conversation to an FM radio, tunable from 88 to 108MHz FM. With a proper antenna & 9v it transmits about 1 mile. The kit is made with surface mounted parts, we have already mounted these parts. You install the leaded parts. Can operate on 6 to 12v DC. Size .35"x.9"

MMWM5 **\$34.95**

## WIRELESS FM MICROPHONE

Small but mighty this little jewel will out perform most units many times its price. It really

stomps out a signal. The WM-1 kit is a buffered wireless mike that operates from 80MHz to 120MHz FM, the frequency of any broadcast FM radio. Includes a mini-electret mike. SIZE: .8"x1" 6 to 12vDC

WM-2 **\$14.95**

## TV NOTCH

FOR CHANNELS  
2 thru 22  
SNOOP & BULLET

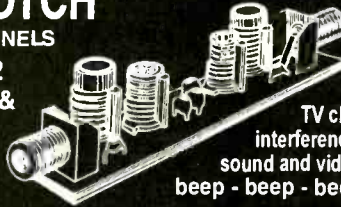

Our TV filters eliminate unwanted TV channels or interference that alters both sound and video with a beep - beep - beep.

NOTE: All TV Filter Kits are sold for educational purposes only. You must obtain permission from your local cable company before using these filters on your cable system.

DF-222 Kit **\$14.95**

## FILTERS

## FM STEREO TRANSMITTER

Own your own FM radio station. Any stereo signal you plug into the FMST-100 will be transmitted to any FM radio tuneable

from 76 to 108MHz FM. Transmit a wireless link through an auditorium, from your car to your camper, listen to your cd's while mowing the lawn, Play music on one channel sing on the other. Clarity is excellent, approx. 40dB stereo separation. Length of antenna determines the distance of transmission. Complete with stereo input level controls, & crystal for stereo separation. 9v battery operation

FMST-100 \$29.95 / FMSTC cabinet \$8.95

## PHONE TRANSMITTER

Small but mighty, it fits anywhere. Phone line powered, never needs batteries. Transmits both sides of a phone conversation loud and clear, wireless, to any FM radio at great distances. Variable tunes from 70MHz to 130MHz FM. You can also use it as a speaker phone. SIZE .5"x1"

TEL-B1 **\$12.95**

BUILT **\$29.95**

## 5.0 mW Laser Diode

Great for making a gun sight, use as a transit, makes a super experimenters project. The beam is

visible with a wavelength of 670 nm. Size of beam is 6mm at 5 meters. Operates on 3 volts DC at 85mA. Size: 10.5mm x 18.5mm with an adjustable collimating lens.

LDM-5

**NEW LOW PRICE**  
**\$59.95**

## SUPER SNOOPER BIG EAR

Listen through walls, hear conversations across the room. Add a parabolic reflector and hear blocks away. The BIG EAR can be hidden about anywhere. Makes an ultra sensitive intercom. Can be used as a 1.5W AMP. We supply a mini-electret mike in the kit. SIZE: 1"x.75" 6 to 12vDC

AA-1 **\$10.95**

BUILT **\$29.95**

This Manual contains all schematics, parts lists, P.C.B., layouts for most of the Rainbow Kits. Use your own parts to construct any of our kits.

**KIT BOOK**  
**\$14.95**

**\$9.95** with the purchase of any kit.



Please add sufficient postage First lb \$5.00 Canada \$7.00  
Additional LB. Add \$1.00 US FUNDS ONLY  
We will accept telephone orders for Visa or Mastercard



To Order Call  
**317-291-7262**



**ELECTRONIC RAINBOW INC**

6254 LaPas Trail • Indianapolis, IN 46268  
FAX 317-291-7269

# CircuitMaker® vs. Electronics Workbench®

## A NEW STANDARD HAS BEEN SET!

### State-Of-The-Art Analog Simulation

**CircuitMaker's** analog simulation results are shown in graph windows that provide powerful, interactive analysis options. You can plot multiple waveforms by clicking on the desired nodes and can select linear or logarithmic axes. Horizontal and vertical cursors facilitate quick and accurate measurements. You can also zoom in on any portion of the graph to obtain additional detail.

**Electronics Workbench** offers a single, small scope or Bode plot instrument window. The windows are not sizeable and only two waveforms can be plotted at a time. EWB has a single measurement cursor and provides no direct way to read results from the instruments.

### Superior Digital Simulation

**CircuitMaker** has an exclusive Trace feature where the state of every node is indicated in color as the simulation runs. You can monitor as many waveforms as your screen will allow, set edge or level breakpoints for analysis, and interactively see the state of any node by touching the logic probe to it. The data sequencer provides 1024 words of pattern data. Additional digital instruments include ASCII and HEX input keys and an ASCII display. CircuitMaker includes tri-state devices and devices have programmable propagation delays.

**Electronic Workbench** has no interactive logic probe or Trace capability and no Hex or ASCII keys. Their "word generator" is limited to 16 words. EWB does not have tri-state devices and digital devices do not have programmable propagation delays.

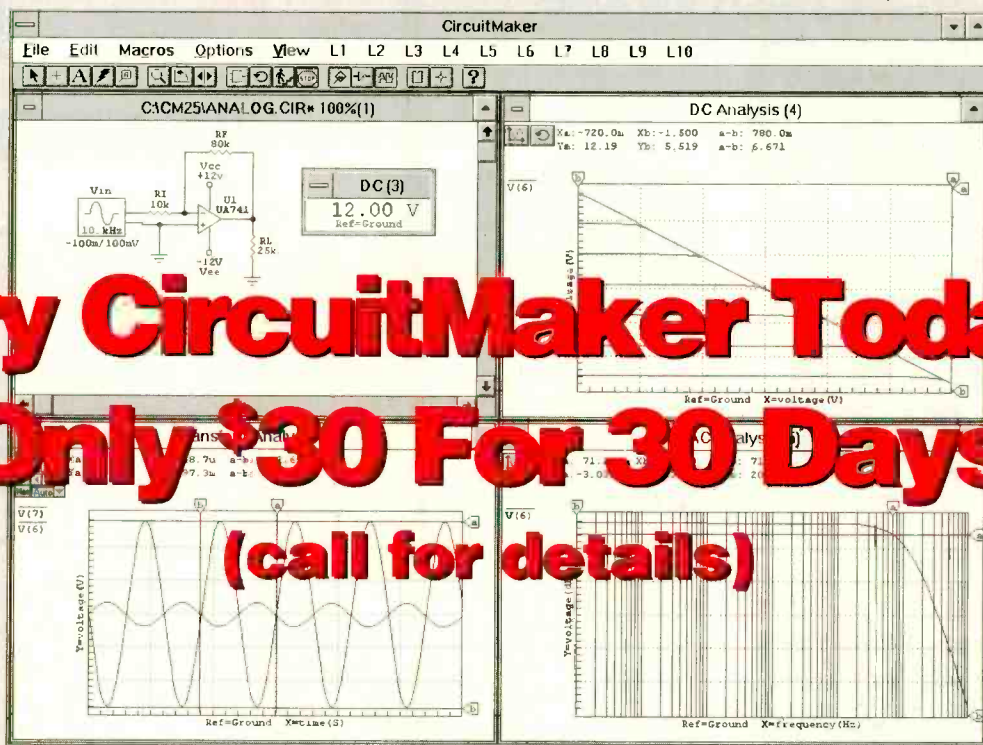

**Try CircuitMaker Today**  
**Only \$30 For 30 Days**  
**(call for details)**

### Comprehensive Device Libraries

**CircuitMaker** includes libraries containing programmable, TTL, CMOS, generic analog and digital devices, and many powerful I/O devices. With CircuitMaker's macro function you can quickly and easily create your own functional devices and symbols. Now that's giving you the tools you need to get the job done right!

**Electronics Workbench** ships with only 17 digital devices. If you want additional devices you pay extra.

### High-Performance Schematic Capabilities

**CircuitMaker** puts you in control of your schematic with SmartWires™, bussing, page connectors, and rubberbanding. You can label devices and pins, add fully stylized multiline text, and create a parts list or netlist. With the Macro feature you can add user defined symbols to your device library.

**Electronics Workbench** dictates wire placement to you. EWB limits your overall "workbench" layout to 2 by 1 pages. EWB has no bussing, page connectors, pagebreaks, print scaling, labeling, free text fields, netlisting, zoom, undo, and no Toolbar or Toolbox.



### Competitive Upgrade Offer

You deserve the best. Upgrade from any competing product for only \$149 (Call for details). For new users CircuitMaker is a tremendous value at just \$299.

### Technical Support

**MicroCode Engineering** supports its customers with free unlimited phone support from knowledgeable engineers. And, you won't find yourself endlessly listening to music when you call for help. The quality of our customer support is unmatched!

Comparison based on CircuitMaker 2.6 for Windows and Electronics Workbench 3.0 for Windows. All products and company names are trademarks of their respective owners.

**FREE FUNCTIONAL DEMO VERSION**

available on most major IBS's or sent direct for \$10 s&h

**CALL 800-419-4242**

**MicroCode Engineering**

573 W. 1830 N. Suite 4

Orem, UT 84057 USA

Phone (801)226-4470 Fax (801)226-6532



CIRCLE 42 ON FREE INFORMATION CARD

# ALL ELECTRONICS CORP.

QUALITY PARTS • DISCOUNT PRICES • FAST SERVICE • HUGE SELECTION

## JUMBO LEDs

Liton # LTL 327C - 8MM  
Ideal for eye-catching indicators and displays. A recent quantity purchase of these BIG, 8mm diameter, red diffused LEDs enables us to provide some very special pricing. The leads on these devices are 0.325" long with plenty of room for soldering.

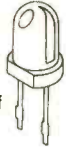

**5 for \$1.00** CAT# LED-23  
100 for \$15.00  
1000 for \$120.00

## GREAT DEAL! SURFACE MOUNT SPEAKERS

These surface mount speakers were designed for use with car stereo, but they will work as well, or better as intercom or communications speakers in your home or workshop.



4", 4 ohm, speakers mounted in an unbreakable black plastic, slant-faced enclosure. They are rated 5 watts. Enclosure measures 4.82" X 4.5" X 2.45"h. Each pair is boxed and includes two short pieces of hook-up wire.

CAT# SK-411

**\$3.75**  
per pair

## "HI-8" VIDEO CASSETTE (USED)

8 mm Video Camcorder Users!

SONY HI-8  
Top quality, metal particle 120 minute video cassettes. Used for a short time, then bulk-erased. Each cassette has its own plastic storage box. Satisfaction Guaranteed.



**\$3.00**  
each

CAT # VCU-8

10 for \$28.00 • 100 for \$250.00

## SUPER SAVINGS (USED) SUPER VHS TAPES

Super VHS tape users! Save a bundle on name-brand S-VHS tapes, T-120. These tapes were used for a brief period, then bulk erased. The record-protect tabs have been broken out, so you will have to cover the notch with a piece of tape, but they work great and cost a fraction of the "new" price. Try some, you'll be back for more.



CAT# S-VHS

**\$3.00**  
each

10 for \$28.00  
100 for \$250.00

## SMALL ELECTRET MIKE



0.31" diameter X 0.325"  
0.7" long leads terminated with a two pin connector (0.1" centers).

**\$1.75**  
each

CAT # MIKE-18

## MINIATURE SWITCHES



### D.P.D.T. (ON-ON)

ALCOWITCH # MTM206NPC  
Short bat handle, 0.25" long.  
PC terminals

CAT # MTS-82PC **\$1.25**  
each

25 for \$25.00 • 100 for \$90.00

REDUCED  
PRICE!

## MINIATURE D.P.D.T. PUSH/ON PUSH/OFF

Augat/Alcoswitch # MPE206N  
Miniature DPDT, push/on push/off switch. Splashproof: O-ring on shoulder and inside movable shaft provides moisture seal. Rated 6 amps @ 125 Vac. RED 0.4" dia. cap. 0.25" diameter threaded bushing. 0.8" behind panel depth. Solder lug terminals. UL and CSA listed.



**\$1.75**  
each

CAT# MPB-20  
25 for \$37.50

## 9 VOLT 60 MA SOLAR PANEL

These 6" X 6" glass enclosed photovoltaic panels produce 9 Vdc at 60 ma. Ideal for charging batteries and powering small devices. Put two or more together for more current and voltage. Includes hook-up instructions.



CAT # SPL-960

**\$5.25**  
each

## 7 Vdc MOTOR

Matsushita  
# MMX-7AC O 8A  
1.25" diameter x 1.25" high motor. Prepped with 1.61" diameter flywheel, pulley and fiberglass mounting board.



CAT# DCM-54

**\$1.00**  
each

10 for \$9.00  
100 for \$80.00

## A.C. LINE CORDS

### 6 INCH IEC POWER CORD



THATS RIGHT! 6 INCHES... Standard 3 prong grounded male one end and 3 prong IEC receptacle on other end. CSA listed. Large quantity available.

**2 for \$1.00** CAT # LCAC-36

10 for \$4.50  
100 for \$35.00

### ROUND 4' BLACK 16/3 CORD



0.32" od, SJT insulation. Standard 3 prong grounded plug one end, moulded strain relief on other end. Pigtail leads. CSA listed. Large quantity available

CAT # LCAC-35  
100 for \$150.00

**\$1.75**  
each

MANUFACTURERS - We Purchase EXCESS INVENTORIES... Call, Write or Fax YOUR LIST.

CALL, WRITE  
or FAX For A  
Free 64 Page  
CATALOG.

Outside the U.S.A.  
send \$2.00 postage.

ORDER TOLL FREE **1-800-826-5432**

MAIL ORDERS TO:  
ALL ELECTRONICS CORP.  
P.O. BOX 567  
VAN NUYS, CA 91408-0567

FAX (818) 781-2653  
INFO (818) 904-0524

NO MINIMUM ORDER • All Orders Can Be Charged to Visa, Mastercard or Discover • Checks and Money Orders Accepted by Mail • Orders Delivered in the State of California must include California State Sales Tax • NO C.O.D. • Shipping and Handling \$5.00 for the 48 Continental United States - ALL OTHERS including Alaska, Hawaii, P.R. and Canada Must Pay Full Shipping • Quantities Limited • Prices Subject to change without notice.



CIRCLE 28 ON FREE INFORMATION CARD

www.americanradiohistory.com



**100-LE**  
 AC/DC Voltages  
 Cont. Tester-  
 Buzzer  
 3-1/2 Digit LCD  
 Low Battery  
 Indicator  
 Battery Test  
 #990087  
**\$19<sup>95</sup>**



**150-LE**  
 Transistor  
 Battery Test  
 DC Current  
 10 Amp  
 #990122  
**\$29<sup>95</sup>**



**200-LE**  
 Freq. Counter  
 up to 20MHz  
 Capacitance  
 from 1pF to 20uF  
 Transistor  
 AC/DC Current  
 10 Amp  
 #990123  
**\$49<sup>95</sup>**



**400-LE**  
 Inductance  
 resolution of 1uH  
 Freq. Counter  
 up to 20MHz  
 Cap. from  
 1pF to 200uF  
 AC/DC Current  
 Transistor  
 Duty %  
 20 Amp  
 #990124  
**\$79<sup>95</sup>**

**STANDARD FEATURES:** ▲ AC/DC Voltages ▲ DC Current ▲ Resistance  
 ▲ Continuity Tester Buzzer ▲ Diode Test  
 ▲ 10M ohm Input Imp. ▲ Accuracy +/- 0.5% RDG

Protective Meter Cases for 100-300LE .... 990088...\$4.95  
 Protective Meter Case for 400LE ..... 990094...\$4.95

## THE ULTIMATE METER

Popular Electronics (reviewed 5/93)

"Not only does the Kelvin 94 boast a lot of features...the features go the extra distance."

"If we had to run into a burning building to do some emergency trouble-shooting and could carry only one piece of equipment, the Kelvin 94 would be it!"

★ True RMS, LCR, Hz, dBm ★ 0.1% Accuracy ★



**12 INSTRUMENTS IN ONE!**

DC Voltmeter,  
 AC Voltmeter,  
 Ohmmeter,  
 AC Current,  
 DC Current,  
 Diode Tester,  
 Audible Cont.  
 Tester, dBm,  
 Freq. Counter,  
 Capac. Meter,  
 Inductance  
 Meter,  
 Logic Probe  
 #990111

**\$199<sup>95</sup>**

## HC Protek MODEL B-803



### 2MHz Sweep Function Generator

- ★ Output Frequency of 0.02Hz to 2MHz on 7 ranges
  - ★ Output: sine, triangle, square, pulse, ramp or slewed sine wave
  - ★ 4 digit frequency counter
  - ★ With sync output (TTL), VCF, DC offset, variable symmetry
  - ★ Square wave rise time: 100ns or less
- #720129 **\$299<sup>95</sup>**

## HC Protek MODEL P-3502C



### 20MHz "Afford-A-Scope"

- ★ 2 Channels
  - ★ Built-in component tester for resistors, capacitors, and diodes
  - ★ 6" CRT with internal graticule
  - ★ TV trigger
  - ★ CH2 Invert
  - ★ 2-Axis input
  - ★ Includes 2 probes
  - ★ 2-Yr. warranty
- #720085 **\$385**

## HC Protek MODEL P-3003



### Regulated DC Power Supply

- ★ 0-30V, CV; 0 to 3A, CC
  - ★ 2 Separator LED displays (green for voltage, red for current)
  - ★ Constant voltage & constant current operation
  - ★ Fully isolated outputs allow series or parallel operation
  - ★ Includes (1) set of test leads & operation manual
  - ★ Overload protected
  - ★ 2-Yr. warranty
- #690038 **\$225**

# New and Pre-Owned Test Equipment

Substantial **SAVINGS** on New & Pre-Owned B+K Precision, Fluke, Hewlett-Packard, Goldstar, Leader, Tektronix, and more ...



**GoldStar Precision**

**New Oscilloscope Specials**

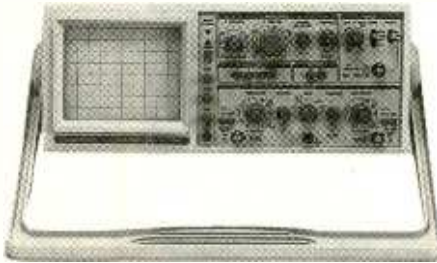

**Model OS-9100P**

**Full 100 MHz Bandwidth!**

**SUPER SALE! \$999.00**

- TV Synchronization Trigger
- Dual-Channel, High Sensitivity
- Calibrated Delayed Sweep
- Two Probes Included
- 2 Year Warranty

**FREE SHIPPING!**  
ON ALL GOLDSTAR EQUIPMENT  
ANYWHERE IN THE U.S.  
Excluding AK & HI

**Model OS-904RD**

**On-Screen Measuring Cursors & Readout!**

**40 MHz Bandwidth \$699.00**



**Professional Quality DMM  
at an Affordable Price!**

**Model DM-334 \$99.00**

- 3.75 Dgts, 4000 Cnt, Auto Ranging
- DC/AC Volts (1000/750V)
- DC/AC Current (10 A)
- Resistance (40 Meg Ohm)
- Bar Graph, Min/Max, Data Hold
- Frequency Counter (1 MHz)
- Safety Holster & Test Leads Included
- 1 year Warranty

## Pre-Owned Oscilloscope Specials

Tektronix 465	100 MHz	\$499.00
Tektronix 465B	100 MHz	\$599.00
Tektronix 475	200 MHz	\$749.00
Tektronix 475A	250 MHz	\$849.00

- Professionally Refurbished
- Calibrated to Original Specifications
- Dual Channel, Calibrated Delayed Sweep
- 90 Day Warranty



**BK PRECISION**  
MAXTEC INTERNATIONAL CORP.

**NTSC Generator with RGB**

**Model 1249A \$569.00**

- NTSC Color Bars  $\pm 5^\circ$  and  $\pm 5$  IEEE Units
- Ch. 3, 4, and IF Outputs Crystal Controlled
- Calibrated 1 Vp-p or Variable Composite Video Output
- RGB Outputs on BNC or 9-pin D Connector
- Composite, Vertical, and Horizontal Sync. Outputs
- Interlaced or Progressive Scan
- 1 Year Warranty

**Hand-Held Parts Tester**

**Model 815 \$99.00**

- Large 0.8" digits, 26 User Ranges
- Tests Transistor hFE and Leakage Icco
- Checks SCR's, Diodes, LED's, Capacitors, and Resistors
- Tests Batteries Under Actual Load Conditions
- 1 Year Warranty

Full line of Oscilloscopes, RF, Video & Audio Test Equipment,  
Power Supplies, Meters, Probes and Accessories.

**TOLL FREE 1-800-99-METER**

1-800-996-3837



**FOTRONIC  
CORPORATION**

P.O. BOX 708  
Medford, MA 02155

FAX (617) 665-0780



# NEW PRODUCTS

Electronic Equipment Bank...Nation's Largest Radio Outlet!

**AOR AR2700(A)** .5-1300MHz<sup>(1-4)</sup>

- Replaces older AR1000/TR1200 models w/Hi Quality surface mount technology, many advanced features, cloning, computer I/O (opt. RS232 converter), 1000 memory 50ch x 20 bank, AM/FM/FMW auto band.

List \$499.95  
Introductory \$...CALL



**AOR AR8000** .5-1900MHz<sup>(1-4)</sup>

- The only TRUE SSB scanner on the market. Listen to AM/SSB voice from around the world as well as local signals. Several new-patented features. Alpha-Numeric, 4 level LCD read out, bar graph "S" meter, Band scope spectral display, computer I/O (opt. RS232 & Software), 1000 memory 50ch. x 20 banks.

List \$799.00  
Special Sale \$599.95



**AOR AR3000A** .1-2036MHz<sup>(1-4)</sup>

- Compact, Professional quality, a favorite with many agencies that want Hi-Performance at a low cost. All mode, including SSB, one small unit does it all. 400 memory 100ch. x 4 banks, RS232 computer ready (opt. DOS & WINDOWS software) EEB offers many options to satisfy any special need...CALL

List \$1195.00  
EEB \$1029.00



(1) Pending FCC certification (2) Cellular Block (not restorable)  
(3) Cellular Block, but can be restored  
(4) Un Blocked O.K. to qualified buyers (Govt., Export, etc.)

**AOR AR3030** 30kHz-30MHz<sup>(opt. VHF)</sup>

- Superior Performance & value, leading edge technology in an HF receiver design. Compare features with receiver costing over \$1000. Collins Filter, AMW 6kHz opt., .5, 2.4 & 4kHz. DDS tuning, 3 ant. inputs, 10Hz step tuning Sync AM, RIT. RS232 ready (opt. Software).

List \$949.00  
EEB \$799.95

FREE CW filter or VHF converter (till July)...a \$149 value!



**AOR SDU5000A**

- Imagine "seeing" the spectrum up to ±5MHz from the station you're tuned to. A Spectral Display Unit (SDU) allows just that. Input 10.7MHz (ICOM 7000, 7100, 9000, mod AR3000A PRO2006, digital control AR3000 or ICR7100)

SDU5000A (AOR) \$995.00



**SONY ICF SW7600G**

SONY's hot selling receiver now at an unbeatable price!!

- AM/FM/SW/SSB/CW Digital

list \$249.95 EEB \$199.95  
NOW \$169.95  
(AC adpt. AC-E60HG \$24.95)

At time of purchase ask for a FREE Radio Stand and KOSS Headset (No Dealers Please)

Other SONY's at Special Spring Prices

ICFSW55 \$339.95 • ICFSW100 \$344.95  
ICFSW77 \$459.95 • ICFSW30 \$104.95  
ICF2010 \$344.95 • ICFSW33 \$159.95

**GRUNDIG SAT700** \$388.00

**YB400** \$188.00



**SANGEAN**

ATS606P \$169.00  
ATS818 \$169.00  
ATS818CS \$219.00



**PANASONIC RFB45** \$159.00



**DRAKE** Both Hot Sellers...

- R8A Special \$1069.00
- SW8 Special \$679.00



Check out EEB's NEW BBS!!!  
Dial in and give us your comments on  
1-703-938-3781

**LOWE HF 150**

- Rated ★★★★★ by IBS. 30kHz - 30MHz, 60 memories, multi-mode AM/AMN/LSB/USB/CW, power 10-15VDC, 120VAC incl, synchro detection. OPTIONS: Keypad, RS232 computer control, PR150 Preselector (shown), AP150 (shown) RK150 (shown)

LIST \$699.00 EEB \$599.00



**Bearcat Scanners**

**BC3000XLT** 25-550/760-1300MHz<sup>(1)</sup>

- Scan 100ch/sec, search 300ch/sec, 400 memory channels, 20 x 20 banks.

LIST \$499.95 EEB \$369.95

**BC9000XLT** 25-550/760-1300MHz<sup>(1)</sup>

- Alpha numeric LCD on all 500 memory ch. Scan 100 ch/sec, search 300 ch/sec, data skip, attenuator 15dB, Cor recorder control.

LIST \$769.95 EEB \$389.95

**BCT-7** All Band 26-956MHz<sup>(1)</sup>

- A must for the frequent highway traveler. 7135 pre-programmed channels, search by state & service. Police, HP, DOT, Fire, News, WX, CB, plus 100 User memories, scan 100 ch./sec. LIST \$319.95 EEB \$179.95

Other BEARCAT Scanners...

BC120XLT \$144.95 BC760XLT<sup>(1-2)</sup> \$229.95  
SC150Y/B<sup>(1)</sup> \$194.95 BC860XLT<sup>(1)</sup> \$189.95  
BC148XLT-1<sup>(1)</sup> \$99.95 BC890XLT<sup>(1-2)</sup> \$244.95  
BC220XLT<sup>(1)</sup> \$229.95

**REALISTIC SAVE!!!**

CALL EEB before you buy  
PRO 2035 \$359.95  
PRO 62 \$259.95

**FREE Catalog...**

- By now you should have our 95 Catalog.
- If not...CALL/FAX/Write today!
- 96 Pages • SWL Scanners • Amateur 2-way • GPS • Enlarged book section

FREE in the U.S., 3rd class (4 weeks). \$2 1st class (1 week). \$2 Can/Mex. \$5 elsewhere.



**EEB ELECTRONIC EQUIPMENT BANK** 323 MILL Street NE Vienna, VA 22180

ORDERS: 800-368-3270  
Local Tech: 703-938-3350  
FAX: 703-938-6911

\*We accept VISA/MasterCard/American Express/Discover \*We ship via UPS, Federal Express and Mail

• Sorry, no COD's • Free Catalog in USA  
• Prices Subject to change • Prices do not include freight  
• Returns subject to restock fee up to 20%

July 1995, Popular Electronics

# PROBE MASTER

## Heavy Duty Scope Probe 3900 SERIES



**RUGGED FIXED TIP**  
(.055" DIA.)

MADE IN USA

**100 MHz**

**\$26**

MODEL 3901-2 SHOWN  
SWITCHABLE 1X, REF, 10X

PROBE KITS

REPLACEMENT  
PROBE ONLY

MODEL	ATTEN.	LENGTH FT. M.	BW MHz AT-3DB	RISE TIME ns	LOADING pF mΩ	PRICE	MODEL	PRICE
3901-2	SWITCHABLE 1X/R/10X	5 1.5	10/100	35/3.5	57/15 1/10	\$26.00	3901-2P	\$20.00
3903-2	1X	5 1.5	26	13.5	54 1	\$24.00	3903-2P	\$20.00
3904-2	10X	5 1.5	100	3.5	15 10	\$25.00	3904-2P	\$20.00

**12 PIECE KIT \$75**

PM3915 Master Kit  
100 MHz

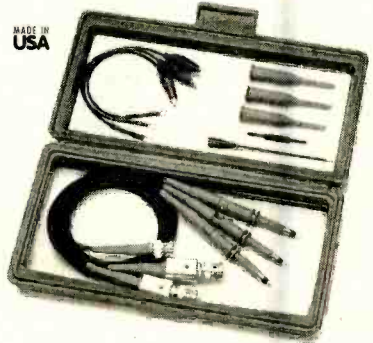

The PM3915 "Master Kit" contains three probes (a 1X, 10X and switchable probe) in a high impact protective case. Included are sprung hooks, ground leads, trimmer tool, and a 4" extender tip.

## Modular Test Lead Kit 9100 SERIES

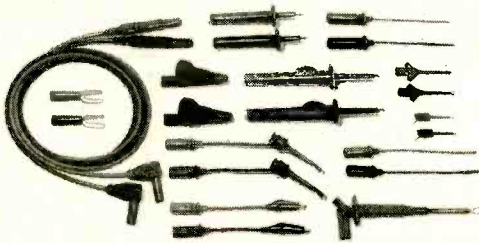

**\$64.90**  
PM9104R

INCLUDES: (2) Leads PM9152; (2) Probes PM9153; (2) Spade Lugs PM9159; (2) Alligator Clips PM9156; (2) Extender Probes PM9154; (2) Minigator Leads PM9161; (2) Sprung Hook Leads PM9164; (2) .025" Wire Wrap Leads PM9168; (2) Pico Hooks for W.W. PM4958; (2) Pincer Hooks for W.W. PM4956; (2) Sprung Hook Probes PM9169; (1) Pincer Probe PM9171; (1) Pouch PM9176

- SILICONE LEADS, BURN RESISTANT
- 18 GAUGE (440 STRANDS) • 48" LONG
- 1000 WORKING VOLTS • 10 AMP RATED

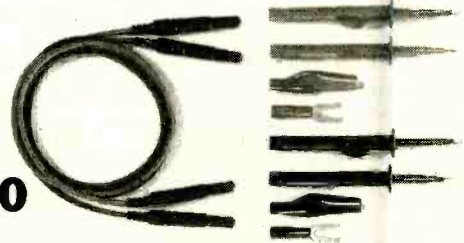

**\$27.90**  
PM9102S

INCLUDES: (2) Leads PM9151; (2) Probes PM9153; (2) Sprung Hook Probes PM9169; (2) Alligator Clips PM9156; (2) Spade Lugs PM9159; (1) Pouch PM9175



## Softie Test Lead Kit 2000 SERIES



IT'S SOFT  
IT BENDS

**\$19.90**

PM2026S  
SHOWN

SILICONE LEADS  
18 GAUGE

SCREW ON ACCESSORIES

Standard Size Safety Banana Plug	90° MALE Safety Standard Size Banana Plug
PM2028S	PM2043S

**BUY FACTORY DIRECT**  
**800-772-1519**

**24 HOUR SHIPMENT**   
(IF REQUESTED)

**CALL FOR FREE CATALOG**  
(OVER 200 ITEMS)

FAX 619-258-7413

**PROBE MASTER**

215 Denny Way  
El Cajon, California 92020



# ARE YOU BEING "BUGGED?"

OUR FINEST

# Counter-Surveillance Device

EVEN AS YOU READ THIS, countless individuals and firms are being enormously damaged by having their private conversations overheard, monitored, and/or recorded. Almost without exception and AFTER the fact, the victims make a statement something along the lines of "But, I never thought it would happen to ME!"

## THE ULTIMATE IN "BUG" DETECTION EQUIPMENT "DEBUGS" ROOMS AND TELEPHONES!

If you require GUARANTEED PROTECTION against electronic telephone monitoring devices and also require COMPLETE CONFIDENTIAL PRIVACY in certain rooms and areas, we highly recommend the COUNTER-SURVEILLANCE DETECTOR CSD-18.



### CONDUCT A PROFESSIONAL SEARCH... ANYTIME... ANYWHERE!

Every newspaper and magazine article and every radio and TV story discussing some new episode involving "Bugging" devices, continues to increase the ever growing demand for electronic Counter-Surveillance "sweeps" and equipment. The very limited supply of competently trained and equipped Counter-Surveillance specialists has created a situation where "sweep" rates exceeding \$250 per hour are now considered reasonable and appropriate.

This is an exciting, immensely interesting and profitable field that you can enter with a minimum investment. Two hours actual practice with the CSD-18 will have you "reading" and "clearing" telephones and rooms with professional ease and competence. The average fee for "debugging" a single telephone is over \$200.00. It requires about 45 minutes to complete the job and once it gets around that YOU can provide this service, you'll quickly have more clients than you can handle. Even if you choose to provide "sweeps" for only a small number of friends and associates, your initial investment will quickly be returned many times over.

### FREE BONUS!

#### FASCINATING HI-TECH INFORMATION PACKAGE INCLUDED FREE!

##### LATEST EAVESDROPPING DEVELOPMENTS

A detailed analysis of a variety of extremely fascinating hi-tech devices and procedures used for ultra-sophisticated audio and video eavesdropping including infrared monitoring, multi-data eavesdropping and interception, miniature micro-wave devices, new methods for listening thru walls, etc., with many schematics included. You'll learn about electronic voice changers, corporate spying, how data banks are accessed to research anyone and anything, eavesdropping by neighbors, space age personnel and vehicle tracking systems, how missing persons are found, how lie detectors are deceived, and a fact-filled section on Eavesdropping Law.

##### BIG MONEY IN COUNTER-SURVEILLANCE

Complete information describing the fantastic opportunities that are now open to trained Counter-Surveillance technicians and exactly how a number of individuals and firms are reaping a huge bonanza in the booming "Debugging" business! You'll learn how the ever increasing use of Electronic Listening Devices by investigative agencies, government agencies, unscrupulous business competitors, jealous suitors, etc., has created a tremendous demand for this type of service.

A comprehensive information package JAM-PACKED FULL of some of the most exciting and fascinating reading imaginable. Reads like a James Bond novel, with one important exception...IT'S NOT FICTION!

### EXTREME SENSITIVITY!

This is our finest piece of detection equipment! The CSD-18 quickly locates electronic eavesdropping devices in telephones, homes, offices, vehicles, boats, or concealed on the body. It will actually pick up many eavesdropping transmitters at ranges exceeding 25 feet! Extreme sensitivity is obtained via ultra-efficient amplification circuitry following the RF detection stages. Excellent quality Dynamic Headphones exclude all external sounds to further enhance detector output.

The presence of any "bug" is immediately indicated via a pronounced meter deflection. The CSD-18 quickly "homes-in" on eavesdropping transmitters and immediately pinpoints their location. The closer you get to the "bug", the further the needle moves to the right. It's as simple as that.



FULL RANGE DYNAMIC HEADPHONES

### "FLASHING" LED Warns You Instantly!

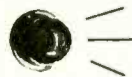

And, for maximum telephone security, the CSD-18 automatically analyzes a sophisticated series of electronic measurements along the telephone line and converts the analysis into an easy to follow, step by step, test procedure. No technical knowledge is required or necessary. A visual indication (via a flashing LED) immediately reveals the presence of the various types of telephone "taps" and the flashing sequence identifies the actual type of eavesdropping device.

### MAXIMUM SECURITY — EASY OPERATION!

Latest Computer-Age IC circuitry designed exclusively for maximum security and ease of operation, assures the utmost privacy protection possible today against virtually all types of room "bugs" and telephone "taps". The CSD-18 detects even the very latest ultra-sophisticated devices specifically designed to defeat detection via polarity negating circuitry. Also includes multi-line option for testing business telephones.

### THE ONE "BUG" TO FEAR MOST!

While most individuals are now somewhat guarded in their telephone conversations, they still rather naively feel secure in the "privacy" of their own home or office. However, the most common type of tap presently used by eavesdroppers picks up ALL SOUNDS AND CONVERSATION WITHIN A ROOM...WITH THE TELEPHONE STILL ON THE HOOK!

Due to this devastating capability, this "Infinity" tap (variously referred to as Infinity Transmitter, Hookswitch Bypass, 3rd Wire, Hermonica Bug, etc.), has become the "bug of choice".

In flagrant violation of federal law prohibiting their use and sale, these devices in various forms are openly advertised in many technical publications for as little as \$75. Literally thousands of these devices are now in the hands of unscrupulous individuals all over the country!

In response to this ever-growing threat, a uniquely engineered feature of the CSD-18 now also detects Infinity type devices anywhere "down the line".

In other words, if anyone ... ANYWHERE ... is utilizing the telephone tap and/or ring wires to monitor your private room conversations while your telephone is on the hook, you'll immediately be made aware of it via a flashing LED!

#### 100% POSITIVE INDICATION

The CSD-18 also flawlessly detects "Series" and "Parallel" telephone transmitters and "Telephone Recording Devices". And, a separate feature silently indicates when extension phones are picked up or being used. The CSD-18 completely eliminates all doubt and guesswork.

#### EXCLUSIVE "LISTEN-IN" FEATURE!

The CSD-18 will even allow you to "listen-in" to exactly what the eavesdropper is monitoring. And, without the eavesdropper ever becoming aware that he has been detected! We are unaware of ANY other detection equipment having this combined capability AT ANY PRICE!

### MAXIMUM PROTECTION

The CSD-18 provides maximum protection against ALL major categories of surveillance equipment including:

- ALL TYPES OF "CONCEALED TRANSMITTERS"
- "BUMPER BEEPERS"
- "INFINITY" DEVICES
- "BODY" TRANSMITTERS
- "TELEPHONE RECORDING DEVICES"
- "SERIES" & "PARALLEL" PHONE TRANSMITTERS

CSD-18 \$295 Complete

Including batteries, antenna/probe, headphones, all plugs & adapters, extensive information package and instructions.

### HOW TO ORDER

Order NOW by Mail or Telephone. 10 DAY MONEY BACK GUARANTEE if you're not 100% pleased and completely satisfied. We pay shipping charges on all prepaid & credit card orders. Add \$15 for CODs.

(c) 1992 Great Southern Security  
513 Bankhead Highway (SF)  
Carrollton, Georgia 30117

FOR FASTEST SERVICE CALL TOLL FREE

ORDER BY PHONE



1 800 732-5000



# EARN MORE MONEY!

## Be an FCC LICENSED ELECTRONIC TECHNICIAN!



Learn at home in spare time. No previous experience needed!

No costly school. No commuting to class. The Original Home-Study course prepares you for the "FCC Commercial Radio-telephone License." This valuable license is your professional "ticket" to thousands of exciting jobs in Communications, Radio-TV, Microwave, Maritime, Radar, Avionics and more... even start your own business! You don't need a college degree to qualify, but you do need an FCC License.

**No Need to Quit Your Job or Go To School**  
This proven course is easy, fast and low cost! **GUARANTEED PASS**—You get your FCC License or money refunded. **Send for FREE facts now. MAIL COUPON TODAY!**

Or, Call 1-800-932-4268 Ext. 240

### COMMAND PRODUCTIONS

FCC LICENSE TRAINING, Dept. 240  
P.O. Box 2824, San Francisco, CA 94126  
Please rush FREE details immediately!

NAME \_\_\_\_\_  
ADDRESS \_\_\_\_\_  
CITY \_\_\_\_\_ STATE \_\_\_\_\_ ZIP \_\_\_\_\_



## CABLE TV Converters & Descramblers

Compatible with  
**Jerrold, Scientific Atlanta,  
Pioneer, Oak, & Hamlin  
Equipment**

**BRAND NEW!**

**6-MONTH GUARANTEE**

**LOWEST PRICES**

*Volume Control & Parental Lockout Available*

**Greenleaf Electronics**

**1-800-742-2567**

**NO ILLINOIS SALES**

It is not the intent of Greenleaf Electronics to defraud any pay television operator and we will not assist any company or individual in doing the same.

## DESKTOP MANUFACTURING!

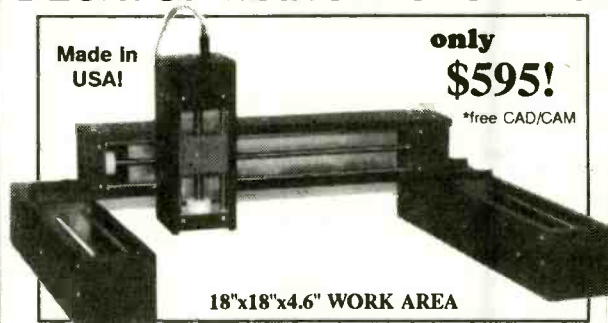

### THIS IS THE MACHINE YOU'VE BEEN WAITING FOR!

Have you ever dreamed of letting your computer manufacture products directly from your CAD drawings? If so, the Neuractor CNC-4+ Desktop Manufacturing System may be just the edge you need! This fourth-generation CNC machining center can automatically drill, mill and route three-dimensional products in wood, plastic and light metals DIRECTLY FROM YOUR CAD DRAWINGS! You've seen the rapid-prototyping and "Santa Claus" machines that cost thousands of dollars, but did you know that as an electronic technician you can assemble one yourself from this inexpensive kit? Utilizing patent pending technology the Neuractor CNC-4+ kit provides you with everything you need to machine products in three dimensions with a resolution of .001". All mechanical components are pre-fabricated, pre-machined, plated and painted. Includes four 83 oz/in digital CY-MOTORS, interface card, 5 amp power supply, 10 pitch steel lead screws, 4 proprietary Slide Block actuator mechanisms, 4 aluminum linear actuator channels, polished steel guide-rods, Dremel bracket, hardware, etc. (You provide Dremel MotoTool(tm) or flex-shaft router and work surface.) It's a complete kit! All you do is put it together and calibrate it! IF THAT'S NOT ENOUGH, WE'RE THROWING IN A FREE FULL-FEATURED 3D CAD/CAM SOFTWARE PACKAGE WITH EACH UNIT! Large 18"x18"x4.6" cutter travel for crafts, electronics and printed circuit board drilling and routing, not to mention model-making, mold-making and even painting!. Get started by ordering your own Neuractor CNC-4+ today! ACT NOW! Kit \$595 + \$24.95 UPS S/H. (For heavy-duty upgrade add \$149) Allow 4-8 weeks for delivery. U.S. CYBERLAB, 14786 Slate Gap Rd., West Fork, AR 72774 (501) 839-8293.

**Free info! X-Y Power/Rotary Tables and larger CNCs now available!**

# SETTING THE STANDARD **SA1300B SPECTRUM ANALYZER**

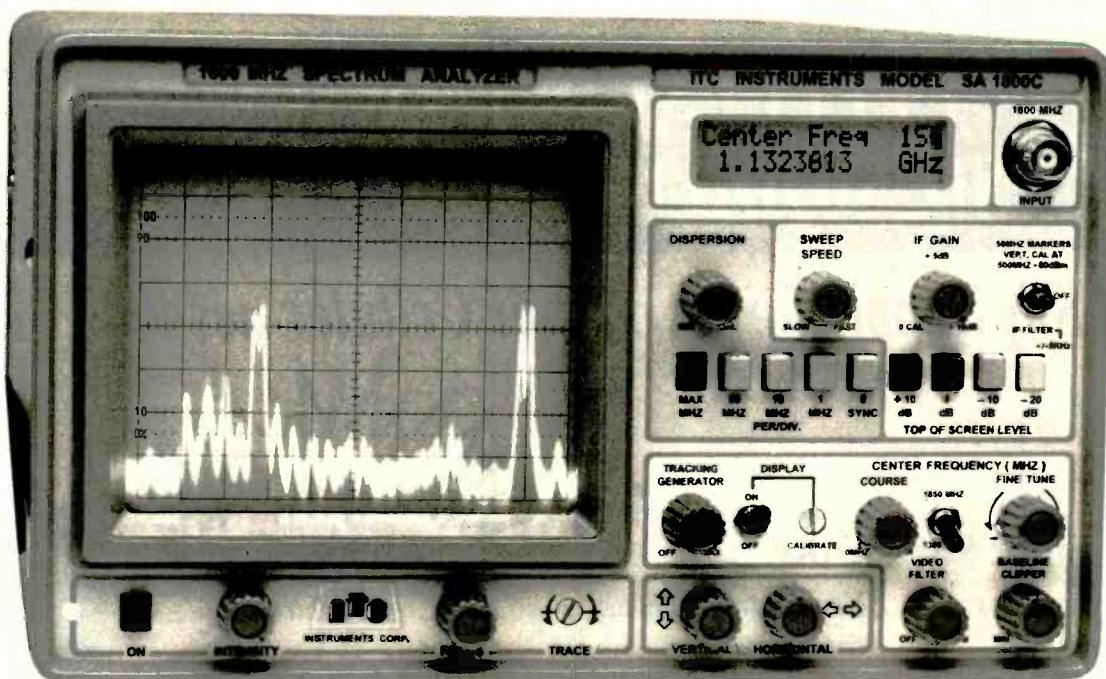

6" x 12" x 16" (H x W x D) (only 16 LB)

SA1800C Shown \$2395.0

**MADE IN THE USA 1-1300 MHz In One Sweep \$1995.00 1 YR. WARRANTY**  
**COUNTER SURVEILLANCE, CATV, AM-FM-SW, TWO WAY-HAM RADIO, FCC TESTING, SATELLITE**

## **SPECTRUM ANALYZER /DISPLAY MONITOR \$995**

The SA500A easily attaches to any receiver IF output jack. Providing a panoramic signal display of your scanner or communication receiver. The SA500A is a Full Function Spectrum Analyzer with +/- 5KHz Narrow Band Filter, Center Freq. Display, 50 MHz Marker. SA500A The first affordable Professional Spectrum Monitor/Analyzer for all serious Ham Radio and Radio Monitoring Operators. With Opt. 1,3,5,6

**CHOOSE FROM 2 FULL FUNCTION ANALYZERS**  
 Quality & Performance with 80dB on Screen, -110 dBm Sensitivity, Center Freq. Display, +/- 5KHz Narrow Band Filter 50 MHz Marker. **DISPERSION ZOOM**, Baseline Clipper, Adjustable Sweep Speed, Video Filter, and 40dB Input Attenuation. SA1300B 1-1300MHz

**SA1800B 1-1300 & 850-1850MHz \$2395** With Opt. 1,3,5,6

## **1.3GHz FREQUENCY COUNTER .001ppm \$499.00**

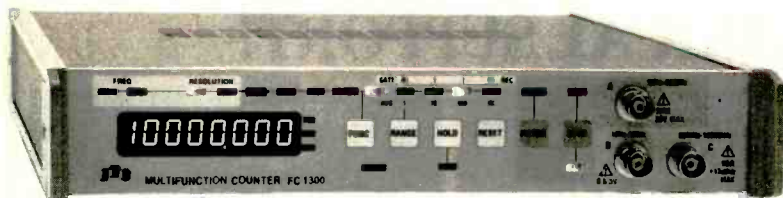

**ITC FC1300: the first truly Accurate low cost Frequency Counter.** Accuracy is the #1 Frequency Counter Requirement. The \$200 - \$800 counters being advertised the past few years are but toys when it comes to accuracy. These **guess-so-matic** units are off 5 to 10 PPM over temperature & time (That's +/- 6,000 -13,000 Hz at 1.3 GHz) The FC1300 is accurate to within +/-13 Hz at 1.3 GHz 0-40 degrees C.

Period Averaging, Time Interval, External Counter, Freq. Ratio, 4 Gate Times

**FIVE YEAR WARRANTEE REG. \$599.00 Save \$100 on FC1300 Laboratory Performance Stabilized Oven Osc .001 ppm**

## **All New ITC Low Cost High Performance Oscilloscopes**

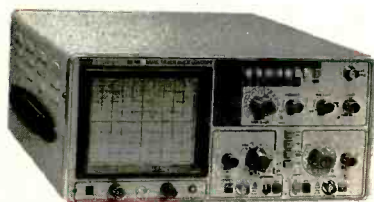

**25 MHz Scope**  
 Model ST3304 only \$349.95  
 1 mV Vertical Sensitivity  
 X-Y Modes Z axis (intensity modulation)  
 6" Bright 2KV CRT <14ns Rise time  
**25 MHz Scope / Tester**  
 Model ST3324 only \$469.95  
 Dual Component Comparator/Tester  
 Triple DC Supplies +5/A, +/-12/.2A

**40MHz Delayed Sweep Scope**  
 Model ST3315 only \$569.95  
 Delayed Sweep 1ns-1 Sec <8ns Rise Time  
 ITC Oscilloscopes fill the bill without emptying the pocket book. ITC Scopes are a cut above all other low cost scopes on the market today. You can depend on our ISO9002 certified factory to provide performance and dependability. Backed by a 2 year warranty on parts labor.

**TAKE ADVANTAGE**  
 Call 800-566-1818  
 Free 1995 Catalog  
 To Order or Info.



**ADVANTAGE INSTRUMENTS CORP. MC-VISA - DISCOVER - COD - CHECK call 800-566-1818**

3579 Hwy. 50 East Carson City, Nevada 89701 702-885-0234 FAX 702-885-7600

PRICES & SPECIFICATIONS SUBJECT TO CHANGE WITHOUT NOTICE OR OBLIGATION. F.O.B. CARSON CITY NV. NV. RESIDENTS ADD SALES TAX.  
 CIRCLE 164 ON FREE INFORMATION CARD

# CELLULAR SOFTWARE AND MODIFICATION GUIDES

*Call Spy Supply for all of your Cellular needs!*

*We Carry:*

## CELLULAR SOFTWARE

(We have the software to do New Motorola Phones)

## CELLULAR CABLES

(For the Motorola, Panasonic, and Nokia Phones)

## CELLULAR MODIFICATION GUIDES

(Covers all cellular manufacturers)

## CELLULAR PHONES

(We carry a complete line of cellular phones)



## FREE TECHNICAL SUPPORT!

We now offer Cellular Phones cloned with your existing number! Buy a handheld, transportable or car mounted phone ready to go and have only one monthly bill!

### *Don't Get Ripped Off!*

Before you buy our competitor's manual, call and ask if they offer **FREE TECHNICAL SUPPORT**

### **SPY SUPPLY**

Find out why the CIA - FBI - DEA - SECRET SERVICE Have ordered from our catalog To receive yours, send \$5.00 to:

### **SPY SUPPLY**

1212 Boylston St. #120  
Chestnut Hill, MA 02167

**SPY SUPPLY**, 1212 Boylston St. #120, Chestnut Hill, MA 02167

**(617) 327-7272**

*Sold for educational purposes only*

# There's No Easier Way to TROUBLESHOOT AND REPAIR Your Electronics!



It's easy, fast and rewarding to do it yourself with the Electronics Repair Manual!

- TVs VCRs
- Hi-Fi Stereo Amplifiers
- Turntables
- Speakers
- Shortwave Radios
- Camcorders
- Tape Decks
- CD Players
- Walkmans
- AM & FM Receivers
- PC Systems
- Automobile Sound Systems
- PC Peripherals
- Telephone Systems
- Fax Machines
- Electronic Home Appliances

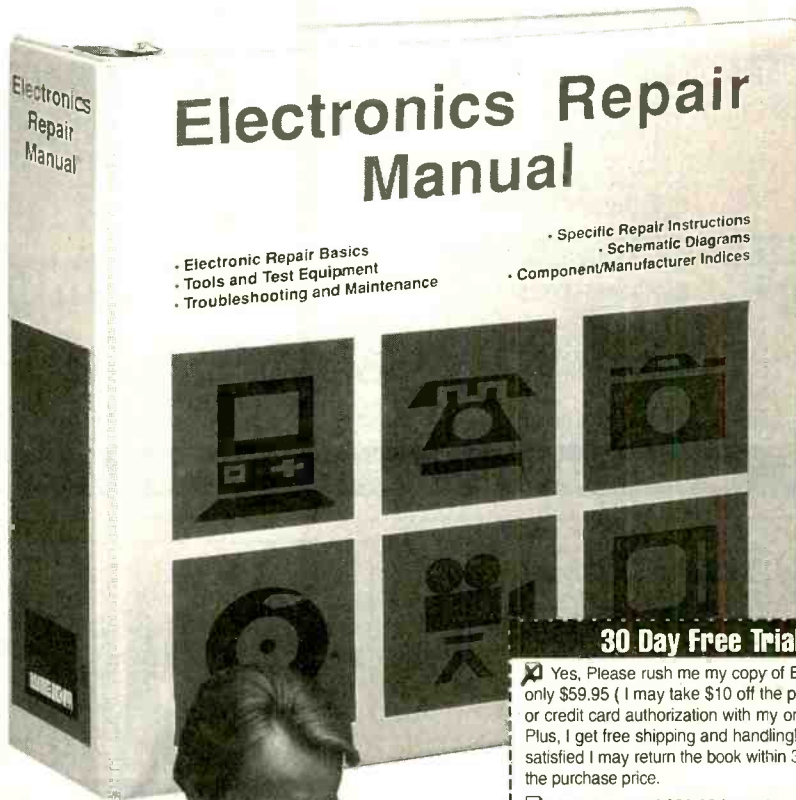

- 900-PAGE, MODULAR FORMAT MANUAL
- TROUBLE ANALYSIS FLOWCHARTS
- SCHEMATIC DIAGRAMS
- HANDS-ON, DETAILED, TROUBLESHOOTING INSTRUCTIONS
- "HOW TO" PRIMER FOR TEST EQUIPMENT SUCH AS OSCILLOSCOPES, FREQUENCY COUNTERS, AND VIDEO ANALYZERS
- SAFETY PRECAUTION CHECKLISTS
- COMPREHENSIVE REPLACEMENT PARTS LISTS
- PREVENTIVE MAINTENANCE TECHNIQUES
- DIRECTORY OF MANUFACTURERS



## 30 Day Free Trial Order Form

Yes, Please rush me my copy of Electronics Repair Manual for only \$59.95 ( I may take \$10 off the price when I enclose my check or credit card authorization with my order within the next 30 days. Plus, I get free shipping and handling!) I understand that if I am not satisfied I may return the book within 30 days for a full 100% refund of the purchase price.

My payment of \$59.95 is enclosed (\$49.95 when ordering within the next 30 days.)

**VISA**     **MasterCard**     Check enclosed.

Optional express delivery (available in U.S. only). Enclose an additional \$10.00 and we'll guarantee delivery within 5 business days from receipt of your order (prepaid orders only).

\_\_\_\_\_|\_\_\_\_\_|\_\_\_\_\_|\_\_\_\_\_|\_\_\_\_\_|\_\_\_\_\_|\_\_\_\_\_|\_\_\_\_\_|\_\_\_\_\_|\_\_\_\_\_|  
Credit card no.

\_\_\_\_\_|\_\_\_\_\_|\_\_\_\_\_|\_\_\_\_\_|\_\_\_\_\_|\_\_\_\_\_|\_\_\_\_\_|\_\_\_\_\_|\_\_\_\_\_|\_\_\_\_\_|  
Expiration Date    Daytime phone no.

Signature \_\_\_\_\_

Bill me later for \$59.95 plus \$6.50 shipping and handling, subject to credit approval. Signature and phone number required to process your order. P.O. Box addresses must be prepaid.

Mr./Mrs./Ms. \_\_\_\_\_

Company \_\_\_\_\_

Address \_\_\_\_\_

City \_\_\_\_\_ State \_\_\_\_\_ Zip \_\_\_\_\_

Shipping and handling to Canada, \$10 (U.S. currency); Overseas, \$15 (foreign orders must be prepaid); CT residents add 6% sales tax. Supplements will be sent 4-5 times a year on a fully-guaranteed, 30-day trial basis. They may be cancelled at any time.

MAIL TO: WEKA Publishing, Inc. **31171**  
1077 Bridgeport Avenue, Shelton, Connecticut 06484

**1-800-222-WEKA    FAX: 1-203-944-3663**

## Keep Your Skills Up-to-Date!

The Electronics Repair Manual will be a valuable reference for years to come. Supplements, each containing 140 pages, add new repair projects, valuable insights into new technologies, diagnostic and repair techniques, and more schematic diagrams into your manual. Just \$30 each plus shipping and handling. Supplements are sent 4-5 times a year and are fully guaranteed. Return any supplements you don't want within 30-days and owe nothing. Cancel anytime.

# MIRACLES NEVER CEASE



## MICRO TX2000 KIT

**\$59<sup>95</sup>**

- SMALLEST 120 MW FM VOICE/PHONE TRANSMITTER
- SMALL SIZE 1-7/16" x 21/32"
- 88-110mhz ON ANY BROADCAST RECEIVER
- ROCK SOLID TUNING, DOESN'T DRIFT
- 5 MIN. ASSEM., HEAR A WHISPER UP TO 2 MILES
- SMT PARTS PREASSEMBLED
- INCLUDES TXMTR, MIC, ANTENNA, BATTERY CLIP, TUNING TOOL, AND INSTRUCTIONS

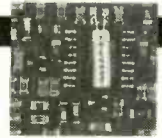

## VOICE SCRAMBLER/DESCRAMBLER KIT

**\$69<sup>95</sup>**

**2 FOR \$129.95**

- WORLDS SMALLEST AUDIO SCRAM/DESCRAM.
- TALK IN PRIVACY ON AUDIO, SPKR. OR MIC LINE
- HEAR THOSE GARBLED SCANNER VOICES
- SMALL SIZE 1"x7/8"x1/4"
- CRYSTAL CONTROLLED DIGITAL SPEECH INVERSION
- 7-15 VOLT DC SUPPLY
- LOUD HALF WATT AUDIO AMPLIFIER
- EXCELLENT AUDIO QUALITY
- INCLUDES FULL DOCUMENTATION
- DUPEX SCRAMBLE & DESCRAMBLE AT THE SAME TIME



## MICRO 1.2 VOICE RECORDER

**\$69<sup>95</sup>**

- SMALL SIZE 1-1/4"x15/16"x1/4"
- HUNDREDS OF APPLICATIONS
- EXCELLENT AUDIO QUALITY
- 60 SECONDS REC/PLAY
- 8 OHM SPEAKER OUTPUT
- 7-15 VOLT DC SUPPLY
- 100 YEAR MEMORY WITHOUT POWER
- INCLUDES MIC, SWITCHES AND FULL DOCUMENTATION



## MICRO 2B VOICE RECORDER

**\$109<sup>95</sup>**

### MICRO 2B FEATURES

- SAME AS 1.2 PLUS:
- MULTI MESSAGES (UP TO 600 MEM.)
- SMALL SIZE 1-5/16"x1-5/8"x1/8"
- VARIABLE AUTO PLAY TIMER
- 5 VOLT KEY OUT DURING PLAYBACK

ORDER BY PHONE OR MAIL  
IN U.S.A. ADD \$5 FOR S&H

C.O.D. CHARGES APPLY  
NYS RESIDENTS ADD SALES TAX

## VFC400 VHF/UHF FM VOICE TRANSMITTER KIT



ONLY  
**\$99<sup>95</sup>**

**NEW**

- SMALLEST 400 MILLIWATT VOICE TRANSMITTER ANYWHERE! (1.5" x .56")
- RECEIVE ON ANY SCANNER OR VHF/UHF SURVEILLANCE RECEIVER
- RELIABLE CRYSTAL CONTROL OSCILLATOR
- 5 MILE RANGE (OR BETTER)
- SUPER SENSITIVE OP-AMP PICKS UP SOUNDS AT WHISPER LEVEL
- LINE LEVEL AUDIO INPUT FOR DATA, STATION ID, OR INTERFACE TO OUR POPULAR VOICE RECORDERS
- SIMPLE 5 MINUTE ASSEMBLY, ALL CHIP COMPONENTS ARE PRE-ASSEMBLED
- CUSTOM FREQUENCIES AVAILABLE FOR LAW ENFORCEMENT
- INCLUDES TRANSMITTER, CRYSTAL, BATTERY HOLDER, MICROPHONE, ANTENNA, & INSTRUCTIONS
- CHANNEL A) 146.565 MHZ B) 149.000 MHZ (SELECT ONE WHEN ORDERING)

## MICRO-4 MULTI-MESSAGE VOICE RECORDER

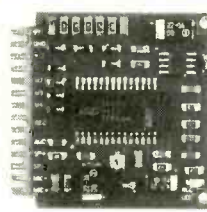

- EXACT SOUND REPRODUCTION
- SMALL SIZE 1-3/4" x 1-5/8"
- NEW EDGE CARD DESIGN IS STANDARD, 100 SPACING
- 4 MESSAGE MAX. UP TO 20 SECONDS
- LED INDICATES RECORDING IN PROGRESS
- 6 VOLT INPUT ONLY DRAWS .5 uA STANDBY
- 7-13.8 VOLT REGULATED INPUT @ 30ma
- 8 OHM 50 MILLIWATT SPEAKER OUTPUT
- LINE LEVEL AUDIO OUTPUT (VARIABLE)
- FULLY ASSEMBLED (NOT A KIT)
- 100'S OF APPLICATIONS, ALARMS, PRODUCT DISPLAY, NOTE PAD, HAM, CB, MUSEUMS, ETC
- SWITCHES, MICROPHONE, & INSTRUCTIONS INCLUDED

**NEW**

ONLY **\$89<sup>95</sup>**

**COMING SOON**



1145 CATALYN STREET  
SCHENECTADY, NY 12303

## MICRO-3

RECYCLE UP TO 4.5 MINUTES  
UP TO 1800 MESSAGES (NO DIODES)  
MESSAGE CUEING (FAST FORWARD)

TECH. FAX: 518-381-1058

TO ORDER: CALL 1-(800)-588 4300



TECH. SUPPORT: 518-381-1057

## Motion Control System

**\$249.95**

Includes Stepper Controller Card, 12VCT Transformer, (2) 4 Phase Stepper Motors, Easy to use I.B.M Software! Connects to any I.B.M. Compatible LPT Port (1,2,3)...

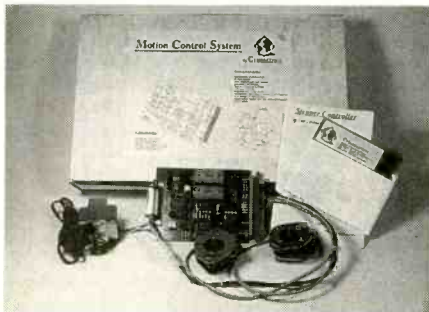

- \* **Nothing more to Buy!**
- \* Easy Installation 15 minutes or Less!
- \* No Tools Required!
- \* Design Robots, Plotters, Laser Systems!
- \* Drives (2), 4 Phase Stepping Motors!
- \* Bi-Directional 8 Bit Read and Write Port!
- \* Board Addressable, 16 Possible Choices!
- \* Fits in Standard 19" inch Card Rack!
- \* With Additional Cards Control 32 Motors on 1 LPT Printer Port!
- \* Features Include: Variable Speed, Step, Range, Direction, and On/Off Control!
- \* Free QBasic & Gwbasic Source Code \$ 59.95 value! \*

Send Check or M.O. to:

**CYBERMATION**

"Intelligent Controllers"

1943 Sunny Crest Dr., Suite 288,  
Fullerton, CA 92635

Call Us Today!

Tel (714) 879-2000

Visa/Master Charge Accepted

\* Add \$12.00 S&H; CA residents please add sales tax \*



# CABLE HOTLINE

Cable TV Descramblers \* Converters

## Absolutely The Lowest Prices!

All Major Brands \* #1 In Customer Service  
30 Day Money Guarantee - 2 Year Warranty  
Call For Price Quote. Please Have Make And Model  
Number Ready When You Call.

Frequent Buyer And Quantity Discounts

**1-800-203-7077**

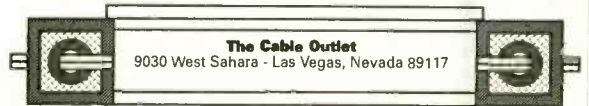

AMERICAN RELIANCE

**AMREL Offers Lowest Prices & Best Warranties on DC Power Supplies ANYWHERE!**

3 YEAR WARRANTY



3 YEAR WARRANTY

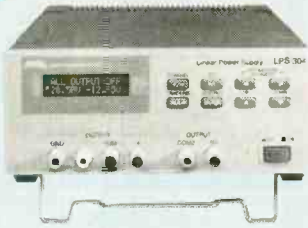

**AMREL Offers Superior Analog Power Supplies Starting as Low as \$149.00**

- Low Output noise rating less than 0.3mV.
- Line/load regulation rated at low 0.01% + 1mV.
- Transient response time of 50µ Sec.
- Overload protection, and Output enable/disable.
- Coarse and fine voltage/current adjustment.
- Auto series/parallel operations for triple output supplies.

**AMREL Offers Features And Prices on Digital Power Supplies That The Competition Can't Beat!**

- Microprocessor controlled.
- User friendly keypad data entry.
- Low output noise rating less than 1mV.
- Line/Load regulation rated less than 2mV.
- Output enable/disable and Power off memory.
- Optional RS-232 interface capability.

Model	LPS-101	LPS-102	LPS-103	LPS-104	LPS-105	LPS-106	LPS-301	LPS-302	LPS-303	LPS-304	LPS-305
Rating	30V/1A	30V/2A	30V/3A	+30V/1A -30V/1A 3-6.5V/3A	+30V/3A -30V/3A 3-6.5V/3A	60V/1A	15V/2A(H) 30V/1A(L)	15V/4A(H) 30V/2A(L)	30V/3A	+30V/1A -30V/1A 5V/2A	+30V/2.5A -30V/2.5A 3.3-5V/3A
List Price	\$195	\$225	\$295	\$395	\$495	\$245	\$249	\$299	\$469	\$399	\$599
Sale Price	\$149	\$179	\$199	\$375	\$469	\$219	\$199	\$285	\$450	\$379	\$569

**PR**INT™  
Products International Inc.



Call: 1-800-638-2020



8931 Brookville Road • Silver Spring, Maryland 20910 • Fax: 800-545-0058

CIRCLE 46 ON FREE INFORMATION CARD

**ATTENTION CABLE VIEWERS**

**CABLE VIEWERS... get back to your BASIC Cable Needs**

**Call 800-577-8775**

For information regarding all of your BASIC cable needs.



**5 GOOD REASONS TO BUY OUR FAR SUPERIOR PRODUCT**

- ❖ PRICE
- ❖ EFFICIENT SALES AND SERVICE
- ❖ WE SPECIALIZE IN 5, 10 LOT PRICING
- ❖ ALL FUNCTIONS (COMPATIBLE WITH ALL MAJOR BRANDS)
- ❖ ANY SIZE ORDER FILLED WITH SAME DAY SHIPPING

**BASIC  
ELECTRICAL  
SUPPLY &  
WAREHOUSING  
CORPORATION**

We handle NEW equipment ONLY - Don't trust last year's OBSOLETE and UNSOLD stock!  
**COMPETITIVE PRICING—DEALERS WELCOME**

**HOURS: Monday-Saturday 9-5 C.S.T.**

It is not the intent of B.E.S.W. to defraud any pay television operator and we will not assist any company or individual in doing the same.  
\*Refer to sales personnel for specifications.

**P.O. Box 8180 ■ Bartlett, IL 60103 ■ 800-577-8775**

July 1995, Popular Electronics

# FM TRANSMITTERS ELECTRONIC KITS AND MORE

**SATISFACTION  
GUARANTEED!**

WE ACCEPT VISA, MC, MO, COD  
SHIPPING & HANDLING EXTRA



**BUY WITH CONFIDENCE FROM XANDI**  
• 30-DAY REFUND POLICY  
• TECH SUPPORT NUMBER (602-894-0992)

- Tunes 88-108 MHz.
- Powerful 2 stage audio amplifier.
- Sensitive, picks up sounds at the level of a whisper.
- Up to 1 mile range.
- Requires 9V battery. (Not incl.)



**SUPER-MINIATURE FM TRANSMITTER**  
Super small FM transmitter. Use with any FM broadcast receiver. Easy to assemble, all chip (SMT) parts are pre-assembled to the circuit board.

**XST500 (E-Z) Kit .....\$44.95**

- Miniature photo battery mounts right on circuit board. (Included)
- Tunes 88-108 MHz.
- Up to 1/2 mile range.
- Sensitive 2 stage audio amplifier, picks up sounds at the level of a whisper.



**MICRO-MINIATURE FM TRANSMITTER**  
Including the battery, this is the Worlds smallest FM transmitter. Use with any FM broadcast receiver. Easy to assemble, uses pre-assembled circuit board.

**XWB1000 E-Z KIT .....\$49.95**

- Up to 1 mile range.
- Miniature photo battery mounts right on circuit board.
- Transmits at 143 MHz.
- Amazing audio sensitivity, picks up sounds at the level of a whisper.



**CRYSTAL CONTROLLED FM TRANSMITTER**  
Including the battery, this is the Worlds smallest crystal controlled FM transmitter. Transmits to any scanner type receiver. Easy to assemble, uses pre-assembled circuit board.

**XTL1000 E-Z KIT .....\$69.95**

- Smallest Phone transmitter anywhere!
- Tunes 88-108 MHz.
- No batteries required, powered by phone line.
- Up to 1/4 mile range.
- Attach to phone line anywhere in house, even inside phone.



**SUPER-MINIATURE PHONE TRANSMITTER**  
Worlds smallest FM phone transmitter. Use with any FM broadcast receiver. Easy to assemble, all chip components are pre-assembled to the circuit board.

**XSP250 (E-Z) Kit .....\$34.95**

- Dial your phone from anywhere and listen to the sounds inside your home.
- Two digit Touch Tone code for secure operation.



**TELEPHONE SNOOP**  
Call home from anywhere, enter a two digit security code, and hear the sounds in your home. Automatically turns on without ringing the phone. Verifies code, then activates for one and a half minutes.

**XPS-CASE KIT .....\$13.95**

**XPS1000 (C) KIT .....\$33.95**

- Transmits a continuous beeping tone.
- Adjustable from 88 to 108 MHz.
- Up to 1 mile range.
- Works with any FM broadcast receiver.



**TRACKING TRANSMITTER**  
Only 0.7 by 2.4 inches, the XTR100 operates at voltages of 3 to 18 Volts and is ideal for use in locating lost model rockets, bicycles, automobiles, games of hide and seek, and contests.

**XTR100 (C) Kit .....\$33.95**

- Uses sensitive microwave transistor amplifier.
- Covers 1 to 2,000 MHz.
- Compact hand held unit.
- Includes miniature loud speaker for audio indication of detected signals.



**SUPER SENSITIVE BUG DETECTOR**  
When the XBD200 intercepts a signal in the 1 to 2,000 MHz range, it emits a growl that increases to a high pitched squeal as the signal strength increases.

**XBD200 (C) Kit .....\$49.95**

- Use with any FM broadcast receiver.
- Hear every sound in an entire house!
- Up to 1 mile range
- Powerful 2 stage audio amplifier.



**MINIATURE FM TRANSMITTER**  
The XFM100 has a super sensitive microphone and is capable of picking up sounds at the level of a whisper and transmitting them to any FM broadcast receiver.

**XFM100 (C) Kit .....\$32.95**

- Digital voice changing: male to female, female to male, adult to child, child to adult.
- Maintain anonymity on any call.
- Button for normal operation.
- 16 levels of voice masking.

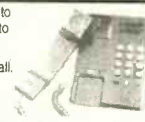

**VOICE CHANGING TELEPHONE**  
STOP THOSE ANNOYING TELEPHONE CALLS! Sound older and tougher when you want to. Not a kit. Fully assembled. Single phone operation only.

**TRANSITION 2000 .....\$89.95**

- Digital voice changing: male to female, female to male, adult to child, child to adult.
- Use with any modular phone.
- 16 levels of voice masking.
- Connects between handset and phone.



**VOICE CHANGING ACCESSORY**  
STOP THOSE ANNOYING TELEPHONE CALLS! Sound older and tougher when you want to. Not a kit. Fully assembled. Use with single or multi-line phones.

**TRANSITION 2001 .....\$59.95**

- Uninterrupted 800 to 950 MHz coverage.
- Works with any scanner that can receive 400 to 550 MHz.



**800-950 MHz SCANNER CONVERTER KIT**  
If your scanner can receive 400-550 MHz, just add the XLC900 for uninterrupted 800-950 MHz coverage. It converts all 800-950 MHz signals to 400-550 MHz so your scanner can receive them! Add our custom case kit for that "Professional" look.

**XLC-CASE KIT .....\$13.95**

**XLC900 (C) KIT .....\$49.95**

- Transmit high quality stereo to any FM stereo receiver.
- Built-in output level monitor for quick and easy tuning.
- Ideal for use with personal CD player.



**FM STEREO TRANSMITTER**  
Transmit full-bodied Hi Fi stereo to any FM stereo receiver. Separate left and right inputs and gain controls. Includes an output booster stage for greater range.

**XFS-CASE KIT .....\$13.95**

**XFS108 (C) KIT .....\$41.95**

**XANDI ELECTRONICS** *Serving the public since 1981*  
1270 E. Broadway Rd. # 113, Tempe AZ 85282

**TOLL FREE ORDER LINE**  
1-800-336-7389  
ASK FOR FREE CATALOG OF OUR PRODUCTS

**SEND MAIL XANDI ELECTRONICS**  
ORDERS TO: BOX 25647  
TEMPE AZ 85285-5647

CIRCLE 134 ON FREE INFORMATION CARD

## Make your projects speak for themselves... Ours do!

### DIGITAL VOICE RECORDERS

- Record up to 218 seconds
- 1 to 8 messages
- High quality speech 12 bit
- Switch-closure actuation
- Sample rates up to 20Khz
- On-board backup
- Direct speaker output
- Wide operating range
- Small size 2.6" X 2.6"
- Made in U.S.A.

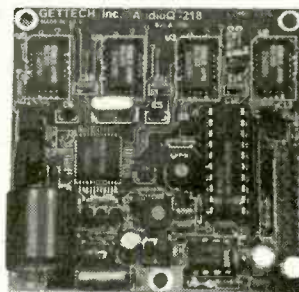

MODEL AudioQ™-218

Call or write for more information  
OEM price and delivery available  
Custom designs and enclosures  
Single unit price \$149.00 plus s+h  
Quantity pricing as low as \$99.00

**GETTECH, Inc.**

402 Riley Road, New Windsor, NY 12553  
(914) 564-5347

Specifications and price subject to change.

## Digital Storage Oscilloscope For \$169.95 ???

And much, much more!

O-Scope I turns PC-ATs into DSO, spectrum analyzer, frequency counter, DVM. DC-50KHz

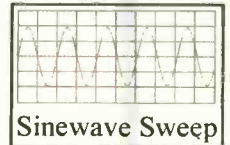

Sinewave Sweep

Actual O-Scope  
Signal Traces

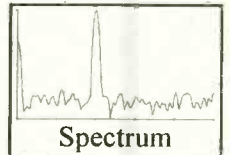

Spectrum

For Orders and Inquiries Call: 1-800-980-9806  
For Technical Assistance: 1-713-777-0401

**Allison Technology Corporation**  
8343 Carvel, Houston, TX 77036  
FAX and BBS 1-713-777-4746



## PE MARKET CENTER CLASSIFIEDS

### REPAIRS-SERVICES

**TEST EQUIPMENT:** repair including power supplies and other measuring devices excluding oscilloscopes, power supply repair of computer equipment, call (812) 295-4240.

### BUSINESS OPPORTUNITIES

**START** your own technical venture! Don Lancaster's newly updated **Incredible Secret Money Machine II** tells how. We now have autographed copies of the Guru's underground classic for \$18.50. **SYNERGETICS PRESS**, Box 809-C, Thatcher, AZ 85552. (520) 428-4073. Visa/MC.

**GREAT EXTRA** income! Assemble craft products at home. Easy/fun! Program guaranteed! Call: 1 (800) 377-6000 ex7930.

**EARN COMPUTER \$\$\$\$\$** Start a home computer business or enhance **ANY** business with computer business needs. Complete packages! Manuals, video tapes, business software, turn-key computer systems. **FREE** brochure. The Harsin Company, 8681-F West New Bethel Road, Lexington, IN 47138. (812) 866-4076 (24 hr. message)

**MAKE \$75,000 to \$250,000 YEARLY.** Repairing all kinds IBM monitors. Successful home based business, anywhere. Telephone required. Details: USA \$3.00 cash (no checks), Dealerships: Canada-all foreign countries: \$85.00 for application-brochure. Randall Display, Box 2168H, Van Nuys, CA 91404.

### PUBLICATIONS

**HISTORIC AND Classic** hardware support magazine. **The Computer Journal** provides how-to information on keeping S-100, Kaypro, Z80, 6809, CP/M, and PC/XT systems running. Over **TEN** years of hardware, software projects. 6 issues \$24.00. Free sample. 1 (800) 424-8825. TCJ, PO Box 535, Lincoln, CA 95648.

**MASTERCARD AND VISA** are now accepted for payment of your advertising. Simply complete the Classified Ad order form and we will bill you.

**Yours for only  
\$3.50**

**Prices includes  
shipping!**



**HAVE A THOUSAND YUCKS FOR ONLY THREE AND A HALF BUCKS!** That comes to one-third of a cent per laugh. **Electronics Comics** is a compilation of over 125 riotous, outrageous and phenomenal cartoons that appeared in **Popular Electronics** and **Electronics Now**. Only \$3.50—price includes shipping. **Clagck, Inc., Reprint Bookstore**, P.O. Box 4099, Farmingdale, NY 11735-0793. All payments in U.S. funds. Sorry, no orders outside U.S.A. and Canada. Check or money order only—send no cash. NY state residents add applicable tax. MA04

# CABLE TV DESCRAMBLERS

Best Wholesale Prices in the U.S.A.!

	1-4	5-9	10-19	20-49	50+
<i>For Jerrold Systems</i>					
TNT+	59	55	49	45	40
Stealth+	55	49	44	39	34
FTB3	49	39	35	32	30
<i>For Scientific Atlanta Systems</i>					
M80	69	62	55	45	40
SA3	55	45	40	36	33
<i>For Pioneer Systems</i>					
Super-PIO+	69	62	55	45	40
<i>Panasonic Converter</i>					
TZPC1003	75	67	62	59	57

**1-800-818-9688**

**U.S. Cable TV Inc. M-F: 9-6 EST**

**4100 N. Powerline Rd., Bldg. F4 Pompano Beach, FL 33073**

U.S. Cable will only sell the cable equipment to authorized cable subscribers. It is illegal to operate this equipment without paying for the basic and the premium services. U.S. Cable will not sell to anyone who will not comply with Federal and State laws. **No Florida Sales.**

## SURVEILLANCE

### FM TRANSMITTERS MINI (KITS)

- 3-VOLT FM XMTR, up to 300 ft. indoors, 1500 ft. outdoors
- PHONE XMTR, range to 500 ft., uses phone-line power
- Sound-Activated XMTR, range to 500 ft.
- 2-STAGE XMTR, 9-Volt, very powerful

All above require simple soldering at 2 to 4 places. **\$29.95\*\***

**TELE FM WIRELESS MONITORING SYSTEM.** (Kit) **\$99.00\***

**TELE CALL FORWARDER.** Transfers incoming calls. **\$99.00\***

**CALLER ID.** Registers incoming number. **\$99.00\***

**TEL REGISTER WITH PRINTER.** Records dialed number, duration, and prints record. **\$139.00\***

**12-HOUR LONG-PLAY RECORDER.** Modified Panasonic. Records 6 hrs. on each side of 120 tape (supplied). Compatible with VOX and Tel Rec Adapter. **\$119.00\***

**VOX VOICE-ACTIVATED SWITCH.** Makes recorder self-activating with voices or other sounds. **\$28.50\*\***

**TELE RECORDING ADAPTER.** Records incoming and outgoing calls. **\$28.50\***

**TELEPHONE SCRAMBLERS.** Over 4,000 separate codes. **\$199.00\***

**VOICE CHANGER.** Changes man's voice to lady's and vice versa. **\$49.00\*\***

For Shipping & Handling add \$5.00 and \*\*\$2.00 per item. Colo. residents add sales tax. Mail Order, VISA, M/C, COD's o.k. Inquire for dealer prices. Free catalog.

**MUCH, MUCH MORE — OUR 25TH YEAR!**

**TOLL FREE 1-800-926-2488**

**A.M.C. SALES, INC.**

193 Vaquero Dr., Boulder, CO 80303  
Tel: (303) 499-5405, Fax: (303) 494-4924  
Mon.-Fri. 8 a.m.-5 p.m. Mtn. Time

CIRCLE 140 ON FREE INFORMATION CARD

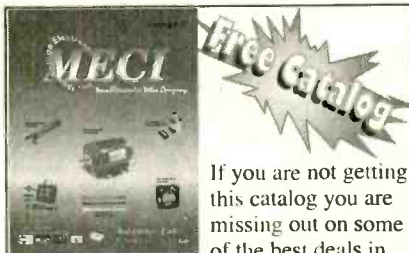

If you are not getting this catalog you are missing out on some of the best deals in electronics today! We have thousands of items ranging from unique, hard-to-find parts to standard production components. Call, write, or fax today to start your free subscription to the most unique catalog in the industry, filled with super values on surplus electronic and hobbyist type items. If you have a friend who would like to receive our catalog, send us their name and address and we will gladly forward them a complementary 100 page catalog.

Why pay more? Call today.



340 East First Street Fax Order Line  
Dayton, Ohio 45404 1-800-344-6324

**Order Toll-Free  
1-800-344-4465**

CIRCLE 149 ON FREE INFORMATION CARD

# TOP SECRET

**CONSUMERTRONICS**  
2011 Crescent Dr., P.O. Drawer 537  
Alamogordo, NM 88310

Voice: (505) 439-1776, 439-8551;  
8AM - 8PM MST, Mon - Sat

Fax: (505) 434-0234, 434-1778 (orders  
only; if you get voice, enter #11 #11 any time); 24-hr

Free Tech Support (relates directly to your  
order or prospective order): Tues. and Thurs. only.

10% Off on orders \$100+. 15% Off over \$200+  
Add \$5 total SH (US, Canada). All items in stock. VISA,  
MCARD OK. No CODs or "bill me's". New Catalog (200+ offers)  
\$2 w/ order, \$5 w/b (check or MO) - NO free catalog.  
NO dealers. Since 1971. As seen on CBS "60 Minutes",  
Forbes, etc. By John Williams - former Lockheed Senior  
Engineer, NMSU Computer Science Professor, NIH Health  
Physicist. Wanted: 9 MAC IIcl, PC386, better - buy, trade.

\*All software supports all IBM-PC compatible  
x86 systems (8086 - Pentium)

## Off-The-Shelf HARDWARE

Van Eck Systems, Data Card Reader/Writers,  
ATM2, RF/EM Radar/Ultrasonic IR Jammers/Detectors  
Receivers/Amplifiers, Security/Surveillance De-  
vices, EM Lab/Weaponry/Countermeasures, Neuro-  
phone/Rife/Hieronymus/Resonant Crystal Radionics,  
Voice Disguisers, Phone Color Boxes, Line-  
man's Handsets, DTMF Decoder, Bug & Tap Detector/  
Blaster, Carjack/Kidnap Follower, Hearing Assistant,  
Shriek Module, TENS, 6th Sense Communicator,  
Subliminal Mixer/Amp, Levitator, Vortex Generator,  
Noise Cancelling System, Unknown Presence Detector,  
Electronic Dowser, Bacteria Detection Kit - many,  
many more devices. See our New Catalog.

## CELLPHONE MODIFICATIONS

See our Catalog for our infamous cellphone modification  
guide (869) - detailed, comprehensive, covers all  
makes - 10 times more info than competitors' "guides".  
(Do Special Projects (below) for up-to-date hardware  
software).

## SPECIAL PROJECTS

We design/build/obtain/repair/modify/maintain/consult on  
any device/system/process/project - electronic/electromechanical/  
phone/computer/mechanical/optical/Automotive for busi-  
ness/personal/invention need. Confidentiality guaranteed.  
Describe and include \$30 pre-engineering fee (does not  
obrogate you). Time and cost estimates in 7-10 days.

## The HACKER FILES

Compilation of 100s of the best articles written (in  
ASCII) by top hackers & phreakers. Covers every major  
topic in hackerdom! 3 HD Disks\* \$59

## VOICE MAIL HACKING

How Voice Mail Box (VMB) systems are used and the  
specific ways they are hacked. Includes ASPEN, MES-  
SAGE CENTER, BIX, GENESIS, EZ, SYDNEY, PHONE  
MAIL, AUDIX, CINDY, CENTAGRAM, SPERRY LINK,  
RSVP, etc. Absolutely required for all users, sysops and  
security personnel \$29.

## PBX HACKING

1,000s of PBXs are hacked to the tune of \$ Billions/yr!  
While "VOICE MAIL HACKING" details how VMSs are  
hacked for "phun" and profiting - including VMS methods  
for hacking PBXs themselves - "PBX HACKING" ad-  
dresses ALL issues relating to PBX hacking, including  
countermeasures! Can your business or agency afford a  
\$90,000 phone fraud loss (the average loss due to  
hacked PBXs)? As described in Forbes Magazine. \$29

## PHREAKING CALLER ID & ANI

Details on how they work and dozens of effective ways  
of defeating Caller ID, ANI, \*69, \*57, and Call Blocking  
and \*67. Also describes Caller ID, Orange, Beige,  
Cheese and CF Boxes, ESS, SS7, E-911, various  
CLASS services, CNA, NON PUB DA, CAMA, DNR,  
800-ECR, Diverters, Extenders, Centrax - more. \$29

## Beyond PHONE COLOR BOXES

Dozens phone color boxes described - many circuits.  
Plus Call Forwarding, Conferencing, Phreak History,  
Glossary, Diverters, Extenders, Loops, REMOBS,  
Bridging Heads & Cans, Optocam, 3rd Party and many  
other non-box methods - more. \$39.

## ROBOFONE AUTODIALER

Powerful, versatile, menu-driven "Wargames" autodialer  
lets you dial any quantity (up to 10K) or mix of local/  
long distance numbers in any order, over any length of  
time, whether busy or answered (your choice) and log  
the times, commands and results to monitor, printer  
and/or disk. Quick-dial directory of up to 600 numbers.  
BUSY redial options. Direct mode command and control.  
All Result Codes, including VOICE and RINGING.  
Optional shell to terminal program upon CONNECT. Exit  
to menu or DOS (for batching). Manual + Disk\* \$29.

## COMPUTER PHREAKING

Describes in detail how computers penetrate each other,  
and how VIRUSES, TROJAN HORSES, WORMS, etc are  
implemented. Dozens of computer crime and abuse  
methods and countermeasures. Includes disk filled with  
hacker text files and utilities, and the legendary FLU-  
SHOT+ protection system (Ed. Choice, PC Magazine).  
BBS advice, password defeats, glossary - much more!  
Manual + Disks\* \$39.

## Beyond VAN ECK PHREAKING

Leaves dropping on TV and computer video signals using  
an ordinary TV described in detail. Includes security in-  
dustry reports. Range up to 1 KM. Plans include both  
the Consumertronics and the original Top Secret Van  
Eck designs! \$29.

Sold for educational purposes only

## STOPPING POWER METERS

As reported on CBS "60 Minutes": How certain de-  
vices can slow down - even stop - watt-hour meters -  
while loads draw full power! Device simply plugs into  
one outlet and normal loads into other outlets. Also de-  
scribes meter creep, overload droop, etc. Plans \$29.  
I.Q. MANUAL: External magnetic ways (applied to  
the meter itself) to slow down and stop watt-hour meters  
while drawing full loads. Plans. \$19. **KW-HR  
METER:** How watt-hour meters work, calibration,  
error modes (many), ANSI Standards, etc. Demand and  
Polyphase Meters. Experimental results to slow and  
stop meters by others. \$19. Inv. 2. \$38. All 3. \$59.

## AUTOMATIC TELLER MACHINES

ATM crimes, abuses, vulnerabilities and defeats ex-  
posed! 100+ methods detailed, include: Physical, Reg.  
E, cipher, PIN compromise, card counterfeiting, mag-  
netic stripe, false front, TEMPEST, Van Eck, tapping,  
spoofing, inside job, super-cool, vibration, pulse, high  
voltage - others. Case histories, law, security, surveys,  
detailed security checklist, labeled internal photos, fig-  
ures. ATMs contain up to \$250,000 in cash! Recent  
\$350,000 ATM crime spree still unsolved! \$39.

## CREDIT CARD SCAMS

Cardholders, merchants, banks suffer \$ Billions in  
losses annually because of credit card fraud. Describes  
every known means of credit card fraud and scams.  
Protect yourself! \$29.

## CONS. SCAMS & SWINDLES

Cons & scams and related swindles fleece Americans of  
\$100+ Billion per year! The most comprehensive sur-  
vival manual on cons & scams of all kinds - from the  
classic to hi-tech. Details on 100s and their many vari-  
ations, and countermeasures. Protect yourself! \$39

## STEALTH TECHNOLOGY

Police radar is fascinating! It also has error rates of 10-  
20%! Every known error mode - stealth method and ma-  
terial used to minimize radar reflections - tactic and  
strategy to fight unjust radar tickets (that cost you  
\$100s in insurance and risk cancellation) - methods to  
detect and jam signals - fully described! \$29.

## SECRET & SURVIVAL RADIO

Optimum survival and security radio equipment, meth-  
ods, freq allocations and voice/data scrambling/encod-  
ing. Includes small receivers/transmitters, telemetry, an-  
tenna optimizations, remote monitoring and control, se-  
curity, surveillance, and ultrasonic, fiber-optic and infra-  
red commo. 70+ circuit plans, tables. \$29.

## HIGH VOLTAGE DEVICES

HV devices plans: Stun Gun, Taser, Prod. Can, Cane,  
Flasher, Blaster, Zapper, Audio/RF/Radar Jammer,  
Jacob's Ladder, Plasma & Van de Graaf Gen., Fence  
Charger, Gelger Counter, Ozone Gen., Fish Stunner,  
Plant Stim. Kirlian, more! All plans for only \$29.

## UNDER ATTACK!

Electromagnetic Interference and Electronic  
Weapon Attacks cause: Cancer, birth defects, and pro-  
found psychological, neurological, cardiovascular and  
immune system disorders! Destructive to people, ani-  
mals, plants, equipment! Includes ACTUAL CASES OF  
EM ATTACKS (we investigated!) Includes how to verify  
and pinpoint EMI and electronic attack sources, and spe-  
cific countermeasures. \$29. **EM BARRIAGE LA-  
SER:** Tutorial and plans for powerful ELECTROMAG-  
NETIC WEAPONS and LAB DEVICES. Optimum circuits,  
freqs, waveforms, duty cycles, intensities. Thorough.  
\$29. Both \$49.

## RADIONICS MANUAL

Exciting electrical, electronic, electromagnetic therapeu-  
tic, diagnostic & preventive devices (mostly experimen-  
tal). History, descriptions, plans (dozens), availabilities  
of Radionics Devices from early to modern. While drugs  
cost \$ Hundreds, electricity costs pennies! \$29. **HEAL  
YOURSELF!** Plans for 3 major electronic therapeutic  
devices of types approved by FDA. \$19. Both \$39.

## CRYPTANALYSIS TECHNIQUES

Five powerful menu-driven crypto programs (in .COM  
and .BAS source code) to analyze, decrypt "secure" ci-  
phers. Worked-out examples. Recommended by  
prestigious "Computers & Security." Manual + Disk\*  
\$29.

## By an ORDER of the MAGNITUDE

The most comprehensive, hard-hitting, hi-tech sur-  
vival book ever written! Topics include electronics,  
computers, energy, weapons, concealment, revenge,  
alarms, etc to survive today's dangerous world. We all  
face increasingly financially and physically brutal times!  
Field-expedient use of technology in various threat and  
conflict environments and scenarios. \$49.

## ROCKET'S RED GLARE

How to design and build solid-propellant amateur and  
survival rockets. Emphasis on formulation, manufacture,  
installation of propellants, motors, igniters, etc. Includes  
list of commonly available materials, and the design of  
launch pads and test beds and their electronics. \$29.  
**EXPLOSIVES:** How to make rockets, M-80s, mortar  
rounds, cherry bombs, small rockets, volcanos, fountains,  
sparklers and safety fuses are made and colored.  
Simple, cheap, common ingredients. \$9. Both \$36.

## NATURAL BEAUTY SECRETS

Legendary beauties Cleopatra, Helen of Troy, Brunhild,  
others augmented beauty with natural preparations. De-  
scribes in detail how many personal care products (ex-  
skin care, hair care, makeup, soaps, grooming prepara-  
tions and fragrances) are made from safe, natural, inex-  
pensive substances. For all skin colors, shades. Also in-  
cludes theatrical, ceremonial, warpaint makeup. \$29.

## ULTIMATE SUCCESS MANUAL

Underpaid, overworked, harassed or abused? Victim  
of office politics? Stuck in a dead-end job? Can't find a  
good job? Expect to be laid off, fired or transferred soon?  
The ultimate no-holds-barred, looking-after-#1 Machiav-  
ellian techniques to find, obtain, optimize and keep top  
jobs, pay and benefits. THE RULES OF THE GAME FOR  
A GAME WITHOUT RULES! From resume to CEO. \$29.



**PCB Artwork  
Made Easy!**

**PRINTED CIRCUIT DESIGN SOFTWARE**  
for  
**Layout - Autorouting - Schematic**

- \* Supports all Video Modes including SVGA
- \* Copper Flooding for Ground Areas
- \* Mirror Imaging for Laser Output
- \* Circuit Simulation Programs available
- \* **NEW - WINDOWS** m versions
- \* **NEW - DOS** versions
- \* **FREE** - Heat Transfer Film with Order
- \* Great for All Printed Circuit Projects

Download Demos from BBS (205)933-2954

**PCBoards Layout Only ... \$99.00**  
**Layout for Windows** m starts at ... **\$149.00**

Call or Write for Full Product Line, Prices & Demo Packages

**PCBoards** (800) 473-7227  
2110 14th Ave. South Fax (205) 933-2954  
Birmingham, AL 35205 Phone (205) 933-1122



## CABLE TV

**Universal Descrambler  
NEW PRODUCT**



**UNIVERSAL 5000 \$199.95**

Our fully assembled product is factory tested and  
**GUARANTEED** to work on your system.

**MODEL 4000 KIT \$ 79.95**

The 4000 KIT comes with all the electronic parts  
and our Cad designed PC board. We provide parts  
list, full schmatic, wiring diagram and tutorial.

**MODEL 4000A Enclosure \$ 44.95**

The 4000A Enc. Package will provide the hobbyist,  
who has our 4000 Kit, a custom enclosure, AC  
adaptor and finish accessories to enclose their kit.

## MODEL 4000 And 5000 Features

- The latest in Video Amplification Technology.
- New clocking circuits to stabilize color and picture performance.
- The most advanced picture locking circuitry.
- Inverted Video Option is available.
- **NO CONVERTER BOX** is necessary.

**The Halcyon Group 1-800-664-6999**

From Canada Call 1-508-643-4102

# PerformaHome™

## A \$3 Billion Market in '94 Voice Activated Home Automation

The ultimate in luxury, security, safety, convenience, and energy savings for new or existing homes! The ultimate business opportunity of the '90s!

- Huge Untapped Market
- Incredible Profit Potential
- Little or No Competition
- Protected Territories
- Unique Products
- Complete Training & Support
- Simple to Install and Use
- Free National Advertising
- No Experience Necessary

For Free Dealership Brochure & Tape  
Call 24 Hours

**1-800-94HOUSE**

(512) 263-5199 Fax (512) 263-5499

Complete Dealer Package From \$6900



Are you overpaying . . .  
. . . your cable company?

You are if . . .   
. . . you are leasing their equipment.

- Forest Electronics, Inc. offers a complete line of New Cable Decoders and Converters that are fully Compatible with your cable system.
- All systems come with: Remote Control, & Parental Guidance Feature. Volume Control is also available.
- All Equipment is fully guaranteed & comes with a 30 day money back option.

For More Information Call Us 24 Hours a Day At:

**800-332-1996**

FAX: 708-860-9048

## B<sup>2</sup> SPICE

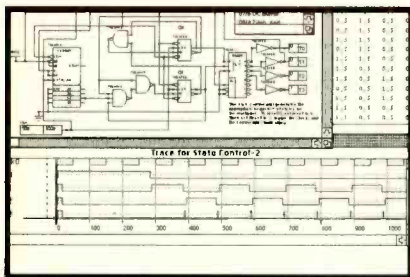

## B<sup>2</sup> LOGIC

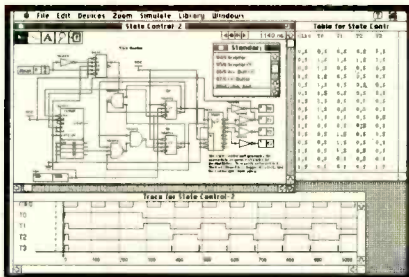

for windows™ and macintosh™

**B<sup>2</sup> SPICE v.1.1 \$149**

- Simulation: Transient, DC Operating Point, DC sweep, and AC sweep
- Library: MOSFETs, BJTs, JFETs, op amps, & many more
- Circuit analysis based on Berkeley SPICE
- Device & Model Property Editing
- Flexible Visualization of Results: customized graphs and tables

**B<sup>2</sup> LOGIC v.3.0 \$199**

- EDIF File Format Output
- Enhanced PLD Simulation Capture
- Subcircuit Probing
- Over 100 components available

**ELECTRONIC DESIGN PACKAGE \$269**

- Includes B<sup>2</sup> SPICE and B<sup>2</sup> LOGIC
- Demo Disks Available
- University & Student Prices Available
- Site Licenses Available
- Dealer Inquiries Welcome
- Visa/Master Card Accepted

## Why Design Circuits the Hard Way?

**B<sup>2</sup> SPICE v.1.1** and **B<sup>2</sup> LOGIC v.3.0** are the most powerful and affordable integrated analog and digital circuit design, simulation, and analysis packages available. B<sup>2</sup> SPICE and B<sup>2</sup> LOGIC neatly integrate the schematic editor, simulator, and graphics post processor. They are fully integrated and interactive and are extremely easy to use for **Windows™**, **Macintosh™**, and **Power Mac™**. Both B<sup>2</sup> SPICE and B<sup>2</sup> LOGIC are currently in use at over 100 major universities and many leading Fortune 500 companies such as The University of Michigan, Stanford, AT&T, General Electric, and Hewlett Packard, to mention a few!



**Beige Bag Software**  
2000 Hogback Road • Suite 2  
Ann Arbor • Michigan • 48105

**Phone** 313. 971. 4227  
**Fax** 313. 971. 3632  
**E-Mail** info@beigebag.com

# INSTEK Test & Measuring Instruments

## 20 MHZ, 2-Channel, OSCILLOSCOPE

- ▣ model #OS-622B
- ▣ 20MHz, Dual Channel
- ▣ High Sensitivity 1mV/DIV
- ▣ TV Synchronization
- ▣ Z axis input
- ▣ ALT Triggering Function
- ▣ Hold Off Function
- ▣ Trigger Level Lock Function
- ▣ CH 1 Output
- ▣ Includes Probes (x1, x10)
- ▣ 2 Year Warranty

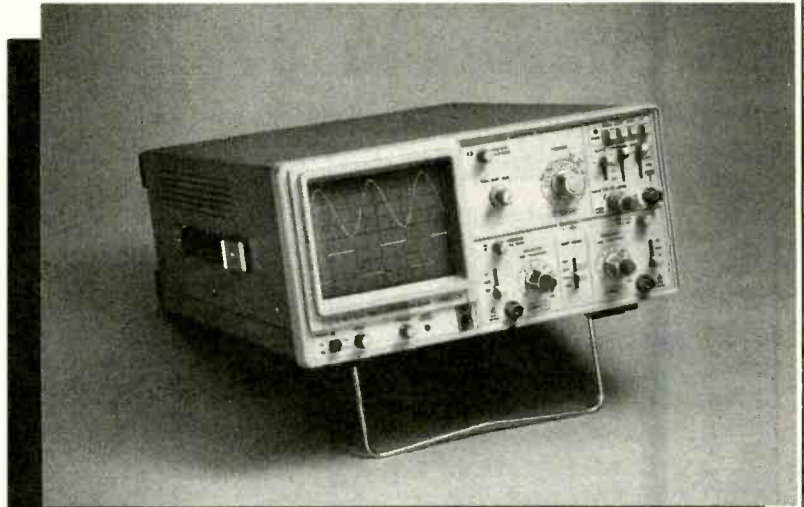

**Regular \$499.00 Sale \$389.95**

**PRINT™**  
Products International

**800-638-2020**



Test Instruments, Equipment, Tools & Supplies For Electronic Production, Maintenance & Service  
8931 Brookville Road, Silver Spring, MD, 20910 \* 800-638-2020 \* Fax 800-545-0058

CIRCLE 162 ON FREE INFORMATION CARD

## PIC Interactive Development Environments for the Microchip Technology, Inc. PIC family of microcontrollers. Microsoft Windows 3.1 MDI Applications

### MicroView™ Simulation Environment

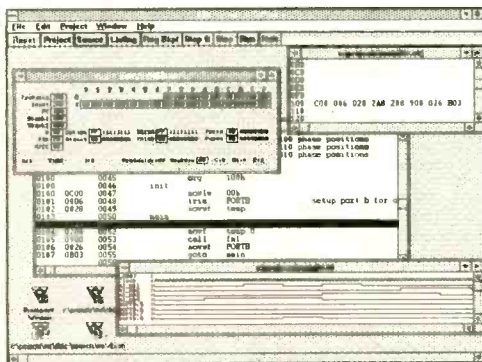

**MICROVIEW™** is a full-featured simulation environment for the Microchip Technology, Inc. PIC 16C5X microcontrollers. Other simulation engines available.

**Features:**

- Integrated Programming Editor, Macro-Assembler
- Simultaneous Multiple Device Simulations
- Graphical Timing Diagrams, Input Stimulus Generation
- Step, Register, Full Break Point Capability
- Direct Download to PICSTART. Compatible with PICMASTER, and the Parallax Downloader

### Assemble!™ Universal PIC Assembler

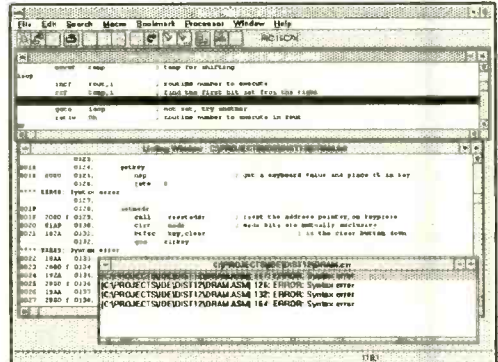

**ASSEMBLE!** is a universal macro assembler for the Microchip Technology, Inc. microcontrollers. Assemble! supports all of the Microchip device families.

**Features:**

- Integrated Programming Editor, Macro-Assembler
- Bookmarks, Macro Key Recording, Search and Replace
- Error Report, Listings, Context Sensitive On-Line Help
- COD File Format. INHX8S, INHX8M, INHX16
- Direct Download to PICSTART. Compatible with PICMASTER, and the Parallax Downloader

**MicroView™ \$149.95USD**

**VISA/MC**

**Assemble!™**

**\$99.95USD**

**VISA/MC**

TRISYS Send check or Money Order, VISA/MC Accepted, Company Purchased Orders Accepted, Shipping and Handling Included.



TRISYS, Inc. P.O. Box 11087 • Glendale, AZ 85318-1087 • USA • PH: (602) 581-1760 • FAX: (602) 516-0582

(PIC, PICMASTER, and PICSTART are trademarks and tradenames of Microchip Technology, Inc., Parallax is the tradename of Parallax, Inc.)



CIRCLE 163 ON FREE INFORMATION CARD

Low Cost CAD Software  
for the IBM PC and Compatibles  
Now In Windows™

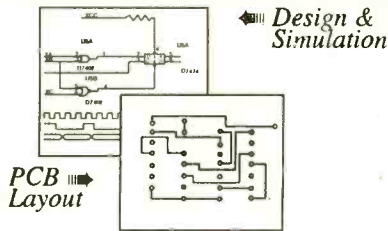

- Easy to use schematic entry program (SuperCAD) for circuit diagrams, only \$149. Includes netlisting, bill of materials, extensive parts libraries, More parts, and automatic wiring available in enhanced CAD package (SuperCAD+) for only \$249.
- Powerful, event-driven digital simulator (SuperSIM) allows you to check logic circuitry quickly before actually wiring it up. Works directly within the SuperCAD editor from a pulldown menu and displays results in "logic analyzer" display window. Starting at \$149 this is the lowest cost simulator on the market. Support for PALs, a larger library, and a separate interactive logic viewer are available in full-featured SuperSIM+ for only \$399. Library parts include TTL, CMOS and ECL devices.
- Circuit board artwork editor and autorouter programs (SuperPCB), starting at \$149. Produce high quality artwork directly on dot matrix or laser printers. You can do boards up to 16 layers including surface mount. Includes Gerber and Excellon file output. Autorouter accepts netlists and placement data directly from the SuperCAD schematic editor.
- Low cost combination packages with schematics and PCB design: 2-layer for \$399, 16-layer for \$649.
- DOS version available.

Write or call for free demo disks:  
**MENTAL AUTOMATION**  
5415 - 136th Place S.E.  
Bellevue, WA 98006  
(206) 641-2141  
BBS (206) 641-2846

## SHOW TIME CABLE

Your Cable  
Connection  
To The Stars!

Order your **FREE**  
catalog today!  
**1-800-643-4258**



### STARGATE SST

- Converters & Descramblers
- All Makes & Models
- Quantity Discounts
- 30-day Money Back Guarantee
- Best Warranties

Show Time Cable  
643 N 98th St STE 260  
Omaha, NE 68114

COD • MasterCard • Visa • Amex • Discover

## Think you have all the tools ?..., What about the ***ELECTRONIC DATA BOOK***

**FINDER MDS** is a **New Electronic Components Data Base**  
software especially designed for Engineers, Repair companies, Students and Hobbyists.

**32,000** components with their data sheets, **283,000** IC's substitutions, more than **9,000** pages of information, **15** families of components, **Thousands** of equivalences for Transistors, Diodes and MosFets, more than **500** package designs, **12 Mb** of Technical information.

### FEATURES

Searching for components by Name, Function or Characteristics - Customizable search forms - User friendly Interface - Graphic and Text Editors included - Ultra fast search - Information can be add to any component - Technical forms similar to Manufacturer's Data Books - Printout facilities - Technical forms can be exported to any word processing software - Custom data base to add your own components.

*FINDER MDS runs on IBM PC/AT or compatible with 1 Mo RAM, HD, EGA/VGA display, DOS 3.1 min.*

**FINDER MDS 5.0 - Now only \$ 149.95** (S&H charges not included)

To order call : **1 (800) 279 0393**

**Electronics Software Solutions**

**3025 N. Ocean Blvd - Fort Lauderdale - FL 33308 - Tel (305) 561 4340 - Fax (305) 561 4418**

Enter A World Of Excitement with a Subscription to

# Popular Electronics®

Get the latest electronic technology and information monthly!

Now you can subscribe to the magazine that plugs you into the exciting world of electronics. With every issue of Popular Electronics you'll find a wide variety of electronics projects to build and enjoy, and feature articles that inform and entertain.

Popular Electronics brings you feature articles on technology, computers, test gear, and more—all designed to keep you tuned into the latest developments in electronics. So if you love to build fascinating projects, just fill out the subscription form below to subscribe to Popular Electronics. . . It's a power-house of fun for the electronics enthusiast.

## EXCITING MONTHLY FEATURES LIKE:

- CONSTRUCTION**—Exciting projects that range from simple radios to working robots
- FEATURES**—Learn about new technology, see how to troubleshoot all types of electronics gear, refresh your knowledge of basic electronics theory, see how components work and how to use them in your own designs, and much more
- PRODUCT REVIEWS**—Get in depth, hands-on reviews of all types of hobby gear, and learn about the latest and the greatest in consumer electronics in our no-holds-barred Gizmo section
- SPECIAL COLUMNS**—Think Tank, Circuit Circus, Computer Bits, DX Listening, Antique Radio, Scanner Scene, Amateur Radio, Multimedia Watch, and more

## PLUS: ALL OUR GREAT DEPARTMENTS!

You'll get 12 exciting and informative issues of Popular Electronics for only \$18.95. That's a savings of \$23.05 off the regular single copy price. Subscribe to Popular Electronics today! Just fill out the subscription order form below.

**AUTOMOTIVE ELECTRONICS FOR THE 21ST CENTURY**  
June 1995

# Popular Electronics

**Build a Radar Speed Gun**  
It works just like the ones used by the police

**Simple PC Upgrades You Can Do**  
Adding hard- and floppy-disk drives

**Build the Sun Tracker**  
Get the most out of solar-power gear

**Build an 8-Channel A/D Converter**  
The cheap and easy way to get analog data into your PC

**Plus:** Computer Bits, Ham Radio, Scanner Scene, Circuit Circus, and More!

\$3.50 U.S.  
\$4.95 CAN.

FOR FASTER SERVICE CALL TODAY

**1-800-827-0383**

(7:30AM-8:30PM) EASTERN STANDARD TIME

## Popular Electronics' SUBSCRIPTION ORDER FORM

APEG5

P.O. Box 338, Mt. Morris IL. 61054

**YES!** I want to subscribe to Popular Electronics for 1 Full year (12 Issues) for only \$18.95. That's a savings of \$23.05 off the newsstand price.

(Basic Subscription Rate—1 yr/\$21.95)

Payment Enclosed  Bill me later

Please charge my:  Visa  Mastercard

Acct. #

Signature

Exp. Date

PLEASE PRINT BELOW:

NAME

ADDRESS

CITY

STATE

ZIP

Allow 6 to 8 weeks for delivery of first issue. U.S. Funds only.

In Canada add \$6.68 Postage (Includes G.S.T.).

All Other Foreign add \$7.50 Postage.

# IF You Service Electronics

## MCM Electronics™ Is The Only Source You'll Ever Need

We understand the needs of today's service professional. Wide selection, fast delivery and competitive prices are vital to the survival of your business. For over 15 years MCM has provided all three. Our 324 page catalog is packed with over 21,000 items including Test Equipment, Semiconductors, Chemicals, Tools, Computer Products, TV/VCR Parts and much more. Deep inventories enable not only competitive pricing, but rapid delivery. Over 99% of all orders are shipped within 24 hours. One call puts all of this at your fingertips. Call today for your free catalog and you'll discover... MCM is your #1 source.



FREE 324 Page Catalog:

# 1-800-543-4330

Product questions ... 1-800-824-TECH(8324)



**MCM ELECTRONICS<sup>SM</sup>**  
650 CONGRESS PARK DR.  
CENTERVILLE, OH 45459-4072  
A PREMIER Company

Hours: M-F 7a.m. - 9p.m.,  
Sat. 9a.m. - 6p.m. EST

GET FAST DELIVERY FROM OUR DISTRIBUTION CENTERS IN DAYTON, OH AND RENO, NV!

POP-20

CIRCLE 160 ON FREE INFORMATION CARD

## CONTROL

RELAYS • LIGHTS • MOTORS

## MEASURE

TEMPERATURE • PRESSURE • LIGHT LEVELS • HUMIDITY

## INPUT

SWITCH POSITIONS • THERMOSTATS • LIQUID LEVELS

MODEL 30 ..... \$79



- PLUGS INTO PC BUS
- 24 LINES DIGITAL I/O
- 8 CHANNEL- 8 BIT A/D/IN
- 12 BIT COUNTER
- UP TO 14K SMP/SEC

MODEL 45 ..... \$189



- RS-232 INTERFACE
- 8 DIGITAL I/O
- 2 ANALOG INPUTS
- 2 ANALOG OUTPUTS
- 2 COUNTERS-24 BIT

MODEL 100 ..... \$279

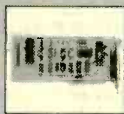

- 12 BIT 100 KHZ A/D
- 4 ANALOG OUTPUTS
- 3 TIMER COUNTERS
- 24 DIGITAL I/O

MODEL 150-02 ..... \$179



- RS-232 INTERFACE
- TRMS, 20 AMPS
- 12 BIT A/D
- OPTO-ISOLATED
- COMPLETE DMM

MODEL 40 ..... \$99



- RS-232 INTERFACE
- 28 LINES DIGITAL I/O
- 8 ANALOG INPUTS
- PWM OUTPUT

MODEL 70 ..... \$239



- RS-232 INTERFACE
- 18 BIT A/D
- 5.5 DIGIT
- UP TO 60 SMP/SEC

## Prairie Digital, Inc.

PHONE 608-643-8599 • FAX 608-643-6754  
846 SEVENTEENTH STREET • PRAIRIE DU SAC, WISCONSIN 53578

## PROTOTYPE PC BOARDS!

Made in USA!

only \$595!

\*free CAD/CAM

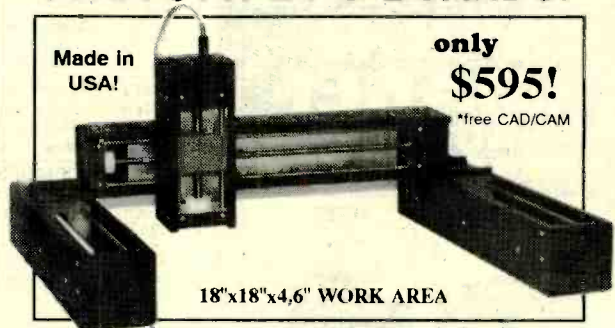

18"x18"x4.6" WORK AREA

### THIS IS THE MACHINE YOU'VE BEEN WAITING FOR!

Have you ever dreamed of letting your computer prototype PC boards directly from your CAD drawings? If so, the Neuractor CNC-4+ Desktop Manufacturing System may be just the machine you need! This fourth-generation CNC machining center can automatically drill, mill and route printed circuit boards, not to mention three-dimensional products in wood, plastic and light metals DIRECTLY FROM YOUR CAD DRAWINGS! You've seen the rapid-prototyping and "Santa Claus" machines that cost thousands of dollars, but did you know that as an electronic technician you can assemble one yourself from this inexpensive kit? Utilizing patent pending technology the Neuractor CNC-4+ kit provides you with everything you need to machine products in three dimensions with a resolution of .001". All-mechanical components are pre-fabricated, pre-machined, plated and painted. Includes four 83 oz/in digital CY-MOTORS, interface card, 5 amp power supply, 10 pitch steel lead screws, 4 proprietary Slide Block actuator mechanisms, 4 aluminum linear actuator channels, polished steel guide-rods, Dremel bracket, hardware, etc. (You provide Dremel MotoTool(tm) or flex-shaft router and work surface.) It's a complete kit! All you do is put it together and calibrate it! IF THAT'S NOT ENOUGH, WE'RE THROWING IN A FREE FULL-FEATURED 3D CAD/CAM SOFTWARE PACKAGE WITH EACH UNIT! Large 18"x18"x4.6" cutter travel directly from CAD-generated or scanned ASCII, DXF & HPGL plot files!. Get started by ordering your own Neuractor CNC-4+ today! ACT NOW! Kit \$595 + \$24.95 S/H. (For PC board routing the heavy-duty upgrade is suggested, add \$149) Allow 4-8 weeks for del. U.S. CYBERLAB, 14786 Slate Gap Rd., West Fork, AR 72774 (501) 839-8293.

Free info! X-Y Power/Rotary Tables and larger CNCs now available!

Enter No. 47 on Reader Service Card

P.O. Box 421, Batavia, OH 45103

Educational Kits for the Serious Hobbyist

### Caller Block

Connects between your telephone and its wall jack, and prevents the phone from ringing unless the calling party is one which you've entered into memory using your touch-tone phone. Your answering machine can handle all other calls. Change between two separate directories of callers with a simple flip of a switch. \$46.00

### Telephone Caller ID

Connects to telephone wall jack. Shows the telephone number of the calling party along with the time of day the call was received, on a 16x1 character LCD display. Stores the info from the last five calls in memory. Complete stand alone, no computer interface needed. \$52.50

### Telephone Call Restrictor

Connects to telephone wall jack. Disables all phones on the line if attempting to either: dial a number that has been stored in memory "Block Mode" or, dial a number that has not been stored in memory "Allow Mode". Use touch-tone phone to enter telephone numbers into memory, and choose mode. Program from any phone on the line using your password. \$35.00

### 50 MHz Frequency Counter

Reads frequency from 1Hz to 50MHz and displays it on a 16x1 character LCD display. Auto-range feature provides floating decimal point and automatically affixes the correct suffix (Hz, KHz, or MHz). Microcontroller based, very few additional components. \$46.50

### Telephone Scrambler

Scrambles your voice before sending it over the telephone line, and descrambles it on the other end. Connects between your telephone and wall jack. No modifications are required to your telephone. Full duplex operation. \$43.00

### Electronic Message Module

Use a set of four pushbutton switches to write and store your own personal message in a 8-pin non-volatile EEPROM, which can then be printed across a 16x1 LCD display. Message can be up to 240 characters long. EEPROM can be removed from socket and still retain message. Re-program over and over with new messages. \$44.50

### Vocal Filter

An audio device which can be used with a home component stereo system, to filter out the main vocal sound track from standard stereo recordings (CD, tape, record or FM), leaving the background music to sing along with. Produce your own karaoke tapes. \$40.00

### DTMF Decoder/Logger

Keep track of all numbers dialed from any telephone on your line. Connects to your telephone wall jack. Decodes all 16 touch-tones and displays them on a LCD display. Holds the last 240 digits in a nonvolatile memory. Use the "shift back" and "shift forward" buttons to scroll through and view all numbers in memory. \$54.50

## Cable Test Aids Information

Test chips for JERROLD, TOCOM, ZENITH, S.A. & more. Puts cable boxes in full service mode. Easy installation. Zenith only \$39.95. Most others under \$50ea. FAX: (310)902-0851. Quantity prices available. No Ch. mikes. Not for use in cable co. wood equip. For use on a test aid only.

## PE MARKET CENTER CLASSIFIEDS

### MISCELLANEOUS ELECTRONICS FOR SALE

**THE CASE Against Patents.** Thoroughly tested and proven alternatives that work in the real world. \$28.50. SYNERGETICS PRESS, Box 809-C, Thatcher, AZ 85552. (520) 428-4073. Visa/MC.

**TURBO CHARGE your amplifier.** Guide to increase wattage of existing power amplifiers. Send \$7.50 for complete book. JAM Electronics, 7391 St. Hwy 78, Gratiot, WI 53541.

**CATV TEST CHIPS** for testing converter boxes in full service mode. Jerrold, Tocom, Scientific Atlanta, Zenith, Pioneer. Descramblers clears E2-E5 Micro Masters, 1 (800) 360-7654 PST.

**REMOTE CONTROL** miniature encoded transmitters and receivers. Send for free catalog to: Inventive Solutions, PO Box 8, Stratford, NY 13470.

**TESLA COIL** parts, enameled wire, secondary coils, more. Catalog \$1.00. K&D Electric, PO Box 659, Newcastle, OK 73065.

### CABLE TV

**"BULLET" BUSTER.** Protect your cable box against the infamous cable "bullet." The "Bullet" Buster acts as an electronic shield. Installs in-line in seconds. Don't wait until it's too late! \$19.95 + \$3.00 S&H. Visa/MC. ELECTROMAN, Box 24474, New Orleans, LA 70184. (504) 482-3017.

**CABLE — SAFE.** Guarantee cable privacy. The one way valve for your cable TV signal. Cable signals come in, but they don't go out! \$29.95, + \$3.00 S&H. Visa/MC. ELECTROMAN, Box 24474, New Orleans, LA 70184. (504) 482-3017.

**DESCRAMBLER SCHEMATICS REVEALED.** A powerful guide to descrambling schemes. \$10.00. Visa/MC. ELECTROMAN, Box 24474, New Orleans, LA 70184. (504) 482-3017.

**CABLE UNSCRAMBLED.** Everything you want to know about cable, but are afraid to ask. \$10.00. Visa/MC. ELECTROMAN, Box 24474, New Orleans, LA 70184. (504) 482-3017.

**UNIVERSAL DESCRAMBLER.** Unscramble signals using your VCR as the tuner. Works with virtually any system, this is the only one you need. Declare cable box independence! \$129.95 + \$5.00 S&H. Visa/MC. ELECTROMAN, Box 24474, New Orleans, LA 70184. (504) 482-3017.

**ATTN. CABLE** box owners. Get your Bullet and ID stopper before it's too late. Send \$20.50 to R.R. Enterprise, Box 3532, Easton, PA 18043.

**CABLE DESCRAMBLING, New secret manual.** Build your own descramblers for cable and subscription TV. Instructions, schematics for SSAVI, gated sync, sinewave, some free methods (HBO, Cinemax, Showtime, UHF, Adult) \$12.95, \$2.00 postage. CABLETRONICS, Box 30502PE, Bethesda, MD 20824.

**OWN YOUR cable box or ZAP IT!** Quality products. Money back guarantee. 1-year warranty. Toll free: 1 (800) 899-9707.

### MISCELLANEOUS ELECTRONICS WANTED

**TEST EQUIPMENT WANTED.** I will buy your late model test equipment, electronic components, commercial and military connectors. Small quantities or entire inventories. Bob Morgan, Test Equipment Sales, Ph/Fx (717) 842-1534.

## IMPROVE YOUR IMAGE! WITH OUR VIDEO STABILIZERS

BEFORE



AFTER



**SUPER VHS MODEL AVAILABLE!**

The clearest picture possible playing back movies. **GUARANTEE** to eliminate copy protection.

- No Rolls/Jitters/Flickers/Fading
- Works on all TV's, VCR's Beta & Cable
- Gold Video Connectors & Cables Included
- 2 Year Warranty
- Money Back Guarantee



## VISION ELECTRONICS

1-800-562-2252

2125 S. 156TH CIRCLE • OMAHA, NE 68130

### Quality Microwave TV Antennas

**WIRELESS CABLE - IFTS - MMDS - Amateur TV**  
Ultra High Gain 50db(+). Tuneable 1.9 to 2.7 Ghz.  
• 55-Channel Dish System \$199.95  
• 36-Channel Dish System \$149.95  
• 20-Channel Dish System \$124.95  
• Optional Commercial Grid Antenna (not shown) Add \$50.00  
• Yagi Antennas, Components, Custom Tuning Available  
• Call or write (SASE) for "FREE" Catalog

**PHILLIPS-TECH ELECTRONICS**  
P.O. Box 8533 • Scottsdale, AZ 85252  
(602) 947-7700 (\$3.00 Credit all phone orders)  
MasterCard • Visa • American Express • COD's • Quantity Pricing

### SECURITY

**HI-TECH. ELECTRONICS.** The best for less, (spy, security, laser), catalog \$5.00 postage. F & P Enterprises, Box 51272, Palo Alto, CA 94303-A.

### EDUCATION

**LEARN IBM PC ASSEMBLY LANGUAGE.** Disk \$5.00, Book \$18.00. ZIPFAST, Box 12238, Lexington, KY 40581-2238.



# Learn MICROCONTROLLERS EMBEDDED SYSTEMS and PROGRAMMING with the New AES-10

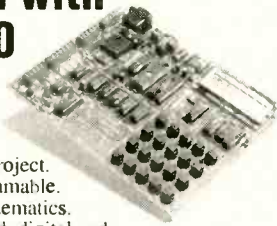

The AES-10... a complete learning system, a complete embedded control system. Extensive manuals guide you through your 8051 development project. Assembly, BASIC, and C programmable. All hardware details, complete schematics. Learn to program the LCD, keypad, digital and analog I/Os. The entire board is software reconfigurable for your applications. Everything you need, nothing extra required.

### 80C32 Computer/Microcontroller board with:

- 32K Byte ROM , 32K Byte RAM • 2 by 16 Liquid Crystal Display • 4 by 5 Keypad • Two serial ports • 5 interrupt sources • 3 timers • A/D , D/A, PWM and digital I/O • Built in Logic Probe • Power supply (can also be battery operated) • Extended Intel BASIC and AES Monitor in ROM • RS-232 cable to connect to PC for programming • 8051/52 DOS Cross Assembler • Program disks with well documented examples • User's Manual, Language Manual, and Text (over 400 pages).

AES-10 \$285 Complete  
Money Back Guarantee

Free Info Pack, M/C Visa  
714 - 550-8094  
Fax 714 - 550-9941



**CALL 1 - 800 - 730-3232**

Advanced Educational Systems  
970 W. 17th St., Santa Ana, California, 92706 USA

Tap into a World of...

## FREE ELECTRICITY

Our 150+ page *Self-Reliance Catalog*  
IS JUST LOADED WITH DC to AC  
ENERGY INDEPENDENCE ...

We offer:

- Solar, Wind & Hydroelectric energy systems. True Sine Wave DC to AC Inverters.
- Electric Boat & Car kits.
- Portable power packs.
- Solar Lighting & Cooling systems. Solar Pool Heaters.
- Solar Battery chargers. Solar Books & Toys. DC Appliances.
- Active & Passive Solar Air & Water Heating Systems.
- Composting Toilets. Hydroponic, Fish-Farming, Solarium & Greenhouse Systems. Water Testing, Treatment, & Pumping Systems.
- Emergency Food & H<sub>2</sub>O Kits. High Efficiency AC/DC Refrigeration + More...

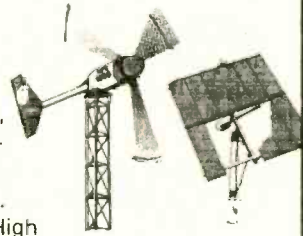

A LOT OF INFORMATION FOR ONLY \$5.75 ...

SEND CHECK or MO TO:

*Self-Reliance Company Inc.*

**P.O. Box 306, Florissant, MO 63032**

# Cellular Programming Software

## \$\$ BLOW OUT PRICES \$\$

### WE'LL BEAT ALL COMPETITORS' ADVERTISED PRICES

- |  |   |
|--|---|
| <b>MOTOROLA</b> .....                    | ABOVE 9122 ALLMODELS SOFTWARE OR LOADER FROM \$395.00               |
| <b>NOKIA &amp; TECHNPHONE</b> .....      | 100 - 101 - 121 - 201 - 400 - 405 - 415 - 515 — TANDY MODELS        |
| <b>NEC</b> .....                         | P100 - P110 - P120 - P180 - P400 - P600 — ATT3610                   |
| <b>PANASONIC</b> .....                   | ALL PORTABLES HP600 - HH700 - HH900 - EBH30 - EBH40 - EBH50 - EBH60 |
| <b>GE &amp; ERICSSON</b> .....           | HOTLINE - POCKET II - MICROPORTABLE - AH97 - AH98 - CT100 - CT700   |
| <b>MITSUBISHI &amp; DIAMONDTel</b> ..... | 3500 - 4500 - 20X - 22X <b>SONY</b> ..... CMR - 111 - 333           |

### MOTOROLA SOFTWARE TO REPAIR LOANER AND OOFFFFF

**ALL PRODUCTS ARE IN STOCK  
SHIPPED OVERNIGHT UPS/COD**

# CELLSOFT®

**609-751-2242 Ext 2**

**FAX 609-751-5549 • FREE TECHNICAL SUPPORT**

## CopyCat®

No PC — No Loaner  
Only 10 Seconds  
Programs & Repairs  
Complete with Cables

\*\*\*  
All Motorola Including  
Digital - Analog - All Versions  
\*\*\*  
Models Available from \$2300.00

\*\*\*  
Sony - Ericsson - Panasonic  
Audiovox - NEC - Mitsubishi  
Dimontel - GE - Uniden



# CABLE TV DESCRAMBLER KITS

## Universal-New Product

This Product includes all the Parts, PC Board, Complete Schematic with Functional Guide. Generates Sync for most Video Applications.

**\$79.95**

## Tri-Mode Descrambler

This product includes all the parts PC Board and AC Adaptor. NO Enclosure included.

**\$59.95**

## SB-3 Descrambler

This Product includes all the Parts, PC Board and AC Adaptor. Enclosure is not included.

**\$44.95**



**Call Toll Free 1-800-886-8699**

**M & G Electronics, P.O. Box 3310, No. Attleboro Mass. 02761**



Anyone implying theft of Cable service will be denied assistance.

NO MASSACHUSETTS SALES!

## PE MARKET CENTER CLASSIFIEDS

### CABLE TV EQUIPMENT

We carry a complete line of all major brands including test chips and all accessories  
**BELOW WHOLESALE PRICES • QUANTITY DISCOUNTS**  
**30 DAY MONEYBACK GUAR. • 1 YR. WARRANTY**  
**YEARS OF CUSTOMER SATISFACTION**  
**C & C ELECTRONICS**  
**CALL NOW 1-800-995-1749**  
*Immed. Delivery from Giant Stock! Sorry no Florida Sales.*

### Prototype it..... FAST!

with ProtoQuick 8051 or 28

- Complete single board computers
- Up to 32K EPROMs and 64K RAM
- 12 80 in plated through proto. area
- RS232 C serial port w/ 0825 conn.
- Op. sys. in EPROM w/ source code
- Assembly ready to run - 5v only
- MS-DOS 2.033 assembly included

**ProtoQuick 28 and 8051**  
**\$99.00 each**

Software Science  
 3750 Roundstone Road  
 Cleveland, OH 44134  
 (513) 561-2060

Run prototype applications or experimental hardware from the serial port - WITHOUT PROGRAMMING!

### PLANS-KITS-SCHEMATICS

**BUILD — FIVE-digit, ohms, capacitance, frequency, pulse, multimeter. Board and instructions \$9.95. Bagnall Electronics, 179 May, Fairfield, CT 06430.**

**ALL-IN-ONE catalog. AM/FM/ham/spy, transmitters, amplifiers, receivers. Voice scramblers/disguisers, audio, TV, Tesla coils, plans, "secret" books, kits, imports, exports and more. Start your own licensed or unlicensed radio station, 60 full pages for \$1.00. PAN-COM INTERNATIONAL, PO Box 130-H7, Paradise, CA 95967.**

**FM STEREO TRANSMITTER** kit broadcasts any audio signal to FM stereo radios throughout your home. Uses unique BA1404 IC. Complete kit: PC board/components — \$24.00. Visa/MC. **TENTRONIX, 3605 Broken Arrow, Coeur d'Alene, ID 83814. (208) 664-2312.**

**HOBBYIST CIRCUITS — Remote room monitor, tone decoder, long distance circuit control and more. Simple experiments for the beginner. CAT-ALOG \$2.00 — Garrett Plans, Box 155, Jamesburg, NJ 08831.**

**SURVEILLANCE TRANSMITTER kits. 65 to 305 MHz. Quick & Easy. Partially assembled units. Five minutes completion. 110-volt duplex receptacle, room battery types, and telephone. Counter-surveillance. Catalog: \$2.00. SHEFFIELD ELECTRONICS, PO Box 377940-B, Chicago, IL 60637-7940.**

**CRYSTAL SET Handbook — Visit antiquity by building the radios your grandfather built. Assemble a "Quaker Oats" rig, wind coils that work and make it look like the 1920's! Only \$10.95 plus \$4.00 for shipping and handling. CLAGGK Inc., PO Box 4099, Farmingdale, NY 11735. US funds only! USA and Canada — no foreign orders.**

**SCHEMATICS, PARTS, equipment — can't find? Arnold Enterprises, 1218 Dandridge Drive, Lynchburg, VA 24501.**

**CIRCUITS! CIRCUITS! The very best in plans, kits, schematics, and books. Too many to list. Satisfaction guaranteed! Send for free listing. HOBBYTECH, Dept. PE1, 1748 SE Alder, Hillsboro, OR 97123.**

**UNBELIEVABLE! MICRO 1.5V FM transmitter kit. Reg. \$39.95, now \$12.00! HURRY! RJJ, Box 6555 Stn. D. London, Ontario N5W 5S5 Canada.**

**YOU WON'T** be caught flashing with **SILENT SAM**. Patented vehicle turn signal reminder warns when not to. See PE's Apr. '95 Hands-On Report. Call toll free 1 (800) 398-5605 Visa/MC. Kit w/case \$15.00, \$22/\$27.00 wired models, plus \$2.50 P&H. Flyer: 1627 Basil Dr., Columbus, OH 43227.

**NIGHT VISION kits!** Build a night vision scope with our easy to assemble, complete kits. Save \$! Our best scopes are capable of 0.0005 lux! U.S. made image intensifiers, I.R. tubes, etc. Great for astronomy, science projects or any nocturnal activity. We also sell a complete line of brand name U.S. and foreign units to suit any need. North East Night Vision Supply, PO Box 1088, 320 Main Street, Sturbridge, MA 01566. Ph/Fax (508) 347-7238.

### SATELLITE EQUIPMENT

**SATELLITE RADIO BOOK AND GUIDE.** New book covers all audio services, SCPC, subcarriers, FM squared, facsimile, press services, weather services. Simple how-to-receive instructions. \$16.95 plus \$3.00 Priority Mail. **UNIVERSAL ELECTRONICS, 4555 Groves Road, #12, Columbus, OH 43232. (614) 866-4605.**

**VIDEOCYEPHER II descrambling manual.** Schematics, video and audio. Explains DES, EPROM, CloneMaster, Pay-per-view (HBO, Cinemax, Showtime, Adult, etc.) \$16.95, \$2.00 postage. Schematics for Videocypher Plus, \$20.00. Schematics for Videocypher 032, \$15.00. Collection of software to copy and alter EPROM codes, \$25.00. VCII Plus EPROM, binary and source code, \$30.00. **CABLETRONICS, Box 30502PE, Bethesda, MD 20824.**

**LOWEST PRICES.** Shop around, call us last. Free price list. 43 years in business. **ANTENNA KING, 6502 6th Ave., Bayridge, NY 11220. 1 (800) 814-5377. International (718) 745-8200. Fax (718) 921-3900.**

### AUDIO-VIDEO-LASERS

**LASERS, LIGHTSHOWS, Holography.** Lowest prices. For free catalog write: Midwest Laser Products, PO Box 2187, Bridgeview, IL 60455. Or call: (708) 460-9595.

### !!! BROADCAST FARTHER !!!

The model 1525 is a 75-110MHz RF amplifier that connects to mono or stereo FM transmitters and produces a powerful 15-20 watt signal which could broadcast up to 5 miles or more! Requires 75-250 mW drive.  
 Step by step plans complete with part source information and antenna designs... **ONLY \$14 PLUS \$2 S&H NO C.O.D.'S**

**Progressive Concepts**  
 1434 N. MILLS AVE., SUITE A  
 CLAREMONT, CA 91711 (909) 626-4989

Software Science  
 3750 Roundstone Road  
 Cleveland, OH 44134  
 (513) 561-2060

### SURVEILLANCE & COUNTERSURVEILLANCE Electronic Devices

Hidden Video Cameras • Electronic Kits • Voice Changers  
 Bug and Phone Tap Detectors • Shotgun Mics • Micro Recorders  
 • Vehicle Tracking • Locksmithing • AND MORE!

**Extra Long Play Telephone Recorders - Silently Tapes Incoming/Outgoing Phone calls automatically... \$125.00 and up**

**SDY FOR CATALOG SEND \$5.00 TO...P.O. Box 337, BUFFALO, NY 14226 (716) 691-3476 - (716) 695-8660**

# DC/CAD

introducing...

## THE TERMINATOR

Super High Density Router  
(Complete with Schematic & PCB EDITOR)

Features the following powerful algorithm & capability:

- Rip - up and Retry
- Pre-routing of SMT components
- Real-Time via minimization
- Real-Time clean up passes
- User defined strategies
- Window 3.0 capability as DOS Task
- 1-mil Autoplacer and Autopanning
- Two-way Gerber and DXF
- Automatic Ground Plane w/ Cross-Hatching
- Complete w/ Schematic & Dolly Libraries
- Optional simulation capability & protected mode for 386 users

Call for  
**DC/CAD - \$95**  
(available for students only)  
normal price range  
**\$295 - \$2500**

\* PCB LAYOUT SERVICE AT LOW COST \*

LEASE PROGRAM & SITE LICENSE AVAILABLE



Design  
Computation

1771 State Highway 34  
Farmingdale, NJ 07727  
(908) 681 - 7700 • (908) 681 - 8733 (FAX)

"DC/CAD . . . The focal point of future CAD market"

## CABLE T.V. EQUIPMENT

Friendly, Knowledgeable Service



**ORDERS CALL:**  
**1-800-361-4586**

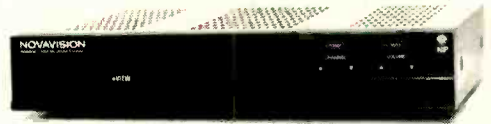

- All Equipment New
- Convertors & Descramblers
- 30 Day Money Back Guarantee
- 6 Month Warranty
- Visa, MC, C.O.D. Welcome

**KDE ELECTRONICS, INC.**

P.O. Box 1494  
Addison, IL 60101  
Info. 708-889-0281  
Fax 708-889-0283

# Electronics made Easy with UCANDO

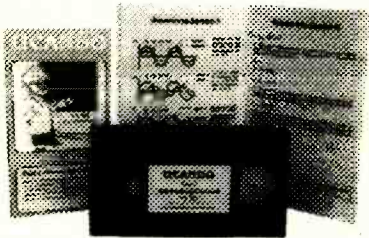

UCANDO's unique computer animation makes learning electronics fast and easy. These videos will...allow you to learn at your own pace...help you remember more of what you learn ... give you years of quality use... become a valuable source of reference material...make your understanding of electronics complete ... and help you build your future today. Call today and see how UCANDO is...

**"Changing The Way The World Learns Electronics."**

**New Release!!!**

VT102 Introduction to VCR Repair ...	\$44.95
VT103 VCR Maintenance & Repair ...	\$29.95
VT201 Direct Current .....	\$44.95
VT202 Alternating Current .....	\$44.95
VT203 Semiconductors .....	\$44.95
VT204 Power Supplies .....	\$44.95
VT205 Amplifiers .....	\$44.95

**VT405 TV Part 2 "The Front End" ..... \$44.95**

VT206 Oscillators ....	\$44.95	VT401 AM Radio .....	\$44.95
VT301 Digital 1 .....	\$44.95	VT402 FM Radio Part 1 .....	\$44.95
VT302 Digital 2 .....	\$44.95	VT403 FM Radio Part 2 .....	\$44.95
VT303 Digital 3 .....	\$44.95	VT404 TV Part 1 "Intro to TV" ..	\$44.95
VT304 Digital 4 .....	\$44.95	VT501 Fiber Optics .....	\$44.95
VT305 Digital 5 .....	\$44.95		
VT306 Digital 6 .....	\$44.95		

**SAVE!!! Buy any 6 videos for only \$240 ... SAVE MORE!!! Buy any 12 videos for only \$450**

**MONEY BACK GUARANTEE! Call for details.**

**Call toll-free 1-800-678-6113**

or mail check or money order to:

UCANDO Videos, P.O. Box 928, Greenville, OH 45331

**FREE Shipping ... FREE Catalog**



# BLACK FEATHER ELECTRONICS

## 3 1/2 Digit LCD Panel Meter

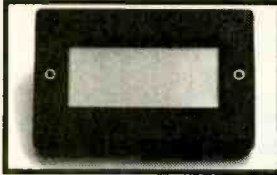

Features: 200mV full scale input 9VDC operation. Decimal point selectable. 13mm digit height, auto polarity indication, zero reading for 0 volt input. Measures 2.67" x 1.73" x 0.28" above panel thickness, 0.57" overall thickness. LCD size: 1.83" x 0.8". Has many useful applications and is easy to install.  
CAT# PM-1 **\$17.00 each**

## Stepper Motor Controller Kit



This kit allows you to adjust the speed and direction of a stepper motor. You can move the motor in one step increments or rotate it at a constant speed. Visual indicators show the sequence of motion. Includes stepper motor, pc board, parts and instructions. (12vdc power source not included.)  
CAT# SMK-1 **\$25.00 each**

## Camcorder Video Tape



HI-8 120 MINUTE TAPE (used)  
They were recorded on once and played only a few times. Made by a major brand name manufacturer. Professional series metal tapes. Includes plastic jewel box.  
CAT# CCT-1 **\$3.00 each**  
**10 or more - 2.80 each**

**1-800-526-3717**

645 Temple 78 ▲ Long Beach ▲ California 90814  
▲ (310) 434-5641 ▲ FAX (310) 434-9142 ▲

1. California residents must include sales tax.
2. Checks and money order accepted.
3. Quantities limited - prices subject to change.



**Black Feather  
ELECTRONICS**



One tree can make  
3,000,000 matches.



One match can burn  
3,000,000 trees.



A Public Service of This Magazine  
& The Advertising Council

## New Jerrold "Descrambler"!

**Only \$69.95!**

(plus \$8 S&H)

**30 Day Warranty!**

Wireless command the  
Jerrold box you rent to  
descramble ALL channels!  
So small, it fits in the  
palm of your hand!

Works on DP5, DPV5, DP7,  
DPV7, DPBB, CFT models.

Jerrold & SA 8600 test  
chips also available.

**Order Toll Free 24 hrs  
1-800-417-6689**

VISA/MC/DISC, MO & COD

Do not use these devices without authorization  
from your local cable company.  
No GA & TN sales.



Video #TEL-002



Video #TEL-003

- Learn how to repair today's electronic communication equipment and SAVE big \$\$\$\$ by repairing it yourself!!!
- Electronic equipment seem to always break down just when the warranty expires. By using these training videos, you can do most repairs quickly without added expense.
- These well-illustrated videos show you how communication devices operate, from the features down to component level.

Previously released Video  
TEL-001 also available



Video #TEL-001

**Order today!!!**

Video #TEL-001

Video #TEL-002

Video #TEL-003

for **only \$39.95 each**  
(includes \$4.00 S&H cost)

Illinois Residents add (7%)  
state and/or sales tax

Satisfaction Guaranteed - OYMB

Send Check or Money Order to:

**PCW Technical Productions**  
P.O. Box 1492  
Arlington Heights, IL  
60006-1492

## SUMMERTIME, AND THE LIVIN' AIN'T EASY.

Especially for one person like yourself who's trying to do the work of three. So why not hire one or two of the thousands of young disadvantaged people looking for work this summer. Hiring them can also help you get as much as an 85% tax credit on the first \$3,000 in wages you pay to one of these summer employees. For further information, write the National Alliance of Business at P.O. Box 7207, Washington, D.C. 20044. And support your local summer-jobs-for-youth programs. Make living in the summertime easy.

**LET'S GET ALL OF AMERICA WORKING AGAIN.**



A PUBLIC SERVICE  
OF THIS PUBLICATION &  
THE ADVERTISING COUNCIL

## Satellite-TV

SAVE 40% - 60%

800-334-6455  
218-739-5231 Int'l  
218-739-4879 Fax

**Skyvision Inc.®**

1048 FRONTIER DRIVE - FERGUS FALLS, MN 56337

**FREE  
Catalog**



**PROFESSIONAL SURVEILLANCE EQUIPMENT**  
Used By Law Enforcement Agencies

**VHF-FM CRYSTAL CONTROLLED TRANSMITTERS**  
A - 139MHz, B - 139.970 MHz, C - 149 MHz, D - 149.450 MHz  
All kits assemble in less than 5 mins.

<p><b>AD-F300</b> Georgio us brass plant with 6 mirrors and concealed B&amp;W video camera and video transmitter. Great for monitoring in living room, conf. room, office, or anywhere. Range 150 ft. \$880 (\$990 w/aud)</p>	<p><b>AD-700</b> Mic Range: up to 5 Mile Power 750MW \$272</p>	<p><b>AD-80</b> Mic Range: up to 1.8 Mile Power 80MW \$187</p>	<p><b>AD-550</b> Tel Range: up to 5 Mile Power 35MW \$150</p>	<p><b>AD-400</b> Mic Range: up to 2.5 Mile Power 400MW \$163</p>
---	--	--	---	--

If you need our technology in a diff. configuration for your needs, call! We can probably build it for you. We have other state-of-the-art surveillance equip. too!

We sell a variety of cameras, bug detectors, night vision equipment, video transmitters, time lapse recorders, remote video monitoring systems, and many more...

**A&D ELECTRONICS**

P.O. Box 601, Monsey, NY 10952  
914-356-7541 • Fax 914-356-7505  
Request our full catalog for \$6, get \$10 off your first order.  
Credit Cards accepted

**Free Catalog!**

Featuring the Best New Products from Many Major Manufacturers

- ✓ Hand Tools
- ✓ Tool Kits & Cases
- ✓ Test Equipment
- ✓ Soldering Supplies
- ✓ Wire/Cable/Connectors
- ✓ Bench Accessories



Call: 800-426-1194 • FAX: 800-366-9662



**JENSEN TOOLS INC.**  
7815 South 46<sup>th</sup> Street  
Phoenix AZ 85044-5399

CIRCLE 116 ON FREE INFORMATION CARD



**Parts Express™**



Parts Express is proud to announce that we now stock the NTE line of replacement semiconductors. NTE has been supplying the electronics industry with top notch replacement parts for over 15 years. All NTE products meet or exceed industry specifications and offer an exclusive 2 year manufacturer warranty. We also offer a complete line of parts for the service repair industry. Test equipment, loudspeakers, video and audio heads, magnetrons,

belts, idler assemblies, tools, soldering equipment, just to name some of the 12,000 items we stock. Ask about our new dealer program for resellers. Call toll free for a copy of our FREE 212 page catalog. Source Code: POM

**CALL TOLL FREE 1-800-338-0531**

Parts Express 340 E First St Dayton, Ohio 45402-1257  
Phone: 513-222-0173 Fax: 513-222-4644

CIRCLE 148 ON FREE INFORMATION CARD

**NEW EASY PC**

BRITISH DESIGN AWARD

**SCHEMATIC and PCB C.A.D**

ONLY **\$195**

Includes

- MGA, CGA, EGA & VGA compatible.
- Design large multi layer boards.
- One level pull down menu and quick keys for fast layout.
- Dot matrix, laser, plotter, Gerber & N.C. drill output.
- 6 Month Free update Free Demo

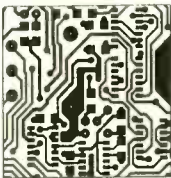

7840 ANGEL RIDGE ROAD  
ATHENS, OHIO 45701  
(614) 592-1810

Visa & MasterCard Accepted



**The Pocket Programmer**

The portable Eprom programmer that uses the printer port of your PC instead of an internal card. The software has 24 easy to use functions and programs 27/25/28/68764 & Cmos from 16K (2K x 8)—2M (256K x 8) Eproms (32 pin socket, UpGradeable to 8Meg). Adapters available for MCU's, 40-Pin Eproms, 5-Gang and Eprom Emulator to 32K x 8.

**\$129.95**

INTRONICS, INC.  
Box 13723  
Edwardsville, KS 66113  
(913) 422-2094

Add \$4.00 for shipping.  
Add \$4.50 for COD.  
Visa/Master Charge

**PROGRAMMERS**

- 1349 DATA I/O CHIPLABS 4800
- 799 DATA I/O CHIPLABS 3200
- 579 EETOOLS ALLMAX
- 249 XELTEK SUPERPRO (R)
- 599 LOGICAL DEVICES 3000
- 599 ADVANTECH PC-UPROG
- 269 SUNSHINE UNIVERSAL
- 449 TUP-300 HILO SYSTEMS
- 449 JDR MCT-EMUP
- 539 TUP-400 HILO
- 429 NEEDHAMS EMP-20
- 679 NEEDHAMS SA-20
- 139 EETOOLS 1 GANG
- 199 EETOOLS 4 GANG
- 49 SUNSHINE 1 GANG
- 99 SUNSHINE 4 GANG
- 169 SUNSHINE 8 GANG
- 349 SUNSHINE 16 GANG



**GENERAL DEVICE INSTRUMENTS**  
(408) 241-7376 Fax 241-6375 BBS 983-1234

**CABLE TV CHANNELS EQUIPMENT**

Direct! **GUARANTEED**  
The nationwide source for cable TV equipment.

"BUY WHERE THE DEALERS BUY."

**FREE** TV Cable Descramblers and Converters Catalog. Open Every Day!

**YOUR VCR TAPES CAN PLAY AS CLEAR AS DAY!**

Why put up with Inconsistent Color, Flashes and Streaking and Interference!

**UNJAM NOW WITH Video Decoder**

- Easy Connections
- Eliminates "jamming"
- Copy any tape
- RC Plugs included
- 2 Year Warranty
- 30 Day Money Back Guarantee

**MEGA ELECTRONICS**  
VISA • MC C.O.D. **1-800-676-6342** SAVE 100%\*

21 S. Main St., Winter Garden, FL 34787

**CABLE TV DESCRAMBLERS**



We have Descramblers for:

- Jerrold™ Systems
- Scientific Atlanta™ Systems
- Tocom™ Systems
- Zenith™ Systems
- Pioneer™ Systems

**GUARANTEED TO WORK OR YOUR MONEY BACK!**

**BEST PRICES FREE CATALOG**

Please have the MAKE & MODEL # of your area's cable box ready when you call!

**ALLSTAR ELECTRONICS**  
**800-782-7214**  
HOURS: 9-6 M-F 10-3 Sat EST

It is not the intent of Allstar Electronics to defraud any pay TV operator. Anyone implying help of service will be denied assistance. All brand names are registered trademarks of their respective owners and are used for reference only.

# Motorless Motion!



Includes Complete Plans

Create direct linear action with Muscle Wires®—they actually contract up to 5% when powered! Use them in robots, planes, railroads — anywhere you need small, strong all-electric motion.

## What are Muscle Wires?

Muscle Wires are highly processed strands of a nickel-titanium alloy called *nitinol*. At room temperature they are easily stretched by up to 5% of their length. When conducting an electric current they return to their original "unstretched" shape with a force *thousands of times* their weight.

## How strong are Muscle Wires?

This varies with the wire's size. A single wire can lift from 35 to 930 grams (over 2 lbs!) For more strength, use several wires in parallel.

## How fast can Muscle Wires activate?

They contract as fast as they are heated — as quickly as 1/1000 of a second. To relax, the wire must cool again. Rates of many cycles per second are possible with active cooling.

### Flexinol Muscle Wire Specifications

Wire Diameter ( $\mu\text{m}$ )	50	100	150	250
Resistance ( $\Omega/\text{m}$ )	510	150	50	20
Contract Force (grams)	35	150	330	930
Typical Current (mA)	50	180	400	1000

## How much power do Muscle Wires need?

Power varies with wire diameter, length, and surrounding conditions. Once the wire has fully shortened, power should be reduced to prevent overheating.

## What are the advantages of Muscle Wires?

Small size, light weight, low power, very high strength-to-weight ratio, precise control, AC or DC activation, long life and direct linear action and much more!

Get our new 128 page *Muscle Wires Project Book* with full plans for Boris and 14 other motorless motion projects, and our Deluxe Sample Kit with one meter each of 50, 100 and 150  $\mu\text{m}$  dia. Muscle Wires — everything you need to get moving today!

24-hour Voice Order Line — VISA, MasterCard

**Order Toll Free!** **800-374-5764**

Request our FREE Muscle Wires Technical Brochure

**Mondo-tronics**

524 San Anselmo Ave. #107-62  
San Anselmo, CA 94960

Questions: 415-455-9330  
Fax: 415-455-9333  
Internet: mondo@holanet.net

**New Book & Deluxe Kit only**

**\$59.95**

Plus \$5.00 P&H  
CA orders add tax

International Orders Welcome! First Class P&H: \$11.00

It started in America!

# The creators are the masters in manufacturing the finest video products...

You probably don't associate VCR's with American technology. Fact is, video recording has its origins in America and it was 3M that brought video recording out of the lab and into your living room. Today, 3M video tape is the choice of all the major networks. No other tape company has ever won an Oscar or an Emmy. 3M Black Watch tape follows in this tradition—service and quality go hand in hand. Here are three Black Watch products you should be using at home!

**Clean up!** With constant playing and using of degrading dry or wet cleaners, the output of your video tapes has slowly diminished to an unacceptable level and the VCR plays as if it has a head cold! The culprit is most likely clogged and dirty video and/or audio heads. The 3M Black Watch™ Head Cleaner Videocassette uses a patented magnetic tape-based cleaning formation to remove head clogging debris. No foreign substances such as cloth, plastics or messy liquids and no harsh abrasive materials are present. The cleaner's usable life is 400 cleanings or more!

It's easy to use. Place the 3M Black Watch™ Head Cleaner Videocassette in the VCR and press the Play button. A pre-recorded message will appear clearly on your screen and an audible tone is heard, telling you that the cleaning process is now completed. No guess work; you never over clean! Priced at \$19.95.

**For the VCR!** Once your VCR's record and playback heads are cured, and the unit plays like new, consider using the finest videocassette you can buy—the 3M Black Watch™ T120 Hi Pro VHS 4410 Videocassette. The 4410 is the highest performing videocassette available today for use with all standard format VHS recording hardware!

Here's what you hear and see...A sharp, clear picture—brightest ever colors—freedom from streaks, flashes and snow—outstanding high-fidelity audio reproduction—optimum camcorder performance—maintains recording integrity. 3M Black Watch™ video tape is 100% laser inspected to guarantee surface smoothness and drop-out free performance. Priced at \$8.00

**You saw it here first!** 3M Black Watch™ 0900 8mm video tape cassette loaded into your Hi Band camcorder delivers the finest picture and sound possible in the 8mm format. Extremely fine particles of pure iron alloyed with nickel and cobalt deliver a video performance exceeding 400 lines of horizontal resolution. You get the advantage of an exceptional video image with superior audio re-



**For the clearest pictures you ever record!**

production. This means your Hi 8 format camcorder will produce the best video and audio definition possible. With the 3M Black Watch™ 8mm cassette, the recording capability and performance of your camcorder will be significantly enhanced. Priced at \$14.95.

**Clagg Inc. — 3M VHS Special Offer**  
P.O. Box 4099,  
Farmingdale,  
New York 11735

Yes, I like your offer and here is my order for 3M Black Watch™ products!

- \_\_\_ 3M Black Watch™ 0900 Hi Band-120 8mm Cassette (\$14.95 each) \$ \_\_\_\_\_
- \_\_\_ 3M Black Watch™ T120 Hi Pro VHS 4410 Videocassette (\$8.00 each) \$ \_\_\_\_\_
- \_\_\_ 3M Black Watch™ Head Cleaner Videocassette (\$19.95 each) \$ \_\_\_\_\_

Shipping and handling per order \$4.00

Total Amount in U.S. Funds only \$ \_\_\_\_\_

New York residents add local sales tax. Canadians add \$6.00 per order. No foreign orders. Do not send cash.

Bill my  VISA  MasterCard  
Card No. \_\_\_\_\_

Expire Date \_\_\_/\_\_\_/\_\_\_

Signature \_\_\_\_\_

Name (Please print) \_\_\_\_\_

Address \_\_\_\_\_

City \_\_\_\_\_ State \_\_\_\_\_ ZIP \_\_\_\_\_

# Data Acquisition & Control Hardware for PC's

ANA100 Analog I/O ..... \$ 99



- \* 8 Channel 8-Bit 0 to 5 Volt input
- \* 14 TTL I/O lines
- \* Analog output
- \* 400 Khz sampling

DIG100 Digital I/O..... \$ 39



- \* 8255 PPI
- \* 24 or 48 TTL I/O Lines
- \* Selectable Base Address

ANA150 Analog/Counter... \$ 89



- \* 8 Channel 8-Bit 0 to 5 Volt input
- \* 3 16-Bit Counters
- \* 400 Khz sampling

DIG200 Counter I/O..... \$ 79



- \* 3 16-Bit Counters
- \* 8-Bit input port
- \* 8-Bit output port
- \* Selectable Clock frequency input

ANA200 Analog I/O..... \$ 79



- \* 1 Channel 12-Bit 0 to 5 Volt input optional bi-polar
- \* 100 Khz sampling
- \* 24 TTL I/O lines

ANA201 Analog ..... \$ 129



- \* 8 Channel 12-Bit
- \* x1, x5, x10, x50 Programmable channel gain
- \* 100 Khz sample

## Engineering Software - PC/MSDOS

Analyser III - Linear Circuit Analysis .....	\$ 149	
AutoSkem - Schematic Drawing program .....	\$ 29	More Hardware and
CompDes - Circuit Design program .....	\$ 29	Software items available
EasyPC - PCB Layout and Circuit Drawing .....	\$ 149	
Filterch - Filter Circuit Design and Analysis .....	\$ 229	Ask for our current catalog
PC-Scope - Digital Storage Oscilloscope for ANA100		
ANA150 or ANA201 board .....	\$ 39	MasterCard/Visa accepted
Pulsar - Logic Circuit Analysis .....	\$ 149	

## BSOFT Software, Inc.

PHONE 614-491-0832 \* FAX 614-497-9971  
444 COLTON ROAD \* COLUMBUS, OHIO \* 43207

“What a great  
collection  
of \_\_\_\_\_.”  
(noun)

The Tax Information Booklet has all the info to fill out your taxes right. Pick one up wherever you find tax forms.



Internal  
Revenue  
Service

A public service message

## EPROM+ PROGRAMMING SYSTEM USES PARALLEL PORT

EPROMS (24,28,32 & 40 PIN\*) PLUS 27CXXX  
1702\*,2708,TMS2716\*,32,32A,64,64A,128,128A  
256,512,513,011,010,101,1001,1002,4210,020  
2001,220,2048,4001,040,240,4096,25XX,68764/66  
FLASH EPROMS 28F256, 28F512, 28F010  
28F020, 29C257, 29C010, 29F010  
EEPROMS & NVRAMS (18,24 & 28 PIN+CXX)  
2210,2212,2804,2816,2816A,2817,2864,2865,28256  
28C010, DS1220, DS1225, DS1230  
SERIAL EEPROMS\* (8 & 14 PIN PLUS CXX)  
ER1400,MS8657,2401,02,04,08,16,2444,59C11  
9306, 46, 56, 66, 8572, 82, 92  
BIPOLAR PROMS\* (16 THROUGH 24 PINS)  
74SXXX AND 82SXXX FAMILY  
MICROCONTROLLERS\* 8741, 42, 48, 49, 8751  
C51, 8752, 87C52, 87C55, 87C751, 87C752, 68705  
68HC705, 68HC711E9, PIC16C5X, TMS7742

\*ADAPTER REQ'D - DIAGRAMS INCLUDED

SOFTWARE - READ, VERIFY, PROGRAM, COPY  
DISK FILE LOAD/SAVE, CHECKSUM, FULL  
SCREEN BUFFER EDITOR W/20 COMMANDS  
READS HEX, S-RECORD AND BINARY FILES  
FAST-DEVICES PROGRAM IN UNDER 60 SEC  
RUGGED (8"X7"X3")ENCLOSURE W/HANDLE  
MADE IN USA - 1 YEAR WARRANTY

ANDROMEDA RESEARCH, P.O. BOX 222, MILFORD, OH 45150  
(513) 831-9708 FAX (513) 831-7562



SYSTEM INCLUDES:  
PROGRAMMING UNIT  
PRINTER PORT CABLE  
POWER PACK, MANUAL  
AND SOFTWARE.

# \$289

ADD \$5.00 SHIPPING  
\$5.00 C.O.D.  
VISA/MASTERCARD

## MICRO CAMERA

Sees an entire room through an 1/8" hole

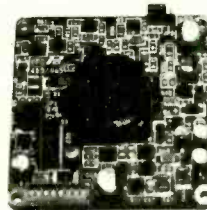

\$215 introductory price

Only 1.65 x 1.65 x .5 inches  
90° field of view  
operates on 12 volts DC  
380 lines of resolution  
built in electronic iris  
low light .5 lux  
standard video output

1-201-794-9766  
ext. 828

Po box 175 Elmwood Park NJ 07407

NortheastMicro



## AUTOMATE YOUR HOME



Hundreds of hard-to-find home automation and wireless control products. Computer control of your home, security systems, surveillance cameras, audio/video control, HVAC, pet care automation and much more. Easy do-it-yourself installation on most products. Affordable, systems start at about \$20.

Largest Selection of X10 Compatible Products in the World  
Call for our Free 64 page Color Catalog

800-SMART-HOME (800-762-7846)  
HOME AUTOMATION SYSTEMS, INC.

151 Kalmus Dr., Ste L4, Dept. FE2, Costa Mesa, CA 92626  
Questions 714-708-0610 Fax 714-708-0614

# USE PE MARKET CENTER CLASSIFIEDS

## READ BY 87,877 BUYERS OF ELECTRONIC EQUIPMENT ACCESSORIES AND PARTS

### INSTRUCTION FOR PLACING YOUR AD!

#### HOW TO WRITE YOUR AD

TYPE or PRINT your classified ad copy CLEARLY (not in all capitals) using the form below. If you wish to place more than one ad, use a separate sheet for the additional ads (a photocopy of this form works well). Choose a category from the list below and write that category number into the space at the top of the order form. If you do not specify a category, we will place your ad under Miscellaneous or whatever section we deem most appropriate.

We cannot bill for classified ads. Payment in full must accompany your order. We do permit repeat ad or multiple ads in the same issue, but in all cases, full payment must accompany your order.

#### WHAT WE DO

The first two words of each ad are set in bold caps at no extra charge. No special positioning, centering, dots, extra space, etc. can be accommodated.

#### RATES

Our classified ad rate is \$1.00 per word. Minimum charge is \$15.00

per ad per insertion (15 words). Any words that you want set in bold or caps are 20¢ each extra. Bold caps are 40¢ each extra. Indicate bold words by underlining. Words normally written in all caps and accepted abbreviations are not charged as all-caps words. State abbreviations must be Post Office 2-letter abbreviations. A phone number is one word.

#### CONTENT

All classified advertising in the PE Market Center is limited to electronics items only. All ads are subject to the publisher's approval. We reserve the right to reject or edit all ads.

#### DEADLINES

Ads received by our closing date will run in the next issue. For example, ads received by November 13 will appear in the March, 1995 issue that is on sale January 17. The PE Market Center is published monthly. No cancellations permitted after the closing date. No copy changes can be made after we have typeset your ad. NO REFUNDS, advertising credit only. No phone orders.

**AD RATES: \$1.00 per word, Minimum \$15.00.**

Send your ads with payment to:

Popular Electronics Market Center, 500-B Bi-County Blvd. Farmingdale, NY 11735

### CATEGORIES

- |                              |                                 |  |                           |
|------------------------------|---------------------------------|--|---------------------------|
| 100 — Antique Electronics    | 270 — Computer Equipment Wanted | 450 — Ham Gear Wanted                    | 630 — Repairs-Services    |
| 130 — Audio-Video-Lasers     | 300 — Computer Hardware         | 480 — Miscellaneous Electronics For Sale | 660 — Satellite Equipment |
| 160 — Business Opportunities | 330 — Computer Software         | 510 — Miscellaneous Electronics Wanted   | 690 — Security            |
| 190 — Cable TV               | 360 — Education                 | 540 — Music & Accessories                | 710 — Telephone           |
| 210 — CB-Scanners            | 390 — FAX                       | 570 — Plans-Kits-Schematics              | 720 — Test Equipment      |
| 240 — Components             | 420 — Ham Gear For Sale         | 600 — Publications                       |                           |

### CLASSIFIED AD COPY ORDER FORM

Ad No. 1—Place this ad in Category # \_\_\_\_\_

1 - \$15.00	2 - \$15.00	3 - \$15.00	4 - \$15.00
5 - \$15.00	6 - \$15.00	7 - \$15.00	8 - \$15.00
9 - \$15.00	10 - \$15.00	11 - \$15.00	12 - \$15.00
13 - \$15.00	14 - \$15.00	15 - \$15.00	16 - \$16.00
17 - \$17.00	18 - \$18.00	19 - \$19.00	20 - \$20.00
21 - \$21.00	22 - \$22.00	23 - \$23.00	24 - \$24.00
25 - \$25.00	26 - \$26.00	27 - \$27.00	28 - \$28.00

29 - \$29.00	30 - \$30.00	31 - \$31.00	32 - \$32.00
33 - \$33.00	34 - \$34.00	35 - \$35.00	36 - \$36.00
37 - \$37.00	38 - \$38.00	39 - \$39.00	40 - \$40.00

Ad No 1—Total words \_\_\_\_\_ x \$1.00 per word = \$ \_\_\_\_\_  
 All Caps words \_\_\_\_\_ x .20 per word = \$ \_\_\_\_\_  
 Bold words \_\_\_\_\_ x .20 per word = \$ \_\_\_\_\_  
 Bold Cap words \_\_\_\_\_ x .40 per word = \$ \_\_\_\_\_

**TOTAL COST OF AD No. 1 \$ \_\_\_\_\_**

Card # \_\_\_\_\_

Expiration Date \_\_\_\_ / \_\_\_\_

Signature \_\_\_\_\_

Total classified ad Payment \$ \_\_\_\_\_ enclosed.

Check  MasterCard  Visa (\$15.00 minimum credit card order)

Name \_\_\_\_\_ Phone \_\_\_\_\_

Address \_\_\_\_\_ City State Zip \_\_\_\_\_



## DESCRAMBLERS

\$\$\$\$ SAVE \$\$\$\$

Specializing in  
CANADIAN MARKET

Call us for all your  
Electronic needs

**Jolly R. Electronics**  
Visa, Mastercard, C.O.D.

**1-800-279-0614**

## Control your project

with a PC. Operate relays, motors, fans, lights etc. via the parallel port. No programming necessary. Includes IBM compatible software and a step-by-step manual. Send \$29.50 to:



**Project Solution**  
242 Ashbourne Trail  
Lawrenceville, GA 30243  
(404) 963-6382

**RCA** NOW USA  
DSS AVAILABLE

SHARPER PICTURE •  
CLEARER SOUND •  
GREATER CHOICE

**\$699.00**

U.S. CURRENCY

Introducing the RCA brand DSS™ (Digital Satellite System) the ultimate digital entertainment experience. The advanced digital compression technology delivers broadcast pictures with laser disc precision accuracy and CD-quality sound clarity. All from a small 18" dish that can be easily installed on your home or property. RCA Brand DSS. The future of television today... and beyond!

+S&H AND RECEIVE  
1 MONTH  
FREE **USSB**  
HBO



**TRI★STAR SATELLITE**  
1-800-929-2485

## Get your copy of the CRYSTAL SET HANDBOOK



Go back to antiquity and build the radios that your grandfather built. Build the "Quaker Oats" type rig, wind coils that work and make it look like the 1920's! Only \$10.95 plus \$3.50 for shipping and handling. Claggg Inc., P.O. Box 4099, Farmingdale, NY 11735 USA Funds ONLY! USA and Canada—no foreign orders.

## DC/AC POWER INVERTER



Just plug the DC/AC Power Inverter into your CAR, RV, or BOAT cigarette lighter and you've got up to 400 Watts of peak power (200W continuous) for your AC-operated appliances! The DC/AC Power Inverter is perfect for TVs, VCRs, stereos, CD players, computers, mobile phones, fax/copy machines, lamps, battery chargers, and hundreds of other AC-operated items. Features low battery alarm/shutdown, high surge current capability, and modified sine wave output for stable power source. HIGHER POWER UNITS ALSO AVAILABLE. 1 year warranty and 30-day money back guarantee. Order Now! Call for your FREE CATALOG! 9-6 M-F 10-3 Sat. EST

**ONLY \$59.95 + S/H**  
**A-Plus Electronics 1-800-877-7587**  
110-64 Queens Blvd. #465, Forest Hills, NY 11375

Save Big \$ and watch what you want!

## Cable TV Descramblers

Converters \* Filters \* Accessories

30 day Free Trial - NO RISK!  
Unbeatable wholesale prices!  
Affordable extended warranty  
1 Year Warranty on all products

Free  
Catalog

Call the cable professionals!

Credit Cards Welcome!

**1-800-379-3976**

We'll beat anyone's price!

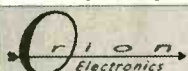

Prices starting  
as low as \$99!

## SOLAR ELECTRIC PANELS

### POWERGLASS™

**\$79.95**

350 mA at 14.5 VDC  
17.5" x 16.0" x 1.25"  
3.8 lbs.

### POWERGLASS™ PLUS

**\$169.95**

1.0 A at 14.5 VDC  
17.5" x 16.0" x 1.25"  
4 lbs.

These affordable solar panels generate useful electric power without noise, pollution, fuel costs, or electric bills. Stop buying and throwing away batteries. Start using Solar Photovoltaic Electric Panels from SECO.

To order call 1-800-700-1867  
Visa /Master Card Accepted

Radiotelephone - Radiotelegraph

**FCC** Commercial  
License

## Why Take Chances?

Discover how easy it is to pass the exams. Study with the most current materials available. Our Homestudy Guides, Audio, Video or PC "Q&A" pools make it so fast, easy and inexpensive. No college or experience needed. The new commercial FCC exams have been revised, covering updated Aviation, Marine, Radar, Microwave, New Rules & Regs, Digital Circuitry & more. We feature the Popular "Complete Electronic Career Guide" 1000's of satisfied customers Guarantee to pass or money back. Send for FREE DETAILS or call

**1-800-800-7588**

WPT Publications  
4701 N.E. 47th Street  
Vancouver, WA 98661

Name \_\_\_\_\_

Address \_\_\_\_\_

City \_\_\_\_\_ St. \_\_\_\_\_ Zip \_\_\_\_\_

**1-800-800-7588**

## CABLE DIRECT

CONVERTERS  
DESCRAMBLERS  
VIDEO STABILIZERS  
FILTERS



100%  
MONEY BACK  
GUARANTEE!

30 DAY  
FREE  
TRIAL!

FREE Cable TV Catalog.



Now you can tune-in your favorite cable TV programming and SAVE \$100'S - EVEN \$1000'S on premium CABLE TV EQUIPMENT.

## MODERN ELECTRONICS

**1-800-906-6664**

2125 S. 156TH CIRCLE • OMAHA, NE 68130

# ADVERTISING INDEX

POPULAR ELECTRONICS magazine does not assume any responsibility for errors that may appear in the index below.

Free Information No.	Page	Free Information No.	Page		
—	A&D Electronics	129	—	Intronics	129
—	A-Plus Electronics	133	116	Jensen Tools	129
125	Ace Communications	100	—	Jolly R Electronics	133
164	Advantage Instruments	111	—	KDE Electronics	127
—	Agrelo Engineering	114	38	Kelvin Electronics	105
26	Alfa Electronics	96	—	M&G Electronics	126
28	All Electronics	104	160	MCM Electronics	123
—	Allen Engineering	125	—	MD Electronics	97
—	Allison Technology	116	—	Mega Electronics	129
—	Allstar Electronics	129	149	Mendelsohn's	117
140	AMC Sales	117	—	Mental Automation	121
—	Andromeda Research	131	42	MicroCode Engineering	103
—	Antique Radio Classified	76	—	Modern Electronics	133
—	Basic Electrical Supply	115	—	Mondo-tronics	130
161	Beige Bag	119	115	Mouser Electronics	29
—	Black Feather	128	167	National Electronic Wholesalers	7
—	Bsoft	131	—	Northeast Micro	131
—	C&C Electronics	126	—	NRI Schools	35
—	C&C Specialties	124	—	Nu-Tek Electronics	4
132	C&S Sales	98	—	Ohio Automation	129
—	The Cable Outlet	114	43	Optoelectronics	CV4
—	Cellsoft	125	—	Orion Electronics	133
—	Circuit Specialties	101	148	Parts Express	129
—	CLAGGK, Inc.	83, 90, 130	—	PC Boards	118
—	Cleveland Inst. of Electronics	23, 71	—	PCW Technical Production	128
—	Command Productions	110	—	Performa Home	119
—	Comtrad Industries	8, 13, 17	—	Phillips Tech	124
—	Consumertronics	118	47	Prairie Digital Inc.	123
—	Copyright Clearance Center	75	46	Print	115
—	Cybermation	114	162	Print	120
—	Design Computation	127	—	Probemaster	108
—	EDE Spy Outlet	126	—	Progressive Concepts	126
—	EIA	27	—	Project Solution	133
—	Electronic Equipment Bank	107	—	RP Enterprises	114
147	Electronic Rainbow	102	—	SECO	133
—	Electronics Software Solutions	121	—	Self-Reliance Co. Inc.	125
—	Electronics Tech. Today	CV3, 73	—	Show Time	121
—	Electronics Tech. Today	81, 87	—	Skyvision	128
154	Foley-Belsaw Institute	29	—	Software Science	126
—	Forest Electronics	119	—	Spy Supply	112
—	Fotronic Corporation	106	—	Tab Books	5, 53
—	General Device Instruments	129	—	Tri Star Satellite Systems	133
—	Get-Tech Inc.	116	163	Trisys	120
—	Grantham College of Engineering	3	136	UCANDO Videos	127
—	Great Southern Security	109	—	US Cable (Zentek)	117
—	Greenleaf Electronics Inc.	110	—	US Cyberlab	110, 113
—	Halcyon Group	118	—	Vision Electronics	124
—	Home Automation Systems	131	—	Weeder Technologies	124
—	I.E.C.	128	—	Weka Publishing	113
—	Information Unlimited	31	—	WPT Publications	133
134	Interactive Image Technologies	CV2	134	Xandi Electronics	116

## ADVERTISING SALES OFFICE

**Gernsback Publications, Inc.**  
500-B Bi-County Blvd.  
Farmingdale, NY 11735  
1-(516) 293-3000

**Larry Steckler, EHF/CET**  
President

**Christina Estrada**  
Assistant to the President

**For Advertising ONLY**  
516-293-3000  
Fax 1-516-293-3115

**Larry Steckler**  
publisher

**Arline Fishman**  
advertising director

**Denise Mullen**  
advertising assistant

**Kelly Twist**  
credit manager

**Subscription/  
Customer Service/  
Order Entry**  
1-800-827-0383  
7:30 AM - 8:30 PM EST

## ADVERTISING SALES OFFICES EAST/SOUTHEAST

**Stanley Levitan**  
Eastern Sales  
1 Overlook Ave.  
Great Neck, NY 11021  
1-516-487-9357, 1-516-293-3000  
Fax 1-516-487-8402

**MIDWEST/Texas/Arkansas/  
Oklahoma, Colorado, Arizona**

**Ralph Bergen**  
Midwest Sales  
One Northfield Plaza, Suite 300  
Northfield, IL 60093-1214  
1-708-446-1444  
Fax 1-708-559-0562

## PACIFIC COAST/Mountain States

**Anita Bartman**  
Hutch Looney & Assoc., Inc.  
6310 San Vicente Blvd.  
Suite 360  
Los Angeles, CA 90048  
1-213-931-3444  
Fax 1-213-931-7309

# Hobbyist's Paperback Budget Books

## Popular Electronic Circuits Book 1



BP80/98—Popular Electronic Circuits—Books 1 and 2...\$11.90. Contains a wide range of circuits which are accompanied by text giving a brief introduction, circuit description and special notes on construction and setting-up that may be necessary.

## Coil Design and Construction Manual

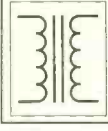

#160—Coil Design and Construction Manual...\$5.95. A complete book for the home builder on how to make RF, IF, audio and power chokes and transformers. Practically every possible type is discussed and calculations are explained in detail.



BP271—How to Expand, Modernize and Repair PC's and Compatibles...\$7.75. All the practical information you are likely to need to upgrade your PC and compatible. Also contains useful information and illustrations to help you with repairs.



BP276—Shortwave Superhet Receiver Construction...\$6.95. Provides construction details, including coil winding, of a number of advanced-design receivers which should have performance levels at least equal to commercial sets of similar complexity.

## 50 Projects Using IC CA3130



#223—50 Projects Using IC CA3130...\$5.00. One of the more practical and useful operational amplifiers (opamp), the CA3130 integrated circuit chip is the heart of several easy-to-assemble projects covered in the book. The projects are divided into five categories: audio projects, RF projects, test equipment, household projects and a catch-all miscellaneous group. Ideal for all skill levels.

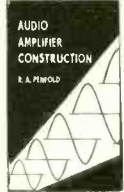

BP122—Audio Amplifier Construction...\$5.75. Practical designs are featured and include circuit diagram and description, Veroboard or printed-circuit board layout and construction notes. The text is divided into two parts. The first deals with many types of preamplifiers. The second covers power amplifiers from a simple low-power battery type to a 100-watt DC-coupled amplifier using four MOSFETs in the output stage.



BP107—30 Solderless Breadboard Projects—Book 1...\$5.95. Each project is designed to be built on a "Verobloc" breadboard and is presented with a brief circuit description, circuit diagram, component layout diagram and components list. Notes on construction and applications are provided. Wherever possible, the components are common to several projects to keep project costs down.

## Electronic Modules and Systems for Beginners



BP266—Electronic Modules and Systems for Beginners...\$7.25. Shows the reader how to build a number of simple analog and digital circuit modules, all suitable for battery operation, and all based on only 1 or 2 transistors or ICs.



BP329—Electronic Music Learning Projects...\$6.25. A beginner's book that will assist you in assembling such projects as the Elexyphone, Gildaphone, Melody Ranger, Cordmaker, Appealing Handbells, Electronic Sol-Fa, Tune-up Box and more.

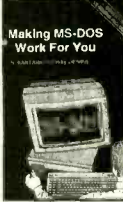

BP319—Making MS-DOS Work for You...\$6.50. What you need to know first, comes first, however the text is written in a circular style so that the reader can start anywhere in the text. This book is relevant to all versions of both MS-DOS and PC-DOS.



BP303—Understanding PC Software...\$6.95. Covers main types of PC software, giving details of typical uses, the basics of how they are used and their limitations. Each chapter covers popular software and programs of a similar type.

## Aerial Projects



BP105 Aerial (Antenna) Projects...\$5.50. In this book the author has considered practical antenna designs, including active, loop and ferrite antennas which perform well and are relatively simple and inexpensive to build. The complex theory and mathematics of antenna design have been avoided. Also included are construction details of a number of antenna accessories including a pre-selector, attenuator and filters.



BP33—Electronic Calculator Users Handbook...\$5.75. The book eliminates the mysteries of the calculator and offers unique ideas for the simplest to most complex calculators. Covers the basic functions plus trigonometric, hyperbolic, logarithms, square roots and powers. Included are formulas and data for VAT, discounts, and mark up, currency conversion, interest, binary and octal numbers, and much more!



BP125—25 Simple Amateur Band Antennas...\$5.50. Plans to build antennas that are simple and inexpensive to construct and perform well. From the simple dipole to beam, triangle and even mini-rhombic types made from four TV masts and about 400 feet of wire. After the antenna discussion you will find a complete set of dimension tables that will help you "tune" an antenna on a particular frequency.

## A Concise Introduction to dBASE



BP263—A Concise Introduction to dBASE...\$6.95. The most popular data-base program, dBASE, is difficult to master without help. This book helps you spend your time using dBase, not setting it up. A user's guide that covers all the basics up to dBase IV.



PCP104—Electronics—Build and Learn...\$9.95. Construction details are given to build a circuit demonstrator that is used throughout the book to introduce common electronic components and how these components are built up to useful circuits.



BP302—A Concise Users Guide to Lotus 1-2-3 Release 3.1...\$6.25. Written to help existing spreadsheet users upgrade to 1-2-3 Release 3.1, which has the ability to work 3-dimensionally with both multiple worksheets and files.



BP146—The Pre-BASIC Book...\$6.95. Another book on BASIC but with a difference. It concentrates on introducing technique by looking in depth at the most frequently used and more easily understood computer instructions.

## Just What the Project Builder Is Looking For!

- |   |         |  |        |
|---|---------|--|--------|
| <input type="checkbox"/> #160—Coil Design and Construction Manual .....           | \$5.95  | <input type="checkbox"/> 1596T—24 Silicon-Controlled Rectifier Projects..... | \$9.95 |
| <input type="checkbox"/> #219—Solid State Novelty Projects .....                  | \$4.95  | <input type="checkbox"/> BP58—50 Circuits Using 7400 Series ICs .....        | \$5.50 |
| <input type="checkbox"/> #222—Solids State Shortwave Receivers for Beginners..... | \$5.50  | <input type="checkbox"/> BP69—Electronic Games.....                          | \$5.50 |
| <input type="checkbox"/> #223—50 Projects Using IC CA3130.....                    | \$5.00  | <input type="checkbox"/> BP71—Electronic House Projects .....                | \$5.00 |
| <input type="checkbox"/> #225—Practical Introduction to Digital ICs.....          | \$5.25  | <input type="checkbox"/> BP84—Digital IC Projects.....                       | \$5.50 |
| <input type="checkbox"/> PCP111—Electronic Test Equipment Handbook.....           | \$13.95 | <input type="checkbox"/> BP93—Electronic Timer Projects.....                 | \$5.50 |

**ELECTRONIC TECHNOLOGY TODAY INC.**  
P.O. BOX 240, Massapequa, NY 11762-0240

Name \_\_\_\_\_  
Address \_\_\_\_\_  
City \_\_\_\_\_ State \_\_\_\_\_ Zip \_\_\_\_\_  
PE5 Allow 6-8 weeks for delivery

**SHIPPING CHARGES IN USA AND CANADA**

\$0.01 to \$5.00 .....	\$2.00
\$5.01 to \$10.00 .....	\$3.00
\$10.01 to 20.00 .....	\$4.00
\$20.01 to 30.00 .....	\$5.00
\$30.01 to 40.00 .....	\$6.00
\$40.01 to 50.00 .....	\$7.00
\$50.01 and above .....	\$8.50

**SORRY** No orders accepted outside of USA & Canada

Total price of merchandise ..... \$ \_\_\_\_\_  
Shipping (see chart) ..... \$ \_\_\_\_\_  
Subtotal ..... \$ \_\_\_\_\_  
Sales Tax (NYS only) ..... \$ \_\_\_\_\_  
Total Enclosed ..... \$ \_\_\_\_\_

Number of books ordered

**All payments must be in U.S. funds!**

# SCANBLASTER™

**BLAST** your way through the Frequency Spectrum

Featuring the SCOUT and the OPTOSCAN456

9200 MHz	Police	12:59:23
9250 MHz	Police	12:57:38
4875 MHz	Police	12:56:02
7750 MHz	Marina	12:55:32
0500 MHz	University	12:50:35
3000 MHz	Airport	12:50:14
9750 MHz	Local Government	12:49:58
3700 MHz	Fire Rescue	12:49:57
3700 MHz	Hwy Patrol	12:49:55
0625 MHz	Local Police	12:49:53
5875 MHz	Hardware Store	12:49:52
5375 MHz	Hardware Store	12:49:48

Local Hotel	Marina
Police	Fire Rescue
Police	Playland
Police	Emergency
Police	County Zoo
Police	Police
Police	Cruise Line
Police	Charter Air
Police	Power Compa
Police	Power Compa
Police	Wholesale C
Police	Hardware St
Police	Hardware St
Police	Local Polie
Police	Sheriff's O

STOP	LOCKOUT	EDIT	RESET
LOG	TMP L/O	OPTIONS	HELP
STORE		BAND	
CLOSE	NEW		



Each **SCANBLASTER™** series includes in the accessory set:

- **CX12A** Computer Interface
- **N1C0** FM Notch Filter
- **BLP-70** Low Pass Filter
- **BHP-800** High Pass Filter
- **DB32** UHF/VHF Mini Antenna
- **RD27** 27 MHZ Antenna
- **RD440** 440 MHZ Antenna
- **RD800** 800 MHZ Antenna
- **Spectrum** CD-ROM FCC Database
- **Utility Disk** SCOUT Download Program
- **AC100** Rapid Charge Adaptor
- **Cable/Adaptor** SCOUT Reaction Tune Pat. Pend.
- **CC30** Carry Case for SCOUT

**3 YEAR EXTENDED WARRANTY**

### SCANBLASTER™ I

Includes:  
SCOUT Pat. Pend.  
OPTOSCAN456  
Accessory Set

**\$999**

*(Save \$328)*

### SCANBLASTER™ II

Includes:  
SCOUT Pat. Pend.  
Accessory Set

**\$849**

*(Save \$179)*

### SCANBLASTER™ III

Includes:  
OPTOSCAN456  
Accessory Set

**\$699**

*(Save \$179)*

### SCANBLASTER™ UPGRADE

Accessory Set Only

**\$459**

*(Save \$120)*

# OPTOELECTRONICS

**ORDER LINE 800-327-5912**

TEL: 305-771-2050  
FAX: 305-771-2052

5821 NE 14th Avenue • Ft. Lauderdale, FL 33334 • Contact Factory for shipping prices. Visa, Master Card, & C.O.D. (cash or money order only)

• OPTOSCAN456 software featured, SCANSTAR COMM™ Software also available from: PROBE, SCANCAT, SCANNERWEAR, and RADIO MGR.

All prices and specifications are subject to change without notice or obligation. CIRCLE 43 ON FREE INFORMATION CARD