

SIMPLE PC UPGRADES THAT YOU CAN DO

April 1995

Popular Electronics®

All About

HOME THEATER

It's easier than ever to bring theater-quality sound and video into your living room

Build The Sprinkler Guardian

Make sure your lawn or garden gets just the right amount of water

The History Of The Personal Computer

The devices and personalities that made today's PC possible

Build An Electronic Stethoscope For Your Car

Hunt down whines, r other aut



THE GUIDE

#BXBDCCCH*****SCF 950
MAR 1997
#95014DRK654MR003# RESP 113
SCF
LLOYD DARKNELL
6540 MYRTLEWOOD DR
CUPERTINO CA 95014

\$3.50 U.S.
\$3.95 CAN.

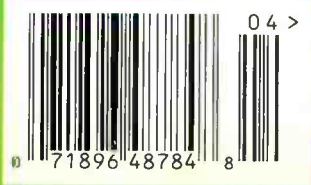

A GERNSBACK PUBLICATION

“Electronics Workbench – As an affordable tool for performing design trade-offs, you can’t beat it.”

Prof. M.A. Chapman, (retired)
University of California San Diego Physics Dept.

Electronics Workbench is a highly productive bench where you design and verify circuits in a fraction of the time. Connections are always perfect. Wires route themselves. And the simulated components and test instruments work just like the real thing.

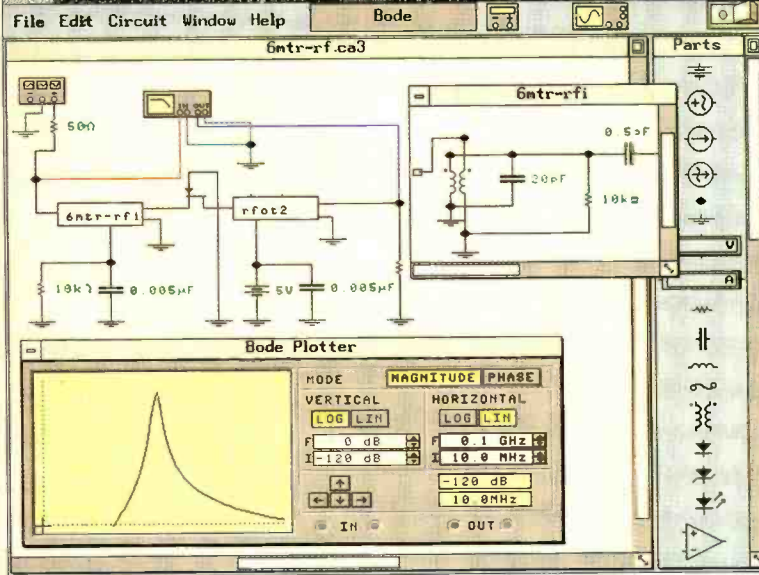
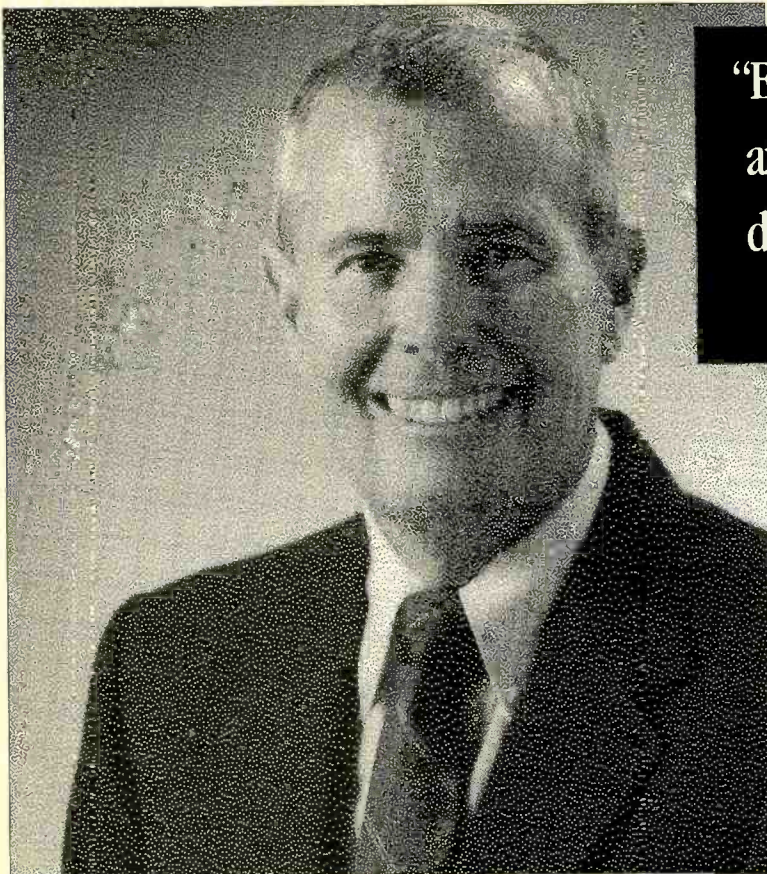

Analog Module: Tuning an RF front end.

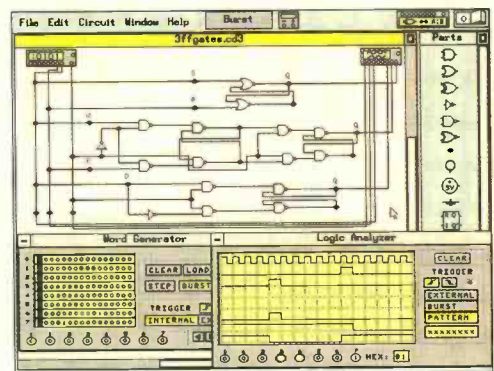

Digital Module: Analyzing a logic circuit.

It's faster than building with actual components because you change connections and component values instantly. And since the simulated components are free, you don't need to replace burnt-out parts or keep an extensive inventory. The result: You save precious time and money. Guaranteed!*

The standard for simplicity and power for over six years, Electronics Workbench is the most popular tool of its kind. It has gained worldwide acclaim as the ideal complement to any test bench. **Fact: Over 90% of our customers recommend it to their friends and colleagues.**

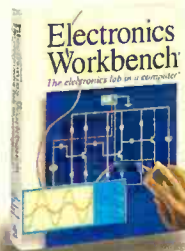

Electronics Workbench[®]

The electronics lab in a computer™

Call: 800 263-5552

Just \$299*

For DOS, Windows or Mac Version.



INTERACTIVE IMAGE TECHNOLOGIES LTD.
908 Niagara Falls Blvd. #068, North Tonawanda, NY 14120-2060
Telephone: (416) 361-0333 FAX: (416) 368-5799

* 30-day money-back guarantee.

Prices in U.S. dollars, shipping \$15. Offer valid in U.S. and Canada only.
All trademarks are the property of their respective owners.

CIRCLE 164 ON FREE INFORMATION CARD

AmericanRadioHistory.Com



INTERACTIVE

Popular Electronics®

APRIL 1995

Vol. 12, No. 4

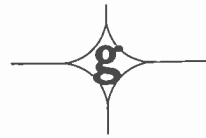

CONSTRUCTION

33 Build the Sprinkler Guardian

Make sure that your lawn or garden gets just the right amount of water. It works with any existing sprinkler system—*Walter Schopp*

46 Build the Auto Stethoscope

Track down the sources of annoying car noises with this handy electronic listening aid—*Charles Hansen*

53 Build an Audible Level

A variation on the common carpenter's level—*Peter Cartwright*

56 Build a Preselector for the AM Broadcast Band

Improve your receiver's performance on the crowded AM broadcast band—*Joseph J. Carr*



Page 9

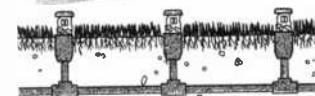
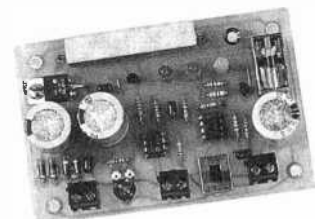

Page 33



Page 49

FEATURES

36 BURIED BYTES: A History of the Personal Computer

The technology and personalities that made today's PC possible —*Karl T. Thurber, Jr.*

49 Upgrading and Maintaining your Personal Computer

Easy upgrades that anyone can do—*Marc Spiwak*

52 A Vacuum-Tube Ram

Give your personal computer the warm, nostalgic glow of vacuum-tube technology this April 1—*Michael A. Covington*

59 All About Current-Crowbar Circuits

Protect your designs from damage with these shutdown circuits—*Imanga Kaliangile*

POPULAR ELECTRONICS (ISSN 1042-170-X) Published monthly by Gernsback Publications, Inc. 500-B Bi-County Boulevard, Farmingdale, NY 11735. Second-Class postage paid at Farmingdale, NY and at additional mailing offices. One-year, twelve issues, subscription rate U.S. and possessions \$21.95, Canada \$28.84 (includes G.S.T. Canadian Goods and Services Tax Registration No. R125166280), all other countries \$29.45. Subscription orders payable in U.S. funds only, International Postal Money Order or check drawn on a U.S. bank. U.S. single copy price \$3.50. Copyright 1995 by Gernsback Publications, Inc. All rights reserved. Hands-on Electronics and Gizmo trademarks are registered in U.S. and Canada by Gernsback Publications, Inc. Popular Electronics trademark is registered in U.S. and Canada by Electronics Technology Today, Inc. and is licensed to Gernsback Publications, Inc. Printed in U.S.A.

Postmaster: Please send address changes to Popular Electronics, Subscription Dept., P.O. Box 338, Mount Morris, IL 61054-9932

A stamped self-addressed envelope must accompany all submitted manuscripts and/or artwork or photographs if their return is desired should they be rejected. We disclaim any responsibility for the loss or damage of manuscripts and/or artwork or photographs while in our possession or otherwise.

As a service to readers, Popular Electronics publishes available plans or information relating to newsworthy products, techniques, and scientific and technological developments. Because of possible variances in the quality and condition of materials and workmanship used by readers, Popular Electronics disclaims any responsibility for the safe and proper functioning of reader-built projects based upon or from plans or information published in this magazine.

A P R I L 1 9 9 5

P R O D U C T R E V I E W S

9 Gizmo

All about home theater, plus reviews of a video projector, a Dolby Pro-Logic amp and preamp combination, a surround-sound speaker system, and more

24 Hands-On-Report

Silent Sam Turn-Signal Alert

C O L U M N S

6 Multimedia Watch

Tiny multimedia toys—*Marc Spiwak*

29 Think Tank

Lock circuits—*John Yacono*

64 Antique Radio

The Minerva Tropicmaster—*Marc Ellis*

67 Computer Bits

Methods, attributes, and messages—*Jeff Holtzman*

68 Circuit Circus

Motorcycle circuits—*Charles D. Rakes*

74 DX Listening

Shortwave from South Africa—*Don Jensen*

78 Ham Radio

Building with the NE-602—*Joseph J. Carr*

80 Scanner Scene

Deep-space scanning—*Marc Saxon*

D E P A R T M E N T S

3 Editorial

4 Letters

76 Electronics Market Place

82 Electronics Library

85 New Products

97 Popular Electronics Market Center

136 Advertiser's Index

137 Free Information Card

Popular Electronics

Larry Steckler, EHF, CET,
editor-in-chief and publisher

EDITORIAL DEPARTMENT

Carl Laron, editor

Dan Karagiannis, associate editor

Teri Scaduto, assistant editor

Evelyn Rose, editorial assistant

Marc Spiwak, editorial associate

Joseph J. Carr, K4IPV,
contributing editor

Marc Ellis, contributing editor

Jeffrey K. Holtzman,
contributing editor

Don Jensen, contributing editor

Charles D. Rakes,
contributing editor

Marc Saxon, contributing editor

John Yacono, contributing editor

PRODUCTION DEPARTMENT

Ruby M. Yee, production director

Karen S. Brown,
production manager

Kathy Campbell,
production assistant

ART DEPARTMENT

Andre Duzant, art director

Russell C. Truelson, illustrator

Jacqueline P. Cheeseboro,
circulation director

Michele Torrillo,
POPULAR ELECTRONICS bookstore

**BUSINESS AND EDITORIAL
OFFICES**

Gernsback Publications, Inc.
500-B Bi-County Blvd.

Farmingdale, NY 11735

1-516-293-3000

FAX: 1-516-293-3115

President: **Larry Steckler**

**SUBSCRIPTION
CUSTOMER SERVICE/
ORDER ENTRY**

1-800-827-0383

7:30 AM - 8:30 PM EST

**Advertising Sales Offices
listed on page 136**

Composition by Mates Graphics

Cover by Loewy Design

Illustration by Robert Roper



Since some of the equipment and circuitry described in POPULAR ELECTRONICS may relate to or be covered by U.S. patents, POPULAR ELECTRONICS disclaims any liability for the infringement of such patents by the making, using, or selling of such equipment or circuitry, and suggests that anyone interested in such projects consult a patent attorney.

EDITORIAL

UPGRADING YOUR PERSONAL COMPUTER

If you regularly use a PC, and are like most of us, you've probably been tempted to toss aside your old, or not-so-old, machine for one of the new, flashy Pentium models. If you haven't already done so, it's probably because of one of the following three factors:

The first is money. It is tough to justify spending \$2000 to \$3000, or even more, if your old machine is working, and working reliably.

The second is convenience. It probably took you quite a while to set up your PC exactly the way you wanted it.

The third is fear. While the error discovered in the Pentium's floating-point unit last year has been corrected and Intel is offering replacement CPU's to those who request it, the mere existence of the error has stopped more than a few potential buyers dead in their tracks.

Whatever the reason, if you are looking for better performance or more features, but are reluctant to just replace your old computer, there are some practical alternatives, especially if you own a 486 machine. This month, **Popular Electronics** begins a series of occasional articles that explores those alternatives. Titled "Upgrading and Maintaining Personal Computers," the series looks into ways to improve your current PC's performance and extend its useful life via simple, relatively inexpensive upgrades.

The upgrades covered are things that almost anyone can do. Among other things, we will look at how to add multimedia capability to an older machine; how to install or replace floppy- and hard-disk drives; and much more. In this issue's first installment, we look at one of the easiest and most effective upgrades you can do: adding memory. The story begins on page 49.



Carl Laron
Editor

EARN YOUR B.S. DEGREE IN COMPUTERS OR ELECTRONICS

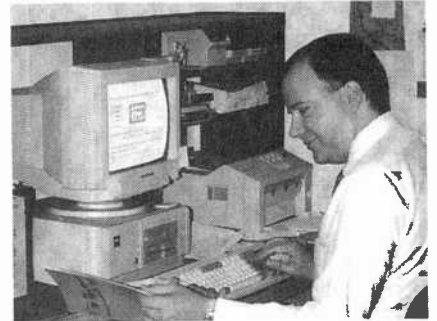

By Studying at Home

Grantham College of Engineering, now in our 45th year, is highly experienced in "distance education"—teaching by correspondence—through printed materials, computer materials, fax, modem, and phone.

No commuting to class. Study at your own pace, while continuing on your present job. Learn from easy-to-understand but complete and thorough lesson materials, with additional help from our instructors.

Our Engineering Technology B.S. Degree Program is available in either of two options:

- (1) The B.S.E.T. with Major Emphasis in Electronics, OR
- (2) The B.S.E.T. with Major Emphasis in Computers.

Our Computer Science B.S. Degree Program leads to the B.S.C.S.—the Bachelor of Science in Computer Science.

An important part of being prepared to *move up* is holding the right college degree, and the absolutely necessary part is knowing your field. Grantham can help you both ways—to learn more and to earn your degree in the process.

Write or phone for our free catalog. Toll free, 1-800-955-2527, or see mailing address below.

Accredited by
the Accrediting Commission of the
Distance Education and
Training Council

GRANTHAM
College of Engineering
Grantham College Road
Slidell, LA 70460

PLL ULTRASONIC CORRECTIONS

A reader named Larry King pointed out an error in Fig. 2 of my column on ultrasonic generators (**Popular Electronics**, January 1995, page 72). The positive lead of C11 should go to Q5's collector, not to its base. I hope that this error did not cause anyone too much confusion.—CHARLES D. RAKES

I am starting my senior year at the University of Dayton, majoring in electronics engineering technology. I plan to use ultrasonics in my senior graduation project, so I particularly enjoyed seeing the articles on ultrasonics that appeared in the December 1994 and January 1995 issues of **Popular Electronics**.

However, in the December issue, the schematics and parts list for the PLL Ultrasonic Generator (Fig. 3, page 73) and the Ultrasonic Receiver (Fig. 4, page 74) seemed to be transposed. I figured that Fig. 4 should be the schematic for the transmitter and Fig. 3 for the receiver, and the figure numbers in the Parts List were also reversed.

I just wanted to let other readers know about this error so that any confusion does not cause the usefulness of these versatile circuits to be overlooked.

I also found an inexpensive source for ultrasonic transducers. All Electronics Corp., P. O. Box 567, Van Nuys, CA 91408 (Tel. 800-826-5432) charges \$2 for a matched set of Panasonic transmitter/receivers with a center frequency of 40 kHz.

I'd like to see continued ultrasonics articles in the area of location/distance finders. R.P.

Dayton, OH

TUBE-AMPLIFIER POINTER

I enjoyed the tube-amplifier project in the January issue of **Popular Electronics**. However, I would like to point out that it is not advisable to try to force single-ended operation by disconnecting the plate of one tube, as the author suggests.

LETTERS

First of all, because the tube's heater and screen grid would still be energized, the electrons leaving the cathode would (I believe) migrate to the screen. That could destroy the tube.

Also, push-pull and single-ended output transformers are purpose-built and, for most intents and purposes, are not interchangeable.

D.S.

New York, NY

BEAM-AIMER MODIFICATIONS

Fred Blechman's article, "A DX Beam-Aimer Program" (**Popular Electronics**, January 1995) was very interesting to me. For 20 years, I did computer programming for a U.S. government mapping agency using geographic data. It appears to be a very good program.

As suggested by Mr. Blechman, I made several modifications to the program, in addition to modifying it for my Commodore 128 computer. (I also owned an American Motors automobile until two or three years ago!) I tried his suggestion of converting the input to degrees, minutes, and seconds, but it got too long. Besides, most maps that would be used for data don't show seconds. I also tried an optional input in degrees and decimal minutes, but it was also too long. It is easier to estimate, unless a large-scale map is used for data; then a calculator makes the conversion quickly. (I would suggest dividing minutes by 60 to get decimal degrees, rather than multiplying by 0.01667.)

I eliminated the "E" or "W" and "N" or "S" from the input, using a negative number for west longitude and south latitude. (That is the convention used by geographers and cartographers.) Even if I wanted to keep the "E" or "W" and "N" or "S" input, I would convert to negative numbers in the program, as it simplifies the

calculations. The modified program will also accept longitude as a positive number between zero and 360 degrees, which is frequently used.

I also eliminated the need to input whether point B is east or west of point A, determining that from an internal calculation. (That was the hardest part of my programming modifications.) Finally, I added an option to calculate more points before exiting the program.

If anyone is interested, I would be willing to send a disk with the Commodore program, for the same price as Mr. Blechman charges—\$5 U.S. and \$7 foreign. The program works correctly, giving the same output as in Table 2 of the article on both a Commodore 128 and a 64.

BILL STILES, CET
4599 Jarvis Road
Hillsboro, MO 63050

Bill also sent along the listing for the modified program. Unfortunately, space prevents us from printing it here. If you are interested in obtaining a copy, send a self-addressed, stamped envelope to Beam-Aimer, Popular Electronics, 500-B Bi-County Blvd., Farmingdale, NY 11735.
—Editor

HAVES & NEEDS

I would like to obtain a service manual or schematic/dial-cord stringing for a GE model T2280A AM/FM table radio. All responses will be answered. Thank you.

JAMES P. KOCH
3867 Kelley Circle South
Memphis, TN 38111

I am in serious need of schematics for a Gretsch Fury model, tube guitar amplifier. I contacted the nice people at the Gretsch factory, and was told that the offices had burned down twice since their inception, and most, if not all, of the amplifier schematics were lost. I have also called the folks at Groove Tubes; no luck there,

either. If anyone can help me, I would be happy to pay photocopy and mailing costs.

Thank you for your help.
MICHAEL EARHART
P. O. Box 181041
Arlington, TX 76096-1041

I need the operating manual and schematics for an Olson R-C analyzer model TE-189. Perhaps a fellow reader can help me. I will pay for copying costs and postage, of course.

Thanks.
ED ORTIZ
582 Rambla
Ponce, PR 00731

I have really enjoyed reading your articles since I picked up my first issue back in 1989. I've also enjoyed building various projects, which have helped me understand electronics. And it was **Popular Electronics** that inspired me to take the N.R.I.'s Industrial Electronics Course. Thanks for making that possible.

I went back through some past issues and found a circuit that I wanted to build. The article was "Build a Programmable Garage/Yard Light" (**Popular Electronics**, June 1990). However, when I tried to find the IC, LS7210, I was told that it is no longer made. I would like to know if anyone might have some LS7210's in their parts bins that I might buy? Again, thanks.

RUBEN L. GONZALES
1609 Willow Drive
Hearne, TX 77859

I've been given a Panasonic SW Double Superheterodyne Receiver, RF-B600. It performs well except that the frequency display doesn't work. Panasonic says that service information is unavailable, and so does Sams.

Can anybody give or sell me a service manual or circuit diagram, or some clues? Thanks in advance for any help that anyone can give me.
MELVIN M. LEVINE
2 Meadow Lane
Saranac Lake, NY 12983

The Four-Year Electronics Degree Program That Really Hits Home!

Bring The Technology Home With A Bachelor Of Electronics Engineering Degree. No Hassles. No High Cost!



Now's the time to prepare for a profitable career.

We've lowered the cost of higher education.

It's true! You can earn a four-year Bachelor of Electronics Engineering Technology degree today ... and prepare yourself for a high-paying electronics career ... without quitting your job or ever leaving your home. Because World College, an affiliate of the Cleveland Institute of Electronics, offers you the total flexibility of independent study programs proven effective for people like you who truly want to succeed! World College independent study lessons help you build valuable skills

**Mail/Fax Today
or Call
1-800-696-7532**

step-by-step, and expert instructors are personally available to you with a toll-free call. What a way to earn an education!

A world of opportunity.

Where is your career headed? With a four-year bachelor's degree from World College, you call the shots, choosing from incredible, high-paying opportunities in electronics, telecommunications, computer, electrical power, and many other growing fields.

World College gives you the skills, the knowledge, the power to take advantage of your best opportunity in electronics. And you can do it all at your own pace!

Without leaving home.

World College continually works to provide its students with the most advanced education tools. From the latest equipment and reference books to breakthrough computer-simulated experiments, students are exposed to the latest technological advancements.

All the equipment, parts, and software you need are included in your affordable tuition, including more than 300 hands-on lab experiments you can complete in your home.

Choose your own pace.

Earn your bachelor's degree on your time — and at your pace — because you pay tuition to World College only as you complete the upper-level semesters close to graduation. The faster you make it through, the less you pay. So you have an incentive to make your future happen quickly — yet the freedom to choose your own pace!

Send today for your FREE course catalog — and give yourself that future you've always wanted — with an electronics degree education from World College.

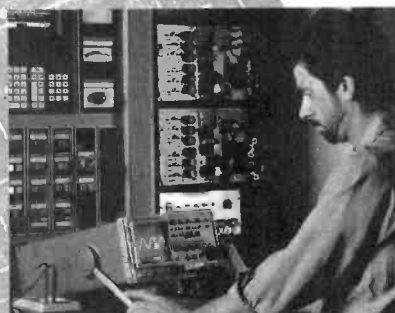

Take charge of your future in electronics.

Four Powerful Reasons To Connect With World College Today:

1. Earn your four-year degree!
2. Self-paced training!
3. Independent study in your home!
4. Expert instruction!

Give Me The Power!

Send me a FREE World College course catalog today!



(Please Print Neatly)

Name _____

Address _____

City _____

State, Zip _____

Phone () _____

Age _____

**For faster service, call
1-800-696-7532,
or call
1-804-464-4600.**

**Or fax this coupon to
1-804-464-3687.**



Lake Shores Plaza
5193 Drive, Suite 113
Virginia Beach, VA 23455-2500



Affiliated with
Cleveland Institute of Electronics
WAH19

MULTIMEDIA WATCH

By Marc Spiwak

Tiny Multimedia Toys

Multimedia comes in all sizes. In the past year I've seen some large multimedia accessories, including full-sized chairs (the Thunderseat), heavy speakers, and unusual joysticks. This month, however, I've got two items that are small in size but full of features.

First on my list is the *Vivid 3D Plus* from NuReality. I mentioned the Sound Retrieval System, or SRS, a few times in the past, and how it

licensed technology; they differ only in features. What's more, they are all very small and won't clutter up your workplace.

The unit I checked out was the \$99.95 *Vivid 3D Plus*. The unit accepts the line-level outputs from your sound card and drives a pair of powered speakers. The speakers are not included, but an AC power adapter and the hook-up cables are.

I've always liked the effect that SRS has on audio, and the *Vivid 3D Plus* did not disappoint. It is an inexpensive way to add a surround-effect to your multimedia audio, and since it is a line-level device, it can be used with regular audio and video equipment, too.

RENO

Media Vision's *Reno* portable CD-ROM drive is second on my list. *Reno* surely is a thing of the nineties. It's a sleek, portable CD-ROM player that doubles as a portable music CD player.

Reno is a double-speed drive with a very fast seek time of 180 milliseconds. That even beats many non-portable double-speed drives. It features a SCSI2 interface and will work with either a PC or Mac. For PC use, it comes with a SCSI interface card; Macs have the SCSI connector built in. *Reno* comes with rechargeable batteries, an AC adapter, headphones, and a carrying case.

The drive itself is about the same size as a regular,

portable CD player—maybe even a little slimmer. The back of the drive plugs into a SCSI-interface/battery-charger/AC-adapter docking station that links the drive to the computer. The docking station adds about 4 inches in length to the player. A SCSI cable connects from the back of the docking station to either the SCSI adapter card installed in a PC or to the SCSI connector in a Mac. An optional parallel-to-SCSI adapter is available that will let the *Reno* interface with a parallel port instead.

The player and docking station both have 13.5-volt-DC input jacks that the AC adapter can plug into; the jack on the docking station is used when the two are "docked." Two custom NiCd battery packs install in the docking station, and one pack installs in the player.

When power is applied, *Reno* will trickle charge all three packs over a period of about 30 hours. The unit can be used while it is trickle charging. There is also a quick-charge mode that charges the three battery packs in about 7 hours. The *Reno* can't be used while it's quick charging.

For portable use as a CD-ROM drive, *Reno* runs off the two packs in the docking station. When the player is removed from the station, it runs off its own single pack. The player is surprisingly light, even with the battery pack installed. When playing a music CD, the player resists skipping even when shaken, even



The *Vivid 3D Plus* generates realistic three-dimensional sound from only two speakers using SRS-licensed technology.

generates realistic three-dimensional sound from only two speakers. SRS really works, and it works with any audio source.

The only problem with SRS has been its price—SRS gear has been relatively expensive until now. But the *Vivid 3D* line—featuring four products with list prices ranging from \$79.95 to \$149.95—has changed all of that. All of the items in the line use the same SRS-

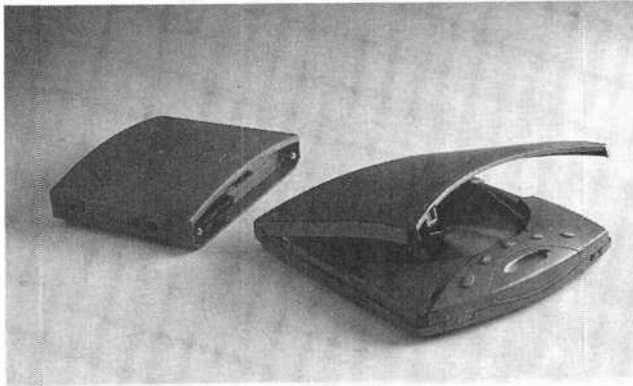

The Reno from Media Vision makes a great portable CD player, but it makes a better external CD-ROM drive.

though a firm lateral knock can cause it to jump.

When I first heard what Reno's list prices were going to be, I figured that nobody would want to risk carrying around such an expensive CD-ROM drive just to listen to music CD's. However, I've seen street prices as low as \$275, and even without a sound card, at that price I think it's an excellent toy. What's more important, however, is that Reno is a fine CD-ROM drive.

NEW STUFF

I recently received the new 1995 *Compton's Interactive Encyclopedia* on CD-ROM. It has been completely updated in its design and content and is easier than ever to use. Patrick Stewart from "Star Trek: The Next Generation" is a special on-line video guide. With street prices at about \$70, it is both an excellent gift and valuable thing to have at home.

The *Mega Movie Guide 3.0* from InfoBusiness has been updated to include movies produced up to and including summer 1994. Over 42,000 movie reviews are featured. Information on run time, rating, place of origin, availability on video, and more can be accessed. In addition, there are over 1000 in-depth reviews from movie critic Rex Reed. Almost two hours of

film clips are contained on the disc. It lists for \$49.95.

Activision has recently released *The Zork Anthology* collection on CD-ROM. The disc contains the five original Zork text adventure games for both the PC and the Mac. Zork has been around since 1979. It has a list price of only \$19.95.

I've been receiving lots of new CD-ROM titles from Creative Multimedia. The

Face of LIFE is a multimedia collection of classic images and covers from *LIFE* magazine from 1936 through 1972. *Smithsonian's America* is an interactive study of American history. *Who Killed Taylor French*, starring Sheryl Lee from "Twin Peaks," is fourth in a series of interactive murder mysteries. *Sports Illustrated For Kids* teamed up with Creative Multimedia to produce *The Everything You Want To Know About Sports Encyclopedia* on CD-ROM. Those discs range from \$29.99 to \$39.99.

If you're curious about earthquakes and want to see footage of the worst such recorded disasters, you will find *Earthquake* from Sony Imagesoft quite interesting. The disc contains over 40 minutes of video and thousands of photographs and sells for

\$59.95.

I recently judged a bikini contest. I made up my own rules as to what I felt were important attributes for contestants to have in my contest. The contest was held on the screen of my PC with a little help from Jasmine Multimedia's *Perfect 10 Bikini Contest* CD-ROM. The disc is fun, and even my wife got into judging the contest. However, my wife's contest rules were different than mine.

Every so often a CD-ROM comes along that really makes having a drive worthwhile. *Monty Python's Complete Waste of Time* from 7th Level is an awful lot of fun—for Monty Python fans, that is. The disc is packed with screen savers, icons, and all sorts of fun stuff to waste time with. Priced around \$59.95, this disc is a real gem. ■

WHERE TO GET IT

Activision
11601 Wilshire Blvd., Suite 1000
Los Angeles, CA 90025

Compton's NewMedia, Inc.
2320 Camino Vida Roble
Carlsbad, CA 92009

Creative Multimedia
513 NW 13th Ave., Suite 400
Portland, OR 97209

InfoBusiness, Inc.
887 South Orem Blvd., Suite B
Orem, UT 84058

Jasmine Multimedia Publishing
6746 Valjean Ave., Suite 100
Van Nuys, CA 91406

Media Vision
47300 Bayside Parkway
Fremont, CA 94538

NuReality
2907 Daimler Street
Santa Ana, CA 92705

7th Level, Inc.
1771 International Parkway
Suite 101
Richardson, TX 75081

Sony Imagesoft
2400 Broadway Ave., Suite 550
Santa Monica, CA 90404

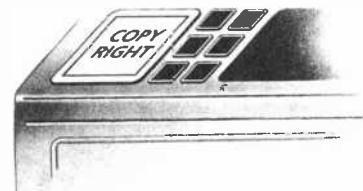

THE MOST
**AN IMPORTANT PART
OF YOUR PHOTOCOPIER
ISN'T PART OF
YOUR PHOTOCOPIER**

Having a machine may not permit you to photocopy books, journals, newsletters and magazines. The Copyright Clearance Center CAN. Contact us to find out how you too can COPY RIGHT!™

COPYRIGHT CLEARANCE CENTER

222 Rosewood Drive, Danvers, MA 01923 □ Tel. (508) 744-3350 □ Fax (508) 741-2318

© 1993 Copyright Clearance Center

900 MHz breakthrough!

New technology launches wireless speaker revolution...

Recoton develops breakthrough technology which transmits stereo sound through walls, ceilings and floors up to 150 feet.



Breakthrough wireless speaker design blankets your home with music.

By Charles Anton

If you had to name just one new product "the most innovative of the year," what would you choose? Well, at the recent *International Consumer Electronics Show*, critics gave Recoton's new wireless stereo speaker system the *Design and Engineering Award* for being the "most innovative and outstanding new product."

Recoton was able to introduce this whole new generation of powerful wireless speakers due to the advent of 900 MHz technology. This newly approved breakthrough enables Recoton's wireless speakers to rival the sound of expensive wired speakers.

Recently approved technology. In June of 1989, the *Federal Communications Commission* allocated a band of radio frequencies stretching from 902 to 928 MHz for wireless, in-home product applications. Recoton, one of the world's leading wireless speaker manufacturers, took advantage of the FCC ruling by creating and introducing a new speaker system that utilizes the recently approved frequency band to transmit clearer, stronger stereo signals throughout your home.



Crisp sound throughout your home. Just imagine being able to listen to your stereo, TV, VCR or CD player in any room of your home without having to run miles of speaker wire. Plus, you'll never have to worry about range because the new 900 MHz technology allows

150 foot range through walls!

Recoton gives you the freedom to listen to music wherever you want. Your music is no longer limited to the room your stereo is in. With the wireless headphones you can listen to your TV, stereo or CD player while you move freely between rooms, exercise or do other activities. And unlike infrared headphones, you don't have to be in a line-of-sight with the transmitter, giving you a full 150 foot range.

The headphones and speakers have their own built-in receiver, so no wires are needed between you and your stereo. One transmitter operates an unlimited number of speakers and headphones.

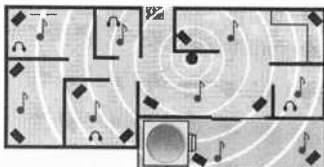

Recoton's transmitter sends music through walls to wireless speakers over a 75,000 square foot area.

stereo signals to travel over distances of 150 feet or more through walls, ceilings and floors without losing sound quality.

One transmitter, unlimited receivers. The powerful transmitter plugs into a headphone, audio-out or tape-out jack on your stereo or TV component, transmitting music wirelessly to your speakers or headphones. The speakers plug into an outlet. The one transmitter can broadcast to an unlimited number of stereo speakers and headphones. And since each speaker contains its own built in receiver/amplifier, there are no wires running from the stereo to the speakers.

Full dynamic range.

The speaker, mounted in a bookshelf-sized acoustically constructed cabinet, provides a two-way bass reflex design for individual bass boost control. Full dynamic range is achieved by the use of a 2" tweeter and 4" woofer. Plus, automatic digital lock-in

tuning guarantees optimum reception and eliminates drift. The new technology provides static-free, interference-free sound in virtually any environment. These speakers are also self-amplified; they can't be blown out no matter what your stereo's wattage.

Stereo or hi-fi, you decide. These speakers have the option of either stereo or hi-fi sound. You can use two speakers, one set on right channel and the other on left, for full stereo separation. Or, if you just want an extra speaker in another room, set it on mono and listen to both channels on one speaker. Mono combines both left and right channels for hi-fi sound. This option lets you put a pair of speakers in the den and get full stereo separation or put one speaker in the kitchen and get complete hi-fi sound.



These wireless stereo headphones have a built-in receiver.

Factory direct savings. Our commitment to quality and factory direct pricing allows us to sell more wireless speakers than anyone! For this reason, you can get these speakers far below retail with our 30 day "Dare to Compare" money-back guarantee and full one year manufacturer's warranty. For a limited time, the Recoton transmitter is only \$69. It will operate an unlimited number of wireless speakers priced at \$89 and wireless headphones at \$59 each. Your order will be processed in 72 hours and shipped UPS.

Recoton Transmitter (you must have a transmitter to operate speakers and headphones).....\$69 \$7 S&H
 Wireless products compatible with the Recoton transmitter:
Recoton Wireless Speaker.....\$89 \$9 S&H
Recoton Wireless Headphones.....\$69 \$6 S&H
 Please mention promotional code 165-PL114

For fastest service call toll-free 24 hours a day

800-992-2966



To order by mail send check or money order for the total amount including S&H (VA residents add 4.5% sales tax). Or charge it to your credit card by enclosing your account number and expiration date. Send to:

CONTRAD INDUSTRIES

2820 Waterford Lake Drive Suite 106
 Midlothian, Virginia 23113

AWARD WINNING WIRELESS SPEAKER

Built-in receiver and amplifier:

The wireless speaker and headphones both contain a built-in receiver and amplifier. Signals are picked up and transmitted as far as 150 feet away through walls without the use of wires.



Volume Power Tuning Tuned ports
 2" tweeter
 4" woofer
 Individual left, right & mono switch and Individual bass boost control (on back)

Size: 9"H x 6"W x 5.5"L
 Signal-to-noise ratio: 60 dB
 Channel Separation: 30 dB
 Two-way bass reflex design
 10 watts/channel RMS amps
 Frequency Response: 50 Hz-15 KHz

Don't take our word for it. Try it yourself. We're so sure you'll love the new award-winning Recoton wireless speaker system that we offer you the Dare to Compare Speaker Challenge. Compare Recoton's rich sound quality to that of any \$200 wired speaker. If you're not completely convinced that these wireless speakers offer the same outstanding sound quality as wired speakers, simply return them within 30 days for a full "No Questions Asked" refund.

Recoton's Design and Engineering Award



GIZMO®

A CHRONICLE OF CONSUMER ELECTRONICS

At Home With Home Theater

The movie industry rates films by specific, objective criteria—violence, sex, adult language, adult situations, and nudity. The resulting ratings—G, PG, R, NC-17, or X—allow parents to judge whether a film is appropriate for children to view, and whether their own sensibilities might be offended by a film's content. But when adult viewers are debating whether or not to venture out of their comfortable homes to stand on a long line and shell out \$7 or more each—not including refreshments—at a movie theater, those ratings play a small role in the decision-making process. Most of us use our own "rating system," based on the answer to one question: Is the movie a "theater" picture, or should we wait for it to come out on videotape?

The answer to that question is purely subjective. Some folks like to see comedies in a theater; somehow, they seem funnier when everyone else is laughing too. Other people prefer not to hear an audience howling with laughter—it makes it difficult to hear all the jokes. We know people who rush out to see critically acclaimed independent or foreign films, knowing that those are not likely to ever make it to the shelves at Blockbuster.

Some movies, however, definitely cry out for a theater setting. That's why such a large percentage of box-office hits are action/adventure films—those movies have big-screen appeal. Frame-by-frame, the fast-moving action fills the screen, while the soundtrack fills the theater. Moviegoers feel as if they are right in the thick of things.

It's no longer necessary, however, to go to a movie theater to capture that total experience. You can recreate the experience in your living room, with your own home theater. Virtually every audio/video manufacturer has jumped on the home-theater bandwagon, and all the equipment you need to set up your own home theater is readily available at your local home-electronics store.



The only missing ingredient is the know-how to put it all together. That's where we come in. This issue of *Gizmo* is devoted solely to home theater—what it requires, what it costs, what features you should look for, and how you can connect all the pieces into a seamless system. Our home-theater overview is followed by hands-on reviews of several possible component choices.

GETTING DOWN TO BASICS

The goal of every home-theater installation is to create a theater-like setting: high-quality video to keep your eyes glued to a large screen, and a realistically reproduced soundtrack that makes you feel as if you're part of the action. How that goal is achieved, however, depends on several factors. At the top of the list are the size of your budget and the size of your viewing area. Also important is the level of sophistication that you and your family prefer—do you want all the bells and whistles,

or is ease of use a top priority?

Fortunately, there are components to meet every budget, every room configuration, and every level of sophistication. (See the "National Home-Theater Award Search" box for a look at award-winning systems in widely differing price ranges.) The idea is to follow some basic guidelines to create a system that's right for *you*—and your home and family.

No matter how large or small the system, home theaters all start out with the same basic components. Front and center is a large-screen TV—27 inches or larger. That is augmented with a sound system consisting of an A/V receiver with a built-in or separate surround-sound processor and a minimum of four speakers. A Hi-Fi VCR and/or a laserdisc player round out the system.

As you can see, all of the components are truly basic—in fact, you might already have some, or even most, of them in your home. Be sure to take a good look at what



Why suffer from long lines, expensive prices, sticky floors, and noisy neighbors at your local multiplex cinema when you can get the same movie-theater experience in your own home? This Pioneer system, consisting of a 50-inch rear-projection television, a matched set of small home-theater speakers, a CD/laserdisc combi-player, and an A/V receiver, fits unobtrusively in a family room to provide a comfortable, private viewing experience.

you currently own, with an eye toward incorporating it into your home theater, before you begin to shop.

You'll also want to be armed beforehand with some knowledge about what you want from each component. The selection of products in each category is overwhelming, and trying to put it all together into one coherent system can be truly daunting. To remove some of the confusion, and make you less likely to fall for eager sales pitches, let's examine what your options are, and what features to look for, in each category.

THE BIG PICTURE

In the video category, you will need one or more video sources, and a television or monitor on which to view them. The idea is to get the best and biggest picture for your viewing environment. That means select the best quality video sources that your budget will allow, and match the screen size to your room size.

Depending on where you live, cable television offers equivalent video quality, but more programming than you can get with a broadcast-TV antenna. Satellite television—whether from a standard large dish or one of the new small-dish digital services—provides significantly better picture and sound quality, and the most programming choices.

For viewing prerecorded movies, a laserdisc player offers the best video and

CD-quality audio. Next in line is a Super-VHS VCR; last choice is a standard VHS VCR.

As for your TV, bigger is not necessarily better. If you sit too close to a super-large screen, particularly a projection screen, imperfections in the picture can become so obvious as to become a distraction.

Television/monitor. This will be the focal piece of your home theater, and the item on which you probably will spend the most money. There are two basic requirements—the screen must be the right size for the room, and the set must be stereo—

and three basic options—direct-view, rear-projection, or front-projection.

The optimum screen size corresponds directly to the distance between it and the furniture from which you will watch it. To determine the correct size screen for your viewing room, the first step is to decide the placement of the TV and the sofa. Measure the distance from the screen to the headrest on the sofa; it should be between four and six times the height of the picture. That translates to approximately 2.5 to 3.5 times the diagonal measurement of the screen. If, for instance, your sofa is 15 feet (180 inches) from the TV, the proper screen size could range from 52 to 72 inches (six feet).

Also consider your viewing preferences. Do you head for the front row in a movie theater for a total sensory experience, or do you prefer the perspective offered from the back? Select the largest size within the recommended range for that close-up feeling, or the minimum size to retain some distance from the on-screen events.

If possible, situate the sofa so that it is parallel to, and centered with, the screen. The angle of vision is an important factor in viewing, particularly with a projection system. Try not to set any seating at an angle of more than 30° on either side of the screen.

When using your existing television in a new home-theater system, you might need to arrange the furniture to fit the screen size. In its "Consumer Guide to Home Theater" videotape, Dolby Laboratories offers a simple method of determining furniture placement based on screen size.

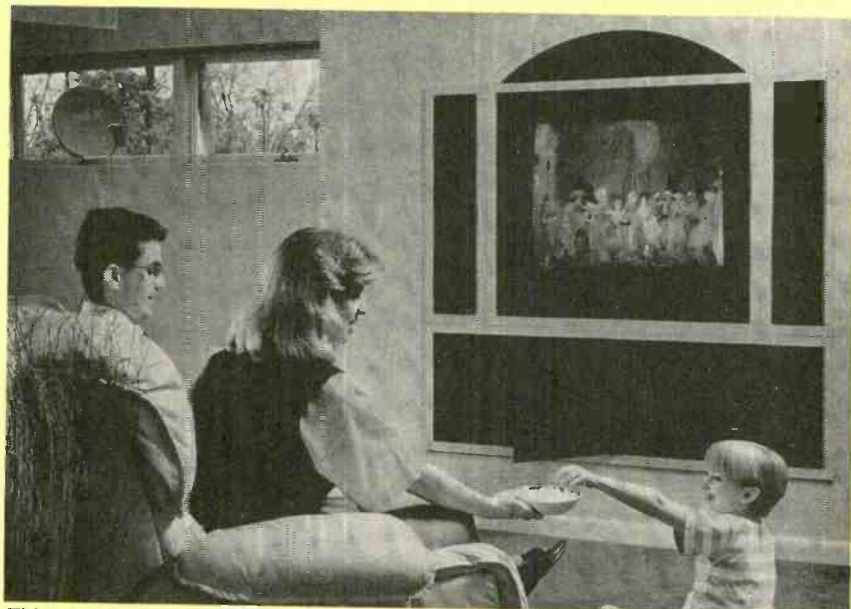

This custom home-theater in-wall system is linked to the RCA DSS digital satellite receiving system with its 18-inch dish antenna. The system includes a built-in 35-inch color TV, a Dolby Pro Logic surround-sound receiver, and audio/video components, all controlled by a single remote, for a suggested retail price of under \$8000. The DSS system is priced from \$699.

Measure the *width* of your TV screen and mark off a square with each side four times that width. Ideally, the screen should run along the center of one side of the square, and the back cushion of the sofa (where the viewer's head would be) should be centered on the side opposite the screen. That might mean placing the sofa away from a wall to be close enough to the screen. In a large room, you might want to divide the furnishings into separate seating areas for home-theater and other activities.

If your room is large and you intend to buy a new TV to fit the scale of the room, one part of your TV-purchasing decision has been made for you—a direct-view set will not be big enough for your home theater. Mitsubishi manufactures the largest commercially available direct-view TV, a 40-incher; 35-inch sets are much more common. Although their size is limited, direct-view sets offer the brightest, highest-contrast picture, which is particularly important if you watch television during the day or prefer to leave some lights on. Larger rooms, however, demand either a front- or rear-projection set.

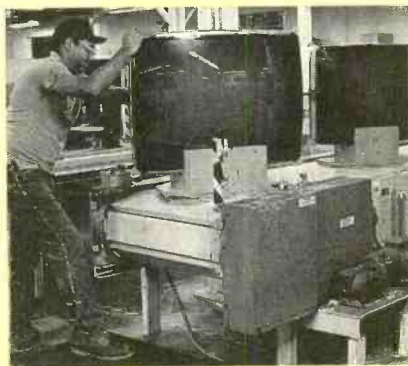

The 40-inch cathode-ray tube, shown being assembled in Mitsubishi's Braselton, GA, plant, is 31% larger in screen area than the 35-inch CRT pictured next to it.

Front-projection systems, which offer the largest size picture (up to 25 feet diagonally), usually have two separate pieces: a projector and a screen. Although placing two pieces might seem like twice the work, it's possible to install them so that they are practically invisible. Some manufacturers build projectors right into coffee tables. Other projectors can be ceiling mounted, or, where there is enough headroom, can be mounted on a lift that disappears into the ceiling when not in use. Screens, of course, can be rolled up and hidden in a soffit or a specially built cabinet; some are even remote controlled. Although it's possible to project the picture onto a blank wall, screens have special reflective surfaces to enhance the picture image.

There are two different types of front projectors available. With LCD proj-



Sharp's LCD projection system, the SharpVision XV-H35U, features a space-saving design that allows the projector to be ceiling-mounted.

ectors, the image produced by a liquid-crystal display is magnified for projection onto a screen. Other projection systems use three separate, ultra-bright picture tubes to create the three primary television colors—red, green, and blue—which are focused through a system of filters and lenses and projected onto the screen as a single, full-color picture.

Rear-projection sets also use a three-tube system, but the projector, optics, and screen are housed in one unit. Diagonal screen sizes typically range from about 40 inches up to six feet, so it's not surprising that such sets are becoming the most popular home-theater choices.

With rear-projection sets, however, the screen size is not the only measurement that must be considered. Although some leading manufacturers are now producing short-focus CRT's, which serve to keep cabinet size as narrow as possible, projection cabinets are generally deep as well as wide. It's important to make sure that the set will fit through your door and into your furniture layout. It isn't uncommon, particularly in custom installations, to build a false wall around the rear-proj-

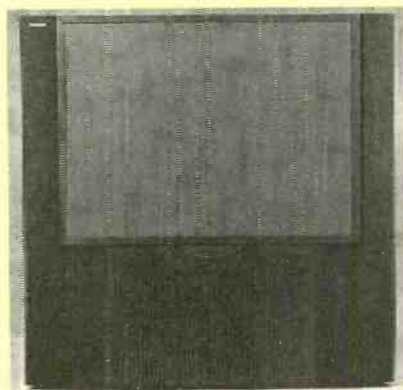

This Thomson ProScan 52-inch rear-projection television takes up less floor space with its new slim-design cabinet. The set offers built-in Dolby Surround Sound and front-firing speakers.

ection set. Shelves to house audio and video components and front speakers can be set into the false wall, for a clean, unified look.

Once you've decided which type of television to go with, you need to decide what features you want. Full stereo capability is an absolute must for any home-theater TV. Picture-in-picture is now common; top-of-the-line models even offer two tuners, so that you can watch two programs without connection to a separate video source. Also frequently offered are on-screen menus for adjusting video settings, programming favorite channels, and otherwise customizing your viewing via remote control. Many sets come with universal remotes that can be used to control several audio and video components along with the TV. Some sets are, in effect, complete home-theater systems in a box, offering a built-in Dolby Pro-Logic surround-sound decoder and a center-channel speaker along with the amplifiers needed to power the included front-left and -right and rear-surround speakers.

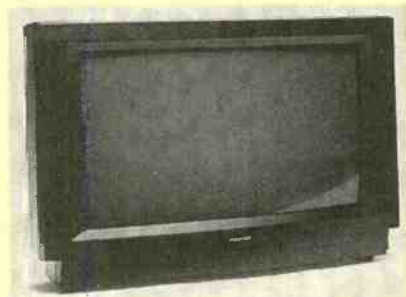

Widescreen TV's, such as Proton's 34-inch DT-3360 digital monitor/receiver, require a different formula for determining how far you can comfortably sit from the screen.

Some front-projection sets, however, not only lack stereo amplification and speakers, but also have no television tuner. They are merely projectors that must be connected to a video source and audio equipment. Others offer built-in tuners, speakers, stereo amplifiers, and even Dolby Surround decoders. Some also feature "line doublers," which create twice the number of scan lines for a smoother, clearer on-screen image that allows the viewer to sit much closer to the screen.

Yet another option in today's televisions is the widescreen set. Instead of the standard 4:3 aspect ratio, widescreen sets are intended to more closely match the aspect ratio of motion pictures: 16:9. They are increasing in popularity as more program material is becoming available in 16:9 format, primarily on laserdisc.

The formula for determining the distance between screen and viewer changes when you select a widescreen set. Because its height is slightly less than half its diag-

NATIONAL HOME-THEATER AWARD SEARCH

When considering what type of home theater would work best in your own home, you might want to take a peek at some of the systems judged the best in their categories in the National Home-Theater Award Search. *Video Magazine* and the EIA/CEG reviewed hundreds of entries in four categories—under \$1500, \$1500–\$3000, \$3000–\$5000, and over \$5000.

"While the more expensive home-theater systems often get a lot of attention, home theater is available in many price ranges, and people can install it themselves," said Gary Shapiro, group vice president, EIA/CEG. "Our contest's four outstanding, winning systems are great examples of the wide variety of home theaters that are out there—from small, self-installed systems to large custom-designed and -installed systems."

The entries were judged for originality and aesthetics of the system's decor and its components, as well as by the owners' written descriptions explaining what makes their systems special. The results clearly illustrate that home theater is nothing if not versatile. The possibilities are endless, and as individual as the people who create and use them. Let's take a look at the four contest winners and their systems.

The system that Brad Tompkins, of House Springs, MO, put together cost less than \$1500 in a house he shares with a roommate. For privacy's sake, Brad's bedroom doubles as his living room—and now as his home theater. His system, consisting of a Zenith TV, a Pioneer laserdisc player and A/V surround-sound receiver, an RCA Hi-Fi VCR, and Infinity front speakers, all fits neatly in one corner of the room. A pair of JBL rear speakers rounds out the system. Brad's small, compact system "has all the vital ingredients of an impressive, larger home theater."

Tito M. Famacion, of Daly City, CA, complained that his family's "home atmosphere was boring" until they set up a home-theater system from scratch. Their winning (in the \$1500–\$3000 cat-

egory) system, complete with Toshiba 26-inch TV, Pioneer laserdisc player, Sharp Hi-Fi VCR, Bose front speakers, DCM center-channel speaker, Pioneer rear speakers, Carrera subwoofer, and Sony A/V receiver, has changed all that. Now the family is "closer than ever, as we are together most of the time enjoying the movies and music from our home-theater system."

Donald R. Thomson, of Glenford, NY, faced quite a challenge in designing a home theater to fit in his circa-1826 post-and-beam house. It had to blend in with such decorative antiques as a pipe organ and a spinning wheel, and architectural details including a sloping, beamed ceiling and a huge, rustic hearth.

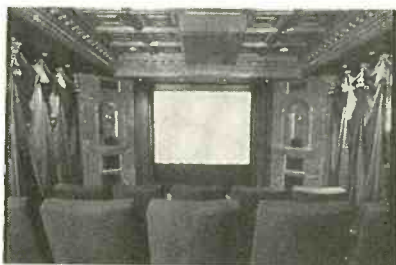

At the high end of the home-theater spectrum is the over-\$5000 award-winning system, designed to resemble a plush, old-fashioned movie palace.

His solution: an entertainment center built into a wall of bookshelves, behind "Dutch doors" that slide open into an overhead pocket. With the doors closed, you'd never guess that they conceal a 46-inch screen. The system includes a Hitachi rear-projection TV, a Pioneer A/V receiver with surround sound, a Panasonic Hi-Fi VCR, Yamaha front and rear speakers and subwoofer, and Advent center speakers.

The winning system in the over-\$5000 category is a luxurious, Victorian-style theater, complete with drapery and three rows of theater-style seats. Designed by Charles Clark from ASID, and Suzanne Hudson from The Design Center, Douglasville, GA, the system includes a Harmon video projector and line-doubler, a Stewart 100-inch screen, a Yamaha DSP audio/video processor, four Parasound power amps, a Mitsubishi Hi-Fi VCR, a Pioneer laserdisc player, and a Miller & Kreiser subwoofer and high-pass filter. Accessories include a Panamax AC line conditioner, Makita drapery motors, and a Macro Corporation lighting/dimming panel. Says the homeowner, the theater is "a constant source of entertainment." Its "unparalleled surroundings" are enjoyed by the entire family, as well as friends and church groups.

Each contest winner was awarded a plaque and a Sony laserdisc player to add to his home theater. ■

onal size, a distance of four times the height would be about two times the diagonal. In our example (15 feet between sofa and screen), that formula would suggest using a seven-foot diagonal screen. However, many widescreen sets incorporate line doublers, which allow you to sit at half the distance that would normally be recommended—a 1:1 ratio between screen size and distance—meaning that a 15-foot diagonal picture would be acceptable in our example.

Video Sources. A laserdisc player should be your first choice of video source. However, outside of urban areas, the selection of video discs available for sale or rental is often scanty, particularly when compared with videotape availability. So, even if you already own, or are planning on purchasing, a laserdisc player, you'll want a VCR as well—for the ability to record programming off the air, as well as for the superior selection.

Even the least-expensive laserdisc player will provide far better video and audio quality than the best VCR. As the price goes up, more features are added. Although all laserdisc players also play CD's, for versatility, you might want a player that also offers a CD changer. For convenience, double-sided play can't be beat: Both sides of a disc can be played without the viewer having to get up and manually flip the disc over. It's also possible to get a player with plenty of "bells and whistles"—special video effects and editing functions, for instance.

The only feature that a VCR *must* have to fit into your home-theater system is full stereo capability—look for "Hi-Fi Stereo" marked on the front panel. But there are a lot of other features that can improve a deck's home-theater performance. At the top of the list is Super VHS, a technical refinement that produces a picture with higher resolution than normal VHS. (Note, however, that a high-resolution television with an S-Video input is needed to take full advantage of an S-VHS VCR.) Four heads are better than two: they provide clearer freeze frames and slow-motion special effects (of course, virtually all stereo decks also have four video heads). Digital tracking automatically makes adjustments to compensate for differences in tapes recorded on other units.

Other VCR features won't necessarily improve your home-theater experience, but can be important nonetheless. Those include easy programming; today's almost universally available on-screen menus make timeshift recording easy. Built-in VCR Plus+ is becoming more common, and makes it even easier to record programs. A front-panel camcorder jack is convenient for editing and playing back home videos, and you might want to look for advanced tape-editing functions as well.



The winner of the \$1500–\$3000 category in the National Home-Theater Award Search is this deceptively modest system in the Daly City, CA, home of Tito M. Famacion.

SURROUNDED BY SOUND

Video is only half of home-theater. Without realistic audio, the experience falls flat. In fact, the advent of a standardized audio system that recreated the sound systems used in movie theaters played even more of a role in the home-theater boom than the advent of large-screen TV. That system, of course, is Dolby Surround Sound, now widely available in its updated form, called Dolby Pro Logic. (For an in-depth look at home-theater sound, see the "Sound Decisions" box.)

Look for the Dolby Pro-Logic logo when buying a surround decoder. Such decoders come in several forms: You can buy a stand-alone unit or purchase a TV or an audio/video receiver with a built-in decoder. In general, if you're building a full-scale home theater/audio system from scratch, you'd look for a Dolby Pro-Logic A/V receiver. Dolby Surround Sound isn't

SOUND DECISIONS

Dolby Surround Sound is the audio standard that has brought home theater to life, wrapping viewers in the realistic sound that the moviemakers intended them to hear in the theater environment. The idea is to heighten the illusion of reality with lifelike sounds that correspond to the images on screen. Correctly mastered, a soundtrack can lend a three-dimensional quality to a film, while conveying a realistic sense of speed and motion.

Movie soundtracks are recorded in four channels. Using Dolby Laboratories' process, the four channels are encoded, combined, and printed onto two audio tracks on the same 35mm film as the movie's images. At a movie theater equipped for Dolby Stereo playback, those two channels are decoded into four channels that are then routed to a center channel for dialog, left- and right-front channels, and a rear (surround) channel that comes through speakers arrayed in the back, and usually along the sides, of the theater.

When a film is recorded onto videotape or laserdisc, so is the encoded soundtrack. If your audio system is equipped with a Dolby Surround Sound decoder, all you need to recreate that cinema sound in your home is a set of speakers.

The original home Dolby Surround Sound decoders, which became available in the mid-1980's, offered three channels—left, right, and surround. A "phantom" image was created to compensate for the missing center channel. Today's Dolby Pro-Logic decoders, however, include the center channel for dialog, along with front-left and -right channels, and a mono surround channel that's played through a pair of rear speakers. A subwoofer is often added to reproduce the low-frequency sounds from all four channels.



Available from Dolby Laboratories, the "Consumer Guide to Home Theater" videotape not only explains how surround-sound works, but also shows viewers how to set up a working home theater, including how to hook up all the components into a smoothly integrated system.

encoded only on movies and TV programs; such a receiver will allow you to take full advantage of the many compact discs and broadcast radio programs available in surround-sound. For a smaller-scale home theater, intended primarily for viewing (as opposed to serious music listening), you might consider an all-in-one Pro-Logic TV package. If you already own a large-screen TV and a good audio receiver, you'd probably opt to add a stand-alone Dolby Pro-Logic decoder.

Audio/Video Receivers. We prefer to use an audio/video receiver designed for home-theater applications. Besides providing Dolby Pro-Logic, such a receiver should serve as command central for all your audio and video components—TV, VCR, laserdisc player, compact-disc player, tape deck, satellite receiver, and speakers. It should also come with a universal remote, to make it easy to use each and every one of those other components. The A/V receiver should incorporate the amplifiers needed to drive all five of the speakers, as well as an optional subwoofer output.

Because the A/V receiver plays such an important role in your home theater, it's vital that everyone in the family can easily learn to use it. (You certainly won't want to be in charge of switching from VCR to laserdisc to CD player to Nintendo every

time someone else wants to use the system!) If the receiver's remote will be used to control the other devices in your system, be sure it has clearly marked keys and is easy to use.

There are a few other features that aren't required for home theater, yet can enhance your system's performance and/or convenience. For instance, some home-theater receivers offer on-screen guides to simplify setup. "Multiroom" receivers can control not only the home-theater system in your living room, but also can route video and audio signals to other rooms in the house. That way you can watch a ball game in the living room while your son watches music videos (played on the laserdisc player located in the living room) upstairs in his bedroom. Digital signal processing (DSP) is used to recreate the ambience of different listening venues. Switch to stadium for watching a football game, arena for a live concert music video, or club for a jazz CD.

Speakers. According to Dolby, the goal in setting up a home-theater audio system is to create a wide, diffuse, "cloud" of sound, so that the viewer can be surrounded by sounds such as wind, rainfall, or crowd noises. At the same time, you must create the directionality needed to hear a plane pass overhead, from one side of the room to the other. But the dialog must anchor your attention to the screen. It should not play second-fiddle to the sometimes overwhelming surround-sound effects.

It is possible to create a decent effect with just four speakers (front right and left, surround right and left), as was done in the original Dolby Surround Sound systems. However, the fifth (center) speaker used with Dolby Pro-Logic creates a significantly more realistic soundfield—we consider five speakers to be the minimum for an average-sized home theater. In large rooms, additional surround speakers might be required. Regardless of room size, the addition of a subwoofer can greatly enhance the low-frequency response of the system, lending a rumbling realism to the roar of an engine or the pounding of horses' hooves.

There is an incredible selection of speaker styles available today, including full-size, bookshelf, and in-wall models. Each has its place in home-theater. When deciding which ones are right for your system, you'll want to consider where you will be putting them. Are you using a home-theater entertainment center that has shelf space set aside for the center and front speakers? That would dictate what size speakers you could buy. Do you prefer to keep your system as unobtrusive as possible? In-wall speakers would be the best bet, followed by tiny wall-mount or bookshelf units (perhaps ones that match

World's first wireless home theater system makes professional-quality surround sound affordable...

Now you can add surround sound to your home entertainment lineup with the amazing new Chase Technologies decoder that works with your existing stereo and an assortment of wired and wireless speakers.

by John Lindner

Let's face it. As much fun as renting a video can be, it's just not the same as seeing a movie in a theater. I remember the first time I saw *Jurassic Park*—I nearly jumped out of my seat when the dinosaurs roared. One of the reasons movies seem so real is because surround sound makes it seem

The secret of surround sound

Surround sound has become the rage of the '90s because it adds depth and realism to stereo sound, giving you the home theater experience. In short, it makes you feel like you are actually at a concert or a theater.

To get surround sound, some people have tried simply adding additional speakers to their home entertainment lineup. But it takes more than additional speakers to get surround sound; there needs to be a way of separating the original signal into distinct channels so that you're not just duplicating the same sounds and broadcasting them from different areas of the room.

The new Chase Technologies HTS-1 surround sound decoder does just that, and in a revolutionary way that rivals the best Dolby Pro-Logic and THX systems available. The HTS-1 provides five channels of sound from any two-channel stereo source.

The HTS-1 works with a variety of speakers. In the front, you can use your existing stereo speakers. For the rear, choose from inexpensive wired speakers, high-quality wireless speakers, or even an audiophile-quality wireless satellite subwoofer system. The HTS-1 also gives you the ability to add a powered center channel speaker (instead of using your TV's built-in speaker).



like you're actually there when events are happening. Now there's an incredible new device that lets you use your stereo receiver to get that same surround sound in your home.

The secret's in the signal. To get surround sound, you need to do more than simply add extra speakers. There needs to be a way of separating the signal from the musical score or movie soundtrack into distinct channels for each speaker. The new Chase Technologies HTS-1 surround sound decoder does just that, and in a revolutionary way that rivals the best Dolby Pro-Logic and THX systems available today.

Wins over critics. In the September 1994 issue of "High Performance Review," noted audio critic Daniel Kumin said "the HTS-1 can do quite a job of recreating a 3D theatrical experience...surround effects emanated with satisfying fullness...sound was clean at any level...with quite involving and natural sound ambience."



The new HTS-1 decoder won the *Design and Engineering Award* at the *Consumer Electronics Show* for being one of the best and most innovative new products.

Decoding breakthrough. Last year, audio industry veteran Bob Rapoport invented a new five-channel "passive" circuit for decoding the *Dolby Surround™* signals in every stereo, videotape or laserdisc. This passive method is superior to active decoders such as Dolby and THX because it requires no AC current to decode. As a result, you experience more clarity, more detail, and a greater sense of space. Plus, you won't experience the noise or distortion which can occur with active decoding methods. You don't need any extra amps! Just connect the HTS-1 to your stereo, add your speakers, and you'll experience the magic of home theater at a fraction of the cost of other systems.



Five channel options. The HTS-1 decoder can be used with two, three, four or five channels of amplification, making it the most cost effective method for upgrading your stereo system to full home theater performance on the market. Best of all, the HTS-1 works with a variety of hard wired and wireless speakers.

In the front, most people use wired stereo speakers. Use your existing stereo's speakers or use one of a variety of wired speakers. Comtrad also offers the Chase Dialog center channel speaker. If your front speakers are more than eight feet apart, adding a center channel speaker will help keep voices and sound effects centered on the screen for stunning localization and clarity. The Dialog is self powered and video shielded to prevent interference with your television set.

The Chase HTS-1 decoder is the most cost-effective method for upgrading an existing stereo system to full home theater performance on the market.





The new Chase Technologies HTS-1 surround sound decoder gives you the option of using either traditional wired speakers like the Chase ELF-1s, or using wireless speakers or a wireless satellite subwoofer system for additional convenience and enhanced sound quality.

Speaker Options

Wired Speaker Options

Front Speakers: The Chase HTS-1 surround sound decoder can utilize your existing stereo speakers, or any of a variety of wired speakers available through Comrad or your local electronics dealer.



Center channel speaker. If the front speakers are more than eight feet apart, adding a center channel speaker will keep voice cues centered on the screen. We offer the Dialog. It is self-powered and video shielded to prevent interference with TVs. Dialog \$75 \$8 S&H



Rear channel speakers. We recommend the quality Chase ELF-1 in either white or black for inexpensive rear channel speakers. Mount them with the enclosed color-matched mounting brackets or flush mount them on the wall. ELF-1\$99/pair \$10 S&H

Wireless Speaker Options



Rear channel speakers. Recoton W440 wireless speakers are the perfect option for people who want quality stereo rear channel speakers without having to run speaker wire. Their two-inch tweeters and four-inch woofers deliver 10 watts per channel—clear, strong stereo fill sound. The speakers work up to 150 feet from the transmitter without loss of sound quality. TX1000 transmitter (works unlimited speakers)\$69 \$7 S&H
W440 wireless speaker (each) ... \$89 \$9 S&H

Get the Chase HTS-1 half off (\$49) when you buy the W440 speaker system!



Rear channel speakers. For true audiophile-quality rear channel speakers, we offer the Recoton wireless satellite subwoofer system. This first-of-its-kind system combines a 10-inch rear-firing subwoofer with a pair of 25-watt satellite speakers. The subwoofer provides that distinctive "low-end punch" that you feel in movie theaters, while the satellites are designed to coincide



with surround sound processor specifications balance perfectly with the front speakers. WHT470 transmitter ... \$69 \$7 S&H
WHT421 wireless 50-watt subwoofer \$299 \$24 S&H
WHT462 pair of wireless 25-watt satellite speakers \$329 \$24 S&H

Get the Chase HTS-1 FREE when you buy the satellite subwoofer system!

Wireless freedom. When it comes to rear speakers, you can again choose standard wired speakers like the Chase ELF-1s. But if you want to avoid the hassle of running speaker wire up and down walls, behind furniture, and under carpet, you can add the freedom and convenience of wireless speakers.

Recoton wireless speakers utilize a transmitter which broadcasts sound signals up to 150 feet through walls, floors and ceilings. The speakers can be placed anywhere; they plug into a standard electric outlet. This eliminates the need to have wires running from the stereo to the speakers, which can be a nuisance with surround sound since the rear speakers are often elevated or wall mounted.

Affordable option. Recoton's W440 speakers allow you to add wireless rear channel speakers without compromising the sound quality that wired speakers deliver. Each self-amplified speaker contains a two-inch tweeter and four-inch woofer. They deliver 10 watts per channel for strong, clear fill sound. Their compact design (9" high x 6" wide x 5.5" long), make them the perfect bookshelf-sized companion to your home entertainment set up.

Audiophile quality. For the true stereo enthusiast, we offer the Recoton self-amplified wireless satellite subwoofer system. The satellite speakers in the system each bolster 25 watts of clean, distortion-free sound. The subwoofer adds a whole new dimension to your home theater with its 50-watt amplifier that's capable of creating enough rumble to make you feel like you're in the middle of an earthquake.

The Recoton wireless subwoofer's 50-watt 10-inch speaker delivers thunderous bass that adds depth and realism to the surround sound experience.



Even the most discriminating surround sound enthusiast will be engulfed by the abundant power and delighted with the full-range, first-rate sound from these black oak vinyl veneer speakers.

Easy to install. Every speaker option offered by Comrad can be easily installed with the HTS-1 in a matter of minutes. Just connect the speaker outputs of your receiver or amp to the HTS-1, then

connect speaker wire to the front and rear speakers. When using wireless speakers, connect the transmitter to the output. One transmitter will broadcast to each wireless speaker.

Risk-free home trial. The best way to evaluate surround sound is in your home—not a showroom. That's why we're offering the 30-day risk-free home trial. Try these products in your home and if you're not delighted with the the surround sound experience, return them for a full "No Questions Asked" refund.

HTS-1 surround sound decoder.....\$99 \$10 S&H

Please mention promotional code 711-PL-1113.

For fastest service call toll-free 24 hours a day

800-704-1211



To order by mail, send check or money order for the total amount including S&H (VA residents add 4.5% sales tax.) Or charge it to your credit card, enclosing your account number and expiration date.

COMRAD INDUSTRIES

2820 Waterford Lake Drive, Suite 106
Midlothian, Virginia 23113



Sony's SA-VA1 home-theater speaker system, shown here with a 32-inch TV, features two front tower speakers that include a Dolby Pro Logic decoder, amplifiers, subwoofers, and inward-firing center-channel drivers. Two rear surround-sound speakers complete the system.

HOME-THEATER RESOURCES

CUSTOM ELECTRONIC DESIGN & INSTALLATION ASSOCIATION (CEDIA)
9202 North Meridian Street
Suite 200
Indianapolis, IN 46260
Tel. 800-CEDIA30
For recommendations of custom-installation firms

DOLBY LABORATORIES
100 Potrero Avenue
San Francisco, CA 94103-4813
Tel. 1-800-241-4115
"Consumer Guide to Home Theater" video; \$19.95

ELECTRONIC INDUSTRIES ASSOCIATION/CONSUMER ELECTRONICS GROUP (EIA/CEG)
2500 Wilson Boulevard
Arlington, VA 22201
Tel. 703-907-7600
"Guide to Home Theater" booklet; free

SHARP ELECTRONICS CORPORATION
Sharp Plaza
Mahwah, NJ 07430-2135
Tel. 1-800-BE-SHARP
"Hollywood at Home" brochure; free

the color of the walls). If you want your home theater to be the focal point of the room, full-size speakers would be your choice.

If possible, all the speakers in a system should be of the same type, but that isn't always practical. After all, an entertainment center houses only three of the five speakers. You might not have room for free-standing surround speakers behind your sofa—in-wall speakers might better serve the purpose.

No matter which type you select, there are two important rules to follow. First, any speakers that will be placed in close proximity to a direct-view TV must be magnetically shielded to avoid picture-dis-

torting interference. Second, your speakers must be *matched*, in both power and tone.

Of course, the easiest way to buy a matched set of speakers is to buy a speaker system that has been specifically designed for home theater. Many manufacturers offer such systems, which often include subwoofers as well as five or more matched speakers.

If you plan to use a pair of existing speakers for the front-left and -right channels, your best bet is to buy the same brand speakers for your center and surround channels. Again, make sure that they are tonally matched, and that the center-channel speaker is magnetically shielded.

There are also some basic, definitive rules to follow in placing the speakers in your viewing room. The center-channel speaker should be as close to the screen as possible, usually immediately above or below it. The right- and left-front speakers should be placed in line with and equidistant from the screen. The surround speakers should go behind the couch, spaced evenly to either side of, and just above, the viewer's head. If the size of the room demands additional surround speakers, those are mounted along the sides of the room, again, slightly above the viewer's head.

A subwoofer can be placed just about anywhere in the room. Keep in mind that the closer it is to a wall, the deeper the bass. The deepest bass is achieved when the subwoofer is placed in a corner.

SETTING IT UP

Before you even begin shopping, it's important to decide where in your home your theater will go. The obvious choice is usually the family room, because that's where you all tend to gather in the evenings, and that's usually where your audio and video components already are.

But does every member of your family enjoy watching video in the evening? And do you all share the same taste in video fare? If not, you might want to keep the family room an all-purpose spot—where one person can do homework while another plays a video game and another reads



How do you solve the seating-arrangement problem in a room with two focal points—a fireplace and a big-screen TV? Viewings Audio/Video Automation of Cincinnati, OH, took the "If you can't beat 'em, join 'em" approach, by placing the TV *above* the fireplace, and grouping all the furniture to face both.

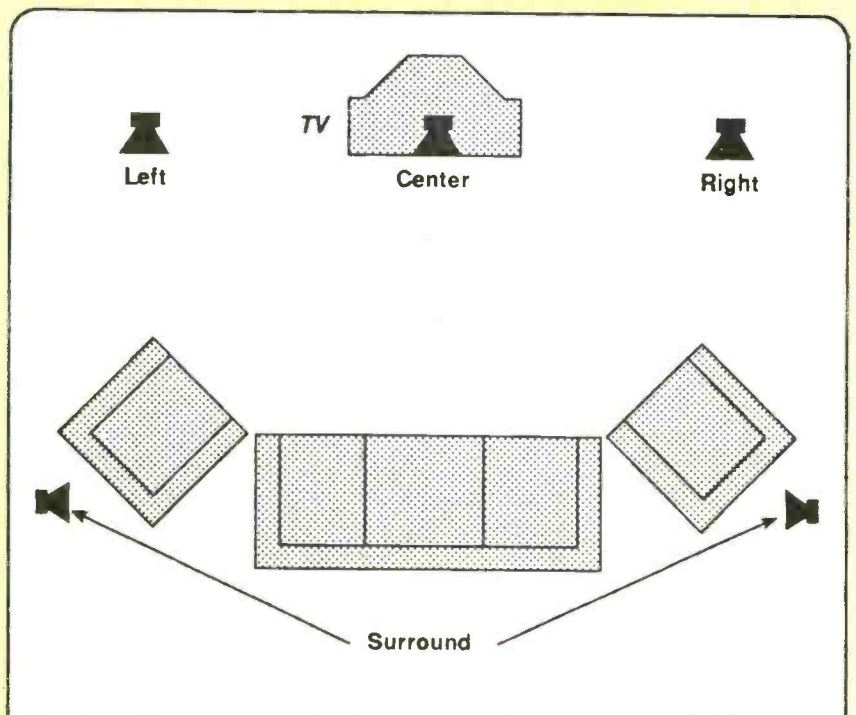

Dolby recommends the above arrangement of speakers in relation to the TV and furniture in a home theater. In a large room, where the sofa is at a distance from the TV, side speakers could be used to fill in the surround-sound.

THINKING OF THX?

Used correctly, a Pro Logic surround system creates an authentic sound environment that will thrill most home-theater enthusiasts. Purists, however, might want to take it a step further, by using a THX system in their home-theater setup.

Star Wars creator George Lucas wanted theatergoers to experience his films exactly as they looked and sounded in post-production. But the sound systems in many, if not most, theaters were not up to the task. He urged technicians at Lucasfilm Ltd. to come up with a solution, and, led by corporate technical director Tomlinson Holman, they did: THX.

To meet the THX objectives—achieving clear dialog, a high degree of sound localization from every seat in the theater, and non-localized but pervasive surround sound—components such as the surround decoder, amplifiers, and speakers are matched to the size and shape of individual theaters. Where needed, acoustical modifications are made as well. THX-equipped theaters (more than 600 worldwide) are tested upon initial setup, and again at periodic intervals, to be sure they meet THX specifications.

Problems arose when trying to recreate THX-quality sound in home theaters, where the acoustics of a smaller room tended to make the sound, which had been processed for a large theater, seem unnaturally brilliant or shrill. Lucasfilm's Home THX technology, designed to solve those problems, consists of a controller, amplifier, and speakers that meet standards that allow them to provide home-theater sound reproduction as close as possible to that heard in the production sound studio.

Building upon Dolby Pro Logic decoding, Home THX applies three enhancement techniques to the audio input before the signals are reproduced. The system requires specialized equalizers and circuitry that modify the characteristics of Dolby Pro Logic decoded signals to meet Home THX specifications.

The first, called "re-equalization," is intended to compensate for the overly bright sounds caused when soundtracks that have been processed for playback in large theaters are reproduced in smaller rooms. Re-equalization reduces the highs to restore the original flat-response characteristics before the signals are amplified.

The second technique, known as "decorrelation," splits the mono surround channel into two uncorrelated

outputs for left- and right-surround speakers. It is intended to reduce localization, which has been found to detract from the sense of envelopment, and to create a more spacious sound.

Finally, "timbre matching" strives to ensure that there is no change in timbre between the front and rear speakers. Because the human ear responds differently to sounds coming directly from the front than to those coming diffusely from the sides, even if the front and rear speakers had identical reproduction characteristics, the listener would hear a change in timbre. Timbre matching filters the signals as they cross between front and rear speakers to reduce the perception of a change in timbre.

Home THX equipment must meet the specifications for re-equalization, decorrelation, and timbre matching, as well as requirements for power amplifiers, loudspeakers, and interconnections. THX-certified power amps must be able to amplify the controller's signals to provide high-level, low-distortion outputs. THX front speakers are designed to aim sound directly at the viewers to assure clear dialog and pin-point sound localization. Dipolar surround speakers are situated so that the viewers receive no direct sound.

There is a debate raging within the A/V world as to whether or not that additional THX circuitry truly enhances the home-theater experience. There is general agreement that, when viewing laserdiscs produced by Lucasfilm, THX-certified equipment significantly improves the quality of the soundtrack. And some folks firmly believe that THX-approved gear is the only way to go for *all* home-theater listening.

But others feel that, while Home THX enhances the viewing experience, it can cause muddy reproduction of musical recordings. Yet another group thinks that those three additional circuits produce effects that are so obvious as to be obtrusive—not just when listening to music, but also when watching films.

The only way to know if THX is right for you is to listen for yourself—and then check your bank account. A Home THX-certified sound system is a big-ticket item. It can cost more than an entire Dolby Pro Logic home-theater system including TV and audio/video sources. The least-expensive THX surround-sound processor is Kenwood's KC-X1, priced at \$1000. Prices jump from there to around \$2500 and much higher. THX-certified speaker systems also carry hefty price tags, typically ranging from \$3000 to \$8500, or more.

pealing in other rooms—lots of natural light, fireplaces, vaulted ceilings, and fancy architectural detailing—can actually detract from a home theater.

Do you have a basement "rec room" that young kids use during the day? Per-

haps it's too dark and the ceilings are too low for anyone else to use the space. But with the addition of a comfortable sofa and home-theater components (possibly stored in a locked cabinet to discourage small hands from inserting peanut-butter sandwiches into the VCR tape slot), the basement can do double-duty as a home theater after the kids are tucked in for the night.

A spare bedroom is another good home-theater candidate. The closet—no longer needed for clothes—can easily be converted into a built-in home theater. A decent-sized closet can house all your components, as well as a large collection of CD's, videotapes, and laserdiscs. Once again, when you're not watching a movie, the room can pull double duty as a home office, guest room, or hobby room.

If you do decide to situate your home theater away from the main living areas of your house, you should consider buying an A/V receiver with multi-room capabilities. That way, you can route the source material from your home-theater components to speakers and monitors throughout the house.

If you're still not sure where to put your home theater, or what to put into it, professional help is available. Shop at an audio/video specialty store instead of one of those large discounters, and the extra money you'll spend on components will include expert advice on setting it up. And, if you'd prefer to have a pro make all the decisions—based on your budget, viewing habits, and aesthetic preferences—contact CEDIA: the Custom Electronics Design & Installation Association. Custom installers and designers can handle everything from pre-wiring a new home to designing a whole-house audio/video-distribution system to fine-tuning the controls on your new home theater. CEDIA can recommend a qualified custom-installation company in your area.

MAKING GOOD CONNECTIONS

If you decide to do the job yourself, designing the system and buying all the components can be a piece of cake compared to the chore of properly connecting everything. After all, you'll need to connect to your A/V receiver a TV; five or more speakers; an antenna, cable box, or satellite IRD; a VCR and/or laserdisc player; and possibly a subwoofer, additional amplifiers, a CD player, and a tape deck. The idea is to plug everything into its proper jack, and somehow avoid creating a tangled jumble of wires and cables.

If you're not completely comfortable making those connections, we highly recommend Dolby's "Consumer Guide to Home Theater" videotape.

(Continued on page 12)

the newspaper—and put the home theater elsewhere.

"Elsewhere" can be just about anywhere in the house, even in spaces that you wouldn't consider comfortable for other activities. Features that are considered ap-

Larger than Life

CRYSTAL ONE LCD PROJECTOR. From Vidikron of America, 150 Bay Street, Jersey City, NJ 07302. Tel. 201-420-6666. Price: \$7995.

A large-screen TV isn't an essential ingredient for enjoyable home theater, but it can sure enhance the experience. And for the biggest possible picture, a projection TV, such as Vidikron's *Crystal One* is called for.

Unlike all of Vidikron's other projectors and most projection TV's on the market, the *Crystal One* generates its image with liquid-crystal display (LCD) panels instead of cathode-ray tubes (CRT's). Historically, LCD projectors have not been able to match the performance of CRT models, but they are far easier to install and maintain. The *Crystal One*, however, approaches CRT-quality, and could hardly be easier to install.

The main problem that most users (and installers) face with CRT projectors is that the beams from the three guns must be converged properly—a time-consuming and somewhat difficult task. LCD projectors, by contrast, have only a single light source, which passes through LCD panels that are aligned properly during manufacturing. The convergence on our *Crystal One* was close to—but not quite—perfect.

The projector measures about 8 × 22 × 15 inches and weighs 44 pounds, and is intended to be mounted on a high shelf or suspended from the ceiling. The top of the projector is intended to be at the same height as the top of the viewing screen at a distance that varies with the desired picture size. For example, for a six-foot diagonal screen size, the projector could be mounted anywhere between 15 and 26.5 feet from the screen. For a ten-foot screen, the projector could be mounted at a distance from about 23 to 42 feet. The 2 × zoom lens incorporated into the projector allows the picture size to be varied.

The simplicity of the LCD projector, however, eliminates some mounting flexibility. For example, consider the constraint of mounting the top of the projector at the same height as the top of the screen. Mounting it lower and tilting the projector up at an angle toward the screen would result in *keystoning*, where the top of the picture would be wider than the bottom. A CRT projector can compensate for *keystoning* even if it is not installed at the optimum height. Typically, a mounting angle of at least 20 degrees can be accommodated by such projectors. With the *Crystal One*, it is possible to compensate



for *keystoning* by tilting the screen toward the projector at the same angle as the projector is tilted up from its horizontal position.

Although the requirement for mounting the *Crystal One* at the same height as the top of the screen might seem an unreasonable restriction, it does have some advantages. First, it makes it easier to walk in front of the screen without getting in the way of the projected beam. Second, it makes the noise generated by the projector's cooling fan less noticeable. If the projector is still too intrusive for your tastes, you might consider mounting it behind a screen intended for rear projection. The picture can be flipped to its mirror image with a couple of remote-control button pushes.

Just how easy is the *Crystal One* setup? For our tests, we installed the projector on a high shelf in the rear of a 16-foot-deep room. We turned it on, and adjusted the zoom and focus controls. Although we could have manually focused the projector, we used the zoom and focus buttons on the remote control instead. An on-screen display allows the projector to be focused even without a video input signal.

The entire procedure took maybe five minutes—and most of that was spent unpacking the projector. It took somewhat longer to set up the screen. Although the projector can project an image onto a plain white wall, we chose to use a flat screen—with a reflectivity of 1.3 times a standard white surface, the screen allows viewing in brighter environments.

The longest part of the setup procedure was neatly routing the audio, video, and antenna cables—all originating 16 feet away on the far side of the room—to the projector.

The rear panel of the *Crystal One* accepts video, audio, and antenna or cable inputs—a full TV tuner is built in, as is a front-panel speaker. In its simplest installation, an antenna cable is connected to

the rear-panel F connector, and the internal speaker provides audio. For all practical purposes, that would be a nonsensical installation—a three-inch speaker can't support a six-foot picture. Nonetheless, we applaud the inclusion of the speaker for a couple of reasons. First, it is a convenient aid in setting up the *Crystal One*. Second, it allows the projector to be set up quickly in a bare-bones arrangement. For example, we could imagine some users popping the projector in the trunk of their car to take up to the vacation home, and others taking it to clients' offices for business presentations.

Rear-panel outputs are also provided for powering external stereo speakers at ten watts per channel. The internal amplifier can provide adequate audio in a pinch, but we wouldn't be satisfied with it in a home theater.

Stereo audio inputs are provided on the rear panel, as are two BNC connectors for video inputs, one S-video input, and an RGB input. The projector, therefore, can be used to project the image from a computer with a CGA card. A \$1300 adapter is available for displaying VGA signals. An S-video input is also provided on the rear panel, and an additional one is located behind the control door on the front panel.

In operation, the *Crystal One* is a pleasure to use, thanks, in part, to the remote control supplied with it. A sensible menu system makes it easy to change the audio, video, and feature settings. In many ways, the projector acts very much like a standard TV. For example, it provides switchable closed-captioning, parental channel lockout, automatic channel-scan for finding active channels, channel display, and user-programmable station-identification labels.

The *Crystal One* provides a couple of menu options that are not found on most TV's. An operating-hours timer allows users to track the life of the projector's light source. The *Crystal One* has a 200-

watt metal-halide bulb that has an estimated working life of about 2000 hours. A spare bulb is included with the projector, and is user-replaceable. A personal-preference menu allows a user to configure each source with default brightness, color, tint, audio settings, and more.

The display panels in the Crystal One are transmission-type active-matrix LCD's. They create an image in conjunction with a series of folding and dichroic mirrors that direct red, green, and blue light to the appropriate LCD. The LCD's let the light pass through them to create the on-screen image.

The 200-watt metal-halide bulb can produce an image that is considerably brighter than most LCD projectors that we've seen. Although a darkened room provides the best viewing, it is not essential for casual viewing. Even in a room without draperies, we were able to enjoy the projector on all but the sunniest days.

The quality of the picture that is produced is exceptional for an LCD projector. The projected image consists of 455 horizontal rows of pixels, and 479 vertical columns of pixels; the pixel layout is in a delta pattern that makes them less noticeable. The projector's horizontal scan frequency is 32 kHz, and a line-doubling process called "interlaced double-line addressing" makes the picture incredibly smooth by making the scan lines virtually invisible even when a viewer sits closer than the recommended distance of twice the screen's diagonal size. No observable motion artifacts are introduced by the line-doubling technique. Our testing indicated a horizontal resolution that approaches 400 lines, which is ideal for enjoying NTSC video.

The screen was free of the "hot spot" that we've come to expect from LCD projectors. Instead, the brightness was almost perfectly uniform from side to side and from top to bottom. Differences were noticeable only with the careful observance of test patterns.

The only place where the Crystal One falls short of quality tube projectors is in producing a high-contrast ratio. Deep blacks are attainable in a darkened room, but in brighter environments, we could not obtain good blacks at what we consider an adequate, average picture level. Increase the average picture level to an acceptable level, and the blacks are not quite black, and the picture takes on a little bit of a washed-out look.

All things considered, the Crystal One projector can be an easy way to enjoy incredible video. Its superb picture, coupled with its ease of setup and use, is a combination that is difficult to beat. Set up the projector in your home theater, and you'll never feel the need to go out to the movies again.

Home-Theater Sound Central

CT-27V A/V PREAMPLIFIER/TUNER AND AV-405 POWER AMPLIFIER. Manufactured by Carver Corporation, P.O. Box 1237, Lynnwood, WA 98046. Tel. 216-775-1202. Price: CT-27V, \$850; AV-405, \$750.

The TV or projection screen might be the first thing that you notice about a home theater, but the thing that determines whether you just watch a movie—or become part of it—is the sound. When we installed Carver's CT-27V A/V preamp/tuner and AV-405 5-channel power amplifier, we became a part of every movie we turned on.

With its video-switching and audio-processing circuitry, the audio system is the real heart and brains of a home theater. In our setup, the CT-27V became the brains, and the AV-405, the heart.

The CT-27V is a Dolby Pro Logic audio/video preamplifier and tuner. It allows the power amplifier(s) that are best suited to your home theater to be used. It also allows the heavy, bulky power amplifier to be mounted out of sight. The unit measures 4.4 × 19 × 15 inches, and can be rack-mounted. Alternatively, the rack handles can be removed so that the preamp will fit in 17-inch equipment racks.

The preamp offers seven sets of stereo audio inputs: phono, CD, tape, DCC, laserdisc, VCR1, and VCR2. Video inputs include composite connectors for a laserdisc and two VCR's. A composite output jack is also provided for connection to a monitor. One S-video input and an S-video output are provided.

Preamp outputs include right- and left-

front channels, right- and left-surround channels, a center-channel output, and a subwoofer output. The relative volume level of the subwoofer output with respect to the other channels can be adjusted with a rear-panel rotary control.

Switched and unswitched AC outlets are available on the rear panel of the preamplifier. Unfortunately, they cannot provide sufficient power for a power amplifier, which is a minor inconvenience.

The preamp is compatible with the RC-5 remote-control bus, which allows remote-control signals to be passed among daisy-chained components. The remote that is supplied with the preamp can also be used to control a TV and VCR.

The CT-27V is an AM/FM tuner as well as a preamplifier. Plus, a CATV input permits tuning of stereo signals that might be supplied over your cable system. A total of 30 AM, FM, or CATV frequencies can be stored in memory presets. They can be entered manually by pressing the MEMO key and then entering the memory position. Alternatively, the receiver can scan through the band, stopping at any receivable station for about five seconds. The station will be stored in the next available memory unless the TUNING/SCAN button is pressed, the band is changed, or the reception mode is changed.

The preamplifier's digital signal processing (DSP) circuits not only decode Dolby Pro Logic signals, but provide four additional surround-sound modes as well: Movie Surround, 3Logic, Hall 1, and Hall 2.

Our preference is to watch movies in the Dolby Surround mode, and to listen to music in plain ol' stereo. However, although they are not to our tastes, we can appreciate the inclusion of the other modes. Movie Surround, for example, allows the delay time for the rear channel to



be set for up to 90 milliseconds, whereas Dolby surround allows for settings between 15 and 30 milliseconds. That longer delay might be appropriate for unusually small rooms, so that the surround speakers sound as if they are located farther from the listening position. Under most circumstances, the long delays just create an unnatural listening experience.

The intent of the 3Logic mode is to improve the center of the sound field if the left and right speakers are located too far apart. The Hall 1 and Hall 2 surround modes expand the sound field and add reverberations. Under most circumstances, the effect is not to our liking, but it is undoubtedly a popular feature.

A matrix surround mode, in which a delayed stereo-difference signal is fed to the surround channels, is also provided. The rear channel delay can be set anywhere from zero to 90 milliseconds.

A front-panel VOCAL ZOOM knob is provided to adjust the presence of dialog in the center channel in Dolby Surround, Movie, and 3Logic modes. Left in its center position, the control has no effect. Rotate it clockwise, and the vocals seem to move forward. Rotate it counterclockwise, and the vocals recede.

Like all Pro-Logic decoders, the CT-27V includes a test tone for adjusting the volume levels of the front and surround channels. An input/output loop is provided for the connection of an external processor such as a graphic equalizer.

The A/V 405 is a five-channel power amplifier that was designed specifically for home theaters. Electrically, it mates perfectly with the CT-27V preamp. The amplifier can supply a total of 410 watts to eight-ohm loads: 100 watts to the left- and right-channel speakers, 110 watts to the center channel, and 50 watts to each of the two surround speakers.

The A/V 405 amplifier was designed following Carver research that led to the conclusion that the center channel requires slightly more power than the left and right channels, and that the surround channels require roughly half the front power rating. In the best of all worlds, we would normally prefer that all channels were equally powered. However, we can't fault Carver's design. Sounds remained consistent as they panned from right to left, or from front to rear. There was also no hint of variance in either the power level or tonal quality.

The AV-405 sports gold-plated phono jacks, heavy-duty 5-way binding posts for speaker outputs, intermodulation distortion ratings of less than 0.1%, and total harmonic distortion of less than 0.2%.

By themselves, both the CT-27V and AV-405 are admirable performers. Together, they're a formidable combination for any home theater. ■



Up Front and Center and Surround

SYSTEM 250 HOME-THEATER SPEAKER SYSTEM. From Atlantic Technology International, 343 Vanderbilt Avenue, Norwood, MA 02062. Tel. 617-762-6300. Price: System 250, \$1446; 252 PBM Bass Module, \$549; 251 LR front-channel speakers, \$299 per pair; 253C center-channel speaker, \$279.95; 254 SR surround speakers, \$299 per pair.

The importance of the speakers in a home-theater system cannot be overstated. They can pull the listener into the movie, making the experience a thrill, or they can turn an excellent film into washed-out fare.

For example, the front speakers in a home-theater must create a realistic sound field that draws the listener's attention to the screen. Their imaging must be precise, and they must be consistent from right to left.

In a movie theater—which is what a home theater should strive to emulate—most of the sound comes from speakers that are located directly behind the acoustically transparent screen. The reason, of course, is that most of the dialog and action takes place on the screen, so the sound should come from there as well.

In many homes, the front speakers for the TV are located on either side of the screen. That's not too much of a compromise if the screen is small and the viewer is sitting centered between the speakers. Sit off to one of the sides, however, and the sounds that should be coming from on-screen will instead seem to be coming from the speaker you're sitting near. If your speakers can be localized, you know that your home-theater experience is not what it could be—you are watching and listening to a movie instead of becoming part of it.

A Dolby Pro Logic A/V receiver will provide a "phantom" mode that allows the two front speakers to create what sounds like a realistic center channel. It does eliminate the "hole in the middle," but can't create the realistic soundfield that three speakers can. Remember: about three quarters of a movie's sound comes from the center channel.

Unfortunately, you can't take just any speaker and make it a center-channel speaker. First off, the center-channel speaker should be placed as close as practical to the video screen, so if you have a direct-view TV set, you must get a magnetically shielded center-channel speaker.

Second, the center-channel speaker must acoustically match the right- and left-channel speakers so that dialog sounds natural as it is panned across the screen, and so all sounds maintain their tonal balance as they move from one side to another. That is the most difficult problem that faces people who want to use their existing stereo speakers in their home theater.

It is possible, of course, to get a decent match even with speakers from different manufacturers. Speakers built specifically for the task—such as Atlantic Technology's 251-LR front-channel speakers and 253-C center-channel speakers—will do a better job.

The 251-LR front-channel speakers feature two 4-inch woofers and a ¾-inch dome tweeter and deliver a frequency response of 80 Hz to 20 kHz, ± 3 dB. Their nominal impedance is 8 ohms. The 253-C features the same driver configuration, and the same power-handling capability (150 watts). The most obvious difference between the speakers is that the 253-C's cabinet is narrower so that it can be placed horizontally on top of a TV. A special base that is supplied with the speaker allows it to be "aimed" at the listening position for optimum sound.

There are a couple of other, more important differences that make the 253-C a dedicated center-channel speaker. First, the speaker has an adjustable midrange

timbre, so that it can be a better sonic match for whatever speakers you have for your left and right channels. The control, on the speaker's rear panel, has a position labeled "251" that automatically matches the 253-C to Atlantic Technology front speakers. Even if your front speakers are from a different manufacturer, obtaining a good match is surprisingly easy: Just turn the control as you listen to the test tone (hiss) from a Pro Logic decoder until the speakers sound identical.

A second control on the speaker's rear panel allows the high-frequency level to be adjusted. That can also be used to match the left and right speaker characteristics. But it also can be used to compensate for the brightness of most movie soundtracks. (The high frequencies are usually boosted to compensate for the absorption of the movie screen.)

Although most of the action takes place in the middle and high frequencies, some of the most dramatic sounds come from the low frequencies. That's where Atlantic Technology's 252 PBM powered bass module comes into play.



The 252 PBM powered bass module is versatile enough to fit in virtually any home theater.

The 252 PBM is incredibly versatile and can become a part of virtually any home-theater system. First, it can operate in what Atlantic Technology calls a "passive" mode, in which the internal amplifiers power only the subwoofer with 90 watts. In that mode, the speaker outputs of an A/V receiver are fed directly to the subwoofer's input. The front left- and right-channel speakers can be connected to the subwoofer's passive speaker outputs. In a second passive mode, the line-level subwoofer output of an A/V receiver is fed to one of the line-level inputs of the subwoofer module.

In the powered modes, the internal amplifiers provide amplified outputs for the right- and left-channel speakers as well as for the subwoofer. The amplifier configuration in the powered mode is 3 × 40 watts.

The module's crossover point can be selected with the flip of a switch as either 80 Hz or 120 Hz. The 80-Hz position pro-

vides the most accurate, natural-sounding bass. With a 120-Hz crossover, the bass sounds excessively boomy. The driver element is a 12-inch, long-throw, polypropylene woofer.

Of course, not all of the drama in a movie's soundtrack occurs in the deep bass or the center channel. Some of it should come from all around you via the surround channel.

Most of the sounds in the surround channel, however, are not intended to be localized or even consciously noticed. Instead, they are supposed to wash over the listener, providing ambience and fill. The only time you should ever be able to localize on the surround channel is when directional information is deliberately placed there—such as when an airplane or spaceship flies overhead from the back to the front.

In movie theaters, the surround speakers are located along the side walls and in the rear. In home theaters, the surround channel is usually reproduced by a pair of speakers in the rear of the room. If they are not placed correctly, however, they can reduce the realism of the surround experience. Unlike most speakers, the surround speakers should not be mounted at ear level and they should not, in most cases, even face the listening position!

Such considerations become difficult as people increasingly choose to wall mount their speakers. Atlantic Technology's Model 254 SR, which is intended for on-wall or in-wall mounting, solves the dilemma with a pair of 3½-inch surround drivers that are mounted on a curved front baffle that protrudes slightly out from the front of the speaker (or the wall). The 3½ inch drivers are angled outward to the left and right so that they will disperse the sound widely throughout the listening room. A third driver, a 4-inch long-throw woofer, increases the low bass response down to 50 Hz, and improves the power-handling capability to 150 watts.

The driver-mounting scheme does give the speakers wide dispersion characteristics. They produce a surround field that fills the room, and they cannot be localized almost regardless of where they are mounted. That allows for a great deal



The surround-channel speakers sport drivers that are angled to produce a wide acoustic scatter.

of mounting flexibility. They can be placed on a bookshelf, mounted on speaker stands, mounted on a wall, or recessed into the wall. (Brackets for new-construction and retrofit mounting are available for \$99.)

The individual members of Atlantic Technology's System 250 performed admirably. The real strength, however, is how the components performed together. For movies, the six speakers became one, filling the room with sound that came from where it was supposed to. When T-Rex was pounding along in Jurassic Park, we could feel the footsteps. And that's what home theater is all about. ■

HOME THEATER

(Continued from page 17)

CURTAINS UP!

Now that you've put it all together, it's time to reap the benefits of home theater—and there are many. At the top of the list, of course, is the convenience of watching films in the comfort and privacy of your own home. But there are other perks as well.

First, after the initial capital outlay required to set up your home theater, the money savings can be substantial. At \$7 a head, it costs a family of four \$28 before snacks to go out to the movies. Add in \$4 for a bucket of popcorn and \$1.50 each for sodas, and you can easily approach \$40 for the evening's entertainment. Compare that to the \$3 or so charged by your local video-rental shop, and the price of some microwave popcorn and a two-liter bottle of cola!

Second, with your own home theater, what you see (and hear) is what you get. You know what quality you can expect from the sound system and the video components. You don't have to worry that the seats will be uncomfortable, that the room will smell funny, that your feet will stick to the floor, that the temperature will be too hot or too cold, or that the people behind you will reveal the ending of the movie before the lights go down. You'll never get stuck sitting in the first row, or behind a very tall person, or next to a very large person. In fact, your only worry is that you'll be so comfortable you'll fall asleep during the movie!

Finally, families with home theaters often report an increase in "quality time" spent with the kids, watching films together and maybe even talking about them afterward.

So relax and enjoy your home theater, knowing that you've made a sound investment in your family and your home—after you read the following reviews of some home-theater products, of course! ■

ELECTRONICS WISH LIST

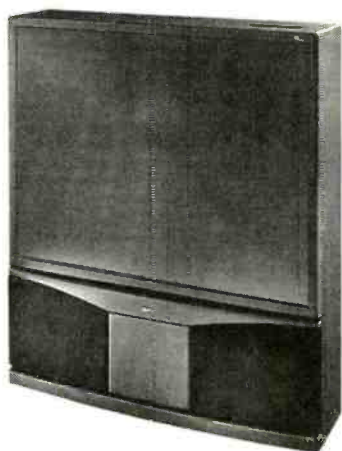

Zenith Dolby Pro Logic TV

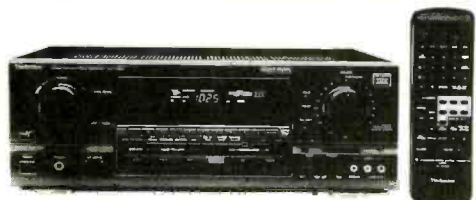

Technics Home THX Receiver



Disk-Tek CD Repair Kit

Dolby Pro Logic TV

The *Model PV5269BT* 52-inch rear-projection TV from *Zenith Electronics Corporation* (1000 Milwaukee Ave., Glenview, IL 60025) features built-in Dolby Pro Logic surround-sound capability and the StarSight interactive on-screen program guide. The short-focal-length projection system allows the set to fit in a smaller-footprint, "Slim-Profile" cabinet (less than 25 inches deep). With built-in Pro Logic, no additional audio components are needed. However, jacks are provided for adding powered woofers and tweeters. Audio processing modes include "concert hall" and "theater" settings. Coming attractions can be seen listed on the StarSight programming guide, which also allows one-touch time-shifted VCR recording. Price: N/A.

Home THX Receiver

Technics' (One Panasonic Way, Secaucus, NJ 07094) *Model SA-TX1000* Home THX receiver boasts the full complement of THX-certified sound-enhancing features. Relying on Dolby Pro Logic circuitry to steer signals to four channels, in home-theater mode, the receiver pumps out 120 watts to each of the three front channels, plus an additional 110 watts to the surround channel. In stereo mode, it delivers 125 watts. The SA-TX1000 uses Class-H+ amplifier circuitry: several different power supplies accommodate low and high power output, resulting in a more efficient multi-channel amplifier in a standard-size housing. It also assures that dialog will be clear and properly positioned, even when it's competing with music or sound effects, and that audio will move smoothly to follow the on-screen action. The noise commonly associated with other Class H+ circuits has been eliminated through the use of three patented operations. The SA-TX1000 provides 30 AM or FM station presets, and can handle up to three audio and four video inputs. Two S-Video jacks are provided, as is a subwoofer output. A built-in "help" function scrolls pointers across the unit's display. Price: \$1199.95.

Dracula Unleashed

Following in the footsteps of *Viacom New Media's* (1515 Broadway, New York, NY 10036) interactive CD-ROM movie, "Dracula Unleashed," is a combination PC- and Macintosh-formatted version of the *Dracula Unleashed CD-ROM*. The sophisticated horror movie offers desktop players the chance to test their wits in the search for the Prince of Darkness. More than 40 actors appear in 135 scenes—over 90 minutes of video—that are interwoven into a realistic narrative setting using Viacom New Media's proprietary compression scheme. In the game, players are transported to Edwardian England for a period of four days. They assume the identity of Alexander Morris (brother of Quincy Morris from the original novel), and must identify and destroy Dracula before he gets them. Price: N/A.

Quick Fix for Discs

Scratches or scuffs can interfere with disc play, but the *CD Repair Kit* from *Disk-Tek, Inc.* (2345 South Federal Blvd., Suite 125, Denver, CO 80219) is said to restore the original play quality of scratched audio CD's, laserdiscs, CD-ROM's, Photo CD's, karaoke discs, and all forms of interactive CD's. The two-step maintenance system is easy to use and will improve disc quality without harsh chemicals, toxins, or petroleum distillates. The CD Repair Kit includes the CD cleaner, which safely removes dust and dirt; CD polish, which permanently restores the surface of the disc to its original transparency, removing fine scratches and minor abrasions; and a disposable, non-abrasive, lint-free cloth. Up to 50 discs can be repaired with the kit. Price: \$9.99.

Take this GIANT CIRCUIT LIBRARY for only \$9.95

when you join the *Electronics Engineers' Book Club*®

THE ENCYCLOPEDIA OF ELECTRONIC CIRCUITS —Vols. 1, 2 & 3 by Rudolf F. Graf

Hundreds of circuit ideas alphabetically arranged — from Alarm circuits to Zero crossing detector circuits!

"... includes schematics for the latest electronics circuits from industry leaders..."
—Popular Electronics

Turn to this comprehensive circuit library for hundreds of project ideas . . . valuable troubleshooting and repair tips . . . and concise pinout diagrams and schematics. In each volume you'll find more than 700 electronic and integrated circuits and 100+ circuit categories right at your fingertips to give you ideas you can use on the job or at your workbench.

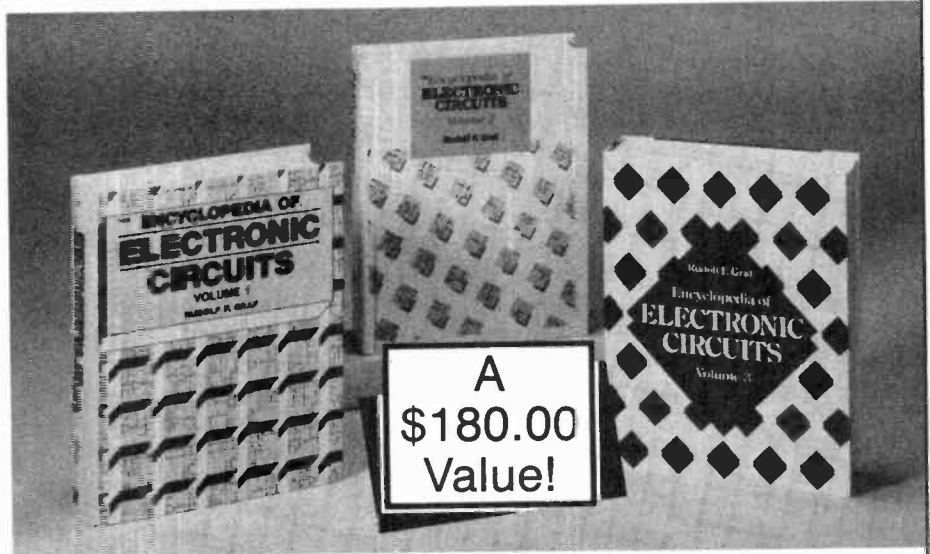

2,344 total pages 3,490 total illustrations

Book No. 5489C Hardcover

If coupon is missing, write to: Electronics Engineers' Book Club, P.O. Box 549, Blacklick, OH 43004-9918

As a member of the Electronics Engineers' Book Club . . .

. . . you'll enjoy receiving Club bulletins every 3-4 weeks containing exciting offers on the latest books in the field at savings of up to 50% off of regular publishers' prices. If you want the Main Selection do nothing and it will be shipped automatically. If you want another book, or no book at all, simply return the reply form to us by the date specified. You'll have at least 10 days to decide. And you'll be eligible for **FREE BOOKS** through the Bonus Book Plan. Your only obligation is to purchase 3 more books during the next 2 years, after which you may cancel your membership at any time.

Publisher's price shown. © 1995 EEBC

ELECTRONICS ENGINEERS' BOOK CLUB

A Division of McGraw-Hill, Inc., P.O. Box 549, Blacklick, OH 43004-9918

YES! Please send me *The Encyclopedia of Electronic Circuits—Vols. 1, 2 & 3 (5489C)*, billing me \$9.95 plus shipping/handling & tax. Enroll me as a member of the **Electronics Engineers' Book Club** according to the terms outlined in this ad. If not satisfied, I may return the books within 10 days and have my membership cancelled.

Name _____
Address _____
City _____
State _____
Zip _____ Phone _____

Valid for new members only, subject to acceptance by EEBC. Canada must remit in U.S. funds drawn on U.S. banks. Applicants outside the U.S. and Canada will receive special ordering instructions. A shipping/handling charge & sales tax will be added to all orders.

PPIF495



SILENT SAM TURN-SIGNAL REMINDER

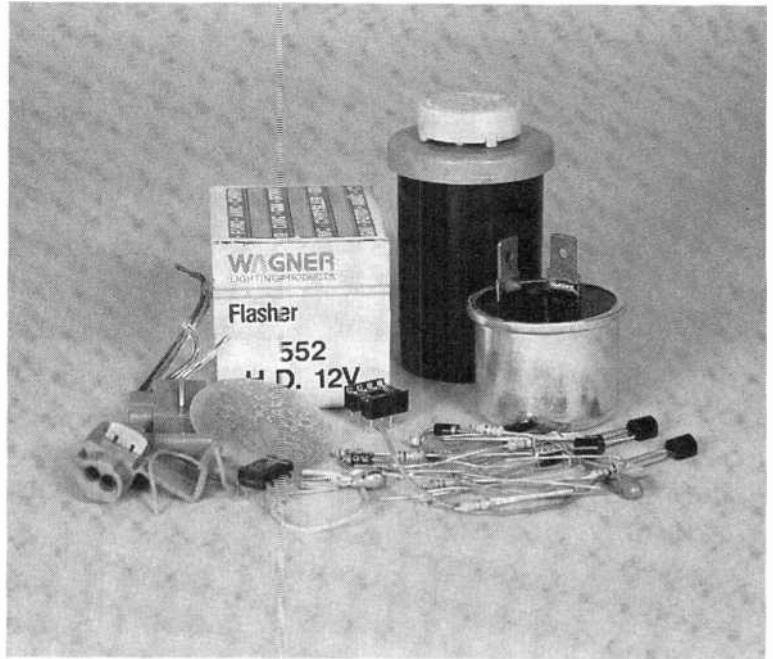

CIRCLE 119 ON FREE INFORMATION CARD

Prevent accidents, and nasty stares, with this automobile accessory.

Automobiles of today are a far cry from what they were years ago, at least as far as electronic accessories are concerned. You'll find cars equipped with heated seats and mirrors, headlight wipers, CD players . . . you name it. But we actually came across an automobile accessory that is not available as factory equipment in any passenger car that we know of. That's surprising, because the feature that this accessory offers makes so much sense that all cars should come equipped with it.

The *Silent Sam Turn-Signal Reminder*, or TSR, installs in your car and beeps to remind you that you've left your turn signal on—which, besides being a hazard to other motorists, makes you look like a jerk! Silent Sam is cleverly designed to be as unobtrusive as possible, yet still remind you that you've left your turn signal on. It does that by sounding a series of beeps 15 seconds after you turn on your blinker, and every 10 seconds thereafter, but *only* if your foot is *not* on the brake pedal. In other words, Sam is silent if you're merely waiting at a light with your blinker on.

Silent Sam is very inexpensive, priced at \$15 as a kit and \$22 pre-assembled. There is also a "high-output" version for high-noise environ-

ments, such as inside a truck, that sells for \$27 pre-assembled.

The Kit. If you're the type of guy—or girl—who always likes to do as much work yourself as possible, or if you just like building electronic kits, then purchasing Silent Sam as a kit is the way to go. But be warned, though, that less-experienced builders might not want to tackle the kit. A handful of parts must be mounted on a PC board that is about the size of a quarter. A well-seasoned builder shouldn't have too much trouble building the unit, but a beginner might be overwhelmed.

Four leads come off the finished TSR assembly, which is installed in a small, plastic, film-canister-type case. Two of those leads must be soldered to the terminals of the flasher unit in your car's electrical system, one lead to ground, and one to the low side of the brake-pedal switch.

Installation. Installing Silent Sam is actually a simple matter, as long as you can find the flasher buried under your dashboard. The flasher is, usually a small metal can with two terminals on it that makes a clicking noise when your blinker is on (it's actually a relay that allows your turn signals and hazard lights to flash). We actually had a

hard time finding it in the 1986 Chevy Camaro that was used as the test car, as it was quite hidden. To find it we had to turn on the blinker and listen for it!

If the flasher in your car is located a great distance from the steering column, you can order Silent Sam with a length of wire separating the flasher and the alarm circuit. That way you have access to the flasher socket and can still mount the alarm near the steering column for maximum audibility—not that Silent Sam is hard to hear from anywhere in your car, unless your stereo is blasting.

If you choose to buy Silent Sam as a fully-assembled unit, you also have the option of having it pre-wired to a new flasher at a slight additional cost. That configuration provides the quickest installation, as you have to connect only two wires to your car's electrical system (one to ground and one to the low side of the brake-pedal switch), unplug your old flasher, and plug in the new flasher.

One thing that you might have to do if you buy Silent Sam pre-wired to a flasher is reverse the two leads soldered to the flasher terminals. That depends on your car's electrical system. To test Silent Sam, all you have to do is plug in the flasher, temporarily

Be a high-paid computer service technician

Train With NRI — America's #1 Choice in Computer Training

Only NRI gets you inside a powerful 486DX2/66 MHz Intel-based computer system you keep—giving you the hands-on experience you need to work with, troubleshoot, and repair today's most widely used computer systems. There's no more affordable way to start a money-making career, even a business of your own, as a computer service technician.



NEW!
486DX2/66 MHz
Multimedia PC and
Windows 95



Rely on the original — NRI

Over a decade ago, NRI pioneered at-home training in computer servicing. Today, NRI offers the *only* computer servicing course with real-world experiments using state-of-the-art computer equipment and professional diagnostic tools.

There's no doubt about it: Working "hands-on" with all the most sought-after technology gives you practical skills and lasting confidence. Performing key tests and demonstrations, you're able to see for yourself how things work, what can go wrong, and how you can fix it.

Train with and keep the most advanced computer in home study today

NRI's unique training has you explore a top-notch computer system and its peripherals, beginning with the 486DX2 Intel CPU and Pentium Overdrive-ready motherboard.

Your computer features 8 meg RAM, 420 meg hard drive, and fax/modem to store, receive, and send huge amounts of data.

You'll also appreciate the brilliant display of your Super VGA color monitor, the drama of your CD-ROM drive and 16-bit sound card, as well as the cutting-edge technology of Windows 95.

Plus learn to use Ultra-X professional diagnostic hardware and software to pinpoint problems on any IBM-compatible machine.

No experience needed, NRI builds it in

Studies show that jobs for computer service technicians will be up by 38% in the next 10 years. Even if you've never worked with

computers before, NRI's interactive training builds such a solid foundation of know-how and practical experience that tomorrow's jobs can be yours.

Right from the start, hands-on experiments reinforce concepts presented in NRI's bite-sized lessons. And because your work is reviewed by your personal instructor, you know for certain that you can apply theory to real-world demands.

FREE NRI catalog tells more

Send today for your free, full-color catalog describing every aspect of NRI's innovative computer training in the up-and-coming field of your choice.

IBM is a registered trademark of the IBM Corporation. R.A.C.E.R. and QuickTech-PRO are registered trademarks of Ultra-X, Inc.

YOU GET EVERYTHING YOU NEED FOR SUCCESS

POWERFUL 486DX2/66 MHz INTEL-BASED COMPUTER

Features IBM compatibility, 8 meg RAM, Pentium Overdrive-ready motherboard, and math coprocessor

SUPER VGA COLOR MONITOR

With .28mm dot pitch for high-resolution graphics and tilt-swivel base

420 MEG HARD DRIVE

For greater data storage capacity and data access speed

EXCITING MULTIMEDIA PERIPHERALS

Double-speed CD-ROM drive, 16-bit sound card with speakers, and reference CD

FAX/MODEM

Gives you access to a world of on-line information

ULTRA-X DIAGNOSTIC PACKAGE

R.A.C.E.R. plug-in card and

QuickTech-PRO software help you detect problems on virtually all IBM-compatible machines, even if computer is 5% operational

NRI DISCOVERY LAB

Complete breadboarding system lets you design and modify circuits, diagnose and repair faults

DIGITAL MULTIMETER

Professional, hand-held test instrument for quick and easy measurements

WINDOWS 95

The time-saving operating system that everyone will be using tomorrow

If the coupon is missing, write to: NRI Schools, McGraw-Hill Continuing Education Center, 4401 Connecticut Avenue, NW, Washington, DC 20008.

SEND TODAY FOR FREE NRI CATALOG!



McGraw-Hill Continuing Education Center
4401 Connecticut Avenue, NW, Washington, DC 20008



Check one FREE catalog only

MICROCOMPUTER SERVICING

Computer Programming

TV/Video/Audio Servicing

Desktop Publishing & Design

LAN Specialist

Bookkeeping and Accounting

Programming in C++ with Windows

Check for details on career courses approved under GI Bill

Name (please print)

Age

Address

City

State

Zip

Accredited Member, National Home Study Council

18-0495

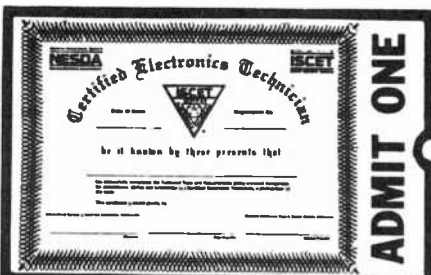

Your Ticket To SUCCESS

Over 28,000 technicians have gained admittance worldwide as certified professionals. Let your ticket start opening doors for you.

ISCET offers Journeyman certification in Consumer Electronics, Industrial, Medical, Communications, Radar, Computer and Video. For more information, contact the International Society of Certified Electronics Technicians, 2708 West Berry Street, Fort Worth, TX 76109; (817) 921-9101.

Name _____
Address _____
City _____
State _____ Zip _____

Send material about ISCET and becoming certified.

Send one "Study Guide for the Associate Level CET Test." Enclosed is \$10 (inc. postage).

50,388

ELECTRONIC COMPONENTS

Whether you order 1 part or all 50,388...MOUSER stocks and...ships same day!!

CALL... (800) 992-9943

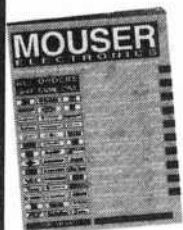

for your
FREE
CATALOG

2401 Hwy 287 N.
Mansfield, TX 76063

MOUSER ELECTRONICS

Sales & Stocking Locations Nationwide

TIPS FOR MAIL ORDER PURCHASE

It is impossible for us to verify the claims of advertisers, including but not limited to product availability, credibility, reliability and existence of warranties. The following information is provided as a service for your protection. It is not intended to constitute legal advice and readers are advised to obtain independent advice on how to best protect their own interests based upon their individual circumstances and jurisdictions.

1. **Confirm price and merchandise information** with the seller, including brand, model, color or finish, accessories and rebates included in the price.

2. **Understand the seller's return and/or refund policy**, including the allowable return period, who pays the postage for returned merchandise and whether there is any "restocking" or "return" charge.

3. **Understand the product's warranty.** Is there a manufacturer's warranty, and if so, is it for a U.S. or foreign manufacturer? Note that many manufacturers assert that, even if the product comes with a U.S. manufacturer's warranty, if you purchase from an unauthorized dealer, you are not covered by the manufacturer's warranty. If in doubt, contact the manufacturer directly. In addition to, or instead of the manufacturer's warranty, the seller may offer its own warranty. In either case, what is covered by warranty, how long is the warranty period, where will the product be serviced, is there a charge for service, what do you have to do to obtain service and will the product be repaired or replaced? You may want to receive a copy of the written warranty before placing your order.

4. **Keep a copy of all transactions**, including but not limited to cancelled check, receipt and correspondence. For phone orders, make a note of the order including merchandise ordered, price, order date, expected delivery date and salesperson's name.

5. **If the merchandise is not shipped within the promised time**, or if no time was promised, within 30 days of receipt of the order, you generally have the right to cancel the order and get a refund.

6. **Merchandise substitution** without your express prior consent is generally not allowed.

7. **If you have a problem with your order or the merchandise**, write a letter to the seller with all the pertinent information and keep a copy.

8. **If you are unable to obtain satisfaction from the seller**, contact the consumer protection agency in the seller's state and your local Post Office.

If, after following the guidelines, you experience a problem with a mail order advertiser that you are unable to resolve, please let us know. Write to Advertising Department, Gernsback Publications Inc., 5008 Bi-County Blvd. Farmingdale, NY 11735.

Be sure to include copies of all correspondence.

touch a spade lug on one of the leads to ground, and turn on the blinker; you should hear Silent Sam after about 15 seconds. If you don't hear any beeping, the two leads must be reversed (that's done by opening up the Silent Sam unit and swapping two connections on the PC board).

The unit's ground connection is made to a grounded screw under the dash—that is no problem, as most dashboard screws are grounded. The last step is to connect the lead to the low side of the brake-pedal switch. That connection keeps Sam silent when your foot is on the brakes. A 12-volt tester can be used to quickly identify which lead on your brake-pedal switch goes high only when you push on the brake pedal. Just make the connection to that lead using an included quick-connector, and installation is complete. You can also find the correct brake-pedal-switch lead via trial-and-error.

The only other problem you might encounter is if you have a newer car that uses a solid-state flasher. Silent Sam is designed to work with thermal flashers that were used universally in cars until just recently. Fortunately, you can easily replace a solid-state unit with a thermal one with no effect on turn-signal function. The literature that accompanies Silent Sam covers how to do that in more detail.

Life With Sam. Silent Sam has been with us for a week's worth of driving, and it has remained silent except for once: We inadvertently did not have our brakes on when waiting for a turn—which is possible, but not wise, with a manual transmission. So Silent Sam is also good as a "keep your foot on the brakes when you're not moving" reminder, at least as long as your blinker is on. We're also happy to know that nobody is ever going to look at us and say "look at that idiot driving with his blinker on!"

For more information on the Silent Sam Turn-Signal Reminder, contact the Silent Sam TSR Co. directly at the address given in the box, or circle No. 119 on the Free Information Card. ■

FOR MORE INFORMATION

Silent Sam TSR Co.
1627 Basil Dr.
Columbus, OH 43227

THINK TANK

By John J. Yacono
Technical Editor
Windows Magazine

Electronic Locks

This month's letters contain some digital-lock concepts. We'll get to those later, but first, let's discuss resistor tolerance. Like all else in life, no component is perfect. For example, a 100-ohm resistor is rarely a perfect 100-ohms. For that reason, resistors have a tolerance rating—a percentage that indicates the maximum error possible in the parts value. For example, a resistor rated 100-ohms with a 10% tolerance could have a real value between 90 and 110 ohms.

Parts values in circuits are seldom so critical that deviations due to wide tolerance are troublesome. However, there are times when knowing a resistor's

tolerance is important. Resistors can be 1%, 2%, 3%, 4%, 5%, 10%, or 20% tolerance units. Those values are represented by a brown, red, orange, yellow, gold, silver, or no-color band, respectively. A gap separates the tolerance band from the bands that represent the resistor's value. The tolerance band is usually the fourth band, but it is the fifth band on high-tolerance units.

If you find a silver or gold band in the third position, it's intended as a divisor for the parts value, not as a tolerance marking. Instead of adding zeroes to the parts resistance value, it shifts the decimal point left so the first two bands can be used to indicate resistance values lower than 10 ohms. A silver band means you divide by 100, and a gold one means you divide by 10. So a resistor with yellow (4), violet (7), and gold ($\div 10$) markings has a value of:

$$47/10 = 4.7 \text{ ohms}$$

Sometimes you'll find the actual tolerance band followed by another band. That last band indicates the failure rate of the component. Failure rate is measured in percent per 1000 hours. Ratings are 1, 0.1, 0.01, and 0.001; and are marked brown, red, orange, and yellow, respectively.

Well that's enough tutorial for now, but before I get to the letters I'd like to ask you all a favor: Please send in circuits dealing with NiCd batteries, the weather, or doorbells. I need one more of each topic to make a column based on it.

SIMPLIFIED DIGITAL LOCK

I'm 15 years old. I really enjoy **Popular Electronics** very much (especially the *Think Tank* section). In the **Popular Electronics**, July 1994 issue, on page 70 there is an article titled "Build a Digital Combination Lock," by Jim Stephens. I felt that the circuit is a little difficult for beginners, so here's my version (see Fig. 1). This new lock provides a high degree of security while being very simple.

The heart of the circuit is a 4022 octal counter. When first powered up, C2 is charged via R5, so the reset input of the counter is kept high. That causes output Q₀ to go high while all other outputs are low. With the switches wired as shown, when S4 is pressed, the BS170 is switched on via debouncing network R2/C1, and U1 receives a clock pulse. Also, C2 is discharged via R4 and D1, removing the reset signal of the counter, allowing it to advance. The time required for C2 to charge via R5 (i.e., to reset the counter), is the maximum time that can lapse before the next key is pressed. The above cycle is therefore repeated only if S8 (connected to the Q₁ output) is pressed in time. When all keys have been pressed in time and in the correct order, Q₇ goes high for about 4 seconds to drive the "unlock" circuitry (e.g., a relay driver for an automatic door opener).

The code shown is only an example; a builder can change the code to whatever he or she likes by rewiring the switches. The

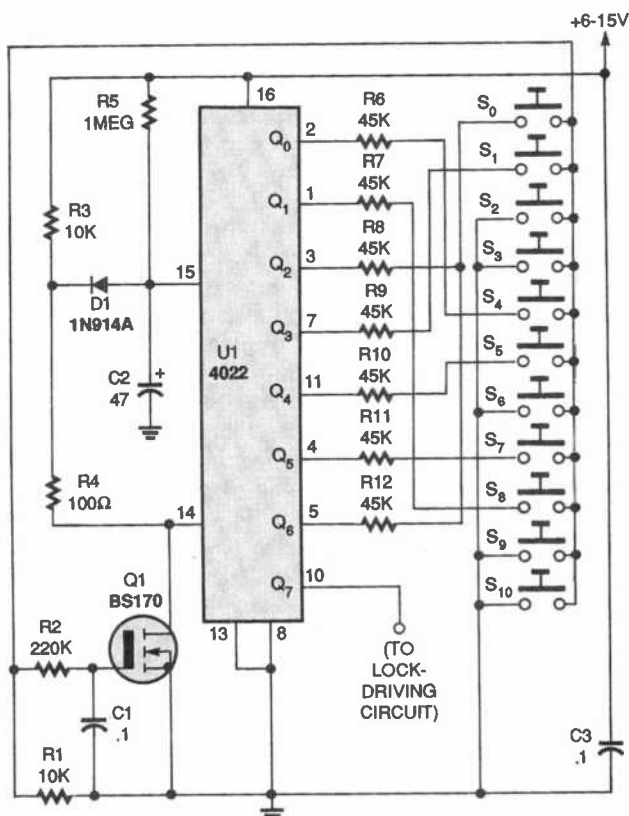

Fig. 1. A one-IC answer to your digital lock needs, this circuit will not activate a lock unless it receives the correct 7-digit code.

code for the lock shown in the circuit diagram is 4-8-0-1-5-7-0. However, if a 7-digit combination code is considered too simple to crack, the 4022 octal counter can be replaced by a 4017 divide-by-10 counter. That will make it possible to add two more digits to the combination.

The quiescent current consumption of the lock is a negligible 0.5 mA, so battery operation is feasible. The circuit requires between 6 and 15 volts. It is a very interesting and inexpensive circuit.

—Goh Chia Chieh, Perak, Malaysia

That is super! I have one suggestion to make the circuit even simpler. Remove resistors R6–R12 (connect the outputs of U1 directly to the switches) and insert a single 45K resistor between the common to all the switches, and the R1/R2 junction. That has the added advantage of preventing the circuit from registering a correct entry if someone punches all the buttons at once.

A neat construction tip would be to connect the outputs of U1 (except for Q₇) to one side of an IC socket, and the switches to the other side. A combination can then be easily set (and changed) by arranging jumpers across the socket.

LOCK REVISION

On page 70 of your July 1994 issue is an article showing a digital combination lock. The circuit was fun to build and use. I found it a little time consuming, though, if I or someone else wanted to change the combination, so here is the solution I used to solve that problem (see Fig. 2). I used the outputs of the 4042 latches to drive the inputs of BCD to decimal de-

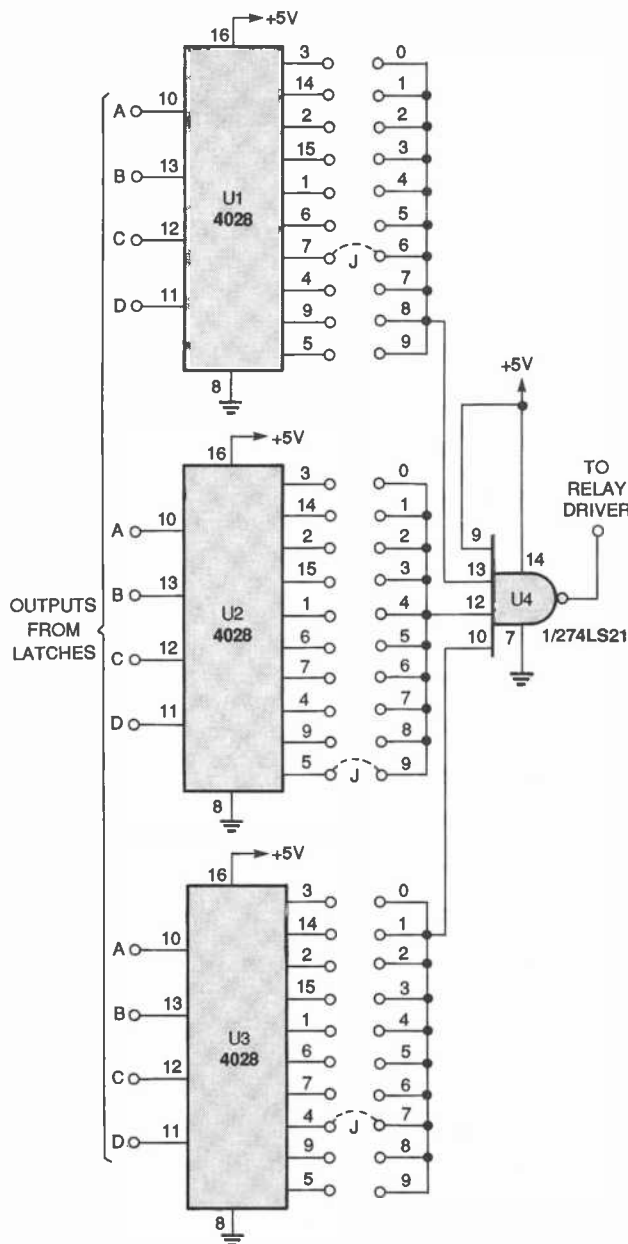

Fig. 2. This revision of a former circuit requires a matching 3-digit code to permit entry.

coders, which eliminates the need for the inverters and all but one AND gate. By using the decoders, it's just a matter of moving the jumper to the decimal output desired for each digit. Only the jumpered outputs will drive the AND gate to energize the relay. Jumpered as shown, the code is 697.

Thanks for a great magazine.

—Rick Thompson, Niles, OH

Very nice. When I was a kid, I came up with a neat electric dead bolt. I started by removing the core from a small power transformer. The coil, which was used as a solenoid, was mounted inside a cabinet so that the hole in its center was vertical. A thick nail (the "deadbolt") was dangled from a cord so that the majority of its length protruded from the bottom of the coil hole. The door on the cabinet was fitted with

an eyelet that faced the nail. When the coil was inactive, the nail dangled low enough to engage the eyelet, preventing anyone from opening the cabinet. When the coil was energized, the nail pulled up away from the eyelet to permit access.

JACK LOCK

I have just graduated from high school, where I majored in electronics. I've spent a lot of time designing and testing electronic circuits that had a subversive nature. After having created a small handful of the circuits, I decided that it would be a good idea to make a simple electronic key to operate them.

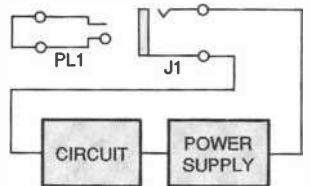

Fig. 3. Only an appropriately wired plug of the right size will activate circuits with a non-shorting jack in their power-supply circuit.

I came up with an extremely simple key (see Fig. 3). A phone jack (the type headphones are plugged into) is attached to the device's chassis in a convenient place. The phone jack should have two terminals, and must be a non-shorting type. Cut one of the wires connecting the power supply to the protected circuit and connect it to one of the jack's terminals. Then connect the other jack terminal to the circuit at the point at which the wire was cut. That way, the jack acts as an open switch, keeping the circuit inactive.

A key is made from a phone plug that mates with

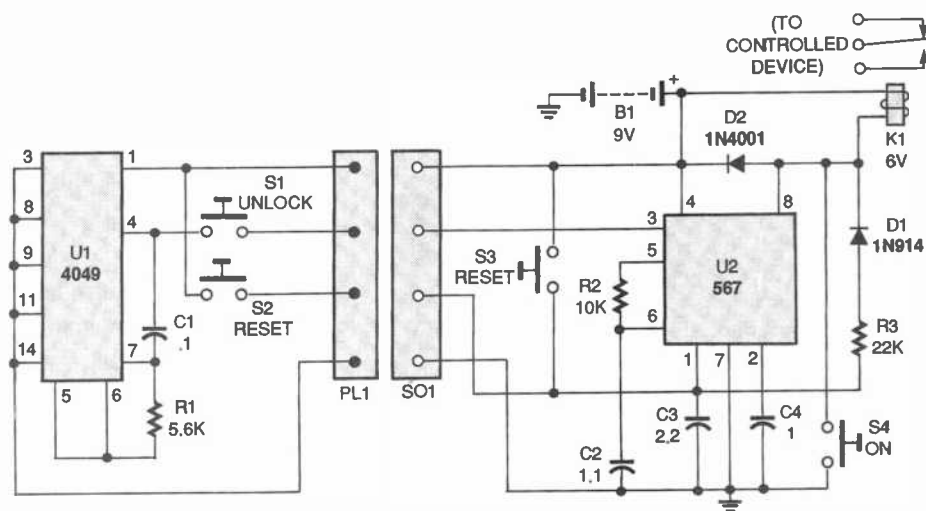

Fig. 4. This complete lock and key system uses frequency matching to provide security. The frequency of the tone-generating key must match the one looked for by the tone-decoding lock.

the jack. The terminals of the phone plug are soldered together. When the key is plugged in, it closes the circuit, operating the device. If the power required by the circuit is larger than the jack and plug can handle, then the jack can be used to turn a relay on or off to control the load.

—Andrew Meyers, Ontario, Canada

It's also a good idea to use a low-voltage relay if line-current is to be switched. You don't want AC at the jack.

A stereo jack and plug could also be used to further enhance the security of the lock, especially if one combination of contacts are used to short the relay preventing it from working if a person sticks any old piece of metal in the jack.

FREQUENCY-BASED LOCK

The circuit I've included this time is a frequency-based entry lock. The system is formed by two separate circuits—a key and a keyhole. They key engages the keyhole by means of a mating pair of connectors (the type is not important although I used a

male and female D-sub-miniature pair).

The key (see Fig. 4) is a tone-generator circuit consisting of a 4049 hex inverter CMOS IC (U1), switches (S1 and S2), a resistor (R1), and a capacitor (C1). The value of the tone generated by that circuit in Hz is determined by:

$$1/(1.4 \times R1C1)$$

The keyhole is a 567 tone-decoder circuit that can be configured to detect any frequency from 0.01 Hz to 500 kHz. The frequency it detects (f_o) is set by resistor R2 and capacitor C2, according to:

$$f_o = 1.1/(R2C2)$$

When the key is inserted into the lock, and switch S1 is pressed, a tone is supplied to the input of the keyhole circuit. If the tone frequency is close enough to f_o , the 567 IC turns on the relay (K1), which should be connected to the electronic locking device. (In my case the circuit controls a solenoid bolt, but you can use it to control a device of your convenience.) Components R3 and D1 are used to latch the circuit, so the output stays on even after the input tone is re-

moved. When S2 is pressed, the system is reset. Switch S3 resets the circuit from inside.

Note: The accuracy with which the keyhole circuit detects f_o can be set by changing the values of three components. First, R2

should be between 2000 and 20,000 ohms. Second, the value in microfarads of capacitor C4 should be:

$$n/f_o$$

where n is a value between 1300 (which gives a detection accuracy of up to 14% of f_o) and 62,000 (for an accuracy of about 2% of f_o). Finally, capacitor C3 should have about twice the capacitance of capacitor C4. Battery B1 supplies both circuits.

—Luis Balpuesta, Texcoco Edo. Mex., Mexico

Excellent piece of work. The use of multi-contact connectors makes defeating the lock a time-consuming affair.

Please send your circuits to me here at Think Tank, Popular Electronics, 500-B Bi-County Blvd., Farmingdale, NY 11735.

Earn \$1000

A Week While You Learn High Paying VCR Repair.

Earn While You Learn . . . Secrets Revealed . . .



Train at Home

If you are able to work with small hand tools and possess average mechanical ability, you could earn top dollar part time or full

time. Our learn by doing method teaches you how to work on VCR's without boring unnecessary electronic basics.

For Free Information Package Send Coupon to:
 Foley-Belsaw Institute, 6301 Equitable Road,
 Kansas City, MO 64120

(Check One Box Only)

Check VCR or another High Paying Career Field

VCR Repair, Dept. 62290

Computer Repair, Dept. 64188

TV/Satellite Dish, Dept. 31078

Advance VCR Repair, Dept. 65034

Camcorder Repair, Dept. 66044

Fax Repair, Dept. 67044

Printer Repair, Dept. 68043

Since 1926

Name _____

Address _____

City _____

State _____ Zip _____

CIRCLE 154 ON FREE INFORMATION CARD

What Do These Prestigious Companies Have In Common?

Aerovox®

DC Film and RFI Suppression Capacitors, Aluminum Electrolytic and AC Oil Capacitors, EMI Filters

AMP

Electrical/Electronic Connectors, IC Sockets, PCB Switches

AMRAD Engineering, Inc.

Motor Run Capacitors, HID Lighting Capacitors, Power Factor Correction Capacitors



Miniature and Subminiature Coaxial Connectors and Cable Assemblies.

AVX CORPORATION

MLC, Tantalum and Thin Film Capacitors, Resistors, Networks, Integrated Passive Components, Trimmers, Oscillators, Resonators, Filters, Piezo Devices, and Connectors

BERG ELECTRONICS

High Density and Industry Standard Connectors/Subsystems

CAROL

Electronic and Electrical Wire and Cable and Power Supply Cords

COLE FLEX

Tubing, Conduits, Hose, Sleeveings, Splices, Insulation and Cable Harness Products, Power Cords and Cordsets

Communications Instruments, Inc.

CII Midtex
Relays and Solenoids

COOPER

Bussmann
Fuses, Fuseholders, Fuse Blocks, and Fuse Accessories

CORNELL DUBILIER

Capacitors-Aluminum Electrolytics, Mica, AC Oil, Film, MICA Paper and Relays



A COMPANY OF

Dale Electronics, Inc.
Resistors, Networks, Oscillators, Displays, Inductors, Thermistors, Connectors, & Transformers

DANTONA INDUSTRIES, INC.

Batteries: Computer, Cordless Phone, Laptop, Scanner, Alarm and Medical
Antennas: Cordless Phone and Scanner

DEARBORN WIRE AND CABLE L.P.



EATON

Eaton Corporation, Commercial & Military Controls Operation
Switches, Relays, Displays and Keyboards



Quartz Crystals, Clock Oscillators, Surface Mount Products, Programmable Devices

GERNSBACK PUBLICATION

Popular Electronics
Electronics Now Magazine

GUARDIAN

Relays and Solenoids

KEMET

Electronics Corporation
Multilayer Ceramic and Solid Tantalum Capacitors

KOA SPEER

Resistors, SMT Tantalum Capacitors Inductors, Resistor Networks, SMT Thermistors

MALLORY

North American Capacitor Company
Tantalums, Aluminums, Sonalerts® Ceramics, Films and AC's

M-tron

Quartz Crystal
Hybrid Oscillators

muRata®

Fixed Ceramic Capacitors, Variable Capacitors and Resistors, Crystal Oscillators, Ceramic Filters, Resonators, EMI Filters, Hybrid Circuits and more.

Panasonic Industrial Company

Resistors, Resistor Networks, Ceramic, Film, Electrolytic, Double Layer Capacitors, Potentiometers, Switches, Inductors, Filters, Resonators, Varistors, Thermistors

Philips Components

Philips Electronics North America Corporation
Resistors, Ferrite Components
Aluminum Electrolytic, Film & Ceramic Capacitors

They sell through distributors.
They belong to the E.I.A.
They belong on your vendor list.

Quam

Loudspeakers and Commercial Sound Products

ROHM

Rohm Electronics Division
Resistors, Ceramic Capacitors, Transistors/Diodes, Opto Components and IC's

SELECTA

Switches, Relays, Terminals, Indicator/Pilot Lights, LED Indicators, Test Clips, Test Leads, Cable Ties and Heat Shrinkable Tubing

SPRAGUE

Tantalum Capacitors, Wet & Foil Capacitors, Resistor Networks, Resistor Capacitor Networks, Filters

Switchcraft

Switches, Connectors, Jacks, Plugs, Jackfields & Audio Accessories, Cable Assemblies

Leadership in electronics is not just a matter of designing products better and manufacturing them better, but also of marketing them better. And the sponsors of this message understand that better service to customers requires effectively involving distributors as part of their marketing teams.

Distributor involvement means lower prices, quicker deliveries, better service over-all. The Buyer wins...the Seller wins.

Distributors help achieve marketing leadership. So does the manufacturer's involvement in the Components Group of the Electronic Industries Association. EIA fosters better industry relations, coherent industry standards, and the sharing of ideas, which helps one another and serves customers better.

In choosing your component supplier, look for the marks of leadership--

availability through distribution membership in E.I.A.



Our 70th Anniversary Year

Electronic Industries Association/Components Group
2001 Pennsylvania Avenue, N.W., 11th Floor
Washington, D.C. 20006
Phone: (202) 457-4930
Fax: (202) 457-4985

Committed to the competitiveness of the American electronics producer.

BY
W. SCHOPP

Build the Sprinkler Guardian

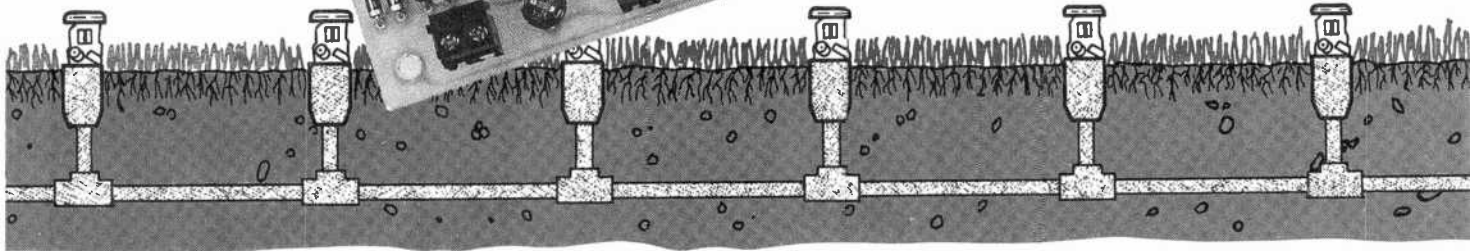
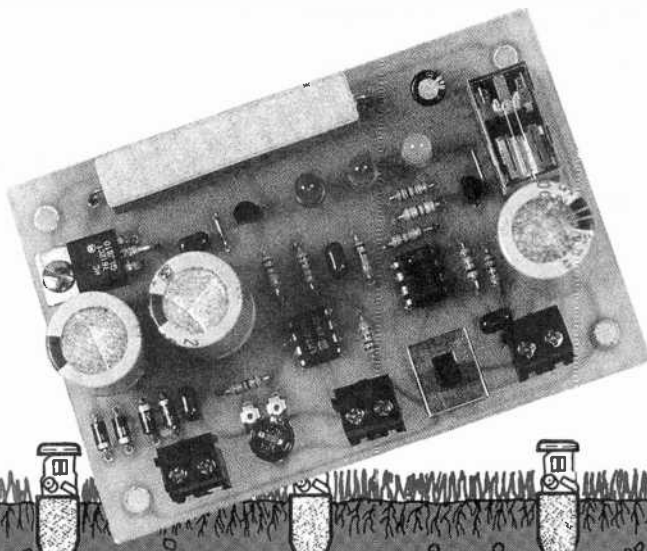

*Here is a rain shut-off for your automatic sprinkler-system
that overcomes common problems, and can save dollars on your water bill.*

Ever drive by a yard during the height of a rain storm and wonder why the sprinkler system was working? The answer is simple: sprinkler systems are on timers, and don't know that it's raining. If you would like to keep your system from running in the rain, you can do one of two things: you can either turn off your sprinklers every time it looks like rain, or build the *Sprinkler Guardian* described in this article.

The Sprinkler Guardian is an add-on unit that works with your sprinkler controller and turns off your system when the ground is damp. Using it can significantly cut the watering bill for your lawn. The Guardian also solves some of the shortcomings with a few commercially available sensing units.

Some commercial units that detect lawn moisture have this problem to contend with: when the sprinklers turn on, the probes get wet, causing the unit to shut off the sprinklers (because the unit "thinks" it is raining). That problem is usually solved by telling the installer to bury the probes 4 to 6 inches below the ground. Doing so allows time for the water to soak down from the surface before it indicates that the ground is wet and the sprinklers should be off. There are a couple of drawbacks to that: For one thing, it solves the control problem by adding more work to the installation. In addition, that type of sensing does not detect dry soil at the surface where grass roots are, but waits for soil to dry clear

down to the depth of the sensors before calling for watering.

The above method also presents a problem with systems that have multiple branches. If the sensor probes are located in the first branch being watered, the probes might get wet and the second and remaining branches might never turn on. To avoid that, the probes must always be placed where they are in the last area watered.

Another type of sensing unit detects the resistance of water trapped in a small cup during a rain storm, and waits for that water to evaporate before it turns on the sprinklers. The obvious drawback to that type of sensor operation is that it has nothing to do with the amount of moisture in the ground.

How It Works. The Sprinkler Guardian can be used in conjunction with any sprinkler controller that uses standard, 24-volt AC valves. The add-on unit senses the moisture content at the ground surface, and if the ground is dry, the unit allows the controller to execute all the on-times preset by the controller clock. If there is enough moisture in the ground already, however, the Guardian will prevent the valves from opening.

The schematic for the Sprinkler Guardian is shown in Fig. 1. The unit obtains its power from the 24-volt AC power supply of the controller it is used with. That power is supplied to terminals 1 and 2 of terminal block TB1,

and the AC is then rectified by the bridge composed of diodes D1 through D4. Capacitors C1 and C2 act as supply filters, while C5 and C8 are bypass capacitors. The 10-watt resistor, R1, drops the supplied 24 volts down to about 14 volts, which is input to U1, the 12-volt regulator. The output of U1 supplies a regulated 12 volts to the rest of the circuit.

The ground probes are connected to terminals 1 and 2 of TB2. Resistor R2 is used to balance the resistance of the earth between the two probes so that op-amp U2, which is configured as a comparator, outputs a high when the ground is dry. When that happens, PNP transistor Q1 is turned off, K1 is not energized, and terminals 1 and 2 of TB3 are shorted. Under those conditions, if the controller calls for watering the lawn, watering will commence.

Now, let's assume that it rains, and that the ground is wet. The resistance between the probes drops, causing the output of U2 to go low, which turns on Q1. That energizes K1, causing its contacts to open. Under those conditions, even when the controller is programmed to water, the valves will not open. That covers the wet and dry conditions normally encountered.

Now let's assume the soil is dry. Relay K1 is off and all is ready for the needed watering-cycle. When the programmed watering time arrives, the water valve is opened, starting the timed watering-cycle. The probes are wetted immediately and U2 goes low.

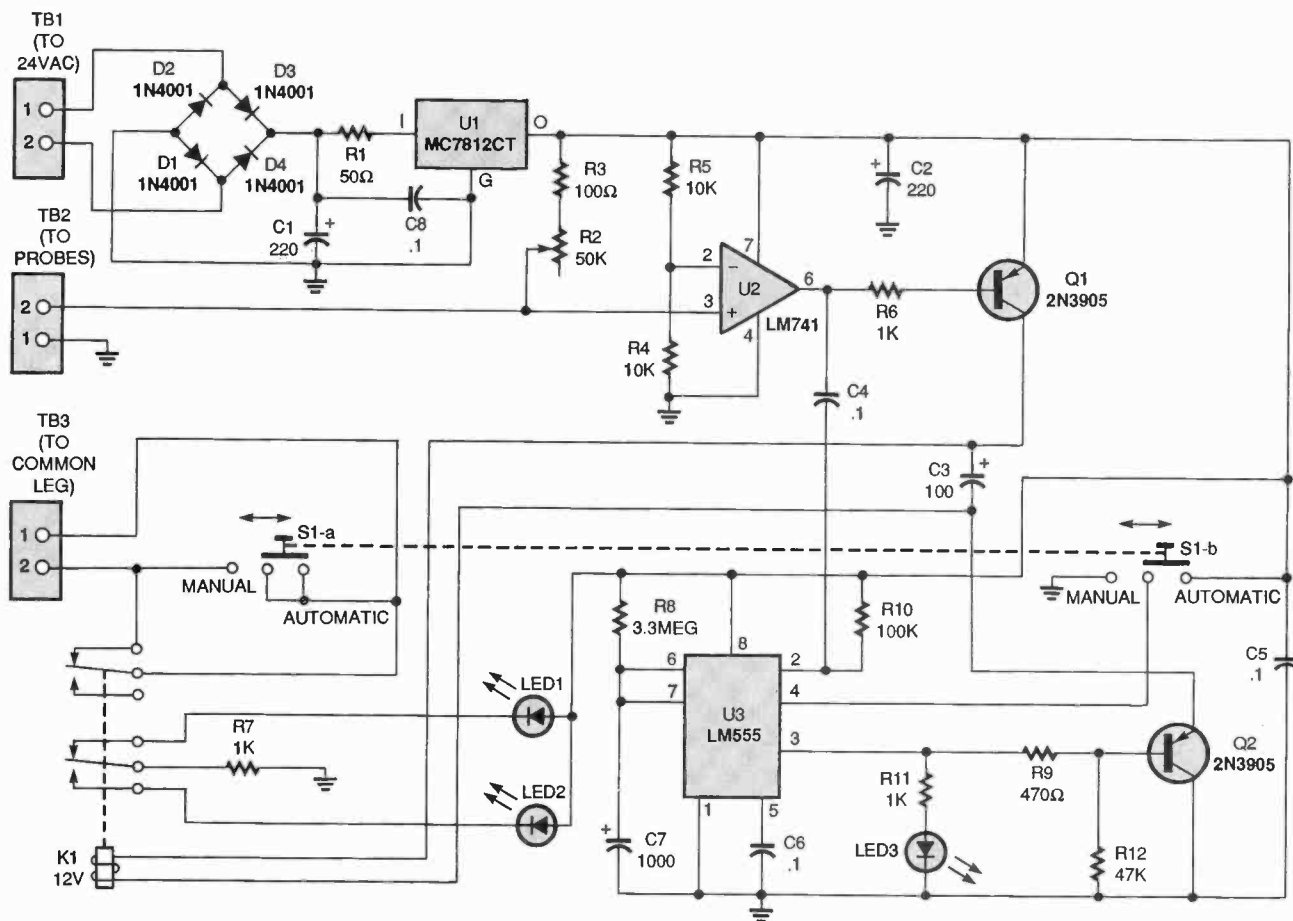

Fig. 1. The Sprinkler Guardian uses probes to sense the change in the ground's resistance when moist. If the moisture is caused by the sprinkler system, U3, a 555 timer, allows the sprinkler to run for about an hour with the values shown for R8 and C7.

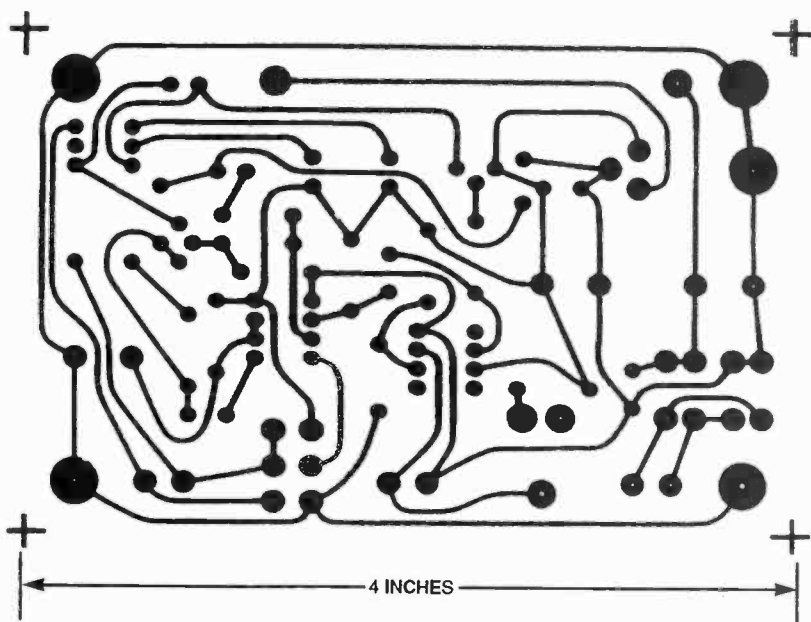

Fig. 2. The Sprinkler Guardian prototype was assembled on a printed-circuit board. A full-size template of it is shown here.

tion. The timer output from pin 3 turns Q2 off, which keeps K1 from closing during the time cycle determined by R8 and C7. That allows time for the sprinkler system to complete the watering cycle.

By the end of the U3 time period, the controller has most likely completed its on-time and has shut off. With the component values shown, the time period set on the Sprinkler Guardian is about one hour, after which the sensor becomes active again. If an hour is not long enough, the U3 period can be adjusted using the formula:

$$T = R \times C \times 1.1$$

where T is the time in seconds, R is the resistance of R8 in ohms, C is the capacitance of C7 in farads, and 1.1 is a constant.

A DPDT switch, S1, is used to place the circuit in either the "automatic" or "manual" modes. In the "automatic" mode, the circuit operates as previously described. In the "manual"

As the voltage output of U2 drops, a negative-going pulse is delivered

through C4 to pin 2 of U3, a 555 timer, which triggers the timer into opera-

PARTS LIST FOR THE SPRINKLER GUARDIAN

SEMICONDUCTORS

- U1—MC7812CT, 12-volt regulator, integrated circuit
- U2—LM741 op-amp, integrated circuit
- U3—LM555 timer, integrated circuit
- Q1, Q2—2N3905, general-purpose PNP transistor
- D1—D4—1N4001, 1-amp, 50-PIV rectifier diode
- LED1—Red light-emitting diode
- LED2—Green light-emitting diode
- LED3—Yellow light-emitting diode

RESISTORS

- (All fixed resistors are 1/4-watt, 5% units, unless otherwise indicated.)
- R1—50-ohm, 10-watt, 10%
 - R2—50,000-ohm, potentiometer, PC-mount (Digi-Key K4A54 or similar)
 - R3—100-ohm
 - R4, R5—10,000-ohm
 - R6, R7, R11—1000-ohm
 - R8—3.3-megohm
 - R9—470-ohm
 - R10—100,000-ohm
 - R12—47,000-ohm

CAPACITORS

- C1, C2—220- μ F, 50-WVDC, electrolytic
- C3—100- μ F, 16-WVDC, electrolytic
- C4, C5, C6, C8—0.1- μ F, metallized-film
- C7—1000- μ F, 25-WVDC, electrolytic

ADDITIONAL PARTS AND MATERIALS

- K1—12-volt DC relay, AROMAT #HB2-DC12V (Jameco 18577 or equivalent)
- TB1—TB3—2-terminal, terminal block, PC-mount
- S1—DPDT slide switch
- Printed-circuit materials, two 20D nails, insulated wire, solder, hardware, etc.

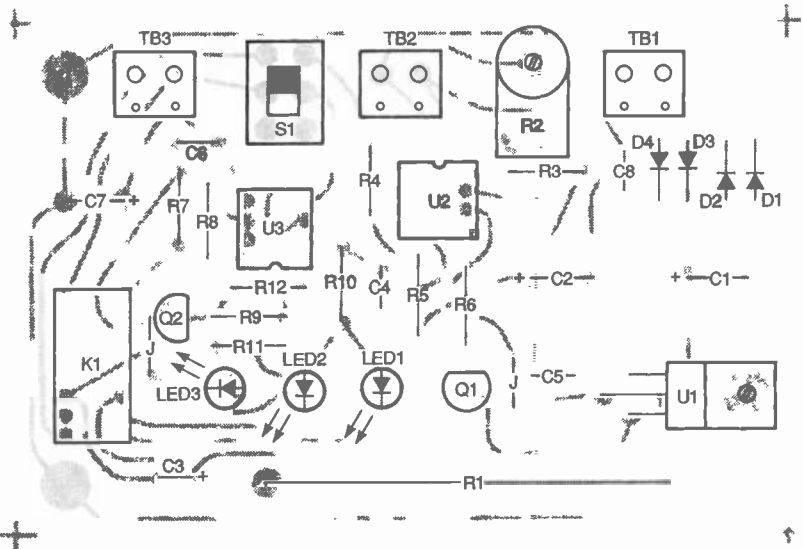

Fig. 3. Assemble your unit using this parts-placement diagram as a guide. Be sure to leave a 1/4-inch space between the PC board and R1 for ventilation.

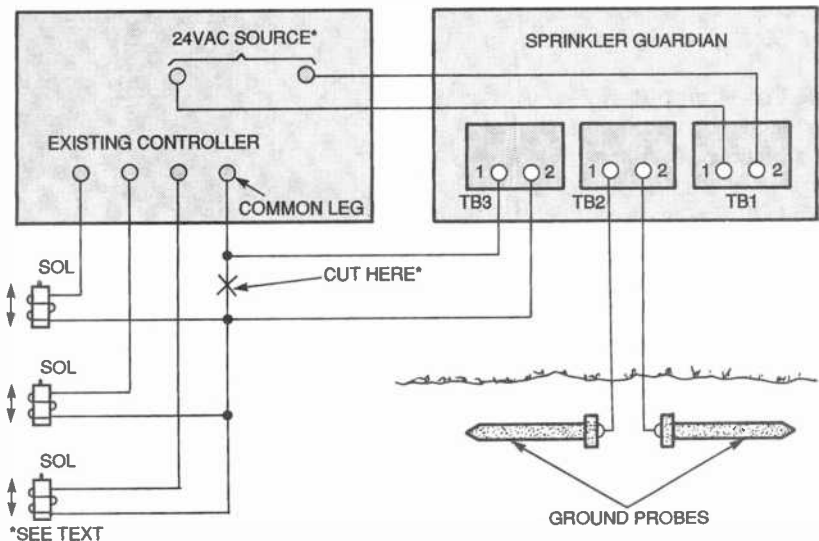

Fig. 4. This illustration shows how to properly connect the Sprinkler Guardian to your sprinkler-system controller and to the buried ground probes.

mode, the terminals of TB3 are shorted, effectively removing the Guardian from the system, and U3 is removed from the Guardian circuit, allowing R2 to be adjusted without worrying about the action of the timer. Note that R2 should always be adjusted with S1 in the "manual" position.

Two LED's are used to indicate the condition of the relay. When green LED1 is on, it indicates that the relay is off and that all watering cycles will be completed. When the relay is ener-

gized, red LED2 is on, indicating that the sensor is wet and that the demand for water by the controller will not be accommodated. Because the timer keeps the relay from being energized even if the probe is moist, it is essential to know if the timer is in its timing cycle or if it is off. Yellow LED3 is on when the timer is in its timing cycle.

Construction. The unit can be built on either perforated construction board or on a printed-circuit board. For those who want to use a PC board, a template is shown in Fig. 2, and the parts-placement diagram is shown in Fig. 3. Using the PC-board layout elimi-

nates wiring mistakes, but might limit parts substitutions, because of physical differences in part sizes.

All the components are mounted flush on the board except for R1. Leave about a 1/4-inch space between that high-wattage resistor and the surface of the PC board to allow better air-flow cooling. When installing capacitors C1, C2, C3, and C7, be sure to check that their polarity matches that shown in Fig. 3. Also, be sure to install the two jumper connections at the correct places.

The probes can be two 20D nails, with the needed length of insulated
(Continued on page 93)

One of the first personal computers ever made available to the public was the \$400 MITS Altair that **Popular Electronics** featured as its January 1975 cover story. That PC, to coin an unfamiliar term, had few options and amenities; memory was 256 bytes, there was no permanent storage, and it came without a keyboard. Not only that, but you were expected to build it yourself—it was offered as a kit.

Computers have changed dramatically since then, especially since the advent of the IBM PC. PC choices have multiplied and prices have plummeted so that computer technology is no longer beyond the average person's budget. But what went on before the 1981 debut of the IBM PC? Let's take an archaeological look backward at the many fascinating people and PC's that changed the computer world, and find out.

The First Computers? In this article, we'll loosely refer to desktop personal computers as PC's. That's fine, but exactly what is a computer? Definitions vary, but a computer is basically any instrument or tool for measuring, counting, or calculating in a variety of fields—architecture, astronomy, ordnance, electricity, and electronics, to name a few. However, a computer need not have anything to do with bits and bytes.

The ancient abacus is considered by many to be the first "computer." Before the Hindu-Arabic number system came into use, people counted, added, and subtracted with an abacus, which probably was invented by ancient Sumerians in Mesopotamia. The Greeks and Romans used pebbles or metal disks as counters, moving them on marked boards to solve arithmetic problems. Later, the counters were strung neatly on wires mounted in a frame.

The Egyptians, Chinese, and others also used the abacus. The Hindu-Arabic system of counting, which included zero as a number, made written calculations much easier, so the abacus passed out of favor in Europe. However, people in Asia, particularly in China, still use it, especially in business.

Joseph-Marie Jacquard's automatic silk-weaving loom of 1800 is often cited as the harbinger of modern-day

computing. Jacquard used "loom cards" to help control and automate the complex process of silk weaving.

Jacquard's loom served as the incentive for the technological revolution of the textile industry. The loom, which could perform all necessary weaving motions, produced complex patterns just as well as conventional machines produced unadorned cloth. In 1806 the loom was declared public property, and the French gave Jacquard a pension and a royalty payment for each machine. The loom eventually gained acceptance because of its many advantages, and by 1812 there were about 11,000 of them

in France. The loom soon spread to England and the New World.

Around 1827, the British mathematician Charles Babbage tried unsuccessfully to design a working "differential calculating machine." A later, more ambitious, 1833 Babbage design, the analytical engine, contained all of the necessary elements of a modern computer: there were input devices, memory (including a built-in library of often-used programs), a mill or computing unit, a control unit, and output devices. The design called for more than 50,000 moving parts in a steam-driven machine as large as a locomotive.



Buried Bytes: A History of the Personal Computer

BY
KARL T. THURBER, JR.

*A look at the people and devices
that made today's personal computer possible.*

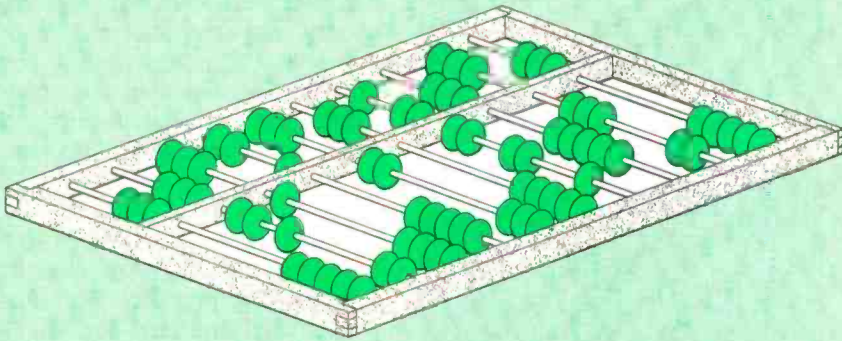

Considered by many to be the first computer, the abacus was most likely invented by the Sumerians about 5000 years ago. The device is still in use in Asia.

Significantly, most of the actions of the analytical engine were to be executed using small perforated cards—an adaptation of the method already used to control Jacquard's automatic silk-weaving looms. Assisting Babbage was Augusta Ada Byron, Countess of Lovelace, said to be the first "computer programmer" because she devised a control program for the analytical engine. However, although Babbage worked hard on the analytical engine for nearly 40 years, he never actually built a fully working machine.

Early Calculators. Mechanical, electromechanical, and electronic devices that perform arithmetic operations automatically are called calculators. But the early calculators were strictly mechanical devices: they performed their computations using machine parts—drums, disks, and gears—powered by hand or (later on) by electricity.

One early, special-purpose mechanical calculator was the platform scale, invented by Thaddeus Fairbanks in 1830. Later in 1879, the first cash register was built by James Ritty, a storekeeper, to ensure his clerks' honesty. Six years later, Dorr E. Felt invented the comptometer, a high-speed, mechanical calculating machine. The first "bookkeeping machine"—an adding and printing device—was built in 1888 by William S. Burroughs, a bank clerk, although some credit the concept to the French philosopher, mathematician, and physicist Blaise Pascal as early as 1642.

Charles Hollerith, an American inventor and Census Bureau engineer, perfected the ideas of Jacquard and

Babbage. In 1889, Hollerith patented a calculating machine that counted, collated, and sorted information stored on punched cards. When placed in his machine, the cards pressed on a set of metal pins that corresponded to the set of possible perforations. When a pin found a hole (which was punched to represent some variable or characteristic), it completed an electrical circuit and advanced the count for the appropriate category.

The patent that Hollerith obtained represented the first data-processing machine. His highly innovative device was first used to sort statistical information for the 1890 U.S. census. In 1896 Hollerith founded the Tabulating Machine Company to produce similar machines and better exploit his invention, and left the Census Bureau. Hollerith's company changed names to become the Computing, Tabulating, and Recording Company in 1911.

Later, in 1924, after several mergers the company again changed its name to become the International Business Machines Corporation (IBM). IBM made punched-card-based office machinery the dominant business-information system until the late 1960's, when a new generation of computers rendered the punched-card machines obsolete. The digital-computing era had begun.

Proto-Computers. Vannevar Bush, an American engineer, is generally credited with developing the mechanical computer in 1928. His invention, the differential analyzer, was the first calculator capable of solving differential equations. The device calculated with decimal (not binary) numbers and therefore required hun-

dreds of complicated gears and shafts to represent the various movements and relationships of the ten digits.

In 1939 two American physicists, John V. Atanasoff and Clifford Berry, developed a novel computer based on the binary numbering system. They correctly reasoned that binary numbers were better suited to computing than decimal numbers because the digits 1 and 0 could more easily be represented by electrical circuits, which were either on or off, plus or minus.

Further bolstering binary computing was the math of George Boole, a gifted British mathematician. He already had devised a complete system of binary algebra—Boolean algebra. Its two-valued nature could be applied readily to computer circuits. The digital computer was taking shape.

WWII Computers and Beyond.

Computers really didn't play a revolutionary role in the world around us and in our everyday lives until at least the 1940's. It took World War II to turn the still-mysterious "electronic brain" from sci-fi talk into a household word. The war spurred development of all kinds of technologies, including computing, especially for calculation-intensive military projects. Fortunately for us, the Allies were more interested in computing than were the Axis countries.

In 1941 the German inventor Konrad Zuse produced an operational computer, the Z3, which was used in aircraft and missile design during World War II. An unreceptive, wartime Nazi government hampered his attempts to build what would probably have been the first electronic general-purpose computer.

Two years later, in 1943, the British secretly developed Colossus, the first fully electronic (vacuum-tube based) computer, to crack secret German-military codes. Colossus was the brainchild of Alan M. Turing, an extraordinary English mathematician and logician whose theoretical universal computer, popularly called the Turing machine, provided the theoretical basis for the digital computers that were developed throughout the 1940's.

In 1944, working under a govern-

ment contract, Harvard mathematician Howard Aiken directed development of an early electromechanical computer. That was the Harvard-IBM Automatic Sequence Controlled Calculator, the first large-scale, automatic digital computer. It was later known as the Mark I, a sort of universal calculator that used clunky, electrical relays for calculations and punched paper tape for input. It used an amazing 3,304 electromechanical relays as on-off switches.

The Mark I contained over 700,000 failure-prone electrical parts. It was so large that it even had its own building in which to live at Harvard. Its primary function was to create ballistics tables to make Navy artillery more accurate. An improved all-electric computer, the Mark II, was completed by Aiken and his colleagues in 1947.

Because the British Colossus was designed for only one task, recognition as the first full-scale, modern, general-purpose, electronic digital computer belongs to ENIAC (Electronic Numerical Integrator and Calculator), the prototype for the modern computer. In 1946, John W. Mauchly and J. Presper Eckert, Jr., completed ENIAC, having begun work on it secretly in 1943.

Housed in Philadelphia at the University of Pennsylvania, ENIAC was a 30-ton monster. It contained over 17,000 vacuum tubes, used some 500 miles of wiring, and occupied 15,000 square feet of floor space. Even in that pre-solid-state world, however, it could perform an amazing 100,000 operations per second. ENIAC now is retired from service and housed in the Smithsonian Institution.

There were other early behemoth electronic brains. In 1948, Mauchly and Eckert completed BINAC, the Binary Automatic Computer, which stored information on magnetic tape rather than on punched cards. Another example was MANIAC, short for Mathematical Analyzer, Numerical Integrator and Computer; it was used to perform extremely complex hydrogen-bomb calculations. Remington Rand's prized UNIVAC, the Universal Automatic Computer, was used heavily by the Census Bureau in the 1950's.

A Solid-State Age Dawns. The transistor was invented in 1948 by the Americans Shockley, Brattain, and



In the late 1960's, computer technicians had a much harder time trouble-shooting than they do today—most computers had miles of cable to trace!

Bardeen, and their work netted them a Nobel prize in physics. Their invention also greatly facilitated electronics and computer development. Hot, large, and unreliable vacuum tubes could now be replaced by small and highly reliable germanium (later silicon) transistors that generated little heat yet functioned as switches or amplifiers.

A further breakthrough in computer miniaturization came in 1958 when Jack Kilby, an American engineer employed by Texas Instruments, designed the first true integrated circuit (IC). Initially, Kilby's IC was a simple germanium wafer that included transistors, resistors, and capacitors, the essential components or building blocks of electronic circuits.

In 1959, just six months after Kilby designed the IC, physicist and Intel Corporation founder Robert Noyce introduced a more practical version of the IC, using a silicon chip. His invention helped bring the PC revolution of the 1970's and 1980's closer, and it led to the extensive use of microchips in all sorts of consumer products, not just in computers.

By the early 1960's, many mechanical calculators were replaced by electronic calculators. Those devices contained IC's to rapidly perform mathematical functions. Today's sophisticated electronic calculators actually are dedicated, special-purpose computers. While there indeed are analog calculators, digital calculators are the devices most commonly

thought of as calculators. They deal directly with numbers or digits, and they work by counting, listing, comparing, and rearranging those digits. Digital calculators include cash registers, adding machines, and handheld or desktop electronic calculators.

To many, the 1960's were the glory days of the computer revolution. In that era, large computers—the heavy-weight, solid-state, big-business descendants of ENIAC, MANIAC, BINAC, UNIVAC, and the like, occupied whole floors or even buildings of universities and businesses. Mid-century America was full of big computers years before anyone even dreamed of calling them "personal." After all, no one but a tinkerer or an egomaniac would want a computer occupying every last square inch of his or her office, let alone having one that might noticeably sag his or her desk with its weight. But things were about to change.

PC Industry's Incubation. It turned out that in the 1960's and 1970's, there were a few visionaries who wanted desktop computer power they could control themselves. They wanted to forever dispense with the isolation, elitism, and centralized control associated with the large computers, called mainframes. Those early hackers and technoids who influenced the development of the PC predate what we'll call the 1970's PC incubator. At the outset, those PC enthusiasts were mainframe and mini-computer hobbyists.

Hobbyist interest in computers can be traced back at least to the 1960's when Digital Equipment Corp. (DEC) introduced its PDP series minicomputer, particularly the "relatively inexpensive" (\$24,000) PDP-8 mini. Also, in the mid-1960's, the ad hoc Midnight Computer Wiring Society of MIT (Massachusetts Institute of Technology) took shape. It was spontaneously and nocturnally convened when the current crop of young hackers needed to creatively work around MIT's extensive regulations against unauthorized tampering with its valuable digital computers.

What was emerging at MIT, Stanford, and other academic institutions with their bright computer-science students is often referred to as the Hacker Ethic. That ethic states, among

other things, that access to computers should be unlimited and total, information should be free to all, centralized authority is to be mistrusted, and computers are good in that they can change your life for the better. That ethic, which is still alive today in one form or another, is much better suited to the PC than it is to the mainframe or mini.

While all of that was going on, microchip technology continued to evolve. One of the most important steps in that evolution occurred in 1971 when an American engineer, Ted Hoff, placed the essential elements of a computer on one silicon chip, which he called a microprocessor. The Intel 4004 and the many CPU- (central-processing unit) chip variations that followed it, are actually the "kernels" that have operated untold millions of modern products and formed the brains of almost every general-purpose electronic computer.

Because the chip-sized CPU represented the very heart of a digital computer, computer hobbyists quickly realized that it was just a matter of time before computers would become affordable to the average guy or gal. That realization helped spawn one of the earliest computer-user's groups—the Homebrew Computer Club of Menlo Park.

Homebrew was formed in 1975 to exchange information, swap ideas, and work on projects related to computers, terminals, and various other digital devices. The club's real significance was that its pioneering, basement- and garage-tinkering, hacker-oriented members strongly influenced the development of the PC on the West Coast. Homebrew also encouraged the formation of similar clubs around the country.

Between the efforts of hackers and the technological developments of the time, the stage was set for computers to indeed become much smaller and reside where an individual could control them, right on his or her desk or workbench. Let's take a look at some of the small "microcomputers" that emerged as a result in the 1970's.

The Altair—A Revolution Begins.

By the mid-1970's, the microprocessor and other IC's had dramatically reduced the cost of the electronic com-

EXPERIENCE COMPUTER HISTORY AT THE SMITHSONIAN

If you want to experience computer history firsthand, be sure to visit the Smithsonian Institution in Washington, DC. It is a vast museum complex, research center, and educational institute that houses the historical, cultural, and scientific collections of the United States. Of special interest is the National Museum of American History, which documents the country's history, illustrating American progress in industry and science (including communications, computing, and electronics).

The museum's 14,000-square-foot information-age and computing displays on the first floor are superb. They focus on instruments for measuring and computing in the fields of architecture, astronomy, and ordnance. There also are many computing aids, from the ancient abacus, to punched-card systems, mainframes, minicomputers, and PC's.



You can stop at more than 40 stations for hands-on use of computers and interactive equipment. The displays also treat electronic computer and software development since the 1940's. The world's first full-scale, general-purpose, electronic digital computer, ENIAC, is on display there.

The good news is that admission to the Smithsonian museums is free. Most of the museums are open daily (except Christmas Day) from 10 a.m. to 5:30 p.m., and during spring and summer the hours are extended. **Note:** Those who have access to *America Online* can use the Smithsonian Online service to get the latest information on planning a visit. The service is found in *America Online's* Learning and Reference department, and can also be accessed by typing in the keyword "SI" or "Smithsonian." ■

ponents required in a computer. The first affordable desktop computer

specifically for personal use was the Altair 8800, sold by Micro Instrumentation Telemetry Systems (MITS) of Albuquerque, New Mexico.

The MITS Altair 8800 was the microcomputer that hardware hackers loved. Some consider it to be the first commercially available microcomputer, the one that truly kicked off the microcomputer revolution. Even though the Altair was advertised as a minicomputer kit; today we would call it a microcomputer. The term "PC" hadn't caught on just yet.

To keep the record straight, two other microcomputers actually predated the Altair. One was the Mark 8, designed by Jonathan Titus; he published the details in *Radio Electronics* (presently *Electronics Now*) in July 1974. However, it wasn't commercially available. Rather, it was just a list of parts for the builder to obtain, not a complete kit as was the Altair. The other pre-Altair challenger computer kit was Nat Wadsworth's Scelbi-8B, which used the 8008 chip (a less powerful one than the Altair's 8080). The computer was dropped when Wadsworth suffered health problems and couldn't support it.

The \$400 Altair kit (you could buy it assembled, but paid a much higher price) was the brainchild of enigmatic inventor, and former Air Force engineer, Ed Roberts who, incidentally, ultimately left the computer business and attended medical school. He used the 8-bit 8080 chip, announced by Intel in 1974, as the machine's heart. The signal bus on the Altair (the S-100) had 100 pins, which brought out every signal of the 8080 CPU. That made it fairly easy to add memory and peripheral devices for anyone who could solder well.

The Altair never became a commercially suitable computing appliance. For a user to end up with an 8K BASIC-speaking computer, he or she would have to spend nearly \$2000 in add-ons for the machine. But the Altair did give a real boost to Bill Gates and Paul Allen, who licensed their version of BASIC to MITS, which enabled the Altair to actually "do something."

Some competition for the Altair was offered by William Millard's IMSAI, Inc. (Millard later founded the ComputerLand chain). They developed the IMSAI 8080, an 8-bit Intel-8080-based computer. While not identical to the

Altair, the IMSAI did use the same Altair-style S-100 bus structure, and it also had a cleaner design. The IMSAI made a valiant attempt to be a sturdy, capable, businesslike desktop appliance, one that even came equipped with a real user's manual.

IMSAI wisely licensed the capable Control Program for Microcomputing (CP/M) operating system for 8-bit computers from Gary Kildall's Intergalactic Digital Research, now owned by Novell, Inc. CP/M, generally recognized as the first microcomputer-operating system, made using the computer (and especially floppy disks) much simpler and more practical.

Polishing the Apple. Perhaps the Homebrew Computer Club's greatest influence was on the Apple Computer Company of Palo Alto. In 1976, two young computer enthusiasts and Homebrew members, Steve Wozniak and Steve Jobs, began selling a remarkably small and cheap PC, the Apple I, for \$666.66. It was based on the brand-new, inexpensive (\$20), 8-bit, MOS-Technology 6502 CPU.

Wozniak, known as "the Woz," was a gifted hardware hacker who built the Apple I for his own pleasure and for the enjoyment of his friends, unveiling it in the spring of 1976 at the Homebrew Computer Club. But expecting to actually sell a computer to a non-hacker user was risky business in the mid-1970's. That was a time when gaining acceptance for a PC wasn't an easy task.

Enter Steve Jobs—non-techie visionary, deal-maker, and marketeer. He took the Woz's Apple I and his later Apple II and turned them into real, marketable products. Realizing what a user-friendly and good-looking computer the Apple really was, Jobs made a name for his fledgling company in the industry. The rest, of course, is history. If the Altair kicked off the PC revolution, the Apple defined just what a PC was and ensured that the PC would be a commercial success.

The Commodore PET. The Apple II wasn't the only hot product around. The Personal Electronic Transactor, or PET, was calculator-maker Commodore International's first computer. Commodore introduced it at the 1977



Mainframe computers like this UNIVAC used to take up entire rooms or floors in buildings. Some even occupied entire buildings! Of course, today, those machines have been made obsolete by computers that are a lot smaller, lighter, and faster.

Consumer Electronics Show in New York. The PET was the brainchild of Chuck Peddle, a gifted engineer who worked for the semiconductor manufacturer, MOS Technology. Commodore, under the leadership of hard-charging entrepreneur Jack Tramiel, presciently acquired MOS Technology to ensure it always had chips available for its use.

The 8-bit, 6502-based PET was quite capable for 1977, being equipped with either a 4K or 8K memory, a built-in green-screen monitor, a tiny keyboard that looked suspiciously like a Commodore calculator keyboard rather than the expected typewriter keyboard, and a built-in cassette recorder for data storage. The PET was priced at a bargain-basement \$795, but the backlog for the machines was so great that you had to wait months to get one.

Sure, the machine was a little strange, typical of Commodore's off-beat approach. Besides the odd keyboard, all the ports were nonstandard, so you were locked into buying Commodore-supplied peripherals such as disk drives and printers. Later, an almost-standard typewriter keyboard was substituted for the calculator model. But the machine only

became suitable for serious business use when it metamorphosed into the CBM 4032, which had a then-respectable 32K memory. More on Commodore later.

The Affordable TRS-80. In 1977, Tandy Corporation became the first major electronics firm to produce a PC. They added a keyboard and CRT to their basic computer and offered a means of storing programs on a cassette-tape recorder.

The first TRS-80, Model I, Level I, was sold in August 1977. The pride of Fort Worth and designer Steve Leininger, the earliest Tandy Radio Shack TRS-80 (for Tandy Radio Shack) was priced at \$599.95, but it was not a very capable machine. Using the Zilog Z-80 CPU, a faster and more powerful version of the aging 8080, it still had but 4K RAM, a flaky cassette recorder, and no capability to hook up a printer.

The machine's affordability was its greatest asset, even though Radio Shack had never before sold anything for more than \$500. Above all, the TRS-80's widespread availability introduced the public to computers. No longer did you have to be a hardware hacker to work with bits and bytes: a real digital computer was as close as



The original TRS-80 Model I released in 1977 introduced an unknowing public to computers: you could take it home, plug it in, and actually do something with it within minutes.

your local Radio Shack store. You could take your Tandy home, plug it in, and actually do some real computing with it within a few minutes.

Unfortunately, Radio Shack's early policy was to not cooperate with third-party software and hardware developers, so that, as with Commodore, you had to stick with Radio Shack peripherals and software programs. Even the TRSDOS operating system, a CP/M variant, wasn't compatible with the popular mainstream CP/M operating systems of the period. If you owned a TRS-80, you were stranded in your own computing world.

The players described so far had the most significant and lasting impact on the emerging PC industry. If you'd like to read about some of the other PC-manufacturing companies that surfaced in the 1970's, refer to Stan Veit's *History of the Personal Computer* (see the "Books on Computer History" box for more information).

The PC Comes of Age. The Commodore PET was, well, just another PC in a new and chaotic industry. But in

1978, Commodore's MOS Technology subsidiary developed a very special chip that let a computer use a color display rather than a black-and-white



It's no secret that today's crop of ultra-light portable PC's—laptops and notebooks—pack more memory and overall computing power than the early mainframes. This ZEOS notebook packs a punch that 1981 Osborne I portable-PC owners would surely envy.

screen. The Video Interface Chip (VIC), with its colorful 22-column capability, became the impetus for the revolutionary Commodore VIC-20 computer that Commodore introduced in 1981 for under \$300.

A consumer could bring the little, one-piece PC home from the local discount store, hook it up to his or her color TV set, and enjoy the computing world in eight glorious colors. No one seemed to mind that it had but 22 columns of rather large and clunky letters as its display, and that it had less than 5K of main-system memory.

The pioneering VIC-20 was followed in 1982 by the legendary Commodore 64, arguably the most popular single computer ever built. The C-64, many thousands of which are still running today, had it all: a 40-column screen, a music-synthesizer chip, easily programmed graphics, and a seemingly infinite 64K RAM.

VIC-20 owners loved the C-64 because they could use their notoriously nonstandard VIC peripherals (disk drives, printers, and modems) with it. The C-64 was initially list-priced at \$595, but eventually sold for about one-fourth of that price. In 1983, price cuts and price wars reportedly made Commodore the first personal-computer company to reach \$1 billion in sales.

Jack Tramiel was the driving force behind Commodore as its long-time president, but resigned abruptly in mid-1983 in a dispute with the company's chairman. In a complex deal, Tramiel and his sons took over the struggling game and PC maker, Atari, from its parent, Warner Communications. Tramiel, then marketed the graphically oriented, Macintosh-like Atari 520ST, with its TOS (Tramiel Operating System), a CP/M variant, and its nifty GEM graphics interface. In fact, the Atari ST was so Mac-like that the trade press creatively dubbed it the "Jackintosh."

Atari, founded by legendary Pong video-game inventor Nolan Bushnell, made a name for itself with its Atari 2600 Video Computer System, and also earned respect for its Model 400 and 800 personal computers, well-known for their superb graphics quality. However, under its new management, led by Tramiel and his sons, Atari did not do well. As this is written, Commodore has liquidated and Atari is

struggling for survival. Like so many other PC pioneers, both companies became engrossed in their own vision of the way the world should be, ignored their customers, and in the end lost their ability to compete in the marketplace.

Some Competition. Could a major semiconductor manufacturer penetrate the "home-computer market" to follow up on their success with consumer-oriented products like calculators? In 1980, Texas Instruments (TI) introduced the TI 99/4, which boasted excellent color and graphics but was a closed system that discouraged third parties from developing software and accessories for it.

Though a consumer-oriented machine, the TI 99/4 was priced well out of the consumer market with its initial and highly unrealistic \$1200 price tag. An improved machine, the TI 99/4A, was eventually developed; it could be sold in department stores and discount houses for under \$500. TI became involved in computer-price wars with Atari and Commodore in 1983, and even announced a snazzy Professional Computer and the CC-40 Portable. Although the TI 99/4A was a high-quality machine, TI never could make any money on it.

Consequently, in late 1983 the TI 99/4A went out of production, and the existing inventory was dumped at fire-sale prices. That action instantly created a large community of users, many of whom still use their bargain-priced machines today.

There were many other competing manufacturers who left their mark on the still-fledgling PC industry of the early 1980's. A few of them merit a closer look:

Adam Osborne, a Ph.D. in chemical engineering, formed the Osborne Computer Corporation to turn out a no-frills, low-cost PC for traveling professionals. The Osborne 1, a heavy clunker designed to fit under an airplane seat, hit the market in 1981. Priced at \$1795, it used the fairly standard CP/M operating system and also included some useful productivity software. The 64K computer, which used the Z-80 CPU, was popular and sold well, but competition from others including Kaypro, Cromemco, and Morrow contributed to doing in the Osborne company.

BOOKS ON COMPUTER HISTORY

One way to acquire an appreciation for the early days of computers is through a personal library of historical-reference books. The following books cover a variety of interesting topics relating to computer history. Most of them are available through your local bookseller, though a few of the older titles might be out of print.

Accidental Empires, by Robert X. Cringely, 1992, \$24.00. Addison-Wesley Publishing Company, 1 Jacob Way, Reading, MA 01867; Tel. 617-944-3700. ISBN: 0-201-57032-7.

Big Blues: The Unmaking of IBM, by Paul Carroll, 1993, \$24.00. Crown Publishing Group, 201 E. 50th St., New York, NY 10022; Tel. 212-751-2600. ISBN: 0-517-59197-9.

Dvorak Predicts: An Insider's Look at the Computer Industry, by John C. Dvorak, 1994, \$16.95. Osborne McGraw-Hill, 2600 Tenth St., Berkeley, CA 94710; Tel. 800-227-0900. ISBN: 0-07-881981-4.

Gates: How Microsoft's Mogul Reinvented an Industry—and Made Himself the Richest Man in America, by Stephen Manes and Paul Andrews, 1993, \$25. Bantam, Doubleday, Dell, Inc., 666 Fifth Ave., New York, NY 10103; Tel. 800-223-6834. ISBN: 0-385-42075-7.

Hard Drive: Bill Gates and the Making of the Microsoft Empire, by James Wallace and Jim Erickson, 1992, \$22.95. John Wiley & Sons, Inc., 605 Third Ave., New York, NY 10158-0012; Tel. 800-225-5945. ISBN: 0-471-56886-4.

Heath Nostalgia, by Terry Perdue, K8TP, 1992, \$9.95. Heath Nostalgia, 4320-196th S.W., Suite B-111, Lynnwood, WA 98036-6754. ISBN: 0-9637627-0-2.

Stan Veit's History of the Personal Computer, by Stan Veit, 1993, \$19.95. WorldComm Press, 65 Macedonia Road, Alexander, NC 28701; Tel. 704-252-9515. ISBN: 1-56664-030-X.

Tandy's Money Machine, by Irvin Farman, 1992, \$19.95. Published for Radio Shack distribution by Mobium Press, 414 Orleans, Chicago, IL 60610-4487. ISBN: 0-916371-12-3. ■

Best known for the CP/M-based Kaypro II and several portables, Andrew Kay and his well-positioned Kaypro firm rushed in to fill the void when the Osborne failed. Originally intended for engineers, the compact, portable, and affordable Kaypro II computers were popular in the business market. Kaypro went on to become one of the largest sellers of desktop computers, and also was a pioneer in laptops. Reportedly more than 300,000 CP/M Kaypros were produced.

Another company, Vector Graphic, had been around since the mid-1970's. It was best known for its smart-looking desktop computer, the Vector 1, that used an 8080A CPU. The firm also turned out a line of small-business oriented, Z-80-based computers in the early 1980's. One of those, the Model 3005, even had a 10-MB hard disk when hard disks (then called "Winchesters") were uncommon and almost prohibitively expensive. But the days of CP/M and 8-bit computers were numbered, and the company didn't survive the IBM PC onslaught.

English inventor Clive Sinclair undercut even master price cutter Jack Tramiel of Commodore and Atari fame. In 1980, Sinclair offered the first under-\$200 PC, the tiny ZX-80. It sported a Z-80 CPU, a 1K RAM, a membrane keyboard, and a 4K ROM that contained the operating system and a bare-bones BASIC. Later, the ZX-81 offered more for less, with its 8K ROM and expandability to 16K RAM, all for \$99.95 (\$79.95 in kit form).

Timex took over distribution and sold the little PC's like watches, making the Sinclair the first mass-marketed computer. It dubbed them the Timex/Sinclair, but withdrew about eight months later when heavy post-sale service and support demands became too great for the watchmaker. Ultimately, huge inventories caused the PC's to be sold for a few dollars apiece or to be given away as premiums and prizes. Sinclair was eventually acquired by AMSTRAD, another British firm.

In 1977, the Heath Company introduced the H8 and H11 PC's—unusual machines that used the Altair-style S-100 bus, and Heath's HDOS operating system. Heath was bought out by Zenith Electronics Corp. in 1979, and offered computer kits and factory-wired equivalents. Their H-100 series kit (Z-100 if factory-wired) had two microprocessors: an 8088 to run under MSDOS (like the IBM PC) and an 8085 chip to run under CP/M. Despite the popularity of the PC's, however, losses by Zenith in its TV business, declining interest in kit-building, competition in computers, and other business-related factors eventually forced Heath to largely abandon the kit and computer business and concentrate on

(Continued on page 89)



3795P \$19.95

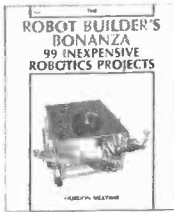

2808P \$17.95



3627P \$19.95

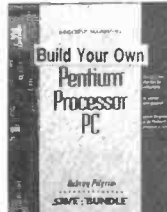

0501637 \$32.95 Hardcover

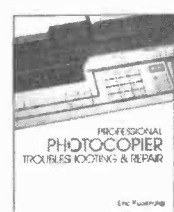

4331H-XX \$29.95 Counts as 2/Hardcover

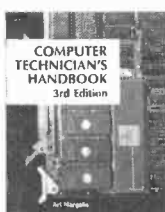

3279P \$26.95



4270H \$29.95 Hardcover



0156697 \$44.95 Hardcover



4416P \$9.95



4362P \$16.95



2613P \$19.95

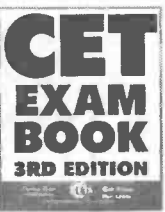

4199H \$29.95 Hardcover



3825P \$17.95



3711P \$19.95

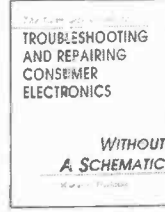

0156482-XX \$34.95 Counts as 2/Hardcover

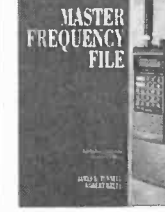

4229P-XX \$29.95 Counts as 2



4227P \$15.95

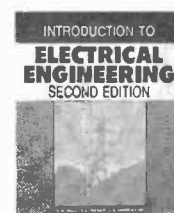

011322X-XX \$50.53 Counts as 2

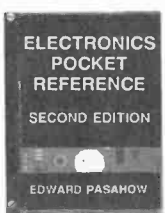

0487375 \$24.95

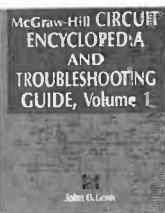

0376034-XXX \$58.50 Counts as 3/Hardcover

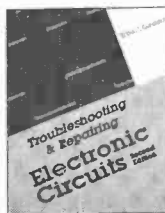

3258P \$19.95



4190P \$16.95



4230H-XX \$39.95 Counts as 2/Hardcover



3765P \$19.95

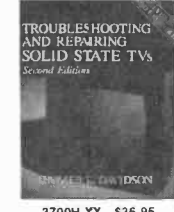

3700H-XX \$36.95 Counts as 2/Hardcover



2790P \$17.95

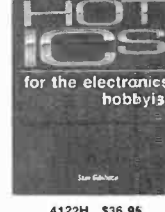

4122H \$36.95 Hardcover



3871P \$18.95

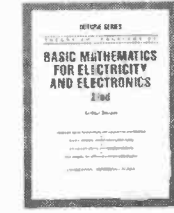

0044392 \$12.95



0673764-XX \$54.95 Counts as 2/Hardcover

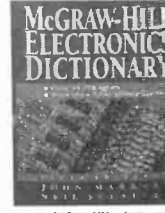

0404348-XX \$48.50 Counts as 2/Hardcover

Select any 5 books

for only \$4⁹⁵

(values up to \$174.75)

Plus 1 book FREE upon prepayment

when you join the Electronics Book Club®

As a member of the Electronics Book Club . . .

. . . you'll enjoy receiving Club bulletins every 3-4 weeks containing exciting offers on the latest books in the field at savings of up to 50% off of regular publishers' prices. If you want the Main Selection, do nothing and it will be shipped automatically. If you want another book, or no book at all, simply return the reply form to us by the date specified. If you ever receive a book you don't want due to late delivery of the bulletin, you can return it at our expense. You'll have at least 10 days to decide. And you'll be eligible for FREE BOOKS through the Bonus Book Program. Your only obligation is to purchase 3 more books during the next 12 months, after which you may cancel your membership at any time. A shipping/handling charge and sales tax will be added to all orders. All books are softcover unless otherwise noted. (Publishers' prices shown) If you select a book that counts as 2 choices, write the book number in one box and XX in the next. If you select a book that counts as 3 choices, write the book number in one box and XXX in the next 2 boxes. ©1995 Electronics Book Club PE495

If card is missing, write to: Electronics Book Club, A Division of McGraw-Hill, Inc., Blue Ridge Summit, PA 17294-0810

Hunting down car noises is not easy because of the high background-noise level of the automobile. The cheapest method involves using a length of tubing or hose held up to one's ear to focus the noise, but that has a number of disadvantages. First of all, the tube acts as an audio filter that tends to resonate in a narrow frequency range determined by its length. Also, the limited bend radius of the tube restricts motion, and might not allow you to focus on the noise. Another option is to use an inexpensive mechanic's stethoscope, which is a metal probe connected to a metal or plastic diaphragm. However, that requires that you be in phys-

headphone amplifier, which is built around the other half of the dual op-amp. That audio output can be heard on any "Walkman-style" 32-ohm headphones.

Figure 1 is the schematic for the Electronic Auto Stethoscope. That circuit is powered by a 9-volt battery, B1, and power-supply filtered by capacitor C1. The NE5532 audio op-amp, U1, directly drives low impedances and can therefore drive the headphones without the need for a dedicated power-amplifier IC such as the LM386. A bipolar power supply has to be used with U1. So, to replace the bipolar-supply ground connection, two resistors, R1 and R2, are used to split the

through C6, to the tone-control circuit consisting of C7, C8, R7, R8, and R9. Tone-control potentiometer R8 allows the user to peak the amplifier response to the frequency of the noise being investigated. When R8 is centered, the frequency response is flat from 20 Hz to 15 kHz. When R8 is moved toward the bass or treble position, response in the rejected frequency range (i.e. bass is rejected in the treble position) is cut by as much as 12 dB.

The output of R8 is connected to volume-control potentiometer R10, and U1-b amplifies the signal at the wiper of R10. Gain is determined by R11 and R12. The output of U1-b is bi-

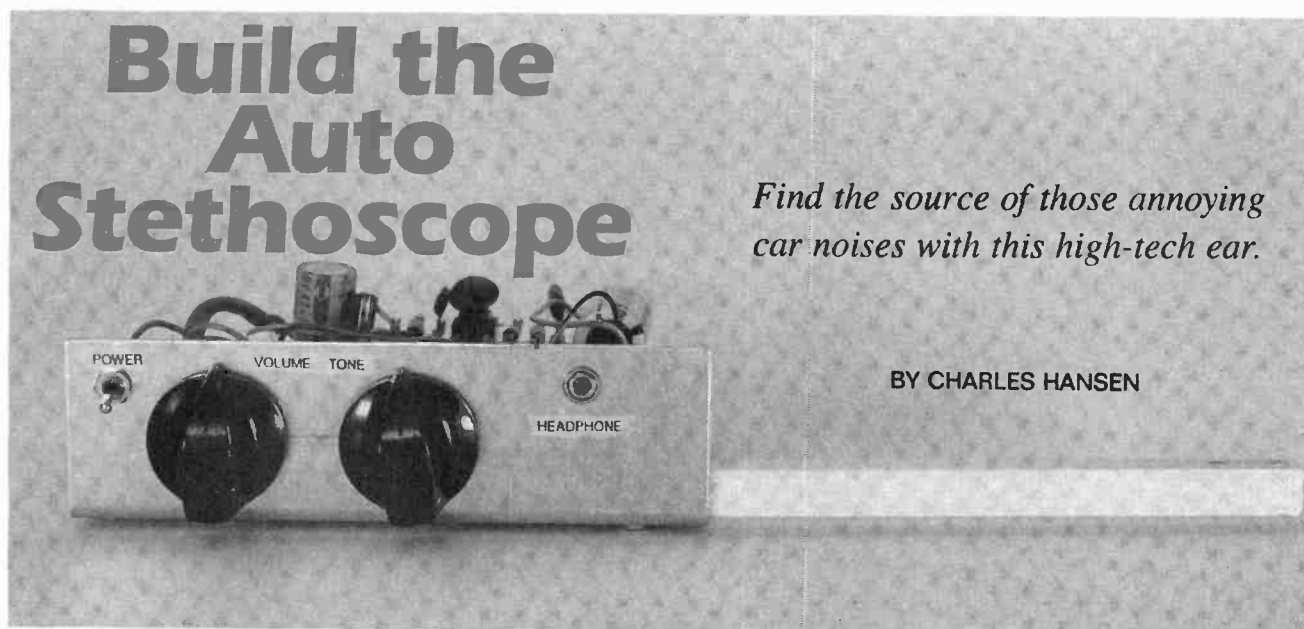

Build the Auto Stethoscope

Find the source of those annoying car noises with this high-tech ear.

BY CHARLES HANSEN

ical contact with the noise source.

The Electronic Auto Stethoscope presented in this article has a number of advantages over the previously mentioned mechanical ones. It has a built-in amplifier that amplifies low-level sounds, earphones to help block out other background noises, and a tone control that allows you to focus on the frequency range of the noise being investigated, whether it is low-frequency road noise or a high-pitched wind whistle or rattle.

How it Works. The Stethoscope uses an electret-microphone element, MIC1, which is amplified by $\frac{1}{2}$ of U1, an NE5532, dual audio op-amp. The output of the op-amp is connected to the tone-control section and the volume control, where it is sent to the

9-volt, DC power supply and provide a "virtual ground." To provide balanced headroom for the audio signals, R1 and R2 are of an equal resistance. Capacitor C2 provides a bypass for audio signals and improves load regulation.

The 4.5-volt DC bias for the electret microphone, MIC1, is obtained from B1 through resistor R3. Capacitor C3 couples the audio output from MIC1 to U1-a, resistor R4 provides the virtual-ground connection, and resistors R5 and R6 determine the audio gain of U1-a. High-frequency roll-off above 15 kHz is provided by capacitor C4, and capacitor C5 rolls off the low-frequency response below 20 Hz. Capacitor C11 provides decoupling for the power-supply pins of U1.

The output of U1-a is coupled,

used to the virtual-ground voltage of 4.5 volts by R1 and R2. If that output were fed directly to the headphones, there would be a DC voltage continuously applied to them, which could limit battery life. For that reason, it was decided to isolate the headphones from the DC voltage.

To couple only the audio signal to the headphones, capacitor C10 is connected in series with the output. Large capacitive loads have a tendency to cause instability, peaking, and ringing in the output of a closed-loop op-amp circuit. To prevent that, R13 is connected in series to decouple the output of U1-b from C10. Feedback-capacitor C9 then provides a high-frequency feedback bypass, restoring stability to the amplifier.

The stereo headphones are con-

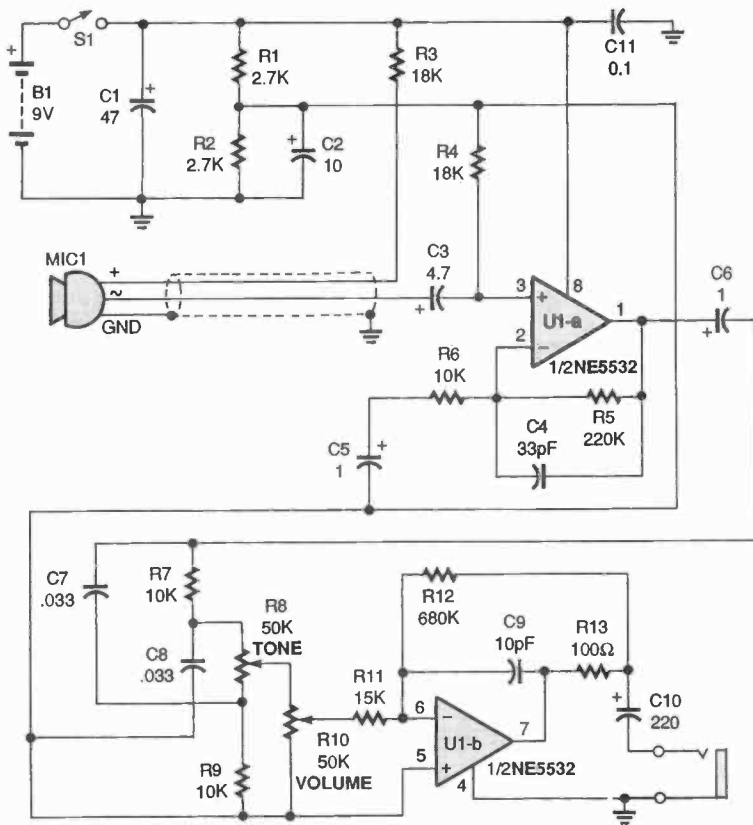

Fig. 1. The heart of the Stethoscope is the NE5532 audio op-amp, U1. That component directly drives low impedances and allows the use of headphones without adding another amplifier.

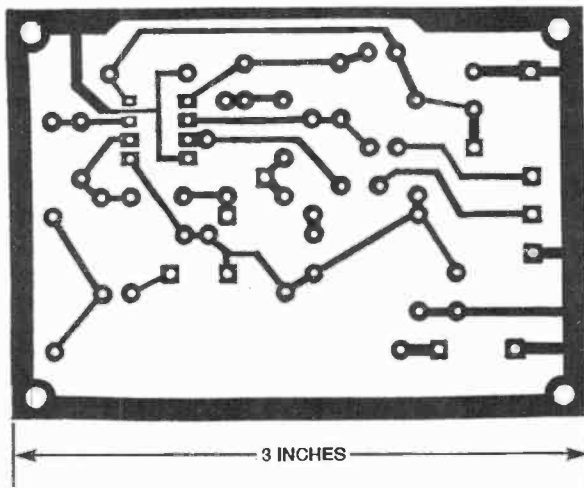

Fig. 2. If you would like to build the project on a PC board, use this full-size template to etch your own.

nected in series to make it easier for the op-amp to drive them to a useful volume. Because the microphone signal is monophonic, there is no need for stereo output.

Construction. The prototype Electronic Auto Stethoscope was built on a perforated board. Because of the high gain used, wire lengths were kept

short to prevent noise pickup and oscillation. For your convenience, a printed-circuit board template is provided in Fig. 2 if you prefer to etch and drill one. If that is the case, use the parts-placement diagram shown in Fig. 3 to make building the project easier. Select a project enclosure that has sufficient room for the perforated board or PC board and all chassis-

PARTS LIST FOR THE ELECTRONIC AUTO STETHOSCOPE

RESISTORS

(All fixed resistors are ¼-watt, 5% units, unless otherwise noted.)

- R1, R2—2700-ohm
- R3, R4—18,000-ohm
- R5—220,000-ohm
- R6, R7, R9—10,000-ohm
- R8—50,000-ohm, linear potentiometer
- R10—50,000-ohm, audio-taper potentiometer
- R11—15,000-ohm
- R12—680,000-ohm
- R13—100-ohm

CAPACITORS

- C1—47-µF, 35-WVDC, electrolytic
- C2—10-µF, 35-WVDC, electrolytic
- C3—4.7-µF, 35-WVDC, electrolytic
- C4—33-pF, mica or metallized-film
- C5, C6—1-µF, 35-WVDC, tantalum
- C7, C8—0.033-µF, metallized-film
- C9—10-pF, mica or metallized-film
- C10—220-µF, 35-WVDC, electrolytic
- C11—0.1-µF, ceramic-disc

ADDITIONAL PARTS AND MATERIALS

- U1—NE5532N, low-noise dual op-amp, integrated circuit
- MIC1—electret microphone (Radio Shack #270-092 or equivalent)
- J1—3.5-mm phone jack
- S1—SPST toggle switch
- B1—9-volt alkaline battery
- Printed-circuit materials, project enclosure, 9-volt-battery snap with leads, ⅜-inch ID tubing (see text), two-conductor shielded microphone cable, control knobs, 32-ohm stereo headphones, standoffs, wire, solder, hardware, etc.

mounted components.

In keeping with good assembly practice, install the least-sensitive parts first, followed by the more-sensitive parts. Start by installing the battery connector and an IC socket at the position for U1. Next, connect the wiring to potentiometers R8 and R10, switch S1, and jack J1. Solder in the passive parts (resistors, then capacitors) and double check the orientation of the polarized components.

Before installing the last on-board component, U1, into its socket, and before attaching MIC1, test the power supply. Turn on S1 and measure the

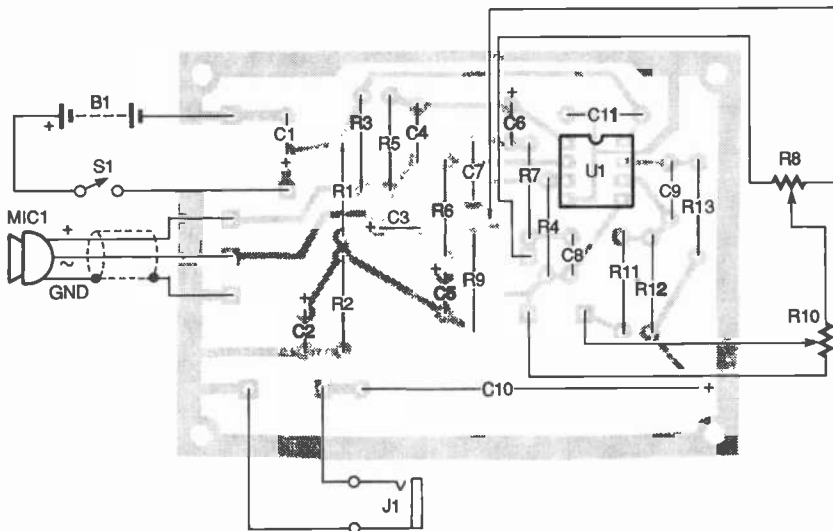

Fig. 3. Use this parts-placement diagram as a guide when assembling the Stethoscope. Be sure to double check the alignment of the polarized components.

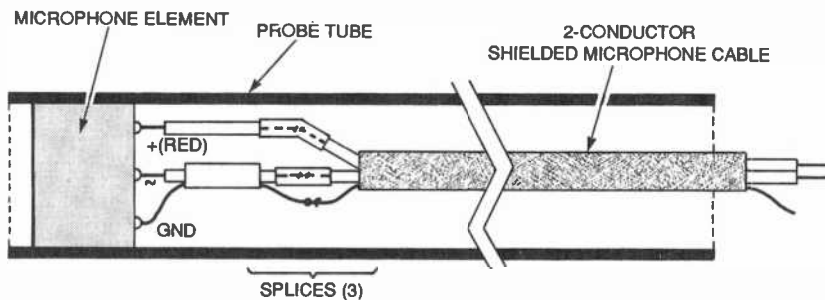

Fig. 4. The electret microphone element, MIC1, needs to be mounted in a tube assembly. Before doing that, extend the reach of MIC1's short leads by attaching them to a two-conductor, shielded microphone cable.

battery voltage across C1. Then check the virtual-ground voltage across C2; it should read half the battery voltage. If that is the case, turn off S1 and prepare the microphone assembly for attachment. If the voltage seems too high, check for wiring mistakes.

Microphone MIC1 can be mounted in a number of ways. The prototype has the microphone installed inside a six-inch-long, 3/8-inch diameter, plastic tube "wand," with the end of MIC1 just below flush with the open end of the tube. Because the leads on MIC1 are only a couple of inches long (as supplied by the vendor), they need to be extended (as shown in Fig. 4) before the microphone is mounted in the tube.

To extend the leads of MIC1, use two-conductor, shielded microphone cable; splice the red (+) microphone wire to the red wire in the cable, and then splice the white microphone-signal wire to the black wire in the cable.

Finally, splice the ground wire of the microphone to the shield of the cable. Use shrink sleeving over each of the splices, and then cover them all with one larger piece of shrink sleeve for ruggedness. You can then either directly connect the other end of the cable to the circuit board (as indicated in Fig. 1) or you can add another jack and plug to make the microphone detachable.

If you do mount the microphone probe directly to the case of the amplifier module, the tone and volume controls of the Stethoscope will be easier to use because the entire case can be aimed at the noise source. That is why a six-inch-long probe was recommended.

Once the microphone assembly is prepared and the leads are connected to the circuit board, turn on S1 again and measure the voltage across the red microphone lead to the shield. It should be 3.5- to 6-volts DC (4.5-volts DC nominal). If that is so,

turn off S1. You can then safely insert U1 into its socket.

If you want to use the Stethoscope in physical contact with engine noise sources (similar to a mechanical probe-diaphragm unit), mount MIC1 in a metal tube. That will provide the necessary rigidity to transmit mechanical sounds to the microphone. Be sure to electrically insulate the case of the microphone element from the metal tube. It is also a good idea to cover the metal tube with a non-conductive material such as shrink sleeving to prevent the tube from causing any electrical shorts under the hood.

Checkout and Use. Plug in the headphones and turn on the Stethoscope. Place the TONE control, R8, in the center of rotation and turn the VOLUME control, R10, all the way down (to the left). There should be no sound in the headphones. If you do not get any noise, proceed as follows.

Aim the microphone at a known low-volume audio source such as a radio speaker, and turn the volume up until you can hear the audio source through the headphones. You should then be able to turn up the volume high enough so that the sound in the headphones drowns out the source. Also, you should be able to greatly affect the tone of the audio source with the TONE control. That completes the check-out procedure.

When selecting headphones to use with the Stethoscope, keep in mind that the differences in sensitivity and frequency response between various Walkman-style headphones is surprising. Of course, the more expensive headphones have higher volume and fidelity; however, the Stethoscope can drive even the cheapest headphones to adequate volume. Watch out for small headphones, though. At high volume, acoustic feedback can occur between them and the microphone. Closed earpiece headphones are less prone to feedback than the smaller, open type.

The author originally built the Stethoscope to track down a rattle in the console of his car (which turned out to be a lost jeweler's screwdriver). Without the Stethoscope, that wouldn't have been possible, even with someone else driving. You should find it to be just as useful. ■

Upgrading and Maintaining



your Personal Computer

Squeeze more performance out of your PC with these easy and easy-to-do upgrades.

BY MARC SPIWAK

If you own a PC, sooner or later you will face the need, or urge, to upgrade. You might need or want additional memory. Drives, both hard and floppy, sometimes need to be replaced or reformatted, or larger-capacity ones are required. Adding peripherals such as internal modems or video cards can occasionally give even experienced PC users fits.

Then there is multimedia. Multimedia has been the hot area in computers for the last little while, and these days, all but the most-basic systems come equipped with a CD-ROM drive and sound card. That is fortunate, because if you've ever had to

add a multimedia set-up to an existing system you know what a nightmare it can be. Still, occasions arise when a CD-ROM or sound card must be installed, upgraded, or replaced.

When upgrade time arrives, you have two choices: pay someone to do it for you, or do it yourself. The first choice is the lazy way out. What's more, it is (obviously) more expensive and totally unnecessary for anyone with a little technical know-how and a small amount of manual ability.

Unfortunately, when it comes to PC's, many otherwise competent individuals feel a little intimidated. The fact is, though, that anyone with a bit

of technical knowledge and some patience and concentration can perform those types of basic upgrades without fail. In this first installment in an occasional series of articles, we will discuss the work involved in adding different types of memory to a PC. Future articles will cover other types of upgrades.

Upgrading PC's. As you can imagine, there are variations in the procedures involved in installing hardware in PC's from different manufacturers, so there's no way we can lead you by the hand with yours. However, you should be able to adapt what we

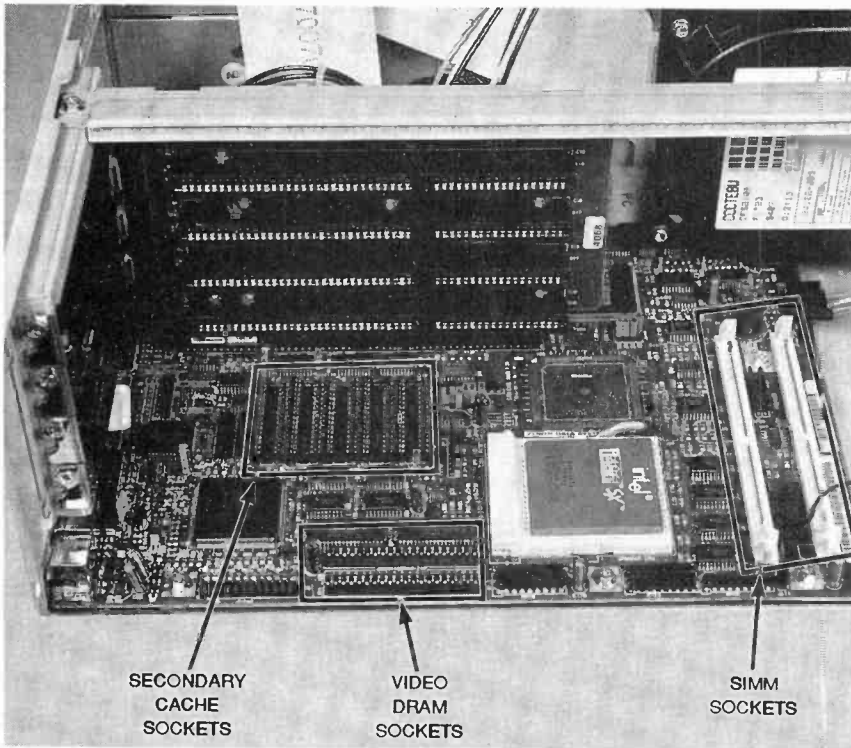

Fig. 1. This motherboard contains two SIMM sockets for adding more RAM, five DIP sockets for adding a secondary cache, and two ZIP sockets for adding more video DRAM.

cover here to your own PC. Some PC's make upgrades a snap, while others might involve extra disassembly procedures just to get at what you want to upgrade. A modern motherboard design can make a job much less scary for a beginner.

The motherboard in the PC that is discussed in this article is practically state-of-the-art as far as compactness and integration is concerned (see Fig. 1). Older motherboards had different numbers of expansion slots for different machine configurations. This newer motherboard has only one expansion slot in which mounts a vertical riser containing four expansion slots. Smaller or larger risers can be installed on the same motherboard for different PC layouts.

A super I/O processor chip on the motherboard controls all I/O interface circuits. That includes the IDE hard-drive controller, the floppy-disk-drive controller, two serial ports, and one parallel port. Four megabytes of RAM are permanently mounted on the board, and there are two SIMM sockets for adding more memory; the computer supports up to a total of 64 megabytes of RAM. A bus-controller IC integrates all peripheral, bus,

memory, data, and address-buffer logic in a single chip. Also permanently mounted on the motherboard is a local-bus video-accelerator chip and 1 megabyte of video memory with sockets for an additional 1 megabyte. The board also contains a tiny built-in piezoelectric speaker.

That modern motherboard design cuts down on hardware costs, which is one reason why powerful PC's are becoming so cheap. The design also cuts down on power consumption, which benefits everyone but your local power company. It also makes doing upgrades easier because there's less hardware to get in the way. Unfortunately, if you have an older PC with lots of hardware and ribbon cables, you might find that you have to do some disassembly on occasion to get at whatever you are interested in. While that is some extra work, it really is not that big a deal; just be sure to label everything clearly so that you can put everything back together properly.

Adding RAM. When it comes to computers, you can never have too much memory. A PC uses RAM, or random-access memory, to store code that it needs to run the software it has

been asked to run. While most DOS programs can run in less than 640K, some programs, notoriously games, hog almost the entire 640K for themselves, requiring everything else that's running (operating system, TSR's, etc.) to be loaded high into upper memory above 640K. Other DOS programs require extended or expanded memory for them to run.

Windows software, on the other hand, doesn't have so many memory restrictions—it uses memory linearly, and many programs can run at the same time. It's just that Windows needs a lot of memory to do that efficiently, with four megabytes being the minimum practical amount. Depending on what programs are running, Windows will want to transfer chunks of data to and from a swap file on a hard drive. That is much slower than reading from RAM, so it's done only for data that's least-needed at the time. Depending on the amount of RAM installed, more or less information will have to be swapped to and from the hard drive.

A more-realistic minimum amount

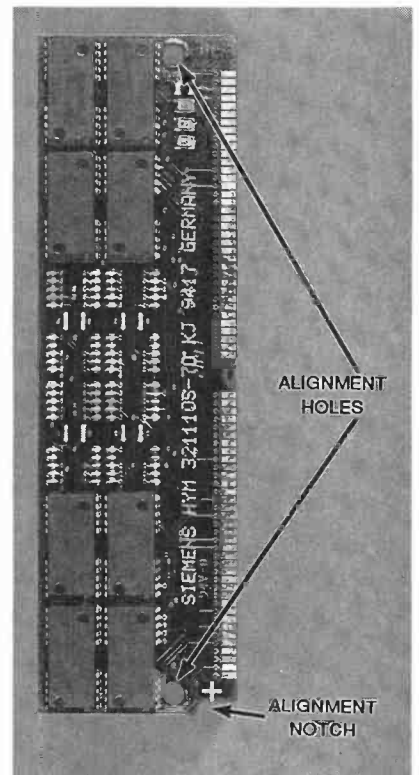

Fig. 2. This 4-megabyte SIMM contains eight 1-megabyte by 4-bit memory IC's arranged as 32-bit wide memory to match the PC's 32-bit data bus. The alignment notch ensures that the SIMM is installed with the correct orientation.

of RAM for a computer that always runs Windows is 8 megabytes, and probably will be 16 for running Windows 95 (once it's released). With only four megabytes, many Windows programs run painfully slow; upgrade from Word for Windows 2 to version 6 on a PC with only four megabytes of RAM and you'll know what we mean.

Our first upgrade will involve adding one non-parity-checking four-megabyte SIMM (single-inline memory module) for a total of eight megabytes of RAM; recall that four megabytes are permanently mounted on the board. Note that the board has two SIMM sockets that can accommodate any combination of 4-, 8-, 16-, or 32-megabyte 72-pin SIMM's.

The four-megabyte SIMM is shown in Fig. 2. It contains eight 1-megabyte by 4-bit memory IC's arranged as 32-bit wide memory to match the computer's 32-bit data bus. Notice the bare space in the middle of the SIMM; that's there because the manufacturer uses the same PC board to make SIMM's that check parity and ones that don't. If your computer does not require SIMM's that check parity (check the documentation that came with your motherboard for details on the SIMM's required), you can save some money by buying the non-parity-checking type.

SIMM's are delicate CMOS memory devices, and should be handled carefully to avoid damage from static electricity. You should discharge yourself on the grounded PC chassis before handling a SIMM, and try to stay in contact with the chassis with one hand or wrist while you handle it. Also, do not touch the contacts on the bottom edge of the SIMM. Naturally, the PC should be turned off when you install anything.

The SIMM is keyed with an alignment notch so that it fits in the socket only one way. It is inserted into the socket at an angle and then pivoted vertically until the alignment pins on the socket fit into the alignment holes on the SIMM. Two small plastic clips on the socket snap into place to hold the SIMM in position; other SIMM sockets might have metal clips that serve the same purpose.

Usually when a PC boots, the RAM is checked and a count of it is displayed. If the count checks out and

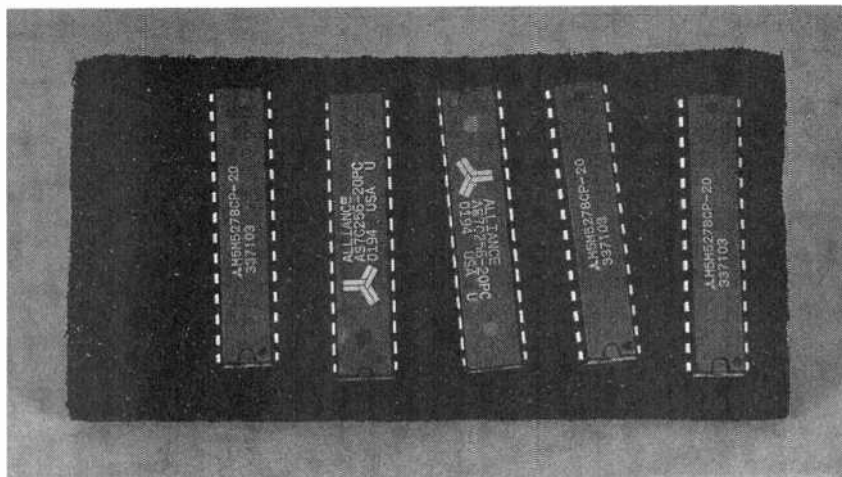

When these five standard-width, 28-pin 32K × 8 chips are installed, the computer will have a 128-kilobyte secondary memory cache.

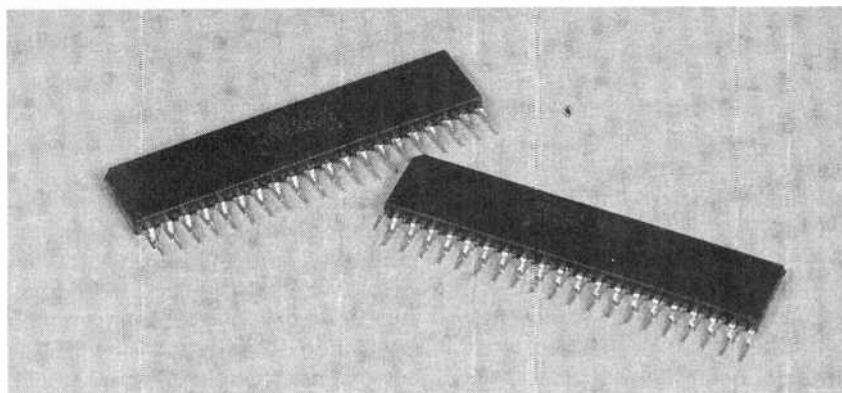

Two ZIP IC's can be installed to increase video memory to 2 megabytes and allow our video controller to display up to 16.8 million colors.

matches the RAM configuration stored in CMOS, the test is passed. After adding the four-megabyte SIMM, our memory check noticed that there was more memory than usual, and told us to enter setup. The setup menu indicated that extended memory was now at 7168 kilobytes, about 4 megabytes higher than before. We were asked to save the new setup configuration in CMOS.

Different motherboards have different requirements concerning SIMM configuration, speed, parity checking, the quantity of SIMM's that can be installed, and the arrangement in which they must be installed in the sockets. An older 486 DX2-50 we have has more-involved memory-expansion procedures. That older motherboard accepts 30-pin SIMM's in two 4-slot banks of sockets. Those SIMM's are similar in appearance to the 70-pin one we installed, and the installation procedure is identical. However, that motherboard demands that if a bank is used, it must be filled, and that all

SIMM's in a bank be of the same type. For example, that machine was once upgraded from 8 to 16 megabytes. Before the upgrade, both banks were filled with 1-megabyte SIMM's; afterwards, one bank was filled with 4-megabyte SIMM's.

In addition to being fussy about SIMM configurations, that PC requires that jumpers on the motherboard be set according to how the SIMM's are installed. That kind of information can only be obtained from the documentation that accompanies a motherboard, or from its manufacturer.

Secondary Cache. A CPU reads data from the data bus, processes it, and writes it back to the bus. All 486 CPU's contain an internal 8K primary data cache between the CPU and the bus. However, a *secondary memory cache* can speed things up by letting the fast CPU work at its own pace and stuff things as needed into temporary storage.

(Continued on page 91)

A Vacuum-Tube RAM

Bring the warm glow of vacuum tubes to your PC this April 1 with this 1-bit computer-memory circuit.

BY MICHAEL A. COVINGTON

Why should high-end audiophiles and antique-radio buffs have all the fun? This project brings the warm glow and mellow ambience of vacuum-tube technology to the computer hobbyist. The *Vacuum-Tube RAM* described in this article interfaces to any PC through the parallel port. Access time is under 100,000 nanoseconds, and there are only 15 components per bit, resulting in an estimated cost of 8.4×10^7 dollars per megabyte (9.4×10^7 if you add parity checking). If that sounds like a lot to you, you can first build a 1-bit, working demonstration unit. That way you can see for yourself the widely acclaimed bene-

fits of vacuum-tube technology, especially for WAV and other sound files.

The Vacuum-Tube RAM. The circuit is a classic in every sense of the word: an Eccles-Jordan bi-stable multivibrator (that's a "flip-flop" in modern jargon)—the very circuit that made digital computers possible, and the heart of the ENIAC and other historic machines. Unlike its 300-volt ancestors, though, this one runs on 12-volt and 5-volt power supplies, so that it can be powered by a personal computer.

That is made possible by the special 12U7 vacuum tube used in it. The 12U7 is part of an almost forgotten family of

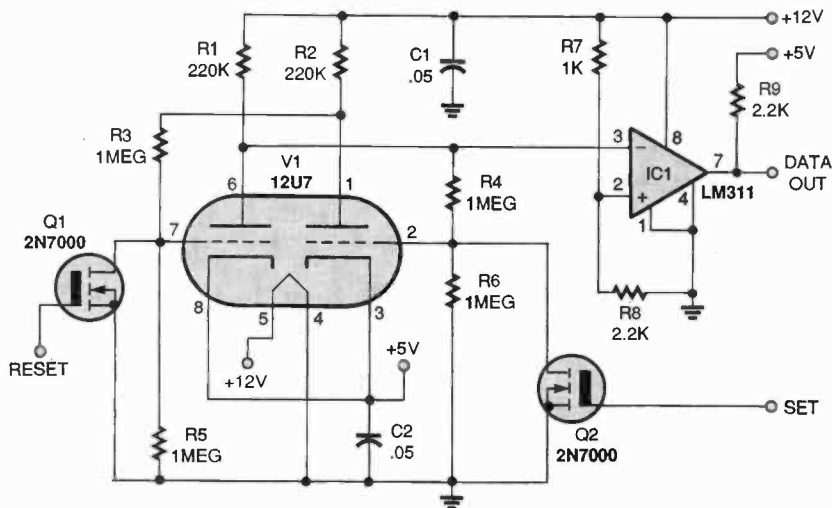

Fig. 1. The circuit is built around a 12U7 low-power dual-triode tube originally developed for car radios. The tube became obsolete about one year after its introduction.

PARTS LIST FOR THE VACUUM-TUBE RAM

RESISTORS

(all resistors are 1/4-watt, 5% units)
 R1, R2—220,000-ohm
 R3-R6—1-megohm
 R7—1000-ohm
 R8, R9—2200-ohm

ADDITIONAL PARTS AND MATERIALS

V1—12U7 low-voltage, dual-triode vacuum tube
 U1—LM311 comparator, integrated circuit
 Q1, Q2—2N7000, switching MOSFET transistor
 C1, C2—0.05- μ F. ceramic-disc capacitor
 Breadboard or prototyping board, 5- and 12-volt power sources, wire, solder, hardware, etc.

LISTING 1

DEFINT A-Z

```
PRINT "Demonstration of vacuum tube RAM"
addr = &H378 ' base addr of parallel port
FOR i = 0 TO 1
  store addr, i
  PRINT "Stored: "; i
  PRINT "Retrieved: "; retrieve(addr)
NEXT i
```

```
FUNCTION retrieve (addr)
  IF (INP(addr + 1) AND 16) <> 0 THEN
    retrieve = 1
  ELSE
    retrieve = 0
  END IF
END FUNCTION
```

```
SUB store (addr, value)
  IF value = 0 THEN
    OUT addr + 2, 13 ' pull RESET high
  ELSE
    OUT addr + 2, 7 ' pull SET high
  END IF
  'Fast computers might need a delay here
  OUT addr + 2, 15 ' both go back to low
END SUB
```

low-voltage tubes that entered the world in 1957 to serve as RF stages in partly transistorized car radios. With the advent of good RF transistors, they became obsolete about a year later and have been abundant on the surplus market ever since. You can get them today from Alltronics (2300-D Zanker Road, San Jose, CA 95131) and Antique Radio Supply (P.O. Box 27468, Tempe, AZ 85285).

The circuit for a 1-bit demonstration unit is shown in Fig. 1. The 12U7, a low-

(Continued on page 91)

Build an Audible Level

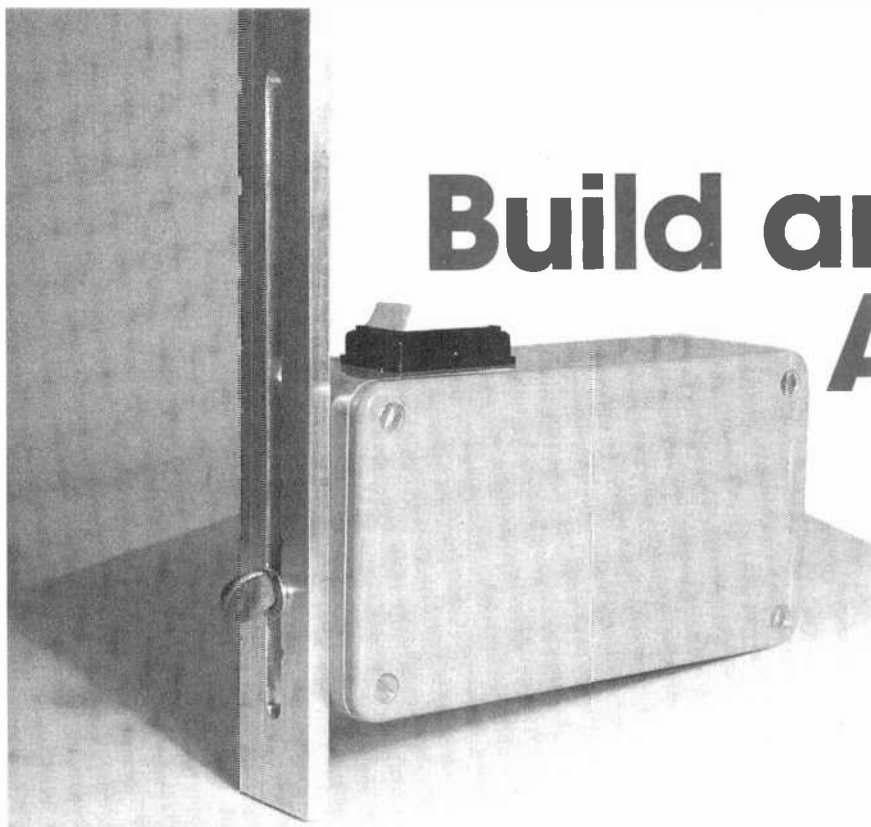

With it you'll never again strain to see if a surface is level—you could listen instead.

BY PETER CARTWRIGHT

If you have ever used a carpenter's level in poor-light conditions, then you know how hard it can be to see the position of the tiny bubble. Or perhaps you have tried to put up a high shelf and found the entire level difficult to see, let alone the bubble. If you have had one of those problems, then the *Audible Level* described here might just be the solution.

The Audible Level is a device that produces a series of tones that serve the same purpose as a bubble in a conventional carpenter's level. It not only signals perfect horizontal levels, but the direction in which a surface is off level as well.

Sensors. Electronic levels have been around for some time in other forms. For example, machines that need to be level to operate have to translate their tilt into electronic form using sensors. Those sensors should ideally be accurate and have a gradual response around the level state. For that reason, the electrolytic gravity transducer is used in most professional applications.

That transducer is a simple component that consists of a vial filled with an electrolyte into which an air bubble is introduced. Electrodes penetrate the liquid and bubble from both ends, and a third electrode is at all times totally immersed in the electrolyte. As

the bubble moves, the amount of wetted area in the electrodes change, but not in phase. Thus the relative resistance between the two end electrodes and the third one indicates the level status. Basically, the sensor forms two arms in an AC-powered bridge circuit.

Unfortunately, to the best of my knowledge, that sensor isn't readily available to the hobbyist. For that reason, an alternative had to be devised for use in the Audible Level. Given the sensor criteria already mentioned, a standard alcohol-filled vial seemed like a good starting point, but the bubble's position still had to be electronically represented in some way. An electro-optical method appeared to be the most feasible way of accomplishing that. The idea that came to mind was to pass the beam from an infrared LED through the bubble. Two correctly placed detectors (phototransistors) could then sense any optical disturbance caused by a tilt and record its direction.

After some experimentation, the correct optical geometry was developed. An infrared LED directs a beam perpendicularly down through the bubble and onto the reflective backplate of the alcohol-filled vial. The beam is then reflected, and is received by two infrared phototransistors that are situated on either side

of the LED in the vial's lengthwise direction. As the bubble moves, the phototransistors pick up differing amounts of reflected radiation. Common sense suggests that because the bubble is transparent, the detector nearest the bubble will receive the most radiation. Actually the opposite is the case. To see why, it must be understood that the meniscus forms a concave lens. That makes the beam diverge as it enters the liquid and then exits, as shown in Fig. 1.

A conventional carpenter's level

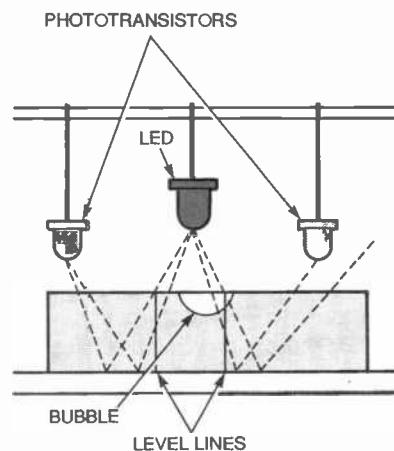

Fig. 1. This is the optical geometry for the sensor used in the Audible Level. Due to the refraction caused by the bubble in the alcohol-filled vial, less infrared light reaches a phototransistor as the bubble moves closer to it.

Key (P.O. Box 677, Thief River Falls, MN 56701-0677; Tel. 800-344-4539).

The infrared LED used in the author's prototype emits a wide-angle beam. If that type of unit isn't available, you might be able to get away with using a more-common round-headed LED. If need be, you can always convert it to a wide-angle type by using a hacksaw to cut the hemispheric end off. The possible necessity for that will be discussed later.

Also in the previously mentioned controlled-voltage circuit are resistors R2, R3, and R4, which set two voltage levels on the inverting inputs of U1-a and U1-b. With the bubble off center in the direction of Q1, Q2 will receive the most radiation. Under that condition, the voltage at the Q1/Q2 junction is near zero. That's below the voltage thresholds on the inverting inputs of both op-amps, putting both outputs low.

Both halves of a 556 dual timer, U2, are wired as oscillators. The output of U2-a (which runs at a low frequency) is fed to the reset input of U2-b at pin 10. With U2-a active, the second oscillator (responsible for the tone) is switched on and off, producing the required pulsed sound.

The output of U1-a is connected via R10 to the control-voltage input (pin 3) of U2-a. That expands or contracts the limits within which the voltage on timing capacitor C2 is held, altering its charge/discharge period and frequency. With the output of U1-a low, a

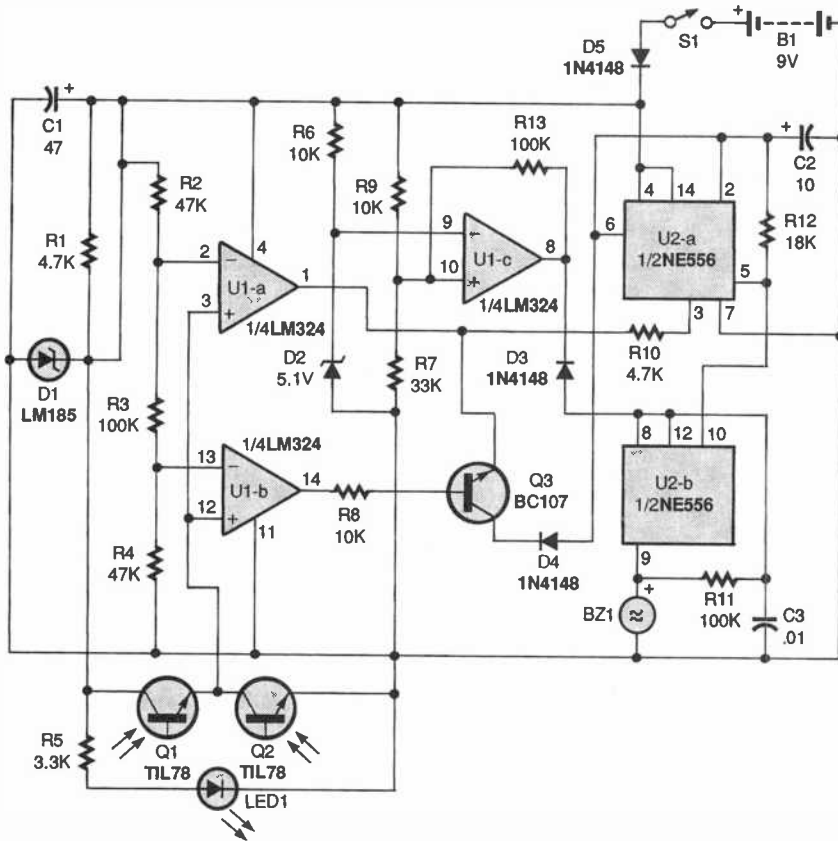

Fig. 2. In this circuit, the amounts of infrared radiation received by phototransistors Q1 and Q2 are translated by op-amp U1 and dual-timer U2 into either a steady tone, or a fast- or slow-pulsing one.

can be regarded as a sensor with a tri-state output. The bubble is either between the cross lines, or elsewhere in one of two significant directions. To make the Audible Level work, unambiguous audible equivalents for each of those three bubble positions had to be chosen. Different tones were avoided because not everybody can clearly differentiate pitches. So instead, the level state is expressed as a continuous tone, and the two off-level states are signaled by fast and slow pulsed tones.

Circuit Description. The schematic for the Audible Level is shown in Fig. 2. To make it portable, the circuit is powered by a 9-volt battery, B1. Unfortunately, there is a drawback to using a battery for power: the ratio of the phototransistors' resistance will change as the supply voltage goes down.

To solve that problem, D1, an LM185, 2.5-volt, voltage-reference diode is used. That way, when the battery voltage declines to a point at which the Level would become inaccurate, the

tones abruptly cease, indicating the need for a new battery. That diode also ensures that there will be a constant current supplied to the infrared LED, LED1. If you can't find the LM185 locally, you can order one from Digi-

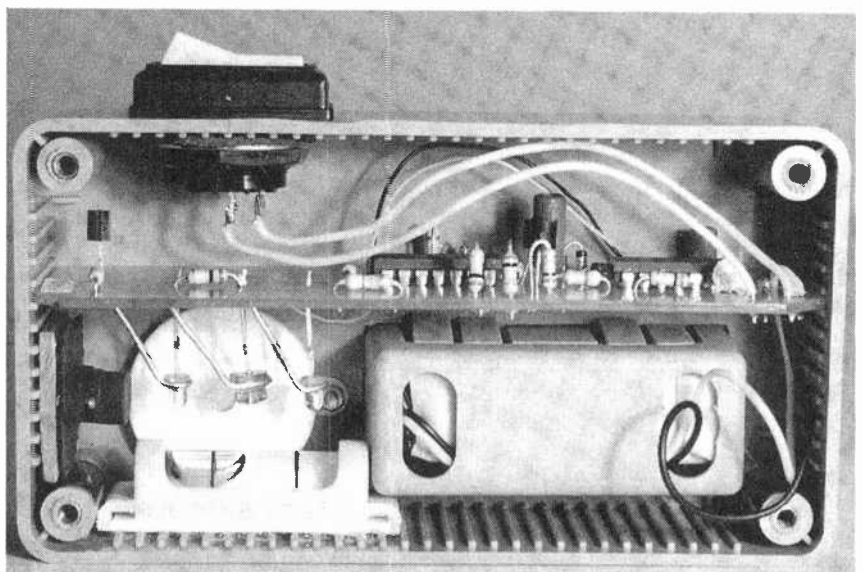

As this internal view shows, stiff copper-wire braces are used to secure the position of the LED and the two phototransistors over the alcohol-filled vial. However, do not solder the braces in place until you have calibrated the Level.

PARTS LIST FOR THE AUDIBLE LEVEL

SEMICONDUCTORS

- U1—LM324 quad op-amp, integrated circuit
- U2—NE5556 dual oscillator/timer, integrated circuit
- Q1, Q2—TIL78 phototransistor
- Q3—BC107 or similar NPN silicon transistor
- D1—LM185, 2.5-volt voltage-reference diode
- D2—5.1-volt, 0.5-watt, Zener diode
- LED1—Wide-angle infrared-emitting diode
- D3—D5—1N4148 general-purpose silicon diode

RESISTORS

(All fixed resistors are 1/4-watt, 5% units.)

- R1, R10—4700-ohm
- R2, R4—47,000-ohm
- R3, R11, R13—100,000-ohm
- R5—3300-ohm
- R6, R8, R9—10,000-ohm
- R7—33,000-ohm
- R12—18,000-ohm

CAPACITORS

- C1—47- μ F, 16-WVDC, radial-lead electrolytic
- C2—10- μ F, 16-WVDC, radial-lead electrolytic
- C3—0.01- μ F, ceramic-disc

ADDITIONAL PARTS AND MATERIALS

- B1—9-volt transistor-radio battery
- BZ1—Piezoelectric buzzer
- S1—SPST switch
- Printed-circuit materials, project enclosure, alcohol-filled vial (see text), battery holder and snap connector, aluminum strip (optional), thumbscrew (optional), metal plate (optional), wire, solder, hardware, etc.

the direction of Q2, Q1 receives the most radiation. The output of U1-a then goes high and blocks off the current through Q3. Simultaneously, the voltage at the control-voltage input (pin 3) of U2-a increases, and the pulsing tone reappears, but at a lower frequency.

The circuit centered around U1-c is responsible for the low-battery alert. Op-amp U1-c normally has its output high, but as the battery voltage drops to about 6 volts, the non-inverting input goes below the inverting input. That switches the output low with the help of the positive feedback introduced by R13, and turns off U2-b.

Construction. To keep the Level as portable as possible, use a PC board (a full-size foil pattern is shown in Fig. 3). Install the passive components first and the heat-sensitive semiconductors last, using the parts-placement diagram in Fig. 4 as a guide. Note that

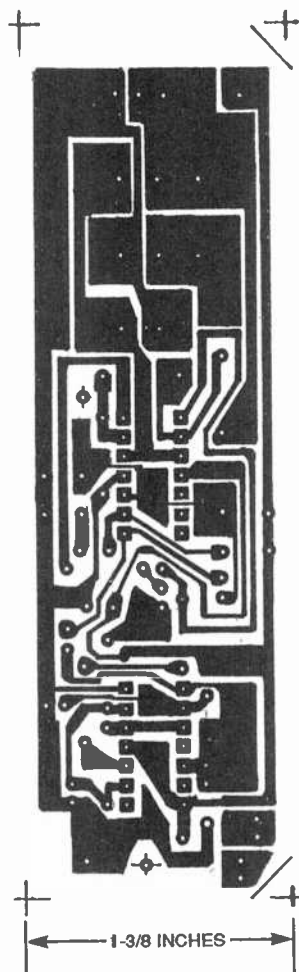

Fig. 3. Here is the full-size printed-circuit template for the Audible Level.

high-speed pulse is generated. The output of op-amp U1-b is also low, which keeps transistor Q3 switched off.

As the bubble moves to a central position, the voltage at the Q1/Q2 junction increases. When the voltage at pin 12 of U1-b exceeds that applied to pin 13 (the inverting input), Q3 turns on. The output of U1-a is still low and sinks current from U2-a, the slow oscillator. Because the trigger input of U2-a (pin 6) is kept low, its output is forced high, producing the constant tone.

Finally, with the bubble off center in

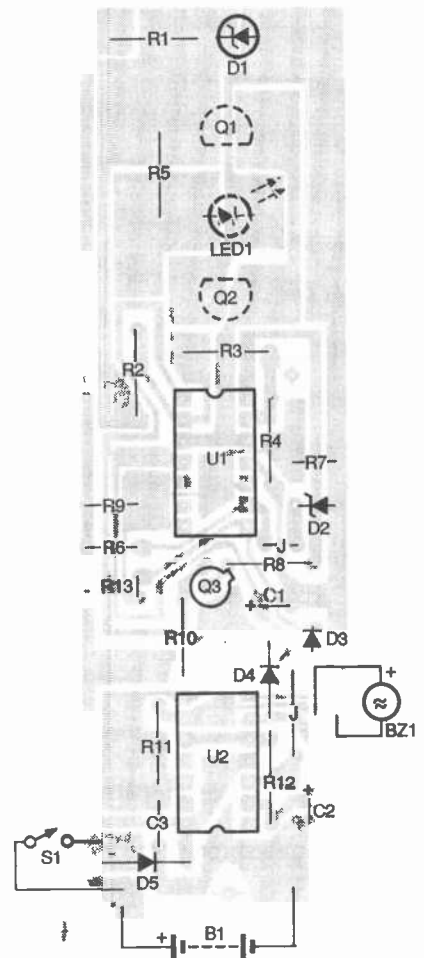

Fig. 4. Use this parts-placement diagram as a guide when building the Level. Note that LED1, Q1, and Q2 all mount on the foil side of the board.

LED1, Q1, and Q2 are mounted on the foil side of the circuit board. Soldering on the same side as the components makes heat damage more likely, so you might want to use a heat sink. Let the aforementioned emitter and two receivers hang 5 mm or so above the alcohol-filled vial, and leave long enough leads so that you can make fine changes to their angles. A length of at least 15 mm is recommended.

To increase the Level's ruggedness, fit the emitter and receivers with braces. You can make those braces out of a length of heavy copper wire. Wind that around the body and glue it in place with epoxy resin. Solder the other end onto the printed-circuit board after calibration.

A conventional level still gives a "level reading" on an angle of about

(Continued on page 92)

Build a Preselector for the AM Broadcast Band

Improve your receiver's performance on the AM broadcast band.

BY JOSEPH J. CARR

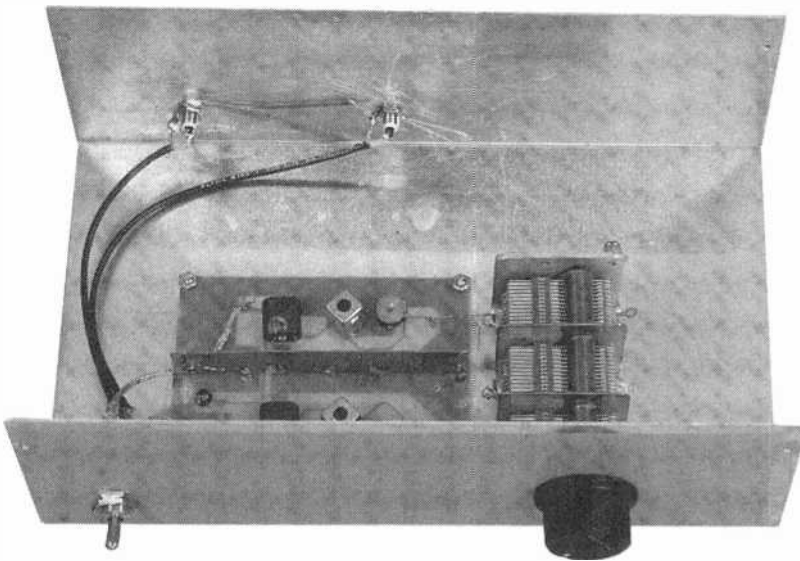

The AM broadcast band presents some of the greatest challenges for radio receivers. Considering that, it is rather unfortunate that the majority of AM receivers have substandard circuitry; even communications receivers that are top performers will sometimes be of lesser quality on the AM broadcast band (BCB) than on the shortwave bands.

Among the factors that those trying to get good AM reception must deal with are huge numbers of stations on the AM BCB and the fact that receivers often lack the front-end and IF selectivity to deal with all that RF energy. Unfortunately, even though it might be fun to improve the dynamic range of the receiver, that's a major engineering undertaking and generally not practical.

So, what can you do to get rid of all that AM-BCB overload? Try building the *AM Broadcast-Band Preselector* described in this article. As the name suggests, it preselects the AM BCB signal ahead of any radio receiver that uses a coaxial antenna input (rather than a loopstick antenna) and is reasonably well shielded. To find out if the Preselector will work with your receiver you can try these simple tests:

Disconnect the antenna from the back of your receiver and then tune across the band. If you hear as many stations without the antenna as with it, then there is an internal loopstick and

the AM-BCB Preselector will not work well. Also, if local stations are only slightly attenuated by disconnecting the antenna, then the shielding of the receiver might be too poor to get any benefit from the Preselector. To confirm that, short the center conductor and shield of a matching coaxial connector (e.g. use a PL-259 plug

when the antenna jack on the receiver is an SO-239 receptacle), and install it on the receiver's antenna-input connector. That effectively shorts out the input circuitry of the receiver. If there is still a signal, then this project will provide only marginal benefits.

Circuit Description. The Preselector

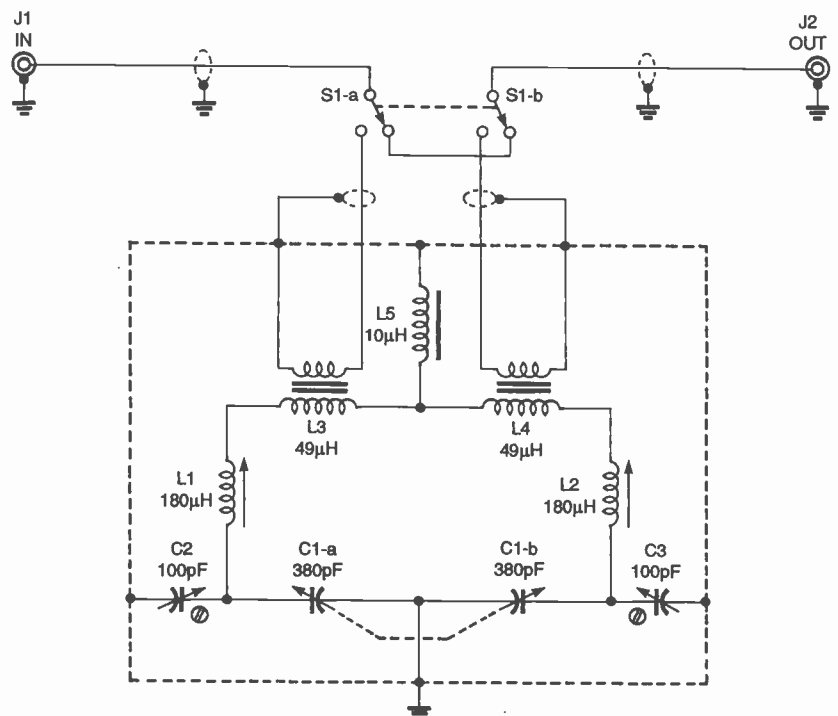

Fig. 1. The circuit for the AM-BCB Preselector is completely bilateral; for that reason, J2 could just as easily be the input jack. That makes connecting the unit to your receiver a breeze. Note that switch S1 can be set so that the unit is bypassed.

circuit shown in Fig. 1 is a doubled-tuned, resonant, L-C tank circuit in which the two resonant circuits are coupled by the mutual-inductance method. Inductor L5 provides the coupling impedance between the two halves of the circuit.

The AM-BCB Preselector is designed to be completely bilateral. That is, it doesn't matter which way it is hooked up. Jack J1 is designated as the input to follow the standard of having the input of a circuit on the left of a schematic, but in practice, you could use J2 as the input instead. Switch S1 is configured so that it either connects the Preselector to the signal line, or bypasses it entirely.

Each half of the Preselector contains two coils in series—L1 and L3 in one half, and L2 and L4 in the other. Variable coils L1 and L2 are Toko coils (part no. TK-1222) that are sold by Digi-Key (P.O. Box 677, Thief River Falls, MN 56701-0677; Tel. 1-800-344-4539); the inductance of those coils is 180 μ H. The fixed coils in each tuning circuit, L3 and L4, are wound on bazoooka BALUN forms and have a value of 49 μ H each. The mutual inductive reactance that couples the two coils together is provided by a 10- μ H toroid coil, L5. We'll deal with how to wind L3, L4, and L5 later.

In each tuning element, the aforementioned series-paired coils have no discernible mutual coupling between their magnetic fields. As a result, the total inductance of each pair is simply the sum of the individual inductances, or about 229 μ H.

The coils are resonated, or tuned, by a two-section, 380-pF air-variable capacitor, C1. Note that in the author's prototype, a three-section unit was used because it was on hand; the third section was simply not connected. Also, because there is a bit of room on the range of the capacitor, a standard dual-section 365-pF tuning capacitor should work quite well. The two sections of C1 are trimmed by the 100-pF trimmer capacitors, C2 and C3.

Winding the Coils. Coils L3 and L4 are wound on type BN-61-202 bazoooka BALUN forms. Those are available from either Amidon Associates (2216 East Gladwick Street, Dominguez Hills, CA 90220; Tel. 310-763-5770) or Ocean State Elec-

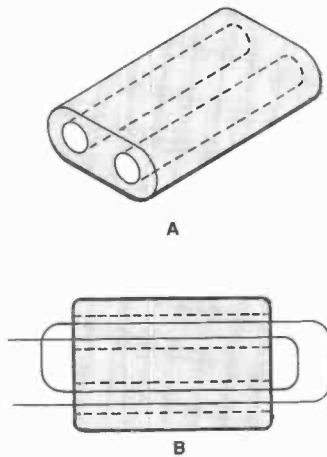

Fig. 2. This is a three-dimensional view of the bazoooka, BALUN coil form (A). Shown here (B) are two turns on the BALUN form.

tronics (P.O. Box 1458, Westerly, RI 02891; Tel. 401-596-3080). The coupling windings of L3 and L4 are each two turns of #26 enameled wire wound in the center of the core (i.e. wound first). The tuning windings of L3 and L4 consist of 11 turns of the same wire wound over the top of the primary.

A view of the bazoooka coil form is shown in Fig. 2A. Note that at its end it has two holes for admitting wire. Figure 2B illustrates the method for winding the coils and counting the turns of L3 and L4. To make each coil, start by passing wire through one of the holes at the left end of the form. Then, pass the wire through the other hole from the opposite end of the coil and bring the wire end back to the same side it started from. The turns count at that point is one turn (the "U-shaped" winding formed by passing the wire through each of the holes once is one turn). As shown in Fig. 2B, pass the wire back through each hole one more time to form the two-turn primary winding. When the winding is finished, make it snug up to the form (but not too snug!) and secure it with a tiny dab of glue or a sliver of tape. Next, wind the 11 turns of the tuning coil over the top of the coupling coil, starting from the opposite end of the form.

The fixed inductor that couples the two sides of the circuit, L5, is wound on an Amidon Associates' T-37-15 (RED/WHT) toroidal coil form. To make that

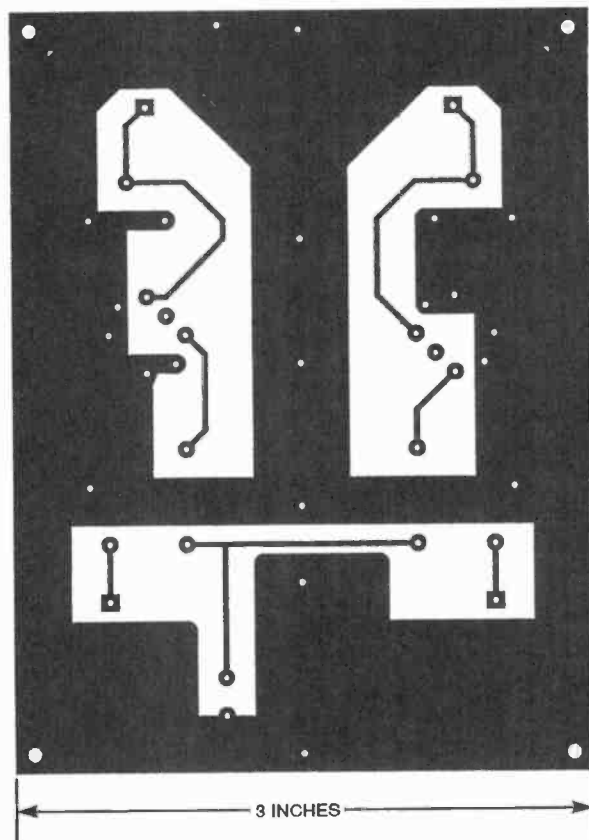

Fig. 3. The printed-circuit board pattern for the Preselector is shown here in its full size of 3 x 4 inches.

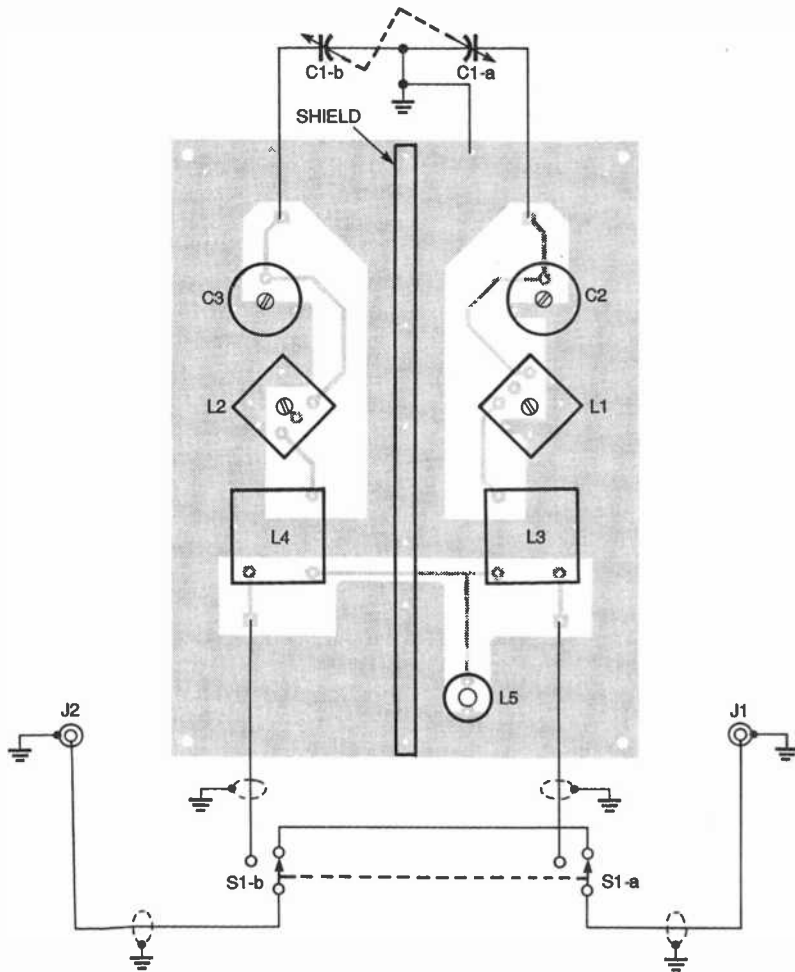

Fig. 4. When building the Preselector, use this parts-placement diagram as a guide. Be careful when making the off-board ground connections; if those aren't made correctly, the unit might cause unwanted noise.

coil, you will need #28 or #30 wire. Start from the outside of the toroid and wind 33 turns. Be careful when doing so; that wire is fragile and being too energetic can cause it to break (which, according to Murphy's Law, usually occurs around turn 25 so you have to start over again).

Once the coils are wound, it is time to turn to the actual construction. Let's do that now.

Construction. A printed-circuit foil pattern for the Preselector is shown in Fig. 3. You can either make the board yourself, or contact the firm noted in the Parts List, which made the board in the author's prototype. The parts-placement diagram is shown in Fig. 4. Once you have either etched or purchased the PC-board, installing the on-board components is straightforward, so do that before going on.

The next step is to connect the on-board shielding indicated in Fig. 4. In

the author's prototype, that was made from a 1- x 4-inch brass-stock strip. One of those can be purchased from a hobby shop that caters to model builders, or from a shop that deals with amateur jewelry makers. Cut six, 3/4-inch pieces of stiff, uninsulated wire. Insert one of those wires into one of the six holes that are shown overlapped by the shielding in Fig. 4. Solder the wire in place so that at least 1/2 an inch of wire protrudes from the component side of the board. Repeat that process for the other five holes and wires. Then, solder the brass strip to one side of the "fence" of wires to form the shield.

The next step is to make the off-board connections indicated in Fig. 4. To connect the positive terminals of capacitor C1 to the board, use regular wire; for the shield or ground connection, mount C1 to the chassis using the ground-terminal screws on the capacitor's bottom. For the connections between the board and jacks J1 and J2 and switch S1, you will need coaxial cable. The off-board ground connections that are indicated in the parts-placement diagram should be made to the chassis to provide shielding. In addition, the board itself should be grounded to the chassis, which is taken care of if you use metal mounts.

Of course, a metal chassis will have to be used to house the project. Don't use a cheap metal box; avoid those boxes that lack an overlapping lip between the two halves, or those that do not fit together well. If RF leaks around the flanges of the box or cabinet, the circuit's performance will almost certainly deteriorate.

Alignment and Use. To align the circuit correctly, you will have to keep in mind that there is a slight interaction between any adjustments you make. For that reason, it is best to go over them several times. If you have a decent signal generator, it helps, but the project can be aligned using signals you get off-the-air.

To begin, connect an antenna to one of the jacks of the Preselector, and connect the other jack to the antenna input of the receiver with a short piece of coaxial cable. Set the dial of the receiver to a station in the lower one-fourth of the AM BCB (e.g. 540-800 kHz). Tune C1 for maximum

(Continued on page 92)

PARTS LIST FOR THE AM BROADCAST-BAND PRESELECTOR

- C1—380-pF dual-section variable capacitor, see text
- C2, C3—100-pF, trimmer capacitor
- L1, L2—100- μ H, variable inductor (Toko TK-1222 or equivalent)
- L3, L4—49- μ H, inductor (see text)
- L5—10- μ H, inductor (see text)
- S1—DPDT toggle switch
- J1, J2—SO-239 connector
- Printed-circuit materials, metal chassis, brass-stock strip, metal mounts (4), coaxial cable, insulated wire, solder, hardware, etc.

Note: A drilled and etched printed-circuit board is available from FAR Circuits (18N640 Field Court, Dundee, IL 60118). When contacting them for ordering information, send a copy of the PC layout and this article.

Most variable power supplies use constant current limiting to keep load current at a fixed maximum value. That method works even when a load is shorted. Another method used is foldback current limiting, which reduces load current if it exceeds a preset value. Foldback limiting is a better approach than constant limiting, because foldback limiting avoids excessive heat dissipation. Despite that advantage, however, foldback limiting is not practical for variable power supplies because the current draw varies for different load voltages.

A better choice is a current-crowbar circuit. A current crowbar is a circuit that responds to current, instead of voltage, and shuts down a power supply if a preset value is exceeded. They can be used with both discrete and integrated variable voltage regulators. Unlike ordinary foldback current limiters, current crowbars also enable voltage regulators to supply the same maximum load current at load voltages with excellent regulation.

Described below are simple current-crowbar circuits you can build. Such circuits combine the advantages of foldback and constant current limiting, while avoiding their disadvantages. But before we examine the operation of current crowbars, let's see how constant and foldback current-limiting circuits work.

Current-Limiting Circuits. The voltage-regulating circuit shown in Fig. 1A uses constant current limiting. Zener diode D1 and operational amplifier U1 (LM741C) regulate the input voltage. The desired output voltage is set using potentiometer R3. When a connected load draws 149 mA, approximately 0.7 volts are applied across R2. With that voltage, transistor Q2 starts conducting and diverts some current away from the base of Q1. That prevents load current, drawn through Q1, from increasing much further.

The performance of the constant current limiter is shown graphically in Fig. 1B. Two points should be noted about that circuit: First, maximum load current is practically the same at all supply voltages. Second, load current

is not reduced when the load is shorted. Therefore, a major disadvantage of the constant current limiter is high power dissipation in Q1 under short-circuit conditions.

A conventional voltage regulator with foldback current limiting is shown in Fig. 2A. In that circuit, R1 and R2 form a voltage divider across the load

voltage. When load current flows through R3, a voltage equal to $I_{out}R3$ is produced and added to the load voltage. Consequently, a total voltage approximately equal to $I_{out}R3 + V_{out}$ is sampled by the voltage divider. That sample is then fed back to the base of Q2. The voltage fraction (K) of the voltage divider is given by:

$$K = R2/R1 + R2$$

If load terminals are shorted, output current is given by:

$$I_{SL} = V_{BE}/KR3$$

where I_{SL} is the shorted load current in amperes, V_{BE} is the base-emitter voltage of Q2 in volts, and R3 is the value of that current-sensing resistor in ohms.

When the load is working normally, maximum load current is given by:

$$I_{max} = I_{SL} + (1 - K)V_{out}/KR3$$

All About Current Crowbar Circuits

Protect your designs from possible damage with these current-crowbar circuits that you can build.

BY IMANGA KALIANGILE

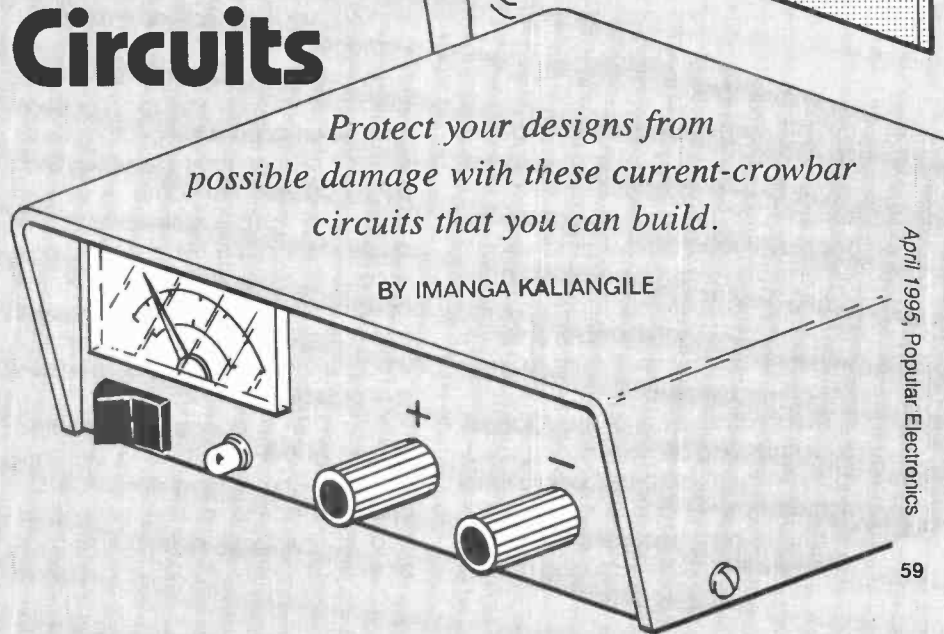

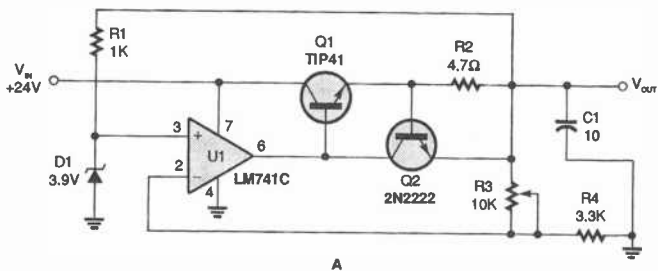

A

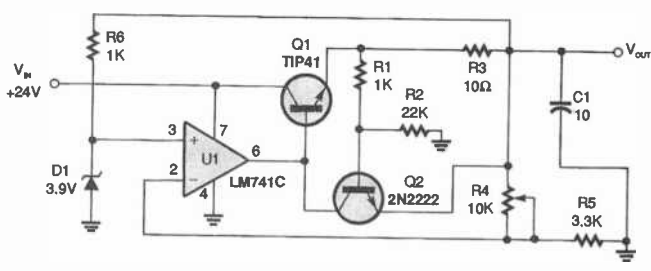

B

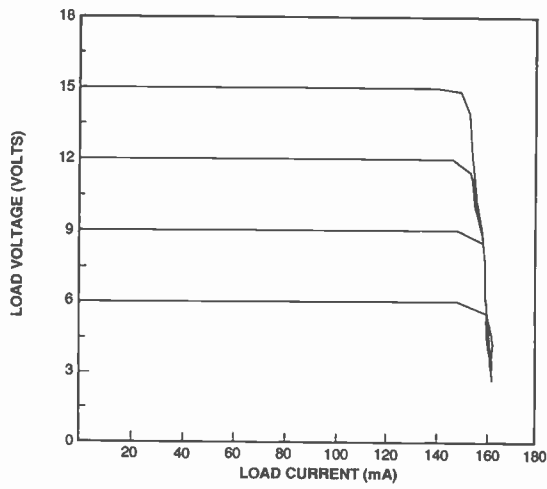

A

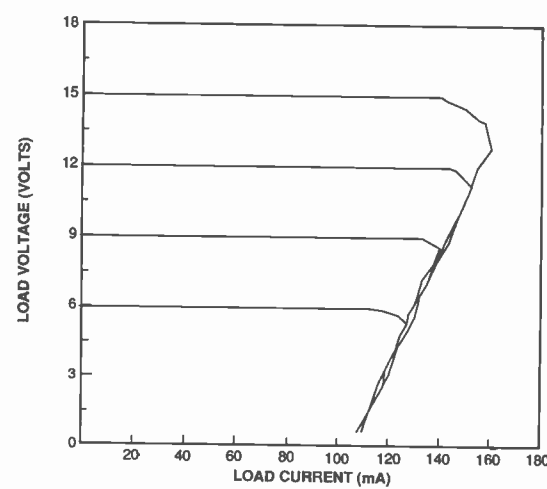

B

Fig. 1. The drawback to the variable voltage regulator with constant current limiting (A) is the high dissipation of power in Q1 under short-circuit conditions. As shown in B, maximum load current is practically the same at all supply voltages with constant current limiting.

Fig. 2. Power dissipation is reduced in this variable voltage regulator with foldback current limiting (A), but when output voltage changes, so will maximum load current (B).

where I_{max} is the maximum load current in amperes, and V_{out} is the output voltage of the regulator in volts.

The output current for the component values given in Fig. 2A is:

$$I_{SL} = 0.7 / (0.9565 \times 10) \approx 73 \text{ mA}$$

Suppose the output voltage is 15 volts, then maximum load current is:

$$I_{max} = 0.073A + \frac{(1 - 0.9565) \times 15V}{0.9565 \times 10R}$$

$$= 0.073A + 0.0682A$$

$$\approx 141 \text{ mA}$$

If the output voltage is changed to 6 volts, then the maximum load current is 100 mA. At 3 volts it is only 87 mA, which is 38 percent lower than the maximum load current at 15 volts. In other words, when the output voltage is changed, maximum load current also changes. That is a major problem with foldback current limiting in variable power supplies.

The performance of the foldback current-limiting circuit is shown graphically in Fig. 2B. Note that load current decreases when the load is shorted, thus reducing power dissipation in Q1. Also note that maximum load current

is reached when output voltage decreases slightly from its desired value.

Current-Crowbar Limiting. So far, we have discussed the advantages and disadvantages of two conventional types of current-limiting circuits. The current-crowbar circuit shown in Fig. 3A combines the advantages of both constant and foldback current limiting, and overcomes their disadvantages.

The circuit shown in Fig. 3A reduces load current and voltage considerably when current exceeds a preset value. It also enables the power supply to provide the same maximum load current at all supply voltages. The circuit shuts down the output supply voltage in a way that is similar to the action of a voltage crowbar, except that it responds to current instead of voltage. That is why it is called a "current crowbar."

Figure 3A is basically a modified version of the circuit in Fig. 2A. That was done by adding transistors Q3 and Q4, and the resistors labeled R4 and R5. Foldback current limiting is provided by transistor Q2 and resistors

R1, R2, and R3, as described earlier. Transistor Q4 supplies most of the load current, while Q3 and R5 determine the maximum load current.

Here is how the current crowbar works: Initially, load current is supplied by Q1 and flows through R4 and R3. When the load draws about 30 mA, sufficient voltage is produced across R4 to turn on Q4. Because most of the load current, which is supplied by Q4, bypasses R3, there is insufficient voltage across R3 to turn on Q2. Therefore, foldback current limiting is not activated even at high load currents. As load current increases through Q4, it reaches a value that produces enough voltage across R5 to turn on Q3. When Q3 conducts, it raises the base of Q2 above the output voltage. Transistor Q2 then starts conducting, because there is more than 0.7 volts between its emitter and base, and foldback current limiting is activated.

With the current crowbar, maximum load current depends only on the value of R5 and is independent of output voltage. That is how it is possible to get the same maximum load current at all

(Continued on page 96)

Just like these Fully Trained Electronics Professionals



"Thanks to CIE I have tripled my previous salary, and I am now in a challenging and rewarding new field where only the sky is the limit."

Daniel Wade Reynolds
Industrial Electrician
Ore-Ida Foods



"CIE was recommended to me by my boss. It was appealing since I could study at my own pace at home and during business travel."

Dan Parks
Marketing Manager/Consumer Products
Analog Devices, Inc.



"I loved the flexibility CIE offered. It was the only way I could continue both school and my demanding job."

Britt A. Hanks
Director of Engineering
Petroleum Helicopters, Inc.



"I liked the way the school was set up with laboratory assignments to enforce conceptual learning. The thing which impressed me the most about CIE's curriculum is the way they show application for all the theory that is presented."

Daniel N. Parkman
Missile Electro-Mechanical Technician
U.S. Air Force



"Completing the course gave me the ability to efficiently troubleshoot modern microprocessor based audio and video systems and enjoy a sense of job security."

Tony Reynolds
Service Manager/Technician
Threshold Audio & Video

Graduate with an Associate Degree from CIE!

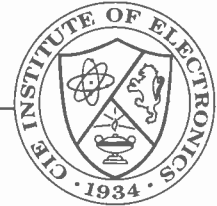

CIE is the best educational value you can receive if you want to learn about electronics, and earn a good income with that knowledge. CIE's reputation as the world leader in home study electronics is based solely on the success of our graduates. And we've earned our reputation with an unconditional commitment to provide our students with the very best electronics training.

Just ask any of the 150,000-plus graduates of the Cleveland Institute of Electronics who are working in high-paying positions with aerospace, computer, medical, automotive and communications firms throughout the world. They'll tell you success didn't come easy...but it did come...thanks to their CIE training. And today, a career in electronics offers more rewards than ever before.

CIE'S COMMITTED TO BEING THE BEST...IN ONE AREA...ELECTRONICS.

CIE isn't another be-everything-to-everyone school. CIE teaches only one subject and we believe we're the best at what we do. Also, CIE is accredited by the National Home Study Council. And with more than 1,000 graduates each year, we're the largest home study school specializing exclusively in electronics. CIE has been training career-minded students for nearly sixty years and we're the best at our subject...
ELECTRONICS... IT'S THE ONLY SUBJECT WE TEACH!

CIE PROVIDES A LEARNING METHOD SO GOOD IT'S PATENTED.

CIE's AUTO-PRO-GRAMMED® lessons are a proven learning method for building valuable electronics

career skills. Each lesson is designed to take you step-by-step and principle-by-principle. And while all of CIE's lessons are designed for independent study, CIE's instructors are personally available to assist you with just a toll free call. The result is practical training... the kind of experience you can put to work in today's marketplace.

LEARN BY DOING...WITH STATE-OF-THE-ART EQUIPMENT AND TRAINING.

CIE pioneered the first Electronics Laboratory

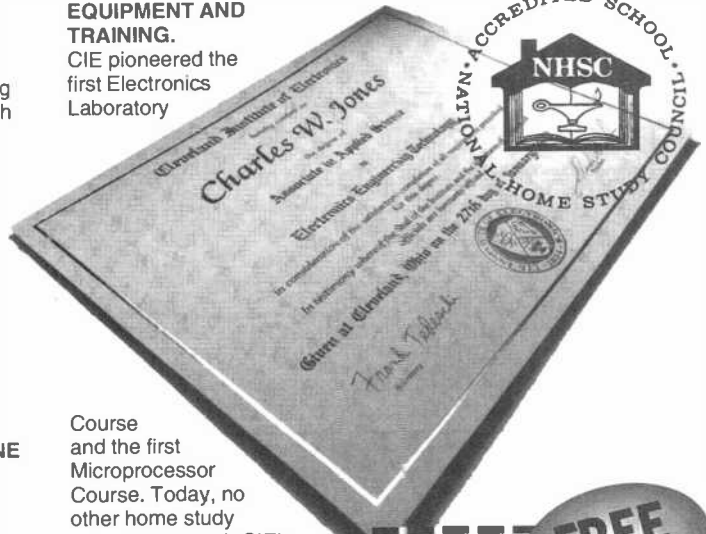

Course and the first Microprocessor Course. Today, no other home study school can match CIE's state-of-the-art equipment and training. And all your laboratory equipment, books and lessons are included in your tuition. It's all yours to use while you study and for on-the-job after you graduate.

PERSONALIZED TRAINING....TO MATCH YOUR BACKGROUND.

While some of our students have a working knowledge of electronics others are just starting out. That's why CIE has developed twelve career courses and an A.A.S. Degree program to choose from. So, even if you're not sure which electronics career is best for you, CIE can get you started with core lessons applicable to all areas in

electronics. And every CIE Course earns credit towards the completion of your Associate in Applied Science Degree. So you can work toward your degree in stages or as fast as you wish. In fact, CIE is the only school that actually rewards you for fast study, which can save you money.



YES!

I want to get started. Send me my CIE course catalog including details about the Associate Degree Program. (For your convenience, CIE will have a representative contact you - there is no obligation.)

Please Print Clearly

Name _____

Address _____

City _____

State _____ Zip _____ Age _____

Phone No. _____

Check box for G.I. Bill Benefits.

Veteran AH64
Active Duty

Cleveland Institute of Electronics, Inc.
1776 East 17th Street
Cleveland, OH 44114

A School of Thousands.
A Class of One. Since 1934.

Send for CIE's FREE Course Catalog and See How We Can Help Your Career Too!

ANTIQUE RADIO

By Marc Ellis

The Minerva Tropicmaster: A Postwar Puzzle



Here's the Tropicmaster all closed up in its box. How about that wild calligraphy!

Actually, I'm hoping that the title for this month's column proves to be a misnomer. While the Minerva Tropicmaster is somewhat of a puzzle to me, it might not be to some of you knowledgeable readers out there. And if anyone does have some good background material on the Tropicmaster and would be gracious enough to send it in, I'd be very interested in sharing it with the other readers in a future column.

We don't get into postwar radios very much on these pages, but when I spotted this set at last September's Antique Wireless Association meet in Rochester, New York, I was struck by its interesting construction and boldly silk-screened logo. The radio belonged to none other than Alan Douglas, author of the highly-regarded three-volume encyclopedia *Radio Manufacturers of the 1920's*.

This was a duplicate set for Alan, who had a better one in his collection, and it

had barely missed being shipped to an overseas collector. It was removed from storage in response to a "Want" ad, but was brought to Rochester after the ad was accidentally misplaced. Alan's price was very reasonable, so I decided to buy it.

GENERAL CONSTRUCTION

The Minerva Tropicmaster, otherwise known as the Model W-117, is definitely a utilitarian set. With its front door shut, it is totally enclosed in a plain (except for the Tropicmaster logo, emblazoned in flamboyant calligraphy) cabinet made of heavy-gauge metal and finished with gray-crackle paint. Pick it up and gravity will exert about a 20-pound downward force on your hand via the unpadded metal fold-out carrying handle.

Two military-style twist-and-snap fasteners are located at the top of the front door. Release them and the door hinges downward to reveal the set's gray-enamelled front panel. It looks like a conventional home-entertainment radio in battle dress. Speaker at the left, behind a grill incorporating the Minerva monogram; pointer-type dial at the right above the four control knobs (volume, tone, band-switch, and tuning). In addition to standard broadcast, the Minerva has a 5.5–18-MHz shortwave band.

Other cabinet details include a frame (empty in my case) on the inside front cover made to hold a chart or a schematic, as well as a

neat slide-open door in back that accesses the antenna and ground terminals (no loop antenna here!) and the stowed AC line cord. Remove four thumbscrews (they match the little knob on the sliding door) at the corners of the back panel and you can slide the entire radio, front panel and all, backwards out of the cabinet.

Even out of the cabinet, the radio and panels form a solid unit. The two metal panels sandwich the chassis and are securely attached to it, at their bottom edges, via insulating spacers (this is an AC-DC set). The two panels are firmly bolted together at their top edges via a couple of sturdy cross-members that span the space between them.

ELECTRICAL DESIGN

If the mechanical design of the Tropicmaster seems a bit on the robust side for a home-entertainment radio, the electrical design isn't far behind. The set's eight tubes include a 6SK7 IF amplifier, a 6SA7 mixer, a 6SK7 IF amplifier, a 6SQ7 detector/AF amplifier/AVC tube, two 50L6 push-pull power-output tubes with an associated 6SC7 phase inverter, and a 25Z6 rectifier.

That is about as many tubes as I have ever seen in the series string of an AC-DC table radio. In fact, the two 50L6 filaments had to be wired in parallel to reduce the voltage drop—which would otherwise have exceeded the 115-volt-AC line voltage. The parallel arrangement was feasible because the total

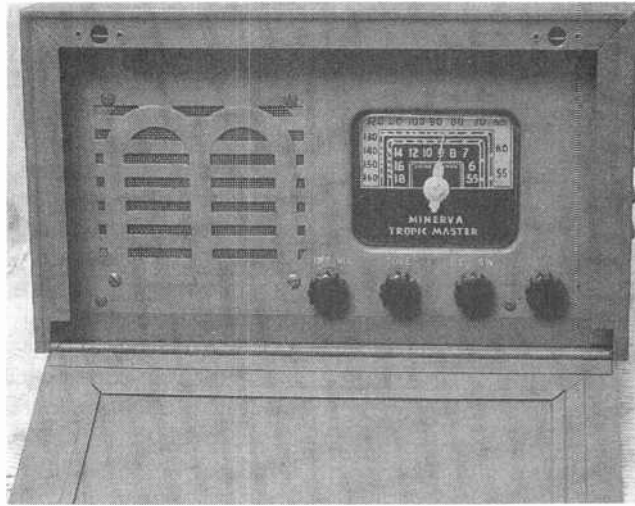

Dropping the front cover reveals the receiver's utilitarian front panel.

current passing through the two 0.15-amp 50L6 filaments is 0.3 amps, which matches the filament current ratings of the other tubes in the string.

I'm not sure why the three-tube push-pull output arrangement was necessary; I'd imagine that the usual single 50L6 in AC-DC sets could easily provide enough audio to overload the built-in six-inch speaker. A jack for a larger external speaker might have justified the powerful output stage, but there is no such jack.

The Minerva's electrical construction parallels its mechanical construction—high quality all the way. The RF and oscillator coils are enclosed in metal cans; leads to and from the volume and tone controls are carried in shielded cables that are carefully solder-bonded to each other and to the chassis base; small power resistors that, in a lesser set, would be supported by their leads, are mounted with through-bolts; hookup wire is carefully routed and of high quality.

A MORALE SET IN "CIVVIES"?

Of course, anyone who has ever looked at a World War II army-morale radio

knows that I have just described one. Where else would you find what is essentially a home radior receiver built to such exacting specifications? Alan Douglas, who has collected several morale sets, feels this set is one that was designed near the end of the war and thus never made it to combat. The surplus stocks, minus the military identification tags and then painted gray wrinkle instead of "OD," were sold in the postwar civilian market.

What we'd both like to know is: Has anyone ever encountered this radio with its military paint and markings? According to some advertising (provided by Alan) for a later Minerva civilian radio, the company claimed to have made wartime radios for military organizations and organizations working "in the interest of the serviceman."

Has anyone come across any advertising for the set in its civilian form as discussed here? And whatever became of the Minerva Company? It appears to have vanished just a few years after the war's end.

WHY DID THEY BUY IT?

It's also fun to speculate

3 NEW BOOKS for the Project Builder



BP350—ELECTRONIC BOARD GAMES\$6.00

Twenty novel electronic board games that you can build from the plans in this book. Whether you are interested in motor racing, searching for buried treasure on a desert island or for gold in Fort Knox, spinning the wheel of fortune, or doing a musical quiz—there is something for you to build and enjoy!

PCP119—ELECTRONIC MUSIC AND MIDI PROJECTS.....\$14.95

Save cash by building the MIDI gadgets you need. Want a MIDI THRU box, program change pedal, Metronome, analog echo unit, MIDI patchbay or switcher? Over 16 practical and very useful music and MIDI projects—all in this book! The projects are explained in detail with full instructions on assembly.

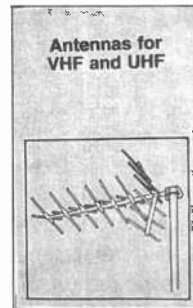
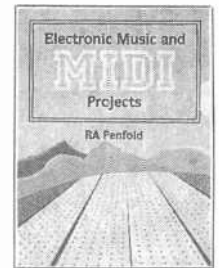

BP301—ANTENNAS FOR VHF AND UHF\$6.00

From installing a TV or FM antenna to setting up a multi-antenna array for shortwave listening or amateur radio, this book explains the basics of VHF and UHF antenna operation and installation. The text describes in easy-to-understand terms the essential information about how antennas work, the advantages of different antenna types, and how to get the best performance from an antenna.

Mail to: **Electronic Technology Today, Inc.**
P.O. Box 240 • Massapequa Park, NY 11762-0240

Shipping Charges in USA & Canada

\$0.01 to \$5.00.....\$1.50	\$30.01 to \$40.00\$5.50
\$5.01 to \$10.00.....\$2.50	\$40.01 to \$50.00\$6.50
\$10.01 to \$20.00.....\$3.50	\$50.01 and above\$8.00
\$20.01 to \$30.00.....\$4.50	

Sorry, no orders accepted outside of USA and Canada. All payments must be in U.S. funds only.

Number of books ordered.

Total price of books \$ _____
 Shipping (see chart) \$ _____
 Subtotal \$ _____
 Sales Tax (NYS only) \$ _____
 Total enclosed..... \$ _____

Name _____
 Address _____
 City _____ State _____ ZIP _____

Please allow 6-8 weeks for delivery.

about why civilians, delighted and relieved to have World War II finally in the past, would be interested in buying a radio that was more at home in the barracks than the living room. I can think of a couple of reasons. Being old enough to remember those heady days just after the war, I recall the hunger for the first peacetime consumer goods. They were slow in coming, it seemed, and people were more than willing to accept compromises.

I still remember the first new car in our community: a Studebaker owned by the high-school principal. We all marveled over it, and I was fascinated by the fact that Mr. Shultz's new "wheels" had bumpers made of wooden planks. The factory would replace them, I heard, as soon as enough chromium became available to produce the genuine issue.

The other point is that many folks were happy to buy the surplus items that were produced for a war we no longer had to fight. Most people did not find them depressing. They were of high quality, had macho overtones, were associated with our victory, and were usually sold at bargain prices. Certainly if the performance of this Minerva matched the quality of its construction, it would be a radio anyone would be proud to own—even if they didn't play it in the living room.

Actually, Minerva seems to have survived long enough to produce a simplified and conventionally styled version of the W-117, which was known as the W-117-3. According to some service notes for the W-117-3 included in Alan's info-package, the chassis was almost identical, but

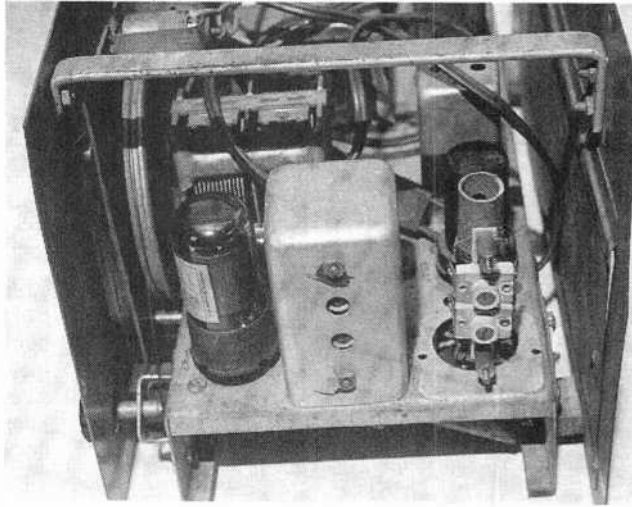

A peek inside the set shows its battleship-style construction. The shield can has been removed from right-hand (oscillator) coil to check for possible damage (see text).

the cabinet was of conventional civilian styling. I can't tell from the photocopy whether it was made of wood or plastic.

Looking at the schematic of the W-117-3, I find it interesting that a loop antenna was added and the phase-inverter stage was eliminated. 50A5's were substituted for the 50L6's and paralleled 35Z5's were substituted for the 25Z6. The latter change increased the voltage drop across the filament series string to the point where the power-dropping resistors used in the W-117 were no longer needed.

RESTORING THE TROPICMASTER

Having developed a healthy curiosity about how well this interesting set will perform, I'm going to make it our next restoration project. Cosmetically, the outside of the set (cabinet and front panel) is in really nice shape, and won't need much more than a cleaning. Inside, it's not quite so nice. The damp environment in which the radio was apparently stored for some time had more of an effect there.

The chassis is pitted in

spots where the plating has been attacked, and the speaker frame is almost completely covered with a light coating of rust. However, all parts seem to be present, and the original factory wiring appears not to have been disturbed, except for the replacement of some caps.

A couple of potential problems were immediately apparent, though. For one thing, the open-frame filter choke, which is mounted above the chassis, had a couple of layers of plastic electrical tape wrapped around it—definitely a bad sign.

For another, the top of the oscillator-coil shield can has some nasty dents. They're not the type of dents that would have been made by an accidental impact; they look more like they were pounded in with a pointed tool—I can't imagine why.

I decided to look into these problems immediately. If the choke had a serious problem, I could begin looking for a replacement. But if the oscillator-coil assembly was damaged, there wouldn't be much point in continuing the restoration until

such time as I might be lucky enough to locate a junker parts set.

Starting with the easier task, I carefully unwound the tape from around the choke and discovered the expected problem. One of the two leads had become separated from the choke and had been simply taped to the side of the unit. The other lead was still electrically attached to the choke, but had apparently been pulled out of its mechanical attachment point. Apparently the tape was there to keep it from flopping around and thereby breaking the electrical connection.

It might be possible to securely reattach both leads; I'll know later. If necessary, a replacement choke with the proper specs wouldn't be too hard to locate.

It was a little bit harder to remove the dented can, which was definitely not intended to be taken off after the coil had been wired in. However, I managed by removing the can's under-chassis mounting nuts and also the nuts on the side of the can that hold the coil in place.

There was just about enough slack in the coil's connecting leads for me to (very carefully!) pull the can away from the chassis until its mounting studs were free. Then I was able to maneuver the can until the coil's mounting studs popped back inside it.

Now there was nothing to stop me from sliding the can off the coil assembly. Once I did that, I was gratified to find that the assembly had not been damaged in any way. I plan to replace the can (after doing my best to remove some of the dents) at the start of my next work session. ■

COMPUTER BITS

By Jeff Holtzman

Methods, Attributes, and Messages

Object-oriented technology (OOT) is the hottest thing in the computer industry since the graphical user interface (GUI) of Windows overtook the command-line interface of DOS. Many of the concepts of OOT date back to the late 1960's and a programming language called SIMULA (for Simulation Language), but it has taken a good twenty-five

So what is an object? A switch is an object. A semiconductor junction is an object. A chunk of software is an object. What those objects share in common is that they can be viewed as entities that:

- Perform actions
- Have characteristics
- Interact with other objects

For example, a plain-old

When you look at a software object, exactly the same principle applies. In fact, you might have a software model of a switch or a pn junction. The object model would have the same characteristics and would perform the same actions. It would also interact with other objects in the "circuit" just as a "real" diode or transistor would.

A software object can perform actions, has characteristics, and can interact with other software objects. In OOT terms, an object's actions are called methods. There is no universally accepted term for its characteristics, but the word "attribute" does appear fairly often. The way an object interacts with other objects is by sending messages. You can summarize the above with a formula:

Object = Methods + Attributes + Messages

SOFTWARE OBJECTS

How can you tell a software object when you see one? You can't, not unless you're a programmer. But it's not hard to make a good guess. For example, Windows is *not* an object-oriented operating environment except to the extent that nearly everything you interact with in a typical Windows program is an object. For example, a button that you "push" by clicking with the mouse is an object. The same is true for the menu bar that appears at the top of your screen; all the buttons in that fancy icon bar; the common dialog boxes of Windows,

(Continued on page 94)

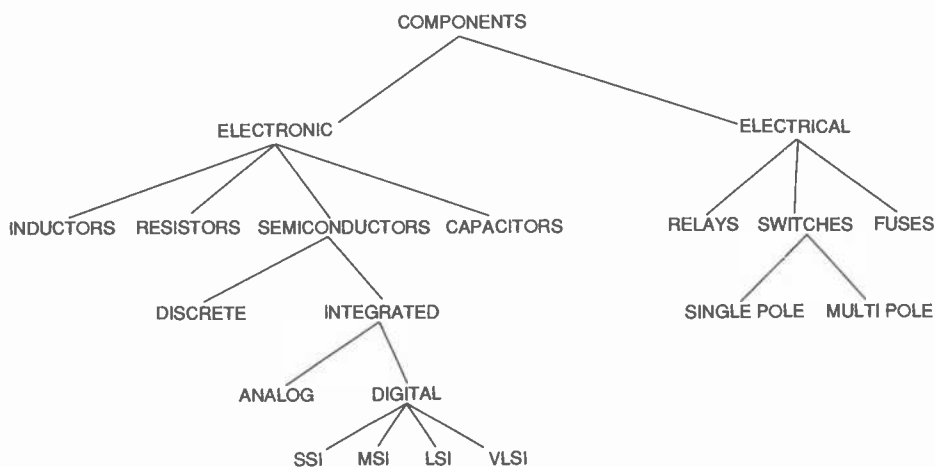

Fig. 1. By organizing objects into a hierarchy, parts with common characteristics can be treated by software in a similar manner. As an example, that approach is taken here with a group of electronic and electric components.

years for OOT to achieve mainstream status. In the mid-1980's, OOT was overhyped as "The Solution" for everything that ailed the process of developing software. Others proclaimed it interesting under-the-hood technology, but irrelevant as far as the user is concerned. Nonetheless, OOT kept inching forward to the point where it now has relevance across all sorts of disciplines.

Last month, we discussed what is probably the key feature of OOT: the hierarchy. This time we're going to discuss what the word object means.

SPST switch can interrupt the flow of current; its primary characteristic is that it can be either on or off. A more complex switch could have other characteristics, such as number of poles, number of positions, make-before-break or break-before-make switching characteristics, current-carrying capacity, voltage isolation, resistance, etc.

A semiconductor junction could be viewed as a more-complex switch object, with a smoothly varying range from on to off. Other characteristics might include sensitivity to light, and leakage current.

CIRCUIT CIRCUS

By Charles D. Rakes

Motorcycle Circuits

With the temperatures warming and the days growing longer, it's a fit and fine time to go motorcycle riding. So what does that have to do with electronic circuitry you might ask? Stick around and you'll see, as we share a number of simple electronic accessories that you can build to add to your cycling pleasure.

HEADLIGHT MONITOR

Our first entry, see Fig. 1, could help keep you from harm's way, and save you from a ticket at the same time. The headlight on most newer bikes is keyed on with the ignition switch to guarantee that you are never underway without your headlight being on.

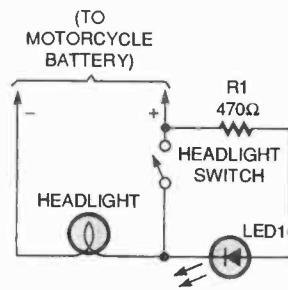

Fig. 1. With this simple circuit, you'll never again forget to turn your headlight on.

However, many older bikes have a factory headlight switch, and a growing number of the newer bikes are owner-modified in the same way. That switch is often added to lessen the load on the battery when starting up the bike, but the problem is that you must remember each time to turn the headlight switch back on before you get

rolling. Riding without your light on will get you a ticket every time.

One solution is to add a simple headlight monitor like the one in Fig. 1. That circuit consists of just an LED and a current-limiting resistor wired across the headlight switch as shown in the figure. When the ignition is on and the headlight switch is off, the LED will glow. A super-bright jumbo-size LED (see Parts List) was chosen to be seen better in bright sunlight.

IMPROVED HEADLIGHT MONITOR

A second solution to the previously mentioned lights-off problem is shown in Fig. 2. In that circuit, a 555 IC timer is connected in a very-low-frequency oscillator circuit. That configuration adds an on/off flashing output to the LED and powers a piezo sounder that chimes in with a beep for each flash. When the ignition switch is on and the light switch is off, power is supplied to the 555 circuitry. The oscillator's frequency is set by the values of R1, R2, and C1 to about 1 Hz. Increasing the value of R2 or C1 will lower the oscillator's frequency and decreasing one of those values will increase the frequency. The IC's output at pin 3 drives the LED through R3 and sends

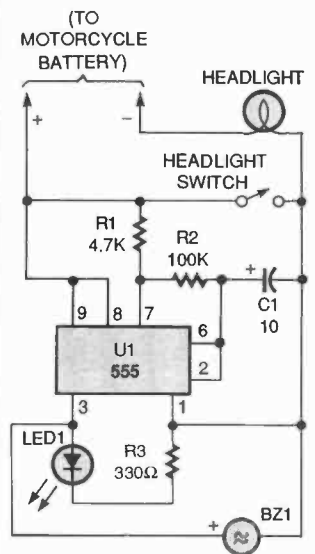

Fig. 2. If the LED in this circuit is flashing and the piezo sounder is buzzing, then your headlight is not on.

power to the piezo sounder.

Use a bright LED so that you will be able to see it in the daytime. If you use an LED other than the one specified in the Parts List, select a value for R3 that will allow the maximum-rated current of that LED to flow. Just divide the LED's maximum current into the supply voltage (12 volts) and use the nearest standard resistor value.

TUNE-UP AID

Our next item (see Fig. 3) can be a big help if you like to do your own carburetor tune-up and happen to own a newer twin-cylinder motorcycle that has an

PARTS LIST FOR THE HEADLIGHT MONITOR (Fig. 1)

- LED1—Jumbo light-emitting diode (Radio Shack 276-086 or equivalent)
- R1—470-ohm, 1/2-watt, 5% resistor
- Wire, solder, etc.

PARTS LIST FOR THE IMPROVED HEADLIGHT MONITOR (Fig. 2)

SEMICONDUCTORS

U1—555 timer, integrated circuit
LED1—Jumbo light-emitting diode (Radio Shack 276-086 or equivalent)

RESISTORS

(All fixed resistors are 1/4-watt, 5% units, unless otherwise noted.)
R1—4700-ohm
R2—100,000-ohm
R3—330-ohm, 1/2-watt

ADDITIONAL PARTS AND MATERIALS

C1—10- μ F, 25-WVDC, electrolytic capacitor
BZ1—Piezo sounder
Wire, solder, IC socket, etc.

electronic ignition system. On the older twins, with the standard breaker-point ignition system, it was possible to just pull the spark-plug wire from one cylinder and make your carburetor adjustment on the running cylinder. You could then repeat the procedure for the

other cylinder.

But on one of the newer bikes equipped with an electronic ignition system, pulling the plug wire with the engine running would blow the ignition coil. The reason is that the newer ignition systems generate a much higher voltage and,

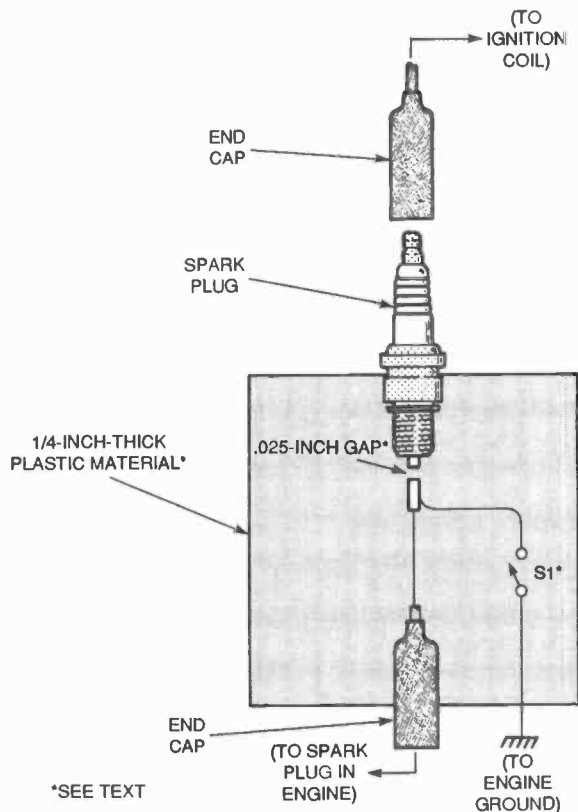

Fig. 3. Performing a tune-up on a newer bike is made a lot easier with this helpful circuit. Because of the high voltages present, make sure S1 has an insulated handle and that the fixture is grounded.

PARTS LIST FOR THE TUNE-UP AID (Fig. 3)

S1—Knife switch (see text)

Wire, solder, spark plug, hardware, end cap, plastic material (see text), etc.

when there is no ground for the spark to jump to, the spark can jump between the coil's windings. If a carbon path is formed by an internal breakdown, the coil's output voltage will be greatly reduced and the coil could be ruined.

Our simple tune-up aid always supplies a gap and ground for the high voltage to jump to. In Fig. 3, a spark plug is shown mounted with nylon cable ties to one end of a 1/4-inch thick piece of plastic or plexiglass (to provide adequate insulation).

Remove the ground gap tab located at the base of the spark plug. Make the fixed gap from a metal screw, or some similar item, and space it about 0.025 inches from the plug's end. Connect an end cap to the fixed gap and hold it in place with a couple of nylon cable ties. Also con-

nect one end of a knife switch, S1, to the fixed gap and connect the other terminal to a grounding clip. Be sure that the knife switch has an insulated handle. Do not use an old switch with a wood handle. It's no fun being the lightning rod for a high-tech ignition system!

With the ignition turned off, remove one of the spark plug wires and connect it to the spark plug on the fixture. Slip the fixture's end cap over the spark plug on the cycle and you're ready to go. Open S1 and start the engine. Then, close S1; the cylinder with the fixture should not fire and a spark should be seen at the fixed gap. Be sure that the fixture is connected to the engine ground before closing S1.

BURGLAR ALARM

The simple burglar-alarm

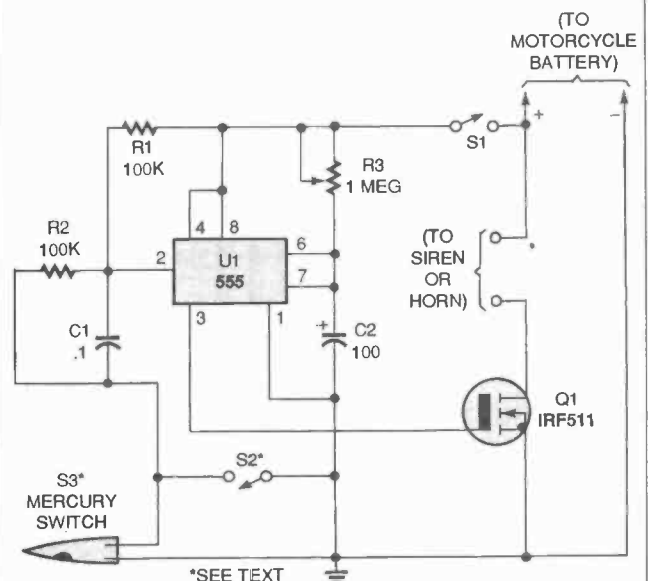

Fig. 4. Feel safer with this alarm circuit. When you're away, S3 makes sure no one touches your bike; when you're on it, S2 doubles as a panic switch.

PARTS LIST FOR THE BURGLAR ALARM (Fig. 4)

SEMICONDUCTORS

U1—555 timer, integrated circuit
Q1—IRF511 FET transistor

RESISTORS

(All fixed resistors are 1/4-watt, 5% units.)
R1, R2—100,000-ohm
R3—1-megohm, potentiometer

CAPACITORS

C1—0.1- μ F, ceramic-disc
C2—100- μ F, 25-WVDC, electrolytic

ADDITIONAL PARTS AND MATERIALS

S1, S2—SPST switch
S3—Mercury switch
Wire, solder, IC socket, siren, etc.

circuit shown in Fig. 4 will only cost a few bucks to build and could save your bike from being stolen or messed with. A 555 IC is connected in a one-shot timer circuit that turns on a FET transistor and either a siren or the bike's horn for a pre-set time period. Switch S1 is used as an on/off switch.

Closing either of two switches, S2 and S3, will trigger the IC. When either

switch closes, pin 2 of U1 goes low. That triggers the IC to produce a positive output at pin 3 and sounds the alarm for the time period set by R3. The mercury switch, S3, is the switch that activates the alarm when someone moves your bike. Switch S2 can be used as a panic switch if you ever feel threatened.

The IRF511 N-channel FET (Q1) will handle currents up to 4 amps. If you need a

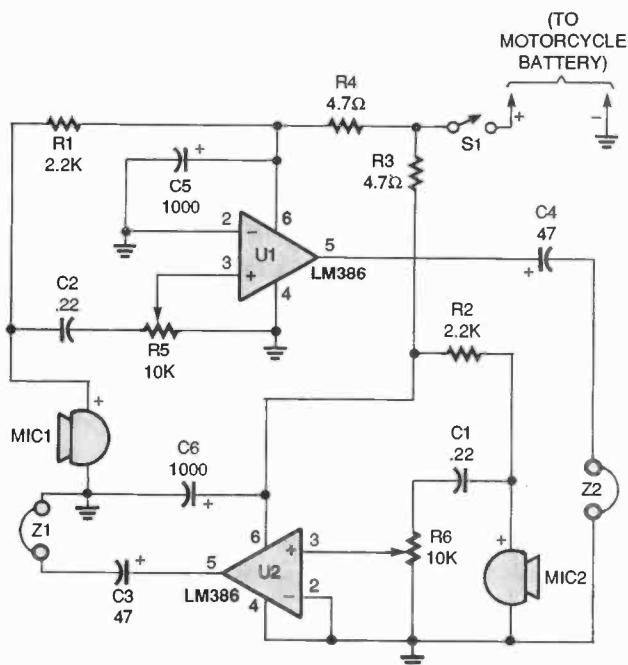

Fig. 5. Why yell at your passenger when you can talk? Use this two-way intercom to make communicating on the open road a lot easier.

PARTS LIST FOR THE TWO-WAY INTERCOM (Fig. 5)

RESISTORS

(All fixed resistors are 1/4-watt, 5% units, unless otherwise noted.)
R1, R2—2200-ohm
R3, R4—4.7-ohm, 1/2-watt
R5, R6—10,000-ohm, potentiometer

CAPACITORS

C1, C2—0.22- μ F, Mylar
C3, C4—47- μ F, 25-WVDC, electrolytic
C5, C6—1000- μ F, 25-WVDC, electrolytic

ADDITIONAL PARTS AND MATERIALS

U1, U2—LM386, power audio amplifier, integrated circuit
MIC1, MIC2—Electret microphone element
Z1, Z2—Stereo or mono headphones
Wire, solder, knobs, etc.

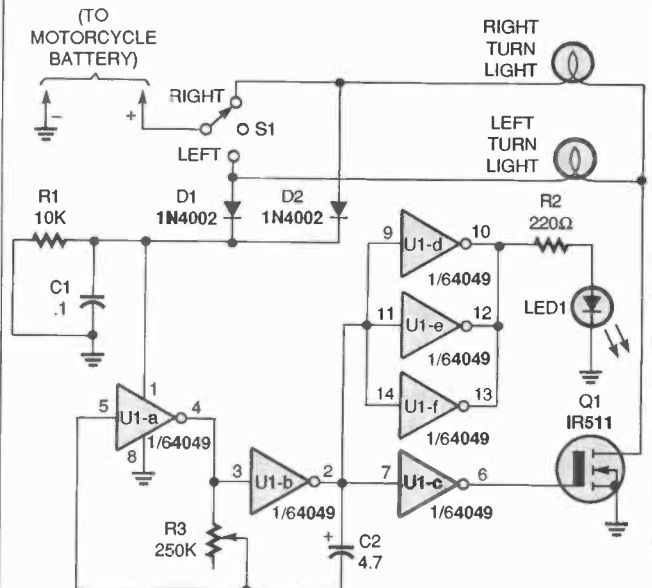

Fig. 6. Tired of making hand signals? Build this simple turn-signal system and keep your hands on the handlebars.

higher-current device, an IRF530, which is rated at 14 amps, can be substituted.

TWO-WAY INTERCOM

A simple "passenger-to-pilot" intercom circuit is shown in Fig. 5. Two LM386 IC's are connected in a low-gain amplifier circuit with the headphone output of one paired to the microphone input of the other. The microphones are electret elements and the earphones can be of the in-ear type or of the small stereo/mono type that will fit inside your helmet.

Both amplifiers in the circuit operate at a minimum gain of 20 dB. That helps to keep the wind and road noise to a minimum. However, that also means that the microphone must be located close to the mouth.

TURN-SIGNAL SYSTEM

Our final motorcycle gadget (see Fig. 6) is a complete turn-signal system. It can be added to an older bike or used as a replacement for a non-working existing system.

Two sections of a 4049
(Continued on page 87)

Be a computer programmer!

Only NRI gives you hands-on training with a 486DX2/66 MHz Multimedia PC! You get all this:

- Super VGA color monitor ■ 420 meg hard drive ■ 8 meg RAM
- CD-ROM drive, sound card, and speakers ■ fax/modem
- Visual Basic ■ Power C ■ Windows 95
- And more!



Only NRI at-home training gives you real-world programming skills in three in-demand languages: QBasic, C, and Visual Basic, today's hot new language designed for writing popular Windows applications. Best of all, you train with a state-of-the-art Multimedia PC: a 486DX2/66 MHz Intel-based computer with 8 full megabytes of RAM, 420 meg hard drive, CD-ROM drive, sound card, speakers, fax/modem, and professional software — including Windows 95 — all yours to train with and keep!



You get hands-on programming experience as you work with a powerful Intel-based 486DX2/66 MHz computer system with 8 full megabytes of RAM, 420 meg hard drive, 3.5" floppy drive, fax/modem, mouse, plus CD-ROM drive, sound card, and speakers!

Plus you explore the extraordinary capabilities of three in-demand programming languages. You learn to design, code, run, debug, and document programs in QBasic, C, and Visual Basic. Best of all, since Visual Basic is specifically designed for creating Windows applications, you learn to generate fully functioning Windows programs, complete with text boxes, command buttons, and other sophisticated graphical interface elements.

NRI's step-by-step lessons and hands-on programming projects help you first master the design concepts used every day by successful PC programmers. Then, with the support of your experienced NRI instructor, you quickly move on to learn programming in three of today's hottest languages.

By the time you complete your course, you have a clear understanding of programming methods, languages, and techniques... and you're ready to handle any programming task with confidence.

NRI, the leader in at-home computer training, shows you how to take advantage of today's newest programming opportunities

Get in on the ground floor of computer programming, one of today's fastest-growing career fields. The Bureau of Labor Statistics forecasts that job opportunities for programmers will increase *much* faster than average over the next 10 years, with as many as 400,000 new jobs opening up by 2005.

And the fastest-growing segment of programming jobs will be PC programming, fueled by the phenomenal popularity of Windows, the efficient power of C, and the rise of exciting new languages like QBasic and Visual Basic.

Now, with NRI at-home training, you can get the new skills you need to build a top-paying career — even a full- or part-time business of your own — in this high-growth, high-opportunity field.

Train with a state-of-the-art 486DX2 multimedia computer, 420 meg hard drive, Windows 95, Visual Basic, and more!

Right from the start, NRI's unique Discovery Learning Method gets you actively involved in the challenge of real-world programming. Step by step, you learn to create the kinds of full-featured, powerful programs today's employers and clients demand...even multimedia programs!

No previous experience necessary

Train with NRI, and immediately start getting the money-making job skills you need to be a computer programmer — no matter what your previous background.

Windows, QBasic, and Visual Basic are trademarks of Microsoft Corporation. Intel Inside logo is a registered trademark of Intel Corp.

Send today for your FREE catalog

See how NRI at-home training gives you the programming know-how, the computer, and the software you need to get started in this top-paying field. Send today for your FREE catalog!

If the coupon is missing, write to us at the NRI School of Computer Programming, McGraw-Hill Continuing Education Center, 4401 Connecticut Avenue, NW, Washington, DC 20008.

SEND TODAY FOR FREE NRI CATALOG!

NRI Schools

McGraw-Hill Continuing Education Center
4401 Connecticut Avenue, NW, Washington, DC 20008



For career courses
 approved under GI Bill,
check for details

- Check one FREE catalog only
- COMPUTER PROGRAMMING
- PC Applications Specialist
- Programming in C++ with Windows

Other Computer Career Courses

- Microcomputer Servicing
- Desktop Publishing
- Bookkeeping and Accounting
- Multimedia Programming

Name _____ (please print) Age _____

Address _____

City/State/Zip _____ Accredited Member, National Home Study Council 5413-0495

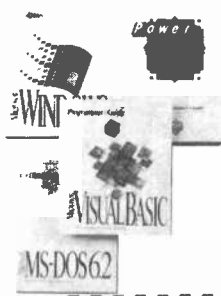

DX LISTENING

By Don Jensen

Shortwave From South Africa

There have been great changes in South Africa in the past several years! One that affected shortwave listeners in the U.S. and Canada was the South African Broadcasting Corporation's change in audience emphasis. In October 1992, the well-known and widely heard South African SW service, *Radio RSA*, changed its name to *Channel Africa*.

That name change heralded a different mission for the external service of the SABC. "We used to broadcast under our old name of

SABC is the continent's only shortwave station providing a daily multi-lingual commercial service to Africa.

Channel Africa has not abandoned English programming however, because that is one of Africa's important languages. The service also airs broadcasts in a half dozen other languages of the region: French, Portuguese, Kiswahili, Chichewa, Silozi, and Tsonga.

Programming, Vorster says, includes news; actualities; economic and socio-political issues; coverage of economic, socio-political, environmental and wildlife issues; education and training; sports; music; and light entertainment. In a continent where commercial radio broadcasting is not widespread, Channel Africa is involved in audience research to provide background data for potential advertisers. It has joined with the British Broadcasting Corporation, Holland's *Radio Nederlands* and Germany's *Deutsche Welle* to survey the African radio audience. Initial studies indicate that between seven- and nine-million listeners in sub-Saharan Africa regularly tune in Channel Africa, Vorster says. They also indicate that 90 percent of the station's African audience prefers Channel Africa's news broadcasts. Not surprisingly, music, entertainment, and sports programming also are popular.

Vorster notes, however, that much of Radio RSA's old audience around the globe is still out there listening. "Our signal is so strong,"

she says, "that we continue to receive letters from shortwave listeners in many parts of the world, including the United States, who receive our transmissions . . . even in a town called Chicken in Alaska!"

North American SWL's who want to try for Channel Africa's English language broadcasts can check these times and frequencies: 0300-0500 UTC: 5,955 and 9,585 kHz; 0500-0600 UTC: 7,185 and 11,900 kHz; 1000-1100 UTC: 17,810 kHz; 1100-1200 UTC: 9,730 kHz; 1500-1600 UTC: 7,225 kHz; 1600-1700 UTC: 7,225 and 15,240 kHz; and 1700-1800 UTC: 7,225 kHz.

If you want to send your reception report to Channel Africa, write to Post Office Box 91313, Auckland Park 2006, South Africa.

WHAT'S IN A NAME

Everyone knows the name Radio Shack, the large, nationwide chain of electronic retail stores. What you might not know, though, is that their tradename had its origins in the early days of the radio hobby. In the 1920's and 1930's, every radio ham or SWL had his or her "radio shack" (no capital letters, you'll note). In many cases, it was just that, nothing more than a wooden shed out back where the radio enthusiast could fool around with his home-built radio sets.

In later years, most SWL's wisely moved indoors. Shortwave equipment was

*CREDITS: William Davenport, TN; Marie Lamb, NY; Ed Newbury, NE; North American SW Association, 45 Wildflower Road, Levittown, PA 19057



Here is the logo used by South Africa's Channel Africa external shortwave service.

Radio RSA to North and South America, Europe, and Australia," says Noeleen Vorster, manager of Channel Africa's corporate communications. "These wider broadcasts ceased when we changed our name to Channel Africa. As our name implies, our target area now is the entire African continent and our communications thrust is directed exclusively to Africa."

While worldwide broadcasting is no longer the SABC's aim, its potential audience remains large. There are an estimated 96 million radios in Africa. With 29 years of experience, the

set up in the basement, attic, den, spare bedroom, or perhaps even in a living-room corner. Though a lot more comfortable and convenient than the backyard woodshed, the old term "shack" stuck.

I'd like to feature photos of our readers and their "radio shacks" as part of our monthly column. So get out the camera and recruit a family member to snap you as you tune your favorite SW stations. Send the photograph to me at DX Listening, **Popular Electronics**, 500-B Bi-County Blvd., Farmingdale, NY 11735. Please identify your SW receiver and any listening accessories that appear in the photo. We'd all like to see what you look like!

A BASIC QUESTION

Here's a question from a new shortwave listener, Fred Pawlowski, who writes from Astoria, OR: "I know its an elementary question, but can you list all the short-wave bands where I can hear foreign SW stations?"

It might be elementary, Fred, but we do have beginning shortwave listeners coming on board every month, reading DX Listening for the first time. So for you, and for them, it is important to cover some of the basics of the listening hobby.

There are 14 groups of SW frequencies, assigned by the International Telecommunications Union. Those SW broadcasting bands are named for the metric lengths of their radio waves and are as follows. They are:

- 11-meter band: 25,600 to 26,100 kilohertz (kHz)
- 13-meter band: 21,450 to 21,750 kHz
- 15-meter band: 18,900 to 19,020 kHz (future band)
- 16-meter band: 17,550 to 17,900 kHz

(future: 17,480-17,900)

- 19-meter band: 15,100 to 15,600 kHz
(future: 15,100-15,800)
- 22-meter band: 13,600 to 13,800 kHz
(future: 13,570-13,870)
- 25-meter band: 11,650 to 12,050 kHz
(future: 11,600-12,050)
- 31-meter band: 9,500 to 9,990 kHz
(future: 9,400-9,990)
- 41-meter band: 7,100 to 7,300 kHz
(future: 7,100-7,350)
- 49-meter band: 5,950 to 6,200 kHz
(future: 5,900-6,200)
- 60-meter band: 4,750 to 5,060 kHz
- 75-meter band: 3,900 to 4,000 kHz
- 90-meter band: 3,200 to 3,400 kHz
- 120-meter band: 2,300 to 2,495 kHz

The expanded bands (designated "future" above) officially will be assigned to shortwave broadcasting at the turn of the century, but you probably can expect that some stations will be using some of those frequencies well before the year 2000. In general terms, look to frequencies of 15,000 kHz and higher during the daylight hours, and the lower frequencies for nighttime listening.

DOWN THE DIAL

Here are some SW stations that are being logged lately:

LEBANON—6,280 kHz. The station *King of Hope* is operated from south Lebanon by High Adventures ministries, a U.S.-based religious organization. It has been noted here at around 0100 UTC with cool jazz and religious talks.

VENEZUELA—9,660 kHz. *Radio Rumbos* in Caracas is noted with Spanish language programming and great Latin and salsa music at about 2200 UTC. ■

VCR Cross Reference

**NOW Find the right Part
for your VCR**

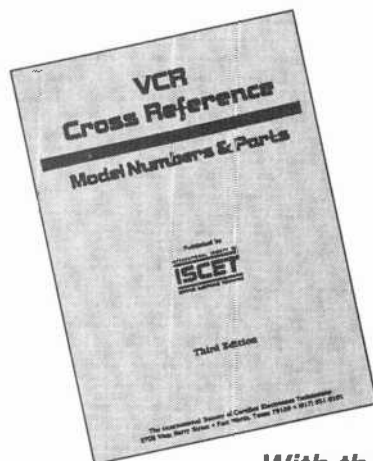

With the ISCET VCR CROSS REFERENCE

This 270-page reference contains both model and part-number cross-references updated to include 1992 units.

VCR's are made in a few factories from which hundreds of different brand names and model numbers identify cosmetically-changed identical and near-identical manufactured units. Interchangeable parts are very common. An exact replacement part may be available only a few minutes away from you even though the manufacturer supplier is out-of-stock. You may be able to cannibalize scrap units at no cost!

The ISCET VCR Cross Reference is pre-punched for standard loose-leaf binding. . . \$38.00 plus \$3.00 for shipping for each Reference.

**Claggk Inc.
VCR CROSS REFERENCE OFFER
P.O. Box 4099
Farmingdale, New York 11735**

Name _____
Business _____
Address _____
City _____
State _____ Zip _____
Phone _____

Enclose \$38.00 for the Third Edition of the ISCET VCR Cross Reference and \$3.00 for shipping for each Reference.

The total amount of my order is \$ _____
Check enclosed—do not send cash.
or please charge my credit card.

Visa MasterCard Exp. Date ___/___/___

Card No. _____

Signature _____

New York State residents must add applicable local sales tax to total.

ELECTRONICS MARKET PLACE

FOR SALE

CABLE test chips. Jerrold, Tocom, S.A., Zenith. Puts cable boxes into full service mode! \$29.95 to \$59.95. 1 (800) 452-7090, (310) 902-0841.

SECRET cable descramblers! Build your own descrambler for less than \$12.00 in seven easy steps! Radio Shack parts list and free descrambling methods that cost nothing to try, included. Send \$10.00 to: **INFORMATION FACTORY**, Dept. 5, PO Box 669, Seabrook, TX 77586. For COD's (713) 922-3512 any time.

PRINTED circuit boards. Design and make PC boards to your requirements. Small runs OK. Fast turnaround. 28 years experience. Call, write or fax for information. **SHORE PRINTED CIRCUITS**, 1658 Route 9, Toms River, NJ 08753. 1 (800) 752-1574, NJ (908) 505-6363, fax 505-6266.

T.V. notch filters, free brochure, MICROTHINC, Box 63/6025, Margate, FL 33063. (305) 752-9202.

CABLE test chips. Put your cable box in full test mode. Call (303) 731-9400.

CABLE TV CONVERTER & DESCRAMBLER
COMBINATION SPECIALS!
All you need for one LOW price



ONLY \$175.00
Stargate Combo limited to X2213
with CMM2 or CMA Descrambler

1-800-228-7404



NU-TEK ELECTRONICS
3250 Hatch Cedar Park TX 78613

300 Experimenters Circuits — Complete in 6 practical books using diodes, relays, FET's, LED's, IC 555's, and IC CA3130's for building blocks. Only \$33.00 plus \$5.50 for shipping. USA and Canada only. US funds. **ETT, INC.**, PO Box 240, Massapequa Park, NY 11762-0240.

CABLE descramblers and test turn-on kits available for most makes and models. No catalog, no 800 number equals your lowest prices. Call others, then compare our prices! We pay cash for unwanted cable boxes. No Florida sales. (305) 425-0751.

THE Case Against Patents. Thoroughly tested and proven alternatives that work in the real world. \$28.50. **SYNERGETICS PRESS**, Box 809-C, Thatcher, AZ 85552. (602) 428-4073. Visa/MC.

★ **1995 CATALOG** ★

**OF THE WORLD'S MOST FAMOUS
CB ANTENNAS & ACCESSORIES**

— **FIRESTIK CB ANTENNAS** —

2614 E. Adams · Phoenix, AZ 85034
Write or Call, 602-273-7151

PARTS for \$1.00. Resistors .25W 12, .5W 8. Capacitors .001uF 5, .01uF 5, .1uF 4, 1uF 3, 10uF 2, 100uF 1. Semiconductors 1N4004 4, 2N2222 1, 2N3904 2, 2N3906 2, TIP31A 1, TIP32A 1, LM741 1, LM555 1, LEDS red 3, green 2. Catalog \$1.00, foreign add \$1.00. **ZIPFAST**, Box 12238, Lexington, KY 40581-2238.

CLASSIFIED AD ORDER FORM

To run your own classified ad, put one word on each of the lines below and send this form along with your check to:

Popular Electronics Classified Ads, 500-B Bi-County Boulevard, Farmingdale, N.Y. 11735

PLEASE INDICATE in which category of classified advertising you wish your ad to appear. For special headings, there is a surcharge of **\$11.00**.

() Plans/Kits () Business Opportunities () For Sale
() Education/Instruction () Wanted () Satellite Television

Special Category: \$11.00

PLEASE PRINT EACH WORD SEPARATELY, IN BLOCK LETTERS.

(No refunds or credits for typesetting errors can be made unless you clearly print or type your copy.) Rates indicated are for standard style classified ads only. See below for additional charges for special ads. **Minimum: 15 words.**

1	2	3	4	5
6	7	8	9	10
11	12	13	14	15 (\$23.25)
16 (\$24.80)	17 (\$26.35)	18 (\$27.90)	19 (\$29.45)	20 (\$31.00)
21 (\$32.55)	22 (\$34.10)	23 (\$35.65)	24 (\$37.20)	25 (\$38.75)
26 (\$40.30)	27 (\$41.85)	28 (\$43.40)	29 (\$44.95)	30 (\$46.50)
31 (\$48.05)	32 (\$49.60)	33 (\$51.15)	34 (\$52.70)	35 (\$54.25)

We accept MasterCard and Visa for payment of orders. If you wish to use your credit card to pay for your ad fill in the following additional information (Sorry, no telephone orders can be accepted.):

Card Number

Expiration Date

PRINT NAME

SIGNATURE

IF YOU USE A BOX NUMBER YOU MUST INCLUDE YOUR PERMANENT ADDRESS AND PHONE NUMBER FOR OUR FILES. ADS SUBMITTED WITHOUT THIS INFORMATION WILL NOT BE ACCEPTED.

CLASSIFIED COMMERCIAL RATE: (for firms or individuals offering commercial products or services) \$1.55 per word prepaid (no charge for ZIP code)...**MINIMUM 15 WORDS.** 5% discount for same ad in 6 issues within one year; 10% discount for 12 issues within one year if prepaid. **NON-COMMERCIAL RATE:** (for individuals who want to buy or sell a personal item) \$1.25 per word, prepaid...no minimum. **ONLY FIRST WORD AND NAME** set in bold caps at no extra charge. Additional bold face (not available as all caps) 30¢ per word additional. Entire ad in boldface, \$1.85 per word. **TINT SCREEN BEHIND ENTIRE AD: \$1.90 per word. TINT SCREEN BEHIND ENTIRE AD PLUS ALL BOLD FACE AD: \$2.25 per word. EXPANDED TYPE AD: \$2.05 per word prepaid.** Entire ad in boldface, \$2.45 per word. **TINT SCREEN BEHIND ENTIRE EXPANDED TYPE AD: \$2.55 per word. TINT SCREEN BEHIND ENTIRE EXPANDED TYPE AD PLUS ALL BOLD FACE AD: \$2.95 per word. DISPLAY ADS:** 1" x 2 1/2"—\$225.00; 2" x 2 1/2"—\$450.00; 3" x 2 1/2"—\$675.00. **General Information:** Frequency rates and prepayment discounts are available. **ALL COPY SUBJECT TO PUBLISHERS APPROVAL. ADVERTISEMENTS USING P.O. BOX ADDRESS WILL NOT BE ACCEPTED UNTIL ADVERTISER SUPPLIES PUBLISHER WITH PERMANENT ADDRESS AND PHONE NUMBER.** Copy to be in our hands on the 13th of the fourth month preceding the date of issue (i.e.; Sept. issue copy must be received by May 13th). When normal closing date falls on Saturday, Sunday or Holiday, issue closes on preceding work day. Send for the classified brochure. **Circle Number 49 on the Free Information Card.**

REAL stuff! Surveillance, people tracking, entry, night vision — lowest prices. Catalog \$15.00. 1 (800) 805-5544. **INTELLIGENCE INC.**, Dept. KJ, 2228 El Camino Real, San Mateo, CA 94403.

DESCRAMBLE cable with simple circuit added to Radio Shack RF modulator and using VCR as tuner. Instructions \$10.00. **TELCOM**, POB 832-P4, Brusly, LA 70719.

PRINTED circuit boards — etched, drilled, tin plated. Single sided \$1.25/sq. inch. **CHELCO ELECTRONICS**, 61 Water Street, Mayville, NY 14757. 1 (800) 388-8521. Fax (716) 753-3220.

BEST BY MAIL

Rates: Write National, Box 5, Sarasota, FL 34230

EDUCATION

HIGH SCHOOL DIPLOMA Fast New Program, Credit For Experience. 1-800-470-4723.

FINANCIAL

SIGNATURE-LOANS \$1000 — \$50,000 No-Collateral (\$3.00) Refundable: **TAYOE ODESANYA**, 427 Church Street, Williamstown, NJ 08094.

OF INTEREST TO ALL

MEXICO TRADE DIRECTORY \$15.00 Postpaid. Box 661, Dallas, GA 30132.

RECYCLE PERSONAL COPIERS Cartridges. Instructions \$14.95. Charles Bruns, Box 543, Applegate, CA 95703.

24 HR. EMPLOYEE RIGHTS HOTLINE 1-900-772-4568 \$1.25 Per Min., 4 Min. Avg. Cost \$5.00, Over 18, Daniel Info., Ft. Worth, TX 817-496-6274.

ANTIQUE RADIO CLASSIFIED

Free Sample!



Antique Radio's

Largest Circulation Monthly.
Articles, Ads & Classifieds.

6-Month Trial: \$17.95. 1-Yr: \$34.95 (\$51.95-1st Class).
A.R.C., P.O. Box 802-L14, Carlisle, MA 01741
Phone:(508) 371-0512 VISA/MC Fax:(508) 371-7129

PLANS & KITS

60 Solderless Breadboard Projects in two easy-to-read pocket books. Complete with circuit descriptions, schematics, parts layouts, component listings, etc. Both books (BP107 & BP113) only \$11.90 plus \$3.50 for shipping. USA and Canada only. US funds. **ETT, INC.**, PO Box 240, Massapequa Park, NY 11762-0240.

SURVEILLANCE/countersurveillance, bugging/phone tapping detector, telephone/fax encryption, vehicle tracking, covert video, transmitter kit, and more...**A.B. ELECTRONICS**, 1 (800) U-ANTI-BUG.

CRYSTAL set Handbook — Visit antiquity by building the radios your grandfather built. Assemble a "Quaker Oats" rig, wind coils that work and make it look like the 1920's! Only \$10.95 plus \$3.50 for shipping and handling. **CLAGGK INC.**, PO Box 4099, Farmingdale, NY 11735. US funds only! USA and Canada — no foreign orders.

BUILD a 486 personal computer. Easy reading guide \$19.95. **QUANTA ENTERPRISES**, PO Box 273, Dept. 50, Northfield, NJ 08225.

FIBER optics experimenters parts, supplies and tools: Fiber, cable, connectors, splices, detectors, lasers, kits, plans, newsletter. Send \$2.00 for catalog. **LIGHTLINE ENGINEERING**, PO Box 24, Mullica Hill, NJ 08062.

EASY to install, low cost, home/auto alarm system schematic diagrams/tips. \$14.95. **QCDOBH**, 270 North Canon #1632G, Beverly Hills, CA 90212-5323.

MASTERCARD AND VISA are now accepted for payment of your advertising. Simply complete the Classified Ad order form and we will bill you.



Learn VCR repair!

Home study. Learn high-profit repairs without investing in high tech instruments. **Free career literature: 800-223-4542.**

Name _____ Age _____
Address _____
City _____ State _____ Zip _____
The School of VCR Repair, Dept. VRE341
PCDI, 6065 Roswell Rd., Atlanta, GA 30328

EDUCATION/INSTRUCTION

COLLEGE degrees by mail from prestigious colleges. Details \$1.00: **BAYSTATE SPECIALISTS**, Box 191 W, Hopkinton, MA 01748.

FCC General Radiotelephone Operator's license. Answers, solutions to latest 889 for elements 1,3 examinations. Prepared by professional engineer. To receive this publication, send \$20.00 to **UNIVERSAL COMMUNICATIONS**, PO Box 11646, Palm Desert, CA 92255-1646.



RECEIVING TUBES

OVER 3000 TYPES IN STOCK!

Also hard-to-find transformers, capacitors and parts for tube equipment.
Send \$2.00 for our 36 page catalog.

ANTIQUE ELECTRONIC SUPPLY
6221 S. Maple Ave. • Tempe, AZ 85283 • 602-820-5411

BUSINESS OPPORTUNITIES

EASY work! Excellent pay! Assemble products at home. Call toll free 1 (800) 467-5566 ext. 5730.

START your own technical venture! Don Lancaster's newly updated **Incredible Secret Money Machine II** tells how. We now have autographed copies of the Guru's underground classic for \$18.50. **SYNERGETICS PRESS**, Box 809-C, Thatcher, AZ 85552. (602) 428-4073. Visa/MC.

GET paid \$268.20 per roll taking easy snapshots! No experience. Film supplied. **PHOTOTEK**, Box 2457, Dept. 2, Pinecove, CA 92549. Recorded information: (909) 659-9757 ext. 8.

GREAT extra income! Assemble craft products at home. Easy/fun to do. Guaranteed! 1 (800) 377-6000 ex7930.

JOB security! Full specifics. \$5.00. You can't afford to wait! **SAGAMORE PUBLISHING**, PO Box 248, Teaneck, NJ 07666.

BECOME AN ELECTRICIAN!

Career-level home study course. Train now to make good money working on electrical systems in homes and businesses. Learn circuits, wiring, lighting, control panels, appliances, phones, cables, more. **Free career literature.**

800-223-4542



Name _____ Age _____
Address _____ Phone () _____
City _____ State _____ Zip _____

THE ELECTRICIAN SCHOOL
Dept. TEE341, 6065 Roswell Rd., PCDI, Atlanta, GA 30328

Be a computer repair expert!

Career-level home study course. Learn all about PC repairs, troubleshooting, installation, upgrading, servicing. Open your own business; become a more valuable employee. **Free literature: send or call 24 hours a day.**

800-223-4542

Name _____ Age _____
Address _____ Phone () _____
City _____ State _____ Zip _____

The School of PC Repair
PCDI, 6065 Roswell Road
Dept. JJE341, Atlanta, Georgia 30328



INVENTIONS

FREE invention package: **DAVISON & ASSOCIATES** offers customized development, patenting, and licensing for new products and ideas. Proven results: 1 (800) 677-6382.

BOOKS

ROBOT books! Free catalog by mail! Write: **COGNITIONS**, Dept. 1200, 71 Widow Sweets Rd., Exeter, RI 02822.

"The family suggests that memorial contributions be made to the American Heart Association." When people want to honor a loved one and fight heart disease.

AMERICAN HEART
ASSOCIATION
MEMORIALS & TRIBUTES



1-800-AHA-USA1

American Heart Association

This space provided as a public service.
©1993, American Heart Association

HAM RADIO

By Joseph J. Carr, K4IPV

Building Receivers With The NE-602

This month we will take a look at building super-het and direct-conversion receivers, frequency converters, and other circuits using the Signetics NE-602 integrated circuit. The material will be presented as a three-part series. I have used that chip in a number of projects, and am quite fond of it—it makes receiver-making a tad easier than it used to be.

You will also want to obtain catalog SC-95 from SESCO, Inc. (Dept. PE, 2100 Ward Drive, Henderson, NV 89015-4249). Their telephone numbers are as follows: orders: Tel. 800-634-3457, Fax: 800-551-2749; technical assistance: Tel. 702-565-3993, Fax: 702-565-4828; and office: Tel. 702-565-3400. The catalog lists dozens of

19-inch rack frames, rack boxes/chassis, cabinets, and RF-tight boxes. SESCO sent me a sample of their SB-series RF construction boxes. Those small RF-tight, hot-tin-plated, steel boxes solve some of the main problems RF builders have with aluminum boxes. They come with tight-fitting top covers, and have removable internal dividers to make separate component compartments. The tin plating means that you can solder directly to the box or dividers, which solves some RF problems right there! Get the SESCO catalog if you are interested in any type of electronic construction, especially RF construction.

By the way, magazines such as **Popular Electronics** live and breathe from advertisements of people who want you to buy their products. When writing to a company mentioned in this column, whether they are PE advertisers or not, how about telling them you "saw them mentioned in **Popular Electronics**." Now, on to our main topic.

integrated circuit containing a double-balanced modulator or mixer (DBM), an oscillator, and an internal voltage regulator in a single, eight-pin package (see Fig. 1). The double-balanced mixer operates to 500 MHz, and the internal oscillator works to 200 MHz. The primary uses of the NE-602 are in HF and VHF receivers, frequency converters, and frequency translators, but it can also be used as a signal generator. The oscillator section will operate in many popular LC variable-frequency-oscillator, piezoelectric-crystal, or swept-frequency circuit configurations. In this three-part series we will explore the various NE-602 configurations for the DC power supply, the RF input, the local oscillator, and the output circuits.

The NE-602 operates over a temperature range of 0 to +70°C. While the circuit is available in a variety of packages, including surface mount, the most common form of the device is probably the NE-602N, which is an eight-pin miniDIP package. Other variants include the improved NE-602AN and NE-602AD devices, as well as the NE-612 device. The latter is a little hard to find in consumer quantities in this country; but suppliers in the United Kingdom stock them. We will feature the NE-602N in our discussions because it is both easily available and easy to use, but the circuits given in this series will also work with the other packages and configurations as well.

Because the NE-602 con-

THE NE-602 DEVICE

The Signetics NE-602 is an

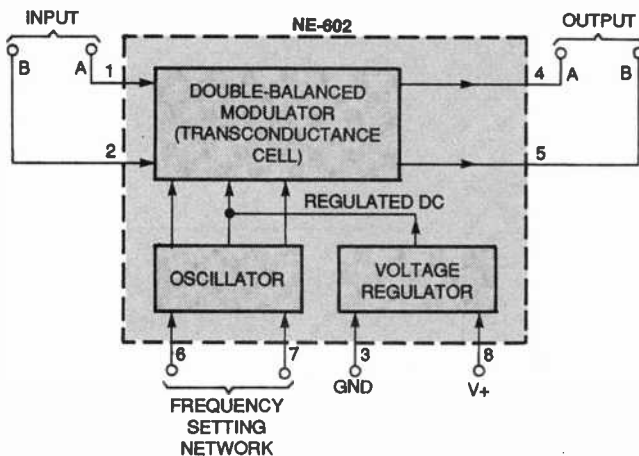

Fig. 1. Here is a block diagram of the NE-602. The chip's features make it ideal for use in a variety of RF circuits.

But first, let's take a look at a couple of suppliers that will be of interest to ham operators and others who build RF projects. The first item is the 64-page catalog of Antennas West (Dept. PE, Box 50062, 1500 North 150 West, Provo, UT 84605-0062; Tel. 801-373-8425, Fax: 801-375-4664). The catalog contains some interesting wire and aluminum-tubing antennas, BALUN transformers, as well as other antenna-related products. They also stock various solar-power items. Along with the antenna listings are brief theory discussions. The Antennas West catalog costs \$1.00.

tains both a mixer and a local oscillator, it can operate as a radio receiver front-end circuit. It features good noise and reasonable, although not exciting, third-order-intermodulation performance. The noise figure is typically 5 dB at a frequency of 45 MHz. The NE-602 has a third-order intercept point on the order of -15 dBm, referenced to a matched input, although it is recommended that a maximum signal level of -25 dBm (approximately 3.2 mW) be observed. That signal level corresponds to about 12 mV into a 50-ohm load, or 70 mV into the 1500-ohm input impedance of the NE-602.

The NE-602 is capable of providing $0.2 \mu\text{V}$ sensitivity in receiver circuits without external RF amplification. One criticism of the NE-602 is that it appears to sacrifice some dynamic range for high sensitivity, a problem that is said to be solved in the "A" series (e.g. NE-602AN).

FREQUENCY CONVERSION AND TRANSLATION

The process of frequency conversion is called heterodyning. When two signals of different frequencies (f_1 and f_2) are mixed in a nonlinear circuit, a collection of different frequencies will appear in the output of the circuit. These are characterized as f_1 , f_2 and $n f_1 \pm m f_2$, where n and m are integers. In most practical situations, n and m are 1, so the total output spectrum will consist at least of f_1 , f_2 , $f_1 + f_2$ and $f_1 - f_2$. Of course, if the two input circuits contain harmonics, then additional products are found in the output. In superheterodyne radio receivers, either the sum or difference frequency is selected as the intermediate

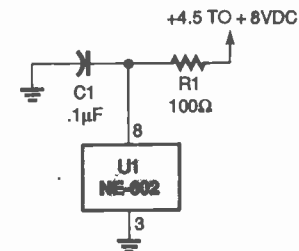

Fig. 2. As long as the supply voltage is 8-volts or less, this simple configuration can be used to power the NE-602.

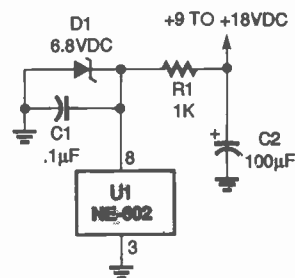

Fig. 3. For supplies of 9- to 18-volts, as is common in automotive applications, use a Zener diode to provide regulation.

frequency (IF). In order to make the frequency conversion possible, a circuit needs a local oscillator and a mixer circuit (both of which are provided by the NE-602).

The local oscillator (LO) consists of a VHF NPN transistor with the base connected to pin 6 of the NE-602, and the emitter connected to pin 7; the collector of the oscillator transistor is not available on an external pin. There is also an internal buffer amplifier, which connects the oscillator transistor to the double-balanced modulator circuit.

Any of the standard oscillator-circuit configurations (discussed later on in this series) can be used with the internal oscillator, provided that access to the collector terminal is not required. That means that Colpitts, Clapp, Hartley, Butler, and several other oscillator circuits can be used with the NE-602 device, while the Pierce and Miller oscillator circuits can not.

The double-balanced mixer circuit consists of a pair of cross-connected differential amplifiers (Q1/Q2 with Q5 as a current source; similarly Q3/Q4 with Q6 working as a current source). That configuration is called a Gilbert Transconductance Cell. The cross-coupled collectors form a push-pull output (pins 4 and 5) in which each output pin is connected to the V+ power-supply terminal through 1500-ohm resistances. The input is also push-pull, and likewise is cross-coupled between the two halves of the cell. The local oscillator signal is injected into each cell-half at the base of one of the transistors.

Because the mixer is "double balanced," it has a key attribute that makes it

range is +4.5- to +8-volts DC, with a current drain ranging from 2.4 to 2.8 mA. It is highly recommended that the V+ power supply terminal (pin 8) be bypassed to ground with a capacitor of 0.01 to 0.1 μF in order to prevent instability (oscillation) and guard against noise interfering with the operation of the device. The capacitor should be mounted as close to the body of the NE-602 as is practical; short leads are required in radio-frequency circuits.

Figure 2 shows the recommended power supply configuration for situations where the supply voltage is +4.5 to +8 volts. For best results, the supply voltage should be regulated. Otherwise, the local-oscillator frequency may not be sta-

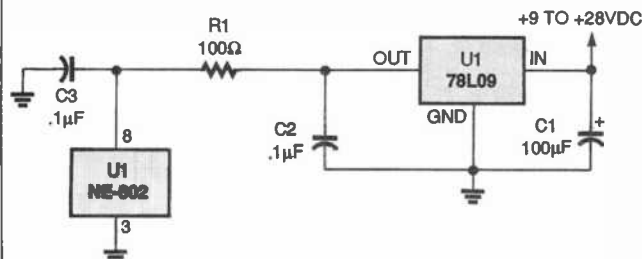

Fig. 4. For higher voltages, and where better regulation is required, use a three-terminal, IC voltage regulator like the 78L09.

ideal for use as a frequency converter or receiver front-end: suppression of the LO and RF input signals in the outputs. In the NE-602 chip, the output signals are $f_1 + f_2$, and $f_1 - f_2$; neither LO nor RF signals appear in the output in any great amplitude. Although some harmonic products appear, many are also suppressed because of the DBM action.

POWER-SUPPLY CONSIDERATIONS

The V+ power-supply terminal of the NE-602 is pin 8, and the ground connection is pin 3; both must be used for the DC power connections. The DC power-supply

ble, which leads to problems. A series resistor (about 100 to 180 ohms) is placed between the V+ power supply and the V+ terminal on the NE-602. If the power-supply voltage is raised to +9 volts, then increase the value of the series resistance an order of magnitude to 1000 to 1500 ohms.

If the DC power-supply voltage is either unstable, or is above +9 volts, then it is highly recommended that a means of voltage regulation be provided. In Fig. 3 a Zener diode is used to regulate the NE-602 V+ voltage to 6.8-volts DC, even

(Continued on page 87)

SCANNER SCENE

By Marc Saxon

Deep-Space Scanning



The Trident TR-1200 handheld scanner is another in the series of receivers offering an extremely wide tuning range, plus loads and loads of memory channels. The radio picks up signals within the range from 500 kHz (that's below the AM broadcast band) to 1300 MHz (1.3 GHz). That means it takes in AM and FM broadcasts,

shortwave broadcasts, and TV audio, as well as all the VHF/UHF scanner-band action. It can receive FM-Narrow, FM-Wide, and AM modes. Tuning increments are selectable in steps as low as 5 kHz.

Within the TR-1200 are 1000 memory channels. The user can set and place into memory up to ten different search ranges. The scanning rate is 25 channels per second.

Power is supplied by four "AA" batteries, and rechargeable types can be used if desired. The Trident TR-1200 comes with a 12-volt DC cigarette-lighter plug, an AC battery charger, an earphone, a belt clip, a rubberized antenna, and mounting hardware. It weighs just 14 ounces.

The manufacturer's suggested retail price is \$629, but we have seen the TR-1200 generally offered in the \$400 (and slightly under) price range. It's an extremely versatile handful of equipment.

HEAD IN THE CLOUDS

Are you aware that your scanner covers some of the frequency bands used by radio astronomers to listen to deep space for naturally generated signals? Such signals arrive here from the sun and many other areas of the cosmos, and are part of an overall pattern of energy radiation that also includes x-rays, gamma rays, UV rays, and infrared and visible light.

While the signals arriving

here undoubtedly exist virtually across the radio spectrum, they peak in certain frequency ranges, which are studied by radio astronomers. Those bands lie between 21 MHz and 265 GHz. That range includes several bands within the range of many scanners.

Mind you, those signals are faint crackles, buzzes, and pops of noise. The thrill lies in knowing that they are arriving from deep space. If you want to have a go at hearing something, you'll want a good outdoor antenna and a good preamplifier.

Radio astronomers like the following bands: 37.50 to 38.29, 73.00 to 75.46, 150.05 to 153.00, 322.0 to 328.6, 406.1 to 410.0, and 606.0 to 614.0 MHz. Yes, many of those frequencies are subject to interference from communications stations.

Search for Extraterrestrial Intelligence (SETI) frequencies include 1000 to 3000 MHz. All or part of that band is within the capabilities of sophisticated scanners. Two frequencies in particular have long been suggested as being the best bets for producing SETI results. Those are 1420.0 MHz (the emission line of neutral hydrogen) and 1720.0 MHz (the hydroxyl emission line).

Those searching for SETI transmissions are hoping to hear noise that has a discernible pattern, indicating deliberate transmission. Give a listen; you never know what you might hear!

The handheld Trident TR-1200 offers a very wide tuning range and 1000 memory channels.

SPEAKIN' BEACON

A man moved into his newly purchased home in Westminster, Vermont, and started to move out the previous owner's left-behind basement clutter. Some cartons were thrown out, with a few left to go.

The following day, as he was mowing his lawn, he wondered why so many aircraft had begun to circle his country home. The next thing he knew, people wearing combat fatigues and carrying loudly beeping radios were swarming across his property. He said it scared the hell out of him!

It was only then that he learned that the former owner of his new home had been a pilot. The fellow had apparently stored an Emergency Locator Transmitter (ELT) in a carton in the basement. Those small devices are intended to automatically trigger a rescue beacon signal on 121.5 MHz when triggered by the impact of a small-plane crash. Moving the cartons around had turned on the rescue beacon, although pilots are supposed to remove the batteries when the units are not in use.

The ELT signal had caused more than 100 U.S. Air Force, Civil Air Patrol, and other rescuers to look for what they thought was a downed aircraft. They traced the signal to the man's basement with direction finders, then turned it off.

OLDIES, BUT ARE THEY GOODIES?

Many readers write and proudly mention how they use this or that scanner, which they have had in service for many years. This week, letters have come in from readers describing the delights of using trusty and trouble-free sets like the Bearcat 210 and 300.

I'm the first to endorse getting the most from your investment, but there does come a time when you should figure you've gotten your money's worth. In the instance of ancient scanners, that time has passed.

Why? First, older scanners were designed when the 450-MHz band was set up with frequencies in 25-kHz increments. They search, and can be programmed, only in 25-kHz increments. These days, many American communications services using bands above 45 MHz are assigned frequencies in 12.5-kHz increments. Modern scanners are designed to deal with this. So, straight away, an older scanner misses out on much of the action on the popular UHF bands. That also makes older units virtually useless for use with an 800-MHz converter.

Second, older scanners don't use low-loss BNC antenna connectors, which are now the industry standard. Furthermore, they don't scan or search as rapidly, have as many memory channels, or offer other features standard on today's moderately priced scanners. In addition, many circuit advancements have taken place during recent years.

FREQUENCY FINDER

Ron A., of California, writes that he's a "Dead Head." That is to say, he's a big fan of the Grateful Dead and has attended many of their concerts. He hopes that we can supply the frequencies of the handheld radios he sees used by the Dead staff.

From what we could find out, the security personnel are on 469.375 MHz, while the stage crew uses 469.775 MHz. For general operations, monitor 462.4875 MHz. ■

Coil Design and Construction Manual

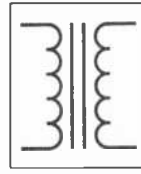

YOU CAN WIND YOUR OWN COILS?

There's no trick to it except knowing what you are doing. In a unique, 106-page book you can become expert in winding RF, IF, audio and power coils, chokes and transformers. Practically every type of coil is discussed and necessary calculations are given with the mathematical data simplified for use by anyone. Get your copy today!

Mail coupon to:

Electronics Technology Today, Inc.
P.O. Box 240 • Massapequa Park, NY 11762-0240

Please send me my copy of *Coil Design and Construction Manual* (BP160). I enclose a check or money order for \$8.45 to cover the book's cost and shipping-and-handling expenses. NY state residents must add local sales tax.

Name _____

Address _____

City _____ State _____ ZIP _____

All orders must be paid in U.S. funds only. Sorry, no orders accepted outside of USA and Canada. Please allow 6-8 weeks for delivery.



In the May, 1995

Popular Electronics®

The editors present an in-depth roundup of products introduced at the Winter Consumer Electronics Show—the sales hub for the industry! Also, they report on the hot topics at CES. Will HDTV ever make it? Will DSS be on-ramp to the entertainment highway? There's much more to be revealed!

Build the "g" Machine — Measure acceleration with this easy-to-build portable project.

Security in the Information Age — Unravel the facts on DES, PGP, the Clipper Chip, and more!

Build a Variometer Radio — A sliding coil receiver that's a blast from the past.

PLUS outstanding columns and departments like Gizmo, Think Tank, DX Listening, Scanner Scene, Computer Bits, Circuit Circus, Multimedia Watch and a whole lot more!

ON SALE

March 16, 1995

Pick up *Popular Electronics* at your favorite Newsstand, Bookstore, Convenience Store or Supermarket

ELECTRONICS LIBRARY

Police Call Radio Guide 1995 Edition

by Gene Hughes

The 32nd edition of this popular frequency guide for scanner users has been revised and updated to include up-to-the-minute listings. By no means limited to police bands, it also lists the frequencies used by paramedics, search and rescue operations, fire departments, railroads, civil defense, hospitals, armed forces, highway patrols, national parks, forest rangers, lifeguards, pilots, and more. A new section contains a glossary of terminology and slang used by law-enforcement officers and firefighters. Public Safety radio systems are ar-

information for scanner enthusiasts of all levels. It explains how to select and set up antenna systems and how to get a license, and discusses radio-wave propagation and the latest scanning technologies. The book also offers an exclusive, consolidated frequency list of both FCC and federal radio-channel assignments.

Nine different versions of the book are available, each covering a different region of the continental United States and Puerto Rico. Volume One, for instance, covers the Northeast, with listings for Maine, Vermont, New Hampshire, Massachusetts, Connecticut, Rhode Island, and New York. Each volume contains approximately 200 to 350 pages.

Each volume of *Police Call Radio Guide, 1995 Edition* costs \$9.99 and is available in electronics retail stores including Radio Shack. For more information, contact Hollins Radio Data, P. O. Box 35002, Los Angeles, CA 90035.

CIRCLE 83 ON FREE INFORMATION CARD

CATALOG OF HIGH-TECH ELECTRONIC KITS

from LNS Technologies

This 20-page catalog offers practical, fun, and easy-to-build electronic kits. Designed so that you learn as you build, each kit includes detailed, illustrated assembly manuals that show you how to identify each part, guide you step-by-step through construction, show the circuit diagrams, explain the theory of operation, and provide a troubleshooting section. If a new or unusual component is used in a project, a copy of the manufacturer's data sheet is included.

The catalog includes kits for building lasers, solid-state re-

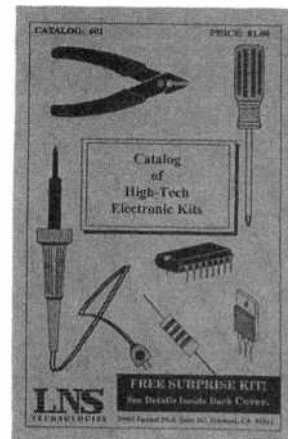

orders, voice changers, gas sensors, motion detectors, microprocessors, and more. New products include a "Super-Secret Spy Microphone." Each project is rated with an assembly skill level.

The *Catalog of High-Tech Electronic Kits* is available for \$1 (refundable with order) from LNS Technologies, 20993 Foothill Blvd., Suite 307P, Hayward, CA 94541-1511.

CIRCLE 84 ON FREE INFORMATION CARD

VCRS & CAMCORDERS FOR DUMMIES

by Gordon McComb & Andy Rathbone

Millions of people use their VCR's only to play back rental movies, because they can't figure out how to make them do anything more complex. They can't get the clock to stop flashing, let alone set a timer to record a time-shifted program. Also, camcorders have created the 1990's equivalent of the dreaded 8-mm home movie of the past—boring material, poor video quality.

This book contains friendly advice to help the technologically impaired get the most from their video gear. It

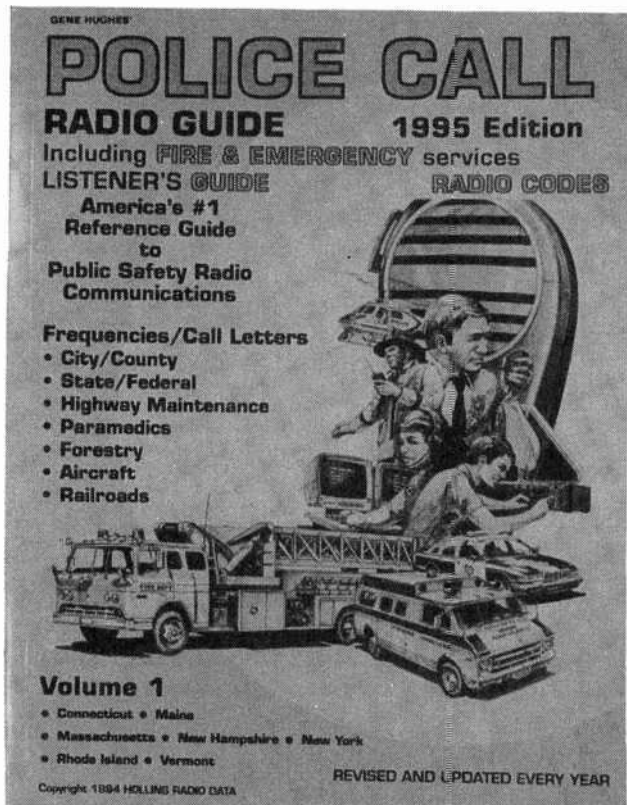

ranged by both user name and by frequency.

The book also contains an illustrated "Listener's Guide Book," which is full of practical

explains how to record one show while watching another; set that blinking VCR clock; connect your TV, VCR, and camcorder; edit home videos; and buy the right camcorder and videotapes. The book also

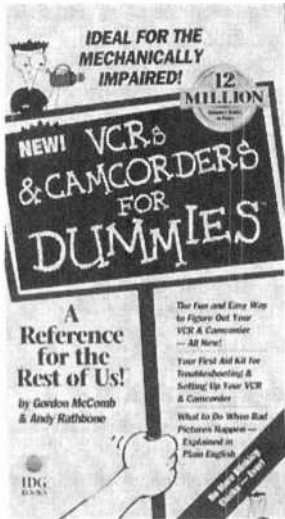

includes fix-it tips for VCR's and, for advanced readers, advice on how to make money using your camcorder.

VCRs and Camcorders for Dummies costs \$19.95 and is published by IDG Books Worldwide, 919 East Hillsdale Blvd., Suite 400, Foster City, CA 94404; Tel. 1-800-762-2974 or 415-312-0650.

CIRCLE 85 ON FREE INFORMATION CARD

THE INTERNET NAVIGATOR: 2nd Edition

by Paul Gilster

Subtitled "The Essential Guide to Network Exploration for the Individual Dial-Up User," this book helps individual users to steer through the sea of cyberspace. Because the Inter-

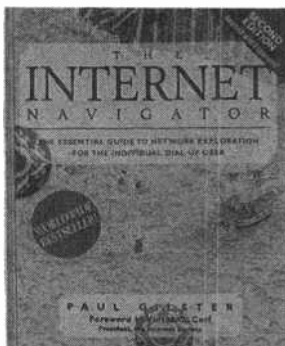

net grows and changes so rapidly, the second edition contains nearly 40% new material, allowing users to set a quick and efficient course for online exploration.

The book contains new and/or updated information on several subjects. Its coverage of E-mail now includes the entire range of commands for the pine program. It explains new search options for finding people on the Internet, and lists service providers, including an expanded appendix with domestic and international information. The book also explains how USENET and "killfiles" can be used to delete unwanted files; and discusses FTP, ncftp, and the unique problems faced by DELPHI users when using the FTP command.

The Internet Navigator, 2nd Edition, costs \$24.95 and is published by John Wiley & Sons, Inc., 605 Third Avenue, New York, NY 10158-0012; Tel. 1-800-CALL-WILEY.

CIRCLE 87 ON FREE INFORMATION CARD

COMMUNICATIONS LICENSING AND CERTIFICATIONS EXAMINATIONS: The Complete TAB Reference

by Sam Wilson and Joseph A. Risse

This comprehensive study guide provides electronics technicians with all the expert advice and information they need to pass the various examinations given by the FCC and other sponsoring organizations. It gives readers the edge they need to pass the tests for IS-CET certification, Global Marine Distress and Safety Service, General Radio Operator License, Radar Endorsement, Amateur Radio Technical Class License, Marine Radio Operator Permit, National Association of Radio and Telecommunications Engineers certification, Electronics Technicians Association (ETA) Journeyman Communications certification, and FCC Radio and Aircraft License.

The book includes important information on AC and DC circuits and components, UHF and microwave systems, anten-

Want To Be A Partner In A Group That Has A Multi-Billion Dollar Surplus Each Year?

You Are.

If you're one of the 133 million working Americans and 6 million employers who contribute to Social Security each year, you're already a partner in a group with a multi-billion dollar surplus. Social Security was designed to provide every working member of society with a foundation for retirement. In addition, you get disability insurance and survivor benefits for your family. It's a partnership you can rely on. Learn more about *your* benefits. Write: Dept. 37, Pueblo, Colorado 81009.



Department of Health and Human Services

COMMUNICATIONS LICENSING AND CERTIFICATION EXAMINATIONS THE COMPLETE TAB REFERENCE

Sam Wilson and Joseph A. Rose

FCC
ISCEET
ETA

nas, television systems, power equipment, transmitters and receivers, digital basics, television systems, electronic circuits and components, and many other topics. It also offers helpful chapters on tests, measurements, troubleshooting, and the mathematics of communications. Each topic is followed by a quiz; answers and explanations appear in the back of the book.

A companion book titled *Practice Tests for Communications Licenses and Certification Programs: The Complete TAB Reference* is also available. Together, the two books provide an overall review of the materials needed for passing required tests for the licenses and certifications mentioned above.

Communications Licensing and Certification Examinations: The Complete TAB Reference costs \$29.95; *Practice Tests for Communications and Certification Examinations* costs \$24.95. Both are published by Tab Books Inc., Blue Ridge Summit, PA 17294-0850; Tel. 1-800-233-1128.

CIRCLE 98 ON FREE INFORMATION CARD

CONSUMER-ELECTRONIC REPAIR PARTS & ACCESSORIES CATALOG

from MCM Electronics

With more than 21,000 items and numerous name brands to choose from, this catalog is a valuable resource for service technicians and electronic enthusiasts. It contains more than 2600 new items, including project accessories; semi-conductors; connectors; test

equipment; computer products; and audio-, video-, and appliance-repair parts. The catalog is MCM's first to offer Nady microphones, Perma-Seal heat-sealable nylon splices, Gemline appliance-repair parts, and the new line of Eveready products.

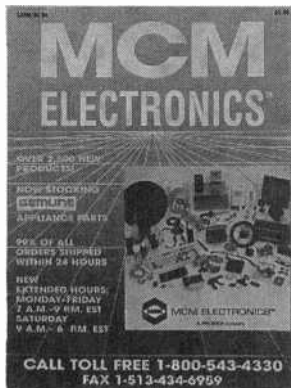

The Consumer-Electronic Repair Parts & Accessories Catalog (number 34) is free upon request from MCM Electronics, 650 Congress Park Drive, Centerville, OH 45459-4072; Tel. 1-800-543-4330.

CIRCLE 97 ON FREE INFORMATION CARD

COMMUNICATIONS CATALOG: 1995 PREVIEW EDITION

from Universal Radio Inc.

Aimed at amateur-radio enthusiasts, hobbyists, and communications professionals, this 100-page catalog introduces the latest in equipment from major manufacturers including Grundig, Sony, Yaesu, Panasonic, Icom, Kenwood, Drake, and many more. Product categories include communications receivers, headphones, portable receivers, scanners,



shortwave and scanner antennas, marine radios, amateur transceivers, equipment-protection devices, antenna switches, audio filters, logging supplies, Morse-code accessories, study materials, books, computer interfaces, radioteletype readers and decoders, cable and wire, and frequency counters. The catalog also contains informative essays on shortwave, radioteletype, and amateur radio.

Communications Catalog: 1995 Preview Edition is available for \$2 from Universal Radio Inc., 6830 Americana Parkway, Reynoldsburg, OH 43068-4113; Tel. 1-800-431-3939; Fax: 614-866-2339.

CIRCLE 86 ON FREE INFORMATION CARD

CONSTRUCTOR'S HARDWARE FOR THE 90'S

from Sescum, Inc.

This catalog features an extensive selection of innovative electronics packaging systems for the hobbyist and professional electronics-project builders. It includes blank rack panels, components, RF-shielded steel boxes, heavy- and standard-duty boxes, cabinets, punches, hardware, and more.

With the addition of the "Rackem'n'Stackem" and "Box-

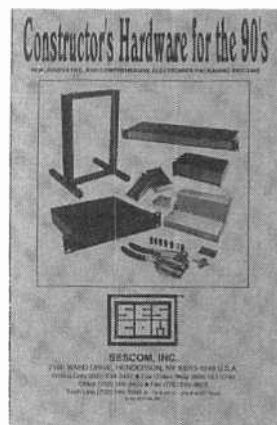

em'n'Stackem" product lines, the catalog has doubled in size to almost 50 pages. The Rackem'n'Stackem series is a complete selection of boxes, mounting hardware, mini table-top racks, wall-mounted racks,

and power supplies for a complete solution to your packaging problems. The Box-It System was designed for quick assembly of a project. Virtually every possible rear and front panel is available pre-punched, so that assembly becomes a simple job of mounting the parts and wiring the circuit to the panels.

Constructor's Hardware for the 90's is available from Sescum, Inc., 2100 Ward Drive, Henderson, NV 89015-4249; Tel. 1-800-634-3457 (orders only) or 702-565-3400; Fax: 1-800-551-2749 (orders only) or 702-565-4828.

CIRCLE 88 ON FREE INFORMATION CARD

PROGRAMMABLE LOGIC CONTROLLERS: Principles and Applications, Third Edition

by John W. Webb and Ronald A. Reis

Intended for use in any technician-level first course in programmable logic controllers (PLCs), this practical introduction to the subject combines comprehensive, accessible coverage with a wealth of industry examples. It offers students a broad-based foundation that will serve them well on the job.

Every aspect of controller usage is covered in clear, jargon-free language, with an emphasis on applications. The book opens with an examination of basic layout and programming and progresses through fundamental, intermediate, and advanced functions. Students are actually programming by Chapter 5. Applications for each PLC function are discussed, and examples and problems help students achieve an understanding of PLCs and the experience needed to use them. New to the third edition are chapters on buying your first PLC and on alternate programming languages.

Programmable Logic Controllers: Principles and Applications, Third Edition costs \$50.00 and is published by Prentice Hall, Englewood Cliffs, NJ 07632; Tel. 800-947-7700.

CIRCLE 89 ON FREE INFORMATION CARD

NEW PRODUCTS

Personal LCD Color TV

According to *Marantz*, the four-inch Thin Film Transistor (TFT), active-matrix color screen on its *Model LCD-410* LCD TV displays an astoundingly bright, crisp, and clear picture. Designed for on-the-go viewing, the LCD color television weighs just 13 ounces and is only one-inch thick when closed. The high-contrast picture can easily be viewed from several feet away, making it possible for more than one person to enjoy a program.

The LCD-410 is equipped with audio/video inputs and outputs for easy connection to a VCR or laserdisc player, and



even allows viewing in two widescreen modes (16:9 and 21:9) as well as the standard 4:3 aspect ratio. Camcorder users can playback their home videos immediately on the LCD TV. A built-in screen-flipping feature allows the user to turn the screen image upside down at the push of a button. Through its external A/V input, the LCD-410 is compatible with the

European PAL video standard, as well as the U.S. NTSC standard, making it ideal for travelers abroad who want to watch TV or record with a PAL camcorder or VCR. The portable LCD TV features a 69-channel VHF/UHF broadcast TV tuner and a built-in AM/FM radio tuner.

The LCD-410 LCD color TV, complete with a detachable battery pack that accepts six "AA" batteries, has a suggested retail price of \$799. For more information, contact Marantz America, Inc., 440 Medinah Road, Roselle, IL 60172; Tel. 708-299-4000; Fax: 708-299-4005.

CIRCLE 100 ON FREE INFORMATION CARD

HANDHELD VIDEO/AUDIO GENERATOR

Compuvideo's PocketGen handheld, battery-operated video/audio generator is designed for use in editing studios, TV broadcast studios and field operations, post-production, and video service. Offered in NTSC or PAL models, the device runs for more than 40 hours on four "AA" batteries, or can be used with the included AC adaptor. It can be used for recording SMPTE color bars with tone at the beginning of a tape and is switchable to black burst for blanking tapes. The *PocketGen* will also genlock video equipment through the use of a black burst. It provides ten patterns

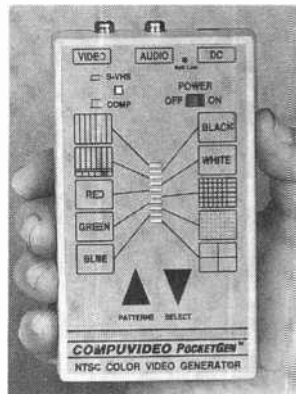

including full field bars; SMPTE bars; crosshatch; dots; center cross; and red, green, blue, white, and black rasters.

Prices for the *PocketGen* handheld video/audio generator start at \$399. For additional information, contact Compuvideo Inc., 3861 Oceanview Avenue, Brooklyn, NY 11224; Tel. 718-714-9873; Fax: 718-265-0234.

CIRCLE 101 ON FREE INFORMATION CARD

ELECTROMAGNETIC FIELD METER

Amprobe's Model PY-17 FieldProbe is a portable, handheld instrument specifically designed and calibrated to measure low-level (60-Hz) electromagnetic field (EMF) radiation generated by transformers, high-voltage power lines, televisions, circuit-breaker panels, electrical appliances, and computers. By simply pointing it at an object, the *FieldProbe*

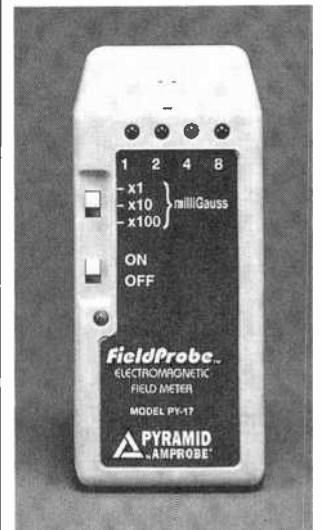

instantaneously displays EMF levels to determine if there is a potential health hazard. The rugged, compact meter allows one-handed measurement of EMF from 1 to 800 milliGauss.

The *Model PY-17 FieldProbe* EMF meter carries a trade price of \$29.95. For further informa-

tion, contact Amprobe Instruments, 630 Merrick Road, Lynbrook, NY 11563; Tel. 516-593-5600; Fax: 516-593-5682.

CIRCLE 102 ON FREE INFORMATION CARD

MULTIPLE-PC SWITCH

The *OmniView* "super switch" from *Belkin Components* allows a user to control up to six PC's from a single monitor, keyboard, and mouse. It uses standard cables that plug into any PC keyboard, requires no software installation or changes to a user's regular PC setup, and can be cascaded to provide control of up to 216 personal computers. It offers many of the advantages of networks without the expense.

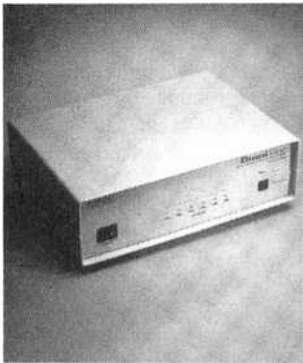

The keyboard-controlled switch is intended for system administrators, LAN's with multiple file servers, computer rooms, test labs, trade-show demonstrations, and similar applications. When the user boots each PC, the *OmniView* automatically sends the correct signals to the keyboard and mouse port so that each PC acts as if the keyboard and mouse are connected directly to it. That feature prevents PC's from aborting the boot sequence due to a keyboard error—a common problem with keyboard switches that fail to send those signals.

Once all the PC's are booted, the user can select the PC he or she wants to control and view, either by using a push-button on the switch or a simple hotkey sequence. The hotkey sequence works with all popular operating systems. The *OmniView* supports AT-style and PS/2 keyboards, serial mice,

and SVGA, VGA, and Multi-synch monitors.

The *OmniView* switch has a suggested list price of \$349. For more information, contact *Belkin Components*, 1303 Walnut Park Way, Compton, CA 90220; Tel. 310-898-1100; Fax: 310-898-1111.

CIRCLE 103 ON FREE INFORMATION CARD

DMM FIELDPACK

Fieldpiece Instruments developed the *LT16 Fieldpack* to provide service technicians with a low-cost, versatile, all-in-one meter kit. A zippered case contains the *LT16* digital multimeter; a pair of deluxe test leads with sleeved, male banana plugs on the end and female banana plugs built into the handle; a yellow lead with an alligator clip; two short probe tips; and a current clamp.

Phase rotation makes the *LT16* meter unique; it tells how to connect a three-phase motor so that it rotates in the right direction, and allows a technician to determine the rotation direction of a motor before it is turned on. The *DMM* can also be used to measure start and run capacitors to determine if only the capacitor need be replaced instead of the whole motor; measure AC and DC volts, ohms, and AC and DC amps; indicate continuity with a beep; and test power semicon-



ductors for catastrophic failure. With the included current clamp, a technician can also measure AC current up to 300 A with resolution to 0.1 A. Because the meter has the 200 mV range, he can measure relative humidity to 0.1% and temperature to 0.1°F with optional *Fieldpiece* accessories.

All accessories are modular, with all connections made using standard banana plugs and

jacks. For hard-to-reach test points, the standard probe tips can be replaced with optional long probe tips. Test leads can be daisy-chained to form extra-long test leads.

The *LT16 Fieldpack* costs \$99. For more information, contact *Fieldpiece Instruments*, 231 East Imperial Highway, Suite 250, Fullerton, CA 92635; Tel. 714-992-1239; Fax: 714-992-6541.

CIRCLE 104 ON FREE INFORMATION CARD

SKYLOG PERIODIC ANTENNA

Aimed at hams who would like to have a single antenna that covers 10 meters through 20 meters (actually 13.5 through 32 MHz), the *Cushcraft ASL-2010 Skylog* is a high-gain, five-band, easy-to-install, log periodic an-

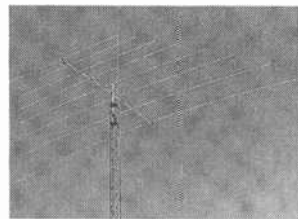

tenna. It eliminates the need for two Yagis to cover the traditional bands and 12 and 17 meters, and uses a single feed line (balun included), so there is no need to switch antennas when changing bands. Because the *Skylog* does not use traps of any kind, the wind load is significantly reduced. The antenna is not power limited and will easily operate continuously at full legal limit. Gain is 6.4 dBd.

The *Skylog* antenna features 6063-T832 aluminum tubular elements and boom. The boom is 18 feet long, and the longest of the eight elements is 38 feet long. The brackets and mounting plates are also aluminum, and all u-bolts and worm clamps are made entirely of stainless steel.

The *ASL-2010 Skylog* log periodic antenna has a list price of \$800. For additional information, contact *Cushcraft Corporation*, P. O. Box 2680, Manchester, NH 03108; Tel. 603-627-7877; Fax: 603-627-1764.

CIRCLE 105 ON FREE INFORMATION CARD

MACINTOSH SERIAL CONVERTERS

B&B Electronics' Models 232MAC and *485MAC* are Macintosh-based serial converters. The *232MAC* converts a Macintosh printer or modem port into a standard RS-232 port for communicating with modems, serial printers, and other devices that use the RS-232 standard. Instead of just adapting the Macintosh mini-DIN connector to the DB25 connector, the *232MAC* also is an active device that uses RS-232 driver/receiver IC's to fully comply with the RS-232 standard.



The device has a DB25 male connector for the RS-232 connection and supports transmit-and-receive data, request to send, clear to send, and carrier detect.

The *485MAC* allows a Macintosh printer or modem port to connect directly to RS-422 equipment or to a multidrop RS-485 system. Transmit-and-receive data are converted from the Mac serial port to a balanced differential signal that fully complies with the RS-485 standard. The RS-485 side of the converter brings out the transmit lines and receive lines on screw-down terminal blocks for easy connection to RS-422/485 two-wire or four-wire systems.

Each converter requires 12-volts DC at about 100 mA, includes a six-foot cable for connection to a Macintosh, and costs \$74.95. Optional power supplies, available for each model, cost \$14.95.

For more information, contact *B&B Electronics Manufacturing Company*, 707 Dayton Road, Ottawa, IL 61350; Tel. 815-434-0846 (8:00-4:30 CST); Fax: 815-434-7094 (24-hour); BBS: 815-434-2927 (24-hour).

CIRCLE 106 ON FREE INFORMATION CARD

HAM RADIO

(Continued from page 79)

though the supply voltage ranges from +9 to +18 volts (a situation found in automotive applications).

An alternative voltage-regulated configuration is shown in Fig. 4. That circuit uses a three-terminal IC voltage regulator to provide V+ voltage to the NE-602. Because the NE-602 is a very-low-current-drain device, the lower-power versions of the regulators (e.g. 78Lxx) can be used. The low-power versions also permit the NE-602 to have its own regulated power supply, even though the rest of the radio receiver uses a common DC power supply. Input voltages of +9- to more than +28-volts DC, depending on the regulator device selected, can be used for that purpose. The circuit of Fig. 4 uses a 78L09 to provide +9 volts to the NE-602, although both the 78L05 and 78L06 can also be used to good effect.

In the United States, NE-602 devices can be ordered from JDR Micro-devices (1850 South 10th Street, San Jose, CA 95112-4108; Tel. 800-538-5000). That company has two catalogs: one is for personal-computer products (boards, peripherals, etc.), while the other is for electronic components. Ask for the components catalog if you want a good small-parts catalog.

The NE-602AN, plus more-advanced devices such as the NE-604 and NE-612, can be mail-ordered using U.S. credit cards from sources in the UK such as Viewcom Electronics (77 Upperton Road West, Plaistow, London, E13 9LT, England; Tel. 011 44 081-471-9338).

CIRCUIT CIRCUS

(Continued from page 70)

inverting hex buffer, U1, are connected in a very-low-frequency oscillator circuit. The output at pin 2 of the inverter U1-b drives the remaining inverter stages; the output of inverter U1-c drives the gate of the FET transistor, which in turn operates the turn-signal lamps. Also, the oscillator's output at pin 2 drives the three remaining inverters, which flash the turn-signal indicator LED.

The directional switch, S1, is a center-off switch; when the switch is in the center position, no power reaches the circuitry. When S1 is switched to either the left or right position, power for the oscillator circuit passes

PARTS LIST FOR THE TURN-SIGNAL SYSTEM (Fig. 6)

SEMICONDUCTORS

U1—4049 hex inverting buffer, integrated circuit
D1, D2—1N4002 silicon diode
Q1—IRF511 FET transistor
LED1—Light-emitting diode

RESISTORS

(All fixed resistors are 1/4-watt, 5% units.)
R1—10,000-ohm
R2—220-ohm
R3—250,000-ohm, potentiometer

CAPACITORS

C1—0.1- μ F, ceramic-disc
C2—4.7- μ F, 25-WVDC, electrolytic

ADDITIONAL PARTS AND MATERIALS

S1—SPDT, center-off switch (see text)
Wire, solder, IC socket, etc.

through either D1 or D2, and the power for the turn-signal lamps flows through the switch contacts.

The flashing rate of the

lamps is set by R3. Again, the IRF511 FET (Q1) can only handle up to 4 amps. If more current is needed, use an IRF530. ■

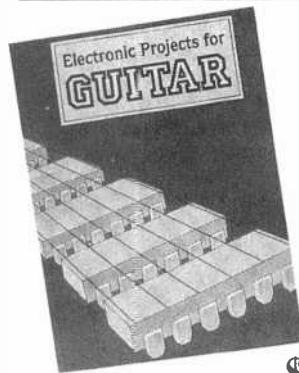

Whether you wish to save money, boldly go where no guitarist has gone before or simply have fun building electronic gadgets designed for your musical pleasure, then read

Electronic Projects for GUITAR

Some of the add-on guitar gadgets you can build are:

Preamplifier • Headphone Amplifier • Soft Distortion Effects Unit • Compressor • Auto-waa • Waa-waa Pedal • Phaser • Dual Tracking Effects • Distortion Unit • Expander • Dynamic Treble Booster • Direct Injection Box • Dynamic Tremelo • Thin Distortion Unit • and Guitar Tuner.

Anyone with some previous electronic project building experience should have no problem assembling the projects.

ELECTRONICS TECHNOLOGY TODAY INC.
P.O. Box 240, Massapequa Park, NY 11762-0240

Yes, send my copy of ELECTRONIC PROJECTS FOR GUITAR by RA Penfold to the address at right. I am enclosing \$12.95 plus \$2.95 for shipping charges in USA and Canada. All payments must be made in US funds. Sorry, no orders accepted outside of USA and Canada. New York State residents add local sales tax. Allow 6-8 weeks for delivery.

Check enclosed.

Please charge my Visa MasterCard

Signature _____

Account No. _____ Expir. Date _____

Name _____

Address _____

City _____ State _____ ZIP _____

GET THE LATEST ADVANCES IN ELECTRONICS

SUBSCRIBE TO—

Electronics NOW



ENJOY THE WORLD OF ELECTRONICS EACH MONTH!

Subscribe to the best informed electronics magazine—the one that brings you the latest high-tech construction projects, feature articles on new technology, practical troubleshooting techniques, circuit design fundamentals, and much more.

Electronics Now looks to the future and shows you what new video, audio and computer products are on the horizon. You'll find helpful, monthly departments such as Video News, Equipment Reports, Hardware Hacker, Audio Update, Drawing Board, Computer Connections, New Products, and more. All designed to give you instruction, tips, and fun.

Electronics Now gives you exciting articles like:

- Buyer's Guide to Digital Oscilloscopes
- Build A Scanner Converter
- Single-Chip Voice Recorder
- Build A MIDI Interface for your PC
- Troubleshoot Microprocessor Circuits
- Build A High-Power Amplifier for your Car
- Add Music On Hold to your Phone
- All About Binaural Recording
- VGA-to-NTSC Converter



FOR FAST SERVICE CALL OUR TOLL-FREE NUMBER!

1-800-999-7139

DON'T DELAY — SUBSCRIBE TODAY!

If you prefer, just fill out the order card in this magazine and mail it in today.

BURIED BYTES

(Continued from page 42)

educational, security, and many other products.

Big Blue and its Legendary PC.

IBM, as the top mainframe outfit, probably didn't want to create anything that might threaten its "big-computer" business. Therefore, it's questionable just how much effort Big Blue really put into developing a PC in 1974, when it produced the \$10,000 IBM 5100 desktop and, later, the IBM 5500. Both never went anywhere.

In August 1981, however, IBM, the biggest computer manufacturer, introduced a desktop computer. That lent legitimacy to the concept of the PC, even if IBM wasn't fully committed to its own project and never fully grasped its true significance.

The original 1981 IBM PC used the 8088 CPU—a 16-bit processor in an 8-bit body (because it used a less-technically attractive, 8-bit data bus). The PC came with 64K RAM, one or two 160K floppy-disk drives, and no hard disk; PC-DOS Version 1 didn't support hard disks of any size. That was a big problem, so the IBM PC-XT came out in 1983 with the same 8088 CPU but with 128K RAM, a 360K floppy, and a 10-MB hard disk.

Graphics were optional; the early PC came from the factory only able to display text. Color graphics awaited the development of IBM's Color Graphics Adapter (CGA). In 1984, IBM introduced the then-revolutionary IBM AT (Advanced Technology) PC that used the true 16-bit 80286 CPU. The 80286 was considerably faster and more capable than the 8088.

Many industry observers maintain that IBM has never known what to do with its "little" computers, and much has been written about IBM not properly marketing its own PC's ever since their 1981 introduction. Sadly, IBM's history in the PC business has been marked by failed approaches that focused too heavily on solving its own problems rather than meeting users' needs. Also, IBM let the myriad XT- and AT-clone makers, and the makers of peripheral devices and expansion boards, walk away with most of the hardware profits that might have been IBM's. ■

One of IBM's biggest failures was its PCjr—a small, stripped-down computer that is remembered today for its spongy, "chiclet-style" keyboard that almost no one liked. The original 1983 model was priced at \$669 and didn't sell. IBM was forced to work off its inventory any way it could, and eventually sold the juniors to its own employees for less than cost. IBM's PCjr fiasco brought into serious question whether or not there really was a home-computer market at all.

The company has recently been through some wrenching times. Tens of thousands of IBM employees have lost their jobs and countless investors have seen their stakes shrink. IBM's own market share of PC sales is quite small today as it tries to adapt itself to radically new ways of doing computer business. Only the passage of time will tell if IBM reinvents itself.

Giving Thanks Where It's Due. We owe a great deal to IBM and its PC. Thanks to IBM's initial decisions and the ability of clone makers to legally reverse-engineer IBM's Basic Input/Output System (BIOS) technology (IBM's BIOS chips themselves were, of course, not for sale), most PC's today are open-architecture systems that help minimize hardware obsolescence and make troubleshooting straightforward.

Before the IBM PC's debut in 1981, the popular machines of the day—such as the Apple, Tandy TRS-80, Commodore PET, and most others—were largely proprietary, closed systems in which users were locked into buying parts, upgrades, software, and service from the original equipment manufacturer (OEM). Even the external screws on some computers carried dire warnings about users even opening their boxes, much less servicing them. Now you pop your PC's lid without fear. You need have little worry about voiding your warranty, and for that we must thank Big Blue.

Today's personal computer is several hundred times faster than ENIAC, about 3000 times lighter, and millions of dollars cheaper. In rapid succession, computers have shrunk from room-size to tabletop to laptop, and finally to palm size. Personal computers have come a long way since the 1970's, and the PC revolution is still nowhere near complete. ■

Bill Nave
saved these
kids from
drowning.



He's not a
lifeguard— he's a
teacher. But to the
kids he's reached,
he's a hero.

**BE A TEACHER.
BE A HERO.**

Call
1-800-45-TEACH.

Ad Council
A Public Service of
This Publication

Photo: Robin Sachs

Reach for the Power
TEACH
RECRUITING NEW TEACHERS, INC.

April 1995, Popular Electronics

89

Electronics Paperback Books



BP88—How to Use OpAmps...\$5.95. A designer's guide that covers operational amplifiers. Serving as both a source book of circuits and a reference book for design calculations. The text is non-mathematical and easy to understand by most readers.



BP113—30 Solderless Breadboard Projects-Book 2...\$5.95. Numerous hobbyist projects of useful gadgets and circuits using "Verobloc" breadboards. All the breadboard projects in this book are based on CMOS logic integrated circuits.



BP177—Introduction to Computer Communications...\$5.95. Details on types of modems and their suitability for specific application, plus details of connecting various computers to modems, and modems to the telephone system.



BP276—Shortwave Superhet Receiver Construction...\$6.95. Provides construction details, including coil winding, of a number of advanced-design receivers which should have performance levels at least equal to commercial sets of similar complexity.



BP61—Beginners Guide to Digital Techniques...\$5.00. Covers the basics of digital techniques—decimal, binary, octal and hexadecimal numbering systems are covered plus insights on weighted and non-weighted binary-coded-decimal codes and alpha-numeric codes. The basic building blocks of circuit logic, the common AND, OR, NAND, NOR and EXCLUSIVE-OR gates and bi-stables, are thoroughly covered.



BP285—A Beginners Guide to Modern Electronic Components...\$6.50. It is easy for newcomers to electronics to become confused. There are a great many different types of components available often with numerous variations of each type. This book presents the reader with a vast amount of invaluable parts information to enable the right component to be selected every time for repairs and projects.



PCP103—Practical MIDI Handbook...\$9.95. The Musical Instrument Digital Interface (MIDI) is surrounded by a great deal of misunderstanding. This book is aimed at musicians and technicians who want to explore the vast capabilities of MIDI. It covers MIDI-based equipment you can use: keyboards, drum machines, sequencers, effects units, mixers, drum pads guitars. There's also a section on computer music.



BP90—Audio Projects...\$5.50. Details the construction of preamplifiers and mixers, power amplifiers, tone controls and matching projects. All projects are fairly simple to build and include a number of board layouts and wiring diagrams.



BP121—How to Design and Make Your Own PCBs...\$5.75. Simple methods for copying printed-circuit board designs from magazines and books on to copper. Covers all aspects of simple PCB construction as comprehensively as possible.



BP44—IC 555 Projects...\$5.95. Every so often a device appears that is so useful that one wonders how life went on before without it. The 555 timer integrated-circuit chip is one such device. Included are basic and general circuits used by most hobbyists.

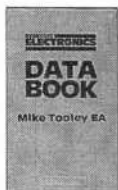

PCP109—Everyday Electronics Data Book...\$10.00. An invaluable source of electronics information—the text contains sections that deal with the underlying theory of electronic circuits and a wide range of practical electronic uses for everyone.



BP60—Practical Construction of Pre-Amps, Tone Controls, Filters and Attenuators...\$5.50. The book offers practical designs and details thereby enabling the project-builder enthusiast to construct, with the minimum of difficulty and expense, various audio pre-amplifier and tone control circuits, etc., which may be used with home-constructed audio equipment or even complex commercial gear.



BP297—Loudspeakers for Musicians...\$6.25. Contains all the information that a working musician needs to know about loudspeakers; the different types, how they work, the most suitable for different instruments, for cabaret work, and for vocals. It gives tips on constructing cabinets, wiring up, available fittings, finishing and how to connect multi-speaker arrays, etc. Includes ten enclosure designs with plans.



PCP110—Electronic Power Supply Handbook...\$10.95. All types of power supplies used for electronics purposes are covered in detail, starting with cells and batteries and extending by way of rectified supplies and linear stabilizers to modern switch-mode systems, IC switch-mode regulators, DC-converters and inverters. The devices, their operating principles and typical circuits, are dealt with in detail.



BP254—From Atoms to Amperes...\$6.50. Explains in crystal-clear terms the fundamentals behind the whole of electricity and electronics. Really helps you to understand the basis of the complex subject perhaps for the first time ever.



PCP101—Practical Digital Electronics Handbook...\$9.95. An introduction to digital circuits, logic gates, bi-stables, timers, micro-processors, memory and I/O devices. A special feature of the book is the section on digital test gear projects.



BP315—Introduction to the Electromagnetic Wave...\$5.95. A fundamental and easy-to-understand approach to a complicated theory topic. The beginner requires no more than elementary mathematics and basic knowledge of electronics.



#228—Essential Theory for the Hobbyist...\$5.25. Supplies to the hobbyist background knowledge tailored to the specific requirements of their activities. Relevant material is presented in a readable manner with a minimum of mathematics.

TEST EQUIPMENT SPECIALS

- BP239—Getting the Most from Your Multimeter...\$5.95**
Covers analog and digital gear, component and gear testing.
- BP267—How to Use Oscilloscopes & Other Test Equipment...\$6.95**
Get with the next step to proficient troubleshooting.
- PCP111—Electronic Test Equipment Handbook...\$13.95**
The all-inclusive text covering test gear you'll use!

SUBSTITUTION GUIDES FOR HOBBYISTS

- BP85—International Transistor Equivalents Guide...\$7.50**
The ultimate guide to replacing foreign and domestic transistors.
- BP108—International Diode Equivalents Guide...\$5.95**
Rectifiers, Zeners, LEDs, OCIs, diacs, triacs...all hobby types.
- BP140—Digital Equivalents and Pin Connectors...\$12.50**
A master reference for builders who design projects.

ELECTRONIC TECHNOLOGY TODAY INC.
P.O. BOX 240, Massapequa, NY 11762-0240

Name _____
Address _____
City _____ State _____ Zip _____
PE1

SHIPPING CHARGES IN USA AND CANADA	
\$0.01 to \$5.00	\$1.50
\$5.01 to \$10.00	\$2.50
\$10.01 to 20.00	\$3.50
\$20.01 to 30.00	\$4.50
\$30.01 to 40.00	\$5.50
\$40.01 to 50.00	\$6.50
\$50.01 and above	\$8.00

SORRY No orders accepted outside of USA & Canada

Total price of merchandise	\$ _____
Shipping (see chart)	\$ _____
Subtotal	\$ _____
Sales Tax (NYS only)	\$ _____
Total Enclosed	\$ _____

Number of books ordered

All payments must be in U.S. funds!

COMPUTER UPGRADES

(Continued from page 51)

Our newer motherboard has sockets that can support a secondary cache of either 128K or 512K of 20-nanosecond SRAM (static random-access memory) in five DIP (dual inline package) IC sockets. The sockets can accommodate two different-sized DIP's; either five standard-width 28-pin 32K × 8 chips to make up a 128-kilobyte cache or five wide 32-pin 128K × 8 chips to make up a 512-kilobyte cache. Your motherboard probably uses different types of memory IC's than ours, so be sure of what you have to install and how to do it before you start.

We installed five 28-pin 32K × 8 SRAM chips for a 128K secondary memory cache. Those DIP IC's plug into the sockets like any other DIP IC's. They are very sensitive to static electricity, and so the same handling precautions we discussed for the SIMM should be observed with the secondary-cache chips.

Unlike the SIMM upgrade, upon boot-up, the secondary cache is noticed and immediately made use of. No setup information had to be changed. Note that not all motherboards have the same kind of secondary cache parameters as this one, and some can't be upgraded.

For example, our older motherboard has a 64K secondary cache consisting of eight 8K × 8 SRAM DIP's. Those can be replaced with 32K × 8 chips for a maximum 256K cache. Changes made to the cache require that changes also be made to some DIP-switch settings on the motherboard. The secondary cache upgrade is not difficult on either of the PC's we have, and you should find the procedures to be similar for yours.

Video DRAM. A video-controller chip uses external memory much like the CPU does, but to store picture information. The larger the picture and the more colors, the more video DRAM (dynamic random-access memory) is needed to display it.

Our Cirrus Logic GD5428 32-bit video controller can display up to 16.8-million colors, given enough video memory. Unfortunately, with only the 1 megabyte of DRAM installed, it can't;

the number of colors it can display varies by window size, but it is limited to a maximum of only 65,000 colors. Of course, most software can get by with only 256 colors, and that also cuts down on the amount of computing power wasted on displaying colors. But for some applications, such as photographic work, 16.8-million colors are required.

Our motherboard has sockets for adding another megabyte of video DRAM using two ZIP (zig-zag inline package) IC's. The ZIP IC's must be installed with the proper polarity (a notch indicates pin 1), and must also be handled carefully with regard to static electricity. Upon boot-up, our video controller recognizes how much memory it has to work with and doesn't concern us about it. The upgrade allows it to display up to 16.8 million colors in a 640 × 480 window.

Many video cards don't allow for memory expansion. If you are in such a predicament, and need to display more colors than your present video card will allow, you have no choice but to replace the card. For example, our 3-year-old PC came with a 16-bit ATI Graphics Ultra accelerator card. That high-end card (for its day) has 1 megabyte of expensive, fast video RAM (VRAM) permanently installed, yet it can display a maximum of only 256 colors and memory cannot be added. The only way to display more colors would be to replace that card.

That completes our three memory upgrades. Our PC is now a lot more capable, and runs Windows faster, too. If you would like to squeeze a little more performance out of your PC, those upgrades are relatively inexpensive, and easy to do.

In the next installment of this occasional series, we will show you how to install and/or upgrade both hard- and floppy-disk drives. Watch for it! ■

COMPUTER SERVICING COURSE

The information presented in this article comes, in part, from Heathkit's *Personal Computer Servicing Course*. That \$2495 course includes the 486 SX25 PC trainer, full documentation, software, tools, books, upgrade parts, and more. Contact Heathkit (The Heath Company, Benton Harbor, MI 49022, Tel. 800-253-0570) directly for more information. ■

VACUUM-TUBE RAM

(Continued from page 52)

voltage version of the 12AT7 or ECC81 dual triode, serves as a switching element in this circuit. The triodes are connected so that if one of them is in cutoff, the other goes to saturation, and vice versa.

At power-up, there is a battle of wills between the two triodes, and the circuit starts up in a random state. But

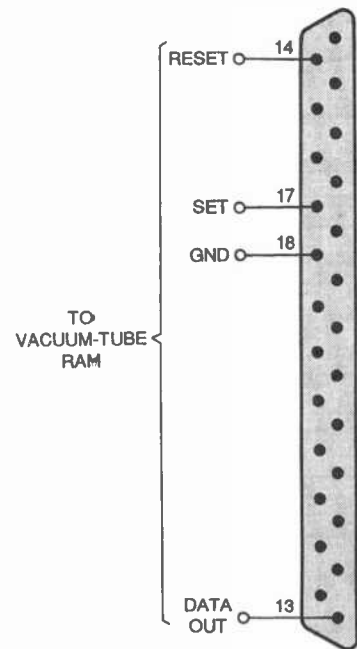

Fig. 2. If, for some reason, you chose to build the circuit, this diagram shows how it should be interfaced to your PC's parallel port.

then the computer intervenes and grounds one or the other grid via switching MOSFET's Q1 and Q2. That turns one triode off and the other one on, and they remain in that state until the computer intervenes again. For output, it is necessary to translate the plate voltages (about 6.5 and 10.5 volts) back to TTL levels. That's done by IC1, an LM311 comparator with open-collector output.

Figure 2 shows how to connect the 1-bit RAM to your computer's parallel port, and Listing 1 shows the interface software. If you actually build the circuit (recommended only on April 1), it is best to interface it to your computer only via a conventional printer port that uses TTL IC's. ■

AUDIBLE LEVEL

(Continued from page 55)

1/2 a degree. To agree with that, the sensor in the Audible Level should be made as insensitive as possible. Just enough infrared should be received to switch on phototransistors Q1 and Q2. There are two ways to accomplish that: adjust the current supplied to the emitter, or move the printed-circuit board toward or away from the alcohol-filled vial. To increase the emitter power, reduce the value of resistors R1 and R5 by an equal proportion. Because the sensitivity of phototransistors varies, either one or the other of the procedures might be necessary.

The continuous tone might be produced at an angle other than the horizontal. That erroneous angle will be thirty degrees or more off level, making it no more than an aesthetic irritant. But if you wish, the error can be cured by a combination of procedures. First of all, you can widen the distance between the phototransistors. If that doesn't work, and if the infrared LED you are using is a narrow-

beam type, try modifying the LED by either flattening its end or frosting its surface with sandpaper.

The alcohol-filled vial used in the author's prototype was cut out of a small two-way level used in leveling hi-fi's, etc., but any small vial will do. The only important point to remember is that it must have a reflective backing. Once you have a vial, you can make a base for it (the author used epoxy resin) and glue it to the case, under the emitter and receivers.

When selecting a project case, make sure that it is light-proof. Also, the case should be rectangular, so that the Audible Level can be used to measure verticals and horizontals; its accuracy will only be limited by the base length of the case. Of course, you could extend the base; try attaching a beam of aluminum to the case using screws.

Another possible feature of the Level is the reproduction of slopes. To prepare the Level for that application, glue a small metal plate to the inside of the front of the case. Then, drill a hole through the case and the metal (the plate reinforces the hole). Find a length of aluminum strip that has a slot cut out. Insert a thumb screw through the slot and into a hole that you drilled. The aluminum strip can then be slid up or down to the desired angle and secured by the thumbscrew.

Setup. For the task of calibration, you will need a conventional carpenter's level and a flat plane, which could be a flat piece of glass or some other smooth surface. Place the Audible Level and the carpenter's level on the surface. With the lid of the Audible Level closed, tip the plane to the right and left. See if the carpenter's level position agrees with the audible output. If the two levels do not agree, and the level tone comes on while the bubble is right of center (closest to Q2), open the lid and move the infrared emitter to the left. The opposite applies if the bubble is left of center. Close the lid and re-test. Once you are satisfied, solder the braces that you fitted earlier.

Temperature will affect the phototransistors' response, so it is necessary to wait at least 5 minutes between soldering and testing. You can save a lot of time by making fine adjustments with a pair of pliers. ■

BCB PRESELECTOR

(Continued from page 58)

signal. If there are two peaks close together, either select one of them (the stronger one is obviously better), or set C1 about midway between the two peaks. Then adjust L1 and L2 for a peak reading; do the same to C2 and C3. Repeat the process several times until there is only one peak, or only a slightly noticeable dip between two closely spaced peaks. Next, tune to a station above 1,400 kHz and re-peak C1. When the peak is found, adjust C2 and C3 for peak response.

A slight disadvantage to the circuit is that it has an insertion loss of about 2-3 dB, so it might reduce some signal levels. On the other hand, by attenuating nearby off-channel signals, you will find that the weak ones are easier to dig out of the mud. If you find that the loss of signal level is too high for you, however, you can insert a wideband preamplifier between the output of the preselector and the antenna input of the receiver to compensate for it. ■

Make
U.S. Savings Bonds
part of your
retirement savings
program.



They're the safe, easy and affordable way to save for retirement. Buy U.S. Savings Bonds for as little as \$25. Ask your banker or your employer about including U.S. Savings Bonds in your retirement savings program.

For more information, write U.S. Savings Bonds, Washington, DC 20226. For a recorded message of current rate information, call 1-800-4US BOND • 1-800-487-2663



HOW FAR
YOU GO
DEPENDS ON
WHERE
YOU GET YOUR
START.

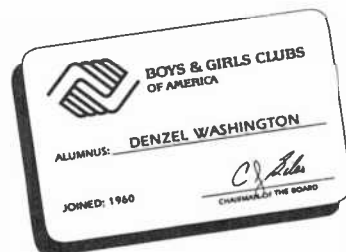

1-800-854-CLUB



BOYS & GIRLS CLUBS
OF AMERICA

The Positive Place For Kids.

SPRINKLER GUARDIAN

(Continued from page 35)

wire soldered to the nail heads. The probes should be buried horizontally, about 1 to 2 inches below the surface and about two feet apart.

Installation. Before you can use the Guardian, you have to know the resistance of the ground when it is dry. To find the resistance, bury your two probes as described before and wait a few days. Then, measure the resistance across the probes when the ground is dry and needs watering. The resistance value between the probes must fall within the range of R2 and R4, or between 10K and 40K ohms. If it falls out of that range, the distance between the probes might have to be adjusted.

The connections between the sprinkler controller and your Guardian are shown in Fig. 4. Three solenoids are shown in that system to show how the common leg connects to each; of course, there are probably more solenoids in your own system.

To install the Sprinkler Guardian, cut the common leg from the valves, and connect the leads to terminals 1 and 2 of TB3. Then, connect the buried probes to the terminals of TB2. Finally, pirate power from the supply of the controller using insulated wires, and connect the wires to terminals 1 and 2 of TB1.

Checkout and Use. Place S1 in the "manual" position; then turn R2 fully counter-clockwise. Relay K1 should be off and LED1 should be on. Slowly advance R2 clockwise until LED1 goes off and LED2 comes on indicating that K1 has closed. Now, slowly turn R2 counter-clockwise again until LED1 comes back on. Place S1 in the "automatic" position, and the unit is ready to use.

If adjusting R2 turns on LED1 but not LED2, the probe resistance is too high. On the other hand, if adjusting R2 turns on LED2 but not LED1, the probe resistance is too low. Decrease or increase the distance between the probes as needed to get the resistance in the proper range.

Once you get the Sprinkler Guardian up and running, you'll never have to worry about the costs of watering your lawn in the rain again. ■

It started in America!

The creators are the masters in manufacturing the finest video products...

You probably don't associate VCR's with American technology. Fact is, video recording has its origins in America and it was 3M that brought video recording out of the lab and into your living room. Today, 3M video tape is the choice of all the major networks. No other tape company has ever won an Oscar or an Emmy. 3M Black Watch tape follows in this tradition—service and quality go hand in hand. Here are three Black Watch products you should be using at home!

Clean up! With constant playing and using of degrading dry or wet cleaners, the output of your video tapes has slowly diminished to an unacceptable level and the VCR plays as if it has a head cold! The culprit is most likely clogged and dirty video and/or audio heads. The 3M Black Watch™ Head Cleaner Videocassette uses a patented magnetic tape-based cleaning formation to remove head clogging debris. No foreign substances such as cloth, plastics or messy liquids and no harsh abrasive materials are present. The cleaner's usable life is 400 cleanings or more!

It's easy to use. Place the 3M Black Watch™ Head Cleaner Videocassette in the VCR and press the Play button. A pre-recorded message will appear clearly on your screen and an audible tone is heard, telling you that the cleaning process is now completed. No guess work; you never over clean! Priced at \$19.95.

For the VCR! Once your VCR's record and playback heads are cured, and the unit plays like new, consider using the finest videocassette you can buy—the 3M Black Watch™ T120 Hi Pro VHS 4410 Videocassette. The 4410 is the highest performing videocassette available today for use with all standard format VHS recording hardware!

Here's what you hear and see....A sharp, clear picture—brightest ever colors—freedom from streaks, flashes and snow—outstanding high-fidelity audio reproduction—optimum camcorder performance—maintains recording integrity. 3M Black Watch™ video tape is 100% laser inspected to guarantee surface smoothness and drop-out free performance. Priced at \$8.00

You saw it here first! 3M Black Watch™ 0900 8mm video tape cassette loaded into your Hi Band camcorder delivers the finest picture and sound possible in the 8mm format. Extremely fine particles of pure iron alloyed with nickel and cobalt deliver a video performance exceeding 400 lines of horizontal resolution. You get the advantage of an exceptional video image with superior audio re-



For the clearest pictures you ever record!

production. This means your Hi 8 format camcorder will produce the best video and audio definition possible. With the 3M Black Watch™ 8mm cassette, the recording capability and performance of your camcorder will be significantly enhanced. Priced at \$14.95.

Clagg Inc. — 3M VHS Special Offer
P.O. Box 4099,
Farmingdale,
New York 11735

Yes, I like your offer and here is my order for 3M Black Watch™ products!

___ 3M Black Watch™ 0900 Hi Band-120
8mm Cassette
(\$14.95 each) \$ _____

___ 3M Black Watch™ T120 Hi Pro VHS
4410 Videocassette
(\$8.00 each) \$ _____

___ 3M Black Watch™ Head Cleaner
Videocassette
(\$19.95 each) \$ _____

Shipping and handling per order \$4.00

Total Amount in U.S. Funds only \$ _____

New York residents add local sales tax.
Canadians add \$6.00 per order. No foreign orders. Do not send cash.

Bill my VISA MasterCard
Card No. _____

Expire Date ___/___/___

Signature _____

Name (Please print) _____

Address _____

City _____ State _____ ZIP _____

Popular Electronics[®]

REPRINT BOOKSTORE

- | | |
|---|--|
| <input type="checkbox"/> 225 Popular Electronics (1995 back issues) \$5.00
Write in issues desired _____ | <input type="checkbox"/> 211 Radio-Electronics (1991 back issues) . \$5.00
Write in issues desired _____ |
| <input type="checkbox"/> 224 Popular Electronics (1994 back issues) \$5.00
Write in issues desired _____ | <input type="checkbox"/> 210 Radio-Electronics (1990 back issues) . \$5.00
Write in issues desired _____ |
| <input type="checkbox"/> 223 Popular Electronics (1993 back issues) \$5.00
Write in issues desired _____ | |
| <input type="checkbox"/> 222 Popular Electronics (1992 back issues) \$5.00
Write in issues desired _____ | |
| <input type="checkbox"/> 221 Popular Electronics (1991 back issues, Jan., Mar. not available) \$5.00
Write in issues desired _____ | |
| <input type="checkbox"/> 220 Popular Electronics (1990 back issues) \$5.00
Write in issues desired _____ | |
| <input type="checkbox"/> EH94S Experimenters Handbook
Summer Edition (1994) \$5.00 | |
| <input type="checkbox"/> EH94W Experimenters Handbook
Winter Edition (1994) \$5.00 | |
| <input type="checkbox"/> EH94 Experimenters Handbook (1994) \$5.00 | |
| <input type="checkbox"/> EH93 Experimenters Handbook (1993) \$5.00 | |
| <input type="checkbox"/> EH92 Experimenters Handbook (1992) \$5.00 | |
| <input type="checkbox"/> EH90 Experimenters Handbook (1990) \$5.00 | |
| <input type="checkbox"/> HH94S Hobbyist Handbook
Spring Edition (1994) \$5.00 | |
| <input type="checkbox"/> HH94F Hobbyist Handbook
Fall Edition (1994) \$5.00 | |
| <input type="checkbox"/> HH93 Hobbyist Handbook (1993) \$5.00 | |
| <input type="checkbox"/> HH92 Hobbyist Handbook (1992) \$5.00 | |
| <input type="checkbox"/> HH91 Hobbyist Handbook (1991) \$5.00 | |
| <input type="checkbox"/> HH90 Hobbyist Handbook (1990) \$5.00 | |
| <input type="checkbox"/> GIZ Gizmo—The Consumers Guide to
Electronics \$5.00 | |
| <input type="checkbox"/> Radlocraft 1993 Projects for Hobbyists ... \$5.00 | |
| <input type="checkbox"/> 215 Electronics Now (1995 back issues) ... \$5.00
Write in issues desired _____ | |
| <input type="checkbox"/> 214 Electronics Now (1994 back issues) ... \$5.00
Write in issues desired _____ | |
| <input type="checkbox"/> 213 Radio-Electronics/Electronics Now (1993 back
issues) \$5.00
Write in issues desired _____ | |
| <input type="checkbox"/> 212 Radio-Electronics (1992 back issues) \$5.00 | |
| | REPRINTS REPRINTS |
| | <input type="checkbox"/> 174 Electronics Comics (The Best of) \$2.00 |
| | <input type="checkbox"/> 173 From Not-Working to Networking
Troubleshooting Local-Area Networks \$5.00 |
| | <input type="checkbox"/> 172 33 Bench-Tested Circuits \$2.00 |
| | <input type="checkbox"/> 171 36 Time Tested Circuits \$2.00 |
| | <input type="checkbox"/> 170 High-Voltage Projects for Fun and
Science Book 1 \$4.00 |
| | <input type="checkbox"/> 170A High-Voltage Projects for Fun and
Science Book 2 \$4.00 |
| | <input type="checkbox"/> 169 Think Tank (133 Circuits) \$3.50 |
| | <input type="checkbox"/> 169A Think Tank Vol. 2 \$3.00 |
| | <input type="checkbox"/> 168 Fact Cards (#34-66) \$3.00 |
| | <input type="checkbox"/> 168C Fact Cards (#67-99) \$3.00 |
| | <input type="checkbox"/> 168D Fact Cards (#100-132) \$3.00 |
| | <input type="checkbox"/> 167 Designing With IC's \$4.00 |
| | <input type="checkbox"/> 166 Collected Works of Mohammed Ulyses
Fips(62 pages, April Fools Collection) \$5.00 |
| | <input type="checkbox"/> 165 How to Repair CD Disc Players \$5.00 |
| | <input type="checkbox"/> 164 Modern Electrics (April 1908) \$3.00 |
| | <input type="checkbox"/> 163 Receiving Satellite TV \$5.00 |
| | <input type="checkbox"/> 162 Build Your Own Satellite TV Receiver \$5.00 |
| | <input type="checkbox"/> 161 Descrambling (Feb. 1984) \$4.00 |
| | <input type="checkbox"/> 160 New Ideas - 42 Circuits \$3.50 |
| | <input type="checkbox"/> 159 Low Frequency Receiving Techniques
Building and using VLF Antennas \$5.00 |
| | <input type="checkbox"/> 158 Electro Importing Co. Catalog
(Circa 1918) \$5.95 |
| | <input type="checkbox"/> 157 All About Kits \$2.00 |
| | <input type="checkbox"/> 156 How To Make PC Boards \$2.00 |
| | <input type="checkbox"/> 154 How To Repair VCR's \$3.50 |

To order any of the items indicated above, check off the ones you want. Complete the order form below. **Include your payment**, check or money order (DO NOT SEND CASH), payable to and mail to **Claggg Inc.**, Reprint Department, P.O. Box 4099, Farmingdale, NY 11735.

Please allow 4-6 weeks for delivery.

To place a credit card order by phone, Visa or Mastercard only.

CALL: 516-293-3751.

To use your Visa or Mastercard, complete the following:

Bill my Visa - Mastercard

Card No. _____

Exp. Date _____

Signature _____

MAIL TO: Claggg Inc.

Reprint Bookstore, P.O. Box 4099, Farmingdale NY 11735

All payments must be in U.S. funds

SHIPPING CHARGES IN USA & CANADA

\$0.01 to \$5.00	\$1.50	\$30.01 to 40.00	\$5.50
\$5.01 to \$10.00	\$2.50	\$40.01 to 50.00	\$6.50
\$10.01 to 20.00	\$3.50	\$50.01 and above	\$8.00
\$20.01 to 30.00	\$4.50		

SORRY — We only ship to USA & Canada

Total price of merchandise \$ _____

Shipping Charge (see chart) \$ _____

Subtotal \$ _____

Sales Tax (New York State Residents only) \$ _____

Name _____ Total Enclosed \$ _____

Address _____

City _____ State _____ Zip _____

PE495

COMPUTER BITS

(Continued from page 67)

which allow you to open and save files, choose colors, and set print parameters; the scrollbars along the edge of your word processor; and the title bar of your application. All of the things we just mentioned do things, have attributes, and send and receive messages. For instance, when you click the print button, what really happens behind the scene is that the mouse driver sends a message to the button, which in turn sends a message to some other part of the program that "knows" about printing.

If you've been brave enough to try out IBM's OS/2 (version 2.1 or later), you can see OOT applied to the user interface of an operating system in a consistent, elegant way. Microsoft's upcoming Windows 95 moves a step beyond Windows 3.1x, but does not go as far as OS/2 (smart marketing move, but a shame technically).

So what's the relationship between an object and the hierarchies we discussed last time? The answer is that objects can be grouped (classified) in ways that make sense, as shown in Fig. 1. The hierarchical form arises by abstracting common features of objects into higher and higher levels. We'll discuss the reasons why the hierarchical structure is advantageous next time. ■

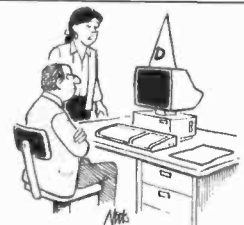

"I told you not to buy a Pentium."

Enter A World Of Excitement with a Subscription to

Popular Electronics®

Get the latest electronic technology and information monthly!

Now you can subscribe to the magazine that plugs you into the exciting world of electronics. With every issue of Popular Electronics you'll find a wide variety of electronics projects you can build and enjoy.

Popular Electronics brings you informative new product and literature listings, feature articles on test equipment and tools—all designed to keep you tuned in to the latest developments in electronics. So if you love to build fascinating electronics, just fill out the subscription form below to subscribe to Popular Electronics... It's a power-house of fun for the electronics enthusiast.

EXCITING MONTHLY FEATURES LIKE:

- CONSTRUCTION**—Building projects from crystal sets to electronic roulette
- FEATURES**—Educational training on digital electronics, Ohm's Law, Antennas, Communications, Antique Radio, Simplified Theory
- HANDS-ON-REPORTS**—User test comments on new and unusual consumer products
- SPECIAL COLUMNS**—Think Tank, Circuit Circus, Computer Bits, DX Listening, Antique Radio, Scanner Scene, Amateur Radio

PLUS: ALL OUR GREAT DEPARTMENTS!

You'll get 12 exciting and informative issues of Popular Electronics for only \$18.95. That's a savings of \$23.05 off the regular single copy price. Subscribe to Popular Electronics today! Just fill out the subscription order form below.

MODEL ROCKET LAUNCHER • CES ROUND-UP • TELEPHONE-CALL ROUTER

Popular Electronics

MAY 1994

TIME-DELAYED MODEL-ROCKET LAUNCHER

Add a touch of class and safety with this deluxe controller.

CONSUMER ELECTRONICS SHOW ROUND-UP

Satellite TV gets small, multimedia gets big...100 gets real, and other news direct from the show floor.

Build A Distinctive Ring Switch

It routes your telephone calls to the right person or device.

A Relay Station For Your Remote Control

It routes your remote control.

Save
55%
Off The Regular
NEWSSTAND
Rate

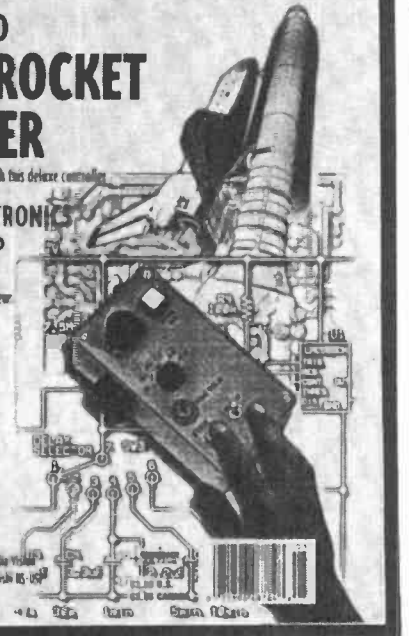

FOR FASTER SERVICE CALL TODAY

1-800-827-0383

(7:30AM-8:30PM) EASTERN STANDARD TIME

Popular Electronics® SUBSCRIPTION ORDER FORM

APED5

P.O. Box 338, Mt. Morris IL. 61054

YES! I want to subscribe to Popular Electronics for 1 Full year (12 Issues) for only \$18.95. That's a savings of \$23.05 off the newsstand price.

(Basic Subscription Rate—1 yr/\$21.95)

Payment Enclosed Bill me later

Please charge my: Visa Mastercard

Acct. #

Signature

Exp. Date

PLEASE PRINT BELOW:

NAME

ADDRESS

CITY

STATE

ZIP

Allow 6 to 8 weeks for delivery of first issue. U.S. Funds only.

In Canada add \$6.88 Postage (Includes G.S.T.). All Other Foreign add \$7.50 Postage.

CROWBAR CIRCUITS

(Continued from page 60)

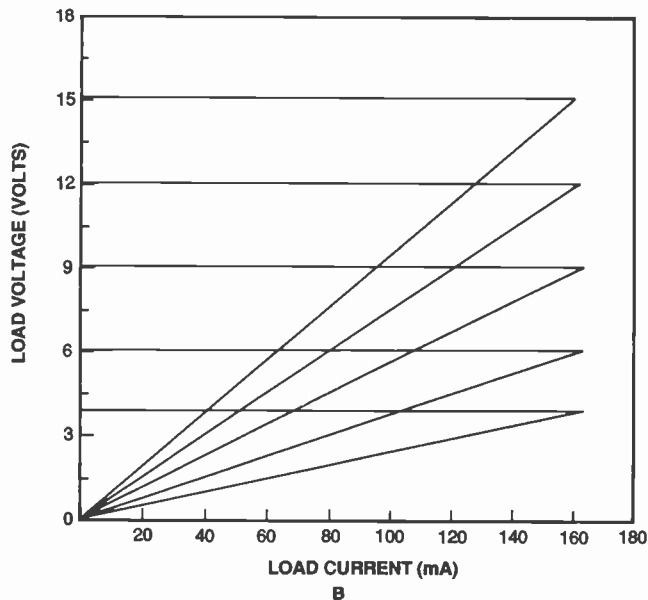
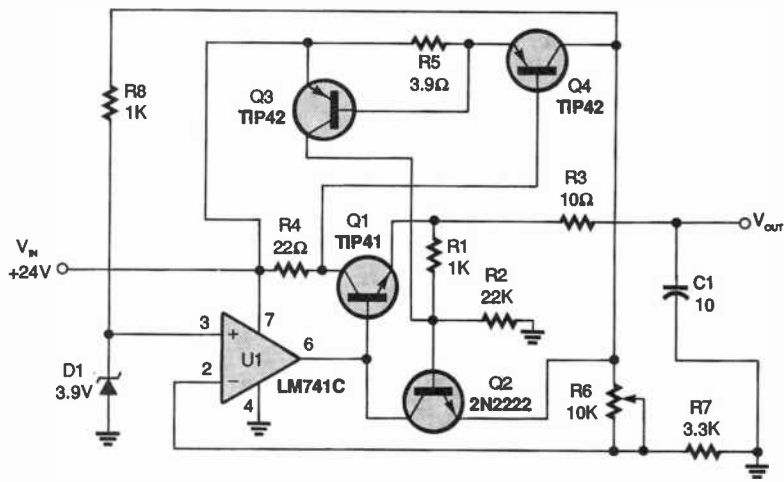

Fig. 3. The variable voltage regulator with current-crowbar limiting, shown in A, overcomes the disadvantages of constant and foldback limiting. As you can see in the graph (B), the current crowbar quickly shuts down the supplied power when a preset current is exceeded. It also has excellent load regulation over its operating range.

output voltages, without the loss of foldback current limiting, if a preset value is exceeded.

Figure 3B shows the performance of the circuit. Note that the maximum load current is the same at all output voltages, down to 4 volts. Once activated, foldback response quickly reduces both load current and voltage, effectively shutting down the power supply. The circuit has excellent load regulation over its operating current range and, compared to conventional current-limiting circuits, the su-

periority of the current crowbar limiter is obvious.

An Improvement. Here is an improvement you can make to the current-crowbar circuit shown in Fig. 3A. If you would like to have a preset current limit that is variable over a wide range, replace R5 with a 15-ohm resistor, and connect potentiometer R9 from the collector of Q1 to the base of Q4 (see Fig. 4). For the components shown, the lowest current limit, when R9 is set to zero ohms, is about 47 mA. If

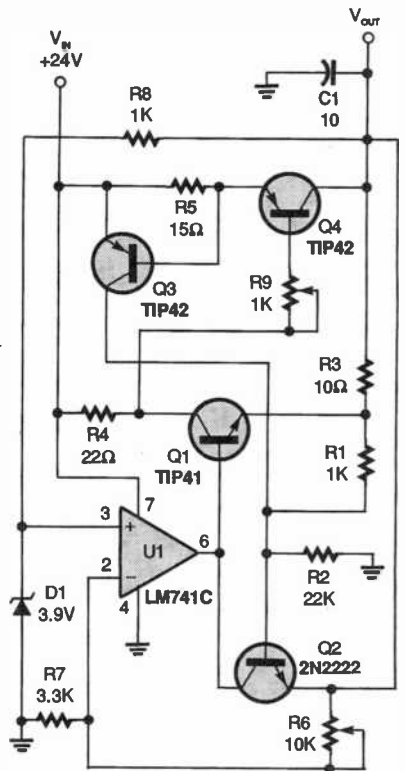

Fig. 4. The variable voltage regulator in Fig. 3A was modified—by changing the value of R5 and adding potentiometer R9—to make the circuit variable over a wide range. Connecting a fixed resistor in series with R9 will set a fixed upper current limit.

you have a specific high current limit you would like to set, connect an appropriate fixed value resistor in series with R9.

As you can see, using current crowbars is the most effective way of protecting equipment from the damage caused by short circuits. With just a few inexpensive parts, you can build one of the above crowbars for yourself, and make any power supply you add it to truly safe. ■



Market Center™

GET THE SESCOM SOLUTION!

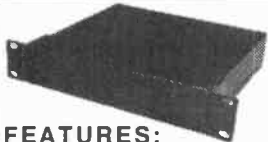

FEATURES:

- 1/2 RACK SIZE FOR COMPACT DESIGN
- CAN BE USED ON TABLE OR IN RACK
- FULL LINE OF MOUNTING ACCESSORIES
- CLEAR FINISH STANDARD, FOR BLACK OR GOLD ADD \$5.00 PER BOX

Boxes		
MODEL	DESCRIPTION W x H x D (IN.)	PRICE \$
RSB-3	7.5 x 1.65 x 3	25.00
RSB-5	7.5 x 1.65 x 5	31.25
RSB-7	7.5 x 1.65 x 7	38.00
RSB-9	7.5 x 1.65 x 9	45.00
RSB-11	7.5 x 1.65 x 11	51.50
RSB-13	7.5 x 1.65 x 13	58.25



FEATURES:

- FOUR MODELS AVAILABLE IN HALF AND FULL RACK WIDTHS
- CLEAR, BLACK AND GOLD ANODIZED FINISHES
- CONSTRUCTED OF 1.0" SQUARE ALUMINUM TUBING

Table Top Racks		
MODEL	DESCRIPTION W x H x D (IN.)	PRICE \$
RSR-6	11.5 x 15.2 x 11.25	60.00
RSR-8	11.5 x 18.8 x 11.25	65.00
RSR-10	11.5 x 22.6 x 11.25	70.00
RSR-12	11.5 x 26.4 x 11.25	75.00
RSR-6-19	21.0 x 15.2 x 11.25	70.00
RSR-8-19	21.0 x 18.8 x 11.25	75.00
RSR-10-19	21.0 x 22.6 x 11.25	80.00
RSR-12-19	21.0 x 26.4 x 11.25	85.00

New, Low Cost Mini Shear



SHR-2
\$300.00

SHIPPED WITHIN 48 STATES

- 8" CUTTING CAPACITY
- SMALL SIZE: 10.8" X 5.5" X 22.7"
- CUTS PCB MATERIAL & PLASTICS UP TO .080" & ALUMINUM TO .063"

RACKEM 'N' STACKEM™ SERIES



RACK CHASSIS

PANELS ARE .063" ALUMINUM; STANDARD FRONT AND REAR PANELS ARE CLEAR ANODIZED, BLACK OR GOLD PANELS ALSO AVAILABLE FOR ADDITIONAL \$5.00

Rack Chassis		
MODEL	DESCRIPTION W x D x H (IN.)	PRICE \$
1RU5	19 x 5 x 1.75	34.00
1RU7	19 x 7 x 1.75	36.50
1RU10	19 x 10 x 1.75	38.75
*1RU12	19 x 12 x 1.75	42.75
*1RU15	19 x 15 x 1.75	45.75
*1RU17	19 x 17 x 1.75	48.75
2RU5	19 x 5 x 3.5	36.50
2RU7	19 x 7 x 3.5	38.75
2RU10	19 x 10 x 3.5	41.25
*2RU12	19 x 12 x 3.5	45.25
*2RU15	19 x 15 x 3.5	48.25
*2RU17	19 x 17 x 3.5	51.25
3RU5	19 x 5 x 5.25	46.00
3RU7	19 x 7 x 5.25	48.50
3RU10	19 x 10 x 5.25	51.00
*3RU12	19 x 12 x 5.25	54.00
*3RU15	19 x 15 x 5.25	57.00
*3RU17	19 x 17 x 5.25	60.00

Dual Slope Cabinets

MODEL	DESCRIPTION W x D x H (IN.)	PRICE \$
DS-1	4 x 6 x 4	40.00
DS-2	6 x 6 x 4	43.00
DS-3	8 x 6 x 4	46.00
DS-4	10 x 6 x 4	49.00
DS-5	12 x 6 x 4	52.00
DS-6	18 x 6 x 4	55.00
DS-7	4 x 8 x 6	50.00
DS-8	6 x 8 x 6	54.00
DS-9	8 x 8 x 6	58.00
DS-10	10 x 8 x 6	62.00
DS-11	12 x 8 x 6	66.00
DS-12	18 x 8 x 6	70.00

LOWER PRICES!

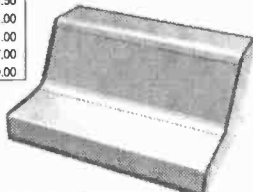

DUAL SLOPE CABINET
PANELS ARE .063" ALUMINUM

BOX-IT™ SYSTEM

A NEW MODULAR SYSTEM FOR FAST AND EASY CONSTRUCTION WITH NO TOOLS

- ASSEMBLES WITH ONLY A PHILLIPS SCREWDRIVER
- OVER 180 PREPUNCHED FRONT AND REAR PANELS TO MIX AND MATCH IN CLEAR, BLACK & GOLD ALUMINUM
- FULL RANGE OF BOXES AVAILABLE IN FULL & HALF RACK WIDTHS; RACK MOUNT OR TABLE TOP STYLES
- ELECTRONIC COMPONENTS (VU METERS, SWITCHES, POTS, CONNECTORS, ETC.) ALSO AVAILABLE

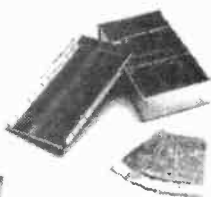

RF SHIELDED BOXES
HOT TIN-PLATED STEEL

PERFECT FOR RF AND CLOCK TYPE CIRCUITS AND ALLOW THE ELIMINATION OF SPILLOVER OF UNWANTED SIGNALS. THE BOXES COME WITH DIVIDERS AND THE LIDS CAN BE SOLDERED TO THE CASE. 1000 pF/50VDC FEED THRU CAPACITORS ARE AVAILABLE AS SOLDER OR SCREW-IN TYPES.

RF Shielded Steel Boxes		
MODEL	DESCRIPTION L x W x H (INCHES)	PRICE \$
SB-1	2.1 x 1.9 x 1.0	4.50
SB-2	3.3 x 1.9 x 1.0	6.00
SB-3	4.2 x 1.9 x 1.0	9.00
SB-4	6.3 x 1.9 x 1.0	10.50
SB-5	3.3 x 2.7 x 1.1	9.50
SB-6	4.8 x 2.7 x 1.1	11.50
SB-7	6.4 x 2.7 x 1.1	13.20
SB-8	2.6 x 2.7 x .63	7.00
SB-9	3.2 x 2.7 x .63	8.25
SB-10	4.8 x 2.7 x .63	9.00
SB-11	6.3 x 2.7 x .63	10.75
FTS-1	1000 pF/50VDC SOLDER TYPE	.85
FTSI-1	1000 pF/50VDC SCREW-IN TYPE	3.50

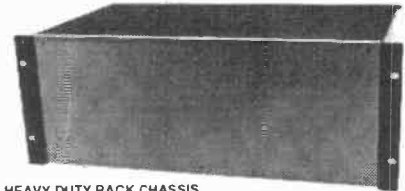

HEAVY DUTY RACK CHASSIS

PANELS ARE .080" ALUMINUM AND ARE FIELD REMOVABLE; STANDARD FRONT & REAR PANELS ARE CLEAR ANODIZED. BLACK PANELS AVAILABLE FOR ADDITIONAL \$15.00

Metal Cabinets		
MODEL	DESCRIPTION W x D x H (IN.)	PRICE \$
MC-1A	4 x 3 x 2	12.00
MC-2A	6 x 3 x 2	14.00
MC-3A	8 x 3 x 2	16.00
MC-4A	4 x 5 x 3	14.00
MC-5A	6 x 5 x 3	16.00
MC-6A	8 x 5 x 3	18.00
MC-7A	4 x 7 x 4	16.00
MC-8A	6 x 7 x 4	18.00
MC-9A	8 x 7 x 4	20.00

LOWER PRICES!



Heavy Duty Rack Chassis

MODEL	DESCRIPTION W x D x H (IN.)	PRICE \$
3RU7 HD	19 x 7 x 5.25	120.75
3RU10 HD	19 x 10 x 5.25	127.00
3RU14 HD	19 x 14 x 5.25	140.75
4RU7 HD	19 x 7 x 7.0	127.00
4RU10 HD	19 x 10 x 7.0	135.50
4RU14 HD	19 x 14 x 7.0	140.75
5RU7 HD	19 x 7 x 8.75	132.25
5RU10 HD	19 x 10 x 8.75	139.75
5RU14 HD	19 x 14 x 8.75	150.25

METAL CABINET
PANELS ARE .063" ALUMINUM; STANDARD FRONT AND REAR PANELS ARE CLEAR ANODIZED. BLACK OR GOLD PANELS AVAILABLE FOR ADDITIONAL \$5.00

Quantity Discount (per order non-assortable)	
10-99	10%
100 - UP	20%



SESCOM, INC.
2100 WARD DRIVE
HENDERSON, NV 89015

ORDER TODAY!
PREPAID ORDERS ARE
SHIPPED SURFACE AT NO CHARGE
(U.S. 48 STATES, MEXICO AND CANADA)



ORDERS (800) 634-3457
FAX ORDERS (800) 551-2749
OFFICE (702) 565-3400 ■ FAX (702) 565-4828
TECH LINE (702) 565-3993 M-Th 8 am to 4 pm (PST)
SESCOM, INC. is not responsible for inadvertent typographical errors
Prices and specifications are subject to change without notice

RAINBOW KITS

Laser Pens 4 mW

Beam visible up to 500'.

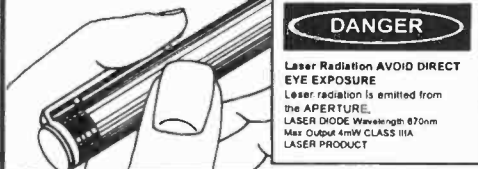

DANGER
Laser Radiation AVOID DIRECT EYE EXPOSURE
Laser radiation is emitted from the APERTURE.
LASER DIODE Wavelength 870nm
Max Output 4mW CLASS IIIA
LASER PRODUCT

INCLUDES
2 AAA Batteries
Pen Size: 5 1/2" x 1/2"

**SUPER
NEW LOW PRICE**
\$59.95



STROBE LIGHT

Do you need an attention getter, warning light, or flashing light for model airplanes? Then this kit is for you. Use it as an emergency light for your auto, radio tower, even use it on your bicycle. Has a variable flash rate. Size 3.5"x1.8" operates on 6 or 12v DC only.

ST-1 **\$9.95**

The Exciting New TELEPHONE MONITOR



Monitors your phone system, See how accurate your phone company really is!

- RECORDS OUTGOING CALLS :**
 - Date & time of each call.
 - Length of the call.
 - What number was dialed.
 - If you use a credit card it records the card number.
- RECORDS INCOMING CALLS :**
 - Date & time of call.
 - How many times phone rings.
 - If answered the length of call.
- RECORDS ANY DTMF TONE :**
 - Detects any tone on line sent by phone company or any other source.

Records to Screen or Floppy Disk

EASY TO INSTALL

- Connects to parallel port
- Phone line in.
- Phone line out to telephone.

All software included!

\$99.95
TM-1 ONLY KIT

BUILT \$169.95

WIDE BAND PREAMP

The ideal preamp for scanners, hand held radios, frequency counters. Amplifies low level

(weak) signals. If the signal is extremely low 2 amps can be used in series. 1MHz to 2.5MHz @ 2.8dB nf 1dB compression = +0 dBm gain: 1MGHz-20dB to 2.5Hz-6dB Requires 12vDC @ 16Ma WBA-6 **\$19.95**

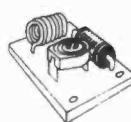

MICRO-MINIATURE PHONE TRANSMITTER

We haven't seen a smaller phone transmitter than the MMPT2 kit. Powered by the phone, it requires no battery. Transmits both sides of a phone conversation to an FM radio up to a 1/4 mile away. Tunable from 88 to 108MHz FM. Attach it to one phone or add it to the line to pick up all incoming calls. The MMPT2 is undetectable if properly installed. Unit has surface mounted parts, you install the leaded parts. Size .45"x.6"

MMPT2 **\$29.95**

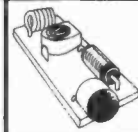

MICRO-MINIATURE WIRELESS MIKE

So small you could hide this one on some real bugs! It's the smallest we've ever seen. With it's super sensitive mike it transmits a whisper or a room of conversation to an FM radio, tunable from 88 to 108MHz FM. With a proper antenna & 9v it transmits about 1 mile. The kit is made with surface mounted parts, we have already mounted these parts. You install the leaded parts. Can operate on 6 to 12v DC. Size .35"x.9"

MMWMS **\$34.95**

WIRELESS FM MICROPHONE

Small but mighty this little jewel will out perform most units many times its price. It really

stomps out a signal. The WM-1 kit is a buffered wireless mike that operates from 80MHz to 120MHz FM, the frequency of any broadcast FM radio. Includes a mini-electret mike. SIZE: .8"x1" 6 to 12vDC WM-2 **\$14.95**

TV NOTCH FOR CHANNELS

2 thru 22 SNOOP & BULLET

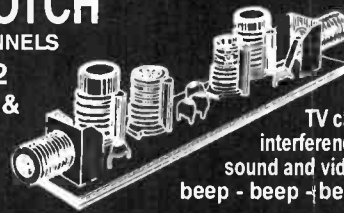

FILTERS

Our TV filters eliminate unwanted TV channels or interference that alters both sound and video with a beep - beep -beep.

NOTE: All TV Filter Kits are sold for educational purposes only. You must obtain permission from your local cable company before using these filters on your cable system.

DF-222 Kit **\$14.95**

FM STEREO TRANSMITTER

Own your own FM radio station. Any stereo signal you plug into the FMST-100 will be transmitted to any FM radio tuneable

from 76 to 108MHz FM. Transmit a wireless link through an auditorium, from your car to your camper, listen to your cd's while mowing the lawn. Play music on one channel sing on the other. Clarity is excellent, approx. 40dB stereo separation. Length of antenna determines the distance of transmission. Complete with stereo input level controls, & crystal for stereo separation. 9v battery operation FMST-100 \$29.95 / FMSTC cabinet \$8.95

5.0 mW Laser Diode

Great for making a gun sight, use as a transit, makes a super experimenters project. The beam is

visible with a wavelength of 670 nm. Size of beam is 6mm at 5 meters. Operates on 3 volts DC at 85mA. Size: 10.5mm x 18.5mm with an adjustable collimating lens.

LDM-5

NEW LOW PRICE
\$59.95

PHONE TRANSMITTER

Small but mighty, it fits anywhere. Phone line powered, never needs batteries. Transmits both sides of a phone

conversation loud and clear, wireless, to any FM radio at great distances. Variable tunes from 70MHz to 130MHz FM. You can also use it as a speaker phone. SIZE .5"x1"

TEL-B1 **\$12.95**

BUILT \$29.95

SUPER SNOOPER BIG EAR

Listen through walls, hear conversations across the room. Add a parabolic reflector and hear blocks

away. The BIG EAR can be hidden about anywhere. Makes an ultra sensitive intercom. Can be used as a 1.5W AMP. We supply a mini-electret mike in the kit. SIZE: 1"x.75" 6 to 12vDC

AA-1 **\$10.95**

BUILT \$29.95

This Manual contains all schematics, parts lists, P.C.B., layouts for most of the Rainbow Kits. Use your own parts to construct any of our kits.

KIT BOOK
\$14.95

\$9.95 with the purchase of any kit.



Please add sufficient postage First lb \$5.00 Canada \$7.00 Additional LB. Add \$1.00 US FUNDS ONLY

We will accept telephone orders for Visa or Mastercard



To Order Call
317-291-7262



ELECTRONIC RAINBOW INC

6254 LaPas Trail • Indianapolis, IN 46268
FAX 317-291-7269

ACE COMMUNICATIONS



Get instant tech information FREE from your Fax or Computer!

You can obtain specs, freq. info, software and more from our automated services. For fax facts, call from your stand alone fax machine and follow the voice prompts. Use the BBS from your modem of fax/modem equipped computer. Dial 317-849-8683 for fax back service, or dial 317-579-2045 for our computer bulletin board service.

Continuous Coverage



Three new Bearcat units offer expanded coverage and more memory than before. The 890 offers 200 channels, base/mobile operation, VFO tuning, service search, weather alert, search and store, and more. The 2500 hand held has 400 channels, fast scan and more. The Bearcat 8500 has 500 channels in 20 banks, VFO, auto store, alpha numeric display, 10 priority channels, aux tape output jacks, and coverage to 1.3 Gigahertz.

Bearcat 2500XLTA hand held.....\$349.95
 Bearcat 8500XLTC mobile.....\$389.95
 Bearcat 890XLTB mobile.....\$259.95
 25-1300MHz, 500 ch. in 8500, 400 in 2500. 890 has 200 ch. & 29-956MHz. All cell locked. Features include turbo scan, VFO, search and store, Priority, LCD display, and more. Fax Facts 474, 475, 476

Mobile Scanners

TRIDENT
TR2C
Police & CB
\$69.95



Scans police pre-programmed by state channel *plus* the CB channel of your choice. Also has Mobile Repeater and Weather. Extra cost option of CB and laser detectors built in. Compact size allows for dash or visor mounting. Mtng hardware and power connectors included. Size: 5 5/8 x 4 7/8 x 1 3/4. Wt: 1.5lbs. Fax fact #580

Bearcat 700AX 50Ch w/800..... \$159.95
 Bearcat 350A 50 Ch H/L/U..... \$119.95
 Bearcat 560XLJ 16 Ch H/L/U..... \$ 89.95
 Bearcat 760XM100Ch H/L/U/Air/800 \$219.95
 Bearcat T2 state/state scan..... \$144.95

Shortwave Radios

Sangean ATS-818CS..... \$219.95
 Sangean ATS-818..... \$184.95
 Sangean ATS-803A..... \$169.95
 Sangean ATS-808..... \$179.95
 Sangean ATS-606..... \$149.95
 Sangean ATS-606P..... \$169.95
 Sangean ATS-800..... \$ 89.95
 Grundig YB400..... \$219.00
 Grundig Satellit 700..... \$399.00



Hand Held Scanners

Bearcat 200XLTN

\$209.95 200 Channels 800 MHz
 Ten scan banks plus search. Covers 29-54, 118-174, 406-512 and 806-956MHz (with cell lock). Features scan, search, delay, 10 priorities, mem backup, lockout, WX search, keylock. Includes NiCad & Chgr. Size: 1 3/8 x 2 11/16 x 7 1/2.



Bearcat 120XLTLJ 100Ch H/L/U..... \$149.95
 Bearcat 150XLT 100Ch H/L/U/8..... \$199.95
 Bearcat 220XLTLJ 200 Ch H/L/U/8.... \$249.95
 Coverage of above hand helds is: 29-54, 136-174, 406-512, and 800MHz band as indicated. Fax facts #475

Table Top Scanners

Bearcat 855XLTE 50 Ch w/800..... \$159.95
 Bearcat 142XLM 10Ch H/L/U..... \$ 73.95
 Bearcat 147XLJ 16 Ch H/L/U..... \$ 89.95
 Bearcat 172XM 20Ch H/L/U/Air..... \$124.95
 Bearcat 145 16Ch H/L/U..... \$ 79.95

Accessories & Etc.

Mag Mount Mobile Ant MA100..... \$ 19.95
 Base Ant. 25-1000MHz AS300..... \$ 59.95
 Pre-Amp .1-1500MHz GW2..... \$ 89.00
 Wide Coverage Antenna..... \$119.95
 Base Discone Ant DA300..... \$ 89.00
 External Speaker MS190/opt. amp.... \$ 19.95
 Old Scanner Repair, all brands..... \$ CALL
 Extended Warranties..... \$ CALL
 Frequency Info FaxFact/Modem..... \$ FREE
 On Glass Mobile Antenna..... \$ 32.95

2 Way Radios

VHF hi band programmable mobiles as low as \$299.95. Call for quotes or Fax Fact #775

Total Coverage Radios

TRIDENT

TR1200XLT
AM Broadcast to
Microwave 1000 Scan
Channels \$389.00

500KHz to 1300MHz coverage in a programmable hand held. Ten scan banks, ten search banks. Lockout on search and scan. AM plus narrow and broadcast FM. Priority, hold, delay and selectable search increments. Cell Lock. Permanent memory. 4 AA ni-cads and wall plus cig charger included along with belt clip, case, ant. & earphone. Size: 6 7/8 x 1 3/4 x 2 1/2. Wt 12 oz. Fax fact document # 205



TRIDENT

TR4500 \$449
2016 Channels
1 to 1300MHz
Computer Control

62 Scan Banks, 16 Search Banks, 35 Channels per second. Patented Computer control for logging and spectrum display. AM, NFM, WFM, & BFO for CW/SSB. Priority bank, delay/hold and selectable search. Cell Lock Permanent memory. DC or AC with adaptors. Mtng Brkt & Antenna included. Size: 2 1/4H x 5 5/8W x 6 1/2D. Wt. 1lb. Fax fact #305



TRIDENT

TR980 \$279.00
125 Channels
5MHz to
999MHz



Most Economical receiver in its class, offers AM, NFM Wide FM, modes. 5KHz increments. Delay & hold & Search. Cell Lock NiCads, chgr & whip ant. Size: 5 7/8H x 1 1/2W x 2 D. Wt 14oz.



TRIDENT Winner of the 1994 INNOVATIONS
Design & Engineering Honors, Electronic Industries
Association. Trident TR2400 Total Coverage Receiver

Trident TR2400: 100KHz to 2060MHz. Ten scan banks of 100 channels each, ten search banks. Tuning increments as low as 1KHz. Beat Freq. Oscillator for SSB and CW modes. Search lockout and store. VFO tuning knob. Permanent memory. Bank lock and linking. Attenuator switch. Backlit LCD. 1 Yr Warranty. AM/NFM/WFM. Selectable increments. Delay, Hold, Priority. 5 7/8H x 1 1/2D x 2W. Wt 14 oz. \$499.00



Toll Free, 24 Hours! 800-445-7717 Fax Orders 800-448-1084 Fax Facts 317-849-8683

Computer BBS Modem & Fax/Modem, 317-579-2045. Toll Free Tech Support, Dial 800-874-3468

International Fax: en Espanol, en Francais, und auf Deutsch, or just fax in plain English to: 317-849-8794



ACE Communications 6975 Hillside Court, Indianapolis, IN 46250

Service & Support hours: Mon.-Fri. 9AM to 6PM, Sat. 10-4 EST. MasterCard, Visa, Checks, Approved P.O.'s & COD (add \$5.50) & AMEX, Discover. Prices, specifications and availability subject to change. Flat rate ground shipping and handling charge only \$6.95 per unit. Express Air only \$9.95, for most units, to most locations. One week trial, no returns accepted two weeks after original receipt without substantial restocking charge. All units carry full factory warranty. Indiana residents add 5 per cent sales tax.



FLY IT! ONLY \$9.95

B&S SALES

CALL (810) 566-7248 • FAX (810) 566-7258 24 hrs.

**Hours: Monday through Friday 8am to 7:30pm EST - Saturday 10am to 3pm.
51756 Van Dyke St. #330, Shelby Township, MI 48316**

Free Calculator with order!

CONVERTER

	5	10		5	10
PANASONIC TZ-PC 145362 ..	\$68	\$64	DRX-3 PJ.....	\$37	\$33
WAVEMASTER	\$65	\$60	DRZ-3 PJ.....	\$38	\$34
DRZ-3 A & B DUAL INPUT.....	\$39	\$35	8528 PJ	\$45	\$42

CONVERTER/DESCRAMBLERS

	5	10		5	10
8600	\$275	\$265	DPV-5	\$145	\$130
8590	\$260	\$250	DP-5	\$125	\$110
8580	\$195	\$185	DRZ-3-DIC	\$95	\$85
DPV-7	\$225	\$215	DRX-3-DIC	\$89	\$79

ADD-ON DESCRAMBLERS

10 LOT SPECIAL

PIONEER GREEN	\$65	J-TVT-GOLD.....	\$42
SA-M80	\$65	J-MINI TVT.....	\$42
J-TNT	\$65	H-MLD 1200-3	\$35
J-PURPLE	\$49		

NOTE: MENTION AD FOR THESE PRICES! NO MICHIGAN SALES

We are now offering a 6 month warranty. In order for warranty to be in effect, this form must be signed and returned. FOR VCR, SECOND, THIRD, ETC. HOOK-UPS.

YES, I agree all units are to be used or resold in compliance with Federal and State laws.

Signature _____ Date _____

NAME _____ ADDRESS _____

CITY _____ STATE _____ ZIP _____ PHONE _____

It is not the intent of B&S Sales to defraud any pay television operator and we will not assist any company or individual in doing the same.

500 MHz SPECTRUM ANALYZER \$895

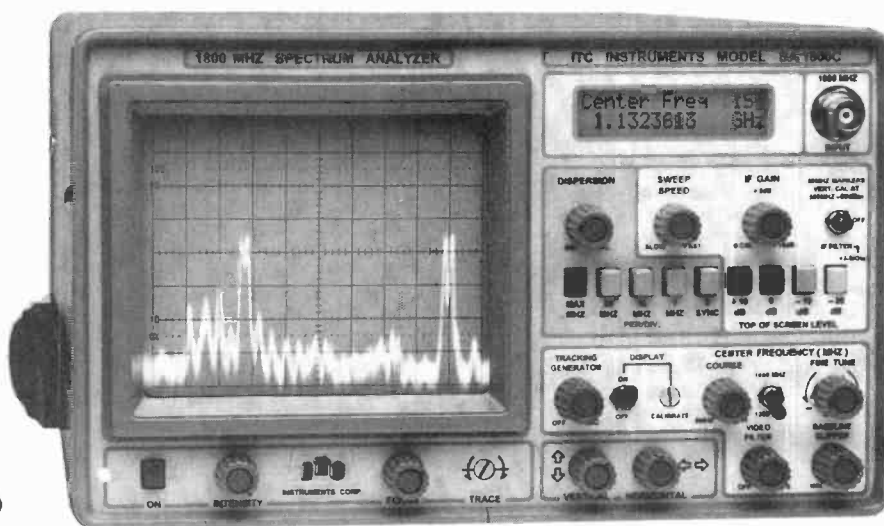

6" x 12" x 16" (H x W x D)
(only 16 LB)

SA1800C SHOWN
\$2295.00

1-1300 MHz *In One Sweep* \$1895 MADE IN THE USA

ALL NEW SPECTRUM DISPLAY MONITOR PLUS FULL FUNCTION SPECTRUM ANALYZER

LET THE SA500A SPOT THOSE HIDDEN SIGNALS
The SA500A easily attaches to any receiver IF output jack. Providing a panoramic signal display of your 1-30 MHz and 30 to 2000 MHz scanner or communication receiver. The SA500A is a Professional Spectrum Surveillance Technology Monitor. A Full Function Spectrum Analyzer with +/- 5KHz Narrow Band Filter, Center Freq. Display, 50 MHz Marker Generator. Capable of Tuning Duplexes, Amps, Filters Receivers, Transmitters & Perform EMI, RFI, FCC, Testing. SA500A First affordable Professional Spectrum Monitor/Analyzer for all serious Ham Radio and Radio Monitoring Operators. just \$895.00

.2-1.3GHz SA1300B THE ULTIMATE LOW COST ANALYZER
Quality & Performance that's what ITC Spectrum Analyzers are known for. 80 dB on Screen, -110 dBm Sensitivity, Center Frequency Display, +/- 5KHz Narrow Band Filter (for 5KHz resolution band width) 50 MHz Marker. DISPERSION ZOOM, Baseline Clipper, Sweep Speed, Adjustable Video Filter, 40dB of Input Attenuation. Standard on all ADVANTAGE Spectrum Analyzer specials. The SA1300B and SA1800C provide Laboratory Performance at a fraction of the normal cost. The SA1300B \$1895.00 -SA1800C .2-1.3GHz & .8-1.8GHz \$2295.00. Add a 1.3GHz Tracking Generator to any unit

1.3GHz FREQUENCY COUNTER .001 ppm

\$479.00

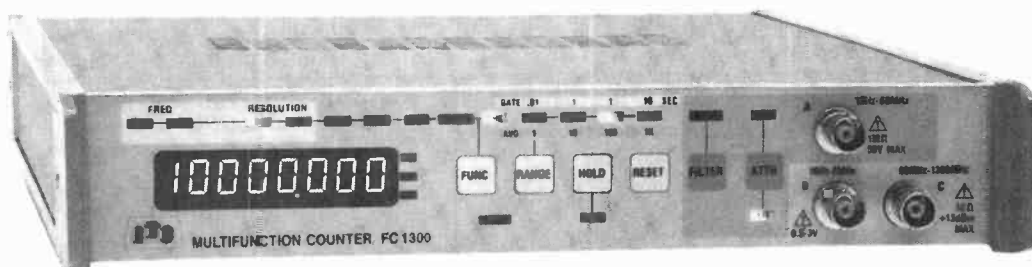

ISO9002 CERTIFIED
FIVE YEAR
WARRANTEE
REG. PRICE \$599.00
SAVE \$120.00

Laboratory Performance PROCESSOR STABILIZED OVEN OSCILLATOR .001 ppm

ITC FC1300: the first truly Accurate low cost Frequency Counter. Accuracy is the #1 Frequency Counter Requirement. The \$200 - \$300 counters being advertised the past few years are but toys when it comes to accuracy. These guess-so-matic units are off 5 to 10 PPM over temperature & time (That's +/- 6,000 -13,000 Hz at 1.3 GHz) The FC1300 is accurate to within +/-13 Hz at 1.3 GHz 0-40 degrees C. Sensitivity is < 5mV 1Hz to 13 GHz, 50 Ohm & 1 Meg Ohm inputs, LP filter, 1x -10x input Att. Frequency Measurement, Period Averaging, Time Interval, External Counter, Freq. Ratio, Hold & Reset Functions, 4 Gate times .01 to 10 Sec. Tired of guess-so-matic Counters: Serious About Accuracy: Ready to step up to Laboratory Performance Accuracy: Call Today & Order

Call 800-566-1818
To Order or Info.
Free 1995 Catalog
ADVANTAGE
Carries a full line of
Scopes - Analyzers
Frequency Counters
Generators
LCR Bridges & DMM'S

ADVANTAGE INSTRUMENTS CORP. MASTER CARD -VISA - DISCOVER - AMX

3817 S. CARSON ST. # 818 CARSON CITY NV. 89701 Terms: COD - Check - Money Order

702-885-0234 FAX 702-885-7600 Call Toll Free 800-566-1818 - BBS 310-549-0321

PRICES & SPECIFICATIONS SUBJECT TO CHANGE WITHOUT NOTICE OR OBLIGATION. F.O.B. CARSON CITY NV. NV. RESIDENTS ADD SALES TAX.

CIRCLE 153 ON FREE INFORMATION CARD

CALL TOLL FREE
1-800-292-7711
1-800-445-3201 (Can)

C&S SALES

EXCELLENCE IN SERVICE

**WRITE FOR
FREE CATALOG**

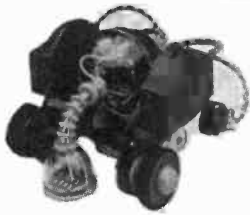

Line Tracker
MV-963
\$52.95
(Infra-red Sensor)
The robot follows
a black line
on white paper
Preassembled PCB



**Dual-Display
LCR Meter**
w/ Stat Functions
B+K Model 878
\$239.95
Auto/manual range
Many features
with Q factor
High Accuracy

Electronic Tool Kit Model TK-1000
A professional organizer tool kit at affordable prices. No student should be without this unique tool kit that holds all the tools you need.
Including:
Diagonal Cutter
Long Nose Pliers
6" Wire Stripper
Solder 60/40
6" Screwdriver
6" Phillips Driver
Safety Goggles
IC Puller
3pc Nut Drivers
Iron 25W
Iron Stand
Solder Wick
Desoldering Pump
5 pc Solder Ease Kit
6pc Precision Screwdrivers
\$39.95



Robotic Arm
Y-01
\$49.95
(Wired Control)
Movement grabs
& releases,
lifts & lowers,
pivots from side to side

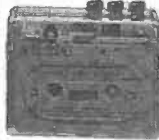

Stereo Cassette Player
Kit
Model
TR-18K
\$16.95
Headphones
Included



**Digital
Multimeter**
EDM-83B
\$175.00
Almost every
feature available
Bargain of the decade



**Elenco
LCR + DMM**
LCM-1950
\$79
12 Functions
Freq to 4MHz
Inductance
Capacitance



**Digital
Capacitance
Meter**
CM-1555
\$49.95
Measures capacitors
from .1pf to 20,000µf



**Digital
LCR Meter**
LCR-680
\$79.95
3-1/2 Digit
LCD Display
Inductance
1uH to 20MΩ



Function Generator
GF-8026
\$239
Int/Ext
Operation
Sine, Square, Triangle, Pulse
Ramp, .2 to 2MHz, Freq Ctr



3-3/4 Digit Multimeter
BK-390
\$139.00
0.1% DCV accy
Analog bar graph
Auto/manual ranging
Capacitance meas
Temperature probe



**Digital
Multimeter Kit**
w/ Training Course
M-2665K
\$49.95
Full function 34 ranges
Ideal school project
M-2661 (Assembled) **\$55.00**



Frequency Counter
F-1225
\$225.00
8 Digit LED display
Wide meas range
High sensitivity
Data hold function
Input impedance 1MΩ or 50Ω
10:1 input attenuation function

Fluke Multimeters
(All Models Available Call)

Scopemeters	70 Series
Model 97 \$1,795	Model 7011 \$69.95
10 Series	Model 7311 \$97.50
Model 10 \$62.95	Model 7711 \$149
Model 12 \$84.95	Model 7911 \$175
20 Series	80 Series
Model 2911 \$175	Model 87 \$289

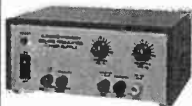

**Triple Power
Supply**
XP-620
By Elenco
\$75.00
3 fully regulated supplies; 1.5-15V @ 1A, -1.5 to -15V @ 1A or 3-30V @ 1A & 5V @ 3A Kit XP-620K **\$49.95**



**Quad Power
Supply**
XP-581
By Elenco
\$79.95
Four supplies in one unit; 2-20V @ 2.5A, 5V @ 3A, -5V @ .5A and 12V @ 1A. All regulated and short protected



**High Current DC
Power Supply**
BK-1686 **\$169.95**
3 to 14 VDC Output
12A @ 13.8V
For servicing high
power car stereos,
camcorders, ham radios, etc.
Connect 2 or more in parallel



**Wide Band
Signal
Generators**
SG-9000
\$124.95
RF Frequency 100K-450MHz
AM modulation of 1KHz Variable
SG-9500 150MHz **\$239.00**

Telephone Kit
PT-223K
\$14.95



Available
Assembled
PT-223
\$15.95

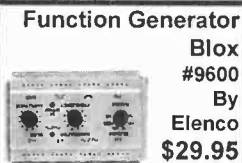

Function Generator
Blox
#9600
By
Elenco
\$29.95
Kit **\$28.95**
Sine, Triangle, Square Wave

**Learn to Build & Program
Computers with this Kit**

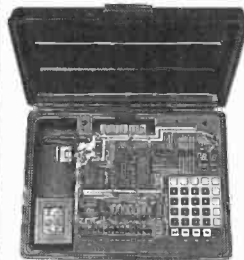

From scratch you build a complete system. Our Micro-Master trainer teaches you to write into RAMs, ROMs and run a 8085 microprocessor, which uses similar machine language as IBM PC.
MM-8000
By Elenco
\$129.00

Digital/Analog Trainer
Complete Mini-Lab For Building,
Testing, Prototyping Analog and Digital



Designed for school projects, with 5 built-in power supplies. Includes a function generator with continuously variable, sine, triangular, square wave forms. All power supplies are regulated and protected against shorts.
By Elenco
in U.S.A.
XK-525
\$159.95
Kit
XK-525K
\$129.95

**AM/FM Transistor
Radio Kit**
with Training Course
Model AM/FM 108
\$29.95

14 Transistor, 5 Diodes
Easy to build because
schematic is printed on the PCB
Makes a great school project
Model AM-550 AM Only **\$17.95**

**Telephone Line
Analyzer**



Kit TT-400K **\$19.95**
Assembled TT-400 **\$26.95**

WE WILL NOT BE UNDERSOLD
UPS SHIPPING: 48 STATES 5%
IL RES 7.5% TAX (\$3 min \$10 max)
OTHERS CALL

C&S SALES INC.
1245 ROSEWOOD, DEERFIELD, IL 60015
FAX: 708-520-0085 (708) 541-0710



**15 DAY MONEY BACK
GUARANTEE**
FULL FACTORY WARRANTY
PRICES SUBJECT TO CHANGE WITHOUT NOTICE

**FREE PROBES
WITH ALL
SCOPES**

**ELENCO ♦ HITACHI ♦ B+K
SCOPES
AT GUARANTEED LOWEST PRICES**

**WRITE FOR
FREE
CATALOG**

**QUALITY - ELENCO OSCILLOSCOPES
2-YEAR WARRANTY**

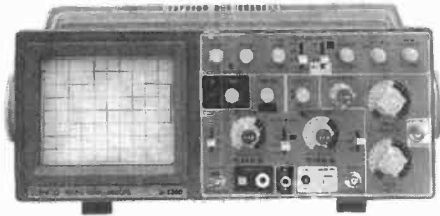

60MHz

S-1360 \$775

Delayed Sweep

S-1365 \$849

Cursor Readout

- ♦ Voltage, Time
- ♦ Frequency differences displayed on CRT

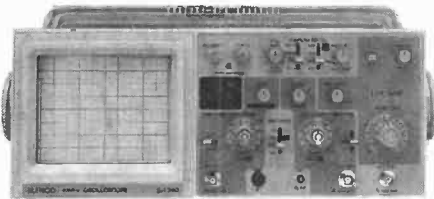

40MHz

S-1340 \$495

2- Channel

S-1345 \$575

Delayed Sweep

- ♦ Beam Find
- ♦ Component Tester



25MHz

S-1325 \$349

2- Channel

S-1330 \$449

Delayed Sweep

- ♦ Beam Find
- ♦ Component Tester

Dependable Equipment at Affordable Prices

B+K 20MHz

2 Channel

Model 2120 \$389.00



Delayed Sweep

Model 2125 \$539.95

40MHz DUAL - TRACE

Model 1541B

\$749.95

- 1mV/div sensitivity
- Video sync separators
- Z axis input
- Single sweep
- V mode-displays 2 signals unrelated in frequency

60MHz DUAL-TRACE

Model 2160

\$949.95

- 1mV/div sensitivity
- Sweep to 5ns/div
- Dual time base
- Signal delay line
- Component tester
- V mode-displays 2 signals unrelated in frequency

100MHz THREE-TRACE

Model 2190

\$1,379.95

- 1mV/div sensitivity
- Sweeps to 2ns/div
- Dual time base
- Signal delay line
- 19kV accelerating voltage
- Calibrated delay time multiplier

**20MHz ANALOG with
DIGITAL STORAGE**

Model 2522A

\$869.95

- 20MHz analog bandwidth
- 20MS/s sampling rate
- 2k memory per channel
- 20MHz equivalent time sampling

HITACHI POPULAR SERIES

V-212 - 20MHz, 2 Channel	\$425.00
V-222 - 20MHz, DC Offset	\$695.00
V-422 - 40MHz, Dual Trace	\$849.00
V-522 - 50MHz, Dual Trace	\$975.00
V-523 - 50MHz, Delayed Sweep	\$995.00
V-525 - 50MHz, w/ Cursor	\$1,069.00

HITACHI COMPACT SERIES SCOPES

V-660 - 60MHz, Dual Trace	\$1,375.00
V-665A - 60MHz, DT, w/cursor	\$1,449.00
V-1060 - 100MHz, Dual Trace	\$1,549.00
V-1065A - 100MHz, DT, w/cursor	\$1,695.00
V-1085 - 100MHz, QT, w/cursor	\$2,125.00
VC-6045A - 100MHz, Digital Stor	CALL
VC-6025A - 50MHz, Digital Stor	CALL

**Elenco DS-203 20MHz, 10MS/s
Digital Storage Oscilloscope**

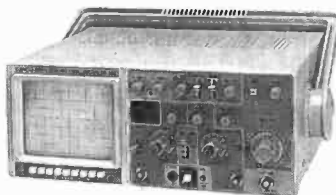

\$749

2K Word Per Channel • Plotter Output
8 Bit Vert. Resolution • 2048 Pts Hor.
Resolution • Much More.....

FLUKE SCOPEMETERS

A handheld instrument that combines a 50MHz, 25MS/s dual channel digital storage oscilloscope with feature-packed 3000 count digital multimeter.



Model 93 - \$1,225
Model 95 - \$1,549
Model 97 - \$1,795

- Autoset, automatically sets voltage, time & trigger
- Multimeter display;
- 3-2/3 digits (>3000 counts)
- True RMS volts; AC or AC+DC up to 600V

C&S SALES INC.

1245 ROSEWOOD, DEERFIELD, IL 60015
FAX: 708-520-0085 (708) 541-0710

CALL TOLL FREE

1-800-292-7711

1-800-445-3201 (Can)



**15 DAY MONEY BACK GUARANTEE
FULL FACTORY WARRANTY
ALL PRODUCTS ARE FACTORY NEW**

PRICES SUBJECT TO CHANGE WITHOUT NOTICE

CIRCLE 132 ON FREE INFORMATION CARD

April 1995, Popular Electronics

DIGITAL READY STEREO AMPLIFIED SPEAKERS

SALE

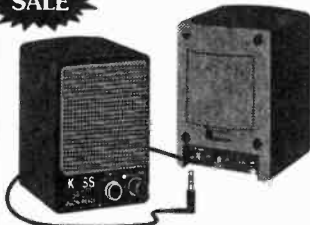

G6411 ~~was \$16.95~~ **\$12.99**

Great for computers, CD players and headphone radios! These compact amplified speakers produce high quality room filling sound from any of the above! Features bass boost, treble boost volume control and red indicator light on each speaker. Very high quality. These attractive 4 3/4" x 3 1/4" speakers are black with gold lettering. Require 4 "C" size batteries (not included). Has a 6VDC adaptor Jack (adaptor not included). These are new but not in original factory cartons so they may have slight marks or scratches on case. These marks do not affect the performance or general appearance as you have to inspect them closely to see them!

HEAVY DUTY 12VDC MOTOR

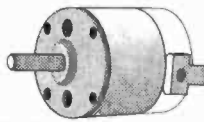

G6441 **\$1.79**
8/\$12.00

Great for larger robots or other heavy duty applications. Made by Brevet Motors, these motors feature 5/8" long x 3/16" diameter shaft and a body size of 2 1/8" L x 1 5/16" Dia. Very good torque even at 6VDC. These have been in storage for a while and may have slight corrosion or rust on body and shaft, however, it is only cosmetic and in no way effect the mechanical performance of the motor.

SUPER LED ASSORTMENT

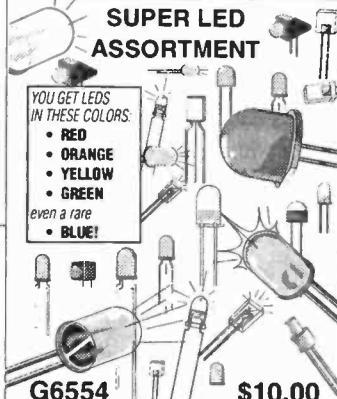

YOU GET LEDS IN THESE COLORS:

- RED
- ORANGE
- YELLOW
- GREEN
- even a rare
- BLUE!

G6554 **\$10.00**

Assortment of all types, colors, sizes and shapes of prime high quality LEDES. This large assortment even contains a clear LED that lights up blue! Our largest and most spectacular assortment contains 250 pieces.

PEOPLE DETECTING LIGHT

SALE



G6145 ~~was \$14.95~~ **\$11.95**

Portable light detects you up to 10 ft. away using a sensitive PIR (passive infrared) detector and lights up for 20 seconds. No more bumping into objects when you get up at night! Requires only 4 AA batteries (not included). Features attractive white case with a 3" diameter light. Can be mounted anywhere in house-hallways, bathroom, stairs, bedroom, kitchen, etc. Completely automatic and it even has a sensor to prevent daytime operation. Size about 5 1/2" x 3 5/8" x 2 5/8". In retail box.

FLAT PANCAKE SPEAKER



G6553 **99¢**

Super thin speaker is about 1/8" thick and 1 5/8" square. Good sound. Rated 8Ω, 0.4W

PLEASE NOTE: All sale prices are valid only until the end of the cover date of this magazine.

PIR MINI ALERT



SALE

G6153 ~~was \$14.95~~ **\$12.95**

Passive infrared alarm and announcer is activated whenever anyone enters its field of view. Features exit delay, switchable "chime" or alarm modes. Wall mounting swivel can be used or removed for portable operation. Great for mounting near front door, back door windows, hallways, etc. Alarm mode output is a loud 80dB. Can be used as a visitor announcer by just selecting "chime" mode. Now, as someone enters, you will hear just a pleasant chime. Unit resets itself in the alarm mode after sounding for about one minute. Operates on 3 AA batteries (not included). Size of unit only 4" x 2 3/4" x 1 5/8". In retail box.

IF YOU CAN'T FIND WHAT YOU ARE LOOKING FOR, CALL FOR A FREE COPY OF OUR LATEST CATALOG. THIS CATALOG CONTAINS OUR ENTIRE PRODUCT LINE OF OVER 3,000 ITEMS AND IT IS STILL GROWING!

COPPER CLAD ASSORTMENT

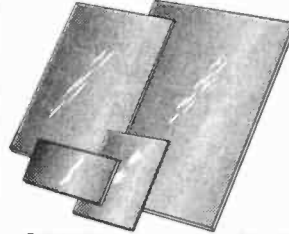

G2679 **\$5.00**

Our best assortment ever. Contains 25 pieces of various size copper clad circuit board blanks. Each is double sided and you will receive thickness types from ultra thin to standard thickness. Minimum size 2" square to a maximum of 6" square. A PC board makers delight.

TDK VOLTAGE CONVERTER

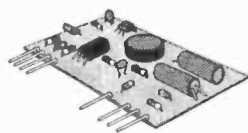

G6546 **\$2.00**

Brand new voltage converter converts 3VDC to 9VDC. Size only 1 7/8" x 1 3/16" x 1/4". Made by TDK for a major manufacturer. Output current is 60 ma at 9VDC. Use 2 penlight batteries to operate transistor radios, calculators, etc, or any electronic device that can operate on 9VDC at up to 60ma. With hookup diagram (only 3 leads are used).

REJECT POWER SUPPLY

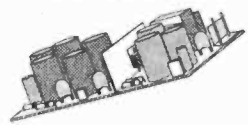

G5543 **\$1.69**

5VDC, 1 amp and 12VDC, 1 amp outputs with 120VAC input. These look new but have something wrong. Size: only 6" x 2". Has a great assortment of high quality parts on PC board-Sold "as is" only.

SUPER POWER MINIATURE IR TRANSMITTER UNIT

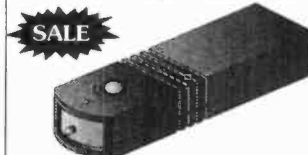

G5535 **\$1.25**

12/\$12.00 • 120/\$100.00

Make all kinds of IR remote activated projects with this transmitter and an IR receiver module. These were originally designed to activate a burglar alarm system (which we don't have) by remote control. The transmitter features a red activation button, a dip switch inside to change output code, operation from 9V battery (not included), red LED transmit indicator to show when IR energy is being transmitted and a compact 4 1/4" x 1 3/16" x 3/4" black stylish case. Brand new in blister pack with 2 peel and stick "premise protected" stickers. We also supply an info sheet that shows how to convert this transmitter unit into a programmable IR receiver so a pair of these transmitter units could cover both transmit and receive functions.

THE AMAZING RADIOSONDE



SALE

~~was \$8.95~~

G5058 **\$6.95**
2/\$12.00

Very late model Radiosonde made for tracking all types of weather data. These were to be sent aloft attached to a weather balloon (not included). Each is about 10 1/2" long x 3 3/8" thick x 8" wide. Inside of the removable cardboard sleeve is a styrofoam chamber housing a sophisticated 8 IC circuit board which has sensors attached to measure atmospheric pressure, temperature and humidity. As it gathers the information, it transmits the data at about 1.677 gigahertz (GHz). These are prime, brand new units that were waiting shipment from the manufacturer (Space Data Corporation) to the government when the contract ended. These are complete except for the 24V battery (we connected two 9V batteries in series and the unit worked perfectly from them). Sorry, no schematic available. These cost the government a bundle to have made but we are selling them at a giveaway price. Hurry, get your Radiosonde today!

TRANSISTORS BY THE SCOOP



Less than 1¢ each!

G5071
1 scoop **\$5.00**
10 scoops (about 5,000) **\$40.00**

We just purchased close to a 1/2 million prime house numbered transistors made for an OEM. Each is house numbered and has full length leads. They are absolutely first quality - not rejects. We think there are Darlington and small signal NPN transistors. We do know that there is at least 4 different house numbers. Most are regular size TO92 cases however, there are also a few 1 watt TO92 cases. Tremendous value as we are selling them by the scoop. Each scoop holds at least 500 transistors! Sorry we can't separate them, but at this price you can and you'll save a bundle!

POPULAR ELECTRONIC KITS

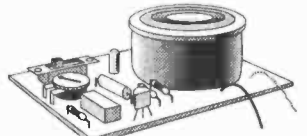

We have about 150 different kits. Here's a small sampling.

- Insanity Alarm KitC6240.....\$6.20
- Wheel of Fortune KitC3806.....\$13.75
- SMD IR Detector KitC6489.....\$7.20
- Borglar Alarm KitC6280.....\$6.75
- Phasor Sound KitC6406.....\$7.25
- Portable Filtered Black Light Kit -C6471.....\$23.95
- 20W + 20W Car Stereo Amp Kit -C6442.....\$24.95

For Phone Orders Call (602) 451-7454
Or Fax Your Orders To (602) 451-9495

ELECTRONIC GOLDMINE

Minimum Order: \$10.00 plus \$4.00 Shipping and Handling. We accept MasterCard, Visa and Money orders. Canadians and orders that need US MAIL send minimum \$5.00 S&H.

ELECTRONIC GOLDMINE
P.O. Box 5408
Scottsdale, AZ 85261

KELVIN
ELECTRONICS
10 HUB DRIVE, MELVILLE, NY 11747

(800) 645-9212
(516) 756-1750
(516) 756-1763/FAX

Established 1945

MIC & VISA \$20 Minimum Order

KELVIN CATALOG \$3
Stock No. 650412



150 LE - Student 200 LE - Technician 300 LE - Auto-Range 400 LE - Engineer

KELVIN 100 Basic
990087 \$19⁹⁵

- AC & DC VOLTAGES
- DC CURRENT
- RESISTANCE
- 3 1/2 Digit LCD
- CONTINUITY TEST
- -Buzzer
- LOW BATTERY INDICATOR
- DIODE TEST • BATTERY TEST



CAPACITANCE KELVIN METER 250 LE \$59⁹⁵
990126

- 0.5% ACCURACY
- RANGES: 20mF, 2000uF, 200uF, 20uF, 20nF, 20nF, 2000pF, 200pF
- Zero Adjust
- Safety Test Leads
- Test Socket for Plug-in Components



150 LE
Stock # 990122
\$29⁹⁵

200 LE
Stock # 990123
\$49⁹⁵

300 LE
Stock # 990125
\$49⁹⁵

400 LE
Stock # 990124
\$79⁹⁵

Standard Features • AC & DC VOLTAGES • DC CURRENT • RESISTANCE • CONTINUITY TESTER - Buzzer • DIODE TEST • 10M ohm INPUT IMPEDANCE • ACCURACY +/- 0.5% RDG

TRANSISTOR BATTERY TEST
DC CURRENT
10 Amp

FREQ COUNTER
up to 20MHz
CAPACITANCE
from 1pF to 20uF
TRANSISTOR
AC/DC CURRENT
10 Amp

AUTO RANGE
with 3200 counts
AC CURRENT
DC CURRENT
ANALOG BAR
10 Amp

INDUCTANCE
Resolution 1uH
FREQ COUNTER
up to 20MHz
CAPACITANCE
from 1pF to 200uF
AC/DC CURRENT
TRANSISTOR
DUTY %
20 Amp

Designed to meet IEC-348 & UL-1244 safety specifications.

Protective Cases

For Models 100 Basic, 150LE, 200LE, 300LE
..... \$4.⁹⁵ (#990088)

Case For Model 400LE \$9.⁹⁵ (#990116)

2 Year Warranty
(Parts & Labor)

The Ultimate Meter
TRUE RMS - LCR - Hz - dBm

Popular Electronics (Reviewed - May 1993)

"Not only does the Kelvin 94 boast alot of features ... the features go the extra distance."

"If we had to run into a burning building to do some emergency trouble-shooting and could carry in only one piece of equipment, the Kelvin 94 would be it!"

12 INSTRUMENTS IN ONE -

DC VOLTMETER, AC VOLTMETER, OHMMETER, AC CURRENT, DC CURRENT, DIODE TESTER, AUDIBLE CONTINUITY TESTER, dBm, FREQ COUNTER, CAPACITANCE METER, INDUCTANCE METER, LOGIC PROBE

- **0.1% ACCURACY** ON DC VOLTAGES
- **TRUE RMS** ON AC VOLTAGES & CURRENT
- **FREQUENCY COUNTER** TO 20 MHz
- **LARGE EASY-TO-READ** 3 3/4 DIGIT LCD DISPLAY
- **AUTO SLEEP & AUTO POWER OFF** BUILT-IN TO SAVE BATTERY LIFE with Bypass
- **SHOCK RESISTANT** HEAVY DUTY CASE WITH YELLOW RUBBER HOLSTER & TILT STAND
- **WATER RESISTANT SEALED CASE**
- **30 DAY MONEY BACK** SATISFACTION GUARANTEE

\$199⁹⁵
MODEL 94
#990111

COMES COMPLETE WITH
YELLOW HOLSTER, PROBES,
BATTERY, FUSE, STAND

0.1% ACCURACY on DC Voltages **Water Resistant**

Freq Counter to 20 MHz

Protective Cases for Model 94
Regular Padded Zippered \$9.⁹⁵ (#990116)
Deluxe Padded Zippered \$14.⁹⁵ (#990115)

Meter is designed in accordance with safety requirements specified in IEC-348, UL-1244 VDE-0411.

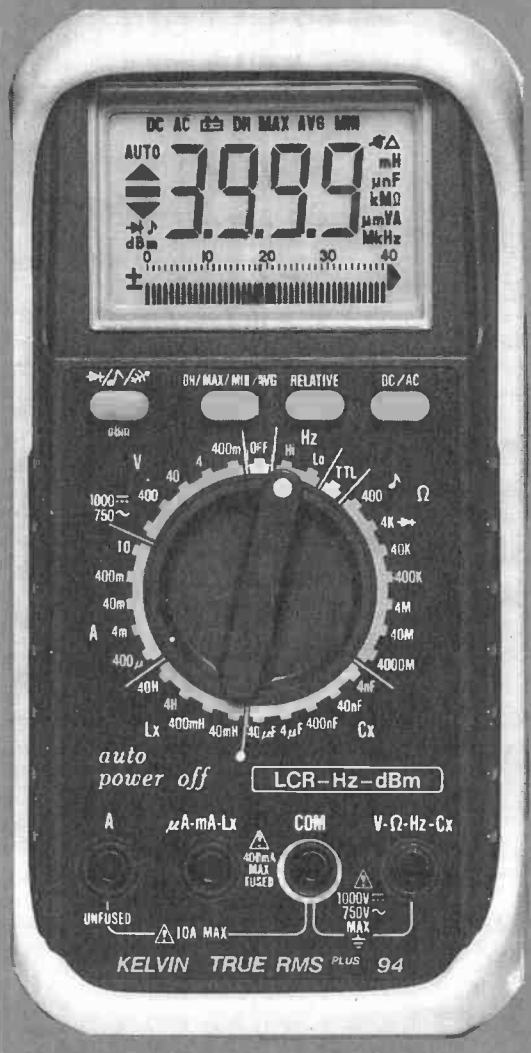

April 1995, Popular Electronics

AMAZING

Electronic and Scientific Products

Mystery Levitating Device!



Remember War of the World? Objects float in air and move to the touch. Defies gravity, amazing gift, conversation piece, magic trick or great science project.

ANT1K Easy to Assemble Kit / Plans \$19.50

Laser Ray Gun

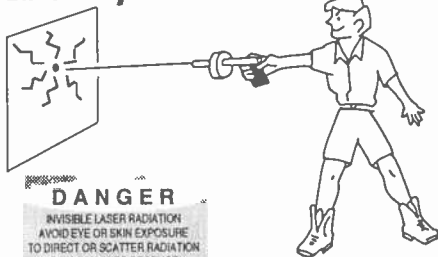

DANGER

INVISIBLE LASER RADIATION
AVOID EYE OR SKIN EXPOSURE
TO DIRECT OR SCATTER RADIATION
CLASS IV LASER PRODUCT

Advanced project produces a burst of light energy capable of burning holes in most materials. Hand-held device uses rechargeable batteries. 500 joules of flash energy excite either a neodymium glass, yag or other suitable 3" laser rod. This is a dangerous CLASS IV project (individual parts/assemblies available). LAGUN1 Plans \$20.00
LAGUN1K Kit / Plans Price on Request

Extended Play Telephone Recording System



READY TO USE! Automatically controls and records on our X-4 extended play recorder, taping both sides of a telephone conversation. Intended for order entry verification. Check your local laws as some states may require an alerting beeper. TAP20X Ready to Use System \$129.50



Shocker Force Field / Vehicle Electrifier

Neat little device allows you to make hand and shock balls, shock wands and electricity objects, charge capacitors. Great payback for those wise guys who have wronged you!
SHK1KM Easy to Assemble Electronic Kit \$24.50



Blaster Pulser

Pocket-sized wand produces 100,000 watts of power for personal defense, field and lab use, etc. BLS3 Plans \$10.00
BLS3K Kit / Plans \$69.50

Homing / Tracking Transmitter

Beeper device, 3 mile range.
HOD1 Plans \$10.00 HOD1K Kit / Plans \$49.50

Listen Through Walls, Floors

Highly sensitive stethoscope mike.
STETH1 Plans \$8.00 STETH1K Kit/Plans \$44.50

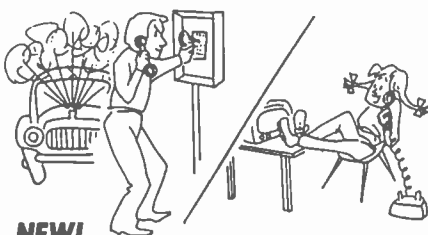

NEW!

INFINITY TRANSMITTER++ Room Monitor / Phone Line Grabber

ALL NEW! The Ultimate in Home or Office Security & Safety! Simple to Use! Call your home or office phone, push a secret tone on your telephone keypad to access either: A. On premises sounds and voices; or B. Existing telephone conversation with break in capability for emergency messages. CAUTION: Before assembly or use, check legalities with your state Attorney General's office as you may require "beepers" or other 3rd party alerts. TELEGRAB1 Plans Only \$10.00
TELEGRAB1K Kit / Plans \$99.50

Visible Beam Laser

Easy to build, RED Beam, visible for miles. Use for light shows, window bounce holography, cloud illumination and much more! LAS1KM Kit w/1mw Laser Tube, Class II. \$69.50
LAS3KM Kit w/2.5mw Laser Tube, Class IIIA \$99.50

100,000V Intimidator / Shock Wand Module

Build an electrical device that is affective up to 20 feet. May be enclosed for handheld, portable field or laboratory applications. ITM2KM Easy-to-Assemble Electronics Kit \$49.50
ITM2 Plans only, credit-able to kit \$10.00



Ion Ray Gun

Projects charged ions that induce shocks in people and objects without any connection! Great science project as well as a high tech party prank. IOG3 Plans \$8.00
IOG3K Kit/Plans \$69.50

Invisible Pain Field Generator

Shirt pocket size electronic device produces time variant complex shock waves of intense directional acoustic energy, capable of warding off aggressive animals, etc. IPG7 Plans \$8.00 IPG7K Kit/Plans \$49.50
IPG70 Assembled \$74.50



1000 Ft++ Potato Cannon

NOT A TOY. Uses electronic or piezo ignition. CAUTION REQUIRED!
POT1 Plans \$10.00 (Dangerous Product)

FireBall Gun

Shoots flaming ball - two shot capacity Great for special effects and remote fire starting. CAUTION REQUIRED!
FIREBALL Plans (Dangerous Product) \$10.00



TV & FM Joker / Jammer

Shirt pocket device allows you to totally control and remotely disrupt TV or radio reception. Great gag to play on family or friends. Discretion required.
EUK1KM Easy to Assemble Electronic Kit \$24.50

ATTENTION: High Voltage Fans!

4,000 volts in the palm of your hand! Experiment with anti-gravity, hovercraft, ion guns, force fields, plasma guns, shock devices, wireless energy and electrical pyrotechnics. Input: 9-14VDC.
MINIMAX4 Ready to Use \$19.50

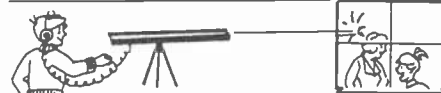

"Laser Bounce" Listener System

Allows you to hear sounds from an area via a lite beam reflected from a window or other similar objects. System uses our ready-to-use LATR1 Laser Terminator gun site as the transmitter. The receiver section is supplied as an easy-to-build kit, including our cushioned HS10 headsets. LLIST2 Plans \$20.00
LLIST1K Kit of Both Transmitter and Receiver \$199.50
LLIST20 Assemble with Laser Gun Site \$299.50

3mw Visible Red Pocket Laser

Utilizes our touch power control!
VRL3KM Kit / Plans \$74.50

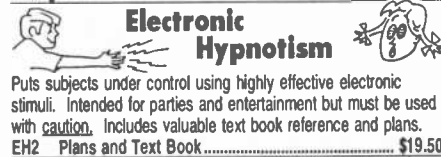

Electronic Hypnotism

Puts subjects under control using highly effective electronic stimuli. Intended for parties and entertainment but must be used with caution. Includes valuable text book reference and plans.
EH2 Plans and Text Book \$19.50

Automotive NEON!



Easy-to-Install 4-Tube Kit for Cars, Trucks, Vans! Available in Pink, Purple, Blue or Green - please specify color when ordering. RG4K (Specify Color) \$129.50
Flash-To-Music Option for above kit FMU1 \$29.50

3 MI FM Wireless Microphone

Subminiature! Crystal clear, ultra sensitive pickup transmits voices and sounds to FM radio. Excellent for security, monitoring of children or invalids. Become the neighborhood disk jockey!
FMV1 Plans \$7.00 FMV1K Kit and Plans \$39.50

Telephone Transmitter - 3 Mi

Automatically transmits both sides of a telephone conversation to an FM radio. • Tunable Frequency • Undetectable on Phone • Easy to Build and Use • Up to 3 Mile Range • Only transmits during phone use. VWPM7K Plans \$7.00
VWPM7K Kit/Plans \$39.50

INFORMATION UNLIMITED

Dept PEM17, Box 716, Amherst, NH 03031

Phone: 603-673-4730 FAX 603-672-5406

MC, VISA, COD, Checks accepted Please add \$5.00 Shipping & Handling

CATALOG

With many more items!
Free with Order or send \$1 P&H

Order by Mail or by 24 Hour Orders-Only Phone
800-221-1705

SKYVISION INC.®

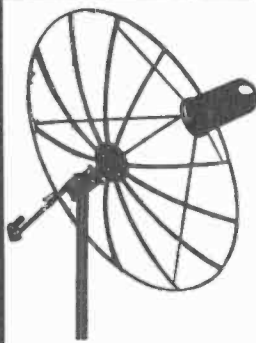

ORBITRON

Known the world over for their superior reception and picture quality, the Orbitron satellite dish features an exclusive Spincilnflon mount, which allows declination to be set by rotating the antenna to correct the latitude setting on the scale. Their compact shipping cartons allow these antennas to be shipped very economically to any point in the world. Let Orbitron help you expand your viewing choices.

1514001	6.7'	SX-7	Polar/Spin	\$45 (S&H)	\$259
1514002	8.3'	SX-8.5	Polar/Spin	49 (S&H)	319
1514004	10.0'	SX-10	Polar/Spin	63 (S&H)	449
1514005	11.7'	SX-12	Polar/Spin	84 (S&H)	649

and many more...

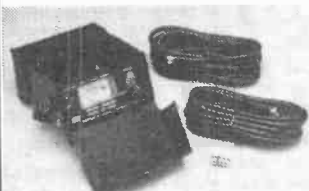

Pico Peaker

You can now accurately aim your satellite dish to receive *all* the satellites using a tool the experts use. Whether installing a new system, moving your dish, or realigning your dish due to wind or frost, the Pico Peaker will save you both time and money. This unit can be used on any receiver system with block down-converted frequencies between 400 and 1450 MHz. It will also eliminate the need for those expensive service calls. The unit includes everything you need—even the cables. A "must" for every satellite enthusiast.

900038 Pico Peaker S&H \$5 \$89.95

Superjack Actuators

Is your actuator no longer doing its job because of wear and tear? As the hardest working part of your satellite system, the actuator must move your dish from east to west across the entire satellite belt. Each time you change satellites, your actuator sends pulses to the receiver telling the receiver when to stop moving the dish. Most older actuators sent only 10-16 pulses for each inch of travel, which may not be enough to stop the dish at the maximum signal strength. Today's new heavy duty actuators with high resolution reed sensors send 48 pulses per inch of arm travel. So if your old actuator is getting tired, let a new SuperJack insure the finest picture possible.

18" arm 1019018 S&H \$15 \$89
24" arm 1019026 S&H \$16 139

Satellite Television

Wherever
You
Live ...

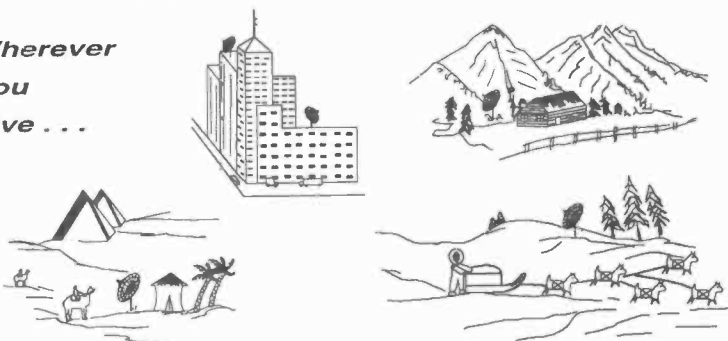

... at down to earth prices!!!



Ultra

The Ultra is Uniden's newest, smallest fully-integrated C/KU receiver ever. This unit includes the ability to control dish movement and is ready for an optional internal program decoder. The Ultra comes preprogrammed for 49 satellite positions and allows you to add satellites as they are launched. Move directly to the satellite by entering the abbreviation from the included infrared remote control. Forty programmable favorite channels can be accessed immediately from your easy chair. Run across something you don't want your kids to see? Just touch a button and eliminate that channel from their access. A complete variety of color menus allow you to control everything from your remote control. The Uniden Ultra is an ideal receiver to get you started in Direct-To-Home Satellite TV.

4527008 Ultra S&H \$22 \$379.00

uniden®

The UST 4600 sets a standard in value and performance for home satellite receivers. This unit features automatic satellite programming, 160 favorite channels can be instantly recalled for easy access. All 160 can be changed or updated at any time. This IRD features a stereo processor, enabling you to tune both left and right channels for a full stereo effect from over 100 radio stations found in satellite. The QulKTune feature quickly optimizes the satellite picture for the sharpest image. The 4600 offers other features including IR/UHF remote, 55 satellite position memory and direct satellite access. The versatility makes this an excellent choice.

4527009 UST4600 S&H \$22 \$499.00



UST 4600

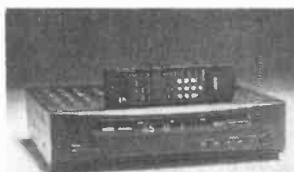

UST 4900

The Uniden UST 4900 is one of the most sophisticated satellite television receiver systems available today. This receiver will open your home to the universe of satellite viewing and is designed to be one of the most user-friendly IRDs available anywhere. Sophisticated microcomputer technology brings in crystal clear audio and video broadcasts with a minimum of user effort. The UST 4900 front display features easy-to-read icons that show you vital information including satellite, channel, polarity, timer status, antenna position and much more. This receiver is capable of storing the positions of the satellites, as well as the tuning details for each channel. The picture-in-picture feature allows you to view two video sources at the same time. You can have it all, including advanced technology and lasting quality, with the UST 4900.

4527010 UST4900 S&H \$22 \$689.00

All Major Credit Cards
Accepted

Skyvision Inc.®

1048 Frontier Drive, Fergus Falls, MN 56537 - Toll Free 800-334-6455

Mail in coupon or call today for the SKYVISION Satellite TV Product Catalog/Buyers Guide Delivered free to your mail box in U.S. and its possessions.

Send Free Domestic Satellite TV Products Catalog

Send International Satellite Catalog (For Int'l Catalog add \$8.00 for S&H)

Name _____ Phone () _____

Address _____

City _____ State _____ Zip _____

Install A System, Upgrade & Repair Yourself And Save \$\$\$\$

Call Toll Free 800-334-6455 • International 1-218-739-5231 • Fax 218-739-4879

ALFA ELECTRONICS

HIGH QUALITY TEST EQUIPMENT
BEST PRICE



DMM 89 \$199.95
Most Advanced DMM
All Purpose & Communication
-80.7 to 81.4 dBm with 4Ω-1200Ω
20 reference impedances
True RMS
Frequency counter: 0.01Hz-10MHz
Capacitance: 1pF-50,000μF
Measure AC volt to 20kHz
5000 counts, 0.1% accuracy
Auto/manual range, fast bar graph
Min/Max/Ave/DH/Relative/Zoom
Auto power off
Input warning
Splash proof
Volt, amp, ohm, logic, diode, continuity
Ruggedized case
Rubber holster included



DMM 2360 \$119.95
DMM+LCR Meter
Very Versatile DMM
Inductance: 1μH-40H
Capacitance: 1pF-40μF
Frequency: 1Hz - 4MHz
Temperature: -40-302 °F
TTL Logic Test: 20MHz
Diode, Continuity
Volt, Amp, Ohm
3999 count display
Peak Hold
Auto power off
Ruggedized case.
Temperature probe included
Rubber Holster \$8.00



DMM 20 \$74.95
Inductance: 1μH-40H
Capacitance: 1pF-200μF
Frequency: 1Hz-20MHz
Volt, amp, ohm, diode,
20 Amp AC/DC current
Transistor HFE
Continuity, duty %
Peak hold/Max
Ruggedized case
Rubber holster \$8.00

Full line of DMMs,
economy, compact,
ruggedized, solar cell,
automotive, heavy
duty, industrial
starts from \$15.95

Fluke Multimeter
Fluke 12 \$84.95
Holster C-10 \$10
Fluke 70 II \$67.5
Fluke 73 II \$94
Fluke 75 II \$129
Holster C-70 \$16
Fluke 77 II \$149
Fluke 79 II \$169
Fluke 29 II \$169

Fluke 83 \$225
Fluke 85 \$259
Fluke 87 \$287

Fluke 97
Scope Meter \$1785



LCR Meter 131D \$229.95
Most Advanced LCR
Dual display: L/Q or C/D
Inductance: 0.1μH-1000H
Capacitance: 0.1pF-10,000μF
Impedance: 1mΩ-10MΩ
0.7% basic accuracy
Auto/manual range
Dissipation factor & Q factor
Serial & parallel mode
Relative mode for comparison
and to remove parasitics
Statistics, tolerance
Best for design, incoming
testing & production
SMD and chip component
test probe \$25.00



LCR Meter 814 \$189.95
Best Resolution LCR
Inductance: 0.1μH-200H
Capacitance: 0.1pF-20,000μF
Resistance: 1mΩ-20MΩ
1% basic accuracy
Dissipation factor indicates leakage
in capacitor and Q factor in inductor
Zero adjustment to reduce parasitics
Best for high frequency RF
SMD and chip component test probe
\$25.00
LIMITED QUANTITY SPECIAL
DIGITAL LCR METER \$74.95
0.1pF, 1μH, 10mΩ resolution

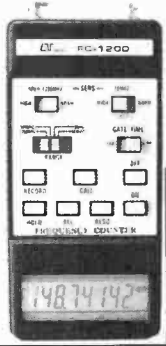

Frequency Counter FC-1200 \$129.95
Frequency: 0.1Hz-1.25GHz
Display: 8 digit LCD
Period: 0.1μs-0.1s
Records Max/Min/Average
Data hold, relative mode
Telescoping antenna \$8.00
Deluxe case \$5.00

Also Available:
AC/DC clamp meter, Light meter,
Thermometer, pH meter, High
voltage probe, Digital caliper,
Anemometer, Electronic scale,
Force gauge, Tachometer,
Stroboscope, Humidity & EMF
adapter, Sound level meter,
Frequency counter, SWR/field
strength/power meter, Dip meter

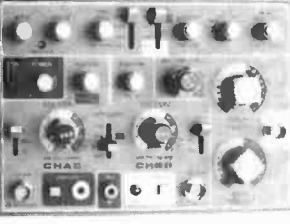
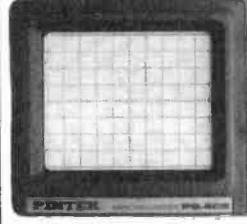

20 MHz Oscilloscope with Delay Sweep PS-205 \$429.95
Dual Trace, Component test, 6" CRT, X-Y Operation, TV Sync, Z-Modulation, CH2 Output, Graticule Illum, 2 probes each has x1, x10 switch. Best price with delay sweep.
PS-200 20 MHz DUAL TRACE \$339.95
PS-400 40 MHz DUAL TRACE \$494.95
PS-405 40 MHz DELAY SWEEP \$569.95
PS-605 60 MHz DELAY SWEEP \$769.95
Scope Probe: 60MHz x1, x10 \$15, 100MHz x1, x10 \$22
250MHz x1, x10 \$29, 250MHz x100 \$39

Digital Storage Scope
DS-203 20MHz, 10M Sample/sec \$729.95
DS-303 30MHz, 20M Sample/sec \$849.95
DS-303P with RS-232 interface \$1,049.95
Switchable between digital and analog modes
2 K word per channel storage
8 bit vertical resolution (25 Lere/div)
Expanded Timebase 10ms/div - 0.5 s/div
Refresh, Roll, Save all, Save CH2, Pre-Trig
Plotter control

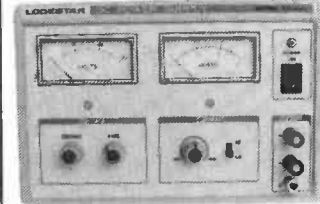

DC Power Supply PS-303 \$159.00
0-30 VDC, 0-3A output
Constant voltage & constant current mode
0.02% + 2mV line regulation
0.02% + 3mV load regulation
1 mVrms noise and ripple
Short circuit and overload protected
PS-8200 with digital voltmeter \$179.00
Also available: 30V/5A, 60V/3A, 60V/5A
16V/10A, 30V/10A

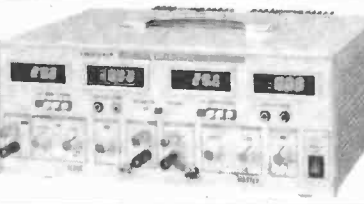

DC Power Supply Triple Output PS-8202 \$499.95
Two 0-30 VDC, 0-3A outputs
One fixed 5VDC, 3A output
Capable of independent or tracking operation
Constant voltage and constant current mode
Four digital meters for volt and current display
Excellent regulation and low ripple
Short circuit and overload protected
Also available: 30V/5A triple output \$549.95
Dual tracking 30V/3A, 30V/5A, 60V/3A, 60V/5A

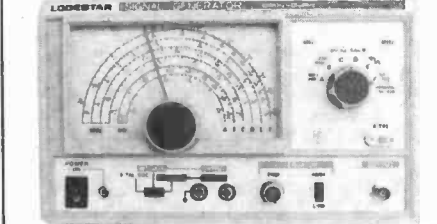

RF SIGNAL GENERATOR SG-4160B \$119.00
100 kHz-150MHz sinewave in 6 ranges
RF Output 100mVrms to 35 MHz
Internal 1kHz, External 50Hz-20kHz
AM modulation
Audio output 1 kHz, 1 Vrms

AUDIO GENERATOR AG-2601A \$119.00
10Hz - 1MHz in 5 ranges
Output: 0-8Vrms sinewave
0-10Vp-p squarewave
Synchronization: ±3% of oscillation frequency per Vrms
Output distortion:
0.05% 500Hz - 50kHz
0.5 % 50Hz - 500kHz
Output impedance: 800 ohm

FUNCTION GENERATOR FG-2100A \$169.95
0.2 Hz - 2 MHz in 7 ranges
Sine, square, triangle, pulse and ramp
Output: 5mV-20Vp-p
1% distortion, DC offset ± 10V
VCF: 0-10V control frequency to 1000:1

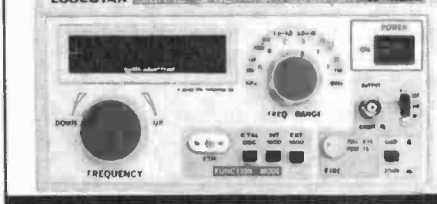

RF SIGNAL GEN./COUNTER SG-4162 AD \$229.95
Generates RF signal same as SG-4160B
6 digit frequency counter 1Hz - 150 MHz for internal and external source Sensitivity <50mV

AUDIO GEN./COUNTER AG-2603AD \$229.95
Generates audio signal same as AG-2601A
6 digit frequency counter 1Hz-150MHz for internal and external sources Sensitivity <50mV

FUNCTION GEN./COUNTER FG-2102AD \$229.95
Generates signal same as FG-2100A
Frequency counter 4 digits
Feature TTL and CMOS output

SWEEP FUNCTION GEN./COUNTER \$329.95
0.5Hz to 5 MHz in 7 ranges
Sweep: Linear 10:1/Log 10:1 20ms to 2s
AM Modulation
Gated Burst, Voltage Control Generator
Generator Control Voltage & 6 digit counter
1Hz-10MHz for internal & external sources

ALFA ELECTRONICS
741 Alexander Rd., Princeton, NJ 08540

(800) 526-2532/(609) 520-2002 15 DAY MONEY BACK GUARANTEE. 1 YEAR WARRANTY
FAX:(609) 520-2007 CALL OR WRITE FOR FREE CATALOG AND BEST OFFER.
Visa, Master Card, American Express, COD, Purchase Order Welcome

CIRCLE 26 ON FREE INFORMATION CARD

April 1995, Popular Electronics

MICRO Kits

An educational and fun to build module line

<p>Long range, high sensitivity FM microphone. 1.5-12 V bat. Tiny. Use it to monitor sounds from a distance or to sing or play an electric guitar on your stereo.</p>  <p>FM MICROPHONE K100 \$14.99</p>	<p>250 mW general purpose audio amp. Ideal as a bench monitor or together with K104 to hear sounds at a distance. 2-30 Ω output, Hi or Lo input Uses 5-12V</p>  <p>MINI AMP K101 \$11.99</p>	<p>2.5 W discrete transistor audio amp. Low Z input. Great for understanding audio amps. Ideal for monitoring an electric guitar on headphones or a loudspeaker.</p>  <p>2.5 W AUDIO AMP K102 \$14.99</p>	<p>8 W Audio amp, 2-16 Ω output. Ideal for singers, electric musical instruments, car radio power boosting, etc. Great sound quality. Overload protected.</p>  <p>8 W AUDIO AMP K103 \$19.99</p>
<p>High gain audio preamplifier. Boosts any signal level for a power amplifier. Ideal combo with K101 for "snooping" sounds at a distance. Uses 5-12V.</p>  <p>AUDIO PREAMP K104 \$10.99</p>	<p>Understand the secrets of regeneration with this simple and fun to build FM superregenerative, 2 transistor receiver. Uses 9 V battery.</p>  <p>REGENER. RADIO K105 \$17.99</p>	<p>0.1 to 20 minute programmable/ resettable timer. Relay rated at 250 V 2.5 A. Requires 12 V DC. Use it to warm up your car, turn off your TV or lights, etc.</p>  <p>TIMER K106 \$19.99</p>	<p>Transistor tester tells if device is NPN, PNP, FET-N, FET-P, OK or bad. Ideal for any shop, even professionals. Uses 9 V battery.</p>  <p>TRANSISTOR TESTER K107 \$12.99</p>
<p>Regulated power supply (1.2-32 V, 1.5 A). Overload protected. Transformer is not included.</p>  <p>POWER SUPPLY K108 \$19.99</p>	<p>Prevent skids from your bit when drilling printed circuit boards or mock-ups. Controls rate of acceleration and speed on 12 V mini drills.</p>  <p>SPEED CONTROL K109 \$24.99</p>	<p>Antenna booster. Amplifies signals for any radio (1-100 MHz). Ideal for older receivers, SW listening or car radios.</p>  <p>ANTENNA BOOSTER K110 \$11.99</p>	<p>Busy & hold button. When the green LED is on, the line is free. Press the button to put on hold. Plugs between the phone and the socket in the wall.</p>  <p>PHONE HOLD K111 \$14.95</p>

#680-177 Telegraph Rd.
Bellingham WA 98226
TOLL FREE: (800) 474 7644
Fax: (604) 985 6417

Add \$7 shipping & handling
We accept VISA, MO or cheques (sorry, no COD)
Check our BBS at (604) 985 1380 for other products



Are you overpaying . . .
... your cable company?

You are if . . .
... you are leasing their equipment.

- Forest Electronics, Inc. offers a complete line of New Cable Decoders and Converters that are fully Compatible with your cable system.
- All systems come with: Remote Control, & Parental Guidance Feature. Volume Control is also available.
- All Equipment is fully guaranteed & comes with a 30 day money back option.

For More Information Call Us 24 Hours a Day At:
800-332-1996
FAX: 708-860-9048

GENUINE Electronics, Inc.

Cable TV & Electronic Equipment

Genuine Electronics, Inc. can help you with virtually any electronic need:

- Cable TV Descramblers/Converters
- Bullet Protectors
- Immunizers
- Voice-Mail Systems
- Digital On-Hold Announcers
- Laser Pens

GUARANTEED & LOWEST PRICES!

CALL GENUINE ELECTRONICS INC.

1-800-833-2915

ALL ELECTRONICS CORP.

QUALITY PARTS • DISCOUNT PRICES • FAST SERVICE • HUGE SELECTION

JUMBO LEDs

Liton # LTL 327C - 8MM
Ideal for eye-catching indicators and displays. A recent quantity purchase of these BIG, 8mm diameter, red diffused LEDs enables us to provide some very special pricing. The leads on these devices are 0.325", long with plenty of room for soldering.



5 for \$1.00 CAT# LED-23
100 for \$ 15.00
1000 for \$ 120.00

7.2 Volt, 1000 mAh NICKEL-CAD PACK



3.56" X
2.12" X 0.75"
CAT# NCB-72

Brand new re-chargeable nickel-cadmium battery pack fits Olympus and other camcorders. Originally sold for over \$35.00.

\$5.50 each

MICROPROCESSOR HEATSINK

Wakefield 1.5" square X 0.25" high black anodized aluminum heatsink for 15 X 15 PGA type chips. 13 vertical fins for maximum cooling efficiency.

CAT # HS-38

\$1.50 each



"HI-8" VIDEO CASSETTE (USED)

8 mm Video Camcorder Users!

SONY Hi-8

Top quality, metal particle 120 minute video cassettes. Used for a short time, then bulk-erased, each cassette has its own plastic storage box. New, these high quality cassettes sell for considerably more. Satisfaction Guaranteed.

CAT # VCU-8

\$3.00 each

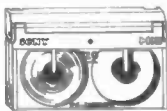

10 for \$28.00 • 100 for \$250.00

MINIATURE TOGGLE

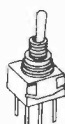

D.P.D.T. (ON-ON)

ALCOSWITCH # MTM206NPC

Short bat handle, 0.25" long.

PC terminals

CAT # MTS-82PC **\$1.25** each

25 for \$25.00 • 100 for \$90.00

ALUMINUM KNOBS

6 FLUTE DESIGN W/ INDICATOR LINE

Alcoknob # KA700B1/4

0.75" diameter X 0.63"

6-32 set screw. CAT # KNB-73



\$1.00 each • 25 for \$ 18.75

3 FLUTE DESIGN W/SKIRT AND INDICATOR LINE

Alcoknob # KS 500B1/4

0.5" dia. knob with 0.75" dia.

skirt. 0.63" high. 6-32 set screw.

CAT # KNB-75



\$1.00 each • 25 for \$ 18.75

7 Vdc MOTOR

Matsushita

MMX- 7AC O 8A

1.25" diameter x 1.25" high

motor. Prepped with 1.61"

diameter flywheel, pulley

and fiberglass mounting

board.

\$1.00

CAT# DCM-54

100 for \$80.00



2 1/2" 8 ohm SPEAKER



Special purchase of these 8 ohm, 1 watt speakers allows us to sell quantities at very special low prices. Mounting frame is 2.6" square. Overall depth, 0.75."

CAT# SK-251

\$1.25

10 for \$10.00

100 for \$75.00

1000 for \$ 600.00

9 VOLT 60 MA SOLAR PANEL



These 6" X 6" glass enclosed photovoltaic panels produce 9 Vdc at 60 ma. Ideal for charging batteries and powering small devices. Put two or more together for more current and voltage. Includes hook-up instructions.

CAT # SPL-960 **\$5.25** each

LASER POINTER



The "Infiniter"™ # QPON-670-210

Projects a bright red spot up to 100 meters. An excellent business or educational aid. Settings for continuous or flashing beam. LED indicator. Low battery indicator. Includes 2 AAA batteries. Hi-tech ergonomic gun-metal gray and black case.

CAT # LP-210

\$69.95 each

480 X 128 DOT LCD ASSEMBLY

Hitachi # LM215B

Originally built for Federal Express, these

brand-new assemblies consist of a

heavy-duty plastic display housing

with a metal mounting

bracket. Housing size:

13.18" X 4.93" X

1.2". Inside

the housing and

is easily

removable

is a stan-

dard Hitachi

480 X 128

graphic and

alphanumeric

display with

built-in drivers.

Requires an external

controller (HD61830 or equiv.).

Display area is 9" X

2.71." Module size is 10.6"

X 4.33". Includes spec.

and hook-up sheet.

CAT # LCD-24

\$32.00 each

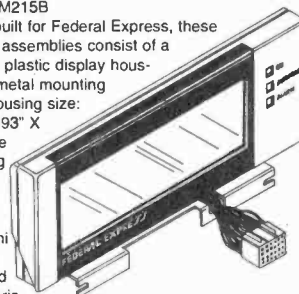

MANUFACTURERS - We Purchase EXCESS INVENTORIES... Call, Write or Fax YOUR LIST.

CALL, WRITE
or FAX For A
Free 64 Page
CATALOG.

Outside the U.S.A.
send \$2.00 postage.

ORDER TOLL FREE

1-800-826-5432

MAIL ORDERS TO:
ALL ELECTRONICS CORP.
P.O. BOX 567
VAN NUYS, CA 91408-0567

FAX (818) 781-2653
INFO (818) 904-0524

Minimum Order \$10.00 • All Orders Can Be Charged to Visa, Mastercard or Discover • Checks and Money Orders Accepted by Mail • Orders Delivered in the State of California must include California State Sales Tax • NO C.O.D. • Shipping and Handling \$4.00 for the 48 Continental United States - ALL OTHERS including Alaska, Hawaii, P.R. and Canada Must Pay Full Shipping • Quantities Limited • Prices Subject to change without notice.



CIRCLE 28 ON FREE INFORMATION CARD

ARE YOU BEING "BUGGED?"

OUR FINEST

Counter-Surveillance Device

THE ULTIMATE IN "BUG" DETECTION EQUIPMENT
"DEBUGS" ROOMS AND TELEPHONES!



EVEN AS YOU READ THIS, countless individuals and firms are being enormously damaged by having their private conversations overheard, monitored, and/or recorded.

Almost without exception and AFTER the fact, the victims make a statement something along the lines of "But, I never thought it would happen to ME!"

If you require GUARANTEED PROTECTION against electronic telephone monitoring devices and also require COMPLETE CONFIDENTIAL PRIVACY in certain rooms and areas, we highly recommend the COUNTER-SURVEILLANCE DETECTOR CSD-18.



CONDUCT A PROFESSIONAL SEARCH... ANYTIME...ANYWHERE!

Every newspaper and magazine article and every radio and TV story discussing some new episode involving "Bugging" devices, continues to increase the ever growing demand for electronic Counter-Surveillance "sweeps" and equipment. The very limited supply of competently trained and equipped

Counter-Surveillance specialists has created a situation where "sweep" rates exceeding \$250 per hour are now considered reasonable and appropriate.

This is an exciting, immensely interesting and profitable field that you can enter with a minimum investment. Two hours actual practice with the CSD-18 will have you "reading" and "clearing" telephones and rooms with professional ease and competence. The average fee for "debugging" a single telephone is over \$200.00. It requires about 45 minutes to complete the job and once it gets around that YOU can provide this service, you'll quickly have more clients than you can handle. Even if you choose to provide "sweeps" for only a small number of friends and associates, your initial investment will quickly be returned many times over.

FREE BONUS!

FASCINATING HI-TECH INFORMATION PACKAGE INCLUDED FREE!

LATEST EAVESDROPPING DEVELOPMENTS

A detailed analysis of a variety of extremely fascinating hi-tech devices and procedures used for ultra-sophisticated audio and video eavesdropping including infrared monitoring, multi-data eavesdropping and interception, miniature micro-wave devices, new methods for listening thru walls, etc., with many schematics included. You'll learn about electronic voice changers, corporate spying, how data banks are accessed to research anyone and anything, eavesdropping by neighbors; space age personnel and vehicle tracking systems, how missing persons are found, how lie detectors are deceived, and a fact-filled section on Eavesdropping Law.

BIG MONEY IN COUNTER-SURVEILLANCE

Complete information describing the fantastic opportunities that are now open to trained Counter-Surveillance technicians and exactly how a number of individuals and firms are reaping a huge bonanza in the booming "Debugging" business! You'll learn how the ever increasing use of Electronic Listening Devices by investigative agencies, government agencies, unscrupulous business competitors, jealous suitors, etc., has created a tremendous demand for this type of service.

A comprehensive information package JAM-PACKED FULL of some of the most exciting and fascinating reading imaginable. Reads like a James Bond novel, with one important exception...IT'S NOT FICTION!

EXTREME SENSITIVITY!

This is our finest piece of detection equipment! The CSD-18 quickly locates electronic eavesdropping devices in telephones, homes, offices, vehicles, boats, or concealed on the body. It will actually pick up many eavesdropping transmitters at ranges exceeding 25 feet! Extreme sensitivity is obtained via ultra-efficient amplification circuitry following the RF detection stages. Excellent quality Dynamic Headphones exclude all external sounds to further enhance detector output.

The presence of any "bug" is immediately indicated via a pronounced meter deflection. The CSD-18 quickly "homes-in" on eavesdropping transmitters and immediately pinpoints their location. The closer you get to the "bug", the further the needle moves to the right. It's as simple as that.



FULL RANGE DYNAMIC HEADPHONES

"FLASHING" LED Warns You Instantly!



And, for maximum telephone security, the CSD-18 automatically analyzes a sophisticated series of electronic measurements along the telephone line and converts the analysis into an easy to follow, step by step, test procedure. No technical knowledge is required or necessary. A visual indication (via a flashing LED) immediately reveals the presence of the various types of telephone "taps" and the flashing sequence identifies the actual type of eavesdropping device.

MAXIMUM SECURITY - EASY OPERATION!

Latest Computer-Age IC circuitry designed exclusively for maximum security and ease of operation, assures the utmost privacy protection possible today against virtually all types of room "bugs" and telephone "taps". The CSD-18 detects even the very latest ultra-sophisticated devices specifically designed to defeat detection via polarity negating circuitry. Also includes multi-line option for testing business telephones.

THE ONE "BUG" TO FEAR MOST!

While most individuals are now somewhat guarded in their telephone conversations, they still rather naively feel secure in the "privacy" of their own home or office. However, the most common type of tap presently used by eavesdroppers picks up ALL SOUNDS AND CONVERSATION WITHIN A ROOM...WITH THE TELEPHONE STILL ON THE HOOK!

Due to this devastating capability, this "Infinity" tap (variously referred to as Infinity Transmitter, Hookswitch Bypass, 3rd Wire, Harmonica Bug, etc.), has become the "bug of choice".

In flagrant violation of federal law prohibiting their use and sale, these devices in various forms are openly advertised in many technical publications for as little as \$75. Literally thousands of these devices are now in the hands of unscrupulous individuals all over the country!

In response to this ever-growing threat, a uniquely engineered feature of the CSD-18 now also detects Infinity type devices anywhere "down the line".

In other words, if anyone ... ANYWHERE ... is utilizing the telephone tip and/or ring wires to monitor your private room conversations while your telephone is on the hook, you'll immediately be made aware of it via a flashing LED!

100% POSITIVE INDICATION

The CSD-18 also flawlessly detects "Series" and "Parallel" telephone transmitters and "Telephone Recording Devices". And, a separate feature silently indicates when extension phones are picked up or being used. The CSD-18 completely eliminates all doubt and guesswork.

EXCLUSIVE "LISTEN-IN" FEATURE!

The CSD-18 will even allow you to "listen-in" to exactly what the eavesdropper is monitoring. And, without the eavesdropper ever becoming aware that he has been detected! We are unaware of ANY other detection equipment having this combined capability AT ANY PRICE!

MAXIMUM PROTECTION

The CSD-18 provides maximum protection against ALL major categories of surveillance equipment including:

ALL TYPES OF "CONCEALED TRANSMITTERS"
"BUMPER BEEPERS"
"INFINITY" DEVICES
"BODY" TRANSMITTERS
"TELEPHONE RECORDING DEVICES"
"SERIES" & "PARALLEL" PHONE TRANSMITTERS

CSD-18 \$295 Complete

including batteries, antenna/probe, headphones, all plugs & adapters, extensive information package and instructions.

HOW TO ORDER

Order NOW by Mail or Telephone. 10 DAY MONEY BACK GUARANTEE if you're not 100% pleased and completely satisfied. We pay shipping charges on all prepaid & credit card orders. Add \$15 for CODs.

(c) 1992 Great Southern Security

513 Bankhead Highway (SF)
Carrollton, Georgia 30117

FOR FASTEST SERVICE CALL TOLL FREE

ORDER BY PHONE 1 800 732-5000



Solutions for the Test Instrument

1 YEAR WARRANTY
15 DAY MONEY BACK GUARANTEE

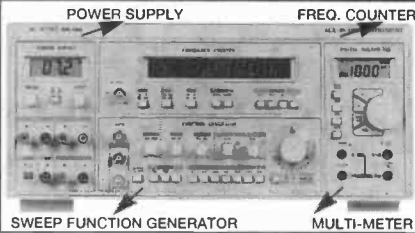

MT-100
Reg. \$599.
\$399.00

Four Instruments in One Instrument

- Function Generator**
 - Sine, Square, Triangle, Pulse, Skewed Sine, Ramp, TTL
 - 0.2 Hz - 2MHz
- Frequency Counter**
 - 8 Digit LED
 - 1 Hz - 100MHz
 - ± (1 Hz + 1 dgt. + Time Base Error)
- Power Supply**
 - 3-1/2 Digit LCD
 - Triple output: #1. 0-50V, 0.5A MAX #2, 15V, 1A #3. 5V, 2A
- Digital Multimeter**
 - 3-1/2 Digit LCD
 - DCV, ACV, Ω, DCA, ACA
 - ± (0.5% + 2 dgts)

FG-140 2MHz Function Generator
Reg. \$249. **\$149.00**

- 0.2 Hz - 2.0 MHz, 7 Decades
- Sine, Square, Triangle, Pulse, Ramp, Skewed Sine
- VCF, Symmetry
- Variable DC Offset Control

2MHz Sweep Function Gen. w/Freq. Counter
FG-150
Reg. \$399. **\$229.00**

- 4 Digit LED Display
- Sine, Square, Triangle, TTL, Pulse, Ramp, Skewed Sine
- Linear/Logarithmic Sweep
- 10 MHz Freq. Counter

1.0GHz Frequency Counter, High Resolution
FC-200
Reg. \$399. **\$209.00**

- 1.0 Hz - 1.0 GHz
- 8 Digit LED Display
- Auto & Manual Range
- 4 Selectable Gate Times
- 1MΩ & 50Ω Input Impedance

AG-350 Audio Generator
Reg. \$199. **\$119.00**

- 10 Hz - 1 MHz, 5 Ranges
- Sine Output: 10Hz - 1MHz
- Square Output: 10Hz - 100KHz

PS-500 DC Power Supply
Reg. \$249. **\$159.00**

- 0 - 30 VDC
- 0.1 - 3A
- Short & Overload Protection

PS-540 DC Power Supply
Reg. \$399. **\$289.00**

- 0 - 16 VDC
- 0.1 - 10A
- Short & Overload Protection

Deluxe O'scopes w/Phillips CRT. 2 yr. Parts/Labor Warranty

OS-3304
Reg. \$499.
\$339.00

OS-3304 25MHz, Dual Trace

- DC to 25 MHz. Dual Channel
- 6" Rectangular CRT with Internal Graticule 10x8cm (Phillips P31)
- Uncalibration LED.
- High Sensitivity 1 mV/div to 20V/div X-Y modes, Z Axis (intensity modulation)
- Rise time 14n Sec. or less.
- Full TV Trigger for TV-V & TV-H
- Acceleration Potential 2kV
- 60MHz (X1.X10) Probe Kit: 2 sets
- Power: 115/230V AC

OS-3315 40MHz, Dual Trace Sweep Delayed
Reg. \$799. **\$549.00**

OS-3324
Reg. \$599.
\$399.00

OS-3324, 3 Function

- OS-3304
- Dual Component Tester/Comparator
- Triple DC Power Supply 5VDC, +12 VDC, -12VDC

- DC to 40 MHz. Dual Channel
- Delayed Sweep 100nS to I.O.S.
- 7 decade
- 6" Rectangular CRT with Internal Graticule 10x8cm (Phillips P31)
- Uncalibration LED.
- High Sensitivity 1 mV/div to 20V/div X-Y modes, Z Axis (intensity modulation)
- Rise time 8.5nS or less.
- Full TV Trigger for TV-V & TV-H
- Acceleration Potential 12kV
- Variable Hold Off
- 16ns - 1.0s Time Base
- 60MHz (X1.X10) Probe Kit: 2 sets
- Power: 115/230V AC

OS-3344
Reg. \$899.
\$649.00

OS-3344, 5 Function

- + 2 + 3 • OS-3324
- Frequency Counter 100MHz, 7 Digit LED Display
- Function Generator 0.02 Hz to 2.0 MHz

Capacitance Meter Reg. \$79. **\$49.00**
Digital Clamp-On Reg. \$89. **\$54.00**

CM210
• 3 1/2 Digit LCD
• 0.1p - 20,000µF
• 9 Ranges
• 0.5% basic Accu.
• Zero Adjust Knob

DA400
• 400 Amp AC
• 3 1/2 Digit
• Auto
• Data Hold
• Continuity
• Over Range Mark
• Case Included

Multimeter+ Extended Range Capacitance
Reg. \$149. **\$89.00**

DM5050C
• 9 Function / 42 Range
• Basic DCV Accu.: ± 0.25%
• Multimeter Volt: AC/DC Amp: AC/DC 2A Ohm: Up to 2000MΩ Diode, Continuity Beeper
• Capacitance (9 Range) 0.1pF - 20,000 µF Zero Adj. Knob
• Trig Lamp
• Double Insulated Jack
• Alligator Clip Test Leads
• Deluxe Holster w/Strap

Wide Range Multimeter w/Logic
Reg. \$149. **\$89.00**

DM5100
• 11 Function / 45 Range
• Basic DCV Accu.: ± 0.25%
• 3 1/2 Digit Manual
• Auto Power Off
• Data Hold & Peak Hold
• Amp: Up to 20A AC/DC
• Ohm: Up to 200 MΩ
• Freq: Up to 20MHz
• Capacitance: 1p - 200µF
• Logic: TTL
• TR hFE, Diode
• Continuity Beeper
• Double Insulated Jack
• Alligator Clip Test Leads
• Deluxe Holster w/Strap

Oscilloscope Probe Kit
Switch Selectable X1/X10

HP-9060, 60MHz
Reg. \$29. **\$17.00**
HP-9150, 150MHz
Reg. \$49. **\$24.00**
HP-9250, 250MHz
Reg. \$59. **\$32.00**

Pen-Type DMM w/Logic
Reg. \$79. **\$59.00**

DM150
• 3 1/2 Digit
• Dual Display
• Auto & Manual
• DCV, ACV, ACA, DCA, Ω
• Logic CMOS/TTL
• Data Hold
• Diode
• Continuity

DMM w/Holster
Reg. \$59. **\$39.00**

DM2500
• 3 1/2 Digit
• 1.5" Big LCD
• 10A AC/DC AC/DC V, Ω
• Signal Injector
• Diode
• Continuity
• Holster

Multifunction DMM
Reg. \$89. **\$59.00**

DM3050
• 3 1/2 Digit
• 1.5" Big LCD
• Heavy Duty, 20A AC/DC
• Capacitance
• Frequency
• TR-hFE
• Diode
• Continuity
• Holster

BMC Your Best Source for High Standard Electronics
20 Highpoint, Dove Canyon, CA 92679

Order & Free Catalog
800-532-3221
(714) 586-2310 Fax (714) 586-3399



DALBAVI

CALL • FAX
OR WRITE
FOR A FREE
CATALOG



THE ULTIMATE SAVING SOURCE

(305) 716-1016

4225 N.W. 72nd Ave., Miami, Florida 33166 FAX (305) 594-6588

CIRCLE 151 ON FREE INFORMATION CARD



Serving the public since 1981

XANDI ELECTRONICS

1270 E Broadway Rd. # 113, Tempe AZ 85282

SATISFACTION GUARANTEED!

BUY WITH CONFIDENCE FROM XANDI

• 30-DAY REFUND POLICY

• TECH SUPPORT NUMBER

(602-894-0992)

- Tunes 88-108 MHz.
- Powerful 2 stage audio amplifier.
- Sensitive, picks up sounds at the level of a whisper.
- Up to 1 mile range.
- Requires 9V battery. (Not incl.)



SUPER-MINIATURE FM TRANSMITTER

Super small FM transmitter. Use with any FM broadcast receiver. Easy to assemble, all chip (SMT) parts are pre-assembled to the circuit board.

XST500 (E-Z) Kit \$44.95

- Miniature photo battery mounts right on circuit board. (Included)
- Tunes 88-108 MHz.
- Up to 1/2 mile range.
- Sensitive 2 stage audio amplifier, picks up sounds at the level of a whisper.



MICRO-MINIATURE FM TRANSMITTER

Including the battery, this is the Worlds smallest FM transmitter. Use with any FM broadcast receiver. Easy to assemble, uses pre-assembled circuit board.

XWB1000 E-Z KIT \$49.95

- Transmits at 143 MHz.
- Up to 1 mile range.
- Miniature photo battery mounts right on circuit board. (Included)
- Amazing audio sensitivity, picks up sounds at the level of a whisper.



CRYSTAL CONTROLLED FM TRANSMITTER

Including the battery, this is the Worlds smallest crystal controlled FM transmitter. Transmits to any scanner type receiver. Easy to assemble, uses pre-assembled circuit board.

XTL1000 E-Z KIT \$69.95

- Smallest Phone transmitter anywhere!
- Tunes 88-108 MHz.
- No batteries required, powered by phone line.
- Up to 1/4 mile range.
- Attach to phone line anywhere in house, even inside phone.



SUPER-MINIATURE PHONE TRANSMITTER

Worlds smallest FM phone transmitter. Use with any FM broadcast receiver. Easy to assemble, all chip components are pre-assembled to the circuit board.

XSP250 (E-Z) Kit \$34.95

- Dial your phone from anywhere and listen to the sounds inside your home.
- Two digit Touch Tone code for secure operation.



TELEPHONE SNOOP

The latest in home or office security. Call home from anywhere, enter a two digit security code, and hear the sounds in your home. Automatically turns on without ringing the phone. Verifies code, then activates for one and a half minutes.

XPS-CASE KIT \$13.95

XPS1000 (C) KIT \$49.95

- Transmits a continuous beeping tone.
- Adjustable from 88 to 108 MHz.
- Up to 1 mile range.
- Works with any FM broadcast receiver.



TRACKING TRANSMITTER

Only 0.7 by 2.4 inches, the XTR100 operates at voltages of 3 to 18 Volts and is ideal for use in locating lost model rockets, bicycles, automobiles, games of hide and seek, and contests.

XTR100(C) Kit \$33.95

- Uses sensitive microwave transistor amplifier.
- Covers 1 to 2,000 MHz.
- Compact hand held unit.
- Includes miniature loud speaker for audio indication of detected signals.



SUPER SENSITIVE BUG DETECTOR

When the XBD200 intercepts a signal in the 1 to 2,000 MHz range, it emits a growl that increases to a high pitched squeal as the signal strength increases.

XBD200(C) Kit \$49.95

- Use with any FM broadcast receiver.
- Hear every sound in an entire house!
- Up to 1 mile range
- Powerful 2 stage audio amplifier.



MINIATURE FM TRANSMITTER

The XFM100 has a super sensitive microphone and is capable of picking up sounds at the level of a whisper and transmitting them to any FM broadcast receiver.

XFM100(C) Kit \$32.95

- Digital voice changing: male to female, female to male, adult to child, child to adult.
- Anonymity on any call.
- Button for normal operation.
- 16 levels of voice masking.



VOICE CHANGING TELEPHONE

STOP THOSE ANNOYING TELEPHONE CALLS! Sound older and tougher when you want to. Not a kit. Fully assembled. Single phone operation only.

TRANSITION 2000 \$89.95

- Digital voice changing: male to female, female to male, adult to child, child to adult.
- Use with any modular phone.
- 16 levels of voice masking.
- Connects between handset and phone.



VOICE CHANGING ACCESSORY

STOP THOSE ANNOYING TELEPHONE CALLS! Sound older and tougher when you want to. Not a kit. Fully assembled. Use with single or multi-line phones.

TRANSITION 2001 \$59.95

- Uninterrupted coverage of 800 to 950 MHz.
- Works with any scanner that can receive 400 to 550 MHz.



800-950 MHz SCANNER CONVERTER KIT

If your scanner can receive 400-550 MHz, just add the XLC900 for uninterrupted 800-950 MHz coverage. It converts all 800-950 MHz signals down to 400-550 MHz so your scanner can receive them! Add our custom case kit for that "Professional" look.

XLC-CASE KIT \$13.95

XLC900 (C) KIT \$49.95

- Transmit high quality stereo to any FM stereo receiver.
- Built-in output level monitor for quick and easy tuning.
- Ideal for use with personal CD player.

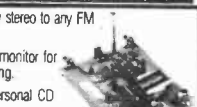

FM STEREO TRANSMITTER

Transmit full-bodied Hi Fi stereo to any FM stereo receiver. Separate left and right inputs and gain controls. Includes an output booster stage for greater range.

XFS-CASE KIT \$13.95

XFS108 (C) KIT \$41.95



WE ACCEPT VISA, MC, MO, CDD
SHIPPING & HANDLING EXTRA

TOLL FREE ORDER LINE

1-800-336-7389

ASK FOR FREE CATALOG OF OUR PRODUCTS

SEND MAIL
ORDERS TO:

XANDI ELECTRONICS
BOX 25647
TEMPE, AZ 85285-5647

CIRCLE 134 ON FREE INFORMATION CARD

Digital Storage Oscilloscope For \$169.95 ???

And much, much more!

O-Scope I turns PC-ATs into DSO, spectrum analyzer, frequency counter, DVM. DC-50KHz

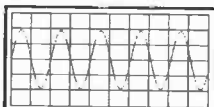

Sinewave Sweep

Actual O-Scope
Signal Traces

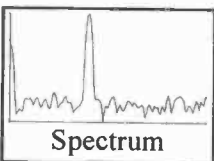

Spectrum

For Orders and Inquiries Call: 1-800-980-9806
For Technical Assistance: 1-713-777-0401

Allison Technology Corporation
8343 Carvel, Houston, TX 77036
FAX and BBS 1-713-777-4746

NOW! A QUALITY SATELLITE SCPC AUDIO RECEIVER

AT AN AFFORDABLE PRICE



UNIVERSAL SCPC-100 AUDIO RECEIVER

SPECIFICATIONS

STABLE, MICROPROCESSOR CONTROLLED TUNING. • 50 CHANNEL MEMORY RECALL. • COMPATIBLE WITH 950-1450 BLOCK SYSTEMS. • 3 MINUTE HOOK-UP. • LARGE L.E.D. TUNING SCALE. • RECEIVES C AND KU BAND SCPC. • DOES NOT DISABLE VIDEO WHEN IN USE.

SERVICES ON SCPC

HUNDREDS OF QUALITY SCPC CHANNELS ON SATELLITES - SPORTS - AP - UPI - RADIO NETS - HOME TOWN SPORTS & RADIO - RACING - TALK SHOWS - CLASSICAL, ROCK & JAZZ - RADIO STATIONS - FINANCIAL NEWS AND MORE.

INTRODUCTORY PRICE \$439 + S&H
TO ORDER CALL: 1 - 800 - 241-8171

UNIVERSAL ELECTRONICS, INC.
4555 GROVES RD., SUITE 13, COLUMBUS, OH 43232
(614) 866-4605 FAX (614) 866-1201

AMPLIFIED SPEAKER PAIR

These units have excellent audio for their small size (approx. 3" x 3" x 5") and are loud enough, too. A 3.5mm stereo plug brings the audio in, and each speaker has its own volume control. They run on 6VDC (four "C" batteries) or an external 6VDC wall transformer. (94V007) **\$9.95/pair**

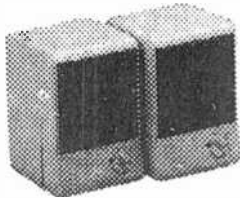

Soundblaster Compatible!

SOUND CARD

Features include: Adlib™-compatible 11-Voice FM music; digitized voice input and output; DMA and hardware decompression; full duplex MIDI interface; joystick port; stereo audio I/O; microphone and line-in jacks; and power amplifier and volume control. Windows software included. (94C038) **\$49.95 each**

PRINTER STAND

Fully adjustable. Saves space. Paper tray. Non-slip rubber feet. Free paper trimmer included. Limited lifetime warranty. (PL-2) **\$5.50 each**

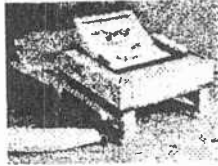

SUPER MOUSE

This mouse comes with its own house - a pocket to hang on the side of your computer for storage. Three buttons with hi-res microswitch type click switches, 400 DPI. Comes with its own mousepad, DB9 to DB25 adapter, DOS and Windows compatible software on both 3.5" and 5.25" disks. (MUSGD) **All for \$9.95**

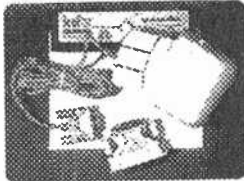

FAMOUS MAKER EARPHONES

Lightweight foam earpads for comfort. Four foot cable ends in 1/8" stereo plug. (94V006) **\$4.95 each**

BLACK TELEPHONE HANDSET

Electret condenser mike, 600 Ohm impedance earphone, 1' curly cord. (94U022) **\$3.95 each**



HELPING HANDS MAGNIFIER

Ball joints on all angles. Nickel-plated fittings. Heavy cast iron base. 2X 2.2" magnifying glass. Alligator spring clips. Locks at any angle. (93U002) **\$5.95 each**



"THE BOX"



There's not much inside this well-made box except for a 54 VCT transformer fused at 5Amps on the secondary. Plenty of room to add rectifiers and regulators. 5 1/2" x 3" x 6 1/2". (94U029) **\$12.95 each**

AIRPAX MINI STEPPER MOTOR

15 deg./step/ 1" diameter. Has mounting ears and small pulley attached. (94M002) **\$1.50 each - 12 for \$9.95**



FUSES

- 10 Amp 250 Volt 3AG fast blow. (94B011)
 - 1.25 Amp 125 Volt 30mm glass. (94B012)
- Your Choice - 100 for \$9.95**

VOLTAGE REGULATOR SALE!

- 7808T • 7812T • 7812K • 7815T • 7818T
 - 7905T • 7912T • 7915T • 7918T
- Your Choice - 49¢ each**

- LM309 - \$1.15
- LM317T - 59¢
- LM317K - \$3.45
- LM337K - \$3.85
- LM338K - \$4.25
- LM345K5.2 - \$1.89
- LM350K - \$3.25

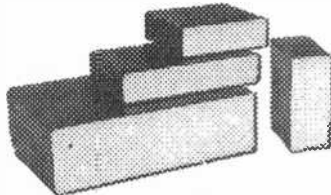

STEEL ENCLOSURES

Features include ventilation holes, self-adhesive rubber feet. Front and rear panels are 0.05" aluminum alodine painted white. Top and bottom covers are 0.04" phosphated steel painted black.

- CG3119A (2.5" x 6" x 7") **\$14.00**
- CG3119B (2.5" x 12" x 7") **17.00**
- CG3119F (2.5" x 17" x 11") **21.00**
- CG3119G (3.5" x 8" x 7") **15.00**
- CG3119K (3.5" x 17" x 11") **26.00**
- CG3114P (5.2" x 17" x 11") **33.00**

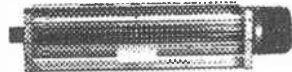

24 VOLT SQUIRREL CAGE FAN

Draws 150mA @ 12VDC or 300mA @ 24VDC. Measures 12.5" long by 2.75" tall by 3.125" deep. (94F006) **\$11.95 each**

SATELLITE TV RECEIVER

70MHz IF type with Dolby stereo, lots of goodies including IR remote control transmitter and receiver, IF strip, power supply, coax connectors, power cord and more. Manufactured by Curtis-Mathes. (94G002) **All for \$9.95**

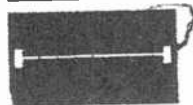

BRAND NEW SOLAR PANELS

- 4Volt, 0.5 Watt, 3" x 5" (92E003) **\$7.95**
 - 12 Volt, 1 Watt, 4" x 12" (92E005) **\$14.95**
 - 12 Volt, 2 Watt, 6" x 12" (92E006) **\$124.95**
 - 12 Volt, 4 Watt, 12" x 12" (92E007) **\$39.95**
- Other sizes and voltages available. Call of fax for stock check.

OEM pricing and custom panels available.

"KHP" SIZE RELAY

DPDT, 24VDC coil, 10A contacts. (94B013) **\$2.00 each**



COMPUTER POWER CENTER

Individually lighted control switches. Lighted master on/off switch. Five heavy duty grounded power outlets controlled individually by front panel switches (Computer, Monitor, Printer, Aux1, Aux2). 15A circuit breaker. (94C006) **\$14.95 each**

RED GLYPTAL INSULATING VARNISH

2-oz. bottle. (94Z034) **\$1.99 each**

FOLDING LOCK KNIFE

Stainless steel blade, 5" open, 3" closed. Wood and brass handle. (94Z032) **\$1.49 each**



1N5818 SCHOTTKY DIODE

30 PIV, 1A. (92S027) **69¢ each - 100 for \$24.95**

NEC NE710 FET

Ku-K Band GaAs. (92S073) **\$9.95 each**

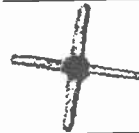

STRAIGHT-TIP HEMOSTAT

Stainless steel, serrated jaws, locking handles. Grip and pull or hold small things together while securing them. These make excellent heatsinks for delicate soldering work. (635FS) **\$2.99 each**

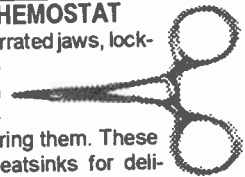

VISA, MC, Amex cards accepted. Minimum order \$15.00. CA & OH residents add local sales tax. Shipping additional on all orders.



ALLTRONICS

2300 Zanker Road - San Jose, CA 95131
(408) 943-9773 - Fax (408) 943-9776

24-Hour BBS
(408) 943-0622
9600 Baud - N-8-1

020495

Tap into a World of...

FREE ELECTRICITY

Our 150+ page *Self-Reliance Catalog* IS JUST LOADED WITH DC to AC ENERGY INDEPENDENCE ...

We offer:

Solar, Wind & Hydroelectric energy systems. True Sine Wave DC to AC Inverters. Electric Boat & Car kits. Portable power packs. Solar Lighting & Cooling systems. Solar Pool Heaters. Solar Battery chargers. Solar Books & Toys. DC Appliances. Active & Passive Solar Air & Water Heating Systems. Composting Toilets. Hydroponic, Fish-Farming, Solarium & Greenhouse Systems. Water Testing, Treatment, & Pumping Systems. Emergency Food & H₂O Kits. High Efficiency AC/DC Refrigeration + More...

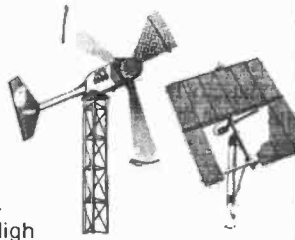

A LOT OF INFORMATION FOR ONLY \$5.75 ...

SEND CHECK or MO TO:

Self-Reliance Company Inc.

P.O. Box 306, Florissant, MO 63032



CABLE TV Converters & Descramblers

Compatible with
**Jerrold, Scientific Atlanta,
Pioneer, Oak, & Hamlin
Equipment**

BRAND NEW!

6-MONTH GUARANTEE

LOWEST PRICES

Volume Control & Parental Lockout Available

Greenleaf Electronics

1-800-742-2567

NO ILLINOIS SALES

It is not the intent of Greenleaf Electronics to defraud any pay television operator and we will not assist any company or individual in doing the same.

TENMA™

*If you service electronics -
TENMA should be on your bench*

TENMA, "The Worlds Most Affordable Test Equipment", has emerged as the top choice among service technicians. All products, such as the new TENMA True RMS DMMs, are engineered to meet the exacting standards of todays service professional. Whether your needs are for a DMM, precision power supply, or oscilloscope, let TENMA be your test equipment source.



True RMS Benchtop DMM



True RMS DMM

Look to MCM Electronics for the complete TENMA test equipment picture. MCM is the one stop shop for all of your needs. You'll find over 21,000 items, including test equipment, repair parts, semiconductors, service tools and more, stocked and ready to ship within 24 hours. Call today for your free 324 page MCM catalog and discover the MCM difference.



FREE CATALOG

New Hours: M-F 7a.m. - 9p.m.,
Sat. 9a.m. - 6p.m. EST
Over 21,000 items stocked and shipped
within 24 hours



MCM ELECTRONICS™
650 CONGRESS PARK DR.
CENTERVILLE, OH 45459-4072
A PREMIER Company

FREE Catalog, call toll free:
1-800-543-4330
Product questions: 1-800-824-TECH(8324)

GET FAST DELIVERY FROM OUR DISTRIBUTION CENTERS IN DAYTON, OH AND RENO, NV!

POP-17

CIRCLE 150 ON FREE INFORMATION CARD



818-913-6735

ORDER TOLL FREE

1-800-669-4406

24 hr. Fax: 818-912-9598

LASER POINTER

The "Infiniter" "210" Laser Pointer's high-tech, lightweight aluminum housing, incorporates a mode switch which allows you to select between a solid beam or flashing beam to enhance any presentation. Projects over 150' and even works well on overhead projection screens. Great for the conference room, exhibition hall, construction site, museum, etc.

#MI-16-0007 \$69.95



DIGITAL VOICE MODULE

The DVM-58D has variable length message capabilities and can store up to 16 individual messages for immediate playback. Use it to add real voice prompting or instruction to any project, via the mic. input. Standard 1Mb DRAM (32 sec.) on-board with options to expand up to 16Mb (8 min.)

#MI-10-5858 \$89.95
1Mb DRAM \$5.15
4Mb DRAM \$21.95

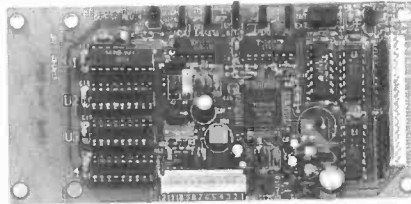

RF ENCODER + TRANSMITTER MODULES

The TX-01 Motherboard can encode a 12-bit address code with 4096 possible code combinations or can be used to encode an 8-bit address code with a 4-bit data code.

#MI-10-001E \$9.95

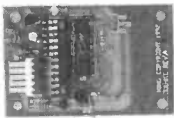

+

The TX-99 interfaces with the TX-01 as the RF carrier module. 300 MHz AM with a typical range of 100' line-of-sight. (A key-chain transmitter is also available)

#MI-10-9903 \$5.95



RF RECEIVER + DECODER MODULES

The RE-99 interfaces with the RE-01 as the RF carrier's receiver module and requires only a few solder connections to mate the two. 300 MHz AM.

#MI-10-9904 \$6.95



+

The RE-01 Motherboard will decode a 12-bit address or 8-bit address with 4-bits of data, depending on which of the two included IC's is installed into the board.

#MI-10-001D \$14.95



PC INTERFACE CARD PROTECTOR

The Data Genie P-300 is a device that allows quick and easy installation of add-on cards or prototype circuits for testing externally on your PC without having to turn off the computer. The P-300 maintains complete protection for your motherboard via the built-in current limit fuses. Adds 3 expansion slots.

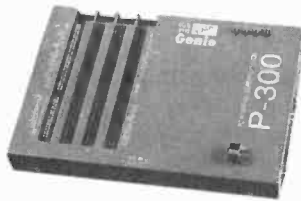

#MI-12-P300 \$349.95

PIR DETECTOR

The Medusa Passive Infrared Detector has been tested at 20V/m over the frequency range 20 to 1000 MHz, proving that the unit has ultra-high RFI protection and reliability. With N.C contacts including tamper plus a selectable pulse count of 1, 3 or 5, the Medusa makes for confident installations.

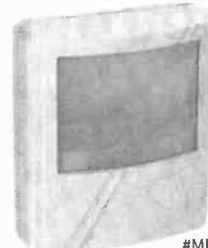

#MI-11-3300 \$24.95
3+ at \$19.95 each.

IC TESTER/IDENTIFIER

The Data Genie HT-28 is a portable, stand-alone IC tester and identifier. It can test and identify most TTL 74 and CMOS 40/45 series of IC's as well as being able to test 4164-411000 and 4416-4425 series of DRAM's. Powered from the included AC adapter or optional alkaline batteries (4-"AA").



#MI-12-2800 \$189.95

Now Available

'95 SPRING/SUMMER Catalog

- X-10 Security Systems & Accessories
- Syntax Prototyping Boards
- Holtek Encoder/Decoder IC's, Sound Effect IC's & other components.
- Data Genie Test Equipment and much, much, more!

If you are a past or current customer, you will soon be receiving your copy by mail.

For
Technical
Support
Call:

(818)
912-9864

ORDER BY MAIL:

ELECTRONICS 123
17921 ROWLAND ST.
INDUSTRY, CA 91748

S&H Charges Continental US, up to 3 lbs. Add:

UPS Ground \$ 6.00
UPS 3-Day \$ 8.00
UPS Blue \$10.00
UPS Red (Next Day) \$20.00
COD's Add: \$4.50
Calif. Orders Add: 8.25% Sales Tax

S&H Charges Canada, up to 3 lbs. Add:

US Postal, First Class \$ 10.00
Prepayment by credit card required.
Sorry No COD orders.

(S&H Charges INTERNATIONAL: Call/Fax for quote.)

All prices subject to change without notice.

New and Pre-Owned Test Equipment

SALES • RENTALS • SERVICE

Substantial Savings on new & pre-owned Fluke, Hewlett Packard, Leader, Tektronix and more ...

LEADER
FOR PROFESSIONALS WHO KNOW THE DIFFERENCE

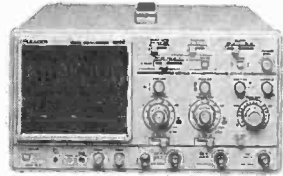

We buy surplus Electronic Equipment. Fax us your list!

*** Pre-Owned Oscilloscope Specials ***

Tektronix 465 100 MHz.....\$499.00
Tektronix 465B 100 MHz.....\$599.00
Tektronix 475 200 MHz.....\$679.00

Fully refurbished and calibrated to original specifications

OSCILLOSCOPES		Reg. \$
8020	20 MHz 2-Ch. High Sens., TV Sync.....	\$525.00
8060	60 MHz 3-Ch. Dlyd. Swp., TV Sync.....	\$1,345.00
8100	100 MHz 2-Ch. Dlyd. Swp., TV Sync.....	\$1,595.00
FREQUENCY COUNTERS		
LDC-822	80 MHz, 7 digit, 5 ppm.....	\$395.00
LDC-823S	250 MHz, 8 digit, 1 ppm.....	\$595.00
FUNCTION & RF SIGNAL GENERATORS		
LFG-1300S	2 MHz Sweep/Function Generator.....	\$575.00
LFG-1310	10 MHz Sweep/Function Generator.....	\$1,095.00
POWER SUPPLIES		
LPS-151	Triple Output, +6V/3A, +/- 25V/0.5A.....	\$555.00
LPS-152	Triple Output, +6A/5A, +/- 25V/1.0A.....	\$645.00

Sale

Call for latest sale price!

Full line of Oscilloscopes, Video & Audio Test Equipment, Power Supplies, Probes and Accessories. Call for a FREE Line Catalog!



TOLL FREE 1-800-99-METER

For more GREAT VALUES Call, Write or FAX • P.O. Box 708, Medford, MA 02155 • FAX (617) 665-0780

FOTRONIC CORPORATION

Electronics made Easy with UCANDO



UCANDO's unique computer animation makes learning electronics fast and easy. These videos will...allow you to learn at your own pace...help you remember more of what you learn ... give you years of quality use... become a valuable source of reference material...make your understanding of electronics complete ... and help you build your future today. **Call today and see how UCANDO is...**

"Changing The Way The World Learns Electronics."

New Release!!!

VT102 Introduction to VCR Repair	\$44.95
VT103 VCR Maintenance & Repair	\$29.95
VT201 Direct Current	\$44.95
VT202 Alternating Current	\$44.95
VT203 Semiconductors	\$44.95
VT204 Power Supplies	\$44.95

VT404 Television Part 1 \$44.95

VT205 Amplifiers	\$44.95	VT305 Digital 5	\$44.95
VT206 Oscillators	\$44.95	VT306 Digital 6	\$44.95
VT301 Digital 1	\$44.95	VT401 AM Radio	\$44.95
VT302 Digital 2	\$44.95	VT402 FM Radio Part 1	\$44.95
VT303 Digital 3	\$44.95	VT403 FM Radio Part 2	\$44.95
VT304 Digital 4	\$44.95	VT501 Fiber Optics	\$44.95

SAVE!!! Buy any 6 videos for only \$240 ... SAVE MORE!!! Buy any 12 videos for only \$450

Call toll-free 1-800-678-6113

or mail check or money order to:

UCANDO Videos, P.O. Box 928, Greenville, OH 45331

FREE Shipping ... FREE Catalog



CIRCLE 136 ON FREE INFORMATION CARD

AMERICAN RELIANCE

AMREL Offers Lowest Prices & Best Warranties on DC Power Supplies ANYWHERE!

3 YEAR WARRANTY



AMREL Offers Superior Analog Power Supplies Starting as Low as \$149.00

- Low Output noise rating less than 0.3mV.
- Line/load regulation rated at low 0.01% + 1mV.
- Transient response time of 50µ Sec.
- Overload protection, and Output enable/disable.
- Coarse and fine voltage/current adjustment.
- Auto series/parallel operations for triple output supplies.

3 YEAR WARRANTY

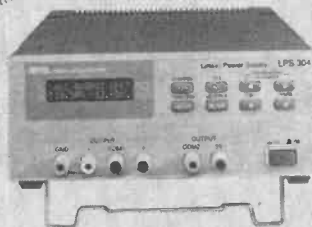

AMREL Offers Features And Prices on Digital Power Supplies That The Competition Can't Beat!

- Microprocessor controlled.
- User friendly keypad data entry.
- Low output noise rating less than 1mV.
- Line/Load regulation rated less than 2mV.
- Output enable/disable and Power off memory.
- Optional RS-232 interface capability.

Model	LPS-101	LPS-102	LPS-103	LPS-104	LPS-105	LPS-106	LPS-301	LPS-302	LPS-303	LPS-304	LPS-305
Rating	30V/1A	30V/2A	30V/3A	+30V/1A -30V/1A 3-6.5V/3A	+30V/3A -30V/3A 3-6.5V/3A	60V/1A	15V/2A(H) 30V/1A(L)	5V/4A(H) 30V/2A(L)	30V/3A	+30V/1A -30V/1A 5V/2A	+30V/2.5A -30V/2.5A 3.3-5V/3A
List Price	\$195	\$225	\$295	\$395	\$495	\$245	\$249	\$299	\$369	\$399	\$599
Sale Price	\$149	\$179	\$199	\$375	\$469	\$219	\$199	\$285	\$350	\$379	\$569

PRINT™
Products International Inc.



Call: 1-800-638-2020



8931 Brookville Road • Silver Spring, Maryland 20910 • Fax: 800-545-0058

CIRCLE 46 ON FREE INFORMATION CARD

NOW Find the Right Part for Your VCR!



with the ISJET VCR CROSS REFERENCE

NEW! The Fourth Edition is contained on a diskette for IBM PC AT/XT compatibles, DOS 2.1 or higher. The disk software allows technicians to search by manufacturer for model numbers and description of part numbers. A parts editing sequence gives an on-screen view of all substitutes for parts entered. With the diskette, the technician can update files by adding model and parts

The 320-page, Fourth Edition of the VCR Cross Reference contains both model and part number cross references. Over 1300 new parts and 360 new models have been added.

VCR's are made in a few factories from which hundreds of different brand names and model numbers identify cosmetically-changed identical and near-identical manufactured units. Interchangeable parts are very common. An exact replacement part may be available only a few minutes away from you even though the original brand-name supplier is out of stock. Also, you may be able to cannibalize scrap units at no cost.

crosses of future models. The Fourth Edition can be printed on pages completely from the diskette.

The ISJET VCR Cross Reference, Fourth Edition, is on 8½ × 11-in., pre-punched pages and sells for \$36.00. The 3¼ inch diskette sells for \$69.95 and you can view listings from a monitor or printed page.

Only \$36.00 for pages
\$69.95 diskette

Claggk Inc.
VCR CROSS REFERENCE OFFER
P.O. Box 4099
Farmingdale, New York 11735

Name _____
Business _____
Address _____
City _____
State _____ Zip _____
Phone _____

Enclosed \$36.00 for the ISJET VCR Cross Reference, Fourth Edition.

Enclosed \$69.95 for the diskette containing the ISJET VCR Cross Reference, Fourth Edition. Please specify:

5¼ Diskettes (2) 3¼ Diskette (1)

Include \$3.00 for shipping each Cross Reference (Pages or Diskette)

The total amount of my order is \$ _____

Check enclosed—do not send cash.

Visa MasterCard Exp. Date ____/____/____

Signature _____

New York State residents must add applicable local sales tax to total.

April 1995, Popular Electronics

TOP SECRET

CONSUMERTRONICS
2011 Crescent Dr., P.O. Drawer 537
Atamogordo, NM 88310

Voice: (505) 434-0234, 434-1778,
439-1776 (orders only) 8AM-6PM MST, Mon-Sat

Fax: (505) 434-0234 (orders only; if you get
voice, enter #11 #11 any time) 24-hour, 7 days/wk

Free Tech Support (relates directly to your
order or prospective order): Tues. and Thurs. only.

10% Off on orders \$100+; 15% Off over \$200.

Add \$5 total SH (US, Canada). All items in stock. VISA,
MC card OK. No CODs or "bill me's". New Catalog (150+ offers)
\$2 w/ order, \$4 w/b (check or MO) - NO free catalog.

NO dealers. Since 1971. As seen on CBS "60 Minutes",
Forbes, etc. By John Williams - former Lockheed Senior
Engineer, NMSU Computer Science Professor, NIH Health
Physicist. Wanted: 9 MAC IIci, PC386, better - buy, trade.

*All software supports all IBM-PC compatible
x86 systems (8088 - Pentium)

Off-The-Shelf HARDWARE

Van Eck System, Data Card Reader/Filer, ATM2,
KK Radar Emitter, Street Sweeper (radar), Lidaro,
Carjack/Kidnap Follower, Voice Disguiser, Hearing As-
sistors, Shirk Module, EM Lab & Countermeasure,
TENS, 6th Sense Communicator, Phone Color Box,
Lineman's Handset, DTMF Decoder, Bug & Tap De-
tector/Blaster, Subliminal Mixer/Amp, NeuronPhone/
Rife/Hieronymus/Resonant Crystal Radionic, Magne-
tometer, Levitator, Vortex Generator, RF & Mi-
crowave, Ultrasonic Jammer & Receiver, Infrared
Detector, Long-Range Eavesdropper, Noise Cancel-
ling System, Unknown Presence Detector, Electro-
nic Downer - many more devices. See Catalog.

CELLPHONE MODIFICATIONS

See our Catalog for our infamous cellphone modifica-
tion guide (\$69) - detailed, comprehensive, covers all
makes - 10 times more info than competitor's "hardw-
(Do Special Projects (below) for up-to-date hardware
software)

SPECIAL PROJECTS

We design, build, repair, modify, maintain and/or consult
on any device, system, process or project - electrical,
electronic, computer, phone, mechanical, optical, auto-
motive. Invention prototyping. Confidentiality guaran-
teed. Describe and include \$25 pre-engineering fee
(does not obligate you). Time and cost estimates in 7-10
days.

The HACKER FILES

Compilation of 100s of the best articles written (in
ASCII) by top hackers & phreakers. Covers every major
topic in hackerdom! 3 HD Disks* \$59.

VOICE MAIL HACKING

How Voice Mail Box (VMB) systems are used and the
specific ways they are hacked. Includes ASPEN, MES-
SAGE CENTER, BIX, GENESIS, EZ, SYDNEY, PHONE
MAIL, AUDIX, CINDY, CENTAGRAM, SPERRY LINK,
RSVP, etc. Absolutely required for all users, sysops and
security personnel \$29.

PBX HACKING

1000s of PBXs are hacked to the tune of \$ billions/yr!
While "VOICE MAIL HACKING" details how VMBs are
hacked for "phun" and profit - including VMS methods
for hacking PBXs themselves - "PBX HACKING" ad-
dresses ALL issues relating to PBX hacking, including
countermeasures! Can your business or agency afford a
\$90,000 phone fraud loss (the average loss due to
hacked PBXs)? As described in Forbes Magazine. \$39

PHREAKING CALLER ID & ANI

Details on how they work and dozens of effective ways
of defeating Caller ID, ANI, #69, #57, and Call Blocking
and #67. Also describes Caller ID, Orange, Beige,
Cheese and CF Boxes, ESS, S57, E-911, various
CLASS services, CWA, NON PUB DA, CANA, DNR,
800-ECR Diverters, Extenders, Calltrax - more. \$29.

Beyond PHONE COLOR BOXES

Dozens phone color boxes described - many circuits.
Plus Call Forwarding, Conferencing, Phreak History,
Glossary, Diverters, Extenders, REMOBS, Bridg-
ing Heads & Cans, Optocom, 3rd Party and many other
non-box methods - more. \$39.

ROBOFONE AUTODIALER

Powerful, versatile, menu-driven Wargames autodialer
lets you dial any quantity (up to 10K) or mix of local/
long distance numbers in any order, over any length of
time, whether busy or answered (your choice) and log
the times, commands and results to monitor, printer
and/or disk. Quick-dial directory of up to 600 numbers.
BUSY redial options. Direct modem command and con-
trol. All Result Codes, including VOICE and RINGING.
Optional shell to terminal program upon CONNECT. Exit
to menu or DOS (for batching). Manual + Disk* \$29.

COMPUTER PHREAKING

Describes in detail how computers penetrate each other,
and how VIRUSES, TROJAN HORSES, WORMS, etc are
implemented. Dozens of computer crime and abuse
methods and countermeasures. Includes disk filled with
hacker text files and utilities, and the legendary FLU-
SHOT+ protection system (Ed. Choice, PC Magazine).
BBS advice, password defeats, glossary - much more!
Manual + Disk* \$39.

Beyond VAN ECK PHREAKING

Eavesdropping on IV and computer video signals using
an ordinary TV! Includes security industry reports.
Range up to 1 KM. Plans include both the Consumer-
tronics and the original Top Secret Van Eck designs!
Order Today! (805) 439-1778

STOPPING POWER METERS

As reported on CBS "60 Minutes": How certain de-
vices can slow down - even stop - wathour meters -
while loads draw full power! Device simply plugs into
one outlet and normal loads into other outlets. Also de-
scribes meter creep, overload droop, etc. Plans \$29.
I.G. MANUAL: External magnetic ways (applied to the
meter itself) to slow down and stop wathour meters
while drawing full loads. Plans. \$19. KW-HR
METERS: How wathour meters work, calibration,
error modes (many), ANSI Standards, etc. Demand and
Polyphase Meters. Experimental results to slow* and
stop meters by others. \$19. Any 2, \$38. All 3, \$59.

AUTOMATIC TELLER MACHINES

ATM crimes, abuses, vulnerabilities and defeats ex-
pected 100+ methods detailed, include: Physical, Reg.
E, cipher, PIN compromise, card counterfeiting, mag-
netic stripe, false front, TEMPEST, Van Eck, tapping,
spoofing, inside job, super-cool, vibration, pulse, high
voltage - others. Case histories, law, countermeasures,
detailed security checklist, labeled internal photos, fig-
ures. ATMs contain up to \$250,000 in cash! Recent
\$350,000 ATM crime spree still unsolved! \$39.

CREDIT CARD SCAMS

Cardholders, merchants, banks suffer \$ billions in
losses annually because of credit card fraud. Describes
every known means of credit card fraud and scams.
Protect yourself! \$29.

CONS, SCAMS & SWINDLES

Cons & scams and related swindles fleece Americans of
\$100+ Billion per year! The most comprehensive sur-
vival manual on cons & scams of all kinds - from the
classic to hi-tech, Details on 100s and their many varia-
tions, and countermeasures. Protect yourself! \$39.

STEALTH TECHNOLOGY

Police radar is fascinating! It also has error rates of 10-
20%! Every known error mode - stealth method and ma-
terial used to minimize radar reflections - tactic and
strategy to fight unjust radar tickets (that cost you
\$100s in insurance and risk cancellation) - methods to
detect and jam signals - fully described! \$29.

SECRET & SURVIVAL RADIO

Optimum survival and security radio equipment, meth-
ods, freq allocations and voice/data scrambling/encod-
ing. Includes small receivers/transmitters, telemetry, an-
tenna optimizations, remote monitoring and control, se-
curity, surveillance, and ultrasonic, fiber-optic and in-
frared commo. 70+ circuit plans, tables. \$29.

HIGH VOLTAGE DEVICES

HV devices plans: Stun Gun, Taser, Prod, Cane,
Flasher, Blaster, Zapper, Audio/Radar Jammer,
Jacob's Ladder, Plasma & Van de Graaf Gen., Fence
Charger, Geiger Counter, Ozone Gen., Fish Stunner,
Plant Stim., Kirlian, more! All plans for only \$29.

UNDER ATTACK!

Electromagnetic Interference and Electronic Weapon
Attacks cause: Cancer, birth defects, and profound psy-
chological, neurological, cardiovascular and immune
system disorders! Destructive to people, animals, plants,
equipment! Includes ACTUAL CASES OF EM ATTACKS
ON PEOPLE (we investigated!) Includes how to verify
and pinpoint EMI and electronic attack sources, and spe-
cific countermeasures. \$29. **EM BRAINBLAST-
ER:** Tutorial and plans for powerful ELECTROMAG-
NETIC WEAPONS and LAB DEVICES. Optimum circuits,
freqs, waveforms, duty cycles, intensities. Thorough.
\$29. Both \$49.

RADIONICS MANUAL

Exciting electrical, electronic, electromagnetic therapeu-
tic, diagnostic & preventive devices (mostly experimen-
tal). History, descriptions, plans (dozens), availabilities
of Radionics Devices from early to modern. While drugs
cost \$ Hundreds, electricity costs pennies! \$29. **HEAL
YOURSELF:** Plans for 3 major electronic therapeutic
devices of types approved by FOA. \$19. Both \$39.

By an ORDER of the MAGNITUDE

The most comprehensive, hard-hitting, hi-tech sur-
vival book ever written! Topics include electronics,
computers, energy, weapons, concealment, revenge,
alarms, etc to survive today's dangerous world. We all
face increasingly financially and physically brutal times!
Field-expedient use of technology in various threat and
conflict environments and scenarios. \$49.

CRYPTANALYSIS TECHNIQUES

Five powerful menu-driven crypto programs (in .COM
and their .BAS sources) to analyze, decrypt "secure" ci-
phertexts. Worked-out examples. Recommended by
prestigious "Computers & Security" Manual + Disk*
\$29.

SOFTWARE PROTECTION SYSTEM

Unique system that highly discourages costly software
piracy while permitting legit archival copies. No known
way to defeat. No special equipment required. Simple
and automatic to install on your distributed software.
Compatible with all other copy-prevention systems.
Manual + Disk* \$59.

ROCKET'S RED GLARE

How to design and build solid-propellant amateur and
survival rockets. Emphasis on formulation, manufacture,
installation of propellants, motors, igniters, etc. Includes
list of commonly available materials, and the design of
launch pads and test beds and their electronics. \$29.

FIREWORKS: How firecrackers (M-80s, blockbust-
ers, cherry bombs), small rockets, volcanos, fountains,
sparklers and safety fuses are made and colored.
Simple, cheap, common ingredients. \$9. Both \$36.

ULTIMATE SUCCESS MANUAL

Underpaid? Harassed or abused? Manipulated?
Taken for granted? Stuck in a dead-end job? Can't find a
good job? Expect to be laid off, fired or transferred soon?
The ultimate no-holds-barred, looking-after-#1 Machiav-
ellian techniques to find, outline, optimize and keep top
jobs, pay and benefits. THE RULES OF THE GAME FOR A
GAME WITHOUT RULES! From resume to CEO. \$29.

Sold for educational purposes only.

CONTROL MEASURE INPUT

RELAYS • LIGHTS • MOTORS

TEMPERATURE • PRESSURE • LIGHT LEVELS • HUMIDITY

SWITCH POSITIONS • THERMOSTATS • LIQUID LEVELS

MODEL 30 \$79

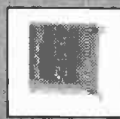

- PLUGS INTO PC BUS
- 24 LINES DIGITAL I/O
- 8 CHANNEL
- 8 BIT A/D IN
- 12 BIT COUNTER
- UP TO 14K SMP/SEC

MODEL 30 SOFTWARE

- SCHOONER... \$29
- REAL TIME DATA PLOT • DISK DATA LOGGING
- SOFTWARE CALIBRATION

PROTEUS (REQUIRES SCHOONER)... \$39

- GRAPHICAL DATA VIEW • ANALYSIS OF DATA

MODEL 150-02 \$179



- RS-232 INTERFACE
- TENS, 20 AMPS
- 12 BIT A/D
- OPTO-ISOLATED
- COMPLETE DMH

MODEL 45 \$189



- RS-232 INTERFACE
- 8 DIGITAL I/O
- 8 ANALOG INPUTS
- 2 ANALOG OUTPUTS
- 2 COUNTERS-24 BIT

MODEL 40 \$99

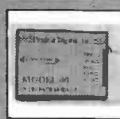

- RS-232 INTERFACE
- 28 LINES DIGITAL I/O
- 8 ANALOG INPUTS
- PWM OUTPUT

MODEL 70 \$239



- RS-232 INTERFACE
- 18 BIT A/D
- 8.5 DIGIT
- UP TO 60 SMP/SEC

Prairie Digital, Inc.

PHONE 608-643-8599 • FAX 608-643-6754
846 SEVENTEENTH STREET • PRAIRIE DU SAC, WISCONSIN 53578

CIRCLE 145 ON FREE INFORMATION CARD

Motion Control System

\$249.95

Includes Stepper Controller Card, 12VCT Transformer, (2) 4 Phase Stepper Motors,
Easy to use I.B.M. Software! Connects to any I.B.M. Compatible LPT Port (1,2,3)...

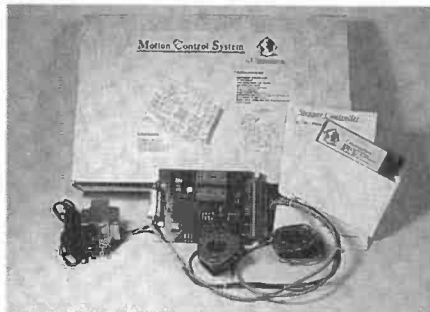

* Nothing more to Buy!

- * Easy Installation 15 minutes or Less!
- * No Tools Required!
- * Design Robots, Plotters, Laser Systems!
- * Drives (2), 4 Phase Stepping Motors!
- * Bi-Directional 8 Bit Read and Write Port!
- * Board Addressable, 16 Possible Choices!
- * Fits in Standard 19" inch Card Rack!
- * With Additional Cards Control 32 Motors on 1 LPT Printer Port!
- * Features Include: Variable Speed, Step, Range, Direction, and On/Off Control!
- * Free QBasic & Gwbasic Source Code \$ 59.95 value! *

Send Check or M.O. to:

CYBERMATION

"Intelligent Controllers"

1943 Sunny Crest Dr., Suite 288,
Fullerton, CA 92635

Call Us Today!

Tel (714) 879-2000

Visa/Master Charge Accepted

* Add \$12.00 S&H; CA residents please add sales tax *

Are Cable Companies Sucking You Dry?



**FREE
Catalog!**

**All Major
Brands!**

Take a Bite out of High Rental Fees
with your own

Converters & Descramblers



Everquest • Panasonic • Jerrold • Zenith • Pioneer
Scientific Atlanta • Oak • Eagle • Hamlin • Tocom



Order
Toll-Free **1 800 624-1150**

Call today for a FREE catalog!

MD Electronics

875 S. 72 Street • Omaha, NE 68114



Cellular Programming Software

\$\$ BLOW OUT PRICES \$\$

WE'LL BEAT ALL COMPETITORS' ADVERTISED PRICES

MOTOROLA..... ABOVE 9122 ALLMODELS SOFTWARE OR LOADER FROM \$395.00
NOKIA & TECHNPHONE 100 - 101 - 121 - 201 - 400 - 405 - 415 - 515 — TANDY MODELS
NEC P100 - P110 - P120 - P180 - P400 - P600 — ATT3610
PANASONIC..... ALL PORTABLES HP600 - HH700 - HH900 - EBH30 - EBH40 - EBH50 - EBH60
GE & ERICSSON HOTLINE - POCKET II - MICROPORTABLE - AH97 - AH98 - CT100 - CT700
MITSUBISHI & DIAMONDTel 3500 - 4500 - 20X - 22X **SONY** CMR - 111 - 333

MOTOROLA SOFTWARE TO REPAIR LOANER AND 00OFFFF

**ALL PRODUCTS ARE IN STOCK
 SHIPPED OVERNIGHT UPS/COD**

CELLSOFT®

609-751-2242 Ext 2

FAX 609-751-5549 • FREE TECHNICAL SUPPORT

CopyCat®

No PC — No Loaner
 Only 10 Seconds
 Programs & Repairs
 Complete with Cables

 All Motorola Including
 Digital - Analog - All Versions

 Models Available from \$2300.00

 Sony - Ericsson - Panasonic
 Audiovox - NEC - Mitsubishi
 Dimontel - GE - Uniden



INSTEK Test & Measuring Instruments

DC POWER SUPPLIES

PR-Middle Series (Analog/Digital)

ISO 9002
 CERTIFICATION
 #934163



- Continuous or Dynamic load for internal selectable
- Low ripple and noise
- 0.01% high regulation
- Overload and Reverse polarity protection
- Constant voltage and constant current modes
- 3½ Digits 0.5" LED display (Digital type only)

MODEL #PR6030D (Digital)

Regular \$500.00
 Sale \$399.95

MODEL #PR6030 (Analog)

Regular \$379.00
 Sale \$299.95

	Model	Output Volts (V)	Output Amps (A)	Weight (kg)
Analog	PR-6030	0~60	0~3	11.5
Digital	PR-6030D	0~60	0~3	11.5

PRINT™

Products International

Test Instruments, Equipment and Tools, Training and Supplies for Electronic Maintenance and Repair
 8931 Brookville Road • Silver Spring, Maryland, 20910 • 800-638-2020 • Fax 800-545-0058



**TOLL FREE
 800-638-2020**

**NEW 84 PAGE CATALOG!!!
 Call Today For Your FREE Copy
 Of The 1994 Print Test
 Equipment Catalog!**

CIRCLE 152 ON FREE INFORMATION CARD

Powerful Integrated Digital and Analog (Berkeley Compatible Spice)
Circuit Design and Simulation Software for Microsoft Windows (network compatible)

Best value in town!! Includes 4 Integrated Modules: LogicDesigner + WinSpice + WinScope + Symbol Editor
Perfect For Students, Technicians and Engineers!!!

Simply connect your circuit on the screen, enter simulation options, then kick back and watch it work! Comes with two Spice libraries plus 5 more libraries of Active Digital Devices CMOS, 74xx, 74xxx, ALUs, counters, MUX, FFs etc. Plus a Passive symbol library of Microprocessors and more. Use the Symbol Library Editor to Design your own symbols and symbols to represent Sub-circuits, True Bussing, Buss pins can be assigned Unique Names, Parts Billing List, Legends, Nested Subcircuits for Hierarchical Top Down or Bottom Up Design, Checks Fan Out Violation and Electronic Rules, Device Unit Numbers/Chip Pincuts Automatically added as per Data Books, Connectors, Spice Netlist Generation, Continuous ZOOM In/Out, Cut/Copy/Paste, Multiple-Rotatable Fonts, Rotatable Symbols, Multipage Zoomed In/Out Printcuts to any Windows Printer. ON LINE HELP

LogicDesigner Digital Simulation/Schematic Capture Module

Interactive Digital Simulation and Schematic Capture, Single Step Mode, Variable Speed Simulation, Programmable Digital Delays, Multi Waveform Scrolling Timing Diagram Memorizes up to 30000 Ticks Worth Of Timing Data, Truth Table Generation, Binary to 7 Segment Displays, Hex Keypads, Programmable Clock Sources, Logic Probes. Built in Logic Analyzer can be set up to generate Edge or Level Sensitive Breakpoints, or when Signals are Equal To, Greater Than, or Less Than a Certain Value or any AND/OR Combination. Sequential Breakpoints help Track Down and Debug Circuit Race Conditions Glitches, Setup and Hold Violation and other Circuit Design Errors. Simulates Tri State, Open Collector & Don't Care Logic, RAM/ROM, One Shot, Carry Look Ahead, Shift reg, Pull Up/Down Resistors.

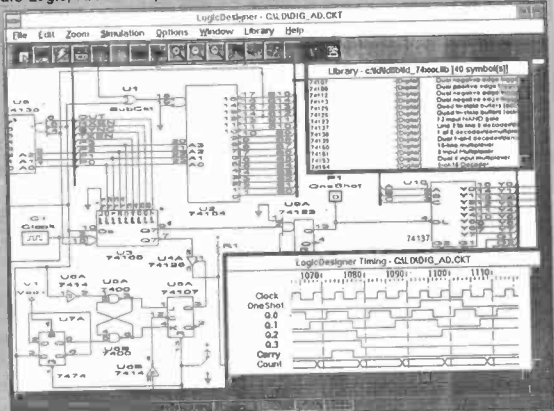
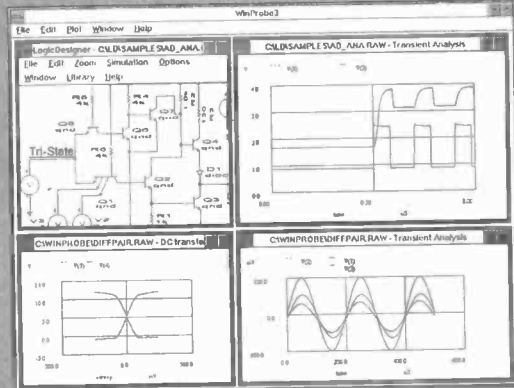

WinSpice Simulator & WinScope Data Analyzer Modules

SPICE LIBRARY: MOSFET, GaSFET, BJT, FET, Diode, OpAmps, Comparitors 555 Timer, Resistor, Cap, Inductor, Transmission Line Controlled, Independent, Dependent, Arbitrary Source, Pulse, Sin, Piece Wise Linear, and FM Sources, Current and Voltage Controlled Switches. All models Expandable And User Modifiable. Imports MACRO MODELS of Your Favorite Manufacturer Supplied Parts.

ANALYSIS TYPES: AC, DC, TRANSIENT, POLE-ZERO, NOISE, SENSITIVITY, FOURIER, TRANSFER FUNCTION, AND OPERATING POINT ANALYSIS.

DATA ANALYZER: Graphs Simulation Results using Multiple Plot Windows and Waveforms. Plots Linear, Logarithmic, Polar, Smith Chart, BODE Type Plots + More. ZOOM in and out of Plot Waveforms. Plots Complex Math Expressions Using Plot Variables As Arguments, Calculates Derivatives, Log, Trig functions, Define Macros of Complex Math Formulas.

Price \$99.99 reg \$179.99 S&H \$3.00 VIS/AMC

ISLAND LOGIX Inc.

920 South West 95 Terrace
Pembroke Pines, Florida 33025 U.S.A.
PH (305) 435-7665 FAX (305) 435-7891



CIRCLE 144 ON FREE INFORMATION CARD

Learn MICROCONTROLLERS
EMBEDDED SYSTEMS and
PROGRAMMING with
the New AES-10

The AES-10... a complete learning system, a complete embedded control system. Extensive manuals guide you through your 8051 development project. Assembly, BASIC, and C programmable. All hardware details, complete schematics. Learn to program the LCD, keypad, digital and analog I/Os. The entire board is software reconfigurable for your applications. Everything you need, nothing extra required.

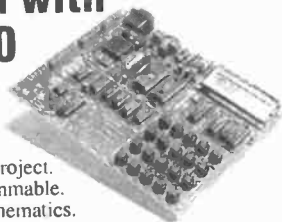

80C32 Computer/Microcontroller board with:

- 32K Byte ROM, 32K Byte RAM • 2 by 16 Liquid Crystal Display • 4 by 5 Keypad • Two serial ports • 5 interrupt sources • 3 timers • A/D, D/A, PWM and digital I/O • Built in Logic Probe • Power supply (can also be battery operated) • Extended Intel BASIC and AES Monitor in ROM • RS-232 cable to connect to PC for programming • 8051/52 DOS Cross Assembler • Program disks with well documented examples • User's Manual, Language Manual, and Text (over 400 pages).

AES-10 \$285 Complete
Money Back Guarantee

Free Info Pack, M/C Visa
714 - 550-8094
Fax 714 - 550-9941



CALL 1 - 800 - 730-3232

Advanced Educational Systems
970 W. 17th St., Santa Ana, California, 92706 USA

PROTOTYPE PC BOARDS!



THIS IS THE MACHINE YOU'VE BEEN WAITING FOR!

Have you ever dreamed of letting your computer prototype PC boards directly from your CAD drawings? If so, the Neuractor CNC-4+ Desktop Manufacturing System may be just the machine you need! This fourth-generation CNC machining center can automatically drill, mill and route printed circuit boards, not to mention three-dimensional products in wood, plastic and light metals DIRECTLY FROM YOUR CAD DRAWINGS! You've seen the rapid-prototyping and "Santa Claus" machines that cost thousands of dollars, but did you know that as an electronic technician you can assemble one yourself from this inexpensive kit? Utilizing patent pending technology the Neuractor CNC-4+ kit provides you with everything you need to machine products in three dimensions with a resolution of .001". All mechanical components are pre-fabricated, pre-machined, plated and painted. Includes four 83 oz/in digital CY-MOTORS, interface card, 5 amp power supply, 10 pitch steel lead screws, 4 proprietary Slide Block actuator mechanisms, 4 aluminum linear actuator channels, polished steel guide-rods, Dremel bracket, hardware, etc. (You provide Dremel MotoTool(tm) or flex-shaft router and work surface.) It's a complete kit! All you do is put it together and calibrate it! IF THAT'S NOT ENOUGH, WE'RE THROWING IN A FREE FULL-FEATURED 3D CAD/CAM SOFTWARE PACKAGE WITH EACH UNIT! Large 18"x18"x4.6" cutter travel directly from CAD-generated or scanned ASCII, DXF & HPGL plot files!. Get started by ordering your own Neuractor CNC-4+ today! ACT NOW! Kit \$595 + \$24.95 S/H. (For PC board routing the heavy-duty upgrade is suggested, add \$149) Allow 4-8 weeks for del. U.S. CYBERLAB, 14786 Slate Gap Rd., West Fork, AR 72774 (501) 839-8293.
Free info! X-Y Power/Rotary Tables and larger CNCs now available!

April 1995 Popular Electronics

MIRACLES NEVER CEASE



MICRO TX2000 KIT

\$59⁹⁵

- SMALLEST 120 MW FM VOICE/PHONE TRANSMITTER
- SMALL SIZE 1-7/16" x 21/32"
- 88-110MHz ON ANY BROADCAST RECEIVER
- ROCK SOLID TUNING, DOESN'T DRIFT
- 5 MIN. ASSEM., HEAR A WHISPER UP TO 2 MILES
- SMT PARTS PREAMBLED
- INCLUDES TXMTR, MIC, ANTENNA, BATTERY CLIP, TUNING TOOL, AND INSTRUCTIONS

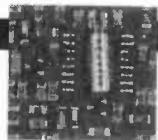

VOICE SCRAMBLER/DESCRAMBLER KIT

\$69⁹⁵
2 FOR \$129.95

- WORLD'S SMALLEST AUDIO SCRAM/DESCRAM.
- TALK IN PRIVACY ON AUDIO, SPKR, OR MIC LINE
- HEAR THOSE GARBLED SCANNER VOICES
- SMALL SIZE 1"x7/8"x1/4"
- CRYSTAL CONTROLLED DIGITAL SPEECH INVERSION
- 7-15 VOLT DC SUPPLY
- LOUD HALF WATT AUDIO AMPLIFIER
- EXCELLENT AUDIO QUALITY
- INCLUDES FULL DOCUMENTATION
- DUPLEX SCRAMBLE & DESCRAMBLE AT THE SAME TIME

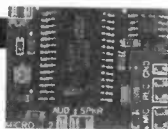

MICRO 1.2 VOICE RECORDER

\$69⁹⁵

- SMALL SIZE 1-1/4"x15/16"x1/4"
- HUNDREDS OF APPLICATIONS
- EXCELLENT AUDIO QUALITY
- 60 SECONDS REC/PLAY
- 8 OHM SPEAKER OUTPUT
- 7-15 VOLT DC SUPPLY
- 100 YEAR MEMORY WITHOUT POWER
- INCLUDES MIC, SWITCHES AND FULL DOCUMENTATION



MICRO 2B VOICE RECORDER

\$109⁹⁵

MICRO 2B FEATURES

- SAME AS 1.2 PLUS:
- MULTI MESSAGES (UP TO 600 MEM.)
- SMALL SIZE 1-5/16"x1-5/8"x1/8"
- VARIABLE AUTO PLAY TIMER
- 5 VOLT KEY OUT DURING PLAYBACK

ORDER BY PHONE OR MAIL
IN U.S.A. ADD \$5 FOR S&H

C.O.D. CHARGES APPLY
NYS RESIDENTS ADD SALES TAX

VFC400 VHF/UHF FM VOICE TRANSMITTER KIT



ONLY \$99⁹⁵

- SMALLEST 400 MILLIWATT VOICE TRANSMITTER ANYWHERE! (1.5" x .56")
- RECEIVE ON ANY SCANNER OR VHF/UHF SURVEILLANCE RECEIVER
- RELIABLE CRYSTAL CONTROL OSCILLATOR
- 5 MILE RANGE (OR BETTER!)
- SUPER SENSITIVE OP-AMP PICKS UP SOUNDS AT WHISPER LEVEL
- LINE LEVEL AUDIO INPUT FOR DATA, STATION ID, OR INTERFACE TO OUR POPULAR VOICE RECORDERS
- SIMPLE 5 MINUTE ASSEMBLY, ALL CHIP COMPONENTS ARE PRE-ASSEMBLED
- CUSTOM FREQUENCIES AVAILABLE FOR LAW ENFORCEMENT
- INCLUDES TRANSMITTER, CRYSTAL, BATTERY HOLDER, MICROPHONE, ANTENNA, & INSTRUCTIONS
- CHANNEL A) 146.565 MHZ B) 148.000 MHZ (SELECT ONE WHEN ORDERING)

MICRO-4 MULTI-MESSAGE VOICE RECORDER

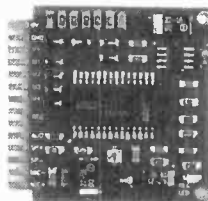

- EXACT SOUND REPRODUCTION
- SMALL SIZE 1-3/4" x 1-5/8"
- NEW EDGE CARD DESIGN IS STANDARD .100 SPACING
- 4 MESSAGE MAX. UP TO 20 SECONDS
- LED INDICATES RECORDING IN PROGRESS
- 6 VOLT INPUT ONLY DRAWS 5 uA STANDBY
- 7-13.8 VOLT REGULATED INPUT @ 30ma
- 8 OHM 50 MILLIWATT SPEAKER OUTPUT
- LINE LEVEL AUDIO OUTPUT (VARIABLE)
- FULLY ASSEMBLED (NOT A KIT)
- 100'S OF APPLICATIONS, ALARMS, PRODUCT DISPLAY, NOTE PAD, HAM, CB, MUSEUMS, ETC
- SWITCHES, MICROPHONE, & INSTRUCTIONS INCLUDED

ONLY \$89⁹⁵

COMING SOON



AGRELO ENGINEERING
1145 CATALYN STREET
SCHENECTADY, NY 12303

MICRO-3

REC/PLAY UP TO 4.5 MINUTES
UP TO 1800 MESSAGES (NO DIODES)
MESSAGE CUEING (FAST FORWARD)

TECH. FAX: 518-381-1058

TO ORDER: CALL 1-(800)-588 4300

TECH. SUPPORT: 518-381-1057

CONTROL AND DATA ACQUISITION FROM A COMPUTER SERIAL PORT (RS232 or RS485)

I/O-232 SMART BOARDS DO NOT REQUIRE PROGRAMMING! These boards connect directly to your computer serial port. Commands are very simple e.g. PRA [Enter] reads Port A. Results are sent back to the computer as an ASCII string allowing the use of PROCOMM, MAC240, or your own programs. In addition to interfacing, the I/O-232 boards have the following embedded functions:

- Uses ITC232-A IC.
- All standard Baud rates (300-115KB) supported.
- Bin, Hex or Dec formats.
- 24 I/O lines configurable individually as Inputs or latched Outputs.
- 8, 10 or 12 bit, 10 channel Analog to Digital converter.
- 10-10,000 Hz, 0-100% Pulse Width Modulation output.
- 3 EASY to use stepper motor logic interfaces (Muxable to more).
- Relative resistance or capacitance measurements using an RC network (ideal to read temperatures using a thermistor).

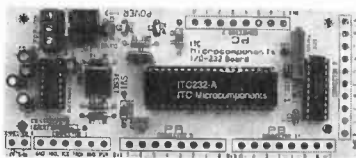

DESCRIPTION	KIT	ASSEMBLED
I/O-232-12 (12 bit ADC)	\$ 109	\$ 119
I/O-232-10 (10 bit ADC)	\$ 99	\$ 109
I/O-232-8 (8 bit ADC)	\$ 79	\$ 89

Enclosure: \$14, Serial cable: \$9 (specify connector), Power Supply: \$11
Add \$10 for manuals, diskette containing program examples and Shipping & Handling. Pay by cheque, M. Order, VISA or Master Card.

ITC MICROCOMPONENTS INC.

814 West 15th St. Unit 206, North Vancouver, B.C. Canada.
V7P-1M6. PHONE US TOLL FREE AT: (800) 474 7644
Fax: (604) 985 6417. Explore our BBS: (604) 985 1380

THE I/O-485 BOARDS are multiple addressable units containing 2 ITC232-A chips and a 10 channel, 8, 10 or 12 bit Analog/Digital converter each. The ITC232-A chips used ensure great simplicity of commands. 32 of these units can be ganged-up on a single RS485 line attached to a computer. A smaller board which plugs onto the computer serial port allows for RS232/RS485 conversion.

I/O-485 boards block diagram

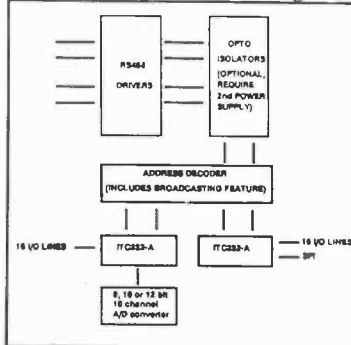

- 32 I/O lines configurable individually as Inputs or latched Outputs organized in 4 x 8 bit ports.
- 10 analog inputs, 8, 10 or 12 bits resolution.
- 32 different addresses plus broadcasting which allows commanding all the boards at once.
- Individual stations or the entire network is software resettable
- Direct or optoisolated link
- Speeds of up to 115200 Bauds.
- All the stations can be hooked onto a single 4 wire cable up to 1 mile long using standard phone jacks.

All of the following boards are pre-assembled and tested.

I/O-485-8 (8 Bit ADC)	\$ 139
I/O-485-10 (10 Bit ADC)	\$ 159
I/O-485-12 (12 Bit ADC)	\$ 179
432/485 Converter	\$ 49

For optoisolated option: Add \$19 to each item.

NEW!

**PE MARKET CENTER
CLASSIFIEDS**

Quality Microwave TV Antennas
WIRELESS CABLE - IFTS - MMDS - Amateur TV
 Ultra High Gain 50db(+)- Tuneable 1.9 to 2.7 Ghz.
 • 55-Channel Dish System \$199.95
 • 36-Channel Dish System \$149.95
 • 20-Channel Dish System \$124.95
 • Optional Commercial Grid Antenna (not shown) Add \$50.00
 • Yagi Antennas, Components, Custom Tuning Available
 • Call or write (SASE) for "FREE" Catalog

PHILLIPS-TECH ELECTRONICS
 P.O. Box 8533 • Scottsdale, AZ 85252
 (602) 947-7700 (\$3.00 Credit all phone orders)
 MasterCard • Visa • American Express • COD's • Quantity Pricing

Dish System
 LIFETIME WARRANTY

**MISCELLANEOUS
ELECTRONICS FOR SALE**

THE CASE Against Patents. Thoroughly tested and proven alternatives that work in the real world. \$28.50. **SYNERGETICS PRESS**, Box 809-C, Thatcher, AZ 85552. (602) 428-4073. Visa/MC.

TURBO CHARGE your amplifier. Guide to increase wattage of existing power amplifiers. Send \$7.50 for complete book. **JAM Electronics**, 7391 St. Hwy 78, Gratiot, WI 53541.

VOICE CHANGER board! All kinds of applications. This is not a kit, but a complete circuit board, new and tested \$39.95 + \$4.00 for (S&H). **Parsec Electronics**, PO Box 34594, Phoenix, AZ 85067-4594.

Prototype it..... FAST!

with ProtoQuick 8051 or Z8

- Complete single board computers
- Up to 32K EPROMs and DR. RAM
- 12 sq. in. plated through hole area
- RS232 C serial port w/ DB25 option
- Cp. sys. in EPROM w/ source code
- Assembled, ready to run - 5c only
- MS-DOS cross assembler included

\$99.00 each
 Software Science 2760 Roundstone Road, Channahon, IL 61615 (815) 561-2060

Run prototype applications or experimental hardware from the serial port - WITHOUT PROGRAMMING!

DATA BOOKS: 2/3 lbs each, updated. Small signal transistors, power MOSFET transistors, fast TTL, fast CMOS, microcontrollers applications. \$11.95 US each + \$3.50 shipping. Minimum \$20.00 orders with Visa/MC. **FGM Sales**, 322 Stuart, Sarnia, Ontario N7T3B8.

MIL-SPEC CONNECTORS—Cannon, Amphenol, Bendix. Yellow Springs Instruments temperature probes. Underwater connectors and transducers. Large assortment miscellaneous parts. Priced to sell! Send \$3.00 and SASE to: **Electronics Inventory**, 3200 French Woods Rd., Charlotte, NC 28269.

AUDIO-VIDEO-LASERS

LASERS, LIGHTSHOWS, Holography. Lowest prices. For free catalog write: **Midwest Laser Products**, PO Box 2187, Bridgeview, IL 60455. Or call: (708) 460-9595.

VIDEO ENHANCER — adds 35"-45" inches to your existing television monitor. Works with 9", 12" and 13" inch sets. \$7.95 **The Turner Co.**, PO Box 162194, Atlanta, GA 30321.

**MISCELLANEOUS
ELECTRONICS WANTED**

HEATH HERO1 robot CPU I/O boards wanted. **John Hinkleman**, 3035 Albacore Circle E6, Silverdale, WA 98315.

CABLE TV DESCRAMBLERS
Best Prices in the U.S.A.! Guaranteed to Work!

WE WILL BEAT ANY PRICE!



JERROLD, SCIENTIFIC ATLANTA, PIONEER, FTB-3, SA3
THE NEWEST & THE LATEST
Stealth - Jerrold Impulse & Starcom Series (advanced version of TNT & TVT)
M80 - Scientific Atlantas incl. 8536/+, 8580, Drop-Field
Super-Pio - Pioneer Systems (advanced version of Pioneer "Green")

PANASONIC TZPC145G 99 Channel Wireless Cable Converters
ZENTEK XL2100 99 Channel Wireless Cable Converters

1-800-818-9688 M-F: 9-6 EST

U.S. Cable TV, Inc. Dept.: KPE025

4100 N. Powerline Rd, Bldg. F-4 Pompano Beach FL 33073

NO FLORIDA SALES!

Technicians Professional Tool Case



This hi-tech, case is designed for versatility, to protect and transport costly tools, electronic devices and instruments. Case is available with aluminum finish (281 TC) or black finish (282 TC).

Thousands of cases already sold to satisfied technicians.

• Other cases also available. • Dealer inquiries welcome.

To order call:

(713) 395-8370 Fax (713) 395-8372

Terms: Visa • M/C • C.O.D.'s or send check or money order to: **RATTNER NORTH AMERICA, Tool Utility Cases, 5090 Richmond, Ste. 334, Houston, Texas 77056**

- Commercial quality
- Removable, reversible tool pallet
- Case bottom consists of six adjustable compartments
- Foam lined interior
- 2 keyed locking latches
- Adjustable shoulder strap
- Reinforced steel corner braces
- Size 18" x 6 1/4" x 13" (Tools Not Included)



Shoreline INSTRUMENTS
Automotive Meter with Auto-Ranging DMM

- RPM, Dwell, Frequency, Temp. (°C & °F)
- AC/DC Voltage & Current
- Continuity Beeper, Ohms
- **Standard Accessories**
- Multi-tip Probe Set, Large Alligator Clips, Temp. Probe, Rubber Boot, Inductive Pick-Up
- 9V Batt.-2 Year Warranty

Sale \$159.95

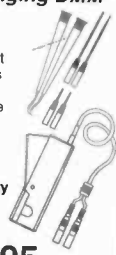

Item# Z6000

Sale \$44.95
Item # Z3910



Versatile DMM w/ Capacitance

- Large LCD Display
- DCV accuracy 0.5%
- Diode test, continuity check with buzzer sound
- Transistor hFE test
- All ranges overload protected
- Rugged case, drop proof
- Capacitance measurement 1pF-20µF in 5 ranges
- Resistance measurement up to 200M
- Auto power off
- Yellow Case

1 Year Warranty

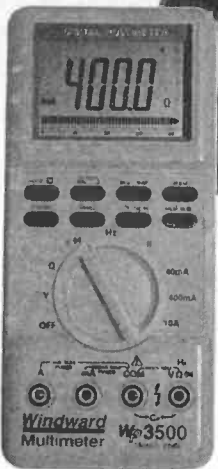

Auto-Range DMM w/Capacitance

- CPU controlled with auto power off function
- 3.75 digit jumbo LCD (max reading 3999)
- 42 segment high speed bar graph
- Full auto-ranging measurement
- Offset adjustment
- Data hold and data memory
- MIN/MAX hold function
- Auto capacitance measurement 1pF to 40µF in 5 ranges
- Auto frequency measurement up to 1 MHz in 5 ranges
- Safety design according to IEC Publication 348
- 1 Year Warranty

Sale \$105.95
Item # Z3500

See Your Local Dealer or Call
9am to 5pm Pacific Standard Time
800-470-WIND (9463)

Dealer List

- Sunex Electronic Supply, Inc.
4 Locations in FL
(813) 885-4074
- Lynntronics
Phoenix, AZ
(602) 841-3900
- Minute Man Electronics
Fremont, CA
(510) 791-5036
- Gateway Elec., Inc.
3 Locations
(314) 427-6116
- ACE Electronics
San Jose, CA
(408) 297-1383
- Alltronic
San Jose, CA
(408) 943-9773
- Weirdstuff
Sunnyvale, CA
(408) 746-1100
- AL Electronics & Robotics
Englewood, CO
(303) 693-6585
- REM Electronics
Warren, OH
(216) 373-1300
- Electrotex, Inc.
8 Locations in TX
1 Location in TN
(713) 526-3456

Additional Dealers Welcome

Windward Products

*We Stand Behind our Products
Satisfaction Guaranteed*

P.O. Box 378, Moffett Field, CA. 94035

C & L ELECTRONICS

BUY — SELL — TRADE

★ 90 DAY GUARANTEE ★
10 Day Inspection Period

Assoc. Research 5040 AT	Hy Pot Tester	500.00
Bertan Assoc. Model 215	H.V. Supply, 3000 Volt, 5 M.A.D.C.	500.00
Datapulse 101	Pulse Generator	75.00
E.S.I. SR1	Standard Resistor, 100 Kilo Ohm	90.00
Fluke 332B	DC Voltage Calibrator	800.00
Fluke 540B-110	Transfer Standard	2,000.00
Fluke 721A	Lead Compensation	500.00
Fluke 1953A	Frequency Counter	450.00
GR 1615A	Capacitance Bridge	1,200.00
GR 1620A	Capacitance System	2,000.00
HP 334A	Distortion Analyzer	600.00
HP 606B	Signal Generator	350.00
HP 853A	Display	2,000.00
HP 1630G	Logic Analyzer	800.00
HP 1725A	Scope, 275MHZ	700.00
HP 3320	Automatic Synthesizer	500.00
HP 3330B	Automatic Synthesizer	800.00
HP 3456A	Digital Voltmeter	900.00
HP 3467A	Logging Digital Multimeter	900.00
HP 3551A	Transmission Set	750.00
HP 3575A/001	Phase Gain Meter	900.00
HP 3575A/002	Phase Gain Meter	1,000.00
HP 3581C	Selective Voltmeter	995.00
HP3722A	Noise Generator	1,250.00
HP 4800A/4801A	Vector Impedance Meter	450.00
HP 4815A w/Probe	Vector Impedance Meter	800.00
HP 5328A w/OPT 011	Counter, DC to 100MHZ, 9 digit	450.00
HP 5340A	Frequency Counter, 10HZ to 18GHZ	1,000.00
HP 5345A	Frequency Counter, DC to 500MHZ	1,000.00
HP 6111A	Power Supply, 0-20V, 0-1A	275.00
HP 6112A	Power Supply, 0-40V, 0-5A	275.00
HP 7004B	X-Y Recorder	400.00
HP 7015B	X-Y Recorder	250.00
HP 7044A	X-Y Recorder	500.00
HP 8405A	Vector Voltmeter	600.00
HP 8443A	Generator (less cable)	300.00
HP 8552A	IF Section	500.00
HP 8552B	IF Section	600.00
HP 8553B	RF Section	600.00
HP 8558B	Spectrum Analyzer, 0-1500MHZ	2,000.00
HP 8620A	Sweep Oscillator Frame	400.00
HP 8620C	Sweep Oscillator Frame	500.00
HP 8750	Storage Normalizer (less cable)	275.00
Krohn-Hite 3500	Wideband Amplifier	400.00
Krohn-Hite 7500	Wideband Amplifier	700.00
Keithley 225	Current Source	375.00
Keithley 247	P.S., 0-3KDCV, 6MA	500.00
Rockland 5100	Synthesizer, 2MHZ	600.00
Rod-L M25	Ground Tester	700.00
TEK P6042	Current Probe, 60 MHZ	500.00
TEK S-4	Sampling Head	600.00
TEK S15010	Programmable Scanner	500.00
TEK SC504	Scope Module, 80 MHZ	600.00
TEK TM5006	TM Mainframe	500.00
TEK 465 w/DM44	Scope, 100 MHZ	650.00
TEK TM503	Mainframe	175.00
TEK TM504	Mainframe	175.00
TEK TM506	Mainframe	200.00
TEK 520A	NTSC Vectorscope	1,000.00
TEK 576	Curve Tracer 220W	1,800.00
TEK 7A13	Differential Comparator LED	400.00
TEK 7A22	Differential Amplifier	500.00
TEK 7A24	Amplifier	500.00
TEK 7A29	Plug-In, 1GHZ	750.00
TEK 7B15	Time Base	650.00
TEK 7B53A OPT06	Plug-In	300.00
TEK 7CTIN	Curve Tracer, 0.5W	450.00
TEK 7D20	Programmable Digitizer	1,500.00
TEK 7L5/L3	Spectrum Analyzer	2,000.00
TEK 7L19	Spectrum Analyzer, 1KHZ to 1.8 GHZ	2,850.00
TEK 1480R	Waveform Monitor	1,000.00
TEK 2901	Time Mark Generator	350.00
TEK 5111A	Storage Scope, 2 MHZ	600.00
TEK 7104	Scope 1GHZ	6,000.00
TEK 7S12	Sampling Plug-in	700.00
TEK 7T11	Sampling Sweep Unit	600.00
TEK 7844	Dual Beam Scope, 400MHZ	750.00

SELLERS! Cash Paid Within 24 Hours!

P.O. Box 52153
Philadelphia, PA 19115 **(215) 426-0177** Fax (215) 464-5856

CIRCLE 139 ON FREE INFORMATION CARD

DESKTOP MANUFACTURING!

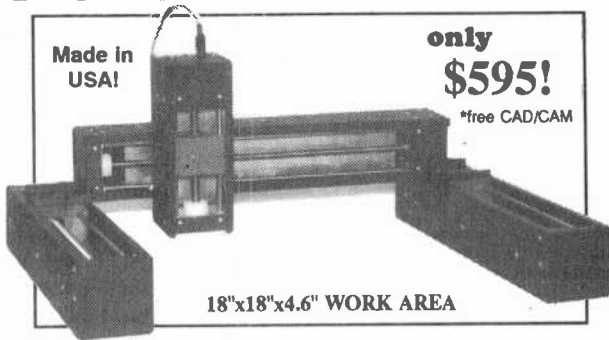

THIS IS THE MACHINE YOU'VE BEEN WAITING FOR!

Have you ever dreamed of letting your computer manufacture products directly from your CAD drawings? If so, the Neuractor CNC-4+ Desktop Manufacturing System may be just the edge you need! This fourth-generation CNC machining center can automatically drill, mill and route three-dimensional products in wood, plastic and light metals DIRECTLY FROM YOUR CAD DRAWINGS! You've seen the rapid-prototyping and "Santa Claus" machines that cost thousands of dollars, but did you know that as an electronic technician you can assemble one yourself from this inexpensive kit? Utilizing patent pending technology the Neuractor CNC-4+ kit provides you with everything you need to machine products in three dimensions with a resolution of .001". All mechanical components are pre-fabricated, pre-machined, plated and painted. Includes four 83 oz/in digital CY-MOTORS, interface card, 5 amp power supply, 10 pitch steel lead screws, 4 proprietary Slide Block actuator mechanisms, 4 aluminum linear actuator channels, polished steel guide-rods, Dremel bracket, hardware, etc. (You provide Dremel MotoTool(tm) or flex-shaft router and work surface.) It's a complete kit! All you do is put it together and calibrate it! IF THAT'S NOT ENOUGH, WE'RE THROWING IN A FREE FULL-FEATURED 3D CAD/CAM SOFTWARE PACKAGE WITH EACH UNIT! Large 18"x18"x4.6" cutter travel for crafts, electronics and printed circuit board drilling and routing, not to mention model-making, mold-making and even painting! Get started by ordering your own Neuractor CNC-4+ today! ACT NOW! Kit \$595 + \$24.95 UPS S/H. (For heavy-duty upgrade add \$149) Allow 4-8 weeks for delivery. U.S. CYBERLAB, 14786 Slate Gap Rd., West Fork, AR 72774 (501) 839-8293. **Free info! X-Y Power/Rotary Tables and larger CNCs now available!**

DC/CAD introducing...

THE TERMINATOR

Super High Density Router
(Complete with Schematic & PCB EDITOR)

Features the following powerful algorithm & capability:

- Rip - up and Retry
- Pre-routing of SMT components
- Real-Time via minimization
- Real-Time clean up passes
- User defined strategies
- Window 3.0 capability as DOS Task
- 1-mil Autoplacer and Autopanning
- Two-way Gerber and DXF
- Automatic Ground Plane w/ Cross-Hatching
- Complete w/ Schematic & Dolly Libraries
- Optional simulation capability & protected mode for 386 users

* PCB LAYOUT SERVICE AT LOW COST *

LEASE PROGRAM & SITE LICENSE AVAILABLE



Design
Computation

1771 State Highway 34
Farmingdale, NJ 07727
(908) 681 - 7700 • (908) 681 - 8733 (FAX)

"DC/CAD . . . The focal point of future CAD market"

Call for
DC/CAD - \$95
(available for students only)
normal price range
\$295 - \$2500

EARN MORE MONEY!

Be an FCC LICENSED ELECTRONIC TECHNICIAN!



No costly school. No commuting to class. The Original Home-Study course prepares you for the "FCC Commercial Radio-telephone License." This valuable license is your professional "ticket" to thousands of exciting jobs in Communications, Radio-TV, Microwave, Maritime, Radar, Avionics and more...even start your own business! You don't need a college degree to qualify, but you do need an FCC License.

No Need to Quit Your Job or Go To School
This proven course is easy, fast and low cost! **GUARANTEED PASS**—You get your FCC License or money refunded. **Send for FREE facts now. MAIL COUPON TODAY!**

Or, Call 1-800-932-4268 Ext. 240

COMMAND PRODUCTIONS

FCC LICENSE TRAINING, Dept. 240
P.O. Box 2824, San Francisco, CA 94126
Please rush FREE details immediately!

NAME _____
ADDRESS _____
CITY _____ STATE _____ ZIP _____

Motorless Motion!



Includes Complete Plans

Create direct linear action with Muscle Wires®—they actually contract up to 5% when powered! Use them in robots, planes, railroads — anywhere you need small, strong all-electric motion.

Q&A

What are Muscle Wires?

Muscle Wires are highly processed strands of a nickel-titanium alloy called *nitinol*. At room temperature they are easily stretched by up to 5% of their length. When conducting an electric current they return to their original "unstretched" shape with a force *thousands of times* their weight.

How strong are Muscle Wires?

This varies with the wire's size. A single wire can lift from 35 to 930 grams (over 2 lbs)! For more strength, use several wires in parallel.

How fast can Muscle Wires activate?

They contract as fast as they are heated — as quickly as 1/1000 of a second. To relax, the wire must cool again. Rates of many cycles per second are possible with active cooling.

Flexinol Muscle Wire Specifications

Wire Diameter (μm)	50	100	150	250
Resistance (Ω/m)	510	150	50	20
Contract Force (grams)	35	150	330	930
Typical Current (mA)	50	180	400	1000

How much power do Muscle Wires need?

Power varies with wire diameter, length, and surrounding conditions. Once the wire has fully shortened, power should be reduced to prevent overheating.

What are the advantages of Muscle Wires?

Small size, light weight, low power, very high strength-to-weight ratio, precise control. AC or DC activation, long life and direct linear action and much more!

Get our new 128 page *Muscle Wires Project Book* with full plans for Boris and 14 other *motorless motion* projects, and our *Deluxe Sample Kit* with one meter each of 50, 100 and 150 μm dia. Muscle Wires — everything you need to get moving today!

24-hour Voice Order Line — VISA MasterCard

Order Toll Free!

800-374-5764

Request our FREE Muscle Wires Technical Brochure

Mondo-tronics

524 San Anselmo Ave. #107-62
San Anselmo, CA 94960

Questions: 415-455-9330
Fax: 415-455-9333
Internet: mondo@holonet.net

New Book & Deluxe Kit only
\$59.95
Plus \$5.00 P&H
CA orders add tax

International Orders Welcome! First Class P&H: \$11.00

CABLE TV CHANNELS
EQUIPMENT **GUARANTEED**
Direct! **FREE 30 DAY TRIAL**

The nationwide source for cable TV equipment.

"BUY WHERE THE DEALERS BUY."

FREE TV Cable Descramblers and Converters Catalog. Open Every Day!

YOUR VCR TAPES CAN PLAY AS CLEAR AS DAY! Why put up with Inconsistent Color, Flashes and Streaking and Interference!

UNJAM NOW WITH Video Decoder

- Easy Connections
- Eliminates "jamming"
- Copy any tape
- RC Plugs Included
- 2 Year Warranty
- 30 Day Money Back Guarantee

MEGA ELECTRONICS SAVE 1000's

VISA • MC C.O.D. **1-800-676-6342**

21 S. Main St., Winter Garden, FL 34787

HC11 KITS

LOW COST kits feature HC11 processor, RS-232, 4-R/C servomotor jacks, 8 analog inputs, EEPROM, RAM, I/O lines, FREE PC software, manuals & more: \$47.00 plus S/H. Parts available separately.

♦ Call or write for free brochure.

ZORIN, Unit F, POB 30547, Seattle, WA 98103-0547 (206) 282-5179. zchris@eskimo.com

IMPROVE YOUR IMAGE!

WITH OUR VIDEO STABILIZERS

BEFORE AFTER

The clearest picture possible playing back movies.

GUARANTEE to eliminate copy protection.

SUPER VHS MODEL AVAILABLE!

- No Rolls/Jitters/Flickers/Fading
- Works on all TV's, VCR's Beta & Cable
- Gold Video Connectors & Cables Included
- 2 Year Warranty
- Money Back Guarantee

VISA MASTERCARD DISCOVER

VISION ELECTRONICS

1-800-562-2252

2125 S. 156TH CIRCLE • OMAHA, NE 68130

MECI **Free Catalog**

VALUES

1-800-344-4465

If you are not getting this catalog you are missing out on some of the best deals in electronics today! We have thousands of items ranging from unique, hard-to-find parts to standard production components. Call, write, or fax today to start your free subscription to the most unique catalog in the industry, filled with super values on surplus electronic and hobbyist type items. If you have a friend who would like to receive our catalog, send us their name and address and we will gladly forward them a complementary 56 page catalog.

Why pay more? Call today.

MECI

340 East First Street Fax Order Line
Dayton, Ohio 45404 1-800-344-6324

Order Toll-Free
1-800-344-4465

CIRCLE 149 ON FREE INFORMATION CARD

“ If I don't get a good education, I could end up an alcoholic or lose my family because I'd be worthless. ”

Katrina Davies
5th grade

America needs more schools that encourage our children to fulfill their promise.

KEEP THE PROMISE.

For information on how you can help change the schools in your community, call 1 800-96-PROMISE.



Education Excellence Partnership

❖ ATTENTION CABLE VIEWERS ❖

CABLE VIEWERS... . .get back to your **BASIC** Cable Needs

Call 800-577-8775

For information regarding all of your **BASIC** cable needs.



5 GOOD REASONS TO BUY OUR FAR SUPERIOR PRODUCT

- ❖ **PRICE**
- ❖ **EFFICIENT SALES AND SERVICE**
- ❖ **WE SPECIALIZE IN 5, 10 LOT PRICING**
- ❖ **ALL FUNCTIONS (COMPATIBLE WITH ALL MAJOR BRANDS)**
- ❖ **ANY SIZE ORDER FILLED WITH SAME DAY SHIPPING**

We handle **NEW** equipment **ONLY** - Don't trust last years **OBSOLETE** and **UNSOLD** stock!
COMPETITIVE PRICING—DEALERS WELCOME

HOURS: Monday-Saturday 9-5 C.S.T.

It is not the intent of B.E.S.W. to defraud any pay television operator and we will not assist any company or individual in doing the same.
*Refer to sales personnel for specifications.

**BASIC
ELECTRICAL
SUPPLY &
WAREHOUSING
CORPORATION**

P.O. Box 8180 ■ Bartlett, IL 60103 ■ 800-577-8775

**Make your projects
speak for themselves...
Ours do!**

DIGITAL VOICE RECORDERS

- Record up to 218 seconds
- 1 to 8 messages
- High quality speech 12 bit
- Switch-closure actuation
- Sample rates up to 20Khz
- On-board backup
- Direct speaker output
- Wide operating range
- Small size 2.6" X 2.6"
- Made in U.S.A.

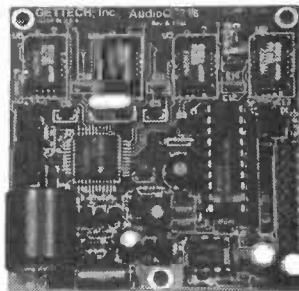

MODEL AudioQ™-218

Call or write for more information

OEM price and delivery available

Custom designs and enclosures

Single unit price \$149.00 plus s+h

Quantity pricing as low as \$99.00

GETTECH, Inc.

402 Riley Road, New Windsor, NY 12553

(914) 564-5347

Specifications and price subject to change.

SHOW TIME CABLE

*Your Cable
Connection
To The Stars!*



Order your **FREE**
catalog today!
1-800-643-4258



STARGATE SST

- Converters & Descramblers
- All Makes & Models
- Quantity Discounts
- 30-day Money Back Guarantee
- Best Warranties

Show Time Cable
643 N 98th St STE 260
Omaha, NE 68114

COD • MasterCard • Visa • Amex • Discover

CELLULAR SOFTWARE AND MODIFICATION GUIDES

Call Spy Supply for all of your Cellular needs!

We Carry:

CELLULAR SOFTWARE

(We have the software to do New Motorola Phones)

CELLULAR CABLES

(For the Motorola, Panasonic, and Nokia Phones)

CELLULAR MODIFICATION GUIDES

(Covers all cellular manufacturers)

CELLULAR PHONES

(We carry a complete line of cellular phones)



FREE TECHNICAL SUPPORT!

We now offer Cellular Phones cloned with your existing number! Buy a handheld, transportable or car mounted phone ready to go and have only one monthly bill!

Don't Get Ripped Off!

Before you buy our competitor's manual, call and ask if they offer **FREE TECHNICAL SUPPORT**

SPY SUPPLY

Find out why the CIA - FBI - DEA - SECRET SERVICE Have ordered from our catalog

To receive yours, send \$5.00 to:

SPY SUPPLY

1212 Boylston St. #120
Chestnut Hill, MA 02167

SPY SUPPLY, 1212 Boylston St. #120, Chestnut Hill, MA 02167

(617) 327-7272

Sold for educational purposes only

CABLE TV DESCRAMBLER KITS

**"New & Improved Version"
Universal Descrambler**
Includes all the parts and an etched & Drilled PC Board. Not included is AC adaptor or enclosure.....**\$69.00**

Tri-Mode Descrambler
Includes all the parts and an etched & drilled PC board & AC adaptor. Not included is the enclosure.....**\$49.00**

SB-3 Descrambler
Includes all the parts & an etched & drilled PC board & AC adaptor. Not included is the enclosure.....**\$39.00**

Call Toll Free 1-800-886-8699
Visa, MasterCard & COD.

M & G Electronics, Inc. 2 Aborn Street, Providence, RI. 02903

It is not the intent of M & G Electronics, Inc. to assist any individual to defraud any pay TV operator or to violate any state or federal laws regarding the use of the descrambler kits. You must understand the kits being purchased for educational and or experimental use only.

EPROM+

**PROGRAMMING SYSTEM
USES PARALLEL PORT**

EPROMS (24,28,32 & 40 PIN*) PLUS 27CXXX
1702*, 2708, TMS2716*, 32,32A, 64, 64A, 128, 128A
256, 512, 513, 01H, 010, 101, 1001, 1000, 1024, 210, 020
2001, 220, 2048, 4001, 040, 240, 4096, 25XX, 68764/66
FLASH EPROMS - 28F256, 28F512, 28F010
28F020, 29C257, 29C010, 29F010
EEPROMS & NVRAMS (18, 24 & 28 PIN+CXX)
2210, 2212, 2804, 2816, 2816A, 2817, 2864, 2865, 28256
28C010, DS1220, DS1225, DS1230
SERIAL EPROMS* (8 & 14 PIN PLUS CXX)
ER1400, M58657, 2401, 02, 04, 08, 16, 2444, 59C11
9306, 46, 56, 66, 8572, 82, 92
BIPOLAR PROMS* (16 THROUGH 24 PINS)
74SXXX AND 82SXXX FAMILY
MICROCONTROLLERS* 8741, 42, 48, 49, 8751
C51, 8752, 87C52, 87CSXXX, 87C751, 87C752, 68705
68HC705, 68HC711E9, PIC16C5X, TMS7742
*ADAPTER REQ'D - DIAGRAMS INCLUDED
SOFTWARE - READ, VERIFY, PROGRAM, COPY
DISK FILE LOAD/SAVE, CHECKSUM, FULL
SCREEN BUFFER EDITOR, W/20 COMMANDS
READS HEX, S-RECORD AND BINARY FILES
FAST-DEVICES PROGRAM IN UNDER 60 SEC
RUGGED (8"X7"X3") ENCLOSURE W/HANDLE
MADE IN USA - 1 YEAR WARRANTY



**SYSTEM INCLUDES:
PROGRAMMING UNIT
PRINTER PORT CABLE
POWER PACK, MANUAL
AND SOFTWARE.**

\$289

ADD \$5.00 SHIPPING
\$5.00 C.O.D.
VISA/MASTERCARD

ANDROMEDA RESEARCH, P.O. BOX 222, MILFORD, OH 45150
(513) 831-9708 FAX (513) 831-7562

AUTOMATE YOUR HOME



Hundreds of hard-to-find home automation and wireless control products. Computer control of your home, security systems, surveillance cameras, audio/video control, HVAC, pet care automation and much more. Easy do-it-yourself installation on most products. Affordable, systems start at about \$20.

Largest Selection of X10 Compatible Products in the World
Call for our Free 64 page Color Catalog
800-SMART-HOME (800-762-7846)
HOME AUTOMATION SYSTEMS, INC.
151 Kalmus Dr., Ste M6, Dept. PE2, Costa Mesa, CA 92626
Questions 714-708-0610 Fax 714-708-0614

**There is a
good time to
call the IRS.**

The best time to call 1-800-TAX-1040 is between 8 and 10 a.m., or after 2:30 p.m. on Wednesday, Thursday or Friday. It's just one more way we're giving you helpful advice.



Internal Revenue Service
Answers. Assistance. At Your Service.



MICRO CAMERA

Sees an entire room through an 1/8" hole

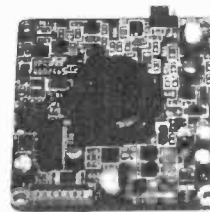

\$215 introductory price

Only 1.65 x 1.65 x .5 inches
90° field of view
operates on 12 volts DC
380 lines of resolution
built in electronic iris
low light .5 lux
standard video output

NortheastMicro

(201) 794-1132

Po box 175 Elmwood Park NJ 07407

Radiotelephone - Radiotelegraph

FCC Commercial License

Why Take Chances?

Discover how easy it is to pass the exams. Study with the most current materials available. Our **Homestudy Guides**, Audio, Video or PC "Q&A" pools make it so fast, easy and inexpensive. No college or experience needed. The new commercial FCC exams have been revised, covering updated Aviation, Marine, Radar, Microwave, New Rules & Regs, Digital Circuitry & more. We feature the Popular "Complete Electronic Career Guide" 1000's of satisfied customers **Guarantee** to pass or money back. Send for **FREE DETAILS** or call **1-800-800-7588**

WPT Publications
4701 N.E. 47th Street
Vancouver, WA 98661

Name _____

Address _____

City _____ St. _____ Zip _____

1-800-800-7588

CABLE TV DESCRAMBLERS



We have Descramblers for:

- Jerrold™ Systems
- Scientific Atlanta™ Systems
- Tocom™ Systems
- Zenith™ Systems
- Pioneer™ Systems

GUARANTEED TO WORK OR YOUR MONEY BACK!
BEST PRICES FREE CATALOG

Please have the **MAKE & MODEL #** of your area's cable box ready when you call!

ALLSTAR ELECTRONICS
800-782-7214

HOURS: 9-6 M-F 10-3 Sat EST
It is not the intent of ALLSTAR ELECTRONICS to defraud any pay TV operator and we will not assist any company or individual in doing the same. Prices subject to change without notice.

PE MARKET CENTER CLASSIFIEDS

!! BROADCAST & SURVEILLANCE !!
70-120MHz FM Transmitters & RF Amplifiers
RF Power/SWR Meters, Stereo Generator, DC Power Supplies, Frequency Counters, Audio Limiters, Amature and Pro Radio Gear, Electronic & RF Components, Plans, Kits, and more! Send \$2 (refundable on first order) for complete catalog.

Progressive Concepts
1434 N. MILLS AVE., SUITE B
CLAREMONT, CA 91711 (909) 626-4969

VISA
MC
(909) 626-4FAX

Satellite-TV
SAVE 40% - 60%
800-334-6455
218-739-5231 Int'l
218-739-4879 Fax
Skyvision Inc.®
1048 FRONTIER DRIVE • FERGUS FALLS, MN 56537
See full page ad in The Market Center

FREE Catalog

Cable Test Aids
Orders only 800-452-7090 Information (310)902-0841

Test chips for **JERROLD, TOCOM, ZENITH, S.A. & more.** Puts cable boxes in full service mode. Easy installation. Zenith only \$39.95. Most others under \$50ea. FAX: (310)902-0851. Quantity prices available. No Cx. min. Not for use in cable co. owned equip. For use as a test aid only.

SMALL COMPANY • BIG DISCOUNTS!
CABLE TV DESCRAMBLERS AND CONVERTERS
Discover Top Brands Available American Express
MasterCard SATISFACTION GUARANTEED! COD
Visa 1-800-775-0444 Check by Phone

T.C. ELECTRONICS
Decoders and Descramblers must be not used without authorization by your local cable operator. No Tennessee sales.

SURVEILLANCE
& COUNTERSURVEILLANCE Electronic Devices

Covert Video Cameras • Transmitter Kits • Voice Changers
Bug and Phone Tap Detectors • Shotgun Mics • Micro Recorders
Vehicle Tracking • Locksmithing • AND MORE!

16 - Hour Telephone Recorder - silently tapes incoming/outgoing phone calls automatically. \$199.00
SDY FOR CATALOG SEND \$5.00 TO... CREDIT CARDS WELCOME
OUTLET P.O. Box 337, Buffalo, NY 14226 (716) 691-3476

BUSINESS OPPORTUNITIES

START your own technical venture! Don Lancaster's newly updated **Incredible Secret Money Machine II** tells how. We now have autographed copies of the Guru's underground classic for \$18.50. **SYNERGETICS PRESS**, Box 809-C, Thatcher, AZ 85552. (602) 428-4073. Visa/MC.

LOOK HERE! We need your help to process our mail. Rush stamped envelope to: **MONEYMASTER-PE**, PO Box 89, Schenectady, NY 12301.

BUY THE company. Nationally marketed product. Sales potential in the millions. Two U.S. patents included. \$75-125K. Owner retiring. Days: (205) 863-6718. Nights: (205) 449-6482. Ask for Boyd.

CABLE TV

"BULLET" BUSTER. Protect your cable box against the infamous cable "bullet." The "Bullet" Buster acts as an electronic shield. Installs in-line in seconds. Don't wait until it's too late! \$19.95 + \$3.00 S&H. Visa/MC. **ELECTROMAN**, Box 24474, New Orleans, LA 70184. (504) 482-3017.

CABLE — SAFE. Guarantee cable privacy. The one way valve for your cable TV signal. Cable signals come in, but they don't go out! \$29.95, + \$3.00 S&H. Visa/MC. **ELECTROMAN**, Box 24474, New Orleans, LA 70184. (504) 482-3017.

DESCRAMBLER SCHEMATICS REVEALED. A powerful guide to descrambling schemes. \$10.00. Visa/MC. **ELECTROMAN**, Box 24474, New Orleans, LA 70184. (504) 482-3017.

CABLE UNSCRAMBLED. Everything you want to know about cable, but are afraid to ask. \$10.00. Visa/MC. **ELECTROMAN**, Box 24474, New Orleans, LA 70184. (504) 482-3017.

UNIVERSAL DESCRAMBLER. Unscramble signals using your VCR as the tuner. Works with virtually any system, this is the only one you need. Declare cable box independence! \$129.95 + \$5.00 S&H. Visa/MC. **ELECTROMAN**, Box 24474, New Orleans, LA 70184. (504) 482-3017.

DIGITAL VIDEO STABILIZER. Eliminates all video copyguards during playback of pre-recorded tapes. \$23.95. For information send a SASE to: Marketing by Design, PO Box 84, Port Murray, NJ 07865.

CABLE DESCRAMBLERS bargain headquarters, wholesale prices. Absolutely the lowest prices! Money back guarantee. Nobody beats us! **RP Electronics 1** (800) 304-3604.

ALL TEST aids \$17.00 each. R-2 V5 500 @ \$12.00, Zenith PZ1 PMI test info \$25.00, raw units PZ1 \$100.00, Tocom 5508 microwave \$100.00, no Eprom 5507 \$100.00. Parts, Tocom, VIP, front rear micros, \$25.00 ea., BB units \$50.00. 1 (800) 219-8618.

OWN YOUR cable box or ZAP IT! We have quality cable products for you. Money back guarantee and 1-year warranty. Toll free: 1 (800) 899-9707.

SATELLITE EQUIPMENT

SATELLITE RADIO BOOK AND GUIDE. New book covers all audio services, SCPC, subcarriers, FM squared, facsimile, press services, weather services. Simple how-to-receive instructions. \$16.95 plus \$3.00 Priority Mail. **UNIVERSAL ELECTRONICS**, 4555 Groves Road, #12, Columbus, OH 43232. (614) 866-4605.

TEST EQUIPMENT

CATV TEST CHIPS as low as \$8.95 for testing converter boxes in full service modes. Jerrold, Tocom, Scientific Atlanta. Pioneer BA5XX — BA67XX cubes clears E2-E5 Micro Masters, 1 (800) 360-7654.

EDUCATION

LEARN IBM PC ASSEMBLY LANGUAGE. Disk \$5.00, Book \$18.00. ZIPFAST, Box 12238, Lexington, KY 40581-2238.

COMPONENTS

STAINLESS STEEL Screws. Kits available. Free catalog. "Rusty Bolt," Box 708X, North Attleboro, MA 02761.

FINDER Modular Data System - The Electronic Data Book -

FINDER MDS Version 5.0 is a program specially designed to search for Electronic components characteristics. It's the perfect tool for Students, Hobbyists, Engineers and repair companies.

MAIN FEATURES

- Searching for components by Name, Function or Technical characteristics.
- Equivalences for Diodes, Transistors and MosFet (including package compatibility).
- Integrated Circuits cross reference table which gives more than 283,000 ICs substitutions.
- Technical forms up to 900 lines of information for a component., customizable forms for Discrete semi conductors search.
- More than 260 layout files wich include package drawings and dimensions.
- Printout facilities for technical forms and drawings, Graphic and text editors included with the program.

The 32,000 component references Data Base covers the following families

DISCRETE SEMI CONDUCTORS

- 15,000 Bipolar Transistors (up to 2,200 V, 200 A) including references for 2SA, 2SB, 2SC, 2SD.
- 2,400 MOSFET, V-MOSFET including references for 2SK, 3SK, 2SJ, 3SJ.
- 4,700 Diodes including Regulation, Varicap, Zener, Signal, Rectifiers...

MEMORIES

2,000 memories including RAM, PROM, EPROM.

INTEGRATED CIRCUITS

More than 7,800 circuits including TTL-LS, CD4000, HC-MOS, Op Amps, Audios Amps, Voltage Regulators / Supervisors / Comparators, PALs, Display Drivers, Data Transmission, TV-Video, Micro Processors 68000 MOTOROLA.

FINDER MDS Version 5.0 - Now Only \$ 149.95 (S & H charges not included)

To order call : 1- 800 (305) 561 3237

Visa & Mastercard accepted - Florida residents must add local sales tax.

FINDER MDS runs on IBM PC AT or true compatibles with 1 Mo RAM, HD, EGA/VGA display, DOS 3.1 min.

Electronics Software Solutions

3025 N. Ocean Bld, Fort Lauderdale, Florida 33308 - Phone : (305) 561 4340 - Fax : (305) 561 4418



CABLE TV



UNIVERSAL PRODUCT
New Technology

UNIVERSAL 5000	\$199.95
Our fully assembled product is factory tested and GUARANTEED to work on your system.	
MODEL 4000 KIT	\$ 79.95
The 4000 KIT comes with all the electronic parts and our Cad designed PC board. We provide parts list, full schmatic, wiring diagram and tutorial.	
MODEL 4000A Enclosure	\$ 44.95
The 4000A Enc. Package will provide the hobbyist, who has our 4000 Kit, a custom enclosure, AC adaptor and finish accessories to enclose their kit.	

MODEL 4000 And 5000 Features

- The latest in Video Amplification Technology.
- New clocking circuits to stabilize color and picture performance.
- The most advanced picture locking circuitry.
- Inverted Video Option is available.
- NO CONVERTER BOX is necessary.

The Halcyon Group 1-800-664-6999
In Canada call 813-751-3262

*** THE BEST ***
8085 MICROPROCESSOR
TRAINING SYSTEM
JUST GOT BETTER

Are you interested in Single Board Computers and Microprocessor-based systems? If the answer is yes and you want to know more about these fascinating subjects the PRIMER Trainer is the place to start. The PRIMER teaches more and is easier to use than other comparably priced trainers. The over 100 page Self Instruction manual takes you from binary number systems to processing interrupts. At the end of the manual are working examples of using a photocell, a temperature sensor, making a waveform generator, a programmable timer with alarm, and a new motor speed control lab using back EMF. The PRIMER comes with everything you need



to start programming in machine language. Continue on to program in Assembler, Forth or BASIC with optional upgrade and software. Upgrade includes: RS232 serial port, a serial cable and, 32K of battery backed RAM. Picture shown with upgrade option and optional heavy-duty keypad installed.

THE PRIMER IS ONLY \$119.95 QUANTITY 1 IN KIT FORM. THE PRIMER ASSEMBLED & TESTED BY EMAC IS \$169.95. ORDER NOW AND RECEIVE ONE FREE POWER SUPPLY WHEN YOU MENTION THIS AD. PLEASE ADD \$5.00 FOR SHIPPING WITHIN THE U.S.

EMAC, inc.
618-529-4525 FAX: 457-0110 BBS: 529-5708
P.O. BOX 2042 CARBONDALE, IL 62902

CABLE DIRECT

CONVERTERS
DESCRAMBLERS
VIDEO STABILIZERS
FILTERS



100%
MONEY BACK
GUARANTEE!

30 DAY
FREE
TRIAL!

FREE Cable TV Catalog.



Now you can tune-in your favorite cable TV programming and **SAVE \$100'S - EVEN \$1000'S** on premium **CABLE TV EQUIPMENT.**

MODERN ELECTRONICS

1-800-906-6664

2125 S. 156TH CIRCLE • OMAHA, NE 68130

Earn \$4,000 Per Month From Your Home With A Computer!



FREE CBSI 486 Computer

Begin part-time and still retain the security of your present position. This is a proven turnkey business an individual or couple can run. If you purchase our software and business program, we will give you the computer and printer. If you already own a computer, you may receive a discount. You do not need to own, or know how to run, a computer—we will provide free, home office training. Financing available. We accept AMEX, MC, Visa and Discover.

To receive free cassettes and color literature, call:

1-800-343-8014, ext. 1681

Or Write:

Computer Business Services, Inc.
CBSI Plaza, Ste. 1681, Sheridan, IN 46069

PROFESSIONAL SURVEILLANCE EQUIPMENT Used By Law Enforcement Agencies

VHF-FM CRYSTAL CONTROLLED TRANSMITTERS

A - 139MHz, B - 139.970 MHz, C - 149 MHz, D - 149.450 MHz
All kits assemble in less than 5 mins.

AD-F300
Gorgeous brass plant with 6 mirrors and concealed B&W video camera and video transmitter. Great for monitoring in living room, conf. room, office, or anywhere. Range 150 ft. \$880 (\$990 w/aud)



AD-700 Mic Range: up to 5 Mile Power 750MW \$272	AD-80 Mic Range: up to 1.8 Mile Power 80MW \$187	AD-550 Tel. Range: up to .5 Mile Power 35MW \$150	AD-400 Mic Range: up to 2.5 Mile Power 400MW \$163
---	---	--	---

If you need our technology in a diff. configuration for your needs, call! We can probably build it for you. We have other state-of-the-art surveillance equip. too!

We sell a variety of cameras, bug detectors, night vision equipment, video transmitters, time lapse recorders, remote video monitoring systems, and many more...

A&D ELECTRONICS

P.O. Box 501, Monsey, NY 10952

914-356-7541 • Fax 914-356-7505

Request our full catalog for \$6, get \$10 off your first order.
Credit Cards accepted

Device Programmers

WE BUY AND SELL NEW & USED DATA I/O PROGRAMMERS

W	\$ 579 EETOOLS ALLMAX
W	\$ 479 EETOOLS PROMAX
L	\$ 350 XELTEK SUPERPRO (R)
L	\$ 599 LOGICAL DEVICES 3000
B	\$ 599 ADVANTECH PC-UPROG
E	\$ 269 SUNSHINE UNIVERSAL
A	\$ 129 PAL PROGRAMMER
T	\$ 449 JDR EMUP UNIVERSAL
A	\$ 429 NEEDHAMS EMP-20
N	\$ 679 NEEDHAMS SA-20 S/ALONE
Y	\$ 139 EETOOLS 1 GANG
	\$ 199 EETOOLS 4 GANG
P	\$ 49 SUNSHINE 1 GANG
	\$ 99 SUNSHINE 4 GANG
R	\$ 169 SUNSHINE 8 GANG
E	\$ 299 SUNSHINE 16 GANG

24
HOUR
BBS
(408)
983-
1234

General Device Instruments
(408) 241-7376 Fax 241-6375

PE MARKET CENTER CLASSIFIEDS

PLANS-KITS-SCHEMATICS

BUILD — FIVE-digit, ohms, capacitance, frequency, pulse, multimeter. Board and instructions \$9.95. Bagnall Electronics, 179 May, Fairfield, CT 06430.

ALL-IN-ONE catalog. AM/FM/ham/spy, transmitters, amplifiers, receivers. Voice scramblers/disguisers, audio, TV, Tesla coils, plans, "secret" books, kits, imports, exports and more. Start your own licensed or unlicensed radio station, 60 full pages for \$1.00. PAN-COM INTERNATIONAL, PO Box 130-H4, Paradise, CA 95967.

FM STEREO TRANSMITTER kit broadcasts any audio signal to FM stereo radios throughout your home. Uses unique BA1404 IC. Complete kit: PC board/components — \$24.00. Visa/MC. TENTRONIX, 3605 Broken Arrow, Coeur d'Alene, ID 83814. (208) 664-2312.

HOBBYIST CIRCUITS — Remote room monitor, tone decoder, long distance circuit control and more. Simple experiments for the beginner. CATALOG \$2.00 — Garrett Plans, Box 155, Jamesburg, NJ 08831.

SURVEILLANCE TRANSMITTER kits. 65 to 305 MHz. Quick & Easy. Partially assembled units. Five minutes completion. 110-volt duplex receptacle, room battery types, and telephone. Counter-surveillance. Catalog: \$2.00. SHEFFIELD ELECTRONICS, PO Box 377940-B, Chicago, IL 60637-7940.

THIS AD COULD SAVE YOUR LIFE, COMBUSTIBLE GAS, CO 2, EMI AND OTHER EXOTIC SENSORS + SMT (Surface Mount Tech) Kits w/tools, manuals, & PCB's both analog and digital. For free catalog write pCSMT Co., 9047 Willis #3, PC, CA 91402. Or call (818) 891-9892 7-5pm PST.

EASILY CONVERT your tape recorder for long-play operation. Plans reg. \$59.95, now \$15.00! FREE FM TRANSMITTER SCHEMATIC with order! HURRY! RJJ, Box 6555, Stn. D, London, Ontario N5W 5S5, Canada. Sorry no cheques.

MANUFACTURERS SERVICE manuals. Samsung, others. TV/stereo 15.00, VCR \$25.00. Shipping \$2.50. Edgewood TV, 9937 Rhode Island Ave., College Park, MD 20740. (301) 441-9116 Visa/Mast, check, money order.

MUSICAL KEYBOARD — multiple settings. Good project for beginners. Send \$5.00 and SASE for schematic. Randall Norman, PO Box 1963, Murfreesboro, TN 37133.

FASCINATING DEVICES! FREE plans with parts special! Super spy microphone \$19.50! Super FM transmitter varactor tuned \$22.50! Vocal truth detector \$39.50! Bug detector 10 GHz bargraph, audible \$47.50! Universal IC tester tests any IC \$24.50! Hypersonic dazer defend yourself \$34.50! Radar cloaker electronic shield \$29.50! Laser jammer \$39.50! PC Boards \$10.00 each. Package of all 8 plans \$25.00! S&H \$5.00, catalog \$4.00 (creditable) or included with order! QUANTUM RESEARCH, 17919 - 77th Avenue, Edmonton, Alberta, Canada T5T 2S1.

YOU WON'T be caught flashing with SILENT SAM. Patented vehicle turn signal reminder warns when not to. Kit w/case \$15.00. Also, \$22.00/\$27.00 wired models plus \$2.50 S&H. Visa/MC. Money back guar. Toll free 1 (800) 398-5605, free flyer. Silent Sam, 1627 Basil Dr., Columbus, OH 43227.

CRYSTAL SET Handbook — Visit antiquity by building the radios your grandfather built. Assemble a "Quaker Oats" rig, wind coils that work and make it look like the 1920's! Only \$10.95 plus \$3.50 for shipping and handling. CLAGGK Inc., PO Box 4099, Farmingdale, NY 11735. US funds only! USA and Canada — no foreign orders.

SPY EQUIPMENT! Transmitters! Surveillance, countersurveillance! Scramblers! Catalog, free plan \$5.00. KDT WHOLESALERS, 2219 Paliswood Place SW, Calgary, Alberta, Canada, T2V 3R3.

WAVEFORM VIEWER. Simplify RF construction filters sweep oscillators detectors. View results on TV screen. Book \$24.95, computer program compatibles disk and booklet \$12.95, information SASE. Waveform Viewer, Box 142042, Gainesville, FL 32614-2042.

MINIATURE TRANSMITTERS! For all kinds of applications. Send \$2.00 for information, refundable on first order. Parsec Electronics, PO Box 34594, Phoenix, AZ 85067-4594.

PUBLICATIONS

HISTORIC AND Classic hardware support magazine. The Computer Journal provides how-to information on keeping S-100, Kaypro, 280, 6809, CPM, and PC/XT systems running. Over TEN years of hardware, software projects. 6 issues \$24.00. Free sample. 1 (800) 424-8825. TCJ, PO Box 535, Lincoln, CA 95648.

P.O. Box 421, Batavia, OH 45103

Educational Kits for the Serious Hobbyist

Caller Block

Connects between your telephone and its wall jack, and prevents the phone from ringing unless the calling party is one which you've entered into memory using your touch-tone phone. Your answering machine can handle all other calls. Change between two separate directories of callers with a simple flip of a switch.

Telephone Caller ID

Connects to telephone wall jack. Shows the telephone number of the calling party along with the time of day the call was received, on a 16x1 character LCD display. Stores the info from the last five calls in memory. Complete stand alone, no computer interface needed.

Telephone Call Restrictor

Connects to telephone wall jack. Disables all phones on the line if attempting to either: dial a number that has been stored in memory "Block Mode" or, dial a number that has not been stored in memory "Allow Mode". Use touch-tone phone to enter telephone numbers into memory, and choose mode. Program from any phone on the line using your password.

50 MHz Frequency Counter

Reads frequency from 1Hz to 50MHz and displays it on a 16x1 character LCD display. Auto-range feature provides floating decimal point and automatically affixes the correct suffix (Hz, KHz, or MHz). Microcontroller based, very few additional components.

Telephone Scrambler

Scrambles your voice before sending it over the telephone line, and descrambles it on the other end. Connects between your telephone and wall jack. No modifications are required to your telephone. Full duplex operation.

Electronic Message Module

Use a set of four pushbutton switches to write and store your own personal message in a 8-pin non-volatile EEPROM, which can then be printed across a 16x1 LCD display. Message can be up to 240 characters long. EEPROM can be removed from socket and still retain message. Re-program over and over with new messages.

Vocal Filter

An audio device which can be used with a home component stereo system, to filter out the main vocal sound track from standard stereo recordings (CD, tape, record or FM), leaving the background music to sing along with. Produce your own karaoke tapes.

DTMF Decoder/Logger

Keep track of all numbers dialed from any telephone on your line. Connects to your telephone wall jack. Decodes all 16 touch-tones and displays them on a LCD display. Holds the last 240 digits in a nonvolatile memory. Use the "shift back" and "shift forward" buttons to scroll through and view all numbers in memory.

Surface Mount Chip Component Prototyping Kits—



Only **\$49.95**

CC-1 Capacitor Kit contains 365 pieces, 5 ea. of every 10% value from 1pf to .33µf. CR-1 Resistor Kit contains 1540 pieces; 10 ea. of every 5% value from 100 to 10 megΩ. Sizes are 0805 and 1206. Each kit is ONLY \$49.95 and available for Immediate One Day Delivery!

Order by toll-free phone, FAX, or mail. We accept VISA, MC, COD, or Pre-paid orders. Company PO's accepted with approved credit. Call for free detailed brochure.

COMMUNICATIONS SPECIALISTS, INC.
426 West Taft Ave. • Orange, CA 92665-4296
Local (714) 998-3021 • FAX (714) 974-3420
Entire USA 1-800-854-0547

ARE YOU LOOKING FOR NEW, AND MOST INNOVATIVE ELECTRONIC PRODUCTS?

If so, we have just the right products for you! Products for all ages can be found in our 3 catalogs. The best known name brands such as: Bell Atlantic, Fuji, Panasonic, Sony, Sharp, Franklin, Casio, Quorum, MCI, Uniden and so much more can be at your fingertips! All you have to do is send \$15.00 to become a member of the great selection of products that Mana Electronics has to offer! After becoming a member and purchasing from our catalog, you are currently updated with catalogs of the newest and most innovative electronic products available today!

ORDER NOW!

To order send cheque or money order to:

MANA ELECTRONICS

P.O. Box 67002 RPO Maples
Winnipeg MB R2P 2T3

Do not send cash

DIGITAL VIDEO STABILIZER

Get clear videos every time! Enjoy a clear picture with pure color and clarity on all your rented video tapes. The Digital Video Stabilizer (DVS) eliminates darkening and shifting of colors, unwanted lines and flashing or jagged edges caused by copyguards. State of the art digital circuitry completely eliminates all copy protection and jamming signals. The DVS is ultra compact and fully automatic. Just pop in one 9V battery and hook it up! Compatible with all VCRs and TVs. 30 day money back guarantee. Order Now!

ONLY \$29.95 + S/H

WARNING: The DVS is not intended to copy rental video tapes that may constitute copyright infringement.
A-Plus Electronics 800-877-7587

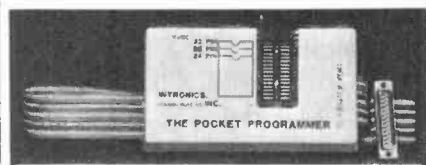

The Pocket Programmer

The portable Eeprom programmer that uses the printer port of your PC instead of an internal card. The software has 24 easy to use functions and programs 27/25/28/68764 & Cmos from 16K (2K × 8)—2M (256K × 8) Eeproms (32 pin socket, UpGradeable to 8Meg). Adapters available for MCU's, 40-Pin Eeproms, 5-Gang and Eeprom Emulator to 32K × 8.

INTRONICS, INC.
Box 13723
Edwardsville, KS 66113
(913) 422-2094

\$129.95

Add \$4.00 for shipping.
Add \$4.50 for COD.
Visa/Master Charge

MARYMAC® The New Realistic® PRO-43 Scanner

Radio Shack® PHONES

Our 19th year of DISCOUNTS
Toll Free 800-231-3680
PRO-2035 List \$449.99

Our Delivered Price \$385.00
IF ON SALE, WE ARE CHEAPER!

We discount everything in the RS catalog

22511 Katy Fwy.
Katy (Houston), TX 77450
1-713-392-0747 FAX 713-574-4567

\$139* Laser LightShow



Draw with a laser beam! Animation, text, music & more! Includes galvos, servo amp, oscillators, software listing, analog & digital computer interfaces. Call for details

Computerized Motors \$39*

Includes: 2 Stepper motors, computer interface, 32 page training manual, & software listing. Expandable system! Up to 12 motors, up to 3 amps per phase. Call for details

* Add \$6 for shipping. Computer with parallel printer port, Assembly, Power supply, & Laser are required

Call or fax for **FREE FLYER**

SVS

Light & Motion
in kit form

1273 Industrial Pky. West Bldg. 460
PO Box 55125
Hayward CA 94545-0125

Voice 510-582-6602
Fax 510-582-6603

ADVERTISING INDEX

POPULAR ELECTRONICS magazine does not assume any responsibility for errors that may appear in the index below.

Free Information No.	Page	Free Information No.	Page	
125	Ace Communications	99	164	Interactive Image Technologies . CV2
—	A&D Electronics	134	—	Intronics 135
—	Agrelo Engineering	124	—	ISCET 28
26	Alfa Electronics	108	144	Island LogiX Inc. 123
28	All Electronics	110	153	ITC Instruments 101
—	Allen Engineering	123	—	ITC Microcomponents Inc. 109, 124
—	Allison Technology	114	38	Kelvin Electronics 105
—	Allstar Electronics	132	—	Mana 135
27	Alltronics	115	—	Marymac Industries Inc. 135
—	Andromeda Research	131	—	MBI, Inc. CV4
—	Antique Electronics Supply 77	—	—	M&G Electronics 131
—	Antique Radio Classified 77	—	150	MCM Electronics 116
—	A-Plus Electronics	135	—	MD Electronics 121
146	B&S Sales	100	—	Mega Electronics 128
—	Basic Electronic Supply 129	—	149	Mendelson Electronics 128
30	Bel Merit	112	—	Ming Engineering 117
—	C&C Specialties	132	—	Modern Electronics 134
—	C&L Electronics	126	—	Mondo-tronics 128
132	C&S Sales	102	163	Mouser Electronics 28
—	Cellsoft	122	—	Northeast Micro 131
—	CLAGGK Inc. 75, 93, 94	—	—	NRI Schools 27, 73
—	Cleveland Institute of Electronics. 63	—	—	Nu-Tek Electronics 76
—	Command Productions 127	43	—	Optoelectronics CV3
—	Communication Specialists 135	—	—	Phillips Tech 125
—	Computer Business Services 134	145	—	Prairie Digital Inc. 120
—	Consumertronics	120	152	Print 122
—	Comtrad Industries 8, 14	—	46	Print 119
—	Copyright Clearance Center 7	—	—	Progressive Concepts 132
—	Cybermation	120	—	Rattner North America 125
151	Dalbani	113	—	The School of PC Repair 77
—	Design Computation	127	—	The School of VCR Repair 77
—	EDE Spy Outlet	132	—	Self-Reliance Co. Inc. 116
—	EIA	32	48	Sescom Inc. 97
—	The Electrician School 77	—	—	Show Time 129
145	Electronic Goldmine	104	—	Silicon Valley Surplus 135
147	Electronic Rainbow	98	—	Skyvision (Small) 132
—	Electronic Software Solutions 133	—	—	Skyvision Inc. 107
—	Electronics Tech Today 65, 81, 87, 90	—	—	Software Science 125
—	EMAC	133	—	Spy Supply 130
—	Firestik II	76	—	Tab Books 23, 45
154	Foley-Belsaw Institute	31	136	UCANDO Videos 118
—	Forest Electronics	109	—	Universal Electronics Inc. 114
—	Fotronic Corporation	118	—	US Cable Supply 132
—	General Device Instruments 134	—	—	US Cable (Zentek) 125
—	Genuine Electronics	109	—	US Cyberlab 23, 127
—	Get-Tech Inc.	129	—	Vision Electronics 128
—	Grantham College	3	—	Weeder Technologies 135
—	Great Southern Security	111	—	Windward Electronics 126
—	Greenleaf Electronics Inc.	116	—	World College (Div. of C.I.E.) 5
—	Halcyon Group	133	—	WPT Publications 132
—	Home Automation Systems	131	134	Xandi Electronics 114
136	Information Unlimited	106	—	Zorin 128

ADVERTISING SALES OFFICE

Gernsback Publications, Inc.
500-B Bi-County Blvd.
Farmingdale, NY 11735
1-(516) 293-3000

Larry Steckler, EHF/CET
 President

Christina Estrada
 Assistant to the President

For Advertising ONLY
516-293-3000
Fax 1-516-293-3115

Larry Steckler
 publisher

Arline Fishman
 advertising director

Denise Mullen
 advertising assistant

Kelly Twist
 credit manager

**Subscription/
 Customer Service/
 Order Entry**
1-800-827-0383
7:30 AM - 8:30 PM EST

ADVERTISING SALES OFFICES EAST/SOUTHEAST

Stanley Levitan
 Eastern Sales
 1 Overlook Ave.
 Great Neck, NY 11021
 1-516-487-9357, 1-516-293-3000
 Fax 1-516-487-8402

**MIDWEST/Texas/Arkansas/
 Oklahoma, Colorado, Arizona**

Ralph Bergen
 Midwest Sales
 One Northfield Plaza, Suite 300
 Northfield, IL 60093-1214
 1-708-446-1444
 Fax 1-708-559-0562

PACIFIC COAST/Mountain States

Anita Bartman
 Hutch Looney & Assoc., Inc.
 6310 San Vicente Blvd.
 Suite 360
 Los Angeles, CA 90048
 1-213-931-3444
 Fax 1-213-931-3444
 Fax 1-213-931-7309

Another bright idea from

OPTOELECTRONICS

But don't just take our word for it...

"I purchased the Scout... WHAT A UNIT! VERY IMPRESSED!!!"

Allen Wilde - Littleton, MA

"I take my Scout with me everywhere - it's very effective in mobile use, either in the car or on foot. I recommend a Scout over another scanner when adding to your collection... the most effective device so far from Opto for the Scannist."

Steve Dawkins - Pensacola, FL

"This is a breakthrough product in everyway... KUDOS!"

Robert Caron - Des Moines, IA

"The Scout is AWESOME-the folks at OPTO keep coming up with winners, and this is their best yet!"

Gordon West

Gordon West Radio School

"Scantastic"

Brad Schroeder - Omaha, NE



- 400 Frequency Memory with 250 Hz Counter
- Sleep Mode to prevent data loss when battery dies
- Reaction Tune - will tune a receiver with CI-V port in .01 seconds
- Beeper and Vibrator Signal Indicator
- Digital Filter and Auto Capture
- CI-V Serial Data Port
- Software for uploading Frequencies to a PC included
- 16 Segment Signal Level Bargraph
- 10MHz to 2.8GHz Frequency Range
- 7 Hour Battery Operation
- Maximized Sensitivity for maximum antenna pick-up

SCOUT.....\$449.00

OPTIONS: Option 1: Mini DB32 Ant....\$29.00 Option 2: AC100 Rapid Charger....\$39.00 Option 3: Spectrum-CD ROM....\$39.00

Scout SPECTRUM-CD ROM



The SCOUT

ORDER LINE: 800-327-5912

TEL: (305) 771-2050 FAX: (305) 771-2052
 5821 NE 14TH AVE, FORT LAUDERDALE, FL, 33334
 VISA, MC, C.O.D., CASH OR MONEY ORDER-SHIPping ADD'L
 ALL SPECIFICATIONS & PRICES ARE SUBJECT TO CHANGE
 WITHOUT NOTICE OR OBLIGATION.

CIRCLE 43 ON FREE INFORMATION CARD

Scout Reaction-Tune



THE MOST POWERFUL COMPACT RADIO IN THE WORLD!

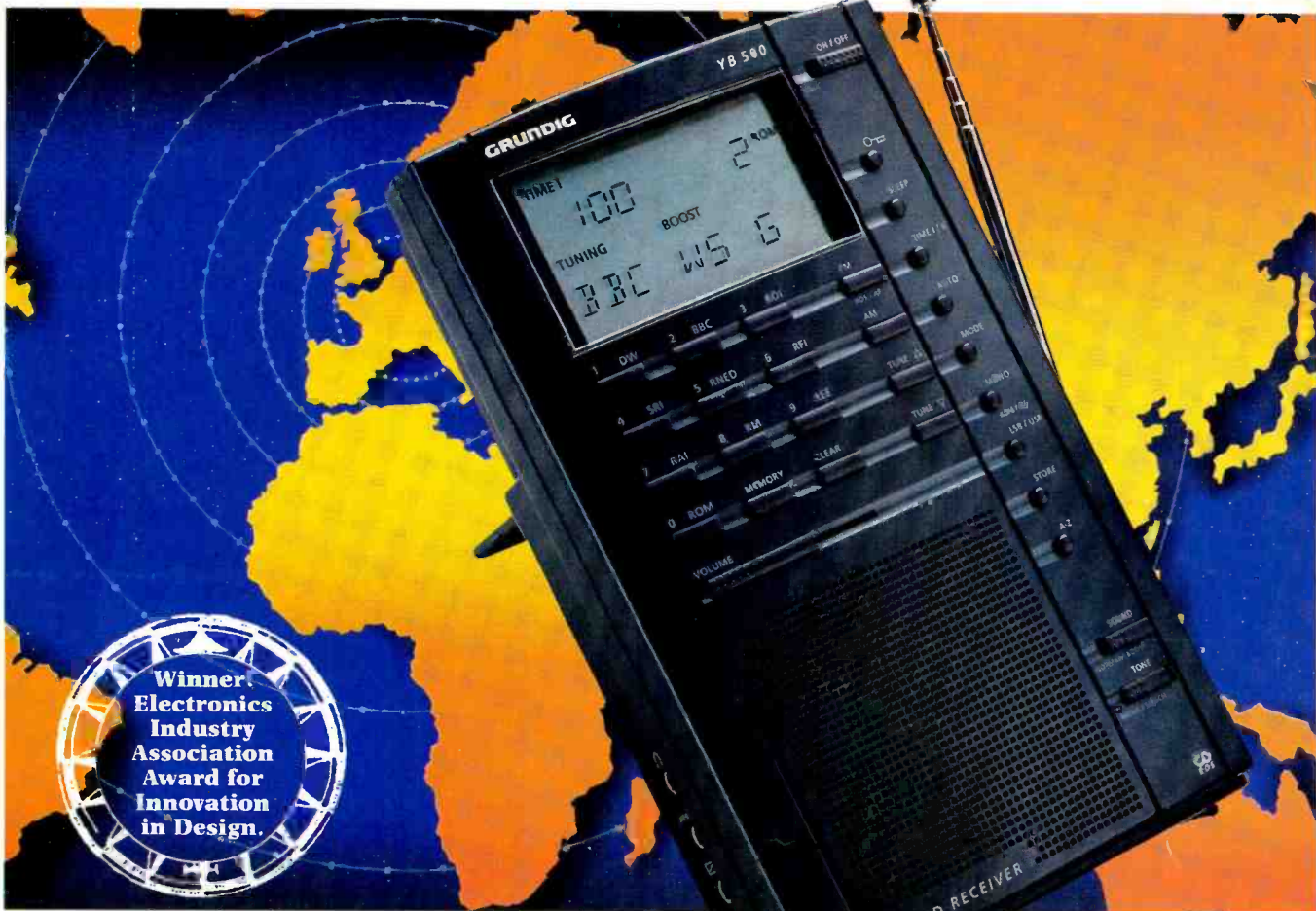

THE GRUNDIG YB-500 FM/AM Shortwave Receiver

Listen! Here is the BIG BREAKTHROUGH in powerful performance and design. Not in stores... Now available to you in the U.S.A. from Willabee & Ward. No other compact radio packs all these powerful features.

▲ **POWERFUL RECEPTION.** The Grundig YB-500 does it all: pulls in AM, FM, FM stereo, every SHORTWAVE band, even aviation, military and ship-to-shore. All with lock-on digital precision.

▲ **POWERFUL SOUND.** Exclusive Audio Power Boost — found on no other world band radio — gives the YB-500 big, rich, room-filling legendary Grundig sound.

Powerful Features.

Power scan! The YB-500 has continuous power scan on shortwave — stops at every signal and lets you listen. When you hear a broadcast you want, you tell the radio to stop. Only Grundig has this feature.

Power timing features! The YB-500 can send you to sleep on FM, wake you with weather on AM, then switch you to BBC shortwave. Even shuts itself off. Elsewhere, you'd pay \$500 for these features.

Powerful Memory.

The BBC and all major world broadcasters are pre-set for instant retrieval. You can add

40 more stations on any band and display call letters for reference. No other radio at this price offers such powerful memory.

Also has instant keypad access to all frequencies. Illuminated, adjustable LCD display for bedside use. Advanced RDS FM station information display. It will be years before other makers catch up with the YB-500. But it is available today from Willabee & Ward.

Powerful Value.

The Grundig YB-500 is only \$299 (plus \$9.50 shipping and handling), payable in eight monthly credit card installments of \$38.56. Includes 4 AA batteries, deluxe travel pouch, stereo headphones, owner's manual, and Grundig's shortwave listening guide. **INTRODUCTORY OFFER: ORDER NOW AND GET A FREE DUAL-VOLTAGE INTERNATIONAL ADAPTER!**

Grundig 1-year warranty on parts and labor. 30-day money back guarantee. Grundig is to radios what BMW and Mercedes are to cars. European look! European sound! European quality! Order now!

Phone orders normally shipped next business day.

Call Toll-Free: 1-800-367-4534
Extension 697-537

First and ONLY world band with award-winning vertical design. Measures approximately 7 7/8" x 4 1/2" x 1 1/2", with built-in stand and retractable ferrite antenna.

© 1994 MBI

RESERVATION APPLICATION

Willabee & Ward
47 Richards Avenue • Norwalk, CT 06857



Call Toll-Free: 1-800-367-4534
Extension 697-537

Please send me _____ Grundig YB-500 Digital All-Band Shortwave Receiver(s). For each receiver, charge eight installments of \$38.56* to my credit card:

VISA MasterCard Discover Am. Ex.

Credit Card No. _____ Exp. Date _____

Name _____

Please Print Clearly.

Address _____

City _____

State/Zip _____

Signature _____

(Orders subject to acceptance.)

I prefer not to pay by credit card and will pay by check. Enclosed is my check for \$299 plus \$9.50 shipping/handling, a total of \$308.50* for each receiver.

*Any applicable sales tax will be billed with shipment. Higher shipping/handling outside U.S.