

HOME SECURITY SYSTEM • LOW-FREQUENCY RADIO • CAR REMOTE CONTROL

October 1994

Popular Electronics



Build A Home-Security System

A commercial-quality system that includes multiple zones, auto-dialer support, adjustable entry and exit delays, and more

An Emergency Remote Control For Your Car

Disable your car, flash your lights, sound your horn, and more with this easy-to-build security accessory

Ground Zero

There's a lot of fun to be had at the bottom of the radio-frequency spectrum

Car Navigation Goes Mainstream

A look at the first system offered by a U.S. automaker



#BXEDCCH CAR-RT 30RT ** C02#
#60506DHM997GAD009# FEB95 P46
ROBERT DAHM RESP
997 GRAND AVE # 107
AURORA IL 60506-2513

\$3.50 U.S.
\$3.95 CAN.

A GERMSBACK PUBLICATION

Design and Verify Circuits. Fast.

DOS and Windows & Mac versions available

Electronics Workbench®

NEW Version 3

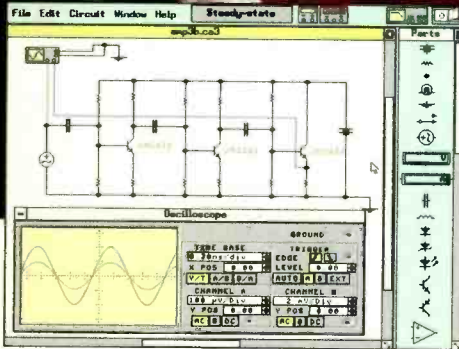

Analog Module includes:

- complete control over all component values
- ideal *and* real-world models for active components
- resistors, capacitors, inductors, transformers, relays, diodes, Zener diodes, LEDs, BJTs, opamps, bulbs, fuses, JFETs, and MOSFETs
- manual, time-delay, voltage-controlled and current-controlled switches
- independent, voltage-controlled and current-controlled sources
- multimeter
- function generator (1 Hz to 1 GHz)
- dual-trace oscilloscope (1 Hz to 1 GHz)
- Bode plotter (1 mHz to 10 GHz)
- SPICE simulation of transient and steady-state response

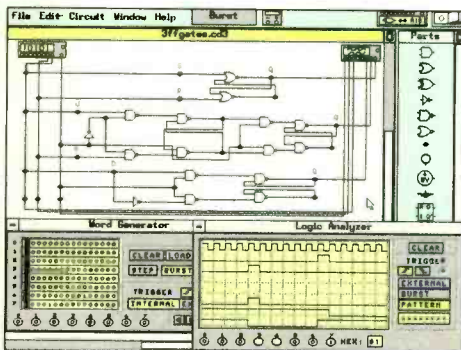

Digital Module includes:

- fast simulation of ideal components
- AND, OR, XOR, NOT, NAND and NOR gates
- RS, JK and D flip-flops
- LED probes, half-adders, switches and seven-segment displays
- word generator (16 eight-bit words)
- logic analyzer (eight-channel)
- logic converter (converts among gates, truth table and Boolean representations)

Complement Your Test Bench

Here's why Electronics Workbench belongs on *your* test bench: Wires route themselves. Connections are always perfect. And the simulated components and test instruments work just like the real thing. The instruments are indestructible and the parts bin holds an unlimited supply of each component. The result: thousands of electronics professionals and hobbyists save precious time and money. **Over 90% would recommend it to their friends and colleagues.** Electronics Workbench: the ideal, affordable tool to design and verify your analog and digital circuits before you breadboard.

And now the best is even better - Electronics Workbench Version 3.0 is here. It simulates more and bigger circuits, and sets the standard for ease of use. Guaranteed!

NEW Features in Version 3

- new components include JFETs, MOSFETs, voltage-controlled and current-controlled sources and manual, time-delay, voltage-controlled and current-controlled switches
- real-world models for opamps, BJTs, JFETs, MOSFETs and diodes - over 100 models available
- MS-DOS version now supports up to 16 MB of RAM for simulation of bigger circuits
- new Microsoft® Windows™ version available
- technical support now also available on CompuServe®

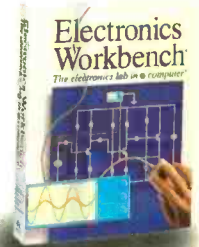

Just \$299!

Electronics Workbench®

The electronics lab in a computer™

Call: 800 263-5552

INTERACTIVE IMAGE TECHNOLOGIES LTD.
908 Niagara Falls Blvd. #068, North Tonawanda, NY 14120-2060
Telephone: (416) 361-0333 FAX: (416) 368-5799

*30-day money-back guarantee.

Prices in U.S. dollars, shipping \$15. Offer valid in U.S. and Canada only. All trademarks are the property of their respective owners.

CIRCLE 167 ON FREE INFORMATION CARD



Popular Electronics®

OCTOBER 1994

Vol. 11, No. 10

A
GERNSBACK
PUBLICATION

COVER STORY

31 Build a Home Security System

Crime is one of this country's top problems, but this full-featured, commercial-quality security system can help reduce your risk of becoming a crime statistic. It features multiple protection zones, programmable entry and exit delays, autodialer support, panic inputs, and much more—*John Taylor, Jr.*

CONSTRUCTION

47 Build a Multifunction Car Security System

Flash your lights, sound your horn, or even disable your ignition from up to 100 feet away—*Anthony J. Caristi*

62 Build a One-Tube AM Receiver

Get great high-fidelity performance from this easy-to-build conversation piece—*Larry Lisle*

FEATURES

41 Variable Frequency RF Oscillators

This introduction to variable-frequency oscillators shows how they work, and how you can use them in your own designs—*Joseph J. Carr*

55 Ground Zero

There's a lot of fun to be had at the low-frequency end of the radio spectrum—*Karl T. Thurber, Jr.*

75 Navigation Systems Go Mainstream

Learn about the first car-navigation system to be officially offered by a U.S. car maker—*Bill Siuru*

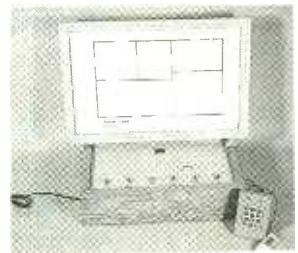

Page 31

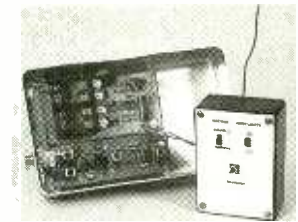

Page 47



Page 75

POPULAR ELECTRONICS (ISSN 1042-170-X) Published monthly by Gernsback Publications, Inc. 500-B Bi-County Boulevard, Farmingdale, NY 11735. Second-Class postage paid at Farmingdale, NY and at additional mailing offices. One-year, twelve issues, subscription rate U.S. and possessions \$21.95, Canada \$28.84 (includes G.S.T. Canadian Goods and Services Tax Registration No. R125166280), all other countries \$29.45. Subscription orders payable in U.S. funds only. International Postal Money Order or check drawn on a U.S. bank. U.S. single copy price \$3.50. © 1994 by Gernsback Publications, Inc. All rights reserved. Hands-on Electronics and Gizmo trademarks are registered in U.S. and Canada by Gernsback Publications, Inc. Popular Electronics trademark is registered in U.S. and Canada by Electronics Technology Today, Inc. and is licensed to Gernsback Publications, Inc. Printed in U.S.A.

Postmaster: Please send address changes to Popular Electronics, Subscription Dept., P.O. Box 338, Mount Morris, IL 61054-9932

A stamped self-addressed envelope must accompany all submitted manuscripts and/or artwork or photographs if their return is desired should they be rejected. We disclaim any responsibility for the loss or damage of manuscripts and/or artwork or photographs while in our possession or otherwise.

As a service to readers, Popular Electronics publishes available plans or information relating to newsworthy products, techniques, and scientific and technological developments. Because of possible variances in the quality and condition of materials and workmanship used by readers, Popular Electronics disclaims any responsibility for the safe and proper functioning of reader-built projects based upon or from plans or information published in this magazine.

PRODUCT REVIEWS

18 Hands-On Report
OrCad Schematic Design Tools 386+

63 Gizmo
Videonics digital mixer, Sonance in-wall speakers, Brother P-Touch PC labeling system, VCR Plus+ Control Tower universal remote control, and much more

COLUMNS

6 Multimedia Watch
Multimedia and the MAC—*Marc Spiwak*

22 Antique Radio
A "baby boomer" from Britain—*Marc Ellis*

24 Think Tank
Some hobby circuits—*John Yacono*

77 Computer Bits
Fishing for knowledge—*Jeff Holtzman*

82 Circuit Circus
Monitor and detector circuits—*Charles D. Rakes*

85 Dx Listening
DX on the tropical bands—*Don Jensen*

87 Ham Radio
Using a double-balanced mixer—*Joseph J. Carr*

89 Scanner Scene
Not-so-private security—*Marc Saxon*

DEPARTMENTS

- 3 Editorial**
- 4 Letters**
- 10 Electronics Library**
- 16 New Products**
- 80 Electronics Market Place**
- 95 Popular Electronics Market Center**
- 138 Advertiser's Index**
- 139 Free Information Card**

Popular Electronics

Larry Steckler, EHF, CET,
editor-in-chief and publisher

EDITORIAL DEPARTMENT

- Carl Laron**, editor
- Robert A. Young**, associate editor
- John Yacono**, associate editor
- Teri Scaduto**, assistant editor
- Evelyn Rose**, editorial assistant
- Marc Spiwak**, editorial associate
- Joseph J. Carr, K4IPV**, contributing editor
- Marc Ellis**, contributing editor
- Jeffrey K. Holtzman**, contributing editor
- Don Jensen**, contributing editor
- Marc Saxon**, contributing editor

PRODUCTION DEPARTMENT

- Ruby M. Yee**, production director
- Karen S. Brown**, production manager
- Kathy Campbell**, production assistant

ART DEPARTMENT

- Andre Duzant**, art director
- Russell C. Truelson**, illustrator

Jacqueline P. Cheeseboro,
circulation director

Michele Torriolo,
POPULAR ELECTRONICS bookstore

BUSINESS AND EDITORIAL OFFICES

Gernsback Publications, Inc.
500-B Bi-County Blvd.
Farmingdale, NY 11735
1-516-293-3000
FAX: 1-516-293-3115
President: **Larry Steckler**

**SUBSCRIPTION
CUSTOMER SERVICE/
ORDER ENTRY**
1-800-827-0383
7:30 AM - 8:30 PM EST

**Advertising Sales Offices
listed on page 138**

Composition by Mates Graphics

Cover by Loewy Design
Illustration by John Zeilinski



Since some of the equipment and circuitry described in POPULAR ELECTRONICS may relate to or be covered by U.S. patents, POPULAR ELECTRONICS disclaims any liability for the infringement of such patents by the making, using, or selling of such equipment or circuitry, and suggests that anyone interested in such projects consult a patent attorney.

EDITORIAL

A MATTER OF SECURITY

In poll after poll, when Americans are asked what the number-one problem facing our country is, crime ranks at or near the top. Many of us no longer feel safe in our homes or even our cars. That's not surprising considering that newspapers and radio and TV news broadcasts are filled with sometimes horrifying accounts of increasingly brazen and sensational criminal deeds.

While some would have you believe otherwise, there is no easy way to immediately solve this important problem. But there are steps you can take to reduce your risk of becoming a crime statistic. This month, Popular Electronics presents two stories to help you do just that.

In Build a Home Security System, we present a full-featured, commercial-quality security system. It has multiple protection zones, programmable exit and entry delays, panic inputs, and much more. It also has provisions to flash your house lights and to activate an autodialer to call for help in the event of a break in. The story begins on page 31.

In Build a Multifunction Car Security System, we show an RF remote control that can be used in a variety of security functions. You can use it to flash your vehicle's lights or to sound its horn from as much as 100 feet away. That can let you easily find your car in a dark, deserted parking lot, scare away suspicious characters who are loitering near your car, or get attention in an emergency.

The remote can also be set up to disable your car's ignition system. That last feature can save your car in the event of a carjacking, while giving you enough distance and time to get to safety. The story begins on page 47.



Carl Laron
Editor

SURVEILLANCE & SECURITY

FM TRANSMITTERS MINIATURE (KITS)

- 3-VOLT FM XMTR, up to 300 ft. indoors, 1500 ft. outdoors
- PHONE XMTR, range to 500 ft., uses phone-line power
- Sound-Activated XMTR, range to 500 ft.
- 2-STAGE XMTR, 9-Volt, very powerful

All above require simple soldering at 2 to 4 places. Broadcast on std FM band. Assemble in less than 5 minutes. Any of the above **\$29.95****

TELE CALL FORWARDER. Transfers incoming calls to any number you select. **\$99.00***

CALLER ID. Registers incoming number and stores to 50 numbers. **\$99.00***

TEL REGISTER WITH PRINTER. Records dialed number, duration, and prints record. 16-digit display with security lock control. Stores up to 40 calls. **\$149.00***

TEL REGISTER W/O PRINTER. Records dialed number and time. 16-digit display. Holds up to 145 numbers in memory. **\$99.00***

12-HOUR LONG-PLAY RECORDER. Modified Panasonic. Records 6 hrs. on each side of 120 tape (supplied). Compatible with VOX and Tel Rec Adapter. **\$119.00***

VOX VOICE-ACTIVATED SWITCH. Makes recorder self-activating with voices or other sounds. Great for radios and scanners. Provisions for external mike and/or patch cord. **\$28.50****

TELEPHONE RECORDING ADAPTER. Records incoming and outgoing calls. Use of handset controls recorder and records both sides of conversation. **\$28.50***

TELEPHONE SCRAMBLERS. Over 51,000 separate codes; impossible to break code. Assures utmost privacy. **\$295.00***

VOICE CHANGER. Changes man's voice to lady's and vice versa. 4 separate settings. Ideal for disguising voice. **\$29.95****

RF BUG DETECTORS, AND MUCH MORE

For Shipping and Handling add *\$5.00 and **\$2.00 per item. Colo. residents add sales tax. Mail Order. VISA, M/C, COD's o.k. Inquire for dealer prices. Free catalog.

TOLL FREE 1-800-926-2488

A.M.C. SALES, INC.

193 Vaquero Drive
Boulder, CO 80303
Tel: (303) 499-5405
Fax: (303) 494-4924

Mon-Fri 8 a.m. - 5 p.m. Mtn. Time

CIRCLE 151 ON FREE INFORMATION CARD

LETTERS

NOISE-REDUCTION SYSTEM CORRECTION

I was very impressed with your presentation of my article, "The Universal Noise-Reduction System" (*Popular Electronics*, July 1994). However, two artwork mistakes did creep in. In the schematic diagram (Fig. 2), resistor R9 is shown in the wrong place: one end should be located at the junction of pin 4 of U2 and R8, and the other end should go to ground. In the parts-placement diagram (Fig. 5), the locations of R7 and R8 have been swapped. I hope that this clears up any confusion.

RICHARD PANOSH

COMMENTS AND SUGGESTIONS

I have been a subscriber to *Popular Electronics* since the late 1960's and I thoroughly enjoy each and every issue. I especially appreciate the construction articles and have built many projects, but that would be a story in itself. Because

everyone seems to be commenting on what they would like to see included in the magazine, I thought I would forward a few of my own.

First, because I have always been fascinated by the growth and diversity of computers, I look forward to every *Popular Electronics* article that covers peripherals. For example: "All About Parallel Port Signals" (January 1992), "Troubleshooting Parallel Connections" (February 1992), "Programming Serial Ports" (August 1993), and "Computer Viruses" (September 1993). Those articles were excellent. Keep up the good work with more articles on disk controllers, disk drives, video/graphic boards, and memory expansion.

Second, I consider myself an

electronics hobbyist, as I suspect a lot of your readers are. I think it would be great to expand the "Haves & Needs" portion of the *Letters* section into a separate column in which readers could exchange parts and information that they have accumulated in their junk boxes. Finding parts and accessories, or even literature, is nearly impossible these days, yet many readers have collections of all sorts of electronics stuff. I, for one, cannot bring myself to throw away good electronic "junk."

For example, I have a Tektronix 3B3 plug-in timebase module that I have no use for. Perhaps one of your readers needs one. On the other hand, I also have a request for "Haves & Needs." I am looking for the operating and service manuals for a C-1B electric power plant manufactured by E.A. Laboratories, Inc., of Brooklyn, New York. I would gladly pay for copying and shipping.

Thank you for hearing me out. I look forward to every issue of *Popular Electronics* because I know there will always be something worth reading about.

JOE NOWINSKY
Route 1, Box 261
Florence, TX 76527

ONE MORE KIT COMPANY

The article on electronic kits that appeared in the July 1994 issue of *Popular Electronics* was very well written and informative. At the end of the article, several firms that offer electronic kits are mentioned. I would like to add one more to your list: PAiA Electronics, Inc. The company is located at 3200 Teakwood Lane, Edmond, OK 73013. The phone number is 405-340-6300, and the fax number is 405-340-6378.

PAiA offers musical, MIDI, audio, audio effects and processors, and audio recording accessory kits. I have assembled two of their kits, and

have been satisfied with the instructions, construction, and performance of the units.

I also bought and assembled the universal noise-reduction system (featured in the July issue) from Vista in Bollingbrook, IL. The kit went together easily and works perfectly. I will be using it in my home recording studio. I called Vista to compliment their product, and found that it was their first consumer-electronics kit. I encouraged them to market more in the future. They were very friendly and helpful in shipping my kit out quickly so that I could have it for the following weekend's recording project.

R.M.
Norcross, GA

HAVES & NEEDS

I'm trying to fix a Goldstar color TV, model #CMT-9325, serial #KC-60401070. I need a copy of the schematics, especially the power supply. I will pay for postage and copying costs.

JODY WHITE
6130 Keating Road
Pensacola, FL 32504

I need to buy an owner's manual, schematic, and probe for a B + K Precision dual-trace oscilloscope model 2120 and a Meguro 1-GHz spectrum analyzer. Can any of your readers help me to obtain those items?

RUDY SERRANO
6 Fl., No. 51, Sec. 2
Chuncking So. Rd.
Taipei, Taiwan, R.O.C.

I am seeking information on a commercial Pacman game. The nameplate on the game has the following information, with Japanese characters on each line: 95-1655 NNO
100 V
100 W
10/60 Hz
666033
NANA0.

Thanks for your help.
JOHN MROZKO
RR1, Box 28
Cohoes, NY 12047



THE MOST
**AN IMPORTANT PART
OF YOUR PHOTOCOPIER
ISN'T PART OF
YOUR PHOTOCOPIER**

Having a machine may not permit you to photocopy books, journals, newsletters and magazines.
The Copyright Clearance Center CAN.
Contact us to find out
how you too can COPY RIGHT!SM

COPYRIGHT CLEARANCE CENTER

222 Rosewood Drive, Danvers, MA 01923 □ Tel. (508) 744-3350 □ Fax (508) 741-2318

© 1993 Copyright Clearance Center

Be The Boss Of Your Own Bookkeeping And Accounting Business

Now NRI makes it easier than ever to be your own boss. NRI's innovative new at-home training in Contemporary Bookkeeping and Accounting guides you step-by-step from the basics of bookkeeping to more advanced accounting techniques...plus gives you hands-on experience with today's most exciting new accounting tool: a powerful AT-compatible computer system you train with and keep!

Your timing couldn't be better! Only NRI's new hands-on training gives you the opportunity to make the most of three of today's most exciting new developments:

- The persistent and growing need for bookkeeping and accounting services by virtually every business, association, and organization operating today
- The computer revolution that's transformed traditional bookkeeping and accounting practices and techniques
- And the home office boom—with more than 25 million Americans currently working in a home based business of their own and more than 15 million more entrepreneurs expected to join the home-based ranks by the year 2000.

Only NRI's Contemporary Bookkeeping and Accounting course prepares you to capitalize on all three, with comprehensive training in every aspect of bookkeeping and accounting, *plus* hands-on training with a powerful IBM-compatible computer and professional General Ledger software, *plus* the business knowledge you need to make your home-based enterprise thrive.

Start earning while you learn

Among the most popular home-based services today, bookkeeping and accounting offers tremendous money-making potential for the trained professional. And NRI's unique new training helps you take advantage of this earnings potential quickly and easily.

NRI starts you out with the tried-and-true basics of bookkeeping and accounting, cutting through unproductive "busy work" to give you the skills that really count. Before you're halfway through your course, you'll be able to pick up part-time income preparing balance sheets, profit-and-loss statements, and other financial reports for local businesspeople. And that's just the beginning!

Only NRI gives you an AT-compatible computer and friendly, "walk-you-through" software to train with and use in your new business

Once you've mastered the essential basics, you're ready to make the leap to contemporary accounting techniques with a computer. And you'll get hands-on training with the IBM-compatible computer that's *included* in your course.

That's right! You get a powerful IBM PC/AT-compatible system featuring a full megabyte of RAM, high-resolution monitor, and floppy disk drive—*plus* professional General Ledger software ingeniously designed to speed your learning process.

Even if you make a mistake, your user-friendly software points you in the right direction with easily understandable instructions in plain English. Best of all, this same training software doubles as a complete bookkeeping and accounting package you can use to set up the books for your business clients.

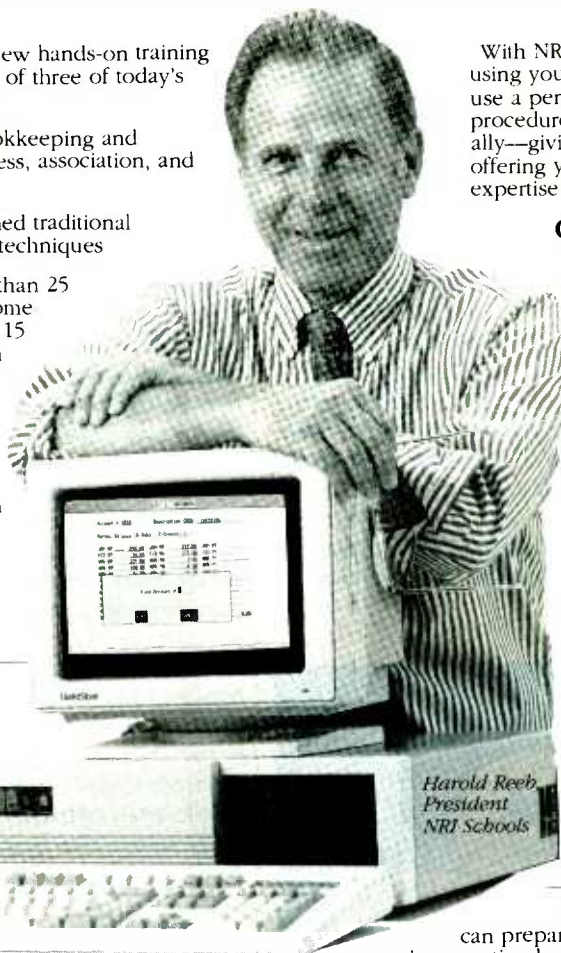

With NRI's step-by-step training, you'll soon be using your computer as comfortably as you now use a pencil, doing in minutes the kinds of procedures that can take hours to do manually—giving you more time to make money offering your bookkeeping and accounting expertise to your clients!

Get the business savvy you need to set up shop at home

NRI goes beyond giving you technical expertise in bookkeeping and accounting to give you the business knowledge you need to succeed as a home-based entrepreneur. You learn how to set up the ideal home office, how to get and keep good-paying clients, how to budget your resources, grow your profits, and much more. And NRI's experienced instructors are always available with technical advice, encouragement, and support as you get your business off the ground.

Even if you decide to wait before setting up shop at home, your new understanding of advertising, customer relations, and other business principles will help you generate part-time income or move up to a responsible position with your present company.

Send today for FREE catalog

To find out how NRI's at-home training can prepare you to start a profitable bookkeeping and accounting business of your own, send for NRI's free, full-color catalog. Or choose to send for information about one of NRI's many other courses designed to help you be your own boss. If the coupon is missing, write to NRI Schools, McGraw-Hill Continuing Education Center, 4401 Connecticut Avenue, NW, Washington, DC 20008.



NRI Schools

McGraw-Hill Continuing Education Center
4401 Connecticut Avenue, NW, Washington, DC 20008

- Check one only**
- | | |
|--|------------------------------------|
| <input type="checkbox"/> Bookkeeping and Accounting | <input type="checkbox"/> Paralegal |
| <input type="checkbox"/> Desktop Publishing and Design | <input type="checkbox"/> Travel |
| <input type="checkbox"/> Word Processing | <input type="checkbox"/> Writing |
| <input type="checkbox"/> Computer Programming | |

Name _____ (please print) Age _____

Address _____

City/State/Zip _____ 2935-1094

Accredited Member, National Home Study Council

MULTIMEDIA WATCH

By Marc Spiwak

The Mac and The PC Worlds Are Similar

As I mentioned last month, I've got a *Macintosh Performa 600* on loan to me for a period of time. That time period is soon to expire, so I figured I would tell you what my initial impressions of a Mac are. I've always worked with PC's, but I've played with a few different Mac's over the years. We all know what a pain in the neck PC's can be, even for expert users, and we know even better what a mystery they are to inexperienced users.

In that respect, Mac's are supposed to be different than PC's, and they are,

connectors are clearly marked and easy to identify. The connectors on PC's are often confusing.

Although I did not have the pleasure of installing new hardware in the Mac, I am told by some reliable sources that it's without a doubt much easier to install, say, a modem in a Mac than it is in a PC. New hardware is instantly recognized and configured by the Mac at power-up. (We all know how miserable life can be when installing a new expansion card in a PC.) So the Mac wins hands-down where hardware upgrades are concerned.

However, I'm not so sure how important that is. It seems to me that experienced PC users will always manage to get a new device to work, although it might take a little blood, sweat, and tears. An inexperienced user, on the other hand, would probably never crack open the case on a computer in a million years.

Most software was already set up for me on the Mac, so I can't say whether software installation in general is easier on a Mac than a PC. Navigating through a Mac interface is quite easy for experienced Windows users, and some aspects are much more user-friendly. For instance, any disc (or diskette) inserted into the Mac generates its own icon on the screen. But as I said before, that is only of significant value for people unfamiliar with PC's, as click-

ing on a drive icon in Windows becomes second nature after a while.

My main interest in the Mac was in how it handled multimedia. Both my PC and the Mac have double-speed, CD-ROM drives, but my PC has a definite edge in memory (16 Megs versus the Mac's 5) and speed (50 MHz versus 32). I have to say that even with the Performa 600's limited horsepower, multimedia applications seem to run quite satisfactorily. I have a bunch of multimedia titles including *Hell Cab* and *Iron Helix* for both the Mac and PC platforms. It seems that the games run almost identically on both machines, except for an edge in speed on the faster PC.

To sum up, I'm sure that a top-of-the-line Mac will blow the doors off my now-dated DX2-50 in multimedia applications, but my DX2 is still far from obsolete. If I had to recommend either platform for a complete computer greenhorn, I would probably go with the Mac because it's easier to set up and use. However, PC's are still much cheaper, and are getting easier to use all the time. (Will plug-and-play cards ever work reliably? We'll know soon enough.) For someone who has had some experience with computers, and is interested in getting into multimedia, I would have to recommend a PC because of its more generic availability. I guess that a long-time PC user will almost always push the PC



The PC GamePad is the perfect controller for quick-response games like *Pac Man*.

especially for people who know little or nothing about computers. A Mac is definitely easier to set up than a PC. All peripherals that come with a Mac are made specifically for the Mac by Apple, so they all work very well together. All

platform and a Mac user will always push the Mac. Maybe that's because both worlds are closer than one might think; the advantages of either are not overwhelming, so users stick with what they know.

WEIRD CONTROLLERS, CONTINUED

I have been testing out a neat little game controller called the *Gravis PC GamePad* from Advanced Gravis. The GamePad is a Nintendo-like controller with a small tiltable thumb pad on one end and four buttons on the other. The

WHERE TO GET IT

Advanced Gravis
1790 Midway Ln.
Bellingham, WA 98226
Tel. 604-431-5020

Apple Computer, Inc.
20525 Mariani Avenue
Cupertino, CA 95014
Tel. 408-996-1010

Aris Multimedia Entertainment
310 Washington Blvd., Suite 100
Marina Del Rey, CA 90292
Tel. 310-821-0234

Corel Corporation
The Corel Building
1600 Carling Avenue
Ottawa, Ontario,
Canada K1Z 8R7
Tel. 613-728-8200

Grolier Electronic
Publishing, Inc.
Sherman Turnpike
Danbury, CT 06816
Tel. 203-797-3500

HyperGlot
P.O. Box 10746
Knoxville, TN 37939
Tel. 615-558-8270

infoBusiness
887 South Orem Blvd.
Suite B
Orem, UT 84058
Tel. 801-221-1100

NovaLogic
19510 Ventura Blvd.
Suite 200
Tarzana, CA 91356
Tel. 818-774-0600

World Library, Inc.
12914 Haster Street
Garden Grove, CA 92640
Tel. 714-748-7197

Heathkit® Heathkit® Heathkit® Heathkit® Heathkit®

Master Course in Electronics Technology

The Best Quality & Best Value in Electronics Training

No one can match the quality and value of this Heathkit course. Using videos, computer-aided instruction, trainers, test instruments, and texts, it's everything you need at the right price.



This comprehensive course delivers superior instruction and makes learning easier and more fun. Compare this course with any and all others. Heathkit offers the most effective and practical training.

What You'll Learn:
This value-packed course offers you so much more than courses from "the other guys." With Heathkit, you get a program of study that is much more effective, more enjoyable, and more practical on your pocketbook and your schedule to success. You'll learn all about DC and AC

Semiconductors, Circuits, and Digital Techniques (more advanced courses are available). You'll get all the training and test equipment all at once, right along with your course materials. You'll get graded examinations, have access to instructors, and earn CEUs. **Call now, before today!**

•Heathkit •455 Riverview Drive •Benton Harbor, MI 49023-1288

For a Full-Line Catalog of Electronics and Computer Courses, call 1-800-44-HEATH
When calling, please mention this code: 107-028

©1994 Heath Company

CIRCLE 155 ON FREE INFORMATION CARD

device is small and easy to hold. The thumb pad is tilt-able in any direction, and a small joystick handle can be screwed into the pad. This provides you with a tiny thumbstick with very fast reaction times, but less accuracy than a full-sized joystick. This thumb action is perfect for a game like *Pac Man* where you have to make rapid movements up, down, left, or right, but not so hot for games like flight simulators. With a list price of only \$29.95, I give the *GamePad* a *Thumbs up!*

If you're more into flight games, then the *Gravis Analog Pro* joystick is what's right for you. This is Advanced Gravis' top-of-the-line joystick, and it shows. This joystick is extremely well-made, and will stand up to years of rough handling. The stick has a built-in

throttle control that lets you put your attention elsewhere. It also has five programmable fire buttons—two on top of the stick, two on the side, and a trigger—so you can customize its operation to your liking. Rare among joysticks is the Pro's ability to adjust the tension on the stick from completely loose (where the stick flops around without centering) to very tight. A six-foot cord and a foam-padded handle complete this very nice \$59.95 package.

NEW STUFF

I recently received one of the most useful and user-friendly CD-ROM's I've ever seen. Part of what makes this package useful is that it comes with a book—you know, the paper kind. Anyway, the package is called

Corel Gallery, and it's published by the Corel Corporation. *Corel Gallery* contains 10,000 high-quality clip-art images on CD-ROM, with over 6000 of them in color.

Now I know that CD-ROM's can make some things in life much easier, but searching through one filled with thousands of images can get tedious, and you're bound to miss the image that's just right for a particular application. The beauty of *Corel Gallery* is that all 10,000 images are also printed in a book. I find that it's much easier, and faster, to look through images in a book than it is on-screen. Then, the chosen clip art can be pulled from the disc quickly. Although I wouldn't have a use for them, the disc includes hundreds of celebrity

portraits (some look accurate and some not so accurate). That aside, thousands of other useful images, in 50 different categories, are also present. The clip-art package has a list price of \$59, and it's the easiest one to use that I've ever seen.

Clip-art of a different sort—photographic rather than drawn—came to me from Aris. Two new *MediaClips* discs—*Americana* and *New York, NY*—contain high-resolution photos, video, and audio clips. Each disc contains 100 photos in TIFF, BMP, and PICT formats; 25 videos in Video for Windows, QuickTime, and MPEG formats; and 100 Music clips in WAV and SND Resource formats. All material is royalty-free, and so you are free to use it as you like. These discs retail for \$29.95.

Also from Aris is the *Multimedia Starter Pack*. This package includes Aris' *MPC Wizard 2.0* which helps you test, tune, and troubleshoot a multimedia PC. Also contained is *WinTutor 3.1*, a multimedia Windows Tutor on CD-ROM, and *WorldView*, a *MediaClips* disc with an outer-space theme. Specially priced at \$29.95, this 3-disc set makes a nice gift for someone new to multimedia.

Another useful disc, especially if you want to learn how to speak Spanish, is *Learn To Speak Spanish* from HyperGlot. This multimedia set is the multimedia way to learn Spanish. While I've mentioned HyperGlot's software before (they have products for many different languages), this is a new version with a much-improved user-interface, and the product now includes

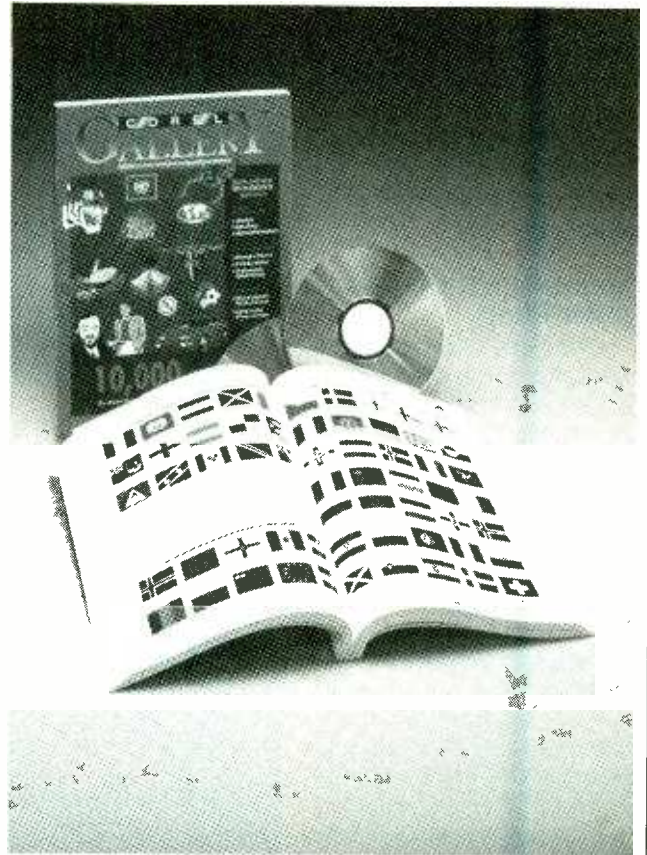

Corel Gallery is a collection of 10,000 pieces of clip art on CD-ROM. A full-color book included in the package makes it easy to search for the clip art that's just right for an application.

digitized video.

From InfoBusiness, *Job-Power Source* is the multimedia way to brush up on your job-finding skills for the 90's. This disc contains complete books and plenty of other text, two hours of video training clips, interactive worksheets, and more. If you're looking to begin a career, or start a new one, then maybe this \$49.95 disc is a good place to start.

Library of the Future, Third Edition, from World Library, Inc., adds the complete text of nearly 1,500 new titles to the second edition of the disc, for a total of 1750 literary titles on one disc. While it's not as convenient to read a book on-screen or laser-printed as it is with an actual book, there is no better way to research one of the books than with this CD-ROM, and for \$395, it's a relative bargain.

A disc that's fun for children and adults is *Prehistoria*, from Grolier Electronic Publishing. This is a very entertaining disc that chronicles all kinds of prehistoric life—not just dinosaurs. *Prehistoria* covers over 500 prehistoric species of animals that roamed the earth over a period of 500 million years. The disc sells for \$69.95.

The folks at NovaLogic write some amazing software, in particular *Comanche CD*, which is the best helicopter-combat simulator we've ever seen. The CD contains all three *Comanche* games in the series, and is an excellent buy at a list of \$74.95. *WolfPack* is another great simulation game, but it's of a World War II naval battle. With a list price of only \$39.95, *WolfPack* can't be beat.

NEXT MONTH

In the November, 1994 Issue

Popular Electronics®

Build the TEST GEAR you need for your work/repair-bench and save big bucks! Here are four winners:

- **Autorangeing Frequency Counter**—Go up to 50 MHz with this easy-to-build project.
- **Autorangeing Capacitance Meter**—If it's between 1 pF and 1000 µF, you get a valid reading.
- **Battery Ampere-Hour Meter**—Provides an accurate indication of battery's condition and remaining charge.
- **"Gate-Dip" Meter**—Determine resonant frequency of tuned circuits and antennas.
- **PLUS** outstanding columns and departments like Gizmo, Think Tank, DX Listening, Scanner Scene, Ham Radio, Computer Bits, Circuit Circus, Multimedia Watch and more!

On Sale
September 16, 1994

Pick up *Popular Electronics* at your favorite
Newsstand, Bookstore, Convenience Store
or Supermarket

Take this GIANT CIRCUIT LIBRARY for only \$9.95

when you join the *Electronics Engineers' Book Club*®

THE ENCYCLOPEDIA OF ELECTRONIC CIRCUITS — Vols. 1, 2 & 3 by Rudolf F. Graf

Hundreds of circuit ideas alphabetically arranged — from Alarm circuits to Zero crossing detector circuits!

... includes schematics for the latest electronics circuits from industry leaders...
—Popular Electronics

Turn to this comprehensive circuit library for hundreds of project ideas... valuable troubleshooting and repair tips... and concise pinout diagrams and schematics. In each volume you'll find more than 700 electronic and integrated circuits and 100+ circuit categories right at your fingertips to give you ideas you can use on the job or at your workbench.

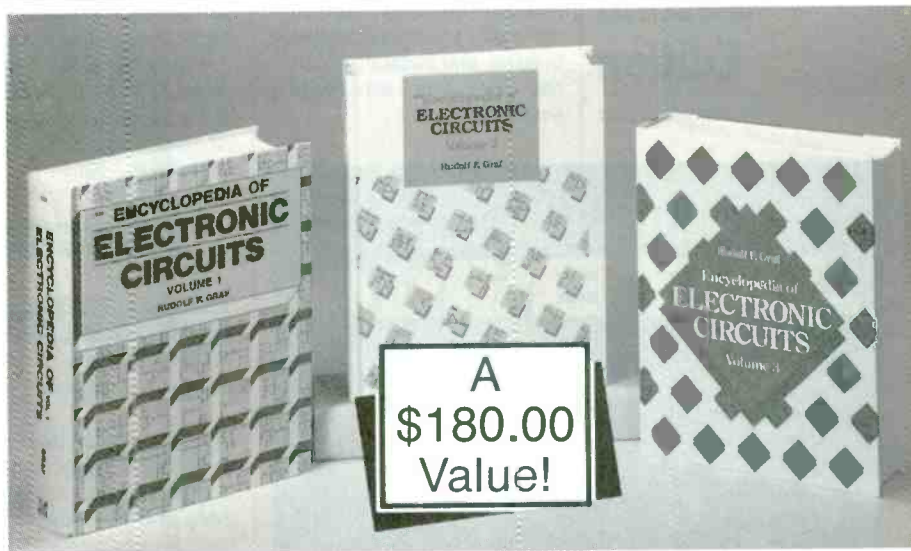

2,344 total pages 3,490 total illustrations

Book No. 5489C Hardcover

If coupon is missing, write to: Electronics Engineers' Book Club, Blue Ridge Summit, PA 17294-0860

As a member of the Electronics Engineers' Book Club...

... you'll enjoy receiving Club bulletins every 3-4 weeks containing exciting offers on the latest books in the field at savings of up to 50% off of regular publishers' prices. If you want the Main Selection do nothing and it will be shipped automatically. If you want another book, or no book at all, simply return the reply form to us by the date specified. You'll have at least 10 days to decide. And you'll be eligible for *FREE BOOKS* through the Bonus Book Plan. Your only obligation is to purchase 3 more books during the next 2 years, after which you may cancel your membership at any time.

Publisher's price shown. ©1994 EEBC

ELECTRONICS ENGINEERS' BOOK CLUB

Blue Ridge Summit, PA 17294-0860

YES! Please send me *The Encyclopedia of Electronic Circuits— Vols. 1, 2 & 3* (5489C), billing me \$9.95 plus shipping/handling & tax. Enroll me as a member of the **Electronics Engineers' Book Club** according to the terms outlined in this ad. If not satisfied, I may return the books within 10 days and have my membership cancelled.

Name _____
 Address _____
 City _____
 State _____
 Zip _____ Phone _____

Valid for new members only, subject to acceptance by EEBC. Canada must remit in U.S. funds drawn on U.S. banks. Applicants outside the U.S. and Canada will receive special ordering instructions. A shipping/handling charge & sales tax will be added to all orders. PPIF1094

ELECTRONICS LIBRARY

Practical Antenna Handbook: Second Edition

by Joseph J. Carr

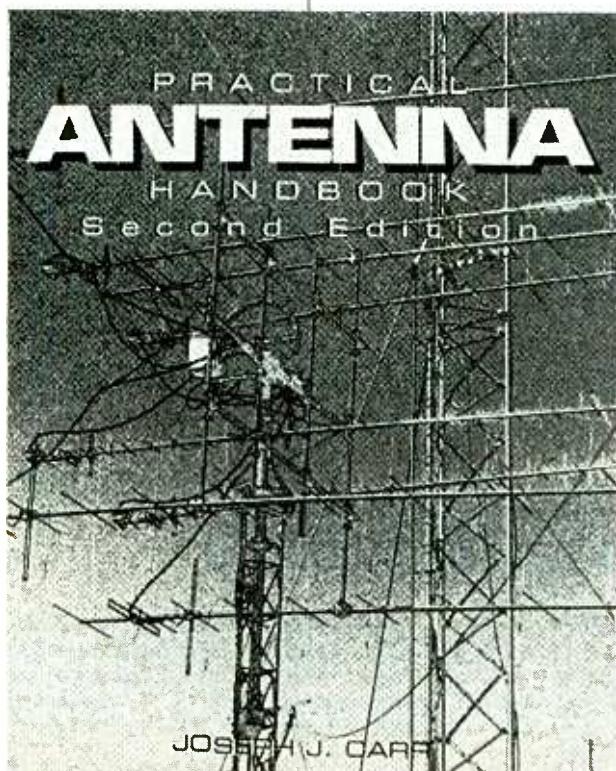

Popular Electronics columnist Joe Carr has updated his hot-selling, project-packed book to include all-new BASIC computer programs for antenna design and impedance matching, expanded coverage of long-wire directional antennas and radio-wave propagation theory, and new material on small loop direction-finding antennas. Like the first edition, the focus is on practical information that you can easily put to use designing, building, and installing antennas—even if your experience is limited.

The book provides all the nuts-and-bolts information you need to make antennas work, and then shows you how to extend that knowledge into new projects that involve designing, building, modifying, or installing antennas. A wide array of antenna types covered, including

high-frequency dipole, vertically polarized HF, hidden and limited-space, VHF/UHF transmitting and receiving, multi-band, tunable-wire, short-wave, microwave, mobile, marine, and emergency antennas. The book also explains how to match antenna load impedance to an RF source or transmission line and how to use the Smith chart for problem-solving, and outlines antenna grounding techniques.

Practical Antenna Handbook: Second Edition costs \$26.95 and is published by Tab Books Inc., Blue Ridge Summit, PA 17294-0850; Tel: 1-800-233-1128.

CIRCLE 98 ON FREE INFORMATION CARD

THE COMPREHENSIVE GUIDE TO MILITARY MONITORING

by Steve A. Douglas

Ironically, the complexity that gives military monitoring much of its appeal also scares off many would-be listeners. This book aims to demystify the world of military monitoring, spelling out in simple terms—with no techno-jargon—how anyone can monitor military radio communications with a minimum of confusion and cost. The book explains the equipment needed to tune military frequencies, and provides a “milspeak” dictionary to help readers understand military lingo. The book also includes a base-by-base listing of all military frequencies, the top nationwide frequency listings, maps of military bases and refueling tracks, a source guide, and a complete listing of the U.S. Navy’s FLTSATCOM channels.

In the final chapter, the author describes the shadowy world of stealth aircraft, which he has been monitoring closely for

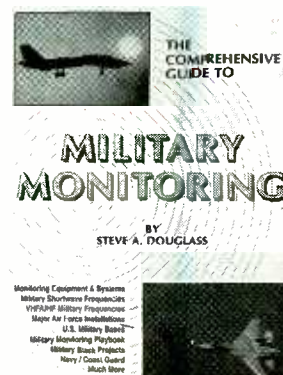

years. He includes photos and illustrations of secret aircraft, and a video still of the “TR-3A Black Manta,” which the Air Force still denies exists.

The Comprehensive Guide to Military Monitoring is available for \$19.95 plus \$4.00 shipping (Priority Mail) from Universal Electronics, Inc., 4555 Groves Road, Suite 13, Columbus, OH 43232; Tel: 614-866-4605; Fax: 614-866-1201.

CIRCLE 90 ON FREE INFORMATION CARD

LEARN DOS 6.2 IN A DAY

by Russell A. Stultz

Designed with the beginner in mind, this tutorial makes it easy to master the most common DOS commands with practical, hands-on activities. It guides readers through the important commands that are found in every version of MS-DOS, and also explains how the new DOS 6.0 and 6.2 utilities can be used to enhance computer operations. The book provides the means to quickly identify which commands are available in later versions, but unavailable in earlier versions, of MS-DOS. With an emphasis on learning by doing, the book has readers formatting disks, copying files, and displaying their contents within minutes after opening its cover.



Learn DOS 6.2 in a Day costs \$12.95 and is published by Wordware Publishing, Inc., 1506 Capitol Avenue, Plano, TX 75074; Tel: 214-423-0090.

CIRCLE 91 ON FREE INFORMATION CARD

EASY MULTIMEDIA: SOUND & VIDEO FOR THE PC CROWD

by Ori Gurewich and Nathan Gurewich

Whether or not you have a CD-ROM drive, sound board, or programming expertise, this book-and-diskette package shows you how you can create vivid, dramatic multimedia presentations for business, educational, or personal use. The book reveals how to put multimedia to work in applications that feature full-motion video, sound and sound recording, and colorful animation. In a humorous, non-technical style, it explains how to add sound and video to presentations, use Windows-compatible sound cards, synchronize music and video files, create animated shows on the PC, and incorporate multimedia into everyday word-processing and

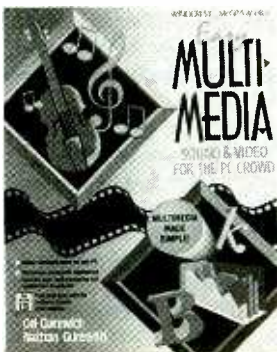

spreadsheet documents. The bundled disk provides source code and exciting multimedia presentations that are ready to be used.

Easy Multimedia: Sound and Video for the PC Crowd costs \$24.95 and is published by Windcrest/McGraw-Hill, Blue Ridge Summit, PA 17294-0850; Tel: 1-800-233-1128; Fax: 717-794-2103.

CIRCLE 96 ON FREE INFORMATION CARD

FISHER WORLD TREASURE NEWS

Volume 5, Issue 1
from Fisher Research Laboratory

This 28-page, magazine-format newsletter documents valuable discoveries made all over the world by people using Fisher metal detectors. The newsletter contains sections on archaeology, gold prospecting, underwater treasure hunting,



and the use of metal detectors in law enforcement. It features stories on the lost legions of Rome, a 23-ounce gold nugget, a Civil War battle site, an 1874 key-date coin worth more than \$10,000, and a scuba-diving show.

The Fisher World Treasure News is free upon request from Fisher Research Laboratory, 200 West Wilmott Road, Dept. PE, Los Banos, CA 93635; Tel: 1-800-M-SCOPE-1.

CIRCLE 92 ON FREE INFORMATION CARD

LOTUS NOTES ANSWERS: Certified Tech Support

by Polly Russell Kornblith

The author teamed up with Cor-

Earn Your B.S. Degree in COMPUTERS or ELECTRONICS



By Studying at Home

Grantham College of Engineering, now in our 44th year, is highly experienced in "distance education"—teaching by correspondence—through printed materials, computer materials, fax, modem, and phone.

No commuting to class. Study at your own pace, while continuing on your present job. Learn from easy-to-understand but complete and thorough lesson materials, with additional help from our instructors.

Our Engineering Technology B.S. Degree Program is available in either of two options:

- (1) The B.S.E.T. with Major Emphasis in Electronics, OR
- (2) The B.S.E.T. with Major Emphasis in Computers.

Our Computer Science B.S. Degree Program leads to the B.S.C.S.—the Bachelor of Science in Computer Science.

An important part of being prepared to *move up* is holding the right college degree, and the absolutely necessary part is knowing your field. Grantham can help you both ways—to learn more and to earn your degree in the process.

Write or phone for our free catalog. Toll free, 1-800-955-2527, or see mailing address below.

Accredited by
the Accrediting Commission of the
National Home Study Council

GRANTHAM
College of Engineering
Grantham College Road
Slidell, LA 70460

porate Software Inc., one of the world's largest providers of technical support, to produce this comprehensive, easy-to-use book. Handling 200,000 technical questions via phone each month, Corporate Software determined the questions most frequently asked by users of Lotus Notes. Both the questions and the answers appear in this book, eliminating the need to call the tech support helpline or waste time trying to find the answer in voluminous user's

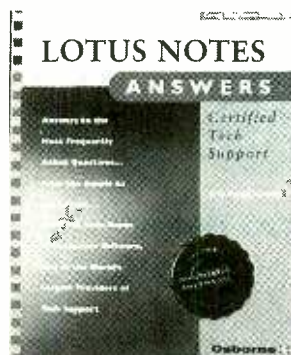

manuals. A wide range of Lotus Notes topics are covered, from adding and opening multiple databases, to using Views, to organizing and retrieving information. The book covers all the common pitfalls and trouble spots associated with Lotus Notes, including protecting and sending documents, and deciphering error messages. It explains how to use functions to look up information in other documents or databases, how to use encryption to protect your mail, and how to import and export data to and from Notes. Finally, the book tackles the "Top Ten Tech Terrors" and offers "Frustration Busters" intended to help prevent problems before they occur.

Lotus Notes Answers: Certified Tech Support costs \$16.95 and is published by Osborne McGraw-Hill, 2600 Tenth Street, Berkeley, CA 94710; Tel: 510-549-6600; Fax: 510-549-6603.

CIRCLE 100 ON FREE INFORMATION CARD

THE VIRTUAL REALITY CONSTRUCTION KIT

by Joe Gradecki

Intended to provide "total immersion" in the virtual-reality

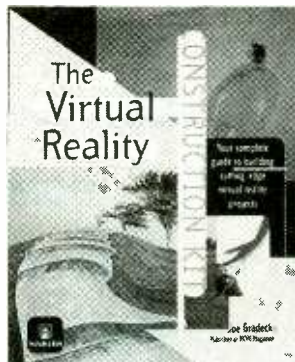

experience, this book shows readers how to create virtual reality in their own homes. It offers plans for 14 inexpensive projects, designed to be hooked up to a home computer, that can be built even by those with no programming or electronics background. Projects include adapting existing hardware (such as Nintendo PowerGloves and VictorMaxx 3D goggles) to work on your PC, and building your own 3D goggles, motion trackers, and 3D sound systems from scratch. The book comes with a disk that includes all the software needed to test, calibrate, and run the gear that you build. Even before you build any of the projects, you can explore the virtual worlds included on the disk using just your mouse and monitor. Programmers will appreciate the C-code tips in the book and the source code on the disk. The disk also includes six virtual worlds in which you can tour a virtual park, play racquetball in a virtual court, fly a jet, battle a robot in a shooting game, construct an ancient Greek temple in three dimensions, and battle a friend via modern or cable hook-up in cyberspace combat simulation.

The Virtual Reality Construction Kit book and disk set costs \$27.95 and is published by John Wiley & Sons, Inc., 605 Third Avenue, New York, NY 10158-0012; Tel: 212-850-6336.

CIRCLE 93 ON FREE INFORMATION CARD

HIDDEN HAM ANTENNAS

by Frank P. Hughes, VE3DQB

If you live in a neighborhood or apartment complex that places restrictions on ham antennas, this is the book for you. Follow-

ing its "So long as what you put up does not look like a ham antenna, it's not likely to be questioned" motto, the book provides a wealth of ingenious ways to hide antennas—including placing them inside flagpoles or arbors, or disguising them as bird-house poles or tomato-plant supports! It covers outdoor, indoor, high-frequency, and VHF/UHF antennas, and presents methods to disguise

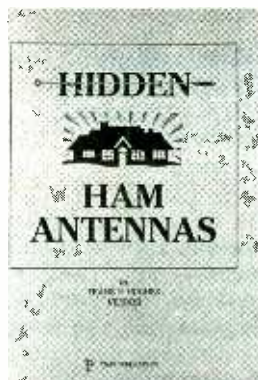

them all. It also discusses antenna tuners, grounds, and counterpoises, and recommends some easily disguised commercial antennas.

Hidden Ham Antennas is available for \$12.95 plus \$2 shipping and handling (\$3 foreign) from Tiare Publications, P. O. Box 493, Lake Geneva, WI 53147; Tel: 800-420-0579.

CIRCLE 101 ON FREE INFORMATION CARD

THE ILLUSTRATED DICTIONARY OF ELECTRONICS: Sixth Edition

by Stan Gibilisco

You can't keep up with any fast-changing field if you don't understand its specialized lingo. This handy reference allows you to find, at a glance, definitions



of electronics and computer terminology. Written for students and hobbyists, as well as professional technicians and engineers, terms are defined clearly and with as little technical jargon as possible.

The dictionary includes scores of abbreviations, acronyms, illustrations, schematics, diagrams, and conversion tables. It thoroughly covers the terminology of computers, robotics, lasers, TV, radio, IC technology, digital and analog electronics, audio and video, power supplies, and more. The new edition contains updated definitions and hundreds of new terms.

The Illustrated Dictionary of Electronics: Sixth Edition costs \$28.95 and is published by Tab Books Inc., Blue Ridge Summit, PA 17294-0850; Tel: 1-800-233-1128.

CIRCLE 98 ON FREE INFORMATION CARD

VOODOO OS/2: TIPS & TRICKS WITH AN ATTITUDE FOR OS/2 2.0 AND 2.1

by Allen G. Taylor

Taking the mystery out of OS/2, this book offers a wealth of tips intended to help users quickly take advantage of the fastest and most reliable PC operating system. Filled with speedy solutions to common problems and answers to questions that are frequently asked but not well-documented elsewhere, the book shows users at all levels how to use OS/2 to accomplish more in less time. The book explains how to launch and navigate OS/2, focusing on dialog boxes and controls. It shows readers how to adapt OS/2 to fit their needs by choosing colors and transforming the desktop. It explains how to run OS/2, Windows, and DOS applications, and how to use the Workplace Shell to manipulate objects and find lost files.

Voodoo OS/2: Tips & Tricks with an Attitude for OS/2 2.0 and 2.1 costs \$24.95 and is published by Ventana Press, P. O. Box 2468, Chapel Hill, NC 27515; Tel: 919-942-0220; Fax: 919-942-1140.

CIRCLE 102 ON FREE INFORMATION CARD

Just like these Fully Trained Electronics Professionals



"Thanks to CIE I have tripled my previous salary, and I am now in a challenging and rewarding new field where only the sky is the limit."

Daniel Wade Reynolds
Industrial Electrician
Ore-Ida Foods



"CIE was recommended to me by my boss. It was appealing since I could study at my own pace at home and during business travel."

Dan Parks
Marketing Manager/Consumer Products
Analog Devices, Inc.



"I loved the flexibility CIE offered. It was the only way I could continue both school and my demanding job."

Britt A. Hanks
Director of Engineering
Petroleum Helicopters, Inc.



"I liked the way the school was set up with laboratory assignments to enforce conceptual learning. The thing which impressed me the most about CIE's curriculum is the way they show application for all the theory that is presented."

Daniel N. Parkman
Missile Electro-Mechanical Technician
U.S. Air Force



"Completing the course gave me the ability to efficiently troubleshoot modern microprocessor based audio and video systems and enjoy a sense of job security."

Tony Reynolds
Service Manager/Technician
Threshold Audio & Video

Graduate with an Associate Degree from CIE!

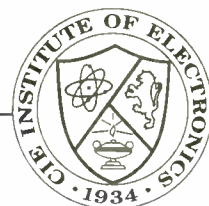

CIE is the best educational value you can receive if you want to learn about electronics, and earn a good income with that knowledge. CIE's reputation as the world leader in home study electronics is based solely on the success of our graduates. And we've earned our reputation with an unconditional commitment to provide our students with the very best electronics training.

Just ask any of the 150,000-plus graduates of the Cleveland Institute of Electronics who are working in high-paying positions with aerospace, computer, medical, automotive and communications firms throughout the world. They'll tell you success didn't come easy...but it did come...thanks to their CIE training. And today, a career in electronics offers more rewards than ever before.

CIE'S COMMITTED TO BEING THE BEST...IN ONE AREA...ELECTRONICS.

CIE isn't another be-everything-to-everyone school. CIE teaches only one subject and we believe we're the best at what we do. Also, CIE is accredited by the National Home Study Council. And with more than 1,000 graduates each year, we're the largest home study school specializing exclusively in electronics. CIE has been training career-minded students for nearly sixty years and we're the best at our subject...
ELECTRONICS... IT'S THE ONLY SUBJECT WE TEACH!

CIE PROVIDES A LEARNING METHOD SO GOOD IT'S PATENTED.

CIE's AUTO-PRO-GRAMMED® lessons are a proven learning method for building valuable electronics

career skills. Each lesson is designed to take you step-by-step and principle-by-principle. And while all of CIE's lessons are designed for independent study, CIE's instructors are personally available to assist you with just a toll free call. The result is practical training... the kind of experience you can put to work in today's marketplace.

LEARN BY DOING...WITH STATE-OF-THE-ART EQUIPMENT AND TRAINING.

CIE pioneered the first Electronics Laboratory

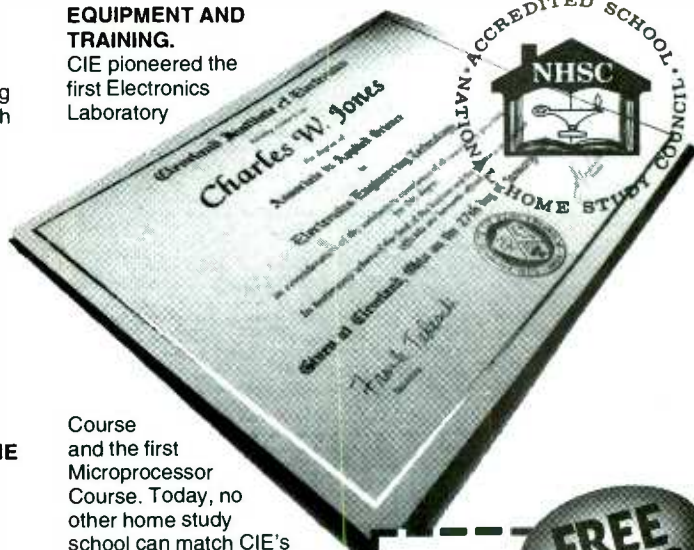

Course and the first Microprocessor Course. Today, no other home study school can match CIE's state-of-the-art equipment and training. And all your laboratory equipment, books and lessons are included in your tuition. It's all yours to use while you study and for on-the-job after you graduate.

PERSONALIZED TRAINING...TO MATCH YOUR BACKGROUND.

While some of our students have a working knowledge of electronics others are just starting out. That's why CIE has developed twelve career courses and an A.A.S. Degree program to choose from. So, even if you're not sure which electronics career is best for you, CIE can get you started with core lessons applicable to all areas in

electronics. And every CIE Course earns credit towards the completion of your Associate in Applied Science Degree. So you can work toward your degree in stages or as fast as you wish. In fact, CIE is the only school that actually rewards you for fast study, which can save you money.



YES! I want to get started. Send me my CIE course catalog including details about the Associate Degree Program. (For your convenience, CIE will have a representative contact you - there is no obligation.)

Please Print Clearly

AH59

Name _____

Address _____

City _____

State _____ Zip _____ Age _____

Phone No. _____

Check box for G.I. Bill Benefits.

Veteran

Active Duty

Cleveland Institute of Electronics, Inc.
1776 East 17th Street
Cleveland, OH 44114

A School of Thousands.
A Class of One. Since 1934.

Send for CIE's FREE Course Catalog and See How We Can Help Your Career Too!

NEW PRODUCTS

Robot Kit

You can build your own robot with the *ADR-1 Robot Kit* from *Aclypse Corporation*. The finished robot stands 27 inches tall, measures 14 inches in diameter, and weighs approximately 16 pounds. Its on-board computer system features voice-recognition capabilities, English speech output, power motor drive, and a battery with monitoring and recharge system.

It should take between two and six hours to build the

robot and a personal computer. The on-board computer is powered by a 16-bit 8086-compatible CPU with 256K of RAM. Optional expansion cards can be connected to add memory, sensors, motors, and other new devices.

The ADR-1 Robot Kit costs \$299. For further information, contact *Aclypse Corporation*, Rt. 2 Box 213H, Worthington, IN 47471; Tel: 812-875-2852; BBS: 812-875-2836.

CIRCLE 105 ON FREE INFORMATION CARD

GRAPHICS ACCELERATOR

Designed for power users of graphic programs such as Windows, Windows NT, OS/2, and AutoCAD, the *VideoBlitz II* graphics accelerator from *Genoa Systems* is available in either PCI or VESA local-bus configurations. The PCI version is based on the Weitek P9100 GUI accelerator chip series and an IBM contemporary palette DAC. Equipped with 2MB VRAM standard, the graphics board is upgradeable to 4MB to meet the advanced requirements of Pentium-based PCI systems.

The *VideoBlitz II* can run at a maximum resolution of 1600 x 1200 pixels (up to 64K colors), and can deliver True Color (16.8 million colors) PCI graphics acceleration at 1280 x 1024 resolution. "FlickerFree" technology provides refresh rates that exceed VESA specifications at all resolutions.

The graphics accelerator includes high-performance drivers for Windows, Windows NT, and OS/2 2.1 environments, as well as for Ventura, Lotus 1-2-3, Microsoft Word, and WordPerfect. In addition, the Turbo DLD drivers from Panacea offer support for AutoCAD, AutoShade, AutoSketch, 3D-Studio, and other AutoDesk programs. An easy-to-use, menu-driven installation program is executable from either DOS or Windows.



The suggested list price for the PCI local-bus version of *VideoBlitz II* is \$589. The 2MB VESA local-bus version, which runs High Color (64K colors) at 1024 x 768 pixels and True Color at 800 x 600 pixels, has a suggested list price of \$549. For more information, contact *Genoa Systems*, 75 East Trimble Road, San Jose, CA 95131; Tel: 408-432-9090 or 800-934-3662; Fax: 408-434-0997.

CIRCLE 106 ON FREE INFORMATION CARD

POINT-TO-POINT RADIO/MODEM PAIR

Intended to replace the RS-232 cable between equipment, *Monitor Electronics' IC-15* point-to-point radio modems create a wireless RS-232 "extension cord." The radio-modems each contain an UHF radio transmitter, offered at either 4800 bits per second or 2400 bps. The device's sensitive receiver, powerful transmitter, and fast protocol confidently support line-of-sight distances up to one mile. Greater distances are possible with optional gain antennas.

Each radio has an intelligent RS-232 communications port that can be completely configured for any terminal. Data rates are up to 19,200 baud. Once configured, the radio-modem replaces the cable.

The IC-15 has applications in portable computers, industrial scales, bar-code readers, and process-control equipment. Each radio/modem comes with a short antenna, a rechargeable battery, and a battery charger.

The 2400-bps and 4800-bps IC-15 radio/modem pairs cost

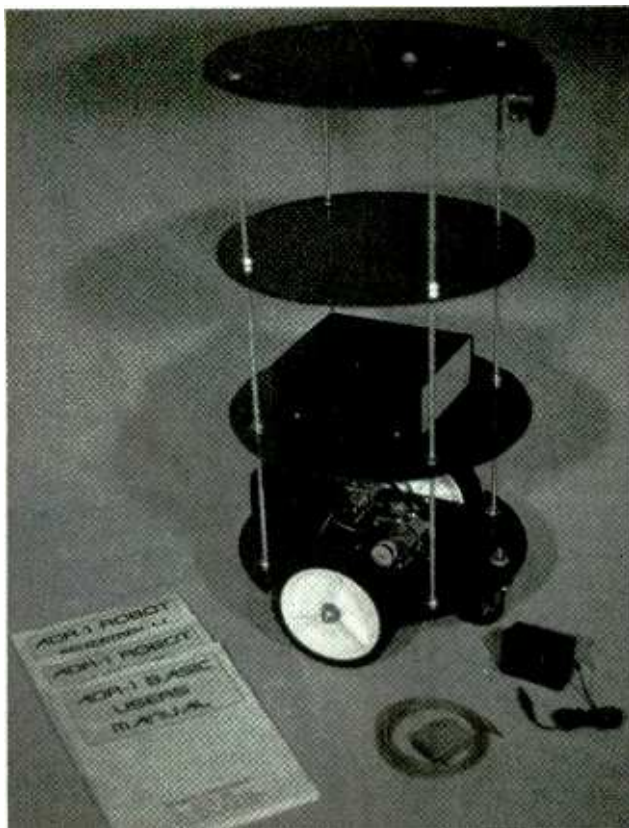

ADR-1 Robot. No special tools or electronics experience is needed to build or use the robot.

The ADR-1 Robot has its own operating system, and a built-in BASIC programming language makes it easy to give the robot instructions. It can be programmed by connecting it to almost any computer or terminal. Program and data files can be sent back and forth between



\$950 and \$1400, respectively. For more information, contact Monicor Electronics Corporation, 2964 NW 60th Street, Ft. Lauderdale, FL 33309; Tel: 305-979-1907; Fax: 305-979-2611.

CIRCLE 107 ON FREE INFORMATION CARD

HAND-HELD GAUSSMETER

The Magnet Source's *Dr. Gauss* is an accurate, easy-to-use gaussmeter that measures electromagnetic fields (EMFs) produced by electrical currents in appliances, electronic equipment, and other AC power sources. *Dr. Gauss* can be used to locate and measure EMFs in and around the house, at school, in the workplace, and in other electrical-transmission areas. By slowly moving the instrument away from an EMF-emitting device while measuring, it is easy to quickly establish a safe distance from the electrical source and reduce possible health hazards.



Dr. Gauss features two settings to measure between 0.1 and 10 milliGauss. Readings are shown on a needle display. An audio signal is emitted when an electrical field is detected

and intensifies as the gauss level increases.

Dr. Gauss costs \$49.95. For further information, contact The Magnet Source, 607 South Gilbert, Castle Rock, CO 80104; Tel: 1-800-525-3536.

CIRCLE 108 ON FREE INFORMATION CARD

MULTIMEDIA PC'S

Two additions to *Canon's* line of multimedia PCs, have been designed to support serious multimedia applications. The *Innova Vision L50/340* and *L33/210* each offers a dual-speed, 680-MB CD-ROM drive, a Sound Blaster 16-bit stereo card, and an extensive software package. The *L50/340* features the Intel 486DX2/50-MHz microprocessor with a 340MB hard drive. The *L33/210* uses an Intel 486SX/33-MHz microprocessor and a 210MB hard



drive. Each system includes 4MB of RAM (upgradeable to 36MB), a graphics accelerator, VESA local-bus architecture, and 1MB of video RAM (upgradeable to 2MB for faster playback and display performance). The multimedia computers also come with a fax modem, shielded stereo speakers, and a 14-inch SVGA monitor. Pre-loaded software includes MS-DOS 6.2, Windows 3.11, MicroFax, Microsoft Multimedia Works, Microsoft Encarta electronic encyclopedia, and two entertainment titles from Microsoft: *Cinematica* and *Golf*.

Estimated street prices for the *Innova Vision Multimedia PC's* range from \$1700 to \$2050. For more information, contact Canon Computer Systems, 2995 Redhill Avenue, Costa Mesa, CA 92626; Tel: 800-848-4123; Fax: 714-438-3317.

CIRCLE 109 ON FREE INFORMATION CARD

AIR-OPERATED DIGITAL DESOLDERING SYSTEM

According to *A.P.E.*, its *EX-680* digital desoldering workstation is the most compact, low-cost digital desoldering workstation to meet MIL-SPEC requirements. Designed for high-volume production touch-up and repair, the *EX-680* operates on in-house air-supply, filtered and regulated from 60–90 psi. The pneumatically powered station converts shop air into a high vacuum flow at 2.5–3.0 cfm. The *EX-680* meets or exceeds all applicable military and civilian EOS/ESD, temperature, and other safety standards.

The *EX-680's* modular LED control panel constantly monitors thermal loads to ensure safe removal of any solder joints, even multi-layer PC boards. The desoldering station features autotune temperature control and a temperature-offset control that continually maintains tip and window temperature for precision control. The high-thermal-mass, low-wattage, static-dissipative



desoldering handpiece allows the user to work at safe temperatures. A programmable security lock on the unit prevents unauthorized changes of settings for maximum and minimum temperature limits, Fahrenheit or Centigrade, timing of heat control, and sensor calibration.

The *EX-680* digital desoldering system has a suggested list price of \$480. For more information, contact Automated Production on Equipment Corporation (*A.P.E.*), 142 Peconic Avenue, Medford, NY 11763; Tel: 516-654-1197; Fax: 516-289-4735.

CIRCLE 110 ON FREE INFORMATION CARD

3M breadboards for less dough.

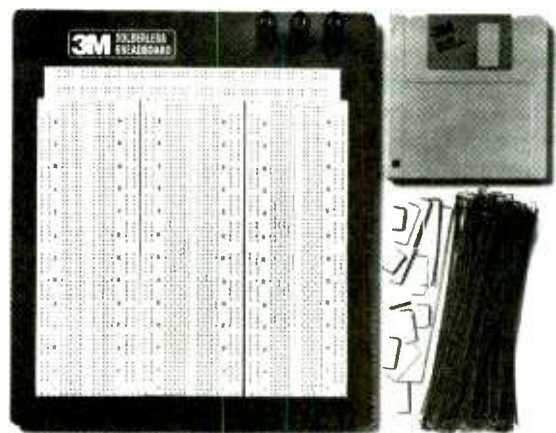

Lower prices, plus jumper wires and a diskette. No wonder interest is rising.

Remember, 3M Breadboards carry a lifetime warranty. For more information, call 1 (800) 328-0016, ext. 103.

© 3M 1994

3M Reliability

CIRCLE 164 ON FREE INFORMATION CARD



ORCAD SCHEMATIC DESIGN TOOLS 386+

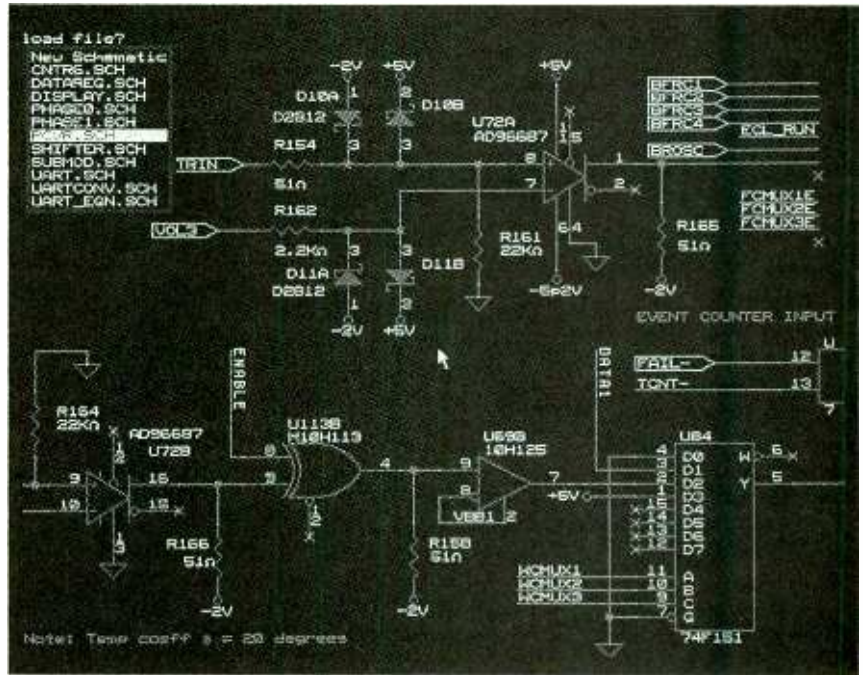

CIRCLE 119 ON FREE INFORMATION CARD

More than a schematic-drawing package, its a fully loaded, expandable design environment for everything from design management to documentation.

I'm definitely what most people would call a power user. I cut my first CAD teeth on various packages in the early eighties and today run a small but successful (read that "in-the-black") engineering-consultation firm that specializes in automated design work for customers that demand fast turn around. Of course, after all this time I've become a bit jaded and seldom come across software that excites me, especially since I've done some interesting software writing of my own.

However, I've recently had the good fortune to take OrCad's Schematic Design Tools 386+ for a spin, and for once I must admit I'm floored. In it I have found the package I will likely use for many, many years to come. Let's discuss why I'm so impressed.

ESP? They Read My Mind!

Organizing all the different files produced by a single CAD project (schematics, netlists, parts lists, report files, etc.), let alone those for a few projects, can be a daunting task. I've spent several evenings (biting my nails and) retracing my steps through a minefield of files begging to be cleaned up. Delete the wrong version of a file—

kaboom!—a day or two of schematic adjustments or netlist edits become a memory unless you undelete them immediately.

Heck, just getting a program or its utilities to generate all that data can be trying. Often times the user must run more than one utility, tool, or processing program to take human or computer-generated input and generate some useful output. Running such programs tends to be both time-consuming and often a little confusing. In the past, I've often asked myself questions like "Am I supposed to run the net lister before or after I associate the schematics of a complex design?" and "What's that utility's name again?" Besides, the program should "know" the answers to those questions and, with the exception of mandatory user input (such as schematic entry), generate the necessary files for you.

Furthermore, dealing with all these files is not intuitive; we humans mentally organize the data as a "design," not a netlist here, a schematic there, etc. What CAD packages have lacked is a more self-reliant user-friendly interface. One that generates support files on the fly, provides a consistent interface for its various tools

and utilities, gives the user the impression of handling a design (not slews of files), and provides some custom hands-on file-management support for times when you have good reason to interfere with all this automation.

The ESP design environment, which is shipped with all of OrCad's design tools, provides all those features and more. It is a graphical interface that is operated by pressing on-screen buttons and selecting options from menus. The buttons are labeled with text rather than so-called intuitive icons so there's no guess work about what each one does. To ease operation, all of the buttons in the environment can be assigned hotkeys from the screen on which it appears. Also, the same hotkey can be assigned to more than one button provided the buttons do not appear on the same screen.

The first screen of buttons allows you to select a tool package, do some hands-on file management, configure ESP, or exit to DOS. (For convenience, all but the last operation can optionally be performed from any screen of buttons.)

The tools you can launch from this screen include Schematic Design Tools (the subject of this review), Digital

Simulation Tools, Programmable-Logic Design Tools, and PCB Tools. All of these separately available tool packages need just ESP to run, so if you only require a schematic-entry package, you needn't buy the whole lot.

Speaking of the tools, there's a feature of ESP that is not readily apparent from its screens: seamless integration of the tools. For example, let's say you're working on a logic schematic in Schematic Design Tools and now wish to run a simulation for the circuit. You just save the schematic while leaving the schematic editor and select the Digital Simulation Tools button. Provided you have purchased the simulation tools, the program will automatically process the schematic file to produce all the files needed for the simulator software; no utilities, exits to DOS, or program commands are needed!

Which points to another advantage of the ESP environment: there are no so-called "extra" options you'll have to purchase to run any given tool to its fullest. If you've ever purchased a "bargain" CAD package only to find shortly afterward you absolutely must buy a so-called "extra" or two just to get some work done, you'll surely appreciate OrCad's bundling philosophy. It makes OrCad's software a good value even over packages at half the price, which tend to be pretty incomplete not to mention lacking the tool integration provided by ESP.

Unlike most CAD packages, all the drivers available for a very large number of monitors, printers, plotters, photoplotters, etc. and all the utilities needed for seamless movement between tools are all provided as part of ESP, and therefore form part of your first OrCad-tool purchase. The number of drivers provided is incredible; I even found one written specifically to handle the particular video-BIOS chip located on my display-adaptor card, let alone the adaptor card itself. There is even a utility provided to help you write your own custom video driver!

Having all those drivers can also translate into a substantial savings of time and money. For example, let's say you want to have a run of PC boards made by a board house. Provided you've purchased the PC Board tools, the drivers could generate the photoplotter output needed by the board house, reducing their fee. You could

even modern them the data for quicker quotes and faster turn around. Best of all, you wouldn't need a laser printer!

The Template. As mentioned earlier, ESP keeps track of which files belong to which design. It does that by segregating files into individual sub-directories, each of which bears the name of its design. There is also a special design called the template that contains those files you would like copied to (or made part of) future designs.

For example, let's say you've got an idea for a nifty keyboard macro that you'll probably want to use from now on. First switch ESP to work on the template design, then perform the steps needed to enter the macro. From now on, whenever you create a design the macro becomes part of the new design.

Note that this is not the same as having a default because it leaves old designs (those created before the template was changed) unaffected. That prevents you from disturbing older designs with new, but less-than-optimal changes in the operating environment.

Also, changes made (even to the design environment) while working on a design only affect that design; they do not affect the template or any other design. So, after selecting a design you could change every color in the environment, select different device drivers, tweak the operating parameters of every tool, or whatever, just to suit that one design without affecting any other design or the default environment. If you do want changes in the template to be incorporated into an older design, or you wish to copy changes between designs, the program can accommodate those requests as well. In fact, the design-management screen accommodates all such operations and more.

The SDT Package. The same one-purchase philosophy applied to ESP is evident in the completeness of the tool packages as well. For example, the Schematic Design Tools set comes with 60 libraries that contain over 20,000 *unique* library parts. The accent is on "unique" because some CAD packages promise libraries that "support" thousands of parts, but ac-

Haven't you always wanted a weather station?



The Weather Monitor II makes a state-of-the-art weather monitoring system affordable enough for home use!

FEATURES INCLUDE:

- Inside & Outside Temps
- Wind Speed & Direction
- Barometer
- Time & Date
- Inside Humidity
- Wind Chill
- Alarms
- Highs & Lows
- Rainfall Option
- Instant Metric Conversions
- Outside Hum. & Dew Point Option
- Optional PC Interface

Order today:

1-800-678-3669

M-F 7 a.m. to 5:30 p.m. Pacific Time • PE6461
FAX 1-510-670-0589 • M/C and VISA
One-year warranty • 30-day money-back guarantee

DAVIS INSTRUMENTS

3465 Diablo Ave., Hayward, CA 94545

CIRCLE 162 ON FREE INFORMATION CARD

Earn \$1000

A Week While You Learn High Paying VCR Repair.

Earn While You Learn . . . Secrets Revealed . . .



Train at Home

If you are able to work with small hand tools and possess average mechanical ability, you could earn top dollar part time or full

time. Our learn by doing method teaches you how to work on VCR's without boring unnecessary electronic basics.

For Free Information Package Send Coupon to:

Foley-Belsaw Institute, 6301 Equitable Road,
Kansas City, MO 64120

<p>Check VCR or another High Paying Career Field</p> <p>FOLEY BELSAW</p> <p>Since 1926</p>	(Check One Box Only)
	<input type="checkbox"/> VCR Repair, Dept. 62181 <input type="checkbox"/> Computer Repair, Dept. 64082 <input type="checkbox"/> TV/Satellite Dish, Dept. 31002 <input type="checkbox"/> Advance VCR Repair, Dept. 65021 <input type="checkbox"/> Camcorder Repair, Dept. 66031 <input type="checkbox"/> Fax Repair, Dept. 67031 <input type="checkbox"/> Printer Repair, Dept. 68031
Name _____	
Address _____	
City _____	
State _____ Zip _____	

CIRCLE 154 ON FREE INFORMATION CARD

tually provide much fewer parts and count their synonyms as though they were different parts. For example, in some programs the LM741 and AD741 (which are depicted the same) are derived from the same part data in a library file, but the advertisement for the program might count them as separate parts.

The folks at OrCad have been equally generous with the supply of schematic tools. The tools are so numerous their buttons have been separated into related groups. The six groups are: Editors, Processors, Transfers, Libraries, Reporters, and User. Let's take each group in turn.

The easiest group to explain is the User group. It consists of four buttons, each of which can be configured to run any user-defined DOS-based program. That saves you from exiting or shelling to DOS to run a program from the command line and getting back to ESP when you're done. The labels

on those four buttons can also be defined by the user to prompt his or her memory.

The Transfer group is also easy to explain. In this group are buttons for any of the other three tool sets you might own and a "To Main" button that takes you back to the main ESP screen. The tool-set buttons allow you to immediately move between the tool sets without going back to the main ESP screen. Of course, doing so causes ESP to automatically generate the support files needed by the chosen set of tools.

Three buttons comprise the Editors group: Draft, Edit File, and View Reference Material. The Draft button places you in the schematic editor. The Edit File button calls up a supplied ASCII file editor or a user-defined one, if desired. The View Reference Material button calls up that ASCII editor to permit you to view some software-related text files (supplied by OrCad)

held in a special sub-directory.

As a creature comfort, you are automatically given the option to use the ASCII editor to view a report file generated by the software if a tool terminates abnormally. When you're finished with the report and exit the editor, you're back in the tool set—no jumping out to DOS, into your editor, out to DOS, and back to the CAD package.

The Library buttons are Edit Library, List Library, Compile Library, Decompile Library, and Archive Parts in Schematic. The Edit Library button calls up an editor designed specifically to handle library parts. That is quite a contrast from using software in which the same tool is used for both generating parts and schematics, and slighting either one function or the other. Even so, if you have a reason to do so, library parts can be generated by a text editor as well. The List Library button generates a file listing all the parts in a given library. Compile Library lets you convert parts source files (in ASCII and written in a special language) into a compressed library file. Decompile Library lets you separate parts in a library and convert them back into their source file form. Last, the Archive Parts button will place all the parts from the current schematic in a library file all its own, so that future modifications of the standard library files will not alter the appearance of the design (a great feature if you're always tampering with the appearance of library parts, and subsequently messing up your old schematics).

The processor group (Annotate Schematic, Update Field Contents, Create Netlist, Create Hierarchical Netlist, Back Annotate, Select Field View, and Cleanup Schematic) is powerful. Annotate Schematic assigns parts-designation numbers (like the "2" in U2) to all parts lacking one, as well as labeling pin numbers in multi-element parts (such as the gates in a quad IC), both of which eliminate human error. Back Annotate allows you to switch old designations with new ones as listed in a "Was/Is" file you create—great for updating schematics. Select Field View allows you to determine how much information is displayed for parts. Up to ten fields can be displayed (say for one part they are the designation, value, toler-

TABLE 1—DRAFT MENU OPTIONS

Main Menu Command	Sub-Menu Commands		
AGAIN	(none)		
BLOCK	Move Drag Fixup	Get Save Import	Export ASCII Import Text Export
CONDITIONS	(none)		
DELETE	Object	Block	Undo
EDIT	Edit Find	Jump Zoom	
FIND	(none)		
GET	(none)		
HARDCOPY	Destination File Mode	Make Hardcopy Width of Paper	
INQUIRE	(none)		
JUMP	A-H tags Reference	X location Y location	
LIBRARY	Directory	Browse	
MACRO	Capture Delete	Initialize List	Read Write
PLACE	Wire Bus Junction Entry (Bus) Label	Module Port Power Sheet Text Dashed Line	Trace Name Vector Stimulus NoConnect Layout
QUIT	Enter Sheet Leave Sheet Update File	Write to File Initialize Suspend to System	Abandon Edits Run User Commands
REPEAT	(none)		
SET	Auto Pan Backup File Drag Buses Error Bell Left Button	Macro Prompts Orthogonal Show Pins Title Block Worksheet size	X, Y Display Grid Parameters Repeat Parameters Visible Lettering
TAG	A-H tags		
ZOOM	Center In	Out Select	

ance, wattage, package styling, and the catalog numbers of five distributors) for each part, so this option lets you keep things neat and simple. Update field contents allows you to alter field information (excluding the parts designation) for a part or group of parts based on an elaborate, but easy to construct, search and replace procedure. Create Netlist generates a netlist in the format of your choice and we mean just that; you may either choose a netlist from one of 30 standard formats, or teach it a new format! Create Hierarchical Netlist does the same thing for complex designs made of separate schematics that are to be interconnected. Cleanup Schematic makes sure that labels, wires or other objects do not overlap or obscure one another. You could fix those problems by hand, but it's nice to know you don't have to.

The Reporters (Cross Reference Parts, Show Design Structure, Generate Bill of Materials, Check Electrical Rules, Convert Plot to IGES, Plot Schematic, and Print Schematic) generate output for human consumption. Cross Reference Parts produces a file listing the location of all the parts in a multiple-schematic design. Show Design Structure generates an outline of all the worksheets (or blocks) that make up each schematic in a multiple-schematic design. Generate Bill of Materials generates a parts list (grouping like parts together), complete with quantity, designations, and the other fields you specify. Partial listings including only the parts you specify in an "include file" can also be generated. Check Electrical Rules examines the connections of a schematic to find wiring errors (such as two non open-collector outputs connected together, a grounded supply line, etc.). It literally marks the trouble spots on your schematics as well as generating a report. The marks are automatically removed if you quit out of the draft editor. The severity of the errors is determined by an interconnection matrix that you can reconfigure to allow for any design idiosyncrasies.

The other options deal with how to output a schematic itself. Convert Plot to IGES converts all the schematics of a design into the Initial Graphic Exchange Specification text format. Plot Schematic allows you to send graph-

TABLE 2—EDIT LIBRARY MENU OPTIONS

Command	Menu Commands		
AGAIN	(none)		
BODY	Kind of Part? Block? Graphic? IEEE		
BODY <Block>	Size of Body?	Kind of Part?	
BODY <Graphic>	Line Text Delete	Circle IEEE Symbol Erase Body	Arc Fill
BODY <IEEE>	Line IEEE Symbol	Circle Delete	Text Erase Body
CONDITIONS	(none)		
EXPORT	(none)		
GET PART	(none)		
IMPORT	(none)		
JUMP	A-H tags	X location	Y Location
LIBRARY	Update Current Delete Part	List Directory Prefix	Browse
MACRO	Capture List	Delete Read	Initialize Write
NAME	Add Prefix	Delete	Edit
ORIGIN	(none)		
PIN	Add Pin-Number Move	Delete Type Jump	Name Shape
QUIT	Update File Suspend to System	Write to File Abandon Edits	Initialize Run User Commands
REFERENCE	(none)		
SET	Auto Pan Left Button Show Body Outline	Backup File Macro Prompts Visible Grid Dots	Error Bell Power Pins Visible
TAG	A-H tags		
ZOOM	Center Select	In	Out

ical output to a plotter, printer, or file. Print Schematic has a subset of those options and takes less processing time.

Going Deeper. Of course each of the tools in the SDT set has an overwhelming number of options, features, and functions, far too many to describe here. So instead, just to whet your appetite, I thought I'd present the commands for the two most demanding applications: the Draft schematic editor and the Edit Library parts editor.

Table 1 lists the commands available in the draft editor. In it, the left column lists the 18 commands immediately available from the Draft main menu. The right column contains the sub commands available to you after you've selected a command (if any). For example if you select the Block command from the main menu, a sub-menu of 9 sub commands appears to continue processing your re-

quest. All total then there are 69 operations you can perform!

Similarly, the commands for the Edit Library parts editor (see Table 2) are equally substantial. There are 65 commands in all, and note that the body command actually has sub-sub-commands. All of the commands are dedicated specifically to handling library parts. That is in contrast to software packages that attempt to make their schematic editor into a jack-of-all-trades by handling parts as well as schematics.

The SDT pack comes with a book/software tutorial to walk you through the commonly used features as well as a Reference Guide, a User Guide, a Manual Supplement, and an ESP Manual.

If this package sounds of interest to you at \$895, and you'd like to learn more about it, contact OrCad directly (9300 S.W. Nimbus Ave., Beaverton, OR 97005; Tel: 503-671-9500), or circle No. 119 on the Free Information Card. ■

ANTIQUE RADIO

By Marc Ellis

A Baby Boomer From Britain

This month, we're going to take a look at the Bush "22 Series," a radio that was called to our attention by Paul Coxwell (Sutton-on-Sea, England). Besides being a reader of *Antique Radio*, Paul is himself a contributor to **Popular Electronics**. Many will remember his article on vacuum tubes in the October, 1993 issue.

The Bush is the first non-American radio to be discussed in this column. As a

GENERAL DESCRIPTION

The 22 Series is a four-tube-plus rectifier design. We'd call it a "five-tuber," but Paul tells us that the British would call it a "four-valve" set. Except for the tuning and power-supply circuits (to be discussed), the radio is of conventional design. It seems to differ little from the circuit used in the typical "All-American Five" AC-DC radios produced here in great quantities during the 1940's and '50's.

However, while some of our "All-American Five" sets sported a shortwave band, most received broadcast only. The Bush set, in contrast, has three bands—listed on the service sheet as 16–50 meters (6 to a bit under 19 MHz); 187–578 meters (about 520–1650 kHz) and 882–2000 meters (about 150–340 kHz). Note that I've listed the frequencies (in MHz and kHz) in reverse order from their equivalent wavelengths (in meters).

The first band is a "shortwave" range such as might be found on many American sets of the era. The second is standard broadcast. The third is a longwave broadcast band used in Britain and Europe.

Looking at Paul's photo of the Bush, you'll see that the front panel is dominated by the tuning dial, which contains "thermometer-type" scales for the three tuning ranges [from left to right: shortwave, medium wave (broadcast), and long-wave]. The three knobs along the bottom of the control panel (from left to

right) are for tone, manual tuning, and volume/power. Note that if this were an American set, the positions of the tone and volume/power controls would probably be reversed.

The American logic, I suppose, is that the controls should be arranged, in order of use, from left to right—the way our eyes scan while reading. The British logic is perhaps that the knob that's needed first should be on the right, where it can be most easily grasped by a right-handed person.

Between the dial scales and the knobs is a row of eight pushbuttons (or "press-buttons," as they are referred to on the service sheet). Three are used for bandswitching; three more are used to select preset stations in the broadcast band; one selects a preset station in the longwave band; and the final button switches between the radio and a phono (or "gramophone") pickup, if one is connected to the terminals on the radio's rear apron.

On an equivalent American set, bandswitching would most likely be handled by a rotary switch, controlled by an additional front-panel knob, and there would be more pushbuttons devoted to station selection. However Paul tells us that only three domestic broadcast stations ("Home," "Light," and "Third") were offered by the BBC in 1950. By the way, the glass dial, says Paul, is easily removable to access the preset tuning adjustments and install the supplied labels for the pushbuttons.



The Bush 22 Series boasts pushbutton tuning, and an imposing three-scale dial.

radio from the "early baby-boomer" era (it was manufactured in about 1950), it also represents a time period we have rarely, if ever, covered in the past.

I believe you will find the design of this receiver interesting in both its similarities to, and its differences from, American design practice of the time. And thanks to the nice photo, helpful letter, and comprehensive service notes supplied by Paul, we're in a position to make a detailed study of our visitor from overseas.

Dimensions of the Bush (W x H x D) are 23 x 16½ x 10 inches. Its original 1950 list price (23 pounds, 8 shillings and 9 pence) was equivalent—at that time—to about \$100 American. Interestingly enough, one could buy either a transformer-powered or AC-DC version of the set for the same price.

Paul's Bush was in almost continuous daily use for the first 25 years of its life, requiring only occasional service or maintenance.

CIRCUIT FEATURES

A look at the schematic shows that, except for the "front-end" network of coils, capacitors, and switches used for bandswitching, tuning, and station presets, the circuit is a fairly simple one. After being tuned in the front end via either a pushbutton preset or main tuning capacitor C47/C48, the signal from the antenna (either an external one connected to terminal A1 or A2 or the internal loop L2) enters tube V1. This is a UCH42 triode-hexode similar to our type 12K8; it serves as an oscillator-mixer, otherwise known as a converter. (In British parlance, it's a "frequency changer.")

Tube V1 converts all incoming signals to a standard "intermediate frequency" of 465 kHz (the standard IF used in most American sets is 455 kHz). The converted signal then passes through IF amplifier tube V2, a UF41 variable- μ pentode. From there, the audio is detected and amplified in tube V3, a UBC41 duo-diode triode similar to our 12SQ7. Volume control R12 (on which is mounted on-off switches S9 and S10) is in the cathode circuit of V3. The audio is further amplified to speaker volume by tube V4, a UL41 power pentode. Tone control R24

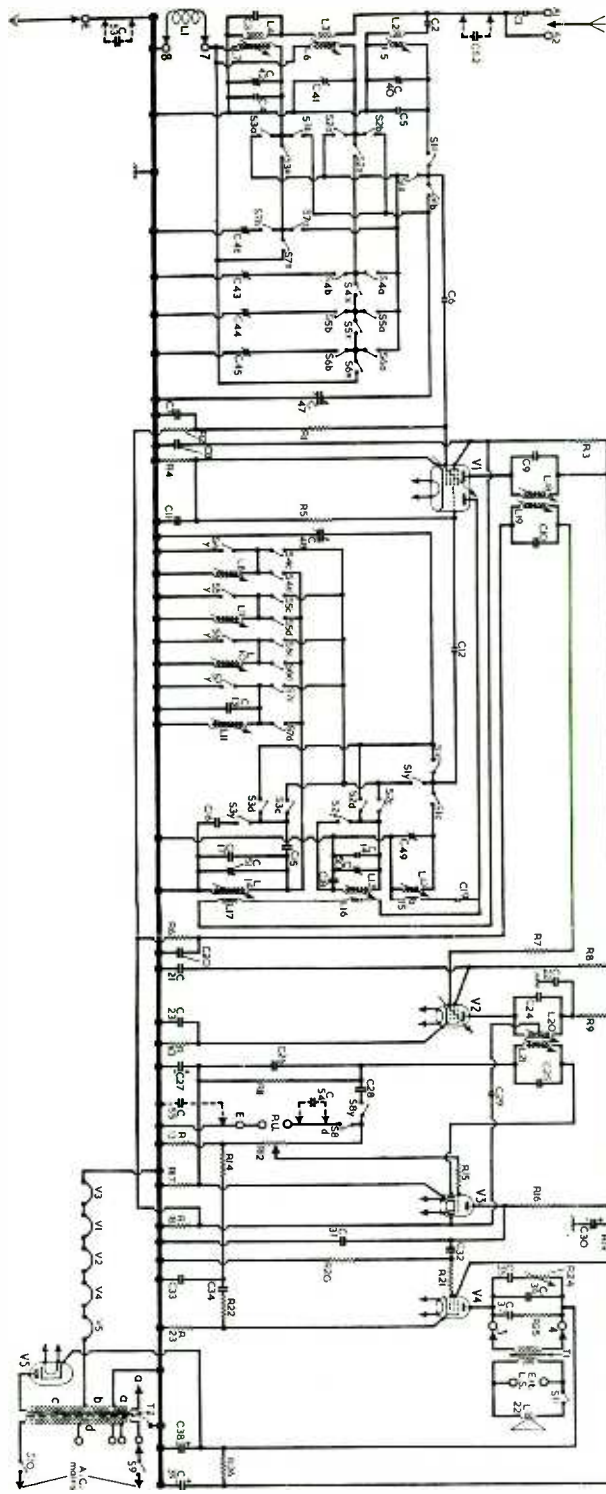

The Bush's schematic is relatively simple and straightforward, except for elaborate pushbutton tuning circuits and a somewhat unusual power supply (see text).

will be found in V4's plate circuit.

The Bush's power-supply circuit is a bit unusual in that it is designed to be easily convertible between AC-DC and transformer opera-

tion. The set could be purchased in either configuration from the manufacturer and later field-converted from one mode to the other through the use of a parts kit.

Note that even in transformer configuration, when a full-wave rectifier tube would normally be used, the tube at V5 (a UY41) is a half-wave device appropriate for use in an AC-DC mode. Also note that the heaters of V1-V5 are connected in a series string, as is required for AC-DC operation, even when being operated off the transformer. Those features facilitate switching between the two types of operation with a minimum of rewiring.

Another feature of the transformer circuit, also apparently intended to facilitate conversion between the two modes with a minimum of rewiring, is that there is but a single secondary winding. The winding is tapped, as required to provide filament, plate, and dial-light voltages. Normally, those voltages would be supplied by individual transformer secondary windings.

RF AND OSCILLATOR TUNING

Here's a brief run-down on the major tuned circuits in the Bush's front end. The signal from the antenna is tuned manually by capacitor C47 and coils L5 (shortwave), L6 (medium wave), or L7 (longwave). The desired coil is selected by its matching pushbutton switch (S1, S2, or S3, respectively). The sections of those switches bear letter suffixes indicating whether they are closed (a, b, c, or d) or open (x or y) when the button is pressed. Of course, the reverse action takes place when the button is released.

For automatic station selection on the broadcast band, L6 is tuned by preset capacitors C43, C44, or C45, selected by their matching switches S4, S5, or S6. (Continued on page 86)

THINK TANK

By John J. Yacono

Some Hobby Circuits

Last month I asked educators and hobbyist groups what I could do with this column to make it more of an educational tool for them. (Perhaps I could present a contest between classes and/or hobbyist groups, or maybe I could present the work of a group each month or so.) While I'm waiting for their input, I've decided to present some tutorials aimed at the complete beginner in electronics. That way, any beginners reading the column will be brought up to speed enough to participate in the columns to come.

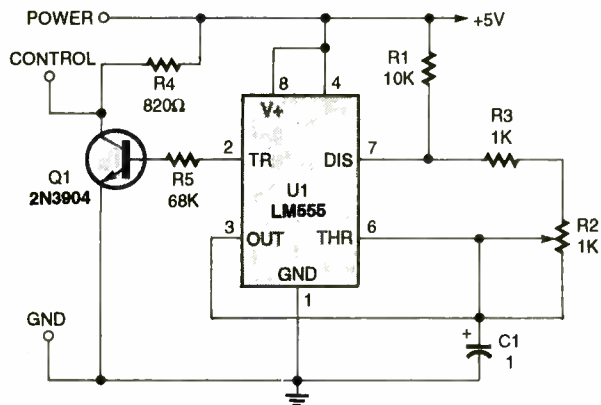

Fig. 1. This servo driver is great for testing suspect servos, or as a project interface. With the component values shown, the circuit can drive a servo through a 90-degree rotation.

Experienced hobbyists might wish to read along just to refresh their knowledge, but I'll tell you now that the first couple of columns will be pretty rudimentary. Still and all, they should take consolation in the reader's letters if they find the tutorial not to their liking.

After this month's tutorial, I'll present circuits that readers have built to suit their particular hobbies. This

month's letters deal with RC (remote-control) and model-railroad endeavors.

TUTORIAL 1

Beginners might be wondering what they'll need to know to understand this first tutorial. Well, you need to understand that the world is made up of very small pieces of matter called atoms. If that concept is new to you, you can look up more information about atoms in your local or school library, or ask a teacher or knowledgeable friend about them.

For our purposes, you'll need to understand that atoms have two important structures: a "nucleus" and a bunch of "electrons." The nucleus is a lump of matter on the other hand are very busy little particles that, unless freed by some external force, will orbit the nucleus at high speed.

You might be wondering what keeps active particles like electrons in orbit. Well, much like the planets are held in orbit by an invisible force of attraction (gravity) due to their mass, electrons are held in orbit by the "electrostatic" force due to a property called "charge." In other words, while objects with mass feel a force of attraction called gravity, particles with charge feel an electrostatic force.

There are two key differences between gravitational force and electrostatic force. First of all, the electrostatic force is much greater than the force of gravity. (Considering how active electrons

are, that's a good thing.) Second, while the force of gravity always pulls objects together, electrostatic force can cause objects to be attracted together or repelled apart. We explain that by saying that charges come in "positive" and "negative" varieties. Like charges repel each other, while particles of opposite charge attract. For example negative charges repel one another, and positive charges repel one another, but negative charges are attracted to positive charges, and vice versa. Electrons tend to orbit nuclei (which is plural for "nucleus") because electrons have a negative charge and nuclei have positive charge; remember, when it comes to electrostatic force, *opposites attract*.

I figure that's enough for a beginner to digest for one tutorial. Next month, I'll describe how we use the electrostatic force to move electrons around. For now let's get to those hobbyist letters.

SERVO DRIVER

A few months ago I saw the schematic diagram of a servo-driver circuit in a hobby magazine. My circuit (shown in Fig. 1) requires fewer parts than the original, yet performs the same function.

A servo's position depends on the pulse width of the control signal it receives. The control signal is a high pulse that is one millisecond wide plus or minus 0.5 ms. The overall period of the signal can vary.

To produce such pulses, I took advantage of the 555 timer's ability to have a variable duty cycle. The overall period in my circuit will vary some, but as I said, that does not matter. For proper polarity, Q1 inverts the signal leaving the timer. With potentiometer R2 centered, the servo will be close to centered. The value of R3 can be changed to accurately center the servo. When R2 is moved, the circuit's duty cycle will change and the servo will move proportionally. The values shown will rotate the servo through 90 degrees (the standard rotation for a hobby servo). To get 180 degrees of rotation, the values of R1, R3, and C2 should be changed to 5,600 ohms, 560 ohms, and 2 μ F, respectively.

—Brad Tompkins,
Bessemer, AL

Remember folks, electrolytics have a wide tolerance, and vary with temperature. The trick here is to use a monolithic capacitor for C1. You might also want to use a trimmer potentiometer for R3 (just like a manufactured unit would have) to account for variances in servo motors.

RECEIVER/MOTOR INTERFACE

I like to motorize things for computer control from toys to home-made projects. Unfortunately, as my projects got more complicated, so did the wiring between my home-made computer interface and the projects. I'll describe how I overcame that with the receiver and transmitter for a cheap R/C car that I bought at a yard sale.

To start, I stripped out the receiver and transmitter. The transmitter (which is not the point of this letter, and you might want to leave intact anyway) was modi-

fied so that its contacts were replaced by transistors controlled by my home-made computer interface.

All the motors that I use are DC, which makes forward and reverse easier. Most of the circuits that I've seen in hobby magazines use a dual-voltage supply (i.e., ± 12 volts) to get forward and reverse. However, my circuit (see Fig. 2) uses two SPDT relays to switch the polarity of the voltage supplied to each motor in my home-brew drive system. As you can see, that requires the use of some diodes to control the relays as the polarity is switched.

When at rest, there is a 0 voltage at all receiver terminals (marked T₁, T₂, T_A, and T_B). When forward motion is desired, T₁ goes positive and T₂ is grounded. That energizes K1 through D1 while diode D2 (which is reverse biased) prevents K2 from activating. So current flows through K1 to MOT1 to K3 and back through K2 to

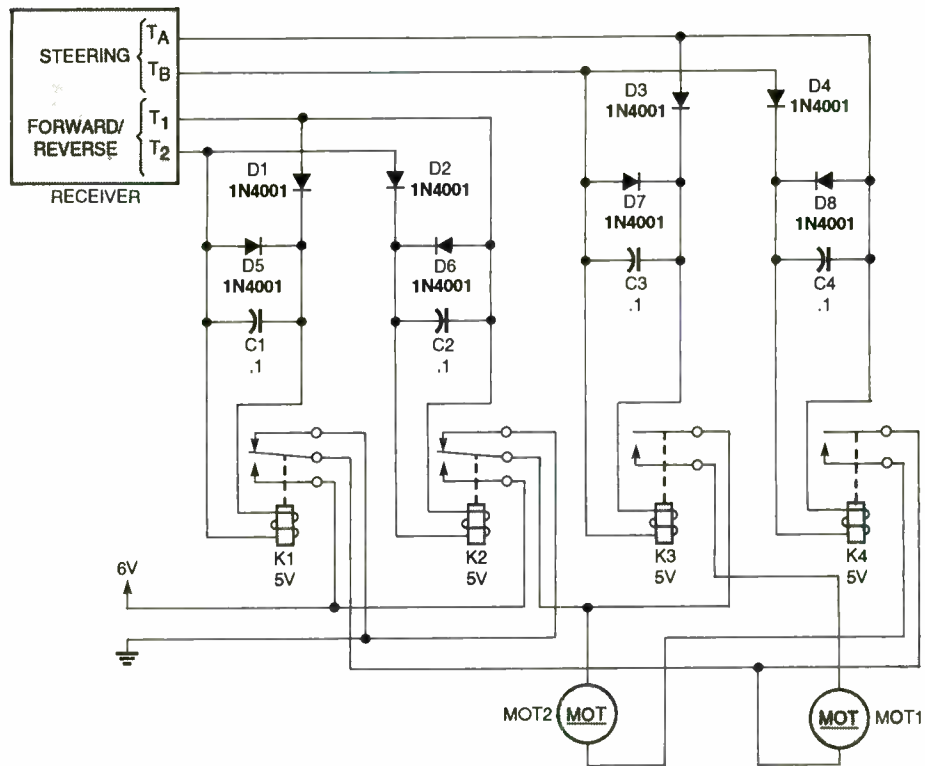

Fig. 2. You can add relays to some inexpensive RC receivers to operate your own chassis.

hello, max...



We would like to introduce you to the Max-100A Frequency Counter, because great things really do come in small packages.

- Full 8-digit display covers 100 MHz range
- Completely automatic-no front panel controls
- Extra large .43" display
- Battery or AC powered
- Automatic decimal point
- Input overvoltage protection
- Automatic overflow indication
- Automatic low battery indicator
- 1 Hz resolution to 100 MHz



GLOBAL SPECIALTIES • (800) 572-1028
70 Fulton Terrace, New Haven, CT 06512
(203) 466-6103 • Fax: (203) 468-0060
CIRCLE 13 ON FREE INFORMATION CARD

an
Interplex
company

ground. Current also flows from K1 to K4 to MOT2 and through K2 to ground.

When reverse is used, T_1 and T_2 reverse polarity; T_1 goes to ground and T_2 goes positive. That energizes K2 through D2, and D1 keeps K1 off. When K2 is energized, current flows through K2 to MOT2, from MOT2 to K4, from K4 to K1, and from there to ground. Current also flows from K2 to K3, from K3 to MOT1, from MOT1 to K1, and then to ground.

When steering is used T_A and T_B work the same as T_1 and T_2 . When relays K3 or K4 are energized, they open the circuit that is either powering their motor or grounding it. That will stop either motor, depending on which relay is energized.

The reason I didn't run a common ground circuit is that there was a 2-volt difference between the signal ground and actual ground. I hope that I've been able to explain this circuitry. Keep up the good work on the column. I hope to see more helpful ideas that I can use.

—Murray Halbert,
Ontario, Canada

Murray also indicated in his letter that D5–D8 and C1–C4 are used for transient suppression. He also notes that MOT1 and MOT2 were taken from an old 8-track tape deck. I really didn't know those motors had the horsepower required to move a chassis. I always assumed they were low-power units with a flywheel that kept them spinning. Using them this way is a neat idea!

RAILROAD-CROSSING FLASHER

I've been reading this column for a pretty long time now and figured I could use a free book. I have enclosed a circuit to operate flashing lights for a

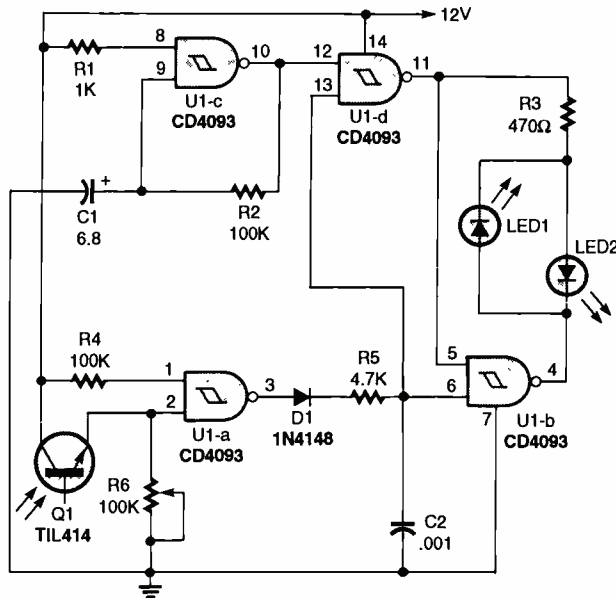
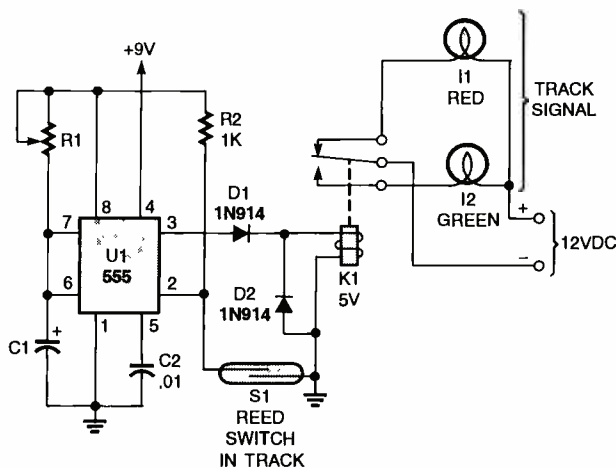

Fig. 3. This model-railroad crossing-light driver turned out to be the answer to a reader's request, provided he can find small LED's to fit his model's scale.



RED-LAMP ON TIME (SECONDS)		
R1 (KILOHMS)	C1 = 10μF	C1 = 100μF
100	2	16
220	3	32
470	6	70
1000	15	175

Fig. 4. A track control signal, like the one shown here, lets the engineer know when a train has passed a certain point on the track.

model-railroad crossing. The unique features of this circuit (see Fig. 3) are its simplicity, minimal use of parts, and full usage of the gates in the IC.

Its operation is pretty straightforward: Gate U1-c is set up as an oscillator whose frequency is deter-

mined by C1 and R1. Gates U1-b and U1-d are set up as an RS flip-flop that is gated on by U1-a. Gate U1-a in conjunction with Q1 operates as the control gate for the flip-flop. Components D1, C2, and R5 act as a delay circuit to compensate for any light getting

through the gaps between cars as they pass over the phototransistors. The light-emitting diodes are connected so that they operate alternately, depending on the outputs of U1-d and U1-b.

Basically, R6 is adjusted so ambient room-light striking Q1 (and any other phototransistors connected in series) keeps the output of U1-a at pin 3 low. When a car passes over the phototransistor, which is installed between ties in the track, pin 3 goes high, allowing a high to be placed on pins 6 and 13. That allows the high output of U1-c at pin 10 to enable pin 12, which in turn allows pin 11 to go low. That makes a complete path for LED2 to operate. When pin 10 goes low, pin 11 goes high. That makes pin 5 high and, thus, enables pin 4 to go low and completes the circuit for LED1. That alternates the LED's, which are installed in a railroad-crossing signal.

The fact that only two wires are necessary to operate the flashers is an added advantage not only for looks but also for construction of the crossbucks themselves. I have cascaded as many as six phototransistors with no problems. I have also driven four LED's from the CD4093 without any problems. I hope this circuit is interesting enough for a book! Thanks.

—Brian F. King, Groton, CT
It certainly warrants a book. By the way, I'd like to hear more from model-railroad hobbyists. Surely there are plenty of home-made railroad add-ons out there (variable-speed controllers and marquee displays come immediately to mind) that we could cover here. This next gentleman feels that way, too.

(Continued on page 78)



3475P \$19.95

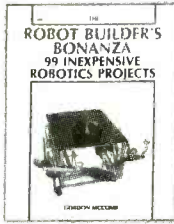

2800P \$17.95

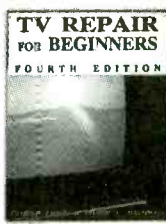

3627P \$19.95



4179H \$28.95 Hardcover



4331H-XX \$29.95 Counts as 2/Hardcover



3671P \$18.95



3279P \$26.95

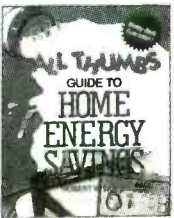

4244P \$9.95

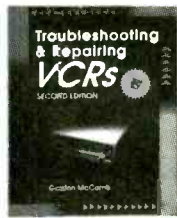

3777H \$32.95 Hardcover



4360H-XX \$34.95 Counts as 2/Hardcover



3802H-XXX \$84.95 Counts as 3/Hardcover

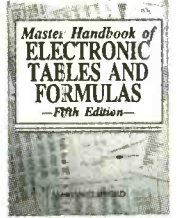

3739P \$22.95

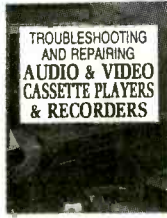

3795P \$19.95



3711P \$19.95



3550H-XX \$34.95 Counts as 2/Hardcover

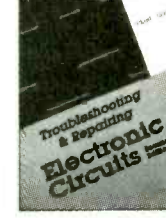

3258P \$19.95

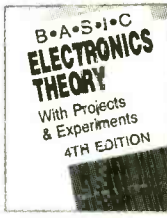

4261H-XX \$35.00 Counts as 2/Hardcover



4325H-XX \$39.95 Counts as 2/Hardcover



0487375P \$24.95

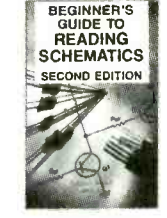

3632P \$10.95

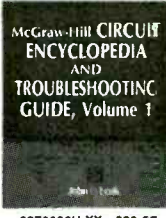

0376026H-XX \$39.50 Counts as 2/Hardcover



4139P \$16.95



2613P \$19.95



4112H-XX \$29.95 Counts as 2/Hardcover

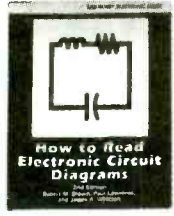

2880P \$15.95

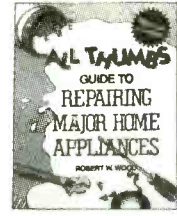

406P \$9.95

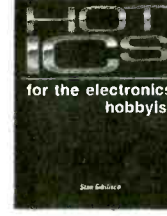

4122H-XX \$36.95 Counts as 2/Hardcover

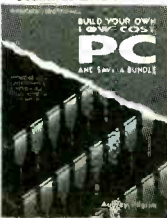

4209P \$19.95



4227P \$15.95

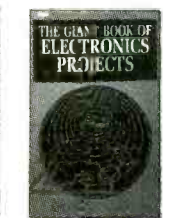

1367P \$29.95



0404348H-XX \$49.50 Counts as 2/Hardcover

Select any 5 books

for only \$4⁹⁵

(values up to \$143.75)

when you join the Electronics Book Club®

As a member of the Electronics Book Club . . .

. . . you'll enjoy receiving Club bulletins every 3-4 weeks containing exciting offers on the latest books in the field at savings of up to 50% off of regular publishers' prices. If you want the Main Selection do nothing and it will be shipped automatically. If you want another book, or no book at all, simply return the reply form to us by the date specified. You'll have at least 10 days to decide. And you'll be eligible for **FREE BOOKS** through the Bonus Book Program. Your only obligation is to purchase 3 more books during the next 12 months, after which you may cancel your membership at any time.

A shipping/handling charge and sales tax will be added to all orders. All books are softcover unless otherwise noted. (Publishers' prices shown) if you select a book that counts as 2 choices, write the book number in one box and XX in the next. If you select a book that counts as 3 choices, write the book number in one box and XXX in the next. ©1994 Electronics Book Club PE1094 If card is missing, write to: Electronics Book Club, Blue Ridge Summit, PA 17294-0810

Your most complete and comprehensive source for the finest electronics books.

The Four-Year Electronics Degree Program That Really Hits Home!

Bring The Technology Home With A Bachelor Of Electronics Engineering Degree. No Hassles. No High Cost!



Now's the time to prepare for a profitable career.

We've lowered the cost of higher education.

It's true! You can earn a four-year Bachelor of Electronics Engineering Technology degree today ... and prepare yourself for a high-paying electronics career ... without quitting your job or ever leaving your home. Because World College, an affiliate of the Cleveland Institute of Electronics, offers you the total flexibility of independent study programs proven effective for people like you who truly want to succeed! World College independent study lessons help you build valuable skills

**Mail/Fax Today
or Call
1-800-696-7532**

step-by-step, and expert instructors are personally available to you with a toll-free call. What a way to earn an education!

A world of opportunity.

Where is your career headed? With a four-year bachelor's degree from World College, you call the shots, choosing from incredible, high-paying opportunities in electronics, telecommunications, computer, electrical power, and many other growing fields.

World College gives you the skills, the knowledge, the power to take advantage of your best opportunity in electronics. And you can do it all at your own pace!

Without leaving home.

World College continually works to provide its students with the most advanced education tools. From the latest equipment and reference books to breakthrough computer-simulated experiments, students are exposed to the latest technological advancements.

All the equipment, parts, and software you need are included in your affordable tuition, including more than 300 hands-on lab experiments you can complete in your home.

Choose your own pace.

Earn your bachelor's degree on your time — and at your pace — because you pay tuition to World College only as you complete the upper-level semesters close to graduation. The faster you make it through, the less you pay. So you have an incentive to make your future happen quickly — yet the freedom to choose your own pace!

Send today for your FREE course catalog — and give yourself that future you've always wanted — with an electronics degree education from World College.



Take charge of your future in electronics.

Four Powerful Reasons To Connect With World College Today:

1. Earn your four-year degree!
2. Self-paced training!
3. Independent study in your home!
4. Expert instruction!

Give Me The Power!

Send me a FREE World College course catalog today!



(Please Print Neatly)

Name _____

Address _____

City _____

State, Zip _____

Phone () _____

Age _____

**For faster service, call
1-800-696-7532,
or call
1-804-464-4600.**

**Or fax this coupon to
1-804-464-3687.**



Lake Shores Plaza
5193 Drive, Suite 113
Virginia Beach, VA 23455-2500



Affiliated with
Cleveland Institute of Electronics
WAH13

Build A Home Security System

Put this full-featured, commercial-quality burglar-alarm system to work protecting your family and property.

BY JOHN TAYLOR, JR.

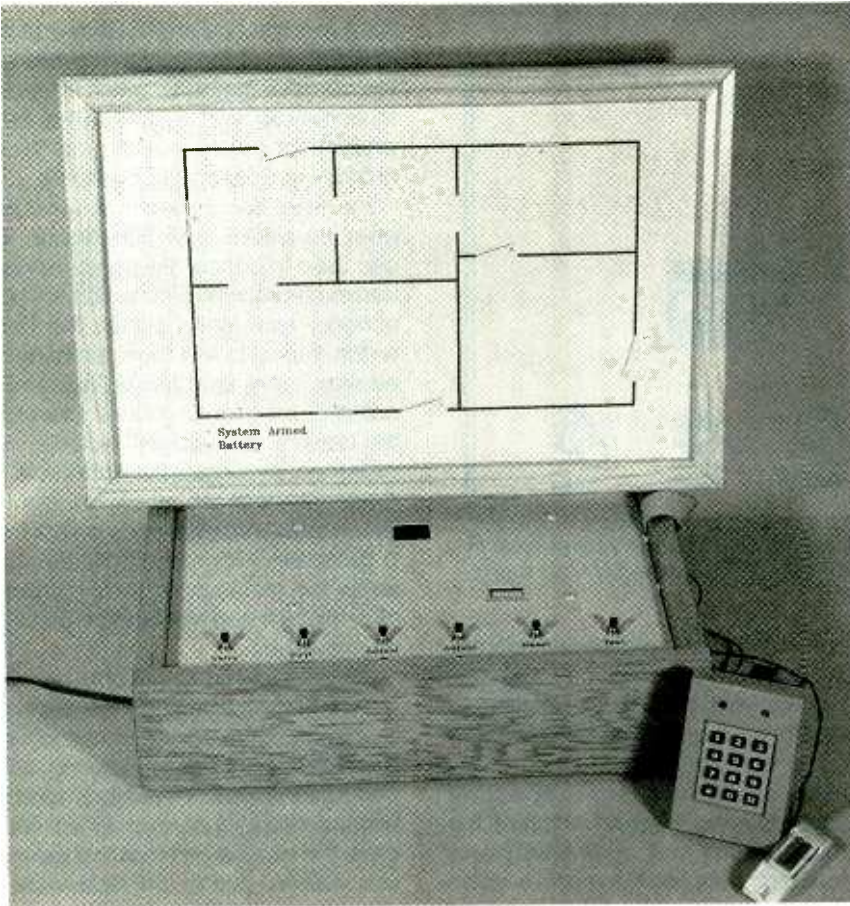

With home burglaries and other crimes against unsuspecting homeowners on the rise, home-security systems have become an increasingly popular means of protection. Security systems are available in varying degrees of complexity ranging from those with simple single-loop protection to those with an impressive list of convenient features, like multiple-zone protection, adjustable entry and exit delays, a panic switch, system-status annunciators, auto system-reset, support for an emergency auto-dialer, X-10 compatibility, and battery-backup operation. As one would expect, the cost of such an elaborate system can range anywhere from several hundred dollars to several thousand dollars.

However, you can have all of those features at a fraction of the cost by building the microprocessor-controlled, *Home-Security System* described in this article. We'll show you how to build the main control unit of our Home-Security System in its standard configuration; optional components can be added at any time to

expand the basic system to provide additional protection.

How It Works. The Home-Security System in its most basic form features eight individual protection zones, adjustable entry and exit delays, a panic switch (for emergency situations), automatic system-reset, support for an auto-dialer (which, in case of emergency, dials pre-programmed telephone numbers), it's X-10 compatible (allowing it to control house lights and appliances), has a backup battery (to keep the system on-line during a power failure), and there is also an optional zone-status panel that is used to individually show the condition of each protection zone.

Most modern security systems are designed for either open- or closed-loop operation. A closed-loop system is a system in which one or more normally-closed sensor switches are wired in series. Opening a single switch in the series disrupts loop current, thereby signaling to the monitoring circuitry that a breach has occurred. The open-loop system is

one in which several normally-open sensor switches are wired in parallel. Violating the protected area causes a switch to close, feeding a signal current to the monitoring circuit, indicating that the protected zone has been breached.

Open-loop systems have the advantage of drawing no current in the idle state, while closed-loop systems circulate some small loop current at idle. Closed-loop systems are easier to wire than their open-loop counterparts and they are less easily defeated since cutting a wire in a closed-loop system is tantamount to opening a sensor switch.

The system's entry delay allows adequate time for one to enter the premises and disarm the system (via the keypad or an optional key switch) before the system registers a legitimate breach and puts out an alarm. Similarly, the exit delay allows sufficient time to exit the premises after the system has been activated.

The system described here is an eight-zone, closed-loop system; an unlimited number of switches (per-

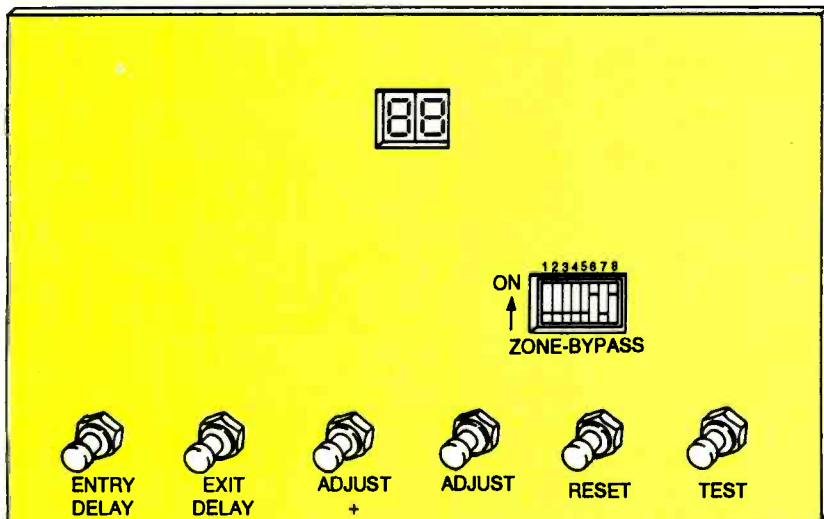

Fig. 1. Six normally-open momentary pushbutton switches (S2-S7) are mounted to the front panel of the main-control unit's enclosure, and are then connected to terminals J2-2 through J2-8 on the printed-circuit board.

haps covering several windows) can be wired in series for each protection zone. Any one zone can be easily bypassed with a simple flip of its corresponding bypass switch, thereby allowing you to disable one or more zones, while maintaining coverage for the rest.

ZONE 1 is an entry-delay zone; a breach in the entry-delay zone (such as when the homeowner returns and enters the premises) while the system is armed sounds a warning buzzer at the keypad and starts the entry-delay timer. If the timer expires before the homeowner reaches and disarms the system, the system sounds its sirens.

Likewise, activating the system (as in when leaving the premises) sounds a warning buzzer and initiates the exit-delay timer (when the delay time expires, the system arms itself). If, at the end of the delay period, one or more zone loops are open, the system puts out an alarm. If, on the other hand, all zones are secure, a confirmation chirp sounds on the external siren and on a buzzer in the keypad, indicating that the system is fully armed. In addition, a buzzer at the keypad also serves as an audible annunciator to indicate an open in any loop, except for zone 8, by sounding a short beep. Zone 8 is considered the silent zone and does not cause the keypad buzzer to beep. That input is ideal for use with motion detectors since those devices are likely to be triggered often.

The system's panic feature allows the alarm to be instantly set off at any time, regardless of the status of the

system. The panic mode, normally activated in an emergency situation such as when a burglar is believed to be on the premises, can be invoked either from the keypad or from any remotely located panic switch (if used). Pressing the reset switch on the main-control unit or entering your four-digit code on the digital keypad cancels the panic mode.

There are six panel-mounted pushbutton switches on the main-control unit (see Fig. 1) that provide control over the entry and exit delays, adjust+ and adjust-, reset, and test functions. Pressing the entry delay and exit delay switches displays the current entry and exit delays, respec-

tively, on the two-digit LED readout. The delays can be varied by pressing the appropriate delay switch while simultaneously holding down either the adjust+ or adjust- switch (see "Programming Entry and Exit Delays").

The reset switch, which is used to reset the system during a violation, is also used to cancel the panic mode, and to clear flashing zone LED's on the optional zone-status panel. The test switch is used to test the internal and external sirens and the LED's on the optional zone-status panel. Pressing the adjust+ and adjust- switches simultaneously toggles the button-click mode on and off; when on, each switch press is confirmed by a click on a piezoelectric buzzer (contained within the main-control unit). Button-click mode is also enabled by default on power-up.

The RESET switch is the only panel-mounted switch that is operational during an alarm condition; the other five switches are disabled during that period. If the system is not in an alarm state, pressing the reset switch displays the number of times the system was violated during the most recent armed period. If the system is violated multiple times before being disarmed, all violated zones are indicated by flashing LED's on the zone-status panel.

Both of the sirens and the zone-status panel LED's can be manually tested by holding down the TEST switch for at least three seconds. If the switch is

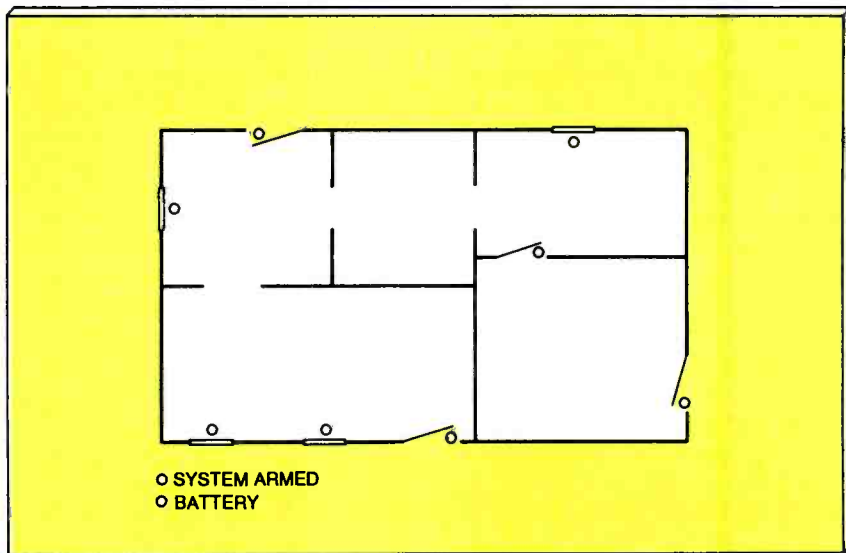

Fig. 2. The optional zone-status panel is used to provide graphic security-system-status information via a floor plan of the protected area, with each area indicated by an LED.

released before three-seconds expires, the test mode will not be initiated. In addition, during tests, the zone-status panel flashes on and off to reveal any defective zone LED's. To cancel the test mode, simply release the TEST switch.

The keypad (available from Radio Shack[®], whose main function is to arm or disarm the system (via a programmable security code) can also be used to invoke the panic mode; pressing the * and # keys simultaneously causes the sirens to immediately sound regardless of whether or not the system is armed. The keypad assembly also contains two built-in LED's (red and green) that are used to indicate the system arming and loop status.

A red LED (arm) lights whenever the system is activated (during the delay period), and flashes (after the delay) to indicate that the system is fully armed. The green LED (loop) turns on when one or more of the enabled zone inputs is open. The keypad also contains a tamper switch that instantly triggers the panic feature if the keypad is tampered with. For maximum flexibility and convenience, the system can support up to four keypads. If desired, the keypad can be replaced (or augmented) by a mechanical key switch.

The optional zone-status panel (see Fig. 2) is used to provide security-system status information. As shown, a floor plan of the protected area is used as a graphic representation of the protected areas, with each area indicated by an LED. A lighted LED indicates an open (unsecured) zone. A flashing LED on the panel signifies that its respective area has been violated. The system-armed LED on the zone-status panel serves the same purpose as the red arm LED on the keypad; a steadily lit LED indicates that the system is about to be armed, and a flashing LED represents a fully armed system. Of course, the zone-status panel can be omitted without adversely affecting the operation of the system, or it can be replaced by a series of LED's mounted on the front panel of the main-control unit's enclosure.

Both of the relay-controlled siren outputs—which are activated by a zone violation or by pressing the panic switch—can handle 12-volt, 1-amp

devices. A variety of suitable sirens are available from Radio Shack for under \$20 (see Parts List). The external siren output, in addition to its alarm duties, is also used to confirm that the system has been successfully armed.

An emergency auto-dialer can also be connected to the system for additional protection. The auto-dialer output provides a dry-contact closure so that whenever an alarm is triggered, the auto-dialer calls up to three pre-programmed telephone numbers. A compatible auto-dialer is available from Radio Shack (see Parts List). It's an attractive alternative to the costly monthly monitoring service offered by security companies.

A serial output on the main-control unit allows it to communicate with an X-10 computer interface—a popular device that is designed send control signals to appliance and lighting modules via household wiring. By linking the main-control unit with an X-10 interface, the main-control unit can access household lighting indirectly. The interface allows the main-control unit to turn on lights in the delayed-entry zone when the area is violated (that's a welcome convenience to the homeowner when he returns after dark and attempts to enter the disarm code before an alarm is triggered). When a protected area is violated, and the disarm code is not entered in time, the main-control unit feeds a signal to the interface, causing all X-10-controlled lights to flash on and off, indicating an intrusion. That feature complements the external siren in alerting neighbors of an intrusion.

The system's rechargeable backup battery (if installed) is constantly trickle-charged while AC power is applied to the system. But should AC power go down, the backup battery kicks in to supply power to the system; the battery can provide up to 12 hours of operation in the idle state, or up to 1 hour during a fully-alarmed condition. During battery operation, an indicator on the zone-status panel lights, signifying that the system is operating from its alternate source.

The system's default entry delay (20 seconds) and the default exit delay (45 seconds) are adjustable from zero to 90 seconds. Pressing the entry or exit delay switch displays the current entry or exit delay, respectively, on the two-digit LED display. To adjust either

delay, hold down the appropriate delay switch while pressing the adjust + or adjust- switch until the desired delay setting in seconds appears.

In the event of a complete power failure, the entry and exit delays revert back to their default values. Entering the proper code at the keypad(s) also causes them to reset to their default settings.

Circuitry. A schematic diagram of the main-control unit is shown in Fig. 3. At the heart of the unit is U16, Zilog's Z8 8-bit microcontroller, which receives its program instruction from U17, a 27C64 8K × 8 EPROM. Integrated circuit U15 (a 74HCT373 8-bit latch) is used to demultiplex the address/data bus of the Z8. Addresses on the address/data bus for all external program memory transfers are clocked on the falling edge of the address strobe (\overline{AS}). The strobe signal is inverted by U13, $\frac{1}{2}$ of a 74HCT00 hex inverter, and used to clock U15.

Integrated circuit U14 (a 74HCT138 3-to-8 line decoder) generates chip select signals for: U17 when reading operating-system code; U11 when writing the zone-status panel LED's; U7 and U10 when writing the two 7-segment LED displays; U8 when writing the system alarm outputs; and U5 when reading panic switch and arm-status inputs. The inputs to U14 consist of the upper three address lines, A13 through A15.

The MAX705 microprocessor supervisory circuit (U18) holds the microprocessor in the reset state during power-up and prevents code execution-errors during power-down or brownouts. On power-up, once the supply voltage exceeds the reset threshold (4.65 volts), an internal timer releases U16's RESET line after about 200 ms. That guarantees that the processor starts in a known state once the power supply stabilizes, and also ensures that U16 stops executing code if the supply voltage falls below 4.65 volts; for instance, if the battery runs low during a power outage.

Integrated circuit U18 also functions as a watchdog timer, monitoring the microprocessor's activity. Periodically the watchdog input (\overline{WDI}) of U18 is toggled to prevent it from resetting the processor. So long as the microprocessor is running properly, the watchdog timer never expires. How-

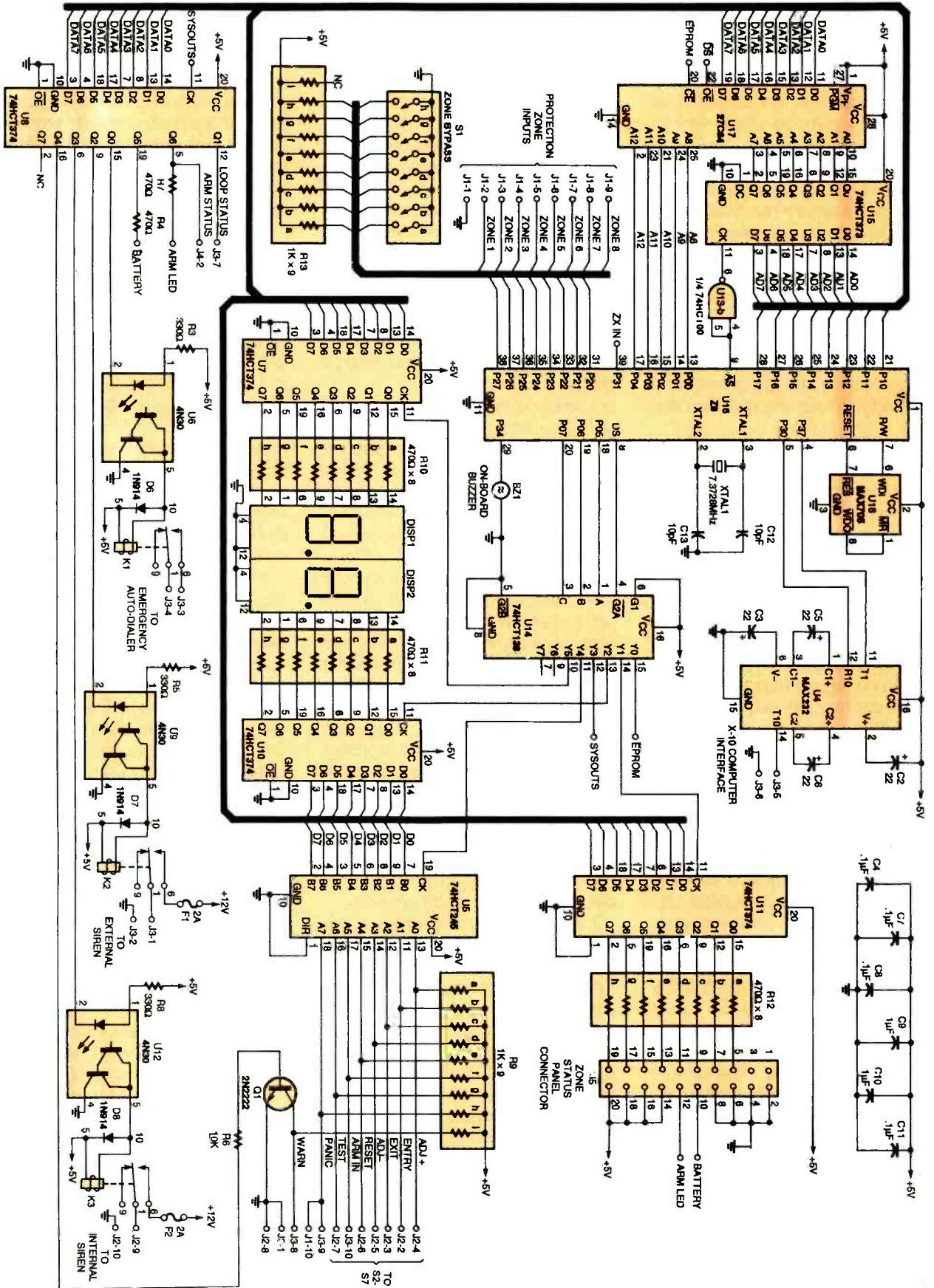

Fig. 3. At the heart of the main-control unit is U16, Zilog's Z8 8-bit microcontroller, which receives its program instruction from U17, a 27C64 8K x 8 EPROM.

ever, should the microprocessor ever get locked up and fail to toggle within 1.6 seconds, pins 1 and 8 of U18 go low, causing the microprocessor to reset.

Although under normal conditions the processor should not lock up, unpredictable behavior can occur, perhaps due to nearby lightning strikes or other conditions that can adversely affect the power-supply circuitry. Essentially, U18 serves as failure protection for the Home-Security System.

The zone (sensor) inputs are applied to port 2 (pins 31–38) of U16, and are pulled high through a 1k resistor network (R13). Switch S1, the ZONE-BYPASS switch (an 8-position DIP unit), is used to selectively disable any of the eight zone inputs. Closing one of S1's eight positions disables its corresponding zone. Octal buffer U5 (a 74HCT245 unit) is used to read inputs from the six panel-mounted switches (S2–S7), the panic switches, and the system arm-status. Those inputs are active-low and are pulled up through 1k resistor-network R9. Switches S2–S7 are used to display and program the entry-and-exit-delay settings, reset the system after having been triggered, and test the sirens, as described earlier.

The two siren outputs are fed to a pair of 4N30 Darlington-output optoisolators (U9 and U12), which in turn, drive a pair of 12-volt, 2-amp relays (however, the power supply only provides for 1 amp per siren). Each 12-volt siren output is protected by a 2-amp slow-blow fuse (F1 and F2). A third optoisolator/relay combination (U6/K1) is used to activate the auto-dialer. A 2N2222 NPN bipolar transistor (Q1, which is capable of sinking up to 75 mA) is used to drive the main-control unit's internal warning buzzer. The three relay-driven outputs, the warning-buzzer output, the keypad loop and arm LED outputs, and the status-panel SYSTEM ARMED and BATTERY LED outputs are all latched by U8.

The two on-board 7-segment common-cathode LED displays (DISP1 and DISP2) are driven by latches U7 and U10 through a pair of 470-ohm resistor networks (R10 and R11). The zone-status-panel LED outputs are available at a dual-row header (designated J5) and are latched by U11 through a 470-ohm resistor network (R12).

Integrated circuit U4 (a MAX232 dual RS-232 transmitter, configured

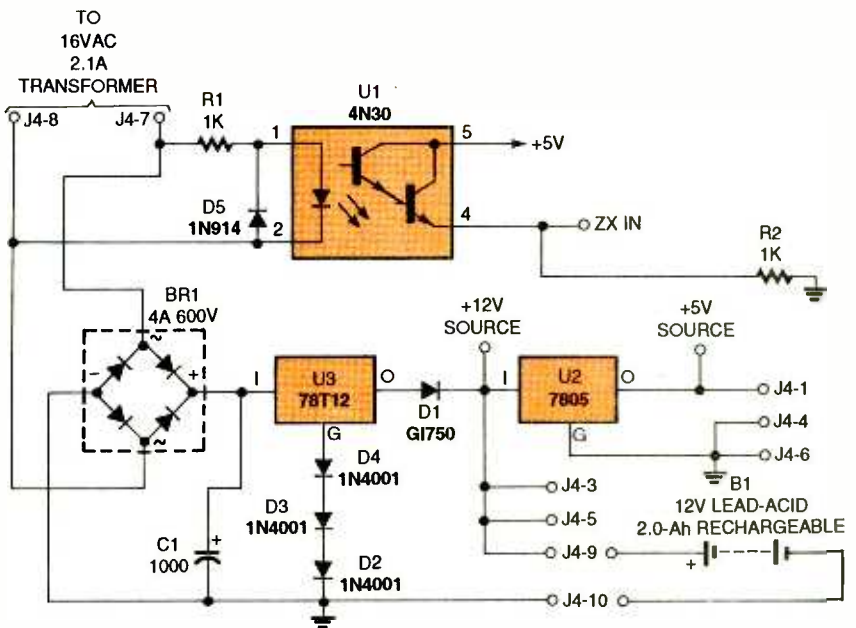

Fig. 4. The system's power supply provides 12 volts DC for the sirens and digital keypad, and 5 volts DC for the on-board electronics, while also providing a constant 12-volt output that's used to charge the backup-battery.

for 600 baud, 8 data bits, no parity, and one stop bit) provides the link between the main-control unit and an X-10 computer interface (the model CP-290 or equivalent is recommended). Since communication between the main-control unit and the X-10 interface is in one direction only (from main-control unit to X-10 interface), only two wires are needed.

The system's power supply, see Fig. 4, which is fed from a 16-volt 2.1-amp transformer (not shown), provides 12 volts for the sirens and the digital keypad, and 5 volts for the on-board electronics, while also providing a constant 12-volt output that's used to charge the backup-battery (B1 in Fig. 4). Diodes D2–D4 are used to raise the reference of U3, thereby raising its output to about 14 volts. The 14-volt output of U3 is reduced one diode drop to about 13.3 volts by D1 and used to keep the lead-acid backup-battery fully charged. Diode D1 also prevents current from the backup-battery from flowing into U3's output terminal. Capacitor C1 (a 1000-µF unit) filters the rectified voltage that is fed to U3.

Optoisolator U1, resistors R1 and R2, and diode D5 form a zero-crossing detector that is used by the microprocessor to determine when AC power is applied to the power-supply circuit. The absence of the zero-crossing signal tells the microprocessor that

the system is operating on backup-battery power, causing it to respond by lighting the battery LED on the zone-status panel.

System Software. The most vital element of the Home-Security System is its operating system. The major tasks of the operating system are to read the ZONE-switch and SYSTEM-STATUS inputs; to display the zone- and system-status information; to control the alarm-output devices; to provide processing-system timing; and to communicate with the X-10 interface. We will briefly discuss each of those tasks and how each is accomplished.

The zone, control-switch, and system-status inputs are all read in at a frequency of 120 Hz, allowing even the fastest changes in any inputs to be detected and processed accordingly. To prevent false alarms, the zone inputs are debounced for a minimum of 100 milliseconds (ms), allowing enough time for them to stabilize (only after at least 100 ms are they considered valid). As with the zone inputs, the control-switch and system-status inputs are also susceptible to noisy or bouncing contacts and are similarly debounced.

System-status information is displayed in three ways—on the optional zone-status panel; via a two-digit 7-segment LED display; and

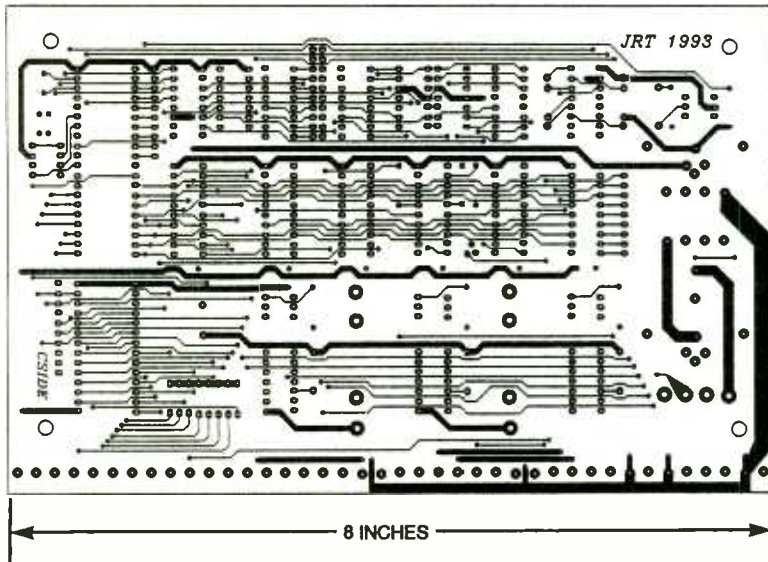

Fig. 5. The Home-Security System's main-control unit was built on a double-sided printed-circuit board with plated-through holes. The foil pattern for the component side of the board is shown here at half scale.

though the system-status LED indicators. The zone-status panel uses an LED to indicate the status of each protected zone. At the time of arming (during the delay interval), any open zone detected causes its corresponding zone LED to light steadily. Once the delay times out and the system is armed, violating any protected zone causes its corresponding LED on the zone-status panel to flash, indicating that zone has been violated.

The two-digit display is used to convey delay-time settings and other system-status information. Pressing either of the delay switches (entry or exit) causes the current delay-time setting to appear on the display. During an alarm condition, the violated loop is indicated on the two-digit display by a flashing "L?," where "?" ranges from 1 to 8 representing the number of the violated zone. A flashing "P" on the display indicates that the panic mode has been invoked. Pressing the RESET causes the total number of violations that have occurred since the system was last armed to appear in the two-digit display. The count is reset to zero each time the system is armed.

The operating-system software is responsible for controlling the various alarm outputs—internal and external siren-control signals, the warning-buzzer control signal, the auto-dialer control signal, and the on-board piezo-buzzer control signal—based on the inputs received. Those signals

are enabled for a specific amount of time, which is precisely measured by the operating-system software. The entry and exit delays, as well as various other system-timing delays, are handled by one of U16's two internal timers. Its other internal timer is used as a bit-rate generator, which is required by the serial I/O for communicating with an X-10 computer interface—a device used by many home-control enthusiasts to control household lighting and appliances via the power line.

The operating-system software communicates with the X-10 interface by transmitting commands to the Z8's serial port. When the entry-delay timer is initiated (as a result of the delay-entry zone door opening while the system is armed), the operating system sends a command to the interface to turn on the X-10 device set to house code A, unit code 8. That allows the delayed-entry zone to be conveniently illuminated to facilitate entering the passcode at the digital keypad after dark.

For those that do not wish to purchase the preprogrammed items listed in the Parts List, the operating-system software can be downloaded from the Gernsback BBS at 516-293-2283.

Construction. The main-control unit of the Home-Security System was built on a double-sided printed-circuit board with plated-through holes. The foil patterns for the component and solder sides of the board are shown at half scale in Figs. 5 and 6, respectively, for those who choose (and have the expertise) to etch their own board. For those who do not wish to make their own board, a double-sided board with plated-through holes is available from the source given in the Parts List; partial and complete kits, as well as fully assembled and tested units, are also available.

Figure 7 is the parts-placement dia-

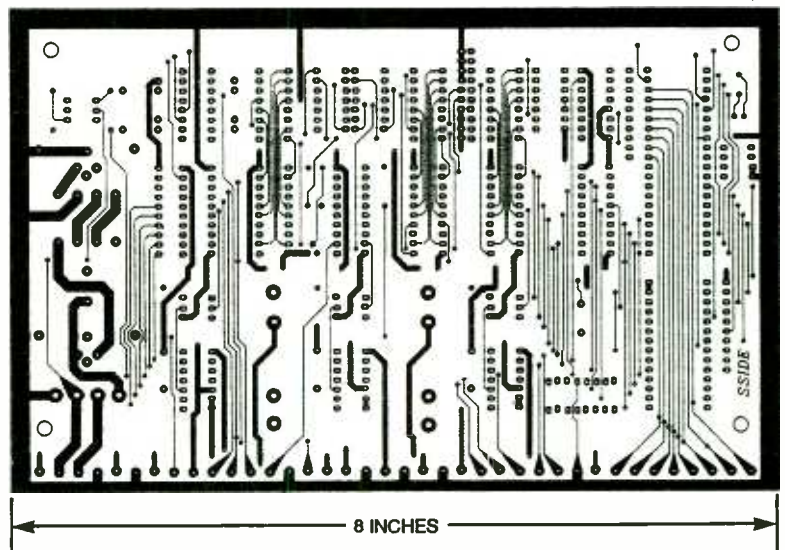

Fig. 6. The foil pattern for the solder side of the board is shown here at half scale. Those who do not wish to make their own board, can purchase the board, a partial or complete kit, or a fully assembled and tested unit from the source given in the Parts List.

gram for the Home-Security System's main-control board. Begin construction by installing C1, D1-D4, U2, U3, and BR1 of the power supply. Before installing any of the other components, test the power-supply circuit by connecting the output of a 16-volt, 2.1-amp transformer to the J4-7 and J4-8 terminals. You should get a reading of approximately +13.3 volts DC from J4-9 to J4-10; those terminals feed charge current to the backup battery. You should also measure about +13.3 volts DC at J4-3 and J4-5.

Measure the voltage from J4-1 to J4-4 or J4-6; you should get a 5-volt DC reading. Next measure the DC voltage at the anode of D1; it should read about 14 volts. None of those measurements should be more than 5% off: If any of them exceeds a 5% tolerance, recheck the power-supply components placement and orientation before proceeding with assembly. That's necessary to prevent damage to the other electronic components that will eventually be

TABLE 1—ZONE STATUS ANNUNCIATOR PANEL CONNECTOR SIGNALS

Pin No.	Signal Description
1	no connection
2	common
3	no connection
4	common
5	Zone 8 Status LED
6	common
7	Zone 7 Status LED
8	common
9	Zone 6 Status LED
10	Battery LED
11	Zone 5 Status LED
12	System Armed LED
13	Zone 4 Status LED
14	+5 volts DC
15	Zone 3 Status LED
16	+5 volts DC
17	Zone 2 Status LED
18	+5 volts DC
19	Zone 1 Status LED
20	+5 volts DC

mounted on the circuit board.

When you are ready to begin installing the remaining components, start with the smallest units first. It is important that you use sockets for U16 (the microcontroller), U17 (the EPROM), DISP1 and DISP2 (the 7-seg-

ment displays), and K1-K3 (the DIP relays). Note: the two 7-segment display modules (along with their sockets) and the zone-bypass DIP switch should be mounted on the solder side of the board. Resistor networks R10-R12 can be replaced by discrete 470-ohm resistors if desired. The majority of the parts are standard-stock items that are available from most mail-order distributors and local electronics suppliers.

The six panel-mounted, normally-open momentary pushbutton switches are mounted to the front panel of the main-control unit's enclosure. The switches are connected to terminals J2-2 through J2-8 on the main-control unit's printed-circuit board though hook-up wire. The switches can be temporarily wired to the main-control unit for testing purposes prior to mounting them on the front panel (see "Preliminary Testing").

The design of the zone-status panel is relatively unrestricted. In fact, status-indicating LED's can, assuming that there is sufficient room, be mounted

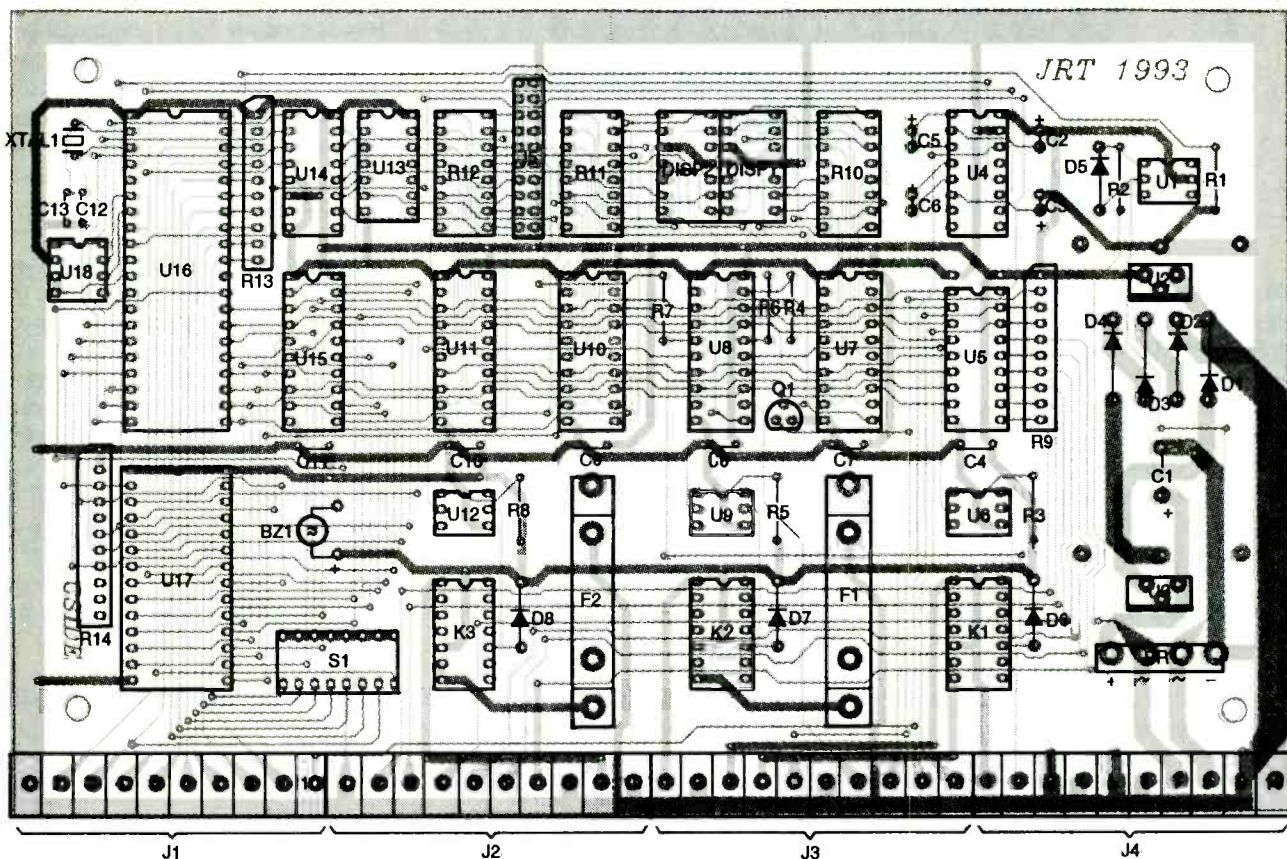

Fig. 7. Begin construction of the Home-Security System's main-control unit by installing power-supply components C1, D1-D4, U2, U3, and BR1 first. Once installed (and before mounting any of the other parts), test the power-supply circuit by feeding a 16-volt, 2.1-amp source to terminals J4-7 and J4-8.

TABLE 2—MAIN CONTROL UNIT TERMINAL CONNECTIONS

Terminal	Signal Name	Signal Description
TS1-1	COMMON	Zone Inputs Common
TS1-2	ZONE 1	Zone 1 Input
TS1-3	ZONE 2	Zone 2 Input
TS1-4	ZONE 3	Zone 3 Input
TS1-5	ZONE 4	Zone 4 Input
TS1-6	ZONE 5	Zone 5 Input
TS1-7	ZONE 6	Zone 6 Input
TS1-8	ZONE 7	Zone 7 Input
TS1-9	ZONE 8	Zone 8 Input
TS1-10	PANIC	Panic Button(s) Input
TS2-1	COMMON	Panic Inputs Common
TS2-2	ENTRY DELAY	Entry Delay Button Input
TS2-3	EXIT DELAY	Exit Delay Button Input
TS2-4	ADJUST+	Adjust+ Button Input
TS2-5	ADJUST-	Adjust- Button Input
TS2-6	RESET	Reset Button Input
TS2-7	TEST	Test Button Input
TS2-8	COMMON	Panel Button Inputs Common
TS2-9	INT SIREN	Internal Siren Positive Terminal
TS2-10	COMMON	Internal Siren Common
TS3-1	EXT SIREN	External Siren Positive Terminal
TS3-2	COMMON	External Siren Common
TS3-3	AUTO-DIALER	Auto-Dialer N.O. Output
TS3-4	AUTO-DIALER	Auto-Dialer N.O. Output
TS3-5	X-10 INTERFACE	X-10 Computer Interface Output
TS3-6	COMMON	X-10 Computer Interface Common
TS3-7	LOOP STATUS	Keypad LOOP LED Output
TS3-8	WARNING	Warning Buzzer Output
TS3-9	PANIC/TAMPER	Keypad Panic Input
TS3-10	ARM INPUT	Keypad Arm Status Input
TS4-1	+5 VDC	Keypad +5-volt Output
TS4-2	ARM STATUS	Keypad ARM LED Output
TS4-3	+12 VDC	Keypad +12-volt Output
TS4-4	COMMON	Keypad Common
TS4-5	+12 VDC	Auxiliary Device +12-volt Output
TS4-6	COMMON	Auxiliary Device Common
TS4-7	16 VAC INPUT	16-volt AC Input
TS4-8	16 VAC INPUT	16-volt AC Input
TS4-9	BATTERY+	Backup-Battery Positive Terminal
TS4-10	BATTERY-	Backup-Battery Negative Terminal

to the front panel of the main-control unit's enclosure and labeled accordingly, eliminating the zone-status panel altogether. Any way, regardless of your zone-status-panel layout, the panel signals are available at J5 (see Table 1). Connections between the status panel and the main-control unit should be made through a length of a 20-conductor ribbon cable.

Preliminary Testing. Once the circuit has been assembled and all off-board components connected to the main control board, it can be tested as a stand-alone unit. Before powering up the main-control unit, however, be sure that heat sinks have been installed on the voltage regulators, U2 and U3, to permit maximum power dissipation. When mounting the heat sinks to the regulators, be sure to use thermal compound between the heat sink and the regulator tab to en-

sure maximum heat transfer.

On power-up, the on-board buzzer should beep once, indicating the successful initialization of the hardware and firmware (system software). The right-hand decimal point of the right 7-segment display (DISP1) flashes at one-second intervals, indicating the proper operation of the system. The panic input can be tested by momentarily shorting the panic-input terminals (terminal connections J1-10 and J2-1). That should result in the letter P flashing on DISP1 and the activation of all three relays (K1-K3). If the zone-status panel is connected to J5, all of the zone-status LED's should also begin flashing. To help identify when the relays are activated, connect a 1k resistor in series with an LED to the output terminals of each relay. Be sure to connect the anode of the LED to the positive-output terminal.

If an X-10 interface is connected to

terminal connections J3-5 and J3-6, X-10-controlled lights (and/or other devices) set to unit codes 1 through 8 (house code A) should cycle on and off at five-second intervals. Cancel the panic mode by pressing the RESET switch, or allow the system to reset automatically in five minutes.

Press the ENTRY DELAY switch to display the default entry-delay setting on the 7-segment displays. Likewise, pressing the EXIT DELAY switch displays the default exit-delay setting. To adjust either delay setting up or down, press the ADJUST+ or ADJUST- switch, respectively, while holding down the appropriate delay switch. The maximum setting for both delays is 90 seconds. Note that pressing any of the panel-mounted switches results in a click sounding on the piezo buzzer. Press both of the adjust switches simultaneously to toggle button-click mode.

There are two test modes that can be invoked. Pressing and holding the TEST switch for at least three seconds invokes a test mode that activates the three relays and flashes the LED's on the zone-status panel. The test mode remains active for as long as the TEST switch is held down. A power-up self-test can be invoked by holding down the TEST switch while applying power to the main-control unit. During the self-test mode, each alarm output device is enabled sequentially for one second in the following order: on-board piezo buzzer, internal siren relay, external siren relay, auto-dialer relay, and keypad-warning buzzer. The two 7-segment displays cycle through digits 0 through 99 during the self-test mode to reveal any defective segments. If the zone-status panel is connected to the main-control unit, the system cycles through the zone-status LED's in sequence. That mode also remains active for as long as the TEST switch remains down. Releasing the TEST switch cancels the self-test and proceeds to normal operation.

Installation. The assembled control unit should be installed in an enclosure suitable for recessed or surface mounting. The selected enclosure should be large enough to house both the backup-battery and the main-control unit. The enclosure should be mounted in an accessible location not near any of the perimeter entrances or windows. Some sug-

gestions include the master-bedroom closet, behind the master-bedroom door, in a utility room, or in a basement closet. The location should be convenient for routing wires either through conduits or through the walls. As many as 29 wires may need to be routed to and from the main-control unit, not including connections for power. (See Table 2 for a description of the terminal connections on the main-control unit.) Connect the output of the 16-volt AC transformer to terminals J4-7 and J4-8 to provide the main control unit with power. If a rechargeable backup-battery is available, connect the positive terminal to terminal J4-9 and connect the negative terminal to J4-10 on the main-control unit. Be sure to observe the polarity of the terminals when making the connections!

The digital keypad should be mounted in a convenient location near the entry door. It should be mounted approximately eye level in a single-gang wall-box. A total of eight wires should be routed from the main control unit to the keypad. The wires should be connected to terminal connections J3-7 through J4-4. Figure 8 describes the connections between the keypad and the main control unit. Connect the positive terminal of the remote warning buzzer to +5 volts, and the negative terminal to the wire connected to terminal connection J3-8 of the main control unit. Program the keypad to respond to a 4-digit code that you select as per the manufacturer's instructions.

After making the appropriate connections to the remote warning buzzer, it should be placed inside the wall-box before mounting the keypad. If additional keypads are desired, they should be wired in parallel with one another. Up to eight normally-closed zones can be monitored by the Home-Security System. Each zone can include as many normally closed switches as necessary to provide the desired protection. Take some time to think about the selection of protection zones before drilling holes to mount the sensor switches. The switches for windows in the same room can be wired in series for a single zone of protection. Each perimeter door, however, should be wired in separate protection zones, if possible. That allows those critical zones to be dis-

HARD-WIRE THESE TWO CONNECTIONS ON BACK OF KEYSWITCH

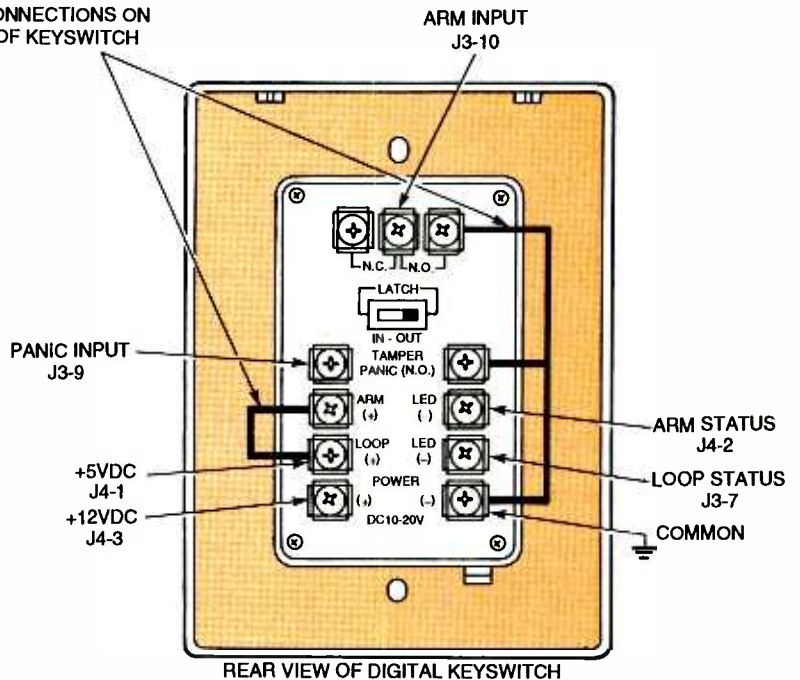

NOTE:

CONNECT NEGATIVE TERMINAL OF WARNING BUZZER TO GROUND AND POSITIVE TERMINAL TO MAIN CONTROL UNIT TERMINAL CONNECTION 28 (J3-8).

Fig. 8. The connections between the keypad and the main-control unit are illustrated here. Simply connect each point on the keypad to the like-labeled point on the main-control unit.

tinguished from one another. Try to keep all wires concealed when wiring the zone switches. Take advantage of crawl spaces, uninsulated interior walls, and accessible attic space whenever possible. As a suggestion, route all zone-switch wiring to a central terminal strip and connect the common wire of each zone input to a single terminal. Then route nine wires (eight zone inputs plus one common) from the terminal strip to the main-control unit terminals J1-1 through J1-9. If the crawl space is used for routing the wires and its access door is accessible from the exterior of the house, be sure to protect it with one of the instant-trigger zone inputs. If a motion detector is to be used with the system, connect it to zone 8 (the silent zone). Power for the motion detector is available on J4-1 (+5-volts DC) or J4-5 (+12-volts DC) depending on the voltage required.

The zone-status panel should be mounted in a location near the main-control unit. The recommended mounting location is on top of the main-control unit enclosure, and preferably, in a position that is visible from the homeowner's bedside.

Multiple panic switches can be located at strategic points throughout the house to provide the homeowner with convenient access should it ever become necessary to invoke the panic mode. The switches should be normally open momentary pushbutton switches wired in parallel with one another. Connect the network of panic switches to the main-control unit via terminal connections J1-10 and J2-1. Radio Shack sells pushbutton switches (for under \$2 each) that are perfect for this application. One panic switch should be mounted on or under a bedside table for convenient access from the bed. Other panic switches elsewhere in the home should be mounted out of the reach of small children.

The emergency auto-dialer should be located in a convenient location near a telephone outlet. The normally open inputs of the auto-dialer should be connected to terminal connections J3-3 and J3-4 of the main-control unit. Refer to the operator's manual included with the emergency auto-dialer for instructions on programming the telephone numbers. The X-10 computer interface can be

PARTS LIST FOR THE HOME-SECURITY SYSTEM

SEMICONDUCTORS

- U1, U6, U9, U12—4N30 Darlington output optoisolator/coupler, integrated circuit
 U2—MC7805C 5-volt, 1-amp voltage regulator (TO-220 package), integrated circuit
 U3—MC78T12C 12-volt, 3-amp voltage regulator (TO-220 package), integrated circuit
 U4—MAX232 5-volt dual transmitter/receiver, integrated circuit
 U5—SN74HCT245 TRI-state octal transceiver, integrated circuit
 U7, U8, U10, U11—SN74HCT374 TRI-state octal D-type flip-flop, integrated circuit
 U13—SN74HCT00 quad 2-input NAND gate, integrated circuit
 U14—SN74HCT138 3-to-8 line decoder, integrated circuit
 U15—SN74HCT373 TRI-state octal D-type latch, integrated circuit
 U16—Z8691 (or Z8681) Zilog Z8 ROMless microcontroller, integrated circuit
 U17—27C64 8K × 8 EPROM, integrated circuit
 U18—MAX705 microprocessor supervisory circuit, integrated circuit
 Q1—2N2222 general-purpose NPN silicon transistor
 D1—GI750 6-amp, 50-PIV rectifier diode
 D2—D4—1N4001 1-amp, 50-PIV rectifier diode
 D5—D8—1N914 general-purpose silicon diode
 BR1—4-amp, 600-PIV full-wave bridge rectifier
 LED1—LED10*—Red light-emitting diode
 DISP1, DISP2—7-segment common-cathode LED display (Radio Shack P/N 276-075)

RESISTORS

(All fixed resistors are ¼-watt, 5% units.)

- R1, R2—1000-ohm
 R3, R5, R8—330-ohm
 R4, R7—470-ohm
 R6—10,000-ohm
 R9, R13, R14*—1000-ohm × 9 DIP resistor network
 R10—R12—470-ohm × 8 DIP resistor network

CAPACITORS

- C1—1000-µF, 35-WVDC, electrolytic
 C2, C3, C5, C6—22-µF, 16-WVDC, tantalum

- C4, C7—C11—0.1-µF, ceramic-disc
 C12, C13—10-pF, ceramic-disc

ADDITIONAL PARTS AND MATERIALS

- B1—12-volt, 2.0-AH rechargeable battery (Mouser P/N 547-PS-1220)
 BZ1—Piezoelectric buzzer (Radio Shack P/N 273-074)
 F1, F2—2-amp, slow-blow fuse
 K1—K3—SPDT 5-volt, 2-amp relay (Radio Shack P/N 275-243)
 S1—8-position DIP switch
 S2—S7—SPST momentary contact pushbutton switch
 J1—J4—10-position terminal block
 J5—20-pin dual-row header
 XTAL1—7.3728-MHz crystal
 Printed-circuit materials, enclosure, two TO-220 heat sinks, five 14-pin DIP sockets, one 28-pin DIP, one 40-pin DIP socket, fuse clips, 16-volt 2.1-amp transformer, digital keypad (Radio Shack P/N 49-535), normally closed magnetic switches (Radio Shack P/N 49-496), panic switches (Radio Shack P/N 49-517), emergency auto-dialer (Radio Shack P/N 49-433), internal two-sound siren (Radio Shack P/N 49-490), high-power external siren (Radio Shack P/N 49-525), X-10 computer interface (Model CP-290 available from X-10 USA), twisted-pair alarm wire, zone status panel materials, 20-conductor ribbon cable, connectors, wire, solder, hardware, etc.

Note: The following items are available from John Taylor, P.O. Box 1281, Lawrenceville, GA 30246-1281 (Tel: 404-682-1368): The main-control unit double-sided silk-screened, printed-circuit board, \$35.50 + 2.50 S/H; preprogrammed and tested EPROM and Z8691, \$36.50 + 2.50 S/H; a partial parts kit (including the printed-circuit board, and a preprogrammed and tested EPROM and Z8691), \$59.50 + 3.50 S/H; a complete parts kit (containing a double-sided silk-screened, printed-circuit board and all parts to build main-control unit), \$149.00 + 5.00 S/H; an assembled (includes 2-AH rechargeable lead-acid backup-battery) and tested main-control unit mounted in an enclosure, \$249.00 + 10.00 S/H.

*Not shown on schematic

placed in any convenient location, and should be connected to the main-control unit via terminals J3-5 and J3-6.

The internal siren should be mounted in a central location in the home, with its positive connected to terminal J2-9 and its ground connected to J2-10. The external siren should be mounted in a location that allows its sound to be directed outside the home. It can be mounted either in the attic facing a gable vent, or outside under a suitable roof overhang. The external siren connects to the main-control unit via terminal connections J3-1 (positive terminal) and J3-2.

System Testing. Once all of the components of the system have been wired together, they can be tested collectively as a system. After applying power to the main-control unit, enable each zone of the system by turning off (opening) the corresponding zone-bypass switch. Secure all zones and check the zone status panel to verify that all zone LEDs are off. Also check the LOOP LED on the digital keypad to see that it is off. Check the operation of each zone input by simulating opening a protected door or window in that zone, and verifying that the corresponding zone LED on the zone-status panel lights. The LOOP LED should also light when any of the enabled zones are opened. A short beep should be heard from the keypad warning buzzer when each zone door or window is opened. If zone 8 is being used, verify that triggering its input is reflected on the zone-status panel and the keypad LOOP LED, but does not sound a beep on the keypad warning buzzer.

Once all zones have been checked, check the operation of each zone input with the system in the armed state. As a courtesy to your neighbors during testing, you may want to disable the external siren by removing fuse F2. You may also want to disconnect the auto-dialer during the system-testing procedures. Arm the system by entering the programmed four-digit code on the digital keypad. The warning buzzer should sound and the ARM LED on the keypad should light. Go to the zone-status panel and verify that the SYSTEM ARMED LED is on,

(Continued on page 92)



Variable Frequency RF Oscillators

BY JOSEPH J. CARR

We present some variable, RF-oscillator designs that you can build.

Variable-frequency oscillators (VFO's) are radio-frequency signal generators that can be continuously tuned using an inductor connected to either an air variable capacitor, mica "trimmer" capacitor, or a voltage-tuned variable-capacitance diode (varactor). A VFO differs from the crystal oscillators used in many transmitters in that a VFO's frequency can be varied, while a crystal oscillator is either fixed or variable over only a tiny range.

Variable-frequency oscillators can be used as signal generators in test equipment, to control ham transmitters, as the local oscillator in either a superheterodyne or direct-conversion receiver, or in any other application where a continuously variable source of RF signals is needed. In this article, you will find some practical circuits that are based on easily obtained components, as well as some general guidelines for modifying the circuits for your own use.

RF Oscillator Basics. Both VFO's and crystal oscillators are part of a class of circuits called feedback oscillators. Figure 1 shows the basic configuration of this type of circuit; it consists of an amplifier with open-loop gain A_{VOL} and a feedback network (which is usually frequency selective) with a "gain" of β (beta). If two conditions—called Barkhausen's criteria—are met, then the circuit will oscillate. The two conditions are: the loop-gain must be unity or greater, and the feedback signal arriving

back at the amplifier input must be phase shifted 360 degrees. For most practical circuits, with 180 degrees of phase shift provided by an inverting amplifier, the feedback network must provide an additional 180 degrees of phase shift.

By the way, it is a good idea to use only regulated DC power supplies with oscillator circuits. That's because most oscillators shift frequency a slight amount when the power-supply voltage changes. In fact, most experts agree that a regulator dedicated to just the oscillator is best because it is not affected by load changes in other circuits. If you are a ham-radio operator familiar with CW (*i.e.*, Morse-code) transmission, then you will recognize such variation as a transmission defect called "chirp." Although not all of the oscillator circuits in this article show a regulator, it is a good idea to use one anyway.

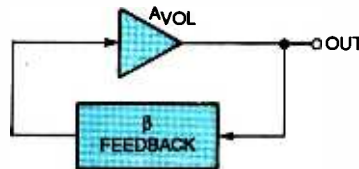

Fig. 1. As this block diagram reveals, a feedback oscillator is comprised of an amplifier and a tuned feedback loop.

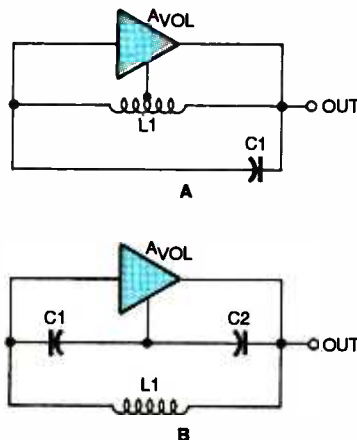

Fig. 2. Shown here are the basic makings of a Hartley oscillator (A) and a Colpitts oscillator (B).

Input. There are two general categories of RF oscillator that we will consider here: those with parallel tuned tanks (such as Hartley or Colpitts circuits), and those with series tuned tanks (for example a Clapp oscillator). The circuit in Fig. 2A is a Hartley oscillator. It is identified by the tapped inductor in the feedback network, which effectively forms an inductive voltage divider. Colpitts and Clapp circuits (see Fig. 2B) are identified by the fact that the feedback network contains a tapped-capacitance voltage divider.

For our circuits, we will use one of three active devices as the amplifier

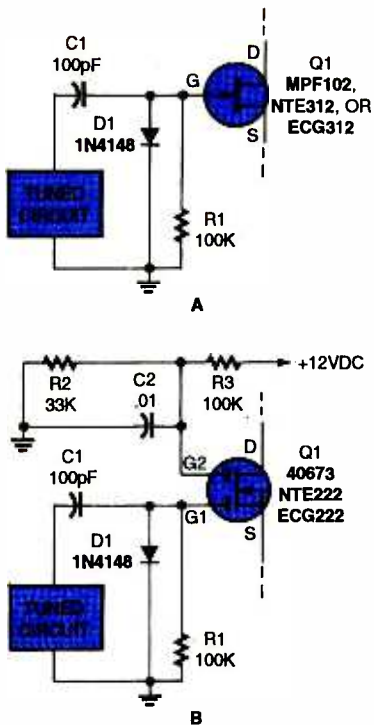

Fig. 3. The gate circuit for a JFET oscillator (A) is the same for a MOSFET oscillator (B) although the MOSFET needs an additional bias network for its extra gate.

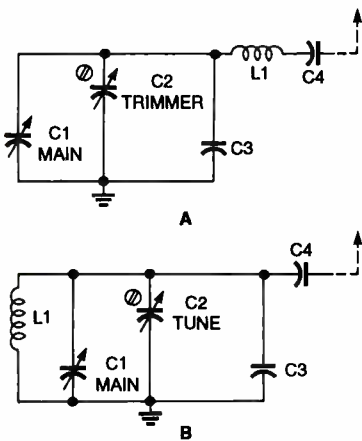

Fig. 4. These are typical tuning circuits. The one in A is parallel resonant, while the one in B is series resonant.

portion: an MPF102 junction field-effect transistor (JFET), a 40673 metal-oxide field-effect transistor (MOSFET), or the Signetics NE602 RF balanced-mixer integrated circuit. Equivalents of the two transistors are also available from distributors who carry ECG or NTE radio/TV replacement parts. The MPF102 is replaced by the ECG312 and the NTE312, while the 40673 is replaced by the ECG222 and NTE222 devices.

Figure 3 shows two input configura-

tions, one each for the MPF102 and 40673. Figure 3A shows the circuit for the JFET device. It consists of a gate resistor of 100k ohms to ground, and a diode (1N914, 1N4148, or equivalent). The diode in the input circuit perplexes some people when they first see it. Its function is to clean up the signal, and make it closer to a low-harmonic sine wave. In many cases, you will need to use a capacitor such as C1 in the gate circuit, especially if there is a DC source or ground directly in the circuit. In order to prevent loading of the tuned circuit, it is customary to make the coupling capacitor small compared to the tuning capacitor; typically values from 2 to 10 pF are used for high-frequency and medium-wave VFO circuits.

The same circuit can be used for the MOSFET, but there must also be a DC-bias circuit for the second gate, G2. The bias network made of R2 and R3 in Fig. 3B is set to bias G2 to about $\frac{1}{3}V+$, but I've also used equal valued resistors (10k each) for R2 and R3. A bypass/decoupling capacitor (C2) is used to ground any RF at G2, while keeping G2 at the bias voltage for DC.

Tuning. The tuned circuit for a Clapp oscillator can be series-tuned (as in

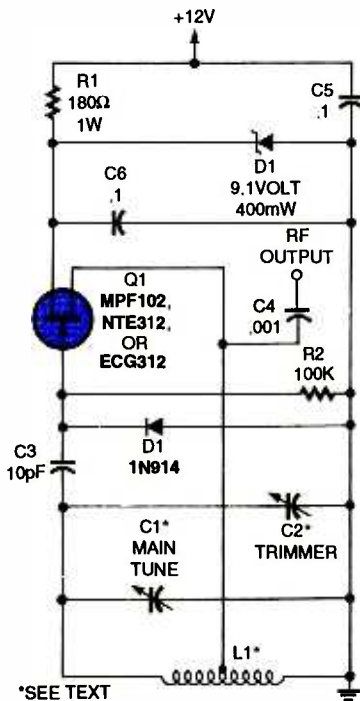

Fig. 5. This simple Hartley JFET oscillator has a built-in Zener-diode regulator to condition the power-supply voltage down to 9.1 volts.

Fig. 4A). For a Hartley or Colpitts oscillator, a parallel-tuned circuit is used (see Fig. 4B). In the case of the Hartley oscillator, the inductor (L1) will be tapped. Both fixed-value and variable inductors can be used for the circuits.

In any LC resonant circuit, resonance is that point where the inductive reactance and capacitive reactance are equal to each other. Because the reactances cancel out, the impedance of such a circuit is purely resistive.

Also, the nature of an LC-tuned circuit is that it can provide a 180-degree phase shift at its resonant frequency. So as long as an LC tank is used with an inverting amplifier, together they will meet the 360-degree phase-shift requirement for an oscillator.

It is generally true that there should be a high C/L ratio, so it is common practice to select a relatively low-value inductor, but a high-value of capacitance. Many of the oscillators in this article are designed for the middle of the 1- to 10-MHz band, and use

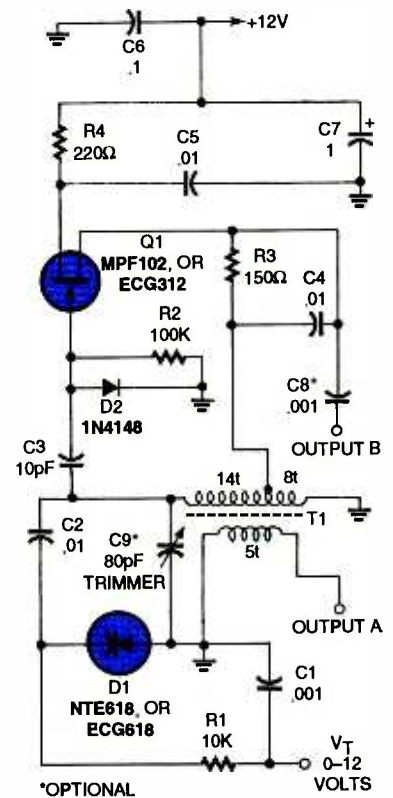

Fig. 6. This voltage-tuned JFET Hartley oscillator can be made to sweep its entire frequency range by applying a sawtooth waveform that rises from 0 to 12 volts to the V_T input.

inductances on the order of 3.3 to 7 mH. Those inductances are relatively easy to obtain when using either "solenoid" (cylindrical) or "toroidal" coil forms. See the Amidon Associates (P.O. Box 956, Torrance, CA 90508) catalog for information on winding both sorts of coils. Also, Barker & Williamson (10 Canal Street, Bristol, PA, 19007; Tel. 215-788-5581) makes air-core coil stock that is suitable.

The capacitance can be made up of more than one capacitor, and that is generally the best practice. The change of frequency is proportional to the square root of the ratio of the capacitance change:

$$f_{\max}/f_{\min} = C_{\max}/C_{\min}$$

That is why a variable capacitor for the AM broadcast band consists of a 25–365-pF air variable capacitor shunted by a 25-pF (or so) trimmer capacitor (which is usually set to around 15 pF). The 3.08:1 ratio of maximum to minimum capacitance is more than sufficient to cover the 3.02:1 ratio of the maximum and minimum frequencies of the AM band.

Selecting values of L and C is a somewhat tedious and iterative affair. One is advised to sit down with a calculator and make a few trials. Part of the problem comes from the fact that both fixed and variable capacitors come in standard values, which may not be exactly what's needed. Juggle the value of the inductor (which can be easily wound to a custom value) to provide the desired frequency change when used with commonly available variable capacitors.

It is common practice to make the total of the fixed capacitors plus the maximum values of the variable (main-tuning and trimmer) capacitors somewhat larger than the total required to resonate at the very lowest frequency in the desired range. When the trimmer is set to a value less than the maximum, the total capacitance will be close to the desired value.

Hartley JFET VFO. The Hartley oscillator, as you might recall from above, is identified by a feedback path that includes a tapped inductor; but the inductor is also part of the resonant tuning circuit of the oscillator. Figure 5 shows a simple Hartley oscillator based on the MPF102 JFET. The output signal is taken

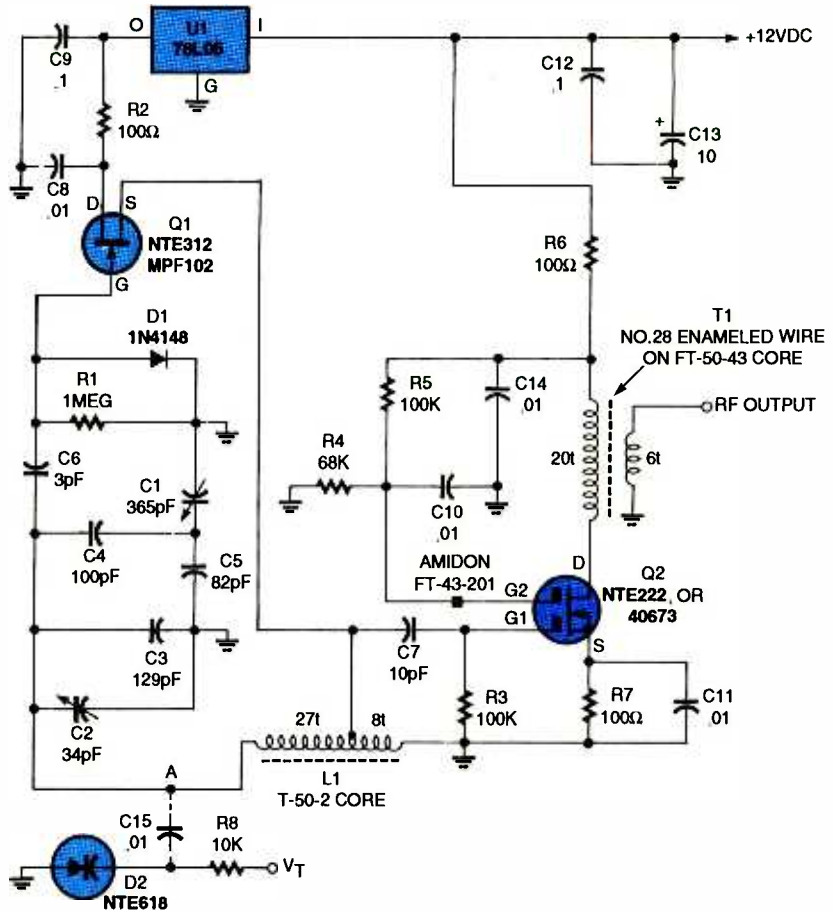

Fig. 7. A Hartley oscillator with buffer amplifier. This circuit can be tuned via C1, or if C1 is removed and the varactor network is connected to point A, a tuning voltage can be used instead.

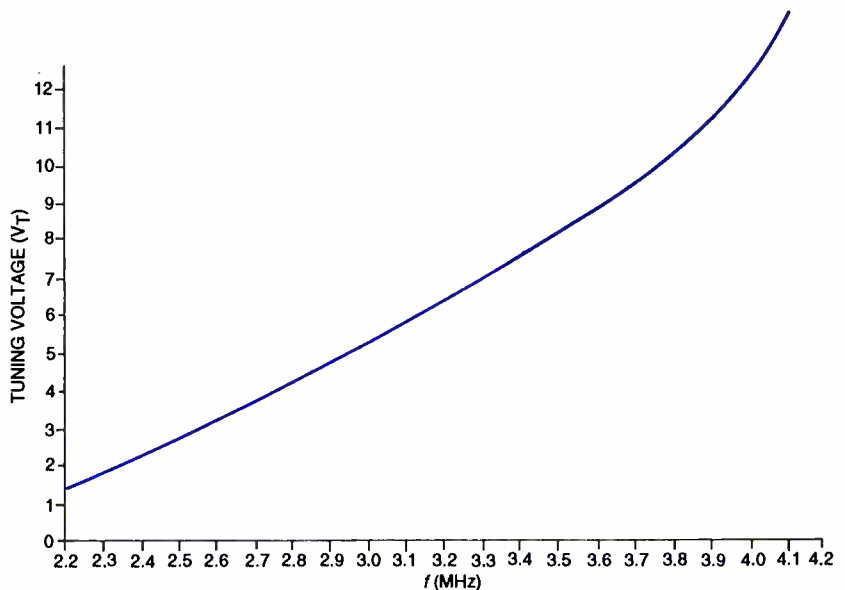

Fig. 8. This tuning characteristic curve shows the relationship between the varactor's tuning voltage and output frequency for the oscillator in Fig. 7. Please note that lower frequencies could've been achieved if lower tuning voltages were used.

through a small-value capacitor (to limit loading) connected to the emitter of the transistor.

The frequency of oscillation is set by the combined effect of L1, C1, and C2:

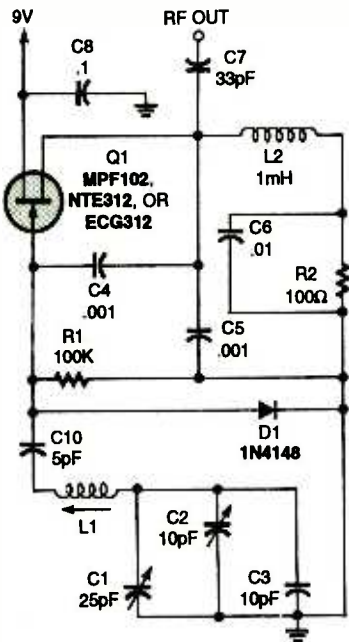

Fig. 9. The JFET VFO circuit shown here can be identified as a Clapp oscillator by its series tuned LC network. The circuit as shown can be used from 0.5 to 7 MHz.

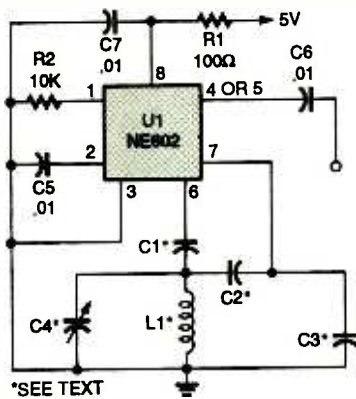

Fig. 10. Three capacitors (C1, C2, and C3) are used in this NE602AN IC Colpitts oscillator circuit, rather than two, because of a need for DC blocking.

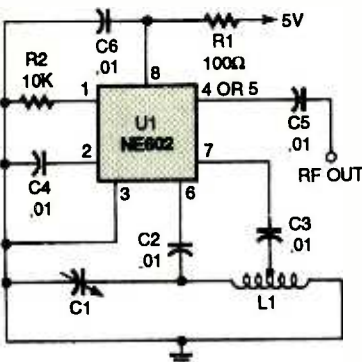

Fig. 11. You can tell this is a Hartley oscillator by noting the tapped coil in the LC tank network. The inductor is tapped from one-fourth to one-third the way from the ground end.

$$f = 1/(2\pi\sqrt{L1(C1+C2)})$$

To resonate at 5 MHz with a 5-mH inductor, a total capacitance of about 200 pF is required. Because of stray capacitance and variations in the values of actual capacitors, it is common practice to use more total capacitance than needed, and use variable capacitors to trim the total down. For example, we could use a 140-pF variable capacitor for main tuning, and an 80-pF trimmer to set the maximum to the required value.

Figure 6 shows a 5-MHz Hartley VFO circuit also based on the MPF102 JFET. It is very similar to the previous circuit in basic concept, but there are some

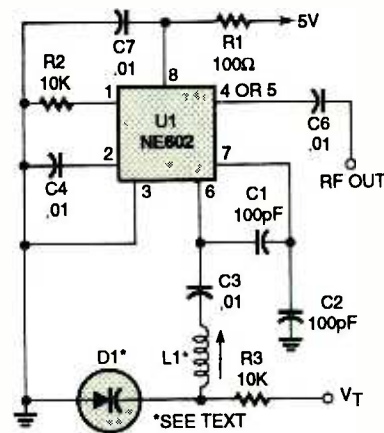

Fig. 12. This voltage-tuned Clapp oscillator uses a varactor diode to set its operating frequency.

differences. The most significant difference is the use of a variable-capacitance diode (varactor) instead of the main tuning capacitor. The diode shown is a 14–440-pF varactor used to tune the AM broadcast band in radio receivers. Another significant difference is that the output signal is taken from a secondary winding on the tuning inductor. That winding consists of fewer turns than the lower portion of the main-tuning inductor. Care must be taken to not load down the circuit by connecting a varying load resistance across the output winding.

The circuit of Fig. 6 can be made to sweep the entire frequency range by applying a sawtooth waveform that rises from 0 to 12 volts to the varactor. This type of circuit makes it relatively easy to build a sweep-generator, or a swept-tuned radio receiver. In general, the sweep rate should be around 40 Hz if the detector has a narrow

band filter. Other sweep frequencies are usable as well, but care must be taken not to "ring" any following resonant circuits or filters because of an excessive sweep rate.

The tuning properties of a varactor-tuned LC circuit are nonlinear because of the nature of varactor diodes. It is recommended that a graph of tuning voltage versus frequency be made, and that only the linear portion of the curve be used for sweep purposes.

The circuit shown in Fig. 7 is capable of producing as much as several volts (yes, volts) of signal in the 1- to 10-MHz range. The actual tuning range depends on the particular components used. The heart of the oscillator is an MPF102 JFET (Q1). Two different tuning schemes are possible. As shown, for a limited range (5000–5500 kHz), main tuning is provided by C1, a 365-pF AM broadcast-band tuning capacitor. In that case, the varactor diode (D2) is disconnected and not used.

The alternate scheme deletes C1, and uses the varactor circuit shown connected at point "A." That version has a wider tuning range for the same capacitance change. That's because in the unmodified circuit, the tuning range was reduced by the capacitor-divider action of C4 and C5.

As an alternative to the varactor circuit, you can connect C1 to point "A" instead of the junction of C4 and C5. That will also provide a wide tuning range.

The circuit can be further modified by adding or subtracting capacitors from the tuning network. As shown, C1–C5 are all part of the tuning circuit.

The main inductor (L1) consists of 35 turns of No. 28 enameled wire on an Amidon T-50-2 (red) toroidal core. The tap is placed at eight turns from the ground end. The tap is formed by winding two separate, but contiguous, windings: one of 8 turns and one of 27 turns. The windings are connected together electrically at the point where they butt together. The two wire ends of the two coils are soldered together and used as a single wire to connect the tap to the source of the JFET.

The drain of the JFET is kept at a ground potential for RF signals by the bypass capacitor, C8. The output sig-

(Continued on page 94)



Build a Multi-Function Car Security System

Protect your second most-valuable investment from carjackings, without placing yourself in harm's way, with this remote-controlled security system

BY ANTHONY J. CARISTI

Although this project was designed specifically as an automotive emergency security system, its capabilities encompass much more than that. It is a complete radio-frequency (RF) remote-control system that allows the user to control one or more vehicular electrical circuits from a distance via a digitally-encoded RF transmitter signal. The controlled circuits can be in a stationary or moving vehicle.

One of the system's most important functions is to help foil attempted carjackings, where the driver would passively surrender the vehicle, and disable it, via the remote transmitter, from a safe distance once the perpetrator has driven off. Once the vehicle stops, the hijacker will have no choice but to abandon the vehicle. However, a more common application would be to use the transmitter to remotely sound the horn or turn on the lights to provide an extra margin of safety when needed, perhaps, to scare off a would-be attacker, or to allow one to quickly locate the vehicle in a large crowded parking area.

The two-part system is comprised of

a handheld crystal-controlled transmitter and a super heterodyne receiver, operating at 49 MHz. As designed, the system can control 4 discrete devices, but its 9-bit data system can be easily expanded to control up to 15 separate circuits on 32 channels. Its digital encoding/decoding scheme prevents accidental operation from stray RF fields or other interference.

The transmitter (powered from a 9-volt transistor-radio battery) is assembled into a very small enclosure that easily fits into a shirt pocket or handbag. The receiver, on the other hand, is powered from the car's 12-volt electrical system, and draws very little current, allowing continuous operation with little or no danger of running down the vehicle's battery.

Transmitter. The Car Security System is based on a pair of digital CMOS chips, the MC145026 programmable encoder, and the MC145027 programmable decoder, which are specifically designed for remote-control applications.

Figure 1 is a schematic diagram of

the transmitter, which is built around U1, the MC145026 programmable encoder. The encoder has five address lines and four data lines. Although the 5-bit address allows up to 32 discrete channels (00000 through 11111), only one address is required in this application. For that reason, U1 pins 1-5 are tied to ground, giving an address of 00000.

The remaining four lines (data inputs) of U1 can be coded for any binary number from 0001 through 1111. A pair of switches (S2 and S3) are used to place either a logic 1 or logic 0 on two of the data lines (pins 7 and 6, respectively) to produce on or off control signals. The remaining two data lines are not used, but the system can easily be expanded to four-channel operation by using those in a similar manner to pins 6 and 7.

Aside from the programmable encoder (U1), the transmitter is comprised of a crystal oscillator, modulator, and a power amplifier, and is powered from a 9-volt transistor-radio battery, which supplies an average of about 7 mA to the circuit. Transistor Q1 (an MPF102 FET) is configured as a

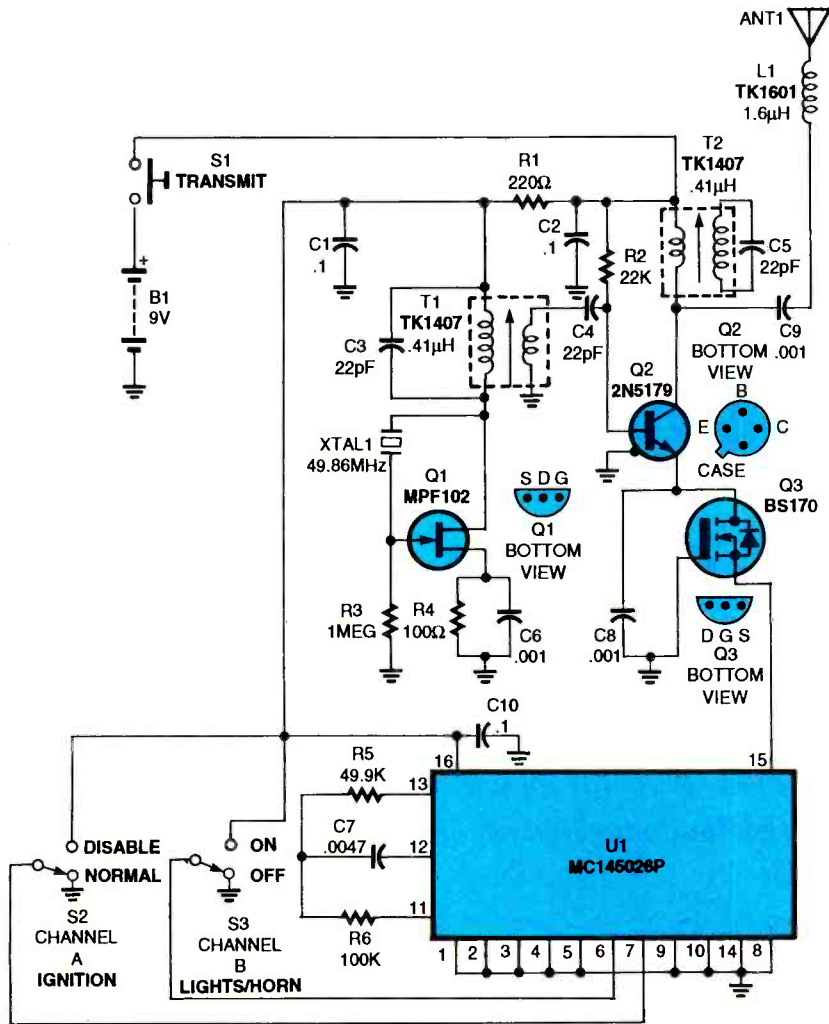

Fig. 1. The transmitter for the Car Security System is built around U1, an MC145026 programmable encoder—one of a pair of digital CMOS chips that are specifically designed for remote-control applications.

crystal-controlled Pierce oscillator, with its feedback from drain to gate provided by XTAL1 (a 49.86-MHz crystal that operates in the third-overtone mode). A parallel tuned circuit consisting of T1's primary and C3 is set to the third-overtone frequency, causing the circuit to oscillate.

The output of the oscillator is fed through T1 to the base of Q2, whose forward base-bias is supplied through R2. The secondary of transformer T2 is placed in the collector circuit of Q2, with the primary parallel tuned to 49.86 MHz via C5. The low-impedance secondary of T2 is then used to drive the antenna circuit.

The transmitter is designed to operate into a 36-inch antenna wire, which is shorter than the nominal 1/4 wavelength at 49.86 MHz (or 54 inches). Such an antenna presents an impedance that is both resistive and

capacitive. Loading coil L1 is used to cancel out the effects of the antenna's capacitive reactance and allow maximum power transfer.

The encoder is activated when power is applied to the transmitter via switch, S1. Integrated circuit U1 provides a serial-data pulse train that contains address (00000), and data information as determined by the settings of S2 and S3. The emitter of Q2 is grounded through Q3, an enhancement TMOFET that acts as a switch. The gate of Q3 is forward biased by the output of U1, amplitude modulating the transmitted signal, which consists of RF pulses that represent logic 1's and 0's.

Receiver Circuit. The super-heterodyne receiver (as shown in Fig. 2) is composed of an NE602 double-balanced mixer (U2), followed by a

combination high-gain intermediate-frequency (IF) amplifier and detector/amplifier circuit, U3 and U4, respectively, an LM358 dual low-noise op-amp (U5), and the MC145027 programmable decoder (U6).

The antenna circuit (composed of C11, C12, and L2) is tuned to the transmitter's operating frequency (49.86 MHz). The RF energy picked up by the antenna is fed to U2, the NE602. The NE602 is used as a mixer/local oscillator, heterodyning the incoming RF with the LO output to extract the intermediate frequency (IF). The frequency of the local oscillator (39.16 MHz) is controlled by a parallel tuned resonant circuit composed of C15, C16, C17, and L3.

PARTS LIST FOR THE TRANSMITTER

SEMICONDUCTORS

- U1—MC145026P programmable encoder, integrated circuit
- Q1—MPF102 general-purpose FET
- Q2—2N5179 NPN silicon transistor
- Q3—BS170 TMOFET

RESISTORS

(All fixed resistors are 1/4-watt, 5% carbon units, unless otherwise noted.)

- R1—220-ohm
- R2—22,000-ohm
- R3—1-megohm
- R4—100-ohm
- R5—49,900-ohm, 1/4-watt, 1%, metal-film
- R6—100,000-ohm, 1/4-watt, 1%, metal-film

CAPACITORS

- C1, C2, C10—0.1-μF, ceramic-disc
- C3—C5—22-pF ceramic-disc or mica
- C6, C8, C9—0.001-μF, ceramic-disc
- C7—0.0047-μF, mylar

ADDITIONAL PARTS AND MATERIALS

- ANT1—Antenna (see text)
- S1—SPST normally-open pushbutton switch
- S2, S3—SPDT toggle or slide switch
- B1—9-volt transistor-radio battery
- L1—1.6-μH inductor (Toko, Digi-Key TK1601)
- T1, T2—0.41-μH, RF transformer (Toko, Digi-Key TK1407)
- XTAL1—49.86-MHz, third-overtone crystal
- Printed-circuit materials, enclosure, IC sockets, 9-volt battery holder and connector, wire, solder, hardware, etc.

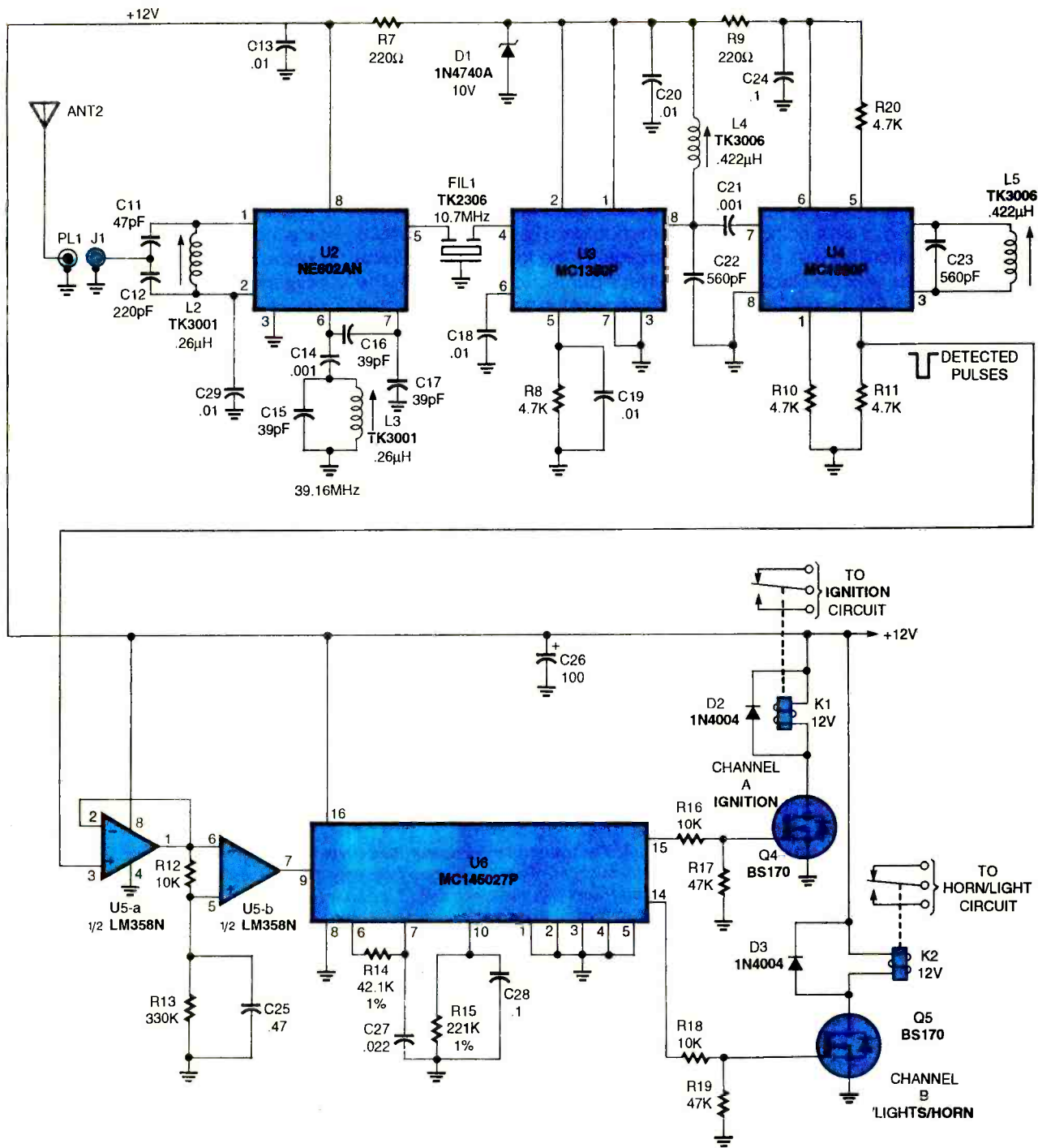

Fig. 2. The superheterodyne receiver for the Car Security System, in addition to the MC145027 programmable decoder, U6 (the other half of the two-chip set), is composed of an NE602 double-balanced mixer (U2), followed by a combination high-gain intermediate-frequency (IF) amplifier and detector/amplifier circuit (U3 and U4, respectively), and an LM358 dual op-amp.

The signal is then fed through FIL1 to the first stage of the IF section. The ceramic filter has a narrow bandpass frequency centered on 10.7 MHz that passes the desired IF while attenuating all other frequencies.

The IF section (comprised of U3 and

U4) includes an AM detector (which is part of U4's internal circuitry) that is set for maximum gain—approximately 93 dB at 10.7 MHz. Two tuned circuits, composed of L4/C22 and L5/C23, are set to 10.7 MHz by adjusting the inductors. Integrated circuit U4 reproduces

the transmitted pulse train that contains the address and data information. The output of U4 (a series of negative-going modulation pulses) at pin 4 is fed to the decoder section of the receiver, through U5, the dual low-noise op-amp.

Op-amp U5-a (configured as a voltage follower) is used as a buffer between the output of U4 and the input of U5-b, which is operated without negative feedback allowing it to act as a voltage comparator. An RC network composed of R12, R13, and C25 controls the operation of U5-b.

The negative-going pulse train, at the output of U5-a at pin 1, riding on a DC voltage of about 5.5 volts, is fed to pin 6 of U5-b. The voltage-divider action of R12 and R13 biases U5-b to ensure that its pin-7 output remains at zero volts at all times, except in the presence of the received pulse train. The negative-going output of U5-a appears at pin 6 of U5-b, but not at pin 5 because of the filtering action of C25. That causes the output of U5-b at pin 7 to be a faithful, but inverted, reproduction of the negative-going detected pulses, the amplitude of which is raised to full V_{dd} level for a solid logic-1/logic-0 representation of the encoded data.

Integrated circuit U6 processes the pulse train, examining it for the correct address (00000). If the data stream is valid for two consecutive cycles, data in the pulse train appears at U6 pins 15, 14, 13, and 12. Only pins 15 and 14 are used in this two-channel system; pin 11 of U6 (not shown) can be used for an optional single channel push-button system. When the transmitted signal stops, the data lines of U2 store the last valid information received.

If an invalid transmission is received, U6's data lines do not change from their original power-up condition (0000) or their status from a previously valid transmission. Two of the four data-output lines of U6 are used to control a pair of power relays. If any of the output data bits is logic 1, the corresponding transistor, Q4 or Q5, is biased on. That, in turn, activates the associated relay. The relay contacts are hard wired to the vehicle circuits to be controlled, allowing them to be activated or disabled. As shown, K1 is used to control the engine-ignition circuit, while K2 is used to actuate the horn or lighting circuit.

The unused data lines (pins 12 and 13) of U6 can easily be used to provide two additional control channels, by adding additional transmitter switching at pins 9 and 10 of U1 (in Fig. 1). The system can also be configured for single-channel operation by using the

output of U6 at pin 11 to control Q4 and K1. In that configuration, the relay will be energized only as long as the transmit button is held down.

Transmitter Construction. In order to ensure proper transmitter operation, printed-circuit construction, using a double-sided printed-circuit board is mandatory. Figure 3A is a full-size template of the foil side of the transmitter's printed-circuit layout. The other side of the board is solid copper

except for a small clearance around each component lead that is not tied to the circuit ground. Figure 3B gives the locations of all holes that must be cleared of copper.

Clearing the copper is easily accomplished with small, sharp drill bit (about $\frac{3}{16}$ inch in diameter). Simply rotate the bit several times in each of the holes that require clearance to remove sufficient copper from around the hole. That helps to avoid short circuits between the compo-

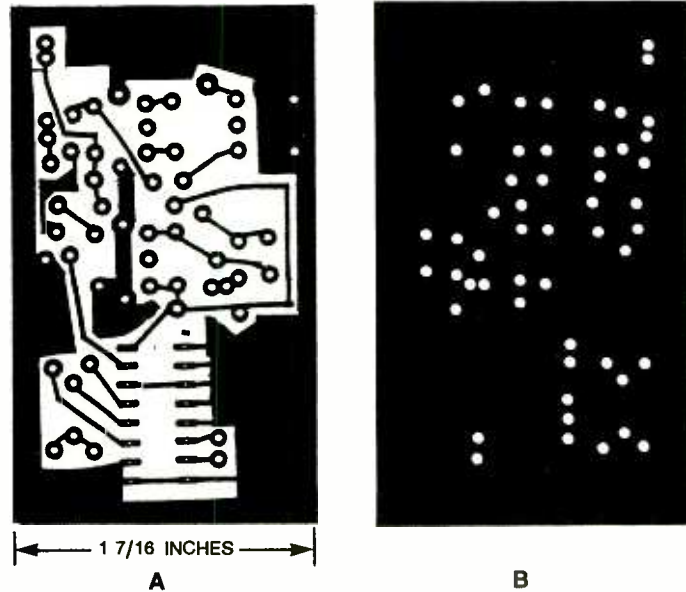

Fig. 3. The transmitter section of the system was assembled on a double-sided printed-circuit board. Copper is removed from only one side of the board to produce the circuit traces (A), the other side of the board serves as a ground plane (B). Copper is then cleared from around the component-lead positions on the ground plane side to prevent shorts.

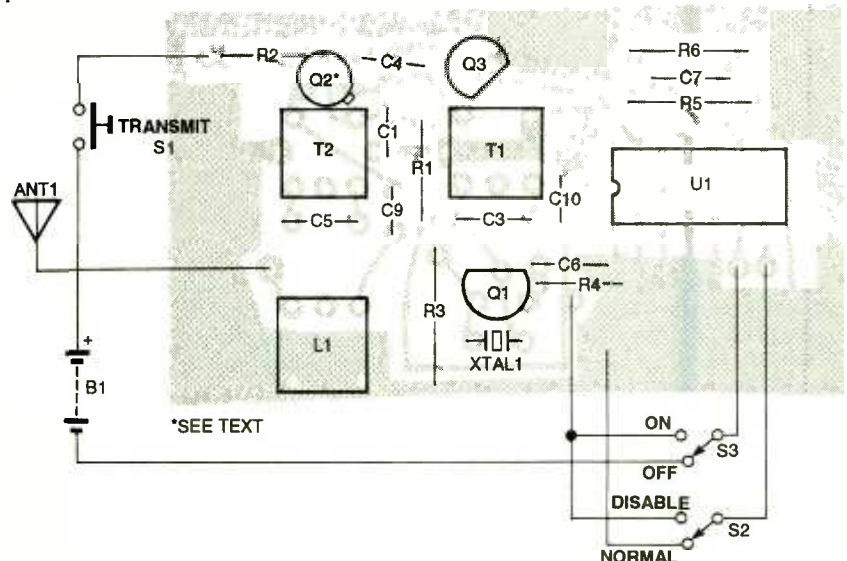

Fig. 4. When assembling the transmitter, be sure that Q1, Q2, and Q3 are properly oriented, and that the wire connection for Q2's metal case is soldered to the ground plane. Also, it is recommended that a socket be used for U1.

nent lead and the ground plane. **Warning!** Do not attempt this operation using a power drill; in doing so, the bit could accidentally cut through the entire board. If you choose not to etch and drill your own boards, boards are available from the source specified in the Parts List.

Figure 4 is a parts-placement diagram for the transmitter's printed-circuit board. It is recommended that a socket be used for U1. Be sure that Q1, Q2, and Q3 are properly oriented, and make sure that the wire connection for Q2's metal case is soldered to the ground plane.

Component leads that connect to ground should be soldered to both sides of the board to ensure a solid ground-plane circuit for those components. On all other component leads, be sure that none is inadvertently touching the copper on the component side of the board. The assembled board can be housed in a small plastic enclosure, with S1–S3 mounted to the front panel as desired. Switch S1 should be a normally-open pushbutton unit, while S2 and S3 can be single-pole double-throw slide or toggle switches, all of which should be labeled accordingly.

Note: If the single-channel option, described under "Receiver Assembly" is chosen, S2 and S3 are not required; in that case pins 6 and 7 of U1 should be tied to circuit ground.

For the transmitter antenna, use a 36-inch length of #20 insulated stranded wire. Drill a hole in the enclosure at an appropriate location to allow the antenna wire to exit. The wire can be conveniently wrapped around the enclosure when the transmitter is not in use, and can quickly be stretched out when needed. Connect a 9-volt battery connector to the board where indicated.

Before proceeding to the receiver assembly, examine the transmitter board for shorts, opens, and cold solder joints. It is much easier to correct any suspect joints at this time, rather than later after discovering that your circuit does not work.

Receiver Construction. The receiver section of the project consists of two printed-circuit boards (RF and digital), which should be housed in a single metal enclosure. As with the transmitter, printed-circuit construction is mandatory for the receiver's RF section to ensure proper circuit operation. The digital part of the receiver can be assembled on either single-sided printed-circuit board or it can be hard-wired on perf-board.

Figure 5A shows a full-size template of the foil side of the board for the receiver's RF section. Note that like the transmitter board, the receiver's RF section is assembled on a double-

sided printed-circuit board. As with the transmitter board, the receiver's RF board uses the copper on the component side of the board as a ground plane. The holes around the component leads must be cleared of copper in a similar manner as was done to the transmitter board. The holes that must be cleared are shown in Fig. 5B. (Again, circuit boards are available from the source given in the Parts List.) Use a small drill bit, rotating it by hand, to remove a small amount of copper around each indicated hole location. Figure 6 is the parts-placement diagram for the receiver's RF board. Note that FIL1 is a 3-terminal bilateral device that can be placed into the circuit board in any direction.

The layout for the receiver's single-sided digital board is shown in Fig. 7. Figure 8 is the parts-placement diagram for the digital board. It is strongly recommended that sockets be used for all IC's. That allows easy troubleshooting should it ever be-

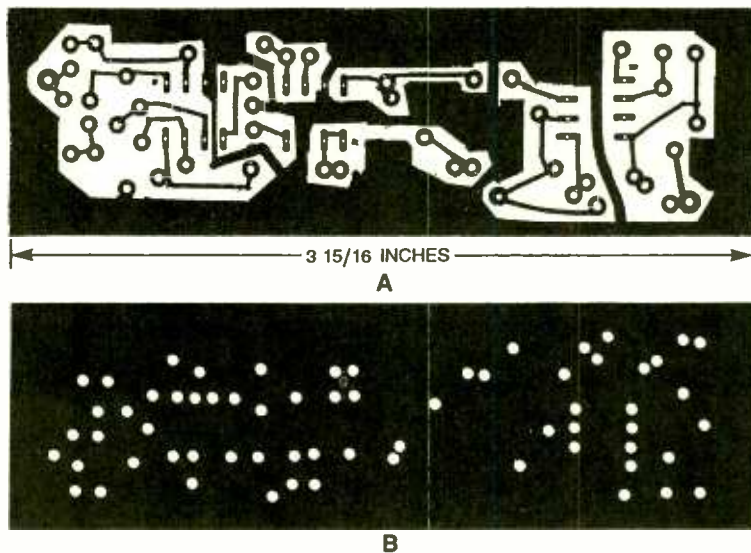

Fig. 5. The RF section of the receiver, like the transmitter, was assembled on a double-sided printed-circuit board, with traces on one side of the board (A) and a ground plane on the other (B).

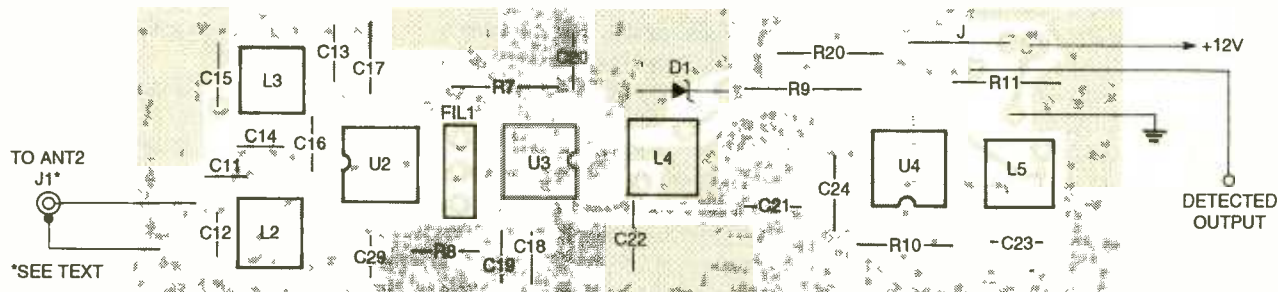

Fig. 6. Here is the parts-placement diagram for the receiver's RF board. Note that the RF board has one jumper wire, and that FIL1 is a 3-terminal bilateral device that can be placed into the circuit board in any direction.

PARTS LIST FOR THE RECEIVER

SEMICONDUCTORS

U2—NE602AN double-balanced mixer, integrated circuit
 U3—MC1350P IF amplifier, integrated circuit
 U4—MC1330P IF amplifier/detector, integrated circuit
 U5—LM358N dual op-amp, integrated circuit
 U6—MC145027 programmable decoder, integrated circuit
 Q4, Q5—BS170 TMOS FET
 D1—1N4740A 10-volt, 1-watt Zener diode
 D2, D3—1N4004 1-amp, 400-PIV silicon rectifier diode

RESISTORS

(All fixed resistors are 1/4-watt, 5% carbon units, unless otherwise noted.)

R7, R9—220-ohm
 R8, R10, R11, R20—4700-ohm
 R12, R16, R18—10,000-ohm
 R13—330,000-ohm
 R14—42,100-ohm, 1/4-watt, 1%, metal-film
 R15—221,000-ohm, 1/4-watt, 1%, metal-film
 R17, R19—47,000-ohm

CAPACITORS

C11—47-pF, NPO ceramic-disc or mica
 C12—220-pF NPO ceramic-disc or mica
 C13, C18—C20—0.01- μ F, ceramic-disc
 C14, C21—0.001- μ F, ceramic-disc
 C15—C17—39-pF, NPO ceramic-disc or mica
 C22, C23—560-pF NPO ceramic-

disc or mica
 C24, C28—0.1- μ F, ceramic-disc
 C25—0.47- μ F, mylar
 C26—100- μ F, 50-WVDC, radial-lead electrolytic
 C27—0.022- μ F, mylar

ADDITIONAL PARTS AND

MATERIALS

ANT2—Antenna (see text)
 FIL1—10-MHz, IF filter (Toko, Digi-Key TK2306)
 J1—RCA phono or radio antenna jack
 K1, K2—12-volt DPDT relay, PB type K10 (see text)
 L2, L3—0.26- μ H inductor (Toko, Digi-Key TK3001)
 L4, L5—0.422- μ H inductor (Toko, Digi-Key TK3006)
 PL1—RCA phono or radio-antenna plug
 Printed-circuit materials, enclosure, AC molded power plug with line cord, battery(s), battery holder and connector, wire, solder, hardware, etc.

Note: The following items are available from A. Caristi, 69 White Pond Road, Waldwick, NJ 07463: A set of three printed-circuit boards for \$29.95; U1—U6 for 6.75 each (specify part numbers); Q1—Q6 for \$3.75 each (specify part numbers); 49.86-MHz, third-overtone crystal (XTAL1) for \$6.00; set of alignment tools for \$6.00. Add \$5.00 postage and handling to all orders. New Jersey residents, please add appropriate sales tax.

come necessary. Pay strict attention to the orientation of the IC's as well as all other polarized components. The relays can be any 12-volt DC units that meet your application requirements. The author used two 10-amp double-throw relays (see the Parts List) in his prototype. The relays were cemented in place using a small amount of silicone RTV as an adhesive, and connected to the appropriate circuit-board pads through hook-up wire. Note: If single-channel operation is selected, Q5, K2, and all related components can be omitted, and resistor R16 connected between U6 pin 11 (instead of pin 15) and the gate of Q4.

Once both of the receiver boards are completed, examine them very carefully for solder bridges, especially between closely spaced copper

traces. Check the solder joints; each should be shiny and smooth. Any rough or dull blobs of solder indicate cold solder joints and must be corrected before proceeding. Just one bad connection will prevent the receiver from operating.

Receiver Enclosure. The receiver's two boards must be housed in a metal enclosure. Plastic enclosures are not recommended since they offer no shielding from interference. Mount the two boards next to each other, using suitable hardware and spacers. Be sure to locate the antenna input (at the junction of C11 and C12) on the RF board close to one edge of the enclosure so that only a short length of wire is needed between the RF board and the antenna jack.

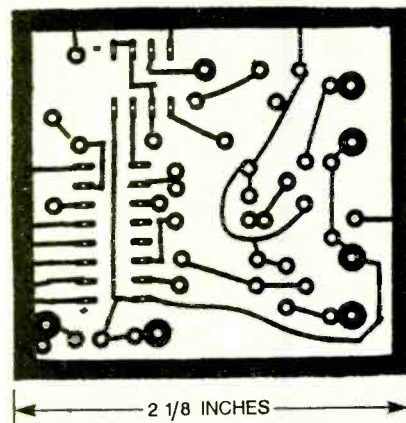

Fig. 7. The digital portion of the receiver was assembled on a single-sided, printed-circuit board, a full-size template of which is shown here.

The interconnections between the two boards require only three wires; +12 volts, ground, and the connection between U4 pin 3 and U5 pin 3. Use stranded hookup wire for the connections (solid wire tends to break). An RCA phono jack or antenna connector is used for J1, which should be mounted to the side of the enclosure.

It's a good idea to connect a 6 position (or more) terminal strip to the side of the enclosure in order to allow easy wiring of 12-volt, ground, and relay-contact connections to the desired vehicular circuits. Make no connections between the receiver and the vehicle circuits at this time.

Transmitter Tests and Adjustments. The transmitter should be checked first, since it will be used for receiver alignment. If available, use a triggered oscilloscope with at least a 50-MHz range for the transmitter and receiver adjustments, and to verify proper operation. The only adjustments required for the transmitter are the tuning slugs in T1, T2, and L1. That should be done with the proper adjustment tool; the slugs are brittle and can be easily damaged if the wrong sized tool is used.

The easiest way to adjust the transmitter is to build an RF pickup loop, consisting of 4 or 5 turns of wire, as shown in Fig. 9. The loop is connected to the scope probe as shown and used to drive the vertical input of the scope. With the scope adjusted to display the RF pulses, the tuning slugs are adjusted for maximum amplitude.

Install a fresh 9-volt battery in the transmitter. Stretch out the antenna

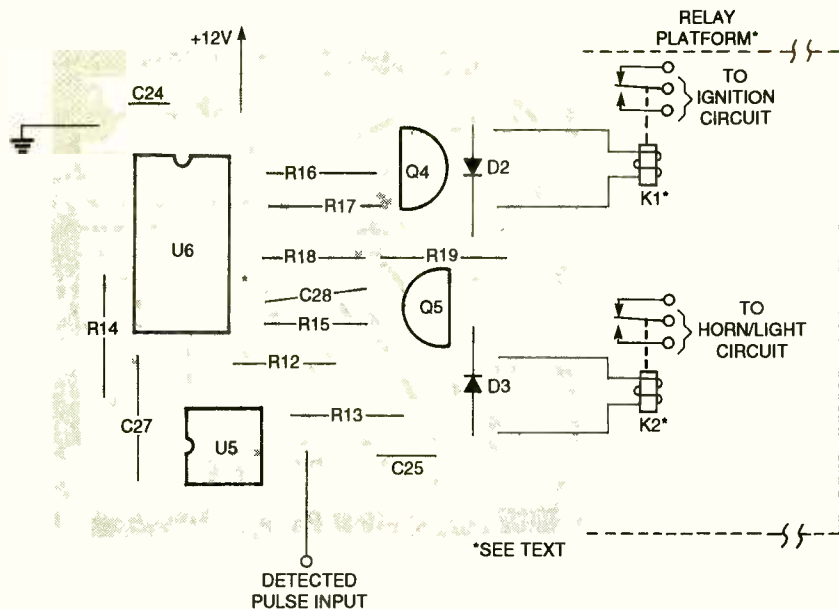

Fig. 8. When assembling the digital board (guided by this parts-placement diagram), it is strongly recommended that sockets be used for all IC's.

wire and place the pickup loop close to the antenna. Turn transmitter on by pressing and holding S1. The position of S2 and S3 is not important at this time. Set the scope for a sweep of 1 ms/cm and maximum vertical gain. Adjust T1 until RF pulses appear in the display, and then tweak T1 for maximum peak-to-peak pulse amplitude.

Adjust the slugs in T2 and L1 for the maximum possible vertical amplitude of the displayed pulses—a display of 20 mV peak-to-peak or greater, depending upon the coupling between the antenna and pickup loop, is to be expected. Readjust T1, T2, and L1 for maximum pulse amplitude. It is best to use as little coupling as possible between the antenna and pickup loop.

If there is no evidence of RF, Q1 may not be oscillating. It is important to note that the circuit will not oscillate if the parallel resonant tuned circuit (composed of T1's primary and C3) is not set close to the operating frequency, 49.86 MHz, of the crystal. Be sure that the value of C3 is correct as specified in the Parts List.

If the tuned circuit is okay, measure the battery voltage under load to be sure that it is delivering at least 8 volts to the circuit. Check the current draw of the circuit; it should be about 7 mA. Check the orientation of Q1, Q2, and Q3 carefully, and be sure that each of those transistors are properly oriented in their respective locations.

Check all other components of the

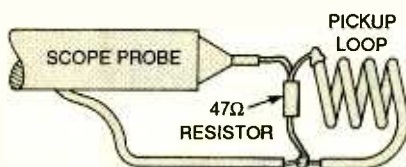

Fig. 9. To adjust the transmitter, the author assembled an RF pickup loop, consisting of 4 or 5 turns of wire, and connected the loop to the scope probe in order to feed the transmitted signal to the scope's vertical input.

transmitter for value and location. Ascertain whether all grounded leads are properly soldered to the ground plane, and that no other leads are shorted to ground. If possible, try another crystal and Q1.

If the scope shows some RF but no pulses are present, U1 may not be operating. Check pin 15 of U1 with the scope to confirm the presence of the encoded pulse train, which consists of positive pulses of about 8 or 9 volts in amplitude. If absent, check the orientation of U1 and Q3. Check all wiring and components associated with U1. If all else fails, try another chip.

Receiver Checkout. Checking and aligning the receiver requires that the transmitter be used as a signal source. Be sure that the transmitter is fully operational and is powered from a fresh battery before attempting any receiver adjustments. Since the transmitter should be operated at some distance from the receiver to avoid

overload, you might wish to have an assistant operate its control switches as the receiver circuit is aligned.

The receiver can be powered from a well-filtered, line-operated, DC power supply of between 12 and 15 volts. An appropriate DC wall transformer, filtered by an external 1000- μ F, 25-WVDC electrolytic capacitor can be used as the power source. The receiver normally draws about 26 mA with no relays energized.

Because the receiver is very sensitive, it can easily be overloaded by strong transmitter signals. For that reason, it is important to keep the signal to a level that will not overload the receiver during the alignment process. The received signal strength is easily controlled by either of two methods; keep the transmitter a sufficient distance from the receiver so as not to cause overloading, or by shortening the transmitter antenna by coiling it and using a short length of wire (about 6 or 12 inches) for the receiver antenna.

As with the transmitter, a triggered oscilloscope should be used for receiver alignment. A digital voltmeter will come in handy to troubleshoot the circuit, should that become necessary.

Apply power to both the receiver and the transmitter, and then check pin 7 of U2 for the local-oscillator signal, which should be 39 MHz with an amplitude of about 0.2-volts peak-to-peak. Examine the RF signal at pin 8 of U3, which should be a 10.7-MHz RF pulse train with an amplitude of about 80-mV peak-to-peak, depending on the strength of the received signal. Very carefully adjust L2-L4 for maximum signal amplitude, using the proper alignment tools. If necessary, separate the transmitter from the receiver as far as possible to simulate a weak signal, consistent with a solid pulse display at U3 pin 8. That permits the most accurate adjustment.

Next, examine the output of U4 at pin 4 for negative-going pulses riding on a DC level of about 5.5 volts, which is a reproduction of the pulse-train output of the transmitter encoder. Adjust L5 for maximum pulse amplitude. As before, it may be necessary to separate the transmitter and receiver further than before to simulate a weak signal in order to perform the adjustment.

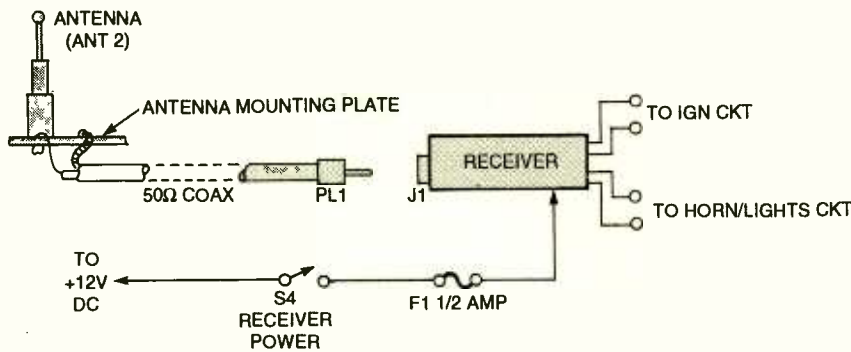

Fig. 10. The ideal location to stash the receiver is in the trunk of the vehicle, where it can be powered by the vehicle battery through a 1/2-amp fuse. A separate switch (which we'll call S4) can be added to allow the circuit to be switched off when not needed.

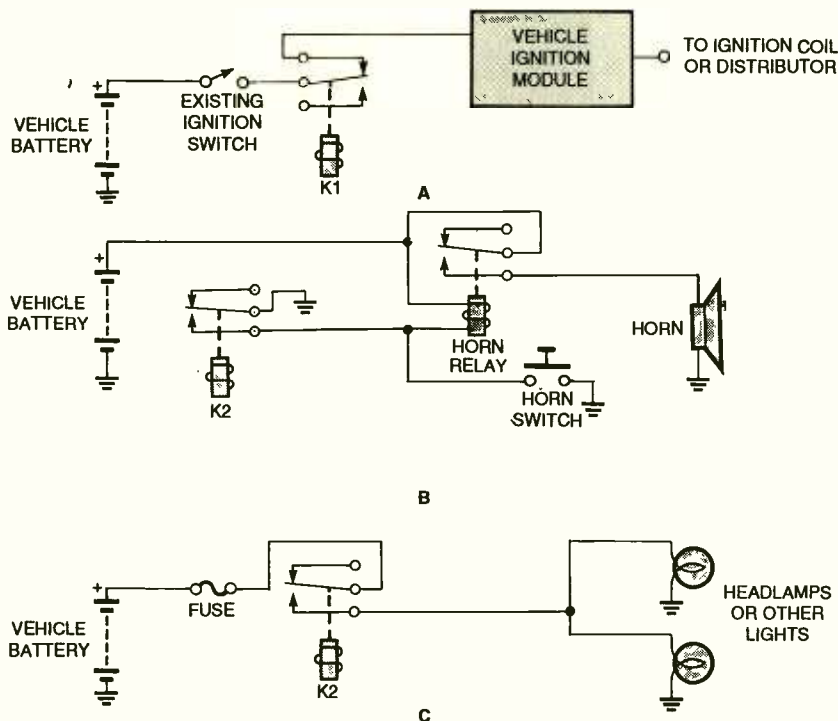

Fig. 11. Here are three typical circuit applications that the car security system can be used in. The sketch in A illustrates how the circuit can be used to disable the vehicle; B shows how to hook-up the circuit to sound the horn (a welcome feature in emergency situations); and C shows how the circuit might be used to flash the vehicle's headlamps (perhaps, to frighten a car thief or to help locate your car in a large crowded parking lot).

Check pin 9 of U6 for a positive-going pulse train with an amplitude of about 12 volts. Check pin 11 of U6 for a logic-1 condition, indicating that the decoder is responding to the encoded pulse train. The operation of K1 and K2 can be checked by using S2 and S3 in the transmitter to set the logic output levels of U6 at pins 15 and 14. When S2 and S3 are set to the NORMAL and OFF positions, respectively, the logic level at pins 15 and 14 should remain at zero and the relays should be dormant. Placing S2 and S3 in the DISABLE and ON positions should pro-

duce a logic-1 condition at pins 15 and 14 of U6 and, in turn, activate the relays.

With transmitter power on, S2 and S3 can be alternately set to each position, which will operate and release the relays. If the receiver performs as described, the only remaining adjustment to be performed is on L2, which should be checked when the receiver is connected to its vehicular antenna. That can be done later, when the range of the system is checked.

If the receiver does not operate properly, the section at fault will be

evident after performing the above checkout procedure by noting where the proper flow of RF and pulse signals stops. Very carefully examine any part of the receiver circuit that does not respond to the transmitter signal for proper IC orientation and component placement. Be sure all grounded component leads are soldered to the ground plane, and that all others are isolated from it. Refer to the schematic diagram and use a digital voltmeter or scope to measure V_{dd} and other voltages at each chip terminal. If all appears normal, try a new chip in the defective section.

Final Receiver Adjustment. Before installing the receiver in a vehicle, you might want to make a final adjustment to L2 (in the receiver's antenna-tuning circuit), using the actual antenna that is mounted to the vehicle. That will allow you to make sure that you have the greatest possible range for the remote control system.

Apply 12-volt DC power to the receiver. Have an assistant operate the transmitter as he or she walks away from the vehicle. By monitoring pin 11 of U6 with a DVM, you'll be able to determine the effective operating range of the system. A logic 1 (+12 volts DC) at pin 11 indicates that the receiver is responding to the transmitted signal. When the voltage goes to zero, the transmitter is out of range.

Inductor L2 can then be adjusted very slightly to bring in the signal. Repeat the procedure until maximum operating range is achieved. The author's prototype has an operating range in excess of 400 feet. Note: The transmitter must be located at least 50 feet away to avoid receiver overload.

Installation. The ideal location for receiver installation is in the trunk of the vehicle. Refer to Fig. 10. The receiver should be powered by the vehicle battery through a 1/2-amp fuse and a separate switch (which we'll call S4). The fuse will protect the circuit, while the switch will allow the receiver to be disabled. The receiver draws only about 26 mA, so it can be left on for extended periods without depleting the battery.

Figure 11 illustrates three typical circuits that may be used to disable the

(Continued on page 94)

GROUND ZERO:

The Other End of the Radio Spectrum

Join us for a guided tour through the relatively unknown, low-tech, low-frequency end of the electromagnetic spectrum.

Karl T. Thurber, Jr.

Must higher always be better? While today's technological imperatives appear to dictate the increased exploration and use of ever-higher operating frequencies, there continues to be considerable interest in the low end of the electromagnetic spectrum.

This article explores the end of the frequency spectrum that lies well below the standard AM broadcast band. We'll survey the spectrum and cover longwave (LW) radio pioneering, LW-band inhabitants and users, the 1750-meter experimenters' band, LW propagation characteristics, receiving equipment, and antennas.

Longwave Characteristics. Let's see just where LW frequencies fit into the electromagnetic spectrum as a whole. The total usable spectrum generally is considered to extend from a few hertz (Hz) to approximately 300 gigahertz (GHz). This truly immense range of frequencies is broken up into smaller groupings that are easier to understand and deal with conceptually.

The lowest range is the group of frequencies known as the ultra low frequencies (ULF), from zero to 3 Hz. Just above ULF lie the extremely low frequencies (ELF); they cover 3 Hz to 3 kHz. Above that, from 3 to 30 kHz, are the very low frequencies (VLF). Next come the low frequencies (LF), from 30 to 300 kHz, the "top end" of what

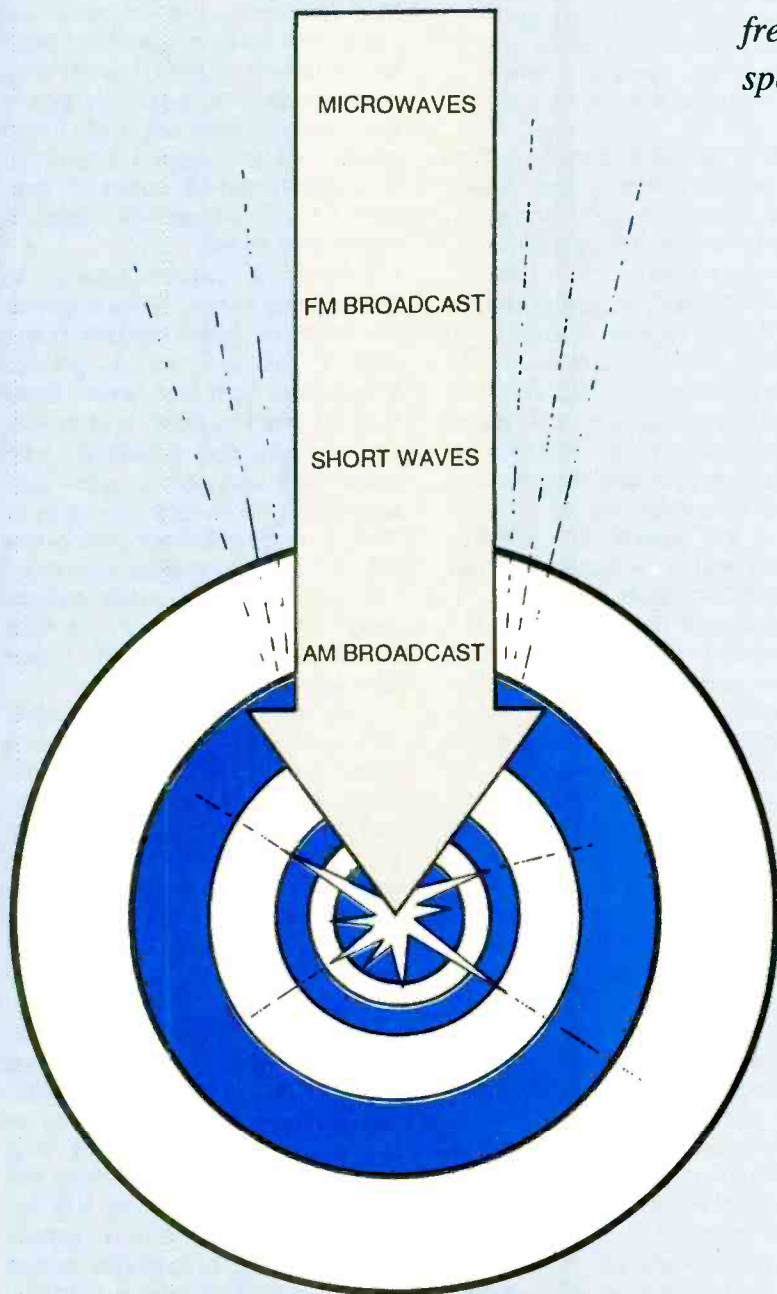

are generally considered the long-waves (although some consider anything below the broadcast band to be LW).

How do signals propagate at the low frequencies? There's no blanket answer to this question because much depends on just how low the frequencies are. At the high end of the LW region, propagation isn't too much different from that of the AM broadcast band. Daytime propagation is limited to groundwave (100 miles or so), but nighttime can extend coverage to several thousand miles.

There are several reasons why LW signals propagate as they do. The ionosphere, the highly charged region of the earth's atmosphere that extends from 30 to 250 miles above the surface, acts like a duct for LW signals. Although medium- and high-frequency signals tend to be absorbed by the lower layers of the ionosphere and by the earth, LW signals are absorbed much less.

The reflectivity of the ionosphere with respect to LW tends to remain fairly constant, making long-distance communications on LW more stable than those on higher frequencies on an hourly, daily, and seasonal basis. This is one reason why LW broadcasting is so popular in many parts of the world: stations operating on LW can be heard coming through remarkably "loud and clear" day or night, every day of the year.

For a given transmitter power, groundwave range is much greater on the longer wavelengths. At the lowest frequencies, range can be global in scope. To benefit from LW DX possibilities, however, transmitter power must be high and antennas large. At the lowest frequencies, very long antennas may be run between mountains or even buried in the earth.

During the daytime, LW propagation is almost exclusively by ground waves traveling close to the surface of the earth. Over land paths, maximum distances are reduced by absorption caused by ohmic resistance of the ground. This is much less of a problem, however, than it is at the higher frequencies.

As the frequency decreases, say to 100 kHz or less, signals propagate in duct-like or waveguide fashion. The groundwave travels over greatly extended distances because it hugs the

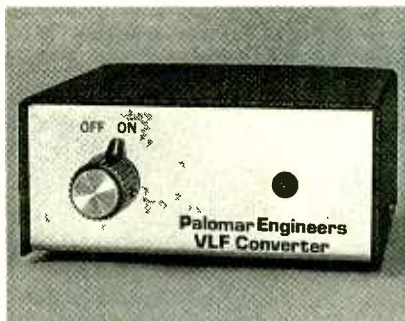

The Palomar Engineers VLF Converter lets you enter the world of VLF radio for about \$80; all you need is a communications receiver and an antenna. Covering the range 10 to 500 kHz, the Model VLF-A converts VLF signals to the 80-meter amateur band, while the Model VLF-S converts the signals to 4010–4500 kHz for use with general-coverage shortwave receivers. (Photo courtesy of Palomar Engineers.)

earth and follows its curvature. The lowest frequencies can easily travel halfway around the world, and even penetrate a short distance beneath the ocean's surface.

There is some skywave propagation on LW. As frequencies increase and approach the medium-wave frequencies (around 300 kHz), skywave propagation becomes more common, especially at night. As evidence of that, signals fade at great distances from the transmitter site.

During the daytime, the low frequencies tend to be slightly reflected from the D or lowest layer of the ionosphere. At night, the D and E layers mostly disappear, so absorption of radio signals decreases. Signals can then be reflected back to earth from the highest ionospheric F layers as skywave or skip signals. Because of phase differences, the skywave tends to destructively interfere with the groundwave if both are incident upon the receiving antenna. That causes "jitter" in reception. At the lower LW frequencies, skywave propagation and the attendant phasing effect become less and less pronounced. Those characteristics make for generally superb, rock-steady signal reception uncommon in medium-wave and HF communications.

There is an important limiting factor in LW communications: atmospheric noise or QRN. High noise levels plague LW, with the tropical regions—where thunderstorm static can be horrendous—being the worst. Man-made

noise, especially from household and industrial appliances and household light dimmers, also affects LW more than the higher frequencies. About the only receiving-end remedy to the noise problem (other than carefully locating antennas away from power lines and buildings) is to use a directive, noise-canceling antenna such as a loop (more on that later).

Radio Pioneering on the Long-waves. Much of the pioneering work in radio communications was performed on LW. In fact, for a long time, the popular view was that the higher frequencies, at least the "shortwaves" lying well above the AM broadcast band, were essentially useless. The intensive use of LW during radio's infancy can largely be explained by the technology of the times. It was much easier to generate substantial amounts of radio-frequency (RF) radiation at such wavelengths than at higher frequencies.

Long-wave frequencies were in vogue until the early 1920's, when radio amateurs went to higher frequencies to escape the murderous interference from high-power, commercial, point-to-point, and broadcast stations, and especially from stations still using broad spark-gap transmitters. Those radio amateurs, or "hams," made an amazing discovery: the higher the operating frequency, the greater the communications range. When the word got out, most hams joined the exodus to the higher frequencies.

Long-wave use went into a decline that only began to reverse after World War II. Long wave's recent renaissance is due in large part to important propagation characteristics that actually make it superior to higher frequencies for some applications such as radiolocation, military and emergency communications, and very precise timekeeping, frequency measurement, and dissemination.

Today, the LW part of the spectrum offers current reports on weather and flying conditions, Morse-code practice, DX reception, and more. The region is populated by signals from time and standard-frequency stations, foreign broadcasters, military installations, unlicensed (but legal) experimenters, weather and navigation beacons, radioteletype stations,

radiolocation systems, and a host of strange and unusual "signals." Let's look at all these in detail.

Beacons and Weather Stations.

Some of the most common LW stations are navigational aids, or radio beacons, found between 190 and 410 kHz and 510–535 kHz. Some are aeronautical beacons, others are marine. Both use very slow, amplitude-modulated (AM) Morse code, and identify continuously, making them easy to ID. Both are a source of DX, especially at night, although most are low powered with a daytime range of around 200 miles.

The marine beacons usually transmit their call signs continuously in an omnidirectional pattern. Sometimes, the call sign, usually consisting of from two to four letters or numerals, is separated by several dashes. Marine-navigation beacons are in for changes—the Coast Guard is decommissioning and reorganizing them. Many now transmit coded Digital Global Positioning System (DGPS) information that allows the user to remove the "dithering" error encoded in GPS satellite signals. Within the beacon's range, it allows full-accuracy resolution from GPS.

Years ago, the mainstay of aeronavigation was the LW radio range system. Small, low-power transmitters located at or near airports formed a network of electronic-range patterns enabling aircraft to home in on them. Although not being decommissioned, these stations now are largely superseded by elements of the more sophisticated VHF Omnicrange (VOR) and Tactical Aid to Navigation (TACAN) aeronavigation systems that operate on VHF and UHF.

Aeronautical beacons are still important aircraft direction-finding aids in remote areas of the United States and Canada, and in other parts of the world. The stations transmit a combination "A-N" signal in a four-leaf pattern, identifying themselves every 30 seconds. They use two pair of antennas to obtain the desired four-leaf radiation pattern.

You should be able to hear at least one or two beacons almost anywhere in the United States or southern Canada. But note that these stations use "identifiers" rather than regular call letters to tie in the ID with station loca-



Palomar Engineers offers an all-purpose amplified loop-antenna system that lets you DX the LW bands from your kitchen table. The LA-1 Loop Amplifier (\$99.95) can be used with any of six plug-in loops, each costing \$89.95. (Photo courtesy of Palomar Engineers.)

tion. Most operate with low power, making for interesting and challenging DX catches.

A good way to update your knowledge of beacon stations is with Ken Stryker's *Aero/Marine Beacon Guide*, available through the Longwave Club of America (see the boxed text entitled "Names and Numbers" for their address). His timely guide mainly deals with radio beacons, but does list the Groundwave Emergency Network (GWEN)—which we'll cover shortly—and other beacon-like stations.

Time and Frequency Standards.

Over the past few years, LW has become a popular source of channels for accurate time-and-frequency standard stations. About a half-dozen such stations around the world now broadcast highly accurate marker signals 24 hours a day, mostly on frequencies below 100 kHz.

Why are such low frequencies used for time-and-frequency standard stations, including those operated by the government's National Institute of

Standards and Technology (NIST)? The frequencies are favored because of the improvement in received-signal accuracy that's possible. At low frequencies, reception doesn't suffer the slight time delays and unpredictable atmospheric variations that distort regular reception of the popular Colorado "time ticker" WWV and its Hawaiian counterpart, WWVH.

While most users aren't concerned with those problems, such potential reception errors make some laboratory applications impossible when the labs are located far from the transmitter sites. Both LF and VLF waves travel almost completely by groundwave, making reception rock-steady, almost totally eliminating such problems.

For those reasons, many of the standards-setting agencies that provide such services have set up LW stations. One of the first broadcast-time services, provided by British station GBR, was instituted in 1926 and was reportedly the world's most powerful radio station. Its 16-kHz signal was, and is, widely received in the United States.

Today, with the proper receiving and decoding equipment, you can obtain accurate time and frequency information from NIST station WWVB, located in Ft. Collins, CO. WWVB transmits on 60 kHz and can be heard in almost all parts of the country.

Radio Location. The stability and range capability of LW propagation has made it very useful for radio-location services such as LORAN and OMEGA. These signals are mostly found in the range of 10 to 14 kHz and around 100 kHz. None of the transmitters associated with those systems broadcasts a recognizable identification, but you can hardly miss their distinctive signals.

LORAN-C is an advanced version of LORAN-A, an obsolete service that once shared the 160-meter band with radio amateurs. The LORAN-C system is used by ships and planes to accurately determine their position anywhere in the coverage area—18-million square miles! LORAN-C can tell you where you are, with 1/4-mile accuracy, and let you return to within 50 to 300 feet of the same spot. It operates continuously, regardless of weather, and it's accurate, dependable, and cost-effective. LORAN-C is heavily used by charter boaters, merchant mariners, and commercial fishermen.

LORAN-C transmitters operate in chains, sending out pulsed 100-kHz signals. A special receiver measures the slight difference in time between the arrival of signals from a pair of transmitters spaced hundreds of miles apart. This time difference, in microseconds, is read off a display in the receiver and correlated with a curved "line of position" (LOP) on a LORAN-C chart. The receiver is then tuned to a different pair of transmitters and a second time difference is determined. That is correlated with a second curved LOP and the intersection of the two LOP's is your location.

Those who merely want to tune in a LORAN-C transmitter and hear what one sounds like can use any standard communications receiver that tunes to 100 kHz. LORAN-C transmitters operate on that frequency and can be readily identified by their characteristic pulsating sound.

On even longer wavelengths is the OMEGA navigation system, which be-

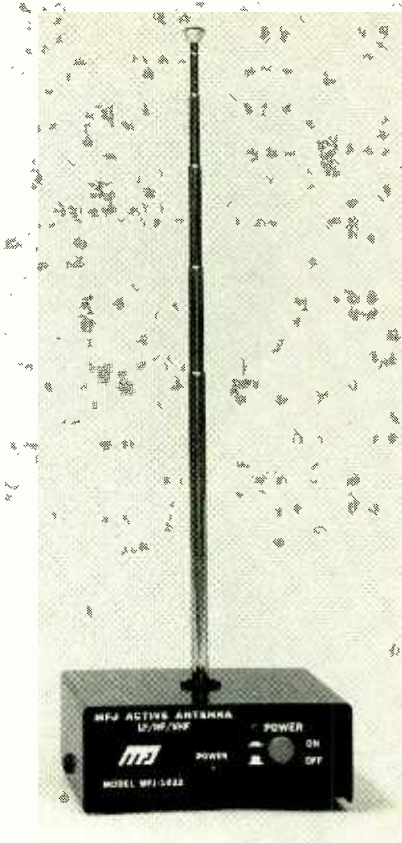

The MFJ-1022 is a popular active antenna that has good gain, low noise, and broad frequency coverage to include much of the LW spectrum. The unit covers 50 kHz to 30 MHz and has both a gain control and a 20-dB attenuator. The control unit operates from 12 VDC, and the remote unit has a 54-inch whip and comes with 50 ft. of coaxial cable. It's \$129.95. (Photo courtesy of MFJ Enterprises.)

gan operation in the late 1960's. It works somewhat like LORAN, but operates between 10 and 14 kHz. That region is more stable from a propagation standpoint than the somewhat higher frequencies used by LORAN-C. The longer wavelengths OMEGA uses are, to some extent, able to penetrate water, making it possible for submerged submarines to determine their positions. OMEGA's range is more than 8000 miles, and so is greater than that of LORAN-C. A network of only eight stations covers the entire world.

You can hardly miss the strange-sounding OMEGA signals, which are still beeping away on 10–14 kHz. However, there is a possibility of some stations shutting down in coming years now that Global Positioning System (GPS) satellites are active.

LW Broadcasters. The 150–285-kHz band is still a popular AM broadcast band in Europe, Africa, and some parts of Asia. In those regions, broadcasters typically use super-high-power transmitters and very large antennas to make transmitted signals as strong as possible. As a result, station range is usually much greater than that on the medium-wave AM-broadcast band.

There are few LW broadcast enthusiasts in this country, although many Americans were exposed to LW broadcasting during service in World War II and the postwar occupation. While they were overseas, they discovered the many good musical programs that Europeans could tune in on LW over long distances.

Also, most shortwave-listener (SWL) clubs don't pay attention to LW DX'ing. That is primarily because few popular receivers cover LW, and it's also tough to pull the broadcasters through the heavy interference from the many beacon stations found in the Western Hemisphere.

Military Uses. Since longwave signals follow the curvature of the earth over vast distances, they are well-suited for the ultra-reliable, worldwide communications that the military requires. The Navy is particularly interested in LW because it offers reliable communications with submerged submarines, something not possible on higher frequencies. Tuning around LW, you'll hear naval call signs on both CW and radioteletype (RTTY). Thus, the Navy operates very-high-power stations in far-flung locations, notably in Washington and Maine. Those stations enable the Navy to maintain dependable, worldwide communications almost unaffected by propagation conditions and solar activity.

Two of the most interesting military LW inhabitants are GWEN and Project ELF. The Ground Wave Emergency Network (GWEN) is a wide-ranging system of LF-radio towers and sites that constitute an emergency network to provide communications in the event of a nuclear attack. The system is intended to overcome nuclear-caused electromagnetic pulse (EMP) effects, relaying teletype messages and linking strategic alerting sensors such as long-range warning radars. GWEN is designed to make sure that

nuclear blasts don't prevent attack warning messages from reaching the President or obstruct his ability to retaliate.

The typical GWEN antenna site is on an 11-acre plot and contains the tower, fences, and three shelters that hold an antenna tuner, radio/data processor, and emergency power supply. About a foot below ground is a large "wheel" of copper wire radiating from the base of the antenna. The 2- to 3-kW stations operate on frequencies between 150 and 175 kHz. The signals are short bursts of digital information that many listeners describe as "ear-shattering."

Operating at much lower frequencies than GWEN, Project ELF is a gigantic ELF system for reliably communicating with (or at least transmitting to) submerged submarines at depths of up to 400 feet. The system reportedly transmits on a bottom-hugging 76 Hz, and uses antennas more than 50 miles long. Few details are available about the system and its exact purposes due to its highly classified nature. In any case, Project ELF is strongly protested by environmentalists and others opposed to building the system at two huge sites in Michigan's Upper Peninsula and in Wisconsin.

There are many other stations found on LW, including Morse and RTTY stations operated by news services. As we'll see, too, there's also a sort of "wannabe" ham band down there, the so-called 1750-meter experimenters' band. There are also a number of what we will refer to as "strange longwave bedfellows" that can be heard as well. Let's look at some of those other LW spectrum inhabitants.

The 1750-Meter Experimenters' Band. Since 1950, a small but enthusiastic group of experimenters has been communicating on an almost totally unknown, license-free band. That so-called "1750-meter band," occupies 1874 to 1578 meters (160 to 190 kHz). Actually it isn't a ham band at all. Rather, this 30-kHz LW chunk was allocated by the Federal Communications Commission (FCC) in 1950 for limited-radiation device use. No operator or station license is required.

The FCC rules governing this type of operation set forth some tough re-

quirements. First, the power input to the final amplifier must not exceed one watt. Second, all emissions below 160 kHz or above 190 kHz (in other words, outside the 1750-meter band) must be suppressed by at least 20 dB. Third, the length of the antenna, transmission line, and ground lead combined can't exceed 50 feet (15.2 meters). These FCC restrictions make operating challenging. Fortunately, there are no stipulations as to the type of emission that can be used; SSB, AM, FM, RTTY, or CW are all acceptable. The same goes for receiving antennas, on which there are absolutely no restrictions as to size and type.

Low-frequency experimental radio stations (or LowFERS) have a great time trying to work other stations operating under the same severe power and antenna restrictions. While signals from aeronautical beacons, which may run several-hundred watts, have been received as far away as 1000 miles or so, amateur DX contacts on 1750 meters of 150 miles are unusual.

GWEN's presence has forced most activity above 175 kHz, and most 1750-meter action has been centered near 189.5 kHz. Most work to date has been on CW, though advanced digital modes using slow phase-shift keying and coherent methods are being tried.

Because the FCC frowns on the use

of ham calls on nonamateur frequencies, many use either their initials, or old-style telegraphers' "sines." Some use their nicknames as ID's. A number of 1750-meter enthusiasts also operate their own home-style LW-beacon stations within the 160-190-kHz band—there's a partial list of these home-brew beacon stations in an article by Steve Ford, WB8IMY, which appeared in October 1993 issue of *QST*.

Working on 1750 can be a refreshing change, but be prepared to do some experimenting. To learn if there are any 1750-meter beacons active in your area, listen on 160 to 190 kHz, especially at night and on the weekends around 189.5 kHz (see the sidebar entitled "Low And Medium Frequency Scrapbook").

Despite all the problems associated with operation on 1750 meters, if you listen in on LW long enough, you're likely to want to communicate on the low frequencies. For the experimentally inclined, working on 1750 is much like communicating in the early days of "spark." Too, with the increasing interest on the 1750-meter band, the American Radio Relay League (ARRL), which represents amateur radio interests, has approached the government regarding a shared amateur radio band in the 190-kHz region. Reportedly, the proposal has been favorably received by the FCC and

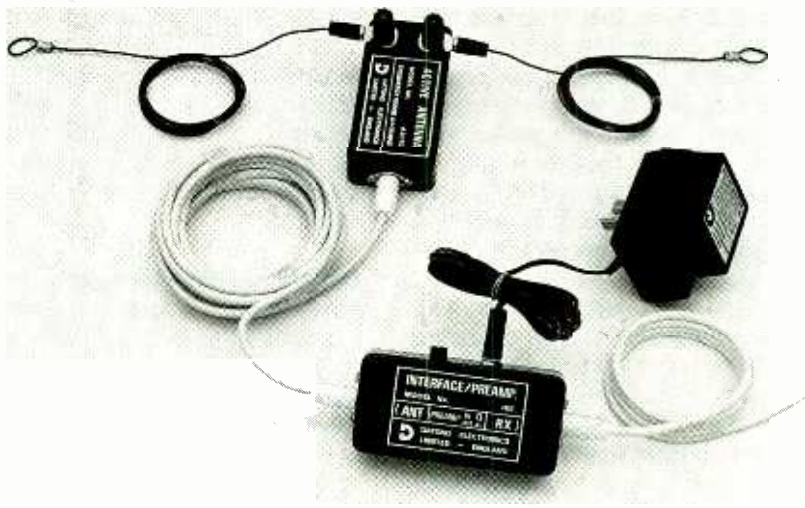

The British AD-170 Datong compact, indoor-antenna system sports wideband coverage from 60 kHz to 70 MHz, making it suitable for LW use. The antenna system is compact, requiring only a 3-meter horizontal space. A newer but similar model, the AD-270, is available from Gilfer Shortwave. (Photo courtesy of Datong Electronics, Ltd.)

other government agencies who must approve it.

Strange Longwave Bedfellows.

Parts of the Extremely Low Frequency (ELF) and Very Low Frequency (VLF) spectra—especially from about 0.05 to 11 kHz—are replete with various “natural radio emissions.” Most of them are created by the interaction of thunderstorms with the earth’s ionosphere and magnetic field. You can’t get away from those “emissions”: there are nearly 2000 such storms in progress worldwide at any given time, and each day more than 1-million lightning strokes are generated.

There’s little commercial or government activity in this oh-so-low outpost of the electromagnetic spectrum. However, in this lonely area, you may hear all sorts of naturally occurring emissions, notably “whistlers,” one of radio’s oldest mysteries.

Some have described whistlers as “sounds” descending in pitch, like falling musical notes. Related naturally occurring emissions include the so-called “dawn chorus” that resembles birds chirping or frogs croaking. Other aurally close relatives include strange sounds known as “risers” and “hooks,” plus other hissing, rushing, and blowing sounds. There’s also the familiar crackling and popping sounds from electrical storms.

As we suggested, these sounds have their origins in ionizing electrical emissions in and from the earth’s magnetosphere. They emanate from lightning discharges and the electromagnetic pulses (EMP) they create. Reportedly, the lightning discharges disturb the earth’s magnetic field, which results in the generation of electromagnetic signals. Many such sounds can be heard on LW receivers and sometimes even on long, high-gain audio lines.

This unusual energy can be electrically ducted and even amplified within the earth’s magnetosphere, travelling from one hemisphere and polar area to the other; researchers call this phenomenon dispersion. The phenomenon helps to explain whistlers, since the higher frequencies tend to arrive progressively before the lower frequencies as the emission travels within a duct. The result is the downward-sweeping whistlers heard on sensitive equipment. Whistlers are

Low- and Medium-Frequency Scrapbook

Those hobbyists who focus on the so-called FCC Part 15 bands (160 to 190 kHz and 510 to 1705 kHz) are frequently known as **LOWFERS** (short for Low Frequency Experimental Radio Station) or **MedFERS** (those who experiment on the medium-frequency bands), respectively. These terms reportedly were coined years ago by LW experimenter Ken Cornell, W2IMB, who has for many years operated the LW beacon station “KEN” on 187.5 kHz.

Cornell has published the *Low and Medium Frequency Scrapbook* for years. Presently it’s a 107-page compendium of information on these interesting bands, dedicated to the radio experimenter. The scrapbook provides basic low frequency information and equipment designs for both reception and transmission. The book has a very useful introduction for would-be beacon operators, an introduction to the 1750-meter band, and several resource lists.

The latest (8th) edition is the 20th-anniversary Scrapbook, available for \$17.50 postpaid book rate or \$18.75 via first class mail. Checks should be payable to Ken Cornell, 225 Baltimore Ave., Point Pleasant Beach, NJ 08742; Tel. 908-899-1664.

heard a few seconds after the lightning stroke’s familiar “pop.”

If you’re intrigued by this specialized phenomenon, The **LOWDOWN**, the Longwave Club of America (LWCA’s) newsletter (see the sidebar entitled “The Longwave Club of America”) features a monthly column of natural radio news. The columnist, Michael Mideke, offers his *Whistler Hunter’s Guide* for \$6; a companion audiotape, *Introduction to Natural Radio*, is \$10.

Solar-Flare Monitoring. The use of the ELF, VLF, and LF regions for monitoring solar flares and their effects on radio propagation is an interesting field, one that’s wide open for experimentation. By monitoring such LW frequencies, it’s possible to observe such specialized solar-related phenomena as Sudden Ionospheric Disturbances (or SID’s), Sudden Enhancement of Signals (SES’s), and Sudden Enhancement of Atmospherics (SEA’s).

More information on this rather esoteric subject can be found in the TAB

book, *The Handbook of Solar Flare Monitoring and Propagation Forecasting*, by Carl M. Chernan. However, it appears to be out of print, so you may have to do some searching for it.

Earthquake Monitoring. An even more interesting, and certainly more speculative field—one whose validity is questioned by many authorities—involves monitoring the ELF, VLF, and LF ranges for electromagnetic radiation that may be caused by earthquake precursors. Both professionals and amateur experimenters alike are heavily involved with intriguing activities along these lines.

Reportedly, a west-coast experimenter who operates an earthquake-detection network noted radio and magnetic anomalies on Saturday, January 15, 1994, two days prior to the big Southern California earthquake that caused so much damage in the region. The experimenter reportedly predicted an imminent quake exceeding 6 on the Richter scale.

For those interested in this type of information and experimentation, a monthly publication, *The Geo-Monitor*, covers earthquake activities worldwide and contains many descriptions of electronic equipment for earthquake precursors. The newsletter covers amateur and scientific earthquake prediction, amateur geophysical monitoring, speleological (cave-exploring) interests, and even theories and legends about earthquakes, including animal behavior prior to earthquake episodes. Published by Vincent T. Migliore, a subscription is \$22/year domestic and \$30 overseas airmail.

Receivers. To most radio buffs, LW is unknown territory. One reason for this has been the lack of commercially available, high-performance low-frequency receiving gear. Now, several suppliers are producing receivers, receiving converters, and compact antennas that make it possible to explore the lower reaches of the spectrum.

Another avenue is military surplus. A fairly large number of surplus receivers tune down to 150 kHz or so, but few reach into the tens of kilohertz. Many surplus receivers require restoration if they are to be put back in

Names and Numbers

Ken Cornell
225 Baltimore Ave.
Point Pleasant Beach, NJ 08742
Tel. 908-899-1664

Curry Communications
737 North Fairview St.
Burbank, CA 91505
Tel. 818-846-0617

Electronic Equipment Bank
323 Mill St. N.E.
Vienna, VA 22180
Tel. 800-368-3270

Geo-Monitor
65 Washington St.
Suite 400
Santa Clara, CA 95050
Tel. 408-749-6770

Gilfer Shortwave
52 Park Avenue
Park Ridge, NJ 07656
Tel. 800-445-3371

Grove Enterprises
PO Box 98
300 South Highway 64 West
Brasstown, NC 28902-0098
Tel. 800-438-8155

LF Engineering Co., Inc.
17 Jeffrey Road
East Haven, CT 06513
Tel. 203-248-6816

S.P. McGreevy Productions
45 Elda Drive
San Rafael, CA 94903

MFJ Enterprises, Inc.
Box 494
Mississippi State, MS 39762

Michael Mideke
PO Box 123
San Simeon, CA 93452-0123

Palomar Engineers
P.O. Box 462222
Escondido, CA 92046
Tel. 619-747-3343

QST
225 Main St.
Newington, CT 06111-1494
Tel. 203-666-1541

Ken Stryker
2856-G West Touhy Avenue
Chicago, IL 60645

Universal Radio, Inc.
6830 Americana Parkway
Reynoldsburg, OH 43068-4113
Tel. 800-431-3939

working order, and most need some modification to be compatible with a source of 120-volt, 60-cycle alternating current (AC). Also, most tube-type surplus sets are pretty old and tired now that we're well into the 1990's.

Among the suitable surplus receivers are the BC-453, BC-1206-A, BC-348, ARB, and RAK-7. If you want to tune down to 10 or 20 kHz, some surplus receivers to consider are the R-439, URM41, RBA, RBL, and R-389 URR. The latter receiver, made for the government by Collins Radio in the 1950's, is an excellent receiver whose coverage extends to VLF.

The LW bands are also covered by a few older commercial communications receivers that you might find on used-equipment racks or at hamfests. In the low price range are the Heathkit DF-2, Hammarlund RDF-10, and National NC-66.

There also are several general coverage receivers that you should consider. One is the Drake SPR-4 that covers 150 kHz to 30 MHz, which sold for about \$700 when new. The Kenwood R-300, originally \$300, is within the reach of most who would like to DX LW bands. It tunes down to 170 kHz. Another possibility is Radio Shack's Realistic DX-300.

Moving upscale, the 1950's-vintage National HR0-60 is an excellent general-coverage and ham-band receiver. With its accessory G, H, and J plug-in coil sets, the receiver will tune down to 50 kHz. The Hammarlund VLF Super Pro, also known as the SP-600-VLF, tunes as low as 10 kHz.

There are some very nice new LW-capable units on the market, too, though they tend to be expensive. As examples, the Watkins-Johnson HF1000 (about \$3800); Drake R-8 (\$960); AOR 3030 (\$800); Japan Radio NRD-525 (\$900) and NRD-535D (\$1700); Kenwood R-2000 (\$670) and R-5000 (\$1000); ICOM R-71A (\$1040) and R-1000 (\$5000); Yaesu FRG-100B (\$560) and FRG-8800 (\$700); and the Lowe HF-150 (\$700), HF-225 (\$850), and HF-235 (\$2000).

Most of those receivers are available through shortwave distributors such as Electronic Equipment Bank (EEB), Gilfer Shortwave, Grove Enterprises, and Universal Radio. Most of the receivers tune as low as 50 or 100 kHz, although the Watkins-Johnson nosedives to a near rock-bottom 5 kHz.

Also, S.P. McGreevy Productions distributes a portable radio, the WR-3 VLF Receiver, specifically for the purpose of listening to whistlers and other natural radio sounds. This handheld, bat-

The Longwave Club of America (LWCA)

Since 1974, longwave listeners (LWL's) and other low-band enthusiasts have had a forum in the Longwave Club of America (LWCA). The LWCA was organized in 1974 to promote LW DX'ing, experimenting on frequencies below 530 kHz, and activity on the 1750-meter band.

The association, which has about 500 members, publishes *The LOWDOWN*, a newsletter for LW enthusiasts. It's a monthly that contains up-to-date loggings, beacon station information, LowFER and MedFER activities, and equipment designs for both reception and transmission. There are several active columns and features that include beacons, LW loggings, the 1750-meter band, and special-interest pursuits such as earthquake precursors.

Membership in the LWCA and a one-year subscription to *The LOWDOWN* is \$18 in the US, \$19 in Canada, and \$26 by airmail delivery overseas. All remittances must be in US funds. Membership information is available from publisher Bill Oliver at The Longwave Club of America, 45 Wildflower Rd., Levittown, PA 19057; Tel. 215-945-0543.

tery-operated receiver contains a proprietary circuit to receive emissions using a 33-inch telescoping whip. The unit has an audio output for stereo headphones. It costs \$65 and includes a seven-page listening and operating guide. A 30-minute demonstration audiocassette of natural radio sounds is \$8.

Converters and Accesories.

There's another, often much less expensive, way to get started with LW listening: buy a VLF/LF frequency converter and hook it up to your present communications receiver.

The Palomar Engineers VLF-A Converter is \$79.95. It uses a crystal-controlled local oscillator and a mixer to heterodyne or translate the 10-to-500-kHz range to the 80-meter amateur band from 3510 to 4000 kHz. The converter is inserted between the antenna and the receiver. A similar unit, the VLF-S, converts VLF to 4010-4500 kHz to work with general coverage (rather than ham-bands-only) receivers.

For the experimenter, David Curry, WD4PLI, at Curry Communications, offers a number of attractive and prac-

(Continued on page 91)

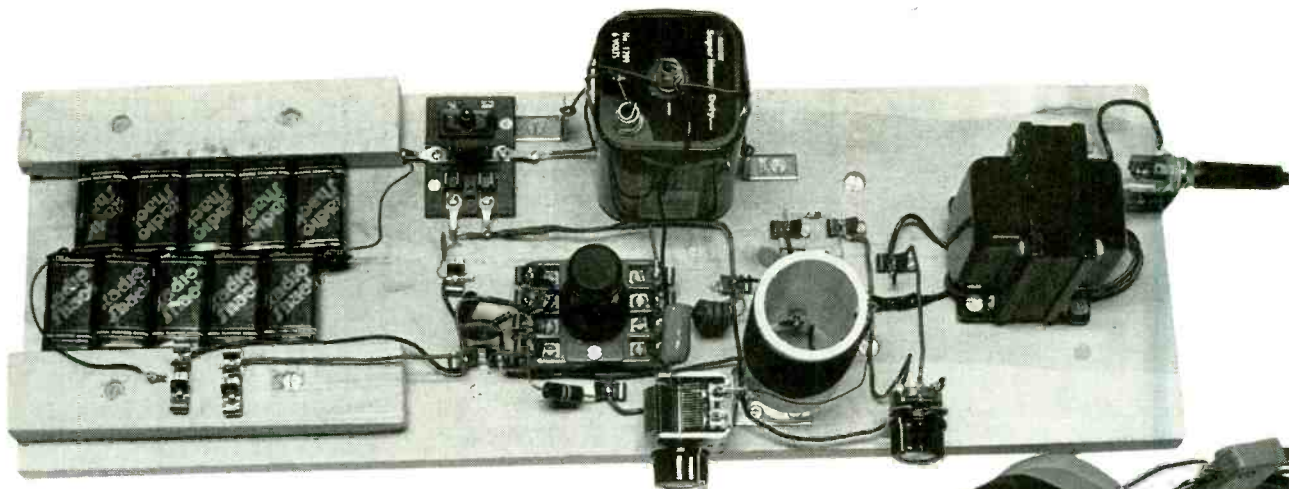

Build a one-tube radio designed for high-fidelity AM reception.

BY LARRY LISLE, K9KZT

Build A One-Tube AM Receiver

In this article we'll describe how to build a great one-tube radio. The output of the radio is amazingly clean because of its wide band pass, good-quality transformer, and the use of headphones. You'll hear more highs and lows than you probably thought possible on AM radio, and without the low-level noise, hum, and distortion that's often present in many superhetrodynes!

How it Works. At first glance, the

circuit (shown in Fig. 1) seems backward. Unlike most AM radios, the tube amplifier is placed ahead of the diode detector instead of behind it. The reason for that is to prevent the "square-law" bend at the beginning of a diode's response curve from distorting the input signal. In a typical circuit, if the signal falls in the bend, the output will be extremely distorted—by 25% or more.

To avoid that problem, the circuit amplifies the signal from the antenna

before it reaches the diode. I've found that a signal level of 1½ to 2-volts will put the operating point sufficiently far up on the linear part of the diode's characteristic curve to produce good-sounding music. A 10-volt signal level is probably ideal.

The radio has no audio amplifier, and subsequently, no audio-amplifier based distortion. An audio amplifier would just make the music sound louder, not better. However, there is the tube-based RF-amplifier stage. It has a pentode tube with an untuned input. Not tuning the grid circuit eliminates the possibility of regeneration, which could narrow the bandwidth and cut off the high frequencies. It also makes it possible to use point-to-point construction. The pentode gives a voltage gain of about 20-dB.

The crystal diode is tapped ⅓ of the way up the output coil. That decreases the output voltage a little, but improves the selectivity. If greater selectivity is needed, L2 can be replaced by a tuned circuit with the same values as L1 and C5. Capacitor C3 should then be reduced to 100-pF or less. The output of the detector is fed through a volume control (R4) to a audio transformer (T1) and on to hi-fi type headphones via J1.

(Continued on page 93)

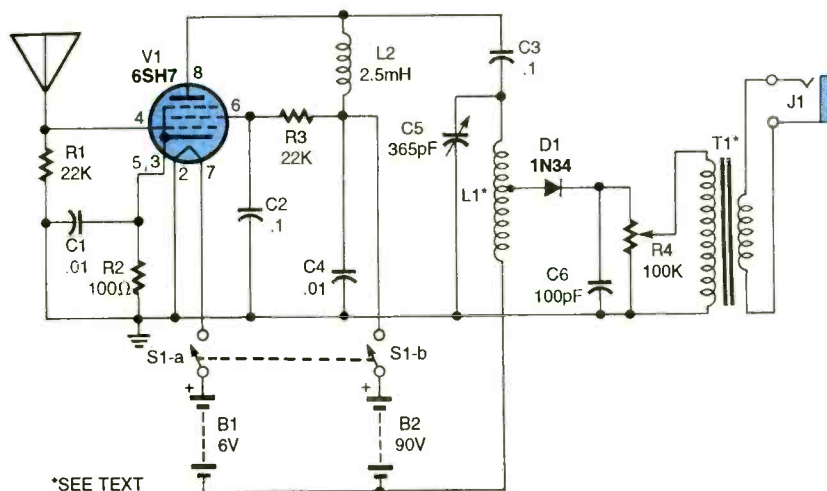

*SEE TEXT

Fig. 1. The radio uses an untuned RF stage to boost the signal voltage to up to the linear portion of the crystal diode's characteristic curve. The circuit's distortion and wide bandpass and a good-quality transformer make for a great-sounding AM radio.

GIZMO®

A CHRONICLE OF CONSUMER ELECTRONICS

Video Mix Master

VIDEONICS MX-1 DIGITAL VIDEO MIXER. Manufactured by Videonics, Inc., 1370 Dell Avenue, Campbell, CA 95008; Tel: 800-338-EDIT, or 408-866-8300. Price: \$1199.

People in the 1990's don't like being subjected to home videos any more than their 1960's counterparts enjoyed watching home movies or slides of their friends' vacations. Now, however, even if its content is less than thrilling, a video can still pack a punch. And even amateur video makers can achieve professional-looking results, thanks to the *Videonics MX-1 Digital Video Mixer*. The mixer offers over 200 special video effects, a timebase corrector, a frame synchronizer, audio mixing, a built-in color generator, picture-in-picture effects, and chroma key.

The digital mixer is targeted at video enthusiasts (the "pro-sumers") and at people who moonlight shooting wedding videos and the like. However, it works so well and is sophisticated enough that we wouldn't be at all surprised to see it pop up in professional television work. In fact, the mixer meets FCC and RS-170A specifications for broadcast quality.

The key features of the mixer are its frame synchronizer and timebase corrector. Without them, it would be impossible to display two video signals at the same time or to dissolve one signal into another, or wipe a new image directly across another.

The mixer shouldn't be confused with lower cost video-effects generators that might allow you to wipe the screen with a solid color and then return to a second image. (The mixer can do that as well, however.) Such generators are "gen-locked," meaning that they generate video that is locked in sync with an input video source. But they cannot mix two independent sources.

What is needed to synchronize video is



a digital memory large enough to store one frame of video. That frame can then be clocked out in sync with the other input.

Although the mixer can work with two inputs at a time, it has four video inputs so that you can leave your sources connected even if they are not part of the video you are creating.

Its rear panel has three sets of A/V inputs, each of which consists of two audio-in RCA-type phono jacks, one RCA-type video jack, and an S-connector. A fourth input, for video only, consists of an RCA jack and S connector. A set of audio/video output connectors (including both S-video and composite video) is also provided, as is a headphone-output jack. A preview output is provided for connection to a second monitor.

Rounding out the rear panel is the power-input jack and a GPI (general-purpose interface) input jack. As on many other Videonics products, the labels for the rear-panel jacks are printed both right side up and upside down so that you can see what you're doing if you lean over the

front panel to connect the wires in the rear.

The mixer is packaged in a slope-front cabinet. Its top panel has a rocker-type power switch, a *take bar* for manual control of scene transitions, six status-indicator LED's, and 41 rubber keys.

Those 41 keys are used to access the more than 200 special effects provided by the Digital Video Mixer. The special effects break down into about 21 main categories:

Fade: Picture A fades away as a solid color (green, for example) fades in.

Dissolve: Picture A fades away as picture B fades in.

Wipe: Picture A is wiped away by Picture B.

Slide: Picture A slides off the screen as Picture B slides on.

Squish, Stretch: Picture A is squished by picture B, which gets increasingly larger.

Wipe combinations: Wipes, squishes, etc. are combined.

Compress or Zoom: Picture is reduced or enlarged.

Flip: A mirror image of the picture is created.

Tumble: Picture A appears to flip like a falling card, leaving picture B in its place.

Fly-in: Picture B starts out very small in a corner, and then moves toward the center as it grows.

Picture-in-Picture: Picture B appears in reduced size, and then varies in size or position over picture A.

Mosaic: The picture is divided up into large pixels.

Freeze: The picture becomes a still image.

Strobe: The picture is changed into discrete, periodic frames

Paint: A posterization effect, in which the number of colors in the picture are reduced.

Solarization: The lightest and darkest values are made dark, and middle tones are made light.

Black-and-white: The color information is removed from the image.

Negative: The picture becomes either a black-and-white or color negative.

Filter: A color tint is added to the image.

Compose: A user-composed image (lines or borders) is added to the video.

Keying: A single color or luminance level is replaced with a second image.

The effects can be combined in various ways to create about 240 separate effects.

Although not essential, using two monitors is the best way to get the most out of the mixer. One lets you view the edited output. The second is connected to the preview-out jack.

The preview screen shows four preview images—the four video inputs—in miniature and with reduced frame rate. The preview screen indicates which is the current source, and which is the next source. Below the four preview images are an array of symbols to indicate the effect that can be used when transitioning between sources.

Let's assume that you want to do a simple wipe, replacing the video at input A with video from the input B. Four steps are required. First, the current source must be set to input A by pressing the CUT A key. Then the next source is selected with the CUT B key. The preview screen indicates which is the active source and which is the next source. On the keyboard, the LED above the CUT A key is on, and the LED above the CUT B key flashes.

The third step is to choose the wipe effect by highlighting the appropriate

effect symbol below the preview screens. Only 30 symbols fit on the screen at a time, but a cursor pad allows you to scroll through the effects quickly. The fastest way to find the right effect is to press the WIPE key, which immediately jumps the cursor to the most common wipe, in which the new image moves from right to left, replacing the original. To use a different wipe, just scroll through the other effects. Related wipes are grouped together. Once the desired wipe is selected, pressing the PLAY key executes it. Pressing PLAY again re-executes the wipe but, of course, with input A wiping over input B.

The speed of the wipe (or any other effect) can be programmed to one of ten speeds. The effects can also be controlled manually with the "take bar," so their duration can be virtually any length. This is important for many special effects. For example, the dissolve transition can be made to last indefinitely, and two video images can be superimposed on top of each other. Using that technique, an image of someone hiking might be superimposed on a map of his route for the duration of the scene.

The video mixer is not a video editor. That is, it can't control video sources. However, it can easily be incorporated into a setup that includes edit controllers and video processors. They can be placed either at the mixer's input or output.

Basic audio-mixing functions are provided by the video mixer. The audio at the output can either follow the video transitions at the inputs, or can follow one input only. Just as with video, audio processors can be used with the mixer, either at its inputs or outputs. If you use an audio processor, however, you lose the advantage of fading the sound automatically with picture fades.

Setting up the mixer is surprisingly easy: Just plug in your video equipment and one, preferably two, monitors. When the mixer is powered up, an automatic connection feature does all the rest. It looks at each of the four inputs and then configures itself to use the jacks that are carrying signals.

If an input has a signal on both the S-video and composite-video connectors, the S connector will be used. If only one input has a signal, that one will be used.

Although the mixer can create some amazingly sophisticated video transitions, its basic operation is reasonably straightforward. We liked its built-in Demo mode, which cycles the mixer through many of its transition effects. If more than one input is connected to the mixer, it will transition between the first two that it finds. If only one is connected, it will transition from that source to itself.

In some situations, the automatic setup mode is not sufficient. A manual setup

screen allows you to route inputs in a variety of ways. For example, you can make one video signal appear on two sources so that you can transition from one signal to a modified version of it. That would allow you to fade, for example, from a normal image to its negative.

The setup screen can also be used to tell the mixer to ignore an audio input, or to route a single mono input to both the left and right channels of another source.

Advanced setup options—which probably will remain untouched by most users—allow the headphone volume to be set, and the noise filters and black level to be adjusted. An automatic gain control for chroma signals can be adjusted to compensate for weak color signals. The time-base corrector can be locked to compensate for deviations in the video frame rates between the inputs and output.

Chroma key is a process that allows you to replace selected colors of one video image with another video image. Chroma key is used extensively in television. Weather forecasters, for example, often appear to be standing in front of a large video weather map. In reality, they are standing in front of a wall that is usually blue or green. Processing equipment uses chroma key to replace the wall—and any other objects the same color—with a second video image of the map. The forecaster views the combined image on a monitor so that he can see what he is pointing to.

Luminance key capability is also provided by the mixer. Luminance key works the same way as chroma key, but video is replaced based on its brightness rather than its color.

Picture-in-picture, or PIP, provides a powerful tool for videographers. PIP can create an image that looks just like that created by a TV's PIP feature. But the mixer's PIP is more powerful—it can be made any size and moved to any place on the screen.

The mixer's compose mode allows multiple still (frozen) video images to be placed on screen along with color lines and rectangles. "Holes" can be cut in any element so that the background video will show through. The background video is the only element of a composed screen that can be moving video.

A "learn" mode allows you to teach the mixer a series of effects or transitions ahead of time. Up to 50 steps (25 transitions) can be memorized. However, they are not stored in memory once the mixer's power is turned off.

In the short time that we had to review the mixer, we never mastered its full potential. However, we were more than impressed by it. In the right hands, the MX-1 Digital Video mixer could create astoundingly good video. ■

Gizmo is published by Gernsback Publications, Inc., 500-B Bi-County Blvd., Farmingdale, NY 11735. Senior Writers: Chris F. O'Brian and Teri Scaduto. ©Copyright 1994 by Gernsback Publications, Inc. Gizmo is a registered trademark. All rights reserved.

Heard but Not Seen

SONANCE S3500 IN-WALL LOUD-SPEAKERS. From Sonance, 32992 Calle Perfecto, San Juan Capistrano, CA 92675; Tel: 714-661-7558. Price: \$489.

NOTE: The Sonance S3500 speakers were reviewed as part of last month's whole-house audio/video custom-installation feature. When we ran out of space, we moved the speaker review to this issue. For more details on the actual installation, see the September issue of Gizmo.

One of the most important requirements of a good whole-house audio/video systems is that it should not "take over" the entire house. It should provide quality audio and video with maximum convenience, and it should not dictate the decorating scheme. The right in-wall speakers help a whole-house system meet all of those goals.

We chose the *Sonance S3500* for our installation. Its hallmark feature is a pivoting tweeter that allows the high frequencies to be directed to the listening area. That's an important advance for in-wall speakers, which can't always be placed in what would normally be considered an optimum position. The S3500 lives up to Sonance's reputation for high-quality in-wall speakers that are easy to install.

Many people have misconceptions about in-wall speakers, and scoff at them as being suitable for nothing more than providing background music. That perception is understandable. After all, quality in-wall speakers are relative newcomers to the audio scene. Most people's experience with in-wall speakers consists of lis-

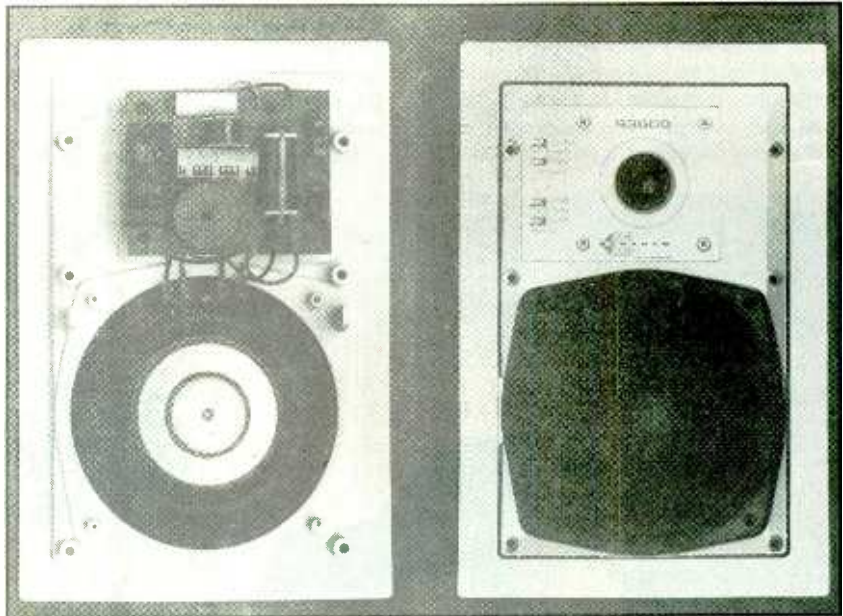

tening to Muzak™ through round, ceiling-mounted speakers that lack any real audio presence. In-home in-wall speakers also lacked fidelity.

Today, however, homeowners who want a built-in look no longer have to build false walls to hide the cabinets of standard speaker systems. Cabinet-free in-wall systems can provide both high-fidelity sound and unobtrusiveness.

If a cabinet is such an important part of a loudspeaker system, how can an in-wall speaker provide high fidelity without a cabinet? A loudspeaker enclosure is, indeed, an important component in a loudspeaker. In some ways, it's the most important component. The world's best driver will sound terrible if it's mounted in a poor cabinet or in no cabinet at all. Take a woofer out of its box, and what was once driving bass sounds puny.

The main job of an enclosure is to pre-

vent the sound from the back of the speaker cone from canceling the sound from the front. Without an enclosure, at low frequencies the front and back air merely moves back and forth around the cone and cancel each other. The closed box acts as an infinite baffle and prevents the interaction of the rear- and front-produced sound. The enclosed air also acts as a spring on the speaker diaphragm, which, with proper design, can be used to benefit the speaker's performance. An in-wall speaker uses the wall as a baffle to isolate the rear of the speaker from the front.

The S3500 is a two-way speaker with a frequency response created at 45 Hz–20 kHz, ± 2 dB. Its 6½-inch woofer features a dual voice coil, which improves its ability to deliver bass frequencies. The dual voice coil can be defeated to tailor the sound for room acoustics or listener preferences. This is done with a three-position

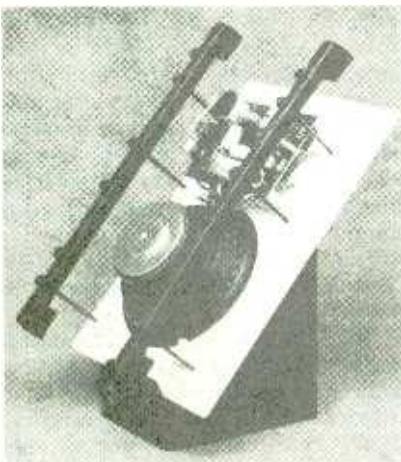

The S3500's Flex-Bar brackets simplify installation. The speaker is simply angled into the hole, and the screws are tightened down. That sandwiches the sheetrock between the Flex-bar brackets and the speaker baffle.

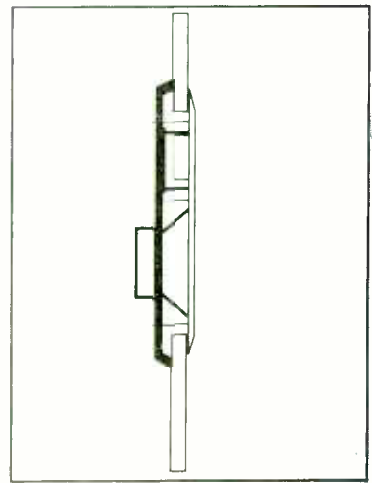
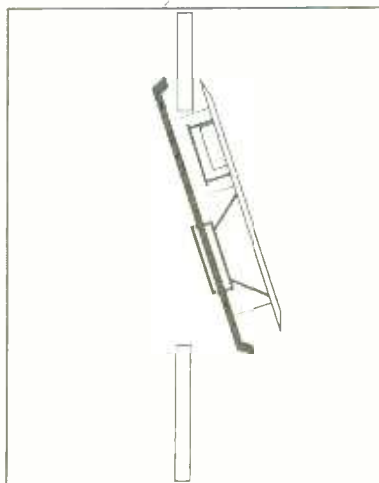

A side view of the Sonance S3500 being installed using the integral Flex-Bar brackets.

slide switch behind the speaker grille. With the switch in the +2-dB position, the dual voice coil is used, and the speaker impedance is 4 ohms. In the 0-dB position, only a single voice coil is used, and the speaker impedance is raised to 6 ohms.

When the switch is moved to its -2-dB position, bass response is attenuated, and the speaker impedance is raised to 8 ohms. The rear of the polypropylene woofer is protected with a perforated basket.

The tweeter of the S3500 is a 1-inch soft-

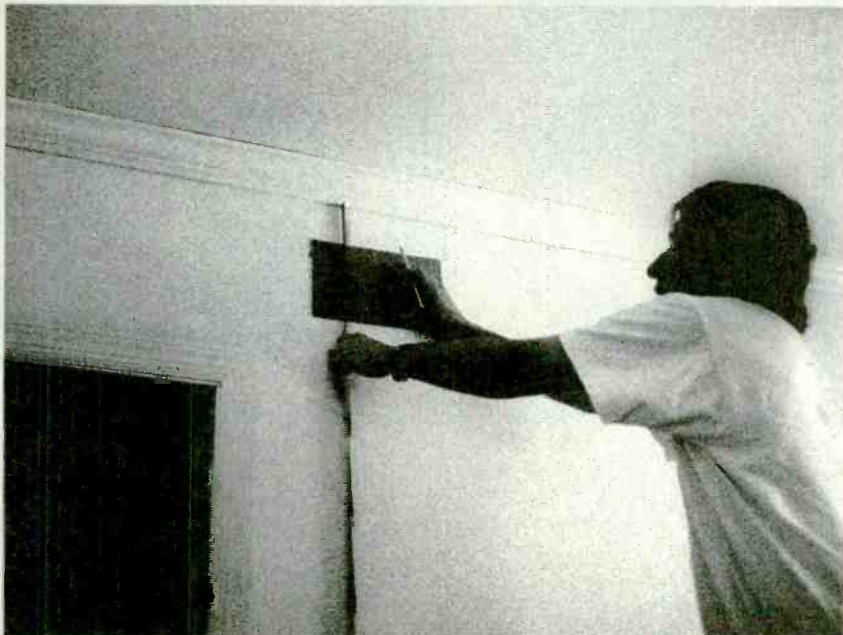

The template supplied with the speaker makes it easy to mark the locations for the holes to be cut.

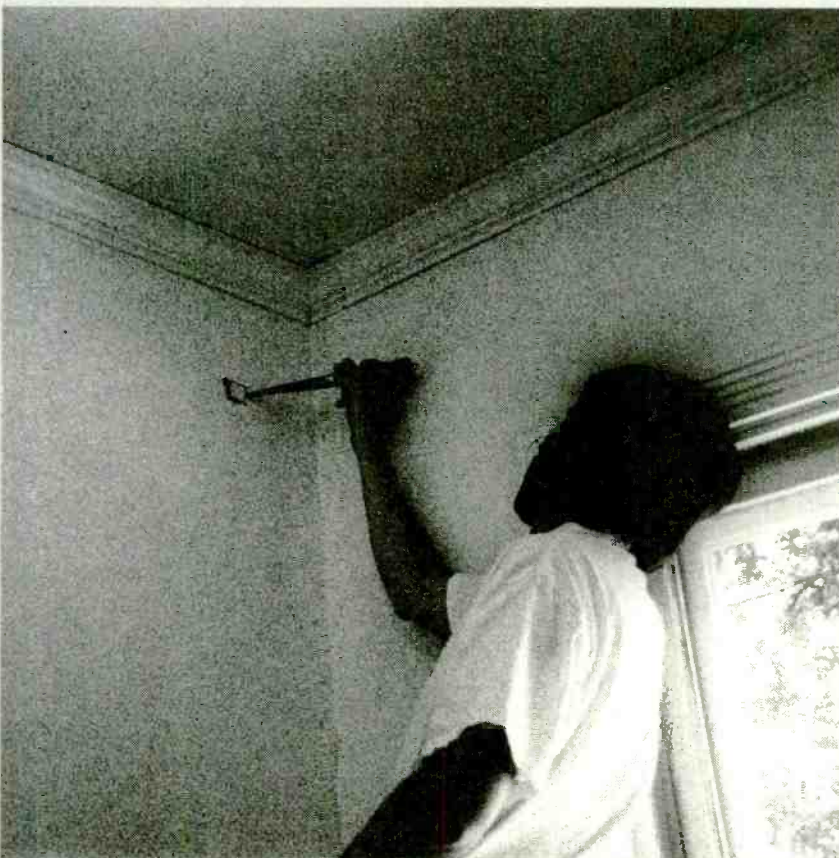

Cutting a "pilot hole" to be sure that there are no behind-the-wall obstacles to the speaker placement.

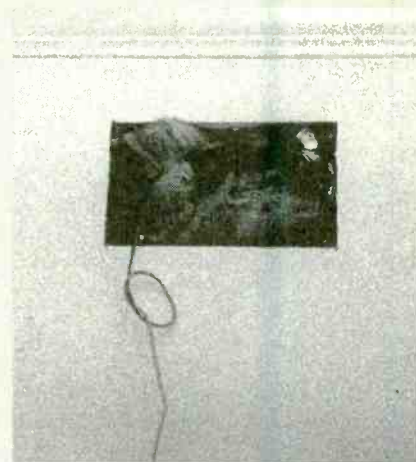

With the hole cut out and the wires run through the wall, the speakers, equipped with Flex-Bar mounts, could be angled into the wall.

dome unit with a Neodymium magnet. Neodymium magnets can be made small and light, yet they still have high magnetic flux. The size and weight were important factors in the design of the pivoting tweeter. The only drawback (besides the price) of Neodymium is its relatively low Curie point: Neodymium loses its magnetic charge once its temperature exceeds 105°C. Ferrofluid (which has a thermal conductivity about eight times that of air) is used in the speaker's air gap to promote heat transfer.

A tweeter adjustment is also provided to tailor the speakers' performance to room acoustics. Three positions, +3 dB, 0 dB, and -3 dB, are available.

The S3500 speakers are rated to work with amplifiers that deliver between 5 and 75 watts. They are rated to produce a sound-pressure level of 90.5 dB measured at 1 meter with a 1-watt input.

The pivoting tweeter makes the S3500 extremely versatile. Because the high frequencies can be aimed toward an area, speaker placement is less of an issue. That's important because in-wall speaker placement is often dictated by aesthetics and construction realities. The pivoting tweeter allows even ceiling-mounted speakers to provide adequate imaging. For surround-channel applications, the tweeter can be pointed at a reflective surface (ceiling or other wall) to disperse the sound.

The S3500's measure $8\frac{1}{2} \times 12\frac{3}{16}$ inches and are $3\frac{1}{8}$ inches deep. They are available with either metal or cloth grilles, both of which can be painted. The speakers can almost be made to disappear on walls where cloth wallpaper is installed. The wallpaper can simply replace the grille cloth.

The S3500 in-wall speakers do what in-wall speakers should. They provide excellent sound almost invisibly. ■

GIZMO NEWS

Subway Cellular

The first cellular subway phone system in the U.S. is now installed in Washington, D.C.'s Metrorail subway system. The installation of the microcell by Bell Atlantic Mobile will enable the half-million daily Metrorail riders to make and receive cellular phone calls in the underground stations and in trains.

With the introduction of the system, which should be extended to all Washington subway stations by the end of the year, Washington joins Hong Kong and Singapore as the only subway systems in the world with cellular coverage.

CD-R Trojan Horse

A computer virus named "CD-IT" was released on the Internet. The program was a shareware PC utility that promised to turn an ordinary CD-ROM drive into a CD-recordable (CD-R) device. That, of course, is impossible.

The file, CD-IT.ZIP, stated that it was copyrighted by Chinon Products. Chinon America, which didn't create it, speculated that the creators of the virus used the Chinon name to give it an air of respectability.

Anyone who was silly enough (or maybe just curious enough) to download the file found that it corrupts some system files on the PC's hard drive, crashes the CPU, forces the user to reboot the system, and stays in memory.

Digital VCR's Coming

At its second general meeting, the HD Digital VCR Conference announced agreement on "Consumer-Use Digital VCR Specifications." Fifty companies from around the world participated in the conference. The specifications will be submitted to the IEC (International Electronics Commission) by the end of this

DIGITAL VCR SPECIFICATIONS

	Standard Definition	High Definition
Recording System	Azimuth recording with rotating heads	Azimuth recording with rotating heads
Video Signal Recording	Digital component recording	Digital component recording
Video Sampling Frequency	Luminance = 13.5 MHz	Luminance = 40.5 MHz
Video Quantization	8 bits	8 bits
Video Recording Rate	25 Mbps (after bit-rate reduction)	50 Mbps (after bit-rate reduction)
Audio Signal Recording	PCM digital recording 2 ch: 48-kHz sampling freq. 16-bit quantization 4 ch: 32 kHz sampling freq. 12-bit quantization	PCM digital recording 2 ch: 48-kHz sampling freq. 16-bit quantization 4 ch: 32 kHz sampling freq. 12-bit quantization
Tape	Metal Evaporated (ME) tape or equivalent	Metal Evaporated (ME) tape or equivalent
Tape Speed	18.8 mm/sec	37.6 mm/sec
Recording Time	Standard cassette: 4.5 hrs. Small cassette: 1 hr	Standard cassette: 2.25 hrs Small cassette: 0.5 hrs
Video Bit Rate Reduction	DCT (discrete cosine transform)	DCT (discrete cosine transform)

year with the hope that they will be accepted as an international standard for digital VCR's for the NTSC, SECAM, and PAL standard TV formats as well as for high-definition TV (HDTV).

The cassettes that are specified for the new format are significantly smaller than VHS tapes. Two sizes are specified, one for home taping and the other for camcorders. The larger, about the size of a standard compact-cassette case, has a recording time of 4½ hours in standard definition, and half that in high definition. The smaller, about the size of a digital audio tape (DAT) cassette, has a recording time of one hour for standard definition

and half that for high definition. An optional IC memory can be built in to the cassette to store a table of contents, date and time of recording, and other relevant information. Automatic tracking will be performed using digitally generated pilot signals.

The first models could appear soon in the broadcast and industrial markets. Consumer models are not likely to appear until after next year. JVC, which invented the VHS standard, participated in the Digital VCR Conference. The company, however, is trying to reassure the public that VHS will be a viable format for many years to come. ■

Label Mania

P-TOUCH PC LABELING SYSTEM. Manufactured by Brother International Corporation, 200 Cottontail Lane, Somerset, NJ 08875-6714; Tel: 908-356-8880. Suggested retail price: \$499.

When we were kids, we managed—once—to come up with a Father's Day gift that didn't end up in the back of a closet with all those ugly ties. The break-through

present was a handy little gadget called something like the "Dymo Labelmaker" that Dad could use to make "custom" labels. The handheld device had a dial stamped with each letter of the alphabet, numbers 0-9, and several punctuation marks. To print a character on a label, Dad had to spin the dial to the correct letter or number, and squeeze the "trigger" to make an imprint on the scroll of adhesive-backed plastic tape. If memory serves, only one label width was available, although, the label tape might have come in three colors: black, red, and blue.

Those limitations didn't slow Dad down a bit—he began cranking out labels for every book, record, and file folder in the house. Then he moved on to the garage, labeling the gardening tools and all those old coffee cans full of a jumble of nails and other fasteners. We kids weren't spared—he labeled our book bags, pencil cases, and looseleaf binders. Mom drew the line when he wanted to tag all the contents of the kitchen cabinets.

We thought his obsessive behavior was a bit odd, but parents are known to do strange things. It was more disturbing

when, in the late 1980's, labeling entered the electronic age, and some of our friends began acting disturbingly like dear old Dad. Armed with P-Touch electronic label makers, they were tagging tennis rackets, hockey sticks, entire album collections—in short, everything in sight.

To date, *Brother International* has sold more than two-million P-Touch units—an impressive figure for a device that doesn't even seem to fit in any particular product category. Of course, the P-Touch was much easier to use than its manual predecessor, and afforded users many more options. And the proliferation of home-offices—with all those files, file cabinets, computer diskettes, and presentation folders—kept sales going strong. Several models are available, ranging in (street) price from \$100 to \$400 for a P-Touch designed for high-volume label-making.

Somehow, though, the label-making mania passed us by. When something needed a label, we just picked up a pen and wrote one.

At least, that's how we *used* to do things, before label-making met the computer age. Brother's latest offering is the *P-Touch PC* computer label printer, which lets you take practically anything that you can view on your computer screen, including a photograph, and put it on a label.

A far cry from the old Dymo Label, the P-Touch PC is incredibly versatile. It offers five different label widths, label lengths ranging from two inches to one meter (2.7 feet), a variety of type and

background colors, a wide selection of print sizes and styles, and dozens of scalable symbols and graphics. The device has the ability to import font styles, text, and images from other programs. It can also print bar codes, using most common barcode protocols.

The P-Touch PC is a desktop peripheral that, at 3.2 × 6.6 × 8.9 inches, doesn't require much space. A compartment on the left side of the unit houses the tape cartridge. (Tapes are available in a wide selection of colors and widths, at prices ranging from \$29.95 to \$44.95 for a single cartridge.)

Installation is reasonably straightforward: Plug the P-Touch PC into an available serial port, then run the SETUP.EXE program from within Windows. The installation program is rather bare-bones. For example, it doesn't give you an option of which port to use. Instead, it assumes that you will install it in COM1. To change the port, you must do so through the Windows Control Panel. That might not be so bad if the on-line help was halfway decent, but it's among the worst we've seen. We expect that Brother's free technical support phone lines will be kept busy.

Once the P-Touch PC was connected, we started out modestly, designing and printing an address label. We selected the fonts and text sizes, aligned the text attractively, added a picture from one of the included graphics files, and printed out a label—all without opening the manual. Despite our somewhat limited experience

with label-making or draw programs, we had no trouble navigating through the Windows-based software.

We were quite happy with the results, except that there seemed to be an excess amount of blank tape on each side of the type. We finally broke down and consulted the manual to resolve that problem. Had we read the set-up instructions before beginning, we would have learned that the Print Settings menu, found in the pull-down File menu, offers an Options submenu. Options is used to select the tape width and length, the amount of tape between each label (tape feed), the intensity of the print, and the auto-cutting and mirroring options. In auto-cutting mode, the P-Touch PC severs the tape between labels automatically. (With auto-cutting on, the minimum tape length is three inches.) If mirroring is selected, a mirror image of the on-screen label will be printed, which comes in handy for placing labels inside windows, for instance.

We also learned, in browsing through the manual, that a tool called the "label stick" was stored in the tape-cartridge compartment. To remove the backing from a printed label, the label is inserted through a slot in the stick (as you would thread a needle). Holding the label inserted halfway through the slot in the left hand, twisting the stick with the right hand, and then pulling the taut label free of the stick loosens the backing, making it easy to peel off.

Next, we set about organizing the Gizmo offices, labeling file folders, magazine holders, boxes of back-up material, floppy disks, and even the outside of file cabinets (in case we forgot what files were in each drawer). Making labels with the P-Touch PC is fun because it's so versatile, yet so easy to use. You can get a bit creative: color-code your files or add images to labels. For example, you can add a little computer icon on the labels for floppies, or import a photo of the birthday girl to the label for a birthday video.

Everything we'd created to this point had been done in the custom-label mode. The P-Touch PC also offers a database mode. You can create databases of names and addresses, and then print out mailing labels, name tags, and the like using the included data.

Each database can consist of up to 20 fields of your choice. A business-contact database would include fields such as first and last name, title, company, street, city, state, zip code, phone, and fax. A personal-contact database might include name and address, home and work telephone numbers, fax number, spouse's name, kids' names, and even such things as birthdays and anniversaries.

The fields in a single database can be manipulated in a number of different

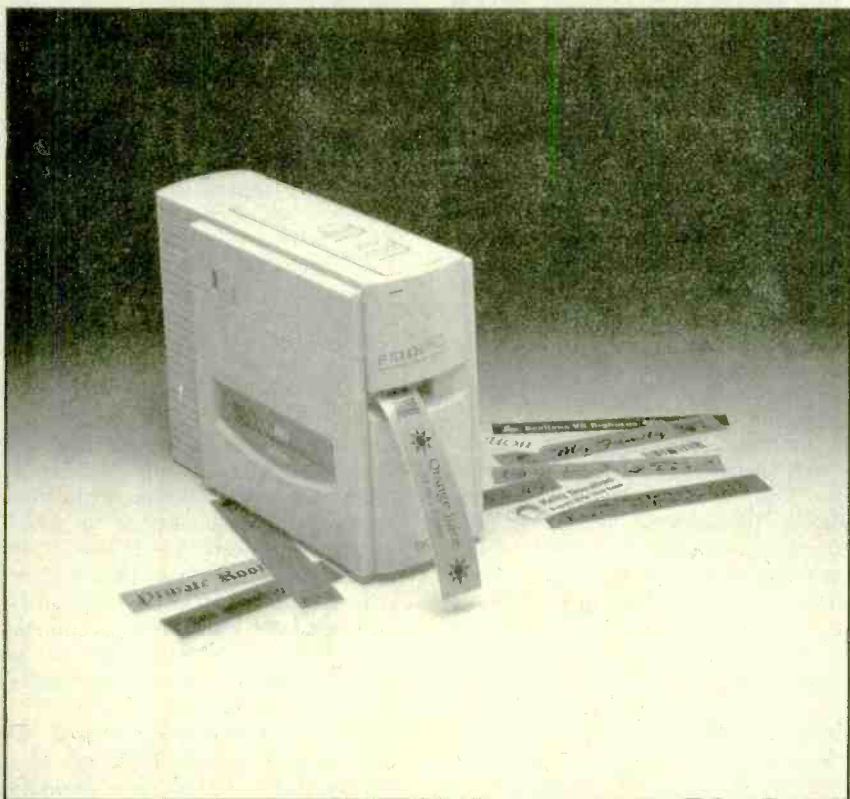

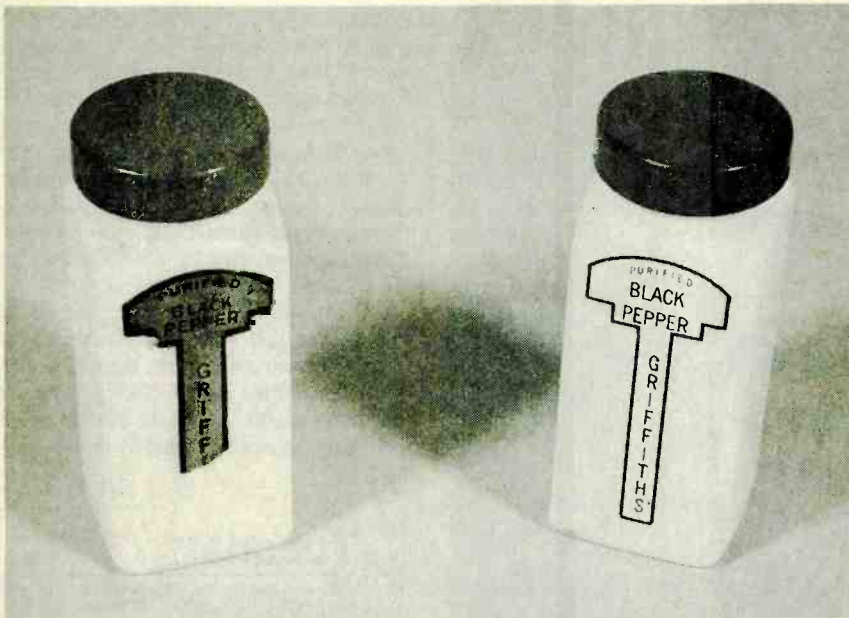

One of the original spice jars, with its torn and faded label (left), and the new-and-improved version, with its plastic-laminated, P-Touch PC label.

ways. City, state, and zip-code fields can be joined on a single line for a mailing label, on which the phone and fax fields would not be printed. A Rolodex could be filled with labels listing all of the fields, perhaps with the phone number in larger size type for easy reference. Before a business meeting, name tags consisting of name, title, and company could be generated. You could even add your company logo to the name-tag labels.

It wasn't long before we were updating our phone books and mailing lists using the P-Touch PC's database function. When it occurred to us that we were acting just like Dad with his Dymo Labelmaker, we rationalized that at least we weren't just labeling for the sake of labeling: We were getting organized—and being creative in the process.

To prove just how creative, we decided to tackle a chore that we'd been putting off because we weren't sure how to go about it: replacing the cracked and peeling labels on a set of "antique" spice jars that we'd picked up at a garage sale. We wanted the new ones to be identical to the originals, so that the set would retain its 1940's-ish charm.

The old labels featured the spice name printed horizontally, with the spice-company name printed vertically beneath it and "purified" printed in an arc above it. The lettering was surrounded by a domed-top border. We'd considered making a stencil of the border, and maybe using those rub-on letters found in art-supply stores, but that seemed like an awful lot of work—after all, there were 16 bottles in the set.

Using the P-Touch PC and the supplied 1-inch wide, white labels, however, it took

us only an hour or so to design and print a close match for each of the 16 old labels. Because the text ran in two different directions, we had to print each label in two parts. But, with some careful matching, the finished results looked great. And the laminated, peel-and-stick labels we created are sure to stand up to washing better than the original paper labels ever could have.

The creative design process gave us a good feel for the P-Touch PC's capabilities, and also its limitations. On the plus side, the software is very easy to use and the font selection is extensive. We found a font that was almost an exact match for the original labels. And, although it was our first experience designing a label that didn't follow the standard format (one or several lines of text), we were able to complete the process quickly and easily, without having to once consult the manual.

When it came to drawing the border, however, we came across some of the software's shortcomings. Because it is designed primarily for label-making, its draw capabilities are an "extra," and are limited. No background grid is available, making it difficult to keep the pattern straight and to ensure that the right side matches the left. There is no way to draw a curved line using the P-Touch software. (To create the top of the border, we drew an oversized circle that met the tops of the vertical lines of the border. Then we trimmed away the unneeded part of the circle after the label was printed, leaving a neat arched top.) There was also no way to type a row of letters along an arc; we had to carefully position each letter in the word

(Continued on page 72)

Tower of Power

VCR PLUS+ CONTROL TOWER UNIVERSAL REMOTE WITH CALLSET. From Gemstar Development Corporation, 135 North Los Robles Avenue, Suite 870, Pasadena, CA 91101; Tel: 818-792-5700. Price \$59.95.

All too often, the products that are supposed to enhance the quality of our lives also end up causing problems and aggravation. The most obvious example, of course, is the videocassette recorder, which, when first introduced, was too complex for many consumers. Not far behind on the "annoying convenience" list is the remote control—a handy device that seems to multiply whenever our backs are turned, filling our living rooms with clutter.

Occasionally, however, a convenience product is introduced that really does make life easier—such as the VCR Plus+ instant programmer from Gemstar. First introduced in 1990, VCR Plus+ technology provides one-step, error-free VCR taping. The user simply inputs a special code number that appears in *TV Guide* and the TV listings pages of more than 800 newspapers and other publications worldwide, and the programmer does the rest. The device automatically changes the channel on the VCR or cable box, and commands the VCR to start and stop recording at the correct times.

Having successfully tackled the problem of time-shifting VCR programming, Gemstar has now come up with a product that goes a step further to take on the remote-control-clutter dilemma as well. The *VCR Plus+ Control Tower* is a universal remote control that contains the automatic-programming technology. It also features a relatively new feature called "CallSet," which allows the initial setup of the device to be done by phone.

The Control Tower literally stands out from the remote-control crowd—it's designed to stand up vertically, rather like some recent models of cordless phones. (In fact, a visiting 19-month-old girl grabbed it, held it to her ear, and proudly said "Phone!") The bronze-tone case with round base is distinctive, as is the liquid-crystal display that spans the top of its face. The buttons arrayed below the display, from top to bottom, are for power on/off and programming, numeric keypad, channel and volume changing, playback functions, and device selection. The Control Tower can operate a TV, VCR, cable box, and one additional TV, VCR, or cable box—but not a laserdisc player or satellite receiver.

Unlike most universal remotes, you



because only the first call is free; subsequent calls cost \$4.95 each. So it's important to have all the necessary information available when you call the first time. The operator asks for the brands and models of your components and your zip code, and then instructs you to place the foam-rubber disc on the bottom of the Control Tower, and place the phone's earpiece next to it. The tones sent over the phone line set up the Control Tower automatically.

With setup complete, the Control Tower works just like most other universal remotes. Pressing one of the device buttons puts the remote in TV, VCR, cable, or auxiliary mode. Channels can be tuned using the numeric keypad or the channel

Tuesday

5:30PM
7PM

11:30 MAKE THE GRADE—Game 751075
12:30 HORSE RACING WRAP-UP 203094
1:30 BUGS BUNNY AND PALS;
 90 min. 777926
5:35 WHO'S THE BOSS? (CC) 201836
6:05 ANDY GRIFFITH—Comedy BW 7824146

EVENING

6 PM CBS NEWS (CC)—Dan Rather 29
6:57 NEWS 71819549
7:00 CHEERS (cc)—Comedy 5933
 Sam's regulars are reluctant to hang out at a bar that's promising to become a gay hangout. Ted Danson, Shelley Long, Tom, Alan Aulry.
11 MacNEIL, LEHRER; 60 min. 64094
20 WOODWRIGHT'S SHOP 98467
20 AMANDA SABATER; 60 min. 86810
20 FAMILY TIES (CC)—Comedy 52758
 Fearing the worst as Steven undergoes heart surgery, Elyse confides her deepest concerns to Alex. Part 2 of three. Young Steven: Michael David Wright.
20 HEALTH—Discussion 655
20 PASIONARIA—Novela; 60 min. 46549
30 GIMME A BREAK!—Comedy 112079
 Nell (Nell Carter) decides that Carl (Dolph Sweet) has been a widower long enough.
35 INDIANA NIGHTLY REPORT;
 60 min. 82536
35 HIGHWAY TO HEAVEN (CC)—Drama;
 60 min. 77487
 Jonathan (Michael Landon) must find a mate for the widow of another angel—who doesn't want her to remarry. Mark: Victor French. Ted: John McLiam. Laura: Martha Scott. Roy: Harvey Vernon. Margaret: Nana Visitor.
40 WORLD OF SURVIVAL 778742
40 THIS IS YOUR LIFE 32926
40 OUR VOICES—Discussion 215839
40 MONEYLINE—Lou Dobbs 730617
45 RENDEZVOUS—Travel 750346
50 COLLEGE BASKETBALL; 2 hrs. 913988
 Clemson vs. Seton Hall in the ACC-Big East Challenge at Syracuse, N.Y. (Live)
10 SCARECROW AND MRS. KING
 —Adventure; 60 min. 555013
10 E.N.G.—Drama; 60 min. 631487
10 HALF HOUR COMEDY HOUR 385181
10 INSPECTOR GADGET—Cartoon 758988
50 SPORTS WRITERS ON TV—Discussion;
 60 min. 807094
10 BABY'S FIRST CHRISTMAS 758013
30 TO BE ANNOUNCED 208549
6:05 HAPPY DAYS—Comedy 2844520
6:30 ENTERTAINMENT TONIGHT (CC) 181
 Scheduled: A segment on backup singers.
5 HARD COPY—Newsmagazine 8433
7 WHEEL OF FORTUNE (CC)—Game 6029
9 NIGHT COURT—Comedy 1365
 Billie (Ellen Foley) invites Harry to her apartment for a birthday dinner, but their evening is disrupted by a flustered intruder. Nick: Oliver Clark. Harry: Harry Anderson.
20 FROM SOCRATES TO SARTRE 18839
20 CURRENT AFFAIR (CC) 63810
30 NEWS 907

142/TV GUIDE

The PlusCodes used for automatic VCR timer-programming now appear in the TV listings of over 800 publications worldwide. To record *Cheers* using the listing shown above, you would input its PlusCode: 5933.

don't reach for the manual as soon as you open the box. Instead, you reach for the telephone. There's no need to look up special codes to be input for each of your components, or to line up the old remotes with the universal one to "teach" it how to control your gear. The CallSet feature allows the initial setup to be done over the phone.

Actually, you do have to open the manual to find the directions for using CallSet. The manual is an accordion-pleated instruction card with virtually no text, just labeled illustrations. It provides directions for the automatic setup procedure, as well as for manual setup, including setup-code lists for TV's, VCR's, and cable boxes.

If you opt to go the CallSet route, there are a few preliminary steps required before

placing the call. Four "AAA" batteries must be inserted in the battery compartment (located in the base of the Control Tower). You must be prepared to tell the Gemstar operator the brand and model number of your video components, your cable-company channel lineup (if applicable), and your personal identification number (which appears in the manual). You must also have a TV listing that contains VCR Plus+ codes on hand, and the included piece of foam rubber that will help provide a better audio transfer between the phone and the remote.

When you place the call (7AM to 7PM Monday through Thursday, 7AM to 6PM Friday, 9AM to 5PM weekends, Pacific Standard Time), you must enter your PIN before you can talk to an operator. That's

up/down toggle key. The VCR and volume controls—including mute—work regardless of what mode is selected. The REVIEW button, which lets you examine the VCR Plus+ timer-record settings, also works as a last-channel-recall button when in TV mode, if your TV offers that feature. The Control Tower doesn't provide access to any other advanced TV features, however.

What sets it apart from other universal remotes, of course, is VCR Plus+ programming. To set the Control Tower to record a program, you must leave the VCR off and the cable box on. Then you find the program you want to record in the TV listings, and enter the PlusCode number that appears next to the program name. Press the ONCE, WEEKLY, or DAILY button for one time, once-a-week, or every-day recording of that program, and you're set. Just make sure that the Control Tower is placed in an upright position with a clear line of sight to the cable box and VCR. At the proper time, the Control Tower turns on the VCR, tunes to the right station, and begins recording.

The Control Tower is compatible with nearly all brands of TV's, cable boxes, and VCR's. With almost 125 different brands of VCR's and 60 brands of cable boxes on the VCR Plus+ compatibility list, your gear is most likely represented. And when you upgrade your system with a new component, the Control Tower can keep pace. By calling and telling the operator the new brand and model of the new TV or VCR, new tones will reprogram the remote control to reflect the change.

Of course, with CallSet costing \$4.95 a pop, you might prefer to do it yourself. Fortunately, that's not very difficult.

If you wanted to program the Control Tower to operate your new TV, for instance, you would press the SET button, the number two, and then the TV button. Then you would enter the TV manufacturer code from the chart in the manual, and press ENTER. If the code is correct, the TV will switch on and turn to channel 9. If the code is incorrect, you must keep pressing ENTER to test the next "subcode" until the right one is found. Rather than scan through all the manufacturer codes in its search, the Control Tower is programmed with one code for each manufacturer and subcodes for various models. In our case, for our Panasonic TV, we entered the Panasonic code (26) and then pressed ENTER twice—the proper code was 26-3. Pressing the SET button then completes the process.

The same process is used to program the Control Tower to operate the VCR and cable box. An additional step is required for the auxiliary component—you must let the remote know if it is a TV, VCR, or cable box before entering the code.

(Continued on page 72)

Small Wonder

FM SOUNDS MINIATURE FM RADIO.
Manufactured by American Technology Corporation, 12800 Brookprinter Place, Poway, CA 92064; Tel: 619-679-2114. Price: \$29.95.

When we heard the claim that the world's smallest FM radio had been introduced by *American Technology Corporation*, we had to get our hands on the *FM Sounds*. We have always loved the miniaturization that electronics has made possible.

It sounded too good to be true: digital touch tuning in an FM receiver that weighed less than a quarter of an ounce and was designed to be worn in the ear! We couldn't wait to try it.

The unit arrived in a protective carrying case that stored the receiver, two batteries, an ear clip, and two antennas. The batteries are two 1.5-volt type-392 button cells. The ear clip, which is removable, helps to hold the receiver snugly in the ear even when you are walking or jogging. Without the ear clip, the receiver has an annoying tendency to fall out of the ear if you move around too quickly.

Two antennas are supplied with the receiver. The first is a stiff piece of wire about four inches long. The second is a flexible wire that is about 27 inches long. Since the short antenna was installed when we received the unit, and because it seemed more convenient, we powered up the radio and gave a listen.

The power switch is also the radio's

volume control. It's not continuously variable as most volume controls are. Instead, it has only two positions, low and high. We weren't too happy about that, but we figured that we had to trade off something to get such a small radio.

Only two other controls are located on the FM Sounds: SCAN and RESET membrane-type buttons. A push of the SCAN button causes the radio to automatically scan up in frequency until a station of adequate strength is found. The RESET button returns the receiver to the bottom of the FM band. When the top of the band is reached, the RESET button must be pushed to return to the bottom of the band. That's not really an inconvenience. On the contrary, because there is no display, it actually helps you to keep track of where you are tuning.

When we first powered up the radio, we hit the RESET button, and then SCAN. Nothing. We heard what we thought was a station being passed, but that was it. Ha!, we thought. Another rip-off! We changed our position slightly and tried again. This time we received one station, a local broadcaster. Needless to say, our opinion didn't change much.

We were so disappointed by the results that we weren't even going to bother to connect the second antenna. When we did, however, we were pleasantly surprised to be receiving stations. Reception was actually quite good—better, in fact, than what was provided by many of the personal stereos that we've tried!

We do have our complaints about the receiver, however, and we would probably be willing to put up with an increase in size to fix the problems. The most troublesome

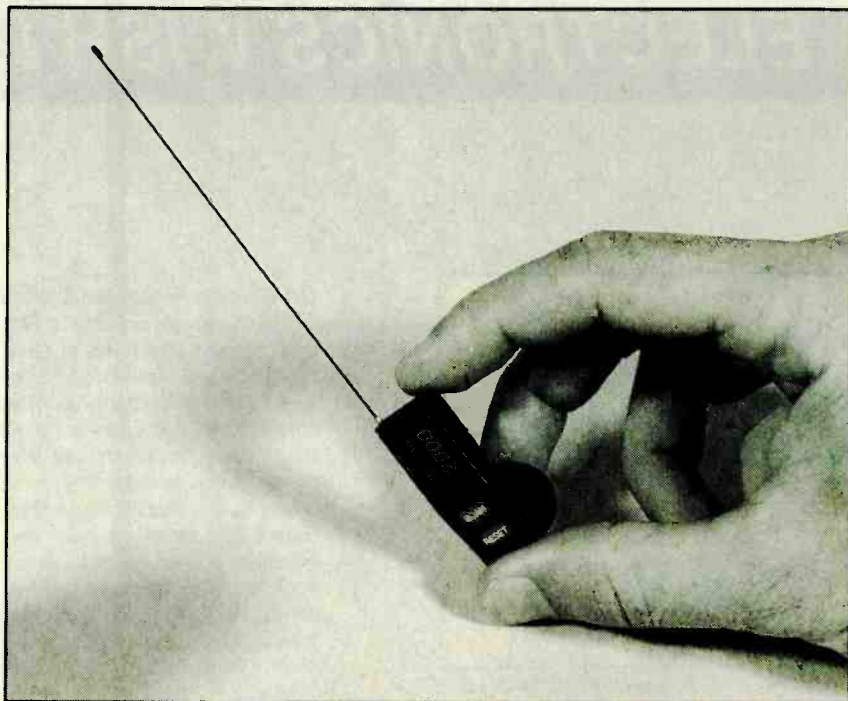

aspect of the receiver is that it is very frustrating to use when you are walking. If you lose a signal momentarily, the radio will scan up in frequency. Then you have to start all over again trying to find it. Our second complaint is that the buttons are not easy enough to press—our ear was hurting after just a short listening time! We would have preferred actual pushbuttons instead of the membrane switches used by the unit.

We would also like to have a manual-tune mode along with the auto-scan mode. And we would like the option of hearing the radio while it scans. As is, it mutes automatically.

The FM Sounds is impressive because of its size. It doesn't really strike us as a very practical receiver, but it is fun. In some instances, however, it can be practical. We used it, for example, in conjunction with a low-power FM transmitter to listen to TV audio as we moved around the house on a Saturday afternoon. Because the transmitter had adequate signal strength, we never lost the signal. The receiver is light enough that it was a very comfortable way to listen.

American Technology Corporation is reportedly expected to introduce a product called Wireless Sounds that bundles such a transmitter with the receiver. Perhaps they should start work on laptop computers—we still haven't found one small and light enough for our tastes. ■

TOWER OF POWER

(Continued from page 71)

If your cable company adds a new station to its lineup, you can enter that manually as well. The newspapers and magazines that offer PlusCode numbers also print a chart that lists TV stations and the corresponding VCR Plus+ guide channel numbers. To add a new station, you follow the same setup procedure as for components, inputting the VCR Plus+ guide channel number and then the actual channel number in place of the model/brand code. The same procedure is used to change channel settings.

Through all the setup steps, the Control Tower's display lets you monitor the information as you input it, and provides prompts to help you through each step—"Press ENTER" for instance. The display provides similar prompts when you use VCR Plus+ to program your VCR.

For our own video setup, we'd have liked the auxiliary mode to operate a laser-disc player or a satellite receiver. For the much more common TV-VCR-cable setup, however, the Control Tower serves its dual purpose admirably. It replaces up to four original remotes—reducing clutter and confusion—and, thanks to VCR Plus+ and CallSet, it makes time-shifted recording a snap, even for those who are technologically impaired. ■

LABEL MANIA

(Continued from page 69)

"purified" to get it to look just like the original.

Those design limitations can be side-stepped, however. The P-Touch PC allows you to create a design using a program specifically intended for drawing, and then import a bitmap of the image into the P-Touch software for printing.

However, we had problems importing general graphic images that we had created or downloaded, even though they were in the BMP format (the only one that the P-Touch PC supports) and displayed properly in any other software we tried. Because the technical-support staff couldn't suggest any fixes, we decided not to waste any time creating another unusable image.

With its street price hovering around \$250, the P-Touch PC would be a handy, affordable addition to many small businesses and home offices. Doctors and dentists could label patient folders, keep databases for mailing purposes, and even label specimen jars without worrying about the writing smudging if it got wet. Shop owners would surely appreciate its ability to print barcodes on labels. Just be warned: It's hard not to get a bit obsessive at first—you just might label everything in sight. ■

ELECTRONICS WISH LIST

THE WALL STREET JOURNAL.

Personal Finance Library

VERTIGO
ActiveBook

On-Screen Financial Adviser

Making an investment in *The Wall Street Journal Personal Finance Library* from Vertigo Development Group (58 Charles Street, Cambridge, MA 02141) could help you decide what to do with the rest of your investments. The Windows-based software contains a collection of articles from *The Wall Street Journal*, combined with interactive software that lets users apply the authors' advice and information directly to their personal situations. The computer handles most of the drudgery associated with financial planning, eliminating the need to pore through a lot of text or do complex calculations or formulas. The on-screen articles feature "ActiveInformation" pages that allow users to input personal finance information. For instance, an article entitled "Buying or Renting: By the Numbers" asks the user to supply the home purchase price, down payment, closing points, etc. Based on that information, a recommendation to buy or rent is offered, with an explanation. Other subjects include paying for college, saving for retirement, choosing the right insurance policies, refinancing mortgages, investment strategies, and paying down debt. Price: \$69.95.

ELECTRONICS WISH LIST

Snail Speakers

If it doesn't bother you to spend more on a stereo speaker system than your parents probably paid for their first house—or to supply it with the eight discrete channels of high-power amplification it requires—check out the *Nautilus Project* loudspeaker from *B&W Loudspeakers of America* (P.O. Box 8, 54 Concord Street, North Reading, MA 01864-0008). Representing a radical departure from conventional speaker design, the Nautilus was inspired by the natural form of the *Ammonite Nautilus*—in layman's terms, the snail. Each of the system's four dynamic drivers operates into a "lossy waveguide" transmission line—a column tapered to follow an exponential curve and smoothed to eliminate any corners or edges that would impose unpredictable resonances or distractions. The 12-inch woofer's transmission line is curled back upon itself, forming the body of the "snail," while the smaller drivers' waveguides each extend to the rear to create the three "antennae." The principle behind the design is to eliminate the internal resonance of conventional speaker cabinets, thus avoiding the highly colored radiation of back waves. The Nautilus has four custom-designed drivers, each developed to behave as a near-perfect piston within its operating range. They are decoupled from the enclosure to keep the Nautilus free of stored energy and cabinet resonance. The 12-inch bass unit's cone produces fully coherent motion to beyond 1.5 kHz. It has two midrange drivers: A four-inch, flat-fronted driver delivers the two octaves (220–880-Hz) between the bass transducer and the more conventional midrange; the next two octaves are reproduced by a two-inch aluminum-dome midrange driver. A one-inch aluminum-dome tweeter delivers the final three-plus octaves of response. Active electronic filtering, supplied in the form of two external electronic crossovers (one per speaker), integrates the four drivers to preserve signal purity. Price: \$35,000/pair.

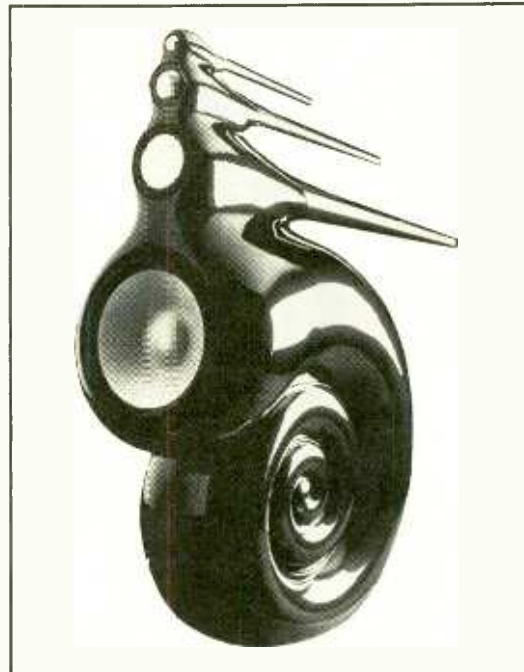

B&W Nautilus Project Speakers

Opto-Link Detachable-Face CD-Player/Receiver

The *XC-6725D* automotive CD player/receiver from *Sherwood Electronics* (14830 Alondra Blvd., La Mirada, CA 90638) features a detachable panel with "Opto-Link." The patent-pending Opto-Link system is said to supply consistently clear sound through a "technologically efficient, advanced optical infrared multiplexed design" that provides a stronger connection between the face panel and the unit. The system replaces the mechanical connector that is normally used, and which is subject to marginal connections due to high resistance and contact tension, as well as normal wear and temperature fluctuations. The *XC-6725D* also features EZ Link for fast, easy installation. The CD player uses a "dual floating anti-vibration damping system" to avoid skips when driving on rough roads. The Compu-Tuner Plus features auto store and preset memory scan for 24 stations. Price: \$385.



Sherwood Opto-Link CD Player/Receiver

Steadyshot Handycam

The *CCD-TR700 Hi8 Handycam*, Sony's (1 Sony Drive, Park Ridge, NJ 07656) top-of-the-line consumer model, features the "SteadyShot" picture-stabilization system. SteadyShot technology uses horizontal and vertical sensors to detect camcorder motion (caused by shaky hands or sudden movements) and then stabilize the image before it is recorded. Aimed at serious videomakers who do a lot of editing, the *CCD-TR700* offers automatic digital recording of RC time-code reference data in hours, minutes, seconds, and frames. An advanced color viewfinder with optical filter provides an enlarged viewing area and more natural color. Other features include AFM Hi-Fi stereo sound with stereo zoom microphone, an optical 10:1 variable-speed power zoom, a manual focus ring, and four auto-exposure modes. Price: \$1900.



Sony Handycam with SteadyShot

ELECTRONICS WISH LIST

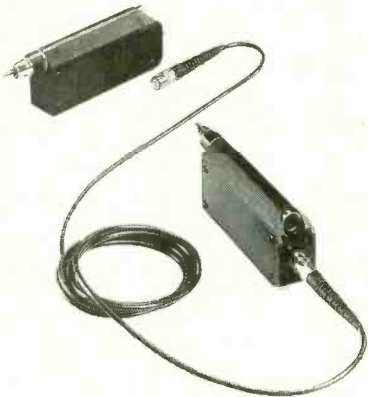

Mongoose Fiber-Optic A/V Cable System

Fiber-Optic A/V Cables

According to *ASM Labs, Inc.* (410 East O'Dell Street, Marionville, MO 65705), their new *Mongoose* cable is the first fiber-optic cable system for stereos, VCR's, and other home audio and video gear. The *Mongoose* cable uses analog optical signals to send information up to a distance of 2.4 miles while "eliminating the noise, interference, and attenuation associated with wire cables." The all-analog format means no digital conversion is necessary, so there is no loss of information, jitter, or need for error correction. The system includes a small electronic transmitter that plugs directly into an audio or video component and converts the output signal to an optical signal. The signal is sent over the fiber cable, which ends in a receiver that converts the optical signal back to an electrical impulse. The small receiver plugs directly into the component via a standard RCA-type connector. The transmitter and receiver are powered by separate, isolated, linear power supplies. As with wire cable, each channel of audio or video information requires its own optical cable, but several pairs of optical fiber can be run in the space needed for one pair of wire cables. The optical fiber cable has a 3mm outside diameter and is lighter and more flexible than wire cable, but far more expensive. Prices: Set of transmitters and receivers for stereo audio (including four power supplies), \$649. Transmitter and receiver for video (including two power supplies): \$369. Twin-lead optical cable for audio: \$125 for the first meter, \$10 each additional meter. Single-lead video cable: \$62.50 for the first meter, \$5 for each additional meter.



Radio Shack Telephone with Equalizer

Telephone With Equalizer

Radio Shack's (700 One Tandy Center, Fort Worth, TX 76102) *ET-145* amplified equalizer telephone has convenient slide adjustment controls that allow users to set the sound frequency and volume to the levels that they find most comfortable. That feature is particularly useful to hearing-impaired people, as is the phone's compatibility with hearing aids that use a "T" (telephone) switch. The *ET-145* features a built-in, four-band equalizer, similar to those found on some stereo receivers. Advanced circuitry blocks feedback and other electronic noises at higher volume levels to enhance sound quality. Other features include a ring-indicator light that flashes when the phone rings, memory dialing for up to three numbers, and last-number redial. Price: \$99.99.

Modular Mini-System

The *GX-5* mini-system from *Yamaha Electronics Corporation, USA* (6660 Orangethorpe Avenue, Buena Park, CA 90620) consists of a pair of speakers and two electronics modules. One module contains the cassette-deck transport and amplifier, while the other houses the tuner, pre-amp controls, and a three-disc CD changer. The 35-watt-per-channel amplifier features Active Servo Technology, a complementary amplifier/speaker system that uses negative-impedance feedback and other electronic processes to derive strong, accurate bass from small speakers. The dual auto-reverse, dual-well cassette deck features Dolby B and C noise reduction, timer-record/play, two-speed dubbing, relay play, and CD Synchro Start for easy recording of CD's. The three-disc changer, with complementary Synchro Start circuitry, features PlayXchange, which allows two of the discs to be swapped while the third is playing. The AM/FM tuner offers 40 presets, auto-tuning, and 10-key direct search. The pre-amp has an input for two additional auxiliary sources. The *GX-5* also features a signal processor with settings for different types of venues and music types; wake-up, sleep, and auto power-off modes; a seven-band graphic equalizer; and a spectrum monitor. Price: \$599.

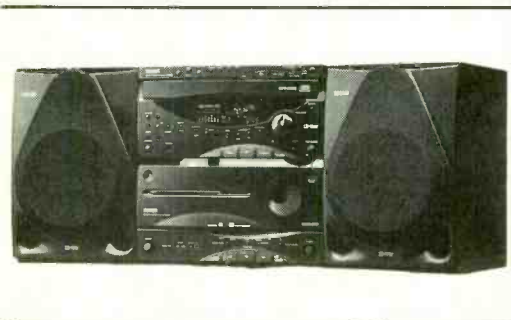

Yamaha Mini-System

We describe the first dealer-installed navigation/information system to hit the streets in North America.

BY BILL SIURU

Navigation Systems go Mainstream

Buyers of the Oldsmobile Eighty-Eight LSS in California are now able to order an on-board navigation and information system as a dealer-installed option. The system costs about \$2000.

While several aftermarket navigation systems are already on the market here, Oldsmobile is the first automaker to "officially" offer such a system in North America. By comparison, an estimated 400,000 automotive navigation systems are already installed in Japanese vehicles, and they are now being sold at the rate of some 150,000 units annually.

How it Works. The Oldsmobile Navigation/Information System was developed by Zexel USA Corporation, a subsidiary of the Japan-based company, in its Sunnyvale, CA laboratory. The system was modified somewhat from the Zexel NAVMATE to meet specifications set by Oldsmobile and GM's Delco Electronics.

The Oldsmobile system uses dead-reckoning navigation and digital map-matching with position updates from the Global Positioning System (GPS). The GPS signals from the space satellites are received by a small antenna. Dead reckoning is done using data from an electronic odometer and a low-cost, vibration-type gyroscope, which determines the direction of travel. A small computer

located in the trunk is used to do the dead-reckoning computations as well as triangulating the signals from GPS for position updating and for the map-matching function.

The system includes automatic sensor compensation and a state-of-the-art intelligent filter for minimum position error. However, the system does not use differential GPS (DGPS) to overcome Selective Availability—a standard in which GPS data has reduced accuracy to limit its benefit to a warring enemy. According to

Oldsmobile, the dead reckoning is very good, so DGPS is not needed. For more information on the GPS system, see the July 1992 issue of **Popular Electronics**.

The Interface. Information is presented to the driver or front-seat passenger on an active-matrix color, liquid-crystal display (LCD). The display screen measures four inches diagonally. The display/control unit attaches to the center of the dashboard on an arm like the one that supports a rear-view mirror. The system has been designed for theft protection with the computer safely located in the trunk. The combination control unit/display screen is easily removed for storage in a secure location.

The system's basic control operations include:

- Route/Map Key—That key permits the driver to switch between item-by-item travel-route instructions and area maps.
- Option Key—Brings up optional display screen to control zoom for maps and voice volume.
- Enter Key—Enters the driver's selections into the computer.
- Cancel Key—Cancels the current operation and reverts to the previous step.
- Cursor Button—Moves the cursor through menu functions. Also moves

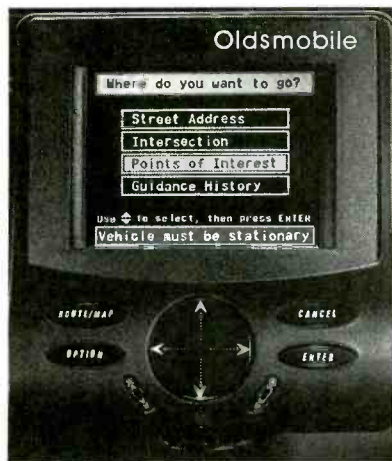

The LCD screen for the Oldsmobile Navigation/Information System is conveniently located for viewing by the driver. Here the driver is entering the requested destination via the easy-to-use menu. (Photo courtesy of Oldsmobile.)

icon on map display. (Push and hold for quick scroll.)

The system is designed for very easy use without special training or even reading of a complicated owner's manual. Once a destination is entered, the system calculates a route and displays it on a simplified digital map. It then provides graphic, turn-by-turn directions with a voice prompt shortly before each recommended maneuver has to be made.

Operation The touch of a single key activates the Navigation/Information system. The menu-driven display screen then prompts you through a few simple steps to enter the desired destination using the cursor. The destination, which is entered with the car stationary, can be a specific address, a road intersection, or a point of interest such as a gas station, hotel, school, hospital, or tourist attraction. The destination can also be a previous destination with the system capable of storing up to 10 previous ones for later recall. The on-board computer calculates the recommended route in just seconds.

A map of the area is then displayed on the screen with the proposed route highlighted in a bright color. As the driver makes the trip, the distance to the destination is presented on another display along with turn instructions displayed with a simple arrow. About two tenths of a mile in advance of each turn, a computer-synthesized voice says "turn left" or "turn right." The



"Turn-by-turn" route guidance provided by simple arrows is augmented by synthesized-voice instructions. The screen also shows the distance to the next required maneuver as well as the direction and distance to the final destination. (Photo courtesy of Oldsmobile.)

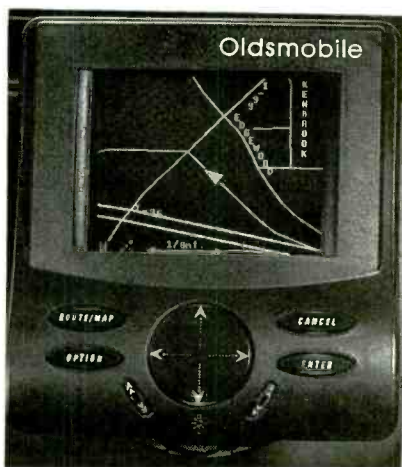

A simplified map is used for maximum ease of viewing by the driver. The recommended route is shown in a different color with the current location shown by the arrow. (Photo courtesy of Oldsmobile.)

audible commands allow the driver's attention to remain on the road.

The system also permits the selection of a preferred route, for instance, via expressways or freeways versus surface streets. If the driver strays off course, misses a turn, or cannot take the suggested route because of construction or congestion, an "off-route detection" capability calculates a new route to the destination.

The digital-map databases and route-guidance software are provided by Navigation Technologies (NavTech) in Sunnyvale, CA. The digital map data is stored on a 1.8-inch PCMCIA card. The computer database "knows" the names of streets, which streets are one way, where left turns are legal, when a turn is 90 degrees, or when it is sharper or more gentle.

For a "Yellow Pages" feature, the operator first selects a category from the

"Points of Interest" menu, then the specific destination point desired. NavTech is currently adding 44 points of interest categories to the database. Those include banks, shopping centers, airports, and more.

Initial systems sold in California will include data for the entire state. Oldsmobile plans to offer the system nationwide in the next two years. By the end of 1995, Oldsmobile says it will offer map data for the 44 most populous US metropolitan areas, plus the US highway system down to the level of county roads.

The system is especially useful to newcomers to an area since it can pinpoint tourist attractions, airports, retail stores, hotels, restaurants and so forth. For that reason, Avis Rent-A-Car, the first volume customer, will add 100 Eighty Eights equipped with the Navigation/Information System to its fleet in the San Francisco Bay area. ■

COMPUTER BITS

By Jeff Holtzman

IdeaFisher

Knowledge is like a web. In fact, knowledge *is* a web, a vastly complex and interconnected network of associated concepts and facts. Take your average Windows help file and multiply it by a billion, a trillion, or maybe even infinity and that's the scale of the sum of human knowledge. Of course there is, as yet, no physical entity corresponding to this knowledge network. That's what the "information superhighway" and the ongoing convergence among the computer, communication, publishing, and entertainment industries are all about.

tool for increasing your "OQ."

IDEAFISHER

IdeaFisher consists of two major components: a hyperlinked, associative database of ideas (Idea Bank), and several sets of structured questions designed to help you focus on a problem (Question Bank). An integrating shell presents the questions, helps you navigate the database, records your answers along the way, and helps you filter and analyze them.

The basic product comes with half a dozen question sets, covering the following

and Grant Proposals.

The database component consists of a three-level topical hierarchy, augmented by 750,000 cross references or hyperlinks. The topic hierarchy is: Major Categories, Topical Categories, and Idea Words and Phrases (IWP). The current version of the program includes approximately 65,000 items at the IWP level.

Unlike some programs of this nature, you can jump in to either the I-Bank or the Q-Bank at any level and start exploring. However, the company does recommend following a structured approach, detailed in the book, but only weakly supported by the software. The company would do well to add "Wizard" or "Assistant" technology to optionally walk users through program components step by step.

PROS AND CONS

My initial Impression of the program was not particularly favorable, although it has grown on me in subsequent uses. I find its screens inelegantly designed, its icons obscure, and its undifferentiated use of different types of windows confusing. I also find the 65,000-item IWP database thin. At first, I often selected items expecting to get more information, as in a thesaurus or encyclopedia, but instead ended up moving to another node in the database.

IdeaFisher's awkward method of navigating topical categories drives

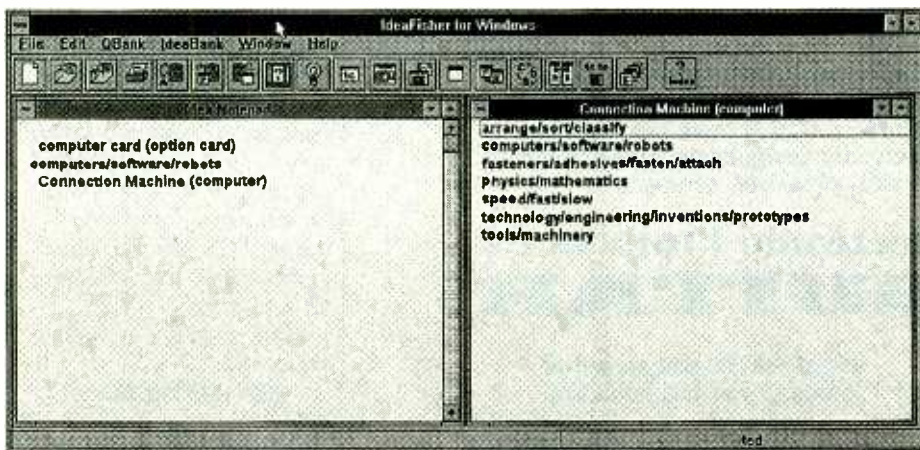

IdeaFisher helps increase your "Originality Quotient" (OQ) with an extensively hyperlinked idea database, and structured goal- and focus-setting.

Nonetheless, there are compelling reasons to be able to tap into that network today: business, entertainment, education, and more. Another reason is to increase your "originality quotient," your ability to be original, to come up with fresh, new ideas, regardless of your field of endeavor. A Windows program called IdeaFisher is a

areas: New Product and Product Development, Name Development, Marketing Strategy, Advertisement and Promotional Material, Story and Scriptwriting, and a general-purpose module for Problem Solving. The company also sells add-on modules for Strategic Planning, Speeches and Presentations, and Business

me crazy. For example, search on the word "compute" and you end up at the beginning of an alphabetical list of 65 computer-related topics. A program of this type should never present long lists; it should *always* break things down into digestible hierarchical groups.

To continue the example: Select "computer language" and up pops a new list containing four items: computers/software/robots, information transfer/information systems/libraries, instructions/orders/commands, and language/foreign languages. Select one of those topics and up pops a dialog allowing you to view example items in one of several categories. As soon as you select one, yet another list replaces the current list. You can continue hypernavigating

like this *ad infinitum*. Each time you go to a new item, its name is added to a text-editing window that acts as a kind of shoebox, collecting new ideas as you traverse them. Later, you can filter the shoebox to extract the key concepts.

Suppose though, that after some hyper-navigating, you come to the end of an idea trail. Now you want to return to the last major fork in the road and take the other branch. Doing so is possible, but awkward. The program desperately needs some sort of interactive, graphical representation of the paths you take.

One last gripe: Although the areas included in the basic Q-Bank are useful, I find one glaring omission: There should be a question group concerned with writing nonfiction essays,

reports, articles, white papers, and the like.

Despite all those faults, I can't simply erase the program from my hard disk. I find that the questions asked in the Q-Bank can be highly useful in helping scope a problem.

I truly believe that the company is on to something. With a better user interface and a more extensive, less pop-culture oriented database, IdeaFisher could be a great weapon in the arsenal of people who demand more of themselves. Let's hear it for a CD-ROM version and a more extensive editorial process! ■

Vendor Information

IdeaFisher (\$199)
IdeaFisher Systems, Inc.
2222 Martin St., #110
Irvine, CA 92715
(800) 289-4332
(714) 474-8111

THINK TANK

(Continued from page 26)

TRACK-CONTROL SIGNAL

One of the areas of electronic circuitry that has been largely overlooked in your column is that of model trains. I have been searching for the past couple of years to find a circuit to operate a flashing crossing guard using 12-volt DC lamps. Just about all the common circuits available use LED's and they are way too big for N-gauge scale models. I have two Radio Shack 272-1092 lamps. Now I need a circuit that will handle those tiny bulbs. Sure hope you can come up with a circuit that does not use a relay to operate my crossing guard.

I am enclosing a circuit diagram (see Fig. 4) for a track-side operating signal that remains green until an engine, with a small magnet glued to the underside comes along and trips the reed switch in the track. The light turns red and remains red for a time, depending on the setting of R1 and value of C1 (see the table in the figure), and then returns to green.

Many thanks for interesting columns.

—Bob Williams, Hemet, CA

I guess you'll be happy with the circuit back in Fig. 3. To use that circuit with your size railroad model, try using mini or sub-mini LED's.

By the way, the only reason I haven't covered the model-railroad hobby is because I've received almost no mail on it.

Well, "that's all folks" for this month. To participate in the column, please write to *Think Tank*, Popular Electronics, 500-B Bi-County Blvd., Farmingdale, NY 11735.

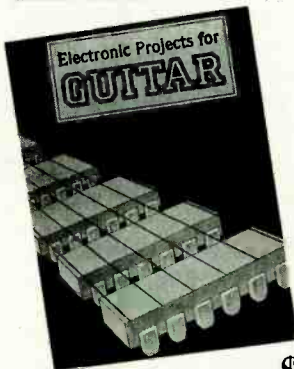

Whether you wish to save money, boldly go where no guitarist has gone before or simply have fun building electronic gadgets designed for your musical pleasure, then read

Electronic Projects for GUITAR

\$12.95

Some of the add-on guitar gadgets you can build are:

Preamplifier • Headphone Amplifier • Soft Distortion Effects Unit • Compressor • Auto-waa • Waa-waa Pedal • Phaser • Dual Tracking Effects • Distortion Unit • Expander • Dynamic Treble Booster • Direct Injection Box • Dynamic Tremelo • Thin Distortion Unit • and Guitar Tuner.

Anyone with some previous electronic project building experience should have no problem assembling the projects.

ELECTRONICS TECHNOLOGY TODAY INC.
P.O. Box 240, Massapequa Park, NY 11762-0240

Yes, send my copy of ELECTRONIC PROJECTS FOR GUITAR by RA Pentol to the address at right. I am enclosing \$12.95 plus \$2.95 for shipping charges in USA and Canada. All payments must be made in US funds. Sorry, no orders accepted outside of USA and Canada. New York State residents add local sales tax. Allow 6-8 weeks for delivery.

Check enclosed.

Please charge my Visa MasterCard

Signature _____

Account No. _____ Expir. Date _____

Name _____

Address _____

City _____ State _____ ZIP _____



Give a Friend a Year of Electronics Fun this Christmas...

Does fighting the crowds at Christmas short-circuit your holiday fun? Don't blow a fuse this year...for the friend who shares your love of project-oriented electronics — or a youngster who may need only a spark to ignite a life-long interest — give a gift subscription to Popular Electronics.

Popular Electronics readers get the know how they need to build exciting, educational, and useful projects like these...a professional-quality home-security system...an autoranging frequency counter...a nine-band shortwave receiver...a radio-controlled car...a telephone scrambler...an aviation receiver...and even a robot!

PLUS...Gizmo, our honest and straight-shooting review of the latest consumer-electronics gear...Market Center, featuring mail-order merchants that are ready to help you in all your hobby activities...articles and columns covering every aspect of the electronics hobby — including antique radio, shortwave listening, ham radio, computers, scanners, circuit design, and more!

SAVE MONEY...A great gift to receive, Popular Electronics is also a great gift for *you* to give! The Special Holiday Rate saves you \$25.05* off the newsstand price on each gift. You can save another \$25.05* when you start or extend your own subscription at the same time. It's our "thank-you" for sharing Popular Electronics with a friend at Christmas.

Send no money, unless you prefer. We'll be glad to bill you in January, 1995. Just take a brief moment to go over your gift list and make sure you haven't forgotten anyone who might appreciate the many benefits of Popular Electronics. Then write the names on the attached Gift Certificate and mail it back in the postage-paid reply envelope...we'll take it from there!

Your friends will receive a handsome gift announcement card signed with your name just before Christmas. And all through the new year they'll remember and appreciate your thoughtful gift! So don't blow a fuse...take it easy and enjoy the holidays. Give Christmas gifts of Popular Electronics!

Popular Electronics[®]

*Basic sub rate—1 yr/\$21.95

ELECTRONICS MARKET PLACE

FOR SALE

CABLE test chips. Jerrold, Tocom, S.A., Zenith. Puts cable boxes into full service model! \$29.95 to \$59.95. 1 (800) 452-7090. (310) 802-0841.

300 Experimenters Circuits — Complete in 6 practical books using diodes, relays, FET's, LED's, IC 555's, and IC CA3130's for building blocks. Only \$33.00 plus \$5.50 for shipping. USA and Canada only. US funds. ETT, INC., PO Box 240, Massapequa Park, NY 11762-0240.

CABLE descramblers and test turn-on kits available for most makes and models. No catalog, no 800 number equals your lowest prices. Call others, then compare our prices! We repair most cable equipment, and pay cash for unwanted cable boxes. No Florida sales. (305) 425-0751.

CABLE converters, accessories below wholesale! Immediate delivery from giant stock! COD orders only! 1 (800) 995-1749.

FREE CD-ROM and shareware catalog. Great prices, free disks. **DATA MATE PRODUCTS**, Box 2811, Lake Ronkonkoma, NY 11779.

NU-TEK ELECTRONICS Video Stabilizer **\$49⁹⁵**

FREE Catalog

CABLE TV EQUIPMENT



1-800-228-7404

NEW PICTURE IN PICTURE Stereo



PIP WORKS ON ALL TV'S. 181 CHANNEL CAPABILITY. REMOTE CONTROL. 4 SOURCE INPUTS

UPS FEDERAL EXPRESS 3250 Hatch Cedar Park TX 78613

THE Case Against Patents. Thoroughly tested and proven alternatives that work in the real world. \$28.50. **SYNERGETICS PRESS**, Box 809-C, Thatcher, AZ 85552. (602) 428-4073. Visa/MC.

CABLE TV converters/descramblers 2 year warranties on Jerrold, Zenith, Tocom, Scientific Atlanta. We service most converters. Money back guarantee. **NATIONAL CABLE SERVICES** (219) 835-4128.

SECRET cable descramblers! Build your own descrambler for less than \$12.00 in seven easy steps! Radio Shack parts list and free descrambling methods that cost nothing to try, included. Send \$10.00 to: **INFORMATION FACTORY**, PO Box 669, Seabrook, TX 77586. For COD's (713) 922-3512 any time!

PRINTED circuit boards — etched, drilled, tin plated. Single sided \$1.25/sq. inch. Free shipping. **CHELCO ELECTRONICS**, 61 Water Street, Mayville, NY 14757. 1 (600) 388-8521.

CB RADIO OWNERS!

We specialize in a wide variety of technical information, parts and services for CB radios. 10-Meter and FM conversion kits, repair books, plans, high-performance accessories. Thousands of satisfied customers since 1976! Catalog \$3.

CBC INTERNATIONAL, INC.

P.O. BOX 31500PE, PHOENIX, AZ 85046

CLASSIFIED AD ORDER FORM

To run your own classified ad, put one word on each of the lines below and send this form along with your check to:

Popular Electronics Classified Ads, 500-B Bi-County Boulevard, Farmingdale, N.Y. 11735

PLEASE INDICATE in which category of classified advertising you wish your ad to appear. For special headings, there is a surcharge of **\$11.00**.

() Plans/Kits () Business Opportunities () For Sale
() Education/Instruction () Wanted () Satellite Television

Special Category: \$11.00

PLEASE PRINT EACH WORD SEPARATELY, IN BLOCK LETTERS.

(No refunds or credits for typesetting errors can be made unless you clearly print or type your copy.) Rates indicated are for standard style classified ads only. See below for additional charges for special ads. **Minimum: 15 words.**

1	2	3	4	5
6	7	8	9	10
11	12	13	14	15 (\$23.25)
16 (\$24.80)	17 (\$26.35)	18 (\$27.90)	19 (\$29.45)	20 (\$31.00)
21 (\$32.55)	22 (\$34.10)	23 (\$35.65)	24 (\$37.20)	25 (\$38.75)
26 (\$40.30)	27 (\$41.85)	28 (\$43.40)	29 (\$44.95)	30 (\$46.50)
31 (\$48.05)	32 (\$49.60)	33 (\$51.15)	34 (\$52.70)	35 (\$54.25)

We accept MasterCard and Visa for payment of orders. If you wish to use your credit card to pay for your ad fill in the following additional information (Sorry, no telephone orders can be accepted.):

Card Number

Expiration Date

PRINT NAME

SIGNATURE

IF YOU USE A BOX NUMBER YOU MUST INCLUDE YOUR PERMANENT ADDRESS AND PHONE NUMBER FOR OUR FILES. ADS SUBMITTED WITHOUT THIS INFORMATION WILL NOT BE ACCEPTED.

CLASSIFIED COMMERCIAL RATE: (for firms or individuals offering commercial products or services) \$1.55 per word prepaid (no charge for ZIP code)...**MINIMUM 15 WORDS.** 5% discount for same ad in 6 issues within one year; 10% discount for 12 issues within one year if prepaid not applicable on credit card orders. **NON-COMMERCIAL RATE:** (for individuals who want to buy or sell a personal item) \$1.25 per word, prepaid...no minimum. **ONLY FIRST WORD AND NAME** set in bold caps at no extra charge. Additional bold face (not available as all caps) 30¢ per word additional. Entire ad in boldface, \$1.85 per word. **TINT SCREEN BEHIND ENTIRE AD:** \$1.90 per word. **TINT SCREEN BEHIND ENTIRE AD PLUS ALL BOLD FACE AD:** \$2.25 per word. **EXPANDED TYPE AD:** \$2.05 per word prepaid. Entire ad in boldface, \$2.45 per word. **TINT SCREEN BEHIND ENTIRE EXPANDED TYPE AD:** \$2.55 per word. **TINT SCREEN BEHIND ENTIRE EXPANDED TYPE AD PLUS ALL BOLD FACE AD:** \$2.95 per word. **DISPLAY ADS:** 1" x 2 1/2" — \$205.00; 2" x 2 1/2" — \$410.00; 3" x 2 1/2" — \$615.00. **General Information:** Frequency rates and prepayment discounts are available. **ALL COPY SUBJECT TO PUBLISHERS APPROVAL. ADVERTISEMENTS USING P.O. BOX ADDRESS WILL NOT BE ACCEPTED UNTIL ADVERTISER SUPPLIES PUBLISHER WITH PERMANENT ADDRESS AND PHONE NUMBER.** Copy to be in our hands on the 18th of the fourth month preceding the date of issue (i.e.; Sept. issue copy must be received by May 18th). When normal closing date falls on Saturday, Sunday or Holiday, issue closes on preceding work day. Send for the classified brochure. Circle Number 49 on the Free Information Card.

★ 1994 CATALOG ★
OF THE WORLD'S MOST FAMOUS
CB ANTENNAS & ACCESSORIES

— FIRESTIK ANTENNA —
 2614 E. Adams · Phoenix, AZ 85034
 Write or Call, 602-273-7151

BEST BY MAIL
 Rates: Write National, Box 5, Sarasota, FL 34230

MONEYMAKING OPPORTUNITIES

EARN \$500-\$1000 WEEKLY stuffing envelopes. For details — Rush \$1.00 with SASE to: KAPPaONE, PO Box 220, Clarion, PA 16214.

RECEIVE \$250,000 + CASH! NO JOKE! SASE: KERNs-(PE), BOX 45488, TACOMA, WA 98465.

Learn to fix computers!

Home study. Earn great money repairing troubleshooting, upgrading, and installing PCs. Free literature: 800-223-4542.

Name _____ Age _____
 Address _____
 City _____ State _____ Zip _____
 The School of PC Repair, Dept. JLL341
 6065 Roswell Road, Atlanta, Georgia 30328

CABLE descrambler liquidation. Major makes and models available. Industry pricing (example: Hamlin combos, \$44.00 each...minimum 10 orders). No California sales. **WEST COAST ELECTRONICS**, 1 (800) 628-9656.

PROTECT yourself and cash in on crime, security devices catalog and special offer, \$5.00, write **GEMINI ENTERPRISES**, PO Box 1658, Bristol, CT 06011-1558.

PLANS & KITS

60 Solderless Breadboard Projects in two easy-to-read pocket books. Complete with circuit descriptions, schematics, parts layouts, component listings, etc. Both books (BP107 & BP113) only \$11.90 plus \$3.50 for shipping. USA and Canada only. US funds. **ETT, INC.**, PO Box 240, Massapequa Park, NY 11762-0240.

SCHEMATIC design program. Free brochure. Write Dept. P., **SCHEME-ADDICT**, 8622 W. 44th Place, Wheat Ridge, CO 80033.

LASER plans. Build your own laser. Diagrams, construction tips, part sources. \$6.00. Satisfaction guaranteed. **K. HARRIS**, PO Box 290729, Phelan, CA 92329.

MAY THE SOURCE BE WITH YOU

Don't let the dark forces of ignorance defeat you. Right in this galaxy, you can tap into the source -- the free **CONSUMER INFORMATION CATALOG**. It lists more than 200 free and low-cost government publications on a variety of important topics. So dispel the darkness and get the source. Just send your name and address to:

• Consumer Information Center
 Department Source
 Pueblo, Colorado 81009

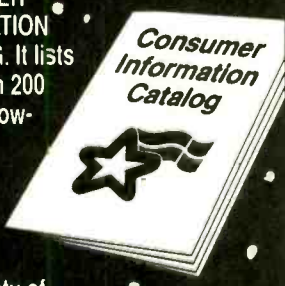

OF INTEREST TO ALL

FREE CD OR TAPE every time you buy another! Save hundreds \$\$\$! Complete details: Fine Tune Marketing, Post Office Box 7269-(PE), Sussex, NJ 07461.

HOW TO BUY FEDERAL surplus property. Simple instructions. \$1.00. **DECY**, Box 1294, Severna Park, MD 21146.

REAL MEN USE SCISSORS! Quality stainless set of 4: nose-hair, mustache/beard, "ice" haircutting, and one pair utility shears for your Workshop! \$16.95 pp. **SCISSOR LADY**, 72 Brink Road, Wantage, NJ 07461.

SPEAK A FOREIGN LANGUAGE. MAKE EASY PART-TIME MONEY. CALL: 1-310-827-1248.

RECYCLE PERSONAL COPIERS Cartridges. Instructions \$14.95. **Charles Bruns**, Box 543, Applegate, CA 95703.

WHAT HAPPENED ON THE DAY YOU WERE BORN?



This special report is **made to order** for you or the person you specify. Tells who shares your birthday (many famous people do!) Gives the headlines, the sports events, the songs, the movies, the price of items back then, and much more! *Suitable for framing!*

GIVE A COPY to a friend or family member! Makes a wonderful gift that will be long remembered! We will send it to you or the person you specify! Do your gift shopping this quick, easy way! *Not available in stores!*

Give us the **birthdate** (month-day-year), the **full name**, and (if you know it) the state the person was born in.

Each copy will be **personalized** with the recipient's name and birth information and printed on gold parchment-like paper and placed in a beautiful presentation portfolio. Only \$9.95, or 2 for \$17.50 (we pay shipping and tax!). Get one for yourself!

To order, call right now:
1-800-900-6974. Or mail order to:
 Conrad Germain, Dept 726-PE, 2020 Pennsylvania Ave., Washington DC 20006. **Money back guarantee! Visa, MasterCard welcome!**

TELEVISION VIDEOS

INEXPENSIVE, proven, colorbar generator alternative! Crosshatch, dot matrix, and more on high grade VHS. 30 minutes. Only \$23.95. **DLD DISTRIBUTORS**, 429 Cessna Road, Concord, NC 28025.

MASTERCARD AND VISA are now accepted for payment of your advertising. Simply complete the Classified Ad order form and we will bill you.

EDUCATION/INSTRUCTION

ELECTRONIC engineering. 8 volumes complete. \$109.95. No prior knowledge required. Free brochure. **BANNER TECHNICAL BOOKS**, 1203 Grant Avenue, Rockford, IL 61103.

BECOME an electronics engineer! Money for college available. Call (609) 266-2887 ext. 112 for recorded message.

BECOME an amateur radio operator ham. Information how \$3.00 **D&S INT.**, PO Box 73560, Metairie, LA 70033-3560.

DIGITAL electronics, learn at home or college for digital computers, full color illustrations 360 pages. Send \$29.95 to **PJ ENTERPRISES**, 26551 Sparks St., Highland, CA 92346.

ELECTRICITY/Electronics training series used by US military. 24 volumes, other courses available. Free info: **FEDERAL TECHNICAL PUBLISHERS**, Box 1218 E, Glen Lake, MN 55345.

ANTIQUE RADIO CLASSIFIED

Free Sample!
 Antique Radic's
 Largest Circulation Monthly.
 Articles, Ads & Classifieds.
 6-Month Trial: \$16.95. 1-Yr: \$31.95 (\$47.95-1st Class).
A.R.C., P.O. Box 802-L12, Carlisle, MA 01741



BUSINESS OPPORTUNITIES

MAKE \$75,000.00 to \$250,000.00 yearly. Learn IBM monitors repairs (solutions most brands). New home based business program. Software available. Information: **USA-Canada** \$3.00 cash (no checks). Dealers wanted worldwide (\$35.00) US funds. **RANDALL DISPLAY**, PO Box 2168-H, Van Nuys, CA 91404, USA.

EASY work! Excellent pay! Assemble products at home. Call toll free 1 (800) 467-5566 ext. 5730.

START your own technical venture! Don Lancaster's newly updated **Incredible Secret Money Machine II** tells how. We now have autographed copies of the Guru's underground classic for \$18.50. **SYNERGETICS PRESS**, Box 809-C, Thatcher, AZ 85552. (602) 428-4073. Visa/MC.

INVENTIONS

FREE invention package: **DAVISON & ASSOCIATES** offers customized development, patenting, and licensing for new products and ideas. Proven results: 1 (800) 677-6382.

Learn VCR repair!

Home study. Learn high-profit repairs without investing in high-tech instruments. **FREE BOOKLET:** 800-223-4542.

Name _____ Age _____
 Address _____
 City _____ State _____ Zip _____
 The School of VCR Repair, Dept. VRL341
 6065 Roswell Road, Atlanta, Georgia 30328



CIRCUIT CIRCUS

By Charles D. Rakes

Monitor/ Detector Circuits

Not too long ago a friend asked how he could check his computer's power supply to see if it was producing or passing glitches that were causing his computer to lock up and/or to lose data. So I offered the detector circuit shown in Fig. 1.

THE GLITCH DETECTOR

In the Fig. 1 circuit, two op-amps (half of an LM324 quad op-amp) and an SCR are direct coupled in a DC-voltage monitoring circuit. Op-amp U1-a is configured as a voltage follower, which feeds the bridged inputs of the second op-amp, U1-b. A

PARTS LIST FOR THE GLITCH DETECTOR (Fig. 1)

SEMICONDUCTORS

U1—LM324 quad op-amp, integrated circuit
SCR1—2N5061 0.8-amp, 60-PIV, silicon-controlled rectifier
LED1—Light-emitting diode (any color)

RESISTORS

(All resistors are 1/4-watt, 5% units.)
R1, R2—10,000-ohm
R3—4700-ohm
R4—1000-ohm

CAPACITORS

C1—0.1- μ F, ceramic-disc
C2—100- μ F, 16-WVDC, electrolytic

ADDITIONAL PARTS AND MATERIALS

S1—Normally open pushbutton switch
Perfboard materials, enclosure, IC socket, 12-volt power source, wire, solder, hardware, etc.

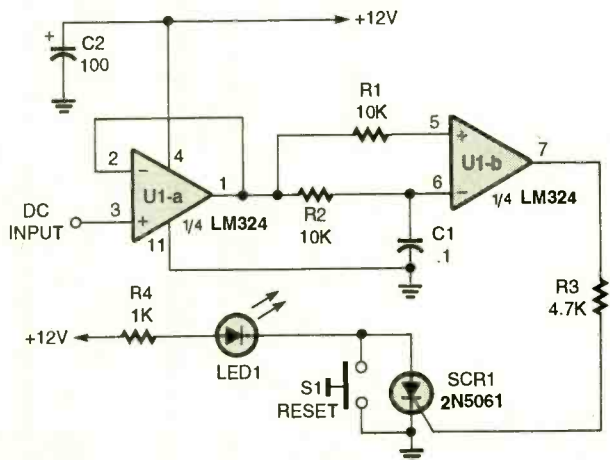

Fig. 1. In the Glitch-Detector circuit, two op-amps (half of a LM324 quad op-amp)—one of which, U1-a, is configured as a voltage follower—and an SCR are direct coupled in a DC voltage monitoring circuit.

resistor/capacitor combination (R2/C1) connected to the negative input of U1-b forms an RC time-delay circuit. As long as there is no change in the DC-voltage level at either of U1-b's inputs, its output is near zero. If a voltage glitch occurs, the RC timing circuit will delay the voltage change at the op-amp's inverting

input, causing its output to go high, triggering SCR1 and causing LED1 to light. The circuit's sensitivity allows it to detect voltage changes in the millivolt range. Pressing S1 diverts the SCR's holding current to ground, causing it to turn off and reset the circuit.

AC NOISE DETECTOR

The glitch detector can

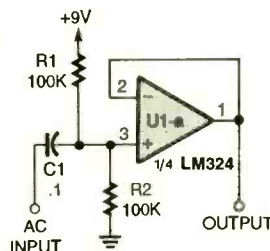

Fig. 2. The AC-Noise Detector is a simple adaptation of the glitch detector, in which the input circuitry has been modified by connecting U1-a's non-inverting input (pin 3) to a fixed DC voltage, and coupling the input to the circuit through a capacitor (C1).

also be used to monitor an AC power source by modifying the input circuitry (as shown in Fig. 2) by connecting U1-a's non-inverting input (pin 3) to a fixed DC voltage. Resistors R1 and R2 form a voltage divider that feeds half the supply voltage to the non-inverting input of U1-a. If the monitored voltage shifts up or down, the change is passed through C1 to the input of U1-a, and on to the inputs of U1-b, causing SCR1 (Fig. 1) to turn on, lighting LED1.

To desensitize the circuit, a resistor can be added in series with C1. In fact, you might consider using a potentiometer in series with C1 so that you can experiment with different resistance values to obtain the desired sensitivity.

LIGHT DETECTOR

Watching a TV surveillance monitor with "fixed eye" all day can be a boring task. The monitoring

circuit in Fig. 3 is designed to relieve the stress of that tiresome job. In that circuit, Q1 and SCR1 are connected as a simple light detector. As long as sufficient light hits Q1, it conducts, keeping its collector at near ground potential. Under that condition, no current flows to the gate of SCR1, so it remains off.

If, on the other hand, the light source fails for a brief period, Q1 turns off, causing its collector to go high and supply current to the gate of SCR1. That causes the SCR to turn on, thereby, turning LED1 on. The LED

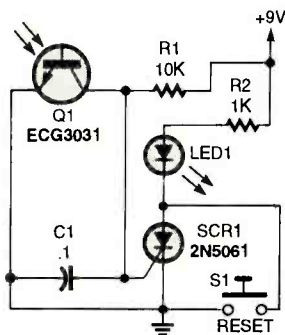

Fig. 3. The Light Detector is a designed to prevent security (and other surveillance) personnel from suffering "fixed eyeball fatigue."

remains on until the circuit is reset by pressing S1.

By placing Q1 over a lit area on a TV/monitor screen, the circuit becomes an electronic luminance sentry. If something gets between the camera and the object under surveillance, the light level sensed by Q1 drops, causing Q1's collector voltage to rise. That rise in voltage turns the SCR on, causing LED1 to light.

If an audible alert is required, a piezoelectric sounder can be connected across R2, so that when the circuit is triggered, the buzzer sounds off. The piezo sounder should be the type

PARTS LIST FOR THE AC-NOISE DETECTOR (Fig. 2)

U1—LM324 quad op-amp, integrated circuit
R1, R2—100,000-ohm, ¼-watt, 5% resistor
C1—0.1-μF, ceramic-disc capacitor
Perfboard materials, enclosure, 9-volt DC source, wire, solder, hardware, etc.

PARTS LIST FOR THE LIGHT DETECTOR (Fig. 3)

SEMICONDUCTORS

LED1—Light-emitting diode (any color)
Q1—ECG3031 or similar phototransistor
SCR1—2N5061 silicon-controlled rectifier

RESISTORS

(All resistors are ¼-watt, 5% units.)
R1—10,000 ohm
R2—1000-ohm

ADDITIONAL PARTS AND MATERIALS

C1—0.1-μF, ceramic-disc capacitor
S1—Normally-open pushbutton switch
Perfboard materials, 9-volt power source, wire, solder, hardware, etc.

that contains its own audio oscillator.

DARKNESS MONITOR

Our next monitoring circuit, see Fig. 4, reverses the operation of the previous circuit, turning on LED1 when light is detected. In that circuit, a 2N2222 general-purpose transistor, Q2, is added to the circuit in Fig.3. The additional transistor serves as an inverter, producing at its collector the complement to the signal at the collector of Q1.

When there's no light hitting Q1, its collector voltage is high, causing current to flow to the base of Q2, turning it on and pulling its collector low. With Q2's collector at near ground potential, no current flows to the gate of SCR1, so it remains off. When light hits Q1, its collector goes low and Q2's collector goes high, turning SCR1 on and lighting LED1.

AC POWER-FAILURE MONITOR

The monitoring circuit in

Fig. 5 can be useful in keeping an eye out for voltage glitches or failures that could cause computer problems. The AC Power-Failure Monitor in Fig. 5 keeps an eye on the AC power line and sounds an alarm whenever a power-line failure occurs. The circuit requires only a few microamps of current during normal operation, rising to a few milliamps when an alarm is sounded.

In that circuit, the AC-line voltage is fed directly to a full-wave bridge rectifier (comprised of D1–D4) through a neon lamp and a current-limiting resistor (R1). The DC output of the bridge rectifier is applied to the LED input of optoisolator/coupler U1. As long as AC power flows, U1's

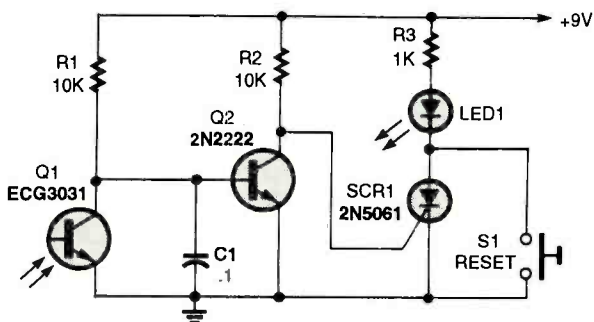

Fig. 4. The Darkness Monitor reverses the operation of the Light Detector, turning on LED1 when light is detected. To reverse the action, a 2N2222 general-purpose transistor, Q2, is added to the circuit to function as an inverter.

PARTS LIST FOR THE DARKNESS MONITOR (Fig.4)

SEMICONDUCTORS

LED1—Light-emitting diode, any color
Q1—ECG3031 or similar phototransistor
Q2—2N2222 general-purpose NPN silicon transistor
SCR1—2N5061 silicon-controlled rectifier

RESISTORS

(All resistors are ¼-watt, 5% units.)
R1, R2—10,000-ohm
R3—1000-ohm

ADDITIONAL PARTS AND MATERIALS

C1—0.1-μF, ceramic-disc capacitor
S1—Normally-open pushbutton switch
Perfboard materials, enclosure, 9-volt power source, wire, solder, hardware, etc.

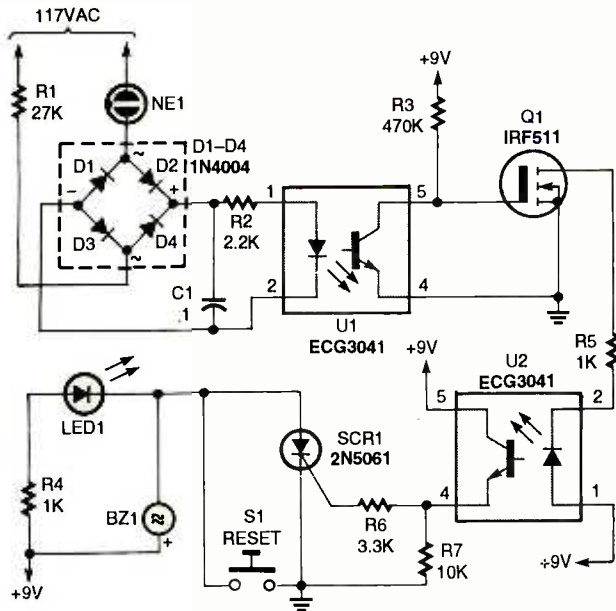

Fig. 5. The AC Power-Failure Monitor is an electronic "snitch" that sounds an alarm whenever a power-line failure occurs.

PARTS LIST FOR THE AC POWER-FAILURE MONITOR (Fig. 5)

SEMICONDUCTORS

U1, U2—ECG3041 optoisolator/coupler, integrated circuit
 SCR1—2N5061 sensitive-gate, silicon-controlled rectifier
 Q1—IRF511 HEXFET power FET
 D1–D4—1N4004 1-amp, 400-PIV silicon rectifier diode
 LED1—Light-emitting diode (any color)

RESISTORS

(All resistors are ¼-watt, 5% units.)

R1—27,000-ohm
 R2—2200-ohm
 R3—470,000-ohm
 R4, R5—1000-ohm
 R6—3300-ohm
 R7—10,000-ohm

ADDITIONAL PARTS AND MATERIALS

C1—0.1-µF, ceramic-disc capacitor
 NE1—NE2 neon lamp
 BZ1—Piezoelectric buzzer
 S1—Normally-open pushbutton switch
 Perfboard materials, enclosure, IC sockets, molded AC power plug with line cord, 9-volt power source, wire, solder, hardware, etc.

internal output-transistor is turned on, keeping its collector at near ground potential.

The gate of transistor Q1 (an IRF511 power FET), which is connected to the collector of U1's output transistor, is grounded through the output of U1, keeping it biased off. With Q1 biased off, no current flows through R5

and the U2's input LED. Thus, U2's output transistor remains off, and no current flows through R7. With no current flow through U2's output transistor, no gate bias is delivered to SCR1, keeping it in the off state, so the alarm will not sound.

When the power fails, the DC output of the bridge rectifier drops to zero, caus-

ing the LED in U1 to go out. At that point, the transistor in U1 turns off, causing its collector current to rise, supplying a gate-bias current to Q1, and causing it to turn on. That causes current to flow through R5, lighting U2's internal LED, and that, in turn, causes U2's output transistor to turn on, supplying gate current to SCR1 and causing it to turn on. Turning on SCR1 causes current to flow to the load

ode and transistor pairs. The first circuit (see Fig. 6) uses a digital voltmeter (DVM) to match the forward-voltage drop of two diodes. The circuit contains a bank of resistors (R1–R6) that are used to set the current flow through the two diodes (D1 and D2) being compared. The digital voltmeter functions as a null meter, indicating any difference between the forward voltage drop across the two

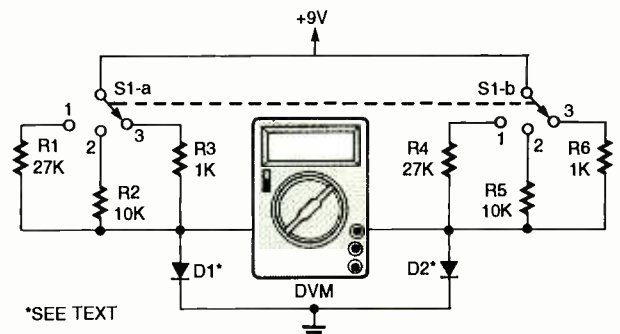

Fig. 6. To match diode pairs with this circuit, simply insert diodes of equal rating in the D1 and D2 positions. When the DVM reading drops to zero or nearly zero, you have found a set.

PARTS LIST FOR THE DIODE MATCHING CIRCUIT (Fig. 6)

RESISTORS

(All resistors are ¼-watt, 5% units.)

R1, R4—27,000-ohm
 R2, R5—10,000-ohm
 R3, R6—1000-ohm

ADDITIONAL PARTS AND MATERIALS

D1, D2—Diode under test (see text)
 S1—DP3T switch
 Perfboard materials, enclosure, DVM, 9-volt power source, wire, solder, hardware, etc.

circuit, lighting LED1 and causing BZ1 to sound.

The value of capacitor C1 can be increased to make the circuit ignore fast or very short power interruptions. You'll have to experiment to determine the capacitor value needed for your particular application.

DIODE MATCHING CIRCUIT

Our next two circuits are designed to help match di-

odes. A zero or near-zero DVM reading indicates a near perfect match.

There are three test-current levels available: When S1 is in position 1, the current is limited to about 8 mA; in position 2, current is held to slightly less than 1 mA; and in position 3, about 300 mA is available. Although the current levels available in the circuit were selected for signal diodes, the available current can
(Continued on page 90)

DX LISTENING

By Don Jensen

DX On The Tropical Bands

As fall approaches, it's a good time to turn some listening attention to the shortwave tropical bands. These are the lower SW frequencies, so nicknamed because most of the stations operating within these bands are located in the tropics. More specifically, there are four tropical SW bands: 120 meters, 2,300 to 2,495 kHz; 90 meters, 3,200 to 3,400 kHz; 75 meters, 3,900 to 4,000 kHz; and 60 meters, 4,750 to 5,060 kHz.

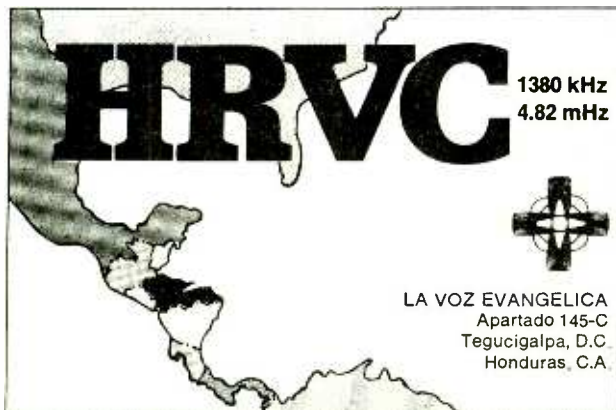

Here is a verification card from HRVC, a Honduras SW station that broadcasts in the 60-meter tropical band.

These, admittedly, are not the frequencies that a beginning SWL might choose. First, there is the "noise" problem during the warmer months. During the summer months, static bursts on the low SW bands can be unpleasant to the ears. But that sort of interference tends to quiet down somewhat with the reduction of lightning storms as the northern hemisphere moves from summer to autumn. Then there is the "language" problem. Many of these stations are directed at "home" audiences in the tropical

countries. Much of the programming you may hear is, for example, in Spanish or Brazilian Portuguese.

Not long ago, Rich McVicar, director of the ANDEX listeners club at HCJB, voice of the Andes, in Quito, Ecuador, put together his suggested list of the ten easiest countries to hear in the 60-meter tropical band. Rich says that with so many powerful stations on the higher shortwave frequencies, many of them programming in English, many SWLs may be perfectly happy to tune only those above 6,000 kHz. But, he notes, the listener who shies away from the lower tropical bands "would be missing the excitement, challenge, and enjoyable listening available. Even though the language may well be a different one than that of the listener, the DX'er nevertheless can understand bits and pieces, especially station identifications." Rich suggests these ten 60-meter targets for the SWL:

ECUADOR—*Radio Quito, La Voz de la Capital* in Quito, capital of Ecuador. All of their programming is in Spanish, with lots of news and information shows. The frequency is 4,920 kHz, and 0200 UTC is a good time to try.

COLOMBIA—*CARACOL* in Bogota, Colombia, has a hefty 50-kilowatt signal on 5,075 kHz, which should boom into many a listening "shack" throughout North America at around 0100 UTC. Years ago, this station was known as *Radio Sutatenza*, part of an educational system. Now it is

owned by one of Colombia's largest networks and identifies by its name. While *CARACOL* is actually an acronym for the full name, *Primer CAdena RADial COlombian* (meaning Colombia's No. 1 radio-broadcasting network), the word *caracol* also means snail in Spanish.

VENEZUELA—*Ecos del Torbes* broadcasts on 4,980 kHz from the city of San Cristobal in Venezuela's western state of Tachira. Its programs of Latin-American music and news, notes Rich, often are the first things an SWL will hear from Venezuela. Try tuning from around 0100 to 0400 UTC, when the station signs off with *Gloria al Bravo*, the Venezuelan national anthem.

HONDURAS—*From Tegucigalpa, the Honduran capital, there's HRVC, La Voz Evangelica de Honduras*, a religious broadcaster that is actually owned by the Conservative Baptist Home Mission Society in Wheaton, IL. That station uses 5 kilowatts of power on 4,820 kHz. Its programs are mostly in Spanish, but it does have some English-language programming from 0300 to 0500 UTC.

COSTA RICA—*TIFC*, San Jose, Costa Rica, is another widely heard Latin-American religious broadcaster. Its alternate name, *Faro del Caribe* means Lighthouse of the Caribbean. The 60-meter band frequency of 5,055 kHz should be the best option and it uses English for its programs between 0300 and 0400 UTC, though the rest of the schedule is broadcast in Spanish.

PERU—*Radio Ancash* in Huaraz is one of the most reliable of dozens of Peruvian stations, says Rich McVicar. It devotes much of its schedule to broadcasting Peruvian *huaynos*, a haunting type of folk music often recognizable by the high-pitched singing, accompanied by violins and guitars. Look for this one at about 0100 UTC on 4,991 kHz.

GUATEMALA—*Sistema Radial Tuezulutlan* in Coban, Guatemala, broadcasts in local Indian languages and some Spanish, but the identification, Radio Tezulutlan is not hard to pick out. Sound it out a few times until you are familiar with it—tesu-Loo-tlan. Tune this one at around 0200 UTC on 4,835 kHz.

CUBA—*Radio Rebelde* is a 60-meter tropical-band alternative to the more widely heard international broadcasts of *Radio Habana Cuba*. Radio Rebelde transmits on 5,025 kHz, in Spanish with some excellent Cuban rhythms. Listen at around 0200 UTC.

GHANA—From the Western Hemisphere, now we skip to West Africa and *GBC Radio One* in Accra, Ghana's capital, another tropical-band signal. Ghana Broadcasting Corp. puts in a very listenable signal almost nightly on 4,915 kHz, after its 0525 UTC sign on. Most programming is in English.

NIGERIA—Another West African SW regular is *Radio Nigeria*, in the northern Nigerian city of Kaduna, which uses 50 kilowatts—a comfortably powerful signal—on 4,770 kHz. Again,

Credits: Julianna Bickus, VA; Ralph Brandi, NJ; Richard D'Angelo, PA; William Davenport, TN; Jerry Klinck, NY; North American SW Association, 45 Wildflower Road, Levittown, PA 19057

that station has quite a bit of English programming. It signs on at 0430 UTC.

So there you have Rich McVicar's suggestions for ten easy countries to hear on the 60-meter tropical band. Some of you may have other favorite, easy-to-hear stations around this 4,750–5,060-kHz SW band. Drop me a line with your suggestions. Or maybe you have some general questions about SWL'ing? The address, as always, is "DX Listening," **Popular Electronics**, 550-B Bi-County Blvd., Farmingdale, NY 11735.

MILITARY MONITORING

Not surprisingly, one of the major users of radio frequencies is the U.S. Military. Many of these frequencies are in the VHF (very high frequency) and UHF (ultra high frequency) sections of the radio spectrum. Some—communications with submarines—are on VLF (very low frequencies), which penetrates deep into the oceans.

But a surprising amount of long-distance military communication can be found on the HF (high-frequency) shortwave bands. Many shortwave listeners—even those who aren't even aware of what they are hearing—have tuned across some of these SSB (single-sideband) signals.

When you begin listening to these transmissions, it can open a whole new dimension to the listening hobby. It has been a few years since I have done much monitoring of these military shortwave signals, and there have been some significant changes in that time. So it was with great interest that I read Steve A. Douglas' recently published *The Comprehensive Guide*

to Military Monitoring (Universal Electronics Inc., 4555 Groves Road, Suite 13, Columbus, OH 43232; \$19.95 + \$4 S&H).

A few words about monitoring the military: The first word is "legal." What Douglas describes in his 280-page comprehensive book is purely legal. The second word is "intriguing." No techno-jargon here. It includes everything a would-be monitor of the military channels would want or need in the way of information, including frequency listings.

Douglas notes that there's a lot to monitor on the SW frequencies, from strategic bombers on global missions to aircraft carriers at sea. U.S. military users of shortwave high frequencies are the Navy's HICOM network, the Air Force Global net, as well as the Mystic Star channels that are used to communicate with Air Force One and other VIP overseas flights.

But the real grabber, at least to me, was the final chapter of *The Comprehensive Guide to Military Monitoring*. It focuses on the latest facts and, yes, rumors surrounding covert and so-called "black" military projects, such as the supposed super-secret spy plane "Aurora." What did Douglas conclude about these topics as a result of his monitoring? You'll have to read it—as I did—to find out. Military SW monitoring is addictive.

DOWN THE DIAL

Here are some other 60-meter band stations that your fellow DX'ers have been tuning in:

BRAZIL—4,805 kHz. *Radodifusora Amazonas* is noted here at around 1030 UTC with echo announcements and

recorded promos in Brazilian Portuguese.

DOMINICAN REPUBLIC—4,780 kHz. *Onda Musical* has been reported on this frequency in Spanish at various times between 2200 and 0130 UTC.

COLOMBIA—4,865 kHz. *La Voz del Cinaruco* is a Colombian shortwave outlet being heard at around 0100 UTC. It was noted with an identification, supermarket ads, and a sports program, all in Spanish.

SOUTH AFRICA—4,810 kHz. South Africa's *Radio 2000* is heard with English and Afrikaans-language programming at about 0130 UTC.

TANZANIA—5,050 kHz. *Radio Uganda* is heard on this frequency from 0400 UTC, with announcements, news, and station identification in English, followed by a musical program. ■

ANTIQUÉ RADIO

(Continued from page 23)

S6, respectively. Preset capacitor C46 (selected by S7) tunes L7 for automatic station selection on the longwave band. Suffix letters on switch sections have the same meaning as before.

Moving over to the oscillator section, note that coils L12 (SW), L13 (MW), and L14 (LW) are tuned manually by C48 (which, though not indicated on the schematic, has to be ganged with antenna-tuning capacitor C47). Automatic tuning is accomplished by shunting preset inductances (L8, L9, or L10 for medium wave; L11 for longwave) across L14. Those are selected by additional sections of switches S4, S5, S6, or S7, respectively. ■

HAM RADIO

By Joseph J. Carr, K4IPV

Using Double Balanced Mixers

A frequency mixer is a nonlinear device in which two signals are combined to produce new frequencies. Such circuits are used in super-heterodyne receivers, direct-conversion receivers, frequency translators and converters, SSB transmitters, and in a host of other devices where one seeks to convert one frequency to another.

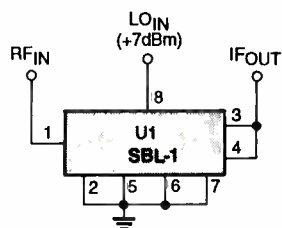

Fig. 1. Here's a basic configuration for the SBL-1. When only a resistive load is connected to the output terminals, the signal appears as an "amplitude modulated" kind of display, with a cacophony of frequencies floating around.

The standard mixer takes two signals, which we'll refer to as frequencies f_1 and f_2 , and produces an output spectrum of $mf_1 \pm nf_2$, where m and n are integers. Although the actual spectrum is quite rich, the principal components are those that exist when m and n are either 0 or 1, so we need only look at the following components: f_1 , f_2 , $f_1 + f_2$ and $f_1 - f_2$. Put in terms of superheterodyne receivers, those are the RF (i.e., f_1), the local oscillator, or LO, frequency (i.e., f_2), the sum intermediate frequency or IF ($f_1 + f_2$), and the difference IF ($f_1 - f_2$).

There are a number of mixer circuits available in

ham-radio and general-electronics literature. However, there is one class of mixer that is particularly well-suited to many ham needs: the double-balanced mixer (DBM). Various articles, based on a number of specialized or discrete components, have been published on how to build a DBM.

The mixer that we'll discuss is based on the very popular MiniCircuits SBL-1 mixer, which accepts RF and LO signals over the range 1 to 500 MHz, and produces IF outputs ranging from DC to 500 MHz. The SBL-1 is available from Ocean State Electronics—RO. Box 1458, 6 Industrial Drive, Westerly, RI, 02891; Tel: 401-596-3080 (voice); 800-866-6626 (orders only); and 401-596-3590 (Fax.)—for less than \$10.

Figure 1 shows a basic application for the SBL-1. The RF signal, which can have any level up to +1 dBm (1.25-mV rms), is applied to pin 1. The local oscillator (LO) signal, which must be about +7 dBm (5-mV rms) for good mixer action to take place, is applied to pin 8. All other pins are grounded.

When only a resistive load is connected to the output terminals of the SBL-1, the signal appears as

an "amplitude modulated" kind of display, with a cacophony of frequencies floating around.

MY EXPERIENCES

Recently I wanted to build a downconverter that would allow me to use my Boyd sweep generator (2–30 MHz) on low IF frequencies (e.g., 455 kHz) and the VLF bands (e.g., 85–340 kHz). I used a 3.58-MHz color-TV oscillator crystal and mixed it with the output of a 3.5- to 5.5-MHz voltage-tuned oscillator, which represented the sweep generator to be added later. The sweep of the VCO is controlled by a sawtooth signal from a function generator. The result is an output of 80 kHz to 1.92 MHz.

A DBM is different from single-ended mixers because it prevents the local-oscillator and RF-input signals from appearing in the output. The only signals that appear are the sum and difference IF signals ($f_1 + f_2$ and $f_1 - f_2$), assuming that the DBM is properly terminated in its characteristic impedance (50 ohms).

In my first attempt, a 9-element low-pass filter (see Fig. 2) designed for a cut-off frequency of 2 MHz was added to the circuit of Fig.

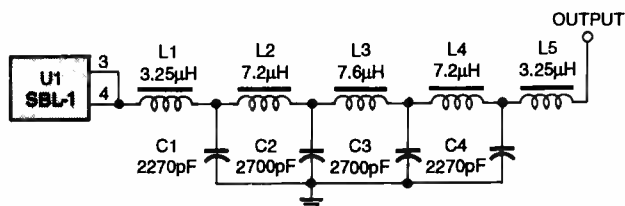

Fig. 2. Adding the 9-element filter to the basic circuit produced considerable improvement in the output, but it still contained the higher frequency element ($f_1 + f_2$).

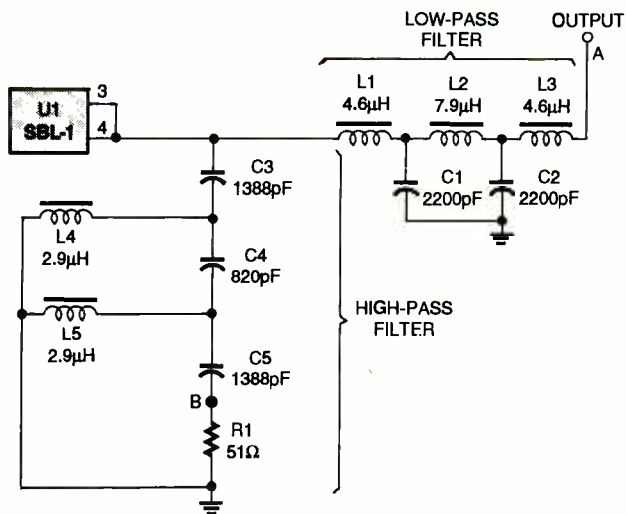

Fig. 3. The final circuit—known as a diplexer—used low-pass and high-pass filters connected across the output of the SBL-1. Both filters were designed for a 2-MHz cut-off frequency.

1. Adding the 9-element filter to the basic circuit configuration produced considerable improvement in the output, but it still contained the higher frequency element ($f_1 + f_2$).

Since the output wasn't as pure as I wanted it, I looked a little further in the DBM literature, and came across several articles that informed me that "proper termination" is required not

only for the desired frequency component, but for the unwanted component as well.

Figure 3 shows the final circuit—known as a diplexer—which consists of two filters (low-pass and high-pass) connected across the output of the SBL-1. Both filters were designed for a 2-MHz cut-off frequency. Because I wanted the difference IF, the output is taken from point "A." That point must be terminated in a 50-ohm load for both the filter and the SBL-1 to work effectively. The high-pass filter is terminated in a 51-ohm dummy-load resistor (R1). Because little power is used in that circuit, a 5%, 1/4-watt resistor can be used; if you wish, the single unit can be replaced by a pair of 100-ohm resistors connected in parallel.

The high-pass filter diverts any unwanted high-frequency components that survive the mixer action and absorbs them into the dummy load. If those signals were not absorbed, they would be reflected back into the mixer by the low-pass filter. That would cause mixer action to be less than it should.

The same circuit can be used for either possible case. In the example shown, the difference signal is output. If you want to output the sum signal, then connect the dummy load resistor (R1) to point A and take the output signal from point B.

The SBL-1 and filter combination has a loss that can approach -10 dB. Of that figure, about -7 dB of the loss is in the DBM itself, and the rest is made up in the filters. In order to make up for that loss, it is common practice to use a fixed-gain amplifier after the filter. The MiniCircuits

MAR-1 preamplifier that was covered in this column (November 1993 and March 1994) is ideal as a postamplifier. (The printed-circuit board and instruction manual for the MAR-1 preamplifier are still available from me for \$10 postpaid).

When I finally finished the circuit, and hooked it up to my Boyd Electronics sweep generator, I was able to test and align several low-frequency projects that are currently on my bench, as well as doing more development of several very-low-frequency (VLF), tuned-radio-frequency (TRF) receivers that I am working on. Those receivers are used by amateur scientists and students doing observations on solar disturbances. It seems that the sudden ionospheric disturbances that whack shortwave out of existence for hours or days actually enhances VLF reception.

Send me a self-addressed stamped envelope with two first-class stamps on it if you are interested in this subject. I'll send you a bibliography and a reprint of an article I did in a science-teacher's magazine on the topic.

FILTER NOTES

The two filter circuits used in Fig. 3 are designed for a cut-off frequency of 2 MHz when 50-ohm input and output impedances are used. That characteristic makes the high-pass version quite useful for suppression of AM broadcast-band signals at the antenna input of receivers. Similarly, the low-pass version can be used for keeping shortwave transmitters (such as ham transmitters) from interfering with AM broadcast-band receivers.

From Not-Working to Networking!

Troubleshooting Local-Area Networks!

Now, complete for the first time in one detailed booklet!

Gain a fuller knowledge of network fundamentals and how they developed from the early days of main frames, from XNS to Ethernet technology, the OSI stack for interconnecting different computers, basic and specialized test instruments, etc. Several tough LAN case histories bring from theory to the practical side of troubleshooting.



ONLY \$5.00

CLAGGK Inc., Reprint Bookstore
P.O. Box 4099, Farmingdale, NY 11735

Please rush my copy of "From Not-Working to Networking." I enclosed payment of \$5.00 which includes shipping charges.

Name _____

Address _____

City _____ State _____ ZIP _____

Sorry, no orders excepted outside of United States and Canada. All Payments must be in U.S. funds. Send check or money order payable to CLAGGK Inc.—do not send cash or stamps. New York State residents add applicable sales tax.

SCANNER SCENE

By Marc Saxon

Not-So-Private Security

Radio Shack's PRO-2030 is a good-looking desktop scanner. Made for the average scannist, it offers 80 programmable memory channels formatted into eight banks of 10 channels each. There are 10 additional monitor memories for temporary storage of interesting frequencies discovered during frequency searches. A front-panel key provides instant access to the NOAA weather band, and also a programmable priority channel.



This handsome desktop scanner from Radio Shack, the PRO-2030, allows users to search and scan in quick (50-channel-per-second) Hyperscan mode, or at a more leisurely 12 channels per second.

The PRO-2030's frequency coverage is liberal, consisting of 29 to 50 MHz and 137 to 174 MHz (scanned in 5-kHz steps), and 380 to 512 MHz and 806 to 956 MHz (scanned in 12.5-kHz steps). The two cellular bands are blocked out. The PRO-2030 also covers the VHF aeronautics band, 108 to 137 MHz, in 12.5-kHz increments.

The radio scans and searches with "Hyperscan" at 50 channels per second, or it can be switched to operate at a slower 12 channels per second. Intermediate frequencies are 10.8 MHz and 450 kHz.

Sensitivity in the VHF aeronautics band is 2.0 μ V. Between 29 and 54 MHz, the sensitivity is 0.5 μ V and from 137 to 174 MHz, it's 0.7 μ V. From 380 to 512 MHz, it's 1.0 μ V, and above 806 MHz, the set is rated at 0.8 μ V.

You can get a close-up look at the PRO-2030 at any Radio Shack store.

ON GUARD

The private security industry is booming. That growth has been spurred on by a combination of rising crime rates and police departments forced by budgetary restraints to operate below their full deployment strength. As a result, private guards, watchman, and security forces have been stepped up around factories, plants, construction sites, and office buildings. On duty day and night, they might provide on-premises security at entrances, in parking lots, and in other areas. Most are uniformed personnel, and many are armed. In almost all instances, the security companies operate their own communications systems.

Hundreds of local security and guard services are presently operating, plus several large, nationwide companies such as Borg Warner Security, Wackenhut

Corp, and Pinkerton's Security. Most companies operate through Business Radio Service repeaters in the general range of 461 to 465 MHz. Those communications can often be most interesting, and very similar to police communications.

Of the national companies, the stations operated by Pinkerton's are very active. Inasmuch as public-safety frequency guides almost never list private security forces, we thought we'd pass along some information on monitoring Pinkerton's. The frequencies indicated are believed to be in use in the parts of those states where the company operates.

In Tennessee, 461.16 MHz. In Indiana, 463.275 MHz. In New York, 462.075 and 463.525 MHz. In Pennsylvania, 463.525 MHz. In Nebraska, 461.125 MHz. In Texas, 461.025 MHz. In Arizona, 461.75 and 461.95 MHz. In Ohio, 461.9375, 463.415, and 462.275 MHz. In Missouri, 463.225 MHz. In Kansas, 463.825 MHz. In Alabama, 463.825 and 464.95 MHz. In Connecticut, 464.175 MHz. In Michigan, 464.70 MHz. In New Jersey, 464.25 MHz. In Virginia, 463.775 MHz. In North Carolina, 463.75 MHz. In Washington, DC, 463.925 MHz.

IT TAKES TWO

When both stations communicating with one another operate on the same frequency (as in VHF aeronautics radio or on the CB band), it's known as

simplex communications. When a repeater is being used, each of the two stations in communication must use a different frequency. That is called duplex operation. Typical examples include cellular phones, some two-meter amateur communications, and VHF ship-to-shore telephone calls. For instance, cellular mobile units transmit in the 824–845-MHz band, while the cell sites (repeaters) transmit back to them in the 869–894-MHz band.

Except in the instances where repeaters are used, VHF and UHF communications normally take place in simplex mode. Can any reader quickly name the one shining example of a VHF two-way radio service that doesn't use repeaters but often has base stations and mobile units that operate on different frequencies?

If you said the Taxicab Radio Service, you'd have been correct. As it turns out, taxi companies aren't obligated to use duplex. They are permitted to use simplex in their band, which runs from 152.27 to 152.465 MHz. Optionally, they can elect to have the cabs operate duplex by receiving the base station's 152-MHz transmissions but transmitting back to the base station on frequencies in the 157.53–157.725-MHz band. Many decide to go this route.

Why? The answer came from a cab driver I asked a few years back. He said that, originally, the cab company's base and vehicles all operated on the same frequency, but the boss was always angry. The boss claimed that the drivers were continually tying up the channel with foul language, griping about small tips, and generally

kidding around. The salty language and candid commentary offended passengers. What was worse, the dispatcher had to fight for use of the wonderful "party line" to send the cabs on calls. The answer was to exile the taxis to a channel where they could hear only the dispatcher and not one another.

That seems like as good a reason as any for the practice to be used so widely in this one radio service. A truly unique set of circumstances called for this strange, but effective, solution to a problem.

GASBAG

From time to time, we receive letters asking for the frequencies used by the Goodyear Blimp, which shows up at ball games and other events. From what I gather, there is more than one blimp operated by The Goodyear Tire and Rubber Company, but they are all similarly equipped.

Blimp air/ground, flight, and docking operations have been reported on 132.0, 151.625, 464.50, 464.55, 465.9625, and 465.9375 MHz. The specific frequencies used depend on the requirements of local broadcast facilities in the various areas visited by the blimps.

CORRECTION, PLEASE

A letter from William P. Chapman Jr., of Albion, Pennsylvania, asked for the frequency of a prison known as SCI Albion, located in his home town. Although I couldn't unlock a frequency for that specific facility, correctional institutions in Pennsylvania usually operate on at least two common frequencies, 45.16 and 453.325 MHz. Try plugging those channels into your scanner and see what you find.

CIRCUIT CIRCUIS

(Continued from page 84)

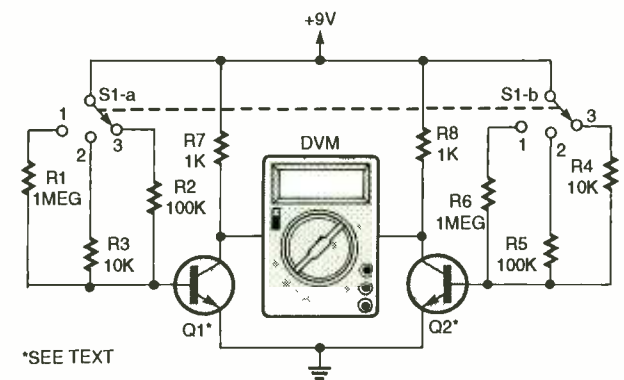

*SEE TEXT

Fig. 7. The Transistor Matching Circuit, like the diode version, simply compares like rated diodes to each other in order to ferret out pairs with identical or near identical electrical characteristics.

PARTS LIST FOR THE TRANSISTOR MATCHING CIRCUIT (Fig. 7)

RESISTORS

(All resistors are 1/4-watt, 5% units.)

- R1, R6—1-megohm
- R2, R5—100,000-ohm
- R3, R4—10,000-ohm
- R7, R8—1000-ohm

ADDITIONAL PARTS AND MATERIALS

- Q1, Q2—NPN transistor under test (see text)
- S1—DP3T switch
- Perfboard materials, enclosure, 9-volt power source, DVM, wire, solder, hardware, etc.

be easily increased (by decreasing the resistor values) for power diodes.

To match diodes using the circuit, place a diode in the D1 position. Then go through your other diodes one at a time, placing them in the D2 position while monitoring the meter for the lowest reading.

TRANSISTOR MATCHING CIRCUIT

The circuit in Fig. 7 can be used to match two transistors for current gain and/or collector saturation voltage. Switch positions 1 and 2 supply a low base current to the transistors being tested so that their current gain can be matched; position 3

is for matching the collector saturation voltage.

The circuit's base-current resistors were selected to match most general-purpose, low-power transistors. Darlington and other very high gain transistors require higher valued base resistors.

Looks like our space is used up for this visit. Good circuitry until we meet here again next month. ■

BE A GOOD NEIGHBOR

Volunteer.

American Heart Association

GROUND ZERO

(Continued from page 61)

fical accessories for those interested in LF/VLF communications, 1750-meter band operation, VLF/ELF natural radio phenomena, LF electronic countermeasures, and the like. Items offered include a transverter kit that allows any amateur-radio operator with 80-meter capability to operate on 1750 meters; the unit includes both a receiver up converter and a transmitter down converter. A high-performance 1750-meter band CW transceiver kit (described in the April 1994 QST) is also offered. Other products include VLF converters and pre-amplifiers, active-antenna systems, longwire and loop receiving antennas, and various accessories. Many of the Curry Communications products are distributed by LF Engineering Co.

Longwave Antennas. Variations on single-wires, longwires, end-feds, Marconis, and combination vertical and horizontal L's are common for LW reception. As a rule, you should get as much wire as possible in the air, and run it well clear of surrounding objects and noise-generating sources.

More familiar types of antennas are used for the upper-LW frequencies. One antenna that has been popular for many years on both long- and medium-wave frequencies is the wave or Beverage antenna. For general LW reception, it consists of a horizontal wire a wavelength or more long, oriented in the direction from which the desired signals arrive. It is usually suspended 10 to 25 feet above the ground and supported at intervals to relieve strain. The simplest Beverage is a single wire terminated in its characteristic impedance on the far end.

There are many types of horizontal and dual-polarized antennas you can adapt for LW applications, although very little has been written about them in recent years. The ARRL Antenna Book will give you some ideas and basic principles. In some ways, LW receiving antennas are much like those you might build for the 160-meter amateur band or for serious medium-wave broadcast band DX'ing, only on a larger scale.

There are some disadvantages to random-length single-wire antennas.

Even if the antenna could be made long enough for efficient signal pickup and good directivity, it would be difficult to take full advantage of the directional characteristic because it's impractical to reorient the antenna. Also, the long wire is likely to be severely affected from the high noise levels that prevail in most urban and suburban locations.

Loops are enjoying a new lease on life at the lower frequencies. That is because they can be made physically small, they can be resonated or tuned to a particular frequency, and they can be rotated to take advantage of their directivity. Most loops give a figure-eight pattern similar to that of a half-wave dipole.

Loops tend to be quieter than single-wire outdoor antennas, are less prone to swamping by strong local broadcast stations, and can be used to null out noise and interference. Some loops allow for greater noise reduction by enclosing the loop wires in a special, non-magnetic shield. That can markedly improve the overall signal-to-noise ratio of the received signal. However, some report poor results with indoor loops as a result of radiation from household wiring.

Palomar Engineers offers an excellent preamp/loop, that's adjustable in both azimuth and elevation, for use with its LW converter, or any LW receiver. The amplifier can be used with several plug-in loops to extend coverage into the shortwave frequencies.

So-called active-gain antennas using a steel-whip or wound-coil element and an antenna-mounted pre-amplifier are also very popular for LW. Some enthusiasts claim they make the best overall-LW receiving antennas. Typically such antenna systems are mounted outdoors, away from noise and distracting objects; the amplified signal is routed to the LW receiver through a length of coaxial cable whose shielding minimizes noise pickup.

For transmitting on 1750 meters, almost any type of antenna will suffice for casual experimentation, out to a mile or two. However, most serious operators use a short, loading-coil resonated vertical antenna, sometimes topped with a large "capacitance top hat," for best transmitter perfor-

mance. The vertical is used in conjunction with a substantial ground rod and a 25-30-foot radial system. As noted, the total length of the antenna, transmission line, and ground lead can't exceed 50 feet. Separate active (gain-type) whip antennas are popular for receiving on 1750 meters.

Going Further. If you want to learn more about this most interesting part of the radio spectrum, a good one-stop tutorial on LW is *The World Below 500 Kilohertz*, by L. Peter Carron, Jr. The 64-page mini-book, probably the only beginner's book on LW, provides an overview of LW and introduces many of the users of these frequencies. It's published by Universal Radio.

We think you'll find LW an interesting complement to the more conventional aspects of higher frequency radio communications. The microwaves may be more exotic, but there's still a lot to learn about the pioneering bands. Twist your dial far below the broadcast band and enjoy a form of radio communications you may not have known existed. ■



ISCED
Certified Electronics Technician
by a license by their province that

Your Ticket To

SUCCESS

Over 28,000 technicians have gained admittance worldwide as certified professionals. Let your ticket start opening doors for you.

ISCET offers Journeyman certification in Consumer Electronics, Industrial, Medical, Communications, Radar, Computer and Video. For more information, contact the International Society of Certified Electronics Technicians, 2708 West Berry Street, Fort Worth, TX 76109; (817) 921-9101.

Name _____
Address _____
City _____
State _____ Zip _____

Send material about ISCET and becoming certified.
Send one "Study Guide for the Associate Level CET Test." Enclosed is \$10 (inc. postage).



*From the Lab
to your
Living Room!*

Does your VCR have a "Head Cold?"

Probably not! However, through constant playing and using of degrading dry or wet cleaners, the output of your video tapes has slowly diminished to an unacceptable level and the VCR plays as if it has a head cold! The culprit is most likely clogged and dirty video and/or audio heads.

The **3M Black Watch™ Head Cleaner Videocassette** uses a patented magnetic tape-based cleaning formation to remove head clogging debris. No foreign substances such as cloth, plastics or messy liquids and no harsh abrasive materials are present. The cleaner's usable life is 400 cleanings or more!

It's easy to use. Place the **3M Black Watch™ Head Cleaner Videocassette** in the VCR and press the Play button. A pre-recorded message appears clearly on your screen and an audible tone is heard, telling you that the cleaning process is now completed. No guess work, you never over clean!

3M Black Watch™ Head Cleaner Videocassette **VHS** **VHS**.....\$19.95

Once your VCR's head cold is cured, and the unit plays like new, consider using the finest videocassette you can buy—the **3M Black Watch™ T120 Hi Pro VHS 4410 Videocassette**. The 4410 is the highest performing videocassette available today for use with all standard format VHS recording hardware!

Here's what you hear and see....A sharp, clear picture—brightest colors—freedom from streaks, flashes and snow—outstanding high-fidelity audio reproduction—optimum camcorder performance—maintains recording integrity. **3M Black Watch™** video tape is 100% laser inspected to guarantee surface smoothness and drop-out free performance.

3M Black Watch™ T120 Hi Pro VHS 4410 Videocassette **VHS**.....\$8.00

CLAGGK INC. — 3M VHS Special Offer
P.O. Box 4099, Farmingdale, New York 11735

Yes, I like your offer and here is my order for 3M Black Watch™ products!

___ 3M Black Watch™ Head Cleaner Videocassette	(\$19.95 each)	_____ \$
___ 3M Black Watch™ T120 Hi Pro VHS 4410 Videocassette	(\$8.00 each)	\$ _____
Shipping and handling per order		\$ 4.00
Total Amount in U.S. Funds only		\$ _____

New York State residents add local sales tax. Canadians add \$6.00 per order. No foreign orders. Do not send cash.

Bill my VISA MasterCard Expire Date ___/___/___

Card No. _____

Signature _____

Name (Please print) _____

Address _____

City _____ State _____ ZIP _____

HOME SECURITY SYSTEM

(Continued from page 40)

indicating that the system will be fully armed once the selected exit-delay time expires.

After the delay timer expires, a chirp should be heard on the external siren and the SYSTEM ARMED and the keypad ARM LED's should flash, indicating that the system is fully armed. Test each zone-bypass switch by turning it on and verifying that opening its corresponding zone door or window does not trip the alarm. If the alarm does trip, disconnect power and check the solder connections of the corresponding DIP-switch position. Also look for solder bridges along the traces running to pins 31 through 38 of the Z8.

After verifying the zone-bypass switches, re-enable all zones and check the non-delayed zone inputs (zones 2 through 8) to see that each trips the alarm when opened. After opening a zone door or window, go to the zone-status panel and verify that the corresponding zone LED is flashing. Reset the sirens by pressing the RESET switch on the main-control unit and repeat the test with the remaining non-delayed zones.

Once all the non-delayed zones have been tested, test the delayed-entry zone input by opening the corresponding protected door while the system is armed. The keypad warning buzzer should sound and the lights in the entry-zone should turn on (assuming an X-10 computer interface is set up properly and connected). If the system is not disarmed before the entry-delay timer expires, the alarm should trip and both sirens should sound. Whenever that alarm sounds and the system is not disarmed, the main-control unit will automatically reset the system in five minutes. You can verify that by timing the reset period with a stopwatch.

Finally, test the backup-battery operation of the main-control unit by disconnecting AC power and verifying that the BATTERY LED on the zone-status panel lights. Following the completion of the system-testing procedures, be sure to reconnect the auto-dialer and reinstall any fuses that were removed from the main-control unit during testing. ■

ONE-TUBE RADIO

(Continued from page 62)

The circuit is powered by batteries—a 6-volt lantern battery for B1, and ten 9-volt batteries for B2—to avoid power-supply hum. Battery operation is also safer for experimenters who are used to low-voltage solid-state equipment. If you want, you can use a 6.3-volt transformer to power the tube filament. Better yet, build a DC supply. A 5-volt power supply that will deliver 300-mA should work fine, and with only slightly reduced gain. The tube only draws about 4-mA from the B2 supply, so those batteries will last a long time. Any well-filtered source of 70 to 250-volts DC can be used though.

Construction. Construction of the radio is almost self-evident from the photo at the beginning of this article. The baseboard is a piece of 21-inch long, 8 × 1-inch pine. A couple of 1 by 4's underneath it help prevent splitting. A front panel can be added if you want.

The ten 9-volt batteries, are held in place by a couple of 1 × 2-inch boards. The tube is mounted in an octal relay socket. I added fahnstock clips under the connecting screws. Octal relay sockets from Amphenol (146-103), Custom Connector (OT08-PC), and Potter & Brumfield (27E122) are suitable. Of course, a conventional tube socket mounted on spacers could also be used.

The coil is wound from No. 22 enameled wire on a piece of plastic pipe 2-inches in diameter. The length of the winding is also 2 inches.

The audio-output transformer is on one end of the baseboard. Almost any tube-type transformer can be used as long as it's primary impedance is at least 1000 ohms (the higher the better), and the secondary is in the 4 to 16-ohm range. The better the quality of the transformer (which usually means bigger and heavier) the better the frequency response. The unused leads of the transformer are taped and tucked away underneath.

The two earpieces of the stereo headphones are connected in series and no connection is made to the "ground" terminal of the plug. If 8-ohm stereo headphones are used,

PARTS LIST FOR THE ONE-TUBE RADIO

RESISTORS

(All fixed resistors are ½-watt, 10% units.)

- R1— 22,000-ohm
- R2— 100-ohm
- R3—22,000-ohm
- R4—100,000-ohm potentiometer

CAPACITORS

- C1, C4—0.01-μF, 400-WVDC, electrolytic
- C2, C3—1-μF, 400-WVDC, electrolytic
- C5—365-pF variable
- C6—100-pF, 400-WVDC, electrolytic

ADDITIONAL PARTS AND MATERIALS

- V1—6SH7, 6SG7, 6SK7, or 6SS7, metal or glass vacuum tube (see text)
- D1—1N34 small-signal germanium diode
- B1—6-volt lantern battery
- B2—Ten, 9-volt batteries connected in series.
- L1—See text
- S1—DPDT knife switch
- T1—Tube-type high-fidelity output transformer (see text)
- Baseboard, angle brackets, socket for tube (see text), Fahnstock clips, screws, solder, wire, etc.

Note: All parts, or usable equivalents, are available from: Antique Electronic Supply, 6221 S. Maple Ave., Tempe, AZ 85283.

connecting them in series will present a total impedance of 16 ohms. So use the 16-ohm output connection of the transformer and connect the full primary winding between the movable contact of the volume control and ground for a start. After the radio is checked out, try different combinations to see what gives the best output and fidelity.

A number of different tubes may be used without any changes in the circuit. Among them are the 6SH7, the 6SG7, the 6SK7, and the 6SS7, and their "-GT" (glass-tube) equivalents. The first two listed give the greatest output in the circuit, but all will work and are reasonably priced—usually under \$4.

If you want to use 7-pin miniature tubes, the 6BA6, or its 12-volt filament cousin—the 12BA6—are excellent choices. "Battery-type" tubes, such as

the 1T4 were tried and found not to have enough gain.

All of the recommended tubes were very popular and should be easy to find for many years to come. The headphone jack, variable capacitor, volume control, and "A" battery are held in place by small angle brackets found in hardware stores. Fahnstock clips are used as tie-points so very little soldering is required.

Using the Radio. I use a 30-foot piece of wire across the ceiling of my basement as an antenna, but an outdoor wire as high, long, and in the clear as possible may be needed if you want to pull in distant stations. It's worth some time and effort to connect a good earth ground to the radio—it really makes a difference.

Close the power switch and allow a minute or so for the tube to warm up. With the volume control at maximum, tune the variable capacitor to the station you want. It's not really necessary, but you can center the bandpass exactly on the station by temporarily connecting a moving-needle type voltmeter in place of the transformer primary and tweaking the variable capacitor for maximum output.

I've had a lot of fun with this little radio and I'm sure you will too. It really does sound great! ■

TANDY

NATIONAL PARTS

WE HAVE THE PARTS FOR YOUR ELECTRONIC PROJECTS!!

PROGRAMMABLE TIMERS

BELTS ICS FUSES

BUZZERS CRYSTALS

CAPACITORS TRANSISTORS

EPROMS / PULLS

AT REASONABLE PRICES

CALL FOR

PRICE & AVAILABILITY

NO MINIMUMS

ORDER TOLL FREE

1-800-322-3690

ASK FOR OPERATOR # 732

"CATALOG KNOCKS SOCKS OFF"

For our free Catalog, just send your name and address to:

Consumer Information Center
Department KO
Pueblo, Colorado 81009

VFO'S

(Continued from page 44)

nal is taken from the source terminal through a 10-pF capacitor (C7). The signal is fed to gate 1 of the 40673 dual-gate MOSFET, which is used as an output-buffer/amplifier stage. That section produces a 44-dB gain, and is responsible for making the signal voltage so large. The output transformer (T1) consists of an Amidon Associates FT-50-43 core wound with 20 turns of No. 28 enameled wire for the primary, and 6 turns of the same wire for the secondary.

The circuit's output signal is huge as RF oscillators go, so it may have to be attenuated in some cases. That job can be done by connecting an attenuator resistor pad in series with the output signal, or by reducing the DC-bias voltage on MOSFET-gate 2. That job can be done by reducing the value of R4 until the desired output signal is achieved (do not reduce it below about 1k).

A version of the circuit using the NTE618 440-pF varactor diode was built without the mica trimmer capacitor (C2). It produced the frequency-versus-voltage (V_f) characteristic shown in Fig. 8 The varactor is comfortable over a range of 0 to 12 volts, although my DC power supply only goes down to 1.26 volts, which is why the plot appears incomplete.

Clapp VFO Circuit. The circuit in Fig. 9 can be identified as a Clapp oscillator by its series tuned LC network. The circuit can be used from 0.5 to 7 MHz, and even higher if C4 and C5 are reduced to about 100 pF.

The output of the circuit is taken from the source terminal of the JFET. The output circuit includes an RF choke (L2) that builds the output amplitude. Bias voltage for the JFET is provided by source-to-drain current flowing through R2.

NE602 VFO Circuits. The Signetics NE602AN is a double-balanced modulator (DBM) and oscillator. Normally, it is used as the RF front-end of radio receivers, but if the DBM is unbalanced by placing a 10k resistor between the RF input (pin 1) and ground, it will function as an oscillator that produces about a 500-mV output signal.

Figure 10 shows an NE602AN Colpits-oscillator circuit. Three capacitors (C1-C3) are used in this circuit rather than two because of a need for DC blocking. These capacitors should be equal to each other, and have a value on the order of $2400/f_{\text{MHz}}$ picofarads. The inductor should have an approximate value of $7/f_{\text{MHz}}$ millihenries. The tuning capacitor, C4, should have a value that will resonate with the selected inductor as follows:

$$C4 = 1/(L1(2\pi f)^2)$$

For example, a 5000-kHz (5-MHz) oscillator should have network capacitors of:

$$2400/5 = 480 \text{ pF}$$

or the standard value of 470 pF. The inductor should be 1.4 mH (17 turns on an Amidon T-50-2 red core). To resonate with the 1.4-mH inductor requires a total of 723 pF. The series network formed by C2 and C3 already provide 236 pF ($470/2$). Thus, the variable capacitor (C4) should be:

$$723 - 236 = 487 \text{ pF}$$

An NE602AN Hartley oscillator is shown in Fig. 11. The circuit is identified by the tapped coil in the LC network. The value of the inductor is about $10 \text{ mH}/f_{\text{MHz}}$ and is tapped from one-fourth to one-third the way from the ground end. The capacitor needs to resonate at the desired frequency. For our 5-MHz example, an inductor of 2 mH is used, which means 20 turns of wire on a T-50-2 (red) core.

A voltage-tuned Clapp NE602AN oscillator is shown in Fig. 12. The circuit uses a varactor diode to set the operating frequency. With the 100-pF capacitors shown, the circuit oscillates from about 6 MHz to about 15 MHz, using an NTE614 (33-pF) diode.

The oscillator circuits in this article can be used in any variable-frequency oscillator (VFO) application in the VLF through middle HF regions. Try 'em, you'll like 'em. ■



CAR SECURITY SYSTEM

(Continued from page 54)

vehicle and control the horn or lights. Bear in mind that both K1 and K2 remain deactivated when power is first applied to the receiver. They remain in that condition until activated by the transmitter signal.

As shown in Fig. 11A, the normally-closed contacts of K1 are connected in series with the +12-volt power source feeding the ignition module. Thus, when K1 is activated, the vehicle is disabled. The normally-open contacts of K2 can be connected to the existing horn-relay coil (as shown in Fig. 11B) to operate the horn. Alternatively, K2's contacts can be wired to any of the vehicle's lights (as shown in Fig. 11C). Both of the latter two circuits can be implemented, if desired, by using a double-pole, double-throw relay. Be sure to use a fuse (with an appropriate current rating) to protect the vehicle wiring.

If the single-channel option has been implemented, the relay will be energized when S1 is depressed and will de-energize when S1 is released. For that reason, the single-channel option should not be used to disable the vehicle. It could be used, however, if it is to operate only the vehicle horn or lights on a momentary basis.

Final Checkout and Operation.

Final checkout can be performed once the system is completely installed. The first test can be done by turning the receiver on and walking away from the vehicle. At some distance (say about 100 feet) stretch out the antenna wire and let it hang vertically. Set S3 to the on position and press S1. The horn or lights should operate. Set S3 to the off position and press S1. The horn or lights should be deactivated.

The disable test will require the help of an assistant. Have him or her drive the vehicle away while you hold the transmitter. Be sure the receiver is turned on. When the vehicle is approximately 100 to 200 feet away, set S2 to the DISABLE position and press S1. The vehicle should roll to a stop. To reactivate the ignition system set S2 to the NORMAL position and press S1. That should allow the vehicle to be restarted. ■

Market Center™

KASCO DISTRIBUTING Your Source for Electronic Tools and Technical Aids
12338 Martin Alexander Rd., Sardinia, Ohio 45171

FREE CATALOG



Computer Care Kit
5 1/4" disk #00648400 \$14.70
3 1/2" disk #00648395 \$14.70
Includes mini vacuum w/ 3 attachments, cleaning disk, head cleaning fluid, cleaning cloth, spray pump, cotton swabs & carrying case.



System Power Center
#01878805 \$28.50
Protect your system from damaging power surges & spikes. Five power switches & master control switch. 15 AMP circuit breaker. 12"(W) x 13"(D) x 2"(H).



PC Pocket Reference
#12148430 \$14.90
Handy reference book for the computer technician. Codes & numeric translation, video standards, keyboard scan codes, port pinouts and much more!

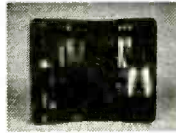

Deluxe 22 Piece Tool Kit
#06248325 \$33.80 (above)
Zippered carrying case includes diagonal pliers, crimper, soldering iron, screwdrivers, nutdrivers, tweezers & more. Call for more details.
Economy 11 Piece Tool Kit
#05947245 \$10.90



Deluxe Punch Down Tool
#04647595 \$36.80 (above)
Adjustable pressure regulator with slow compartment.



Universal Modular Crimp Tool (above)
#05446515 \$79.80
Cut-Strip-Crimp- all in one! Handset plug (4 pin), RJ11 1/12 (4 & 6 pin), DE/CMG offset (8 pin) RJ45 (8 pin) & 10 pin plugs. Customized hand grip. Tough steel construction.
Basic Crimp Tools
#05446495 \$12.50

Simcheck Memory Tester
#09747205 \$895.00
Identifies bad memory chips. Easy to use. Tests all SIMM & SIP memory modules 54Kx8/9, 256Kx8/9, 2Mx8, 4Mx8/9, 16Mx8/9. LCD display. AC adapter.

Modular Flat Telephone Wire

1-99ft	100-499	500+	Item No.	
4 cond.	.08¢	.07¢	.06¢	#02744400
6 cond.	.09¢	.06¢	.07¢	#02744405
8 cond.	.13¢	.12¢	.10¢	#02744425
10 cond.	.20¢	.19¢	.16¢	#02747955

- Telephone accessories
- Cable
- And more!!!

10% OFF
For New Customers
Offer expires 7/31/94



Order Toll Free
1-800-575-2726
24 HR FAX 513-446-2609

30 Day Money Back Guarantee!

CIRCLE 51 ON FREE INFORMATION CARD

MACHINE YOUR DREAM! THIS IS THE MACHINE YOU'VE BEEN WAITING FOR!

Have you ever dreamed of manufacturing and marketing your own products? If so, the Neuractor CNC-4 Desktop Manufacturing System may be just the edge you need! This fourth-generation CNC machining center can automatically drill, mill and route three-dimensional products in wood, plastic and light metals DIRECTLY FROM YOUR CAD DRAWINGS! You've seen the rapid-prototyping and "Santa Claus" machines that cost thousands of dollars, but did you know that as an electronic technician you can build one yourself from this inexpensive kit? Utilizing patent pending technology the Neuractor CNC-4 kit provides you with everything you need to machine products in three dimensions with a resolution of .001". All mechanical components are pre-fabricated, pre-machined, plated and painted. Includes four 83 oz/in CY-MOTORS, interface card, 5 amp power supply, 10 pitch steel lead screws, 4 proprietary Slide Block actuator mechanisms, 4 aluminum linear actuator channels, polished steel guide-rods, Dremel bracket, hardware, etc. (You provide Dremel or flex-shaft router and work surface.) It's a complete kit! All you do is put

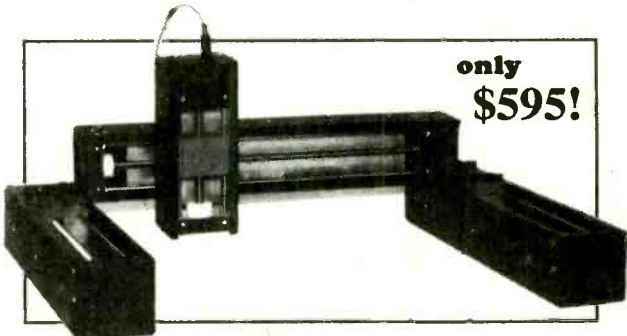

only
\$595!

it together and calibrate it! Using 32 screw-type micro-calibrators, you calibrate your machine and then TURN IT LOOSE! Designed to be used with a Dremel MotoTool(tm), or flex-shaft router for more cutting power, the Neuractor translates your 3D CAD files directly into actual working parts! IF THAT'S NOT EXCITING ENOUGH, WE'RE THROWING IN A FREE, FULL-FEATURED 3D CAD/CAM SOFTWARE PACKAGE WITH EACH UNIT! Imagine using your new Neuractor to experiment with different product designs and concepts BEFORE taking the business plunge! By working out your product's design and Desktop Manufacturing processes, you can virtually automate the "proof-of-concept" phase of your projects! Built-in fonts for custom sign-making and panel engraving, 18"x18"x4.6" cutter travel for crafts, electronics, and printed circuit board drilling, not to mention model-making, mold-making, and painting. These are but a few opportunity areas others are already exploring with their Neuractors. You build it, you calibrate it, you customize it for your applications! Don't miss out on your chance to cash-in on your own at-home business! Get started by ordering your own Neuractor CNC-4 today! ACT NOW! Kit \$595 +\$24.95 UPS S/H. Allow 4-8 wks for delivery. U.S. CYBERLAB, 14786 Slate Gap Rd., West Fork, AR 72774 (501) 839-8293





Get instant tech information FREE from your Fax or Computer!
 You can obtain specs, freq. info, software and more from our automated services. For fax facts, call from your stand alone fax machine and follow the voice prompts. Use the BBS from your modem of fax/modem equipped computer. Dial 317-849-8683 for fax back service, or dial 317-579-2045 for our computer bulletin board service.

Total Coverage Radios

TRIDENT
 TR1200XLT
 AM Broadcast to
 Microwave 1000 Scan
 Channels \$389.00

500KHz to 1300MHz coverage in a programmable hand held. Ten scan banks, ten search banks. Lockout on search and scan. AM plus narrow and broadcast FM. Priority, hold, delay and selectable search increments. Cell Lock. Permanent memory. 4 AA ni-cads and wall plus cig charger included along with belt clip, case, ant. & earphone. Size: 6 7/8 x 1 3/4 x 2 1/2. Wt 12 oz. Fax fact document # 205



TRIDENT
 TR4500 \$449
 2016 Channels
 1 to 1300MHz
 Computer Control

62 Scan Banks, 16 Search Banks, 35 Channels per second. Patented Computer control for logging and spectrum display. AM, NFM, WFM, & BFO for CW/SSB. Priority bank, delay/hold and selectable search. Cell Lock Permanent memory. DC or AC with adaptors. Mtng Brkt & Antenna included. Size: 2 1/4H x 5 5/8W x 6 1/2D. Wt. 1lb. Fax fact #305



TRIDENT
 TR980 \$279.00
 125 Channels
 5MHz to
 999MHz



Most Economical receiver in its class, offers AM, NFM Wide FM, modes. 5KHz increments. Delay & hold & Search. Cell Lock NiCads, chgr & whip ant. Size: 5 7/8H x 1 1/2W x 2 D. Wt 14oz.



Continuous Coverage



Three new Bearcat units offer expanded coverage and more memory than before. The 890 offers 200 channels, base/mobile operation, VFO tuning, service search, weather alert, search and store, and more. The 2500 hand held has 400 channels, fast scan and more. The Bearcat 8500 has 500 channels in 20 banks, VFO, auto store, alpha numeric display, 10 priority channels, aux tape output jacks, and coverage to 1.3 Gigahertz.

Bearcat 2500XLTA hand held.....\$349.95
 Bearcat 8500XLTC mobile.....\$389.95
 Bearcat 890XLTB mobile.....\$259.95
 25-1300MHz, 500 ch. in 8500, 400 in 2500, 890 has 200 ch & 29-956MHz. All cell locked. Features include turbo scan, VFO, search and store, Priority, LCD display, and more. Fax Facts#474,475,476



Mobile Scanners

TRIDENT
 TR2C
 Police & CB
 \$69.95



Scans police pre-programmed by state channel plus the CB channel of your choice. Also has Mobile Repeater and Weather. Extra cost option of CB and laser detectors built in. Compact size allows for dash or visor mounting. Mtng hardware and power connectors included. Size: 5 5/8 x 4 7/8 x 1 3/4. Wt: 1.5lbs. Fax fact #580

Bearcat 700AX 50Ch w/800..... \$159.95
 Bearcat 350A 50 Ch H/L/U..... \$119.95
 Bearcat 560XLJ 16 Ch H/L/U..... \$ 89.95
 Bearcat 760XM100Ch H/L/U/Air/800 \$219.95
 Bearcat T2 state/state scan..... \$144.95

Shortwave Radios

Sangean ATS-818CS..... \$219.95
 Sangean ATS-818..... \$184.95
 Sangean ATS-803A..... \$169.95
 Sangean ATS-808..... \$179.95
 Sangean ATS-606..... \$149.95
 Sangean ATS-606P..... \$169.95
 Sangean ATS-800..... \$89.95
 Grundig YB400..... \$219.00
 Grundig Satellit 700..... \$399.00



Hand Held Scanners

Bearcat 200XLTN
 \$209.95 200 Channels 800 MHz
 Ten scan banks plus search. Covers 29-54, 118-174, 406-512 and 806-956MHz (with cell lock). Features scan, search, delay, 10 priorities, mem backup, lockout, WX search, keylock. Includes NiCad & Chrgr. Size: 1 3/8 x 2 11/16 x 7 1/2.



Bearcat 120XL TJ 100Ch H/L/U..... \$149.95
 Bearcat 150XL TJ 100Ch H/L/U..... \$199.95
 Bearcat 220XL TJ 200 Ch H/L/U/8..... \$249.95
 Coverage of above hand helds is: 29-54, 136-174, 406-512, and 800MHz band as indicated. Fax facts #475

Table Top Scanners

Bearcat 855XLTE 50 Ch w/800..... \$159.95
 Bearcat 142XLM 10Ch H/L/U..... \$ 73.95
 Bearcat 147XLJ 16 Ch H/L/U/8..... \$ 89.95
 Bearcat 172XM 20Ch H/L/U/Air..... \$124.95
 Bearcat 145 16Ch H/L/U..... \$ 79.95

Accessories & Etc.

Mag Mount Mobile Ant MA100..... \$ 19.95
 Base Ant. 25-1000MHz AS300..... \$ 59.95
 Pre-Amp .1-1500MHz GW2..... \$ 89.00
 Wide Coverage Antenna..... \$ 119.95
 Base Discone Ant DA300..... \$ 89.00
 External Speaker MS190/opt. amp.... \$ 19.95
 Old Scanner Repair, all brands..... \$ CALL
 Extended Warranties..... \$ CALL
 Frequency Info Fax/Fact/Modem..... \$ FREE
 On Glass Mobile Antenna..... \$ 32.95

2 Way Radios

VHF hi band programmable mobiles as low as \$299.95. Call for quotes or Fax Fact #775



TRIDENT Winner of the 1994 INNOVATIONS Design & Engineering Honors, Electronic Industries Association. Trident TR2400 Total Coverage Receiver

Trident TR2400: 100KHz to 2060MHz. Ten scan banks of 100 channels each, ten search banks. Tuning increments as low as 1KHz. Beat Freq. Oscillator for SSB and CW modes. Search lockout and store. VFO tuning knob. Permanent memory. Bank lock and linking. Attenuator switch. Backlit LCD. 1 Yr Warranty. AM/NFM/WFM. Selectable increments. Delay, Hold, Priority. 5 7/8H x 1 1/2D x 2W. Wt 14 oz. \$499.00



Toll Free, 24 Hours! 800-445-7717 Fax Orders 800-448-1084 Fax Facts 317-849-8683
 Computer BBS Modem & Fax/Modem, 317-579-2045. Toll Free Tech Support, Dial 800-874-3468
 International Fax: en Espanol, en Francais, und auf Deutsch, or just fax in plain English to: 317-849-8794

ACE Communications 6975 Hillsdale Court, Indianapolis, IN 46250
 Service & Support hours: Mon.-Fri. 9AM to 6PM, Sat. 10-4 EST. Mastercard, Visa, Checks, Approved P.O.'s & COD (add \$5.50) & AMEX, Discover. Prices, specifications and availability subject to change. Flat rate ground shipping and handling charge only \$6.95 per unit. Express Air only \$9.95, for most units, to most locations. One week trial, no returns accepted two weeks after original receipt without substantial restocking charge. All units carry full factory warranty. Indiana residents add 5 per cent sales tax.





FLY IT! ONLY \$9.95

Popular Electronics, October 1994

96

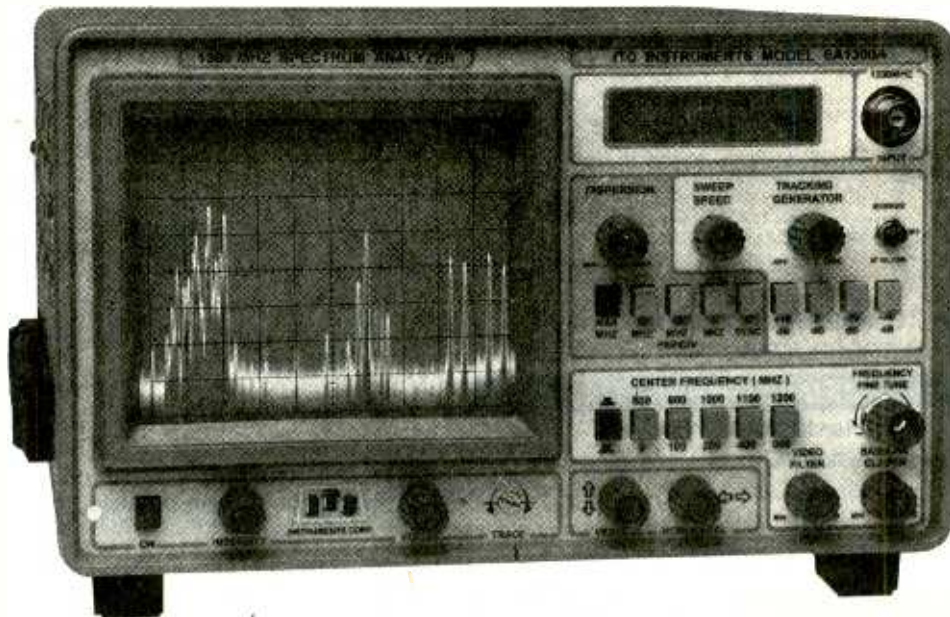
Simply A Superior 1.3 GHz Spectrum Analyzer



1-1300 MHz *In One Sweep* \$1,895.

MADE IN USA -10KHz Resolution Band Width -7 Digit Center Frequency Display

**MARINE, TWO-WAY, HAM, AM FM SW BROADCAST RADIO - CATV, SATELLITE. SYS., SURVEILLANCE
TUNE DUPLEXERS, AMPS, FILTERS, SECURITY TRANS, & RECEIVERS - EMI, RFI, FCC, TESTING**

EXCLUSIVE **DISPERSION ZOOM**

ITC SA Series exclusive Dispersion Zoom lets you zoom in on **any Center Frequency** signal, from any one of five calibrated Dispersion positions. Preset at >140 MHz, 50MHz, 10MHz 1MHz and zero MHz per division. The SA1300A displays greater than 1300 MHz on the screen at one time yet allows instant zoom to any Dispersion Scan Width as low as zero MHz per div. Allowing for total control over all **Dispersion Scan Widths** settings.

80 dB ON SCREEN

130 dB total Dynamic range 110 dBm **Sensitivity**. At Narrow and Wide Band Width settings. Performance you would expect only from a \$10,000 Analyzer.

ULTIMATE **LOW COST** ANALYZER

ITC Spectrum Analyzers are the best performance to price ratio Analyzers on the market today. No other low cost Analyzer comes close to the Superior performance and quality of an ITC Analyzer. **Total flexibility and ease of operation**. SA1300A gives you full control over the Resolution Band Width and Freq. Span widths. Plus Vertical Position, Baseline Clipper, Sweep Speed, Video Filter, 4 Input Attenuator settings, 10 Frequency Select settings.

MODEL **SA1800B 1800 MHz**

Covers 1-1300 MHz and 850-1850 MHz in one sweep. Ideal for Satellite service. The **SA1800B** has the same general specifications as the model SA1300A.

INTRODUCTORY OFFER

**SA1300A & OPT.s 1, 3, 6
ONLY \$1895.00** note 1

**SA1800B & OPT.s 1, 3, 6
ONLY \$2295.00** note 1
\$1995.00 Opt. 1, 6 ONLY

SA1300A	\$1595.00
SA1800B	\$1895.00
OPT. 1 50MHz MARKER	\$200.00
OPT. 3 +/- 5KHz Res B.W	\$350.00
OPT. 5 1000 MHz Tracking Generator	\$250.00
OPT. 6 7 Digit Center Frequency Display	\$300.00

Note 1: Introductory Price for limited time only.

TAKE **ADVANTAGE**

CALL 1-800-566-1818

To: Order - For information & Special Intro. Offer
Terms MC, VISA, AE, Check, COD, PO (OAC), LC, Transfer

DISTRIBUTED BY: **ADVANTAGE** INSTRUMENTS CORP.

3817 S. CARSON ST. # 818 CARSON CITY NV. 89701

1-800-566-1818 702-885-0234 FAX 702-885-7600

PRICES & SPECIFICATIONS SUBJECT TO CHANGE WITHOUT NOTICE OR OBLIGATION. F.O.B. CARSON CITY NV. NV. RESIDENTS ADD SALES TAX. 97

CIRCLE 138 ON FREE INFORMATION CARD

B. G. MICRO

P. O. Box 280298 Dallas, Texas 75228

Orders Only 1-800-276-2206

Tech Support 214-271-9834

Fax 214-271-2462



LCD DISPLAYS

- OPTREX 2x16-DMC 1620H-8 Bit ASCII Input. Dim. 3 1/8 x 1 3/4 x 3/8
Char. Height 19"..... **\$5.99**
- OPTREX 2x20-DMC 20261-8 Bit ASCII Input Dim. 4 9/16 x 1 7/8 x 3/8
Char. Height 19"..... **\$7.99**
- OPTREX 1 x 16 "Backlit"-DMC16187- 8 Bit ASCII Input Dim. 3 1/8 x 1 3/8 x 9/16 Char. Height .11"..... **\$9.95**
- OPTREX 1 x 20-DMC 20171-8 Bit ASCII Input Dim. 7 3/16 x 1 5/16 x 1/2
Char. Height .42"..... **\$9.95**
- OPTREX 2 x 40-DMC 40218-8 Bit ASCII Input Dim. 7 3/16 x 1 5/16 x 1 3/32
Char. Height .19"..... **\$9.95**

VERY EASY TO INTERFACE TO ALMOST ANY MICROPROCESSOR!

MFM CARD

MFM Hard Drive Controller
16 Bit Western Digital Hard Drive/
Floppy Controller

\$17.95

These controllers are getting very scarce.

DC/AC POWER CONVERTER

Plug in AC from a DC source.

Input 12VDC (13.8v) Output
110AC Continuous Power
240 watts 60 HZ +
1% modified sine waves
90% efficiency
1 1/2" x 5 1/2" x 3 1/2"
Plugs into cigarette lighter



\$79.95
+ Shipping

LASER PEN POINTER

Looks like a clip-on fountain pen

Wave length 660-680 nanometers

Max output 3 milliwatt..... **\$79.00**

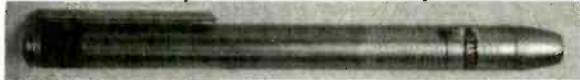

BATTERY BACKUP

Nicad Small Size
Leads solderable

3.6v.
\$6.95

BATTERY BACKUP FOR COMPUTERS

4.5V Alkaline sub. for
Rayovac
#840&844

\$5.95



CHINON CAMERA CX-103/3

3mm Lens
Power Requirements - 9VDC (7VDC - 16 VDC)
Power Consumption - 1W (80MA)
46MM (w) x 44 MM (h) x 25 MM (d)
Works excellent in the infrared range
Makes Great Spy Camera, Very Small.



Very low light 2 lux (F 1.8) **\$149.00**

UV ERASER

THE ULTIMATE PERSONAL

UV ERASER

The DII has a 2-8 minute internal timer with time out beeper. Six month unconditional guarantee. Complete documentation.



\$49.95

- Molded Plastic Case ● Shirt Pocket Size
- Auto Start ● Regulated lamp output for uniform erase time
- Erases most EPROM's/EPLD's in 3 minutes ● Handles all sizes to four at a time

EXPERIMENTERS KEY

For Microprocessor Application

Operating Life-over

5 million times

Operating Temperature

20 deg. to + 75 deg. C

Contact resistance

less than 30 Ohms

Contact bounce

less than 5 ms

\$4.95



EPROM SPECIAL

We bought a large quantity of 2708s, 2716s, 2532s, 2732s, 2764s, 27128s, 27256s, and 27512s from a computer manufacturer who redesigned their boards. We removed them from their sockets, erased and verified them, and now we offer the savings to you. Complete satisfaction guaranteed.

Your Choice	
2708.....	1/20 10/8.00
2716.....	1.75 10/15.00
2532.....	2.00 10/17.50
2732.....	2.00 10/17.50
2764.....	2.00 10/17.50
27128.....	2.50 10/20.00
27256.....	3.00 10/25.00
27152.....	4.75 10/40.00
1Meg.....	8.50 10/77.50
8741.....	7.00
8742.....	7.00
8748.....	7.00
8749.....	7.00
8751H.....	12.95
8755.....	7.00

DTMF

SSI-202 Decoder..... 2.25

8870 Decoder..... 2.25

5087 Generator..... 2.00

5089 Generator..... 1.25

M957 Receiver..... 2.25

Data 50¢ each

COOL IT DUDE!

Finned Heat Sink with Fan
Fits on CPU

\$11.45

EEPROM

2816.....	2.20
2864.....	3.45
28256.....	9.90

8000/80000

8001	5.20	8237	1.90	8088-2	3.25	8257	1.50
8002	2.50	8237-5	2.80	8155	2.25	8259 A	1.85
8010	4.95	8243	1.75	8158	2.25	8259C-5	2.10
8031	2.95	8250	2.95	8202A	8.00	8275	10.95
8032	3.95	(18450)	6.50	8212	1.25	8279	2.25
8035	1.00	(18550)	10.95	8214	2.00	8284	1.49
8038	4.95	8251	1.10	8216	1.25	8286	3.50
8039	1.00	8253-5	1.75	8224	1.25	8287	2.48
8085	1.55	8254	1.80	8228	1.75	8288	3.50
8088	1.55	8255	1.50			8530	3.00
8088	2.20	8255-5	1.75				

GAAIAS Plastic Infra-Red Emitter Diodes

OP290C - 150 MA Max. E_R (APT) 26 MW/CM² 100 MA T 1 3/4 E_B (APT) 300 MW/CM² 1.5 A pulsed; wide beam..... **3/\$1.00**
OP295C - 150 MA Max. E_B (APT) 77 MW/CM² 1.5 A pulsed T13/4 narrow beam. E_R (APT) 6.6 MW/CM² 100 MA..... **3/\$1.00**

TERMS (Unless specified elsewhere) Add \$3.25 postage, we pay balance on Orders Under \$100. Orders over \$50.00 add .85 for insurance. No C.O.D. Texas Res. add 8 1/4% Tax. 90 Day Money Back Guarantee all items. All items subject to prior sale. Prices subject to change without notice. Foreign order US funds only. We cannot ship to Mexico or Puerto Rico. Canada, add \$7.50 minimum shipping and handling. Countries other than Canada, add \$15.00 minimum shipping and handling.

IF YOU DON'T SEE WHAT YOU NEED CALL US. 1-800-276-2206

CALL OR WRITE FOR FREE CATALOG. 1-800-276-2206

KELVIN

ELECTRONICS

10 HUB DRIVE, MELVILLE, NY 11747

(800) 645-9212
 (516) 756-1750
 (516) 756-1763/FAX

Established 1945

M/C & VISA ^{#20 Minimum Order}

KELVIN CATALOG \$3
 Stock No. 650412



150 LE - Student 200 LE - Technician 300 LE - Auto-Range 400 LE - Engineer

KELVIN 100 Basic
 # 990087 **\$19.95**

- AC & DC VOLTAGES
- DC CURRENT
- RESISTANCE
- 3 1/2 Digit LCD
- CONTINUITY TEST
- -Buzzer
- LOW BATTERY INDICATOR
- DIODE TEST • BATTERY TEST



CAPACITANCE KELVIN METER 250 LE \$59.95
 # 990126

- 0.5% ACCURACY
- RANGES: 20mF, 2000uF, 200uF, 20uF, 2uF, 200nF, 20nF, 2000pF, 200pF
- Zero Adjust
- Safety Test Leads
- Test Socket for Plug-in Components



150 LE
 Stock # 990122
\$29.95

FREQ COUNTER
 up to 20MHz
CAPACITANCE
 from 1pF to 20uF
TRANSISTOR
 AC/DC CURRENT
 10 Amp

200 LE
 Stock # 990123
\$49.95

AUTO RANGE
 with 3200 counts
ACCURRENT
 DC CURRENT
 ANALOG BAR
 10 Amp

300 LE
 Stock # 990125
\$49.95

INDUCTANCE
 Resolution 1uH
FREQ COUNTER
 up to 20MHz
CAPACITANCE
 from 1pF to 200uF
 AC/DC CURRENT
 TRANSISTOR
 DUTY %
 20 Amp

400 LE
 Stock # 990124
\$79.95

Designed to meet IEC-348 & UL-1244 safety specifications.

Protective Cases

For Models 100 Basic, 150LE, 200LE, 300LE
 \$4.95 (#990088)
 Case For Model 400LE \$9.95 (#990116)

2 Year Warranty (Parts & Labor)

The Ultimate Meter

TRUE RMS - LCR - Hz - dBm

Popular Electronics (Reviewed - May 1993)

"Not only does the Kelvin 94 boast alot of features ... the features go the extra distance."

"If we had to run into a burning building to do some emergency trouble-shooting and could carry in only one piece of equipment, the Kelvin 94 would be it!"

12 INSTRUMENTS IN ONE -

DC VOLTMETER, AC VOLTMETER, OHMMETER, AC CURRENT, DC CURRENT, DIODE TESTER, AUDIBLE CONTINUITY TESTER, dBm, FREQ COUNTER, CAPACITANCE METER, INDUCTANCE METER, LOGIC PROBE

- 0.1% ACCURACY ON DC VOLTAGES
- TRUE RMS ON AC VOLTAGES & CURRENT
- FREQUENCY COUNTER TO 20 MHz
- LARGE EASY-TO-READ 3 3/4 DIGIT LCD DISPLAY
- AUTO SLEEP & AUTO POWER OFF BUILT-IN TO SAVE BATTERY LIFE with Bypass
- SHOCK RESISTANT HEAVY DUTY CASE WITH YELLOW RUBBER HOLSTER & TILT STAND
- WATER RESISTANT SEALED CASE
- 30 DAY MONEY BACK SATISFACTION GUARANTEE

\$199.95
 MODEL 94 #990111

COMES COMPLETE WITH YELLOW HOLSTER, PROBES, BATTERY, FUSE, STAND

0.1% ACCURACY on DC Voltages Water Resistant

Freq Counter to 20 MHz

Protective Cases for Model 94

Regular Padded Zippered \$9.95 (#990116)
 Deluxe Padded Zippered \$14.95 (#990115)

Meter is designed in accordance with safety requirements specified in IEC-348, UL-1244 VDE-0411.

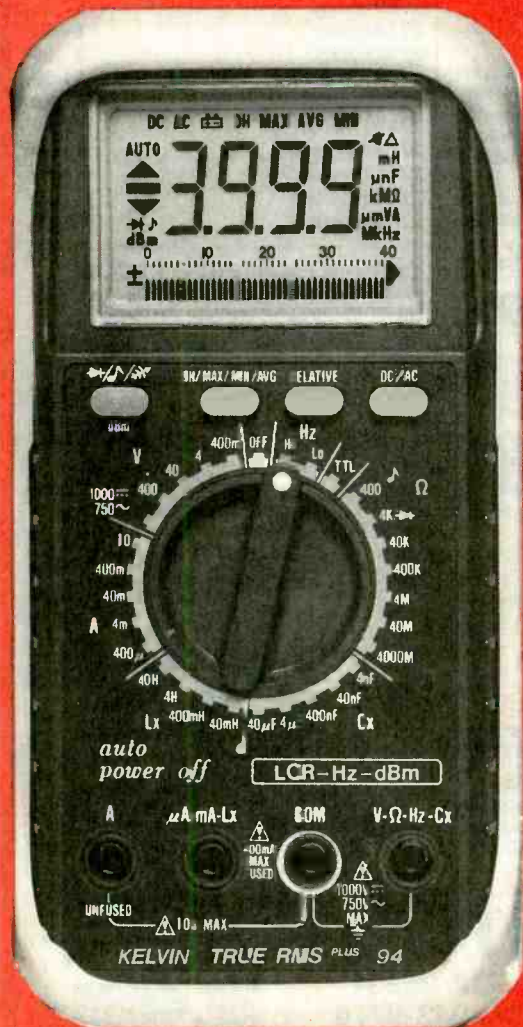

October 1994, Popular Electronics



QUICK-SHOOTER

Goes where regular scopes or DMMs can't. Cuts repair time by 50%. Tests parts without removing them from the board and gives each kind of component under test a specific signature on your oscilloscope. Available in kit form, with VHS video tape that explains how to assemble and use the Quick-Shooter. (94K002) **\$49.95 each**

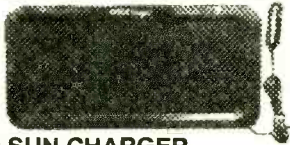

AUTO SUN CHARGER

Solar auto battery trickle charger. Approx. 13.5" x 7" x 0.625". Plugs into cigarette lighter socket. (94E007) **\$29.95 each**

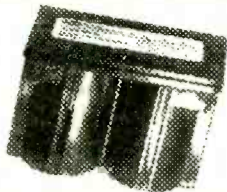

SEALED RECHARGEABLE BATTERY

4.0V @ 5Ah. Size 3.5" x 3" x 2". Gates P/N 0809-0010/D4V. (94E008) **\$4.95 each**

TAPE DRIVES

All units are new, with 30-day warranty.

- Archive 9050B **\$9.95 each**
- Archive 5945S-1 (SCSI) **\$19.95 each**
- Cipher F420-90 **\$9.95 each**
- Wangtek 5099EN24 **\$14.95 each**

STEPPER MOTOR DRIVER IC

UCN5804. Single step, two phase and half step modes. 1.5A rating. New (93E002) **\$4.50 each**

NYLON LACING TAPE

0.200" wide x 250 yards. Waxed finish, black. (94U017) **\$29.95/roll**

NYLON LACING CORD

0.15" wide x 250 yards. Waxed finish, white. (94U018) **\$29.95 /roll**

SWITCH BONANZA

Assorted switches. May include rotary, toggle, slide, "micro," breaker, pushbutton and weird. (92B012) **50 for \$4.95**



SIZE "D" NICAD BATTERIES

Strapped in pairs with welded contacts. May be separated with care. (94E009) **\$4.95**

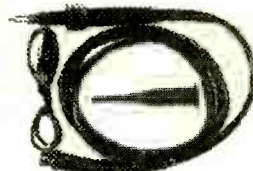

SCOPE PROBE #1

Attenuation: X1 @15 MHz, 60 pF, or X10 @ 60 MHz, 12pF. Working voltage: 600VDC (including AC peak). Working temperature range: -13°F (-25°C) to 158°F (70°C). Compensation range: 15pF to 50pF. Avex model #510-SW60S. (94Z001) **\$19.50 each**

SCOPE PROBE #2

Attenuation: X1 @ 10 MHz, 75 pF; X10 @ 100 MHz, 11 pF. Working voltage: 600 VDC (including AC peak). Compensation range: 15 - 50 pF. Includes 6" ground lead, spring hook, BNC adapter, I.C. tip, insulating tip, and trimmer tool. Avex model #510-SW-1. (94Z002) **\$24.50 each**

13.8 VDC

REGULATED POWER SUPPLY

Rated 5A continuous, 7A peak. Features include illuminated on/off switch, fuse, binding posts and cigar lighter socket. (94E006) **\$39.95 each**

USED VACUUM TUBES

\$1.00 each

12AU7	17DQ6
12B4	19AU4
12SK7	21LR8

50 Lb. CARE PACKAGE

Surplus goodies from Silicon Valley. This is not junk, just material we've acquired in quantities too small to catalog: electronic and mechanical subassemblies for everything from robots to rockets. Assortments may include IC's, caps, connectors, bearings, diodes, hardware, circuit boards, cables. Weird and wonderful stuff. We often get re-orders, so we assume most folks are happy with the assortments we send. Try one. (92U034) **50 Lbs. \$49.95**

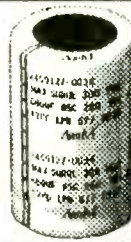

680µF 250VDC ELECTROLYTIC CAP

Radial snap-in type. (94P022) **\$3.49 each**

AUTHENTIC DENTAL EQUIPMENT CONTROLLER

"Moto-Tool" and container set includes:

- Controller-Cabinet for two tools - high/low speed and forward/reverse switch LED indicators. Beeps when in reverse.
- Single footswitch controls motor on/off.
- Stainless steel tray sits atop cabinet.
- AC power cord.
- One motor assembly with long coiled cord (autoclavable). (92Z031) **\$79.95**

EXTRA MOTORS FOR ABOVE

European-made high-performance DC motor with coiled cord. Motors require dental handpiece which is not supplied. (92Z032) **\$17.95**

SUPER BOOM MIKE

Mike = 500Ω, earphones = 100Ω; 0.25" monaural 3-conductor phone plug. Telex No. 500-3. (94A018) **\$39.95**

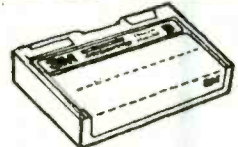

40MB DATA TAPE

... for mass storage. 3M P/N DC600A. (94C023) **\$9.95 each**

ADJUSTABLE VOLTAGE REGULATOR

LM350K. 3-37VDC @ 3A. (94I019) **\$3.25**



STAINLESS STEEL HARDWARE

Popular sizes used in electronic work. Assorted, may contain capscrews, Phillips. Sizes 4-40 and up. (92Z005) **3 Lbs. for \$5.99**

EPROM BLOWOUT!

Erase and save \$\$\$!

- 2708 (92I003) **\$.25**
- 2716 (92I004) **\$.75**
- 2732 (92I005) **\$.99**
- 2764 (92I006) **\$1.09**
- 27128 (92I007) **\$1.29**
- 27256 (93I013) **\$1.49**
- 27C256 (93I014) **\$1.69**
- 27512 (94I001) **\$1.79**
- 27C512 (92I008) **\$1.99**
- 27C010 (93I016) **\$2.99**

CARVER FM-STEREO DECODER

Works with existing tuner-receiver. Improves stereo reception of stations with weak signals and/or multipath distortion problems by as much as 20 dB. New, in box. Requires moving internal switch for 120V operation. (94A019) **\$99.95 each**

HIGH POWER SWITCHERS!

- ETA Power Systems #804-1212-AE: +5VDC @ 120A; -5VDC @ 10A; +12VDC @ 15A; -12VDC @ 15A. (94E010) **\$10.00 each**
- FDK #300-1020-02 +5VDC @ 100A; -5.2VDC @ 6A; +12VDC @ 3A; -12VDC @ 1.5A; +18VDC @ 1.5A. (94E011) **\$5.00 each**



STEPPER MOTOR ASSORTMENT

(92M001) **Ten for \$16.95**

24-Hour BBS
(408) 943-0622

9600 Baud • N-8-1
On-Line Ordering

ALLTRONICS
2300 Zanker Road • San Jose, CA 95131
Phone (408) 943-9773 • Fax (408) 943-9776

Visa, MC, AmEx cards accepted.
Minimum order \$15.00.
CA & OH residents add local sales tax.
Shipping additional on all orders.

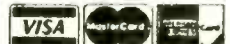

Electronic Chemicals

for Manufacturing, Maintenance & Service

The Next Generation Contact Cleaners, Conditioners and Preservatives

Even the finest equipment cannot guarantee noise-free operation. One "dirty" connection anywhere in the signal path can cause unwanted noise, distortion and signal loss. Considering the hundreds (if not thousands) of connections in electronic equipment today, it is only a matter of time before they begin to fail.

ProGold and **DeoxIT** increase the performance and reliability of electrical components and equipment. They provide long-lasting protection, reducing the expense of repeated cleaning with expensive ozone-depleting solvents. As a general rule, use **ProGold** for best performance and protection on plated surfaces and **DeoxIT** as a general purpose treatment.

ProGold™ Conditioner & Preservative

ProGold outperforms all other contact cleaners, enhancers and lubricants. Due to its unique properties, not only does it deoxidize and clean surface contamination, but it penetrates plated surfaces and molecularly bonds to the base metals. This increases conductivity and contact surface area and reduces arcing, RFI, wear and abrasion - the major cause of intermittent signals, distortion and signal loss. **ProGold** is the only product that conditions & protects plated surfaces and their base metals.



Environmentally-Safe!



Environmentally-Safe!



Environmentally-Safe!



DeoxIT™ & PreservIT™

Deoxidizes, Seals & Protects Electrical Connections

DeoxIT is a fast-acting, deoxidizing solution that cleans, preserves, lubricates & improves conductivity on all metal surfaces. Use as a general treatment for connectors, contacts & other metal surfaces.

PreservIT seals, lubricates and preserves metal surfaces for protection from oxidation and contamination. For use on clean/new surfaces or those pre-cleaned with **DeoxIT**.

Both have excellent migration properties that coat the surfaces and protect them from future oxidation & contamination. These formulas contain improved deoxidizers, preservatives, conductivity enhancers, anti-tarnishing compounds, arcing & RFI inhibitors and provide extended temperature range.



Environmentally-Safe!



Environmentally-Safe!



Environmentally-Safe!



OpticALL™ StaticALL™

OpticALL cleans, polishes and eliminates static electricity on optical viewing surfaces. **OpticALL** is also recommended as a general purpose antistatic cleaner on plastic, glass and metal surfaces. **StaticALL** neutralizes static build-up caused by friction & low humidity conditions. Use on carpets, floors, clothing & other static generating surfaces.



DustALL™ FreezALL™

DustALL quickly & safely removes dust, lint & particles from sensitive electronic equipment, computers, lab equip., optical grade surfaces & other mechanisms & equipment. **FreezALL** quickly and safely cools circuits to -54°C. Locates intermittent components due to heat failure and hairline cracks on PCBs.



MechanicALL™

High Penetrating Anti-Corrosive Anti-Tarnishing Cleaner & Lubricant. Lubricates & Protects; Displaces Moisture, Stops Squeaks, Migrates & Coats Entire Surface.



ElectricALL™

Rejuvenating Solution For All Electrical Applications. Cleans, Preserves, Improves & Protects Connections, Removes Corrosion & Oxidation, Reduces Wear, Abrasion, Arcing & RFI.



CaiKleen™ 41

Approved Freon TF replacement. Cleaning solvent for equipment and parts. Harmless to metal and most plastics & elastomeric parts. No residue, non-flammable, HCFC blend.



CaiKleen™ TRP

For degreasing, cleaning & defluxing equipment and parts. Removes oil, grease, dirt and contaminants including rosin flux from PCBs, components and metal parts. Biodegradable.

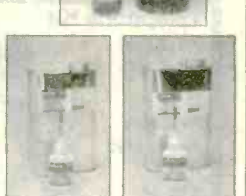

CaiKleen™ IPA

Ultra-pure isopropyl alcohol. Cleaning & degreasing solvent for removal of oil, grease & dirt from instruments, equipment & parts. Use on tape heads, discs, guides, switches, connectors, relays, and other parts for general cleaning.

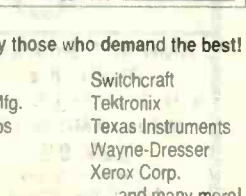

CaiLubé™ 360

Finest quality cutting and lubricating oil for use on various materials; cast-iron, stainless, titanium, gold, platinum, non-ferrous metals, synthetics, etc.

CaiLubé™ X-10S Instrument Oil

Contains silicone. Finest quality instrument oil for use on rubber, plastics and metals. Non-gumming, rust inhibiting, long lasting lubrication.

GAIG Products ... used by those who demand the best!

Boeing
 Dolby Laboratories
 E.I. Dupont
 Federal Express
 General Electric
 Hewlett Packard

Honeywell
 John Fluke Mfg.
 McIntosh Labs
 Motorola
 Nakamichi
 RCA

Switchcraft
 Tektronix
 Texas Instruments
 Wayne-Dresser
 Xerox Corp.
 ... and many more!

CALL TOLL FREE
1-800-292-7711
1-800-445-3201 (Can)

C&S SALES

EXCELLENCE IN SERVICE

**WRITE FOR
FREE CATALOG**



**Line Tracker
MV-963
\$52.95**
(Infra-red Sensor)
The robot follows
a black line
on white paper
Preassembled PCB



**Dual-Display
LCR Meter
w/ Stat Functions
B+K Model 878
\$239.95**
Auto/manual range
Many features
with Q factor
High Accuracy

Electronic Tool Kit Model TK-1000
A professional organizer tool kit at affordable prices. No student should be without this unique tool kit that holds all the tools you need.
Including:

- Diagonal Cutter
- Long Nose Pliers
- 6" Wire Stripper
- Solder 60/40
- 6" Screwdriver
- 6" Phillips Driver
- Safety Goggles
- IC Puller
- 3pc Nut Drivers
- Iron 25W
- Iron Stand
- Solder Wick
- Desoldering Pump
- 5 pc Solder Ease Kit
- 6pc Precision Screwdrivers



\$39.95



**Robotic Arm
Y-01
\$49.95**
(Wired Control)
Movement grabs
& releases,
lifts & lowers,
pivots from side to side



**Stereo Cassette Player
Kit
Model
TR-18K
\$16.95**
Headphones
Included



**Digital
Multimeter
EDM-83B
\$175.00**
Almost every
feature available
Bargain of
the decade

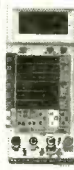

**Digital
Multimeter
DVM-638
\$39.95**
11 Functions
with case



**Digital
Capacitance
Meter
CM-1555
\$49.95**
Measures capacitors
from .1pf to 20,000µf



**Digital
LCR Meter
LCR-680
\$79.95**
3-1/2 Digit
LCD Display
Inductance
1uH to 20MΩ



**Function
Generator
FG-801
\$149.95**
Square,
Triangle
Sine wave
Freq range



**3-3/4 Digit Multimeter
BK-390
\$139.00**
0.1% DCV acy
Analog bar graph
Auto/manual ranging
Capacitance meas
Temperature probe



**Digital
Multimeter Kit
w/ Training Course
M-2665K
\$49.95**
Full function 34 ranges
Ideal school project
M-2661 (Assembled) \$55.00



**Frequency Counter
F-1225
\$225.00**
8 Digit LED display
Wide meas range
High sensitivity
Data hold function
Input impedance 1MΩ or 50Ω
10:1 input attenuation function

**Fluke Multimeters
(All Models Available Call)**
Scopemeters **70 Series**
Model 97 \$1,795 Model 701I \$69.95
10 Series Model 731I \$97.50
Model 10 \$62.95 Model 771I \$149
Model 12 \$84.95 Model 791I \$175
20 Series **80 Series**
Model 291I \$175 Model 87 \$289



**Triple Power
Supply
XP-620
By Elenco
\$75.00**
3 fully regulated supplies; 1.5-15V @ 1A, -1.5 to -15V @ 1A or 3-30V @ 1A & 5V @ 3A Kit XP-620K \$49.95



**Quad Power
Supply
XP-581
By Elenco
\$79.95**
Four supplies in one unit; 2-20V @ 2.5A, 5V @ 3A, -5V @ .5A and 12V @ 1A. All regulated and short protected



**High Current DC
Power Supply
BK-1686 \$169.95**
3 to 14 VDC Output
12A @ 13.8V
For servicing high
power car stereos,
camcorders, ham radios, etc.
Connect 2 or more in parallel



**Wide Band
Signal
Generators
SG-9000
\$124.95**
RF Frequency 100K-450MHz
AM modulation of 1KHz Variable
SG-9500 150MHz \$239.00

**Telephone Kit
PT-223K
\$14.95**
Available
Assembled
PT-223
\$15.95



**Function Generator
Blox
#9600
By
Elenco
\$29.95**
Kit \$26.95
Sine, Triangle, Square Wave



**Learn to Build & Program
Computers with this Kit**



**MM-8000
By Elenco
\$129.00**
From scratch you build a complete system. Our Micro-Master trainer teaches you to write into RAMs, ROMs and run a 8085 microprocessor, which uses similar machine language as IBM PC.

**Digital/Analog Trainer
Complete Mini-Lab For Building,
Testing, Prototyping Analog and Digital**



**By Elenco
in U.S.A.**
**XK-525
\$159.95**
Kit
**XK-525K
\$129.95**

**AM/FM Transistor
Radio Kit
with Training Course
Model AM/FM 108
\$27.95**
14 Transistor, 5 Diodes
Easy to build because
schematic is printed on the PCB
Makes a great school project
Model AM-550 AM Only \$17.95

**Telephone Line
Analyzer
Kit TT-400K \$19.95
Assembled TT-400 \$26.95**



WE WILL NOT BE UNDERSOLD
UPS SHIPPING: 48 STATES 5%
IL RES 7.5% TAX (\$3 min \$10 max)
OTHERS CALL

C&S SALES INC.
1245 ROSEWOOD, DEERFIELD, IL 60015
FAX: 708-520-0085 (708) 541-0710



**15 DAY MONEY BACK
GUARANTEE
FULL FACTORY WARRANTY**

PRICES SUBJECT TO CHANGE WITHOUT NOTICE

**FREE PROBES
WITH ALL
SCOPES**

**ELENCO ♦ HITACHI ♦ B+K
SCOPES
AT GUARANTEED LOWEST PRICES**

**WRITE FOR
FREE
CATALOG**

QUALITY - ELENCO OSCILLOSCOPES

2-YEAR WARRANTY

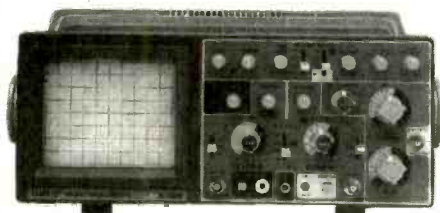

60MHz

S-1360 \$775

Delayed Sweep

S-1365 \$849

Cursor Readout

- ♦ Voltage, Time
- ♦ Frequency differences displayed on CRT

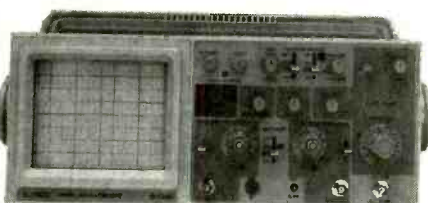

40MHz

S-1340 \$495

2- Channel

S-1345 \$575

Delayed Sweep

- ♦ Beam Find
- ♦ Component Tester

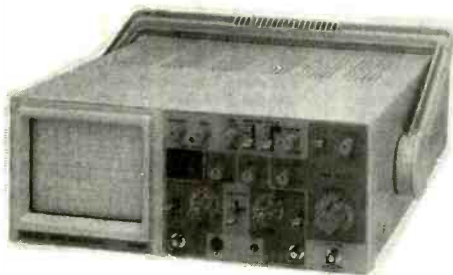

25MHz

S-1325 \$349

2- Channel

S-1330 \$449

Delayed Sweep

- ♦ Beam Find
- ♦ Component Tester

Dependable Equipment at Affordable Prices

B+K 20MHz

2 Channel

Model 2120 \$389.00



Delayed Sweep

Model 2125 \$539.95

40MHz DUAL-TRACE

Model 1541B \$749.95

- 1mV/div sensitivity
- Video sync separators
- Z axis input
- Single sweep
- V mode-displays 2 signals unrelated in frequency

60MHz DUAL-TRACE

Model 2160

\$949.95

- 1mV/div sensitivity
- Sweep to 5ns/div
- Dual time base
- Signal delay line
- Component tester
- V mode-displays 2 signals unrelated in frequency

100MHz THREE-TRACE

Model 2190

\$1,379.95

- 1mV/div sensitivity
- Sweeps to 2ns/div
- Dual time base
- Signal delay line
- 19kV accelerating voltage
- Calibrated delay time multiplier

**20MHz ANALOG with
DIGITAL STORAGE**

Model 2522A \$869.95

- 20MHz analog bandwidth
- 20MS/s sampling rate
- 2k memory per channel
- 20MHz equivalent time sampling

HITACHI POPULAR SERIES

V-212 - 20MHz, 2 Channel	\$425.00
V-222 - 20MHz, DC Offset	\$695.00
V-422 - 40MHz, Dual Trace	\$849.00
V-522 - 50MHz, Dual Trace	\$975.00
V-523 - 50MHz, Delayed Sweep	\$995.00
V-525 - 50MHz, w/ Cursor	\$1,069.00

HITACHI COMPACT SERIES SCOPES

V-660 - 60MHz, Dual Trace	\$1,375.00
V-665A - 60MHz, DT, w/cursor	\$1,449.00
V-1060 - 100MHz, Dual Trace	\$1,549.00
V-1065A - 100MHz, DT, w/cursor	\$1,695.00
V-1085 - 100MHz, QT, w/cursor	\$2,125.00
VC-6045A - 100MHz, Digital Stor	CALL
VC-6025A - 50MHz, Digital Stor	CALL

**Elenco DS-203 20MHz, 10MS/s
Digital Storage Oscilloscope**



\$749

2K Word Per Channel • Plotter Output
8 Bit Vert. Resolution • 2048 Pts Hor.
Resolution • Much More.....

FLUKE SCOPEMETERS

A handheld instrument that combines a 50MHz, 25MS/s dual channel digital storage oscilloscope with feature-packed 3000 count digital multimeter.



Model 93 - \$1,225
Model 95 - \$1,549
Model 97 - \$1,795

- Autoset, automatically sets voltage, time & trigger
- Multimeter display;
- 3-2/3 digits (>3000 counts)
- True RMS volts; AC or AC+DC up to 600V

C&S SALES INC.

1245 ROSEWOOD, DEERFIELD, IL 60015
FAX: 708-520-0085 (708) 541-0710

CALL TOLL FREE

1-800-292-7711

1-800-445-3201 (Can)



**15 DAY MONEY BACK GUARANTEE
FULL FACTORY WARRANTY
ALL PRODUCTS ARE FACTORY NEW**

PRICES SUBJECT TO CHANGE WITHOUT NOTICE

CIRCLE 32 ON FREE INFORMATION CARD

October 1994, Popular Electronics

ALFA ELECTRONICS

HIGH QUALITY TEST EQUIPMENT
BEST PRICE



DMM 89 \$199.95
Most Advanced DMM
All Purpose & Communication
-80.7 to 81.4 dBm with 4Ω-1200Ω
20 reference impedances
True RMS
Frequency counter: 0.01Hz-10MHz
Capacitance: 1pF-50,000μF
Measure AC volt to 20KHz
5000 counts, 0.1% accuracy
Auto/manual range, fast bar graph
Min/Max/Ave/DH/Relative/Zoom
Auto power off
Input warning
Splash proof
Volt, amp, ohm, logic, diode, continuity
Ruggedized case
Rubber holster included



DMM 2360 \$119.95
DMM+LCR Meter
Very Versatile DMM
Inductance: 1μH-40H
Capacitance: 1pF-40μF
Frequency: 1Hz - 4MHz
Temperature: -40-302 °F
TTL Logic Test: 20MHz
Diode, Continuity
Volt, Amp, Ohm
3999 count display
Peak Hold
Auto power off
Ruggedized case
Rubber Holster \$8.00
Temperature probe \$7.00



DMM 21 \$74.95
Inductance: 1μH-40H
Capacitance: 1pF-200 F
Frequency: 1Hz-1MHz
Volt, amp, ohm, diode, continuity
3999 count display
TTL logic, HFE
Peak hold
Ruggedized case
Rubber holster \$8.00

Full line of DMMs, economy, compact, ruggedized, solar cell, automotive, heavy duty, industrial, starts from \$15.95

Fluke Multimeter
Fluke 12 \$84.95
Holster C-10 \$10
Fluke 70 II \$67.5
Fluke 73 II \$94
Fluke 75 II \$129
Holster C-70 \$16
Fluke 77 II \$149
Fluke 79 II \$169
Fluke 29 II \$169
Fluke 83 \$225
Fluke 85 \$259
Fluke 87 \$287
Fluke 97 Scope Meter \$1785



LCR Meter 131D \$229.95
Most Advanced LCR
Dual display: L/Q or C/D
Inductance: 0.1μH-1000H
Capacitance: 0.1pF-10,000μF
Impedance: 1mΩ-10MΩ
0.7% basic accuracy
Dissipation factor & Q factor
Serial & parallel mode
Relative mode for comparison and to remove parasitics
Statistics, tolerance,
Best for design, incoming testing & production
SMD and chip component test probe \$25.00



LCR Meter 814 \$189.95
Best Resolution LCR
Inductance: 0.1μH-200H
Capacitance: 0.1pF-20,000μF
Resistance: 1mΩ-20MΩ
1% basic accuracy
Dissipation factor indicates leakage in capacitor and Q factor in inductor
Zero adjustment to reduce parasitics from test fixture
Best for high frequency RF and surface mount components.
SMD and chip component test probe \$25.00, Deluxe carrying case \$5.00

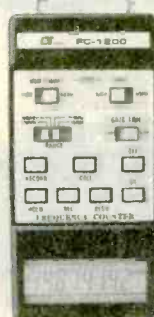

Frequency Counter FC-1200 \$129.95
Frequency: 0.1Hz-1.25GHz
Display: 8 digit LCD
Period: 0.1μs-0.1s
Records Max/Min/Average
Data hold, relative mode
Telescoping antenna \$8.00
Deluxe case \$5.00
Also Available:
AC/DC clamp meter, Light meter, Thermometer, pH meter, High voltage probe, Digital caliper, Anemometer, Electronic scale, Force gauge, Tachometer, Stroboscope, Humidity & EMF adapter, Sound level meter, Frequency counter, SWR/field strength/power meter, Dip meter



20 MHz Oscilloscope with Delay Sweep PS-205 \$429.95
Dual Trace, Component test, 6" CRT, X-Y Operation, TV Sync, Z-Modulation, CH2 Output, Graticule Illum, 2 probes each has x1, x10 switch. Best price with delay sweep.
PS-200 20 MHz DUAL TRACE \$339.95
PS-400 40 MHz DUAL TRACE \$494.95
PS-405 40 MHz DELAY SWEEP \$569.95
PS-605 60 MHz DELAY SWEEP \$769.95
Scope Probe: 60MHz x1, x10 \$13, 100MHz x1, x10 \$22

20 MHz Digital Storage Oscilloscope DS-203 \$729.95
Switchable between digital and analog modes
2 K word per channel storage
Sampling rate: 10 M sample/sec
8 bit vertical resolution (25 Level/div)
Expanded Timebase 10ms/div - 0.5 s/div
Refresh, Roll, Save all, Save CH2, Pre-Trig
Plotter Control
250MHz x1, x10 \$28, 250MHz x100 \$39

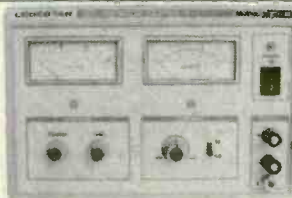

DC Power Supply PS-303 \$159.00
0-30 VDC, 0-3A output
Constant voltage & constant current mode
0.02% + 2mV line regulation
0.02% + 3mV load regulation
1 mVrms noise and ripple
Short circuit and overload protected
PS-8200 with digital voltmeter \$179.00
Also available: 30V/5A, 60V/3A, 60V/5A, 16V/10A, 30V/10A

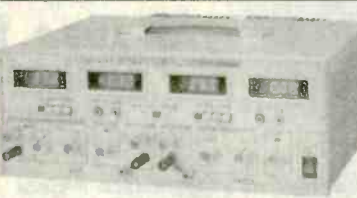

DC Power Supply Triple Output PS-8202 \$499.95
Two 0-30 VDC, 0-3A outputs
One fixed 5VDC, 3A output
Capable of independent or tracking operation
Constant voltage and constant current mode
Four digital meters for volt and current display
Excellent regulation and low ripple
Short circuit and overload protected
Also available: 30V/5A triple output \$549.95
Dual tracking 30V/3A, 30V/5A, 60V/3A, 60V/5A

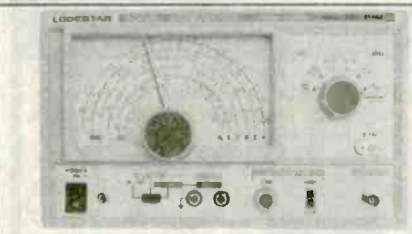

RF SIGNAL GENERATOR SG-4160B \$119.00
100 kHz-150MHz sinewave in 6 ranges
RF Output 100mVrms to 35 MHz
Internal 1kHz, External 50Hz-20KHz
AM modulation
Audio output 1 kHz, 1 Vrms

AUDIO GENERATOR AG-2601A \$119.00
10Hz - 1MHz in 5 ranges
Output 0-8Vrms sinewave
0-10Vp-p squarewave
Synchronization: ±3% of oscillation frequency per Vrms
Output distortion:
0.05% 50Hz - 50kHz
0.5% 50Hz - 500kHz
Output impedance: 600 ohm

FUNCTION GENERATOR FG-2100A \$169.95
0.2 Hz - 2 MHz in 7 ranges
Sine, square, triangle, pulse and ramp
Output: 5mV-20Vp-p
1% distortion, DC offset ± 10V
VCF: 0-10V control frequency to 1000:1



RF SIGNAL GEN./COUNTER SG-4162 AD \$229.95
Generates RF signal same as SG-4160B
Frequency counter 1Hz - 150 MHz for internal and external source
Sensitivity <50mV

AUDIO GEN./COUNTER AG-2603AD \$229.95
Generates audio signal same as AG-2601A
Frequency counter 1Hz-150MHz for internal and external sources
Sensitivity <50mV

FUNCTION GEN./COUNTER FG-2102AD \$229.95
Generates signal same as FG-2100A
Frequency counter 4 digits
Feature TTL and CMOS output
SWEEP FUNCTION GEN./COUNTER \$329.95
0.5Hz to 5 MHz in 7 ranges
Sweep: Linear 10:1/Log 10:1 20ms to 2s
AM Modulation
Gated Burst, Voltage Control Generator
Generator Control Voltage & 8 digit counter
1Hz-10MHz for internal & external sources

ALFA ELECTRONICS
741 Alexander Rd., Princeton, NJ 08540

(800) 526-2532 / (609) 520-2002 15 DAY MONEY BACK GUARANTEE. 1 YEAR WARRANTY
FAX: (609) 520-2007
CALL OR WRITE FOR FREE CATALOG AND BEST OFFER.
Visa, Master Card, American Express, COD, Purchase Order Welcome

CIRCLE 26 ON FREE INFORMATION CARD

Are Cable Companies Sucking You Dry?



**FREE
Catalog!**

**All Major
Brands!**

Take a Bite out of High Rental Fees
with your own

Converters & Descramblers



Everquest • Panasonic • Jerrold • Zenith • Pioneer
Scientific Atlanta • Oak • Eagle • Hamlin • Tocom



Order
Toll-Free **1 800 624-1150**

Call today for a FREE catalog!

MD Electronics

875 S. 72 Street • Omaha, NE 68114



Unbeatable Discount Prices

1 YEAR WARRANTY
15 DAY MONEY BACK GUARANTEE

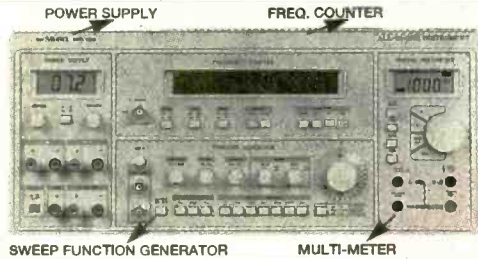

MT-100

Reg. \$595.

\$399.00

Four Instruments in One Instrument

- 1 Function Generator**
 - Sine, Square, Triangle, Pulse, Skewed Sine, Ramp, TTL
 - 0.02 Hz ~ 2MHz
- 2 Frequency Counter**
 - 8 Digit LED
 - 1 Hz ~ 100MHz
 - ± (1 Hz + 1 dgt. + Time Base Error)
- 3 Power Supply**
 - 3-1/2 Digit LCD
 - Triple output: #1. 0-50V, 0.5A MAX
 - #2, 15V, 1A #3. 5V, 2A
- 4 Digital Multimeter**
 - 3-1/2 Digit LCD
 - DCV, ACV, Ω, DCA, ACA
 - ± (0.5% + 2 dgts)

BEST BUY! O'SCOPIES

2 Yr. Parts/Labor Warranty

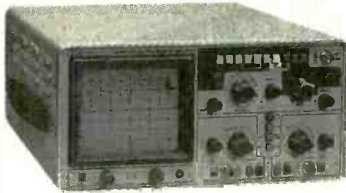

25 MHz Dual
Reg. \$525.

\$299.00

25 MHz Dual
w/Component Test
Reg. \$595.

\$379.00

40 MHz
Dual/Delay
Reg. \$695.

\$499.00

OS-3304/3324, 25 MHz

- DC to 25 MHz. Dual Channel
- 6" Rectangular CRT with Internal Graticule 10x8cm (Phillips P31)
- Uncalibration LED.
- High Sensitivity 1 mV/div to 20V/div X-Y modes, Z Axis (intensity modulation)
- Rise time 14n Sec. or less.
- Full TV Trigger for TV-V & TV-H
- Acceleration Potential 2kV

OS-3315, 40 MHz Sweep Delay

- DC to 40 MHz. Dual Channel
- Delayed Sweep 100nS to 1 Sec.
- 6" Rectangular CRT with Internal Graticule 10x8cm (Phillips P31)
- Uncalibration LED.
- High Sensitivity 1 mV/div to 20V/div X-Y modes, Z Axis (intensity modulation)
- Rise time 8.5nS or less.
- Full TV Trigger for TV-V & TV-H
- Acceleration Potential 12kV

GoldStar Oscilloscopes

- OS-7020A. 20MHz Dual
Reg. \$525. **\$395.00**
 - OS-902RB. 20MHz Dual/Read Out
Reg. \$795. **\$595.00**
 - OS-9040D. 40MHz Delay
Reg. \$695. **\$575.00**
 - OS-904RD. 40MHz Dual/Read Out
Reg. \$895. **\$695.00**
 - OS-8100. 100MHz 8 Trace
Reg. \$1395. **\$1,145.00**
- Other Models Call for Price

FG-150

Reg. \$395. **\$229.00**



2MHz Sweep / Function Generator w/Built-In Frequency Counter

- 4 Digit LED Display
- 0.2 Hz ~ 2.0 MHz
- Sine, Square, Triangle, Pulse, Skewed Sine, Ramp, TTL
- Linear or Logarithmic Sweep
- Variable DC Offset Control
- 10 MHz Frequency Counter

Best Buy!

1.0 GHz Counter FC-200

Reg. \$395. **\$199.00**



High Resolution Frequency Counter

- 1.0 Hz ~ 1.0 GHz
- 8 Digit LED Display
- Auto & Manual Range
- Measured Value Hold
- 4 Selectable Gate Times
- Below 20mV Input Sensitivity
- 1mΩ & 50Ω Input Impedance
- 10:1 Input Switchable Attenuator

Reg. \$199. **\$119.00**

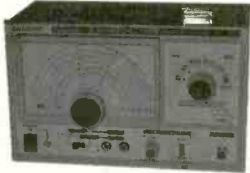

RF Signal Generator, SG-310 100KHz - 150MHz

- 100KHz ~ 150MHz, 6 Ranges.
- Accuracy: ± 5%
- RF Output: 100 m Vrms (Up to 35MHz Unloaded)
- Modulation
Int. 1KHz (AM) 30%
Ext. 50Hz ~ 20KHz
- Audio Output: 1KHz Min 2 Vrms

Reg. \$199. **\$119.00**



Audio Generator, AG-350 10Hz ~ 1MHz

- 10Hz ~ 1MHz, 5 Ranges.
- Accuracy: 5% ± 2
- Output Impedance: 600Ω
- Sine Wave Output
• Range: 10Hz ~ 1MHz
• Output Voltage: 8 Vrms
- Square Wave Output
• Range: 10Hz ~ 100KHz
• Output Voltage: 15Vp-p

Reg. \$249. **\$159.00**

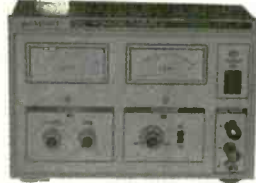

DC Power Supply, PS-500 0-30VDC, 0-3A

- 0 ~ 30VDC Continuously Variable
- Regulation: ≤ 0.01% + 3mV
- Ripple Voltage: p-p ≤ 2m Vrms; ≤ 1mV
- 0.1A ~ 3A Constant Current
• Regulation: ≤ 0.2% + 3mA
- Ripple Current: ≤ 3m Arms
- Short Circuit Overload Protection w/Indicating Lamp

Reg. \$399. **\$289.00**



DC Power Supply, PS-540 0-16VDC, 0-10A

- 0 ~ 16VDC Continuously Variable
- Regulation: ≤ 0.01% + 3mV
- Ripple Voltage: p-p ≤ 2m Vrms; ≤ 1mV
- 0.1A ~ 10A Constant Current
• Regulation: ≤ 0.2% + 3mA
- Ripple Current: ≤ 3m Arms
- Short Circuit Overload Protection w/Indicating Lamp

Oscilloscope Probes Switch Selectable X1 / X10



HP-9060, 60MHz
Reg. \$29. **\$15.00**

HP-9150, 150MHz
Reg. \$49. **\$22.00**

HP-9250, 250MHz
Reg. \$59. **\$29.00**

Auto Bargraph w/Holster



DM3200
Reg. \$99.
\$59.00

- Auto & Manual
- 3-1/2 Digit
- 32 Seg. Bargraph
- Diode Test
- Continuity Beeper
- Data Hold
- Auto Power Off
- Low Battery Mark
- Over Range Mark
- Holster



DM3000
Reg. \$69.
\$44.00

DM3050
Reg. \$99.
\$54.00

DM3100
Reg. \$99.
\$54.00

Multimeter Multi-Function w/Holster

- 3-1/2 Digit
- 1.5" Big LCD
- Heavy Duty, 20A
- Capacitance
- TR-hFE
- Diode
- Low Battery Mark
- Over Range Mark
- Protective Holster
- Tilt Stand

DM3050 Only
• Frequency
• Continuity
• Beeper

DM3100 Only
• Temperature w/
Optional Probe
Reg. \$15 **\$8.00**
• Continuity
• Beeper

BMC Your Best Source for
High Standard Electronics

13700 Alton Pkwy., Ste. 154-282
Irvine, CA 92718

Order & Free Catalog

800-532-3221

(714) 586-2310 Fax (714) 586-3399

VISA.

MasterCard

CIRCLE 30 ON FREE INFORMATION CARD

AMERICAN RELIANCE

Introducing the AMREL Analog and Digital Power Supplies...

EITHER CHOICE PLACES MORE FEATURES ON YOUR BENCH—SAVES YOU MONEY!

3 YEAR WARRANTY



2 YEAR WARRANTY



AMREL LPS-100 Series—For Performance That Sets New Industry Standards!

- Low Output noise rating less than 0.3mV.
- Line/load regulation rated at low 0.01% + 1mV.
- Transient response time of 50µ Sec.
- Overload protection.
- Output enable/disable
- Coarse and fine voltage/current adjustment.
- Auto series/parallel operations for triple output supplies.
- 3 year full warranty— not 1 or 2 years.

AMREL LPS-300 Series—Offer Features And Prices That The Competition Can't Beat!

- Microprocessor controlled.
- User friendly keypad data entry.
- Low output noise rating less than 1mV.
- Line/Load regulation rated less than 2mV.
- Output enable/disable and Power— off memory.
- 2 year warranty.
- Optional RS-232 interface capability.

Model	LPS-101	LPS-102	LPS-103	LPS-104	LPS-105	LPS-106	LPS-301	LPS-302	LPS-303	LPS-304	LPS-305
Rating	30V/1A	30V/2A	30V/3A	+30V/1A -30V/1A 3-6.5V/3A	+30V/3A -30V/3A 3-6.5V/3A	60V/1A	15V/2A(H) 30V/1A(L)	15V/4A(H) 30V/2A(L)	30V/3A	+30V/1A -30V/1A 5V/2A	+30V/2.5A -30V/2.5A 3.3-5V/3A
Retail Price	\$195	\$225	\$295	\$395	\$495	\$245	\$249	\$299	\$369	\$399	\$599

PR INT™
Product International Inc.



Call For Sale Price: **1-800-638-2020**



8931 Brookville Road • Silver Spring, Maryland 20910 • Fax: 800-545-0058 •

CIRCLE 46 ON FREE INFORMATION CARD



Are you overpaying . . .
. . . your cable company?

You are if . . .
. . . you are leasing their equipment.

- Forest Electronic, Inc. offers a complete line of New Cable Equipment that is fully Compatible with your cable system.
- All systems come with: Remote Control, & Parental Guidance Feature. Volume Control is also available.
- All Equipment is fully guaranteed & comes with a 30 day money back option.

For More Information Call Us At:

800-332-1996

FAX: 708-860-9048

TONY TALLI'S ORIGINAL TELEVIEW DISTRIBUTORS

WHERE OUR VALUED CUSTOMERS'

BUSINESS

IS HONESTLY APPRECIATED

OUR PRICES

1 800 847 3773

Call Us Today

90 DAY + GUARANTEE

SCIENTIFIC ATLANTA

JERROLD PIONEER

OAK HAMLIN



HRS. M - F 9-4 PST NO NV. SALES

October 1994, Popular Electronics

LATEST TECHNOLOGY

- DESCRAMBLERS
- CONVERTERS
- COMBINATION UNITS

WE'LL BEAT ANY PRICE!

LATEST DESCRAMBLER MODELS

Add On Descrambler for all JERROLD Systems (Except Base Band) Guaranteed to Work Anywhere Coast to Coast (Model JD-3)

~~\$125~~
\$89 6-10
 \$119 1-5

Add On Descrambler For All PIONEER Systems. Guaranteed to Work Anywhere Coast to Coast. (Model PD-3)

~~\$125~~
\$89 6-10
 \$119 1-5

Add On Descrambler For All SCIENTIFIC ATLANTA Systems (Except 8570, 8590, 8600). Guaranteed to Work Anywhere Coast to Coast. (Model SAD-3)

\$89 6-10
 \$119 1-5



**BRAND NEW
 1 YEAR
 WARRANTY**

SCIENTIFIC ATLANTA 8580

Features

- Wireless Remote Control
- Favorite Channel Recall
- Parental Lockout

\$259 6-10

**BRAND NEW
 1 YEAR
 WARRANTY**

\$289 1-5

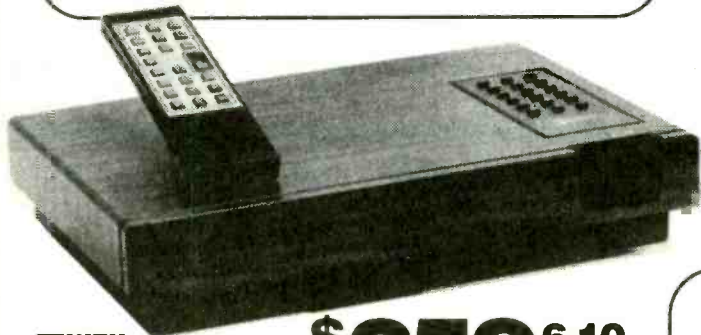

ZENITH

Features

- Wireless Remote Control
- 550MHz (99 Channel) capacity
- Volume Control
- Parental Lock-Out
- Programmable Favorite Channel Memory

\$259 6-10

\$289 1-5

ADD ON DESCRAMBLERS

	1-5	6-10
FTB-3	49.00	39.00
TVT OR TBI	55.00	47.00
SA-3	59.00	49.00
KN12-3	59.00	49.00
MLD1200-3	49.00	39.00

CONVERTERS

	1-5	6-10
PANASONIC 1453G	79.00	69.00
JERROLD DQN7-3	75.00	65.00
STARGATE 2001	75.00	65.00

Call for other models



**DPV7 & DBB7
 8590 & 8600**
 Call for availability & prices



1470 OLD COUNTRY ROAD,
 SUITE 315 - P.E.
 PLAINVIEW, NY 11803
 NO NY SALES

FREE COLOR CATALOG!

1-800-950-9145

ALL ELECTRONICS CORP.

QUALITY PARTS • DISCOUNT PRICES • FAST SERVICE • HUGE SELECTION

JUMBO SAVINGS JUMBO LEDS

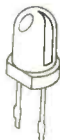

Liton # LTL 327C - 8MM
Ideal for eye-catching indicators and displays. A recent quantity purchase of these BIG, 8mm diameter, red diffused LEDs enables us to provide some very special pricing. The leads on these devices have been trimmed to 0.325", leaving plenty of room for soldering. Normally these parts would sell for more than twice our price.

5 for \$1.00

CAT # LED-23

100 for \$15.00 • 1000 for \$120.00

LONG LIFE MAGNESIUM BATTERY

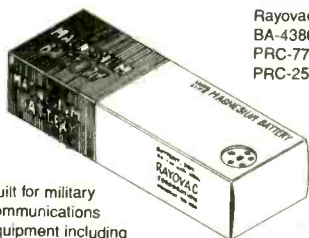

Rayovac #
BA-4386/
PRC-77/
PRC-25

Built for military communications equipment including PRC-77 and PRC-25 radios. Output jacks for 14.4 volts and 3 volts. Extremely long shelf life, should be good for 15 years storage. Ideal for emergency applications. 6 pin output jack can be used with banana plugs. 9.375" X 3.57" X 2.07" cardboard jacketed case. 3 lbs.

\$4.00
EACH

CAT# MB-4386

1 3/4" SPEAKER

8 ohm, 1 watt speaker. Very heavy magnet for its size. Speaker o.d. 1.8". Magnet o.d. 1.35".



CAT# SK-175

\$1.25
EACH

10 for \$11.00

640 X 480 DOT LCD DISPLAY

Sharp # LM64P70
Brand new 640 X 480 dot LCD flat panel display with on board high speed drivers and built-in CCFT backlight (inverter not included). Logic voltage: 5 Vdc. LCD driver voltage: -16.2 Vdc. Viewing area 6.8" X 5.1". Overall module size: 10.1" X 6.23" X 0.33". These displays sold for over \$300.00 new. Includes specs. and hook-up information.

CAT # LCD-17 **\$45.00**
EACH

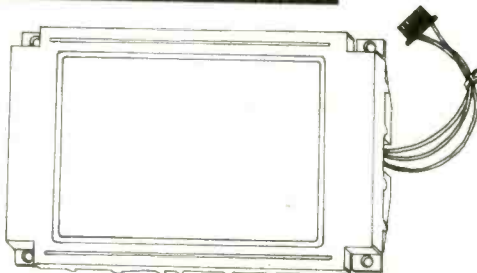

9 Vdc @ 200 ma. WALL TRANSFORMER



Three prong grounded plug. 6 foot long cord terminates to three color-coded pigtail leads.

CAT# DCTX-9200

\$2.00
EACH

100 for \$180.00

VIDEO/RF MODULATOR

Originally made for use with the Commodore computer, these good quality video modulators were probably originally designed for 9 Vdc use,



but they operate well on 6-12 Vdc. They accept color video and audio, and a selector switch is provided for output to channel 3 or 4. Easy to hook-up. Requires a 6-12 Vdc power supply or wall transformer and a connector to interface with your audio/video source.

\$5.00
EACH

Output is an RCA Jack. Hook-up instructions included. 3" X 1.47" X 0.75".

CAT# AVMOD-3

LASER TUBE



Siemens# LGR 7659.
1 mW helium-neon laser tube. 22.5 mm diameter X 146 mm long. 1.7 mrad beam divergence. 7 kV start voltage. 1kV operating voltage. 3.5 mA current.

CAT# LT-1

\$25.00
EACH

"HI-8" VIDEO CASSETTE (USED)

8 mm Video Camcorder Users!

SONY Hi-8 T-120
Top quality, metal particle 120 minute video cassettes. Used for a short time, then bulk-erased, each cassette has its own plastic storage box. New, these high quality cassettes sell for considerably more. Satisfaction Guaranteed.

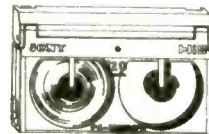

CAT# VCU-8

\$3.00
EACH

10 for \$28.00 • 100 for \$250.00

MANUFACTURERS - We Purchase EXCESS INVENTORIES... Call, Write or Fax YOUR LIST.

CALL, WRITE
or FAX For A
Free 64 Page
CATALOG.

Outside the U.S.A.
send \$2.00 postage.

ORDER TOLL FREE **1-800-826-5432**

MAIL ORDERS TO:
ALL ELECTRONICS CORP.
P.O. BOX 567
VAN NUYS, CA 91408-0567

FAX (818) 781-2653
INFO (818) 904-0524

Minimum Order \$10.00 • All Orders Can Be Charged to Visa, Mastercard or Discover • Checks and Money Orders Accepted by Mail • Orders Delivered in the State of California must include California State Sales Tax • NO C.O.D. • Shipping and Handling \$4.00 for the 48 Continental United States • ALL OTHERS including Alaska, Hawaii, P.R. and Canada Must Pay Full Shipping • Quantities Limited • Prices Subject to change without notice.



CircuitMaker[®] vs. Electronics Workbench[®]

A NEW STANDARD HAS JUST BEEN SET!

State-Of-The-Art Analog Simulation

CircuitMaker's analog simulation results are shown in graph windows that provide powerful, interactive analysis options. You can plot multiple waveforms by clicking on the desired nodes and can select linear or logarithmic axes. Horizontal and vertical cursors facilitate quick and accurate measurements. You can also zoom in on any portion of the graph to obtain additional detail.

Electronics Workbench offers a single, small scope or Bode plot instrument window. The windows are not sizeable and only two waveforms can be plotted at a time. EWB has a single measurement cursor and provides no direct way to read results from the instruments.

Superior Digital Simulation

CircuitMaker has an exclusive Trace feature where the state of every node is indicated in color as the simulation runs. You can monitor as many waveforms as your screen will allow, set edge or level breakpoints for analysis, and interactively see the state of any node by touching the logic probe to it. The data sequencer provides 1024 words of pattern data. Additional digital instruments include ASCII and HEX input keys and an ASCII display. CircuitMaker includes tri-state devices and devices have programmable propagation delays.

Electronic Workbench has no interactive logic probe or Trace capability and no Hex or ASCII keys. Their "word generator" is limited to 16 words. EWB does not have tri-state devices and digital devices do not have programmable propagation delays.

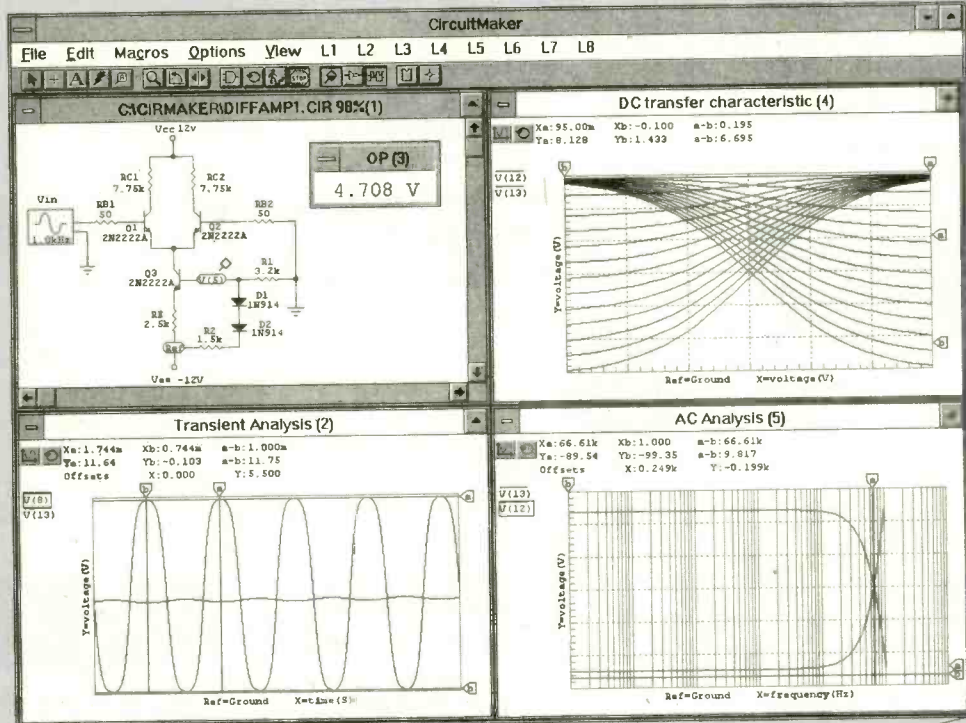

Comprehensive Device Libraries

CircuitMaker includes libraries containing programmable, TTL, CMOS, generic analog and digital devices, and many powerful I/O devices. With CircuitMaker's macro function you can quickly and easily create your own functional devices and symbols. Now that's giving you the tools you need to get the job done right!

Electronics Workbench ships with only 17 digital devices. If you want additional devices you pay extra.

Competitive Upgrade Offer

You deserve the best. Upgrade from any competing product for only \$99. New users can purchase CircuitMaker for a limited time at a special introductory price of just \$269. Suggested Retail Price \$299.

Technical Support

MicroCode Engineering offers free phone support from knowledgeable engineers. And, you won't find yourself listening to music when you call for help.

Interactive Image Technologies offers 3 free calls and then you have to pay for all subsequent calls.

Comparison based on CircuitMaker 2.0 for Windows and Electronics Workbench 3.0 for Windows. All product and company names are trademarks of their respective owners.

CALL 800-419-4242
Risk free 30 day money back guarantee.

MicroCode Engineering
1943 N. 205 W. Orem, UT 84057
Fax (801) 226-6532
Phone (801) 226-4470

FREE FUNCTIONAL DEMO VERSION

available on most major BBS's or sent direct for \$10 s&h



CIRCLE 42 ON FREE INFORMATION CARD

Satellite Television

Order Your **FREE** Catalog/Buyers Guide Today!



The World Supplier of Satellite T.V. Products. . . "Down To Earth Prices"



Satellite Analysis and Antenna Aiming Software

An extremely valuable tool for designing and installing TVRO's, tailored for ease of use by professionals and dealers as well as by technically orientated TVRO owners. Demonstrates how changing parameters such as dish size or LNB noise temperature affect picture quality. The program performs both TVRO system analysis and antenna aiming. The analysis subcomponent, is especially useful for predicting performance when viewing signals from a particularly weak satellite. The aiming subcomponent calculates azimuth and elevation angles and range to all satellites within "view" of a TVRO. The names and latitudes of all world-wide C and Ku-band broadcast satellites, presently in service or to be launched by 1995, are listed. The user simply enters TVRO site latitude and longitude.

5.25" disk \$49.95
3.5" disk \$49.95



SATELLITE SYSTEM DO-IT-YOURSELF INSTALLATION VIDEO

"Now You Can Watch It Being Done"
Install or "Tune up" your satellite system in no time flat with this professional video.
VHS or Beta (45 Min.) \$33.95

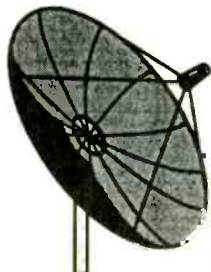

MESH DISHES by ORBITRON

Quality Demonstrated by Performance

Orbitron antennas ("size for size") are known the world over for their superior reception and picture quality.

7ft	dish & polar tracking mount	\$259
8.5ft	"	319
10ft	"	369
10ft H.D.	"	449
12ft	"	649



Pico dish Tuning Meter



Bulz-I-Tuning Meter Now with audio alert

TUNE YOUR DISH TO IT'S MAXIMUM!

Dish tuning meters are a must for the serious dealer or satellite system owner. Saves time, frustration and money. Use when installing a new system, moving your dish, re-alignment of a dish that has been moved by wind, frost heaves etc., gets you right on the satellite belt for the best possible pictures!

Pico meter (meter tuning) \$89.95
Bulz-I-IV meter (meter & audio alert) 154.95

New Powerful Satellites
= Smaller Dishes
Smaller Dish = Less \$\$\$

KU-BAND SYSTEM

Package **INCLUDES** all of this:

- 3ft Quality alum dish
- Pansat BR 1100 Receiver
- Polar tracking mount
- Polarity switching feed
- Low Temperature LNB
- 100ft All in one ribbon cable
- Site data coordinate sheet

***Complete System Only \$499**

C-BAND SYSTEM

Package **INCLUDES** all of this:

- 7ft ORBITRON mesh dish
- uniden 4400 IRD
- Polar tracking mount and motorized arm
- Chaparral Polarity switching feed
- 25°Low Temperature LNB
- 100ft All in one ribbon cable
- Optional Decoder module

***Complete System Only \$859**

*All you need to supply is ground pole to mount dish on. (3.5" O.D.)

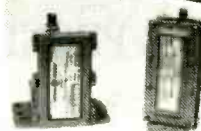

LNBs New Lower Temp's

Hemt Technology Commercial Grade

35° LNB C-band 4GHz	\$ 79
25° LNB	95
0.9dbLNB Ku-band 12GHz	\$ 89
0.7dbLNB	99
0.6dbLNB	119

All Major Credit Cards Accepted

Skyvision Inc.®

1048 Frontier Drive, Fergus Falls, MN 56537 - Toll Free 800-334-6455
Mail in coupon or call today for the SKYVISION Satellite TV Product Catalog/Buyers Guide Delivered free to your mail box in U.S. and its possessions.

- Send Free Domestic Satellite TV Products Catalog
- Send International Satellite Catalog (For International Catalog add \$8.00 to cover S&H)

Name _____ Phone () _____
Address _____
City _____ State _____ Zip _____

Install A System, Upgrade & Repair Yourself And Save SSSS

Call Toll Free 800-334-6455 International 1-218 -739-5231 Fax 218-739-4879

CELLULAR SOFTWARE AND MODIFICATION GUIDES

Call Spy Supply for all of your Cellular needs!

We Carry:

CELLULAR SOFTWARE

(We have the software to do New Motorola Phones)

CELLULAR CABLES

(For the Motorola, Panasonic, and Nokia Phones)

CELLULAR MODIFICATION GUIDES

(Covers all cellular manufacturers)

CELLULAR PHONES

(We carry a complete line of cellular phones)



FREE TECHNICAL SUPPORT!

We now offer Cellular Phones cloned with your existing number! Buy a handheld, transportable or car mounted phone ready to go and have only one monthly bill!

Don't Get Ripped Off!

Before you buy our competitor's manual, call and ask if they offer **FREE TECHNICAL SUPPORT**

SPY SUPPLY

Find out why the CIA - FBI - DEA - SECRET SERVICE Have ordered from our catalog To receive yours, send \$5.00 to:

SPY SUPPLY

1212 Boylston St. #120
Chestnut Hill, MA 02167

SPY SUPPLY, 1212 Boylston St. #120, Chestnut Hill, MA 02167

(617) 327-7272

Sold for educational purposes only

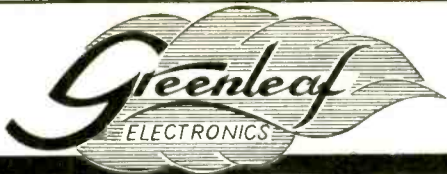

CABLE TV Converters & Descramblers

Compatible with
**Jerrold, Scientific Atlanta,
Pioneer, Oak, & Hamlin
Equipment**

**BRAND NEW!
90-DAY GUARANTEE
LOWEST PRICES**

Volume Control & Parental Lockout Available

Greenleaf Electronics
1-800-742-2567
NO ILLINOIS SALES

It is not the intent of Greenleaf Electronics to defraud any pay television operator and we will not assist any company or individual in doing the same.

GENUINE ELECTRONICS, INC

CABLE TV AND ELECTRONIC EQUIPMENT

Genuine Electronics, Inc can help you with virtually any electronic need:

- * Cable TV Descramblers/Converters
- * Bullet Protectors
- * Immunizers
- * Voice-Mail Systems
- * Digital On-Hold Announcers
- * Laser Pens

90-Day Guarantee & Lowest Prices!

Call
GENUINE ELECTRONICS, INC
1-800-833-2915

MCM ELECTRONICS... WE'VE GOT IT!

• Service • Selection • Value

SAVE TIME — Shop the only source for all your electronic needs — MCM ELECTRONICS! With over 21,000 items stocked, we're ready to ship your order within 24 hours. You'll find test equipment, semiconductors, repair parts, audio components, amateur radio, computer products and much, much more! Call today for your free 288 page catalog and you will discover ...
When you need it, WE'VE GOT IT!



To request a FREE catalog . . .

1-800-543-4330

Product questions
1-800-824-TECH(8324)

**MCM IS NOW
AN RCA/GE
PREMIER
DISTRIBUTOR!**

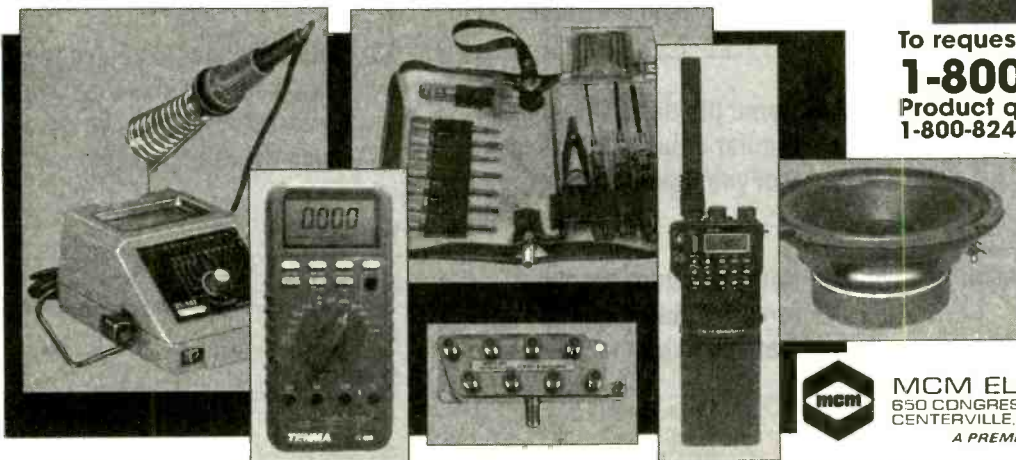

MCM ELECTRONICSSM
650 CONGRESS PARK DR.
CENTERVILLE, OH 45459-4072
A PREMIER Company

POP-11

GET FAST DELIVERY FROM OUR DISTRIBUTION CENTERS IN DAYTON, OH AND RENO, NV!

CIRCLE 52 ON FREE INFORMATION CARD

READERS: TELL US WHAT YOU THINK ABOUT THIS ISSUE

Are you interested in helping us make this magazine as good for you as it can be? Then be one of the first to join the 1994 *Popular Electronics Reader Council*. Twice a year you'll be asked to complete a detailed questionnaire. It will tell us about the things in this magazine that are important to you and give us the information we need to make this your best possible reading.

If you would like to be considered for this special *Popular Electronics* project, take a few minutes to answer the questions on this page and return it to us.

While we cannot accept everyone, we will randomly select our participants, giving each one of you an equal chance of being selected.

Please mail the completed questionnaire no later than November 30, 1994, to:

**Total Recall Research Group
Box 4079
Farmingdale, NY 11735-9622**

Thank you, and I am looking forward to hearing from you!

*Larry Steckler,
Editor-in-Chief*

1. **Where did you get this magazine?**
Subscription Newsstand

2. **Are you:**
Male Female

3. **How old are you:**
I am _____ years old

4a. **Highest education achieved?**
Attended technical school
Graduated technical school
Attended College
Graduated College
Earned PhD

4b. **Do you**
Hold FCC license
Hold other license, Certif.

5. **What is your total household income?**
Total household income, before taxes is \$ _____

6. **Name the article in this issue that you liked the best.**

7. **Name the article in this issue that you liked the least.**

8. **Name the department or regular column in this issue that you liked the best.**

8a. **Name the department or regular column in this issue that you liked the least.**

9. **Do you earn your living working in the electronics industry?**
Yes No

10. **If you were the editor, would you make the articles:**
More complex
Simpler

Longer
Shorter

More build it
Less build it
More how to
Less how to

11. **What articles would you publish?**

12. **What new columns would you add?**

13. **What else would you change?**
Use a separate sheet for your comments. Please give as much detail as possible.

Name _____
Address _____
City _____
State, Zip _____

**Make your projects
speak for themselves...
Ours do!**

DIGITAL VOICE RECORDERS

- Record up to 218 seconds
- 1 to 8 messages
- High quality speech 12 bit
- Switch-closure actuation
- Sample rates up to 20Khz
- On-board backup
- Direct speaker output
- Wide operating range
- Small size 2.6" X 2.6"
- Made in U.S.A.

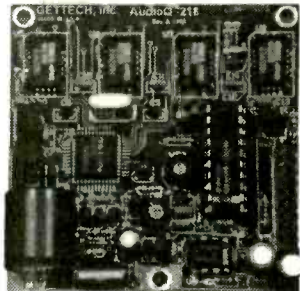

MODEL AudioQ™-218

Call or write for more information
OEM price and delivery available
Custom designs and enclosures
Single unit price \$149.00 plus s+h
Quantity pricing as low as \$99.00

GETTECH Inc.

402 Riley Road, New Windsor, NY 12553
(914) 564-5347

Specifications and price subject to change.

BitBangers



**Proudly Announces
The Arrival Of Laser PCBs**

Introducing Laser Printed Circuit Boards - A revolutionary new method of making in-house prototype PCBs quickly and easily. Our process is simple and requires no special equipment. A computer designed PCB can be printed onto our treated copper by using a standard laser printer. The copper is then adhered to the provided FR4 board and etched. This technique allows you to go from design to prototype in less than 30 minutes. Allow us to show you how you can produce your proto PCBs in-house and save time and money.

Ask about our new customer discount!

**CALL TODAY:
1-800-251-7776
FAX: 1-407-743-3161**

CABLE CONVERTER SPECIALS

	1	5	10+
Sigma 550 NEW — 86 channel O & I compatible Last channel recall — lightning protection 1 year warranty	99.95	75.00	70.00
Timeless 550 P/C Same as above, different manufacturer with parental lockout. HRC switchable 1 year warranty	99.95	75.00	70.00
Northcoast Excell American manufactured!! 70 channel Fine tuning — Standard HRC tuning through remote, sleep timer. Green LED w/dimmer Parental lockout. Deluxe! A/B twinline available. . .	109.95	85.00	75.00



United Electronic Supply

P.O. Box 1206-RE
Elgin, IL 60121

708-697-0600

No Illinois Sales

NEW ITEM

Zenith Universal Remotes
Fully Programmable
New Program / Learn Type
Combines both functions
for
VCR / Cable / TV / Stereo
All in remote.

As low as **\$19.95**

Hours: Mon - Fri: 8:30 — 5:00 pm CST

24 Hour Answering Machine for orders

Electronics made Easy with UCANDO

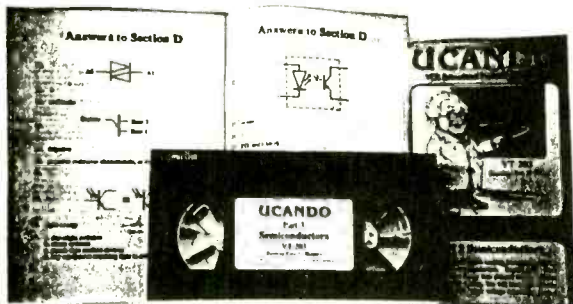

Complete Course in Basic Electronics
Includes 6 one hour videos and 6 workbooks. Everything you need to learn basic electronics. You will learn about Direct Current, Alternating Current, Semiconductor devices, Power supplies, Amplifiers, and Oscillators. These videos are 100% computer animated, they make learning electronics easy and fun. Don't waste any more of your valuable time reading and re-reading the same material to try and understand these simple concepts when you can "see it happen." These videos will ... teach you more in less time ... allow you to learn at your own pace ... help you remember more of what you learn ... give you years of quality use ... become a valuable source of reference material ... make your understanding of electronics more complete ... and help you build your future today. **Your future is too important to gamble with**, so order your course in Basic Electronics Today.

Call Now ... ask about our other popular UCANDO videos in Digital, AM Radio, FM Radio, and Fiber Optics. These videos are currently being used by Tech-Schools, CET's, Military branches, Ham Operators, Industries, and are sold in six foreign countries. After you have seen your first UCANDO video you will understand why UCANDO is

"Changing The Way The World Learns Electronics".

- | | |
|--|---------|
| Part 1 DC | \$44.95 |
| Part 2 AC | \$44.95 |
| Part 3 Semiconductors | \$44.95 |
| Part 4 Power Supplies | \$44.95 |
| Part 5 Amplifiers | \$44.95 |
| Part 6 Oscillators | \$44.95 |
| SAVE ... buy all six for only \$240 | |

Call toll free 1-800-678-6113

CIRCLE 136 ON FREE INFORMATION CARD

Popular Electronics, October 1994

AFFORDABLE DATA ACQUISITION



MODEL 30 \$79.00

- PLUGS INTO PC BUS
- 24 LINES DIGITAL I/O
- 8 CHANNEL 8 BIT A/D IN
- 12 BIT COUNTER
- UP TO 14K SMP/SEC



MODEL 45 \$189

- RS-232 INTERFACE
- 8 DIGITAL I/O
- 8 ANALOG INPUTS
- 2 ANALOG OUTPUTS
- 2 COUNTERS-24 BIT



MODEL 70 \$239

- RS-232 INTERFACE
- 18 BIT A/D
- 5.5 DIGIT
- UP TO 60 SMP/SEC



MODEL 150-02 .. \$179

- RS-232 INTERFACE
- TRMS, 20 AMPS
- 12 BIT A/D
- OPTO-ISOLATED
- CHANGE RANGES, AC/DC, VIA RS-232

Prairie Digital, Inc.

846 17th Street • Industrial Park • Prairie du Sac, WI 53578
(608) 643-8599 • FAX: (608) 643-6754



CABLE TV



NEW Release Universal II

DESCRAMBLER **COD**

Advanced Performance:

- Color, Picture Quality and Stability
- New PC Board Design
- Latest Technology Components

FREE In-House Technical Support

Universal II Kit 4000 \$74.95

Includes our new silk-screened, etched, drilled PC board plus the electronic components.

Kit Enclosure Pak 4000A \$39.95

Includes custom enclosure, AC adaptor, nuts screws, knobs, momentary switch.

1-800-664-6999



No Florida Sales!

It is not the intent of The Halcyon Group to defraud any pay tv operator and we will not assist anyone in doing the same. Kits should be used for educational purposes only.



Move into the 2000's with the Model 1010 12 MHz Synthesized Function Generator for only \$289*

The Model 1010 Synthesized function generator promises to take you into the next century by combining true digital frequency synthesis with the traditional function generator. This instrument performs as three instruments: a **function generator**, a **sweep generator**, and a **pulse generator**. Sine, square, pulse, triangle and ramp waves are synthesized with frequency accuracy regulated by an internal quartz reference with 2 parts per millicca with option 1) spanning over 9 orders of magnitude ranging from .005 Hz to 12 MHz (option 5). The output level can be varied over a range extending from 20 volts p-p to 16 mv p-p. An independent DC offset voltage can be specified anywhere within this range. Both external as well as internal synthesized sinewave modulation sources are available for either AM or FM modulation of a synthesized sinewave carrier. The model 1010 can be programmed for either logarithmic or linear marker calibrated and triggered frequency sweeps. A burst mode allows the user to specify the repetition rate and the number of pulses per burst. An external trigger input allows for synchronization of pulse or burst generation as well as sweeping. User programmable setups are stored in nonvolatile memory for quick setup of repeated operations.

Functions: Sine, Square, Triangle, Pulse and Ramp
Frequency (for all functions)

Frequency Range: 0.007 Hz to 12 MHz w/ opt-5
.005 Hz to 8 MHz w/o opt-5
Frequency Resolution: .005 Hz (.007 Hz w/ opt-5)
Frequency accuracy: ± 25 ppm (±2 ppm w/ opt-1)
Pulse: Single, Burst, Neg. or Pos.
Pulsewidth Range: 200 s to 125 ns
Pulse width resolution: 5 sec to < 1 ns (consult factory)
Sine modes: CW, AM, FM, Sweep
Square modes: CW Sweep and Burst
Triangle modes: CW
Ramp modes: CW, Positive and Negative
Burst modes:
Max number of cycles per burst: 1 to 65535
Burst repetition rate range: .01 Hz to 1 MHz

Internal synthesized modulation source:

frequency range: 1 Hz to 200 kHz
frequency resolution: .005 Hz
External mod. freq. range (AM or FM): DC to 8 kHz
FM modulation deviation range: 1 Hz to 200 KHz
AM modulation depth: 1% to 99%
Output Characteristics
Voltage range: 16 mV to 20 Volts p-p (no load)
DC offset voltage range: -10 V to + 10 V (no load)
Input power requirements: 115 VAC under 20 watts
Options
Opt 1 - ±2 ppm frequency stability - \$60*
Opt 2 - RS-232 Remote Operation - \$50*
Opt 5 - 12 -MHz upper frequency limit - \$N/c

Don't be left behind... Take advantage of the special introductory price of \$289* (no additional charge for units shipped with option 5). **Move into the next Century.** Visa, Mastercard, Amex, Discover. Videospectra, P.O. Box 755, Agoura, CA 91301 Call today: (800) 835-8335. * Limited time offer.

Low Cost CAD Software for the IBM PC and Compatibles Now In Windows™

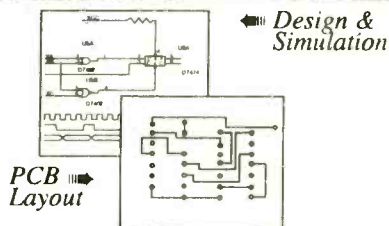

- Easy to use schematic entry program (SuperCAD) for circuit diagrams, only \$149. Includes netlisting, bill of materials, extensive parts libraries, More parts, and automatic wiring available in enhanced CAD package (SuperCAD+) for only \$249.
- Powerful, event-driven digital simulator (SuperSIM) allows you to check logic circuitry quickly before actually wiring it up. Works directly within the SuperCAD editor from a pulldown menu and displays results in "logic analyzer" display window. Starting at \$149 this is the lowest cost simulator on the market. Support for PALs, a larger library, and a separate interactive logic viewer are available in full-featured SuperSIM+ for only \$399. Library parts include TTL, CMOS and ECL devices.
- Circuit board artwork editor and autorouter programs (SuperPCB), starting at \$149. Produce high quality artwork directly on dot matrix or laser printers. You can do boards up to 16 layers including surface mount. Includes Gerber and Excellon file output. Autorouter accepts netlists and placement data directly from the SuperCAD schematic editor.
- Low cost combination packages with schematics and PCB design: 2-layer for \$399, 16-layer for \$649.
- DOS version available.

Write or call for free demo disks:

MENTAL AUTOMATION
5415 - 136th Place S.E.
Bellevue, WA 98006
(206) 641-2141

REGIONAL FREQUENCY DATABASE SYSTEMS ON CDROM

ONLY \$99.95
Plus \$5.00 S&H
Data Access Program Included

- New Data
- More Fields : Now 61
- Many New Program Enhancements
- New Format : Regional / Multi State
- Improved Performance / Faster Radius Search
- Easy Installation
- Easy To Use

Call for more information and pricing on our complete product line. Custom Databases and Services are also available ...

All frequencies within the FCC Master Frequency Database for the entire US on CDROM, Floppy Disk and Printouts

PerCon is the official contractor to the FCC for the Master Frequency Database on CDROM

PerCon Corporation
4906 Maple Springs / Ellery Road
Bemus Point, NY 14712
(716) 386-6015 (716) 386-6013 FAX

B & S SALES

Call(313) 566-7248 • FAX (313) 566-7258 24 hrs.

Hours: Monday through Friday 8 am to 6 pm EST
51756 Van Dyke St. #330, Shelby Township, MI 48316

WE SPECIALIZE IN QUANTITY PRICING 5, 10, 20 LOTS

Make Your Best Deal!

\$ SALE

Y RENT

\$ SALE

Y RENT

<u>JERROLD</u>	<u>SA</u>	<u>PIONEER</u>	<u>HAMLIN</u>	<u>TOCOM</u>	<u>ZENITH</u>
DRX-3-DIC	8590	BA 6110	CR 6600-3M	5507 VIP	1600
DPBB	8580	BA 5135	CR 6000-3M	5503 VIP	
DPV-5,7	8570				
	8550				

NEW PAN
PIONEER
GREEN E LITE
BA 5000 > **SERIES**
BA 6000

NEW PAN
SA-8500 SERIES
(BUT ALL BASE BAND)
THE PREMIER

NEW PAN
JERROLD
PINK PAN

PANASONIC TZ — PC 1453G2

By far the best basic converter on the market today. 550 MHz (1 to 99) parental control, sleep timer, remote batteries, contrast and remote control range.

Superior to all other converters

NO MICHIGAN SALES

MINI TVT:
THE 1/4 POUNDER
LITTLE 4x4
SECOND ONLY TO TVT
GOLD IN POPULARITY

OWN YOUR OWN
SA-3
M-80

SAVE \$

NEW REMOTE CONTROL AB
SWITCH FOR DUAL SYSTEMS
(WITHOUT LEAVING THE
COMFORT OF YOUR CHAIR)

TVT GOLD ORIGINAL
FOR MOST
JERROLD SYSTEMS.
LEADING SELLER
OF ALL PANS

TNT
MLD
OWN YOUR OWN

SAVE \$

FILTERS
POST & NEG
SUBCONTRACTORS
& DEALERS
ONLY QUANTITY

We are now offering a 6-month warranty. In order for warranty to be in effect, this form must be signed and returned.
FOR VCR, SECOND, THIRD, ETC. HOOK-UPS.

Yes, I agree all units are to be used or resold in compliance with Federal and State laws.

Signature _____ Date _____

Name _____ Phone No. () _____

Address _____

City _____ State _____ Zip _____

It is not the intent of B & S Sales to defraud any pay television operator and we will not assist any company or individual in doing the same.

CIRCLE 168 ON FREE INFORMATION CARD

YOU CAN WIND YOUR OWN COILS?

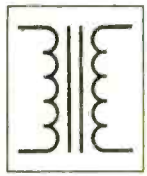

There's no trick to it except knowing what you are doing. In a unique, 106-page book you can become expert in winding RF, IF, audio and power coils, chokes and transformers. Practically every type of coil is discussed and necessary calculations are given

with the mathematical data simplified for use by anyone. Get your copy today!

Mail coupon to:

Electronics Technology Today, Inc.
P.O. Box 240 • Massapequa Park, NY 11762-0240

Please send me my copy of *Coil Design and Construction Manual* (BP160). I enclose a check or money order for \$8.45 to cover the book's cost and shipping-and-handling expenses. NY state residents must add local sales tax.

Name _____

Address _____

City _____ State _____ ZIP _____

All orders must be paid in U.S. funds only. Sorry, no orders accepted outside of USA and Canada. Please allow 6-8 weeks for delivery.

Tap into a World of...

FREE ELECTRICITY

Our 150+ page Self-Reliance Catalog IS JUST LOADED WITH DC to AC ENERGY INDEPENDENCE ...

We offer:

- Solar, Wind & Hydroelectric energy systems. True Sine Wave DC to AC Inverters.
- Electric Boat & Car kits.
- Portable power packs.
- Solar Lighting & Cooling systems. Solar Pool Heaters.
- Solar Battery chargers. Solar Books & Toys. DC Appliances
- Active & Passive Solar Air & Water Heating Systems.
- Composting Toilets. Hydroponic, Fish-Farming, Solarium & Greenhouse Systems.
- Water Testing, Treatment, & Pumping Systems.
- Emergency Food & H₂O Kits. High Efficiency AC/DC Refrigeration + More...

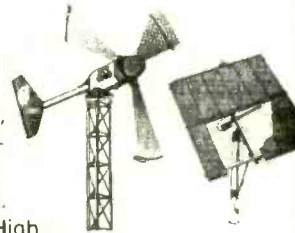

A LOT OF INFORMATION FOR ONLY \$5.75 ...

SEND CHECK or MO TO:

Self-Reliance Company Inc.
P.O. Box 306, Florissant, MO 63032

Serving the public since 1981



XANDI ELECTRONICS

201 E Southern # 205, Tempe AZ 85282 - 5140

SATISFACTION GUARANTEED!

BUY WITH CONFIDENCE FROM XANDI

- 30-DAY REFUND POLICY
- TECH SUPPORT NUMBER (602-894-0992)

- Smallest FM transmitter anywhere!
- Tunes 88-108 MHz.
- Powerful 2 stage audio amplifier.
- Sensitive, picks up sounds at the level of a whisper.
- Up to 1 mile range.

SUPER-MINIATURE FM TRANSMITTER
 Worlds smallest FM transmitter. Use with any FM broadcast receiver. Easy to assemble, all chip (SMT) parts are pre-assembled to the circuit board.

XST500 (E-Z) Kit \$44.95

- Smallest Phone transmitter anywhere!
- Tunes 88-108 MHz.
- No batteries required, powered by phone line.
- Up to 1/4 mile range.
- Attach to phone line anywhere in house, even inside phone.

SUPER-MINIATURE PHONE TRANSMITTER
 Worlds smallest FM phone transmitter. Use with any FM broadcast receiver. Easy to assemble, all chip components are pre-assembled to the circuit board.

XSP250 (E-Z) Kit \$34.95

- Uses sensitive microwave transistor amplifier.
- Covers 1 to 2,000 MHz.
- Compact hand held unit.
- Includes miniature loud speaker for audio indication of detected signals.

SUPER SENSITIVE BUG DETECTOR
 When the XBD200 intercepts a signal in the 1 to 2,000 MHz range, it emits a growl that increases to a high pitched squeal as the signal strength increases.

XBD200 (C) Kit \$49.95

- Transmits high quality stereo to any FM stereo receiver.
- Built-in output level monitor for quick and easy tuning.
- Ideal for use with personal CD player.

FM STEREO TRANSMITTER
 Transmit full-bodied Hi Fi stereo to any FM stereo receiver. Separate left and right inputs and gain controls. Includes an output booster stage for greater range.

XFS108 (C) KIT \$41.95

- Dial your phone from anywhere and listen to the sounds inside your home.
- Two digit Touch Tone code for secure operation.

TELEPHONE SNOOP
 The latest in home or office security. Call home from anywhere, enter a two digit security code, and hear the sounds in your home. Automatically turns on without ringing the phone. Verifies code, then activates for one and a half minutes.

XPS-CASE KIT \$13.95
 XPS1000 (C) KIT \$49.95

- Transmits a continuous beeping tone.
- Adjustable from 88 to 108 MHz.
- Up to 1 mile range.
- Works with any FM broadcast receiver.

TRACKING TRANSMITTER
 Only 0.7 by 2.4 inches, the XTR100 operates at voltages of 3 to 18 Volts and is ideal for use in locating lost model rockets, bicycles, automobiles, games of hide and seek, and contests.

XTR100 (C) Kit \$33.95

- Works with any FM broadcast receiver.
- Turns off when phone is not in use to extend battery life.
- Adjustable from 88 to 108 MHz.
- Up to 1 mile range.

LONG RANGE PHONE TRANSMITTER
 Similar to our very popular XSP250, the XTT100 is battery powered for greater range. It plugs into any phone jack and transmits both sides of conversations on that line.

XTT100 (C) Kit \$32.95

- Use with any FM broadcast receiver.
- Hear every sound in an entire house!
- Up to 1 mile range
- Powerful 2 stage audio amplifier.

MINIATURE FM TRANSMITTER
 The XFM100 has a super sensitive microphone and is capable of picking up sounds at the level of a whisper and transmitting them to any FM broadcast receiver.

XFM100 (C) Kit \$32.95

- Digital voice changing: male to female, female to male, adult to child, child to adult.
- Anonymity on any call.
- Button for normal operation.
- 16 levels of voice masking.

VOICE CHANGING TELEPHONE
 STOP THOSE ANNOYING TELEPHONE CALLS! Sound older and tougher when you want to. Not a kit. Fully assembled. Single phone operation only.

TRANSITION 2000 \$89.95

- Digital voice changing: male to female, female to male, adult to child, child to adult.
- Use with any modular phone.
- 16 levels of voice masking.
- Connects between handset and phone.

VOICE CHANGING ACCESSORY
 STOP THOSE ANNOYING TELEPHONE CALLS! Sound older and tougher when you want to. Not a kit. Fully assembled. Use with single or multi-line phones.

TRANSITION 2001 \$59.95

- Uninterrupted coverage of 800 to 950 MHz.
- Works with any scanner that can receive 400 to 550 MHz.

800-950 MHz SCANNER CONVERTER KIT
 If your scanner can receive 400-550 MHz, use add the XLC900 for uninterrupted 800-950 MHz coverage. It converts all 800-950 MHz signals down to 400-550 MHz so your scanner can receive them! Add our custom case kit for that "Professional" look.

XLC-CASE KIT \$13.95
 XLC900 (C) KIT \$49.95

- Works with most any scanner.
- 10 to 1000 MHz.
- 10 dB typical gain.
- 3 dB typical noise figure.

10-1000 MHz AMPLIFIER
 Designed to help scanners with poor sensitivity pull in those weak signals. Includes OFF/BYPASS switch for returning to normal operation and front panel gain control. Add our custom case kit for that "Professional" look.

XLA-CASE KIT \$13.95
 XLA1000 (C) KIT \$24.95

WE ACCEPT VISA, MC, MO, COD SHIPPING & HANDLING EXTRA

TOLL FREE ORDER LINE
1-800-336-7389
 ASK FOR FREE CATALOG OF OUR PRODUCTS

SEND MAIL ORDERS TO: XANDI ELECTRONICS
 BOX 25647
 TEMPE, AZ 85285-5647

CIRCLE 134 ON FREE INFORMATION CARD

BUILDING BLOCK

FOR YOUR
CONTROL & MONITORING
NET WORK SYSTEMS



DINEX
DISTRIBUTED
INTELLIGENT
NETWORK
CONTROLLER

BY PLUGGING DINEX INTO YOUR PC
RS-232 YOU CAN CONNECT ALMOST
UNLIMITED I/O.

DIO-STD-SM \$69.95
5 TL DIGITAL I/O

ADFC-SM \$96.65
4 CHANNEL 8 BIT 0-5V A/D
1 CHANNEL FREQ INPUT

D-M232-SM \$79.95
RS-232 TO 485 INTELLIGENT
CONVERTER

LIMITED TIME

INTRODUCTORY OFFER:

\$199.95/kit +S/H

P/N SM-KIT Including:
DIO-STD-SM/ADFC-SM/D-M232-SM, POWER
ADAPTER, NETWORK PHONE LINE SOFTWARE,
DEVICE DRIVER, AND UTILITY. OVER \$450 VALUE.

ALSO AVAILABLE:
8 CH. 12BIT A/D, 12 BIT D/A STEPPER MOTOR
SERVO, DISPLAY, CODE INPUT, NETWORK
CONIT-OLLER...ETC.
PLS CONTACT FACTORY FOR DETAIL.

TO ORDER CALL: 15 DAYS MONEY BACK GUARANTEE
I/O CONTROLS CORPORATION VISA, MASTER CARD ACCEPTED.
1359 W. FOOTHILL BLVD. AZUSA, CA 91702
(818) 812-5333 FAX: (818) 812-5332

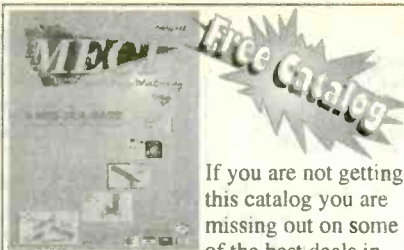

If you are not getting
this catalog you are
missing out on some
of the best deals in

electronics today! We have thousands of
items ranging from unique, hard-to-find
parts to standard production components.
Call, write, or fax today to start your free
subscription to the most unique catalog in
the industry, filled with super values on
surplus electronic and hobbyist type
items. If you have a friend who would
like to receive our catalog, send us their
name and address and we will gladly
forward them a complementary 68 page
catalog.

Why pay more? Call today.



340 East First Street Fax/Order Line
Dayton, Ohio 45404 1-800-344-6324

Order Toll-Free
1-800-344-4465

CIRCLE 169 ON FREE INFORMATION CARD

Motorless Motion!



Create direct linear action with Muscle WiresSM—
they *actually contract* up to 5% when powered!
Use them in robots, planes, railroads — anywhere
you need small, strong all-electric motion.

Q&A

What are Muscle Wires?

Muscle Wires are highly processed strands of a
nickel-titanium alloy called *nitinol*. At room
temperature they are easily stretched by up to 5%
of their length. When conducting an electric cur-
rent they return to their original "unstretched"
shape with a force *thousands of times* their weight.

How strong are Muscle Wires?

This varies with the wire's size. A single wire can
lift from 35 to 930 grams (over 2 lbs)! For more
strength, use several wires in parallel.

How fast can Muscle Wires activate?

They contract as fast as they are heated — as
quickly as 1/1000 of a second. To relax, the wire
must cool again. Rates of many cycles per second
are possible with active cooling.

Flexinol Muscle Wire Specifications

Wire Diameter (μm)	50	100	150	250
Resistance (Ω/m)	510	150	50	20
Contract Force (grams)	35	150	330	930
Typical Current (mA)	50	180	400	1000

How much power do Muscle Wires need?

Power varies with wire diameter, length, and
surrounding conditions. Once the wire has fully
shortened, power should be reduced to prevent
overheating.

What are the advantages of Muscle Wires?

Small size, light weight, low power, very high
strength-to-weight ratio, precise control. AC or DC
activation, long life and direct linear action and
much more!

Get our new 128 page *Muscle Wires
Project Book* with full plans for Boris and 14
other *motorless motion* projects, and our
Deluxe Sample Kit with one meter each of
50, 100 and 150 μm dia. Muscle Wires —
everything you need to get moving today!

**Order
Toll
Free!**

24-hour Voice Order Line — VISA/MasterCard

800-374-5764

Request our FREE Muscle Wires Technical Brochure

Mondo-tronics

524 San Anselmo Ave. #107-62
San Anselmo, CA 94960

Questions: 415-455-9330
Fax: 415-455-9333
Internet: mondo@holonet.net

**New Book &
Deluxe Kit
only
\$59.95**
Plus \$5.00 P&H
CA orders add tax

International Orders Welcome! First Class P&H: \$11.00

CABLE TV DESCRAMBLERS

Best Prices in the U.S.A.! Guaranteed to Work!

WE WILL BEAT ANY PRICE!



JERROLD PANASONIC SCIENTIFIC ATLANTA PIONEER

The Newest & the Latest

DMTB-A - all Jerrold Impulse & Starcom series

SA3-DFA - all Sci. Atlantas incl. 8536/+, 8580, Drop-field

PN-3A - all Pioneer systems

ALSO **FTB3, SA3, TZPC145G**

FAST SHIPMENTS FREE CATALOG 30 DAY MONEY BACK GUARANTEE

1-800-772-6244 M-F: 9-6 EST

U.S. Cable TV, Inc. Dept.: KPE084

4100 N. Powerline Rd, Bldg. F-4 Pompano Beach FL 33073

NO FLORIDA SALES!

DC/CAD

introducing...

THE TERMINATOR

Super High Density Router
(Complete with Schematic & PCB EDITOR)

Features the following powerful algorithm & capability:

- Rip - up and Retry
- Pre-routing of SMT components
- Real-Time via minimization
- Real-Time clean up passes
- User defined strategies
- Window 3.0 capability as DOS Task
- 1-mil Autoplacer and Autopanning
- Two-way Gerber and DXF
- Automatic Ground Plane w/ Cross-Hatching
- Complete w/ Schematic & Dolly Libraries
- Optional simulation capability & protected mode for 386 users

* PCB LAYOUT SERVICE AT LOW COST *

LEASE PROGRAM & SITE LICENSE AVAILABLE



Design
Computation

1771 State Highway 34
Farmingdale, NJ 07727
(908) 681 - 7700 • (908) 681 - 8733 (FAX)

" DC/CAD . . . The focal point of future CAD market "

Call for
DC/CAD - \$95
(available for students only)
normal price range
\$295 - \$2500

* THE BEST * 8085 MICROPROCESSOR TRAINING SYSTEM JUST GOT BETTER

Are you interested in Single Board Computers and Microprocessor based systems? If the answer is yes and you want to know more about these fascinating subjects the PRIMER Trainer is the place to start. The PRIMER teaches more and is easier to use than other comparably priced trainers. The over 100 page Self Instruction manual takes you from binary number systems to processing interrupts. At the end of the manual are working examples of

using photocells,
temperature sensors,
making a waveform
generator, programmable
timer with alarm, and a new
motor speed control lab using
back EMF. The PRIMER
comes with everything you need

to start programming in machine language. Continue on to program in
Assembler, Forth or BASIC with optional upgrade and software. Upgrade
includes: RS232 serial port, a serial cable and, 32K of battery backed RAM.

THE PRIMER IS ONLY \$119.95 QUANTITY 1 IN KIT FORM. THE PRIMER
ASSEMBLED & TESTED BY EMAC IS \$169.95. ORDER NOW AND RECEIVE
ONE FREE POWER SUPPLY WHEN YOU MENTION THIS AD. PLEASE ADD
\$5.00 FOR SHIPPING.

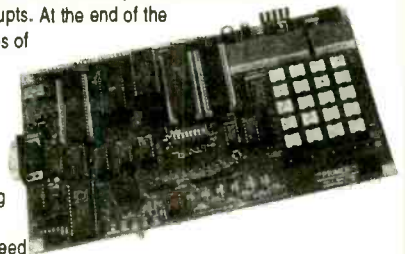

EMAC, inc.

618-529-4525 FAX: 457-0110 BBS: 529-5708
P.O. BOX 2042 CARBONDALE, IL 62902

DATA ACQUISITION

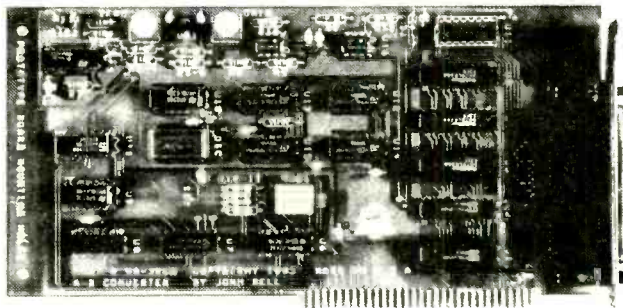
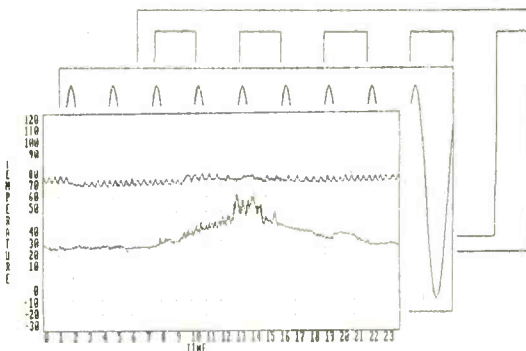

12 Bit 8 Channel Analog to Digital Converter + I/O

Specifications: IBM 486, 386, 286, 8088 PC compatible interface board.

12 Bit 8 Channel multiplexed Analog to Digital Converter. Input Voltage 0 to 2 volts (data 0 to 4095) .00048 volts per count. 12 Bit conversion time is less than 1ms. Accuracy is better than +/- 2 counts Linearity better than +/- 1%. Over Voltage, the counter is a 15 bit counter and this board will handle twice the normal input voltage. MODS: This board can be modified to convert 8 bits to 14 bits. This board also has one 8 bit TTL output port and one 8 bit TTL input port. All I/O is through a 37 pin D connector. A Disk with BASIC programs is included. Programs include a low frequency Oscilloscope, Data logger. Temperature measurement using a Radio Shack Thermistor and Voltage measurement. This board also has mounting holes for a Prototype board to be added.

Order Part Number 93-326A \$149.95 + Shipping (\$6.00 for 2 day air or \$4.00 for 8 day ground)

Circle my number on the FREE INFORMATION CARD to get more info on my other Interface Boards.

John Bell - 1381 Saratoga Street - Minden, NV 89423 - (702) 267-2704

JAN Crystals

FREE 1994 Catalog of General Purpose Crystals Now Available

FOR FREQUENCY CONTROL:

FUNDAMENTAL MODE CRYSTALS

1.001-30.0 MHz FROM \$11.00
HC6/U, HC33/U HOLDERS

FUNDAMENTAL MODE CRYSTALS

2.0-30.0 MHz FROM \$11.00
HC25/U, HC18/U MINIATURE
HOLDERS

THIRD MODE CRYSTALS

18-75. MHz FROM \$11.00
ANY HOLDER

FIFTH MODE CRYSTALS

52-125. MHz FROM \$13.00
ANY HOLDER

SEVENTH MODE CRYSTALS

110.5-150. MHz FROM \$18.00
ANY HOLDER

*Quantity Prices Available
On Request*

FOR MICROPROCESSORS:

...low E.S.R....close tolerance...long-term stability...
frequency deviation from 0° to 70°C max. ± 100 PPM...
tolerance at 25° ± 50 PPM.

HC49/U	
3.0-3.5 MHz	\$5.00
3.5-18.432 MHz	\$5.00
19.6608-24. MHz	\$5.00

When Ordering Please Specify MP-Crystal

*Your reliable source for a
world of crystal clear communication*

Order Toll-Free
1-800-JAN-XTAL
FAX ORDERS: 1-813-936-3750

EXPEDITED ORDER SERVICE AVAILABLE
CALL OR WRITE FOR FREE CATALOG
P.O. Box 60017 Ft. Myers, FL 33906

PRICES SUBJECT TO CHANGE WITHOUT NOTICE



TOP SECRET

CONSUMERTRONICS

2011 Crescent Dr., P.O. Drawer 537
Alamogordo, NM 88310

Voice: (505) 434-0234, 434-1778:
8AM - 8PM MST, Mon-Sat

Fax: (505) 434-0234 (orders only; if you get
answering machine, any time enter #111)

24-hour, 7 days/week
Free Tech Support (must relate directly to your
order or prospective order): Tues. and Thurs. only.

Add \$5 total SH (US, Canada). All items in stock. VISA,
MCARD OK (\$29 min.). No CODs or "bill me's". New Catalog
(150+ offers) is \$2 w/order, \$4 w/ (no free catalog).
In business since 1971. As seen on TV, etc. John Williams - former
Lockheed Senior Engineer, NMSU Computer Science Professor,
Navy, Air Force Weapons Engineer, NIH Health Physicist.

All software supports all IBM-PC compatible
8086 systems (8086 - Pentium)

Off-The-Shelf HARDWARE

Van Eck Systems, Automated Tempest Module, X-R
Radar Emitter, Carjacking Follower, Personal Body Alarm,
Voice Distorter, Hearing Assistor, Shriek Module, EM
Countermeasure, Omnimax TENS, 6th Sense Communicator,
many nifty Phone Boxes, Bumper Beeper, Subliminal
Music/Amp, Super MW0, Rifle Device, Neurophone,
Hieronimus Machine, Magnetometer, Data Card
Reader/Writers, Dwelling Security System, Levitator,
Vortex Generator, Ultrasonic Jammer & Receiver,
Long-Range Eavesdropper, Noise Cancellation System,
Unknown Presence Detector, Electronic Dowsing, Auto-
matic Pet Feeder, Stealth Paint - more! See our Catalog

CELLPHONE MODIFICATIONS

See our Catalog for our infamous cellphone modification
guide (\$69) - detailed, comprehensive, covers all makes -
10 times more info than competitor's "guides". (Do Special
Projects (below) for up-to-date hardware/software).

SPECIAL PROJECTS

We design, build, repair, modify, maintain and/or consult
on any device, system, process or project - electrical,
electronic, computer, phone, mechanical, optical, automa-
tic. Invention prototyping. Confidentiality guaranteed.
Describe and include \$25 pre-engineering fee (does not
obligate you). Time and cost estimates in 7-10 days.

VOICE MAIL HACKING

How Voice Mail Box (VMB) systems are used and the
specific ways they are hacked. Includes ASPEN, MES-
SAGE CENTER, BIX, GENESIS, EZ, SYDNEY, PHONE
MAIL, AUDIX, CINDY, CENTAGRAM, SPERRY LINK,
RSVP, etc. Absolutely required for all users, sysops and
security personnel \$20.

PBX HACKING

How PBXs are hacked to the tune of \$100,000! While
"VOICE MAIL HACKING" details how VMSS are
hacked for "phun" and profit - including VMS methods
for hacking PBXs themselves - PBX HACKING ad-
dresses ALL issues relating to PBX hacking, including
countermeasures! Can your business or agency afford a
\$90,000 phone fraud loss (the average loss due to
hacked PBXs)? As described in Forbes Magazine, \$39

PHREAKING CALLER ID & ANI

Details on how they work and dozens of effective ways
of defeating Caller ID, ANI, *69, *57, and Call Blocking
and *67. Also describes Caller ID, Orange, Beige,
Cheese and CF Boxes, ESS, SS7, E-911, various
CLASS services, CNA, NPN PUB DA, CAMA, DNR,
800-EGR, Diversers, LD Extenders, Centrex - more, \$29.

PHONE COLOR BOXES

As designed by Phone Phreaks! 15 phone color boxes
described. Dozens of circuits, simulator programs. Plus
call-forwarding, conferencing, phreak history, 50 useful
and legal phone circuit plans - more, \$29.

ROBOFONE AUTODIALER

Powerful, versatile, menu-driven "Wargames" auto-
dialer lets you dial any quantity (up to 10K) or mbx of lo-
cal/long distance numbers in any order, over any length
of time, whether busy or answered (your choice) and
log the times, commands and results to monitor, printer
and/or disk. Quick-dial directory of up to 800 numbers.
BUSY redial options. Direct modem command and con-
trol. All Result Codes, including VOICE and RINGING.
Optional shell to terminal program upon CONNECT. Exit
to menu or DOS (for batching). Manual + Disk \$29.

COMPUTER PHREAKING

INDIAN HORSES, VIRUSES, WORMS, etc.
and countermeasures. Includes disk with 300K of hacker
text files and utilities, and legendary FLUSHOT+ pro-
tection system (Editor Choice, PC Magazine). Dozens of
computer crime and abuse methods and countermea-
sures. How systems are penetrated. BBS advice, pass-
word defeats, glossary - much more! Manual +
Disks \$39.

BEYOND VAN ECK PHREAKING

Eavesdropping on TV and computer video signals using
an ordinary TV! Includes security industry reports. Range
up to 1 KM. Plans include both the Consumertronics and
the original Top Secret Van Eck designs! \$29.

CRYPTANALYSIS TECHNIQUES

The powerful menu-driven crypto programs in COM
and their BAS sources) to analyze, decrypt "secure" in-
tertexts. Worked-out examples. Recommended in pres-
tigious "Computers & Security". Manual+Disk \$29.

By an ORDER of the MAGNITUDE

The most comprehensive, hard-hitting, hi-tech sur-
vival book ever written! Topics include electronics,
computers, energy, weapons, concealment, revenge,
alarms, etc. to survive today's dangerous world. We all
face increasingly financially and physically brutal times!
Life-expedient use of technology in various threat and
conflict environments and scenarios, \$49.

STOPPING POWER METERS

As reported on CBS "60 MINUTES": How certain de-
vices can slow down - even stop - wattour meters -
while loads draw full power! Device simply plugs into
one outlet and normal loads into other outlets. Also de-
scribes meter creep, overload droop, etc. Plans \$29.
I.Q. MANUAL: External magnetic ways (applied to the
meter itself) to slow down and stop wattour meters
while drawing full loads. Plans, \$19. KW-HR
METERS: How wattour meters work, calibration,
error modes (many), ANSI Standards, etc. Demand and
Polyphase Meters. Experimental results to slow and
stop meters by others. \$19. Any 2, \$38. All 3, \$59.

AUTOMATIC TELLER MACHINES

ATM crimes, abuses, vulnerabilities and defeats ex-
posed! 100+ methods detailed, including: Physical, Reg-
E, cipher, PIN compromise, card counterfeiting, mag-
netic stripe, false front, TEMPEST, Van Eck tapping,
spoofing, inside job, super-cool, vibration, pulse, high
voltage - others. Case histories, law, countermeasures,
detailed security checklist, labeled internal photos, fig-
ures. ATMs contain up to \$250,000 in cash! Recent
\$350,000 ATM crime spree still unsolved! \$39.

CREDIT CARD SCAMS

Cardholders, merchants, banks suffer \$1 billions in
losses annually because of credit card fraud. Describes
every known means of credit card fraud and scams.
Protect yourself! \$29.

CONS & SCAMS

Cons & scams fleece Americans of \$100+ Billion per
year! The most comprehensive survival manual on cons
& scams of all kinds - from the classic to hi-tech. De-
tails on 100s and their many variations. Protect your-
self! \$29.

HIGH VOLTAGE DEVICES

HV devices plans: Stun Gun, Taser, Prod, Cans,
Flasher, Blaster, Zapper, Audio/Radar Jammer,
Jacob's Ladder, Plasma & Van de Graaff Gens, Fence
Charger, Geiger Counter, Ozone Gen., Fish Stunner,
Plant Stim., Kurlan, more! Shocking! \$29.

UNDER ATTACK!

Electromagnetic Interference and Electronic Weapon
attacks cause: Cancer, birth defects, and profound psy-
chological, neurological, cardiovascular and immune
system disorders! Destructive to people, animals,
plants, equipment! Includes ACTUAL CASES OF EM AT-
TACKS ON PEOPLE (we investigated!) Includes how to
verify and pinpoint EMI and electronic attack sources,
and specific countermeasures. \$29. EM BRAIN-
BLASTER: Tutorial and plans for powerful
ELECTROMAGNETIC WEAPONS and LAB DEVICES.
Optimum circuits, freqs, waveforms, duty cycles, inter-
sensities. Through \$29. Both \$49.

RADIONICS MANUAL

Exciting electrical, electronic and electromagnetic ther-
apeutic, diagnostic and preventive devices (mostly ex-
perimental). History, descriptions, plans (dozens), avail-
abilities of Radionics Devices from early to modern.
While drugs cost \$ Hundreds, electricity costs pennies!
\$29. HEAL THYSELF: Plans for 3 major elec-
tronic therapeutic devices of types approved by FDA.
\$19. Both \$39.

HARD DRIVE MANUAL

Covers all hard drive and controller implementations
(emphasis on PCs). How to select, interface, initialize,
set up, use, maintain, troubleshoot and repair them.
How to protect them from mistakes, sabotage, prying
eyes and sticky fingers. How to recover damaged and
lost files. How to prevent crashes. Includes software re-
views. Loaded with information, advice, tips. \$29.
DISK SERVICE MANUAL: Maintain, trouble-
shoot, repair, adjust, align floppies without special
equipment or software. 3.5x5.25", PCXTA/386/
486, Apple, Commodore, etc systems. All floppies need
occasional upkeep. \$29. DISK DRIVE TUTO-
RIAL: Theory, practical facts on floppy drives, disks,
including many tips, recommendations, formatting, in-
terfacing FDC, etc. \$24. Any 2 \$49. All 3, \$69.

SOFTWARE PROTECTION SYSTEM

Unique system that highly discourages costly software
piracy while not interfering with legit archival copies. No
known way to defeat. No special equipment required.
Simple and automatic to install on your distributed soft-
ware. Compatible with all copy-prevention systems.
Manual + Disk \$39.

STEALTH TECHNOLOGY

Police radar is fascinating! It also has error rates of 10-
20%! Every known error mode - stealth method and ma-
terial used to minimize radar reflections - tactic and
strategy to fight unjust radar tickets (that cost you
\$100s in insurance and risk cancellation) - methods to
detect and jam signals - fully described \$29.

SECRET & SURVIVAL RADIO

Optimum survival and security radio equipment, meth-
ods, freq allocations and voice/data scrambling/encod-
ing. Includes small receivers/transmitters, telemetry, an-
tenna optimizations, remote monitoring and control, se-
curity, surveillance, and ultrasonic, fiber-optic and infra-
red commo. 70+ circuit plans, tables, \$29.

ULTIMATE SUCCESS MANUAL

Underpaid? Harassed or abused? Manipulated?
Taken for granted? Stuck in a dead-end job? Can't find a
good job? Expect to be laid off, fired or transferred
soon? The ultimate no-holds-barred, looking-after-#1
Machiavellian techniques to find, obtain, optimize and
keep top jobs, pay and benefits. THE RULES OF THE
GAME FOR A GAME WITHOUT RULES! From first re-
sponse to CEO. \$29.

ROCKET'S RED GLARE

How to design and build solid-propellant amateur and
survival rockets. Emphasis on formulation, manufacture,
installation of propellants, motors, igniters, etc. Includes
list of commonly available materials, and the design of
launch pads and test beds and their electronics. \$29.

Please Order Today! (505) 434-0234
Sold for educational purpose only.

ELECTRONIC/ELECTRICAL TEST ACCESSORIES

Only ITT Pomona Offers Such Value.

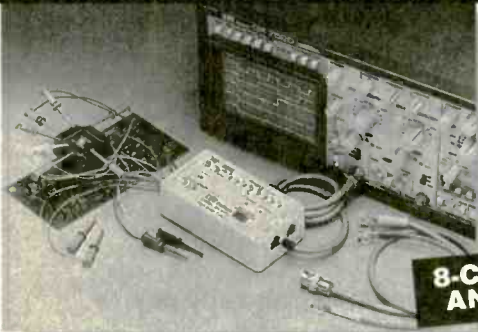

Simply plug it into any scope with a bandwidth of 5MHz or Higher, 200mV/div or better sensitivity, and external triggering, rising edge (+) capability. 20MHz bandwidth covers most microcontroller frequencies.

8-CHANNELS AND MORE!

Turn Your Scope Into A Digital Analyzer.

Pomona's pocket-sized Logic Scope Probe features three modes: logic analyzer, trigger probe and MUX. Kit includes Logic Scope Probe, 11 test leads with Micrograbber® test clips packaged in a reusable blister box that fits into your tool box or scope case.

6004 Logic Scope Probe Kit \$330.00

If You Use A Scope, These Quality Probes Will Make A Difference.

Selecting the right scope probe can be as important as selecting the scope itself because signal accuracy is only as good as the link between your Tek, B&K or Hitachi scope and the item you're testing. Pomona scope probes give you faster rise times for sharper wave forms, and lower impedance for cleaner signals.

100 MHz Standard Modular These low-cost workhorses offer excellent attenuation for most conventional scope uses (up to 100 MHz). Kits include: sealed insulated probe, 1.2 meter cable assembly, insulated alligator clip grounding lead, trimmer tool (except Model 5792), spring hook, BNC adapter, gold plated beryllium copper tip, stainless steel tip, IC tip, insulating tip and a reusable plastic case.

200 MHz Professional Modulator Excellent performance characteristics and full attenuation ranges (including x100 and switchable x1x10). Probe kit contains same accessories as 100MHz Kit.

Part No.	Att'n	Cable Length (m)	Input Impedance R(MΩ)	Input Impedance C(pF)	BW (MHz)	Risetime (nsec)	Max Input (V)	Compensation Range (pF)	Price
5792	x1	1.2	Same as scope	45	20	15	600		31.00
5795	x10	1.2	10	15	100	3	600	10-60	35.00
4550A	x1-x10 Switchable	1.2	x1 x10 Same 10	x1 x10 55 16	x1 x10 15 100	x1 x10 3 3	600	10-60	43.00
5800	x1	1.2	Same as scope	45	30	10	600		41.00
5803	x10	1.2	10	15	200	1.8	600	10-60	45.00
5806	x1-x10 Switchable	1.2	x1 x10 same as	x1 x10 55 15.5	x1 x10 20 200	x1 x10 10 1.8	600	10-60	49.00
5827	x100	1.2	100	6.5	200	1.6	1200	15-50	80.00

Get ITT Pomona's 1994 New Products Catalog. FREE!

Find hundreds of new probes, test leads, clips, kits and accessories for keeping pace with the latest technology. To order your free catalog, visit your nearest Pomona Distributor, write or call us direct at (909) 469-2900.

ITT Pomona Electronics
1500 E. Ninth Street
Pomona, CA 91766-3835
(909) 469-2900 FAX (909) 629-3317

CIRCLE 139 ON FREE INFORMATION CARD

Circuit Test Strips & Panels Let You Test Circuits First.

Pomona test strips and panels are the easy way to test electronic circuits before you build them. Our Circuit Test Strips are rated for over 25,000 insertions. Maximum current is 1A, contact resistance <math><10\text{m}\Omega</math>, with a 10pF capacity between contact points. Circuit Test Panels feature six Circuit Test Strips for larger bread board tests, providing 3,330 test points.

An Accessory Kit is available to replace damaged contact points/buses.

6037 Circuit Test Strip \$ 9.50 ea.

6038 Circuit Test Panel \$65.00

6039 Accessory Kit \$15.00

Great Test Lead Kits For Fluke & Other DMMs.

They're the ideal replacements for Fluke, Wavetek (Beckman), B&K, Amprobe and most DMM test lead sets. Each kit features the right combination of accessories to meet your specific test requirements. And several of our probes and kits are designed to meet IEC1010 specifications for your assurance of safer operation.



Description/Contents of Kit	Part No.	Price
General Use Test Lead Kit* 2 each: Probe Handles, Right Angle to Straight Plug Test Leads, Flexible Maxigrabber® Test Clips and Medium Alligators, one black and one red.	5899	36.00
Industrial Test Lead Kit* 2 each: Probe Handles, Right Angle to Straight Plug Test Leads & Maxigrabber® Grip Clips, one black and one red.	5900	37.00
Deluxe Bench Meter DMM Kit* 2 each: Probe Handles, Straight to Straight Plug Test leads, Flexible Maxigrabber® Test Clips & Medium Alligators, one black & one red; 2 Spade Lugs.	5901	29.00
Electronics Lab Test Kit Switchable x1-x10 Oscilloscope Probe with Accessories, Multi-use kit for Electronics (5543A), Oscilloscope Ground Kit and Double Banana Plug to BNC (f).	6003	92.00
Multi-use Kit for Electronics 2 each: Probe Handles, Pop Jack Leads, one black & one red, 1 each: Medium Alligator, Spade Lug, Minigrabber® Lead & Extended Slide-on Tip.	5543A	34.90
Deluxe Kit for Electronics 2 each: Probe Handles, Medium Alligators, Minigrabber® Leads, Minipincer® Leads, Slide-on IC Tips, Slide-on Extended Tips, & Pop Jack Leads, one black & one red, & 2 Spade Lugs.	5674A	59.90
Maxi-Kit 2 each: Extendable Tip Probe Leads, Replaceable Tip Probe Handles, Pop Jack Leads, Couplers, Medium Alligators, Heavy Duty Alligators, Minigrabber® Leads, Minipincer® Leads, & Slide-on IC Tips, one black & one red, and 2 each: Spade Lugs, Dog Leg Micro Tips, Needle Tips, Shouldered Micro Tips & 4 Std Brass Tips.	5677A	79.90

*IEC1010 safety designed models



The fastest, easiest way to order any of the products featured here is to visit your nearest Pomona Distributor. If you already have our 1994 Catalog, you'll find these and thousands of other test accessory products immediately available. Or, you can charge purchases on your VISA, MasterCard or American Express credit card by phoning, toll free, 1-800-ITT-POMONA (credit card orders only).

ITT Pomona Electronics

AN ITT CANNON COMPANY

October 1994, Popular Electronics

123

CABLE TV DESCRAMBLER KITS

"New & Improved Version"

Universal Descrambler

Includes all the parts and an etched & Drilled PC Board. Not included is AC adaptor or enclosure.....\$69.00

Tri-Mode Descrambler

Includes all the parts and an etched & drilled PC board & AC adaptor. Not included is the enclosure.....\$49.00

SB-3 Descrambler

Includes all the parts & an etched & drilled PC board & AC adaptor. Not included is the enclosure.....\$39.00

Call Toll Free 1-800-886-8699

Visa, MasterCard & COD.

M & G Electronics, Inc. 2 Aborn Street, Providence, RI. 02903

It is not the intent of M & G Electronics, Inc. to assist any individual to defraud any pay TV operator or to violate any state or federal laws regarding the use of the descrambler kits. You must understand the kits being purchased for educational and or experimental use only.

Weeder Technologies

FREE
construction plans for
any of these kits
Call 513-752-0279

Pro-Kit

PO Box 421, Batavia, OH 45103

Educational Kits for the Serious Hobbyist

Caller Block

Connects between your telephone and its wall jack, and prevents the phone from ringing unless the calling party is one which you've entered into memory using your touch-tone phone. Your answering machine can handle all other calls. Change between two separate directories of callers with a simple flip of a switch.

Telephone Caller ID

Connects to telephone wall jack. Shows the telephone number of the calling party along with the time of day the call was received, on a 16x1 character LCD display. Stores the info from the last five calls in memory. Complete stand alone, no computer interface needed.

Telephone Call Restrictor

Connects to telephone wall jack. Disables all phones on the line if attempting to either: dial a number that has been stored in memory "Block Mode" or, dial a number that has not been stored in memory "Allow Mode". Use touch-tone phone to enter telephone numbers into memory, and choose mode. Program from any phone on the line using your password.

50 MHz Frequency Counter

Reads frequency from 1Hz to 50MHz and displays it on a 16x1 character LCD display. Auto-range feature provides floating decimal point and automatically affixes the correct suffix (Hz, KHz, or MHz). Microcontroller based, very few additional components.

Telephone Scrambler

Scrambles your voice before sending it over the telephone line, and descrambles it on the other end. Connects between your telephone and wall jack. No modifications are required to your telephone. Full duplex operation.

Electronic Message Module

Use a set of four pushbutton switches to write and store your own personal message in a 8-pin non-volatile EEPROM, which can then be printed across a 16x1 LCD display. Message can be up to 240 characters long. EEPROM can be removed from socket and still retain message. Re-program over and over with new messages.

Vocal Filter

An audio device which can be used with a home component stereo system, to filter out the main vocal sound track from standard stereo recordings (CD, tape, record or FM), leaving the background music to sing along with. Produce your own karaoke tapes.

Vocal/Effects Mixer

An audio device which hooks up to the "tape monitor" jacks of any home component stereo, and allows you to mix your own voice with the program source (CD, tape, record, FM, etc.) as its being played through your stereo. Features Bass, Treble, and Reverb controls for your voice. Great for having your own karaoke party.

CELLULAR SOFTWARE

**Program ESN & NAM info on
New Cell Phones**

Don't be fooled by software that only programs old phones. You don't have to open the phone. Guaranteed!

MOTOROLA ABOVE 9122

**Panasonic, NEC, Technophone,
Diamondtel/Mitsubishi, Nokia**

Other makes & models Available

ESN Reader kit coming soon!

**Software prices from \$395.00
Sold for Educational Purposes only**

609-751-2242

450 MHz SPECTRUM ANALYZER

Adapted from Nov. '85 QST article by Al Helrick K2BLA



Features: Three digit LED center frequency readout. 12 position calibrated scan width 1 KHz to 50 MHz. switchable bandwidth; wide = 300 KHz, narrow = 15 KHz. Use your low frequency scope for the display. Switchable 10 KHz video filter: Variable IF attenuator, LOG output calibrated in 10 db steps.

**Complete Kit Only \$459.95
Assembled & Tested \$799.95**

CA Residents add 7.75% sales tax. S&H: \$7.50 (insured). Foreign orders add 20%. For more info or price list; send LSASE (52¢) to:

A&A Engineering

2521 W. LaPalma #K • Anaheim, CA 92801 • 714-952-2114



**The National
Arbor Day Foundation**

96,000 acres of irreplaceable rain forest are being burned every day. Join The National Arbor Day Foundation and support Rain Forest Rescue to help stop the destruction. Call now.

**Call Rain Forest Rescue NOW.
1-800-255-5500**

Learn MICROCONTROLLERS and EMBEDDED SYSTEMS with the AES-10

The AES-10... a complete learning system, a complete embedded control system. Extensive manuals guide you through your 8051 development project. Assembly, BASIC, and C programming. All hardware details, complete schematics. Learn to program the LCD, keypad, digital and analog I/Os for your applications.

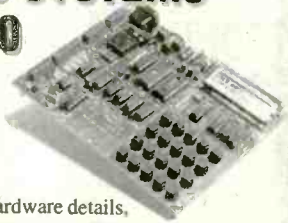

80C32 Computer/Microcontroller board with:

- 32K ROM, 32K RAM
- 2 by 16 Liquid Crystal Display
- 4 by 5 Keypad
- Digital, A/D, D/A, and PWM, I/O
- Built in Logic Probe
- Power supply, (can also be battery operated)
- Extended AES BASIC and AES Monitor in ROM
- Built-in routines for LCD, Keypad, A/D, D/A and Digital I/O ports
- See 80C32 registers while you Step
- See all memory locations and data on LCD
- See memory contents in dec. hex. and binary
- RS-232 cable to connect to PC for programming
- 8051/52 DOS Cross Assembler
- Program disks with well documented examples
- User's Manual, Language Manual, and Text

\$365, Money Back Guarantee
Free Brochure, M/C Visa
800 - 730-3232
714 - 744-0981
Fax 714 - 744-2693



1407 North Batavia Street, Orange, California 92667, USA

CONTROL ANYTHING FROM YOUR COMPUTER SERIAL PORT!

115200 BAUDS SMART BOARDS DO NOT REQUIRE PROGRAMMING! The I/O-232 boards understand simple commands, e.g. PRA [Enter] reads Port A. Results are sent back to the computer as an ASCII string allowing the use of PROCOMM, MAC240, or your own programs. In addition to interfacing, the I/O-232 boards have the following embedded functions:

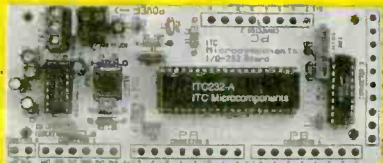

- All standard Baud rates (300-115KB) supported.
- Bin. Hex or Dec formats.
- 24 I/O lines configurable individually as Inputs or latched Outputs.
- 8 or 10 bits, 10 channels Analog to Digital converter.
- 10-10,000 Hz, 0-100% Pulse Width Modulation output.
- 3 EASY to use stepper motor logic interfaces (Muxable to more).
- Relative resistance or capacitance measurements using an RC network (ideal to read temperatures using a thermistor).

I/O-232-8A (8 bit ADC) Assemb. Only US\$109
I/O-232-8K (8 bit ADC) Kit. Only US\$ 89
I/O-232-10A (10 bit ADC) Assemb. Only US\$125
I/O-232-10K (10 bit ADC) Kit. Only US\$ 99
Add \$10 for manuals + Shipping & Handling

ITC MICROCOMPONENTS INC.

18440-57 Ave, Edmonton AB, T6M 1Y2,
Canada. Phone & Fax: 1 (403) 486 2377

EASY TO FABRICATE
DESIGNED FOR SMALL LOT
PRODUCTION

SHEET METAL BOXES FOR CONSTRUCTION

ALL ITEMS STOCKED
FOR QUICK DELIVERY
SHEET METAL BOXES SHIPPED FLAT



DUAL SLOPE METAL CABINETS

MODEL	DESCRIPTION MAJOR DIM. SECONDARY DIM. W x D x H (inches) W x D x H (inches)	PRICE \$
DS-1	4 x 6 x 4 x 12 x 1.9 x 2.4 x 1.6	59.00
DS-2	6 x 6 x 4 x 12 x 1.9 x 2.4 x 1.6	63.25
DS-3	8 x 6 x 4 x 12 x 1.9 x 2.4 x 1.6	67.50
DS-4	10 x 6 x 4 x 12 x 1.9 x 2.4 x 1.6	71.50
DS-5	12 x 6 x 4 x 12 x 1.9 x 2.4 x 1.6	76.00
DS-6	16 x 6 x 4 x 12 x 1.9 x 2.4 x 1.6	81.00
DS-7	4 x 8 x 6 x 2 x 3.1 x 3.5 x 1.9	69.00
DS-8	6 x 8 x 6 x 2 x 3.1 x 3.5 x 1.9	73.00
DS-9	8 x 8 x 6 x 2 x 3.1 x 3.5 x 1.9	78.00
DS-10	10 x 8 x 6 x 2 x 3.1 x 3.5 x 1.9	82.75
DS-11	12 x 8 x 6 x 2 x 3.1 x 3.5 x 1.9	87.75
DS-12	16 x 8 x 6 x 2 x 3.1 x 3.5 x 1.9	100.75



PANELS ARE .063" ALUMINUM

RACK CHASSIS

MODEL	DESCRIPTION W x D x H (inches)	PRICE \$
1RU5	19 x 5 x 1.75	30.85
1RU7	19 x 7 x 1.75	33.10
1RU10	19 x 10 x 1.75	35.25
2RU5	19 x 5 x 3.5	33.10
2RU7	19 x 7 x 3.5	35.25
2RU10	19 x 10 x 3.5	37.80
3RU5	19 x 5 x 5.25	41.90
3RU7	19 x 7 x 5.25	44.10
3RU10	19 x 10 x 5.25	46.30



PANELS ARE .063" ALUMINUM

METAL CABINETS

MODEL	DESCRIPTION W x D x H (inches)	PRICE \$
MC-1A	4 x 3 x 2	18.50
MC-2A	6 x 3 x 2	18.75
MC-3A	8 x 3 x 2	20.95
MC-4A	4 x 4 x 3	18.75
MC-5A	6 x 4 x 3	20.95
MC-6A	8 x 4 x 3	23.15
MC-7A	4 x 7 x 4	20.95
MC-8A	6 x 7 x 4	23.15
MC-9A	8 x 7 x 4	25.75



PANELS ARE .060" ALUMINUM AND ARE FIELD REMOVABLE

HEAVY DUTY RACK CHASSIS

MODEL	DESCRIPTION W x D x H (inches)	PRICE \$
3RU7 HD	19 x 7 x 3.25	115.00
3RU10 HD	19 x 10 x 5.25	121.00
3RU14 HD	19 x 14 x 5.25	134.00
4RU7 HD	19 x 7 x 7.0	121.00
4RU10 HD	19 x 10 x 7.0	129.00
4RU14 HD	19 x 14 x 7.0	134.00
5RU7 HD	19 x 7 x 8.75	126.00
5RU10 HD	19 x 10 x 8.75	133.00
5RU14 HD	19 x 14 x 8.75	143.00

SHEET METAL PUNCHES

MODEL	MOLE SIZE & SHAPE	PRICE \$
PUNCH 1	3/8" ROUND	9.95
PUNCH 2	7/16" ROUND	9.95
PUNCH 3	1/2" ROUND	9.95
PUNCH 4	9/16" ROUND	12.95
PUNCH 5	5/8" ROUND	12.95
PUNCH 6	11/16" ROUND	12.95
PUNCH 7	3/4" ROUND	12.95
PUNCH 8	13/16" ROUND	12.95
PUNCH 9	7/8" ROUND	12.95
PUNCH 10	1" ROUND	13.95
PUNCH 11	1-1/16" ROUND	13.95
PUNCH 12	1-1/8" ROUND	13.95
PUNCH 13	1-3/16" ROUND	13.95
PUNCH 14	1-1/4" ROUND	14.95
PUNCH 15	1-3/8" ROUND	14.95
PUNCH 16	1-1/2" ROUND	16.95
PUNCH 17	1-5/8" ROUND	21.95
PUNCH 18	1-3/4" ROUND	24.95
PUNCH 19	2-5/8" ROUND	61.95
PUNCH 20	1 1/16" SQUARE	32.95
PUNCH 21	3/4" SQUARE	38.95
PUNCH 22	1" SQUARE	48.95
PUNCH 23	2 1/2" x 1 1/4" RECT.	48.95
*PUNCH 24	*THRUST RACES	10.95

\$610.00
(shipped within 48 states)



BRAKE & SHEAR

CUTS METALS, PLASTIC, ETC. TO .063" THICK AND 7 7/8" WIDE AND BENDS UP TO 90°. GREAT SHOP TOOL.

TECH LINE (702) 565-3993 M - Th 8 am to 4 pm (Pacific Time)

HAND TOOLS

MODEL	DESCRIPTION	RANGE (mm)	PRICE \$
MD-1	MICRO REAMER	1.0-5.5	16.50
MD-2	REGULAR REAMER	3.0-12.0	28.00
MD-3	LARGE REAMER	10.0-25.0	48.00
RT-1	RETHREADER	3.0 x 0.5	10.50
AD-1	DRILL BIT ADAPTER FOR POWER SCREWDRIVER		6.50

NEW FOR 1994

RACKEM 'N' STACKEM™ SERIES
A NEW 1/2 RACK SYSTEM WITH ITS OWN TABLE-TOP RACK
AVAILABLE IN CLEAR, BLACK AND GOLD FOR A GREAT PRESENTATION

ORDERS (800) 634-3457
FAX ORDERS (800) 551-2749

One will only be answered by our technician;
If no answer, please try at another time
OFFICE (702) 565-3400
FAX (702) 565-4828

SESCOM, INC.
2100 WARD DRIVE
HENDERSON, NV 89015 USA



CALL OR WRITE FOR YOUR FREE 24 PAGE CONSTRUCTOR'S CATALOG!
PREPAID ORDERS SHIPPED GROUND AT NO CHARGE (48 STATES)



CIRCLE 48 ON FREE INFORMATION CARD

EARN MORE MONEY!

Be an FCC LICENSED ELECTRONIC TECHNICIAN!



Earn up to \$60 an hour and more!

Learn at home in spare time. No previous experience needed!

No costly school. No commuting to class. The Original Home-Study course prepares you for the "FCC Commercial Radio-telephone License." This valuable license is your professional "ticket" to thousands of exciting jobs in Communications, Radio-TV, Microwave, Maritime, Radar, Avionics and more...even start your own business! You don't need a college degree to qualify, but you do need an FCC License.

No Need to Quit Your Job or Go To School

This proven course is easy, fast and low cost! **GUARANTEED PASS**—You get your FCC License or money refunded. **Send for FREE facts now. MAIL COUPON TODAY!**

Or, Call 1-800-932-4268 Ext. 240

COMMAND PRODUCTIONS
FCC LICENSE TRAINING, Dept. 240
P.O. Box 2824, San Francisco, CA 94126
Please rush **FREE** details immediately!

NAME _____
ADDRESS _____
CITY _____ STATE _____ ZIP _____



Model Close Out
Reg. \$59.95
Sale \$24.00*
Item # Z3800 ▶

Full Range DMM

- 5 DCV ranges ±0.5%
- 5 ACV ranges ±0.8%
- 7 DCA ranges ±0.5%
- 7 ACA ranges ±1%
- 6 OHM ranges ±0.8%
- Diode Tester
- Trans. Tester
- Continuity Buzzer
- Highly Visible Yellow Color
- 1 Year Warranty

Versatile DMM w/ Capacitance

- Large LCD Display
- DCV accuracy 0.5%
- Diode test, continuity check with buzzer sound
- Transistor hFE test
- All ranges overload protected
- Rugged case, drop proof
- Capacitance measurement 1pF-20µF in 5 ranges
- Resistance measurement up to 200M
- Auto power off
- Yellow Case
- 1 Year Warranty

Reg. \$54.95
Sale \$42.00*
Item # Z3910



800-470-WIND (9463) Free Shipping

9 am to 5 pm Pacific Standard Time M-F



or send Check or Money order

* CA customers please add Sales Tax
• Prices Subject to Change

*** Quick Delivery via U.S. 2-Day Priority Mail**

24 Hour Fax Order Line
408-987-7735

Windward

Products

We Stand Behind our Products....Satisfaction Guaranteed

P.O. Box 378, Moffett Field, CA. 94035

EPROM+ PROGRAMMING SYSTEM USES PARALLEL PORT

EPROMS (24,28,32 & 40 PIN*) PLUS 27CXXX
1702*,2708,TMS2716*,32,32A,64,64A,128,128A
256,512,513,011,010,101,1001,1000,1024,210,020
2001,220,2048,4001,040,240,4096,25XX,68764/66
FLASH EPROMS 28F256, 28F512, 28F010
28F020, 29C257, 29C010, 29F010
EEPROMS & NVRAMS (18,24 & 28 PIN+CXX)
2210,2212,2804,2816,2816A,2817,2864,2865,28256
28C010, DS1220, DS1225, DS1230
SERIAL EEPROMS* (8 & 14 PIN PLUS CXX)
E1R1400,M58657,2401,02,04,08,16,2444,59C11
9306, 46, 56, 66, 8572, 82, 92
BIPOLAR PROMS* (16 THROUGH 24 PINS)
74SXXX AND 82SXXX FAMILY
MICROCONTROLLERS* 8741, 42, 48, 49, 8751
C51,8752,87C52,87C5XX,87C751,87C752,68705
68HC705, 68HC711E9, PIC16C5X, TMS7742
*ADAPTER REQ'D - DIAGRAMS INCLUDED

SOFTWARE - READ,VERIFY,PROGRAM,COPY
DISK FILE LOAD/SAVE, CHECKSUM, FULL
SCREEN BUFFER EDITOR W/20 COMMANDS
READS HEX, S.RECORD AND BINARY FILES
FAST-DEVICES PROGRAM IN UNDER 60 SEC
RUGGED (8"X7"X3")ENCLOSURE W/HANDLE
MADE IN USA - 1 YEAR WARRANTY

ANDROMEDA RESEARCH, P.O. BOX 222, MILFORD, OH 45150
(513) 831-9708 FAX (513) 831-7562



SYSTEM INCLUDES:
PROGRAMMING UNIT
PRINTER PORT CABLE
POWER PACK, MANUAL
AND SOFTWARE.

\$289

ADD \$5.00 SHIPPING
\$5.00 C.O.D.
VISA/MASTERCARD

Powerful Integrated Digital and Analog (Berkeley Compatible Spice)
Circuit Design and Simulation Software for Microsoft Windows (network compatible)

Best value in town!! Includes 4 Integrated Modules: LogicDesigner + WinSpice + WinScope + Symbol Editor
Perfect For Students, Technicians and Engineers!!!

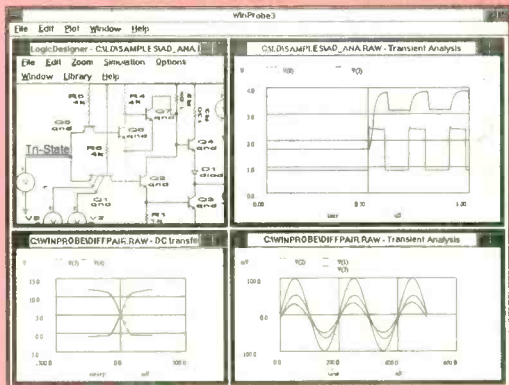

Simply connect your circuit on the screen, enter simulation options, then kick back and watch it work!! Comes with two Spice libraries plus 5 more libraries of Active Digital Devices CMOS, 74xx, 74xx, ALUs, counters, MUX, FFs etc. Plus a Passive symbol library of Microprocessors and more. Use the Symbol Library Editor to Design your own symbols and symbols to represent Sub-circuits, True Bussing, Buss pins can be assigned Unique Names, Parts Billing List, Legends, Nested Subcircuits for Hierarchical Top Down or Bottom Up Design, Checks Fan Out Violation and Electronic Rules, Device Unit Numbers/Chip Pinouts Automatically added as per Data Books, Connectors, Spice Netlist Generation, Continuous ZOOM In/Out, Cut/Copy/Paste, Multiple Rotatable Fonts, Rotatable Symbols, Multipage Zoomed In/Out Printouts to any Windows Printer. ON LINE HELP

LogicDesigner Digital Simulation/Schematic Capture Module

Interactive Digital Simulation and Schematic Capture, Single Step Mode, Variable Speed Simulation, Programmable Digital Delays, Multi Waveform Scrolling Timing Diagram Memorizes up to 30000 Ticks Worth Of Timing Data, Truth Table Generation, Binary to 7 Segment Displays, Hex Keypads, Programmable Clock Sources, Logic Probes. Built in Logic Analyzer can be set up to generate Edge or Level Sensitive Breakpoints, or when Signals are Equal To, Greater Than, or Less Than a Certain Value or any AND/OR Combination. Sequential Breakpoints help Track Down and Debug Circuit Race Conditions Glitches, Setup and Hold Violation and other Circuit Design Errors. Simulates Tri State, Open Collector & Don't Care Logic, RAM/ROM, One Shot, Carry Look Ahead, Shift reg, Pull Up/Down Resistors.

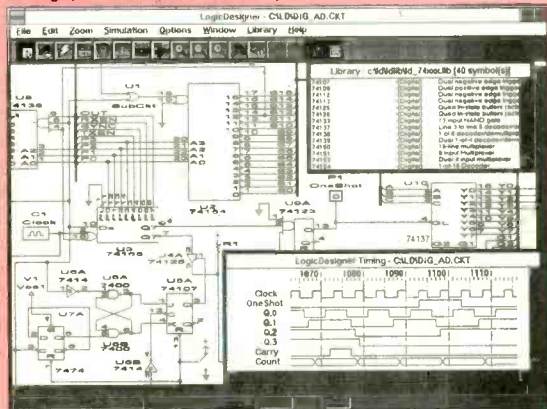

WinSpice Simulator & WinScope Data Analyzer Modules

SPICE LIBRARY: MOSFET, GaSFET, BJT, FET, Diode, OpAmps, Comparators, 555 Timer, Resistor, Cap, Inductor, Transmission Line, Controlled, Independent, Dependent, Arbitrary Source, Pulse, Sin, Piece Wise Linear, and FM Sources, Current and Voltage Controlled Switches. All models Expandable And User Modifiable Imports MACRO MODELS of Your Favorite Manufacturer Supplied Parts.

ANALYSIS TYPES: AC, DC, TRANSIENT, POLE-ZERO, NOISE, SENSITIVITY, FOURIER, TRANSFER FUNCTION, AND OPERATING POINT ANALYSIS.

DATA ANALYZER: Graphs Simulation Results using Multiple Plot Windows and Waveforms. Plots Linear, Logarithmic, Polar, Smith Chart, BODE Type Plots + More. ZOOM in and out of Plot Waveforms. Plots Complex Math Expressions Using Plot Variables As Arguments, Calculates Derivatives, Log, Trg functions, Define Macros of Complex Math Formulas.

Price \$69.99 reg \$179.99 S&H \$3.00 VISA/MC

ISLAND LOGIX INC.

920 South West 95 Terrace
Pembroke Pines, Florida 33025 U.S.A.
PH (305) 435-7665 FAX (305) 435-7891



CIRCLE 145 ON FREE INFORMATION CARD

SMALL MIRACLES



NEW MICRO TX2000 KIT
\$59.95 -SMALLEST 120 MW FM VOICE/PHONE TRANSMITTER
-88-110mhz ON ANY BROADCAST RECEIVER
-ROCK SOLID TUNING, DOESN'T DRIFT
-5 MIN. ASSEM., HEAR A WHISPER UP TO 2 MILES
-SMT PARTS PREASSEMBLED
-INCLUDES TXMTR, MIC, ANTENNA, BATTERY CLIP, TUNING TOOL, AND INSTRUCTIONS

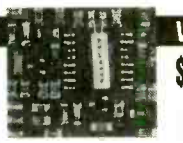

VOICE SCRAMBLER/DESCRAMBLER KIT
\$69.95
2 FOR \$129.95
-WORLDS SMALLEST AUDIO SCRAM./DESCRAM.
-TALK IN PRIVACY DN AUDIO, SPKR. OR MIC LINE
-HEAR THOSE GARBLED SCANNER VOICES
-SMALL SIZE 1"x7/8"x1/4"
-CRYSTAL CONTROLLED DIGITAL SPEECH INVERSION
-7-15 VOLT DC SUPPLY
-LOUD HALF WATT AUDIO AMPLIFIER
-EXCELLENT AUDIO QUALITY
-INCLUDES FULL DOCUMENTATION
-DUPLEX SCRAMBLE & DESCRAMBLE AT THE SAME TIME

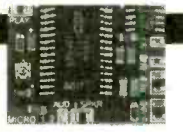

MICRO 1.2 VOICE RECORDER
\$69.95
-SMALL SIZE 1-1/4"x15/16"x1/4"
-HUNDREDS OF APPLICATIONS
-EXCELLENT AUDIO QUALITY
-60 SECONDS REC/PLAY
-6 OHM SPEAKER OUTPUT
-7-15 VOLT DC SUPPLY
-100 YEAR MEMORY WITHOUT POWER
-INCLUDES MIC, SWITCHES AND FULL DOCUMENTATION



MICRO 2B VOICE RECORDER
\$109.95
MICRO 2B FEATURES
SAME AS 1.2 PLUS:
-MULTI MESSAGES (UP TO 600 MEM.)
-SMALL SIZE 1-5/16"x1-5/8"x1/8"
-VARIABLE AUTO PLAY TIMER
-5 VOLT KEY OUT DURING PLAYBACK

ORDER BY PHONE OR MAIL
IN U.S.A. ADD \$5 FCR S&H
C.O.D. CHARGES APPLY
NY'S RESIDENTS ADD 7% SALES TAX
TECH. SUPPORT: 518-381-1057
TECH. FAX: 518-381-1058



TO ORDER: CALL 1-(800)-588 4300



FOTRONIC

QUALITY ELECTRONIC TEST EQUIPMENT

Sales • Service

- Specialists in - Fluke, Hewlett Packard, Tektronix
- NIST Traceable/Mil Spec 45662A Calibration Available

TECHNICAL SUPPORT

Oscilloscope Specials

Tek 465	100 MHZ	\$489.00
Tek 465B	100 MHZ	\$589.00
Tek 475	200 MHZ	\$649.00
Tek 475A	250 MHZ	\$749.00

ALL EQUIPMENT SOLD WITH WARRANTY

For more GREAT VALUES Call, Write, or FAX
P.O. Box 708, Medford, MA 02155

(617) 391-6858 FAX (617) 391-6903

We buy surplus Electronic Equipment FAX your list!!!

October 1994; Popular Electronics

Technicians Professional Tool Case



This hi-tech, case is designed for versatility, to protect and transport costly tools, electronic devices and instruments. Case is available with aluminum finish (281 TC) or black finish (282 TC). Thousands of cases already sold to satisfied technicians.

• Other cases also available. • Dealer inquiries welcome.
To order call:

(713) 395-8370 Fax (713) 395-8372
 Terms: Visa • M/C • C.O.D.'s or send check or money order to: **RATTNER NORTH AMERICA, Tool Utility Cases, 5090 Richmond, Ste. 334, Houston, Texas 77056**

- Commercial quality
- Removable, reversible tool pallet
- Case bottom consists of six adjustable compartments
- Foam lined interior
- 2 keyed locking latches
- Adjustable shoulder strap
- Reinforced steel corner braces
- Size 18" x 6 1/4" x 13" (Tools Not Included)

PE MARKET CENTER CLASSIFIEDS

Cable Test Aids Information
 Orders only 1-800-452-7090 **Test** (310)902-0841

Test chips for JERROLD, TOCOM, ZENITH, S.A. & more. Puts cable boxes in full service mode. Easy installation. Zenith only \$39.95. Most others under \$50ea. FAX: (310)902-0851. Quantity prices available. No Ok. sales. Not for use in cable co. owned equip. For use as a test aid only.

CABLE TV

"BULLET" BUSTER. Protect your cable box against the infamous cable "bullet." The "Bullet" Buster acts as an electronic shield. Installs in-line in seconds. Don't wait until it's too late! \$19.95 + \$3.00 S&H. **Electroman, Box 24474, New Orleans, LA 70184. (504) 482-3017.**

CBTV DOCTOR Stop the Bullet and ID signal in cable lines. Send \$20.00 to: R.R. Enterprise, PO Box 3532, Easton, PA 18043.

CABLE UNSCRAMBLED. Everything you want to know, but are afraid to ask. \$10.00. **Electroman, Box 24474, New Orleans, LA 70184. (504) 482-3017.**

CABLE — SAFE. Guarantee cable privacy. The one way valve for your cable TV signal. \$29.95, + \$3.00 S&H. **Electroman, Box 24474, New Orleans, LA 70184. (504) 482-3017.**

DESCRAMBLER SCHEMATICS REVEALED. A powerful guide to descrambling schemes. \$10.00. **ELECTROMAN, Box 24474, New Orleans, LA 70184. (504) 482-3017.**

CABLE TV DESCRABLERS. All major brands. Have make/model used in your area when calling. 1 (800) 327-3407. For a free catalog write K D Video, PO Box 29538, Minneapolis, MN 55429.

CABLE TV CONVERTERS! JERROLD, OAK, ZENITH, SCIENTIFIC ATLANTA, PIONEER...EXCELLENT PRICES! PERSONABLE SERVICE! 30 DAY MONEY BACK GUARANTEE! INNOVATIVE ELECTRONICS INC., 1 (800) 493-5474. VISA/MC/C.O.D. ASK FOR JOHN OR BILL!

Radiotelephone - Radiotelegraph

FCC Commercial License

Why Take Chances?

Discover how easy it is to pass the exams. Study with the most current materials available. Our Homestudy Guides, Audio, Video or PC "Q&A" pools make it so fast, easy and inexpensive. No college or experience needed. The new commercial FCC exams have been revised, covering updated Aviation, Marine, Radar, Microwave, New Rules & Regs, Digital Circuitry & more. We feature the Popular "Complete Electronic Career Guide" 1000's of satisfied customers

Guarantee to pass or money back. Send for **FREE DETAILS** or call **1-800-800-7588**

WPT Publications
 7015 N.E. 61st Ave Dept. 10
 Vancouver, WA 98661

Name _____

Address _____

City _____ St. _____ Zip _____

1-800-800-7588

MARYMAC®
 The New Realistic®
 PRO-43 Scanner

Radio Shack®

PHONES

Our 18th year of DISCOUNTS
Toll Free 800-231-3680
 PRO-43 List \$349.95
Our Delivered Price \$288.00
IF ON SALE, WE ARE CHEAPER!
We discount everything in the RS catalog

22511 Katy Fwy.
Katy (Houston), TX 77450
1-713-392-0747 FAX 713-574-4567

CABLE TV EQUIPMENT

We carry a complete line of all major brands including test chips and all accessories
BELOW WHOLESALE PRICES • QUANTITY DISCOUNTS
30 DAY MONEYBACK GUAR. • 1 YR. WARRANTY
YEARS OF CUSTOMER SATISFACTION
C & C ELECTRONICS
CALL NOW 1-800-995-1749

Immed. Delivery from Giant Stock! Sorry No California Sales

Satellite-TV

SAVE 40% - 60%
800-334-6455
218-739-5231 Int'l
218-739-4879 Fax
Skyvision Inc.®
 1048 FRONTIER DRIVE • FERGUS FALLS, MN 56337
 See full page ad in *The Market Center*

SATELLITE EQUIPMENT

VIDEOCIPHER II Descrambling manual. Schematics, video and audio, \$18.95. Software, \$25.00. Videocipher II 032, \$15.00. Videocipher II Plus, \$20.00. VCII Plus software, \$30.00. Cabletronics, Box 30502PE, Bethesda, MD 20824.

SAVE \$\$\$ TROUBLESHOOTING your satellite system yourself! Simplified manual \$14.95: T. Dee, POB 858, Fleischmanns, NY 12430.

SATELLITE RADIO BOOK AND GUIDE. New book covers all audio services, SCPC, subcarriers, FM squared, facsimile, press services, weather services. Simple how-to-receive instructions. \$16.95 plus Priority Mail. **UNIVERSAL ELECTRONICS, 4555 Groves Road, #12, Columbus, OH 43232. (614) 866-4605.**

Don't Despair...REPAIR!

Here's how to troubleshoot and repair your electronics successfully!

You Can Be Your Own Repair Expert!

For VCRs, camcorders, audio equipment, TV equipment, computer hardware, office equipment, home appliances, automobile electronics, and outdoor equipment.

- Pinpoint and analyze problems quickly.
- Successfully complete repairs with hands-on troubleshooting instructions.
- Become skilled understanding flowcharts and schematic diagrams.
- Confidently use test equipment such as oscilloscopes, frequency counters, and video analyzers.
- Keep your equipment in top condition with effective preventive maintenance techniques.

Continue to Broaden Your Repair Expertise!

You'll receive quarterly supplements, up to 160 pages, with new step-by-step repair and maintenance instructions, valuable schematics and new repair techniques. Learn how to repair a growing variety of appliances with hands-on repair projects that will keep you up-to-date with later models and technology. You'll be thrilled with your ability to repair a growing list of electronic equipment! Supplements may be returned or cancelled at any time.

SAVE \$10

Call our toll-free number, pay by credit card, and mention this ad. We'll deduct \$10! We'll also waive shipping and handling.

Order today for your 30-day, no-risk review of The Electronics Repair Manual.

For Faster Service Call TOLL-FREE
1-800-222-WEKA
Or Fax To: 1-203-622-4187

CIRCLE 133 ON FREE INFORMATION CARD



One Source For All Your Repair Needs!

Better organized than a magazine, more current than a book.

- 900-page manual
- easy-to-follow, detailed instructions
- trouble analysis flowcharts
- safety precaution checklists
- comprehensive replacement parts list
- directory of manufacturers



Order your copy today!

MONEYBACK GUARANTEE

There's no risk in trying the **ELECTRONICS REPAIR MANUAL** to see if it's right for you. If you are not delighted, simply return the manual after the 30-day trial period and receive a prompt refund.



97 Indian Field Rd.
Greenwich, CT 06830

YES! Please rush me a copy of the new Electronics Repair Manual for only \$59.95 + \$5.50 shipping and handling. I understand that if I am not satisfied I may return the manual within 30 days for a complete refund. Supplements are sent quarterly for 25¢ per page (never more than \$30) and may be returned or cancelled at any time.

- My payment is enclosed Bill me later
 Charge my Visa MasterCard

Acct. No. _____ Exp. Date _____

Signature _____

Phone () _____ Signature and phone number are required for all orders.

Name _____

Address _____

City _____ State _____ Zip _____

All payments must be in U.S. funds. Canada add \$10. All other countries add \$15. CT residents add 6% sales tax.

Mail to: WEKA Publishing, 97 Indian Field Rd.,
Greenwich, CT 06830

400091

PE MARKET CENTER CLASSIFIEDS

Quality Microwave TV Antennas

WIRELESS CABLE - IFTS - MMDS - Amateur TV
 Ultra High Gain 50db (+) • Tuneable 1.9 to 2.7 Ghz.

- 55-Channel Dish System \$199.95
- 36-Channel Dish System \$149.95
- 20-Channel Dish System \$124.95
- Optional Commercial Grid Antenna (not shown) Add \$50.00
- Yagi Antennas, Components, Custom Tuning Available
- Call or write (SASE) for "FREE" Catalog

PHILLIPS-TECH ELECTRONICS
 P.O. Box 8533 • Scottsdale, AZ 85252
 (802) 947-7700 (\$3.00 Credit all phone orders)
 MasterCard • Visa • American Express • COD's • Quantity Pricing

LIFETIME WARRANTY

TIRED OF IRONING? Prototype service for hobbyists & engineers. Single/small quantity ss PCB's. No setup fee. \$10.00 minimum, most boards \$25.00. We scan magazine artwork free! Get out your back issues! **FIRST PROTO**, (407) 392-8677.

SILENT SAM. Patented vehicle turn signal reminder. Outshines others. Brief, timely alerting signal doesn't bug you. Kit complete w/case \$15.00. Visa/MC. 1 (800) 398-5605 literature. Also, \$22.00/\$27.00 wired models. Silent Sam, 1627 Basil Dr., Columbus, OH 43227.

PROJECTS. \$2.00 gets flyer, 100 piece grab bag. Lynn Johnson Electronics, Box 51268, San Jose, CA 95151-1268.

MINI-FM transmitter. Buy parts at Radio Shack. Complete plans \$3.00. Lynn Johnson Electronics, Box 51268, San Jose, CA 95151-1268.

**CABLE TV
DESCRAMBLER LIQUIDATION!**

FREE CATALOG!
 Hamlin Combos \$44, Oak M35B \$60 (min. 5), etc.

WEST COAST ELECTRONICS
 For Information: 818-709-1758
 Catalogs & Orders: 800-628-9656
 No California Sales

CABLE DESCRAMBLERS Build your own, SSAVI, gated sync, sinewave. \$14.95. Cabletronics, Box 30502PE, Bethesda, MD 20824.

HOBBYIST CIRCUITS — Remote room monitor, tone decoder, long distance circuit control and more. Simple experiments for the beginner. **CATALOG \$2.00** — Garrett Plans, Box 155, Jamesburg, NJ 08831.

SURVEILLANCE TRANSMITTER kits. 65 to 305 MHz. Quick & Easy. Partially assembled units. Five minutes completion. 110-volt duplex receptacle, room battery types, and telephone. Counter-surveillance. Catalog: \$2.00. **SHEFFIELD ELECTRONICS**, PO Box 377940-B, Chicago, IL 60637-7940.

FASCINATING DEVICES! FREE plans with parts special! Super spy microphone \$19.50! Super FM transmitter varactor tuned \$22.50! Vocal truth detector \$39.50! Bug detector 10 GHz bargraph, audible \$47.50! Universal IC tester tests any IC \$24.50! Hypersonic dazer defend yourself \$34.50! Radar cloaker electronic shield \$29.50! Laser jammer \$39.50! PC Boards \$10.00 each. Package of all 8 plans \$25.00! S&H \$5.00, catalog \$4.00 (creditable) or included with order! **QUANTUM RESEARCH**, 17919 - 77th Avenue, Edmonton, Alberta, Canada T5T 2S1.

MISCELLANEOUS ELECTRONICS FOR SALE

NEW SURPLUS ELECTRONIC PARTS. Call or fax anytime for catalog #P11. Voice 1(800) 290-2694. Fax (916) 823-0643. **CCSNOW ELECTRONICS.**

VIDEO GAME training videos for NES, Super NES and SEGA Genesis, tools, parts, schematics. Send SASE for free catalog. **Irata Systems**, 2562 East Glade Ave., Mesa, AZ 85204-6208.

FIBER OPTICS EXPERIMENTERS PARTS AND SUPPLIES: fiber, cable, connectors, splices, detectors, lasers, kits, plans, newsletter. Send \$2.00 for catalog, Lightline Engineering, PO Box 24, Mullica Hill, NJ 08062.

THE Case Against Patents. Thoroughly tested and proven alternatives that work in the real world. \$28.50. **SYNERGETICS PRESS**, Box 809-C, Thatcher, AZ 85552. (602) 428-4073. Visa/MC.

AUTOMATIC WIRE STRIPPER with wire cutter, small wire #12 to #24, save time and money, easiest and quickest wire stripper, retail \$29.95. Send \$14.95 each, includes shipping, to D&G International Lighting, PO Box 17668, San Diego, CA 92177. Calif. plus sales tax.

UNINTERRUPTED MUSIC, news networks, sports feeds, reading for sight impaired, and digital data are available from FM subcarriers. For FREE catalog of subcarrier (SCA/SAP) receivers and other devices, write **AJL ENTERPRISES**, Box 5354, High Point, NC 27262.

Prototype it..... FAST!

with ProtoQuick 8051 or Z8

- Complete single board computers
- Up to 32K EPROM and 8K RAM
- 16 bit in parallel through serial bus
- RS232 C serial port w/ 9600 conn.
- Op sys in EPROM w/ source code
- Assembled, ready to run, by only
- MS-DOS cross assembler included

ProtoQuick Z8 and 8051
\$99.00 each

Software license
 1700 Reynolds Road
 Cleveland, OH 44144 USA
 (513) 561-2060

Run prototype applications or experimental hardware from the serial port - WITHOUT PROGRAMMING!

BROADCAST & SURVEILLANCE!!

70-120MHz FM Transmitters & RF Amplifiers
 RF Power/SWR Meters, Stereo Generator, OC Power Supplies, Audio Limiters, Electronic & RF Components, Plans, Kits, and more! Send \$2 for complete information, get \$2 discount on first order.

Progressive Concepts 1434 N. MILLS AVENUE, B
 (909) 626-4969 CLAREMONT, CA 91711

SURVEILLANCE & COUNTERSURVEILLANCE Electronic Devices

Vehicle Tracking • Bug/Phone Tap Detectors • Caller ID
 • Covert Video Phone Scramblers • Voice Changers
 Shotgun Mics • Transmitters • Locksmithing • AND MORE!

7-Hour Telephone Recorder
 Tapes incoming/outgoing phone calls automatically. **\$125.00**

FOR CATALOG SEND \$5.00 TO...
P.O. Box 337, Buffalo, NY 14226 (716) 695-8660

ELECTRIC DOG DOOR, entrancing LED clock, CD scratch remover, computer clocks, awesome phones, plans, kits and more. **FREE CATALOG, CAMPBELL ENTERPRISES**, 27955 Terrace PE10, North Olmsted, OH 44070.

THE ONLY CATALOG NEEDED! Kits, plans, surveillance, test, radios, more! Part locating. Best prices! Send \$1.50 (refundable) **NEUTRONICS**, 4 Croydon Ct., Englishtown, NJ 07726.

LOW COST Current Limiter. Have you ever replaced an expensive component, and had it burn out again. This low cost current limiter can be built for under \$10.00. Complete plans \$5.95. **Grady Electronics**, PO Box 112, Winchendon, MA 01477.

MANUFACTURERS SERVICE manuals. TV — stereo \$15.00, VCR \$25.00. Shipping \$2.00. Edgewood TV, 9937 Rhode Island Ave., College Park, MD 20740. Visa/Mast (301) 441-9116. Check, money order.

PLANS-KITS-SCHEMATICS

BUILD — FIVE-digit, ohms, capacitance, frequency, pulse, multimeter. Board and instructions \$9.95. **Bagnall Electronics**, 179 May, Fairfield, CT 06430.

ALL-IN-ONE catalog. AM/FM/ham/spy, transmitters, amplifiers, receivers. Voice scramblers/disguisers, audio, TV, Tesla coils, plans, "secret" books, kits, imports, exports and more. Start your own licensed or unlicensed radio station, 60 full pages for \$1.00. **PAN-COM INTERNATIONAL**, PO Box 130-H10, Paradise, CA 95967.

FM STEREO TRANSMITTER kit broadcasts any audio signal to FM stereo radios throughout your home. Uses unique BA1404 IC. Complete kit: PC board/components — \$24.00. Visa/MC. **TENTRONIX**, 3605 Broken Arrow, Coeur d'Alene, ID 83814. (208) 664-2312.

BUGGED??

EVESDROPPING is unbelievably widespread! Electronic Devices with amazing capabilities can be monitoring your telephone and room conversations **RIGHT NOW!** Are you sure you're safe? **FREE CATALOG** tells you fast! Includes Free Bonus details on fantastic opportunities now open in Counter-Surveillance field. Exciting, immensely interesting and **EXTREMELY** profitable (up to \$250/hr) full-part-time income. Call Now! **1-800-732-5000**

MUSIC & ACCESSORIES

MUSICAL INSTRUMENTS, discount prices, free catalog. Freeport Music, 41A Shore Drive, Huntington Bay, NY 11743.

SUPERIOR GUITAR EFFECT + FREE 3D Wild-hot sound, drives headphones, belt clip, \$38.00. More - 24 hr sample/infor (407) 727-0137. Visa/MC/Disc/AmExp.

EASY WORK! Excellent pay! Assemble products at home. Call toll free 1 (800) 467-5566 ext. 5192.

GREAT EXTRA income! Assemble products at home. Easy and fun to do. Guaranteed! 1 (800) 377-6000 ex7930.

START your own technical venture! Don Lancaster's newly updated **Incredible Secret Money Machine II** tells how. We now have autographed copies of the Guru's underground classic for \$18.50. **SYNERGETICS PRESS**, Box 809-C, Thatcher, AZ 85552. (602) 428-4073. Visa/MC.

NEED MONEY? Make extra money at home in your spare time. Information FREE. **Bay State Specialties**, Box 191, Hopkinton, MA 01748.

DISTRIBUTORS NEEDED for hi-tech products everyone wants, nobody has. Call 1(800) 326-2963, then get started. (704) 391-7425.

PUBLICATIONS

FREE PROGRAMS, games, information from local computer bulletin boards. "A Guide to Computer BBSing," 87 pages explains, \$11.95. Imprint Publications, 35775 Schmid #103, New Baltimore, MI 48047.

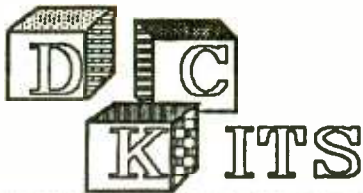

TOLL FREE ORDER
HOT LINE
1-800-423-0070

ALL NEW -- IMPROVED STEREO FM TRANSMITTER

LOADED WITH FEATURES

- * RF AMPLIFIER
- * FRONT PANEL FINE TUNING
- * STABLE OPERATION
- * INPUT LEVEL ADJUSTMENTS
- * WORKS WITH DIGITAL TUNED RADIOS
- * 38KHz CRYSTAL MULTIPLEX CIRCUIT

DC'S all new FM Stereo Transmitter Kit based on the unique BA1404 Stereo Broadcaster Integrated Circuit that includes all the complex circuitry to generate the stereo signal. We've added an RF amplifier circuit to provide excellent transmit range. Additional features like electronic fine tuning, voltage regulation, 38KHz multiplex crystal, input level adjustment makes the Stereocaster the top of the line Stereo FM Transmitter.

ORDER STEREOCASTER \$29.95

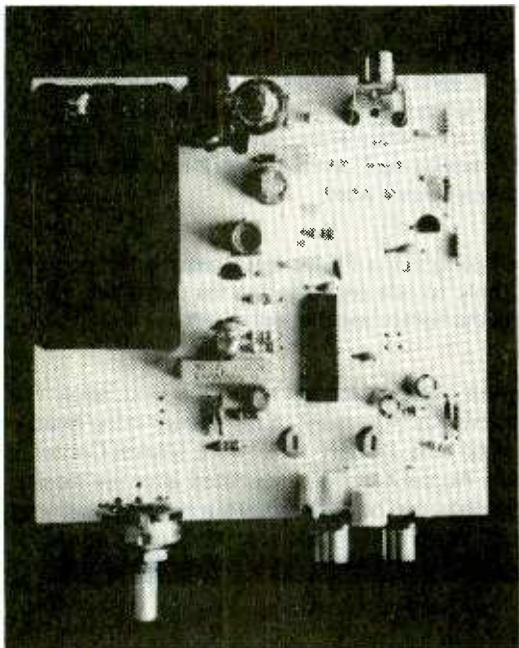

FUNCTION GENERATOR KIT ORDER FG2 KIT

\$19.95

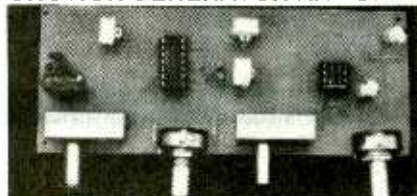

A great project to enhance your bench. This handy little function generator has a built-in buffer amplifier, a 3-decade range selector switch that covers 15 Hz to 25 kHz, output level control and function switch to select sine, square, or triangle.

POWER SUPPLY KIT PS-1 \$16.99

Output of this power supply is continuously adjustable from 1.2 to 25V DC. The LM317T voltage regulator provides excellent regulation and ripple rejection. Includes a 1 A transformer, PC board, LM317T, 2 binding posts, and all small parts.

MORE KITS

3 DIGIT LED DVM ONLY 3" X 3" READS 0 TO 100 V DC ORDER DVM3 \$19.95

FM WIRELESS BROADCASTER FMI \$ 9.95

8038 FUNCTION GEN. KIT FGI \$ 9.50

SEQUENCER PROJECT SEQKIT \$ 9.50

CHRISTMAS TREE PROJECT

Build this unique seasonal project and have an unusual conversation piece. Powered by two D cells, 17 LEDs flash in a seemingly random fashion. Kit includes everything except batteries. ORDER XMASKIT \$16.95

MAKE CIRCUIT BOARDS THE NEW, EASY WAY



WITH TEC-200 FILM

JUST 3 EASY STEPS:

- Copy circuit pattern on TEC-200 film using any plain paper copier
- Iron film on to copper clad board
- Peel off film and etch

convenient 8½ x 11 size
With Complete Instructions

ORDER TEC200-10 (10-SHEETS) \$5.95

UNIVERSAL DECODER IC'S

REFER TO RADIO ELECTRONICS MAY 1990

CD22402E	7.95	CD4040	.65
LM733	.99	CD4053	.59
LM7805	.50	LM7812	.50
CA3126E	1.95	LM7905	.50
74C00	.50	3.58 MHz	1.00
NE564	2.29	18 Uh	.39

October 1994, Popular Electronics

DC ELECTRONICS

SEND MAIL ORDERS TO:

PO BOX 3203 SCOTTSDALE, AZ 85271



ADD \$4.00 S&H

CIRCLE 50 ON FREE INFORMATION CARD

USE PE MARKET CENTER CLASSIFIEDS

READ BY 87,877 BUYERS OF ELECTRONIC EQUIPMENT ACCESSORIES AND PARTS

INSTRUCTION FOR PLACING YOUR AD!

HOW TO WRITE YOUR AD

TYPE or **PRINT** your classified ad copy **CLEARLY** (not in all capitals) using the form below. If you wish to place more than one ad, use a separate sheet for the additional ads (a photocopy of this form works well). Choose a category from the list below and write that category number into the space at the top of the order form. If you do not specify a category, we will place your ad under Miscellaneous or whatever section we deem most appropriate.

We cannot bill for classified ads. Payment in full must accompany your order. We do permit repeat ad or multiple ads in the same issue, but in all cases, full payment must accompany your order.

WHAT WE DO

The first two words of each ad are set in bold caps at no extra charge. No special positioning, centering, dots, extra space, etc. can be accommodated.

RATES

Our classified ad rate is \$1.00 per word. Minimum charge is \$15.00

per ad per insertion (15 words). Any words that you want set in bold or caps are 20¢ each extra. Bold caps are 40¢ each extra. Indicate bold words by underlining. Words normally written in all caps and accepted abbreviations are not charged as all-caps words. State abbreviations must be Post Office 2-letter abbreviations. A phone number is one word.

CONTENT

All classified advertising in the **PE Market Center** is limited to electronics items only. All ads are subject to the publisher's approval. We reserve the right to reject or edit all ads.

DEADLINES

Ads received by our closing date will run in the next issue. For example, ads received by November 15 will appear in the march, 1994 issue that is on sale January 18. The PE Market Center is published monthly. No cancellations permitted after the closing date. No copy changes can be made after we have typeset your ad. **NO REFUNDS, advertising credit only. No phone orders.**

AD RATES: \$1.00 per word. Minimum \$15.00.

Send your ads with payment to:

Popular Electronics Market Center, 500-B Bi-County Blvd. Farmingdale, NY 11735

CATEGORIES

- | | | | |
|------------------------------|---------------------------------|--|---------------------------|
| 100 — Antique Electronics | 270 — Computer Equipment Wanted | 450 — Ham Gear Wanted | 630 — Repairs-Services |
| 130 — Audio-Video-Lasers | 300 — Computer Hardware | 480 — Miscellaneous Electronics For Sale | 660 — Satellite Equipment |
| 160 — Business Opportunities | 330 — Computer Software | 510 — Miscellaneous Electronics Wanted | 690 — Security |
| 190 — Cable TV | 360 — Education | 540 — Music & Accessories | 710 — Telephone |
| 210 — CB-Scanners | 390 — FAX | 570 — Plans-Kits-Schematics | 720 — Test Equipment |
| 240 — Components | 420 — Ham Gear For Sale | 600 — Publications | |

CLASSIFIED AD COPY ORDER FORM

Ad No. 1—Place this ad in Category # _____

- | | | | |
|--------------|--------------|--------------|--------------|
| 1 - \$15.00 | 2 - \$15.00 | 3 - \$15.00 | 4 - \$15.00 |
| 5 - \$15.00 | 6 - \$15.00 | 7 - \$15.00 | 8 - \$15.00 |
| 9 - \$15.00 | 10 - \$15.00 | 11 - \$15.00 | 12 - \$15.00 |
| 13 - \$15.00 | 14 - \$15.00 | 15 - \$15.00 | 16 - \$16.00 |
| 17 - \$17.00 | 18 - \$18.00 | 19 - \$19.00 | 20 - \$20.00 |
| 21 - \$21.00 | 22 - \$22.00 | 23 - \$23.00 | 24 - \$24.00 |
| 25 - \$25.00 | 26 - \$26.00 | 27 - \$27.00 | 28 - \$28.00 |

- | | | | |
|--------------|--------------|--------------|--------------|
| 29 - \$29.00 | 30 - \$30.00 | 31 - \$31.00 | 32 - \$32.00 |
| 33 - \$33.00 | 34 - \$34.00 | 35 - \$35.00 | 36 - \$36.00 |
| 37 - \$37.00 | 38 - \$38.00 | 39 - \$39.00 | 40 - \$40.00 |

Ad No 1—Total words _____ × \$1.00 per word = \$ _____
 All Caps words _____ × .20 per word = \$ _____
 Bold words _____ × .20 per word = \$ _____
 Bold Cap words _____ × .40 per word = \$ _____

TOTAL COST OF AD No. 1 \$ _____

Card # _____

Expiration Date ____ / ____

Signature _____

Phone _____

City State Zip _____

Total classified ad Payment \$ _____ enclosed.
 Check MasterCharge Visa (\$15.00 minimum credit card order)

Name _____

Address _____

CABLE DIRECT

Now you can tune-in to your favorite cable TV programming and **SAVE 100's—EVEN \$1000's** on premium

CABLE TV EQUIPMENT
Converters • Descramblers • Filters

FREE Cable TV Catalog

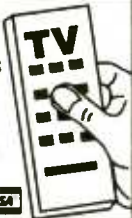

MODERN ELECTRONICS
1-800-906-6664

100% MONEY BACK GUARANTEE! • 30 DAY FREE TRIAL!

ALPHA CABLE MAGIC BOX

Don't waste your money on outdated technology

The Alpha Cable Box offers you leading edge technology to connect to the world's best cable TV programming. Now you can own the multi-video box of the future.

Free Catalog.
"Buy where the dealers buy"

Star Electronics 1-800-282-4336



CABLE TV CHANNELS EQUIPMENT

Direct! → The nationwide source for cable TV equipment.

GUARANTEED
FREE 30 DAY TRIAL

"BUY WHERE THE DEALERS BUY."

FREE TV Cable Descramblers and Converters Catalog. Open Every Day!

MEGA ELECTRONICS
VISA • MC C.O.D. **1-800-676-6342** SAVE 1000's

21 S. Main St., Winter Garden, FL 34787

Infiniter™ Laser Pointer

Attracts the attention of your audience Presenting, Conferencing, Instructing, Directing

Model # NBK Pen Style, Brass casing

— \$49.99

Model # 210 Dual function, Aluminum casing

— \$49.99

*FDA approved & include 2 "AAA" Batteries 1 year warranty

Order call: 800-520-8435

Quarton USA, LTD. CO.

7042 Alamo Downs Parkway, Suite 250,
San Antonio, Texas 78238-4518
Tel: (210) 520-8430 Fax: (210) 520-8433

DEALER AND REP. WANTED

X10 CO-PROCESSOR INTERFACE BOARD

Provides simplified interface to any TW523 module for complete reliable 2way X10 communication. Call or write for details about kits and boards. BBS (407) 322-1429

Marrick Limited, Inc.

P.O. Box 950940

Lake Mary, FL 32795

(407) 323-4467 / 324-1291 FAX

VHS VCR TAPES

CAN PLAY AS

CLEAR AS DAY!

Why put up with Inconsistent Color, Flashes, Streaking and Interference!

UNJAM NOW WITH
INTELESTAR

• Easy Connections
• Eliminates "jamming"
• Copy any tape
• RC Plugs Included

STAR ELECTRONICS
1-800-282-4336

\$59.95

• 30 Day Money Back Guarantee
• 2 year warranty



INSTEK Test & Measuring Instruments

DC POWER SUPPLIES PR-Middle Series (Analog/Digital)

ISO 9002
CERTIFICATION
#934163



MODEL #PR6030D (Digital)
Regular \$500.00
Sale \$399.95

MODEL #PR6030 (Analog)
Regular \$379.00
Sale \$299.95

- Continuous or Dynamic load for internal selectable
- Low ripple and noise
- 0.01% high regulation
- Overload and Reverse polarity protection
- Constant voltage and constant current modes
- 3½ Digits 0.5" LED display (Digital type only)

	Model	Output Volts (V)	Output Amps (A)	Weight (kg)
Analog	PR-6030	0-60	0-3	11.5
Digital	PR-6030D	0-60	0-3	11.5

PRINT™ **Products International**

Test Instruments, Equipment and Tools, Training and Supplies for Electronic Maintenance and Repair
8931 Brookville Road • Silver Spring, Maryland 20910 • 800-638-2020 • Fax 800-545-0058



TOLL FREE
800-638-2020

NEW 84 PAGE CATALOG!!!
Call Today For Your FREE Copy
Of The 1994 Print Test
Equipment Catalog!

CIRCLE 150 ON FREE INFORMATION CARD

Double Your Income! Own your own computer repair business or add computer repair to your existing business.

TechServ can put you into your own computer repair business quickly, economically and efficiently. Research indicates that during a recession, computer repair businesses will grow at twice the rate of hardware sales. TechServ's complete support program gives you the opportunity to be a part of this fast growing industry.

• **Proven Marketing Plan**

• **Recognition**

Nationally recognized trademarks and logos give you immediate recognition as a professional computer repair specialist in your area.

• **Training**

- Level 1 286/386/486/586
Troubleshooting, upgrades, advanced diagnostics
- Level 2 Networking/Novel/Unix/Multi-user/
Multi-tasking configuration/Installation/
Maintenance. Prepare for C.N.E.
(Certified Network Engineer) test

• **Parts and Board Repair**

Single source for OEM/generic parts and board repair. Order 7 days a week/24 hours a day. \$45 million in parts in stock, ready to ship any where, overnight if required.

• **Documentation**

We provide manuals, documentation and advanced diagnostic software.

• **New Hardware**

We provide new hardware for IBM, Compaq, Apple and compatibles at huge discounts. Custom build your own systems.

Over 300 dealers worldwide

Find out why the Wall Street Journal and Fortune Magazine call computer repair the business opportunity of the 1990s.

Call TechServ at (212) 967-1865

or fill out coupon below and mail to:

techserv AUTHORIZED DEALER
SM

**America's largest chain of independent,
licensed computer repair centers**

253 West 28th Street, New York, NY 10001

NAME _____
ADDRESS _____
CITY _____ STATE _____ ZIP _____
TELEPHONE _____

[PE 2/93]

3 NEW BOOKS for the Project Builder

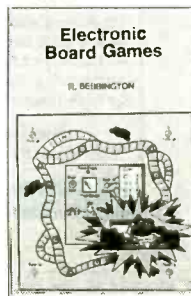

BP350—ELECTRONIC BOARD GAMES\$6.00

Twenty novel electronic board games that you can build from the plans in this book. Whether you are interested in motor racing, searching for buried treasure on a desert island or for gold in Fort Knox, spinning the wheel of fortune, or doing a musical quiz—there is something for you to build and enjoy!

PCP119—ELECTRONIC MUSIC AND MIDI PROJECTS\$14.95

Save cash by building the MIDI gadgets you need. Want a MIDI THRU box, program change pedal, Metronome, analog echo unit, MIDI patchbay or switcher? Over 16 practical and very useful music and MIDI projects—all in this book! The projects are explained in detail with full instructions on assembly.

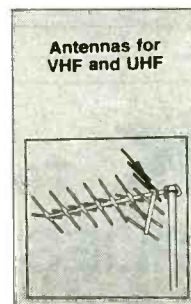
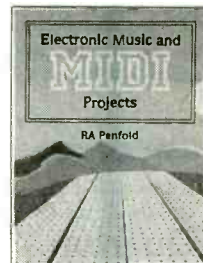

BP301—ANTENNAS FOR VHF AND UHF\$6.00

From installing a TV or FM antenna to setting up a multi-antenna array for shortwave listening or amateur radio, this book explains the basics of VHF and UHF antenna operation and installation. The text describes in easy-to-understand terms the essential information about how antennas work, the advantages of different antenna types, and how to get the best performance from an antenna.

Mail to: **Electronic Technology Today, Inc.**
P.O. Box 240 • Massapequa Park, NY 11762-0240

Shipping Charges in USA & Canada

\$0.01 to \$5.00	\$1.50	\$30.01 to \$40.00	\$5.50
\$5.01 to \$10.00	\$2.50	\$40.01 to \$50.00	\$6.50
\$10.01 to \$20.00	\$3.50	\$50.01 and above	\$8.00
\$20.01 to \$30.00	\$4.50		

Sorry, no orders accepted outside of USA and Canada. All payments must be in U.S. funds only.

Number of books ordered.

Total price of books \$ _____
Shipping (see chart) \$ _____
Subtotal \$ _____
Sales Tax (NYS only) \$ _____
Total enclosed \$ _____

Name _____
Address _____
City _____ State _____ ZIP _____

Please allow 6-8 weeks for delivery.

AMAZING Electronic and Scientific Products

Mystery Levitating Device!

Remember War of the World? Objects float in air and move to the touch. Defies gravity, amazing gift, conversation piece, magic trick or great science project.



Laser Ray Gun

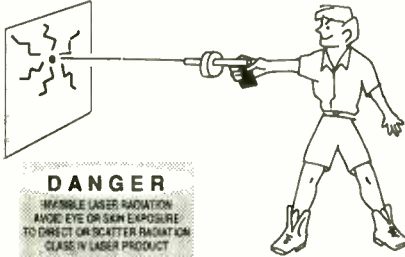

Advanced project produces a burst of light energy capable of burning holes in most materials. Hand-held device uses rechargeable batteries. 500 joules of flash energy excite either a neodymium glass, yag or other suitable 3" laser rod. This is a dangerous CLASS IV project (individual parts/assemblies available).

LAGUN1 Plans \$20.00
LAGUN1K Kit / Plans Price on Request

Extended Play Telephone Recording System

READY TO USE! Automatically controls and records on our X-4 extended play recorder, taping both sides of a telephone conversation. Intended for order entry verification. Check your local laws as some states may require an alerting beeper.

TAP20X Ready to Use System \$129.50



Shocker Force Field / Vehicle Electrifier

Neat little device allows you to make hand and shock balls, shock wands and electrify objects, charge capacitors. Great payback for those wise guys who have wronged you!

SHK1K1M Easy to Assemble Electronic Kit \$24.50



Blaster Pulsar

Pocket-sized wand produces 100,000 watts of power for personal defense, field and lab use, etc. BLS3 Plans \$10.00
BLS3K Kit / Plans \$69.50

Homing / Tracking Transmitter

Beeper device, 3 mile range.
HOD1 Plans \$10.00 HOD1K Kit / Plans \$49.50

Listen Through Walls, Floors

Highly sensitive stethoscope mike.
STETH1 Plans \$8.00 STETH1K Kit/Plans \$44.50



NEW! INFINITY TRANSMITTER++

Room Monitor / Phone Line Grabber

ALL NEW! The Ultimate in Home or Office Security & Safety! Simple to Use! Call your home or office phone, push a secret tone on your telephone keypad to access either: A. On premises sounds and voices; or B. Existing telephone conversation with break in capability for emergency messages. CAUTION: Before assembly or use, check legalities with your state Attorney General's office as you may require "beepers" or other 3rd party alerts.

TELEGRAB1 Plans Only \$10.00
TELEGRAB1K Kit / Plans \$99.50

Ultrasonic Blaster

Laboratory source of acoustical shock waves. Blow holes in metal, produce "cold" steam, atomize liquids. Many cleaning uses for PC boards, jewelry, coins, small parts, etc.

ULB1 Plans \$10.00 ULB1K Kit/Plans \$69.50

100,000V Intimidator / Shock Wand Module

Build an electrical device that is affective up to 20 feet. May be enclosed for handheld, portable field or laboratory applications.

ITM2KM Easy-to-Assemble Electronics Kit \$49.50
ITM2 Plans only, credit-able to kit \$10.00



Ion Ray Gun

Projects charged ions that induce shocks in people and objects without any connection! Great science project as well as a high tech party prank. IOG3 Plans \$8.00
IOG3K Kit/Plans \$69.50

Invisible Pain Field Generator

Shirt pocket size electronic device produces time variant complex shock waves of intense directional acoustic energy, capable of warding off aggressive animals, etc.

IPG7 Plans \$8.00 IPG7K Kit/Plans \$49.50
IPG70 Assembled \$74.50

1000 Ft++ Potato Cannon

NOT A TOY. Uses electronic or piezo ignition. CAUTION REQUIRED!
POT1 Plans \$10.00 (Dangerous Product).....

FireBall Gun

Shoots flaming ball - two shot capacity Great for special effects and remote fire starting. CAUTION REQUIRED!
FIREBALL Plans (Dangerous Product)..... \$10.00



TV & FM Joker / Jammer

Shirt pocket device allows you to totally control and remotely disrupt TV or radio reception. Great gag to play on family or friends. Discretion required. EJK1KM Easy to Assemble Electronic Kit \$24.50

Visible Beam Laser

High brightness red HeNe laser visible for miles. Produces your own light show! Projects a visible beam of red lite clearly visible in most circumstances. Can be used to intimidate by projection of a red dot on target subject. Also may be used to "listen in" using our laser window bounce method #LLIS1 below. Easy to build module makes A working visible laser!

LAS1KM Kit w/1mw Laser Tube, Class II \$69.50
LAS3KM Kit w/2.5mw Laser Tube, Class IIIA \$99.50



"Laser Bounce" Listener System

Allows you to hear sounds from an area via a lite beam reflected from a window or other similar objects. System uses our ready-to-use LATR1 Laser Terminator gun site as the transmitter. The receiver section is supplied as an easy-to-build kit, including our cushioned HS10 headsets. LLIST2 Plans \$20.00
LLIST1K Kit of Both Transmitter and Receiver \$199.50
LLIST20 Assemble with Laser Gun Site \$299.50

3mw Visible Red Pocket Laser

Utilizes our touch power control!
VRL3KM Kit / Plans \$74.50



Electronic Hypnotism

Puts subjects under control using highly effective electronic stimuli. Intended for parties and entertainment but must be used with caution. Includes valuable text book reference and plans.

EH2 Plans and Text Book \$19.50

Pocket Sized Night Viewer

Uses Low Level Starlight to See in the Dark!

- Low Cost
- Ultra-Hi Lite Amplification!
- Auto Brightness Control
- Limited Amount Available
- Made in USA • Night surveillance • Animal studies, etc.

Can be used to fly an airplane or drive a car!



PKV7 Plans \$15.00
PKV7K Easy to Assemble Kit Price on Request
PKV70 Ready to Use Price on Request

3 Mi FM Wireless Microphone

Subminiature! Crystal clear, ultra sensitive pickup transmits voices and sounds to FM radio. Excellent for security, monitoring of children or invalids. Become the neighborhood disk jockey, or go "under cover" using our sunglasses FM radio (see catalog). FMV1 Plans ... \$7.00
FMV1K Kit and Plans \$39.50
SUGL10 Sunglasses with built in FM Radio \$29.50



Telephone Transmitter - 3 Mi

Automatically transmits both sides of a telephone conversation to an FM radio. • Tunable Frequency • Undetectable on Phone • Easy to Build and Use • Up to 3 Mile Range • Only transmits during phone use.

VWPM7 Plans \$7.00
VWPM7K Kit/Plans \$39.50

INFORMATION UNLIMITED

Dept PEM16, Box 716, Amherst, NH 03031
Phone: 603-673-4730 FAX 603-672-5406
MC, VISA, COB, Checks accepted Please add \$5.00 Shipping & Handling

CATALOG With many more items! Free with Order or send \$1 P&H

Order by Mail or by 24 Hour Orders-Only Phone 800-221-1705

Home Automation Enthusiasts

DIRECT WIRE TO FACEPLATE OR SOFT TOUCH BUTTONS!

RIB **RIB** **RIB** **RIB**

REB
Remote Expansion Board

Remote Interface Board

LEARNING REMOTE

UNIVERSAL REMOTE

X-10 OR CUSTOM REMOTE

MORE! **MORE!**

Authorized Distributor:
JAVANCO INC.
501 12th Avenue South
Nashville, TN 37203
(800) 528-2626 Sales Only
(615) 244-4444 Information

Call for our catalog filled with your electronic needs! Quantity discounts available.
Remote Interface Board & complete instructions only \$49.99
RIB Kit (all parts unassembled for \$39.99)
New Introducing REB, The Remote Expansion Board \$29.99
Remote Expansion Board Kit & complete instruction starting at \$29.99
RIB Kit (all parts unassembled for \$39.99)
RIB is an interface. Remote control not included.

CIRCLE 149 ON FREE INFORMATION CARD

PROFESSIONAL SURVEILLANCE EQUIPMENT Used By Law Enforcement Agencies

VHF-FM CRYSTAL CONTROLLED TRANSMITTERS
A - 139MHz, B - 139.970 MHz, C - 149 MHz, D - 149.450 MHz
All kits assemble in less than 5 mins.

SD-200 Smoke Detector	CX-102 Miniature Camera	AD-700 Mic	AD-600 Mic	AD-500 Tel.	AD-400 Mic
400 lines w/Audio	240 lines w/Audio	Range: up to 5 Mile	Range: up to 5 Mile	Range: up to 5 Mile	Range: up to 2.5 Mile
03 lux	2 lux	Power: 750MW	Power: 15MW	Power: 15MW	Power: 400MW
10-14 VDC	7-14 VDC				
\$330	\$235	\$247	\$125	\$115	\$155

We sell a variety of cameras, bug detectors, night vision equipment, video transmitters, time lapse recorders, remote video monitoring systems, and many more...

A&D ELECTRONICS

P.O. Box 601, Monsey, NY 10952
914-356-7541 • Fax 914-356-7505
Call for FREE catalog. Credit Cards accepted

\$129 Laser Light Show

This kit displays animation, text, drawings, & music! Includes 2 Galvos, VCO, Computer Interface, Manual & Software listing. Works from parallel printer port.

Computerized Motors \$39*

Includes: 2 Stepper or 4 DC servo motors, Computer interface kit, 32 page training manual & Software listing. Works from parallel printer port.

* Add \$5 for shipping. Computer and Laser not included.

Call for **FREE** Flyer

SVS
Light & Motion
in kit form

1273 Industrial Pky. W#460
P O Box 55125
Hayward CA 94545-0125
510-582-6602

Universal Programmers

Largest Selection In The World
GDI Also Buy, Sell & Program
Plus Never Undersold!

\$1399 DATA I/O CHIPLABS 4800
\$ 849 DATA I/O CHIPLABS 3200
\$ 579 EETOOLS ALLMAX
\$ 479 EETOOLS PROMAX
\$ 479 XELTEK SUPERPRO II
\$ 350 XELTEK SUPERPRO (R)
\$ 499 LOGICAL DEVICES 3000
\$ 499 ADVANTECH PC-UPROG
\$ 429 NEEDHAMS EMP-20
\$ 779 DATAMAN S4
\$ 499 AMERICAN RELIANCE 9860
\$ 699 NEEDHAMS SA-20 S/ALONE
\$ 139 EETOOLS 1 GANG
\$ 199 EETOOLS 4 GANG
\$ 159 SUNSHINE 4 GANG
\$ 399 SUNSHINE 8 GANG
\$2499 STAG PP42 8 GANG S/ALONE
General Device Instruments
(408) 241-7376 Fax 241-6375

CALL FOR DEVICE LISTS

PE MARKET CENTER CLASSIFIEDS

COMPUTER SOFTWARE

PRINTED CIRCUIT board program. Draw circuit board traces quickly, under MS-Windows. Send \$20.00 to SYTEC, 223 Cambridge Road, Cherry Hill, NJ 08034.

LOTTERY PROGRAM Increase your probability, don't pick in the dark. Send \$10.00 for DOS or \$12.00 for MS-Windows version to SYTEC, 223 Cambridge Road, Cherry Hill, NJ 08034.

CB-SCANNERS

RCI-2950 MODIFICATION Manual \$20.00 pre-paid money order, \$25.50 COD. Scott, PO Box 510408, St. Louis, MO 63151-0408. (314) 846-0252.

AUDIO-VIDEO-LASERS

MUSIC VISION kit displays dynamic multicolor Lissajous patterns on any unmodified television, generated from any audio source. PCB and parts \$140.00 check, moneyorder. USA, Canada only. VHS demo tape \$9.00. **ELECTROKRAFT**, dept. 13B, PO Box 598, Louisville, CO 80027.

HOLOS GAZETTE charter subscription \$15.00. Quarterly publication. **ELECTROPHOTONICS**. Laser hacker related projects: first hologram, diode lasers, meters, etc. **FREE HOLOGRAM** with subscription. Send M.O. to **HOLOS**, 1450 Headon Road, Box 93113, Burlington, Ontario, L7M4A3, Canada.

MISCELLANEOUS ELECTRONICS WANTED

\$100.00 FOR ideas. Taylor, Schrieber, Corey, Mr. Wizard, McIntosh, like. Instit. scholarship award winning. Send ideas to: Invention Millions, 3012 Flax, El Paso, TX 79925.

REPAIRS-SERVICES

WOOFER ROT? Quality re-coning, refoaming, restorations and parts for all speakers. World's largest speaker catalog, 200 pages \$10.00. Tri-State Loudspeaker, 650 Franklin, Aliquippa, PA 15001. (412) 375-9203.

EDUCATION

NEW! ADAPT-11 microcontroller module plugs right into your solderless breadboard! Test-drive your 68HC11 designs instantly! Included software and serial cable make it a breeze to program with any PC! Re-useable thousands of times! Ideal for students, hobbyists and experimenters! Only \$74.95! **TECHNOLOGICAL ARTS**, Suite 1704, 1644 Bayview Avenue, Toronto, ON M4G 3C2.

FOR BEGINNERS, learn Elec. Tech. and/or Computer Repair. You can order either Elec. Tech./Computer Repair 101 or Computer Repair 101. They come in a 4 tape set, each VHS tape is 2HRS. long. Taught at Occupational Center they cover some of the basics you need to know to start a career. To order send a check or money order of \$49.95 (per set) to Mike Kolberg Productions, Box 791, Sun Valley, CA 91352.

Surface Mount Chip Component Prototyping Kits—

Only **\$49.95**

INDIVIDUAL VALUES AVAILABLE

CC-1 Capacitor Kit contains 365 pieces, 5 ea. of every 10% value from 1p to .33µ. **CR-1 Resistor Kit** contains 1540 pieces, 10 ea. of every 5% value from 100 to 10 meg! Sizes are 0805 and 1206. Each kit is ONLY \$49.95 and available for immediate One Day Delivery!

Order by toll-free phone, FAX, or mail. We accept VISA, MC, COD, or Pre-paid orders. Company PO's accepted with approved credit. Call for free detailed brochure.

COMMUNICATIONS SPECIALISTS, INC.
426 West Taft Ave. • Orange, CA 92665-4296
Local (714) 998-3021 • FAX (714) 974-3420
Entire USA 1-800-854-0547

The Pocket Programmer

The portable Eprom programmer that uses the printer port of your PC instead of an internal card. The software has 24 easy to use functions and programs 27/25/28/68764 & Cmos from 16K (2K × 8)—2M (256K × 8) Eproms (32 pin socket, UpGradeable to 8Meg). Adapters available for MCU's, 40-Pin Eproms, 5-Gang and Eprom Emulator to 32K × 8.

\$129.95

INTRONICS, INC.
Box I3723
Edwardsville, KS 66113
(913) 422-2094

Add \$3.00 for shipping.
Add \$3.75 for COD
Visa/Master Charge

BUY BONDS

Countersurveillance

Never before has so much professional information on the art of detecting and eliminating electronic snooping devices—and how to defend against experienced information thieves—been placed in one VHS video. If you are a Fortune 500 CEO, an executive in any hi-tech industry, or a novice seeking entry into an honorable, rewarding field of work in countersurveillance, you must view this video presentation again and again.



CALL NOW!

1-516-293-3751

HAVE YOUR VISA or MC CARD AVAILABLE

Wake up! You may be the victim of stolen words—precious ideas that would have made you very wealthy! Yes, professionals, even rank amateurs, may be listening to your most private conversations.

Wake up! If you are not the victim, then you are surrounded by countless victims who need your help if you know how to discover telephone taps, locate bugs, or “sweep” a room clean.

There is a thriving professional service steeped in high-tech techniques that you can become a part of! But first, you must know and understand Countersurveillance Technology. Your very first insight into this highly rewarding field is made possible by a video VHS presentation that you cannot view on broadcast television, satellite, or cable. It presents an informative program prepared by professionals in the field who know their industry, its techniques, kinks and loopholes. Men who can tell you more in 45 minutes in a straightforward, exclusive talk than was ever attempted before.

Foiling Information Thieves

Discover the targets professional snoopers seek out! The prey are stock brokers, arbitrage firms, manufacturers, high-tech companies, any competitive industry, or even small businesses in the same community. The valuable information they filch may be marketing strategies, customer lists, product formulas, manufacturing techniques, even advertising plans. Information thieves eavesdrop on court decisions, bidding information, financial data. The list is unlimited in the mind of man—especially if he is a thief!

You know that the Russians secretly installed countless microphones in the concrete work of the American Embassy building in Moscow. They converted

what was to be an embassy and private residence into the most sophisticated recording studio the world had ever known. The building had to be torn down in order to remove all the bugs.

Stolen Information

The open taps from where the information pours out may be from FAX's, computer communications, telephone calls, and everyday business meetings and lunchtime encounters. Businessmen need counselling on how to eliminate this information drain. Basic telephone use coupled with the user's understanding that someone may be listening or recording vital data and information greatly reduces the opportunity for others to purloin meaningful information.

The professional discussions seen on the TV screen in your home reveals how to detect and disable wiretaps, midget radio-frequency transmitters, and other bugs, plus when to use disinformation to confuse the unwanted listener, and the technique of voice scrambling telephone communications. In fact, do you know how to look for a bug, where to look for a bug, and what to do when you find it?

Bugs of a very small size are easy to build and they can be placed quickly in a matter of seconds, in any object or room. Today you may have used a telephone handset that was bugged. It probably contained three bugs. One was a phony bug to fool you into believing you found a bug and secured the telephone. The second bug placates the investigator when he finds the real thing! And the third bug is found only by the professional, who continued to search just in case there were more bugs.

The professional is not without his tools. Special equipment has been designed so that the professional can sweep a room so that he can detect voice-activated (VOX) and remote-activated bugs. Some of this equipment can be operated by novices, others require a trained countersurveillance professional.

The professionals viewed on your television screen reveal information on the latest technological advances like laser-beam snoopers that are installed hundreds of feet away from the room they snoop on. The professionals disclose that computers yield information too easily.

This advertisement was not written by a countersurveillance professional, but by a beginner whose only experience came from viewing the video tape in the privacy of his home. After you review the video carefully and understand its contents, you have taken the first important step in either acquiring professional help with your surveillance problems, or you may very well consider a career as a countersurveillance professional.

The Dollars You Save

To obtain the information contained in the video VHS cassette, you would attend a professional seminar costing \$350-750 and possibly pay hundreds of dollars more if you had to travel to a distant city to attend. Now, for only \$49.95 (plus \$4.00 P&H) you can view *Countersurveillance Techniques* at home and take refresher views often. To obtain your copy, complete the coupon or call.

CLAGGK INC. PE
P.O. Box 4099 • Farmingdale, NY 11735

Please rush my copy of the Countersurveillance Techniques Video VHS Cassette for a total cost of \$53.95 each (which includes \$4.00 postage and handling)

No. of Cassettes ordered _____
 Amount of payment \$ _____
 Sales tax (N.Y.S. only) _____
 Total enclosed _____
 Bill my VISA MasterCard
 Card No. _____
 Expire Date ____ / ____

Signature _____
 Name _____
 Address _____
 City _____ State _____ ZIP _____

All payments in U.S.A. funds. Canadians add \$4.00 per VHS cassette. No foreign orders.

ADVERTISING INDEX

POPULAR ELECTRONICS magazine does not assume any responsibility for errors that may appear in the index below.

Free Information No.	Page	Free Information No.	Page
164	3M Electrical/Electronic Products	17	-
-	A&A Engineering	124	-
-	A&D Electronics	136	-
25	Ace Communications	96	-
-	Agrelo Engineering	127	-
26	Alfa Electronics	104	-
28	All Electronics	109	-
-	Allen Engineering	118	-
27	Alltronics	100	-
151	AMC Sales	3	-
-	Andromeda Research	126	-
-	Antique Radio Classified	81	-
30	Bel-Merit	106	-
39	BG Micro	98	-
-	Bit Bangers	115	-
168	B&S Sales	118	-
31	Caig Labs	101	-
-	CBC International Inc.	80	-
-	C&C Electronics	128	-
-	C&C Specialties	128	-
-	Cellsoft	124	-
-	CLAGGK Video	137	-
-	Cleveland Inst. of Electronics	15	-
-	Command Productions	137	-
166	Communications Electronics	CV3	-
-	Communication Specialists	136	-
149	Compco	136	-
-	Consumertronics	122	-
32	C&S Sales	102,103	-
162	Davis Instruments	19	-
50	DC Electronics	131	-
-	Design Computation	121	-
-	EDE	130	-
-	Electronics Technology Today	119	-
-	EMAC	121	-
-	Firestick II	81	-
154	Foley-Belsaw	19	-
-	Forest Electronics	107	-
-	Fotronics	127	-
-	General Device Instruments	136	-
-	Genuine Electronics	113	-
-	Get-Tech Inc.	115	-
13	Global Specialties	25	-
-	Grantham College of Engineering	11	-
-	Great Southern Security	130	-
-	Greenleaf Electronics Inc.	113	-
-	Halcyon Group	116	-
155	Heath Company	7	-
-	Information Unlimited	135	-
167	Interactive Image Technologies	CV2	-
-	Intronics	136	-
-	I/O Controls Corp.	120	-
-	ISCET	93	-
145	Island LogiX Inc.	127	-
138	ITC Instruments	97	-
-	ITC Microcomponents Inc.	125	-
139	ITT Pomona	123	-
37	Jan Crystals	122	-
137	John Bell	121	-
-	JP Video	108	-
51	Kasco Distributing	95	-
38	Kelvin Electronics	99	-
-	Marrick Limited	133	-
-	Marymac Industries Inc.	128	-
52	MCM Electronics	113	-
-	MD Electronics	105	-
-	Mega Electronics	133	-
169	Mendelson's	120	-
-	Mental Automation	117	-
-	M&G Electronics	124	-
42	MicroCode Engineering	110	-
-	Modern Electronics	133	-
-	Mondo-tronics	120	-
-	NRI Schools	5,45	-
-	Nu-Tek Electronics	80	-
43	Optoelectronics	CV4	-
-	Percon	117	-
-	Phillips Tech	130	-
47	Prairie Digital Inc.	116	-
46	Print	114	-
150	Print	133	-
-	Progressive Concepts	130	-
-	Quarton USA	133	-
-	Rattner North America	128	-
-	The School of PC Repair	81	-
-	The School of VCR Repair	81	-
-	Self-Reliance Company Inc.	119	-
48	Sescom Inc.	125	-
-	Silicon Valley Surplus	136	-
-	Skyvision Inc.	111	-
-	Skyvision (Small)	128	-
-	Software Science	130	-
-	Spy Supply	112	-
-	Star Electronics	133	-
-	TAB Books	9,29	-
-	Tandy National Parts	91	-
130	Tech Serv.	134	-
-	Tele View Distributors	107	-
136	UCANDO Videos	116	-
-	United Electronic Supply	115	-
-	US Cable (Zentek)	120	-
-	US Cyberlab	95	-
-	Video Spectra	117	-
-	Weeder Technologies	124	-
-	Weka Publishing	129	-
-	West Coast Electronics	130	-
-	Windward Electronics	126	-
-	World College (Div. of C.I.E.)	21	-
-	WPT Publications	128	-
134	Xandi Electronics	119	-

ADVERTISING SALES OFFICE

Gernsback Publications, Inc.
500-B Bi-County Blvd.
Farmingdale, NY 11735
1-(516) 293-3000

Larry Steckler, EHF/CET
 President

Christina Estrada
 Assistant to the President

For Advertising ONLY
516-293-3000
Fax 1-516-293-3115

Larry Steckler
 publisher

Arline Fishman
 advertising director

Denise Mullen
 advertising assistant

Kelly Twist
 credit manager

**Subscription/
 Customer Service/
 Order Entry**
1-800-827-0383
7:30 AM - 8:30 PM EST

ADVERTISING SALES OFFICES

EAST/SOUTHEAST

Stanley Levitan
 Eastern Sales
 1 Overlook Ave.
 Great Neck, NY 11021
 1-516-487-9357, 1-516-293-3000
 Fax 1-516-487-8402

MIDWEST/Texas/Arkansas/ Oklahoma, Colorado, Arizona

Ralph Bergen
 Midwest Sales
 One Northfield Plaza, Suite 300
 Northfield, IL 60093-1214
 1-708-446-1444
 Fax 1-708-559-0562

PACIFIC COAST/Mountain States

Anita Bartman
 Hutch Looney & Assoc., Inc.
 1800 North Highland Avenue
 Suite 717
 Hollywood, CA 90028
 1-213-462-2700
 Fax 1-213-463-0544

Last chance to buy

Cellular Modifiable Scanners

C COMMUNICATIONS ELECTRONICS INC.
Emergency Operations Center

New FCC Rules Mean Last Buying Opportunity for Radio Scanners

Recently, the FCC amended Parts 2 and 15 of its rules to prohibit the manufacture and importation of scanning radios capable of intercepting the 800 MHz. cellular telephone service. The Electronics Communications Privacy Act prohibits the intentional interception of cellular telephone transmissions. Supplies of scanners that are capable of being modified to receive full 800 MHz. coverage such as the Bearcat 200XLT and 2500XLT are in very short supply. If you need technical assistance or recommendations to locate a special scanner or solve a communications problem, call the Communications Electronics Inc. technical support hotline for \$2.00 per minute at 1-900-555-SCAN.

Radio Scanners

Bearcat® 2500XLT-J

List price \$649.95/CE price \$339.95/SPECIAL
400 Channels • 20 Banks • Turbo Scan
Rotary tuner feature • Auto Store • Auto Sort
Size: 2-3/4" Wide x 1-1/2" Deep x 7-1/2" High
Frequency Coverage: 25.0000 - 549.9950, 760.0000 - 823.9950, 849.0125 - 868.9950, 894.0125 - 1,300.0000 MHz.

Signal intelligence experts, public safety agencies and people with inquiring minds that want to know, have asked us for a world class handheld scanner that can intercept just about any radio transmission. The new Bearcat 2500XLT has what you want. You can program frequencies such as police, fire, emergency, race cars, marine, military aircraft, weather, and other broadcasts into 20 banks of 20 channels each. The new rotary tuner feature enables rapid and easy selection of channels and frequencies. With the AUTO STORE feature, you can automatically program any channel. You can also scan all 400 channels at 100 channels-per-second speed because the Bearcat 2500XLT has TURBO SCAN built-in. To make this scanner even better, the BC2500XLT has AUTO SORT - an automatic frequency sorting feature for faster scanning within each bank. Order your scanner from CEI.

A modification sheet with instructions to restore full 800 MHz. coverage for the Bearcat 2500XLT or Bearcat 200XLT may be ordered for \$8.00. To order any Bearcat radio product call 1-800-USA-SCAN.

Great Deals on Bearcat Scanners

- Bearcat 8500XLT-J base/mobile \$369.95
- Bearcat 890XLT-J base/mobile ..\$244.95
- Bearcat 2500XLT-J handheld \$339.95
- Sportcat 150-J handheld \$199.95
- Bearcat 760XLT-J base/mobile ..\$199.95
- Bearcat 700A-J info mobile \$149.95
- Bearcat 560XLA-J base/mobile \$84.95
- Bearcat 220XLT-J handheld \$229.95
- Bearcat 200XLT-J handheld . \$199.95
- Bearcat 148XLT-J base/WX alert. \$88.95
- Bearcat 120XLT-J handheld \$159.95
- Bearcat BCT2-J info mobile \$139.95

NEW! RELM® WHS150-J

List price \$481.67/CE price \$339.95/SPECIAL
16 Channel • 5 Watt VHF scanning transceiver
Size: 2.45" Wide x 1.38" Deep x 6.4" High
Frequency range: 148.000 to 174.000 MHz. continuous coverage. Will also work 144.000-148.000 MHz. with reduced performance.

The RELM WHS150 is our most popular programmable five watt, 16 channel handheld transceiver with built-in CTCSS, which may be programmed for any 39 standard EIA tones. The full function, DTMF compatible keypad also allows for DTMF Encode/Decode and programmable ANI. Weighing only 15.5 oz., it features dealer programmable synthesized frequencies either simplex or half duplex in both 5.0 and 6.25 KHz. increments. Other features include scan list, priority channel, selectable scan delay, selectable 5 watt/1 watt power levels, liquid crystal display, time-out timer and much more. When you order the WHS150 from Communications Electronics Inc., you'll get a complete package deal including antenna, battery, belt clip and user operating instructions. Other accessories are available. A leather carrying case with swivel belt loop part #LCWHS is \$49.95; rapid charge battery charger, part #BCWHS is \$69.95; speaker/microphone, part #SMWHS is \$54.95; extra ni-cad battery pack, part #BP007 is \$59.95. The radio technician maintaining your radio system must order programming instructions part #PI150 for \$18.00 to activate this radio.

Bearcat® 8500XLT-J

List price \$689.95/CE price \$369.95/SPECIAL
500 Channels • 20 banks • Alphanumeric display
Turbo Scan • VFO Control • Priority channels
Auto Store • Auto Recording • Reception control
Frequency step resolution 5, 12.5, 25 & 50 KHz.
Size: 10-1/2" Wide x 7-1/2" Deep x 3-3/8" High
Frequency Coverage:

25.000 - 28.995 MHz. (AM), 29.000 - 54.000 MHz. (NFM), 54.000 - 71.995 MHz. (WFM), 72.000 - 75.995 MHz. (NFM), 76.000 - 107.995 MHz. (WFM), 108.000 - 136.995 MHz. (AM), 137.000 - 173.995 MHz. (NFM), 174.000 - 215.995 MHz. (WFM), 216.000 - 224.995 MHz. (NFM), 225.000 - 399.995 MHz. (AM), 400.000 - 511.995 MHz. (NFM), 512.000 - 549.995 MHz. (WFM), 760.000 - 823.9875 MHz. (NFM), 849.0125 - 868.9875 MHz. (NFM), 894.0125 - 1,300.000 MHz. (NFM).

The new Bearcat 8500XLT gives you pure scanning satisfaction with amazing features like Turbo Scan. This lightning-fast technology featuring a triple conversion RF system, enables Uniden's best scanner to scan and search up to 100 channels per second. Because the frequency coverage is so large, a very fast scanning system is essential to keep up with the action. Other features include VFO Control - (Variable Frequency Oscillator) which allows you to adjust the large rotary tuner to select the desired frequency or channel. Counter Display - Lets you count and record each channel while scanning. Auto Store - Automatically channels all active frequencies within the specified bank(s). Auto Recording - This feature lets you record channel activity from the scanner onto a tape recorder. You can even get an optional CTCSS Tone Board (Continuous Tone Control Squelch System) which allows the squelch to be broken during scanning only when a correct CTCSS tone is received. 20 banks - Each bank contains 25 channels, useful for storing similar frequencies in order to maintain faster scanning cycles. For maximum scanning enjoyment, order the following optional accessories: PS001 Cigarette lighter power cord for temporary operation from your vehicle's cigarette lighter \$14.95; PS002 DC power cord - enables permanent operation from your vehicle's fuse box \$14.95; MB001 Mobile mounting bracket \$14.95; BC005 CTCSS Tone Board \$54.95; EX711 External speaker with mounting bracket & 10 feet of cable with plug attached \$19.95. The BC8500XLT comes with AC adapter, telescopic antenna, owner's manual and one year limited warranty from Uniden. Order your BC8500XLT from Communications Electronics Inc. today.



CB/GMRS Radios

The Uniden GMR100 is a handheld GMRS UHF 2-way radio transceiver that has these eight frequencies installed: 462.550, 462.725, 462.5875, 462.6125, 462.6375, 462.675, 462.6625 and 462.6875 MHz. This one watt radio comes with flexible rubber antenna, rechargeable ni-cad battery, AC adapter/charger, belt clip, F.C.C. license application and more.

- Cobra 2000GTL-J SSB Deluxe CB Base \$389.95
- Uniden GMR100-J GMRS Handheld \$159.95
- Uniden WASHINGTON-J SSB CB Base. \$189.95
- Uniden GRANTXL-J SSB CB Mobile \$139.95
- Uniden PRO538W-J CB & Weather \$59.95

Shortwave

- ICOM AH7000-J super wideband discone type antenna \$99.95
- Grundig Satellit 700-J portable with 512 memory & AC adapt. ..\$389.95
- Grundig Yacht Boy 400-J digital portable shortwave \$199.95
- Grundig Yacht Boy 230-J portable shortwave \$139.95
- Sangean AT5202-J ultra compact 20 memory shortwave \$79.95
- Sangean AT5606-J ultra compact 45 memory shortwave \$149.95
- Sangean AT5606P-J shortwave with antenna & AC adapter \$169.95
- Sangean AT5800-J portable 20 memory shortwave \$69.95
- Sangean AT5803A-J portable with SSB reception & AC adapter. \$159.95
- Sangean AT5808-J portable 45 memory shortwave \$159.95
- Sangean AT5818-J portable without cassette recorder \$189.95
- Sangean AT5818CS-J with cassette recorder \$209.95
- Sangean ATN60-J portable shortwave antenna \$9.95

Weather Stations

Public safety agencies responding to hazardous materials incidents must have accurate, up-to-date weather information. The Davis Weather Monitor II is our top-of-the-line weather station which combines essential weather monitoring functions into one incredible package. Glance at the display, and see wind direction and wind speed on the compass rose. Check the barometric trend arrow to see if the pressure is rising or falling. Our package deal includes the new high resolution 1/100 inch rain collector part #7852-J; and the external temperature/humidity sensor, part #7859-J. The package deal is order #DAV1-J for \$524.95 plus \$15.00 shipping. If you have a personal computer, when you order the optional Weatherlink computer software for \$149.95, you'll have a powerful computerized weather station at an incredible price. For the IBM PC or equivalent order part #7862-J. For Apple Mac Plus or higher including Quadra or PowerBook, order part #7866-J.

Other neat stuff

- Uniden EXP9200-J 900 MHz. 2 line cordless phone \$289.95
- Uniden EXP9100-J 900 MHz. 1 line cordless phone \$269.95
- Cobra CP910-J 900 MHz. spread spectrum cordless phone \$249.95
- ICOM GP22-J handheld global positioning system \$699.95
- WR200-J weather radio with storm alert \$39.95
- RELM WHS150-J VHF handheld 5 watt, 16 ch. transceiver \$339.95
- RELM RH256NB-J VHF 25 watt synthesized transceiver \$289.95
- Ranger RC12950-J 25 watt 10 meter ham radio \$244.95
- Ranger RC12970-J 100 watt 10 meter ham radio \$369.95
- Uniden LR9000W1-J Super Wideband Laser/Radar Detector \$169.95
- HCP-CJ HamCall CD Rom for IBM PC by Buckmaster Publishing \$39.95
- PWB-J Passport to Worldband Radio by IBS \$10.95
- POL1-J Police Call for CT, ME, MA, NH, NY, RI, VT \$5.95
- POL2-J Police Call for DE, MD, NJ, PA \$5.95
- POL3-J Police Call for Michigan & Ohio \$5.95
- POL4-J Police Call for IL, IN, KY, WI \$5.95
- POL5-J Police Call for IA, KS, MN, MO, NE, ND, SD \$5.95
- POL6-J Police Call for DC, FL, GA, NC, PR, SC, VA, WV \$5.95
- POL7-J Police Call for AL, AR, LA, MS, OK, TN, TX \$5.95
- POL8-J Police Call for AZ, CO, ID, MT, NM, NY, UT, WY \$5.95
- POL9-J Police Call for California, Oregon & Washington \$5.95
- ANTK-J VHF scanner/VHF transmitting antenna PL259 connector \$29.95
- ANTMBN-CJ magnet mount scanner antenna w/ BNC connector \$29.95
- ANTMMOTJ magnet mount scan antenna w/Motorola plug \$29.95
- ANTMPLJ magnet mount scan antenna with PL259 connector \$29.95
- ANTSGBCJ glass mount scanner antenna with BNC connector \$29.95
- ANTSGOTJ glass mount scanner antenna with Motorola jack \$29.95

Buy with confidence

It's easy to order from CEI. Mail orders to: Communications Electronics Inc., Emergency Operations Center, P.O. Box 1045, Ann Arbor, Michigan 48106 U.S.A. Add \$15.00 per radio for U.P.S. ground shipping and handling in the continental U.S.A. unless otherwise stated. Add \$8.00 shipping for all accessories and publications. Add \$8.00 shipping per antenna. For Canada, Puerto Rico, Hawaii, Alaska, P.O. Box, or APO/FPO delivery, shipping charges are two times continental U.S. rates. Michigan residents add state sales tax. No COD's. No returns or exchanges after 15 days. 10% surcharge for net 10 billing to qualified accounts. All sales are subject to availability, acceptance and verification. Prices, terms and specifications are subject to change without notice. We welcome your Discover, Visa, American Express or MasterCard. Call 1-800-USA-SCAN to order toll-free. Call 313-996-8888 if outside the U.S.A. FAX anytime, dial 313-663-8888. For technical assistance to solve your communications problem, call the Communications Electronics technical support hotline for \$2.00 per minute at 1-900-555-SCAN. Order your new electronic equipment from Communications Electronics Inc. today.

Scanner Distribution Center and CEI logos are trademarks of Communications Electronics Inc. See dates 8/15/94 - 10/31/94 AD #70494CZN Copyright © 1994 Communications Electronics Inc.

For credit card orders call 1-800-USA-SCAN
Communications Electronics Inc.
Emergency Operations Center
P.O. Box 1045, Ann Arbor, Michigan 48106-1045 U.S.A.
For information call 313-996-8888 or FAX 313-663-8888

OPTOSCAN456

50 Channels Per Second!!!

OptoScan 456 costs less than any other computer aided scanning system and is supported by all the best software packages including Scan Star™ and Scan Cat™. OptoScan 456 uses the highly regarded Radio Shack Pro 2005 and Pro 2006 VHF/UHF scanners. These popular receivers with the OS456 package installed becomes:

The New Standard—The OptoScan 456.

- CTCSS & DCS Controlled Scanning and Logging
- DTMF Decode & Log with Channel and Time
- PC Software for computer Log, Scan & Search
- RS-232C & CI-V Interface
- No Drill or Solder Installation
- Output for signal level and spectrum display

Why Computer Controlled Scanning? The computer makes the scanner perform, simply and effortlessly. Even when you are not around, the computer can continue to search out frequencies you want and record them—virtually unlimited numbers.

Why Decode CTCSS tones and DCS codes? The OS456 decodes tones, codes and touch-tone characters to provide the Radio Monitoring Enthusiast with a powerful new tool in sorting out who is talking, and accessing a repeater. **Optoelectronics has produced the OptoScan 456 to make the PRO-2006 family radios perform to a new standard that no one else can match for any price!**

Complete Installation Kit, Model OS456, includes the assembled and tested controller board, mounting hardware (no soldering or drilling required), cables, OptoScan 456 basic software for the PC and the installation video.....\$299.

Complete Optoscan 456 and modified Pro-2006 are available from our distributors:
Grove Ent., 1-800-438-8155, NC; Marymac Ent., Inc., 1-800-231-3680, TX; E.E.B., 1-800-368-3270, VA.

A NEW STANDARD FOR SCANNING!!!!



OPTOELECTRONICS

ALL NEW
ALL NEW
ALL NEW
ALL NEW
ALL NEW

Model 25 Scout Electronic Equivalent of Forward Reconnaissance

The Remarkable New Frequency Scout automatically finds and records frequencies for later use and will tune a receiver.

The Scout is pocket size—ready to go anywhere, and, unlike a frequency counter, the Scout can differentiate between random noise and coherent RF transmissions.

It is ideal for surveillance walk-by situations with a built-in vibrator to alert you a frequency was recorded.

For drive-by applications, a beeper lets you know when a new frequency is found or an already recorded frequency is hit. Up to 250 hits can be counted on each of the 50 frequency memories.

Reaction tunes VHF/UHF receivers equipped with CI-V serial communications interface.

- Exclusive Optoelectronics Digital Filter/Capture Technology (pat. pend.)
- 50 Memory Locations for unique frequencies
- 250 Hit Counter for each frequency in memory
- Reaction tunes OptoScan 456 CI-V Communications receivers
- Selectable annunciators include vibrator, beeper and EL back lit display
- Can be interfaced to a PC for data logging using OptoLog Software
- 16 Segment RF signal level bargraph for relative signal level detection
- 10MHz to 2.8GHz single frequency range.
- Six+ hour battery life—one hour rapid charge
- Pocket Sized: 3.7" H x 2.75" W x 1.2" D

The Scout Model 25 with rapid Charge and high capacity NiCad batteries.....\$399.
Scout is pictured with optional DB32, dual band, VHF/UHF miniature antenna.....\$ 29.

DC440 Decoder (pictured above) with New CI-V Interface

If you are into UHF/VHF communications monitoring then you will want to add a DC440 to your system. This popular decoder has been upgraded with a new communications interface port that is CI-V compatible. Now you can take advantage of the new scanning software that supports tones and codes. If you are using an R7100 or R7000 receiver then the DC440 will connect to either the CT17 or CX12 RS-232C Converter for single serial port use.

- Simultaneous off the air detection of 50 CTCSS tones, 106 DCS codes and 16 DTMF characters
- Six measurement modes for maximum flexibility
- Scrollable ten character display of up to 127 stored DTMF characters
- Convenient front panel controls for Power, Mode and Recall

The DC440 with CI-V Interface.....\$259.
NiCad 44 (Optional Internal NiCad battery pack).....\$ 39.

CX12 CI-V to RS-232C Interface Converter

Low cost converter for CI-V logic level data to RS-232C for connection to a Personal Computer serial port. The CX12 is fully equivalent to the Icom CT-17 converter.

The CX12 is an accessory for the Optoelectronics DC440 and Model 25 Scout. Price: \$89.

CIRCLE 43 ON FREE INFORMATION CARD

1-800-327-5912
Fax 305-771-2052

Optoelectronics, Inc.

305-771-2050 • 5821 NE 14 Avenue, Ft Lauderdale, FL 33334
Visa, Master Card, C.O.D., Cash or Money Order. Shipping Charges Additional

All specifications & prices are subject to change without notice or obligation.