

# Popular Electronics<sup>®</sup>

AUGUST 1992

## THE HIGH-TECH HOME OFFICE

A potpourri of electronic work aids to bring your home/small office up-to-date

## BUILD THE ECONOMY SIX

This 6-watt, 40-meter, Morse-code transmitter for hams gets you on the air for under \$20

## BUILD A DIGITAL PHOTO TIMER

Get better results from your darkroom efforts with this high-precision unit

## PRINTER SPOOLING

Ease computer congestion with these hardware and software solutions

## MAKE YOUR OWN HOLOGRAMS

Learn about holograms, and then build the equipment you need to make your own three-dimensional "photographs"

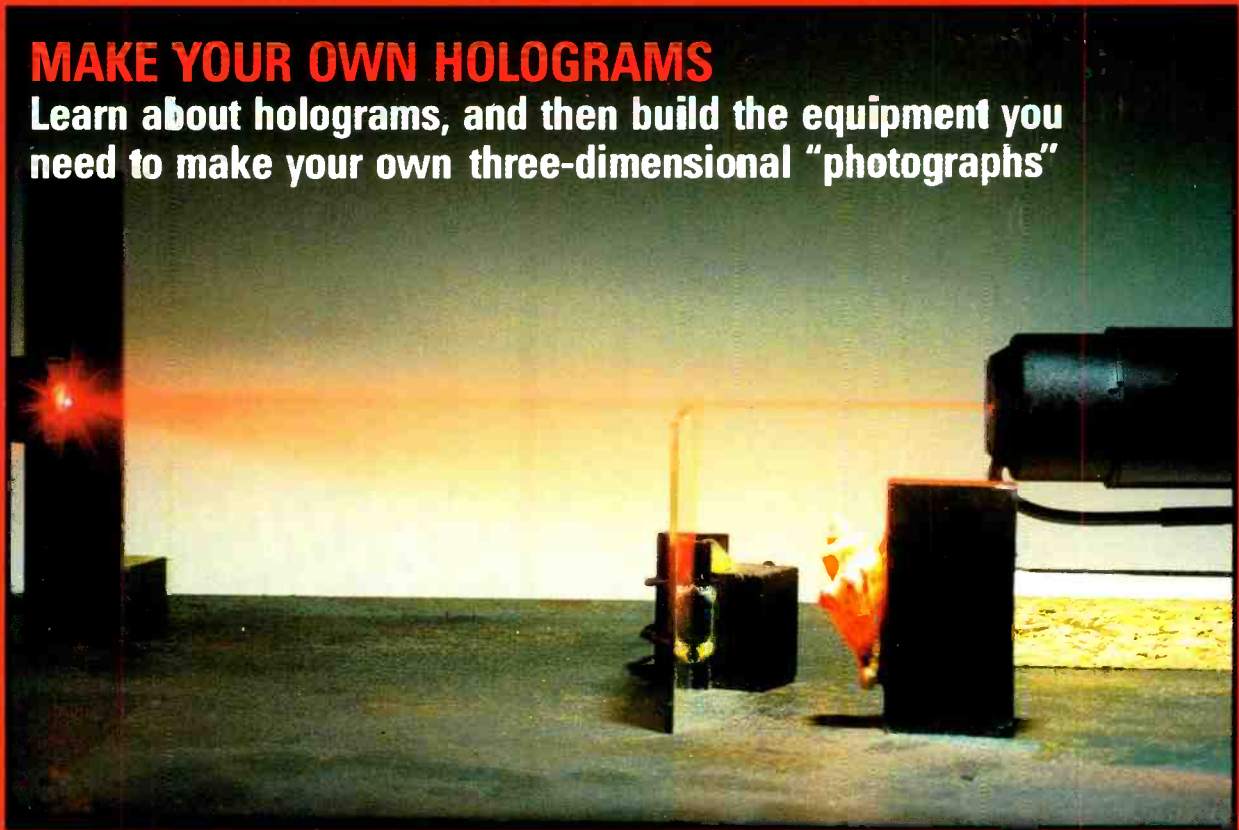

A  
**GERNSBACK**  
PUBLICATION

\$3.50 U.S.  
\$3.95 CANADA

3 NEW  
FactCards  
IN THIS ISSUE



#BXBDCC\*\*\*\*\* 5-DIGIT 60506  
#6J5JEDH1997GA006# FEB93 87  
ROBERT DAHM RESP  
957 GRAND AVE D81  
AURORA, IL 60506

# Electronics Paperback Books

GREAT PAPERBACKS AT SPECIAL PRICES

**BP248—TEST EQUIPMENT CONSTRUCTION** ..... \$5.95. Details construction of simple, inexpensive, but extremely useful test equipment. AF Gen, Test Bench Ampl, Audio Millivoltmeter, Transistor Tester and six more.

Test Equipment Construction



How to Use Oscilloscopes and Other Test Equipment



**BP267—HOW TO USE OSCILLOSCOPES AND OTHER TEST EQUIPMENT** ..... \$6.95. Mastering the oscilloscope is not really too difficult. This book explains all the standard controls and functions. Other equipment is also described.

**BP265—MORE ADVANCED USES OF THE MULTIMETER** ..... \$5.95. Use these techniques to test and analyze the performance of a variety of components. Also see how to build ad-ons to extend multi-meter capabilities.



**BP256—INTRO TO LOUDSPEAKERS AND ENCLOSURE DESIGN** ..... \$5.95. We explore the variety of enclosure and speaker designs in use today so the reader can understand the principles involved.

**CMOS1—CMOS POCKET GUIDE 1** ..... \$18.95. Works like the TTL Guides but covers all commonly used CMOS standard devices. Six major sections. The first shows the device schematic. Next is a brief description of the component and is followed by full operating details. The fourth section lists major applications, while the 5th and 6th sections present essential data for that device and a list of the relevant manufacturers. The final two sections are a valuable cross-reference.



**BP299—PRACTICAL ELECTRONIC FILTERS** ..... \$6.95. Presents a dozen filter-based practical projects with applications in and around the home or in the constructor's workshop. Complete construction details are included.



**BP249—MORE ADVANCED TEST EQUIPMENT CONSTRUCTION** ..... \$6.95. Eleven more test equipment construction projects. They include a digital voltmeter, capacitance meter, current tracer and more.



Digital Audio Projects

**BP245—DIGITAL AUDIO PROJECTS** ..... \$5.95. Practical circuits to build and experiment with. Includes A/D converter, input amplifier, digital delay line, compander, echo effect and more.



**BP247—MORE ADVANCED MIDI PROJECTS** ..... \$5.95. Circuits included are a MIDI indicator, THRU box, merge unit, code generator, pedal, programmer, channelizer, and analyzer

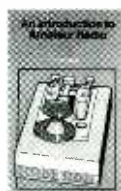

**BP257—INTRO TO AMATEUR RADIO** ..... \$6.95. Amateur is a unique and fascinating hobby. This book gives the newcomer a comprehensive and easy to understand guide to the subject.

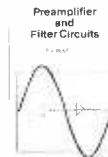

**BP309—PREAMPLIFIER AND FILTER CIRCUITS** ..... \$6.95. Provides circuits and background info for a range of pre-amplifiers, plus tone controls, filters, mixers and more. All are high-performance circuits that can be built at a reasonable cost.

**BP303—UNDERSTANDING PC SOFTWARE** ..... \$6.95. This book will help you understand the basics of various types of business software in common use. Types of software covered include word processors, spelling checkers, graphics programs, desktop publishing, databases, spreadsheets and utilities.



**BP251—COMPUTER HOBBYISTS HANDBOOK** ..... \$8.95. A wrapup of everything the computer hobbyist needs to know in one easy to use volume. Provides a range of useful reference material in a single source.



**PCP115—ELECTRONIC PROJECTS FOR HOME SECURITY** ..... \$10.00. 25 projects ranging from a single-door protection circuit that can be completed in an hour or two, to a sophisticated multi-channel security system. Each project is described in detail with circuit diagrams, explanations of how it works, instructions for building and testing, and how to adapt circuits to meet special requirements.



**BP195—INTRODUCTION TO SATELLITE TV** ..... \$9.95. A definitive introduction to the subject written for the professional engineer, electronics enthusiast, or others who want to know more before they buy. 8 x 10 in.

**BP190—ADVANCED ELECTRONIC SECURITY PROJECTS** ..... \$5.95. Includes a passive infra-red detector, a fiber-optic loop alarm, computer-based alarms and an unusual form of ultrasonic intruder detector.

**BP235—POWER SELECTOR GUIDE** ..... \$10.00. Complete guide to semiconductor power devices. More than 1000 power handling devices are included. They are tabulated in alpha-numeric sequence, by technical specs. Includes power diodes, Thyristors, Triacs, Power Transistors and FET's.

**BP234—TRANSISTOR SELECTOR GUIDE** ..... \$10.00. Companion volume to BP235. Book covers more than 1400 JEDEC, JIS, and brand-specific devices. Also contains listing by case type, and electronic parameters. Includes Darlingtons transistors, high-voltage devices, high-current devices, high power devices.

**BP99—MINI-MATRIX BOARD PROJECTS** ..... \$5.50. Here are 20 useful circuits that can be built on a mini-matrix board that is just 24 holes by ten copper-foil strips.

**BP117—PRACTICAL ELECTRONIC BUILDING BLOCKS—Book 1** ..... \$5.75. Oscillators, Timers, Noise Generators, Rectifiers, Comparators, Triggers and more.

**BP184—INTRO TO 68000 ASSEMBLY LANGUAGE** ..... \$6.95. The 68000 is a great new breed of microprocessor. Programming in assembly language increases the running speed of your programs. Here's what you need to know.

**BP179—ELECTRONIC CIRCUITS FOR THE COMPUTER CONTROL OF ROBOTS** ..... \$7.50. Data and circuits for interfacing the computer to the robot's motors and sensors

**BP239—GETTING THE MOST FROM YOUR MULTIMETER** ..... \$5.95. Covers basics of analog and digital meters. Methods of component testing includes transistors, thyristors, resistors, capacitors and other active and passive devices.

**BP97—IC PROJECTS FOR BEGINNERS** ..... \$5.50. Power supplies, radio and audio circuits, oscillators, timers, switches, and more. If you can use a soldering iron you can build these devices.

**BP37—50 PROJECTS USING RELAYS, SCR'S & TRIACS** ..... \$5.50. Build priority indicators, light modulators, warning devices, light dimmers and more.

**RADIO—100 RADIO HOOKUPS** ..... \$3.00. Reprint of 1924 booklet presents radio circuits of the era including regenerative, neutrodyne, reflex & more.

**BP42—SIMPLE LED CIRCUITS** ..... \$5.50. A large selection of simple applications for this simple electronic component.

**BP127—HOW TO DESIGN ELECTRONIC PROJECTS** ..... \$5.75. Helps the reader to put projects together from standard circuit blocks with a minimum of trial and error.

**BP122—AUDIO AMPLIFIER CONSTRUCTION** ..... \$5.75. Construction details for preamps and power amplifiers up through a 100-watt DC-coupled FED amplifier.

**BP92—CRYSTAL SET CONSTRUCTION** ..... \$5.50. Everything you need to know about building crystal radio receivers.

**BP45—PROJECTS IN OPTOELECTRONICS** ..... \$5.50. Includes infra-red detectors, transmitters, modulated light transmission and photographic applications.

**BP255—INTERNATIONAL RADIO STATIONS GUIDE** ..... \$7.95. Provides the casual listener, amateur radio DXer and the professional radio monitor with an essential reference work designed to guide him or her around than ever more complex radio bands

CHECK OFF  
THE BOOKS YOU WANT

**ELECTRONIC TECHNOLOGY TODAY INC.**  
P.O. Box 240, Massapequa Park, NY 11762-0240

Name \_\_\_\_\_  
Address \_\_\_\_\_  
City \_\_\_\_\_ State \_\_\_\_\_ Zip \_\_\_\_\_

PE892

SHIPPING CHARGES IN  
USA AND CANADA

\$0.01 to \$5.00 ..... \$1.50  
\$5.01 to \$10.00 ..... \$2.50  
\$10.01 to 20.00 ..... \$3.50  
\$20.01 to 30.00 ..... \$4.50  
\$30.01 to 40.00 ..... \$5.50  
\$40.01 to 50.00 ..... \$6.50  
\$50.01 and above ... \$8.00

**SORRY** No orders accepted  
outside of USA & Canada

Total price of merchandise ..... \$ \_\_\_\_\_  
Shipping (see chart) ..... \$ \_\_\_\_\_  
Subtotal ..... \$ \_\_\_\_\_  
Sales Tax (NYS only) ..... \$ \_\_\_\_\_  
Total Enclosed ... \$ \_\_\_\_\_

Number of books ordered

All payments must be in U.S. funds

# Popular Electronics®

THE MAGAZINE FOR THE ELECTRONICS ACTIVIST!

## CONSTRUCTION ARTICLES

<b>MAKE YOUR OWN HOLOGRAMS</b> .....	John Iovine	31
<i>Learn how holograms are made, and then build the equipment you need to make your own</i>		
<b>A CONVENIENCE LIGHT FOR REMOTE CONTROLS</b> .....	Marc Spiwak	37
<i>Shed some light on your remote control with this easy-to-build accessory</i>		
<b>BUILD A LOW-COST MORSE-CODE TRANSMITTER</b> .....	Larry Lisle	45
<i>For as little as \$20, hams can get on the air with this Morse-code transmitter</i>		
<b>BUILD A PRECISION DARKROOM TIMER</b> .....	Rudolf F. Graf and William Sheets	53
<i>A programmable, digital timer for darkroom tasks</i>		

## FEATURE ARTICLES

<b>PRINTER SPOOLING—HARDWARE AND SOFTWARE</b> .....	Fred Belchman	40
<i>Learn about hardware and software solutions to computer congestion</i>		
<b>AN INTRODUCTION TO MILITARY ELECTRONICS</b> .....	Charles Hansen	47
<i>Learn about "mil-spec" parts, and what sets them apart from their consumer cousins</i>		
<b>ALEXANDER POPOV: RUSSIA'S RADIO PIONEER</b> .....	James Rybak	59
<i>Did a Russian scientist beat Marconi to the punch?</i>		
<b>dB OR NOT dB</b> .....	Richard A. Honeycutt	65
<i>Learn what a decibel really is, and how to properly use it</i>		

## PRODUCT REVIEWS

<b>GIZMO</b> .....		5
<i>A look at the high-tech home office, and some electronic aids to make it, and you, work better</i>		
<b>HANDS-ON REPORT</b> .....		26
<i>Elenco MM-8000 Basic Systems Course</i>		
<b>PRODUCT TEST REPORT</b> .....	Len Feldman	28
<i>Memorex Model 153 8mm Camcorder</i>		

## COLUMNS

<b>ANTIQUE RADIO</b> .....	Marc Ellis	68
<i>Mail call</i>		
<b>COMPUTER BITS</b> .....	Jeff Holtzman	71
<i>Buying your first (or next) PC</i>		
<b>CIRCUIT CIRCUS</b> .....	Charles D. Rakes	72
<i>More intruder-detector circuits</i>		
<b>THINK TANK</b> .....	John J. Yacono	75
<i>Telephone-circuit parade</i>		
<b>DX LISTENING</b> .....	Don Jensen	77
<i>Polish radio is back</i>		
<b>HAM RADIO</b> .....	Joseph J. Carr	79
<i>Some new products, and some questions answered</i>		
<b>SCANNER SCENE</b> .....	Marc Saxon	82
<i>A handheld that won't break the bank</i>		

## DEPARTMENTS

<b>EDITORIAL</b> .....	Carl Laron	2
<b>LETTERS</b> .....		3
<b>FACTCARDS</b> .....		49
<b>POPULAR ELECTRONICS MARKET CENTER</b> .....		50A
<b>FREE INFORMATION CARD</b> .....		51
<b>ELECTRONICS LIBRARY</b> .....		84
<b>NEW PRODUCTS</b> .....		86
<b>ELECTRONICS MARKET PLACE</b> .....		93
<b>ADVERTISER'S INDEX</b> .....		96

Popular Electronics (ISSN 1042-170X) Published monthly by Gernsback Publications, Inc., 500-B-BI-County Boulevard, Farmingdale, NY 11735. Second-Class postage paid at Farmingdale, NY and at additional mailing offices. One-year, twelve issues, subscription rate U.S. and possessions \$21.95, Canada \$26.84 (includes G.S.T. Canadian Goods and Services Tax Registration No. R125168280), all other countries \$29.45. Subscription orders payable in U.S. funds only. International Postal Money Order, or check drawn on a U.S. bank. U.S. single copy price \$2.95. © 1992 by Gernsback Publications, Inc. All rights reserved. Hands-on Electronics and Gizmo trademarks are registered in U.S. and Canada by Gernsback Publications, Inc. Popular Electronics trademark is registered in U.S. and Canada by Electronics Technology Today, Inc. and is licensed to Gernsback Publications, Inc. Printed in U.S.A.

Postmaster: Please send address changes to Popular Electronics, Subscription Dept., P.O. Box 338, Mount Morris, IL 61054-9932.

A stamped self-addressed envelope must accompany all submitted manuscripts and/or artwork or photographs if their return is desired should they be rejected. We disclaim any responsibility for the loss or damage of manuscripts and/or artwork or photographs while in our possession or otherwise.

As a service to readers, Popular Electronics publishes available plans or information relating to newsworthy products, techniques, and scientific and technological developments. Because of possible variances in the quality and condition of materials and workmanship used by readers, Popular Electronics disclaims any responsibility for the safe and proper functioning of reader-built projects based upon or from plans or information published in this magazine.

**Larry Steckler**

*EHF, CET*

*Editor-In-Chief and Publisher*

## EDITORIAL DEPARTMENT

**Carl Laron**

*Editor*

**Robert A. Young**

*Associate Editor*

**John J. Yacono**

*Associate Editor*

**Byron G. Wels, K2AVB**

*Associate Editor*

**Teri Scaduto**

*Assistant Editor*

**Kathy Terenzi**

*Editorial Assistant*

**Marc Spiwak**

*Editorial Associate*

**Joseph J. Carr, K4IPV**

**Marc Ellis**

**Len Feldman**

**Jeffrey K. Holtzman**

**Don Jensen**

**Chris F. O'Brian**

**Charles D. Rakes**

**Marc Saxon**

*Contributing Editors*

## PRODUCTION DEPARTMENT

**Ruby M. Yee**

*Production Director*

**Karen S. Brown**

*Production Manager*

**Marcella Amoroso**

*Production Assistant*

**Lisa Rachowitz**

*Editorial Production*

## ART DEPARTMENT

**Andre Duzant**

*Art Director*

**Injae Lee**

*Illustrator*

**Russell C. Truelson**

*Illustrator*

**Jacqueline P. Cheesebore**

*Circulation Director*

**Michele Torriilo**

*P-E Bookstore*

## BUSINESS AND EDITORIAL OFFICES

Gernsback Publications, Inc.

500-B Bi-County Blvd.

Farmingdale, NY 11735

1-516-293-3000

Fax: 1-516-293-3115

President: **Larry Steckler**

**Customer Service/Order Entry**

1-800-435-0715

7:30 AM - 8:30 PM EST

Advertising Sales offices listed on page 96

Cover photography by John Iovine

Composition by  
Mates Graphics



The  
Audit  
Bureau  
of Circulation



The publisher has no knowledge of any proprietary rights which will be violated by the making or using of any items disclosed in this issue.

## THE END OF A LEGEND

Being an active electronics hobbyist has just become a little harder. For those who haven't heard the news, Heath has quietly pulled out of the kit business.

In their heyday, Heathkits represented the best of all worlds. The products regularly outperformed factory-wired equivalents, and often offered features that were unavailable anywhere else. They were also cost effective, usually selling for significantly less than similar factory-wired units. And, of course, they were fun to build.

In that vein, Heath's user support was unparalleled. Their documentation was superb. When builders evaluated competitor's kits, the best review the instructions could receive was "It's almost as good as Heathkit's!" If difficulty was encountered, technical support was readily available and well informed. And if all else failed, the unit could be shipped to Heath for troubleshooting and repair.

So, what went wrong? Unfortunately, times have changed. One-by-one, the advantages and benefits of building Heathkits began to disappear. Primarily, with the advent of solid-state circuitry, and with the increasing complexity of modern equipment, the price advantage kits offered ceased to exist. In fact, especially when it came to consumer gear, it was often more expensive to offer kits than factory-wired units.

Demographics also changed. To be honest about it, today there are just far fewer people who like to build. Electronics hobbyists of all ages, and particularly young ones, have more choices than ever before. Computers, video, and other interests have siphoned off many of those who, in another time, would have been project and kit builders.

And so a legend has passed. To be sure, the Heath Company is still with us, but now they mainly will be offering home-automation, home-security, and educational products. While their decision may ensure that Heath will be with us in some form for years to come, it just won't be the same.

Carl Laron  
Editor

## ELECTRONIC CAR KEYS

In reference to the review of the RACE Remote Key in *Gizmo* (**Popular Electronics**, June 1992), we understand that your objective is to give your readers an objective evaluation. But we feel that the overall tone of the review indicated either insufficient knowledge of the product, or some misunderstandings.

In terms of our installation manual, while the reviewer was correct in saying that it "didn't take into account all possible configurations...", that would be impossible. However, they take into account as many variations as possible while remaining a general guideline.

We understand how cumbersome a seven-digit security code can be. However, most people adapt to that feature in a surprisingly short time. The newest model of the Remote Key will be accessible by a security code consisting of any numerical combination between one and seven digits.

The ability to check function status and know if you are within range *without ever seeing or hearing your vehicle* are patented features unique to the Remote Key. Command confirmation, status check, and automatic alert paging are only possible because of two-way communication technology. Because those features are so unique, I would think that they deserve more elaboration in the review.

If your maximum range was less than 750 feet, that indicates a definite problem with the Remote Key's communication system. Any adjustments to the antenna or antenna wiring during installation could account for a range problem. Although the range varies, there are occasions when you should be able to get at least 1500 to 2000 feet, or more. Had comparison tests been done, I'm sure that the reviewer wouldn't have said that "In effect, the range was roughly equivalent to other, one-way remote starters." We have conducted such experiments under controlled conditions (number of transmissions, temperature, distance, time of day) at various sites (open field, un-

derground parking lot) and found that the Remote Key's range was many times greater than that of any other product. It is also the only product to offer programmable features, defroster control, air-conditioning control, and adaptability to vehicles for disabled drivers. To lump the Remote Key with other products is obviously unfair both to our product and to your readers.

The reviewer postulated that "apparently the other cars and vans [in a parking lot] reduced the range dramatically." According to our observations, other motor vehicles have no effect on the performance of the Remote Key. Interference from electromagnetic fields, however, does affect the transmission of all products using RF technology. If the Remote Key is used near a high-power transmitter or laboratory, you would definitely have communication interference.

If starting your car from the kitchen table is the only major advantage you can see for this product, we assume that's because your range problem has disillusioned you to the other benefits of its patented two-way technology. We would welcome a visit to our facilities in Scarborough so you can judge for yourself what we're all about.  
*Connie Narojek  
Marketing Coordinator  
Remote Automation & Control  
Electronics Inc.  
Scarborough, Ont., Canada*

*We feel that the 750-foot range we measured is adequate for most purposes. And the two-way capability is truly unique. Our problem, however, is that the range we were able to obtain wasn't consistent. In the worst case we cited, the limited range could have been caused by a low-power college FM radio station located about a half mile from the hockey arena not, as we assumed, by other cars in the parking lot. But if an 88-MHz radio station interferes with*

# LETTERS

*Remote Key's 300-MHz transceivers, it's a problem that needs to be addressed.—Chris F. O'Brian and Teri Scaduto, Gizmo Editors*

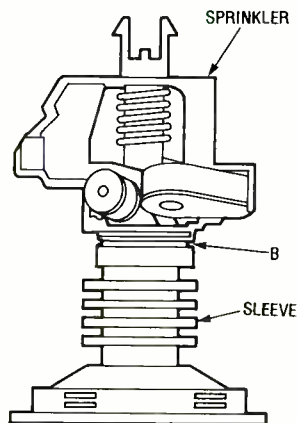

Fig. 1

## POP-UP LIGHTS CORRECTION

I enjoyed seeing my article, "Build a Pop-Up Outdoor-Lighting System" (**Popular Electronics**, May 1992), and hope that your readers will enjoy reading the article and building the project. I was especially impressed with the way your illustrator turned my crude drawings into professional illustrations.

I did find one error. In Fig. 5B, the arrow showing the "B" cut points to the wrong spot. Figure 1 above shows the arrow in the correct place. The cut will be easier and cleaner if it is made where the arrow is shown in the corrected figure.

*David Schmiedeberg*

## TESLA COIL SUPPLIER

Although my article, "Make Your Own High-Voltage Capacitors" (**Popular Electronics**, May 1992), has only been in print for a short while as I write this letter, I've received a lot of mail about it. Many a Tesla-coil builder has inquired about the beautiful coils whose pictures

appear in the article. I can't take credit for making those coils (I wish I could!), since they belong to my friend, John Carbone, who let me use pictures of some of his creations in the article. Inquiries about how he built those Tesla coils, etc., can be sent directly to him at 21 Apt. B Tanager Road, Monroe, NY 10950.

The supplier mentioned in the article, Small Parts, has moved to a new address: 13980 N.W. 58th Court, P.O. Box 4650, Miami Lakes, FL 33014-0650. Catalog inquiries should be directed to Elizabeth at 305-558-1255. Their fax number is 305-423-9009.

One final note: We have some drawings available that show in more detail how to properly space edge margins on a homemade capacitor, how to calculate dielectric thickness based on different voltage waveforms, and some additional construction tips. Builders interested in obtaining the drawings can send \$1.00 (to defray copying and postage charges) to the address below.

*Anthony Charlton  
Allegro Electronic Systems  
3 Mine Mountain Road  
Cornwall Bridge, CT 06754*

## RADIO RECYCLING

I find a very good source of parts for my projects is the local radio shop. I also find parts at car-radio sales and service stores. So get friendly and ask for some of the radios that have been laying around because the customer doesn't want to pay the estimated price and just abandons the radio, or has a new radio installed. Those old radios will be thrown out in the junk heap. If all else fails, an offer of a few bucks for the "junk" should be well received by the shop owner, and the junk should yield a treasure trove of usable parts.

*E. T.  
Palisades Park, NJ*

**START PACKING... You're going on a FREE trip!**



**W**here will it be? Hawaii? Las Vegas? Mexico? The Bahamas? It's up to you. We're going to send you a free coupon for up to six days and five nights of free lodging at the destination of your choice. Now did we get your attention?

Here's how it works: We sell books, and instead of advertising our program on TV (at great expense) we decided to pass the savings along to you.

When you decide to participate in our program, we'll send you a booklet of 40 coupons and a catalog listing our current book offerings. Purchase one book and include one of the coupons for your second book. In all, you'll get 40 books for your \$19.95 investment.

When we receive your fifth coupon, there's a bonus for you in the form of a free membership in the Grocery Savers of America. This will entitle you to save up to \$50 or more on your monthly grocery bill. And on receipt of your 15th coupon, you automatically get a free membership in The Great American Traveler, entitling you to receive a 50% savings on hotels, motels and car rentals. On receipt of your 20th coupon, Bingo! You get that big free lodging for six days and five nights at your choice of Hawaii, Mexico, Las Vegas or the Bahamas.

You're going to be very impressed with the book selections as well. These are not all paperbacks, but the same, high-quality volumes you see in bookstores at many times your own purchase price. Frankly, there just isn't enough room on this page

to outline all of the details, but don't pass this up! Send us your name, address and \$19.95 so we can send you all of the information, including your catalog and 40-coupon book today. MasterCharge and Visa are accepted.

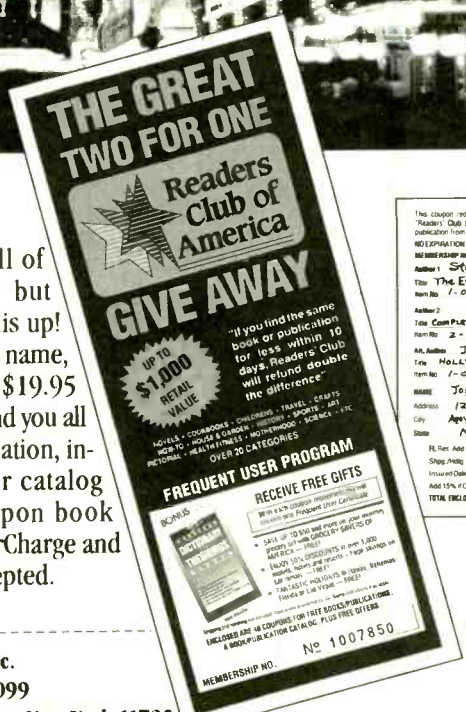

This coupon redeemable for one book/purchase in the "Reader's Club Catalog" when purchasing another Reader publication from this catalog of equal or greater value.

NO EXPIRATION DATE

MEMBERSHIP NO. 000000

Author: Stephen King

Title: THE EVILS OF THE DRAGON

Item No. 1-0121 Price 18.95

Author 2:

Title: THE COMPLETE DECKER PUBLISHING

Item No. 2-0093-10 Price 21.95

Author: JACKIE COLLINS

Title: HOLLYWOOD HARBORS

Item No. 1-0143 Price 18.95

NAME: JOHN SMITH

Address: 123 MAIN ST.

City: ANYTOWN

State: NJ Zip: 08001

FL Per Annu Sales Tax \$3.38

Ship. Post. Insur. on Order \$5

Add 15% if Canadian/Intl

TOTAL ENCLOSED 26.60

**CLAGGK Inc.**  
**P.O. Box 4099**  
**Farmingdale, New York 11735**

Gentlemen: I've enclosed \$19.95 in full payment. Please send my "The Great Two for One Give Away" booklet of 40 coupons and catalog.

Check Enclosed       Visa       MasterCard

Name \_\_\_\_\_

Address \_\_\_\_\_

City \_\_\_\_\_ State \_\_\_\_\_ ZIP \_\_\_\_\_

Credit Card No. \_\_\_\_\_ Exp. Date \_\_\_\_\_

Signature \_\_\_\_\_

*(Clip coupon and mail today! Do not send cash through the mail.)*

# GIZMO

A CHRONICLE OF CONSUMER ELECTRONICS

AUGUST 1992

VOLUME 5,  
NUMBER 8

## Office, Sweet Office

### GIZMO'S HOME-OFFICE ROUND-UP!

Jerry Belski has the dubious honor of being the rider with the longest commute on the Long Island Rail Road. Five days a week, he spends seven hours riding seven trains and subways in his round-trip trek between his East Hampton home and his Manhattan job. And that's simply the longest commute involving the LIRR. We have a friend who used to commute from a small town in Pennsylvania to his job in the Bronx, and we've heard tales of folks who live in New York and commute to Washington DC. While those cases are extreme, there are few people today who haven't, at some point in their working lives, had to spend a significant portion of each day commuting, be it by train, bus, or car. And, according to a medical study conducted several years ago, in which the blood pressure of business executives was measured throughout the working day, the single most stressful activity was found to be commuting.

It's no wonder that the following scenario is becoming increasingly popular: Joe Worker wakes up, sips a cup of coffee, dresses for success in a comfortable pair of jeans and a T-shirt, and prepares for his "commute"—a leisurely stroll (carrying his second cup of coffee) down the hall to his home office. He closes the door, turns on his PC, checks the fax and the answering machine for messages, and begins his workday without ever leaving the comfort of home.

Working at home is certainly not a new concept. Our earliest ancestors did their flint knapping, basket weaving, hide tanning, and spear making in or in front of their cozy caves. In later centuries, farmers worked the land in their own backyards, shopkeepers lived above their stores, and doctors practiced from their homes. It wasn't until the industrial revolution, with large-scale migration to cities, that a significant portion of the population began working outside of their

homes. Although it wasn't unheard of in the ensuing years for some people to work at home, it took the advent of the "information age"—and the ready availability and affordability of powerful personal computers, facsimile machines, and copiers—for the concept of the home office to catch on in a big way.

And we do mean *big*. According to a study by the Electronic Industries Association, more than one in three Americans had some sort of home office, and sales of home-information products accounted for



Sanyo Telephone/Answering System

25% of all consumer-electronics revenues in 1990. There are two types of home offices: areas set aside for bill-paying and other household paperwork, and revenue-producing offices. There are also distinctions between home-office workers: Some bring work home from their regular offices, some moonlight with home businesses to bring in some extra income, and others run full-time businesses from their homes.

BIS Strategic Services, a market research firm, estimated that there were almost 20 million *full-time* home-office workers in 1991. The phenomenon is getting bigger all the time. In the past decade, the number of people working at home has grown at a rate of ten percent per year, and shows no sign of slowing down.

That's hardly surprising, considering all the advantages of working from home. Besides the short commute and the relaxed

dress code—which led Paul and Sarah Edwards, the authors of *Working from Home*, to coin the term "open-collar" worker—working at home allows plenty of individual freedom. You can schedule your time to fit your lifestyle—perhaps "quitting" at 3 PM when the kids get home from school, and then putting in a couple of extra hours after they're put to bed. If it rains all weekend you can work then, and use that bright and sunny Monday to do some gardening or head for the beach. You can get in some relatively inexpensive and uncrowded mid-week skiing. And you never have to worry about squeezing in a doctor's appointment on a lunch hour, or not being able to get to the bank before closing. Similarly, you can create your own work environment—no more generic "cubby" workspaces. Finally, those home offices that actually produce income are considered by the IRS to be legitimate tax deductions, as are the equipment used and



TandyFax 1500 Fax Machine

expenses incurred in operating those offices.

Working at home does have some serious drawbacks, however. First, running a successful enterprise in the face of all that freedom demands a large measure of self-discipline. (You can't spend every day on the slopes or sunning yourself at the beach!) You must be able to motivate yourself to put in the hours needed to get the job done, and to tune out the day-to-day distractions—kids, pets, phone calls, door-to-door sale calls—that are sure to be

TURN PAGE FOR CONTENTS

# This month in GIZMO<sup>®</sup>

Northern Telecom Rhapsody Telephone .....	pg. 7
Panasonic Plain-Paper Fax Machine .....	pg. 7
PhoneMate Private Answering Machine 2 .....	pg. 7
Radio Shack TandyFax 1500 .....	pg. 7
Sanyo Telephone/Answering System .....	pg. 7
Canon Personal Copier .....	pg. 8
Canon StarWriter Word Processor .....	pg. 8
Royal Electronic Typewriter .....	pg. 8
Artisoft LANtastic Network Starter Kit .....	pg. 12
AT&T Two-Line Answering System Telephone 1532 .....	pg. 13
Multi-Link SR2 Selective Ring Processor .....	pg. 15
Command Communications ASAP FAX PC-Based Plain-Paper Fax .....	pg. 20
SoftWorx PC-InterLink File and Printer Sharing System .....	pg. 21
Desk Tech Fun Phone/TAD .....	pg. 23
Nine-Hour Videotape .....	pg. 23
Portable Radio/Cassette/CD .....	pg. 23
Videonics Video Title Maker .....	pg. 23
Full-Size Keyboard .....	pg. 24
Harmon-Kardon Speaker System .....	pg. 24
Security Light Control .....	pg. 24
13-Inch Color TV .....	pg. 24

Gizmo is published by Gernsback Publications, Inc., 500-B Bi-County Blvd., Farmingdale, NY 11735. Senior Writers: Chris F. O'Brian, Teri Scaduto. ©Copyright 1992 by Gernsback Publications, Inc. Gizmo is a registered trademark. All rights reserved.

present. Then there's the double-edged sword: lack of privacy versus isolation. If you don't live alone, you're likely to be frequently interrupted by other family members. Even if you do live by yourself, you'll have to field calls from well-meaning friends who can't get it through their heads that being at home doesn't mean that you're not working. The flip side is the feeling of isolation you experience once family and friends get the message: There's no gossiping around a water cooler when you work at home.

Finally, home offices tend to have a life of their own. Remember that old sci-fi flick, *The Blob*? Well, our personal experience has been that as your business grows, so does your office. Sometimes uncontrollably. (We're up to just about 50% of the total square footage of our home.) Worse yet is the continual expansion of the time demands of a home business. Forty-hour week? Dream on! And remember, if you take a day off, there's no co-worker to pick up the slack; the next day, all that neglected work is still sitting on your desk.

If you have the opportunity to work at home, consider all of those factors in terms of your own personality and work habits. If you're ready to take the plunge, read on. We'll tell you the basics of setting up a home office, and go on to describe our hands-on tests of some interesting products intended to make home offices work smoothly.

## SETTING UP YOUR WORKSPACE

An office that's well-planned will end up saving you time and money. Let's start with the basic layout before getting into electronics.

While you're still in the contemplative mode, there are several practical considerations when planning a home office. First is how much space you'll need and where you can fit such a space in your existing home. You'll need to determine what equipment and furniture (computer? fax? drafting table? extra desk space for a partner or employee? storage for samples? reference books?) are required to do your job properly. If you're simply taking home extra work from your office, your needs will be limited and clearly defined: Just ask yourself what the minimum amount of space and equipment is needed to accomplish those tasks in the main office, and try to duplicate it on a small scale at home. On the other hand, if you're starting your own business, whether part- or full-time, think big. After all, you wouldn't be investing your time, money, and effort in an enterprise that you didn't expect to succeed. Go for the most space and best equipment that you can afford; it's easier than having to totally revamp every few months as the business grows.

Particularly for full-time open-collar

workers, comfort is essential. It's not uncommon for people to shunt a home office to some unused part of the house—basement, attic, garage, or even a toolshed. There is probably a reason that each of those spots is not being used as living space. Basements are dark and damp; attics get too hot and stuffy; garages lack heat, plumbing, and windows. If a space is not pleasant enough to eat, sleep, or watch TV in, don't expect to be happy spending eight (or ten, or twelve) hours a day working there.

Ideally, you'll want a room that is devoted solely to your business. If that's not possible, consider usurping part of another room—possibly using bookcases or careful furniture arrangement to make a visual room divider—as your office. If there's too much distraction in such space-sharing, consider "time sharing" instead. Perhaps your formal dining room is used only on major holidays and an occasional Sunday afternoon. You could use that room as your office the rest of the time, as long as you're neat and organized enough to keep the room looking good without having to haul out boxes of papers and paraphernalia before every dinner party. (And you'd better not have any pressing deadlines on the Friday after Thanksgiving!)

While you do have creative freedom in terms of decor, there are some design rules to be followed for the sake of efficiency and ease. Most are common-sensical: If you're right-handed and you spend a lot of time taking down notes while talking on the phone, place the phone on your left. The surface used for your computer should be at least two feet deep, and there should be at least 18 inches of clear surface space on each side of the PC. Computer users should consider using either an L-shaped or a U-shaped arrangement of desks and computer stand, with a chair on casters. (Make sure that chair is comfortable! All the electronic timesavers in the world can't make up for an uncomfortable one.)

Now that you're not working in one of those little cubbyholes, there's a good chance you have a window in your office: Keep the computer screen at right angles to the windows to avoid glare. If you'll be listening to music (very likely, since it lessens the sense of isolation and there's no one to object to your tastes), make sure you have the MUTE button within reach. Nothing sounds less professional than music blaring in the background of a phone conversation.

If all of this sounds too confusing, consider the "Instant Office." Available in three sizes (8×12, 12×12, and 12×16 square feet) and priced from \$5000 to \$7000, the kits include walls, ceilings, doors, wiring, phone jacks, fluorescent lights, outlets, and an instructional video



detailing the assembly. The Instant Office needs only the addition of electronic gear to be complete.

## GEARING UP

The type of electronics with which you'll equip your home office depends, first, on what type of business you do, and, second, what sort of budget you have. Most—but certainly not all—home businesses require a telephone (often a separate line from the home phone), an answering system, a copier, a computer, and a fax machine. In each of those product categories, there is a wide, and often confusing, range of prices and features available. We'll provide an overview of what to look for in each device, as well as descriptions of some specific products, but it's up to you to determine what you need now, and what your growing business might require in the future, before making a purchase. (Keep in mind that the suggested retail prices quoted here are usually significantly higher than the prices you'll see in stores and catalogs.)

## TELEPHONE TALK

If there's one piece of equipment that nearly every home office needs, it's a telephone. There are several features to look for in a business phone that your home phone might lack. One important feature to look for is two-line capability. You'll need a second line to handle your business calls, and you'll also want to be able to pick up personal calls without having to leave your office. A telephone with a built-in answering machine helps to reduce office clutter. (We take an in-depth look at AT&T's two-line Answering System Telephone 1532 later in this issue.) A cordless phone can also be quite handy in a home



CIRCLE 52 ON FREE INFORMATION CARD

### Northern Telecom Rhapsody Telephone

office, because it allows you to stay in touch with business associates even when you decide to do some gardening during working hours.

You can get cordless convenience as well as a built-in answering machine from Sanyo's (21350 Lassen Street, Chatsworth, CA 91311-2329) CAS1500com



CIRCLE 53 ON FREE INFORMATION CARD

### PhoneMate Answering Machine

combination telephone/answering system. The phone features ten-number speed-dialing memory, 256 digital security codes, a standby-battery mode that allows the handset to function for as long as seven days without recharging, and a two-way intercom. The answering machine offers a number of features, including a 16-second digital outgoing message, a voice time/day stamp, a two-digit call counter, and two-way recording that can be activated from the base or the handset. Suggested retail price: \$199.

To conveniently take advantage of Voice Mail and Caller ID services now offered by phone companies in various parts of the country, Northern Telecom's (4001 Chapel Hill Nelson Highway, Research Triangle Park, NC 27709) Rhapsody phone has a light to indicate when voice-mail messages are waiting, and a display that reveals the time, date, and number of Caller ID calls. Programmable feature-access keys simplify the use of voice-mail (message-waiting) commands. An external RJ11 jack is provided for connecting computers, fax machines, and modems to the phone line without disconnecting the phone, and without the use of add-on adapters. Other noteworthy features of the telephone include a hold button, call forwarding, ten memory keys, and back-up memory. Lamps indicate when a call is on hold, call forwarding is in use, or an extension is in use. Suggested retail price: \$139.95.

PhoneMate's (P.O. Box 2914, Torrance, CA 90509-2914) PAM-2 (for Private Answering Machine 2) brings voice mail to the home office. Up to three PAM-2 telephone/answering devices can be combined, along with a primary answering machine, on one phone line. When callers reach the main answering machine, they dial an extension number to reach the desired phone. Users can retrieve their own messages without having to listen to messages intended for others. Features include nine speed-call memories, last number redial, and beeperless remote. Suggested retail price: \$149.95 each

## ALL THE FAX: PLAIN & FANCY

Over the last decade, facsimile machines have changed the way offices communicate. But despite their strong presence in corporate America, they have been slow to gain a toehold in American households—only about 5% of homes in this country have a fax machine. But the market has been growing steadily, and today's lower prices and advanced features are sure to keep sales increasing at a healthy pace. At the low end of the market, you can pick up a conventional, thermal-paper fax machine for between \$300 and \$500. Mid-range models are likely to include such features as automatic redial, automatic paper cutters, automatic paper feed, quick transmission speed, and multiple-page memory. Units that combine phone, fax, and answering machine have begun to hit the shelves in local stores. At the upper end of the market, plain-paper faxes—no more curly pages or fast-fading images—are now available for the home office, priced at around \$3000. (We review a plain-paper alternative later in this issue.) And if you want to go all out, Sharp introduced the first full-color desktop fax machine last summer. (It can receive color



CIRCLE 54 ON FREE INFORMATION CARD

### Panasonic Plain-Paper Fax

faxes only from other Sharp color machines, however; there is no color-facsimile standard to date).

The TandyFax 1500 from Radio Shack (700 One Tandy Center, Fort Worth, TX 76102) is a good example of a mid-range fax machine. It offers an automatic paper cutter and 70 auto-dial numbers (with built-in battery backup). Also built in are a fax/answering machine switch and a telephone. Functions include broadcasting and polling. The TandyFax 1500 features adjustable transmission settings: automatic redial; and a logo, ID, and transaction journal. Suggested retail price: \$799.

An all-in-one office tool, Panasonic's (One Panasonic Way, Secaucus, NJ 07094) first entry into the plain-paper fax market is their KX-F5000, which also includes a built-in telephone/answering system and a copier function. With automatic voice/fax switching, the unit can distinguish the type of call coming in and

route it appropriately. The fax machine features 15-seconds-per-page transmission speed, on-hook dialing, automatic redial, 20 one-touch-dial and 100 speed-dial memories, delayed transmission of up to 20 pages, up to 16 halftones of gray, and a two-line display. As a copier, the KX-F5000 can make up to 99 copies of a document at a rate of 8 copies per minute. A three-in-one supply cartridge packages toner, developer, and drum in one easy-to-replace unit. Suggested retail price: \$2999.

### COPYING THE PRO'S

While most fax machines claim to double as copiers, unless you have a plain-paper fax, the only copies you'll get are those curly, short-lived thermal images. Desktop copiers that do make good copies are readily available at prices ranging from about \$400 to \$800, not including the cartridge, which can add between \$100 and \$200 to the cost. Certain features boost the price significantly, too: in particular, machines with automatic paper feed and the ability to reduce and enlarge copies are more expensive than basic models.

Canon U.S.A.'s (One Canon Plaza, Lake Success, NY) PC-2LX personal cop-



CIRCLE 55 ON FREE INFORMATION CARD

Canon Personal Copier

ier requires no warm-up time and can make copies on a wide variety of materials (including stationary, labels, postcards, overhead-projector transparencies, and colored paper) in sizes ranging from 2 × 3½-inches (business-card size) to 8½ × 14-inches (legal size). The copier can make up to six legal-size or five letter-size copies per minute. Copy runs can be set for one to nine copies or, in the full-feeding mode, the unit will continue to make copies until the paper runs out. Suggested retail price: \$1095; black cartridge: \$94.95; brown, blue, red, or green cartridge: \$99.95.

### TYPEWRITERS AND WORD PROCESSORS

Even though the personal computer is credited with the boom in home offices, not every home-based business requires a

computer. In fact, some typing and printing tasks are easier to handle on a typewriter or word processor—both of which are alive and well, thank you, in this age of computers. Actually, many features taken for granted by computer users are now available on typewriters and word processors.

Today's typewriter bears little resemblance to those hefty old clunkers that some of you might remember. The top-of-the-line *Model RT 7700* portable electronic typewriter from *Royal Consumer Business Products* (765 U.S. Highway 202, Somerville, NJ 08876-1289) weighs less than 12 pounds and features the 12 most requested automated functions. Those are automatic carriage return, right-margin justification, paragraph indent, right margin flush, cen-



CIRCLE 56 ON FREE INFORMATION CARD

Royal Electronic Typewriter

tering, decimal tabulation, bold print, word-by-word and continuous underscoring, index and reverse index, caps lock, and all-tab clear. In addition, the typewriter features such editing tools as spell checking, full-line correction memory, word erase, automatic relocation keys, block move, copy and delete, word search, and a 50,000-word electronic dictionary and punctuation checker. The RT 7700 also has an 8K memory, 5K of which is available for storing about 2½ pages of text for subsequent editing or reprinting. To facilitate editing, the typewriter has a 32-character, two-line display. Suggested retail price: \$249.99.

A high-quality, high-speed printout is provided by *Canon's* (One Canon Plaza, Lake Success, NY 11042) *StarWriter 70* Bubble Jet personal word processor. It provides up to 360 × 360 dots-per-inch resolution at speeds of either 80 or 160 characters per second. The unit has an 80-character by 16-line backlit LCD screen, 28KB internal text memory, and a built-in spell checker/corrector. Operation is simplified with on-screen menus, a tutorial disk, and help messages. The word processor has five built-in fonts, five type styles, and 12 type sizes. An optional cut-sheet feeder (*Model CF-100*) can hold up to 100 sheets. Suggested retail price: \$719; CF-100: \$150.

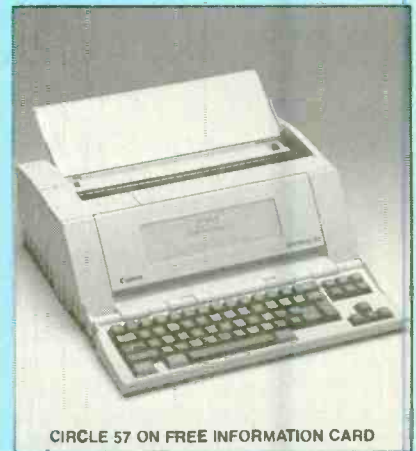

CIRCLE 57 ON FREE INFORMATION CARD

Canon StarWriter Word Processor

### NON-COMMUTER COMPUTERS

Should your needs go beyond word processing, a computer becomes a necessity. Deciding what type of computer best suits your home-office needs is no easy task, and is, for the most part, beyond the scope of this article (there have been entire books written on the subject). We'll give some general guidelines, however.

First, you must decide between the Macintosh and the PC world. Although we're firmly entrenched in the PC world, we understand why the Mac, with its consistent, easy-to-use interface, continues to be successful. Once you decide which family you want to belong to, you have to determine how much power you need. Fortunately, for the most part, you can upgrade on a piecemeal basis. In general, however, we recommend starting out at one step below the current state of the art. For example, in the PC world, where the 486 currently is the high-end microprocessor, we'd suggest a 386-based computer. Prices for those have come down significantly, yet the 386-based machines will be viable for years to come.

Before actually going out to purchase a computer and software, try to outline precisely what you expect it to do for you. We highly recommend seeking the advice of a computer-literate friend or relative—or, ideally, someone in your field of business who is already computerized and who would be willing to show you the solutions that have worked for him. When you do go to the computer store, be sure to clearly communicate your requirements to the salesperson—and if he seems more interested in the sound of his sales pitch than in your questions, find another salesman, or another store.

Also, those interested in PC-type machines may want to check out the series on buying a PC currently running in our *Computer Bits* column.

Now it's time to take a look at some specific items that might make easy work of your home work.

# NRI gives you two unbeatable opportunities for top pay, security, even a business of your own.

Everybody wants to get ahead, but most people want assurance they're making the right job choice. According to the U.S. Department of Labor, jobs for electricians and air conditioning, heating and refrigeration technicians offer high earnings and good job prospects. Now NRI can show you how to go after the high earnings, the steady pay increases, even how to be your own boss in a business of your own. You'll get all the skills to get there. No night school, no need to quit your job until you're ready to make your move. NRI trains you right at home in your spare time.

## No Experience Needed.

NRI starts you with the basics, then builds your knowledge and skill a step at a time, all the while adding practical know-how through hands-on training. You even get tools you need on the job or in a business of your own. Over a million and a half students have trained the NRI way since 1914.

## Be an Electrician.

Each year, the demand for skilled construction, maintenance, commercial and utility electricians continues to grow. The U.S. Department of Labor estimates that close to 100,000 new jobs will open up in the next ten years - a conservative estimate compared to industry and union predictions.

And few jobs can match the money-making potential of the qualified electrician. You can earn a salary in excess of \$25,000 or be your own boss with your own electrical contracting business.

## Only NRI gives you this kind of practical, job-oriented, hands-on training.

You master practical skills like this with the equipment, test instruments, and training materials included in your course. . . you duplicate on-the-job wiring with your NRI Residential Wiring Practical Lab®. . . you learn professional troubleshooting using your Volt-Ohmmeter and Clamp-On Ammeter to test the circuits you build up on your NRI Circuit Demonstrator. . . and by installing and testing an electronic-programmable thermostat and a microprocessor-controlled remote power control, you come to understand today's electronics as it applies to the latest devices electricians install and repair.

## Training in the latest need-to-know electronics required of today's electrician.

NRI created this new course so you can move from the simplest fundamentals of electricity, through professional wiring and trouble-shooting techniques, all the way up to mastering the practical field skills you need to become today's electronic-smart electrician. Be an electrician. It could be the best and last job choice you'll ever have to make.

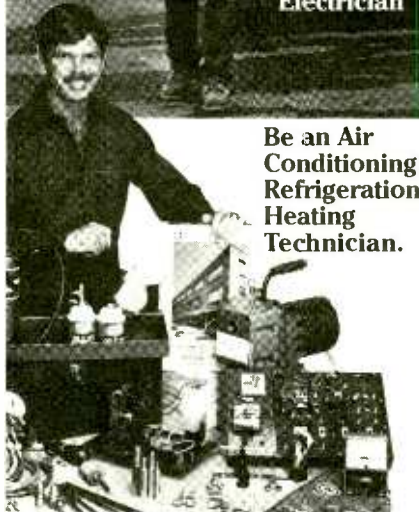
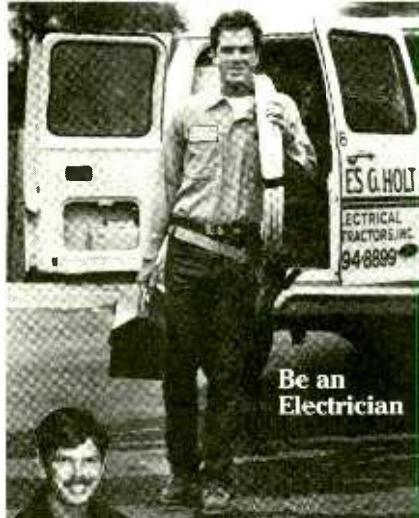

## Be an Air Conditioning, Refrigeration, Heating Technician.

When it comes to targeting the good paying jobs, regular pay increases, and

the steady demand for your skills in this field, the U.S. Department of Labor scores a solid hit...high earnings and good job prospects attract many individuals... because people in business depend on their air conditioning, heating, and refrigeration systems, the need for skilled technicians to do maintenance work has to be met regardless of swings in the economy. Add millions of window units in older homes requiring maintenance and repair; heat pumps so popular they're now as common as furnaces; commercial refrigeration alone calling for skilled technicians to install and service walk-in coolers, freezers, ice makers, and food cases. Wherever you look, there's tremendous opportunities for the trained air conditioning, refrigeration, and heating technician.

## NRI training so complete, professional tools even included.

NRI trains you for this lucrative field, gets you ready to land a good paying job, pick up extra income in your spare time, even start a business of your own. You're ready to jump right in because NRI includes the tools you need: system analyzer, leak detector, tubing and joint tools, a top-quality vacuum pump for purging systems, plus demonstration panel units for hands-on systems training. Graduates of our Master Course also get optional free residential training at the world-famous York Institute in York, PA.

## Go after high earnings, pay increases, a business of your own.

Send for NRI's free catalog. Find out what hands-on projects you do, the professional tools you train with, and the future that can be yours. Act today.

**SEND COUPON TODAY FOR FREE NRI CATALOG!**

**NRI SCHOOLS**  
McGraw-Hill Continuing Education Center  
4401 Connecticut Avenue, NW, Washington, DC 20008

For Career courses approved under GI bill  
 check for details

**CHECK ONE FREE CATALOG ONLY**

<input type="checkbox"/> Electrician	<input type="checkbox"/> Automotive Servicing
<input type="checkbox"/> Air Conditioning, Heating, & Refrigeration	<input type="checkbox"/> Home Inspection
<input type="checkbox"/> Microcomputer Servicing	<input type="checkbox"/> PC Applications Specialist
<input type="checkbox"/> Small Engine Repair	<input type="checkbox"/> Telecommunications
<input type="checkbox"/> Appliance Servicing	<input type="checkbox"/> Desktop Publishing
<input type="checkbox"/> Locksmithing	<input type="checkbox"/> Gunsmithing
	<input type="checkbox"/> Building Construction

**NRI's ELECTRICIAN COURSE**

**New! Electricians Course A**  
Air Conditioning, Refrigeration and Heating

<input type="checkbox"/> TV/Video/Audio Servicing
<input type="checkbox"/> Industrial Electronics
<input type="checkbox"/> Computer Programming
<input type="checkbox"/> Cellular Telephone
<input type="checkbox"/> Digital Electronics Servicing
<input type="checkbox"/> Bookkeeping & Accounting

Name \_\_\_\_\_ Age \_\_\_\_\_

Street \_\_\_\_\_

City/State/Zip \_\_\_\_\_

Accredited Member National Home Study Council 4248-082

# The No-Work Network

**LANTASTIC NETWORK STARTER KIT.**  
From: Artisoft, Artisoft Plaza, 575 E. River Rd., Tucson, AZ 85704. Price: \$699 (with 300-user license).

Computer networks are a leading area in PC sales for a very good reason. If any large organization is going to use PC's efficiently, its workers *have* to be able to share files, data, and resources. But is there any reason why a small home office would want to get involved with networks, which are notorious for being difficult to set up and time-consuming to maintain? We can answer that question with a resounding "yes," after giving Artisoft's *LANtastic 2-Station Ethernet Local Area Network Starter Kit* a workout.

LANtastic is a flexible peer-to-peer network. Unlike traditional client-server networks (such as Novell's Netware and 3-Com's 3+ Open) any PC in a peer-to-peer network can act as a server or a workstation. One PC, for example, can give others access to its CD-ROM drive, while another might share its printer. And that's where a true network has an advantage over systems that simply let you share files and printers. Even though a network is costlier and more difficult to set up, it is also more powerful and flexible. If installing a network lets you forego buying a second or third tape backup unit and CD-ROM drive, it can pay for itself almost instantly.

We installed the Network Starter Kit in the satellite GIZMO offices of *Popular Electronics*, where the complement of PC's consists of two AT-compatibles (used almost exclusively for text editing), 386 and 386-SX clones (used mainly for product testing), and a couple of older machines that are serving as backups. Regularly used peripheral equipment includes an HP LaserJet and a Panasonic dot-matrix printer, a CD-ROM drive, and a tape backup unit. Because none of the machines were networked together, we'd often find ourselves relying on the old "sneaker net:" walking across the office to output a file on the laser printer, for example. If we were fortunate, we might just have to toss a diskette over to a colleague. (We call that our "air net.")

The most difficult part of installing the starter kit was running the cable through a wall between two adjoining rooms. (The starter kit comes with 25 feet of thin [RG-58A/U] coaxial cable with connectors on either end. Two terminating resistors, two BNC "T" connectors, and, of course, two network adapter cards are



also included.) The Ethernet adapter cards can also support thick Ethernet coax; another version of the card supports twisted-pair cabling.

The rest of the installation consists of setting various jumpers on the adapter cards and plugging them into free slots in a PC (both 8- and 16-bit slots are supported), and installing the software.

We installed one card in an old (circa 1985) AT-compatible that has proven to be cranky and less than compatible over the seven years we've used it. The installation, however, came off without a hitch.

The second machine we used was a 386-SX clone. Things didn't go as smoothly there—whenever we would try to run the network software, the machine would "lock up." Figuring that we had a port or interrupt conflict that we hadn't anticipated, we changed the jumpers from their default positions. After trying several combinations, we realized that our problem was caused by something else. Unfortunately, since our machine was locking up, we weren't getting any error messages, and, therefore, our problem wasn't listed in the manual's "messages" appendix or in its index under "errors" or any other heading we could think of. We did, eventually, find a section in the manual under the heading "Non standard Bus Selection" where our problem was described. Apparently, our 386-SX clone had incompatible bus timing; changing the jumper made the adapter compatible with it.

Although we would have liked a description of our problem to be easier to find in the documentation, that complaint is the exception, not the norm. Three manuals are included in the starter kit. One describes the Ethernet adapter cards and their installation. Two others—a user's manual and reference manual—describe the LANtastic network operating system.

All are well-written and seemed to answer any questions we came up with as we configured our system. Although Artisoft does offer a technical support line, we didn't have any occasion to use it. Based on our experience with other networks, we expected more problems. The only problems we did encounter, however, were caused by our haste in trying to guess proper procedures instead of taking the time to read the manuals.

In our setup, LANtastic was configured so that both PC's ran as server/workstations. That way we could have access to as many resources as possible from either PC, and use either PC as a workstation. (Specifically, we wanted access to both the CD-ROM drive and the laser printer at all times from either machine.) Sometimes, however, we just wanted to access a resource on one of the machines while we used the other as a server/workstation. A server performs better if it isn't running simultaneously as a workstation. Fortunately, changing one of the machines to run strictly as a server is as easy as typing **ALONE** at the DOS prompt.

LANtastic offers messaging ("chat") and mail functions as well as file and resource sharing. The chat feature lets you "call" another user in real time. You can carry on a two-way typed conversation, although each line of text is transmitted only after you hit the **ENTER** key. When both machines were running DOS applications, it performed flawlessly. When one of the machines was running Microsoft Windows 3.0, however, we ran into a problem. Instead of a message being announced by a pop-up box, all the Windows machine would do is beep. Exiting Windows let us get the message. Although that problem is one caused by Windows more than by LANtastic, there is a solution:

(Continued on page 22)

## Double Talk

**AT&T ANSWERING SYSTEM TELEPHONE 1532.** Manufactured by AT&T Consumer Products, 2 Wood Hollow Road, Parsippany, NJ 07054-2899; Price: \$239.99.

These days, when telephones are found not only in homes and businesses, but in cars, boats, and airplanes (not to mention bathrooms at fancy hotels), it's difficult to imagine life without one. It's even harder to imagine conducting business without a telephone. Yet our culture been dependent on that device for only about a hundred years. Since its invention in the 1870's—a decade in which the mimeograph, typewriter, and switchboard also made their debuts—the telephone has become firmly entrenched as the lifeline of virtually every type of enterprise.

Home offices are certainly no exception. A phone allows you to keep in touch with the main office, with customers, and with the business world at large. To keep your home life separate from your business life, it's a good idea to spring for a second phone line for business calls—and for a good two-line telephone. If your wife and kids use the phone frequently during “office hours,” or your parents call for long chats twice a week, your business is effectively out of commission during those calls unless you have a separate line.

It's important for home-based businesses to keep up a professional image, and the first impressions many clients and associates will get is the way in which your telephone is answered. With a separate line, you don't have to worry about your toddler answering it in babytalk, or your teenager sounding disgruntled when she discovers that your important business caller wasn't her boyfriend. Similarly, a separate answering machine is a must—a cutesy outgoing message might be humorous on a personal line, but not on a business line.

Flexibility is a key concept in home offices, and it's important for home-office gear to be flexible too. After all, if you must leave a regular office, whether for business or personal reasons, there is generally someone (or something) available to take your messages while you're out. In a home office, your telephone and answering system must take the place of a receptionist and secretary (or voice mail). The *AT&T Answering System Telephone 1532* is about as flexible a system as you could possibly want. The system includes a full-featured two-line phone as well as a two-line answering machine that can store up to four separate outgoing messages in addition to a personal memo.



CIRCLE 59 ON FREE INFORMATION CARD

For instance, you might designate line 1 for personal use and line 2 for business calls. Then, you could use one outgoing message for your personal calls (“Hi! You've reached the Carter house. Leave a message and Allen or Betty will call you back. Bye!”), set another to pick up line 2 calls during business hours (“This is ABC Computer Repair. Please leave your name, number, and a brief message and we'll return your call as soon as possible. Thank you.”), and use the third to pick up line 2 calls on evenings and weekends (“ABC Computer Repair is open on Monday to Friday from 10 to 6. Please leave a message and we will call you back during business hours.”). The fourth message is an announcement only; it doesn't allow for incoming messages. You might want to use that to let clients know that you can temporarily be reached at another number, or to give a description of your product or service, or to give directions to your office.

The two-line answering system is, according to AT&T, the first to be able to answer calls on one line while taking a message on the other. In that event, the second caller will hear a digitized voice say “Please wait to leave a message.” As soon as the caller on the first line is finished leaving his message, the system plays the outgoing message for the number that the second caller has dialed, and then records the second caller's message.

Finally, you can use the personal memo to leave vocal messages for family members (“I went across town to give an estimate on a job. I should be back at about 7:30; I'll call before leaving. Please put the

casserole in the oven at 6:45.”), instead of tacking a note up on the refrigerator and hoping that someone will notice it. That personal message can be retrieved remotely by someone who knows the correct two-digit code. That person could even record their own personal message over yours from a remote location, so that when you called to say you were on your way home at 7:45 and got no answer, by checking the personal message feature you might hear “I got hung up at the office and won't be home until almost 8:00. Too late for the casserole. I'll pick up a pizza on my way home.”

The system sets another precedent: It's the first with the ability to respond to rotary phones and voice commands in the remote retrieval of messages. If you're calling from a touch-tone phone, you can simply punch in your two-digit access code to hear your messages, as is standard practice for beeperless-remote TAD's. If you decide to get away from it all at a cabin or cottage equipped with an old rotary phone, however, you can still call in for messages without driving for miles to find a McDonald's or 7-11 equipped with a more modern, touch-tone pay phone. Instead, you can use the 1532's voice-activated commands. If you call the system and remain silent for about seven seconds following the beep after which you'd normally leave your message, the system will say “Enter remote access code.” When you immediately respond by saying (quickly and loudly) “Enter code,” the system replies, “First digit,” followed by “Enter 0,” “Enter 1,” etc. When you hear the first digit of your code, you must say

"Enter code" again. The process is repeated for the second digit. At that point the system tells you how many messages you have and begins to play them all. At the end of each message, the digitized voice asks if you want it repeated; at the end of all the messages, it asks if you want to erase them all or play them again. (While the manual suggests phrasing your replies by simply repeating the words used by the system to ask the question, the 1532 doesn't recognize actual words. It responds to any loud enough auditory signal. You could say "Don't enter code," and it will still work.)

Even without taking into account the 1532's ability to respond to remote vocal commands, it's in the unit's remote capabilities that its flexibility is most evident. Functions that can be accessed remotely include listening to, replaying, and clearing all messages or just those on line 1 or line 2; listening to new messages; skipping a message; advancing or rewinding the tape; playing the personal memo (which requires a separate personal access code); changing the outgoing announcements or personal memo; and turning the answering machine on or off.

Three separate personal access codes are used to operate various remote functions. If you choose to use the factory-preset codes, "10" allows you to retrieve messages and operate all the functions outlined in the previous paragraph. Pressing in "20" lets you hear any personal message that might have been recorded. And pressing "30" makes your call a "priority call." Should you decide to personalize your access codes, you can easily do so in person—or remotely.

One unfortunate side-effect of all that flexibility is increased complexity. What happens, you might ask, if I lose the little wallet-sized instruction card that AT&T supplied and can't remember which buttons access which functions? The 1532 is quick to provide a solution to that dilemma—and in its own voice. It offers an "on-line" Voice-Help Menu. Once you press in your remote access code (that much, at least, you must remember on your own), pressing the pound key (which you must also commit to memory) causes the digitized voice to begin speaking: "To play all messages, press 7," "To play new messages, press 6," and so on.

Before we go on to describe the telephone portion of the 1532, we'd like to point out a few other well-received answering-machine features. First, if the answering machine picks up a call before you can reach the phone, as soon as you lift the receiver (either on the 1532 or on an extension), the recording stops immediately. There's no need to shout over your own recorded voice "Hang on! I'm really here!" Second, if you use the answering

machine to avoid taking calls even while you're in the office (as you're struggling to finish a project on time, for instance), you can do so without audible interruption by turning down the volume. But you can still receive important calls by giving those callers the special "priority call" access code. When detected, that code causes a special tone to sound, indicating an incoming priority call. Finally, besides the digital display that shows the number of calls received, you can set an audible tone that beeps every ten seconds to indicate that you have messages. And (thankfully), with the flip of a switch, you can turn that feature off!

There are a few convenient playback features as well. For instance, you can opt to listen to only the calls that came in on line 1 (or line 2), by pressing the LINE 1 (OR LINE 2) BUTTON BEFORE PRESSING THE MESSAGE bar. Alternately, you can listen to all the messages and hit SKIP/FAST FORWARD to bypass those that aren't intended for you. Following each message, a digitized voice tells the user the day and time that the message was recorded. (That feature can also be used as an "audible clock"; when you press and release the CLOCK button, the current day and time are announced.) After the last recording, that same voice lets you know: "End of messages." It's important to remember not to press REPEAT/REWIND if you think you might want to replay any of the messages later; that key erases all messages. To keep things from getting too unwieldy when messages start to build up, it's possible to play back only those new ones that you haven't heard before.

The telephone portion of the 1532 offers all the features you'd commonly use in a business phone, including nine speed-dial numbers, last-number redial, hold, and mute. A conference button bridges the two lines together for a three-way conversation. If you have rotary service, but occasionally need tone dialing, you can use the telephone's temporary tone feature to access voice-mail systems or do banking by phone, for instance. If you subscribe to custom services, such as call-waiting or three-way calling, from the local phone company, the phone's FLASH button can be used as a substitute for pressing the switch-hook to activate those services.

For all its features and functions, the 1532 doesn't look much different from any other combination phone/answering machines. The handset is on the left side of the unit. The middle section is devoted to the answering machine. Two micro-cassettes fit in a recessed part of a covered compartment that also contains infrequently used answering-machine controls for recording messages and setting personal access codes. Beneath the compartment

is an LED readout that displays the number of messages received (0–25) and various status messages. Below the display are the frequently used answering-machine and personal-memo controls for listening to your messages. On the right side of the 1532 are phone controls, including the nine speed-dial buttons and a chart on which to write the associated names; the function keys; and the dial pad. The dial numbers, along with the frequently used answering-machine controls, are all large, round keys that are easy to use without accidentally hitting the wrong one.

Grouped with the function keys are indicator lights for line 1 and line 2. According to the manual, those light only when their respective lines are in use. When the phone is ringing or a call is on hold, the indicator light should flash quickly or slowly, respectively. In our installation, however, the indicator for line 1 remained lit even when that line was not in use. Perhaps as a result, whenever we picked up the handset, line 2 was automatically selected for use. While that was not the way the unit was supposed to work (and we double-checked our installation), it was a fortuitous arrangement for us: Since line 2 is our business line and the phone sits in our office, we preferred to automatically be on that line when we wanted to place a call.

In our real-life tests, the 1532 turned out to be a good, all-round solution for our home and office telephone and answering-system requirements. Being able to play back messages from only one line came in handy, and we particularly liked being able to switch our business line to a weekend message on Friday evening. (It gave us the illusion of shutting the shop down for the weekend, even when we knew we'd be putting in time on both Saturday and Sunday!) Most of all, we liked the sense of control over our home-office and personal communications that we had when using the 1532. ■

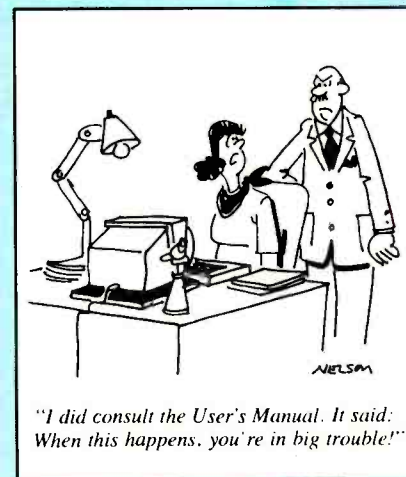

# Distinctive Phone Switcher

SR2 SELECTIVE RING PROCESSOR.  
Manufactured by: Multi-Link, Inc., 1391  
Leestown Road, Lexington, KY 40508.  
Price: \$79.

One lesson that a small business must learn quickly—if it is to succeed—is that expenses add up quickly. Small businesses—especially those run from the home—must also learn, right from the start, that it's essential to project a professional image. Since most home-office business is conducted via the telephone, the way you handle your phone can make or break you. If a caller to your business encounters a young child whose standard phone greeting is "who's this?" your credibility might not be salvageable.

Many home offices, especially when they're just starting out, can't justify the installation of a second line because of the expense it incurs. In our area, for example, the basic charge for a separate line is over \$150 per year, which can put a big dent in a shoe-string budget. Thanks to the latest digital telephone switching equipment, many phone companies offer a new way to make your business calls different from other calls: distinctive ringing. Distinctive ringing—also called, depending on the phone company, "Custom Ringing," "Smart Ring," "Ring Mate," "Ident-A-Ring," or some other similar name—gives you a second (and, in some areas, a third) phone number on a single phone line. A call to the second number will sound different from one to the first—two quick rings instead of a single long ring,

for example. Distinctive ringing costs a fraction of what a second phone line costs, yet it should help you—and your family—distinguish personal calls from business calls. (Unfortunately, you'll probably find yourself getting twice as many unsolicited telephone sales calls!)

Distinctive ringing isn't perfect for business users, however. New York Telephone, for example, will not give you a directory listing for your second number. They market the service—which was introduced little more than a year ago—as a way for parents and teenagers to peacefully coexist.

Potentially, distinctive ringing could be much more valuable to small, home-based businesses. In a two- or three-person business, each person could have his own ring—with no time wasted routing calls. And wouldn't it be great if you could teach your fax machine and your computer to recognize distinctive ringing?

Since you can't do that, *Multi-Link Electronics* has come up with the next best thing: a telephone switching device that can route incoming calls to the appropriate person—or machine—by "listening to" the ringing signal. With the SR2 or SR3 *Selective Ring Processor* you can, in effect, have a dedicated fax line for a fraction of the cost of a real dedicated line. (The SR3, which is for phone lines equipped with three distinct numbers, works in the same manner as the SR2 that we describe here. It costs \$109.) In our area, the savings on your phone bill will pay for the SR2 in less than a year.

The device works by counting the number of bursts in the ring pattern and directing the call to one of the numbered device ports at the rear of the unit. According to Multi-Link, the device, unlike some similar products, will work on any selec-

tive-ringing system. The caller can't tell that anything different is on the line.

Installing the SR2 is not at all difficult, but it does require some thought to get the desired results. For the SR2 to direct your calls properly, the phone lines have to pass through the device. Let's assume, for example, that you wanted to use the selective-ring service to distinguish business calls from personal calls, and also that you didn't want to be bothered by business calls during your off hours—whenever those are for a home-office worker. In that case, you would be best off installing the SR2 where the phone line enters the house. The incoming line would connect to the line input of the SR2. The outputs would go to the rest of the house. One would be connected to all of your personal phones, while the other output would go only to your office phones. Your business calls would ring only in the office, and your personal calls wouldn't interrupt your work.

Of course, you can wire your phones in different ways. You might, for example, want to receive personal calls while you're in your office, or business calls in your kitchen. You may not, however, want to have to rewire your entire house for the convenience. Fortunately, you don't have to. Phone lines require only two wires. Yet, you'll note that your telephone wires contain four wires. By using a two-line splitter, you can use the four-wire cable to distribute the two lines throughout the house.

We installed the SR2 in a couple of different ways. First, we installed it where the phone wires enter our premises. Our GIZMO test office had two incoming lines, one of which had distinctive ringing. The manual calls this installation scheme "the Waterloo of many an arm-chair telephone man," and suggests hiring a professional to help with the installation.

Despite the manual's warnings, the system installation wasn't all too complicated. Its main drawback is that you must run additional wiring—unless your current wiring consists of six wires.

We settled on an alternate scheme. We installed the SR2 only in the office, where its job was to control access to a fax machine. With this installation, the distinctive ring was heard throughout the house. But that worked as something of an advantage. Since the fax machine was set to pick up on the first ring, the ring served as a signal that fax was received.

Selective ringing isn't the solution to all small offices. Yet if you're looking for a way to get most of the benefits of a second line, and a way to add convenience and the air of professionalism to your office, then distinctive ringing—coupled with an SR2 ring processor—will do it without breaking your budget. ■

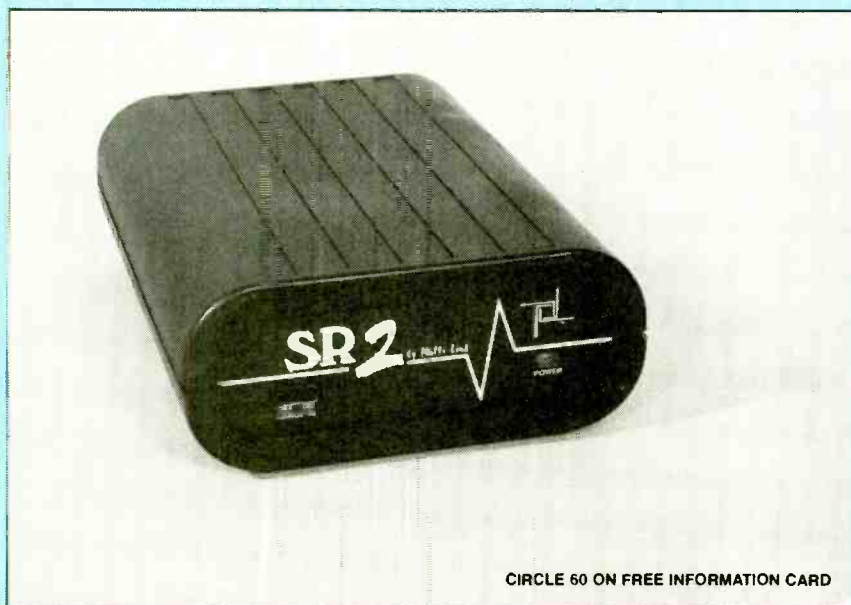

CIRCLE 60 ON FREE INFORMATION CARD

# If You're Serious About a Future in Electronics, Ensure that Future with the Best Educational Training Available.

## FREE!

SEND FOR YOUR CIE HOME  
STUDY COURSE CATALOG AND  
RECEIVE A FREE 24 PAGE CIE  
ELECTRONICS SYMBOL HANDBOOK!

Includes hundreds of the most frequently  
used electronic symbols. Published by  
CIE exclusively for our students and  
alumni. Yours free when you  
request a CIE Course Catalog.

electronics

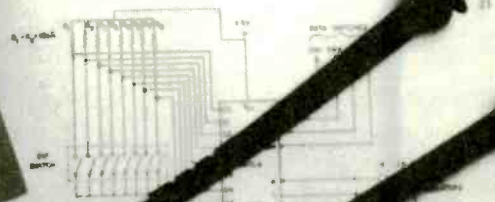

Fig. 16 Circuit for Experiment 3



Fig. 17 Pin diagram for 74151A.

### Procedure

Figure 16 shows the circuit diagram for this experiment. You'll note the pin numbers for the IC area included on the diagram. For the data switches, you'll refer to Fig. 17, which shows pinout for 74151A data. For the data switches, you'll use an 8-pin DIP switch in combination with 10K pull-up resistors. For the Switch and Status lines, finally, you'll use the breadboard switches.

1. With the power off, install the 74151A IC and the DIP switch on the breadboard.
2. Connect the eight 10K resistors to the DIP switch as shown in Fig. 16. Connect the opposite end of each of these resistors to the +5V power supply. The second terminal of each switch is to be connected to the trainer ground.
3. Connect the 16Vcc pin to +5V, connect the GND pin to trainer ground.
4. Next, connect the trainer data switches to the Switch and Status lines on the IC using Fig. 17 as a guide. Finally, set the IC to the 74151A.
5. Connect the Trainer LED to the Y output, and connect the Trainer LED to the B output.

6. Turn the power on. The LED in your trainer should be off, and the LED should be on. If you don't observe these conditions, turn off the power and check your connections.
7. From the present input conditions on the inputs, you can see that the output will be enabled.
8. Set the appropriate DIP switch III (input), and verify your operation. Record your results in terms of the selected input D<sub>i</sub> (where i is the number of the selected data line) in the appropriate space in the truth table in Fig. 18.



If you want to learn about electronics, and earn a good income with that knowledge then CIE is your best educational value.

CIE's reputation as the world leader in home study electronics is based solely on the success of our graduates. And we've earned that reputation with an unconditional commitment to provide our students with the very best electronics training.

Just ask any of the 150,000-plus graduates of the Cleveland Institute of Electronics who are working in high-paying positions with aerospace, computer, medical, automotive and communication firms throughout the world.



They'll tell you success didn't come easy...but, it did come....thanks to CIE. And today, a career in electronics offers more opportunities and greater rewards than ever before.

### CIE's COMMITTED TO BEING THE BEST....IN ONE AREA....ELECTRONICS.

CIE isn't another be-everything-to-everybody school. We teach only one subject and we believe we're the best at what we do. Also, CIE is accredited by the National Home Study Council. And with more than a 1,000 graduates each year, we're the largest home study school specializing exclusively in electronics. CIE has been training career-minded students like yourself for nearly 60 years and we're the best at our subject .....  
ELECTRONICS ... BECAUSE IT'S THE ONLY SUBJECT WE TEACH!

### CIE PROVIDES YOU WITH A LEARNING METHOD SO GOOD, IT'S PATENTED.

CIE's Auto-programmed lessons are a proven learning method for building valuable electronics career skills. Each lesson is designed to take you step-by-step and principle-by-principle. And while all CIE lessons are designed for independent study, CIE's instructors are personally available to assist you with just a toll-free call. The result is practical training... the kind of experience you can put to work in today's marketplace.

### LEARN BY DOING...WITH STATE-OF-THE-ART FACILITIES AND EQUIPMENT.

In 1969, CIE pioneered the first Electronics Laboratory course and in 1984, the first Microprocessor Laboratory course. Today, no other home study school can match CIE's state-of-the-art equipment and training. And all your laboratory equipment, books, and lessons are included in your tuition. It's all yours to use while you study at home and for on-the-job after graduation.

### PERSONALIZED TRAINING....TO MATCH YOUR BACKGROUND.

While some of our students have a working knowledge of electronics others are just starting out. That's why we've developed twelve career courses and an A.A.S. Degree program to choose from. So, even if your not sure which electronics career is best for you, CIE can get you started with

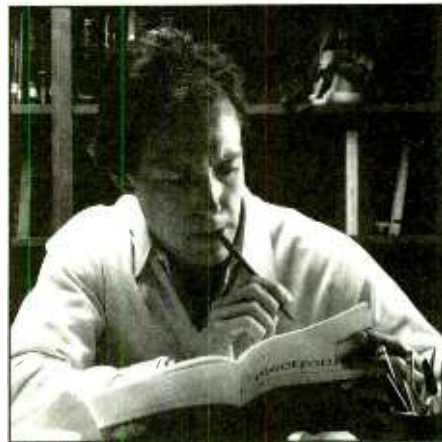

core lessons applicable to all areas of electronics. And every CIE course you take earns you credit towards completion of your Associate in Applied Science Degree. So you can work toward your degree in stages or as fast as you wish. In fact, CIE is the only school that actually rewards you for fast study, which can save you thousands of dollars.

SEND TODAY FOR YOUR CIE COURSE CATALOG AND WE'LL SEND YOU A FREE 24 PAGE CIE ELECTRONICS SYMBOL HANDBOOK!

#### WHY CHOOSE CIE FOR YOUR TRAINING?

- 150,000 successful graduates from every country around the world.
- Only CIE rewards you for fast study. CIE offers an Associate Degree program based on actual study time used. The faster you complete your degree the less your overall tuition.
- State-of-the-art laboratory equipment is yours to keep and it comes assembled, ready for hands-on experiments.
- Approved for educational benefits under the G.I. Bill for veterans and other eligible persons.
- Upon graduation, CIE offers free preparation to pass the Certified Electronics Technician Exams.

**YES!** I want to get started.  
Send me my CIE school catalog including details about the Associate Degree Program. (For your convenience, CIE will have a representative contact you - there is no obligation.)

AH31

Name: \_\_\_\_\_

Address: \_\_\_\_\_

City: \_\_\_\_\_ State: \_\_\_\_\_

Zip: \_\_\_\_\_ Age: \_\_\_\_\_

Phone No. ( \_\_\_\_\_ ) \_\_\_\_\_

Check box for G.I. Bulletin Benefits

Veteran  Active Duty



**CLEVELAND INSTITUTE OF ELECTRONICS**

1776 East 17th Street  
Cleveland, Ohio 44114  
(216) 781-9400



A school of thousands.  
A class of one  
Since 1934.

## PC-Based Plain-Paper Fax

**ASAP FAX.** Manufactured by Command Communications, Inc., Command Center, 10800 E. Bethany Drive, Aurora, CO 80014. Price: \$700.

Although many people think that fax machines are a relatively new invention, they've actually been around since the 1930's. The big, expensive, difficult-to-maintain machines were used only by people who could justify the expense and hassles—mainly newspapers and large businesses. The fax machine didn't start to become an almost essential part of an office until the late 1980's, when digital technology and Japanese manufacturing caused prices to drop dramatically.

Despite their significant improvements, today's mid-priced fax machines leave a lot to be desired. The major complaint is that they print on thermal paper. The annoying curling is bad enough. Worse is the way they fade over time. (If you've ever pulled an old fax out of your filing cabinet, you know what we mean. If you've ever had the misfortune of leaving a fax on your car's dashboard on a hot summer day, you know how quickly heat can destroy a thermal-printed fax.)

Of course, faxes don't *have* to be printed on thermal paper. Thermal printers are the choice of most manufacturers because they're cheaper than competing technologies. Laser faxes provide clear, crisp, plain-paper copies that don't curl or fade. Unfortunately, they're expensive, with prices hovering around \$3000. But what if we told you that you could use your laser printer to receive faxes? Well you can, with *Command Communications' ASAP FAX*.

The ASAP FAX receives faxes and converts them to a form that's compatible with the Hewlett Packard LaserJet or Canon laser printers. So if you already own a laser printer, you don't have to buy a new machine that duplicates the laser engine. And the ASAP FAX is even compatible with Epson-compatible dot-matrix printers. You don't have to leave your computer—or your printer—on all day to receive faxes, and you can send faxes of computer-generated documents of graphics, too. (If you want to send a noncomputer-generated fax, however, you'll need a scanner as well.)

Besides plain-paper capability, ASAP FAX also gives you some features found only on high-end machines. For example, you can schedule transmissions to take advantage of lower phone rates, or you can use a polling feature, which allows a remote fax machine to call ASAP FAX and



CIRCLE 61 ON FREE INFORMATION CARD

request a document. You can screen out junk faxes, forward faxes from your home office to a remote site, and "broadcast" faxes to multiple sites. A record of all activity is stored on the fax's floppy disk, as are all received faxes.

For all of its features, ASAP FAX is a rather unassuming beige box that measures about  $5\frac{1}{2} \times 2\frac{1}{2} \times 7$  inches. Its front panel contains a  $3\frac{1}{2}$ -inch floppy disk drive and two LED's. The rear panel contains a modular phone jack, a power jack, a Centronics-type printer port, a DB-25 connector, and a single pushbutton. No other controls are needed, as the user interface is through a PC.

Hooking the unit up is easy enough. The phone jack is connected to the phone line; the power jack is connected to the wall-mounted DC adapter. The Centronics connector takes the output of your computer, and the DB-25 connector goes to your printer. In other words, the machine sits between your computer and your printer. (Both a phone cord and printer cable are supplied.) You also have to insert a  $3\frac{1}{2}$ -inch diskette (also supplied with the fax) into the unit's drive.

Software installation is equally straightforward, requiring that you simply copy files from the supplied floppy disk. Running the FAX.EXE program brings up the main menu from which you can send documents, print an activity log, reprint a fax that's stored on the data diskette, and change basic settings for your printer and the fax itself.

The menu-driven software is easy enough to use, although not all of the functions were immediately intuitive.

The Fax Settings menu is where most of the advanced features of the ASAP FAX can be manipulated. From it, you can set the time and date and the fax header line (which are printed on the top of each fax sent). You can also select the file that will be sent if ASAP FAX is polled by another machine, set the number of rings on which ASAP FAX will answer, set the number of retries it will make, turn fax forwarding on and off, and set junk-fax screening.

When junk-fax screening is enabled, you will receive faxes only from machines that are on your list. (You must identify, usually by their phone number, the machines from which you will accept faxes.) Similarly, you can set polling security so that only those machines on your list will be able to poll the ASAP FAX to request the transmission of the selected fax stored on the floppy disk.

Sending a fax can be done in one of two ways. From FAX.EXE, you can fax any file that is either in ASCII or Epson FX-80 format. (Any original document must be scanned in a compatible format before it can be sent.) You can also fax directly from a PC application. To do that, you must run a memory-resident program that is supplied with ASAP FAX. Let's say you wanted to fax a file from Word Perfect, a popular word processor. You would start by running FAXTSR.EXE (the memory-resident program), and then run Word Perfect. Once inside Word Perfect, the memory-resident program is called up using a hot-key sequence. You are then presented with a menu of your fax-phone directory, or you can enter a new number. Once you select a phone number, you have thirty seconds to

send your fax. You do that by entering whatever command your application uses to print a file. (You must have your application set up to use an Epson FX-80 print driver. After two minutes, anything that you try to print from your application is sent directly to the printer.)

Incoming faxes can be handled in a couple of different ways. If you wish, you can leave your printer on all the time, and incoming faxes will be printed as they are received. One of the nicest features of ASAP FAX—unlike other computer-based fax machines—is that it can, most of the time, operate as a stand-alone device. If your printer isn't on, faxes will simply be stored on the floppy. The front-panel LED will alternately blink red and green to show that the printer was off-line when a fax was received.

If you wish, you can view faxes on the screen instead of printing them out, but you must first remove the diskette from the ASAP FAX and copy the file of interest to your PC. You can then run a supplied viewing program. If you wish, you can also print or reprint files from the ASAP FAX. Unfortunately, that isn't as easy as it should be. Instead of being able to pick a file of interest from an on-screen menu, you must enter the exact file name, which consists of the date and time that the fax was received.

Another problem that we had with the unit is that it wasn't completely transparent to our computer. When we used ASAP FAX between our PC and HP LaserJet IIP, we experienced no problems. When we used a PostScript emulation cartridge in the LaserJet, however, we could not print long files unless we removed the ASAP FAX. A software upgrade, including a Windows-compatible version of the ASAP FAX software, was due to be released shortly after we went to press. We were unable to determine whether the new software addresses any of our complaints.

Our minor complaints about ASAP FAX are tempered by our appreciation for the features it offers—features that are not available on conventional fax machines anywhere near its price. Although some of its features—such as being able to keep an electronic archive of all received faxes—are available on other PC-based faxes, they require that the PC be on to receive a fax. They also require the user to take some action to get a physical copy of the fax. If you choose, you can set ASAP FAX up with a printer to act as an unattended fax receiver. Transmitting faxes is only slightly more difficult. Once you get used to laser-printed plain-paper faxes, you'll never want to go back to thermal paper. We feel that ASAP FAX is as far ahead of standard thermal-printer faxes as Group 3 machines are ahead of the first faxes of 1930's. ■

## The Network Alternative

**PC-INTERLINK FILE AND PRINTER SHARING SYSTEM.** Manufactured by SoftWorx, Inc., 801 E. Campbell Road #355, Richardson, TX 75801. Price: \$229.95

For many small offices, getting that first computer was a big step, often taken grudgingly, with a mixture of fear and loathing. Once the fear subsided, and the computer proved to be an essential part of the office, the number of PC's in even the smallest office grew. Now that networks are a leading area of growth in the PC market, many small offices are debating whether they need a network to tie their independent computers together so that they can share data.

Networks have, indeed, changed the way we use PC's. But they're not the answer for everyone. Many small offices with multiple PC's share data only infrequently. One person may work on the books, another on correspondence, while a third uses CAD software; they rarely exchange any files. Each of them, however, needs a printer. The person handling the books uses a wide-carriage dot-matrix printer, while correspondence is output on a laser printer, and the CAD output goes to a plotter. There are times, of course, when each person is dissatisfied with his output device. The designer, for example, might want to print a set of drawings on the laser printer, while the accountant might want to print out some correspondence of his own. If such instances are frequent enough, the office might install printer switch boxes

and extra cabling. Or they might use the old-fashioned "sneaker net," that is, actually walking over to the other computer, carrying the file to be printed on a floppy disk.

There is an easier, more efficient way to share files and printers between as many as four PC's without the expense, training, and hassles that come along with a network. *PC-InterLink*, a file and printer sharing system from *SoftWorx, Inc.*, is, indeed, easy to set up, even for the most hardware-unfriendly among us. How easy? We'd imagine that during a lunch hour, you could run out to Staples, BizMart, or another office-supply store, come back, get *PC-InterLink* up and running, (although, perhaps, not necessarily neatly installed), and *still* have time to grab a quick byte to eat.

The entire system consists of four port adapters, a junction box, software (on both 5¼- and 3½-inch diskettes), a manual, four 25-foot lengths of cable, and a wall transformer. The installation instructions are printed on the outside of the box: "1. Install parallel port adapter and connect printer cable (optional). 2. Connect the *PC-InterLink* junction box. 3. Install software. Repeat these steps for each PC to be linked together." Things are a little more complicated than that, of course (but not much more so), and the excellent manual does give comprehensive installation and operating instructions.

The port adapters plug into your computer's parallel port—between your computer and printer if that PC has a printer attached. A second output on the adapter is a six-conductor RJ-12 jack that connects to the junction box, via one of the 25-foot cables. (The maximum cable length for any one leg of the system is 100 feet, and should be a single cable—multiple short

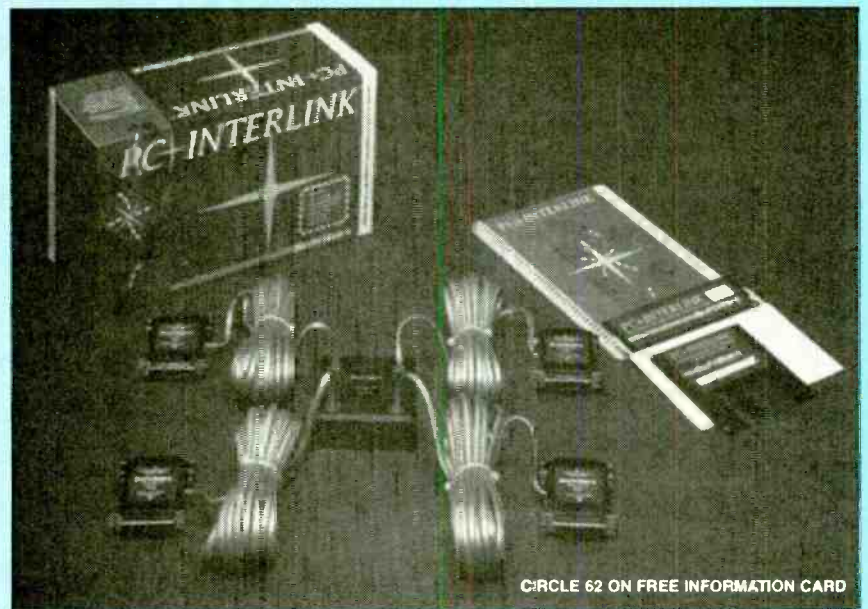

CIRCLE 62 ON FREE INFORMATION CARD

cables will degrade the signal quality. Although cables are available from SoftWorx, the manual does give instructions on how to make your own.) The junction box is the "hub" of the PC-InterLink system through which all PC's and printers are linked. It's a small, black 3-inch square box, about 1 inch thick. It's powered by the wall transformer, and contains four RJ-12 jacks to link the PC's together.

Installing the software is even easier than getting the hardware set up. The installation program is automated, but can be over-ridden by the user at any step along the way. You can choose to have the PC-InterLink software automatically start each time you boot your computer, or you can call up the program manually. Even if you choose to load the program automatically at boot-up, you can unload the program—which requires about 55K—from memory at any time with a simple command. (However, you can unload the PC-InterLink program only if it is the last memory-resident program loaded into memory.) If you do choose to unload the software, other users on the system will be informed that your printer is no longer available.

PC-InterLink is very easy to use and, for the most part, is transparent to users. Even those users who have a difficult time grasping the idea of physical and logical network drives won't be confused by PC-InterLink. To them, it will just seem that their printer cable is longer.

Each PC on the system can have up to three local printers—if they have three LPT ports, of course. A four-PC system can therefore control up to a total of 12 printers. Any user who expects to be busy and wants to have exclusive use of a printer can reserve their local printers so that other users on the system will not have access to them. Any other user who tries to access the printer will get a message informing them of its busy status.

A print spooler, which spools output to the hard disk to give you back control of your PC back in less time, is also included. It can be configured to work with all printers, or just specific printers or ports, with various sized capture buffers.

Sharing printers is, of course, only one of aspect of PC-InterLink. File sharing is the second main feature of the system, and is accessed using PCIFILE.EXE, the file-sharing utility. Unlike the printer sharing software, PCIFILE is not memory resident, and must be run from the DOS command line.

The main menu gives you four choices: Get File, Put File, Directory Listing, and Tree Options. If you want to copy a file from another user, you select Get File from the main menu, and you are then presented with a submenu that lists the other users on

PC-InterLink. Selecting one of the other users gives you a list of his directories—but only those directories that are "available." Each user, using the Tree Options selection from the main menu can tag those directories he wants to make available to other users.

The Put File selection works just like Get File, allowing you to copy files from your PC to other users. As with Get File, you can tag individual files, or all files in a directory. At all levels, if you run into problems, pressing the F1 key brings up on-line help information.

The last network-like feature of PC-InterLink is messaging. Using the "Chat Box" selection from the main PC-InterLink menu, you can select another user to whom you wish to chat. The other user can refuse your "call" if he prefers not to be interrupted. Otherwise, the screen will change to a large box with the lower portion displaying the text that you send, the upper showing the text that the other user sends.

In practice, PC-InterLink works almost exactly as claimed. We had the system running on up to three PC's simultaneously, two with printers attached. Our laser printer was hooked to an AT-compatible, the machine we use for most of our text generating. Although we occasional use Microsoft Windows, we don't have it installed on the AT—it simply runs too slowly on that type of computer. We do have Windows installed on the 386-SX, however. Before we installed PC-InterLink, we had to create print files on disk and walk to the AT in the other office to get laser-printed material. With PC-InterLink, we just had to install another printer in Windows, and change the printer port in the Control Panel/Printers/Configure window. The laser printer acted just as a local printer would have.

We did find one bug in the system. Theoretically, the PC-InterLink software scans your printer ports to find where a port adapter is attached. You might, for example, have a local-only printer attached to LPT1:, with a second printer and port adapter attached to LPT2:. Although this usually worked, on one machine, it would not find the printer on LPT2:. We were not able to find a reason for the anomaly, nor was SoftWorx technical support able to give us any hints about what might have been happening. However, aside from that anomaly, the PC-InterLink system performed flawlessly.

For any office that doesn't have to have a network, PC-InterLink is a logical alternative. If you're not sure if a network is right for you, PC-InterLink can be an inexpensive first step. It will provide the most often needed network features while giving you more time before you have to make the network plunge. ■

## LANTASTIC NETWORK

(Continued from page 12)

*LANTastic for Windows* (\$299 with a network license), a Windows interface for the network.

LANTastic for Windows not only takes care of the messaging problem (windows pop up to announce incoming mail or chat requests) but offers Windows-style control over all aspects of the network's operation. Using the NET program, you can link drives and printers, handle mail, chat with other users, log into and out of the network, manipulate the printer queue, manage your network account, and view activity on a server, graphically, if you desire.

A Network Manager program lets you handle LANTastic's robust set of management tools. You can, for example, set up or disable user accounts, change account privileges, set account expiration dates, and set password-expiration dates (so that users are forced to change their passwords frequently.) You can also limit log-in privileges to certain times of the day. You can define groups of users, and then assign the access rights to network resources to groups instead of individual users.

Is the Windows utility the only easy way to use and manage a LANTastic network? Not on your life! In some ways, Windows makes things more difficult. Non-Windows users use the one-stop program NET.EXE to perform most common functions (log into the network, see which servers and network resources are available, access E-mail, view the printer queue, and the like). A memory-resident LAN pop-up utility (LANPUT.EXE) gives users instant access to basic network functions. Network management functions are handled by NET-MGR.EXE.

For readers interested in some of the technical specifics of the network, the data transfer rate is 10 megabits per second. A server/workstation requires about 56K of memory; a workstation less than 30K. Those memory requirements can be cut even further by loading drivers into high memory.

After using LANTastic (we used Version 4.0 and were upgrading it to 4.1 as we went to press), we understand why it has such a good reputation among peer-to-peer networks. The tools for administering the network are impressive, as are the security features that are available. We didn't run into any software incompatibilities, and—at least on our two-station network—we didn't run into any serious performance complaints. Something tells us, however, that our LANTastic network won't remain just a two-station setup for long—especially with Artisoft's sensible licensing policy. ■

For more information on any product in this section, circle the appropriate number on the Free Information Card.

# ELECTRONICS WISH LIST

## Winning Titles

Most modern camcorders let you add titles—maybe two lines of alphanumeric characters—to your videos. That just won't do for sophisticated videographers. Nor will shooting handmade title cards to introduce scenes. *Videonics* (1370 Dell Ave., Campbell, CA 95008) has introduced the "world's first home video titlers with broadcast-quality resolution" to address the needs of the amateur videographer who doesn't want to produce amateurish videos. With a horizontal resolution of 480 lines (with 720 pixels per line), the ability to produce "more than a million colors" for titles, backgrounds, and borders, the *Video Titlemaker* should fill the needs of semi-pro or professional videographers, too. Special effects that are available include the ability to make messages crawl across the top or bottom of the screen or to scroll up the screen. Eleven combinations of fonts and sizes are available. Price: \$499.

CIRCLE 66 ON FREE INFORMATION CARD



Video Titlemaker

## Fun Phone with TAD

We didn't think there was anything new in the world of telephone/answering-machine combinations—that is, until we took a look at the *DeskTech Fun Phone* from Fun Products (2397 Shattuck Avenue, Suite 201, Berkeley, CA 94704). It offers all the usual stuff—hold, redial, speakerphone, message save/skip/erase/repeat, remote access to messages, and personalized security code. It's available in a transparent case, for those who get a kick out of seeing the inner workings, and in black or white for those with more traditional tastes. Its answering system is digital, which is still something of a rarity. But what truly sets the DeskTech apart from the crowd is the "Fun FX Sound Effects System," which includes eight individual sound effects that, when activated, are transmitted over the phone line to the listener on the other end. Those include such noises as a barking dog, laughter, screaming, and five others. Price: \$199.95.

CIRCLE 67 ON FREE INFORMATION CARD



Fun Phone with TAD

## Portable Cassette Recorder with CD

Easy on the wallet, the *PT 399* portable radio/cassette recorder from *Lloyd's Electronics* (6450 West Cortland, Chicago, IL 60635) also features a CD player with 20 track programming and an LCD readout for displaying track and time status. The boom-box style unit has a front-mounted cassette deck that can be used to record from the internal AM/FM stereo radio, the CD player, or from the built-in condenser microphone. Dual wide-range speakers let the listener benefit fully from the three-band graphic equalizer and separate bass-boost circuitry. The unit runs on batteries or AC current. It features a telescoping rod antenna for improved FM reception and an internal ferrite-rod antenna to pick up AM signals. Price: \$160.

CIRCLE 68 ON FREE INFORMATION CARD

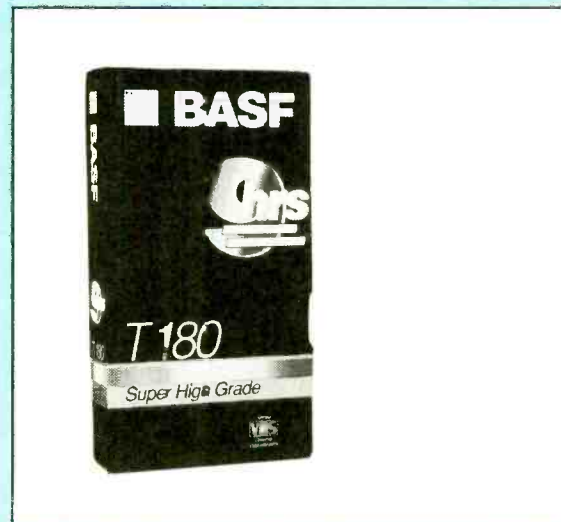

BASF Nine-Hour Videocassette

## Nine-Hour Videocassette

Good news for couch potatoes: Now you can sprawl on the sofa for nine uninterrupted hours of video viewing, with *BASF Corporation's* (Information Systems, 35 Crosby Drive, Bedford, MA 01730) *T 180* Super High Grade videocassette. It provides nine hours at the EP speed, six hours at LP, and three hours at standard play. Price: \$10.99.

CIRCLE 69 ON FREE INFORMATION CARD

# ELECTRONICS WISH LIST

For more information on any product in this section, circle the appropriate number on the Free Information Card.



Intermatic Light Control

## Light Control

We're sure we're not the only ones who forget to turn the porch light on when we leave the house in the afternoon and aren't planning to return until after dark, or who go to sleep without turning the outside light off. *Intermatic* (Intermatic Plaza, Spring Grove, IL 60081) knows there are plenty of forgetful people out there, and came up with the *Automatic Security Light Control* to keep those lights burning when they're needed. Designed to screw into any standard incandescent light socket and accept bulbs up to 150 watts, the device turns lights on at dusk and off at dawn, thanks to a photocell-controlled switch. A dual-photocell system eliminates flickering when the light level is at the verge of turning the bulb on or off, and, to save energy, special circuitry cuts bulb brightness by 50%. Price: \$9.95.

CIRCLE 70 ON FREE INFORMATION CARD



Casio Tone Bank Keyboard

## Full-Size Keyboard

Aimed at intermediate to advanced musicians, *Casio, Inc.'s* (570 Mt. Pleasant Avenue, Dover, NJ 07801) model *CT-395 Tone Bank* is a full-size, portable keyboard that runs on batteries or on AC with an optional adaptor. The "Tone Bank" provides 110 digitally sampled instrument sounds and various special effects, all of which are listed on the face of the keyboard for easy access. The touch of a button creates sounds ranging from a rock band to a full orchestra. The CT-395 offers 55 background rhythms and full auto-accompaniment, which automatically adds a full base line and orchestral support for each rhythm. Other features of the 49-key instrument include built-in speakers, and LED readout that indicates the current voice and rhythm selection, a preprogrammed demonstration song, and a 12-bit PCM sound generator. Price: \$199.

CIRCLE 71 ON FREE INFORMATION CARD



Harmon Kardon Speaker System

## 13-Inch Color TV

Although the trend in TV's leans toward the large-screened, sometimes a small set does the job better. The kitchen, for example, is one room in which a large television simply won't fit. For kitchens and other small rooms, the *CS-1348R* 13-inch color television from *Mitsubishi Electronics America Inc.* (Consumer Electronics Group, Audio Video Division, 5757 Plaza Drive, Cypress, CA) features a dark-tint, black-matrix picture tube for superior picture quality and "Quick View" for switching between the channel being watched and the last one viewed. A timer can be programmed to turn the set off after a predetermined period. The set and its remote come in a clean white finish (model *CS-1347R* comes in black). The remote controls color, tint, brightness, contrast, and sharpness, all with on-screen confirmation. The cable-ready set has 181-channel compatibility and frequency-synthesized tuning. Price: \$329.

CIRCLE 72 ON FREE INFORMATION CARD

## Speaker of the House

Designed for those who consider normal speakers too unsophisticated, *Harmon Kardon* (8380 Balboa Boulevard, Northridge, CA 91329) offers elegant loudspeakers finished in a "black piano-like gloss." The top-of-the-line, 3-way, floor-standing speaker is said to provide accurate tonal balance, stable imaging, freedom from resonance and coloration, and a wide sweet spot, thanks to a number of careful design considerations. Those include careful selection and design of driver elements, crossover frequencies, cabinet materials, damping material, baffles, and grilles. Price: \$3,198/pair.

CIRCLE 73 ON FREE INFORMATION CARD



1367P \$29.95 Softcover



3804P \$19.95 Softcover



2925P \$10.95 Softcover

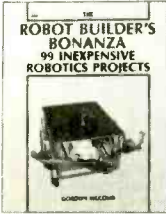

2800P \$16.95 Softcover



2613P \$17.95 Softcover

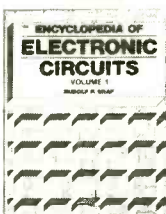

1938 \$60.00 Counts as 3

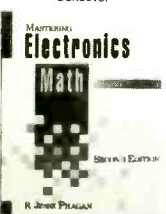

3589 \$27.95

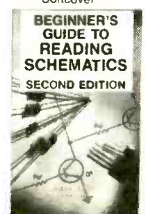

3632 \$18.95

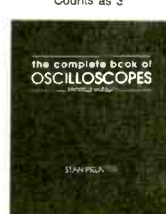

3825 \$26.95



2980P \$19.95 Softcover

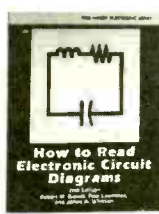

2880P \$14.95 Softcover



2867P \$18.95 Softcover



2790P \$15.95 Softcover

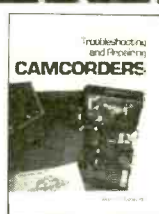

3337 \$35.95 Counts as 2



3374P \$16.95 Softcover



3671 \$29.95



3258 \$28.95 Counts as 2

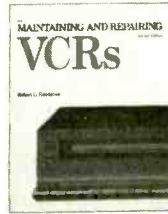

3103 \$27.95



3922 \$26.95



3550 \$34.95 Counts as 2



3627P \$19.95 Softcover



3765 \$29.95



3279P \$36.95 Counts as 2

# Select any 5 books

# for only \$4.95 (values up to \$145.75)

## when you join the Electronics Book Club<sup>SM</sup>

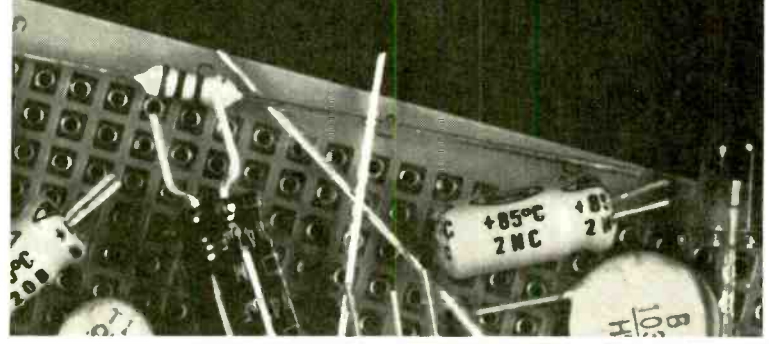

**As a member of the Electronics Book Club . . .**

. . . you'll enjoy receiving Club bulletins every 3-4 weeks containing exciting offers on the latest books in the field at savings of up to 50% off regular publishers' prices. If you want the Main Selection do nothing and it will be shipped automatically. If you want another book, or no book at all, simply return the Reply Form to us by the date specified. You'll always have at least 10 days to decide. Your only obligation is to purchase 3 more books during the next 12 months, after which you may cancel your membership at any time.

(Publishers' Prices Shown)

**Your most complete and comprehensive source for the finest electronics books**

If coupon is missing, write to: Electronics Book Club, Blue Ridge Summit, PA 17294-0810



**YES!** Please accept my membership in the **Electronics Book Club** and send the 5 volumes listed below for just \$4.95 plus shipping/handling and tax. If not satisfied, I may return the books within ten days without obligation and have my membership cancelled. I agree to purchase at least 3 books at regular Club prices during the next 12 months and may resign anytime thereafter. A shipping/handling charge and sales tax will be added to all orders.

--	--	--	--

Note: Any 'Counts as 2 or 3' book may be chosen instead of 2 or 3 single books.

Name \_\_\_\_\_

Address \_\_\_\_\_

City/State \_\_\_\_\_ Zip \_\_\_\_\_

Phone \_\_\_\_\_

Valid for new members only, subject to acceptance by EBC. Applicants outside the U.S. and Canada will receive special ordering instructions. Canada must remit in U.S. funds. All books are hardcover unless otherwise noted. ©1992 EBC

PE892

August 1992, Popular Electronics



# ELENCO ELECTRONICS MICRO-MASTER MM-8000 BASIC SYSTEMS COURSE

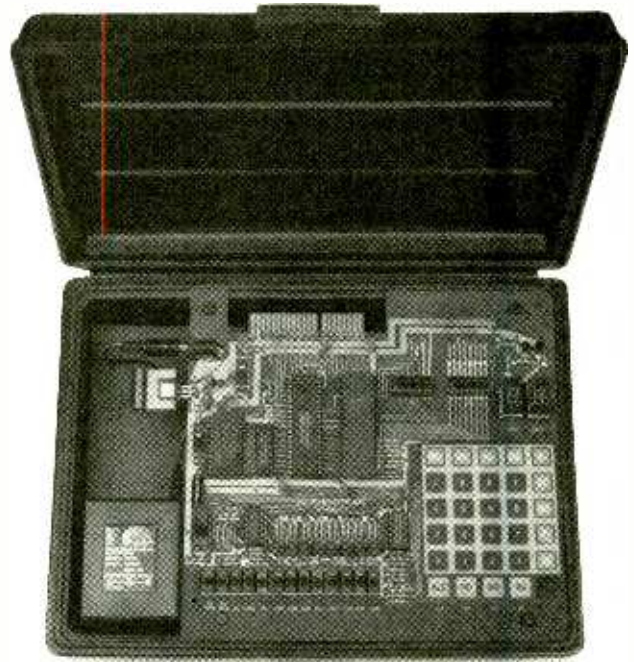

CIRCLE 119 ON FREE INFORMATION CARD

*All the hardware you'll need to program an 8085 is present in this training kit*

It's a little early in the game to predict exactly what the hallmark of the 90's will be. World peace, environmental awareness, the dissolution of the Soviet Union, the end of styrofoam—at this point it's anyone's guess. Most experts agree, however, that on the technical side of things, the 90's will be the decade when the computer becomes a household-consumer item. It's been said that by the end of the decade each home will have a computer as advanced as today's top-of-the-line workstations—sitting in the basement next to the furnace, just like any other household appliance. A glance at the consumer-electronics field shows that computers have infiltrated practically everything. You need an EE degree (or a twelve year old) to even program a VCR.

People are becoming more advanced, as well. Most of the electronic hobbyists reading this are familiar with several high-level computer languages. Graphical user interfaces are making machines friendlier, and in a recent survey one out of ten respondents actually knew what DOS was! At

some point, most technically oriented computer users will want to dig deeper. At that point assembly language or machine language starts to look interesting. The real desire is to talk directly to the chip itself—to find out how a microprocessor really works.

**Some Good Methods.** Once a person realizes that his interest lies at this level (over his head), there are several routes to take. One can simply read about microprocessors. That will give one an understanding of the basic principles involved, but it's difficult to get a feel for programming from a book. Vocational schools and colleges often have evening courses, but these can be expensive, and one has to run on their schedule—not yours. Another solution is a home-study course, used in conjunction with a micro trainer. This route has all of the advantages of a structured class situation, and you get to keep the "lab." Unfortunately, these courses can cost several hundred dollars—more of a financial commitment than most hobbyists are willing to make.

However, a new entry in the micro-

trainer field provides what might be the ideal compromise for the majority of experimenters. The Elenco Electronics MM-8000 course consists of a complete microprocessor system, along with a fourteen-lesson tutorial, all for only \$129.00. The system is built around the 8085 processor chip, working with the 8156 RAM I/O IC, and a 2K 2816 EEPROM. A two-digit display and a keypad for output and input round out the system.

The trainer is built on a high-quality single PC board, which mounts in the included carrying case. The case has room for the included plug-in wall transformer, making the trainer a compact, easy-to-carry unit. The course is presented in a 57-page manual in a 3-ring binder that covers both the construction and the explanation of each section of the system. The lessons are easily digestible—enough to fully explain the operation of each vital part of a micro system, but not enough to overwhelm the student.

**Construction and Use.** Perhaps the best feature of the MM-8000 trainer is



the manner in which the trainer is assembled. Unlike most courses that would have you build the trainer and then get out the book to learn about it, the Elenco approach blends the learning with the building. Each section of the computer is built and tested, one at a time. For instance, the first sections install and test the power supply and data-bus indicators and switches. The 8156 RAM I/O chip is installed next, followed by the 2816 EEPROM. The procedure continues until lesson ten when the micro is installed, and various programs are installed and run.

This method of construction has two extremely important advantages. First, the instruction about each section of the board takes place right after the student has assembled that section, not three weeks later. All of the parts and their locations are still fresh in his or her head. Second, in the event that there might be a problem with the board, troubleshooting is greatly simplified. The best time to catch a wiring mistake is right after it was made. Indeed, trying to troubleshoot two separate problems on two sections of the board could be a nightmare—but one that's totally eliminated with the MM-8000.

Once the MM-8000 is built and the course completed, the obvious question is "Now what can I do with it??" Since the system has a two-digit hex display and 2K of memory it's probably not worth trying to upgrade it to a 486 clone. Still, the trainer can be "trained" to perform several jobs. Smart amateur-radio repeater controllers, Morse-code contest keyers, security-system monitors, and industrial-control systems are some of the several applications that come to mind. The MM-8000 has a 44-pin edgeboard connector that allows external access to all the necessary signals, so it's ready to be put to work. Once you work your way through the course, however, you'll probably want to hang on to the MM-8000 to use as a program developer for the other 8085 systems you'll be ready to build.

If you'd like more information on the Micro-Master MM-8000 Basic Systems Course you can contact Elenco Electronics, Inc. (150 West Carpenter Ave., Wheeling, IL 60090; Tel. 708-541-3800) directly, or circle No. 119 on the Free Information Card.

**SUPER LONG PLAY TAPE RECORDERS**  
**12 Hour Model — USES 120 TAPE \$119.00\***  
 Modified Panasonic Slimline, high quality AC-DC provide 6 continuous hours of quality recording & playback on each side of cassette • Voice level control • Digital counter, etc. TDK - 120 Cassette Furnished.

**PHONE RECORDING ADAPTER**  
 Records calls automatically. All Solid state connects to your telephone jack and tape recorder. Starts recording when phone is lifted. Stops when you hang up. **\$28.50\*** FCC APPROVED

**VOX VOICE ACTIVATED CONTROL SWITCH**  
 Solid state Self contained Adjustable sensitivity. Voices or other sounds automatically activate and control recorder. Uses either recorder or remote mike. **\$28.50\***

\* Add for ship & handling. Phone Adapter & Vox \$2.00 each. Recorders \$5.00 each. Calif. Res. add tax. Mail order, VISA, M/C, COD's OK. Money Back Guarantee. Free data available. Dealer Inquiries invited. Free data

**AMC SALES INC.** Dept. B #935 Tubec Street  
 Box 918 Downey CA 90241  
 Phones (310) 869-8519 1-800-926-2488  
 FAX (310) 923-1478  
 Mon-Fri 8-5 PAC TIME

CIRCLE 5 ON FREE INFORMATION CARD

**BIG PROFITS IN VIDEO REPAIR!**

**WORK FROM HOME—EARN \$85 HR!**

With the tens of millions of VCRs and Camcorders in use, there currently is a **serious shortage** of trained techs to perform cleaning and repair jobs on these popular devices... Learn how you can start your own highly profitable, **Home-Based** video servicing business... And since up to 95% of all VCR and Camcorder malfunctions are due to a simple **mechanical or electro-mechanical** failure, you need not spend months or even years of complicated study before starting paid, professional service work!

Let Viejo's Training Program show you how!

CALL TOLL-FREE **1-800-537-0589** or mail coupon today!

**VIEJO PUBLICATIONS, INC.**  
 4470-107 Sunset Blvd., Suite 600  
 Dept. PE Los Angeles, CA 90027

Yes! Rush me your **FREE OPPORTUNITY KIT** today! (Check appropriate box)

VCR Repair  
 Camcorder Repair  
 Advanced VCR Repair  
 Fax Machine Repair

Name \_\_\_\_\_  
 Address \_\_\_\_\_  
 City/State \_\_\_\_\_ Zip \_\_\_\_\_ Dept. PE

CIRCLE 9 ON FREE INFORMATION CARD

## Earn Your B.S. Degree in ELECTRONICS or COMPUTERS



### By Studying at Home

Grantham College of Engineering, now in our 42nd year, is highly experienced in "distance education"—teaching by correspondence—through printed materials, computer materials, fax, and phone.

No commuting to class. Study at your own pace, while continuing on your present job. Learn from easy-to-understand but complete and thorough lesson materials, with additional help from our instructors.

Our Computer B.S. Degree Program includes courses in BASIC, PASCAL and C languages — as well as Assembly Language, MS DOS, CADD, Robotics, and much more.

Our Electronics B.S. Degree Program includes courses in Solid-State Circuit Analysis and Design, Control Systems, Analog/Digital Communications, Microwave Engr, and much more.

An important part of being prepared to *move up* is holding the right college degree, and the absolutely necessary part is knowing your field. Grantham can help you both ways—to learn more and to earn your degree in the process.

Write or phone for our free catalog. Toll free, 1-800-955-2527, or see mailing address below.

Accredited by  
 the Accrediting Commission of the  
 National Home Study Council

**GRANTHAM**  
**College of Engineering**  
 Grantham College Road  
 Slidell, LA 70460

# PRODUCT TEST REPORTS

By Len Feldman

## Memorex Model 153 8mm Camcorder

The 8mm camcorder market is growing rapidly—so rapidly, in fact, that consumers are now faced with a sometimes bewildering array of units from which to choose. One of those units is the lightweight (under 3 pounds) Memorex Model 153, which is sold exclusively by Radio Shack stores nationwide.

The Memorex Model 153 is loaded with just about all of the features that you would expect to find on a better camcorder. It is supplied with a remote control that lets you shoot an image from a distance, or

photographic filters. Automatic focus, automatic white balance, and auto iris are all available, and a backlight function lets you compensate for bright backlighting.

An edit-search feature lets you move the tape forward or backward a few frames at a time. A clock/calendar generator lets you display the time and date in the viewfinder and allows you to record that information on the tape. A "Recording Review" feature lets you check the last two seconds of a recording. A high-speed shutter lets you make sharper recordings of fast motion. A title superimposer allows you to store title text or simple graphics and insert them into a tape in any one of five colors during recording.

Sound can be recorded using the built-in microphone or via an external microphone, and an ear-phone jack lets you monitor sound during recording as well as during playback. Freeze-frame and visual search let you quickly scan your recording and view individual frames. A combined multiple-pin input/output connector lets you play back a tape on a regular TV or TV monitor. You can also copy tapes from this camcorder to a VCR, or to dub to the camcorder from a VCR or another video-program source.

### CONTROLS

The camcorder's rear surface contains the power

on/off switch, the counter-reset and "memory" buttons, the edit on/off switch, a cassette-eject button, and the date/time button. Buttons along the top surface of the camcorder are essentially used for the VCR functions. They include fast forward and rewind buttons; play, pause, and stop buttons, and the "+" and "-" edit-search buttons.

The left side surface of the camcorder contains buttons for choosing auto or manual focus, auto macro (for ultra close-up automatic focusing), white balance, high-speed shutter settings, and backlight compensation. Buttons used for title superimposition are found just behind the lens.

The power-zoom function is activated by means of a two-way rocker switch. That switch, as well as the record stop/start switch, are positioned for easy use when the camcorder is held normally in the right hand.

The battery (or AC power adaptor, also supplied) is mounted on the right side of the camcorder body, while the 8mm videocassette is inserted into a compartment located at the rear of the left side of the camcorder. The built-in microphone is located up front, near the lens, and nearby is a miniature jack that can accept an external microphone. The built-in microphone is automatically disconnected when an external microphone is plugged in.



The Memorex 153 8mm Camcorder

initiate playback of tapes remotely. Its real-time tape counter, with memory, lets you mark and return to specific locations, and also shows how much time is left on a tape. An 8-to-1 power-zoom lens lets you go from wide-angle to telephoto shots, and also accommodates most 49mm

The electronic viewfinder displays the status of the camcorder. Indicators inform the user of things such as end-of-tape, low battery-power, graphics color, focus (automatic or manual), shutter speed, and date/time as applicable.

The controls on the supplied remote control duplicate those found on the camcorder itself, except that on the remote control there are two record buttons. Both of these must be pressed simultaneously to place the camcorder into the record mode. That scheme prevents the user from accidentally recording over a previously recorded tape.

### TEST RESULTS

The camcorder was turned over to the Advanced Product Evaluation Labs (APEL) for in-depth testing. APEL used Sony P6-120MP as the reference tape on which test recordings were made.

Minimum illumination required by this camcorder to produce a full-amplitude video output signal was only 2.5 lux, a bit better

than the 3 lux claimed by the manufacturer. White balance, when optimally set, was very good, with only 4 IRE worth of chrominance (color) appearing on a neutral object. Color contamination (the amount of color bursts that appeared on a fine black and white pattern) was also quite low, measuring only 6 IRE. Color phase accuracy and saturation, measured using a totally red field, was just about perfect, as displayed on APEL's vectorscope.

The camcorder uses a solid-state CCD (charge-coupled device) pickup. Thanks to that, there was virtually no streaking, lag, or image retention as the camcorder was panned quickly across scenes of varying light intensity.

The horizontal resolution for the camera signal itself was an impressively high 350 lines. However, when a recording was made and played back, resolution dropped to 250 lines. That is still a bit better than we typically encounter with most standard 8mm camcorders.

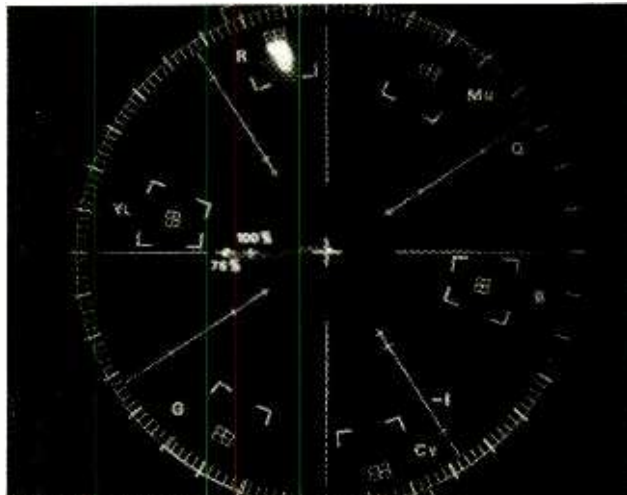

The "spot" resting almost precisely at the cross mark on this vectorscope display indicates that color-phase accuracy and saturation, measured using a totally red field, was just about perfect.

The chroma AM signal-to-noise ratio measured 49.5 dB directly from the camera, decreasing to 41.4 dB when measured through the entire record/play cycle. Luminance signal-to-noise ratio measured 41.9 dB from the camera and was actually a bit higher—42.8 dB—when measured from a recorded tape produced by the camcorder.

The maximum output from the built-in microphone and its associated amplifier circuitry was 0.49 volts, which would be enough to deliver adequate sound levels through most audio systems. The external microphone sensitivity measured 4 millivolts. That is actually on the low side and suggests that if an external microphone were to be used, it should be one having a fairly high output. The audio signal-to-noise ratio measured a more-than-adequate 62.5 dB.

In its normal mode, the camcorder was able to focus upon objects at a minimum distance of 44 inches. In the macro mode, focusing was possible even at distances as close as 3/8 inch.

### HANDS-ON TESTS

We found the Memorex Model 153 camcorder fairly easy to use, and its light weight allowed for long periods of use without experiencing significant hand fatigue.

Its small size led to our only real complaint about the unit. Because of its size, you must be careful not to push the wrong button and, in fact, it is easy to confuse the battery release arrow on the rear surface of the unit with the index mark for the combination record/play AV-cable connector located just below it.

Still, once you've had some time with the unit, that problem should not be serious. In our opinion, the Memorex 153 camcorder holds its own with other contenders in the increasingly popular, and confusing, 8mm format. And it is very competitively priced!

For more information on the Memorex Model 153 (catalog no. 16-854), visit your local Radio Shack store, contact Radio Shack (1700 One Tandy Center, Ft. Worth, TX 76102) directly, or circle no. 120 on the Free Information Card. ■

### TEST RESULTS—MEMOREX MODEL 153 8mm CAMCORDER

Specification	Mfr's Claim	PE Measured
Minimum illumination	3 lux	2.5 lux
White balance	N/A	4 IRE
Color contamination	N/A	6 IRE
Horizontal resolution		
Camera	N/A	330 lines
Rec/play	N/A	250 lines
Video signal-to-noise		
Chroma AM		
Camera	N/A	49.5 dB
Rec/play	N/A	41.4 dB
Luminance		
Camera	N/A	41.9 dB
Rec/play	N/A	42.8 dB
Max. microphone output	N/A	0.49 volts
Ext. mic. sensitivity	N/A	4.0 mV
Audio S/N ratio	N/A	62.5 dB
Minimum focus distance	N/A	44 inches
Macro focus (min.)	N/A	3/8 inch
Power requirements	7.5 watts	8.5 watts
Dimensions (HxWxD, inches)	6 x 4 3/4 x 11 3/4	Confirmed
Weight (less battery/cassette)	2.5 lbs.	Confirmed
Suggested price: \$899.00		

# The Amazing Maze.



## **YOUR HOME . . . the television series, will help guide you through it.**

For most families . . . our homes are the biggest purchase we'll ever make. From time to time we've all thought about making changes to our homes. By watching the YOUR HOME television series, you can catch all of the latest ideas and trends designed to get you through the maze of products that will enhance the beauty, functionality, and quality of the time that you spend at home. Whether you're building a dream kitchen or attempting to create the home theater experience, from the simple to the exotic, YOUR HOME has a wealth of great ideas. It's like going to the world's biggest home and garden store each and every week.

Tune into upcoming shows to check out the best and brightest in home products and services:

### **WAMSUTTA PACIFIC HOME PRODUCTS**

One of America's Leading Manufacturer of Fine Bed Linen and Bedding Accessories.

### **THE DUCANE CO.**

American Made, high performance Gas Grills.

### **POLK AUDIO**

CS100-Surround Sound speaker system with Dolby Pro Logic.

### **AMX CORP.**

Sophisticated control units for audio, video, and electronics installations.

### **TOASTMASTER**

America's Breakfast Maker for over 65 years.

### **ROYAL APPLIANCES**

Dirt Devil Upright Vacuum with the Micro Fresh Filtration System.

### **BLANCO AMERICA INC.**

Blankostar Quartz kitchen sinks and food preparation centers.

*Check your local cable listing for the time and channel number in your area.*

A presentation of

WJMK • 2424 N. Federal Highway • Boca Raton, FL 33431 • (407) 367-0703

# Make Your Own

# HOLOGRAMS

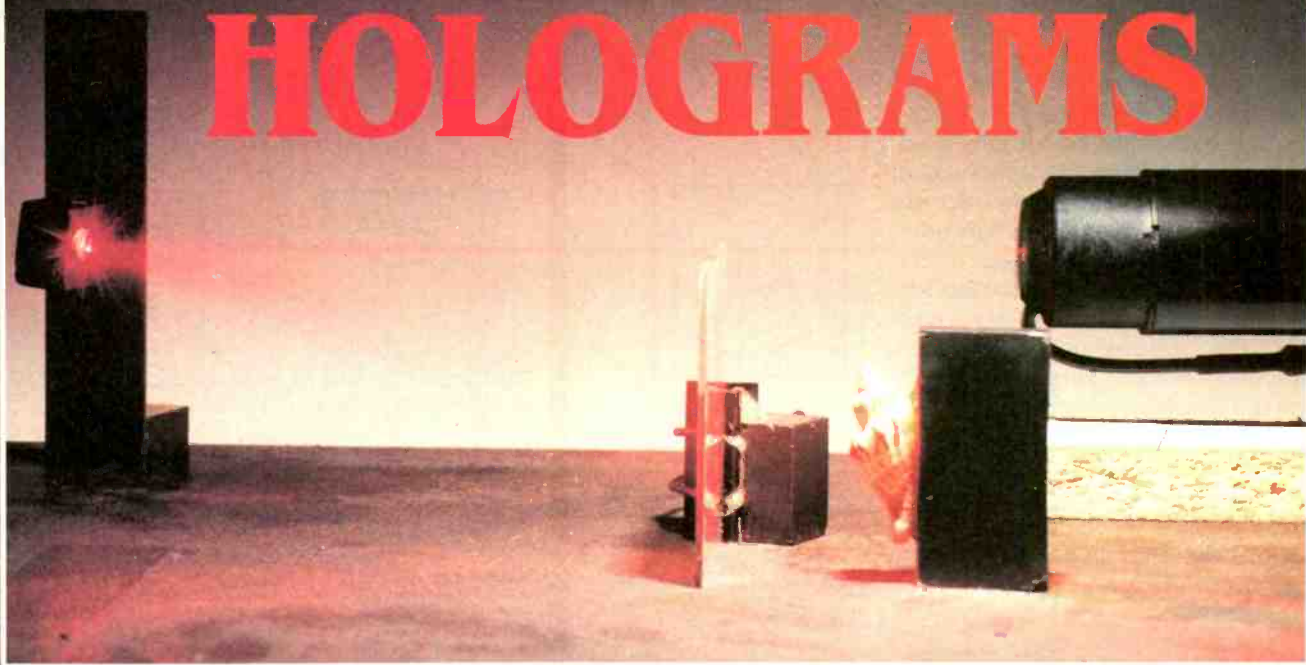

**H**olograms (three-dimensional photographs) are becoming commonplace. If you own a credit card, chances are it is embossed with a hologram to prevent forgery. In fact, although there are many holographic frontiers yet to conquer and develop, the science of holography has advanced to the point where it is possible for you to make your own holograms.

In this, the first part of a two-part article on holography, we will take a look at some basic concepts of holography and build a laser system capable of producing holograms. As you will discover for yourself, you don't have to be an expert in all the technical aspects of holography to shoot and develop your own first-rate holograms. Since there is much information to present, let's get right to it.

## Holography Versus Photography.

Holography, like photography, is a technique that produces an image on film. However, there are some key differences between photography and holography. To help explain, look at the simple box camera in Fig. 1. The

*Learn how holograms are made, then build the equipment you need to record your own three-dimensional images. This month we build the laser.*

BY JOHN IOVINE

**WARNING!!** This article deals with and involves subject matter and the use of materials and substances that may be hazardous to health and life. Do not attempt to implement or use the information contained herein unless you are experienced and skilled with respect to such subject matter, materials and substances. Neither the publisher nor the author make any representations as for the completeness or the accuracy of the information contained herein and disclaim any liability for damages or injuries, whether caused by or arising from the lack of completeness, inaccuracies of the information, misinterpretations of the directions, misapplication of the information or otherwise.

image formed by the lens onto the film is a real image as seen from a single unchangeable viewpoint. The third dimension (depth) is "collapsed" onto the plane of the film (the depth information is lost during the process). Looking at the subject in a photograph from an angle just creates a foreshortening of the flat image—the image remains at the one viewpoint alone.

Holography, however, records "true" three-dimensional images onto film. I say true three dimensional, because the resulting image is not an optical illusion or trick. Holograms record all the visual information of a three-dimensional image, including depth. Subsequently, that allows you to view the original scene from many different angles. In essence, you can look around objects in the hologram.

As a result, holograms have some other interesting properties such as "redundancy"—the ability of each point in a hologram to reproduce the captured image. If a hologram is broken into small pieces, the entire image would still be viewable through any of the broken pieces (see Fig. 2).

Imagine that the holographic film is a window with memory. It will faithfully record any subject behind the window from any viewpoint. So if you covered the hologram with a black piece of paper with a peep hole in it, you could still view the entire subject through the peep hole as if you were looking through a window. Where you placed the peephole on the hologram, determines from which perspective you would see the subject.

That is because holography does not record images the same way a camera does. Holography records the interference pattern of light generated when a reference beam combines with reflected light (called the "object beam") bouncing off the subject. The light source required must be monochromatic (composed of light of a single frequency) and coherent (all of the waves in phase), such as produced by a helium-neon (HeNe) laser. That is in contrast to lighting for photography, which can come from a number of sources (sun, electric lights, or flash tubes).

Figure 3 shows a typical "split-beam" holographic setup. In such a system, the reference and object beams are produced by splitting a single beam of laser light in two. Note how the reference beam is aimed right at the film via a mirror and lens, while the object beam is reflected off the subject before reaching the film. At the surface of the film they interfere and the patterns of interference are recorded on the film.

We will use a similar concept to

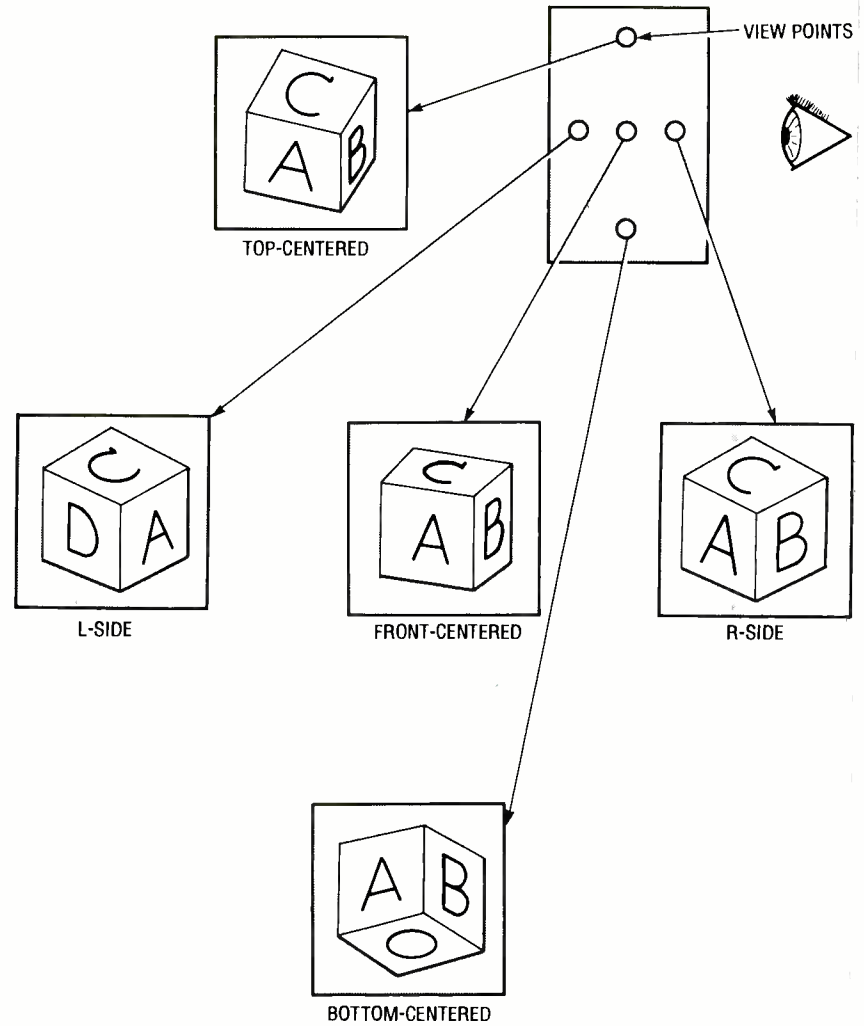

Fig. 2. Holograms have the property of "redundancy." That allows each point in a hologram to reproduce the captured image from its own unique perspective.

make our holograms. However, instead of splitting the beam, we will allow it to pass through the film (which

is partially transparent), then reflect off the subject, and head back toward the film. The beam coming from the laser (the reference beam) will interfere with the portion of the beam reflected by the subject (the object beam) creating an interference pattern at the surface of the film.

By the way, there is no negative required to reproduce the image as there is in photography; the original film that is exposed and developed is the hologram. The method used to view a hologram depends on whether it is a "transmission" or "reflection" hologram. Transmission holograms require a monochromatic (single-frequency) light source for viewing. For such a hologram, a laser is typically used for illumination during viewing. However, reflection holograms can be viewed using ordinary white light. That is the type of hologram we will produce.

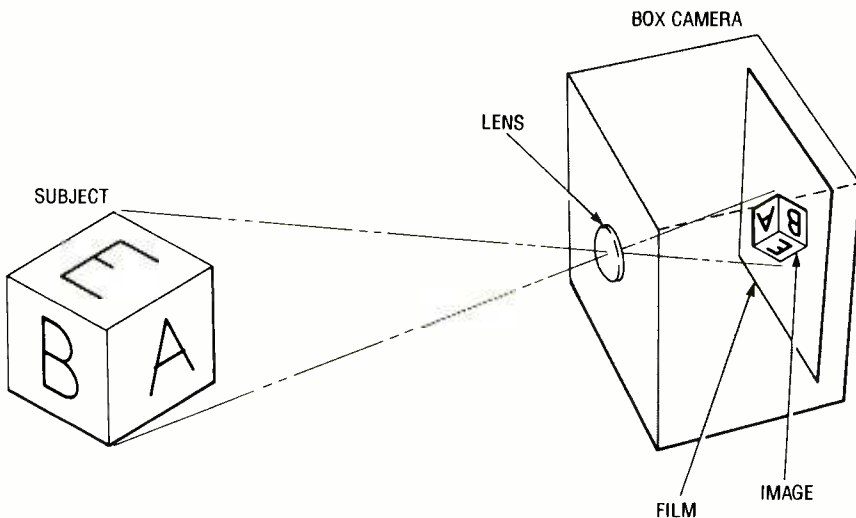

Fig. 1. A camera, such as this simple box camera, compresses the depth of its subject to form a two-dimensional image.

**Laser Light.** As mentioned, you will need a laser to make your own holograms. Before we get into the nuts and bolts of building (or at least purchasing) a laser, let's first discuss what a laser is.

The word "laser" is an acronym that stands for *light amplification by stimulated emission of radiation*. The process of stimulated emission begins when an electron orbiting an atom absorbs energy, causing it to jump up to a higher energy level. An electron in this state is said to be "excited." When the electron spontaneously falls back down to a lower energy level, it will emit a photon of radiation. The energy and frequency of the photon depend on the difference in the energy levels, which in turn depends on the atomic-structure of the material being used. If this emitted photon collides with another electron, it will stimulate the electron atom to release a photon with the the same frequency and phase as the colliding photon. That is what is meant by stimulated emission.

To achieve light amplification, we need to produce a "population inversion"—we must have slightly more atoms with excited electrons than atoms with unexcited electrons. That will ensure that as an excited electron loses a photon an unexcited electron will gain a photon, keeping the whole process going. We will also be "stealing" some excess photons to develop our hologram, so we must invert even more of the atomic population. To ensure sufficient population inversion, we trap many of the photons between two mirrors. The mirrors are spaced to support only the photons of a particular frequency and phase as well.

As energy is pumped into this "optical cavity," the stimulated electrons produce more and more photons. The photons stimulate electrons, and the electrons in turn generate photons. Eventually there is a build up of photons with the same frequency (determined by the material that is emitting them and the distance between the mirrors) and phase (because an excited electron emits a photon in phase with the photon that excited it and because of the distance between the mirrors). That has the effect of concentrating all the energy in the laser at one frequency and

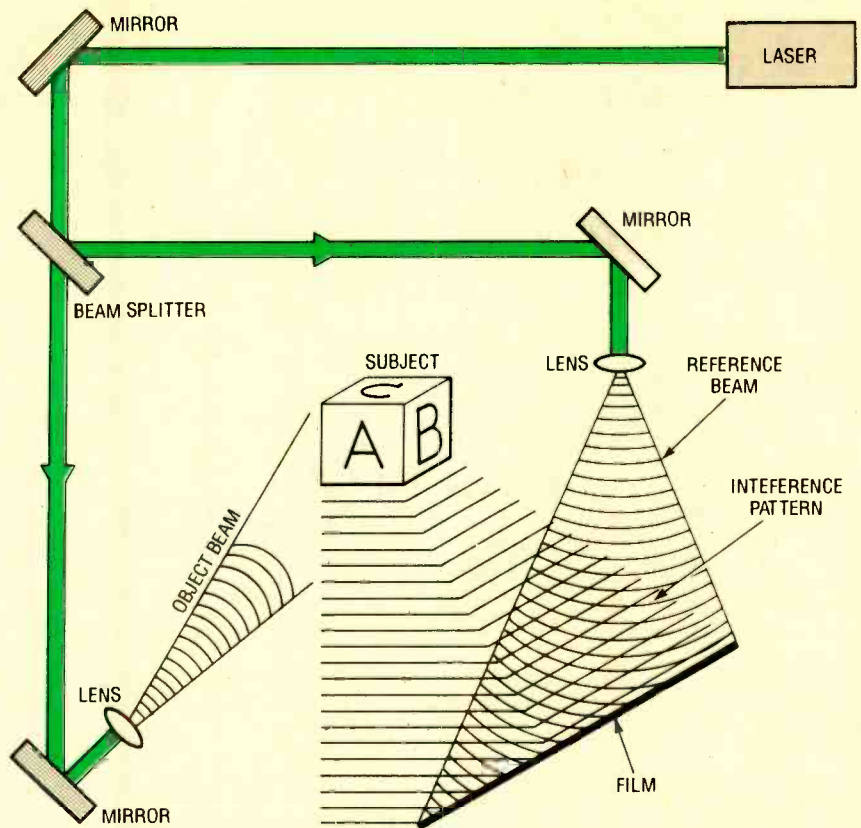

*Fig. 3. In split-beam holography the object and reference beams are taken from a single laser-light source. The two beams are then recombined once the object beam bounces off the subject.*

in one phase. It would seem as though the amount of energy at that one frequency was amplified.

One of the mirrors is less than 100% reflective, so that mirror allows a small percentage of light to pass through to do work. We will use that light—tuned by the laser—to expose our holograms.

**A Light Source.** The first step in producing holograms is acquiring a laser light source. We already mentioned that a Helium-Neon (HeNe) laser will fit the bill, so you need to decide either to build or buy one. Whatever your choice, the laser must meet certain specifications to be capable of producing holograms. The most important specification is that it operates in TEM<sub>00</sub> Mode. You don't have to understand what that means, just make sure the laser you acquire operates in that fashion.

The power output is the next consideration. The power of the laser is directly related to the exposure time. For example, shooting a hologram with a 1-milliwatt laser will require a longer

exposure time than a 2-milliwatt laser. For beginners, either a 1 or 2-milliwatt laser is suitable, and will keep your start-up costs down. Later, if the holography bug bites you harder, you can upgrade to a more powerful laser.

A 1-milliwatt laser tube costs about \$30; 2-milliwatt tubes cost about \$55. Laser tubes can be purchased from the supplier mentioned in the Parts List. Regardless of which laser tube you buy, **never look directly into the beam of your laser.** Even an unspread beam from a small 0.5-milliwatt laser is well above the ANSI standard for eye safety! So don't assume that a low-power laser is safe to look at, it simply isn't. Next, you will need a power supply for your laser tube, so let's discuss that now.

**Power Supplies.** A commercial power supply for either of the tubes mentioned costs about \$80. However, we'll describe how you can build one for less than \$40. Figure 4 contains the schematic of the power supply.

The line transformer (T1) provides power to the circuit. The transformer

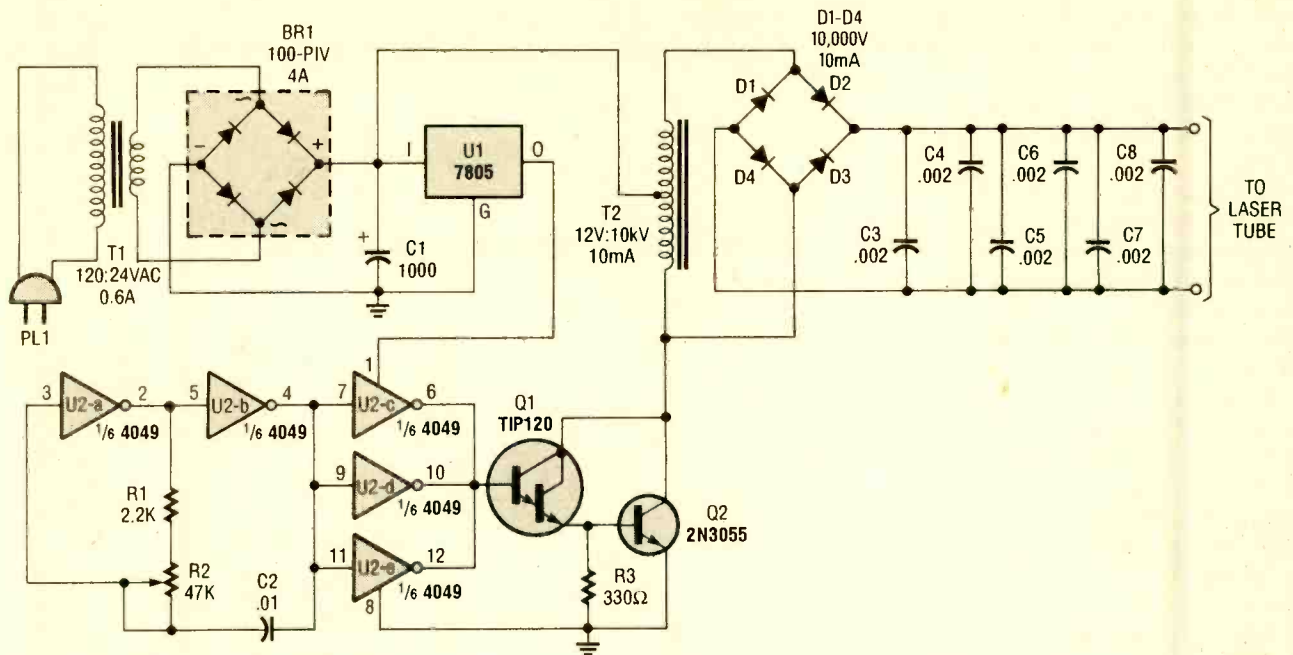

Fig. 4. The laser-tube power supply is just a CMOS-based oscillator that pulses a high-voltage transformer. The transformer output is rectified, filtered, and sent to the tube.

specified (120VAC:24VAC, 0.6 amps) is ideal for powering laser tubes from 0.25 milliwatts up to and including 1.5 milliwatts. The output of that transformer is rectified by a bridge (BR1) and filtered by C1. The filtered voltage is passed on to T2 (a high-voltage step-up auto-transformer) and U1 (a 5-volt regulator).

The regulator powers U2, a hex inverter. Two gates of U2, are configured to form an adjustable squarewave oscillator, whose frequency is controlled by a 47k potentiometer (R2). The output of the oscillator is buffered by three other gates on U2 that are placed in parallel to boost the drive current. The buffered squarewave is applied to Q1, an NPN Darlington transistor. The Darlington transistor amplifies the signal to provide sufficient current to switch transistor Q2 on and off.

When Q2 switches on, it grounds one side of T2's primary causing the transformer to produce high voltage in its secondary. The high-voltage output of T2 is rectified by four high-voltage diodes, D1-D4, and filtered by six high-voltage capacitors.

**Circuit Assembly.** The author's prototype was built using point-to-point wiring, which is okay provided that you obey a few simple precautions. First of all, Q2 must be adequately

heat sunk. The need for adequate heat sinking is to allow the circuit to power the laser for many hours without degradation of the beam. That is critical for producing holograms.

Although one should typically use plastic enclosures for high-voltage circuits, the author made an exception with this unit for that reason. In order to provide greater heat-sinking for Q2, the author attached Q2 to the wall of a metal enclosure and added some metal strips to increase the thermal mass. Since a transistor in a TO-220 package is easy to heat sink in this

fashion, we recommend that you use such a transistor for Q2.

The high-voltage capacitors and diodes should be assembled on a separate piece of perfboard. That isolates the high-voltage assembly from the oscillating section of the circuit. That is particularly important to protect the CMOS-based 4049 IC.

**CAUTION: The laser power supply is a high-voltage device so handle it with appropriate caution. The power supply should never be operated without a load connected to its output. Failure to do so will cause**

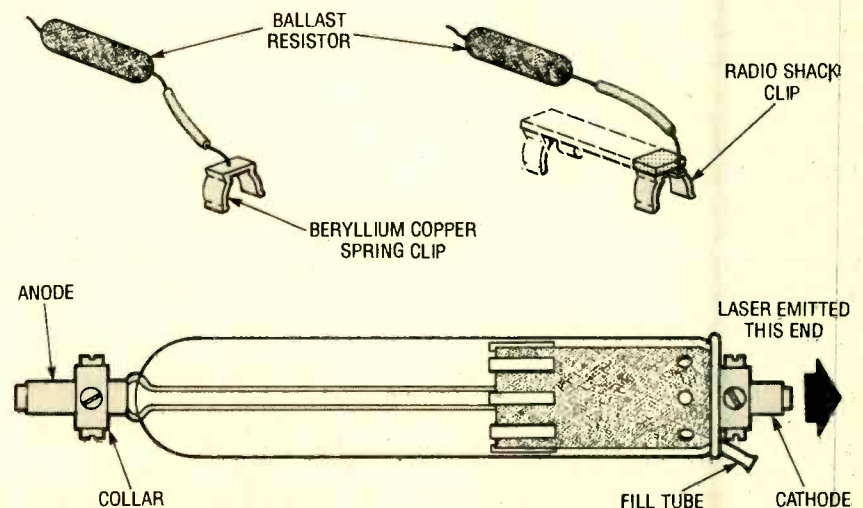

Fig. 5. If you cannot get beryllium-copper laser-tube clips, you can make suitable replacements from a Radio Shack fuse holder.



## PARTS LIST FOR THE LASER POWER SUPPLY

### SEMICONDUCTORS

- U1—7805 5-volt regulator integrated circuit  
 U2—4049 hex inverting-buffer, integrated circuit  
 Q1—TIP120 NPN Darlington pair  
 Q2—2N3055 NPN transistor (T0-220 case recommended)  
 BR1—4-amp, 100-PIV bridge rectifier  
 D1-D4—10,000-volt 10-mA diode

### CAPACITORS

- C1—1000- $\mu$ F, 50-WVDC, electrolytic  
 C2—0.01- $\mu$ F, ceramic-disc  
 C3-C8—0.002- $\mu$ F, 6,000-WVDC, doorknob-type

### ADDITIONAL PARTS AND MATERIALS

- R1—2200-ohm,  $\frac{1}{4}$ -watt, 5% resistor  
 R2—47,000-ohm potentiometer  
 R3—330-ohm,  $\frac{1}{2}$ -watt, 5% resistor  
 T1—120 to 24-volt, 0.6-amp, transformer  
 T2—12 to 10,000-volt, auto-transformer

PL1—AC line cord and plug  
 Fuse clips, suitable ballast resistor, tube mounts (see text), solder, wire, perfboard, etc.

The following are available from Images Co. (P.O. Box 140742, Staten Island, NY 10314; Tel. 1-718-698-8305): T1, \$8.00; T2, \$17.95; C3-C8, \$2.00; D1-D4, \$1.50. Please add \$4.50 for shipping. NY residents add 8.25% sales tax.

The following HeNe laser tubes (with ballast resistors) are available from Allegro Electronic Systems (3 Mine Mountain Road, Cornwall Bridge, CT 06754; Tel. 1-203-672-0123): 0.5- to 1-mW (part No. LPT-005), \$25.95; 0.5- to 1-mW (part No. LPT-007), \$31.95; 1- to 2-mW (part No. LPT-015), \$35.95. Add \$3.50 for shipping. CT residents must add appropriate sales tax.

**arcing and electrical discharge that may damage the power supply, or you!**

### Connecting the Power Supply and Tube.

All helium-neon laser tubes require a ballast resistor to limit the current flowing through the tube. When you purchase your laser tube, be sure you also purchase the ballast resistor. Most ballast resistors range between 50 kilohms and 200 kilohms, with a 3- to 5-watt capacity. The resistor generally connects to the anode (+) side of the laser tube.

It is sometimes hard to distinguish the anode and cathode terminals on the tube. Sometimes the positive terminal is marked with an "A," "+," or a small red dot. The negative terminal is sometimes marked with a "C" or "K." The cathode may also be identified by a small metal tube on one end that was used to fill it with gas. If you are powering a laser head (a laser tube enclosed in a housing), identify the polarity by the color of the leads coming out of the housing.

Most tubes today are hard sealed. The metal terminals on the end are also mirror mounts. The mirrors are precisely aligned to form the optical cavity. That makes it a bad idea to

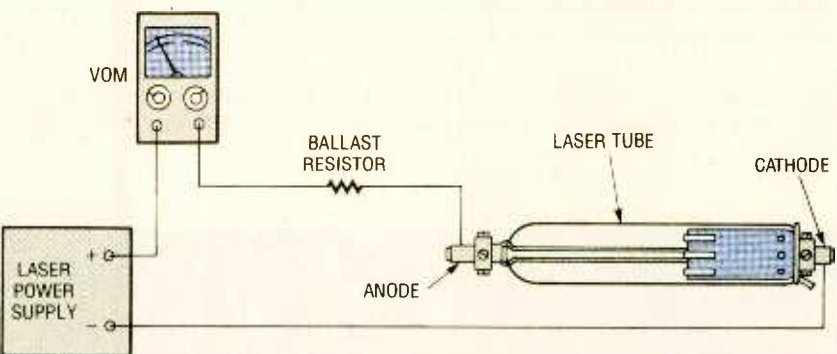

Fig. 6. Calibrating the power supply to suit your laser tube is simple. Just adjust the oscillator to achieve the lowest amount of tube current that yields the steadiest beam.

solder wires directly to the terminals because the heat of soldering may throw the mirrors out of alignment.

Some companies sell beryllium-copper spring clips that can clip onto the terminal instead (see Fig. 5). In a pinch, you can use  $\frac{1}{4}$ -inch fuse clips, like those available from Radio Shack (Cat. No. 270-1219). The clips are attached to a small board so cut the board in half so you can separate the clips. Then bend the clips open a little to adjust each to the size of a laser terminal. Solder leads to the clips and connect the ballast resistor in series with the anode clip. Attach the cathode lead to the appropriate point in

the circuit, but do not attach the free end of the ballast resistor to the circuit just yet.

**Testing and Calibration.** To calibrate the power supply to your laser tube, use a multimeter connected to the system as shown in Fig. 6. Set the meter to read milliamps.

Turn on the laser supply and adjust potentiometer R2 until the meter reads the proper current for your tube (typically around 5 milliamps) and make sure the laser is producing a steady beam. Use the laser beam as your final guide as the tube may require a little more current to produce a steady unwavering beam. Allow the power supply to operate for 30 minutes or so. During that time the components will "break in;" if the power output drops, readjust R2.

When you are finished adjusting the power supply, turn it off. Since the capacitors will retain a charge for awhile, either bleed them by shorting the output leads with a wire or wait an hour for them to completely dis-

charge by themselves before removing the meter from the circuit. Then connect the ballast resistor to the power supply.

**Laser-Tube Housing.** After you have finished checking out and adjusting the power supply, you'll need a suitable mount and enclosure for the laser tube. The author used a laser head that has the laser tube already enclosed.

One simple mount idea is to mount the tube to a block of wood using two plastic snap-in clamps (used to mount large electrolytic capacitors) with the same diameter as the tube.

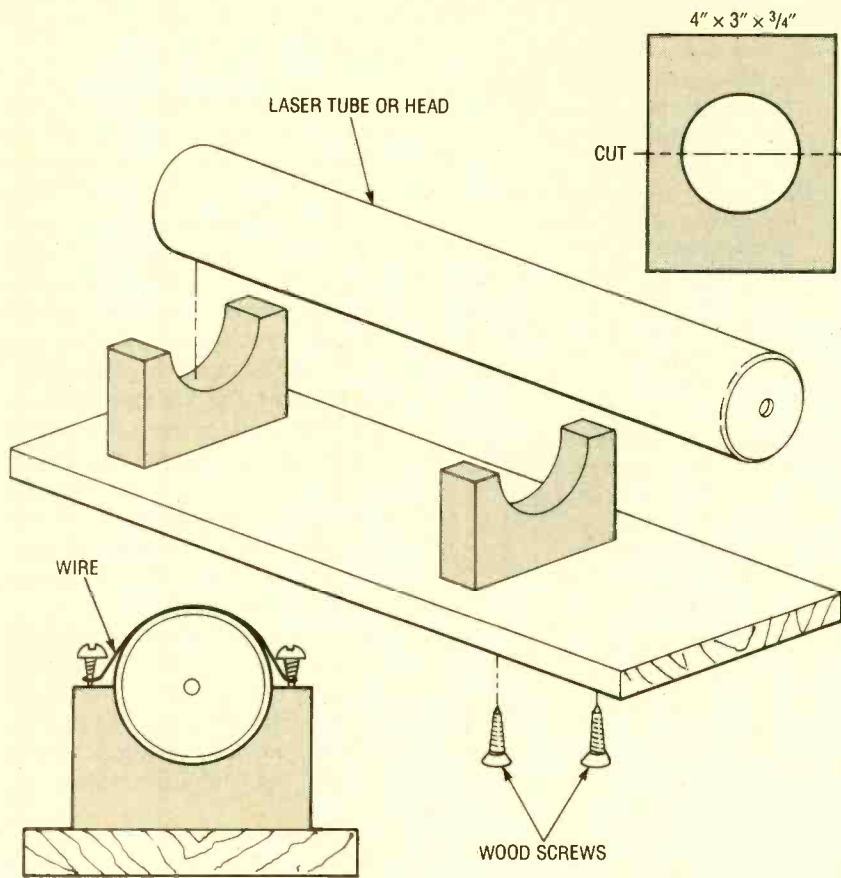
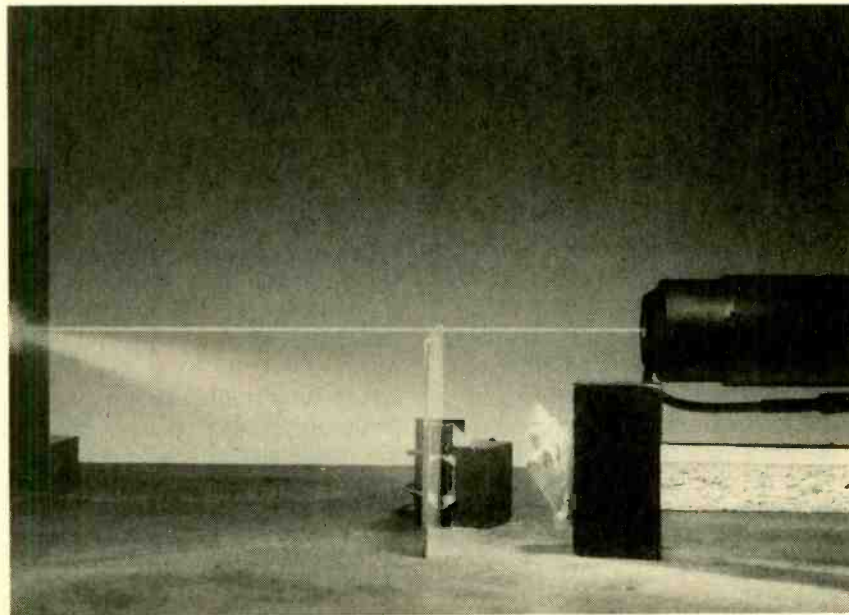

Fig. 7. Mounts for a laser tube or laser head can be easily made from two pieces of wood, some screws, and wire. However, you will also need to make an enclosure for a laser tube.



This photo shows an actual hologram being made. This month, we built the laser shown at the right. When we conclude this article next month, we will build the isolation table and discuss the photo-processing techniques that are used to create a hologram.



Select a metal (TO-220) package for Q2, and mount it to the side of the enclosure as shown here.

Another way is to use a piece of lumber 4 x 3 x 3/4 inches thick (see Fig. 7). Drill a hole in the center of the piece with a hole of the same diameter as the tube or laser head. You will have to use a large-diameter cut-out bit used to drill holes for door-lock assemblies. If you can't find a bit with the same diameter as the tube, select the next largest diameter. After you drill the wood, cut the wood in half so that you have two semi-circles in each piece. They will act as supports for the laser.

Mount the supports to a piece of wood with wood screws. Place two wood screws in the top edge of each support as shown in the drawing. Place the laser on the supports and lash the laser down to each support using a length of 22-gauge insulated wire wrapped around the two screws.

If you are using an enclosed laser head, you're finished. If you are using a standard laser tube, you need to build an enclosure. The reason you need an enclosure is to prevent the glow of light from the tube from exposing the film you plan to shoot. Paint the inside of the enclosure black, and don't forget to drill a hole in one end of the enclosure to allow the laser beam to pass through.

On another laser project, I used a rectangular aluminum "pipe" for an enclosure. However, I encountered a problem you should be aware of: Because of the close proximity of the tube to the walls of the enclosure, the high-voltage arced to the tube walls. I solved this problem by masking the inside of the pipe with electrical tape.

Once finished, you should have an enclosed operational laser, with a steady output. Next month we will describe how to use the laser to make your own holograms. ■

# A Convenience Light



# for Remote Controls

BY MARC SPIWAK

*Tired of changing channels in the dark? Then shed some light on your remote with this easy-to-build accessory.*

**W**e've certainly come a long way from the days when TV's had tuning dials and you actually had to get up to change the channel. Remote controls have become an integral part of almost any entertainment appliance, and a luxury on some appliances that you would never expect to see them on—you can actually buy an IR remote-controlled quartz heater! There are those who feel that remote controls are just a prescription for laziness, but those are usually the people whose TV sets don't have remotes anyway.

Contrary to what those people believe, a remote control has become a necessity where a modern video system is concerned. Not because you have to be able to change the channels from your easy chair, but because modern setups (with VCR's, videodisc players, and more) offer lots of user-adjustable features—on-screen displays, pausing, slow motion, and "marking" tapes for editing, just to name a few. And many adjustments must be made from where you're sitting. As an example, you must adjust the Surround Sound level (if you've got it) in accordance with the main audio

level and where you are sitting to achieve desirable results. Otherwise the sound levels will be out of balance and you won't be hearing the movie the way you're supposed to.

One problem that exists with remotes is the fact that the buttons can't be seen in dim light, which is usually the case when watching TV. How many times have you had to position the remote keypad toward the TV screen so you could see which button is which? And memorizing the keypad layout isn't that easy on a 40-function remote—especially if you've got two or three of them!

The Illuminator described in this article will eliminate that problem. It is an add-on for any remote control. It clips onto the end of a remote control and lights up whenever you complete the circuit by touching the metal strips on the bottom of the unit. The metal strips are recessed so that placing the unit on a conductive surface will not turn it on, but when it's held as you would hold any remote, it lights up.

The Illuminator's light source is a high-intensity LED, but you can use any kind of LED that you like, as well as an incandescent bulb. One nice thing

about the LED though, is that its red light does not distract you or others from viewing the program.

**Circuitry.** A circuit can't get much simpler than that of the Illuminator. Basically the entire circuit consists of a battery, a current-limiting resistor, an LED, and a Darlington transistor to turn on the LED (see Fig. 1). There are also two pieces of adhesive-backed metal tape that are used as the touch pads.

The battery (B1) is a 6-volt N-cell camera battery. It was used because it has the right voltage and its size lends itself well to this application. The value for the current-limiting resistor (R1) was chosen according to the manufacturer's recommendation, although any value between 200 and 500 ohms ought to do just fine. Just keep in mind that the greater the resistance, the less current will flow through the LED, and the less bright it will be.

Although it's not recommended, most LEDs will work for brief periods without a current limiter—and with much added brightness. However, because you don't want to be replac-

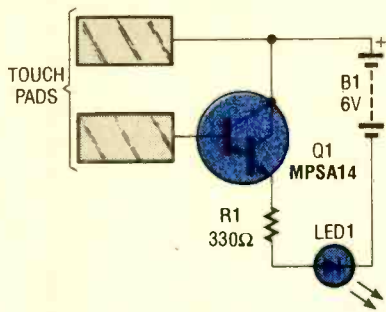

Fig. 1. The entire circuit consists of a battery, a current-limiting resistor, an LED, a Darlington transistor, and two metallic touch pads.

ing the LED every so often, you'll definitely want to use a current limiter. Perhaps a 500-ohm potentiometer is the best solution, but it will take up more space than a fixed resistor.

Let's talk about transistor Q1 for a minute. The part used in the prototype is an NPN-type Darlington transistor, meaning that it is actually two transistors in one package, arranged as a Darlington pair as shown. It physically looks like an ordinary 3-lead transistor, but the gains of the two transistors multiply to yield a gain of 10,000.

In order to understand how it works, let's first analyze it one transistor at a time. With an ordinary NPN transistor (a 2N2222, a 2N3904, etc.) arranged as shown in Fig. 2, a direct connection between  $V_{CC}$  and the base will cause the transistor to turn on and pass current from the collector to the emitter. A

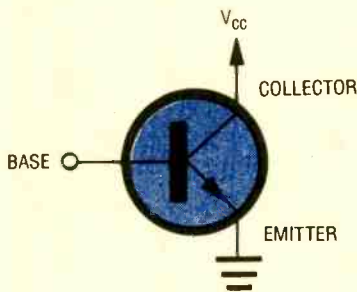

Fig. 2. When an NPN transistor is arranged as shown here, a direct short between  $V_{CC}$  and the base will cause the transistor to turn on and pass current from the collector to the emitter.

not-so-direct connection—say if you connected the base to  $V_{CC}$  with your finger—would cause the transistor to partially turn on, resulting in much less current flowing from the collector to the emitter. That's because only a tiny bit of current flows through the rela-

tively high impedance of your finger, as compared to a direct short. Keep in mind though, that there is a current gain even though the slight collector-to-emitter current flow isn't of much use.

So, an ordinary transistor isn't of much use as a touch switch because the current gain is simply not high enough. But if we take two ordinary NPN transistors, and arrange them in a Darlington configuration (look back at Fig. 1), the slight current gain of the first transistor provides more than enough current to turn on the second transistor, which can then easily power a load—in our case, an LED.

If you can't find the Darlington we used, or a similar one that will work just as well, you can take two ordinary 2N2222 transistors (they have a gain of about 100), arrange them as shown inside Q1 in Fig. 1, and you'll then have the functional equivalent of the part we used.

**Construction.** The construction method for the Illuminator can vary quite a bit depending on how good you want it to look, how bulky a device you can live with, what parts you already have on hand, how much you want to spend on additional parts, and so on. Our's cost us absolutely nothing, as we had every part on

## PARTS LIST FOR THE ILLUMINATOR

- R1—200–500-ohm resistor (see text)
- B1—6-volt camera battery
- Q1—MPSA14 Darlington transistor (or equivalent, see text)
- LED—High-intensity light-emitting diode (Radio Shack No. 276-086 or equivalent)

Perforated construction board, stranded wire, bus wire, solid copper wire, metal washers, large stationary clip, small screws, metal tape for touch pads, double-sided tape, heat-shrink tubing, paint, solder, etc.

hand—actually we did spend about \$2 on flat black spray paint.

The most logical material to use—at least for us anyway—was perforated construction board. It's easy to cut to size; accommodates circuitry quite well; can be glued, painted, or whatever; and we already had a bunch of it on hand.

Construction details and approximate measurements of the prototype Illuminator are shown in Fig. 3. First we cut out a piece of perforated construction board that was the right size for the main part of the unit and for

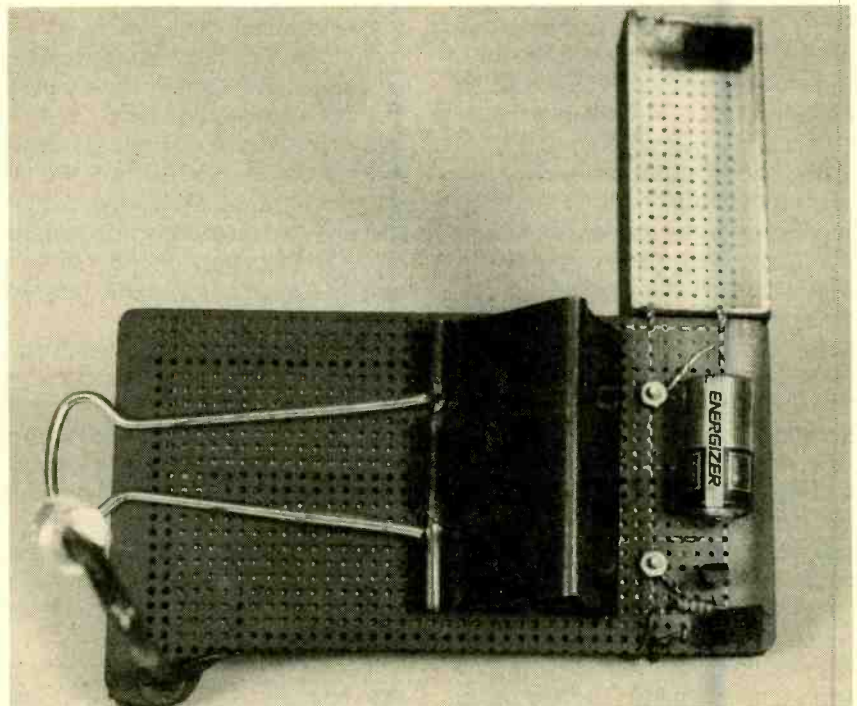

The battery, resistor, and Darlington transistor are housed under a perfboard cover (shown open here). When the cover is closed it is held down with Velcro.

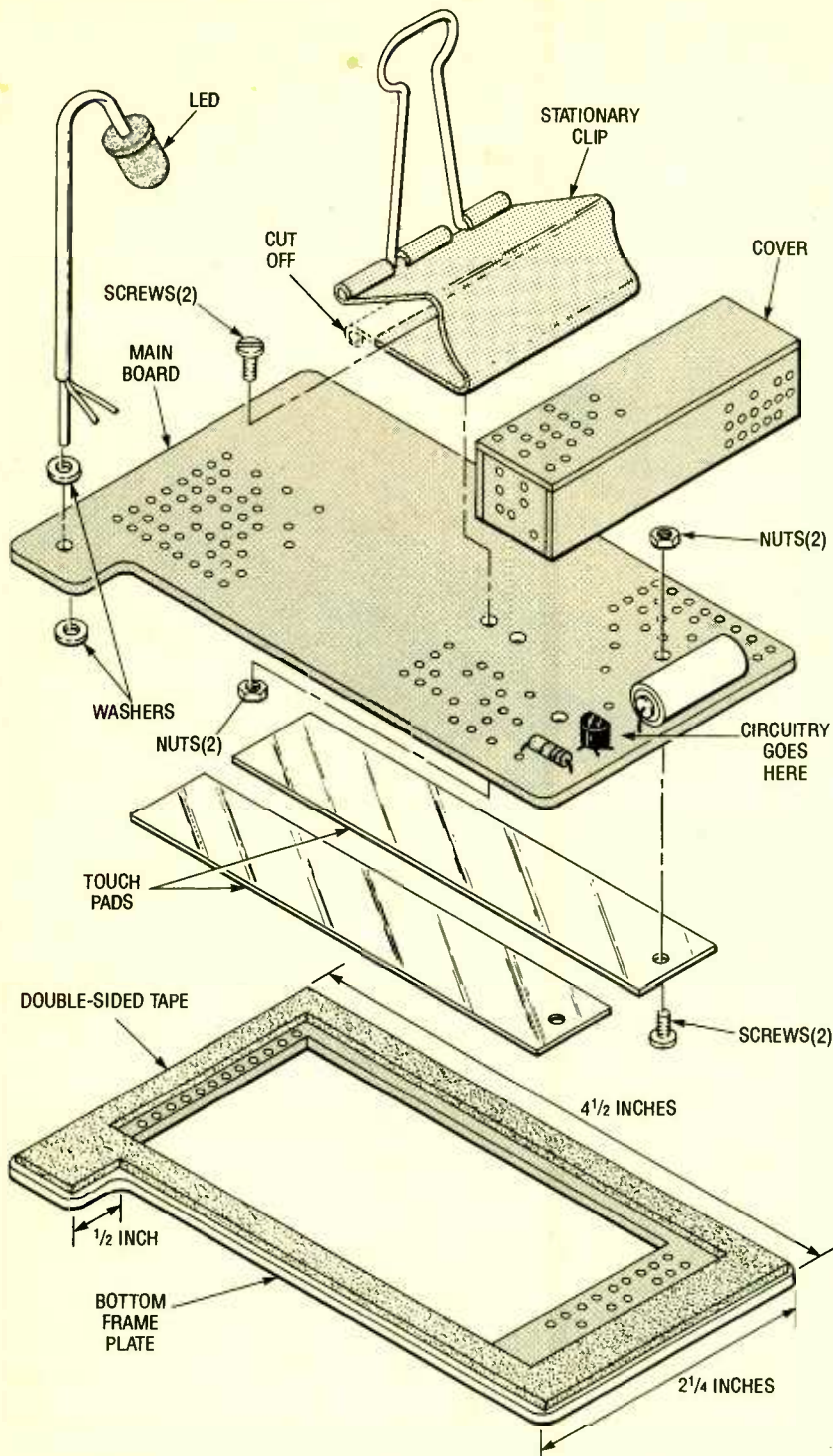

Fig. 3. The Illuminator consists of a main board with the components installed on one end with a cover over them, metal-tape strips on the bottom of the board, a "gooseneck" LED lamp, a frame plate on the bottom of the unit, and a stationary clip to secure the unit to a remote.

the remote control we initially had in mind. The components were installed on one end of the board, leaving room to put a cover over them later.

Since we didn't have a battery holder on hand for the 6-volt battery, we simply soldered leads directly to the battery terminals—changing the battery won't be as easy as it could be

with a holder, so use a holder if you've got one. Leads from the Darlington pair were attached (electrically) to the metal-tape strips on the bottom of the board using two small screws. If you can't find adhesive-backed metal tape, you can use aluminum foil or some other metal and some double-sided tape.

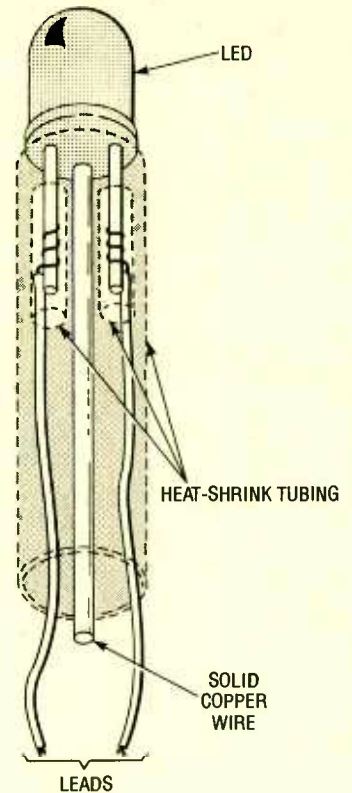
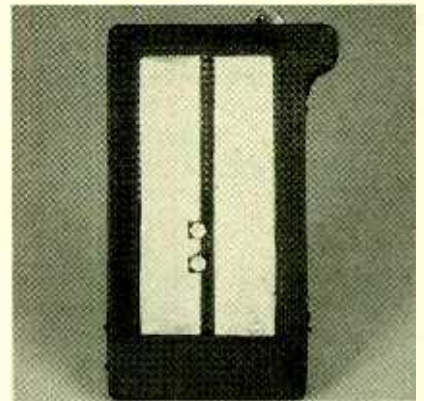

Fig. 4. The LED has leads attached to it with a length of solid copper wire running the length of the leads and heat-shrink tubing holding everything together. Two metal washers will be soldered to one end of the wire to hold the lamp assembly onto the board.



The metal tape strips run almost the full length of the unit. The hardware that holds the stationary clip in place is visible from this perspective.

As the LED must point down toward the buttons on the remote, leads were attached to it, and a length of solid copper wire running the length of the leads was added (see Fig. 4). Heat-shrink tubing holds everything together, so you end up with a stiff, yet flexible LED "gooseneck." Some of the  
(Continued on page 96)

# Printer Spooling-

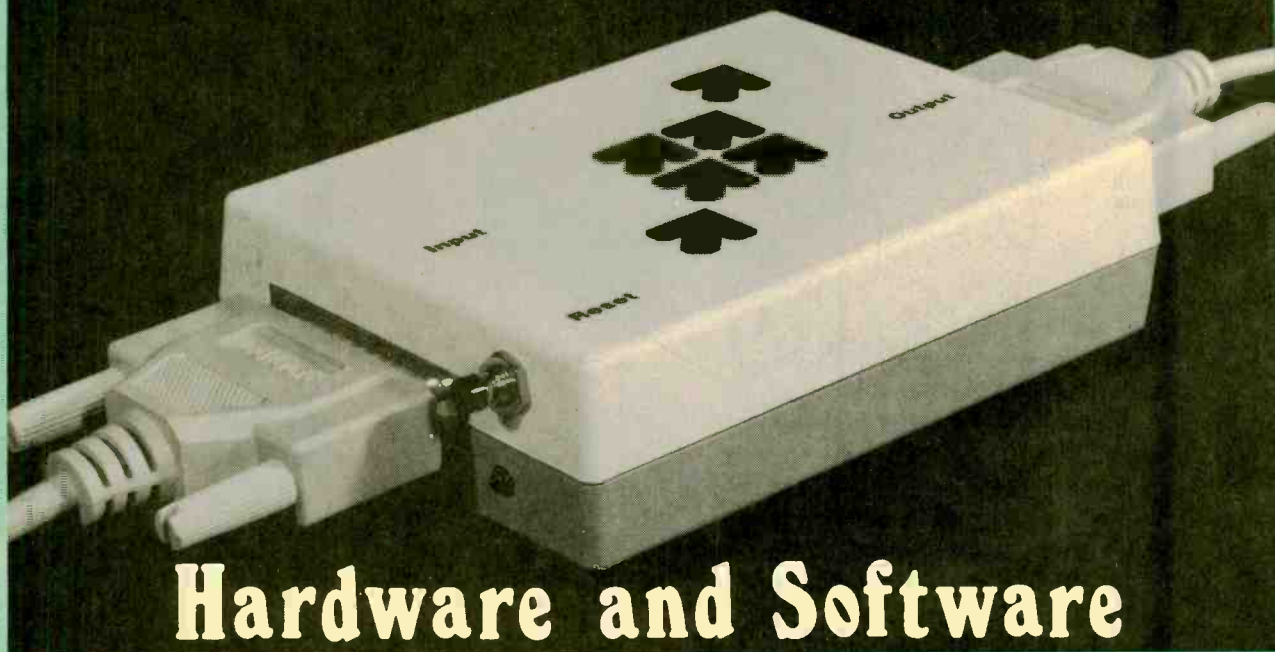

## Hardware and Software

*"To spool or not to spool, that is the congestion," is a statement William Shakespeare might have made if he were involved with computer printers today.*

BY FRED BECHMAN

**Y**ou've finally up-graded your computer setup by buying the slickest and fastest main unit you could afford. After having it work out some lighting-fast spreadsheet computations, you're ready for a printout. You stroke the appropriate keys and the print out begins—unfortunately your slow printer makes you feel like it will never end. What a let down.

Of course you could try spooling: the process of sending data to memory or another fast-acting storage device before actually going to the printer. Spooled data is directed to a "buffer," which can be a place in computer memory, a disk drive file, or a specific device called a "printer buffer." A printer buffer provides an area where the computer can dump the data and go on to other tasks, while the printer picks up the data at its own pace.

But modern printers work really fast, don't they? Some dot-matrix printers claim printing speeds of 400 characters per second (CPS) or more, but those claims can be misleading. For example it takes significant time to

process and implement linefeeds, carriage returns, print formatting instructions, and graphic codes. Therefore, the actual printing "thru-put" for text could easily be 150 CPS or less, even with a printer rated at 400 CPS. Furthermore, in the graphics mode there is no relationship to CPS, since you are really dealing in bytes per second, not characters, and much greater internal printer interpretation and processing time.

This holds true for laser printers, too. Although laser printers are faster than dot-matrix printers, there is significant input-processing time, so laser-printer spooling is useful as well.

Some printers contain internal buffers, but these are generally only from 2K to 8K—too small to be really useful except for short printing jobs. Long tabulations or text files can easily run over 100,000 characters. With micro-computer memories very commonly 640K, an 8K printer buffer is really very limited in time saving for long print jobs.

As mentioned already, spoolers can be external hardware or computer-run software. Let's discuss the hard-

ware alternative in detail before moving on to software.

**Simple Hardware Buffers.** You might only need a simple hardware-based printer buffer that accepts computer output very quickly, then passes it to the printer as fast as it can be accepted by that particular printer. You might want some additional features like being able to make additional copies, or pausing during printing.

Simple hardware buffers are transparent to the user. You just issue printer commands in the normal way, from the keyboard or within a program. There is no "software driver" required, and no special commands. You operate as if the buffer was not even there. The big difference is that you regain control of the computer long before the printer has completed its job.

Installation generally involves plugging your computer printer cable into the buffer, and using another cable from the buffer to your printer. Some designs include the buffer-to-printer cable, but most don't.

You'll also have to plug the buffer

into an external AC-power source, since these units draw no power from either the computer or printer. They typically only require a few watts, and power is usually provided from an included wall-plug transformer. Sometimes an internal power supply and a line cord are used.

If your needs are more demanding, such as feeding a long queue of documents, or sending different documents to five different printers, more sophisticated hardware is needed. However, such devices are expensive and hard to program. This report will only cover simple less expensive buffers.

**Comparison Chart.** Table 1 shows five typical hardware printer buffers and a comparison of their features and costs. They vary from the minimum-featured Stewart Instruments' PC Spooler to Consolink's full-featured MicroSpooler. Costs vary from \$100 to \$359 for units with 256K of memory.

and one unit is available (for \$219) with a whopping 2 megabytes of memory! Consolink will have 4 megabyte units by the time you read this.

Although only the "parallel interface" units are described here, most companies also offer "serial interface" buffers. The parallel interface is much preferred, since there is almost total standardization in connectors and signals among computer and printer manufacturers, especially in the IBM PC marketplace. Serial interfaces, commonly used by Apple computers, can pose significant problems in trying to match various connectors, wiring, and protocols.

To better explain what some of the features involve, we'll take a closer look at each unit listed in Table 1. For more specific information, including current prices and shipping charges, call the sources shown in the chart.

**Stewart Instruments PC Spooler.** The PC Spooler from Stewart Instru-

ments is a relatively straightforward printer buffer. It includes the buffer-to-printer cable and a wall-plug power adapter. Since there is nothing else to buy, and there is no shipping charge in the USA with prepaid orders, the PC Spooler is the least expensive 256K printer buffer in this report.

Housed in a 4.5-by-4.5 by 1.5-inch chocolate brown plastic case, the PC Spooler has an inlaid brushed aluminum coverplate that identifies the functions of two pushbutton switches and one light-emitting diode (LED.)

The PC Spooler does not have an on/off switch. Plugging in the wall-plug power adapter turns the unit on, as with many other units. The power used is only about 3 watts, so it could be left on without significant cost. The LED does not light or blink to indicate power is applied.

The two switches are used to start or pause printing, or to clear the Spooler memory. There is no repeat function to make additional copies, and you can't bypass the buffer function. The LED flashes only when the PC Spooler is receiving a signal.

I tested the Spooler for text and graphic thru-put using a 12MHz IBM PC/AT clone and an Epson LX-800 9-pin dot-matrix printer. The printer had an internal 3K buffer and is rated for text at 150 characters per second when used in the pica draft mode (10 characters-per-inch). In the graphics mode, it can produce 240 dots-per-inch horizontally, and 216 dots-per-inch vertically.

The first test involved printing a 15.8K, 2000-word text file, with 255 formatted lines of 62-characters-per-line maximum. Printing that text from my word processor took 149 seconds without the spooler. Since the printer had a built-in 3K buffer, I was able to regain the use of my computer in 110 seconds. Therefore, the printer's internal buffer saved me 39 seconds.

When I did the same printout with the PC Spooler, I regained computer use in 21 instead of 110 seconds, therefore saving another minute and a half. Obviously, more time would be saved with a larger file.

I ran another text test, but this time I printed out a BASIC-program listing using the LLIST command. The file was almost 10K in length in 278 lines. This took 149 seconds to print, and without an external buffer I regained comput-

TABLE 1—HARDWARE PRINTER BUFFERS

Model & Source	Price (\$)	RAM	Display	Self-Test	Copy	Clear	Pause	Bypass	Cable Included	On/Off Switch	Type of Power (included)
PC Spooler Stewart Instruments, Inc. P.O. Box 11926 Prescott, AZ 86304 (800) 722-8937	100	256K	One LED	Yes	No	Yes	Yes	No	Yes	No	Ext. Adapter
BF3+ Technologic Systems 421 South Main St. Marysville, OH 43040 (513) 644-2230	100 129 149 219	256K 512K 1M 2M	One LED	Yes	Yes	Yes	No	Yes	No	No	Ext. Adapter
PB-64 Practical Programs 1104 Aspen Drive Toms River, NJ 08753 (908) 349-6070	110	64K	Eight LEDs	Yes	Yes	Yes	Yes	Yes	No	Yes	Ext. Adapter
UG-411 Computer Friends, Inc. 14250 NW Science Park Dr. Portland, OR 97229 (503) 626-2291	129 215 450	64K 256K 1M	Four LEDs and Two Digits	Yes	Yes	Yes	Yes	No	No	Yes	Ext. Adapter
Micro Spooler Consolink Corporation 600 South Sunset St. Longmont, CO 80501 (303) 651-2642	233 269 296 359 539 719	16K 64K 128K 256K 512K 1M	Three .5" High Digits	Yes	Yes	Yes	Yes	No	No	Yes	Internal



*The 256k PC Spooler, with cables included, is the least expensive printer buffer covered in this article.*

er control in 139 seconds, thus saving me only 10 seconds. However, when I plugged in the PC Spooler, I had computer control back in only 12 seconds, instead of 139, saving over two minutes in printing out that one listing!

You might wonder why the printer thru-put was slower with a BASIC listing than the text test, since the same printer was used. Well, as mentioned earlier, a significant amount of time is involved generating line feeds and carriage returns, and the BASIC listing (with many short lines) had more line feeds and carriage returns than the regular text, slowing the printing process. Printer thru-put is also effected by command codes that require interpretation, as well as the acknowledge and strobe timing of the printer buffer.

The real test comes with graphic printouts, since they traditionally can take several minutes for a single screen. I used a screen-capture program that provides a graphic dump in high-density mode, pretty much exercising the maximum capabilities of the LX-800. Printing out a full screen took 168 seconds without a spooler. I was able to regain computer use in 158 seconds due to the printer's 3K buffer, saving me ten seconds. When I did the same printout with the PC Spooler, I had computer control back in only 44 seconds—a saving of almost two minutes for a single screen dump!

**Technologic Systems' BF3+ Buffers.** Technologic Systems is one of

the most aggressive marketers of low-end printer buffers, with many different types. The BF3+ series of buffers offer the highest capacity of any of the units covered here—as high as 2 megabytes. However, even the 256K unit has the most commonly used features.

The buffers are housed in a beige 5.8- x 4- x 1.5-inch plastic case with a DB-25 25-pin female connector on each end. In addition to your regular printer cable, you'll need a cable with a DB-25 25-pin male plug on each end, with all wires connected straight through. Commonly available, Technologic sells this cable for \$9.95.

A single pushbutton switch controls all functions, and a single LED provides status. When you power the unit (there is no on/off switch) from the external wall-plug adapter, you can press the pushbutton and get a printed self-test. By proper use of the switch you can make repeated cop-

ies, clear memory, or bypass the buffer entirely. You cannot pause printing.

I tried the same tests with the BF3+ as with the PC Spooler, and found the BF3+ slightly faster. I regained computer control in 20 seconds for the text test, in 11 seconds for the BASIC listing, and 25 seconds for the graphic screen. Only the graphic screen dump showed a significant time saving (25 seconds versus 44 seconds) compared to the PC Spooler.

**Practical Programs.** I didn't actually have one of these units to test, but the information sheet from Practical Programs is quite detailed. This buffer has only a 64K capacity, and is not upgradeable to a larger capacity. It comes in an extruded metal case measuring 5- x 2- x 7-inches, and has a lot of features. In addition to self-test, reset, multicopy, and bypass capability, there is a built-in auto-diagnostic function that lets you troubleshoot problems.

Not one, but eight LED's are used to display buffer status. Buffer Ready, Printer Error, Bypass, and Copy LED's indicate those functions, while the 16K, 32K, 48K, and 64K LED's glow as the memory fills.

Four switches are present: Reset clears memory, and Bypass allows the unit to be bypassed. When you want additional copies, you use the Start/End switch to mark the beginning and end of what you want copied, and then press Plus for the number of copies.

This repeat capability can save enormous time, since the computer is entirely free during the repeat printing process. Be aware, however, that you can't repeat a document that uses more RAM than the buffer has.



*The UG-411 Spooler Buffer from Computer Friends has four status LED's as well as a 2-digit display that indicates the number of copies requested.*



By the way, a Centronics male-male cable is required, and is available from Practical Programs for \$10.

**Computer Friends.** All the information I have on the UG-411 from Computer Friends is from the User's Manual and a photo. The front panel has an on-off switch, five touch switches, four discrete LED's, and a two-digit display.

A green LED lights when the unit is ready after a short internal self-test. A red LED lights when the buffer is full. The red two-digit display is used during the self-test, and to indicate the number of repeat copies—up to 99—that the user presets. Erase and Pause LED's light for those functions.

Centronics female connectors are used for both input and output, so an external Centronics male-male cable is required. A 9-volt external wall-plug power adapter is included. Computer Friends has an extensive line of more sophisticated buffers that share up to four printers and six computers.

**MicroSpooler.** I have to admit a personal bias regarding the MicroSpooler from Consolink Corporation. This was the first printer buffer I ever bought, and it is by far the best of the several I've had since. Of course, it is also the most expensive. Although Consolink makes several other units (Mini-MicroSpooler, MegaSpooler and MicroSpooler II) only the MicroSpooler will be discussed here.

This unit reeks of class. It's large (6.3- x 2.5- x 8.3-inches) and heavy compared to the other units, but it has important features the other units don't offer. For example, it has a 0.5-inch high three-digit LED display that indicates the number of copies that are preset (yes, Virginia, you can preset up to 199 copies on the 64K model, and 999 copies on the 1 meg model!) as well as the number of kilobytes of internal RAM that is being used.

As you send data to the printer you can watch the RAM used increase in 1K increments. The MicroSpooler digits count down the number of copies as they are printed, and then show the buffer emptying in 1K increments on the last copy. This display also blinks during a pause.

Copy, pause, and reset are supported, as well as a self-test. The only thing missing is a bypass function. You'll need a Centronics female-male

cable. The MicroSpooler has an on-off toggle switch, and the power supply is internal, so a power cord is used. A battery backup modification is available to preserve data during a power outage.

In the past I've checked the time-savings gained by using the MicroSpooler for printing articles generated using my TRS-80 Model III and Zorlof, The Magnificent Word Processing System. I don't have those figures handy, but I know I'm not exaggerating when I say that all totaled I've saved several working days, and much frustration in avoiding printer boredom—especially in the days of 80 CPS printers!

My MicroSpooler is only a 64K unit with a two-digit display (no longer manufactured), so I could not compare it directly with the 256K PC Spooler or BF3+ buffers mentioned earlier in this report. However, I printed a double-spaced preliminary 3300 word (22K) draft of this article, using a TRS-80 Model 4, the 64K MicroSpooler, and an Epson LX-810 printer (rated at 150 CPS in pica draft mode, with an internal 4K buffer). The entire print job took 273 seconds, but I had control of the TRS-80 back in 98 seconds, for a saving of 175 seconds (almost three minutes) on just this one printout.

Why so long for a 22K file to get into the buffer? The test used a s-l-o-w computer (a Z80 microprocessor running at about 2 MHz), and a word processor that echoes to the screen as it is sending data.

Today I would feel seriously hampered without my 64K MicroSpooler, which is always connected to the TRS-80 Model 4 I use for my writing. In seconds I can continue working with the computer while the printer dutifully continues to grind away for minutes.

**Software Spooling.** You really don't have to add any hardware at all to have printer spooling. In fact, your DOS disk has a program called PRINT.COM. It is a software driver with some fairly sophisticated functions that may take some time to learn. It will only print out disk files, so it is not useful for screen dumps.

There are also a number of shareware programs that will provide printer spooling. These are called "RAM spoolers," and may require use

of extended or expanded memory. Usually these spoolers are placed in memory as "TSR" (Terminate and Stay Resident) programs. Not only do these spoolers use RAM (which may be scarce), but they sometimes interfere with other TSR programs. Hardware spoolers, on the other hand, take no computer memory, and the simple ones don't conflict with software.

A number of software companies offer print-spooling programs, but the most sophisticated of these I've run across is called "PrintRite." I'll cover that a little further on. For now, we'll take a quick look at PRINT.COM.

**DOS PRINT.COM.** Even if you're still using MS-DOS 2.0, you'll find PRINT.COM on one of your DOS disks. This is an "external DOS command," meaning that when you use it, the program must be in the directory you are in, or accessible through your PATH command. Generally it will be found in the DOS directory of your hard drive. It prints only from disk files, not RAM.

The command can be as simple as PRINT FILENAME.EXT (where the FILENAME and .EXT are the filename and extension you wish to send to the printer.) DOS 2.0 provided only a few software switches (such as /P; to add a file) to modify this command. DOS 3.0 added several more switches. With 3.0 you can set the buffer size, route the printing to different devices, set up print queues, and more. Some of these switches are difficult to explain. Refer to your DOS manual.

Bear in mind that this program uses a portion of conventional RAM, reading the disk file in the background and sending data to your printer while you use your computer in the foreground. That slows down computer processing.

I suppose if I researched PRINT more, I might find it useful. I never use it, since my external hardware buffers are already in place and require no special attention.

**PrintRite.** If you are a real power user, especially in a situation where you need to send printing to as many as five printers (for example, one for text, another for labels, another for letters, etc.) you can go crazy with external buffers and their extra cables and switches. This is when you'll want to consider "PrintRite" (Bloc Publishing,

800 Southwest 37th Avenue, Suite 765, Coral Gables, FL 33134; Tel. 1-800-888-2562 or 1-305-445-0903, price: \$99.95).

The main feature of PrintRite is that it will spool up to 255 print files to as many as five different printers, in any sequence you specify. Using pull-down menus and help screens, and unique file compression that saves disk space, you can group printing jobs together, such as spreadsheets, forms, letters, graphics, and so forth. PrintRite uses advanced mainframe "time-slicing" techniques so information is processed quickly and efficiently.

Once loaded, PrintRite actually monitors and intercepts all output directed to a printer. A window pops up asking for a filename, then another window (see Fig. 1) pops up allowing you to set various parameters. When you press F10 the printer data is sent to RAM, compressed, saved to a disk file, printed, then automatically added to the printer queue. That all happens so fast you don't even really know it, and all the while you can continue using your computer in whatever application you are in.

```

Print Parameters For FLIGHT.ASC
Description      : [ ]
Print file ?    : [Yes ]
Delete after printing ? : [No ]
Number of copies : [ 1 ]
Beginning page number : [ 1 ]
Priority level  : [5]
- Page Format -
Form name or paper type : [ ]
Lines per page  : [ 66 ]
Form alignment  : [None ]
- Printer/Print Style -
Print report to  : [EPS_RMF ]
Translate output ? : [No ]
Edit style settings ? : [No ]

Optional descr. for reference
  
```

Fig. 1. PrintRite allows you to set various printing parameters. Note that it even performs some simple file maintenance, such as deleting a file after printing it.

A pull-down menu lets you add print files to the queue, view a file in the queue, delete files from the queue, or perform a number of other functions. Figure 2 shows the addition of a file to the queue.

Can you see yourself sitting at your computer, waiting for a dot-matrix printer to finish printing labels before you can send a spreadsheet to a daisy-wheel printer, and then per-

```

PrintRite Version 1.3
  Spool Files  Queue  Printing  Configuration
  Add File To Queue
  File Name : [ C:\MSLSCRIPT ]
  Enter name including the full path ((Drive):\Path).
  Add a spooled or ASCII file to the Queue.

  Files to Print (Queue)
  #  Name      From Program /Description  Date   Time   Print? / < # of Pages >  Copies
  #  Name      /Description  Date   Time   Priority Printed Total      Left
  1  FLIGHT    Ext. File    12/85  1:45p  Printd/5  1  *****  0
  2  AUTOEXEC  Ext. File    12/85  1:46p  Printd/5  1  *****  0
  3  CONFIG    Ext. File    12/85  1:47p  Printd/5  1  *****  0
  4  FLIGHT    Ext. File    12/85  1:47p  Printd/5  1  *****  0

  File Spooling: None  Printer Status: On Line  # of Files: 4
  
```

Fig. 2. Adding another file to the print queue is easy with PrintRite, as it prompts you every step of the way.

haps have a form printed on a laser printer? With PrintRite you can set the files in a queue, specifying which files go to which printers in what order. Once started, the program is in control of the printing and works in the background while you can do foreground work. PrintRite supports Local Area Networks (LAN's), printers on networks, and will print up to 65,535 copies of a file!

Of particular interest to laptop users, who are frequently disconnected from a printer, is the ability of PrintRite to store printer files for later printing. When a printer is available, it is simply a matter of hooking up, and running PrintRite to print out the files in any order you like.

PrintRite is RAM-resident, requiring less than 50K, and pops-up when a user presses a hot-key combination. Each document is saved as a separate compressed file. That minimizes the fragmentation created by spoolers that save all the queued files into one large file. It also allows each file to be moved within a queue or bypassed.

Twenty-six printer drivers, covering most dot-matrix, ink-jet, daisywheel, HP LaserJet, and PostScript printers, and even plotters are included. Custom drivers can be added with a few keystrokes. Printing can be either portrait (as you see it) or landscape (sideways).

Be forewarned that PrintRite is not a simple program, and will probably take a few days to learn to use. It does so many things that it takes a 138-page, liberally-illustrated User Manual to explain them all.

Although the manual appears to be well written, I found myself confused a good deal of the time. I believe that's because I was not trying to accomplish some particular task, but instead was just cruising around the program and trying out different things. The program never crashed, although I'm sure I made a lot of wrong moves. If you have multiple printer requirements, it will probably be worth your time to try out PrintRite.

**Spool Days.** A minute here, and a minute there—it all adds up. I know I've saved a total of several working-days over the years since I bought my first spooler. Furthermore, when you're waiting for a printer to grind out a long file, it seems like an eternity.

Do you need a printer spooler? That depends on how much, and how, you use your printer. If your printing tasks are minimal, the time saved by a spooler will be small. However, if you are frequently involved with print-intensive programs, desktop publishing, or graphics, you'll love spooling. You'll soon wonder how you ever had the patience to deal with those I-o-n-g printer delays. ■

BY LARRY LISLE, K9KZT

# Build a Low-Cost Morse-Code Transmitter

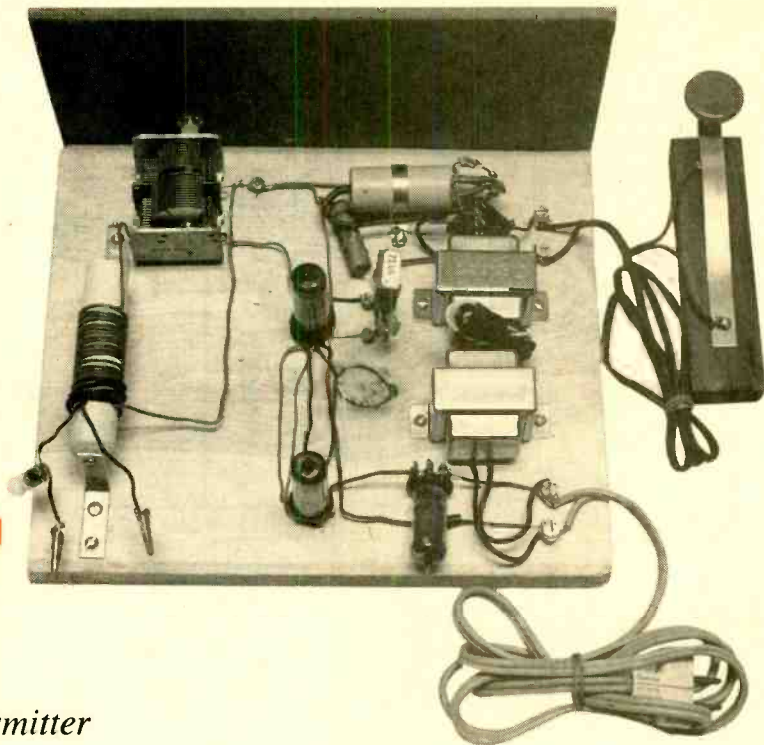

*For as little as \$20, hams can get on the air with this Morse-code transmitter*

**W**hether you are an "old pro" or a newcomer to the ham-radio hobby, the *Economy Six*—a 6-watt, 40-meter Morse-code transmitter—may be of interest to you. The circuit is made almost entirely from parts that were salvaged from old broadcast radios. The other parts can be scrounged from junk that may be just lying around or purchased from local suppliers. The only electronic parts that you may have to buy are a crystal, two easy-to-find low-voltage transformers, and a standard fullwave bridge rectifier. With just a little ingenuity on your part, the whole project shouldn't cost more than \$20 to build.

**A Look at the Circuit.** The *Economy Six* (see Fig. 1) consists of a pair of 50C5 audio-output tubes connected in parallel. The vacuum-tube portion of the circuit is connected in series with an interrupt circuit, and is fed from a 117-volt DC power supply. Power for the tube filaments is tapped directly from the AC line. The filaments of the two 50C5's are connected in series with the filament of a 12-volt tube (in our case, a 12BA6). Only the filament of the 12-volt tube (V3) used; its purpose is to balance out the filament string. The parallel-connected tubes (V1 and V2), coupled with crystal

XTAL1, form a standard crystal-oscillator circuit.

Electrons emitted from the cathodes of the tubes (which are heated by the filament) strike the grid, sending a jolt of current through the crystal, causing it to oscillate at a radio frequency (RF). The RF signal is amplified by the tube and output across L1 and C1. That LC network is tuned to the frequency of the crystal. Most of the tube output is coupled to the antenna via L2; but a small portion of the signal is fed back to the grid via internal tube capacitances to sustain oscillation. Resistor R1 provides a bias voltage for the tubes, and capacitor C2 bypasses RF energy to ground.

The power supply is comprised of two 12.6-volt transformers connected back-to-back, forming a sort of isolation transformer. The first transformer reduces the 117-volt AC line voltage to 12.6 volts. That voltage is then fed to the second unit (T2), which steps the voltage back up to 117-volts AC. The 117-volt AC output of T2 is then fed to BR1, a 1-amp, 250-PIV fullwave bridge rectifier. The resulting DC output of the rectifier is filtered by capacitor C3, a 20- $\mu$ F unit. The output of the power supply is fed across R2 (a 27k resistor) to S1 (the key). Resistor R2 serves as a "bleeder" resistor to discharge C3 when the transmitter is unplugged.

**Gathering the Parts.** Almost all of the parts used in the *Economy Six*—including the tube sockets, and capacitors (both fixed and variable)—were taken from two broadcast-band, tube-type, table radios. Many such radios are being thrown away or sold at flea markets, garage sales, or second-hand stores. If you purchase an old set for the parts, plug the set in before removing the parts to make sure that the set plays. If it does, it's a pretty good indication that the parts in the set are all functional. If not, you'll have to check out each component before including it in your project.

Some care should be exercised when removing the needed parts, and don't be too quick to toss out components whose leads are a little short; you can always solder extensions to them. You'll need three tube sockets, a tuning capacitor and two fixed capacitors (of the values, or thereabouts, shown in Fig. 1). Once you've gathered all of the necessary components, construction can begin.

**Construction.** There is nothing critical about the construction or layout of the circuit. The author's prototype was assembled on a chassis made from a piece of scrap wood, measuring about 9 by 11 inches. Start by soldering lengths of hook-up wire to the

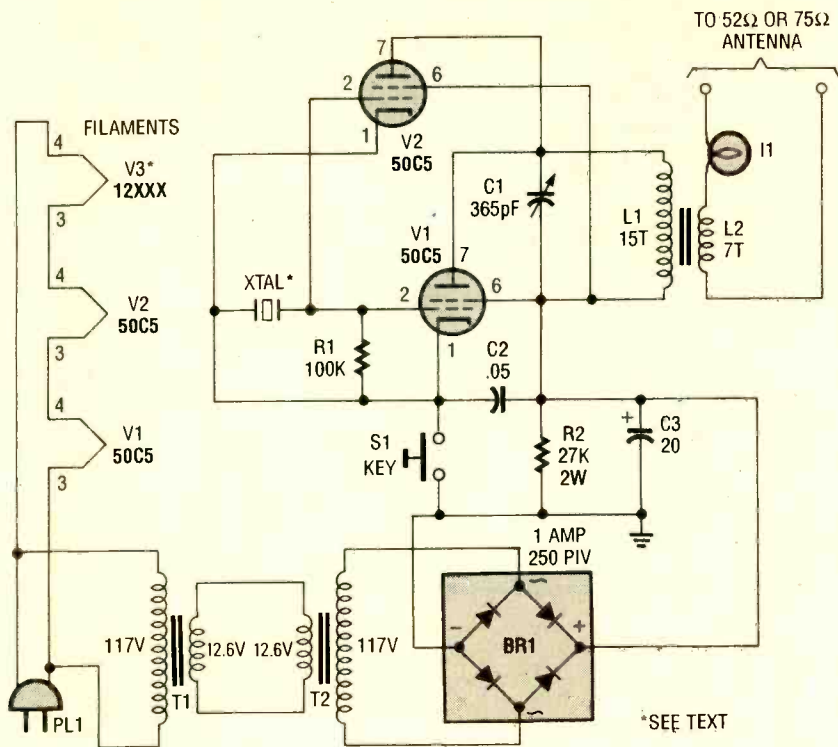

## PARTS LIST FOR THE ECONOMY SIX

### CAPACITORS

- C1—365-pF broadcast variable-capacitor
- C2—.05- $\mu$ F, 200-WVDC capacitor
- C3—20- $\mu$ F, 150-WVDC, electrolytic capacitor

### ADDITIONAL PARTS AND MATERIALS

- BR1—1-amp, 250-PIV, fullwave-bridge rectifier
  - I2—#47 pilot lamp or flashlight lamp
  - L1—See text
  - L2—See text
  - R1—100,000-ohm, 1/2-watt, resistor
  - R2—27,000-ohm, 2-watt, resistor
  - T1, T2—12.6 volt, 1-amp transformer
  - V1, V2—50C5 vacuum tubes
  - V3—12BE6, 12BA6, or 12AV6 (or similar vacuum tube with 12.6, 150-mA filament)
  - XTAL—40-meter (7000–7300 kHz) crystal
- Molded AC power plug with line cord, 9- x 11-inch chassis board, hook-up wire, brass wood screws, brass angle brackets, alligator clips, 6-inch brass strip, drawer pull, solder, hardware, etc.

Fig. 1. The Economy Six uses a standard pentode crystal oscillator circuit and is back a step or two from the cutting edge of high tech! But it works, you can get the parts, and anyone can build it and have a lot of fun with it on the air!

appropriate terminals of the tube sockets, using Fig. 1 as a guide.

It is a good idea to color coordinate the tube socket wires to make the final wiring of the project a bit easier. In the author's prototype, green wire was used for the filaments, black for the cathode, red for the plate and the screen grid, and another color for the control grid. The wires soldered to the sockets should be longer than necessary; they can always be trimmed to the proper length later.

Mount the tube sockets, the two transformers, tuning capacitor, and bridge rectifier to the chassis board. The sockets can be fastened to the board by feeding a small screw, finishing nail, or brad through the center hole of the socket.

Coils L1 and L2 are hand-wound units that were wound on a 4-inch length of 7/8-inch diameter mop handle. Coil L1 was made by winding 15-turns (2 inches long) of solid, plastic covered hook-up wire on the coil form. After that, 7-turns of hook-up wire was wound over L1 for L2. A pilot lamp was then soldered in series with one of L2's leads. The ends of L2 were then terminated in alligator clips, and the coil assembly was mounted to the

chassis board using brass angle brackets.

No socket was used for the crystal; instead, it is connected to the circuit via two alligator clips (allowing you to use any type of crystal). In the author's unit, the alligator clips were soldered to short lengths of heavy-gauge bus wire, and the bus-wire leads were then soldered to a pair of brass screws (which also serve as wiring tie points). If you expect to do much crystal changing, make the wires longer and hook the clips to the top of the panel; you should not reach into the circuit when the transmitter is plugged in.

Brass screws were also used for tie points elsewhere in the circuit. You can just wrap the wires around them for testing, but they should be soldered to avoid problems later. The wires carrying high voltage should be covered with electrical tape at all joints for safety. Don't forget to tape the heads of the screws used to fasten the variable capacitor to the board from underneath. After all the components are in place, wire the circuit together using Fig. 1 as a guide.

Once that's done, the next task is to make the transmitter key. The key was made from a thin strip of brass about

1/2-inch wide and 5 1/2-inches long. The brass strip was fastened to a 1 1/2 by 5 1/2-inch piece of wood (which serves as the key base) with a screw. The screw end of the assembly serves as the stationary end of the key and is used as one of the key's tie points. At the opposite end of the key base, another screw was screwed into the base; that screw is used as the key's contact, and also serves as the key's second contact. A drawer pull was fastened to the contact end of the key.

Once the key is complete, connect two lengths of wire to it; one going to the screw that holds the brass strip, and the other to the screw at the contact end of the key. Then connect the free ends of the key wires to the transmitter circuit.

The front panel was made from an 11-by-6-inch piece of Masonite panel, which was attached to the chassis board using a couple of screws.

**Operation.** After the transmitter is finished and the wiring checked, you're ready to put it on the air. Put a plastic bag over the key; the plastic  
(Continued on page 92)

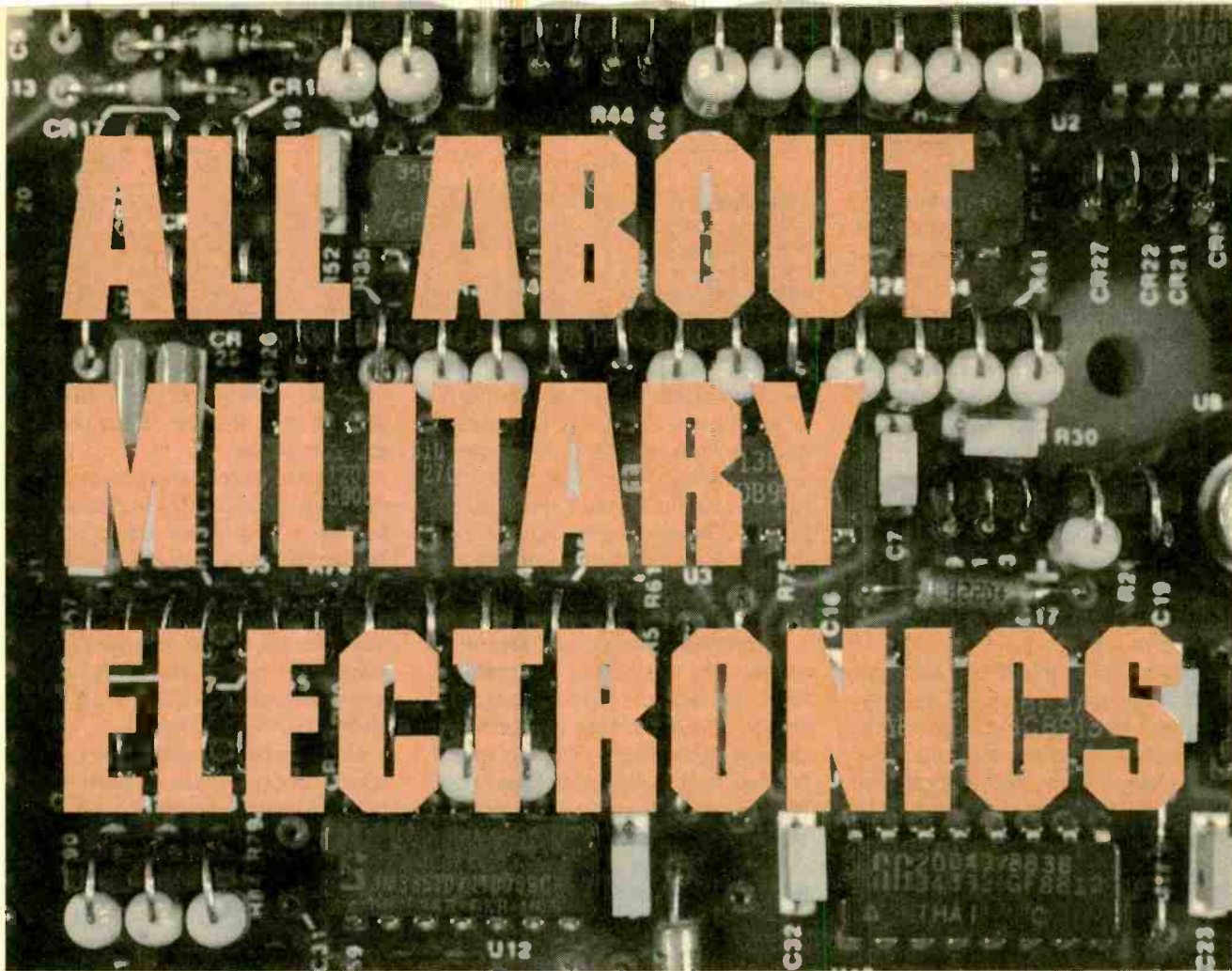

*We explore the exacting standards of the military and aerospace industries that make the electronics they use so expensive.*

BY CHARLES HANSEN

**A**nyone entering a career in the aerospace-electronics field will find that their circuit designs and component selections are tightly controlled by an imposing number of Military Specifications, or Mil-Specs. The specifications describe the types of components to be used, the derating factors that will be allowed to achieve good reliability, and the performance requirements for the final product. Furthermore, extensive documentation is required at defined intervals of the design, testing, and production phases of any such undertaking.

#### **What are Military Components?**

The components we refer to as Military Standard or "MIL-STD" parts do not come disguised in olive-drab camouflage. They are so named because they must conform to rigorous military specifications in order to be

designed into the "black boxes" used in aerospace equipment.

The military electronic environment is a difficult one. Black boxes are exposed to wide temperature and altitude variations, vibration, shock, acceleration, fungus, humidity, salt spray, sand and dust, and a hostile electromagnetic-interference (EMI) environment. They are also exposed to corrosive fluids such as fuels, hydraulic fluids, lubricants, and cleaning agents. Military components are hermetically sealed to resist the effects of these severe surroundings. The equipment is often packaged in sealed boxes to withstand this abuse, and packaging density is made high to ensure minimum weight. Aerospace-circuit designers are constantly pushing the state-of-the-art to obtain maximum performance from their designs.

Most of the basic devices available

as hobbyist parts are also available as military parts, sometimes called JAN (Joint Army-Navy) parts. The difference between the two lies in processing, packaging, and screening tests. With regard to screening, the yield for military-quality parts may be less than 50%. The less worthy parts are not completely useless since most will meet the less stringent limits for industrial and consumer applications, which have their own category.

Take the LM324A quad op-amp for instance. The military version is called the LM124A. It is housed in a more costly hermetically sealed, ceramic, dual in-line package, and operates from  $-55^{\circ}\text{C}$  to  $+125^{\circ}\text{C}$ . It also has better input offset, bias, CMRR, and gain specifications than the LM324A (see Table 1). Consequently, the cost of the LM124A is about ten times more than that of the LM324A.

The op-amps which fail to meet the

**TABLE 1—DIFFERENCES IN SPECIFICATIONS**

Parameter	LM124A	LM224A	LM324A
Maximum Input Bias Current (nA)	50	80	100
Maximum Input Offset Current (nA)	10	15	30
Maximum Input Offset Voltage (mV)	2	3	3
Minimum Large-Signal Gain (V/mV)	50	50	25
Minimum Common-Mode Rejection (dB)	70	70	65

military specifications may be assigned to the "extended" or "industrial" class and designated LM224. Those op-amps have an operating temperature range of  $-25^{\circ}\text{C}$  to  $+85^{\circ}\text{C}$  and performance specs somewhere between the LM124A and the LM324A. Parts which meet the most relaxed, or "commercial" specification limits become the LM324A in a plastic DIP package with an operating temperature range of  $0^{\circ}\text{C}$  to  $+70^{\circ}\text{C}$ . Some manufacturers also have an "automotive" grade of components, which, in terms of temperature-range and parameter specifications, lie somewhere between the military and industrial grades. A typical temperature range for automotive components is  $-40^{\circ}\text{C}$  to  $+85^{\circ}\text{C}$ .

Parts below commercial grade are sometimes sold in bulk lots to independent distributors who will determine what standards they do meet and market them accordingly. The lowest grade parts often appear in swap meets or as grab-bag packs.

**Further Requirements.** Since military circuit boards are covered with conformal coatings (such as polyurethane) to withstand harsh environments, parts replacement is difficult and requires special tools and training. For that reason only the best quality and highest reliability parts can be used. Quality is assured by testing at every step of the manufacturing process, both of the individual components and the final equipment.

However, a manufacturer must demonstrate reliability both by calculation and by extended operation of early prototypes in order to service the military. Theoretical reliability is assured by following conservative cir-

cuit-design practices that limit the electrical stress applied to the parts. Operational reliability is assured through "burn-in" testing at high stress levels to eliminate failures due to "infant mortality"—flaws that cause failures within the first few hours of operation. Such flaws are normally attributed to manufacturing, assembly, and packaging defects.

Burn-in testing includes a number of procedures to uncover a variety of flaws. For example high-temperature baking reveals surface-contaminant defects; temperature cycling might uncover seal, bond, or packaging defects; accelerated-life tests expose device-process defects; and poor electrical ratings at high temperatures indicate out-of-spec devices.

Devices that survive the burn-in program have a high probability of lasting a long time (as indicated by Fig. 1). The manufacturer is often required to ensure this high reliability by means of a warranty that may be as long as six years. Other guarantees, such as meeting a stringent mean time between unscheduled removal (MTBUR) may also apply.

**High Reliability Parts.** High-reliability (HI-REL) parts are military-grade components that undergo additional testing and burn-in to provide high mean-time-between-failure (MTBF) lifetimes. Integrated circuits

must comply with the MIL-M-38510 standard to be called HI-REL, or comply with class-S specs to be used in space missions.

Discrete semiconductors must meet MIL-S-19500 JAN-TX (Tested extra) levels for a Hi-Rel rating, or JAN-TXV for space or very Hi-Rel applications. Passive components each have their own Mil-Specs that qualifies them to be called Established Reliability (ER) parts. Failure rates range from "M-level" (1%/1000 hours) to "S-level" (0.001%/1000 hours).

Most modern military and aerospace programs now require the use of Hi-Rel parts. Even black boxes used in airline service must now have the high reliability that previously was only expected for flight-critical military equipment. Airliners, like military aircraft, have more computerized equipment than they did in the past. Computers have replaced many of the duties that were previously assigned to the flight engineer in older airliners, and the need for high reliability is greater than ever.

**Qualified Parts Suppliers.** Not just anyone can produce military parts. A rigorous qualification program and demonstration of reliability is required before a manufacturer is added to the Defense Electronics Supply Center (DESC) Qualified Parts List (QPL) which is the list of government-approved component suppliers.

Even after being selected as a QPL source, the vendor must continue to demonstrate and document quality and reliability. Vendors with problems in these areas can be removed from the QPL. When problems are discovered in the field, by the manufacturer or by government auditors from DESC, a GIDEP (Government-Industry Data Exchange Program) Alert is issued. The problems can range from simple paper-work errors to serious potential failures. If the problem is severe enough, the DESC Alert Coord-

*(Continued on page 90)*

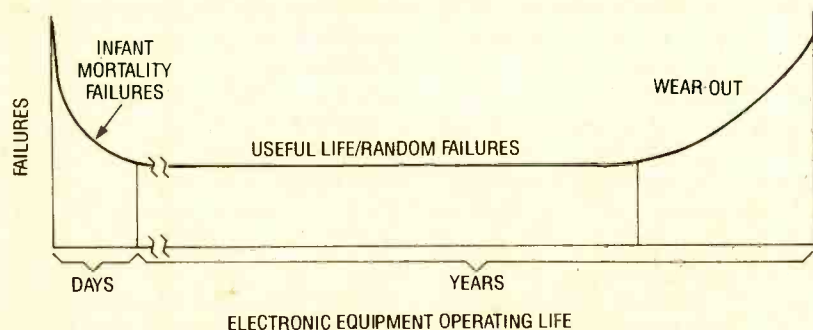

*Fig. 1. How a part failure is characterized depends very much on when it occurs. If it happens within the first few days of operation, it is attributed to a manufacturing defect. If it happens before the part's useful life should have ended, the failure is considered random. Anytime after that the part is simply thought to be worn out.*

**M**ost photographic processes require some form of timing. Traditionally, that task has been handled by a mechanically-controlled switch that's governed by a clock motor or similar device that is synchronized to the 50- or 60-Hz AC power line. Early electronic timers used a relay driven by a vacuum tube or transistor amplifier that, in turn, got its timing signal from a circuit that was dependent on a resistance-capacitance network.

Although either method usually

timer like the one described in this article. The timer, dubbed the *Digital Darkroom Timer*, features a 3-digit LED display that shows the user-set time interval that has been programmed (through thumbwheel switches) into the circuit.

Using the 60-Hz AC line as a clock source, the Digital Darkroom Timer allows time intervals to be set in 1 second increments with a maximum of 999 seconds or 0.1 second increments with a maximum of 99.9 seconds. Since most enlarger lamps take

switch (not shown in Fig. 1). When a timing sequence is initiated by pressing the START switch, the control latch is toggled. That enables the BCD counters, whose outputs are sent to the BCD-to-7-segment decoder/drivers, which are used to drive the 7-segment LED displays. During a timing cycle, the displays (which show the time left to the completion of the cycle) count down from the set interval to zero. When the zero count is reached,

*This programmable timer lets you precisely control exposure times during printing and enlarging, and doubles as a visual timer for developing and other darkroom tasks*

BY RUDOLF F. GRAF AND WILLIAM SHEETS

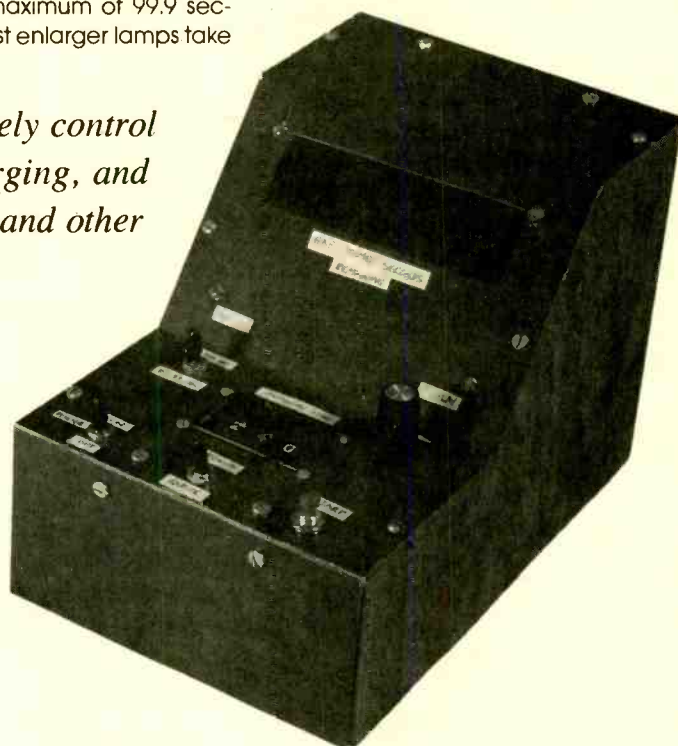

# Build a Precision Darkroom Timer

provided satisfactory results, they both lacked definite repeatability because the time-interval setting depended on an analog dial scale (or pointer setting). It's difficult to accurately repeat a given dial setting. That may not have been a problem where long time intervals (20 seconds or so) were involved. However, many of today's papers and certain photographic materials require short exposures—1 to 3 seconds. Because of that, the typical 0- to 60-second mechanical timer leaves much to be desired.

However, using a few commonly available components, you can build a fairly accurate programmable

100 to 200 milliseconds to turn fully on or fully off, the use of higher resolution than 0.1 second is of little value.

**Block Diagram.** Figure 1 shows a block diagram of the Digital Darkroom Timer, which is comprised of a clock generator, three BCD counters, three display drivers, three displays, a control latch, a power supply, and a power controller.

The clock generator produces a selectable 1-Hz (1-pulse per second) or 10-Hz (10-pulse per second) timebase for the 0-999- or 0-99.9-second ranges, respectively. The timing interval is programmed into the circuit through a 3-digit BCD thumbwheel

a signal is sent to the control latch, causing the circuit to reset.

The power controller, which is driven by the control latch, is used to control the AC power provided to the enlarger. DC power for the circuit's operation is supplied by a regulated power supply. A variable 0- to 12-volt source (tapped from a pre-regulation point in the power supply) acts as a brightness control for the LED displays.

**Circuit Discussion.** A detailed schematic diagram of the Digital Darkroom Timer is shown in Fig. 2. When S3 (the POWER switch) is turned on, the AC line voltage divides along two paths. In one path, the AC power

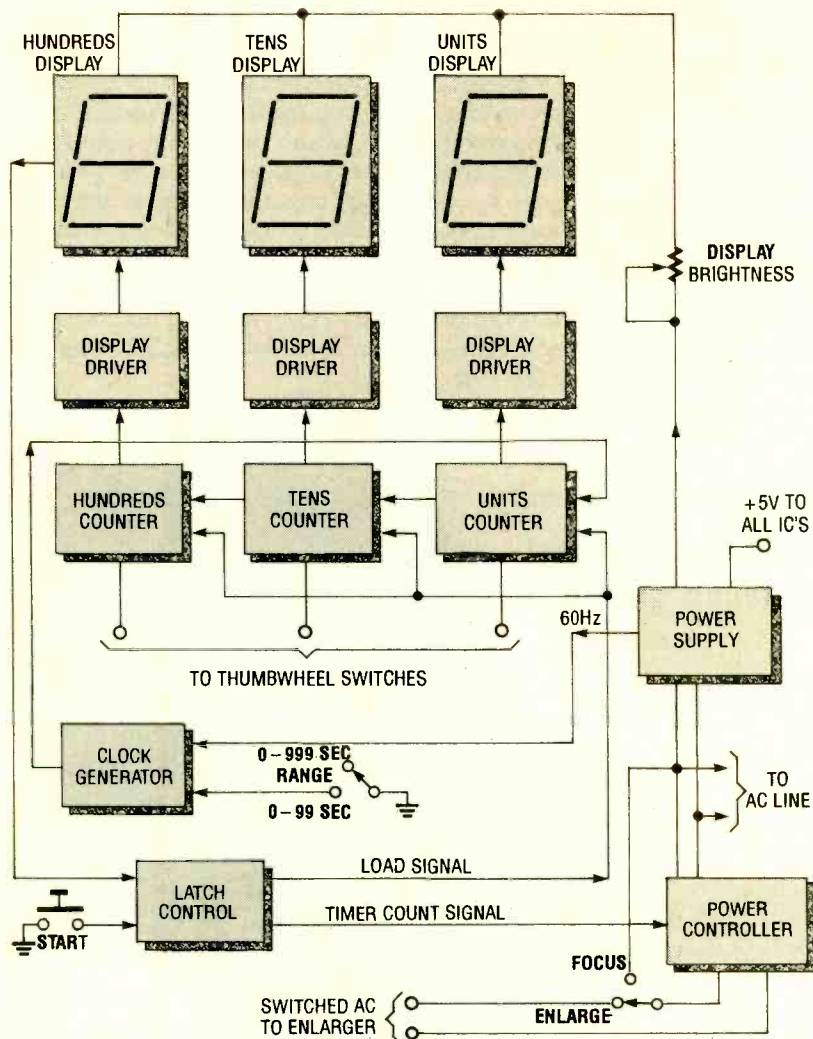

Fig. 1. The Digital Darkroom Timer is comprised of a clock generator, three BCD counters, three display drivers, three displays, a control latch power supply, and a power controller.

is applied to a regulated DC supply consisting of T1, a fullwave bridge rectifier formed by D1-D4 (four 1N4007 1-amp 1000-PIV rectifier diodes), and a 7805 5-volt 1-amp voltage regulator (U12). In the other path, AC is fed to a power control circuit that is comprised of S1, TR1, and SO1.

A 12-volt 60-Hz AC signal taken from the secondary of T1 is fed to an RC filter formed by R38 and C18. The filter removes line spikes that could cause erratic counts. From the filter, the 60-Hz signal is capacitively coupled (via C17) to the base of Q4. Transistor Q4's output (a 5-volt 60-Hz signal taken from its collector) is fed to a double-inverting buffer stage, consisting of U7-a and U7-b (half of a 7400 quad two-input NAND gate). The double-buffer circuit is used to provide a TTL compatible squarewave. That square-

wave signal is applied to U10—a 7492 divide-by-12 counter, configured for divide-by-6 operation.

That counter (U10) provides a 10-Hz output that divides into two paths; one going the speed-selection circuitry (comprised of U11, a 7400 quad two-input NAND gate, and a single-pole single-throw switch, S4) and the other to U9 (a 7490 decade counter/divider). That IC (U9) further divides the signal to provide a 1-Hz output that is also fed to the speed-selection circuitry.

The speed-selection circuitry deserves a bit of explaining. When S4 (RANGE) is closed, pin 2 of U11-a is pulled low, forcing its output high (regardless of the output state of U9). In essence, the low from switch S4 disables U11-a. The high output of U11-a is applied to pin 13 of U11-d as an enabling signal.

At the same time, pins 4 and 5 of U11-b are held low via S4, forcing its output at pin 6 high. That high is applied to pin 10 of U11-c, forcing its output high. As the output of U10 alternates between high and low states, the output of U11-c follows suit, producing a low output at pin 8 when pin 9 is high and *vice versa* when it's low. That signal is applied to pin 12 of U11-d, producing a 10-Hz squarewave signal at its output (pin 11). The low from switch S4 also pulls the decimal-point pin of DISP1 low, lighting the decimal point for a count of 99.9 to 0.

When S4 is open, the inputs to U11-b are pulled high via R35, forcing the output of that gate low. That low is applied to pin 10 of U11-c, forcing its output high, and effectively disabling that gate so that the output of U10 (which is applied to pin 9 of U11-c) is ignored (does not cause U11-c to change states). The high output of U11-c is fed to the pin 12 of U11-d, enabling it.

At that same time, pin 2 of U11-a is pulled high. That high enables U11-a so that its output goes low each time that the output of U9 goes high. Each time that the output of U11-a goes high, the output of U11-d is forced low, at a rate of 1 Hz. Because the decimal-point pin of DISP1 is now held high, the decimal point does not light. The display now counts down from 999 to 0.

Before S1 (START) is pressed, pin 11 of U4, U5, and U6 are held low, allowing the data (from three BCD switches, S5-S7) appearing at pins 15, 1, 10 and 9 of U4, U5, and U6 to be latched into the counters.

When S1 is pressed, pin 13 of U7-d is pulled low, causing its pin 11 output to go high. That high divides along two paths. In one path, that high is fed to pin 11 of U4, U5, and U6, preventing any new data from being latched into the counters. In the other path, that low is fed to pin 10 of U7-c. At the same time pin 4 of U1 (which is connected to pin 9 of U7-c) floats high, causing U7-c pin 8 to be low. That low is fed to the base of Q2, holding it off. With Q2 off, a bias current is applied to the base of Q3 through R29 and R30, causing it to turn on. Turning on Q3 activates U8, causing TR1 to fire, applying power to SO1 and any equipment that happens to be connected to it.

While that's going on, the square-wave output of U11-d (either 1 Hz or 10



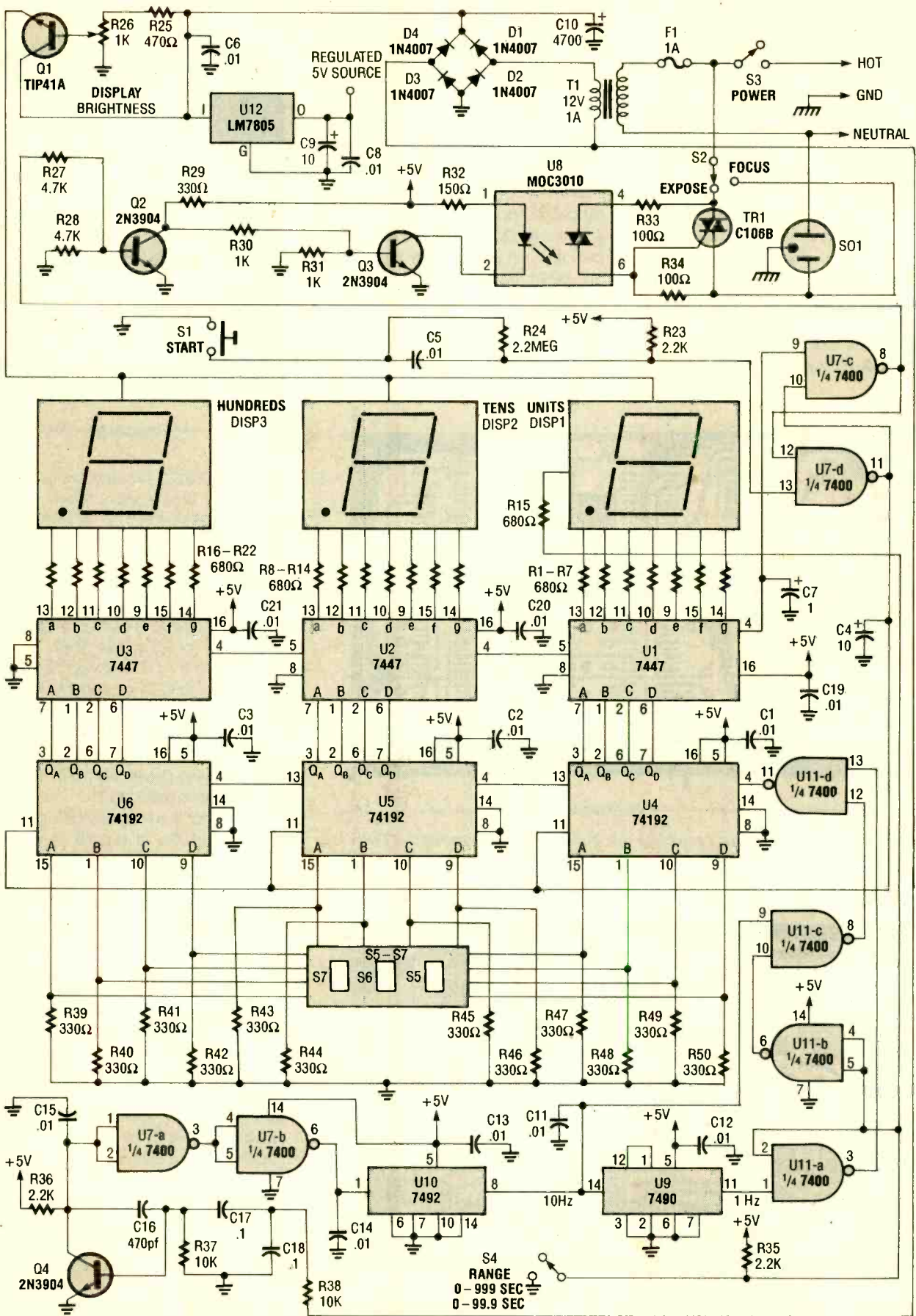

Fig. 2. The Digital Darkroom Timer uses a pair of counters in its speed-selection circuitry to provide selectable count ranges.

Hz, depending on S4's setting) is fed to the count-down input of U4 (the first of three 74192 BCD up/down counters) at pin 4. The squarewave signal causes U4 to count down one digit for each clock pulse received. Every tenth clock pulse causes U4 to output a borrow pulse at pin 13. That pulse is applied to U5's count-down input at pin 4, causing it to count down one digit for each clock pulse received. On the tenth count received by U5, that counter outputs a borrow pulse at pin 13 that is applied to U6 pin 4, causing it to count down one digit for each clock pulse received.

While all of that is going on, the counts of U4-U6 are transferred to three 7447 seven-segment decoder/drivers (U1-U3, respectively), which are used to decode the BCD input from their respective counters and light the appropriate segments of DISP1-DISP3. When U6 reaches zero, it outputs a ripple-blanking pulse at pin 4 that is fed to the ripple-blanking input of U5 at pin 5. While that's going on, DISP1 (the hundreds display) is blanked. As the count continues and U5 comes to its zero count, it too outputs a blanking pulse that is fed to U4, while U5's associated display (DISP2) is

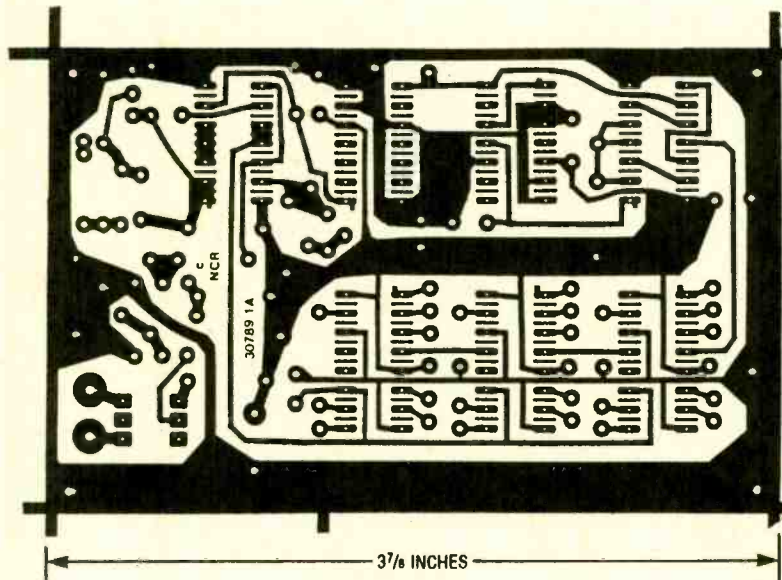

Fig. 3. The bulk of the author's prototype was built on three printed-circuit boards; a template for the first of those boards—the counter board—is shown here.

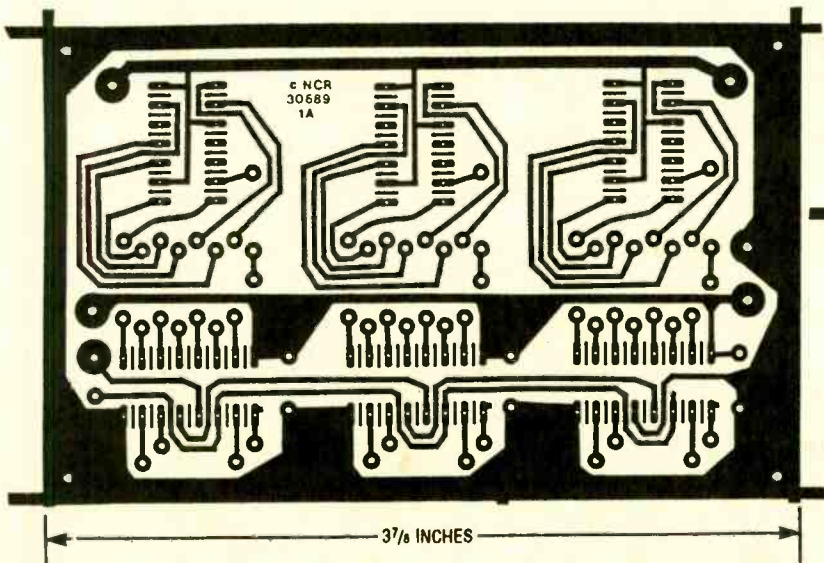

Fig. 4. The display board for the timer contains only the three display modules accompanied by their respective display drivers and other support circuitry.

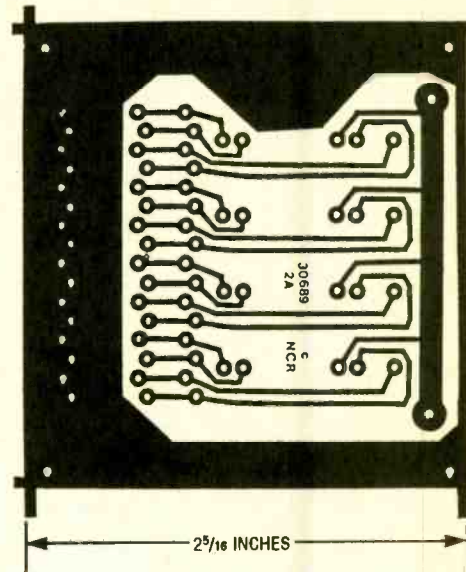

Fig. 5. The BCD-switch board may or may not be used in your project; it will be up to you to determine its worth in the overall scheme of the project.

blanked. When U4 reaches the zero count (and all displays are blanked), it outputs a blanking pulse at pin 4, pulling pin 9 of U7-c low. That, in turn, causes pin 8 of U7-c to go high. That high is fed to Q2, causing it to turn on. With Q2 turned on, Q3 is deprived of base bias, causing it to turn off, cutting off U8. That, in turn, causes TR1 to turn off, removing power from SO1 and the device connected to it.

Power for the majority of the circuit is provided by a simple regulated power supply, comprised of F1, T1, D1-D4, C6, C8, C9, C10, and U12; the display is powered from an unregulated 0-12-volt DC source built around Q1, R25, and R26. Transistor Q1, along with R26, forms a brightness control for the display. Resistor R25 is used to limit the maximum voltage that can be applied to the display.

**Construction.** The bulk of the author's prototype was built on three printed-circuit boards; the counter board, the display board, and the BCD-switch board. The remaining components—S1-S4, R26, and the power-supply components (including SO1, T1, Q1, TR1, and U12)—were mounted to an inside wall of the project's enclosure or to the enclosure's front panel.

Printed-circuit templates of the board patterns used in the construction of the author's prototype are

## PARTS LIST FOR THE DIGITAL DARKROOM TIMER

### SEMICONDUCTORS

U1-U3—7447 BCD-to-7-segment decoder/driver, integrated circuit  
 U4-U6—74192, 74LS192, or equivalent, programmable up/down counter, integrated circuit  
 U7, U11—7400 quad 2-input NAND gate, integrated circuit  
 U8—MOC3010 optoisolator/coupler Triac driver, integrated circuit  
 U9—7490, decade counter/divider, integrated circuit  
 U10—7492 divide-by-12 counter, integrated circuit  
 U12—LM7805 5-volt, 1-amp regulator, integrated circuit  
 Q1—TIP41A NPN silicon, power transistor  
 Q2-Q4—2N3904 general-purpose NPN silicon transistor  
 TR1—C106B or similar 4-amp, 200-PIV Triac  
 DI-D4—1N4007 1-amp, 1000-PIV, rectifier diode

DISP1-DISP3—MAN74 or similar, common-anode, 7-segment LED display

### RESISTORS

(All fixed resistors are 1/4-watt, 5% units.)  
 R1-R22—680-ohm  
 R23, R35, R36—2200-ohm  
 R24—2.2-megohm  
 R25—470-ohm  
 R26—1000-ohm linear-taper potentiometer  
 R27, R28—4700-ohm  
 R29, R39-R50—330-ohm  
 R30, R31—1000-ohm  
 R32—150-ohm  
 R33, R34—100-ohm  
 R37, R38—10,000-ohm

### CAPACITORS

C1-C3, C5, C6, C8, C11-C15, C19-C21—.01- $\mu$ F, ceramic-disc  
 C4, C9—10- $\mu$ F, 16-WVDC, electrolytic  
 C7—1- $\mu$ F, 16-WVDC, electrolytic  
 C10—4700- $\mu$ F, 16-WVDC, electrolytic  
 C16—470-pF, ceramic-disc  
 C17, C18—0.1- $\mu$ F, 50-WVDC, Mylar

### SWITCHES

S1—Normally open pushbutton (or toggle)  
 S2—SPDT toggle  
 S3, S4—SPST toggle  
 S5-S7—Thumbwheel switches, BCD output

### ADDITIONAL PARTS AND MATERIALS

T1—12-volt, 1-amp (or more) power transformer  
 SO1—AC outlet (panel mount)  
 F1—1-amp pigtail fuse  
 Printed-circuit board materials, enclosure, molded AC power plug with line cord, wire, solder, hardware, etc.

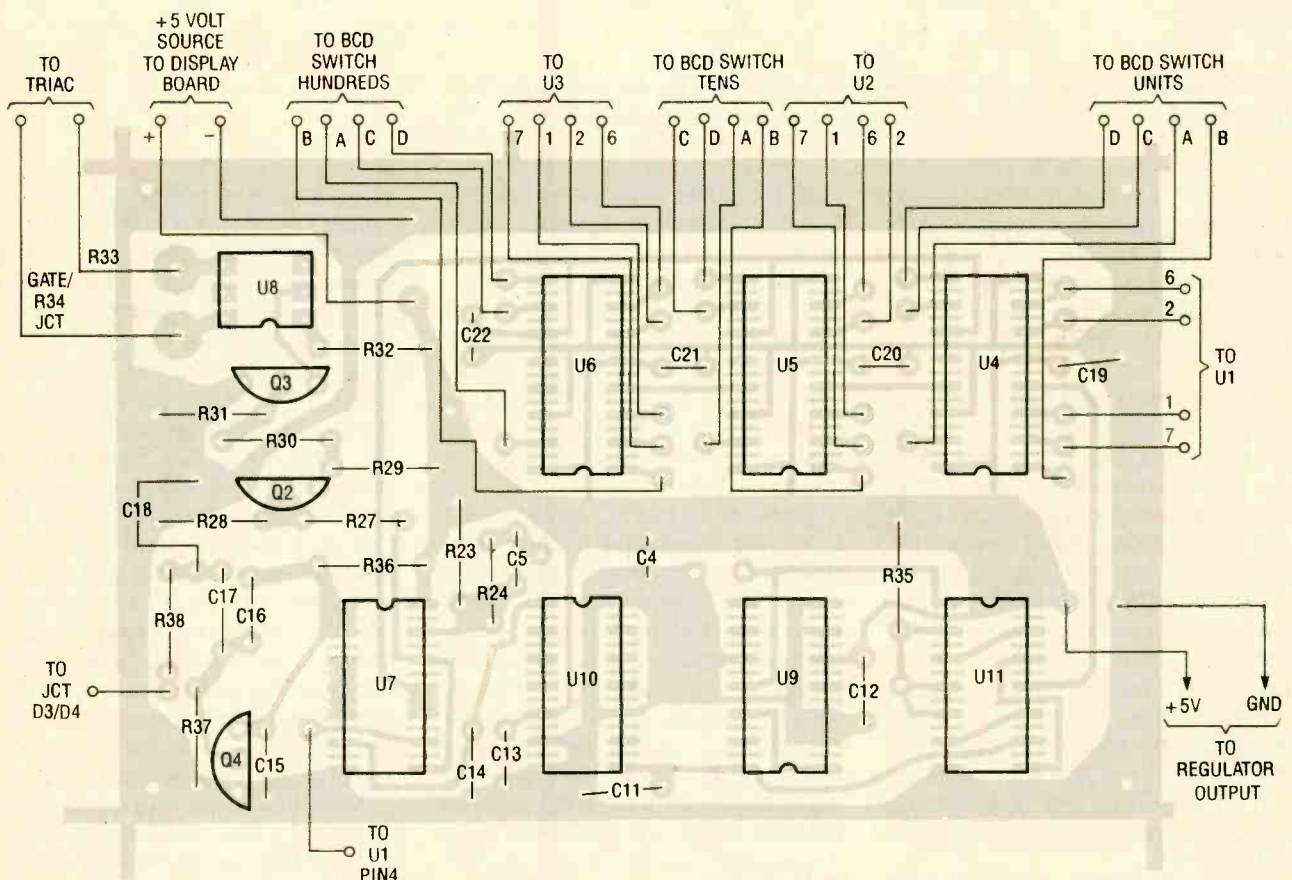

Fig. 6. Install sockets on the counter board where indicated in this parts-placement diagram, but do not place the IC's in their respective sockets until instructed to do so. After the IC sockets, install the passive components, followed by the semiconductors.

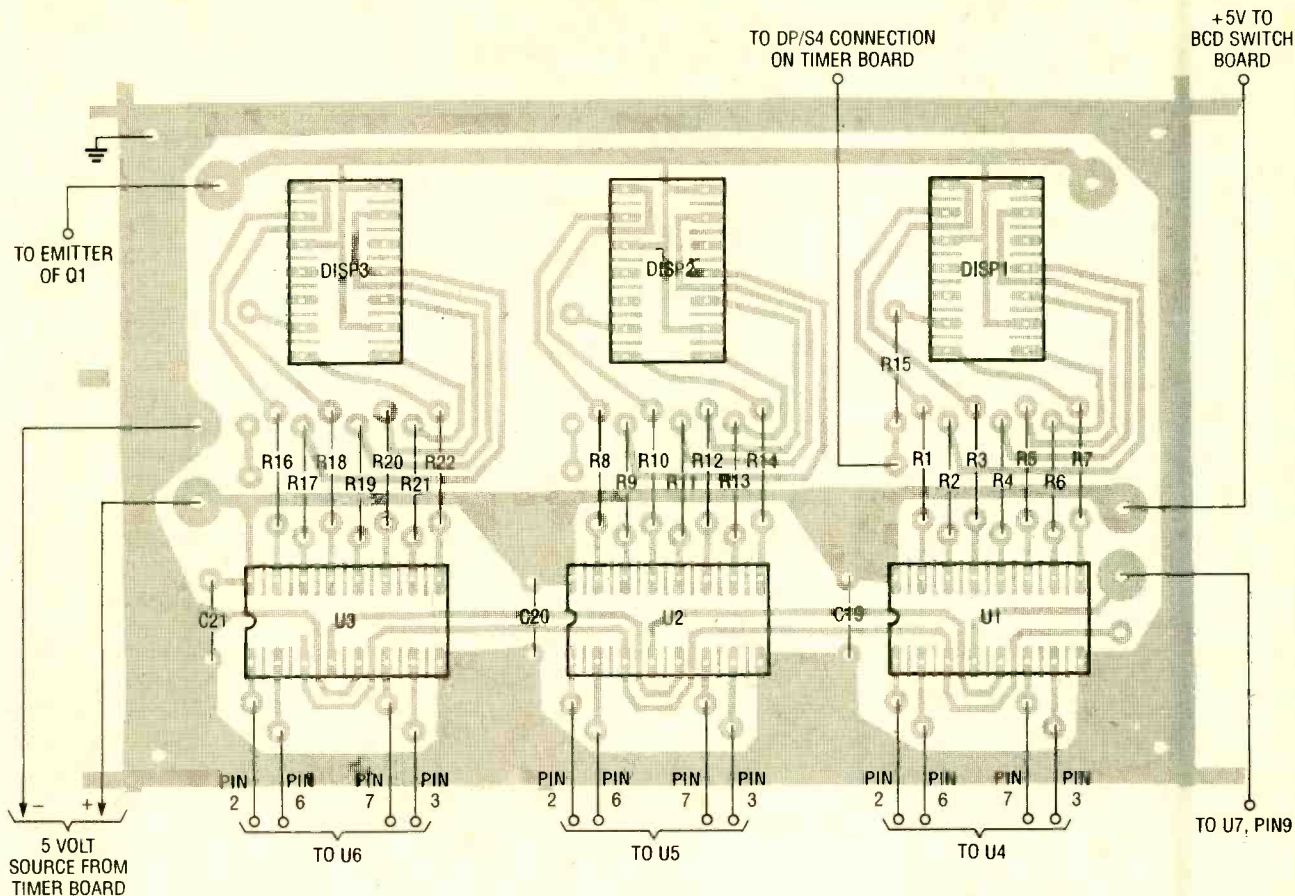

Fig. 7. Follow the same assembly procedure when populating the display board; i.e., IC sockets, followed by the passive components, and then the semiconductors.

shown in Fig. 3 (the counter board), Fig. 4 (the display board), and Fig. 5 (the BCD-switch board). Once you have etched the three printed-circuit boards, and gathered the parts listed in the Parts List, construction can begin.

It is recommended that sockets be provided for all of the IC's. Starting with the counter board (Fig. 3), install sockets where indicated in the parts-placement diagram shown in Fig. 6, but do not place the IC's in their respective sockets until instructed to do so. After the IC sockets, install the passive components, followed by the semiconductors. Once all the parts have been installed, check your work for errors. When you are satisfied that the circuit contains no errors, place the board to the side and populate the display board (Fig. 4) guided by the parts-placement diagram shown in Fig. 7.

Upon completion of the display board, check the board for errors, and when you are satisfied with your

work, place the display board to the side and assemble the BCD switch board. A parts-placement diagram for the BCD-switch board is shown in Fig. 8. Note that the BCD switch that you select for your project may not fit the PC pattern shown in Fig. 5; in that case, it will be necessary to mount the BCD switch to the enclosure and run wires from the switch to the appropriate switch-board pads.

Once all of the PC boards have been fully assembled (excluding installing the IC's in their sockets), give the individual boards a final check against the three parts-placement diagrams in Figs. 6, 7, and 8, and then prepare the enclosure that will house your timer project. In preparing the enclosure, it will be necessary to make a cut-out in the front panel of the enclosure for the display, and drill holes for S1-S4 and R26. When that's completed, begin preparing the power supply.

Next, mount the power-supply components to one of the inner walls

of the enclosure, and wire the power supply together guided by Fig. 2. In the author's prototype, much of the power supply was assembled on a pair of 6-terminal solder-eye barrier strips. Components SO1, T1, Q1, TR1, and U12 were mounted to a metal panel at the rear of the enclosure. In the prototype, the metal panel serves as a heat sink for Q1, TR1, and U12; if the same scheme is used in your timer, it will be necessary to first smear the tabs of those components with silicon heat-sinking compound, and then insulate the tabs of the components from the metal panel with the appropriate mica insulators. Components R26 and S1-S4 were mounted to the front panel of the enclosure, and connected to the circuit-board assemblies through insulated hook-up wire.

When the power supply has been completed and checked for errors, wire the four subassemblies together, guided by Figs. 6, 7, and 8. If you have any problem with how those circuits

(Continued on page 89)

# Alexander Popov:

**T**he date was May 7, 1895 and the occasion was a meeting of the Russian Physical and Chemical Society held in the (then) capital city of St. Petersburg. On this day, Alexander Popov presented a demonstration that would become recognized as a historic achievement. This demonstration, together with another by Popov that reportedly took place the following year, would eventually produce controversy among historians concerning whether the credit for inventing radio should be given to Marconi or to Popov.

Those in attendance for Popov's May 7 presentation were very much impressed when he demonstrated a receiver that could detect the electromagnetic waves produced by lightning discharges in the atmosphere many miles away. The value the instrument had for weather forecasting was obvious.

Only seven years earlier, Heinrich Hertz had conducted laboratory experiments in Germany that conclusively demonstrated that the electromagnetic waves predicted by James Clerk Maxwell in 1865 actually do exist. Prior to Popov's work, however, few practical uses for those electromagnetic or "Hertzian" waves had been found.

Popov's receiver consisted of a "metal-filings coherer" he had developed as the detector, an antenna, a relay, and a bell. The relay was used to activate the bell that both announced the occurrence of a lightning discharge and served as a "decoherer" (tapper) to prepare the coherer to detect the next lightning discharge.

While this demonstration by Popov did not involve the transmission and reception of a message, it nonetheless was a significant scientific achievement for that time.

**First Wireless Telegraphy?** Reports also exist that some ten months later on March 24, 1896 Alexander Popov demonstrated the transmission and



## Russia's Radio Pioneer

*Did a Russian scientist beat Marconi to the punch? We present the facts so you can decide for yourself.*

BY JAMES P. RYBAK

reception of information by wireless telegraphy. The occasion was another meeting of the Russian Physical and Chemical Society and the location was St. Petersburg University. Wireless-telegraph signals, transmitted a distance of over 800 feet from another building on the campus, were audible to all in the meeting room.

The President of the Society, F. F. Petrushevsky, stood at a blackboard holding a paper on which a listing of the letters of the alphabet and their equivalents in Morse Code were writ-

ten. As the signals were received, Petrushevsky referred to the paper and wrote the appropriate letter on the blackboard. The letters spelled out the name "Heinrich Hertz."

Unfortunately, no written record was made at the time of this wireless telegraphy demonstration to provide documentation for historical purposes. The reports of the event that do exist are based on the recollections of several persons present at the time, but were not recorded until almost thirty years later.

**Who was First?** Marconi's first wireless patent application was filed in England on June 2, 1896 and his first public demonstration of wireless signaling to a group of scientists took place in July of that year. Both events occurred after the March 24 date claimed for Popov's transmission and reception of the words "Heinrich Hertz." It seems clear to most present day American and European historians, however, that Marconi's work had achieved a significant level of development, including the unpublicized transmission and reception of simple messages, prior to March 24.

Historians from the former Soviet Union have maintained for many years that Alexander Popov, not Guglielmo Marconi, should be recognized as radio's "inventor." Their claim, however, is based largely on his well documented May 7, 1895 demonstration of a lightning detecting receiver rather than on the later

and less well documented demonstration. Each year on May 7, "Radio Day" is still celebrated with considerable enthusiasm there in recognition of Popov's achievements.

Determining who has claim to the title "Inventor of Radio" is complicated somewhat by issues of nationalistic pride, inadequate documentation of events, and differing interpretations of what constitutes "inventing" radio. By what most persons in the West consider objective analysis of the facts known, however, Marconi's work invar-

ably is recognized as having priority over Popov's. Nonetheless, Popov's numerous achievements do merit both recognition and respect.

### **Ural Mountain Beginnings.**

Alexander Stepanovich Popov was born on March 16, 1859 in the village of Turinsk in the Ural Mountains. As a boy, Alex was intrigued by the many types of iron mining and manufacturing machines he saw functioning in the vicinity. He often spent his spare time building small but quite sophisticated working models of the water-powered machines he had seen. Very early in his life, Alex became interested in the study of natural science.

Popov's father was a priest who encouraged all seven of his children to get a good education. Alexander completed his elementary education in two years and then entered the seminary at Perm. The seminary provided him with a good education in the natural sciences and mathematics as well as in theology. It was here that Alexander Popov became fascinated by the study of physics.

After completing his seminary education, Popov enrolled in the St. Petersburg University to continue his study of physics. The curriculum at the University was modern and heavily emphasized the practical applications of scientific principles.

### **An Excellent Experimentalist.**

Alexander Popov excelled at experimental work. He seemed to have a natural aptitude and love for designing and building laboratory equipment. Popov spent every available moment conducting experimental investigations with the equipment he built. Scientific knowledge concerning electricity was expanding rapidly in the 1880's. This was the area of physics Popov knew he wanted to pursue.

The superior experimental research talents of Alexander Popov were readily apparent to the physics faculty at St. Petersburg University. Upon graduating in 1882, he was offered the opportunity to stay on at the University as a laboratory assistant. Alex readily accepted the position because it enabled him to remain close to the laboratories and the work he loved.

Funds for teaching and research at the University were meager, however. Popov, having a family to support, accepted a more promising position in 1883 at the Russian Navy's Torpedo School located at Kronstadt. The Kronstadt naval base located on Kotlin Island in the Gulf of Finland was the home of Russia's Baltic fleet.

The Torpedo School offered an outstanding program of study in applied physics for naval electricians (electrical engineers) and torpedo officers. It had the best scientific library and

physics laboratories in Russia. Here Popov found the better environment for experimental research he wanted and needed. His early laboratory investigations at Kronstadt involved magnetic phenomena and electrical heating effects in metals.

**Electrical Sparks of Interest.** In the late 1880's, the use of electrical power on ships was beginning to be introduced in Russia. A problem was soon noted when electrical wiring was routed along the metal hulls of the ships. Sparks that damaged the electrical insulation were observed where they were least expected.

Popov determined that the sparking was due to large voltages produced by unanticipated high-frequency oscillations. Today, we would identify resonance as the cause of the sparking. At the time, however, the phenomenon of electrical resonance was not understood.

These findings turned Popov's interests toward the practical applications of high-frequency currents and the invisible electromagnetic waves produced by those currents. Very quickly, Popov became aware that Hertzian-wave theory might well provide a means for finding solutions to many electrical-engineering problems.

**Popov Visits Chicago.** Popov's knowledge of electrical research around the world was not limited to what he read in foreign journals. In 1893, he was sent as the representative of the Torpedo School to the Chicago World Exhibition where the latest developments related to the generation, distribution, and utilization of electrical energy were on display. While in the United States, Popov also took the opportunity to visit factories and laboratories where numerous other recent achievements in the rapidly developing field of electrical technology could be seen first hand.

Among even the most optimistic electrical visionaries of the early 1890's, the idea that electromagnetic waves might someday enable telegraphy without wires was little more than a wild fantasy. After all, the electromagnetic waves being generated at that time could be detected at distances of only a few feet, not the many miles that would be necessary to make wireless telegraphy a prac-

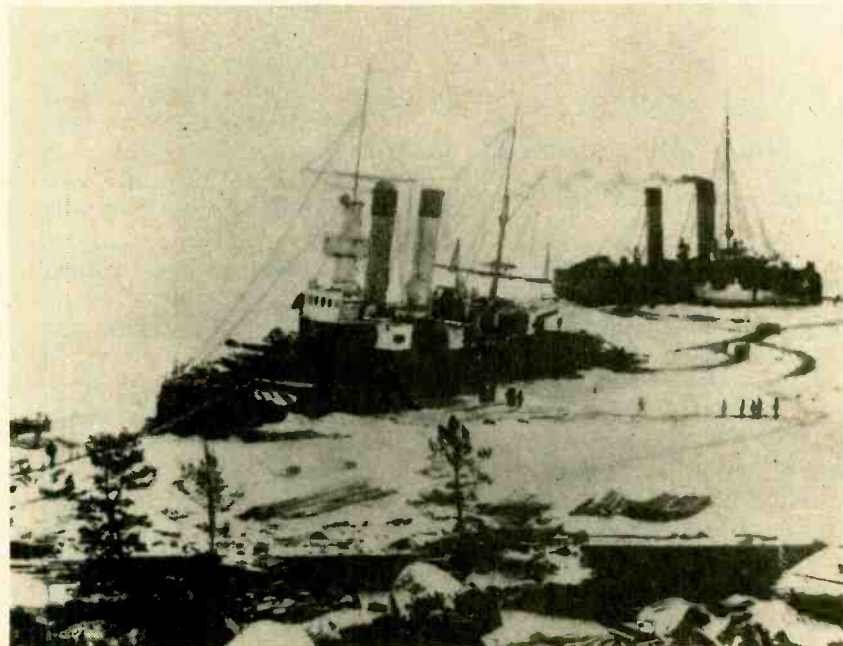

*This photo shows the General-Admiral Apraksin aground on Gogland Island with the icebreaker Yermak in the background.*

tical reality. Fortunately, Popov was both a visionary and an excellent experimenter who would not be easily discouraged by seemingly insurmountable obstacles.

**Development of a Detector.** By 1894, Popov had succeeded in making a reliable generator of electromagnetic waves. The receiving or detecting systems in common use, however, were not at all satisfactory. The problem of finding a detector that was both sensitive and reliable was one that plagued all who experimented with Hertzian waves at that time.

Heinrich Hertz had used a wire-loop resonator equipped with an adjustable spark gap as a detector when he demonstrated the existence of electromagnetic waves in 1888. Two years later, the French scientist Edouard Branly observed that the electrical resistance of fine metal particles decreased dramatically when a spark discharge occurred nearby.

A non-conducting tube containing metal particles packed between two electrodes came to be known as a "Branly tube" detector. It was a much more sensitive detector than was Hertz's wire loop. However, the metal particles in the Branly tube had to be shaken or "tapped back" between each electrical discharge in order to restore the detecting ability of the tube.

Oliver Lodge, an English physicist, noticed in 1892 that the contact between two small metal spheres, barely touching each other, ordinarily was not sufficient to permit a current to flow. However, when a spark discharge occurred near them, the spheres became fused together and current could easily flow through the junction. The spheres would remain joined until lightly tapped.

Lodge called the phenomenon he had observed the "coherer" effect. Initially, he was unaware that he was observing the same effect noted by Branly. Like Branly, Lodge at first saw no use for the effect. Very soon, however, Lodge realized that the coherer effect both Branly and he had observed could be utilized to detect the presence of the electromagnetic waves produced by a distant spark discharge.

In 1894, Lodge publicly demon-

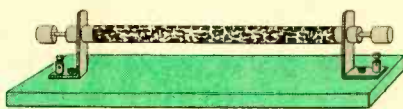

*Fig. 1. The coherer tube (above) used by Oliver Lodge was a modification of the "Branly tube" detector.*

strated to a group of noted scientists the detection of electromagnetic waves by means of a metal-sphere coherer located a distance of 60 yards from a transmitter. However, at the time the idea that wireless telegraphy might be possible never occurred to him or, apparently, to anyone else who witnessed his demonstration.

It was obvious to Lodge that Branly's tube of metal filings was a more convenient detection device than was his own arrangement of metal spheres. Lodge improved the coherer tube's operation as a detector by using as the metal particles the relatively coarse chips produced when iron is drilled.

Oliver Lodge also found that the amount of pressure exerted by the electrodes on the metal particles affected the coherer's performance. Loosely packed particles between metal plugs in a glass tube 6 to 8 cm long and approximately 1 cm in diameter worked best for Lodge.

Lodge mounted the tube containing the metal particles on a stand, which also supported an electric bell. The bell was activated when a Hertzian wave caused the coherer to conduct. The mechanical vibrations from the bell traveled through the stand and "decohered" the metal particles in the coherer tube making them ready to detect the arrival of the next electromagnetic wave.

The transmission of vibrations through the stand was not always a reliable way to restore the detecting ability of the coherer. Lodge later used a clock mechanism to provide an automatic and more dependable tapping back of the metal particles.

### **Popov Refines the Coherer.**

Alexander Popov had read of Lodge's work in scientific journals. Popov further improved the sensitivity of the coherer tube and developed a signal-actuated tapping mechanism for re-

storing its detecting ability. He found through experimentation that platinum foil electrodes together with iron powder of a particular fineness resulted in increased sensitivity of his coherer tube.

The "tapping back" arrangement Popov devised was comprised of a relay and a doorbell mechanism. When the coherer tube was made highly conductive due to the presence of a Hertzian wave, a DC signal was produced to close the relay. The closed relay, in turn, allowed current to flow to the bell mechanism. The bell hammer struck the bell on the first half of its cyclic motion and gently struck or tapped the coherer tube on the second half.

Tapping the coherer tube in this manner reliably decohered the iron powder, causing its resistance to increase to its original high level. That reduced the current through the relay to the point where the relay contacts opened and the bell mechanism was no longer activated. Thus, an electromagnetic wave was signaled by the bell and also made the coherer ready to detect the next wave.

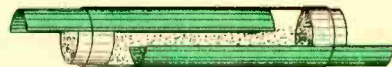

*Fig. 2. Popov's improved coherer utilized platinum-foil electrodes and iron powder.*

**A Lightning Detector.** Popov found that he could detect distant atmospheric lightning discharges by connecting one end of the coherer to a wire antenna and the other end to a good earth ground. The coherer and the relay also were used to activate a pen-based recording device. The pen made a mark on a slowly rotating cylinder when a lightning discharge occurred.

It was this lightning detection apparatus that Popov demonstrated to the members of the Russian Physical and Chemical Society on May 7, 1895. Later that same summer, he set up his thunderstorm detecting and recording instrument at the Institute of Forestry in St. Petersburg. With Popov's equipment, lightning discharges occurring as far as 20 miles away were detected.

During 1896, teaching respon-

periments with the recently discovered Roentgen rays (X-rays) kept Popov busy. He had little time to devote to new electromagnetic-wave experiments. However, it was during this year that the demonstration resulting in the transmission of the words "Heinrich Hertz" is reported to have occurred.

Unfortunately, no recollections of this demonstration by those in attendance were recorded until almost thirty years had passed. The writing of these recollections in 1925 coincided with the first earnest attempts by the Soviet Union to claim that Popov's use of electromagnetic waves for signaling preceded that of Marconi.

### News of Foreign Wireless.

Beginning in October of 1896, articles appeared in Russian newspapers concerning the experiments that were being conducted in other countries to develop practical wireless telegraphy. Upon reading those articles, Popov was both surprised and

somewhat annoyed by the way journalists were treating this "news."

What was being reported with great interest by the press were two announcements made at the recent meeting in Liverpool, England of the British Association for the Advancement of Science. The first announcement reported was that J. C. Bose, whose laboratory was in Calcutta, had demonstrated an instrument for the detection of Hertzian waves.

A description of Bose's work already had appeared in the scientific journals which Popov read regularly. Popov knew that Bose's instrument was very similar to the one he himself had been using for over a year at the Institute of Forestry to detect lightning discharges. There was nothing new in Bose's work as far as Popov was concerned.

The second announcement of interest at the Liverpool meeting had been made by William Preece, chief engineer for the British Post Office. He reported that a Mr. Marconi, from Italy,

recently had come to England and had succeeded in sending telegraph signals a distance of one and one-quarter miles without wires.

**Popov Mystified.** Alexander Popov could not understand why so much attention was being given to Marconi. For some time, Popov had maintained that wireless telegraphy would one day be a reality.

The demonstration of his thunderstorm-detecting instrument to the Russian Physical and Chemical Society that occurred on May 7, 1895 had been described by Popov in the January 1896 edition of that organization's journal. At the end of the article, Popov had stated: "In conclusion, I may express the hope that my apparatus, when further perfected, may be used for the transmission of signals to a distance by means of rapid electric vibrations if only a source of such vibrations can be found possessing sufficient energy."

In the process of developing his lightning discharge detector, Popov very apparently had tried to send wireless signals (but evidently not "messages") over extended distances as early as 1895, but found the range attainable to be limited. Popov incorrectly had assumed that transmitter power, rather than receiver sensitivity, was the important factor in establishing wireless telegraphy.

Popov was somewhat irritated when he read of the attention that was now being paid to Marconi's wireless-telegraphy achievements. He knew that his own earlier work was very similar to that for which Marconi now was getting loud acclaim. The feelings of irritation Popov felt, however, were directed at himself, not toward Marconi. Popov knew he should have pursued his own wireless work more vigorously and with greater persistence.

Popov felt no personal resentment toward Marconi. In 1902 when Marconi visited Kronstadt, Popov met with him and the two wireless pioneers had a very cordial discussion. Marconi later received a silver samovar and a sealskin coat from Popov as wedding presents. Popov was much too much of a true scientist and a gentleman to harbor personal grudges over the legitimate scientific successes of another.

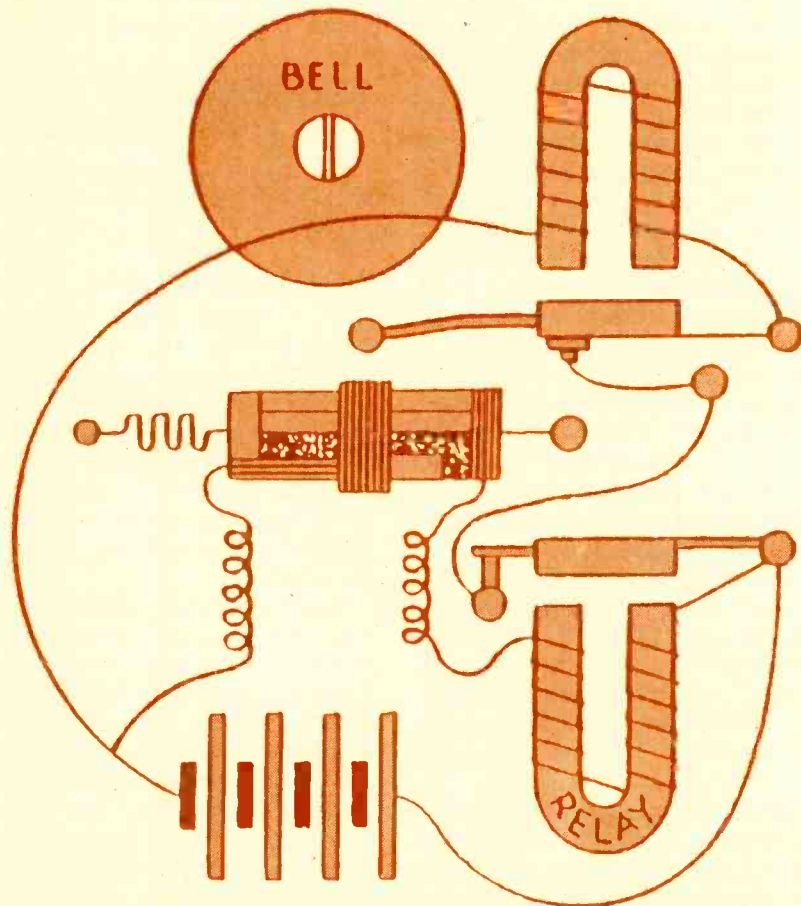

Fig. 3. Popov's lightning-discharge detecting receiver utilized his improved coherer with the "tapping back" arrangement shown here.



**Why Didn't Popov Act?** It is claimed by his proponents that Popov conceived of the principles of wireless and even demonstrated it in rudimentary fashion prior to Marconi. Why then is it that Popov, unlike Marconi, did not refine and promote his concept?

Alexander Popov was first and foremost an academician, not an entrepreneur. He loved to learn and he loved to help others to learn. Knowledge and understanding of the physical principles which governed the world in which he lived was Popov's goal.

Popov believed in science for the sake of science, not in science for personal profit. Limiting the ability of others to make use of scientific discovery by filing for protective patents was a concept foreign to Popov.

Personal modesty and a reserved nature also were strong characteristics of Popov. He was reluctant to describe his scientific achievements to others for fear he would be thought of as a braggart and self-promoting. Popov was particularly reluctant to describe to others any accomplishment of his that was still in its preliminary stages. The thought of orchestrating a scientific demonstration in order to make headlines in the newspapers and receive public recognition probably would have turned Popov's stomach.

Marconi, on the other hand, was truly an entrepreneur. He enjoyed the challenge of developing technology to produce things the world needed and would buy. Obtaining patent protection for the technology he developed was critically important for protecting his investment of time and money.

Another important element for success as an entrepreneur is getting public recognition for the product and the company producing it. Marconi understood this well and acted accordingly. He seldom missed an opportunity to have the press report a demonstration he had given of his scientific achievements. Marconi understood human nature as well as he understood technology.

While Popov thoroughly enjoyed his scientific research and devoted countless hours to it, he did not approach it with a sense of urgency. Developing wireless telegraphy was of



*The U.S.S.R. issued this stamp to commemorate Popov's 1895 demonstration of a lightning-discharge detecting receiver.*

great interest to Popov, but so were other scientific topics such as the newly discovered Roentgen rays.

Marconi, in contrast, was single-minded in his determination to develop wireless telegraphy into a commercially useful technology. His goal was not to merely bring new scientific knowledge to the world. Rather, Marconi sought to provide the world with a new technology that would serve a need and bring to him both fame and fortune. He had to pursue his goal without delay lest someone else achieve it first. Marconi not only believed that signaling without wires was possible, he had the vision and will to make that belief a reality.

**Marconi's Breakthrough.** The differences in attitudes and motivations

between the two men were important in determining the way each approached his work. However, it probably was a key scientific observation made by Marconi early in his work that ultimately enabled his continued progress and success in perfecting wireless telegraphy. Marconi had discovered that if both his receiver and transmitter were each connected to earth grounds and wire antennas, the distances over which electromagnetic waves could be sent and detected increased tremendously.

Popov, however, seemingly did not realize at first that the earth ground and antenna connections that enabled his receiver to function well when detecting lightning discharges, were also critically important to his transmitter's operation. Without that

realization, Popov could not send electromagnetic waves over significant distances. Perhaps this lack of success at transmitting signals over significant distances helps explain why Popov shifted his attention to other work during much of 1896.

The publicity accorded to Marconi abruptly shook Popov out of whatever state of inaction he was in concerning his own wireless telegraphy work. Popov now undertook a deliberate effort to make his earlier wireless accomplishments better known to other Russian scientists. He also resumed in earnest his own work toward the development of a practical wireless telegraphy system.

When specific details of Marconi's 1896 work were published in 1897, it became apparent that Marconi's receiver was very similar to the one that Popov had used to detect lightning discharges in 1895. However, there never was any accusation on Popov's part that Marconi had copied his receiver design. Unquestionably, Marconi knew nothing of Popov's work.

The coherer was the only practical detector of Hertzian waves then available and the published reports of its use as such by Lodge were known to both Marconi and Popov. It is not surprising, therefore, that both Popov and Marconi would develop nearly identical receivers.

**Popov's Demonstrations.** Popov wanted to demonstrate the value wireless could have for communicating with and between ships to the Russian Navy. The Tsar's admiralty responded slowly to his offers to demonstrate the capabilities of wireless. By 1899, however, Popov had successfully carried out demonstrations of wireless telegraphy communications to a distance of 20 miles between ships of the Black Sea fleet.

If the Russian Navy had any remaining doubts concerning the value of wireless telegraphy, they were dispelled when the battleship General-Admiral Apraksin ran aground on Gogland Island in the Gulf of Finland in November of 1899. No direct means of communication existed between Gogland Island and the mainland. Word of the Apraksin's predicament had been relayed by another ship.

Efforts to free the ship had to be

## Books and Articles

*The Principles of Electric Wave Telegraphy*, J.A. Fleming, Longmans-Green & Co., 1906.

*My Father Marconi*, Degna Marconi, Frederick Muller Ltd., 1962.

"An Application of the Coherer," A. Popov, *The Electrician*, vol. 40, pg. 235, December 10, 1897.

"Apparatus for the Detection and Registration of Electrical Vibrations," A. Popov, *The Electrical Review* (London), vol. 47, pg. 845, November 23, 1900.

*Alexander Popov—Inventor of Radio*, M. Radovsky, Foreign Languages Publishing House, 1957.

"Marconi, Popov and the Dawn of Radio-communication," R.L. Smith-Rose, *Electronics and Power*, vol. 10, pg. 76, March, 1964.

"Popov and the Beginnings of Radiotelegraphy," Charles Susskind, *Proceedings of the Institute of Radio Engineers*, vol. 50, pg. 2036, October, 1962.

started immediately. The crew of the Apraksin was in no immediate danger, but the water in the Gulf was beginning to freeze. If the ship survived without serious damage until spring, it likely would be crushed by ice floes.

Because the Gulf was beginning to freeze, it was not possible to lay a submarine cable to communicate with the ship and coordinate the effort to free it. Popov's wireless equipment provided the only link.

Due to bad weather and bureaucratic red tape, the crew to establish a wireless station on Gogland Island did not arrive until January, 1900. By February 5, however, messages were being received reliably.

The wireless messages were relayed to Gogland Island by a station some 25 miles away at Kotka on the Finnish coast. Kotka was selected as the location for the wireless relay station because it was the point closest to Gogland Island served by telegraph wires connected to Russian naval headquarters.

**Lives Saved.** A distress alert was one of the first wireless messages received on Gogland Island. An iceberg with 50 Finnish fishermen on it had broken loose nearby. Little time could be lost if the 50 lives were to be saved.

The icebreaker Yermak which had brought supplies and was trying to

free the Apraksin was immediately ordered to go to the aid of the stranded fishermen. A little more than 24 hours after the message had been received, all 50 persons had been rescued. By the time the Apraksin was freed from the rocks at the end of April, 440 official messages had been handled by the Gogland Island station.

Popov continued his efforts to develop a wireless telegraphy capability for the Russian Navy. Despite the seemingly convincing demonstrations Popov had provided, the Tsar's naval bureaucracy was not very receptive to innovation.

Prior to 1900, Popov had urged the Russian Navy to establish a wireless-equipment manufacturing facility and to begin the training of wireless operators. His recommendations were accepted in principle, but were given only minimal financial support. The wisdom of Popov's recommendations became evident, however, when the Russo-Japanese War seemed imminent in 1904 and the Russian Navy had to purchase the wireless equipment it needed from Germany.

**Professional Recognition.** Popov's outstanding capabilities as a teacher and scientist won him a professorial appointment at the Electrotechnical Institute in St. Petersburg in 1901. In September of 1905, he was elected Director of that Institute.

Unfortunately, the political situation in Russia was very unsettled in 1905. As the country moved dangerously close to civil war, the Tsar's policies became more and more reactionary. Popov, always a strong believer in the principles of academic and political freedom, found the oppressive climate in St. Petersburg a very difficult one in which to function.

When Popov was ordered by the government to take repressive measures against the growing student movement at the Electrotechnical Institute, he became very upset. Popov's health had never been robust due to the strenuous pace he always had set for himself. The thought of having to take measures against what he considered to be legitimate student activities was too much. Popov fell seriously ill on January 10, 1906 and died of a brain hemorrhage on January 13 at the age of 46. ■



is the same as:

$$\log^{-1}(1.36)$$

**TU's and Napiers.** It did not escape the early telephone engineers that the attenuation in 800-cycle miles could be obtained mathematically from the expression:

$$10.56 \log(P_{out}/P_{in})$$

where  $P_{out}$  and  $P_{in}$  are the output and input power levels for a one-mile length of cable, respectively.

In 1924, the standard unit of attenuation was changed to the "Transmission Unit," or TU. The attenuation in TU could be calculated by:

$$TU = 10 \log(P_{out}/P_{in})$$

The TU was very close to the old 800-cycle mile, and had the advantage of being mathematically simpler to express. The unit was proposed as a worldwide standard to the International Advisory Committee on Telephony (IACT), and met with approval from the many nations who were already using similar units.

However, other nations were using a

**TABLE 1—STANDARD CONVERSIONS**

Power Ratio	$\left(\frac{P_{OUT}}{P_{IN}}\right)$	dB
0.00001		-60
0.0001		-40
0.001		-30
0.01		-20
0.1		-10
0.25		-6
0.5		-3
1.0		0
2		3
4		6
10		10
100		20
1000		30
10,000		40
1,000,000		60

unit called the "nepier," named after the Scottish mathematician Sir John Napier. This unit differed from the TU in two fundamental ways: First, it represented current ratios rather than power ratios. And second, it was based on natural logarithms (see the text entitled Natural Logarithms elsewhere in this article). Naturally, these nations were not eager to change their standard of measurement.

In 1928, the IACT decided to standardize two units. One was based on natural logarithms and was called the "neper." The other was based on common logarithms and was called the bel, after Alexander Graham Bell. These units were roughly equal in magnitude, and were defined mathematically as follows:

$$\begin{aligned} \text{loss or gain in nepers} &= 0.5 \ln(P_{out}/P_{in}) \\ \text{loss or gain in bels} &= \log(P_{out}/P_{in}) \end{aligned}$$

It turns out that a neper is 1.151 bels.

Since the bel is equal to 10 TU, the old TU was renamed the "decibel" (one-tenth of a bel), and abbreviated dB. Thus was born the decibel, which began as a standard unit for power loss in telephony and has become a standard unit for all sorts of other measurements also. Table 1 gives several useful loss/gain ratios and their corresponding dB values.

**Using Decibels for Gain.** A useful feature of logarithms is the way they can be used to handle combined losses and gains. If you have two am-

plifiers, each with a gain of 10, without using decibels you would have to find the total gain by multiplying the two individual gains:

$$10 \times 10 = 100$$

To take another example, losses are "fractional" gains, so we might have a circuit with a cable loss of 0.01 followed by an amplifier with a gain of 3162 followed by another cable with a loss of 0.16. The total loss or gain could still be found by multiplying:

$$.01 \times 3162 \times .016$$

which comes out to around 5.

However, it's much easier to use dB's. A loss of 0.01 is -20 dB, a gain of 3162 is 35 dB, and a loss of 0.16 is -8 dB. All we have to do is just sum those dB values together:

$$-20 \text{ dB} + 35 \text{ dB} - 8 \text{ dB} = 7 \text{ dB}$$

A gain of 7 dB is the decibel equivalent to the gain of 5 that we got earlier.

The reason you can add logs is because they are exponents. For example, you probably know that:

$$10^2 \times 10^3 = 10^{2+3} = 10^5$$

Note how the exponents add to provide the final result of the multiplication. Of course, this can usually be done mentally; whereas multiplication requires a calculator, or pencil and paper, for most of us.

**Power, Voltage, and Current.**

Measuring power is really inconvenient, and even the telephone company—although they talked about signal "power"—actually measured voltage. Since most of their circuits had 600-ohm impedances, they had voltmeters with scales labeled in milliwatts; the scale provided a built-in conversion from voltage to power that worked as long as the resistance was 600-ohms.

Since power can be found from the equation:

$$P = V^2/R$$

we can substitute into the definition of dB and find a way to express voltage losses and gains in dB:

$$\begin{aligned} 10 \log(P_{out}/P_{in}) &= \\ 10 \log((V_{out}^2/R_{out})/(V_{in}^2/R_{in})) \end{aligned}$$

But in telephone circuits  $R_{out} = R_{in} = 600$  ohms we can cancel the resistances and get:

**Natural Logarithms**

It is actually possible to define logarithms based on any number. John Napier, the Scottish mathematician who invented logarithms, first proposed a system based on the number 10<sup>7</sup>. He soon saw the simplicity of logs based on the number 10, and in 1614 he published his first table of base-10 (or common) logs, the *Mirifici Logarithmorum canonis descriptio*.

It was during this same period of time that calculus was being developed simultaneously by Sir Isaac Newton and Baron Wilhelm Gottfried von Leibnitz. In the process of finding the derivative of the expression:

$$1/x$$

the so-called natural logarithmic function was discovered. This is a number whose value is approximately 2.72. It is universally identified as "e." Soon after, a system of logarithms based on e was introduced. These are called natural logarithms, and abbreviated as ln. Thus if we say that 3.6 is the natural log of a certain number, we mean that e<sup>3.6</sup> equals that number. Natural logs and their inverse function are available on most scientific calculators. In some countries, natural logs are called Napierian logs.

It is possible to convert between common logs and natural logs as follows:

$$\begin{aligned} \ln(x) &= \ln(10) \times \log(x) = 2.3 \log(x) \\ \log(x) &= \log(e) \times \ln(x) = 0.43 \ln(x) \end{aligned}$$

$$10\log(V_{out}^2/V_{in}^2) = 10\log(V_{out}/V_{in})^2$$

Since we can square a number by doubling its exponent, and logs are exponents, this becomes:

$$20\log(V_{out}/V_{in})$$

which is the equation for voltage loss and gain, as well as power loss or gain.

Remember that strictly speaking, this equation is only valid for power in dB's if the input and output resistances of the circuit are equal. In fact, in most electronic systems they seldom are equal. So what happens if we incorrectly use this equation to express voltage losses and gains in dB when the resistances are not equal? Nothing very bad. The voltage loss or gain will just not be equal to the power loss or gain.

We can do exactly the same trick with current gains and losses, although the need for them is less common. We come out with:

$$20\log(I_{out}/I_{in})$$

As for voltage in dB's, the current in dB's is only equal to power in dB's if the input and output impedances are equal.

**A Milliwatt Reference.** So far, we have demonstrated a great method that allows us to express a huge range of power, voltage, and current ratios with a relatively small range of numbers, and also allows us to combine gains and losses using simple addition and subtraction rather than multiplication. But what if we want to find the output power of a circuit using gains and losses given in dB? We could find the total circuit gain/loss in dB, convert to a numerical value, and multiply the input power by that value. But that sounds like a system invented

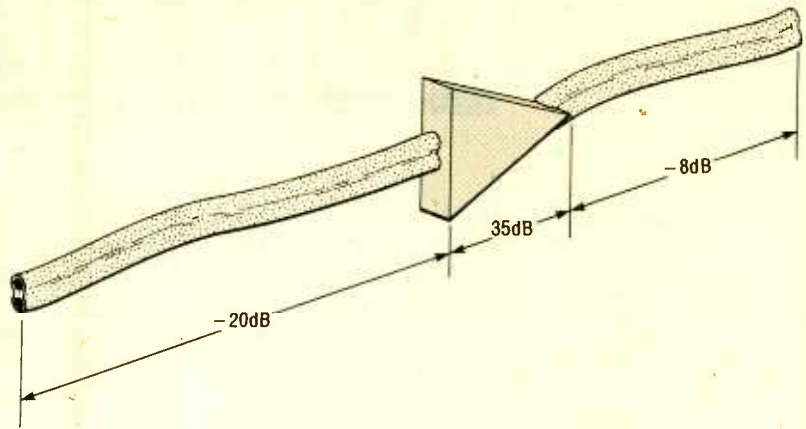

Fig. 1. Using dB's to find the output power of a circuit is easy. All it takes is a little addition and subtraction.

by the people who gave us Form 1040—there must be a better way, and there is. All we have to do is agree to state our power levels in proportion to a reference level, such as a milliwatt. Instead of specifying an input power of 3 milliwatts, we'd say that:

$$P_{in}/1 \text{ mW} = 3$$

Now that we have the power expressed as a ratio, power ratios can be expressed in dB:

$$P_{dBm} = 10 \log(P/1\text{mW})$$

where  $P_{dBm}$  is the power expressed in dB referenced to a milliwatt.

Notice that a standard dB represents ratios of two power, voltage, or current levels, while dBm represents actual power levels. Thus 0 dBm equals 1 mW, -10 dBm equals 0.1 mW, 6 dBm equals 4 mW, etc.

To use an example, if an input of 4 mW (which is 6 dBm) is fed to the circuit in Fig. 1, with the losses and the gain shown we can find the power output as follows:

$$4 \text{ dBm} - 20 \text{ dB} + 35 \text{ dB} - 8 \text{ dB} = 11 \text{ dBm}$$

Adding dBm's to dB's is equivalent to multiplying power by gain. Engineers for the telephone company, commercial radio stations, and many other communications facilities routinely measure levels in dBm, so there's no conversion necessary to do loss and gain calculations in dB.

**Voltage Revisited.** Well what's sauce for the watt is sauce for the volt; by expressing the voltage in reference to one volt, we can define the dBV as:

$$20 \log (V/1 \text{ volt})$$

In practice, that just means that we take the log of the voltage and multiply by 20.

How do we convert from dBV to volts? Let's look at a practical example: The output voltages of many high-impedance microphones are expressed in terms of dBV at a certain sound-pressure level. If a certain microphone produces -60 dBV at a certain sound level, and we want to know the output in volts at that sound level, we just reverse the process:

$$\begin{aligned} V &= \log^{-1}(V_{dBV}/20) \\ &= \log^{-1}(-60 \text{ dBV}/20) \\ &= \log^{-1}(-3) \\ &= 0.001 \text{ V} \end{aligned}$$

The same approach can be used for changing from dBm to milliwatts, or from dB gains/losses to simple gain factors.

**Sound.** If you asked 100 average persons on the street what a decibel is, you'd probably get blank stares from about 85% of them, the words (Continued on page 92)

TABLE 2—COMMON CONVERSIONS

dB	Power Ratio	Voltage or Current Ratio
-12	$\frac{1}{16}$	$\frac{1}{4}$
-6	$\frac{1}{4}$	$\frac{1}{2}$
-3	$\frac{1}{2}$	$\frac{1}{\sqrt{2}}$ or 0.707
3	2	$\sqrt{2}$ or 1.414
6	4	2
12	16	4

# ANTIQUE RADIO

By Marc Ellis

## Mail Call

Last month, we detoured from the Hallicrafters Sky Buddy restoration project to recognize the latest (and final) group of entrants to our "With the Collectors" contest. This month, I had every intention of getting back to the restoration—until I took a close look at the bulging file of accumu-



This Crosley Model 637 from Ivan Smith's collection has an interesting mirrored dial.

lated letters not relating to the contest. Many of these fine communications have been neglected because of the priority given to contestant letters.

So let's just keep going through the mailbag until we get to the bottom. There's quite an interesting pile of information to be shared, questions to be asked, and more!

### PHILCO "XX" TUBES

A good Philco mystery always seems to smoke out a bunch of helpful reader comments, and the question raised last March by reader Barry Stephens (Austin, TX) was no exception. At

that time, I ran a letter from Barry asking for information about a type-XXL tube found in a Philco console he was restoring. I admitted that I needed to be brought up to speed on this matter myself.

Thanks to several readers who wrote in, we learned that, in keeping with its many innovative engineering ideas, Philco had some innovative designations for certain "Loctal"-style tubes. The most common of these were XXL (commonly known as the 7A4), XXFM (commonly known as the 7X7), XXD (commonly known as the 14AF7), and XXB (commonly known as the 3C6).

Readers who supplied information were: *Michael D. Troiano* (Providence, RI), *Vincent J. Burnetter* (Ravena, NY), *Marion J. Haby* (Danville, VA), *John A. Harlan* (Chicago, IL), *Paul Wappler* (Houston, TX), *Ray Loewen* (Inola, OK), *Don Diers* (Milwaukee, WI), *Tom Baker* (Craigs ville, WV), *Roger Peterson* (Francesville, IN), *Henry Schanding* (Elizabeth City, NC), *Alton A. Dubois, Jr.* (Queensbury, NY), *George W. Carr* (Lancaster, OH), *Jeff Lawrence* (city unknown), *John Polk* (San Rafael, CA), *Stewart Humphreys* (Blue Springs, MO), *Charles Webster* (Binghamton, NY), *Manuel Cancel* (city unknown), *N.A. Haight* (Castro Valley, CA), and *Philip Kassner* (Milwaukee, WI).

### SCHEMATICS WANTED

The following folks are looking for schematics and/or general information on specific sets. *Delwin Vriend* (9326 - 110 Avenue, Edmon-

ton, Alberta, Canada T5H 1H1), *Philco Model 71*; *Oren Johnson* (P.O. Box 109, Villa Grande, CA 95486), *Browning Eagle CB radios*; *Ivan W. Smith* (Rt. 1 Box 288, Glen Morgan, WV 25847), *Philco Model 96*, *Emerson BQ-225*, and *dial-cord stringing and tuning button-setting instructions for Zenith 7S598*, and *Echophone EC-18*; and *Byron R. Bernor* (2479 W. Sierra Highway, Acton, CA 93510), *schematics and test data for Superior Instruments Model 450 tube tester*.

*Mark Phillips* (2416 Hazlett Ave., Wheeling, WV 26003-7241), *Stromberg-Carlson 61-H*; *George Fuller* (88-B-Westgrove Way, Winnipeg, Manitoba, Canada R3R1R7), *DeForest Crosley Type 6D731—made by Rogers-Majestic*; *Steve Kallista, Sr.* (Bear Creek Lake Dev., 9 Maple Dr., Jim Thorpe, PA 18229), *GC Test Equipment Test Pattern Generator Model 36-610*, *Precision Tube and Transistor Tester Model 10-60*; and *Jason Ingraham* (Site 5, Box 30, RR#1, Windsor Junction, N.S., Canada B0N 2V0), *Research Industries 2-Way Industrial Radio Model PS150C*, *Fairchild 767H Oscilloscope*, *LFE Model 401 Oscilloscope*.

*Marion J. Haby* (2970 N. Main St., Danville, VA 24540-2064), *Eria 3-tuber circa 1924*; *Mark Hallock* (13 Lehigh St., Moutaintop, PA 18707), *Westinghouse Model WR-272*; and *Werner Schwiering* (463 Elizabeth St., Oshawa, Ontario, Canada L1J 5S9), *Simpson Test Master Model 440*, *Cetron CE201A tube* (not a conventional 01-A).



A few items from the collection of Harry Alenik.

Robert Jackson (4365 Hillcrest Dr., Traverse City, MI 49684), Hallicrafters Model S-38D; Bob also has, for sale or trade, a nearly complete set of *Radio and Television News* magazines dating from 1954 through 1991. Dale Simonson (1422 Youngfield, Golden, CO 80401) is looking for a schematic, or at least specifications for the "A," "B" and "C" voltages, for an ERLA S-11.

#### OTHER NEEDS

Ray Loewen (P.O. Box 793, Inola, OK, 74036) needs an EM4 tuning eye tube for a Grundig radio. Dr. Franklin Krichbaum (3011 Oak St., Lakewood, CO) is looking for dial-cord stringing instructions for a Sparton model 1068. And Bill Bennett (RD#1 Whiting Way Box #31, Conklin, NY 13748) needs the dial-cord scheme for the UHF tuner used in an Admiral Model TV1811 Chassis #1981. Jess Fronabarger is working on a Grunow Model 1291 "Tele-dial Twelve." He has the schematic, but needs information on how the dial operates.

Charles and Irene Porter (535 N 20th St., Louisville, KY

40203), would like to get their hands on a copy of the article "1600 Miles on a Crystal Receiver" by Edward T. Jones from *Radio News* for October, 1923. Robert Rugg (538 Liberty St., Penn Yan, NY 14527) would like an idea of the market value of his late 1920's Atwater Kent. No identification given, but it sounds like one of the metal-box table models with separate speaker.

A few readers are just entering our hobby and need some guidance. For example, Joseph J. Maranto (925 W. 32 St., Hialeah, FL 33012), a TV serviceman for the past 12 years, could use some pointers on acquiring old sets and setting up to repair them. John Bullister (516 Division St., Sewickley, PA 15143), could use some help finding substitutes for the bad electrolytic capacitors ( $2 \times 8 \mu\text{F}$  @ 450 volts and  $16 \mu\text{F}$  @ 450 volts) in a Zenith that he is restoring.

Rob Valdran (RR3, Box 146A, Monroe, NY 10950) was given three old radios by a neighbor who was moving away: a Zenith 8S661, a Philco 39-6443, and an RCA 67V1. He'd like to know something about the age and value of the

radios and he's interested in learning how to repair them. Kevin Fraser (524 Second St. W, Cornwall, Ontario, Canada K6J 3M5) is also embarking on a first restoration: an RCA 5T1 of about 1932 vintage. He'd like a schematic of the set, background information about it, a source of replacement tubes, and some general advice.

Finally, I'd like to recommend that Dr. Wesley Seymour (Charleston, SC) and Dick Kowalski (Warren, MI) contact Antique Electronic Supply, 6221 S. Maple Ave., Tempe, AZ 85283 to fill their needs. Dr. Seymour is looking for a cat's whisker type crystal detector, and Mr. Kowalski wants a copy of Tony Jacobi's "Ballast Tube Handbook" and some high-voltage capacitors.

#### MORE WPE'ERS!

Prompted by a letter received some time back from a fellow who mentioned his "WPE" call letters, I once asked if there were any other old WPE'ers in the crowd. (For those not in the know, the WPE call letters were issued by **Popular Electronics** to interested short-wave listeners back in the late 1950's and early '60's.) Ever since then, a slow but steady stream of readers have been writing to make their old call letters known.



Al Colianni's Philco Radiobar still has its original decanters and glasses.

This month's batch includes five more. Albert J. Colianni, WPE9EY (Arlington Heights, IL) received his certificate in 1959. With his note, Al included a photo of the Philco Radiobar purchased by his parents in the mid-thirties. All the glasses and decanters are intact, although the original grille cloth has been replaced. Harry Bertino, Jr., WPE1PW (So. Weymouth, MA) sent a note on his ham QSL card (ham call letters are K1QVU).

Harry Alenik, WPE2EHS (14003 Judah Ave., Hawthorne, CA 90250) received his call around 1960. He sent along some shots of part of his radio collection and invites readers from his area to contact him for help in restorations. Chuck Furtack, Jr., WPE9HEV (241 Oak St., Elmhurst, IL) was "licensed" in 1964. He has a set of Rider's manuals and is willing to help readers who need information (be sure to include an SASE for your reply).

Phil Kassner (2613 N. Bartlett Ave., Milwaukee, WI) was assigned the call WP9EKE around 1963. He's an engineer for an industrial battery-charger company and is interested in obtaining antique chargers using bulb-type rectifiers.

#### SAFETY COMMENTS

Captain David M. Elliott (401 12th St. S., Apt. 1212, Arlington, VA 22202), being new to the hobby, was happy to get the information in the two safety columns (November and December, 1991). He clipped them to post at his workbench. Dave's first project is a Pilot Model TC601 FM tuner, and he could use some information on it—particularly the functions of the seven numbered screws on the back panel.

## SPECIAL FROM ETT

TTL1 —  
TTL POCKET GUIDE,  
Volume 1,  
7400 — 74200  
..... \$18.95.



TTL2 —  
TTL POCKET GUIDE,  
Volume 2,  
74201 — 74640  
..... \$18.95.



TTL3 —  
TTL POCKET GUIDE,  
Volume 3,  
74641 — 7430640  
..... \$18.95.



TTLX —  
ALL THREE GUIDES,  
Vols 1, 2, & 3  
(save \$6.00)  
..... \$50.85.

Each volume provides a comprehensive listing of all commonly used TTL integrated circuits within the range of types noted. The combination of three volumes covers 7400 through 7430640 TTL products from all major manufacturers. All current families are covered: standard, low power, Schottky, low power Schottky, advanced Schottky, advanced low powered Schottky, high speed and fast Schottky. There are eight sections to the book. Section 1 illustrates the device schematic using a clear and simple logic diagram. Next a brief description of the components, providing quick reference to the internal structure. The next section details input signals or levels at individual pins. The fourth section lists major applications and is followed by a summary of essential data. Below this, a table indicates the TTL families in which the device is available, and finally, device description and type number are highlighted for easy reference. A manufacturer's index at the back of the book shows in tabular form which companies manufacture each package.

MAIL TO: **Electronic Technology Today, Inc.**  
P.O. Box 240  
Massapequa Park, NY 11762-0240

### SHIPPING CHARGES IN USA AND CANADA

\$0.01 to \$5.00 . . . \$1.50	\$30.01 to \$40.00 . \$5.50
\$5.01 to \$10.00 . . \$2.50	\$40.01 to \$50.00 . \$6.50
\$10.01 to \$20.00 . \$3.50	\$50.01 and above \$8.00
\$20.01 to \$30.00 . \$4.50	

**SORRY, No orders accepted outside of USA and Canada**

Total price of merchandise . . . . .	\$ _____
Shipping (see chart) . . . . .	\$ _____
<b>Subtotal</b> . . . . .	\$ _____
Sales Tax (NYS only) . . . . .	\$ _____
<b>Total Enclosed</b> . . . . .	\$ _____

Name \_\_\_\_\_  
Address \_\_\_\_\_  
City \_\_\_\_\_ State \_\_\_\_\_ Zip \_\_\_\_\_

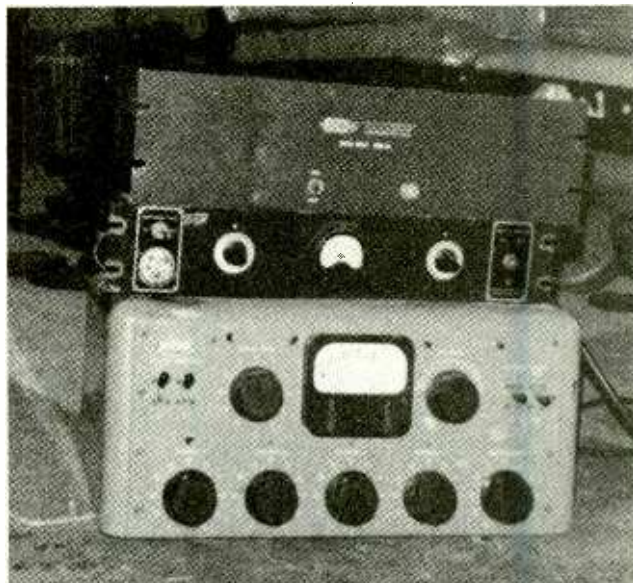

Part of the loot from Brent Mellor's garage cleanout adventure. From the top: ITA Mod-Max, Millen Exciter, and Raytheon audio mixer.

Michael Kiley sent a long letter commenting on both safety columns, and made one point that I want to repeat here. Since a radio's filter capacitors can store lethal voltages even after the set is shut off, I had recommended shorting out such capacitors, to discharge them, before working on the equipment. Mike suggests bleeding off the charge through a (well-insulated!) 10-watt wire-wound resistor in the 1000–10,000-ohm range. A direct short might develop enough current to damage the capacitor.

Thanks also to A. Santoriella (Yorktown Heights, NY) for writing me about the same issue.

### THIS N' THAT

Letters are still coming in concerning the theremin columns, which, without a doubt, were among the most popular ever published in *Antique Radio*. Thanks to *Al Van der Kloot* (Chicago, IL) for the schematics from an early theremin kit and to *G.D. Paterson* (Las Cruces, New Mexico) for the new product sheet on the high-tech

theremin, produced by Big Briar, which looks almost identical physically to the original 1928 model. Interested readers can write that company at Rt. 3, Box 115A1, Leicester, NC 28748.

*Billy Pogue* (4039 Blue Canyon Rd., Lake Havasu City, AZ), who has helped many readers of this column with technical information, cautions everyone to hang on to their tube collections! At the rate that prices are going up, even a smallish collection could eventually become a valuable asset!

*Brett Mellor* (14 Hood St., Saugus, MA 01906) recently had the opportunity to clean out a garage containing a large quantity of miscellaneous old ham-radio and commercial-broadcasting equipment. It's all for sale at reasonable prices. Write for details.

*Don Diers* (4276 North 50th St., Milwaukee, WI 53216) has issued a new, 16-page catalogue of tubes, parts, and supplies. Don's chatty, illustrated catalogs are fun to browse through and contain many hard-to-find items. Send \$2.00 for a copy.



# COMPUTER BITS

By Jeff Holtzman

## Buying Your First (or Next) PC

Last time we talked about an appropriate PC-buying philosophy. Our basic conclusion was that although DOS-only machines based on 8088 and 80286 microprocessors have become dirt cheap, they are dead-end purchases with guaranteed short-term obsolescence. The PC world is moving to graphical environments (Windows and OS/2) that require much more power than did the DOS programs that fueled the first decade of the personal-computing revolution. The really good news is that the intense competition in the PC industry has forced the prices of today's powerhouses to absurdly low levels.

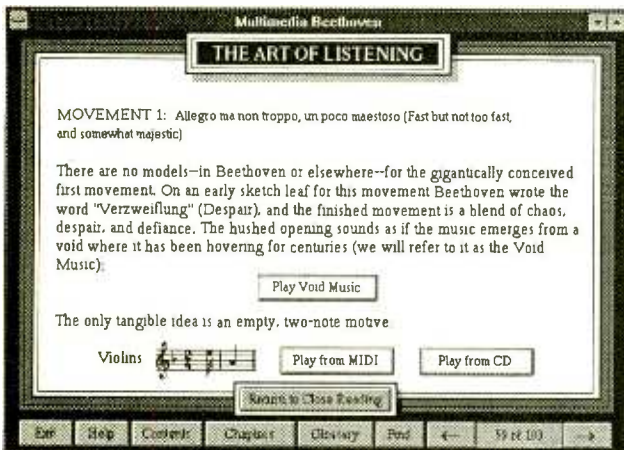

*Multimedia Beethoven: The Ninth Symphony is a landmark product knelling the death of text-mode DOS applications. It is the richest, best-constructed multimedia experience available for PC's today.*

Now let's talk specifics. To do so, let's consider each major subsystem: CPU, memory, and bus; video system; mass storage; and peripherals. In each category, we'll outline three basic system configurations: minimum, comfortable, and really nice. Then we'll go on

to show you how to put together the best compromise package. All quoted prices come from reputable mail-order dealers and were current as of mid-March, 1992.

### CPU, MEMORY, AND BUS

Don't buy anything with "SX" in the name. SX-based CPU's are purposely crippled. They offer a very small price advantage—typically a few hundred dollars—but greatly limit potential performance. For example, one mail-order vendor currently offers 20-MHz 386SX systems starting at \$1135, and 25-MHz 386DX systems starting at \$1285. The extra \$150 costs 13% more, but likely gives 50% better performance.

Don't buy anything with "upgradeable" in the name. Upgradeables make engineering compromises that limit performance to the least common denominator. For example, I regularly use two machines, an optimized 486/25 that performs as well as an upgradeable 486/33.

Buy as much CPU speed and memory as you can possibly afford. To run Windows, a bare minimum is a 386/25 with four megabytes of RAM. A comfortable system is a 486/25 with eight megabytes. Really nice is a 486/33 with 16 megabytes. A few years ago, 16MB of memory was almost prohibitively expensive in the PC world; today, it costs only about \$600. Whatever you buy, make sure that the motherboard can accept at least 16 megabytes of RAM directly, without using

a special memory card. Avoid bargain-basement systems that do not include cache memory. Avoid small-chassis boxes. They're cute, but they typically lack expansion slots and drive bays. Avoid EISA- and MCA-bus machines unless you know enough about them to know why you might need them.

If possible get a motherboard with built-in serial and parallel ports to save expansion slots.

### VIDEO

Avoid motherboards with built-in video. Video standards are still evolving rapidly; the video system is something you can likely upgrade economically before the machine becomes obsolete. Don't buy anything less than monochrome VGA; that is the bare minimum. Adding color typically adds about \$150 to the price of a complete system; go for that added comfort unless you're on a bare-bones budget.

Standard VGA resolution is 640 × 480 with 16 colors. Increasing resolution to 1024 × 768 gives you much more screen space to work on. Increasing the number of colors (to 256 or more) is frosting that few users except professional desktop publishers really need. On the other hand, increased video speed is something that everyone can use.

Complete systems typically don't include fast graphics boards, but some vendors will allow you to substitute. ATI and Video Seven make some of the

*(Continued on page 89)*

# CIRCUIT CIRCUS

By Charles D. Rakes

## More Intruder-Detector Circuits

This month starts off with an answer to a reader's query about adding an exit delay circuit to the burglar alarm featured in the February, 1992 column. The circuit, shown in Fig. 1 on page 65 of that issue, has an entry delay circuit that provides ample time for you to enter the protected area and disarm the alarm before the sounder is activated. But unless a selected entryway door is equipped with a manual override that bypasses (or nullifies) the sensor, there's no way to exit without setting off the alarm. So Steve Davis, our first circuit is for you.

### EXIT DELAY

Figure 1 shows an exit-delay circuit that can be added to the original circuit

begins to charge toward the supply voltage. When C1 is sufficiently charged, a current is applied to the base of Q1 through R3, turning it on. With Q1 turned on, the positive-supply rail is connected to the cathodes of the four diodes (D1-D4). Note that only one diode is needed if only one sensor is used to protect an exit door; the extra diodes (D2-D4) are included in the circuit to show how easy it is to add more exit sensors.

Now back to the February circuit. Connect the cathode of D1 in the delay circuit to the junction of R1 and R9 of the (February) alarm circuit. When S1 (in Fig. 1) is pressed, the door can be opened and the timer circuit will keep the input high for about 15 to 30 seconds. To lengthen the exit-delay time, increase the value of R2; to reduce the time, lower the value. Stay with values between 100k and 500k. Since we're back into alarm circuits, here are a few additional sensor circuits that can be added to your existing or future alarm system.

sensitive end of the LDR facing out through the length of the tube.

Each LDR is connected to the input of one gate of a 4093 quad 2-input NAND Schmitt trigger. A 1-megohm potentiometer is connected between each gate input and ground, and is used to set the circuit's sensitivity. The output of each gate is connected through separate diodes to the base of Q1 (a 2N3904 general-purpose NPN silicon transistor).

As long as light hits the LDR, its resistance remains low. That low resistance path to the positive supply keeps the input of the Schmitt trigger gate high, thereby forcing its output low. With all four circuits looking at a light source, no base-drive current is supplied to Q1, so it remains off. But if a light source to an LDR is blocked, the output of its associated Schmitt trigger goes high, turning on Q1. That sends a low-going output to the alarm system. If needed, a positive sensor output may be taken at the cathode junction of the four diodes.

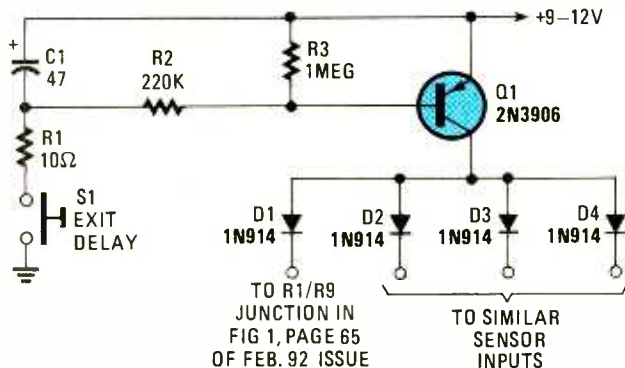

Fig. 1. In the Exit-Delay circuit, Q1 (a 2N3906 general-purpose PNP silicon transistor), which is operated as a switch, is used to supply a timed positive voltage to the input of the alarm circuit.

or to any alarm circuit with a similar sensor arrangement. In that circuit, Q1 (a 2N3906 general-purpose PNP silicon transistor) is operated as a switch. That transistor is used to supply a timed positive voltage to the sensor input of the alarm circuit.

When the exit-delay switch (S1) is pressed, C1

### LIGHT-DEPENDENT SENSOR

The multi-input light-dependent sensor circuit shown in Fig. 2 can be used to cover a room or specific area; if an object moves between any of the sensors and a light source, the circuit sends out an alarm signal. The light-sensing elements in that circuit are cadmium-sulfide light-dependent resistors (LDR's). The LDR's are housed in separate opaque tubes 6 to 12 inches long, with the light-

### BRIDGING TOUCH-PLATE SENSOR

Our next sensor uses two 567 tone decoders in a touch-activated circuit that can be used as a hidden entry, exit, or emergency switch. Two insulated metal plates (TP1 and TP2) serve as the sensor elements. The first tone decoder, U1, is configured as a 275-kHz, fixed-frequency square-wave oscillator. The output of U1 is coupled to TP1 through C7.

## PARTS LIST FOR THE EXIT DELAY

### SEMICONDUCTORS

Q1—2N3906 general-purpose PNP silicon transistor  
D1-D4—1N914 general-purpose silicon diode

### RESISTORS

(All fixed resistors are 1/4-watt, 5% units.)

R1—10-ohm  
R2—220,000-ohm  
R3—1-megohm

### ADDITIONAL PARTS AND MATERIALS

C1—47- $\mu$ F, 16-WVDC, electrolytic capacitor  
S1—Normally open pushbutton switch  
Perfboard materials, enclosure, 9-12-volt power source, wire, solder, hardware, etc.

When a conductive object is positioned close to both sensors, the output of U1 is capacitively coupled to the base of Q1 (a 2N3904 general-purpose NPN transistor, configured as a common-emitter amplifier) through TP2, causing it to conduct. That produces

a signal at the collector of Q1 that is fed to U2 (the second tone decoder) at pin 3. Tone decoder U2's internal oscillator is set to the same frequency as U1 via R9. Upon receiving U1's output signal, U2 outputs a low-going signal that is fed to Q2, causing it to turn off.

## PARTS LIST FOR THE LIGHT-DEPENDENT SENSOR

### SEMICONDUCTORS

U1—4093 quad 2-input NAND Schmitt trigger, integrated circuit  
Q1—2N3904 general-purpose NPN silicon transistor  
D1-D4—1N914 general-purpose silicon diodes

### RESISTORS

(All fixed resistors are 1/4-watt, 5% units.)

R1-R6—4700-ohm  
R7—100,000-ohm  
R8-R11—1-megohm potentiometer  
R12-R15—Cadmium-sulfide, light-dependent resistor

### ADDITIONAL PARTS AND MATERIALS

Perfboard materials, enclosure, opaque tubing, 6-9-volt power source, wire, solder, hardware, etc.

That produces a high output at Q2's collector that is applied to the alarm input. The output of U2 also causes LED1 to light.

The two touch plates can be just about any metal object, ranging in size from as small as a penny to as large as your hand. In any

case, TP2 should not be located near a strong RF or 60-Hz field. If RF is a problem, try connecting a small capacitor between the base and collector of Q1. Start out with a 10-pF unit and use as small a value as is possible to remove the interfering signal. Too much

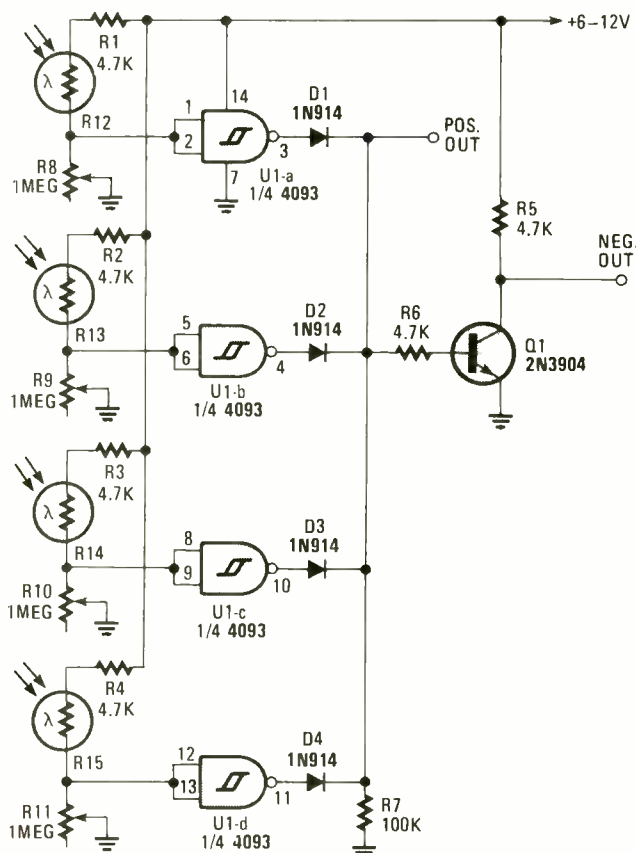

Fig. 2. This Light-Dependent Sensor uses LDR's to detect the presence or absence of light. As long as the light source striking the LDR's remains constant, the alarm does not sound. But when the light is interrupted, the alarm is triggered.

# Be an FCC LICENSED ELECTRONIC TECHNICIAN!

Earn up to \$30 an hour and more!

Learn at home in spare time. No previous experience needed!

No costly school. No commuting to class. The Original Home-Study course prepares you for the "FCC Commercial Radiotelephone License." This valuable license is your professional "ticket" to thousands of exciting jobs in Communications, Radio-TV, Microwave, Maritime, Radar, Avionics and more...even start your own business! You don't need a college degree to qualify, but you do need an FCC License.

**No Need to Quit Your Job or Go To School**  
This proven course is easy, fast and low cost! **GUARANTEED PASS**—You get your FCC License or money refunded. **Send for FREE facts now. MAIL COUPON TODAY!**

**COMMAND PRODUCTIONS**  
FCC LICENSE TRAINING, Dept. 100  
P.O. Box 2824, San Francisco, CA 94126  
Please rush FREE details immediately!

NAME \_\_\_\_\_  
ADDRESS \_\_\_\_\_  
CITY \_\_\_\_\_ STATE \_\_\_\_\_ ZIP \_\_\_\_\_

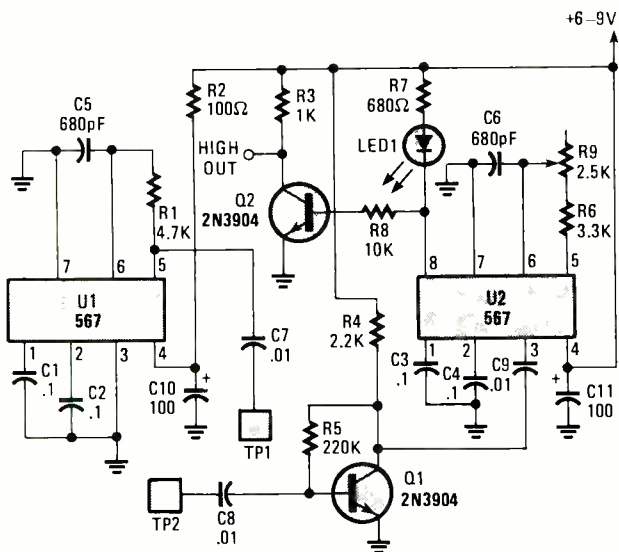

Fig. 3. The Bridging Touch-Plate Sensor is built around two 567 tone decoders, one of which (U1) is configured as a 275-kHz, fixed-frequency squarewave oscillator.

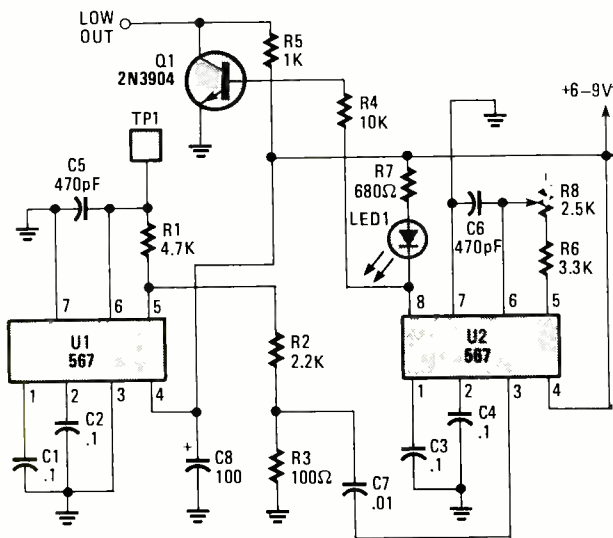

Fig. 4. The Single-Plate Touch Sensor operates on the same principle as a proximity switch; a foreign body coming in contact with the touch plate, alters the operating frequency of U1, thereby triggering the alarm.

capacitance will reduce the circuit's sensitivity.

### SINGLE-PLATE TOUCH SENSOR

Our next circuit uses two tone decoders in a slightly different way to produce a circuit that's triggered by a single touch contact. The first tone decoder, U1, is set up as a 300-kHz, square-wave oscillator. The squarewave output of U1 at

pin 5 is fed to a voltage divider, consisting of R2 and R3, producing a 300 millivolt signal at the R2/R3 junction. Potentiometer R9, which serves as a frequency control, is used to set U2's internal oscillator to the same frequency as U1.

When U2 detects U1's output signal, U2 pin 8 goes low, causing LED1 to light and Q2 to turn off. When contact is made with TP1,

### PARTS LIST FOR THE BRIDGING TOUCH-PLATE SENSOR

#### SEMICONDUCTORS

U1, U2—567 tone decoder, integrated circuit  
Q1, Q2—2N3904 general-purpose NPN silicon transistor  
LED1—Light-emitting diode

#### RESISTORS

(All fixed resistors are 1/4-watt, 5% units.)

- R1—4700-ohm
- R2—1K-ohm
- R3—1000-ohm
- R4—2200-ohm
- R5—220,000-ohm
- R6—3300-ohm
- R7—680-ohm
- R8—10,000-ohm
- R9—2500-ohm potentiometer

#### CAPACITORS

- C1—C4—0.1-μF, ceramic-disc
- C5, C6—680-pF, ceramic-disc
- C7—C9—.01-μF, ceramic-disc
- C10, C11—100-μF, 16-WVDC, electrolytic

#### ADDITIONAL PARTS AND MATERIALS

Perfboard materials, enclosure, touch contacts (see text), IC sockets, 6-9-volt power source, wire, solder, hardware, etc.

### PARTS LIST FOR THE SINGLE-PLATE TOUCH SENSOR

#### SEMICONDUCTORS

U1, U2—567 tone decoder, integrated circuit  
Q1—2N3904 general-purpose NPN silicon transistor  
LED1—Light-emitting diode

#### RESISTORS

(All fixed resistors are 1/4-watt, 5% units.)

- R1—4700-ohm
- R2—2200-ohm
- R3—100-ohm
- R4—10,000-ohm
- R5—1000-ohm
- R6—3300-ohm
- R7—680-ohm
- R8—2500-ohm potentiometer

#### CAPACITORS

- C1—C4—0.1-μF, ceramic-disc
- C5, C6—470-pF, ceramic-disc
- C7—0.01-μF, ceramic-disc
- C8—100-μF, 16-WVDC, electrolytic

#### ADDITIONAL PARTS AND MATERIALS

Perfboard materials, enclosure, IC sockets, touch terminal (see text), 6-9-volt power source, wire, solder, hardware, etc.

U1's oscillator frequency is shifted lower due to the added capacitance at pin 6. If the frequency shift is great enough to go beyond U2's bandwidth, its output goes high, turning

off LED1 and turning on Q1. That causes Q1's output at its collector to go low.

Looks like we have just about filled our space again, so until next time, good circuitry. ■

# THINK TANK

By John J. Yacono

## Telephone Circuit Parade

Last month, I answered some reader mail in this column. The last letter requested some telephone circuits, which I provided. As it turns out, I get a lot of mail on telephone circuits (both requests and submissions). So this month, I'll present some of the more interesting telephone circuits submitted to date.

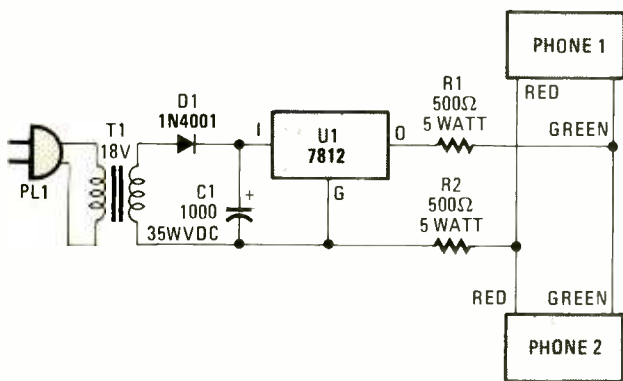

Fig. 1. This circuit, from the June 1991 edition of this column, proved to be pretty popular.

However, first I'd like to answer a letter from a gentlemen that tried one of the circuits from the June 1991 issue without success.

### COMMUNICATION BREAKDOWN

I need help! For several years, I have been building circuits from throughout **Popular Electronics** with 100% working results until I built the Telephone Intercom.

I wanted to replace a raspy squawky intercom between the house and green house (another hobby), and I was so sure it would work that I took out the old intercom.

I followed the details of Fig. 1 to build the 12-volt regulated power supply with the resistors and hooked up the two telephones. I turned the power on and

got nothing! I rechecked all the plus' and minus'—all was in order, but still nothing (no sound). I took the following measurements: both phones on hook: 11.87 volts, 0.00 mA; one phone off hook: 3.47 volts, 7.96 mA; both phones off hook: 2.98 volts, 8.42 mA.

Electronically, the circuit seems to be functioning. Maybe it's the kind of phones being used. Both are Lennox Sound model PH-100 as made by Lennox Electronics Corp. (Chinese made), which work in the local telephone circuits. The phones have only two wires (one red and one green) at their input jacks. Their instruction booklet has the following:

"This phone uses universal pulse (rotary type dialing) and cannot be used with computerized call directing equipment or electronic banking." Where do I go from here? Please advise. I would even talk to the author of the article, Vincent Grabosky of Ruffs Dale, PA if you think it will help.

Thanks for any help you can give me. I'm still a 100% loyal follower of *Think Tank* and *Circuit Circus*.

—George R. Cote,  
Pittsfield, MA

I'm not too sure why you're not getting any results and I can't tell if you made your measurements close to the power-supply end of the line or at the far intercom station. However, you've provided me with enough information to make some hopefully useful observations.

First of all, I wonder why the on-hook voltage doesn't float closer to the power-supply voltage (es-

pecially with less than .01 mA flowing in the circuit). You can't drop 0.13 volts across an open circuit.

It could indicate a lazy power supply. Check the regulator to be sure that the power-supply voltage is close to 12 volts. If it is not, check the current flow directly out of the regulator with both phones on hook (I can't be sure if that's where you took your current measurements). If it is not zero, you have a short somewhere, probably in the intercom line to the far station. If no current is flowing, but the regulator output is low, the supply will need to be beefed up.

If the regulator and the wiring seems fine, then you might be dropping significant voltage across the wiring to one or both of the phones (assuming that you took your voltage measurements at a location some distance from the supply). Note how one phone off hook pulls the line down by 8.4 volts, but the second phone, which should double the load, only pulls it down by an additional 0.49 volts. Check the resistance of the wiring to test this possibility.

If these tests turn up nothing, try reducing the value of the two resistors. However, do not reduce them to less than 100 ohms each. By the way, either problem with the wiring (a short or high resistance) would have caused your original intercom to function poorly (assuming you used the same wiring). If anyone else has some ideas, please send them in so I can pass them along.

The circuit in question has

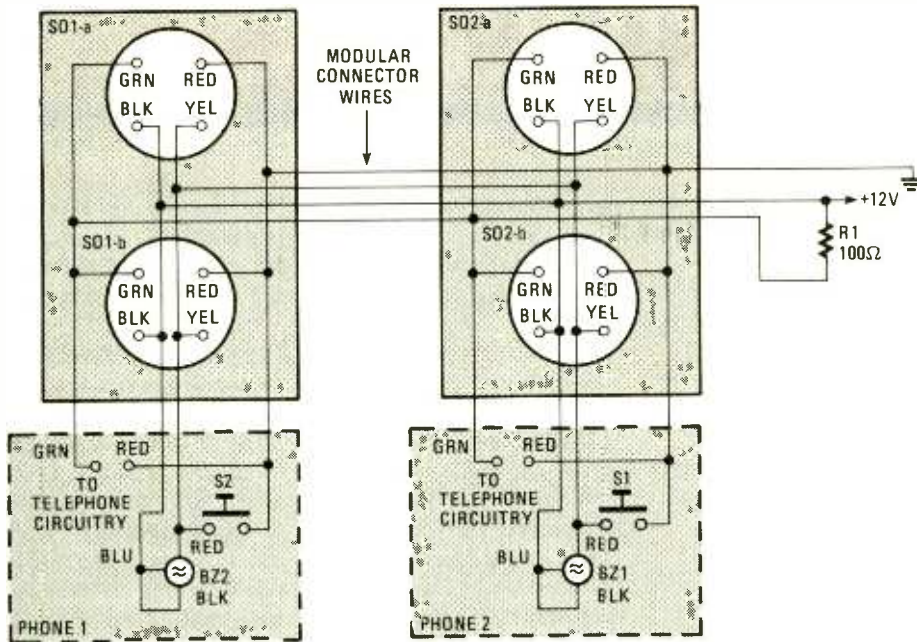

Fig. 2. A telephone intercom can be easily wired together using two dual modular wall jacks. You can make the phones "ring" by adding two buzzers and switches.

proven to be a popular one. So much so that I have received some variations on it, like the one presented in the next letter.

#### WHAT'S THE BUZZ?

I liked the intercom of Vincent Grabosky (see Fig. 1), but needed a ring signal, so this is what I came up

with (see Fig. 2). Take two dual wall brackets and connect all like-colored lines from their bottom sockets to their top sockets. Take one of the brackets and connect its red line to the negative side (ground) of an appropriate 9–12-volt power source (a 9-volt battery, a 9–12-volt adapter, or Mr. Grabosky's regulator). Connect the black line to the supply's positive output. Connect the green line to the resistor as shown, and connect the remaining resistor lead to the positive side of the supply.

Now you will need to modify the phones. In each phone, install a 3-volt 3-wire buzzer (which might already be present) and a normally open switch. Connect them to each other and the phone line as shown.

Each bracket will provide a connection point at each intercom station, so you can put them in place at this time. Connect the two stations by plugging a male-to-male modular cable of the proper length into the two top sockets.

Connect the phones in the bottom sockets.

If you get a hum, increase the value of R1. Mine works fine with 100 ohms and a 75-foot cord from our house to our neighbors house.

—Russell L. Fontenot, Hemphill, TX

Neat idea. I'm a little concerned about the piezo element; they typically require low-level AC to work, so unless your's is working off power-supply ripple, it shouldn't sound. I recommend that readers replace the element with a piezo buzzer with a built-in oscillator and an appropriate voltage rating.

#### A FLASHY PROJECT

John, want a simple, useful telephone project? If so, then this is the one. It's a lamp that oscillates to the ring of the phone. The flasher is simple to make, containing only an NE-2 neon lamp. The lamp is connected across the ring (red) and tip (green) wires leading to the phone (see Fig. 3).

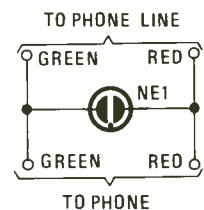

Fig. 3. A neon lamp can easily be added to the phone line to act as a ring indicator. It's perfect for times when you can't hear the phone.

This tip should help those thinking of buying the Fone-Flasher from Radio Shack, which costs \$29.95—2 neon lamps only cost 69 cents! The flasher is useful to those that work in noisy environments, the hearing impaired, and (my personal favorite) those wearing headphones!

(Continued on page 88)

**THE UNCENSORED  
CONTENT OF  
THIS MAGAZINE IS  
MADE POSSIBLE BY  
THE CONSTITUTION  
AND  
THE BILL OF RIGHTS  
OF THE  
UNITED STATES.**

**THE CONSTITUTION. THE WORDS WE LIVE BY.**

To learn more about the Constitution write: Constitution, Washington, D.C. 20006. The Commission on the Bicentennial of The U.S. Constitution.



# DX LISTENING

By Don Jensen

## Radio Polonia is Gone. Polish Radio is Back.

Early this year, broadcasting officials in Warsaw decided, wisely, I think, to drop the Polonia ID and return to the traditional name for Poland's international shortwave. *Radio Polonia* may have been ethnically and aesthetically correct, but it seemed confusing and archaic to a number of newer SWLs, based on some of the letters that I've received over the years.

next year, a transmission beamed specifically to North America was begun. Political tensions increased in the late 1930's, and during that crucial period Polish Radio became one of the major European-shortwave broadcasters with programming in eight languages, including German.

Poland was one of the first countries to experience the Nazi *blitzkrieg*. A dra-

The vast changes in Polish life that have occurred in the last few years also has meant change for Polish Radio, not the least of which has been a financial belt-tightening. This year has seen a cutback in broadcasting hours and the number of languages. Programs in French, Italian, Swedish, and Finnish were dropped. The station continues to broadcast programs in English, German, Russian, Belorussian, Lithuanian, Ukrainian, Esperanto, and, of course, Polish.

Most Polish shortwave broadcasts are aired by seven 100-kW transmitters located near Warsaw, with a smaller 7.5-kW station located at Szczecin. The regular staff—program producers, editors, engineers and technicians—numbers about 100, and their efforts are supported by numerous freelance contributors who are fluent in the various broadcast languages.

A 55-minute English program is broadcast four times daily: 1300 UTC on 6,135, 7,145, 9,525, and 11,815 kHz; 1600 UTC on 7,285, 9,525 and 11,840 kHz; 1800 UTC on 7,145 and 9,525 kHz; and 2000 UTC on 6,090, 6,135, 7,145, 7,270 and 9,525 kHz. The times of those broadcasts suggest that the U.S. and Canada are not the prime targets for Polish Radio, although a number of the transmissions can be heard in North America.

The station is a good verifier of listener's reports. Those reports may be sent to Polish Radio, Al. Niepodleglosci 77/85, 00-950 Warsaw, Poland.

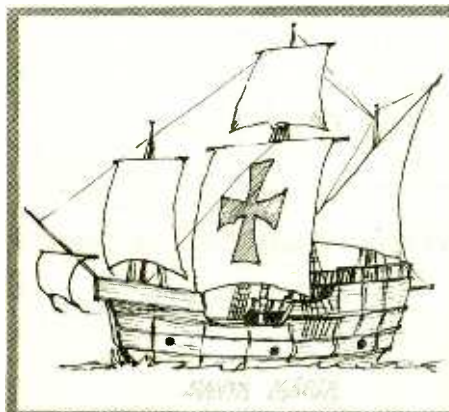

1992 may - mayo														1992 June - junio													
s	m	t	w	t	f	s								s	m	t	w	t	f	s							
3	4	5	6	7	8	9								1	2	3	4	5	6								
10	11	12	13	14	15	16								7	8	9	10	11	12	13							
17	18	19	20	21	22	23								14	15	16	17	18	19	20							
24 <sup>31</sup>	25	26	27	28	29	30								21	22	23	24	25	26	27							
d	i	m	m	j	v	s								d	i	m	m	j	v	s							

1992 July - julio														1992 August - agosto													
s	m	t	w	t	f	s								s	m	t	w	t	f	s							
				1	2	3	4							2	3	4	5	6	7	8							
5	6	7	8	9	10	11								9	10	11	12	13	14	15							
12	13	14	15	16	17	18								16	17	18	19	20	21	22							
19	20	21	22	23	24	25								23	24	25	26	27	28	29							
26	27	28	29	30	31									d	i	m	m	j	v	s							
d	i	m	m	j	v	s								d	i	m	m	j	v	s							

1992 marks the 500th anniversary of Christopher Columbus' first voyage to the New World. The famed admiral's ships appear this year on both the Trans World Radio, Bonaire, calendar and on a special issue QSL card.

Polish Radio has been around a long time. A predecessor station first aired a broadcast for foreign listeners some 65 years ago. The initial broadcast in 1927 from a 12-kW station at Katowice was heard as far away as North Africa and New Zealand—an unexpected range then attributed, improbably, to the presence of extensive coal deposits near the transmitter site.

By 1935, the Polish station was a government operation, no longer just an experiment, but a serious effort to reach expatriated Poles with programs in Polish, English, and French. The

matic appeal for world support was aired by the shortwave voice just hours before besieged Warsaw capitulated. At war's end, the new communist dictatorship resumed shortwave broadcasting as a propaganda outlet. Polish Radio grew in the years that followed to 3000 hours of air time in 1949, to a record-setting 25,000 hours in 1956.

\*Credits: Randy Turner, PA; Ken Cobb, ME; Tom Tabatowski, IN; Don Hosmer, MI; Robert Tucker, GA; Radio Nederland's Media Network; North American SW Association, 45 Wildflower Road, Levittown PA 19057.

## WHEN THE WIND BLOWS

Andrew, Bonnie, Charley, Danielle, and Earl. Those are the names selected for the first five hurricanes of 1992. Perhaps by the time you've read this, some will already be (I hope not too destructive) history. Frances, Georges, Hermine, Ivan, and Jeanne. Those are the next five pre-selected names for this year's tropical storms, several of which may blow up during the next month or so, if the usual weather patterns prevail.

Hurricanes are scary natural events, always dangerous, often destructive, and sometimes lethal. If you live too close for comfort to the threatened Atlantic or Gulf coastal areas, getting up-to-date weather information can be important to your safety. If you live far enough inland to feel safe from high winds and tides, keeping your own hurricane watch still can be fascinating. Shortwave radio, naturally, is a great way to stay in touch.

An early warning of a possible hurricane-to-be can come from the special Atlantic weather warnings broadcast over the U.S. government's standard time and frequency station, WWV, beginning at 8 minutes past each hour, and continuing around the clock on 2,500, 5,000, 10,000, 15,000, and 20,000 kHz. More details on WWV's transmissions can be found in *DX Listening in the May* issue of **Popular Electronics**.

A tropical storm becomes a force-1 hurricane when winds reach 74 mph; at 96 mph, the hurricane becomes a force-2 blow; at 111 mph, it is classified as force 3. A force-4 level has winds of 131 to 155 mph. Anything stronger than that

is a horrific force 5! There are, of course, a number of shortwave broadcasters that announce the geographic coordinates of the major hurricane storm centers as they weave their way across the tropical waters.

During hurricane season, especially, I like to tune in each weekday to *Trans World Radio* on Bonaire, the Island just off the northern coast of South America. The Caribbean weather follows TWR's 1130 UTC News on 11,815 or 15,345 kHz. You might also like to write to Sally Rork at TWR's English Mail Department, in care of Trans World Radio, PO Box 700, Cary, NC 27512-0700, for one of the station's Hurricane Tracking Charts. The chart will let you plot the course of seasonal storms as their geographic coordinates are given in the weather broadcasts. There is no charge for this map and hurricane info pamphlet, but I'm sure TWR would appreciate it if you would tuck a buck into request letter to cover postage and handling costs.

## MAIL CALL

Chuck Roswell—the frequency coordinator for TWR who passed along the hurricane tracking data in a recent letter—also has a tip for those who may still have some problems in keeping the date (which corresponds to UTC) straight when writing reception reports to SW stations.

For a general explanation, check last month's column. But as an additional helper, Chuck suggests that "having a clock set to UTC in the listening post is an important step in keeping the date sorted out." It is even good idea to post a reminder note next to the

clock. For example, 8PM EDT corresponds to UTC midnight the next day.

By the way, SWLs who tune the ham bands as well, may note Chuck, PJ4CR, on the Divi-Divi, amateur-radio net on 14,340-kHz upper sideband at 1130 UTC, Sundays, Tuesdays, and Thursdays.

John Peedell, Long Branch, NJ, writes to say that some times and frequencies of certain stations, which I mentioned in a recent column "are all wrong." Helpfully, he goes on to offer some corrected times and frequencies. Well, John, we're both victim of the same double problem: changing times and frequencies of SW stations and the several month leadtime in preparing, publishing and distributing a magazine like **Popular Electronics**. While, to the best of my knowledge, the schedules are correct when this column is written, they may, in fact, change before you get to read them. Ironically, John, some of your corrected data already has become outdated since you wrote.

So what are we to do? I'll continue to select times and frequencies that I hope will be in use for at least several months. I hope that readers will understand that sometimes there will have been changes in times and frequencies before the dates appear in print here. But if that happens, try tuning around the same SW band. It's a fair bet, at least with a major SW broadcaster, that you will stumble across the new frequency, plus or minus a hundred kHz or so.

## DOWN THE DIAL

Next, some targets for avid SWLs to chase:

**CANADA**—The Northern Quebec Service of the Ca-

nadian Broadcasting Corp. has long been an SWL favorite. The domestic shortwave programming is directed to isolated listeners in Canada's far north. Tune in this one at around 1430 UTC on 9,625 kHz.

**COLOMBIA**—This is a Latin country from which, over the years, few stations have ever broadcast English-language programming. Now, however, the government's *Radio Nacional de Colombia* is airing an English program, including some DX'ing information, on Saturdays at 2330 UTC on 11,822.5 and 17,865 kHz. Reports may be sent to PO Box 94321, Bogota, Colombia.

## DOMINICAN REPUBLIC

This Latin country is underrepresented on shortwave these days. But you may find **Radio Norte** on 4,800 kHz, broadcasting in Spanish with lots of *salsa* about 0500 UTC.

**MOROCCO**—Among the *Voice of America's* African relay stations is one at Tangier, near the entrance to the mediterranean. You may find one of VOA's English programs airing at around 1830 UTC on 21,625 kHz.

**SIERRA LEONE**—An interesting West African shortwave outlet is the Sierra Leone Broadcasting Service on 3,315 kHz, whose English programs for local audiences can include news, obituaries, and toothpaste commercials. ■



"It's a troubleshooting aid—an IC with a vacuum tube attached. When the IC fails, the filament goes out."



# HAM RADIO

By Joseph J. Carr, K4IPV

## Some New Products and Some Questions Answered

From time to time, we dip into the mailbag and pick out a question or two and/or new product announcements for this column. While it is impossible to dedicate this space to answering all queries, we try to pick out some that are of general interest, or those that more than a few readers have expressed an interest in. But first let's take a look at a couple of products for ham-radio operators.

### QSK SWITCH

A QSK switch is connected between the

mechanical relay that's energized by either an RF-sensitive switching circuit (that senses the transceiver's RF output) or an AC or DC line to an internal relay contact inside the transceiver. Very good linear-amplifier switching systems use vacuum relays (which are faster than other mechanical relays) for that purpose.

There are some problems with the usual QSK switch. First, the mechanical switch is not as fast as the PIN-diode switching inside the transceiver, so "relay race" conditions occur. In addition, the de-energizing of the mechanical relay does not occur as rapidly as PIN-diode switching inside the transceiver. That means that there is a brief instant when the linear amplifier is operating, but there is no RF drive. That condition has the potential to reduce the life of the overpriced tubes that are found in high-power linear amplifiers. Also, such hot switching is a source of TVI, BCI, and key clicks (on CW).

The Ameritron (921 Louisville Road, Starkville, MS, 39759, 1-800-647-1800) Model QSK-5 external QSK switch (\$349) is one solution to the problem. The QSK-5 (which uses PIN-diode switching) is six times faster than vacuum relays, so it comes closer to matching the speed of modern transceiver switching. At the same time, it preserves linear-amplifier tubes by turning off their plate current between dots, dashes, and digital words.

It will handle 2500 watts PEP and 2000 watts in normal service (VSWR < 1.5:1).

In continuous modes (such as RTTY, SSTV, and FM), the Ameritron QSK-5 will handle 750 watts, unless the optional CF-5 cooling fan (\$39.95) is used to boost power handling to 1500 watts continuous. The QSK-5 external switch will accommodate keying voltages of up to 25 volts.

### LINEAR-AMPLIFIER PROTECTOR

Two other Ameritron products—the ICP-120 and ICP-240 In-Rush Current Protectors for linear amplifiers—struck me as quite useful, even though many amateurs don't understand the need for such devices. One of the causes of vacuum-tube failure is filament damage due to an in-rush of current at turn/on. At turn/on the filament is cold, so when power is applied to the tube filament, the stress placed on the filament can cause it to burn out.

The ICP-120 and ICP-240 are designed to prolong the life of the tubes by placing a current-limiting resistor in the primary AC circuit for a short while. That allows the filament to heat up a bit before allowing full-power operation. That's an old trick that is used extensively on broadcast and communications transmitters, but it is one that rarely used in ham linear amplifiers.

The ICP-120/ICP-240 also contain varistors to protect the equipment from high-voltage spikes on the AC power line. Without that, those spikes can wreck the rectifier diodes inside the linear amplifier's power-supply circuit.



The Ameritron Model QSK-5 external QSK switch (which uses PIN-diode switching) is six times faster than vacuum relays, and preserves linear-amplifier tubes by turning off their plate current between dots, dashes, and digital words.

antenna connector on a radio transceiver (the high-power linear amplifier) and the antenna, and is used as a transmit/receive (T/R) switch for CW, AMTOR, and packet radio. The problem is that the transceiver has its own internal antenna switching between the receiver and transmitter to allow break-in operation, but the linear amplifier (being external to the transceiver) does not.

The typical linear amplifier T/R switch is a



The ICP-120 and ICP-240 In-Rush Current Protector for linear amplifiers (another Ameritron product) can help increase the life of tubes by preventing filament damage due to in-rush current at turn on.

## SPECTRUM-ANALYZER FILTERS

A reader recently wrote to take me to task about not including some information about filters in the discussion of spectrum analyzers a few months back. With the wideband filters typically used in low-cost spectrum analyzers, much information is lost because the circuit cannot distinguish two or more signals that are close together. A narrow-band filter will separate those signals.

Some commercial spectrum analyzers use wideband filters, but also have one or more narrow-band filters to improve resolution. Try using 1-kHz filters or less (e.g., 500- or 240-Hz CW filters) in the IF output of your homebrew spectrum analyzer.

modern parts, especially IC's, are marked with printing that is too small for him to see. I can identify with that problem.

For those in that predicament, there is the *Optivisor*—a magnifying glass with an adjustable headband. It comes with a  $2\times$  lens, and you can buy new lenses with magnification factors of up to  $10\times$ . There's also an eye-loupe attachment that doubles the power, albeit at the expense of shortening the focal length. Optivisors are available at hobby shops, jewelry-making shops, rockhound/gem shops, and shops that sell a complete line of jeweler's tools. I understand that Edmund Scientific (101 E. Gloucester Pike, Barrington, NJ, 08007-1380) also sells them.

## TERMINATING LONG-WIRE ANTENNAS

Some sharp-eyed readers spot the obvious that others overlook. The long-

gain), with some being as long as  $10\lambda$  (7.5 dB gain). Greater lengths are possible, but become unwieldy. Although long-wire antennas of up to 1500-feet have been built by people that I know, even a 130-foot wire will work as a long-wire antenna on the upper HF bands.

A non-resonant long-wire antenna (see Fig. 1A) consists of a wire radiator element, a downlead, an antenna-tuning unit, and a grounded terminating resistor (R1) at the far end of the wire element. If the wire element is placed at a height of 20 to 30 feet (a usual height for practical ham antennas), the resistor should be about 500 ohms. It should be a high-power, non-inductive type (*i.e.*, a resistor made of carbon composition or metal film over a large ceramic form).

A reader wrote to me about a previous article and asked about that terminating resistor. "All very well and good, but doesn't the long lead between the resistor and ground kinda mess up the ground connection?" Yep, it makes the grounding less effective, and adds a vertically polarized component to the radiated wave, thereby distorting the pattern.

A better solution is to use a counterpoise ground at the far end of the resistor. "So what's a counterpoise ground?" It's nothing more than a fancy engineering word for a  $\frac{1}{4}\lambda$  radial that forms a ground plane. Figure 1B shows the use of a radial placed at one end of the terminating resistor. It works better than simply grounding the resistor directly. As with other radials, the use of one radial per ham band is good, but more is better. Try using three or four radials per band as a minimum. ■

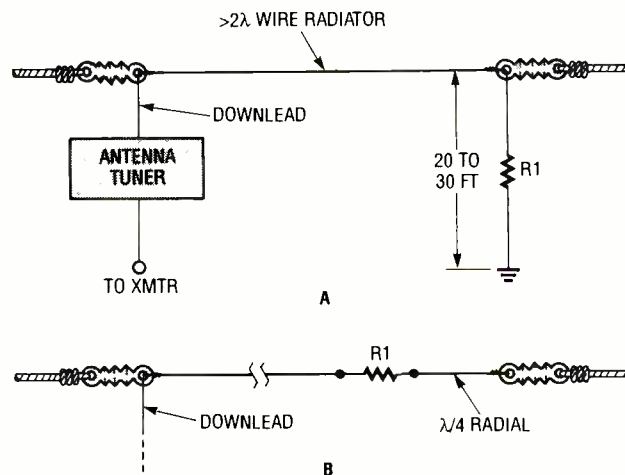

Fig. 1. The traditional configuration for a long-wire antenna is shown in A; shown in B is a version of the long-wire antenna with radials replacing the ground connection.

## COMPENSATING FOR POOR EYESIGHT

Another reader lamented that he is middle aged and his eyesight is poorer today than 20-years ago. The reader complained that

wire antenna (not the  $>1\lambda$  random-length antenna) is capable of providing a pretty good gain over a dipole or isotropic source. Long-wire antennas are longer than  $2\lambda$  (1.3 dB

**FREE  
30-DAY  
EXAM**

# Explore the Latest Advances in Electronic Circuitry



**MODERN ELECTRONIC CIRCUITS REFERENCE MANUAL** by J. Markus. With this jam-packed reference, you get descriptions, performance data, and suggestions for applications on all sorts of circuits—from amplifiers to voltage-reference purposes. 1,000 pp., illustrated #040446-1, \$96.95



**THE RADIO AMATEUR'S DIGITAL COMMUNICATIONS HANDBOOK** by Jonathan L. Mayo, KR3T. Get more enjoyment out of your ham radio with tips on how to • distinguish various modes • use methods of modulation use and set up a communications workstation. 208 pp., 80 illus. #3362H, \$22.95

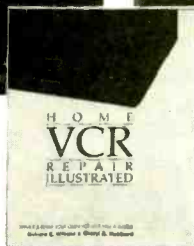

**PROGRAMMABLE CONTROLLERS: Hardware, Software, and Applications** by George L. Batten, Jr., Ph.D. You get details on: how PLCs are used... types of hardware and software... high- and low-level programming languages... interfacing PLCs with peripherals... and creating networks of PLCs. 304 pp., 187 illus. #3147H, \$38.95

**HOME VCR REPAIR ILLUSTRATED** by Richard C. Wilkins and Cheryl A. Hubbard. Repair all types of VCRs with illustrated tips for: cleaning, picture and sound quality, fast forward and rewind, DC motors, tension and roller guides, jammed cassettes, and more. 352 pp., 427 illus. #3711H, \$29.95

**SAVE \$20**  
Includes an index for circuits used in four volumes!  
**ENCYCLOPEDIA OF ELECTRONIC CIRCUITS**—VOL. 4 by Rudolf F. Graf and William Sheets. Turn here for the latest circuitry used in computers, controls, instrumentation, telecommunications, sensors, and more. Over 1000+ all-new circuits in 100+ alphabetically arranged categories. 768 pp., 1000 illus. #3752H, \$39.95 (regularly \$60.00)  
Save 22%—Get thousands of circuits and project ideas in Vol. 1, 2 and 3 (#5489C) for only \$139.95 (regularly \$180.00)

**INTERNATIONAL ENCYCLOPEDIA OF INTEGRATED CIRCUITS**—2ND ED. by Stan Gibilisco. Find the circuits you need fast. This reference gives you: circuit functions and uses, pinout diagrams with external connections, tables listing manufacturer data, and more. 1,168 pp., 4,000 illus. #3802H, \$84.95... Now \$44.95

**THE NEW STEREO SOUNDBOOK** by F. Alton Everest and Ron Streicher. Optimize your stereo equipment and listening environment with: phantom imaging, binaural recordings, comb-filtering effects, combining 3 mono-signals to stereo, and the Ambisonics system. 296 pp., 251 illus. #3789H, \$29.95

**REGULATED POWER SUPPLIES**—4TH ED. by Irving M. Gottlieb. Design and test regulated power supplies with this expanded guide. Build frequency devices such as: the insulated-gate bipolar transistor (IGBT), the mos-controlled thyristor (MCT), and current- and resonant-mode regulators. 464 pp., 365 illus. #3991H, \$39.95

**SECRETS OF RF CIRCUIT DESIGN** by Joseph J. Carr. Build your own radio frequency amplifiers, signal generators, inductor coils, antennas, microwave circuits, and more. Discover receiver operations, RF circuitry components, and radio signal propagation. 416 pp., 175 illus. #3710H, \$32.95

**PRACTICAL ELECTRICAL WIRING: Residential, Farm, and Industrial—15th Ed., Based on the 1990 National Electric Code®** by Herbert P. Richter and W. Creighton Schwan. Get any wiring job done efficiently with this revised guide. Learn about tools and components, "tricks of the trade," and safety practices. 656 pp., 464 illus. #10024H, \$32.95

**GENERAL RADIOTELEPHONE OPERATOR'S LICENSE STUDY GUIDE—3rd Ed.** by Thomas LeBlanc, NX7P. Pass the FCC exam with ease knowing: • time zone considerations • field strength calculations • radiated power calculations • Loran C • binary numbers • and sample tests. 260 pp., 100 illus. #4075H, \$27.95

**OLD TIME RADIOS! Restoration and Repair** by Joseph J. Carr. You get details, instructions and schematics, plus pinout diagrams for fixing up any classic radio—from an old floor-model Phillips to a beehive or cathedral style. 256 pp., 247 illus. #3342H, \$25.95



**To Order Call 1-800-822-8158**

**FAX Orders: 717-794-2080**

Or mail coupon to:

TAB/McGraw Hill, Inc., Blue Ridge Summit, PA 17294-0840

Please cut along dotted line

**Satisfaction Guaranteed**—If you are not satisfied, return the books within 30 days for a full refund.

Please send me the book(s) indicated below:

# \_\_\_\_\_ Price \_\_\_\_\_ # \_\_\_\_\_ Price \_\_\_\_\_ # \_\_\_\_\_ Price \_\_\_\_\_

# \_\_\_\_\_ Price \_\_\_\_\_ # \_\_\_\_\_ Price \_\_\_\_\_ # \_\_\_\_\_ Price \_\_\_\_\_

Check or money order enclosed made payable to TAB/McGraw-Hill, Inc..

Charge my  VISA  AMERICAN EXPRESS  MasterCard Please Print

Acct.# \_\_\_\_\_ Exp. \_\_\_\_\_ / \_\_\_\_\_

Signature \_\_\_\_\_

Name \_\_\_\_\_

Address \_\_\_\_\_

City/State/Zip \_\_\_\_\_

Please add applicable state and local taxes. Orders outside the U.S. must be prepaid in U.S. funds drawn on U.S. banks and include \$5.00 for postage and handling. Prices subject to change. Orders subject to credit approval. PE82

# SCANNER SCENE

By Marc Saxon

## A Handheld That Won't Break the Bank



Radio Shack's Realistic PRO-41 is an affordable choice in a handheld scanner.

You say that the cost of handheld scanners has gotten higher than Kansas cornstalks in August? You say that you would like to have a handheld, but you'll wait until a decent one comes along at the right price? Well, we say that maybe you should consider the *Radio Shack Realistic PRO-41*. At \$119.95, that's about as low cost as new handhelds get.

For that price, you get a scanner that is keyboard programmable and has all of the features you like—well, at least *most* of them. It has scan delay, channel lockouts, keyboard lock,

low-battery beep, a BNC antenna connector, and an earphone jack. It's also extremely simple to operate, and is smaller than a lot of other handhelds that we've seen. The frequencies covered are the standard 29–54-MHz, 137–174-MHz, and 405–512-MHz bands. The PRO-41 operates on five "AA" batteries or an AC adapter.

There are a couple of trade-offs that allow the PRO-41 to be relatively inexpensive. First, it has only 10 memory channels, far less than the 20, or 100, or 200 memory channels available in other current Realistic handhelds. Second, the PRO-41's LCD readout doesn't display the actual frequency or provide any status information; it only displays, by channel number, which of the scanner's memory channels is being received. If those two features are acceptable to your needs, then you have a shot at getting a decent little scanner at a good price.

### OLD BUSINESS

Last February, we mentioned that reader Nelson Eshelman was attempting to locate the company that once produced a scanner known as the ADC SS-16. It was a unit that was unknown to us, but not to Daniel Mellem, of West Covina, CA. Dan advises that this set came from Alpha Delta Communications, and that in 1988 their address was Box 571, Centerville, OH 45459. He

doesn't know if the address is still good, or if this company is the same Alpha Delta Communications, Inc., that currently makes surge protectors, SWL antennas, and lightning arresters—but *that* Alpha Delta has a current address of P.O. Box 51117, Phoenix, AZ 85076.

Try the Ohio address, and if that doesn't work, start tracking!

### NEW BUSINESS

A letter from Dwain A. Coufal, Temple, TX, was the most recent addition to a healthy stack of letters requesting frequency information for scanning at Walt Disney World, Universal City, and other major Florida attractions. This is prime vacation time, so it's as good a time as any to toss out some frequencies. It is worth mentioning that apparently not all tourist attractions appreciate (or allow) the use of handheld scanners in their facilities by guests.

For starters, there are far more frequencies in use than I have the space to mention here. Walt Disney World alone has well over 100 scanner frequencies in use, including pagers, wireless mikes, construction crews, maintenance workers, etc. But the security force is on 464.40 and 464.125 MHz, while the fire fighters use 154.43, 453.875, and 453.925 MHz. The monorails use 462.575 MHz, with the submarines at "20,000 Leagues" on 151.895 MHz.

At Universal City Studios,

almost 20 frequencies are used. A few are 461.75, 462.925, 463.6125, 463.6625, and 463.7125 MHz.

There are at least 40 frequencies in use at Sea World, including 151.775, 461.10, 461.85, 463.825, 464.2875, and 464.525 MHz.

The complete professional-grade monitoring guide to scanner frequencies throughout the entire state of Florida is the new 424-page *Florida Communications Guide*. It lists public safety, news media, marine, resorts, tourist attractions, theme parks, businesses, and many other services. It contains maps, frequency-usage data, code signals, and much more. Listings are by county and city, with a frequency sort, too. Published this year, the book—which weighs more than two pounds!—will certainly be indispensable when monitoring anywhere in Florida. It costs \$29.95, plus \$3.50 for UPS delivery, from CRB Research Books, Inc., P.O. Box 56, Commack, NY 11725. (If you're a New York State resident, please add \$2.68 sales tax.)

Other professional guides now available in this series include one covering Massachusetts; one for Virginia and the Washington, DC area; and one for the New York City, Long Island, and Northern New Jersey metro area. Check with CRB Research for additional information.

#### FROM THE MAIL SACK

Someone gave Kenneth Warner a European scanner. Unfortunately, the unit isn't working properly and needs some repairs. The set is a Handic 1600, which Kenneth tells us originated in Sweden. He wrote to the company in Sweden, but got no reply. Now he'd like to know if any of our read-

ers can furnish him with a schematic or an address in the United States where he can send the scanner for a repair.

Anyone who can help him can contact Kenneth Warner directly at HCR 62, Box 478, Center Harbor, NH 03226.

F.G. Hutchinson, of Redwood City, CA, reports that Space Shuttle launches usually mean that he can tune his scanner to 145.585 MHz and get an earful of the Shuttle crews communicating with the NASA people at Houston. He is curious about the source of these transmissions.

In some areas of the nation, ham operators rebroadcast Space Shuttle communications for others who are interested in hearing this traffic, but who don't have the means to copy it directly. The most popular bands are 144–148 MHz and 420–450 MHz. F.G.'s report of 145.585 MHz identifies what he is hearing as one of those transmissions.

Inbound aircraft frequently require special arrangements on the ground, such as hotel rooms to be reserved for passengers, or that the plane be met by certain persons, limousines, or even an ambulance. Commercial airlines handle these communications on "company" frequencies, but private and corporate aircraft handle such communications and similar ones (like checking for fuel or service availability) on certain specific frequencies. At airports with control towers, listen on 122.95 MHz for those communications. At helicopter pads, try 123.05 and 123.075 MHz. At smaller airports, monitor 122.7, 122.8, 122.85, and 123.0 MHz. Military airports use 372.2 MHz for this type of traffic. ■

## DIGITAL VIDEO STABILIZER ELIMINATES ALL VIDEO COPYGUARDS



While watching rental movies, you will notice annoying periodic color darkening, color shift, unwanted lines, flashing or jagged edges. This is caused by the copy protection jamming signals embedded in the video tape, such as Macrovision copy protection. THE DIGITAL VIDEO STABILIZER: RXII COMPLETELY ELIMINATES ALL COPY PROTECTIONS AND JAMMING SIGNALS AND BRINGS YOU CRYSTAL CLEAR PICTURES.

### WARNING

THE DIGITAL VIDEO STABILIZER IS INTENDED FOR PRIVATE HOME USE ONLY. IT IS NOT INTENDED TO COPY RENTAL MOVIES OR COPYRIGHTED VIDEO TAPES THAT MAY CONSTITUTE COPYRIGHT INFRINGEMENT.

### FEATURES

- Easy to use and a snap to install
- State-of-the-art Microchip technology
- 100% automatic
- Compatible to all types of VCRs and TVs
- The best and most exciting Video Stabilizer in the market
- Light weight (8 ounces) and compact (1x3.5x5")
- Uses a standard 9 Volt battery (last 1-2 years)
- Fast UPS delivery
- Air shipping available
- UNCONDITIONAL 30 day money back guarantee
- 1 year warranty

(Dealers Welcome)  
**FREE 20P Catalog**

To Order: \$59.95 ea + \$5 for p & h  
Visa, M/C, COD Mon-Fri: 9-6 EST

**1-800-445-9285**

ZENTEK CORP. DEPT. CPE8

3670-12 WEST OCEANSIDE RD. OCEANSIDE, NY 11572

CIRCLE 7 ON FREE INFORMATION CARD

## CABLE TV DESCRAMBLERS How You Can Save Money on Cable Rental Fees Bullet Proof



1 Unit 5+

BEST Super Tri-Bi Auto/  
Var. Gain Adjustment \$119.95...\$85  
Jerrold Super Tri-Bi ... \$109.95...\$79  
Scientific Atlanta ..... \$109.....\$79  
Pioneer ..... \$109.....\$79  
Panasonic TZPC145.... \$99.95....\$79  
Stargate Converter..... \$95.....\$69  
Digital Video Stabilizer: \$59.95....\$29  
Wireless Video Sender...\$59.95....\$49.95

**US Cable'll Beat  
Anyone's Price  
Advertised in  
this Magazine!**

**30 Day Money Back Guarantee**  
**FREE 20 page Catalog**

Visa, M/C, COD or send money order to:

**U.S. Cable TV Inc.** Dept. KPE8  
4100 N. Powerline Rd., Bldg. F-4  
Pompano Beach, FL 33073

**1-800-772-6244**

**For Our Record**

I, the undersigned, do hereby declare under penalty of perjury that all products purchased, now and in the future, will only be used on Cable TV systems with proper authorization from local officials or cable company officials in accordance with all applicable federal and state laws. FEDERAL AND VARIOUS STATE LAWS PROVIDE FOR SUBSTANTIAL CRIMINAL AND CIVIL PENALTIES FOR UNAUTHORIZED USE.

Date: \_\_\_\_\_

Signed: \_\_\_\_\_

**No Florida Sales!**

CIRCLE 8 ON FREE INFORMATION CARD

# ELECTRONICS LIBRARY

## Lost Users Manuals

by Bill Smith, N6MQS

Judging from the number of letters sent each month to the "Haves & Needs" section of **Popular Electronics' Letters** column, there is a great demand for user's manuals, particularly from readers who buy second-hand gear that's missing the

book explains the functions of each key and the meaning of display symbols and prompts. Included are key-by-key instructions for performing most of the basic functions, as well as alternate and advanced key functions. Rather than reprints of entire original manuals, the book provides condensed versions that include illustrations of the controls and displays with all features clearly labeled, specifications charts, and explanations of mode settings and keystrokes required to accomplish specific functions. A glossary of terms is also included.

*Lost Users Manual* costs \$19.95 and is published by Artsci, Inc., P.O. Box 1848, Burbank, CA 91507; Tel: 818-843-4080; Fax: 818-846-2298.

**CIRCLE 86 ON FREE INFORMATION CARD**

## ELECTRONIC AND COMPUTER CATALOG: SPRING 1992

from *American Design Components*

Geared to meet the various needs of today's hobbyists, small and large manufacturers, schools, universities, researchers, engineers and computer buffs, this 48-page, fully-illustrated catalog includes a wide selection of electronic gadgets, computers, and related parts and components. It describes such components as integrated circuits, semiconductors, LED's, connectors, switches, relays, fans, rechargeable batteries, pumps, motors, and power supplies. Also featured are computers and related products such as floppy- and hard-disk drives, monitors, add-on boards, and game accessories. The products are accompanied by



photographs, descriptions, and pricing information.

The *Spring 1992 Catalog* is free upon request from *American Design Components*, P.O. Box 2601, Secaucus, NJ 07096-2601; Tel: 800-776-3700.

**CIRCLE 87 ON FREE INFORMATION CARD**

## BOB GROSSBLATT'S GUIDE TO CREATIVE CIRCUIT DESIGN

by Robert Grossblatt

In this book, one of our favorite authors uses a combination of practical experience, common sense, and a hint of humor to teach readers what it takes to bring their ideas to life in working circuits. He explains each step from concept to reality with easy-to-grasp design and construction details for several basic electronic modules. Then he challenges readers to go beyond the basics and combine those modules into larger, more complex projects.

Throughout the book, scientific method is emphasized. Each of the fundamental steps required to build a functioning circuit is explained: listing design criteria, choosing components, calculating component values, identifying alternatives, setting operating parameters, and creating block diagrams. Once the basic cir-

original documentation. It's hard to get the most out of a high-tech radio if you don't know the functions of all the keys. Directly addressing the problem, this book provides instructions for various radios manufactured by Kenwood (27 models), ICOM (23 models), Yaesu (20 models), Uniden (5 models), and Alinco (3 models). Serving as a quick-reference guide for operating an electronic radio, the

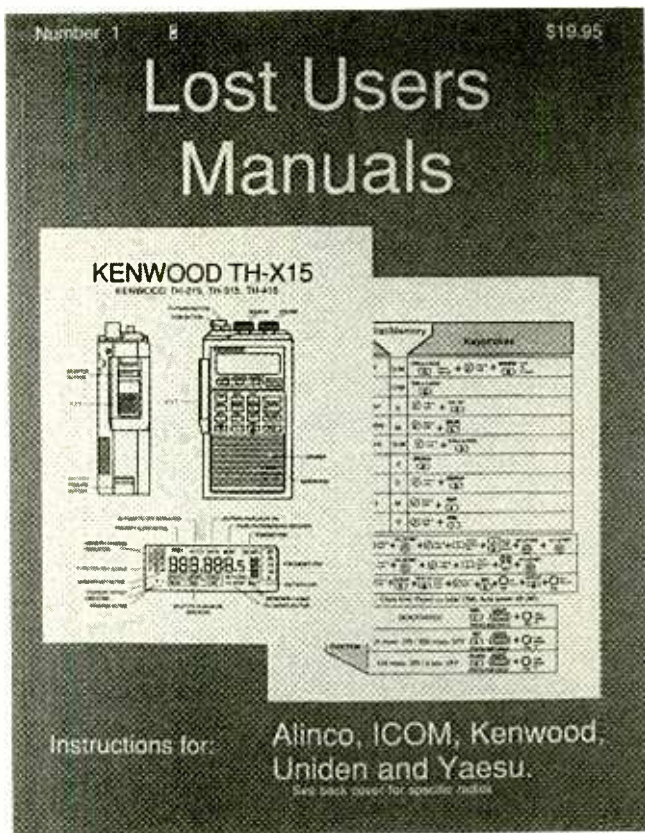

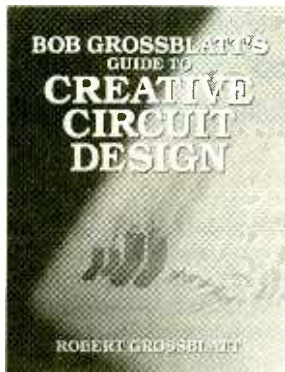

cuit-building techniques are mastered, readers can try them out on some of the practical projects presented, which include a multi-voltage bench power supply, an audio pre-amplifier and amplifier, a fully buffered 64K RAM system, a battery-backup circuit with automatic switch over, a programmable home-control center, a multifunction audio equalizer, a VCR sync stabilizer, and a microprocessor-based waveform generator. The book also explains how to incorporate a wide variety of power supplies, signal generators, detectors, controllers and other primary circuits into larger systems. Details such as block diagrams, pinouts, and oscilloscope traces are included.

*Bob Grossblatt's Guide to Creative Circuit Design costs \$17.95 and is published by TAB Books, Division of McGraw-Hill Inc., Blue Ridge Summit, PA 17294-0850; Tel: 1-800-822-8138.*

**CIRCLE 98 ON FREE INFORMATION CARD**

### GUIDE TO POWER PROTECTION AND CATALOG OF POWER PROTECTION PRODUCTS

from Perma Power

This eight-page brochure contains both a catalog of products and a detailed guide to power protection. It opens with an explanation of the variety of power problems that can adversely affect the performance of computers and peripherals, as well as other sensitive electronics, including modems, telephones, fax machines, and VCR's. The guide also includes descriptions of the three basic

types of power protection: surge suppression, voltage regulation, and uninterruptible power supplies (UPS). Each section explains the applications best suited for each type of protection, as well as what features and specifications to look for when selecting a device.

The catalog section describes the full line of Perma Power protection products. Specifications and applications information are provided on surge suppressors, power control centers, automatic voltage regulators, and UPS power sys-

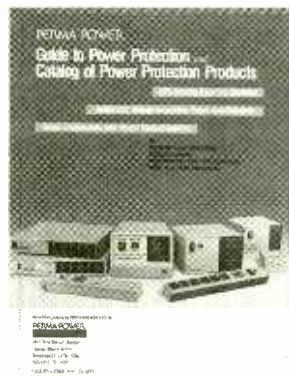

tems for stand-alone PC's and local area networks. Also included are explanation's of Perma Power's patented automatic failsafe shutdown circuit, new and exclusive SIDAC-based telephone/data-line surge suppressors, and the difference between the various protection levels of the company's four grades of power-line surge suppressors.

*The Guide to Power Protection and Catalog of Power Protection Products is free upon request from Perma Power Electronics, Inc., 5601 West Howard Avenue, Chicago, IL 60648; Tel: 312-763-0763; Fax: 312-763-8330.*

**CIRCLE 88 ON FREE INFORMATION CARD**

### CAMCORDER VIDEO: Shooting & Editing Techniques

by Joan Merrill

Aimed at everyone who wants to make their tapes look more polished—home-video makers, business people who use camcorders for simple in-house productions, professional wedding videographers, and film

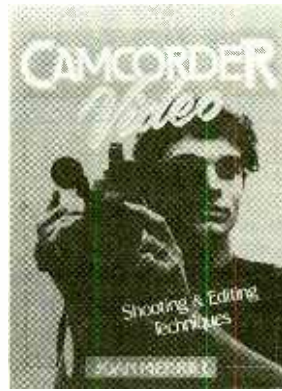

and video students—this book offers practical and helpful suggestions and techniques for producing professional-quality videotapes. The book is divided into four distinct sections. The first begins with an in-depth examination of the camcorder including discussions of its development, how it works, how to expand its capabilities using accessories, and how to properly maintain it. The second section concentrates on shooting, beginning with the basics of lighting, focusing, taking steady

pictures, and getting good sound quality. Also explained are shots and sequences, light and color, and advanced sound techniques. Titled "Subjects," the third section covers such topics as shooting special events (office presentations, weddings, athletic events) and special productions (music videos, family histories, and time capsules). Post-production editing is discussed in Part Four, which explains the types of equipment used, how to use a personal computer for video production, and how to create an aesthetically pleasing finished product. The book includes a glossary of terms and a list of films that can be rented on videotape that illustrate many of the points made in the text.

*Camcorder Video: Shooting & Editing Techniques costs \$45 in hardcover or \$24.95 in paperback and is published by Prentice-Hall, Englewood Cliffs, NJ 07632.*

**CIRCLE 99 ON FREE INFORMATION CARD**

FULL- OR PART-TIME BUSINESS:

## You can make good money in VCR repair!

Professional-level home study program. You will master easy-to-learn high-profit repairs *without* investing in high-tech instruments or an expensive workshop.



Send or call today for more information on our approved home study career course.

## Free career kit: 800-223-4542

Name \_\_\_\_\_  
Address \_\_\_\_\_  
City \_\_\_\_\_ State \_\_\_\_\_ Zip \_\_\_\_\_

**The School of VCR Repair**  
2245 Perimeter Park, Dept. VJ431  
Atlanta, Georgia 30341

**CIRCLE 6 ON FREE INFORMATION CARD**

# NEW PRODUCTS

## Iron-On PC-Pattern System

You can make instant iron-on printed-circuit board patterns, faceplates, component overlays, and custom decals from any laser printer or photocopier, using *Dyna Art Designs' Toner Transfer System*. The system consists of five 8½ × 11-inch sheets of a special process paper, an iron cover sheet, and full instructions. With standard paper stock, the toner gets "locked" into the paper fibers; when ironed onto a substrate, there is no way to remove the paper base without destroying the transferred image. The Toner Transfer System's process paper has a special top coating that allows it to accept 100% of the toner image, fully fused into the soft, absorbent top coating. The coating dissolves when exposed to water, releasing the toner from the paper fiber base.

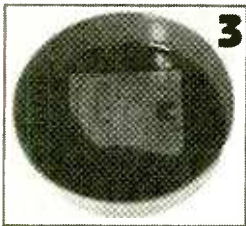
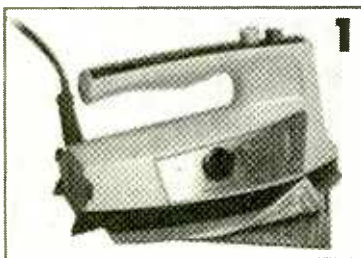

Individual hobbyists and small commercial design houses can create single or double-sided PC boards of moderate complexity, in just three minutes. The process is particularly handy for transferring magazine construction article patterns. The three-step process requires no darkroom or chemicals. First the image is

transferred to the Toner Transfer paper using a 300-dpi laser printer or a dry photocopier. Next the image is ironed directly onto a blank copper-clad board for two minutes. Finally, the board is soaked in plain water for one minute, causing the paper to fall off, but leaving the etch-resist toner pattern intact.

When making custom decals, the system allows you to transfer even full-color pictures to create spectacular visual project enclosures, labels, clear plastic LCD/LED display windows, and much more. Decal fabrication requires the use of clear lacquer spray paint and denatured alcohol.

The Toner Transfer System costs \$9.95 plus \$2.50 shipping and handling (California residents must add 8¼% sale tax). For more information, contact Dyna Art Designs, 3535 Stillmeadow Lane, Lancaster, CA 93536; Tel: 805-943-4746.

**CIRCLE 101 ON FREE INFORMATION CARD**

## VIDEO SURVEILLANCE SYSTEM

Designed for use in homes or businesses, *Radio Shack's Safe House Model VSS-100* video surveillance system makes it easy to monitor activities in remote locations. The system consists of a high-resolution video camera, a 9-inch black-and-white video monitor, an adjustable mounting bracket, and a 60-foot, plug-in connecting cable. Up to three optional 100-foot extension cables can be added, allowing a distance of up to 360 feet between camera and monitor. The adjustable mounting bracket allows the user to



position the camera at the most desirable viewing angle. The system delivers a high-quality image even in low-light conditions. A high-sensitivity microphone can be used for monitoring a baby's nursery or a toddler's play area. The monitor has a VCR output, allowing the user to record activities for later viewing.

The Safe House Model VSS-100 video surveillance system (Cat. No. 49-2500) costs \$299.95 at Radio Shack stores nationwide. Optional 100-foot extension cables cost \$34.95 and the VCR connecting cable costs \$7.95. For further information, contact Radio Shack, 700 One Tandy Center, Fort Worth, TX 76102.

**CIRCLE 102 ON FREE INFORMATION CARD**

## AUTORANGING DIGITAL MULTIMETER

Its rugged case, extra-large display, and small size make the *Model 380501* digital multimeter from *Extech* particularly well suited for industrial field work. The handheld DMM's measurement functions include AC and DC voltage and current, resistance, diode check, and audible continuity. The ¾-inch LCD



readout provides clear readings of all measurements. The Model 380501's features include automatic polarity, low-battery indicator, data hold, overload protection, and automatic or manual range selection. The



3½-digit multimeter measures just 5½ × 3 × 1½ inches and weighs 10 ounces.

The Model 380501 autoranging multimeter costs \$79.00. For additional information, contact Exttech Instruments Corporation, 335 Bear Hill Road, Waltham, MA 02154; Tel: 617-890-7440; Fax: 617-890-7864.

**CIRCLE 103 ON FREE INFORMATION CARD**

## MOBILE ANTENNAS

Designed to fill the need for a high-performance antenna system that also maintains a "low profile," *Electron Processing* has introduced the *Signal Scoop* and *Super Signal Scoop* (pictured) mobile antennas.

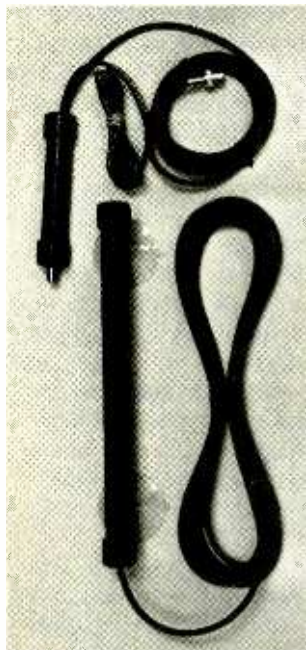

Both are extremely easy to install, using suction cups to attach to either the inside or outside of a vehicle's windows, and can be transferred between vehicles effortlessly. The suction-cup mounts will not leave marks on the windows, as often happens from repeated magnet-mount use.

Six models are available. For the widest frequency range, the *Signal Scoop-AB* covers 0.53–1200 MHz and is ideal for use with super-wide coverage worldband and scanner receivers. For worldband, SWL, and AM reception, the *Signal Scoop-SWL* covers 0.53–30

MHz and is "peaked" for great shortwave reception. Mobile scanner users could opt for the *Signal Scoop-SFT*, which covers 25–1200 MHz, including FM and TV-broadcast bands. Those same three ranges are covered by three models of *Super Signal Scoop* (-AB, -SWL, and -SFT), each of which also includes an internal signal intensifier. All models have a 12-inch reception element and come with 15 feet of coaxial cable with either BNC, PL259, or Motorola-type connector installed.

In any of their three configurations, the *Signal Scoop* and *Super Signal Scoop* mobile antennas cost \$45 and \$80, respectively. (There is an additional \$5 shipping and handling charge.) For more information, contact *Electron Processing, Inc.*, P.O. Box 68, Cedar, MI 49621; Tel: 616-228-7020.

**CIRCLE 104 ON FREE INFORMATION CARD**

## ENERGY-SAVING CELLULAR PHONE

A popular phone with users in Canada, Europe, and the Far East, *Sanyo's Model CMP-330* is compact (2.3 × 7.1 × 1.2 inches), lightweight, and easy to use. The cellular phone features a convenient stand-alone housing and a desktop charger that also acts as a storage area for the phone when it is not in use. Special battery-saving circuitry extends talk/standby time for up to 100 minutes of talk time (based on ½ maximum power) and 14 hours of standby time. The phone's 100-number speed-dialing feature allows numbers to be retrieved using the alphanumeric code or preset-number scan. With scratchpad memory, the LCD readout can be used to take down a number during a call. For people who need separate business numbers or numbers for use in different cities, a special multi-number-assignment feature allows the connection of up to three separate numbers to the telephone. For money-conscious users, the phone gives a warning beep 50 seconds into each minute of a call, so the user can hang up the phone before the minute



(the most common billing unit) is over.

The CMP-330 contains hard and soft-lock security options that are accessed with a four-digit personal security code. The hard-lock option ensures that only one emergency number can be dialed without entering the security code. The soft-lock option allows only the

first five numbers in digital memory to be accessed. Other features offered by the phone include a 30-character display with animated graphic indicators, an on-screen help menu, last-number/recent-number redial, automatic repeat redialing, mute, four mode A/B cellular system selection, air-time indicators, a signal-strength meter, a battery charger with AC adaptor, a low battery alarm, and a retractable whip antenna.

A full line of accessories is available, including a "Hands-Free Kit" that consists of a car-mounting cradle that combines a built-in amplifier, speaker, remote wired microphone, battery charger with a 12-volt power supply, and antenna output for completely hands-free operation.

The CMP-330 cellular telephone has a suggested retail price of \$899.99. For more information, contact *Sanyo*, 21350 Lassen Street, Chatsworth, CA 91311-2329; Tel: 818-998-7322; Fax: 818-701-4149.

**CIRCLE 105 ON FREE INFORMATION CARD**

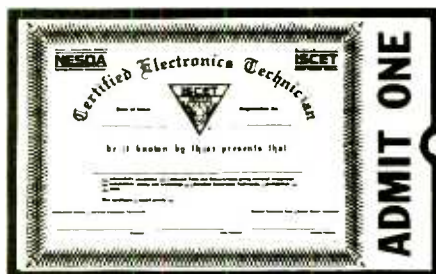

## Your Ticket To SUCCESS

Over 28,000 technicians have gained admittance worldwide as certified professionals. Let your ticket start opening doors for you.

ISCET offers Journeyman certification in Consumer Electronics, Industrial, Medical, Communications, Radar, Computer and Video. For more information, contact the International Society of Certified Electronics Technicians, 2708 West Berry Street, Fort Worth, TX 76109; (817) 921-9101.

Name \_\_\_\_\_  
Address \_\_\_\_\_  
City \_\_\_\_\_  
State \_\_\_\_\_ Zip \_\_\_\_\_

Send material about ISCET and becoming certified.

Send one "Study Guide for the Associate Level CET Test" Enclosed is \$10 (inc. postage).



and sent to the multi-frequency decoders in the chip. A few milliseconds after that, pin 34 and pin 29 would go high, indicating the presence of the tone and that it was decoding, respectively. Next one of the 12 led's (LED5-LED16) would light to indicate which touch-tone signal was detected. In this case, it would light LED8, coming off of pin 24.

The circuit can also detect dial-pulse signals originating from a rotary telephone. As soon as it sees the pattern of a dial pulse signal, it sends pin 10 high, indicating a detection. After it counts all the pulses, it makes pin 34 and the appropriate LED output go high.

You can hear both the DTMF tones and both parties talking on the output speaker SPKR1. Of course, this should only be used as a "testing" device because "eavesdropping" is illegal.

The best part about this circuit is that it is hardly "visible" on the phone line in the way of resistance (impedance) and inductance (4 mH at 1 kHz). I designed the circuit to monitor my phone line and to test touch-tone pads.

I like tinkering with electronics and, just in case you were wondering, I'm 14 years old. Well, did this one earn me a book, John?

—Stan Blosser,

Fruitport, MI

*Not only did you earn a book, you've earned my respect, too. It's really nice seeing a young person taking an interest in the technology that is changing our lives.*

*Well, that's all we have room for this month. Until next time, send your circuits to me at Think Tank, Popular Electronics, 500-B Bi-County Blvd., Farmingdale, NY 11735.*

## COMPUTER BITS

(Continued from page 71)

Seven make some of the best standard super VGA cards.

For example, ATI's VGA Wonder XL with 1MB of memory goes for well under \$250 (you need 1MB to attain 1024 × 768 resolution with 16 colors). One notch up is a class of products called *graphics accelerators*, which function much like standard VGA controllers, but faster. Cards in this category typically go for \$250-\$450; one example is ATI's Graphics Vantage (\$420).

Next up are coprocessed cards, which include on-board special-purpose CPU's (typically TI's 34010 or 34020). These cards are most expensive (\$450 and up), but can provide screaming-fast performance. For example, my main system includes a Hercules' Graphics Station Plus, which goes for about \$700. Just over the horizon is local-bus video, which will provide a dedicated path between the motherboard CPU and the video system. LBV promises coprocessor performance at super VGA prices. As for the monitor, a mono VGA unit is the minimum. A comfortable system includes a 14- or 15-inch screen with 1024 × 768 resolution.

Nice is a 16-inch or larger monitor. Important: Whatever monitor you buy, make darned sure it is non-interlaced. Interlaced monitors paint alternate lines in successive vertical scans down the screen, which causes flickering. They're cheaper, but can be very hard on the eyes. The best monitors are non-interlaced, and can support a 72-Hz video-sync rate.

We'll continue this discus-

sion when we get together next time. In the meantime, here's one additional piece of advice: Don't buy a low-end system with lots of extras. Your money is better spent on a midrange or high-end system with the features you really need.

## PRODUCT OF THE MONTH

You've seen me harping (pun intended) about multimedia for several years. Microsoft's Multimedia Beethoven: The Ninth Symphony is like a dream come true. A single CD (playable in both a regular audio system) and a multimedia PC, contains a quality performance of Beethoven's most famous work by the Vienna Philharmonic. It also contains on-going commentary that explains the structure and meaning of each movement, how different themes develop throughout the piece, sim-

plified MIDI samples of many themes, a game to test your musical knowledge, English and German translations of Schiller's Ode to Joy, a hypertext dictionary of musical terms, historical background, and more.

The product was created in ToolBook (discussed in this column in the July, 1991 issue). Robert Winer, a professor of music at UCLA, developed the commentary. If you like the Ninth, you'll love Multimedia Beethoven. If you're interested in multimedia, it is a must-see.



Forrest Mims Knows ICs!

Over 750,000 readers of earlier editions of

### The Forrest Mims Engineer's Notebook

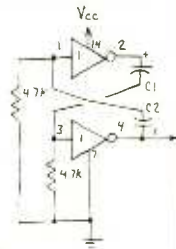

agree—nobody knows practical IC applications like Forrest Mims! This newly-revised edition contains hundreds of proven, tested circuits—hand-drawn by Forrest—using today's most popular linear, TTL, and CMOS ICs. Forrest gives you full data for each device and circuit—pin numbers, logic tables, supply voltages, and signal waveforms—so you can quickly duplicate each circuit. There's also practical information on construction methods, troubleshooting, and interfacing different IC families. If you work with ICs you gotta get this book!

Only \$14.95 at bookstores or electronic parts dealers. Or order direct from HighText! Add \$3 shipping (\$4 to Canada, \$5 elsewhere). CA please add sales tax. U.S. funds only please.

**HighText** 7128 Miramar Road  
Suite 13L  
San Diego, CA 92121

## MILITARY ELECTRONICS

(Continued from page 48)

nators may require that the vendor's parts be removed from equipment already in service.

Most contractors have a Preferred Parts List (PPL) that is designed to minimize the number of different Mil-Parts supplied by the various vendors who make the black-boxes for a given device. Parts listed on the PPL are invariably derived from the Mil-Spec QPL's.

Because of recent problems with counterfeit parts, most manufacturers of aerospace electronics equipment have in-house component test programs that screen all purchased parts to verify that they meet the intended military quality.

**Non-Standard Parts.** A non-standard part is one that is not listed in the QPL. It is sometimes necessary to use non-standard parts in military equipment for reasons of performance or for unusual power-handling requirements. If the engineer wants to use a non-standard part in a design, he or she must generate a non-standard part specification (NSP), which is then submitted to DESC or the customer-quality representatives for approval. The NSP and the approval process ensures that the non-standard part can later be obtained from another source even if the present device supplier ceases production on the part.

**Radiation Hardening.** Radiation occurs naturally in small quantities on Earth, and in large quantities in space, where our atmosphere does not provide a shield for cosmic radiation or the radiation of the Van Allen belt. Radiation on the Earth can also come from peaceful uses of the atom such as in a nuclear power plant or in the radiative treatment of cancer. It can also occur from the not so peaceful use of nuclear weapons. Whatever the source, the electronics used in space, in the nuclear industry, and in weapons systems must operate reliably when exposed to various radioactive environments. In order to withstand radiation, designers employ "Radiation Hardened" (RAD-HARD) parts.

Passive components such as resistors, capacitors, and inductors are

generally not affected by radiation. However, problems do occur in semiconductors. Radiation that can effect discrete semiconductors comes in three forms: neutrons, gamma rays, and X-rays. The lower energy alpha and beta particles cannot penetrate through discrete component packages to cause any problems. However, an exposed IC chip can be affected by those low-energy particles. A number of years ago some RAM chips were mysteriously changing state. The problem was isolated to materials in the DIP packages, which emitted alpha particles directly into the chips. All modern devices now use materials that do not emit radiation.

Neutrons are released by nuclear fusion (nuclear reactors or explosions). The heavy neutrons have no electrical charge, but if they travel at high speed and collide with semiconductors they do damage to the doped layers that define P and N junctions. That in turn permanently changes the electrical parameters of the silicon.

Gamma rays and X-rays are waves called ionizing radiation. They don't have the mass necessary to damage the semiconductor structure directly like neutrons, but instead remove electrons from the atoms, creating unwanted positive charges.

Semiconductors have different responses to radiation depending on a number of device characteristics such as whether the device uses a minority-carrier (bipolar) or majority-carrier (MOS) current mode. While each technology is degraded to some extent by all types of radiation, the effects depend on the current mode and the geometry of the device.

Bipolar devices exposed to neutron radiation suffer reduced gain and higher saturation voltage. However, they are relatively unaffected by the ionizing radiation of gamma and X-rays. The method used to harden bipolar electronics is to select high-gain devices that can withstand a gain reduction after exposure without degrading the operation of the circuit.

MOS devices are inherently hardened against neutrons, but ionizing radiation lowers the threshold voltage of the gate regions, causing changes in logic states. These changes can be temporary or permanent. Temporary effects are called "upset events" and

will cease when the radiation is no longer present. Whether the effect is temporary or permanent depends on the total accumulated amount of ionizing radiation to which the device is exposed, called the "Total Dose." Further hardening of MOS devices can be achieved by process changes or by dielectric isolation of the MOS using an insulating rather than a silicon substrate.

This is a simplified explanation of the process for designing radiation-hardened electronics. The actual methods depend on the levels of radiation to which the circuits will be exposed. Obviously, the higher the level the more complicated the approach.

**High Cost.** Many people view the military procurement process as a wasteful and inefficient bureaucracy. Much of the high cost of aerospace equipment is due to the difficulty of estimating the cost of complex equipment that has never before been built. The higher costs reflect the technical risk involved with pushing the state of the art.

There is also some political risk, which was exemplified by the B1-bomber program initiated during the Nixon administration, killed by President Carter, and then reinstated by President Reagan. An advanced military program can have a development cycle of as much as ten years. However, the Department-Of-Defense budget cycle occurs every year. This can be an upsetting process, with its oversights and audits.

Military equipment is often unglamorous, and design aesthetics do not enter into the picture at all. With the increased attention being given to the high cost of military programs, cost-effective functionality is an important objective. Despite the efforts to design to cost, military electronics is still very expensive when compared to the cost of products that are used in the home.

Unlike consumer products, relatively few black boxes are produced. Extensive qualification testing is performed on a number of units before the unit can be put into production. Any design problems must be fixed at the manufacturer's expense. During production, each unit must be acceptance tested to demonstrate full compliance with the appropriate

performance spec. Test-equipment calibration must have traceability to the National Bureau of Standards (NBS).

The manufacturer is often required to provide burn-in testing for a specified number of failure-free hours to demonstrate reliability, and to maintain a failure-reporting and corrective-action system (FRACAS). All records pertaining to manufacture and testing must be retained for many years.

All purchased parts must have certificates of compliance from the vendors. That includes not only electronic components, but also such items as castings, molded plastic parts, chemicals, and PC boards (which must be manufactured to their own strict Mil-Specs).

Military-parts manufacturers must follow rigorous procedures and maintain extensive documentation to prove they meet the process and test requirements defined by the Mil-Specs. Naturally, they charge high prices for these additional obligations.

Unlike a commercial product, any change to the equipment being produced to a Mil-Spec must be submitted for approval to the prime contractor or to the appropriate military-quality audit representatives. Design improvements are not necessarily a good reason for a change approval because whenever a design is changed it may effect test equipment and maintenance manuals and require additional training of field-maintenance personnel, all adding to increased costs.

**Hi-Rel in Your Living Room.** While high-rel parts are quite expensive, you may already have installed high-rel parts in your own projects. The lowly carbon resistor has such a high intrinsic reliability that the Hi-Rel versions really don't cost much more than the commercial versions. The resistor vendors on the QPL for MIL-R-39008 may ship the high-rel versions to distributors you purchase your parts from. If you see a carbon resistor with a fifth yellow band after the first four code bands (resistance and tolerance), you have yourself a genuine "S" level ER (Established Reliability) part with a failure rate that exceeds 0.001% per 1000 hours. ■

## DARKROOM TIMER

(Continued from page 58)

interconnect, refer back to Fig. 2 for some guidance. Once those sub-assemblies have been wired together, connect a three-conductor line cord (with molded plug) to the power supply. The hot conductor (the one connected to the smaller spade) should go to F1, the other spade conductor (neutral) goes to the free end of T1's primary. The ground wire of the line cord connects directly to the ground terminal of SO1. Check your work one final time to make sure that your subassembly connections correspond to the connections indicated

U7 and U11; and pin 1 of U8). With an oscilloscope, check for a 60-Hz squarewave with a 0-5-volt swing at the collector of Q4. Check for 0-12 volts at the emitter of Q1. Adjust R26 (DISPLAY) throughout its range—the voltage at the emitter of Q1 should vary from 0-12 volts. Remove power, and set S5-S7 for a time interval of 999.

Insert all IC's in their respective sockets, and re-apply power. The displays should light; the readout should show 999—the time interval programmed by the switches. Try all three digits in all positions 0 through 9. The display should change in accordance with the digit shown on the switch. Open S4 (the 999 range) and depress S1. The counter should slowly count down

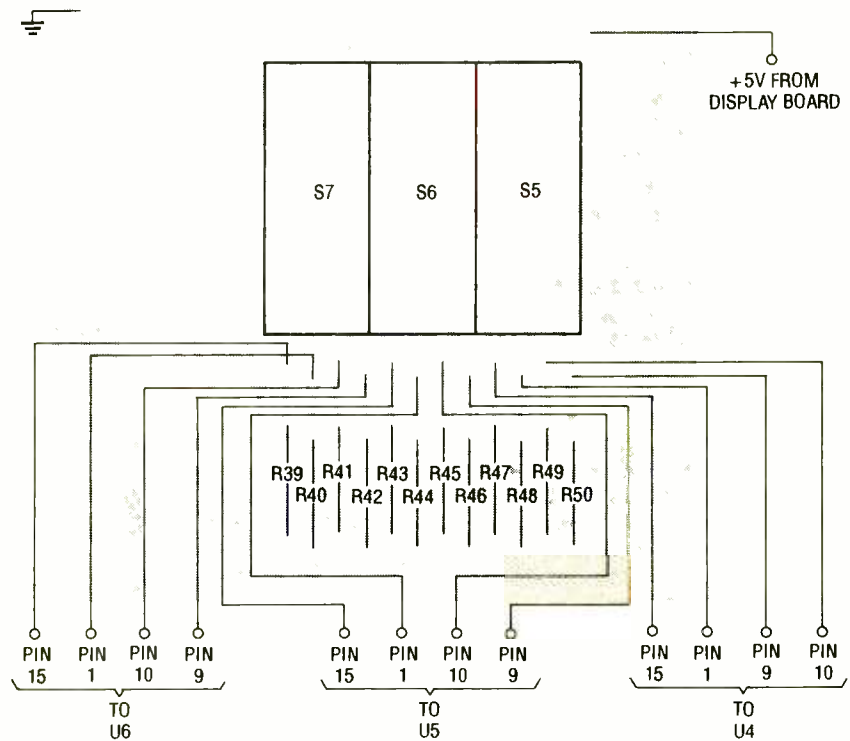

Fig. 8. Here is the parts-placement diagram for the BCD thumbwheel switches. Note that it may be necessary to connect the appropriate terminals of the selected BCD switches to the circuit board through hook-up wire.

in the parts-placement diagrams and that your power supply configuration matches that shown in Fig. 2.

**Checkout Time.** Note: At this point, all IC sockets should be empty. Plug-in the power cord, turn on S3 (POWER), and check for 17 volts DC at the junction of D1 and D4. Check for 5 volts DC at all +V pins of the IC sockets (pins 16 for U1-U6; pin 5 for U9 and U10; pin 14 for

at a rate of 1 Hz. Closing S1 should result in a ten-times faster count.

Next, connect a 100-watt lamp to SO1, and press S1. The timer should start up and the lamp should light. At the count of zero, the lamp should go out and the programmed time should reappear on the display.

If your circuit works as described, you're all set for your next photographic-timing mission. ■

## DB OR NOT DB

(Continued from page 67)

"Oh, it's a unit of sound" from about 14%, and only 1% correct answers. In fact, we have all heard of the decibel used (incorrectly) as a unit of sound level. What's the relation of the "sound decibel" to the stuff we've just been talking about? Well, sound, of course, consists of rapid cyclical variations in air pressure (high pressure, then low pressure, then high pressure, etc.). This variation can be expressed as an rms value of sound pressure, just as an AC voltage can be expressed as an rms voltage. If we select a reference sound-pressure level, such as the threshold of hearing (about 20 micropascals), we can express sound-pressure level in dB's relative to that pressure:

$$dB_{SPL} = 20\log(SPL/20\mu P)$$

where SPL stands for the sound pressure level. Every time you have seen sound levels given as so many dB, you have seen an error. The correct form is so many  $dB_{SPL}$ . A variant on

the  $dB_{SPL}$  is the  $dB_A$ , which is the "A-weighted"  $dB_{SPL}$ . That means that the signal has been filtered by a circuit whose frequency response is similar to that of the human ear at normal levels. Thus, it represents more nearly the sound level we'd perceive, because loud bass sounds (which we can't hear very well) are attenuated.

**Using dB's.** For those of us who don't carry a calculator around all the time, there's a convenient system for approximating the meaning of a certain dB value, or roughly converting from a numerical value to dB. It begins with remembering that you multiply numbers by adding dB. So if you want to mentally convert, say, 37 dBm into milliwatts, you can split the 37 dBm into:

$$30 \text{ dBm} + 6 \text{ dBm} + 1 \text{ dBm}$$

You know that 30 dB is just  $10^3$  or 1000, and 6 dB is 4. So the result is around:

$$1000 \times 4 = 4000 \text{ mW or 4 watts.}$$

Yes, we threw away the other 1 dB, but after all, we're approximating.

Alternatively, if we wanted to express a power gain factor of 800 in dB,

we could factor 800 into:

$$100 \times 4 \times 2$$

A factor of 100 is 20 dB; 4 is 6 dB, and 2 is 3 dB. So a power gain of 800 is  $20 \text{ dB} + 6 \text{ dB} + 3 \text{ dB} = 29 \text{ dB}$ .

It helps to memorize a few very common conversions, as shown in Table 2. With those conversions plus the exponents from the exact powers of 10 (0.1, 1, 10, 100, etc.), you can approximately convert almost anything to or from dB's. Now you should be able to easily apply the conversions to and from dB's in the right fashion.

**Frequency Response.** Now, the last topic: the common practice of specifying frequency response in terms of "plus or minus so many dB." Again, we're talking about ratios. If a power amplifier is rated as "flat from 20 to 20,000 Hz,  $\pm 1$  dB," that means that its power gain does not vary with frequency by a ratio more than 1.26 (+1 dB) or less than 0.794 (-1 dB). In other words, if that amplifier is set to put out 100 watts and the input frequency is varied, at no frequency between 20 and 20,000 Hz will it put out more than 126 watts, nor less than 79.4 watts (assuming that the input voltage stays constant). ■

## HANDS-ON TECHNICAL SEMINARS For Professionals

- "CD School" —EIA/CEG
- "Microprocessor School" —EIA/CEG
- "Camcorder School" —Hitachi
- "Car Audio CD" —Kenwood USA
- "Microwave Oven School"  
—Matsushita Services Co.
- "Cellular Telephones"  
—Mitsubishi Electronics America

- "Digital Compact Cassette  
Overview"  
—Phillips Consumer Electronics
- "Switch Mode Power Supplies"  
—Sencore Inc.
- "LN-1 TV Chassis" —Sony Corp.
- "PIP In the X90-E TV Chassis"  
—Toshiba America

**PLUS: The Introduction of the All New EIA Curriculum  
for Consumer Electronics**

Courses **FREE** when registered at the  
**National Professional Electronics Convention**  
August 3-8, 1992 ★ Worthington Hotel ★ Ft. Worth TX

**Full \$275 Registration Includes:**

- ★ All Technical Seminars
- ★ All Management and Business Seminars
- ★ Continuing Education Units for all seminars attended
- ★ All Sponsored Meals and Functions
- ★ Head-to-head Meetings with Manufacturers' Representatives
- ★ NESDA/ISCET Association Meetings
- ★ Price Discounts Available for Pre-Registration
- ★ Daily Registration Available

**For more information, contact NPEC '92**  
2708 West Berry St., Fort Worth TX 76109 ★ (817) 921-9061; Fax (817) 921-3741

## MORSE-CODE TRANSMITTER (Continued from page 46)

bag provides extra protection against shock hazards. Connect an antenna to the alligator clips at the ends of L2; and a 40-meter crystal to the only other alligator clips in the circuit. Then plug in the transmitter. While you're waiting for the tubes to warm up, tune your receiver to the frequency of the crystal.

Now press the key and rotate the variable capacitor until you hear your signal in the receiver and the lamp glows. Take a few minutes to experiment with the number of turns on coil L2 to match the transmitter to your antenna, which will be indicated by the maximum glow of I1. Now reduce the number of turns by one or move L2 a little away from L1 to reduce the coupling slightly, and open the plates of C1 a bit from the point of maximum power. That will give you a much cleaner signal, which is more effective than a slightly louder but distorted one! ■

# ELECTRONICS MARKET PLACE

## FOR SALE

**CABLE descrambler liquidation.** Major makes and models available. Industry pricing! (Example: Hamlin Combo's, \$44 each... Minimum 10 orders). Call **WEST COAST ELECTRONICS**, 1 (800) 628-9656.

**NEW** electronic mosquito repellent: Great for hunting, camping, or fishing. Rush \$8.00 to **LAKESIDE PRODUCTS**, 5420 Beckley Rd., Battle Creek, MI 49015. Order today! Guaranteed.

**20,000+** hr radio & TV receiving tubes. \$500.00. **OBO** (813) 521-2907.

**HUGE** 92 page communications catalog of short-wave, amateur and scanner equipment. Antennas, books and accessories too. Send \$1.00 to: **UNIVERSAL RADIO**, 1280 Aida Dr., Dept. PE, Reynoldsburg, OH 43068.

**JERROLD**, Tocom and Zenith "test" chips. Fully activates unit. \$50.00. Cable descramblers from \$40.00. Orders 1 (800) 452-7090. Information (310) 867-0081.

## CLASSIFIED AD ORDER FORM

To run your own classified ad, put one word on each of the lines below and send this form along with your check to:

**Popular Electronics Classified Ads**, 500-B Bi-County Boulevard, Farmingdale, N.Y. 11735

**PLEASE INDICATE** in which category of classified advertising you wish your ad to appear. For special headings, there is a surcharge of \$11.00.

( ) Plans/Kits ( ) Business Opportunities ( ) For Sale  
( ) Education/Instruction ( ) Wanted ( ) Satellite Television  
( )

Special Category: \$11.00

### PLEASE PRINT EACH WORD SEPARATELY, IN BLOCK LETTERS.

(No refunds or credits for typesetting errors can be made unless you clearly print or type your copy.) Rates indicated are for standard style classified ads only. See below for additional charges for special ads. **Minimum: 15 words.**

1	2	3	4	5
6	7	8	9	10
11	12	13	14	15 (\$23.25)
16 (\$24.80)	17 (\$26.35)	18 (\$27.90)	19 (\$29.45)	20 (\$31.00)
21 (\$32.55)	22 (\$34.10)	23 (\$35.65)	24 (\$37.20)	25 (\$38.75)
26 (\$40.30)	27 (\$41.85)	28 (\$43.40)	29 (\$44.95)	30 (\$46.50)
31 (\$48.05)	32 (\$49.60)	33 (\$51.15)	34 (\$52.70)	35 (\$54.25)

We accept MasterCard and Visa for payment of orders. If you wish to use your credit card to pay for your ad fill in the following additional information (Sorry, no telephone orders can be accepted.):

Card Number \_\_\_\_\_ Expiration Date \_\_\_\_\_

PRINT NAME \_\_\_\_\_

SIGNATURE \_\_\_\_\_

**IF YOU USE A BOX NUMBER YOU MUST INCLUDE YOUR PERMANENT ADDRESS AND PHONE NUMBER FOR OUR FILES. ADS SUBMITTED WITHOUT THIS INFORMATION WILL NOT BE ACCEPTED.**  
**CLASSIFIED COMMERCIAL RATE:** (for firms or individuals offering commercial products or services) \$1.55 per word prepaid (no charge for ZIP code)...**MINIMUM 15 WORDS.** 5% discount for same ad in 6 issues within one year; 10% discount for 12 issues within one year if prepaid. **NON-COMMERCIAL RATE:** (for individuals who want to buy or sell a personal item) \$1.25 per word, prepaid...no minimum. **ONLY FIRST WORD AND NAME** set in bold caps at no extra charge. Additional bold face (not available as all caps) 30¢ per word additional. Entire ad in boldface, \$1.85 per word. **TINT SCREEN BEHIND ENTIRE AD: \$1.90 per word. TINT SCREEN BEHIND ENTIRE AD PLUS ALL BOLD FACE AD: \$2.25 per word. EXPANDED TYPE AD: \$2.05 per word prepaid.** Entire ad in boldface, \$2.45 per word. **TINT SCREEN BEHIND ENTIRE EXPANDED TYPE AD: \$2.55 per word. TINT SCREEN BEHIND ENTIRE EXPANDED TYPE AD PLUS ALL BOLD FACE AD: \$2.95 per word. DISPLAY ADS:** 1" x 2 1/4"—\$205.00; 2" x 2 1/4"—\$410.00; 3" x 2 1/4"—\$615.00. General Information: Frequency rates and prepayment discounts are available. **ALL COPY SUBJECT TO PUBLISHERS APPROVAL. ADVERTISEMENTS USING P.O. BOX ADDRESS WILL NOT BE ACCEPTED UNTIL ADVERTISER SUPPLIES PUBLISHER WITH PERMANENT ADDRESS AND PHONE NUMBER.** Copy to be in our hands on the 18th of the fourth month preceding the date of issue (i.e.; Sept. issue copy must be received by May 18th). When normal closing date falls on Saturday, Sunday or Holiday, issue closes on preceding work day. Send for the classified brochure. Circle Number 49 on the Free Information Card.

**CABLE TV DESCRAMBLERS**  
★ **CONVERTERS** ★  
and ACCESSORIES.

**SAVE MONEY.**  
**DON'T RENT!**

**PANASONIC,**  
**PIONEER, JERROLD, OAK,**  
**SCIENTIFIC ATLANTA**  
AND MORE. **LOWEST PRICES.**  
FREE CATALOG.

**(800) 234-1006**  
**CABLE READY COMPANY**

**PRINTED** circuit boards — etched, drilled, tin plated. Single sided \$1.25/sq. inch. No setup charge. **CHELCO ELECTRONICS**, 61 Water Street, Mayville, NY 14757. 1 (800) 388-8521.

**SOLAR SYSTEM CONTROLS** — 6 amp shunt regulator — Alternate battery charge control — Low voltage battery disconnect. \$49.95 ea. + \$5.00 s/h. **MPS ENERGY**, R.R. #2, Marmora, Ont., Canada K0K 2M0.

**Quality Microwave TV Antennas**

**WIRELESS CABLE - IFTS - MMDS - Amateur TV**  
Ultra High Gain 50db(+) • Tunable 1.9 to 2.7 Ghz.

- 55-Channel Dish System \$199.95
- 36-Channel Dish System \$149.95
- 20-Channel Dish System \$124.95
- Optional Commercial Grid Antenna (not shown) Add \$50.00
- Yagi Antennas, Components, Custom Tuning Available
- Call or write (SASE) for "FREE" Catalog

**PHILIPS-TECH ELECTRONICS**  
Dish System P.O. Box 8533 • Scottsdale, AZ 85252  
LIFETIME WARRANTY (802) 947-7700 (\$3.00 Credit off phone orders)  
MasterCard • Visa • American Express • COD's • Quantity Pricing

**ATTENTION** Hobbyists: Project boards, bread boards, prototyping boards. Top quality at low prices. Send for free information and price lists. **R AND S ELECTRONICS**, Box 91963, Elk Grove, IL 60009.

**LASER & Solar Energy Products** Lasers from \$15.00. We specialize in laser and solar energy products for commercial, and hobbyist applications. Free catalog: **DESIGN IMAGES**, Dept. P7, Box 292125, Lewisville, TX 75029.

**ELECTRONIC** components! Dependable name brands. Huge selection. No minimum order required. Rapid order processing with low prices. Satisfaction guaranteed. Send for free catalog to: **BUSSER DEBARR**, PO Box 902, Webster Station, Dept. B, Alameda, CA 94501.

## FREE CATALOG

**FAMOUS "FIRESTIK" BRAND CB ANTENNAS AND ACCESSORIES. QUALITY PRODUCTS FOR THE SERIOUS CB'er. SINCE 1962**  
**FIRESTIK ANTENNA COMPANY**  
 2614 EAST ADAMS  
 PHOENIX, ARIZONA 85034

**FREE** electronics catalog. Transistors, IC's, electronic components, etc. Call **INTERNATIONAL MICROELECTRONICS** (817) 561-2244. PO Box 170415, Dept. PE, Arlington, TX 76003.

**MICROWAVE** tester, tests for leaks, hot & cold spots, proper power settings. Easy to use. Just \$9.95 to **LAKESIDE COMPANY**, 5420 Becklay Rd., Battle Creek, MI 49015.

**TOCOM-Jerrold Impulse-Scientific Atlanta** converters, two year warrantys, also **TEST MODULES** for your converters. Contact **NATIONAL CABLE**, (219) 935-4128 full details.

## CB RADIO OWNERS!

We specialize in a wide variety of technical information, parts and services for CB radios. 10-Meter and FM conversion kits, repair books, plans, high-performance accessories. Thousands of satisfied customers since 1976! Catalog \$2.

**CBC INTERNATIONAL**  
 P.O. BOX 31500PE, PHOENIX, AZ 85046

**CELLULAR Hackers Bible.** Theory — Hacks — Modifications — Programming \$53.95. **TELECODE**, PO Box 6426-PE, Yuma, AZ 85366-6426.

**CABLE Test Chips.** S-A 8550, S-A 8500 — 310, 311, 320, 321 (specify) — \$33.95. S-A 8580/338 — \$69.95. **TOCOM** 5503/07 VIP — \$33.95. **TELECODE**, PO Box 6426-PE, Yuma, AZ 85366-6426.

**SECRET Cable Descramblers!** Build your own descrambler for **LESS** than \$12.00 in seven **EASY** steps. Complete instructions \$10.00. Radio Shack parts list and **FREE** descrambling methods that **COST NOTHING** to try included. **HARRYWHITE**, PO Box 1790G, Baytown, TX 77520.

**LOW Cost Logic Analyzer** — A must for companies and serious hobbyists: 8 digital inputs, sampling rate from 50 nsec to 1 msec. Connects to PC or compatible via RS-232. Only \$250.00 US. For info: **OPENTEK**, PO Box 71, Sorel, Quebec, Canada, J3P 2T6.



## RECEIVING TUBES OVER 3000 TYPES IN STOCK!

Also hard-to-find transformers, capacitors and parts for tube equipment.  
 Send \$2.00 for our 32 page catalog.

**ANTIQUE ELECTRONIC SUPPLY**  
 6221 S. Maple Ave. • Tempe, AZ 85283 • 602-820-5411

**OSCILLOSCOPE** 50 MHz, dual channel, solid state calibrated, manual \$250.00. 1 (800) 835-8335 X-123.

**CABLE T.V. descramblers, converters, lowest prices, guaranteed, best quality, free catalog.** **CNC CONCEPTS INC.**, Box 34503, Minneapolis, MN 55434. 1 (800) 535-1843.

**TEST-aids** for testing units in full service mode. Starcom VII, \$40.00; Starcom VI, \$30.00; Starcom DPBB, \$50.00; Pioneer, \$75.00; Tocom VIP 5503/5507, \$25.00; S.A. call; Zenith, \$25.00; **N.E. ENGINEERING** (617) 770-3830.

**CABLE TV descramblers! Absolutely the lowest prices! All major brands. Money-back guarantee! Nobody beats our prices! CABLE PRICE CLUB, 1- (800)-377-9742.**

**LONG play cassette recorder** — Records 12 hours on a single standard cassette. Voice-activated. Also miniature long play recorders, mini microphones, telephone record controllers, stun guns, surveillance/countermeasures devices. Catalog \$3.00. **PRODUCTIVE ELECTRONICS**, Box 930024-E, Norcross, GA 30093.

**COLLECT** movie posters for fun and profit. Decorate home, office. **Cinemabilia** catalog lists 1000's from 1930's to present. Send \$3.00 to: **ACEX**, Box 2512-PE, Chattanooga, TN 37409.

## BEST BY MAIL

Rates: Write National, Box 5, Sarasota, FL 34230

### OF INTEREST TO ALL

**RETIRE EARLY 1-900-776-3348 CODE AB 5180** Mention Code (\$6.95).

**HAIR PROBLEMS? THINNING, FALLING, BREAKING.** Hair Helpers promises results. 1-800-4-HAIR-10.

**RECYCLE PERSONAL COPIERS Cartridges.** Instructions \$14.95. Charles Bruns, Box 543, Applegate, CA 95703.

### BOOKS-CATALOGS-MAGAZINES

**ELECTRONIC ENGINEERING.** 8 volumes complete. \$109.95. No prior knowledge required. Free brochure. **BANNER TECHNICAL BOOKS**, 1203 Grant Ave., Rockford, IL 61103.

### MONEYMAKING OPPORTUNITIES

**"EASY MONEY" TAKING Snapshots.** Send **LSASE** To: Global, 1404-PE) Ouachita 67, Camden, AR 71701.

### FINANCIAL

**CASH, GUARANTEED CARDS.** Send \$10.00: **STARLITE**, POB 60066-PE, Oklahoma City, OK 73146.

## REMOVE LEAD VOCALS

From Records & CD's  
 513-444-2276

Build this kit which removes lead vocals from standard stereo records, CD's, tapes or FM broadcasts. Sing along with the background music. Use with any home component stereo. Additional kit adds reverb to your voice, then mixes it with music. **Pre-assembled** boards also available. Call or write for free info. **Weeder Technologies**, 14773 Lindsey Rd., Mt. Orab, Ohio 45154.

## PLANS & KITS

**HOBBY/broadcasting/ham/CB/surveillance** transmitters, amplifiers, cable TV, science, bugs, other great projects! Catalog \$1.00 **PANAXIS**, Box 130-H8, Paradise, CA 95967.

**BUILD** — five-digit, ohms, capacitance, frequency, pulse, multimeter. Board, and instructions \$9.95. **BAGNALL ELECTRONICS**, 179 May, Fairfield, CT 06430.

**FASCINATING** Electronic Devices! Dazers! Lasers! Transmitters! Detectors! Free energy! Tesla! Kits/assembled! Catalog \$4.00. (refundable) **QUANTUM RESEARCH**, 17919-77 Avenue, Edmonton, Alberta T5T 2S1.

**DESCRAMBLER** kits. Complete cable kit \$44.95. Complete satellite kit \$49.95. Add \$5.00 shipping. Free brochure. No New York sales. **SUMMIT PE**, Box 489, Bronx, NY 10465.

**ETCH** PCB's yourself, no chemicals, easy, cheap, full instructions, \$2.00, **SASE, NICKNAP PRODS.**, PO Box 593, Howell, NJ 07731-0593.

**SPY** — Counterspy — Equipment! Guaranteed low prices! Catalog \$5.00. **SURVEILLANCE COUNTERMEASURE TECHNOLOGIES**, Box 520013-B, Salt Lake City, UT 84152.

**VIDEOCIPHER II /Satellite/Scanner/Cable/Amateur/Cellular/Repair** manuals, modification books & software. Catalog — \$3.00. **TELECODE**, PO Box 6426-PE, Yuma, AZ 85366-6426.

**KENWOOD & ICOM** service bulletins. 175+ pages covering all models. \$33.95. Catalog — \$3.00. **CODs** (602) 782-2316/fax (602) 343-2141. **TELECODE**, Box 6426-RE, Yuma, AZ 85366-6426.

**FREE!** Catalog of fantastic high-tech electronic kits. Write to **LNS TECHNOLOGIES**, 20993 Foothill Blvd., Hayward, CA 94541-1511.

## ANTIQUE RADIO CLASSIFIED

### Free Sample!

Antique Radio's  
 Largest Circulation Monthly.  
 Articles, Ads & Classifieds.

**6-Month Trial: \$15. 1-Yr: \$27(\$40-1st Class).**  
**A.R.C., P.O. Box 802-L8, Carlisle, MA 01741**

**VHF-FM** amplifier kit. 75-110 Mhz, 15-25 watts. Includes all parts, schematics, instructions. For information send SASE to: **PROGRESSIVE CONCEPTS**, 1313 North Grand Ave. #291, Walnut, CA 91789.

**SURVEILLANCE transmitter kits** tune from 65 to 305 MHz. Mains powered duplex, telephone, room, combination telephone/room. Catalog with **Popular Communications, Popular Electronics** and **Radio-Electronics** book reviews of "Electronic Eavesdropping Equipment Design," \$2.00. **SHEFFIELD ELECTRONICS**, PO Box 377785-A, Chicago, IL 60637-7785.

**"SPYSHOP"** catalog of unique & exotic surveillance equipment. \$5.00 for S&H. **"SPYSHOP"** PO Box 6703, Panama City, Fla. 32404. 1 (800) 487-1787.

**ROBOTIC Hand** easy to build, very strong. Send \$5.00 for plans to **ROD LILLEY**, PO Box 10363, Lancaster, PA 17605-0363.

**BUILD** 0-50 volt regulated dual tracking power supply. Schematics and instructions, \$5.95. **SMS ENGINEERING**, 5932 West Bell Road, Suite D106, Glendale, AZ 85308.

**THE perfect third hand.** For those who need more than a clamp for their close-up work. Two alligator clips, 2 1/2" magnifying glass, 6 ball joints. Holds objects at any angle to each other, leaves both hands free. **Glue, solder, repair, assemble** thousands of objects with ease. \$13.95 + \$3.00 S&H. **TPC**, Box 580415, Tulsa, OK 74158.

**CABLE** descramblers, build your own, **SSAVI**, Gated Sync, Sinewave. \$14.95. **CABLETRONICS**, Box 3050PE, Bethesda, MD 20824.

## SATELLITE TV

**FREE** Catalog — Lowest prices worldwide. **SKYVISION**, 1048 Frontier, Fergus Falls, MN 56537. 1 (800) 334-6455. (See full page ad The Market Center).

**SATELLITE TV** the lowest prices guaranteed. Tracker V \$899.00, Startrack 6 \$725.00. All major brands sold & serviced. Used equipment available. Phone, quote, & tech service: **SATELLITE TV**, 120 W. Centennial, Muncie, IN 47303. (317) 288-0074 11-5 E.

**VIDEOCIPHER II** descrambling manual. Schematics, video and audio, \$18.95. **VideoCipher II** 032, \$15.00. **VideoCipher II** plus, \$20.00. Software, \$25.00. **CABLETRONICS**, Box 30502PE, Bethesda, MD 20824.

**SCPC Satellite Receiver**, new microprocessor controlled tuning, 50 channel memory, LED read-out, receive hundreds of SCPC services. Affordable price, call 1 (800) 241-8171.

## T.V. FILTERS

T.V. notch filters, phone recording equipment, brochure \$1.00. **MICRO Thinc.**, Box 63/6025, Margate, FL 33063. (305) 752-9202.

# TODAY'S THE DAY

Stop Smoking.



American Heart Association



★★★★PRESENTING★★★★  
**CABLE TV  
 DESCRAMBLERS**  
 ★★★★★STARRING★★★★★  
**JERROLD, HAMLIN, OAK**  
 AND OTHER FAMOUS MANUFACTURERS

- FINEST WARRANTY PROGRAM AVAILABLE
- LOWEST RETAIL/WHOLESALE PRICES IN U.S.
- ORDERS SHIPPED FROM STOCK WITHIN 24 HRS
- ALL MAJOR CREDIT CARDS ACCEPTED

FOR FREE CATALOG ONLY **1-800-345-8927**  
 FOR ALL INFORMATION **1-818-709-9937**

**PACIFIC CABLE CO., INC.**  
 7325 1/2 Reseda Blvd., Dept. 2017  
 Reseda, CA 91335

### BUSINESS OPPORTUNITIES

**YOUR own radio station!** Licensed/unlicensed. AM, FM, TV, cable. Information \$1.00 **BROADCASTING**, Box 130-H8, Paradise, CA 95967.

**EASY work!** Excellent pay! Assemble products at home. Call toll free **1 (800) 467-5566** Ext. 5730.

**MAKE \$75,000.00 to \$250,000.00** yearly or more fixing IBM color monitors. No investment, start doing it from your home (a telephone required). Information, USA, Canada \$2.00 cash for brochure, other countries \$10.00 US funds. **RANDALL DISPLAY**, Box 2168-H, Van Nuys, CA 91404, USA. Fax (818) 990-7803.

**HOME** assembly work available! Guaranteed easy money! Free details! **HOMEWORK-P**, Box 520, Danville, NH 03819.

**COMPUTER** service business. New market, great profits. Information \$4.00. **CC ELECTRONICS**, Box 1441, Hereford, TX 79045.

**JOBS in electronics.** Companies are still hiring for positions in US and overseas. For a listing of 400 companies plus resume guide send \$10.00 to **BENTHOS-PE**, POB 23336, Barrigada, GU 96921.

**\$800.00** weekly possible! Working at home! 37 different opportunities. Rush \$1.00 and self-addressed stamped envelope to: **INQUIRIES**, PO Box 310, College Park, MD 20740. U.S. residents only.

### SURVEILLANCE EQUIPMENT

**DO you** require the most advanced hitech security, anti-terrorism, covert espionage surveillance, and countersurveillance equipment and products available? If so, send \$10.00 for complete catalog, (refunded on first purchase over \$100.00) to: **COMCON SYSTEMS**, 501 Boston Post Rd., Dept. 153, Orange, CT 06477.

**THIS IS A REGULAR CLASSIFIED AD WITH A TINT BACKGROUND.** To have your ad appear like this one, the cost is \$1.75 per word.

### EDUCATION/INSTRUCTION

**LEARN IBM PC assembly language.** Disk \$5.00. Book \$18.00. **ZIPFAST**, Box 12238, Lexington, KY 40581-2238.

**VCR repair.** Save money — make big profits! Learn how from *How to Keep Your VCR Alive*. "This detailed, step-by-step manual enables anyone with no previous knowledge or experience to fix most VCR problems easily, quickly, and inexpensively with a few simple tools." — *Small Press Review*. Highly recommended by *Electronic Servicing and Technology*, *Modern Electronics*, *Popular Electronics*, *Popular Communications*, *Videomaker*, *Video*, *Nuts and Volts*, and many other electronics and video magazines "Far better than Viejo at 1/7 the cost." 403 page book, with 704 illustrations, plus professional head-cleaning tool. Obtain from **B. Daltons** or send \$24.95 to **WORTHINGTON PUBLISHING**, 6907-202H Halifax River Drive, Tampa, FL 33617. Publisher pays S&H. Money-back satisfaction guarantee!

## LEARN COMPUTERS!



Home study. Become a personal computer expert at home and in business. Learn at your own pace. Exciting and easy to follow. **Send or call today for free literature.**  
**800-223-4542**

Name \_\_\_\_\_  
 Address \_\_\_\_\_  
 City \_\_\_\_\_ State \_\_\_\_\_ Zip \_\_\_\_\_

**SCHOOL OF COMPUTER TRAINING**  
 2245 Perimeter Park  
 Dept. KJ341 Atlanta, Georgia 30341

**BUILDING A Robot: A Straightforward Approach.** 152 pages fully illustrated. Instructions how you can easily construct a robot. **Check or money order.** \$19.95 plus \$3.00 shipping. **HUMANFORM ROBOTICS**, PO Box 158486, Nashville, TN 37215.

**COMPUTER**, fax machine, laser printer service and maintenance. In one training package. Call today **1 (800) 568-3362**.

**ELECTRONICS** tutorial software. Nine diskettes. Over 1000 screens of information and help on DC, AC, analog and digital. Q&A format. IBM \$25.00. **TUTOR-TECH**, 5591 Kimberly St., San Jose, CA 95129. (408) 252-3223.

**ESP**, bioelectricity, microwave hearing introduction, comprehensive booklist... \$1.00. **RESEARCH ASSOCIATES**, PO Box 3583, Boynton Beach, FL 33424-3583.

**COMPUTER** questions???? Over 100 commonly asked questions answered about micro computers, hard drives, monitors, tape drives, memory, speed, operating systems (DOS, Novell etc.) and more! Send \$5.00 (check or money order) to: **CRM**, 2615 Edenborn, Suite B, Metairie, LA 70002.

**FREE CATALOG!**  
**1-800-648-7938**  
**JERROLD HAMLIN OAK ETC**  
**CABLE TV**  
**DESCRAMBLERS**

- Special Dealer Prices!
- Compare our Low Retail Prices!
- Guaranteed Prices & Warranties!
- Orders Shipped Immediately!

**REPUBLIC CABLE PRODUCTS, INC.**  
 4080 Paradise Rd. #15, Dept. PE892  
 Las Vegas, NV 89109  
 For all other information (702) 362-9026

### HOME EXTERMINATION

**NEW book: "Become Roach-Free"** Exterminator explains: in detail. \$20.00 **EPE**, POB 74C, Calhoun, LA 71225-0074.

**ROACHES**, earwigs, ants. Learn what the pro's know and save \$\$. Home pest control manual, \$9.95. **B and J MARKETING**, PO Box 3, Kan-ville, IL 60144.

### WANTED

**HAVE an idea? Inventors for free information package/free review.** Call **FREEDOM MARKETING, INC.** 1 (800) 932-4298.

## FUN WITH ELECTRONICS



**160—COIL DESIGN & CONSTRUCTION MANUAL** .... \$5.95. How to make RF, IF, audio and power coils; chokes and transformers. Practically every possible type is discussed.

**PCP113—THE PC MUSIC HANDBOOK** .... \$13.95. Learn the basics of computer music systems. For the professional musician, gifted amateur or just plain curious.



**BP297—LOUDSPEAKERS FOR MUSICIANS** .... \$6.25. Loudspeaker design from the musician's point of view! All you need to know, and you should be able to design your own after reading this.



**BP277—HIGH POWER AUDIO AMPLIFIER CONSTRUCTION** .... \$6.25. Here's background and practical design information on high power audio amplifiers capable of 300 ± 400 watts r.m.s. You'll find MOSFET and bipolar output transistors in inverting and non-inverting circuits.



**BP302—A CONCISE USER'S GUIDE TO LOTUS 1-2-3 RELEASE 3.1** .... \$6.25. If you are a PC user and want to upgrade to Lotus 1-2-3 release 3.1, this book can teach you how to do that in the shortest and most effective way.



**BP298—A CONCISE INTRODUCTION TO THE MACINTOSH SYSTEM AND FINDER** .... \$6.25. This introduction for those new to the Mac, this book also serves as a quick refresher for experienced owners that have not used the machine in some time.



**MAIL TO: Electronic Technology Today, Inc.**  
 P.O. Box 240  
 Massapequa Park, NY 11762-0240

### SHIPPING CHARGES IN USA AND CANADA

\$0.01 to \$5.00... \$1.50 \$30.01 to \$40.00... \$5.50  
 \$5.01 to \$10.00... \$2.50 \$40.01 to \$50.00... \$6.50  
 \$10.01 to \$20.00... \$3.50 \$50.01 and above... \$8.00  
 \$20.01 to \$30.00... \$4.50

**SORRY, No orders accepted outside of USA and Canada**

Total price of merchandise ..... \$ \_\_\_\_\_  
 Shipping (see chart) ..... \$ \_\_\_\_\_  
 Subtotal ..... \$ \_\_\_\_\_  
 Sales Tax (NYS only) ..... \$ \_\_\_\_\_  
 Total Enclosed ..... \$ \_\_\_\_\_

Name \_\_\_\_\_  
 Address \_\_\_\_\_  
 City \_\_\_\_\_ State \_\_\_\_\_ Zip \_\_\_\_\_

# ADVERTISING INDEX

## ADVERTISING SALES OFFICE

POPULAR ELECTRONICS magazine does not assume any responsibility for errors that may appear in the index below.

Free Information No.	Page	Free Information No.	Page
5	AMC Sales . . . . . 27	—	ISCET . . . . . 76
—	Antique Electronic Supply . . . . . 94	—	NESDA . . . . . 92
—	Antique Radio Classified . . . . . 94	—	NRI Schools . . . . . 11
—	CBC International . . . . . 93	—	Pacific Cable . . . . . 95
—	CIE . . . . . 19	—	Phillips Tech . . . . . 93
—	CLAGGK, Inc. . . . . 4	—	R.E. Video Offer . . . . . CV4
—	Cable Ready Company . . . . . 93	—	Republic Cable . . . . . 95
—	Command Productions . . . . . 73	—	Satman, Inc. . . . . 94
—	Elec. Industry Association . . . . . CV3	—	Science Proce . . . . . 21
—	Electronic Tech. Today . . . . . CV2, 70	6	The School of VCR Repair . . . . . 85, 95
—	Electronics Book Club . . . . . 25, 81	9	Viejo Publications . . . . . 27
—	Firestik II . . . . . 94	—	WJMK . . . . . 30
—	Grantham College . . . . . 27	—	Weeder Technologies . . . . . 94
—	HighText Publications, Inc. . . . . 89	7, 8	Zentek Corp. . . . . 83

Gernsback Publications, Inc.  
500-B Bi-County Blvd.  
Farmingdale, NY 11735  
1-(516) 293-3000  
President: Larry Steckler  
Assistant to the President: Christina Estrada

For Advertising ONLY  
516-293-3000  
Fax 1-516-293-3115  
Larry Steckler  
publisher  
Arlene Fishman  
advertising director  
Denise Haven  
advertising assistant  
Kelly McQuade  
credit manager

Customer Service/Order Form  
1-800-435-0715  
1-800-892-0753  
7:30 AM - 8:30 PM EST

### SALES OFFICES

**EAST/SOUTHEAST**  
Stanley Levitan, Eastern Sales Manager  
1 Overlook Ave.  
Great Neck, NY 11021  
1-516-487-9357, 1-516-293-3000  
Fax 1-516-487-8402

**MIDWEST/Texas/Arkansas/Okla.**  
Ralph Bergen, Midwest Sales Manager  
One Northfield Plaza, Suite 300  
Northfield, IL 60093-1214  
1-708-446-1444  
Fax 1-708-559-0562

**PACIFIC COAST/Mountain States**  
Marvin Green, Pacific Sales Manager  
5430 Van Nuys Blvd, Suite 316  
Van Nuys, CA 91401  
1-818-986-2001  
Fax 1-818-986-2009

## REMOTE LIGHT

(Continued from page 39)

solid copper wire was left exposed at the bottom of the gooseneck so that metal washers could be soldered on—one above the main board and one below—to hold the lamp assembly onto the board. The leads from the LED are then soldered to the rest of the circuit.

At this point the unit was working, although the point-to-point wiring on the bottom of the board was still exposed as were the LED leads, and the metal strips could easily touch any surface the unit was placed on. So, a bottom "frame" plate, with cutouts for the touch strips, was cut to size, and attached to the main board with strips of double-sided tape.

Next came a cover for the circuitry. After some careful measurements, pieces of perforated construction board were cut to size, the edges sanded, and then glued together. It's held onto the unit with two loops of solid bus wire—hinges, if you will—

and held closed with Velcro.

Now it was time to paint our unit. The metal strips were covered with masking tape before painting. (Remember to cover the LED while painting, too.) But then came a surprise: the masking tape covered only the surface of the touch pads, and wet spray paint turned out to be an excellent conductor. The LED turned on and stayed on for about five minutes while the paint dried, so you might want to disconnect power while painting. After the paint dries, you should remove the masking tape.

There was one last thing to do: attach the unit to a remote control. The simplest thing to do would be to use double-sided tape, although the unit couldn't then be used for different remote controls, and many people don't want to stick anything on their remote. It would make changing the remote-control batteries more difficult also. Velcro would allow use of the Illuminator with different remotes, but there would still be the battery-changing problem on some remotes.

Then came a brainstorm: we'd use

a large spring-metal stationary clip to attach the Illuminator to any remote control. There are a few mechanical problems though. First, you have to find one that's big enough. Once you do, one of the curled ends where the handle attaches has to be cut off—and spring metal is extremely difficult to cut. So, a Dremel tool with a cutting wheel did the trick.

If you don't have a Dremel tool, or don't feel comfortable using one, try a pair of tin snips, or use Velcro to mount the remote instead. Next, two holes have to be drilled on the cut side of the clip for screws that will hold the clip onto the Illuminator. Again, drilling this type of metal may be difficult, so use caution. Corresponding holes are then drilled on the Illuminator board, and the clip is attached to the unit with the appropriate hardware. You may have to cut away some of the touch pads to clear the screws. The last step is to cushion the jaws of the stationary clip with some adhesive-backed cork or other suitable material to prevent it from scratching your remote control. ■

# ASAP • JIT • MRP

OUR DISTRIBUTORS HELP  
ABBREVIATE YOUR  
PROCUREMENT CYCLE!

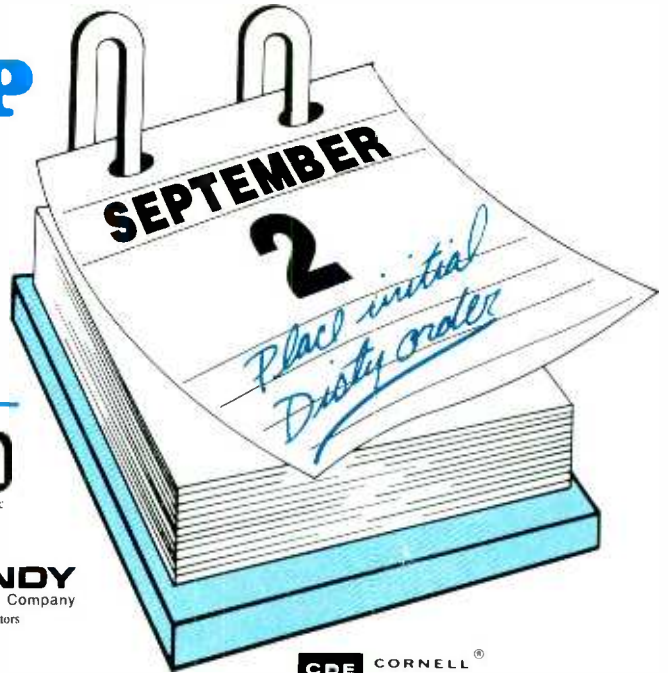

**Aero M, Inc.**

Aluminum Electrolytic Capacitors for DC Applications and AC Motor Starting

**Aerovox®**

DC Film and RFI Suppression Capacitors. AC Oil Capacitors. EMI Filters

**alpha**

Wire, Cable, Tubing, Electronic Interconnect Products

**AMP**

Electrical/Electronic Connectors, IC Sockets, PCB Switches

**AVAX CORPORATION**

MLC, Tantalum and Thin Film Capacitors, Resistors, Networks, Trimmers, Oscillators, Resonators, Filters and Piezo Devices

**BURNDY**  
an FCI Company

Electronic Connectors

**COOPER**

**Bussmann**  
Fuses, Fuseholders, Fuse Blocks, and Fuse Accessories

**CDE CORNELL DUBILIER®**

Capacitors: — Aluminum Electrolytics, MICA, AC Oil, Film and Relays

**Du Pont Connector Systems**

**DUPONT**

An expanding line of reliable Interconnections, Packaging, and Subsystems

**CAROL**

Electronic and Electrical Wire and Cable and Power Supply Cords

**COLE FLEX**

Tubing, Conduits, Hose, Sleeveings, Splices, Insulation and Cable Harness Products

**DEARBORN WIRE AND CABLE INC.**

**Wire Lions**

Wire, Cable and Tubing

**GENERAL DEVICES**

Electronic Hardware Manufacturers  
Slides, Chassis, Cable Carriers, Shelves, Racks, Cabinets, Enclosures

**DALE**

**Dale Electronics, Inc.**

Resistors, Networks, Oscillators, Displays, Inductors & Thermistors

**DANTONA INDUSTRIES, INC.**

BATTERIES: Computer, Cordless Phone, Scanner & R/C.  
ANTENNAS: Cordless Phone (metal & rubber), Scanner Bumpers, Grommets and Stik-On Feet

**EATON**

Eaton Corporation, Commercial & Military Controls Operation  
Switches, Relays, Displays and Keyboards

**GERNSBACK PUBLICATION**

Electronics Now Magazine

**Manhattan\***

Electrical and Electronic Wire, Cable and Connectors

**NTE**

**NTE ELECTRONICS, INC.**

A WORLDWIDE REPUTATION FOR QUALITY SERVICE AND VALUE

Semiconductors, Resistors, Capacitors, Relays

**KOA SPEER ELECTRONICS, INC.**

Resistors, SMT Tantalum Capacitors Inductors, Resistor Networks, SMT Thermistors

**MALLORY**

North American Capacitor Company  
Tantalums, Aluminum, Sonalists Ceramics, Films, AC's and RFI Filters

**MURATA ERIE\***

MURATA ERIE NORTH AMERICA

Monolithics, Discs, Variable Capacitors, Oscillators Potentiometers, RFI/EMI Filters, Microwave, Surface Mount Capacitors

**Quam**

Loudspeakers and Commercial Sound Products

**ROEDERSTEIN**

Film, and RFI Suppression Capacitors, Aluminum and Tantalum Electrolytic Capacitors, and Resistors

**KEMET®**

Electronics Corporation  
Solid Tantalum, Multi-Layer Ceramic, and Surface Mount Capacitors

**Philips ECG**

A North American Philips Company  
Semiconductors, Test Equipment, Relays, A/V Parts and Chemicals

**TECH SPRAY**

Cleaners/Degreasers, Swabs/Wipes, Brushes and Wick

**Thomson Consumer Electronics, Inc.**

Distributor and Special Products Replacement parts for RCA and GE consumer electronics products

**SPRAGUE**

Tantalum Capacitors, Wet & Foil Capacitors, Resistor Networks, Resistor Capacitors Networks, Filters

**Switchcraft**

A Raytheon Company  
Switches, Connectors, Jacks, Plugs, Jackfields & Audio Accessories

Whenever you need electronic products, make your initial call to a distributor. Distributors help speed up your time to market, providing the convenience, the economy, the value, and above all, the service that helps make you competitive.

The sponsors of this message know how important it is — to us and to your MRP — to get product ASAP or JIT. Another important abbreviation is EIA. Our participation in the Electronic Industries Association's Components Group makes us all more competitive, through

fostering better working relations and coherent industry standards, and through the sharing of ideas to help both buyers and sellers.

In choosing your component supplier, look for the marks of leadership — availability through distribution and membership in the EIA.



**Electronic Industries Association/Components Group**  
2001 Pennsylvania Avenue, N.W. 11th Floor  
Washington, D.C. 20006  
Phone: (202) 457-4930 Fax: (202) 457-4985

Committed to the competitiveness of the American electronics producer

**Never before has so much professional information on the art of detecting and eliminating electronic snooping devices—and how to defend against experienced information thieves—been placed in one VHS video. If you are a Fortune 500 CEO, an executive in any hi-tech industry, or a novice seeking entry into an honorable, rewarding field of work in countersurveillance, you must view this video presentation again and again.**

*Wake up!* You may be the victim of stolen words—precious ideas that would have made you very wealthy! Yes, professionals, even rank amateurs, may be listening to your most private conversations.

*Wake up!* If you are not the victim, then you are surrounded by countless victims who need your help if you know how to discover telephone taps, locate bugs, or “sweep” a room clean.

There is a thriving professional service steeped in high-tech techniques that you can become a part of! But first, you must know and understand Countersurveillance Technology. Your very first insight into this highly rewarding field is made possible by a video VHS presentation that you cannot view on broadcast television, satellite, or cable. It presents an informative program prepared by professionals in the field who know their industry, its techniques, kinks and loopholes. Men who can tell you more in 45 minutes in a straightforward, exclusive talk than was ever attempted before.

#### Foiling Information Thieves

Discover the targets professional snoopers seek out! The prey are stock brokers, arbitrage firms, manufacturers, high-tech companies, any competitive industry, or even small businesses in the same community. The valuable information they filch may be marketing strategies, customer lists, product formulas, manufacturing techniques, even advertising plans. Information thieves eavesdrop on court decisions, bidding information, financial data. The list is unlimited in the mind of man—especially if he is a thief!

You know that the Russians secretly installed countless microphones in the concrete work of the American Embassy building in Moscow. They converted



**CALL NOW!**

**1-516-293-3751**

**HAVE YOUR VISA or MC CARD AVAILABLE**

what was to be an embassy and private residence into the most sophisticated recording studio the world had ever known. The building had to be torn down in order to remove all the bugs.

#### Stolen Information

The open taps from where the information pours out may be from FAX's, computer communications, telephone calls, and everyday business meetings and lunchtime encounters. Businessmen need counselling on how to eliminate this information drain. Basic telephone use coupled with the user's understanding that someone may be listening or recording vital data and information greatly reduces the opportunity for others to purloin meaningful information.

**CLAGGK INC. PE**  
**P.O. Box 4099 • Farmingdale, NY 11735**

Please rush my copy of the Countersurveillance Techniques Video VHS Cassette for a total cost of \$53.95 each (which includes \$1.00 postage and handling)

No. of Cassettes ordered \_\_\_\_\_

Amount of payment \$ \_\_\_\_\_

Sales tax (N.Y.S. only) \_\_\_\_\_

Total enclosed \_\_\_\_\_

Bill me  VISA  MasterCard

Card No. \_\_\_\_\_

Expire Date \_\_\_\_\_ / \_\_\_\_\_

Signature \_\_\_\_\_

Name \_\_\_\_\_

Address \_\_\_\_\_

City \_\_\_\_\_ State \_\_\_\_\_ ZIP \_\_\_\_\_

All payments in U.S.A. funds. Canadians add \$1.00 per VHS cassette. No foreign orders

The professional discussions seen on the TV screen in your home reveals how to detect and disable wiretaps, midget radio-frequency transmitters, and other bugs, plus when to use disinformation to confuse the unwanted listener, and the technique of voice scrambling telephone communications. In fact, do you know how to look for a bug, where to look for a bug, and what to do when you find it?

Bugs of a very small size are easy to build and they can be placed quickly in a matter of seconds, in any object or room. Today you may have used a telephone handset that was bugged. It probably contained three bugs. One was a phony bug to fool you into believing you found a bug and secured the telephone. The second bug placates the investigator when he finds the real thing! And the third bug is found only by the professional, who continued to search just in case there were more bugs.

The professional is not without his tools. Special equipment has been designed so that the professional can sweep a room so that he can detect voice-activated (VOX) and remote-activated bugs. Some of this equipment can be operated by novices, others require a trained countersurveillance professional.

The professionals viewed on your television screen reveal information on the latest technological advances like laser-beam snoopers that are installed hundreds of feet away from the room they snoop on. The professionals disclose that computers yield information too easily.

This advertisement was not written by a countersurveillance professional, but by a beginner whose only experience came from viewing the video tape in the privacy of his home. After you review the video carefully and understand its contents, you have taken the first important step in either acquiring professional help with your surveillance problems, or you may very well consider a career as a countersurveillance professional.

#### The Dollars You Save

To obtain the information contained in the video VHS cassette, you would attend a professional seminar costing \$350-750 and possibly pay hundreds of dollars more if you had to travel to a distant city to attend. Now, for only \$49.95 (plus \$4.00 P&H) you can view *Countersurveillance Techniques* at home and take refresher views often. To obtain your copy, complete the coupon below or call toll free.